

# Computers & Electronics

JUNE 1983

\$1.50

formerly Popular Electronics

NEW SMALL COMPUTERS FROM

Mattel, Sinclair and Texas Instruments

The Kaypro II Travelling Computer System

Overvoltage Protection for New Designs

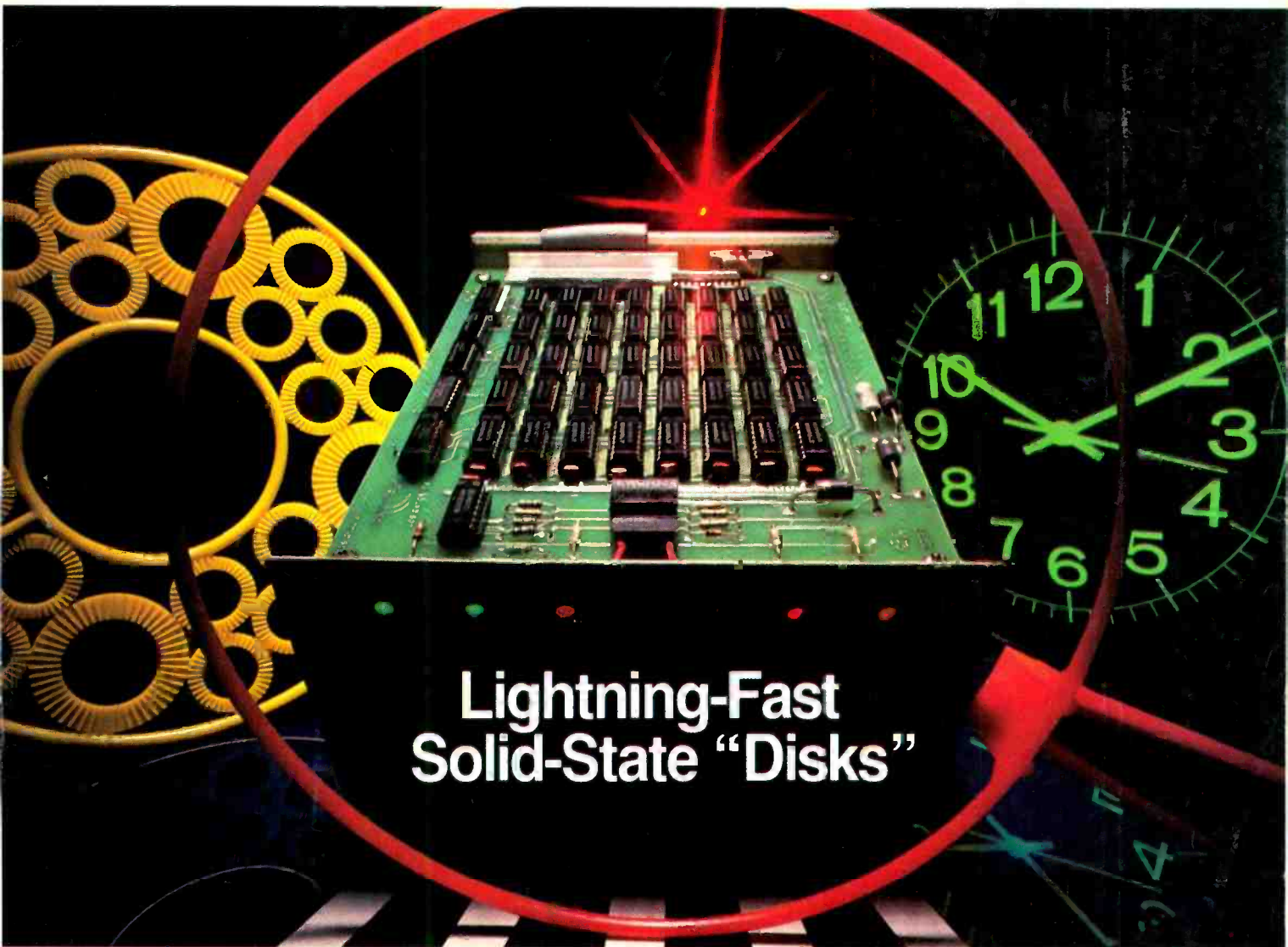

Lightning-Fast  
Solid-State "Disks"

**Tested in This Issue:**

NEC's 25" Component Color TV System  
Kyocera's Stereo FM/AM 65-W/Channel Receiver



14024 14278

CRYSTAL UNIFORMITY  
 ADVANCED BINDER  
 REFINED LUBRICANT  
 IMPROVED JACKET  
 INTENSIFIED CALENDERING

# THE GOLD STANDARD

**You can wait for industry standards to mandate improved performance. Or you can have it now on Maxell. The Gold Standard.**

What distinguishes a Maxell floppy disk? Improvements great and small, achieved in a decade of innovation. We developed unique, uniform crystals to assure dense oxide packing. Intensified the calendaring process to minimize the need for abrasive burnishing. Created an improved binder and lubricant. And a new jacket design that leaves industry standards in our wake.

It would require photomicrographs to make some of these improvements observable. On the job, the advantages become obvious. Resolution enhanced by 20% creates a cleaner

signal output. And guarantees the read/write accuracy in double-density applications. New jacket construction, heat-resistant to 140°F, extends disk use without risk of mistracking. In effect, durability is redefined. And in accelerated tests against the most respected names in the industry, Maxell sustained the highest and most consistent output over time.

We applaud industry standards that aspire to dropout-free, reliable disk performance. The Gold Standard expresses a higher aim: perfection.



**maxell**  
 IT'S WORTH IT.

Computer Products Division, Maxell Corporation of America, 60 Oxford Drive, Moonachie, N.J. 07074 201-440-8020

CIRCLE NO. 30 ON FREE INFORMATION CARD

[www.americanradiohistory.com](http://www.americanradiohistory.com)

SICKORY HILL COMPANY

STATEMENT: 30 SEP 1987

CATEGORY	PLANNED	ACTUAL
SALES	40,000	31,000
COST OF GOODS	20,000	20,000
NET SALES	20,000	11,000
ADMINISTRATION	10,000	10,000
ADVERTISING	4,000	4,000
RESEARCH	3,000	3,000
TOTAL COSTS	17,000	17,000

# HIGH TECHNOLOGY REQUIRES HIGH PERFORMANCE ACCESSORIES

In the fast moving, high technology world of microcomputers, the need for high performance accessories often gets overlooked.

Discwasher, recognized as a world leader in audio/video care accessories, understands this need and has developed a line of computer accessories to allow users to get the most from their computer hardware.

The easy-to-use *Discwasher® Disk Drive Cleaner* is both a problem preventer and problem solver. Its dry format safely cleans single or double-sided drives without altering the delicate head alignment or doing possible damage to rubber drive parts with solvents.

The *Discwasher® Computer Cassette Drive CareSet™* is a total maintenance package for your cassette drive system. It includes both the *Discwasher® Computer Cassette Drive Head Cleaner* and the *Computer Cassette Drive Mechanism Cleaner*. Together, these two maintenance units can keep the high resolution heads and the critical drive system of your cassette drive system in optimum performance.

The *Discwasher® DiscKeeper™* is a magnetically shielded storage system for floppy disks that takes up no more space than conventional folder packs. *DiscKeeper* protects against stray magnetic fields which can destroy valuable software. Three *DiscKeeper* sizes provide loss-free storage and protection for transporting any size disk format.



# discwasher

1407 NORTH PROVIDENCE ROAD, P.O. BOX 6021, DEPT. CE, COLUMBIA, MO 65205 USA

A DIVISION OF JENSEN an ESMARK Company

CIRCLE NO. 84 ON FREE INFORMATION CARD

# Computers & Electronics

JUNE 1983

VOLUME 21, NUMBER 6

## FEATURE ARTICLES

- 33 **SOLID-STATE "DISKS"**  
1. How RAM memory drives work./C. Anderton  
2. Review of Axlon's Ramdisk./A. Marx
- 39 **GUARD PRECIOUS COMPONENTS FROM OVERLOAD DAMAGE**  
Harold Wright/Single IC provides extra protection for circuit devices.
- 48 **IN THIS CORNER . . .**  
Joe Desposito/Comparison of present leaders and challengers in the under-\$200 classes.
- 56 **THE INGENUOUS SWITCHABLE TEST SOCKET**  
Nathan Moskowitz/Decreases IC circuit design and debugging time.
- 57 **OFF AND RUNNING WITH THE KAYPRO II**  
Les Solomon/Evaluation of a new modestly-priced portable desktop microcomputer.
- 61 **A WATER-LEAK DETECTOR**  
Mitchell Lee/Prevent extensive water damage in your home, shop, or boat.
- 65 **THE SOUL OF CP/M**  
M. Waite and R. Lafore/Part 2: Insights to using the CP/M OS to its fullest.
- 74 **LEARNING 16-BIT MICROCOMPUTER TECHNOLOGY**  
George Meyerle/Part 4: Details of the PIT and PPI circuit elements.

## COLUMNS

- 12 **LES SOLOMON ON COMPUTER HARDWARE**  
Computer/Video Game Interference.
- 14 **STAN VEIT ON COMPUTER SOFTWARE**  
Where the UCSD P-System Fits In the DOS War.
- 20 **ENTERTAINMENT ELECTRONICS**  
Len Feldman/Better Sound for VCRs with Beta Hi-Fi.
- 28 **COMPUTER VIDEO GAMES**



## 77 COMPUTER SOURCES

- THE ELECTRONICS SCIENTIST**  
Forrest M. Mims, III  
84 Ultrasonic Sound/Polaroid Rangefinder/  
LM3905 AP Note/Lower Supply Voltages/  
Device Developments.

## EQUIPMENT REVIEWS

- 24 **KYOCERA'S R-651 STEREO RECEIVER WITH MOSFET POWER OUTPUT**
- 79 **NEC 25" COMPONENT COLOR TV**
- 83 **SOAR MODEL ME-531 3½-DIGIT MULTIMETER**

## DEPARTMENTS

- 4 **EDITORIAL**/Art Salsberg  
Mims the Word.
- 6 **LETTERS**
- 8 **NEW PRODUCTS**
- 92 **OPERATION ASSIST**
- 105 **COMPUTER MART/ELECTRONICS CLASSIFIED**
- 111 **ADVERTISERS' INDEX**

COVER PHOTO BY JAY BRENNER

COPYRIGHT © 1983 BY ZIFF-DAVIS PUBLISHING COMPANY. All rights reserved. Computers & Electronics (ISSN 0032-4485) June 1983, Volume 21, Number 6. Published monthly by Ziff-Davis Publishing Co., at One Park Ave., New York, NY 10016. Richard P. Friese, President; Selwyn Taubman, Treasurer; Bertram A. Abrams, Secretary. One year subscription rate for U.S. and Possessions, \$15.97; Canada, \$20.97; all other countries, \$23.97 (cash orders only, payable in U.S. currency). Second Class Postage Paid at New York, N.Y. 10016 and at additional mailing offices. Authorized as second class mail by the Post Office Dept., Ottawa, Canada, and for payment of postage in cash. POPULAR ELECTRONICS including ELECTRONICS WORLD trademark registered. Indexed in the Reader's Guide to Periodical Literature. Ziff-Davis also publishes Boating, Car and Driver, Cycle, Flying, Popular Photography, Skiing, Stereo Review, Electronic Experimenter's Handbook, and Tape Recording & Buying Guide. **POSTMASTER:** Send address changes to COMPUTERS & ELECTRONICS, Circulation Dept. P.O. Box 2774, Boulder, CO 80302. Please allow at least eight weeks for change of address, enclosing, if possible, an address label from a recent issue. **Permissions.** Material in this publication may not be reproduced in any form without permission. Requests for permission should be directed to Elizabeth Amado, Rights and Permissions, Ziff-Davis Publishing Co., One Park Ave., New York, NY 10016.

# IF YOU OWN A COMMODORE COMPUTER, YOU KNOW IT CAN DO ALL THIS.

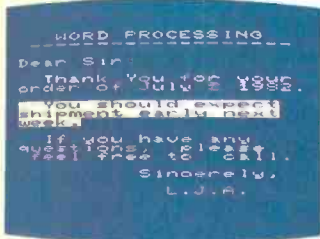

**BUSINESS**



**EDUCATION**



**PROGRAMMING**

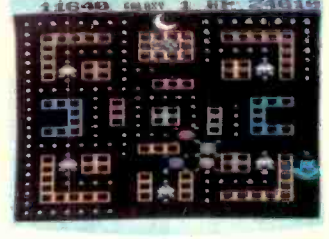

**GAMES**



**MO**

## BUT DID YOU KNOW FOR ABOUT \$100, YOU CAN ALSO GET IT TO DO ALL THIS?

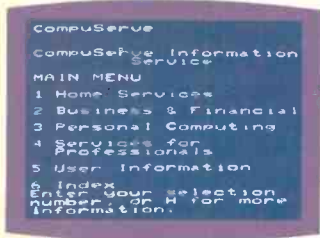

**COMPU SERVE™**

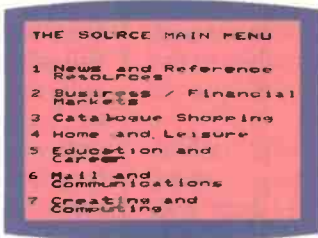

**THE SOURCE™**

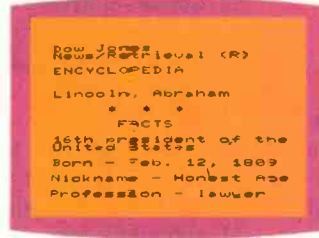

**ENCYCLOPEDIA**



**SHOP AT HOME**

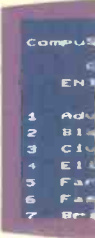

**MO**

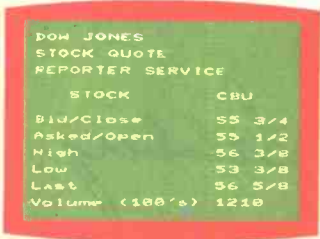

**DOW JONES  
NEWS/RETRIEVAL**

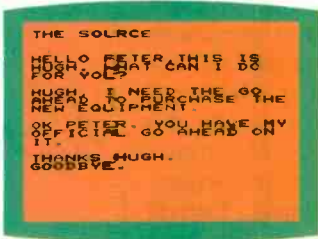

**ELECTRONIC  
MAIL**

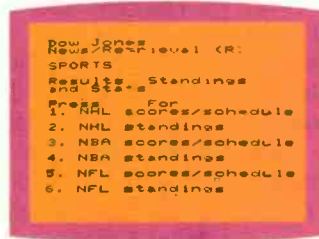

**WIRE SERVICE  
NEWS**

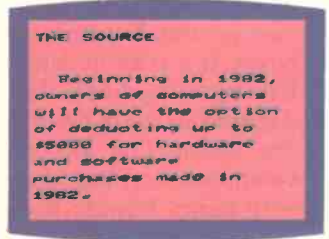

**TAX ADVICE**

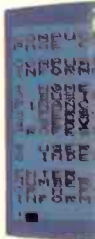

**AC  
CO**



**GAMES**

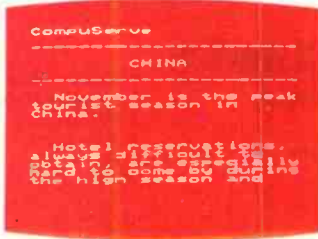

**TRAVEL  
INFORMATION**

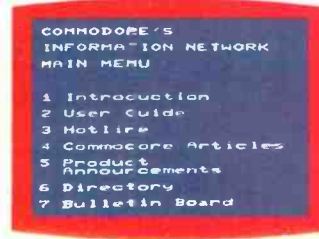

**COMMODORE  
INFO. NETWORK**

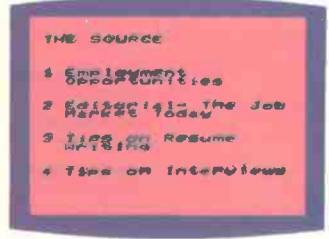

**EMPLOYMENT  
OPPORTUNITIES**

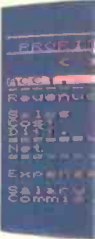

**BU**



The screens at the top of the page show a few examples of how versatile the VIC 20™ or Commodore 64™ can be with the addition of Commodore software.

The screens below them give you a few examples of how much

more versatile they can be with the addition of a Commodore VICMODEM.

For around \$100, the Commodore VICMODEM will turn your VIC 20 or Commodore 64 computer into a telecomputer.

To make matters even better, Commodore includes a few little extras (such as a free hour's time on the two most popular telecomputing services) that add up to a value of \$197.50\*. A nice return on

an investment of about \$100.

Most computer companies think it's reasonable to ask as much as \$500 for a modem that'll give you telecomputing capabilities such as ours.

However, with a VICMODEM priced at around \$100, we think we're being a lot more reasonable. Don't you agree?



U.S.A. - P.O. Box 500, Conshohocken, PA 19428; Canada - 3370 Pharmacy Avenue, Agincourt, Ontario, Canada M1W 2K4. \* Certain offers subject to change. CompuServe is a trademark of CompuServe, Inc. and H & R Block Co. Dow Jones News/Retrieval Service is a registered trademark of Dow Jones & Co., Inc. The Source is a service mark of Source Telecomputing Corporation, a subsidiary of Reader's Digest Corporation, Inc.

## EDITORIAL



### Mims the Word

When Mims writes, people read! Proof of this is that columns by Forrest Mims, III have never failed to win top rank in our editorial readership studies over the years.

His first article for us, in fact, which preceded his columnist work, "made" our November 1970 front cover. It was an in-depth report on light-emitting diodes. Interestingly, a second article of his in the same issue (assembling an optical voice communicator) has shared bylines with Henry Edward Roberts of Altair/S100-bus fame.

Five years later, Forrest launched

his first installment of "Experimenter's Corner," followed in 1978 by a second column, "Project of the Month," and a third in 1980, "Solid-State Developments." As he has noted, "Writing these columns forces me to stay up-to-date and to build circuits that really work rather than merely speculate about hypothetical circuits."

Three columns each month emanating from a corner of Texas leaves plenty of room to describe circuits, present ideas, discuss electronic phenomena, and so on. But sometimes an idea comes along that doesn't quite fit any of the existing columns. Moreover, separate columns do not lend themselves to one building upon the precepts of another.

To overcome the foregoing limitations without diluting content, Forrest's columns have been consolidated into one large column, commencing this issue. It's called "The Electronics Scientist" and will cover the same ground previously explored plus subjects that did not fit the columns' format. Moreover, Forrest will be able to modify and expand coverage of the electronics forefront as developments warrant.

In this first installment, Forrest takes a close look at the ultrasonic rangefinder that automatically fo-

cuses Polaroid's SX-70 instant-picture camera. Then he experiments with a board-level kit version of the rangefinder that Polaroid markets. This is followed by an interesting application for the LM3905 precision timer and an examination of new families of low-voltage logic chips designed specifically for battery-powered operation. Brief mentions of other new devices complete the column.

You're encouraged to try the circuits he writes about, which will be included each month, as well as digesting other column material to keep up with what's developing in electronics. I'm confident that you will enjoy reading Forrest's unitized column, "The Electronics Scientist," every month as much as he does putting it all together. His efforts are directed to busy engineers, technicians, students, experimenters, and just plain scientists. Look for his books, too, which at year-end numbered 42 off the press.

**ARTHUR P. SALSBERG**  
Editorial Director

**LESLIE SOLOMON**  
Technical Director

**JOHN R. RIGGS**  
Managing Editor

**EDWARD I. BUXBAUM**  
Art Director

**ALEXANDER W. BURAWA**  
Senior Editor

**JOSEPH DESPOSITO**  
Technical Editor

**STANLEY VEIT**  
Technical Editor

**ANDRE DUZANT**  
Technical Illustrator

**CARMEN ROBLES**  
Production Editor

**JEFF NEWMAN**  
Editorial Assistant

Contributing Editors:

Walter Buchsbaum, Len Feldman,  
Glenn Hauser, Julian Hirsch  
Jim Keogh, Forrest Mims



Member Audit Bureau  
of Circulations

## Computers & Electronics

formerly Popular Electronics

Editorial and Executive Offices  
One Park Avenue  
New York, New York 10016  
212 725-3500

New York Office  
Advertising Director:  
Richard Govatski 212 725-7460

Sales:  
Tom Ballou 212 725-3578  
Ken Lipka 212 725-3580

Midwestern Office  
Suite 1400, 180 N. Michigan Ave.,  
Chicago, IL 60601 312 346-2600  
Sales: Robert Vanek

J.E.M. Associates  
Francisco Bay Office Park  
1750 Montgomery Street  
San Francisco, CA 94111 415-989-4643  
Joe Mesics

Representation in Japan  
J.S. Yagi  
Iwai Trading Co., Ltd.  
603 Ginza Sky Heights Bldg.  
18-13, Ginza 7-Chome  
Tokyo, Japan 104

Consumer Computers &  
Electronics Magazine Division

Larry Sporn President  
J. Scott Briggs Vice President, Marketing  
Carole Mandel Vice President, Circulation  
Eileen G. Markowitz Vice President,  
General Manager  
Creative Director

Peter J. Blank  
Ziff-Davis Publishing Company  
Richard P. Friese President  
Albert S. Traina President, Consumer  
Magazine Division  
Furman Hebb Executive Vice President  
Paul H. Chook Executive Vice President  
Marketing and Circulation  
Senior Vice Presidents

Phillip T. Heffernan  
Sidney Holtz  
Edward D. Muhlfield  
Philip Sine  
Baird Davis Vice Presidents  
George Morrissey  
Selwyn Taubman Treasurer  
Bertram A. Abrams Secretary

Editorial correspondence: COMPUTERS & ELECTRONICS, 1 Park Ave., New York, NY 10016. Editorial contributions must be accompanied by return postage and will be handled with reasonable care; however, publisher assumes no responsibility for return or safety of manuscripts, art work, or models submitted.

The publisher has no knowledge of any proprietary rights which will be violated by the making or using of any items disclosed in this issue.

# After you ask what it can do for you now, ask what it can do for you later.

If you're about to buy a personal computer, you need to consider two basic issues: What your needs are now, and what they're likely to be a few years from now.

That's why the HP-86 has to be your best choice. It's got the software and the hardware to go the distance.

## Software for today and tomorrow.

Save \$255\* on the Personal Productivity Pac. Here's a good way to get started. With software that, if bought separately, would cost you \$750\*\* We're offering it at the reduced price of \$495\*\* You'll get VisiCalc<sup>®</sup> PLUS, the world-famous electronic spreadsheet for "what-if" planning. (The "PLUS" is a Hewlett-Packard bonus: extra programs

to quickly turn your spreadsheet into bar graphs, line graphs, or pie charts.) Plus WORD/80, for word processing. And FILE/80, for record keeping without paperwork.

**CP/M<sup>®</sup>** Buy this plug-in module, and you'll extend your HP-86 system to accept many popular programs written under the CP/M operating system — programs such as WordStar<sup>™</sup> and dBASE II.<sup>™</sup>

**Graphics Presentations.** When combined with the HP 7470A plotter, our graphics software lets you produce professional-quality pie and bar charts, line graphs, text pages, and overhead transparencies. And you can do it all in color.

**Data Communications.** If you decide you want it, an optional accessory lets you access The Source, the



## The HP-86 Personal Computer.

Dow Jones/News Retrieval Service, or a number of other nationwide information sources. When the time comes for more, consult our 600-page software catalog. Chances are, you'll find what you're looking for.

## Hardware that expands with your needs.

While your computer's ability to expand depends largely on software, naturally, the hardware must keep up. That's why the HP-86 system has a modular design. So you can add a printer or plotter as easily as you hook up a tape deck to your stereo. And operate up to 14 peripherals at once, if you wish.

When you find yourself facing lengthy problems or spreadsheet analyses, simply add more memory — up to 512K bytes.

As you demand more of your HP-86, you'll find that it keeps up. Whether you need a broad range of hardware, software, or peripherals, the HP-86 makes expansion easy, giving you a hard-working system tailored to help solve your specific problems.

If you need more good news, try this: The basic system is only \$2950\*\* (64K computer/keyboard, monitor and disc drive).

Get a hands-on demonstration of the system that works for you now, and will still be working for you later.

For the authorized HP dealer or HP sales office nearest you, call TOLL-FREE 800-547-3400 and ask for operator 96. (Oregon, Alaska, Hawaii: 503-758-1010.)

\*Software savings are based on suggested U.S. list prices and may vary.  
\*\*Suggested retail price. May vary outside U.S.  
VisiCalc is a registered trademark of VisiCorp.  
CP/M is a registered trademark of Digital Research, Inc.  
WordStar is a registered trademark of MicroPro.  
dBASE II is a registered trademark of Ashton-Tate.

Personal computers & calculators  
for professionals on the move.



**APPLE SERVICING**

I can understand the frustration Arthur Thompson feels in his attempts to get parts and service for his Apple II ("Computer Hotline," March 1983). One possible help is as follows: if he will "dump" the on-board ROM contents to disk, he will be able to compare and isolate defective ROMs. Apple does publish schematics for the owner in the back of its Reference Manual. However, I find that most computer manufacturers will not sell individual parts for repairs. As a buyer and user of a computer, I find this hard to take. I would like to be able to make repairs like I can on my television. Perhaps we need legislation to make the computer industry "open up" a little more.—Ron McFarland, Hawthorne, CA.

**POWER SUPPLY STANDARDS**

We read with interest the excellent article on voltage standards for power supplies ("Les Solomon on Computer Hardware") in your April issue. At the most recent committee meeting on MOS memories, it was reiterated that the standard that has been proposed is still up for discussion and only after user responses have been reviewed will a standard be processed for final JEDEC adoption. Therefore, the committee, which is composed of manufacturers, is seeking user input, which should be addressed to:

JEDEC JC-42.3  
Power Supply Standard  
2001 Eye St. NW  
Washington, DC 20006

Thank you for your help.—K. McGhee, JEDEC, Washington, DC.

**ADVANTAGE HARD DISK**

In a recent item in the Computer Hardware column, it was noted that NorthStar had introduced a computer system with 5M bytes of hard disk and one 360K floppy for \$6599. That would be a pretty high price for a 5M-byte capacity which is priced at \$4999. The reference probably got confused with our 15M-byte Advantage, which is \$5999.—Kristine M. Sokoloski, NorthStar Computers, Inc., San Leandro, CA.

**GETTING COMPUTER INFORMATION**

I am one of those thousands of people who have a need to know more about computers, but find it difficult to get help. The various computer stores are helpful as long as you purchase one of their computers, and the discount stores

offer very little assistance. The numerous magazines on the newsstand all seem to look alike and, though they promise information in everyday language, they seem to have difficulty delivering. Your magazine is the exception. The articles sometimes get involved, but the majority are interesting and easy to read. I also read the ads. Keep up the good work.—G. A. Kagan, Westport, CT.

**COMPARING COMPUTERS**

Compliments to Stan Veit for his outstanding comparison of the Apple III, NorthStar Advantage, and Victor 9000 ("A Trio of Desktop business Computers," January 1983). The analysis of the three computers in the graph on page 93 is the best comparison tool I have seen.—Donald Weihl, Belleville, IL.

**DOW JONES NEWS/RETRIEVAL**

We take exception to your reference to The Source and Compuserve as the "two principal information networks available to the public." ("The Computer Network Maze," March 1983). We also take exception to the statement that "the main feature of the Dow Jones service is the Stock Quote Reporter service." This is just one of 20 data bases and so is only a single element of our total service.—J.F. Kelsey, III, The Wall Street Journal, Princeton, NJ.

"Dow Jones News/Retrieval" is indeed the most widely used information service.—Ed.

**RECORDING WITH A VIC-20**

In your "Computer Hotline" column of March 1983, you stated that the Commodore VIC-20 uses digital recording rather than audio and cannot be used with an ordinary cassette recorder. You recommended the VIC1530 Data-ette. Aren't there other possibilities?—John Montgomery, Rolla, AZ.

This is only one of a number of letters received on this subject so perhaps an explanation of how the VIC1530 and other Commodore digital recorders work is in order. Most tape units for personal computers use the frequency shift keying (FSK) method of recording. The logic 1s and 0s are converted into tones of different frequencies for recording (such as, 1070 Hz for 0 and 1270 Hz for 1). Since audio tape recorders are designed for voice or music, they have no problem reproducing these tones.

The Commodore system, however, uses square-wave pulses, varying the width of the pulses to represent the 1s and 0s (short for 0, long for 1). This is called pulse width modulation and it is accomplished by turning the recording head on and off for different periods of time. This

simple system is very reliable and, in fact, is used in mainframe computers.

The fact that no audio reproducing components are used enables Commodore to sell the digital recorders for as little as \$60 to \$75. It has not adopted this system merely to sell its own recorder, but because it is thought to be more reliable.

There are a number of adapters on the market to convert an audio cassette recorder for use with a Commodore computer. One is made by Protecto Enterprises, PO Box 550, Barrington, IL 60010. It can be used with either the VIC-20 or the Commodore 64. However, we still prefer the VIC1530.—Ed.

**TENSENESS LEVEL SAFETY**

Your article "What's Your Tenseness Level?" (February, 1983) presents a device that could be a shock hazard to the user. No provision is made to limit excitation current through the skin or limit current from the computer power supply if the leads are accidentally shorted with the adjustment pot set for minimum resistance. Although the computer may utilize a good transformer, it is not expected to be rated for medical applications.—A. G. Jusko, Piscataway, NJ.

The computer has a regulated power supply in which the +5-V dc is derived from a transformer and a full-wave bridge with two levels of IC regulation. It is highly unlikely that any potential substantially above rated could be available without destroying much of the power supply in the process. Of course, some medical equipment uses optoisolators or isolation transformers. However, even these devices do not provide absolute failsafe protection. In any case, such isolation techniques are practical tradeoffs between cost and degree of risk.

The only way to ensure absolute safety for devices such as the Biobox is to use battery power instead of the computer supply. To do so, simply remove the lead from pin 5 of the DIN plug and connect it, through a switch, to four 1.5-V batteries in series. Then connect the other end of the batteries (ground) in parallel with the lead connected to pin 3 of the DIN plug.—Author

**OUT OF TUNE**

In "Computer-Aided Logic Design" (May 1983), the diagram showing node identification for the Exclusive OR was inadvertently omitted from Fig. 2 on page 70.

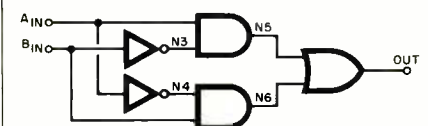





The QX-10.  
No ad can do it justice.

# Epson.

There's an awful lot of computer hype these days. And we think it's time for a little old-fashioned honesty.

So we're going to give you a few solid reasons why — even if you look at nothing else — you should go to your dealer and take a close look at the new Epson QX-10.

**Anybody can use it.**

What makes the QX-10 the most remarkably usable computer to date is a unique software system called VALDOCS, coupled with a new keyboard design called HASCI. VALDOCS reduces the time it takes to master the QX-10 from hours to minutes by displaying exactly what your options are, while the straightforward, detachable HASCI keyboard places all the most-used functions right in front of you, grouped logically and labeled in plain English.

**You may never buy software again.**

VALDOCS may be all the software you'll ever need. Right out of the box it's a sophisticated *word processor*; an *information indexer* for easy access to files; an *electronic mail system*; a *calcula-*

*tor*; an *appointment book and notepad*; and a *high resolution business graph drawing system*.

**A little price tag.**

Mere words are not enough. To fully appreciate the powers of this machine, you must experience it for yourself. So visit your dealer and see what it can do. And if that doesn't sell you, the comfortable price tag will. It sells for under \$3000. And that's no hype.



**EPSON**  
EPSON AMERICA, INC.  
COMPUTER PRODUCTS DIVISION

Call (800) 421-5426 for the Epson dealer in your area.

CIRCLE NO. 25 ON FREE INFORMATION CARD

## NEW PRODUCTS



### GAME & COMPUTER UPGRADES

"Expander" from Milton Bradley and TI provides voice recognition and speech synthesis for TI's 99/4A home computer. The 64-position membrane keypad has overlays for game cartridges. Also has 3-axis joystick and headset/microphone. Joystick controller has 3 buttons for special functions.

Circle No. 100 on Free Information Card



Entex's Model 2000 Piggyback gives video games players (Coleco, Atari, Sears, and Columbia) computing ability. It has a Z80A microprocessor and 2K of RAM expandable to 34K, 1K of video RAM, and 8K of ROM with BASIC interpreter. Typewriter-style keyboard has 9 user-definable keys and separate cursor keys. \$125.

Circle No. 99 on Free Information Card

### COMPACT FUNCTION GENERATOR

Model FP-4 function generator offers sine-, square-, and triangle-wave outputs, plus a one-shot mode that delivers a single pulse when a button is pressed. Four ranges give frequencies from <math><10\text{ Hz}</math> to <math>>100\text{ kHz}</math> or pulse outputs from 50  $\mu\text{s}$  to 50 ms. Four internally presettable frequencies or pulse widths add to its utility for repetitive testing. Power is by 9-V battery or any 5.5-to-26-V source. 5"  $\times$  4 1/4"  $\times$  2". \$49.95 (\$29.95 kit). Address: Kingston Instrument Co., 3805 Ashford Ave., Ft. Worth, TX 76133.

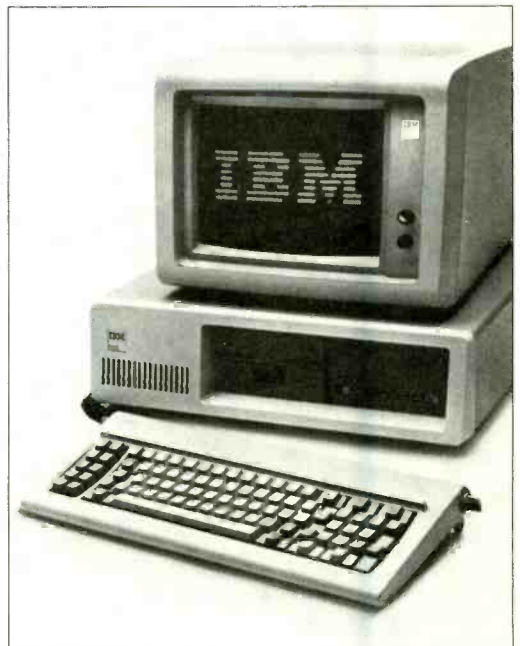
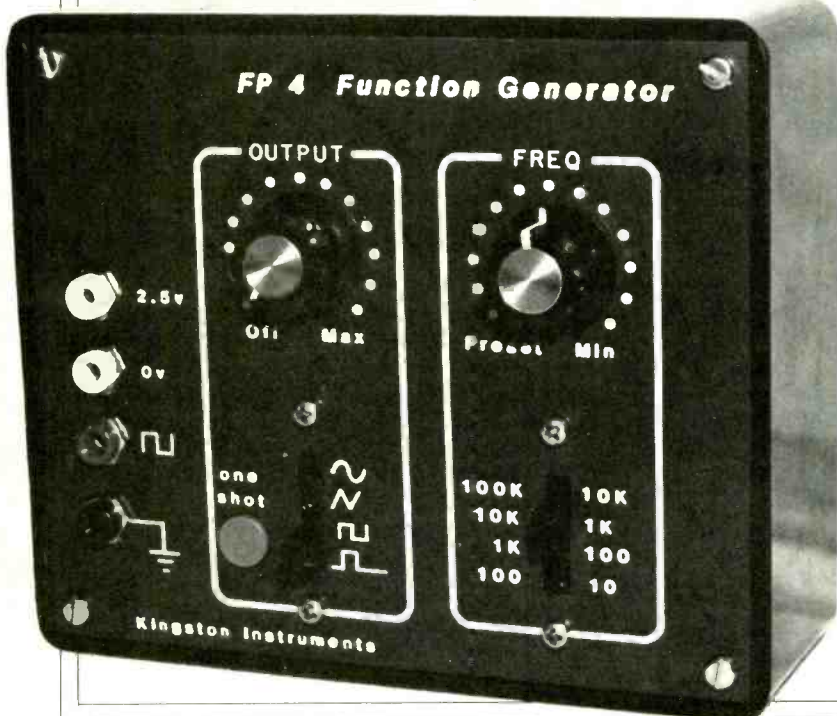

### IBM SMALL COMPUTER

Model XT 16-bit PC has 9 times the storage capacity previously available with 128K of RAM (expandable on-board to 640K); double-sided 5 1/4" floppy-disk drive; 10M-byte hard-disk system; and an asynchronous communications adapter. Has 8 expansion slots; and, with optional expansion, maximum memory can be 22M bytes. Other options are monochrome and color video, graphics printer, and single- and double-sided drives. Uses new version of DOS 2.0. \$4995.

Circle No. 97 on Free Information Card

### APPLE II VIDEO BOARD

The Digital Video Multiplexor board (DVM-II) from Amdek allows the Apple II to be used with an analog or digital RGB-input color monitor, permitting computer control of the RGB inputs and providing 80 x 24 text display when interfaced with 80-column boards. Has two optional additional HiRes modes—all white and 3-color with pure white. \$199.

Circle No. 98 on Free Information Card

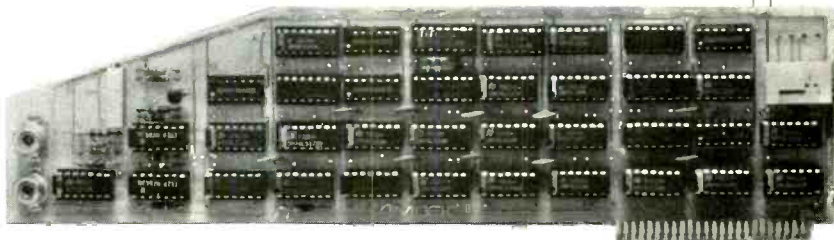

### CONVERTIBLE VIDEOCASSETTE RECORDER

Portable Model VJP900 VCR from RCA has a modular "docking" mechanism to eliminate cables and permit connecting the unit to a companion TV tuner/timer base unit. Three-speed (SP/LP/SLP) system has five video heads, 133-channel capability, 21-day/8-event timer and 4 tape transport motors. Also has express recording, sound-with-sound dubbing, stereo sound, and special effects such as stop action, variable slow motion, frame advance, and reverse play. Comes with IR remote-control system. 10¼" W × 10½" D × 3⅞" H; 7.9 lb. \$1300.

Circle No. 96 on Free Information Card

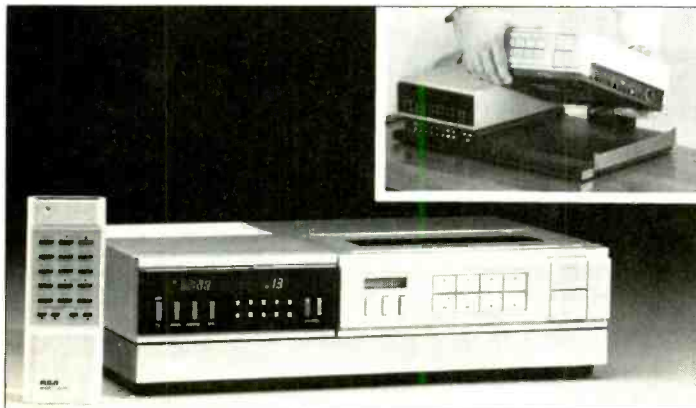

### EDUCATIONAL MICROCOMPUTER

Multitech's Micro-Professor I Plus has 8K of ROM; 4K of user RAM; standard ASCII keyboard; 20-digit, 14-segment alphanumeric green fluorescent display; built-in speaker; audio cassette tape interface; and battery-operated memory backup circuit. User's guide and manuals supplied. \$199.

Circle No. 94 on Free Information Card

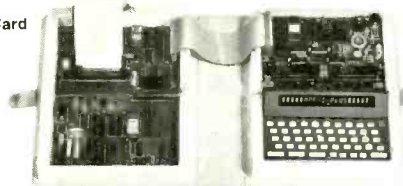

### TAPE NOISE ELIMINATOR

Model NX-40 tape noise eliminator from dbx has simultaneous encode/decode companding process to eliminate noise during record and play while increasing dynamic range up to 110 dB. Frequency response: 50-15,000 Hz ±1.5 dB; harmonic distortion: 0.5%, 100-15,000 Hz. 9⅞" D × 6⅞" W × 1⅞" H. \$159.

Circle No. 95 on Free Information Card



### FRANKLIN ACE 1000 UPGRADE

New Ace 1100 is an add-on disk drive assembly for the Ace 1000 personal computer. With a controller and one or two disk drives, it replaces the cover of the 1000. Controller accommodates two drives, can be used with DOS 3.2 (116K bytes) and DOS 3.3 (143K bytes), and includes a built-in disk drive exerciser. Plugs in one of 8 Ace 1000 peripherals slots and eliminates need for cabling. Single-drive models are easily upgraded to dual-drive. Also Apple II compatible. \$699, including controller, for single-drive. Add \$399 for second drive.

Circle No 93 on Free Information Card



# Hire a fast thinker.

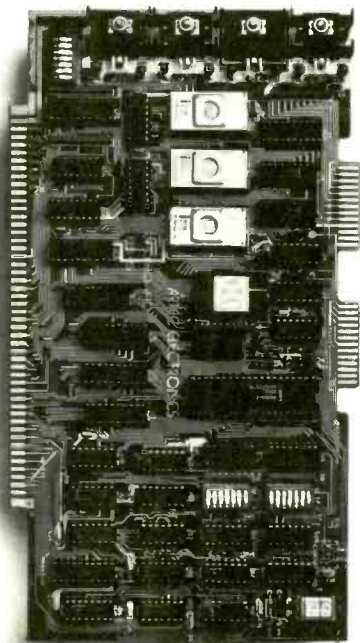

## 5 MHz CPU Card

■ Intel 8085A-2 microprocessor ■ Hardware floating point ■ Performs calculations six times faster than other CPUs ■ On-board monitor in PROM ■ 1K RAM scratch pad ■ Keyboard or RS232C terminal ■ Variable clock frequency

PRICE—\$450

(California residents add 6% sales tax)

Call or write Artec for details.

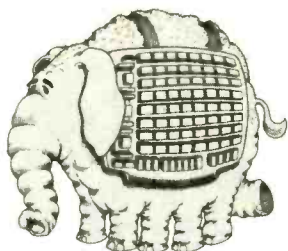

**ARTEC ELECTRONICS, INC.**

605 Old County Rd., San Carlos, CA 94070  
Telephone (415) 592-2740

CIRCLE NO. 55 ON FREE INFORMATION CARD

## ...NEW PRODUCTS



### KEYBOARD ENHANCEMENTS

• Qwik-Stuff kit (above) is \$7.75 and includes Qwik-Key printed plastic overlays for function keys (\$4.50); Qwik-Guide plastic reference cards (\$3.25) containing commands and information; and Qwik-Label identifying labels (\$1.00) for knobs, controls, etc. Address: Compu-Quote, 6914 Berquist Ave., Canoga Park, CA 91307.

• KeyWiz VIP auxiliary keyboard (right top) has 31 user-programmable keys and can be ganged to provide a total of 248 keys. Address: Creative Computer Peripherals, Inc., 1044 Lacey Rd., Forked River, NJ 08731.

• EPS detachable keyboard for Apple users (right center) has plug-in software to provide professional upgrading of keyboard functions. Address: Executive Peripheral Systems, Inc., 800 San Antonio Rd., Palo Alto, CA 94303.

• Keychanger program on diskette (right bottom) operates in CP/M and permits programming of function keys on most terminals. Address: Computer Publishing Co., 1945 N. Fine #101, Fresno, CA 93727.



### COLOR MONITOR FOR IBM-PC



Quadchrome by Quadram is an RGB color monitor designed to deliver up to 690 x 480-pixel resolution with up to 16 colors available on screen simultaneously when used with the IBM-PC. For text applications, display is 25 lines of 80 char./line. Colors include: red, green, blue, yellow, cyan, magenta, black, and white. Dimensions: 15.1" x 11.0" x 16.5". Supplied with 9-pin socket cable. \$795.

Circle No. 92 on Free Information Card



### SORD PERSONAL COMPUTER

Socius M23P portable computer is said to fit into carry-on luggage (without the 12" green monitor). Has memory-mapped 8-bit CPU with 128K of RAM and two 290K 3½" floppy disk drives for mass storage. An acoustic coupler and on-line system can be used to connect different work stations. Power is from ac line or rechargeable built-in battery. Comes with Sord's PIPS Processing System. \$1600.

Circle No. 91 on Free Information Card

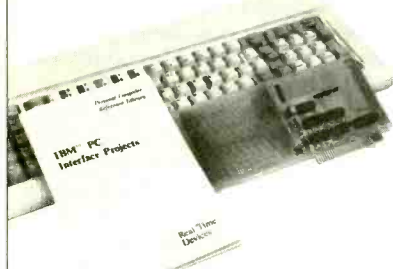
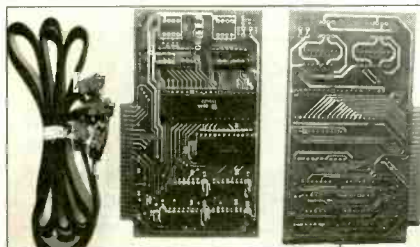

### INTERFACING DEVICES

- "Fly Board" (top) gives Apple II users control over projects from printers to home weather stations. Hardware includes a 6522 interface adapter; two 36" DIP jumper cables; and 2K of EPROM-compatible RAM. \$129.95. Address: Snave Systems, PO Box 957, Niles, IL 60648.
- The PD100 prototype/decoder provides a means of interfacing prototype circuits for the IBM-PC. It contains a switch-selectable address decoder, a switch for up to four unique addresses, and two areas for circuit prototyping, which permits up to four boards to be utilized in one PC system. Available are four I/O device select signals, four supply voltages, and a buffered data bus. Address: Real Time Devices, PO Box 906, State College, PA 16801.

# How to slice a pie.



To organize data in an appetizing way, a manager could certainly use the IBM Personal Computer.

Because it lets you create crisp, high-resolution color graphics — quickly and easily.

Design a pie chart to illustrate your slice of the market, for example.

Draw a bar graph that pinpoints profit margins and sales trends.

Use arcs, plots, lines and boxes (in your choice of color palettes) to help make financial matters clear.

And you can even mix text with your graphics for a labeled visual that communicates more quickly.

For more eye-opening facts, visit an authorized IBM Personal Computer retail dealer. You'll see that the quality of this computer is what you'd expect. The surprise may be that it's as easy as pie to buy.



## The IBM Personal Computer A tool for modern times

For more information on where to buy the IBM Personal Computer, call 800-447-4700. In Alaska or Hawaii, 800-447-0890. CIRCLE NO. 41 ON FREE INFORMATION CARD



## Computer/ Video Game Interference

**L**IVING in relatively crowded urban areas produces its own types of electronic problems. A serious one can occur when certain home computers spoil TV viewing. This can happen when the device is in the same or adjacent room as a TV receiver. Worse, though, is the possibility of interfering with TV reception when a receiver(s) is located some floors above or below, as in an apartment building.

I am not talking about the 15-kHz pulse signal generated by the TV receiver's horizontal-sweep power output stage, whose harmonics seem to be all over the spectrum. Rather, I'm referring to signal radiation from the foil traces and interconnecting leads used in a computer, where the pulses are dashing around. Since a digital system uses square-edged waveforms and a square wave is simply a sine wave embellished with lots of harmonics, the harmonics also radiate. (We should be thankful that the harmonic power drops away very rapidly as the number of the harmonic increases.)

**Why the Confusion?** There may be some confusion among our readers as to why certain computers undermine TV reception, while others do not. It appears that there are two sets of official FCC rules—one for "commercial" systems and another for "home" systems. Moreover, there are many, many computers that do not comply with FCC interference regulations because their manufacture predates the effective dates of the ruling. (There are three separate dates for compliance.)

The existence of these two different Rules brings up a very interesting point.

We usually assume that commercial electronic products, which use MIL spec parts, are superior to "consumer" products. In the case of radio-frequency interference (RFI)—the reason for the two different Rules—the reverse is true. In the case of computers, the *home* system is about three times better than the commercial system!

The FCC has divided the digital world into two parts: class-A devices (digital systems used in commercial, industrial, or a business environment) and class-B devices (essentially calculators, home computers and peripherals designed for a residential environment, even though they may be used for business purposes). Class-B devices can be used legally in a class-A environment, but not vice-versa. The basic reason given for this division is that it was assumed that commercial computers would be physically located farther away from a radio or TV receiver than a digital device used in a home and, thus, would not affect TV reception.

Three separate dates have been given for compliance with the current regulation. For personal computers, where the interference potential is high, the compliance date for meeting RFI specs was January 1, 1981. However, if manufactured after October 1, 1981, compliance will not be required until October 1, 1983.

After that date, any electronic device or system that generates and uses timing signals or pulses at a rate in excess of 10 kHz and uses digital techniques must comply with the following:

- The radiation limits of a Class-A (commercial) device shall not exceed 30  $\mu\text{V}/\text{m}$  over a frequency range from 30 to 88 MHz; 50  $\mu\text{V}/\text{m}$  over the frequency range from 88 to 216 MHz; and 70  $\mu\text{V}/\text{m}$  over the range between 216 and 1000 MHz—all at 30 meters from the source.
- The radiation limits of a class-B (home) device should not exceed 100  $\mu\text{V}/\text{m}$  over the frequency range between 30 and 88 MHz; 150  $\mu\text{V}/\text{m}$  over the range between 88 and 216 MHz; and 200  $\mu\text{V}/\text{m}$  over the range between 216 and 1000 MHz—all at 3 meters from the source.

The difference between the two class-

es seems to be that since (a) the bulk of TV viewing is done in relatively confined residential environments, (b) there are many apartment buildings where vertical spacing is not very great, and (c) conventional walls and floor are not good r-f shields, the radiation level of a home computer must be kept down to avoid possible TV or radio interference.

Since January 1, 1982, manufacturers of personal computers and computer peripherals must obtain this certification from the FCC before the computer or peripheral appears on the market.

Other class-B equipment, such as a desktop calculator or a video game with a clock frequency below 495 kHz (and all class-A), are tested by the manufacturer for specification compliance, and the results need not be submitted to the FCC. However, the FCC can, and does, make a random sampling of the devices to ensure that the specification is adhered to. This applies to all devices produced after October 1, 1982. Again, full compliance with the FCC specifications must be made for any equipment using timing signals or pulses at rates faster than 10 kHz and employing digital techniques after October 1, 1983.

**Labels Required.** All computer and peripheral products must carry a label attesting that the device fully complies with the pertinent class-A or class-B specs. The instruction booklet must also inform the reader not only of the class (A or B) of the equipment, but also must include a warning that class-A devices should not be used in residential (class B) environments. Otherwise, some viewing or listening interference may result.

Obviously, where the devices are actually used is left up to the user. But the user is held responsible in any case for causing interference. Accordingly, if a class-A device is used in a class-B environment, the user must take whatever measures are available, at his own expense, to correct the problem. Assistance for this is at hand through the FCC booklet, *How to Identify and Resolve Radio and TV Interference Problems*. (Available from U.S. Government Printing Office, Washington, DC 20402. Request Stock No. 004-000-00345-4.)  $\diamond$

# Now. Tektronix 60 MHz Performance is just a free phone call away!

**Wide-range vertical sensitivity:** Scale factors from 100 V/div (10X probe) to 2 mV/div (1X probe). Accurate to  $\pm 3\%$ . Ac or dc coupling.

**Two high-sensitivity channels:** dc to 60 MHz bandwidth from 10 V/div to 20 mV/div; extended sensitivity of 2 mV/div at  $> 50$  MHz.

**Sweep speeds:** from 0.5 s to 50 ns. To 5 ns/div with X10 magnification.

**Delayed sweep measurements:** Accurate to  $\pm 3\%$  with single time-base 2213; to  $\pm 1.5\%$  with dual time-base 2215.

**Complete trigger system:** Includes TV field, normal, vertical mode, and automatic; internal, external and line sources; variable holdoff.

**Probes included.** High-performance, positive attachment 10-14 pF and 60 MHz at the probe tip.

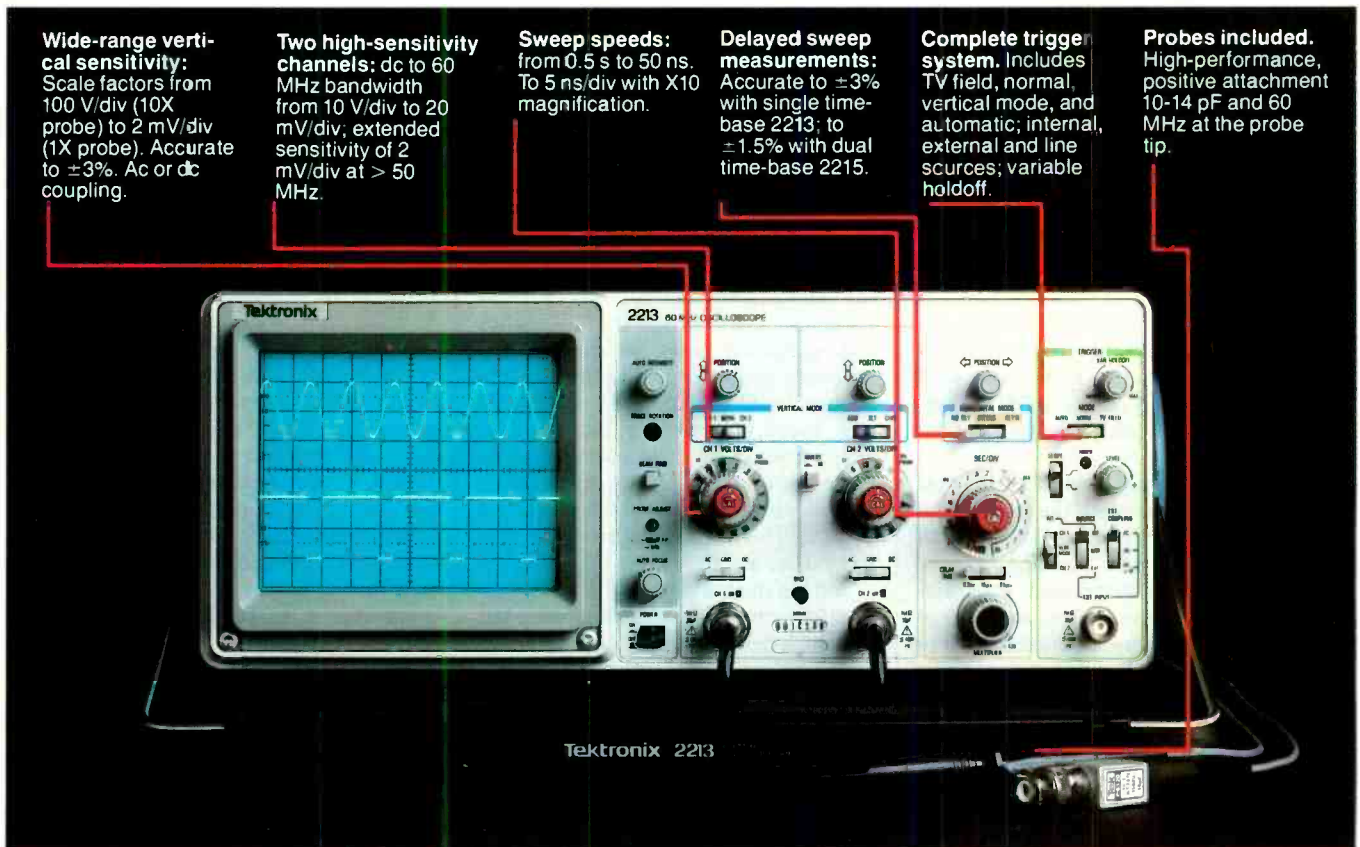

**These easy to order scopes are proof that it's not expensive to have advanced, 60 MHz performance from Tektronix on your bench. It's just practical!** Feature for feature, the Tek 2213 and 2215 set a price/performance standard unmatched among portable scopes. And are backed by the industry's first three-year warranty on all labor and parts, including the CRT.

**So advanced they cost you less: \$1200\* for the 2213! \$1450\* for the dual time base 2215!** These low costs are the result of a new design concept that utilizes

fewer mechanical parts than any other scope.

Yet there's no scrimping on performance and reliability. You have the bandwidth for digital and analog circuits. The sensitivity for low signal measurements. The sweep speeds for fast logic families. And delayed sweep for fast, accurate timing measurements.

**Scope. Probes. Three-year warranty and expert advice. One free call gets it all!** You can order, or obtain literature, through the Tektronix National Marketing Center. Technical personnel, expert in oscil-

loscope applications, will answer your questions and can expedite delivery. Direct orders include probes, operating manuals, 15-day return policy, full Tektronix warranty and worldwide service back-up.

**Get all the facts.  
Call toll free:**

**1-800-426-2200**

**Extension 93**  
In Oregon, call collect:  
(503) 627-9000 Ext. 93

\*Price F.O.B. Beaverton, OR. Price subject to change.

## STAN VEIT ON COMPUTER SOFTWARE



### Where the UCSD P-System Fits in the DOS War

**T**HIS month I return to the continuing saga of the DOS War with some background on the UCSD P-system and where it stands in the order-of-battle.

To get some background on the system, we must start with the story of the development of Pascal. Niklaus Wirth invented Pascal as a teaching tool for the concepts of structured programming. He implemented it on a large mainframe computer and described it in his book *Pascal User Manual and Report*, Jensen and Wirth, Springer Verlag, New York, 1975.

Dr. Kenneth Bowles at the University of California, San Diego, formed the Pascal Project to make Pascal available to universities in the United States as a teaching tool. To do this, the language had to run on the minicomputers and microcomputers that they used and it had to be available at low cost. The project developed a complete operating system including a Pascal compiler, several editors, an assembler, a debugger, and a library of utilities.

This package became known as UCSD Pascal, and it was distributed through colleges and computer clubs at a very low cost. Some computer manufacturers, including Apple, North Star, and Western Digital Corp., took out licenses to use the system.

While the Pascal Project was distributing Version 1.4, Apple was selling Apple Pascal, which included graphics usable on the Apple II+ computer. North Star brought out a version that only ran on its disk systems; Western Digital brought out the Microengine, a computer that used UCSD Pascal P-native code. All of this made UCSD very popular in a short time.

**The Fly in the Ointment.** Something had to happen to spoil everyone's fun (or there wouldn't be any story); and, in this case, The Regents of The University of California were told by someone in the IRS that the Pascal Project was running a software business and thus endangering the tax exempt status of the entire University. They were told to get rid of the commercial aspects of the UCSD Pascal Project.

What happened next is somewhat obscure and I have heard several versions, but the net result was that Softech Microsystems emerged as the sole distributor and manager of UCSD Pascal under license from the Regents of the University of California. They stopped the "almost free" distribution of version 1.4 and sent letters to all the universities and computer clubs informing them that they no longer had licenses to distribute UCSD Pascal. No one could stop those who already had the language from using it, of course. But no more were to be sold or given away! Softech also stopped supporting the 1.4 version. There was a hailstorm of protests, to no avail!

Softech then came out with a new version 2.0 containing some bug fixes but not much new material. It started a new major update that included new features and support for BASIC and FORTRAN as well as Pascal. Since the system was now a full DOS with multi-language support, they renamed it "The UCSD P-System"

The original licensees—Apple, North Star and Western Digital—did not go along with this because they could not come to terms with Softech. Their licenses were irrevocable so they could go on using UCSD Pascal in spite of anything that Softech did. For a while it looked as if they would resolve all the differences and one version of the system would emerge, but that did not happen. Instead, Apple Pascal went its own way (especially Apple III Pascal); North Star did the same; and Western Digital moved into the new language ADA making few updates to its version which was "cast in silicon" as part of the CPU chip set of the Microengine.

When IBM brought out its Personal Computer, it used the UCSD P-System as a secondary operating system. Then as other new 8-bit and 16-bit computers came out, they also adopted UCSD P-System as secondary operating systems.

Today the P-System is the *secondary operating system* for more computers than any other and it runs on almost ev-

ery 8080, 8085, 8088, 8086 and Z80, M6800, M6809, M68000, and 6502-based computer on the market. It is truly a universal system. Never *first* but *second with everybody!* Not a bad position to be in considering that it never had to engage in the "Wars."

**The Future.** There are some clouds on the horizon, though. IBM has "temporarily" withdrawn its version of UCSD P-System for the IBM-PC because of "bugs." A new revision is expected to be released shortly. There is another version of the P-system for the IBM-PC from Network Consulting Inc., Burnaby, B.C., Canada. IBM is also distributing another Pascal compiler from Microsoft. Could it be dropping the P-System? I have not been able to find out.

One thing that might put new life into the P-System is the fact that Niklaus Wirth has developed a *new* language called "Modula-2" as a simple but powerful alternative to assembly language, Pascal, C, and Ada. Modula-2 is easily learned by Pascal programmers, and it solves many of the problems that system designers have had with Pascal. Volition System of San Deigo, CA, has implemented it on the UCSD P-System and are supplying it at this time.

In general, the P-System has been more popular with software developers than with the general public. Since its languages are compiled, and transportable to many computers, it makes a good system for application programs. The designers can write the applications in Pascal, compile it, and only deliver the p-code to the customer. Of course, the P-System kernel (run-time package) must be there. Many computer companies, such as Osborne, are supplying this at no extra cost. If it is not in the computer, the software publisher must supply it as part of the package. Softech is now supplying this package for \$50.

UCSD P-System users, (all 100,000 of them) are a very loyal group. However, while they are loyal to the system, they have had many differences with Softech. In spite of this, Softech has supported the user's group. So have Apple, Western Digital, North Star, and the application software manufacturers.

The official UCSD user's group is called USUS. It was organized in 1980 and maintains a newsletter and an extensive library of contributed and public domain software. There is also a users SIG on CompuServe that is open to members of USUS. To find it, Go PCS-50 on CompuServe. ◇



# We don't care which computer you buy. We'll help you get the most out of it.

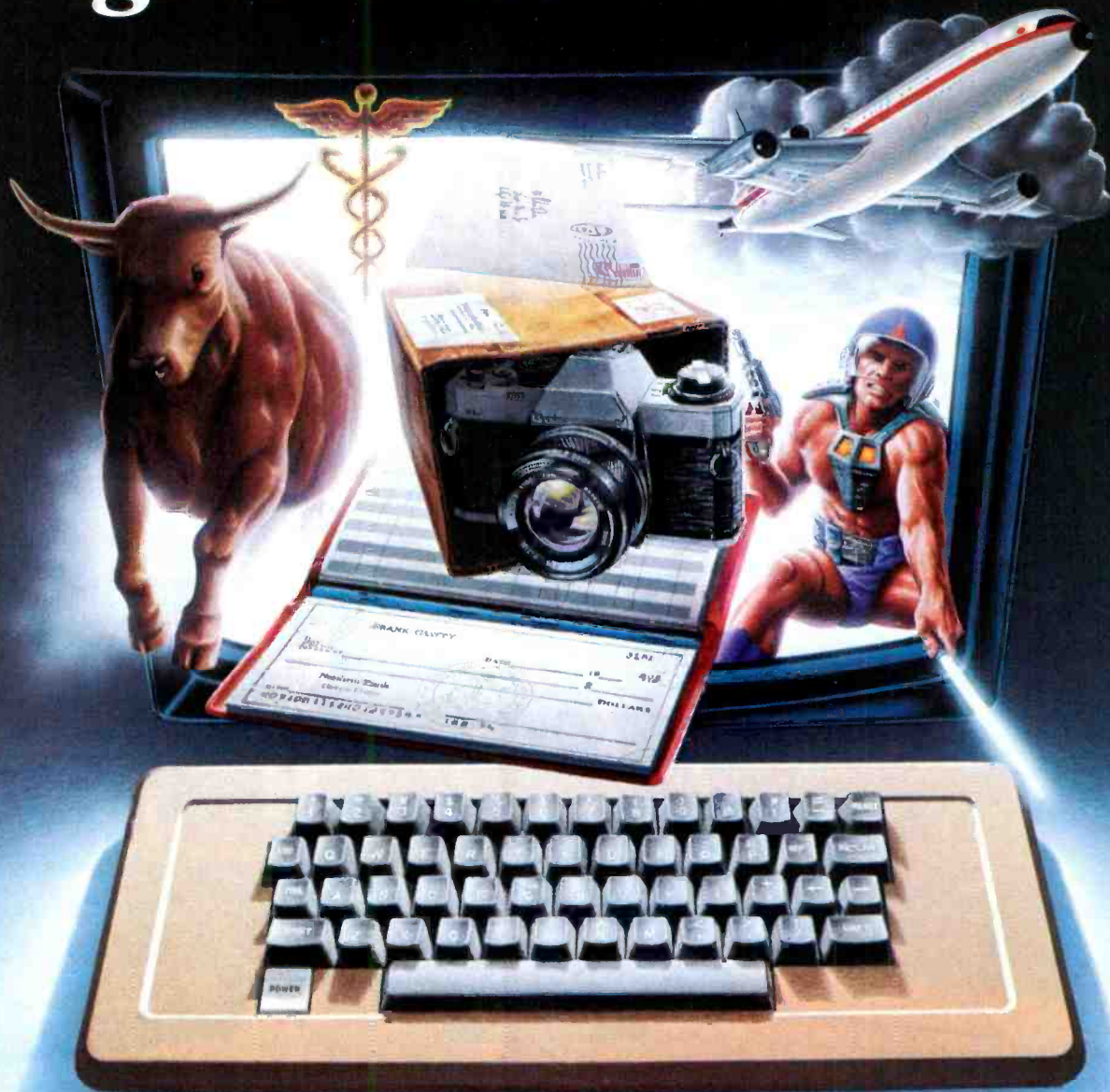

## CompuServe puts a world of information, communications, and entertainment at your fingertips.

CompuServe is the easy to use videotex service designed for the personal computer user and managed by the communications professionals who provide business information services to over one fourth of the FORTUNE 500 companies.

Subscribers get a wealth of useful, profitable, or just plain interesting information like national news wires, electronic banking and shop at home services, and

sophisticated financial data. Plus, a communications network for electronic mail, a bulletin board for selling, swapping, and personal notices and a multi-channel CB simulator.

You get games on CompuServe, too. Classic puzzlers, educational, sports and adventure games and fantastic space games featuring MegaWars, the "ultimate computer conflict."

To learn more about CompuServe, call toll-free, 800-848-8199, for an illustrated guide to the CompuServe Information Service. The videotex service for you, no matter which computer you buy.

## CompuServe

Consumer Information Service  
2180 Wilson Rd., Columbus, Ohio 43228

**800-848-8199** In Ohio Call 614-457-8650  
An H&R Bock Company

CIRCLE NO. 60 ON FREE INFORMATION CARD

[www.americanradiohistory.com](http://www.americanradiohistory.com)

# Only NRI Gives You This Kind of Training and Equipment.

## Only NRI Gives You So Much Professional Preparation For a TV/Audio/Video Servicing Career.

Build this 25" Heath/Zenith Color TV with 112 channel tuning system, infrared remote control, advanced sound system, and in-set space phone.

Get complete, thorough instruction in the theory, servicing, and repair of TV, VCR, video disc players, audio equipment, AM/FM receivers, antenna systems, home video cameras, projection TV, and more with 65 easy-to-digest, bite-size lessons.

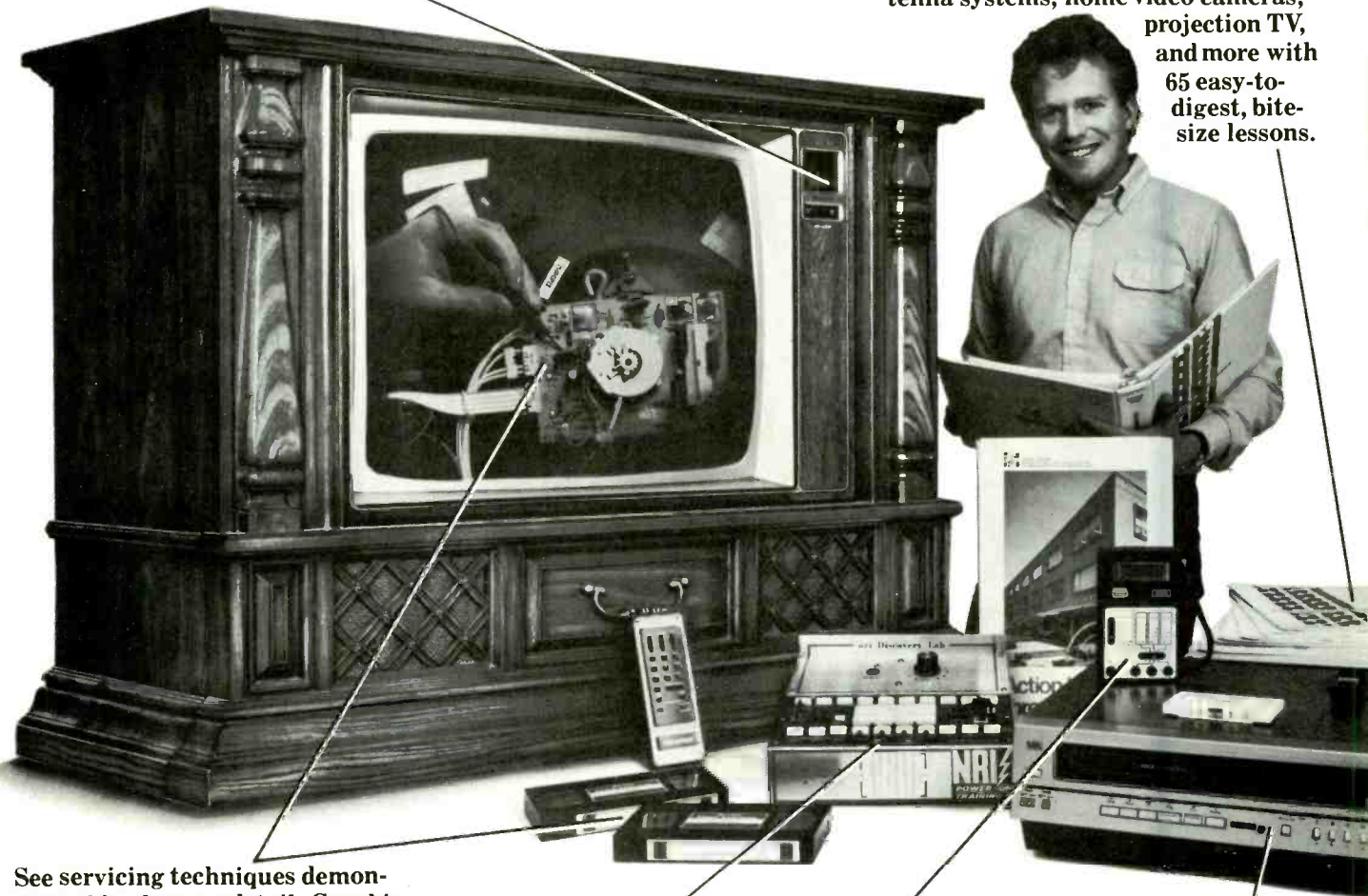

See servicing techniques demonstrated in close-up detail. Graphic presentations make theory and systems come alive on NRI Action Videotapes covering VCRs, disc players, and TVs.

Perform challenging state-of-the-art electronic experiments and demonstrations using your NRI Discovery Lab®.

Learn how to diagnose problems using a professional 3½-digit digital multimeter. Exclusive NRI Action Audio instructions talk you through its complete operation and use.

Learn servicing and adjustment techniques with this 6-hour, remote control videocassette recorder you get as part of your training.

Only NRI gives you so much practical training with equipment you learn on and keep. You learn by doing. That's the way to make it interesting, that's the way to make it enjoyable, that's the way to get the hands-on experience and know-how you need.

## Hands-On Training For Real Bench Experience and Priceless Confidence

You start with experiments and demonstrations on the unique NRI Discovery Lab. You learn basic circuit wiring and soldering techniques, and then quickly move on to more advanced concepts as you come to understand electronic theory, solid-state devices, digital systems, and microprocessors. You learn by actually building and observing the action of circuitry you'll be working with in real-life situations.

## Exclusive NRI Training On Videotape

In addition to profusely illustrated lessons, you get NRI's Action Audio cassette to "talk" you through the use and operation of the professional digital multimeter you receive as part of your equipment. Even more exciting are your NRI Action Videocassettes... videotaped lessons that show you graphic presentations of electronic systems, vivid closeups of servicing techniques and professional "shortcuts" to study and replay as often as you want.

## You Get TV, VCR, DMM and More Equipment To Keep

You also build your own 25" Heath/Zenith color TV, a state-of-the-art unit that includes infrared remote control, a Time Control Programmer, and the incredible Advanced Space Phone that lets you telephone from your chair. Using the videocassette recorder that's included as part of your training, you learn how to adjust, service and re-

pair these fast-selling units. Your front-loading VCR features up to 6-hour recording capacity, remote control, and programmable touch-button tuning.

The digital multimeter you receive is a truly professional instrument. You use it in the experiments throughout your course and as a key servicing tool on the job. Using the meter along with the NRI Discovery Lab, you'll learn how to measure voltage, current and resistance and how to diagnose all types of servicing problems.

## Advanced Systems Demand Advanced Technicians for Service and Maintenance

The art of TV/Audio/Video servicing has taken quantum leaps into the future. Now, successful technicians must understand advanced concepts like digital control, electronic tuning, laser video discs, microprocessors, and more. NRI gives you the training you need for success... state-of-the-art concepts and practical, hands-on experience working with the kind of equipment you'll encounter on the job.

## 7 Decades of Teaching Electronics Skills At Home

NRI is the oldest, largest, and most successful school of its kind in the world. It has pioneered and refined the teaching techniques that make learning at home the NRI way

one of the most economical and effective methods ever conceived. You learn at your convenience as a class of one, backed by skilled NRI instructors and carefully designed lessons that take you a step at a time toward your goal. No time away from your job, no night school grind, no classroom pressures. Yet your training is thorough and complete, with a foundation of hands-on experience unequalled by any other training organization.



## Send For Free Catalog Covering 12 Electronics Courses

Our 104-page catalog gives you all the details. In it, you'll find a summary description of every lesson, and photos and specifications for every item of equipment included in your course. You'll also learn about other fascinating career opportunities in the world of electronics... Microcomputers, Industrial Electronics including robotics, Communications, and more.

Mail the postage-paid card today for your free copy. See how completely and how thoroughly NRI gets you started on your tomorrow today.



**NRI SCHOOL OF ELECTRONICS**  
McGraw-Hill Continuing Education Center  
3939 Wisconsin Avenue  
Washington, DC 20016

## Better Sound for VCRs with Beta Hi-Fi

By Len Feldman

**A**FTER months of speculation, Sony Corp. and its videocassette recorder licensees have finally unveiled the Beta-format method of incorporating stereo sound on a video recording. From what we've actually heard, Sony has a winner with its new Beta Hi-Fi system, which provides far superior sound quality when compared with the already available VHS stereo format. To achieve this superior sound, the Beta group's machines employ considerably more sophisticated technology than is currently used in VHS stereo machines.

Unlike the case with VHS VCRs, Sony's Beta Hi-Fi doesn't split the longitudinal sound track along the top edge of the video tape into two tracks (Fig. 1) to obtain the stereo channels. Instead, a whole new approach has been used to achieve true "high fidelity."

Before we go into the details of the new Beta Hi-Fi system, it's interesting to review the characteristics of conventional VCRs. Whether Beta or VHS, conventional VCRs have inherently poor audio sound quality. Even at the fastest Beta II and VHS-SP tape speeds (used when you want the highest possible video and sound quality), about the best high-end frequency response that can be expected may be to 10 or 11 kHz at the -3-dB roll-off point. Using economy Beta III or VHS-EP tape speeds for longer play time will reduce top-end response to 4 to 5 kHz (as well as picture quality). These figures are hardly what you would expect for "high-fidelity" sound quality.

Limited frequency response isn't the only factor in giving VCR sound channels their characteristically poor sound quality. Record/play signal-to-noise (S/N) ratios are generally no better than 40 to 45 dB in the absence of some form of sound reduction or companding. Even if companding is used, the poor overall bandwidth capability of the conventional VCR system makes tracking subject to large errors. With most conventional VCRs, tape hiss is very audible, even when operating at the faster tape speeds. And bear in mind that even at these speeds, tape motion in a VCR is *slower* than it is in a standard audio cassette deck.



Distortion of the audio track in a VCR is fairly high, too. Harmonic distortion is typically as great as 3%, for maximum recording level. Furthermore, until recently, the audio track on both VHS- and Beta-format machines has been limited to monophonic, or single-channel, sound.

Because the VHS approach to providing stereo sound is to simply split the existing audio track in two, the sound quality of recently introduced stereo-sound VHS machines is no better than for mono machines. In fact, it's 3 dB worse. Finally, you have only to listen to the sound of a sustained musical note from a conventional VCR to hear just how bad wow and flutter from the audio track can actually be.

**Audio In Video Tracks.** In Sony's Beta Hi-Fi system, as many as three sound tracks (including the conventional audio track), but most often two, are audio-frequency modulated (called AFM) and inserted into the picture track. In the Beta format (Fig. 2), existing chroma (color) and luminance (brightness) video signals are spaced far enough apart to accommodate the new sound carriers. Although the sound carriers appear to be partially superimposed on the color and brightness signals, the arrangement doesn't produce crosstalk. Furthermore, with three audio channels, the system can accommodate stereo plus a second language in mono, two or three language sound tracks, or even three-channel sound.

### COMPARISON OF AUDIO SPECIFICATIONS FOR CONVENTIONAL AND BETA HI-FI

CONVENTIONAL				
	S/N	Frequency Response	Wow and Flutter	Distortion
Beta II	> 40 dB	50-11,000 Hz	0.3% (wrms)	3.0%
Beta III	> 40 dB	50-8000 Hz	0.4% (wrms)	3.5%
BETA HI-FI				
	Dynamic Range	Frequency Response	Wow and Flutter	Distortion
Beta II & III	> 80 dB	20-20,000 Hz	< 0.005% (wrms)	< 0.3%

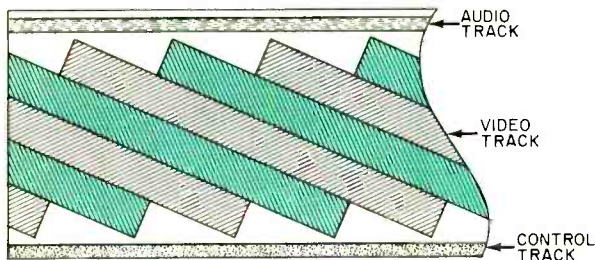

Fig. 1. In conventional VCRs, longitudinal audio track is divided into two narrower tracks for stereo.

Beta Hi-Fi, through the AFM technique, offers a total dynamic range and, therefore, a maximum S/N ratio of 80 dB! (The conventional audio track's figure, however, remains about 45 dB.) This is almost two orders of magnitude better in terms of "audio power" than the best analog LP discs currently available. With its 80-dB dynamic range, Beta Hi-Fi offers almost as great a range as that achievable with the "ideal benchmark" digital-audio sources presently offered by PCM digital-audio processors or by the soon-to-be-released CD discs played on digital-audio disc players.

Other performance figures of the Beta Hi-Fi system are equally impressive. Wow and flutter, for example, is down to a negligible 0.005%. Even at maximum 0-dB reference record level, distortion is 0.3%, or a tenth of that measured on typical conventional VCRs. Frequency response is just about ruler flat from 20 to 20,000 Hz. (A comparison of audio performance specifications for a conventional VCR and a VCR with Beta Hi-Fi is shown in the Table.)

Audio information in the Beta Hi-Fi system is "laid down" on the magnetic tape by the same fast-spinning heads

used to record the video signals. Instead of the tape writing speed for the audio signals being limited to only a couple of centimeters per second, as is the case with a stationary audio record/play head, effective tape writing speed is the same as that used for the video signals, typically 6.9 meters per second (Fig. 3).

Given the wide bandwidth that results from this recording technique, what amounts to two separate r-f carriers is obtained (Fig. 2). Each carrier is frequency modulated by a left- or a right-channel stereo audio signal. In the Beta format, luminance (brightness) signals are located between 3.5 and 4.8 MHz and chroma is centered at 688 kHz. (It's an amplitude-modulated, or AM signal whose upper sideband overlaps the FM luminance signal spectrum somewhat.)

An interesting side benefit is obtained from this arrangement. If the fast-scan feature of a Beta VCR (say, 2x normal viewing speed) is operated, the audio doesn't take on the "chipmunk" quality characteristic of conventional audio tape reproduction run at faster than normal speed. Actual tape-head to tape writing speed doesn't change by much when longitudinal tape speed is increased by 2x (or, for that matter,

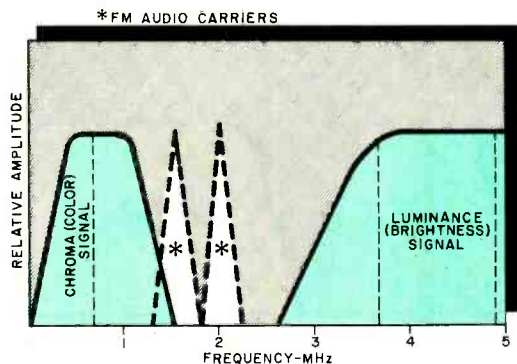

Fig. 2. In Beta Hi-Fi, extra FM audio carriers are inserted in the frequency baseband between chroma and luminance signals.

# SAVE!

## COMPUTERS • VIDEO GAMES

### ORDER TOLL FREE 800-854-6654

If your shopping for a computer for home or business, or already own a computer and want to save money on add-on peripherals and software, you're reading the right ad. We sell over a thousand items for Apple, IBM, Commodore, Atari and more. And all at low, low discount prices. We invite you to join the satisfied customers that buy from us again and again.

HERE'S AN EXAMPLE...

**COMPUTERS**  
COMMODORE 64

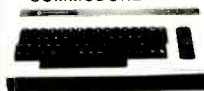

only \$369<sup>95</sup>

**VIDEO GAMES**  
COLECOVISION



only \$187<sup>50</sup>

INTELLIVISION II 149<sup>95</sup>

**Cartridges**

Video game cartridges for Atari, Intellivision and Colecovision up to 25% off! Write for details.

ATARI 800 48K 499<sup>95</sup>  
ATARI 1200XL with 64K 695<sup>95</sup>  
TIMEX 1000 59<sup>95</sup>  
FRANKLIN ACE 1000 Please call for prices  
IBM PC  
OSBORNE I

**MONITORS**

AMDEK 300 12" Green 145<sup>95</sup>  
AMDEK Color 12" 299<sup>95</sup>  
AMDEK COLOR II 12" RGB 699<sup>95</sup>  
NEC, TAXAN, SANYO • MORE

We carry EPSON, STAR GEMINI, OKIDATA, C. ITOH, NEC, in dot matrix and letter quality models.

**PRINTERS**

**NEW! TRANSTAR 7 COLOR PRINTER**  
Only \$529<sup>95</sup>

# CATALOG

Our 1983 Catalog is full of merchandise at incredible prices. There are plenty of pictures, informative descriptions and comparison charts to assist you in choosing the right merchandise for your application.



SEND \$1.00

CREDITED TO YOUR FIRST ORDER

To place orders call toll free. For more information call 619-698-0260. Send check or money order, or use your VISA or MasterCard. Add 3% for shipping. California residents add 6% sales tax. Member Chamber of Commerce and BBB.

VISA NATIONAL COMPUTER PRODUCTS  
8338 Center Drive La Mesa, CA 92041-3791  
CIRCLE NO. 81 ON FREE INFORMATION CARD

# NEW INDOOR ACTIVE ANTENNA

Covers 300 KHz - 30 MHz.  
For SWL, BCL, VLF DXers.

Rivals long wires

\$79<sup>95</sup> (+ \$4.00 shipping)



**MFJ-1020 NEW INDOOR ACTIVE ANTENNA** sits on your desk ready to listen to the world. Rivals, can often exceed, reception of outside long wire. Unique Tuned Active Antenna minimizes intermod, provides RF selectivity, reduces noise outside tuned band. Also use as preselector for external antenna. Covers 300 KHz to 30 MHz in 5 bands. Adjustable telescoping antenna. Controls: Tune, Band Selector, Gain, On-Off/Bypass. LED. FET, bipolar circuitry. Phono jack for external ant. 6x2x6 in. 9-12 VDC or 9 V battery for portable use. 110 VAC with optional AC adapter, MFJ-1312, \$9.95.

Order from MFJ and try it. If not delighted, return it within 30 days for refund (less shipping).

One year unconditional guarantee.  
Order today. Call TOLL FREE 800-647-1800. Charge VISA, MC. Or mail check, money order.

Write for free catalog.

CALL TOLL FREE ... 800-647-1800

601-323-5869 in MS, outside continental USA.

## MFJ ENTERPRISES, INCORPORATED

921 Louisville Road, Starkville, MS 39759

CIRCLE NO. 32 ON FREE INFORMATION CARD

when it's decreased for slow-motion viewing). This is because the longitudinal tape speed, using the video recording heads, is a very small part of total effective tape to tape-head writing speed.

Track configuration of Beta Hi-Fi (Fig. 3) retains the conventional longitudinal audio track, positioned in the usual location, to maintain compatibility between older Beta VCRs and newer Beta Hi-Fi software and vice versa. Played on a new Beta Hi-Fi VCR, the audio track of an older tape will produce a mono sound track with the usual poor S/N ratio, wow and flutter, and frequency response. Conversely, a new Beta Hi-Fi tape's sound tracks will yield only a low-fi mono signal, with left- and right-channel signals blended together, when played on a Beta VCR without the Beta Hi-Fi system.

**Which Way To Go?** Beta VCRs equipped with Sony's new Beta Hi-Fi stereo recording system are expected to cost about \$1000, which gives consumers an interesting alternative to digital audio equipment. At just about the same time Beta Hi-Fi VCRs are introduced (currently scheduled for May/June 1983), the long-awaited CD (compact digital) audio disc players will also be appearing in the U.S. marketplace, priced at \$800 to \$1200, depending on features. Digital audio processors, sometimes called PCM processors, that permit digital audio to be recorded onto video tape, have been selling for about \$2000, which must be added to the price of the VCR. Totalling all the figures, it's obvious that it would currently be far less expensive to record high-quality audio signals using the new Beta Hi-Fi system than to record in the digital-audio medium.

Of course, digital audio has a definite edge over Beta Hi-Fi in terms of published specifications, but in terms of actual *audible* performance, it hardly matters if one audio medium offers 80 dB (Beta Hi-Fi) of dynamic range while another offers 90 dB (digital audio). Both figures are several orders of magnitude better than what the best present-day LP records or analog tapes can provide. It's also difficult to hear the difference between the 0.3% harmonic-distortion level specified for Beta Hi-Fi and the 0.03% figure claimed for digital-audio systems. And Beta Hi-Fi's 0.005% wow and flutter is, for all practical purposes, as inaudible as the unmeasurable level claimed for the new digital audio discs and PCM tape systems.

In sum, Beta Hi-Fi may well prove to

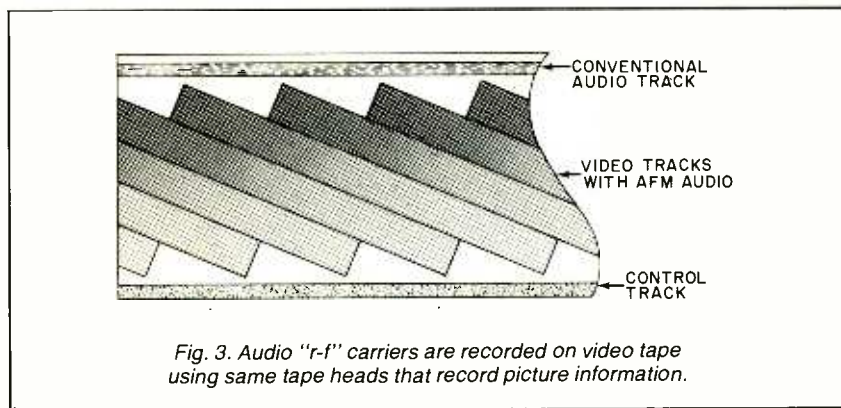

Fig. 3. Audio "r-f" carriers are recorded on video tape using same tape heads that record picture information.

be a serious challenger to digital audio in the months and years ahead. Even if you were to ignore the video side of Beta and use a new VCR equipped with Beta Hi-Fi for only audio recording, the cost might well be justified in terms of the audio quality than can be achieved with this new system. Adding the video recording capability might well make it possible for the Beta-format VCR, long the underdog in the VCR race, to catch up with its faster-selling VHS-format competition.

When queried if FM sound tracks could be used in VHS VCRs, several industry experts initially answered in the negative. As presently designed, they pointed out, the VHS system doesn't lend itself to this approach because there's little or no free spectrum space between chroma and luminance signals (Fig. 4). While luminance could be shifted to make room for the sound tracks, this would limit brightness and degrade picture quality. It would also eliminate compatibility with current VHS hardware and software.

Just as the experts finished explaining why the VHS system couldn't support a sound system similar to Sony's Beta Hi-Fi, Matsushita Electric Co. and JVC demonstrated at last fall's Tokyo Elec-

tronic Show a "hi-fi" version of the VHS system after all. According to reports from Japan, the VHS hi-fi system is conceptually similar to Sony's Beta Hi-Fi system. That is, FM carriers are recorded onto and read from the video tape by helical scanning. Dynamic range is claimed to be 90 dB, and frequency response, distortion, and wow and flutter figures are said to match those of the Beta Hi-Fi system. No marketing plans for the VHS hi-fi VCR were disclosed, but there were indications that the new system would retain the existing linear stationary-head track at the edge of the tape, in addition to new FM sound carriers, to insure compatibility with other VHS VCRs.

**In Closing.** Consumers are the real winners in the battle between Beta and VHS. Timing for better video audio couldn't be better. At the very least, we'll get the opportunity to obtain a better *audio* product than has heretofore been available at moderate price. And on the video end, we'll already be geared up to take advantage of this form of high-quality stereo audio at around the same time the FCC is slated to finally approve stereo audio for TV broadcasting. ♦

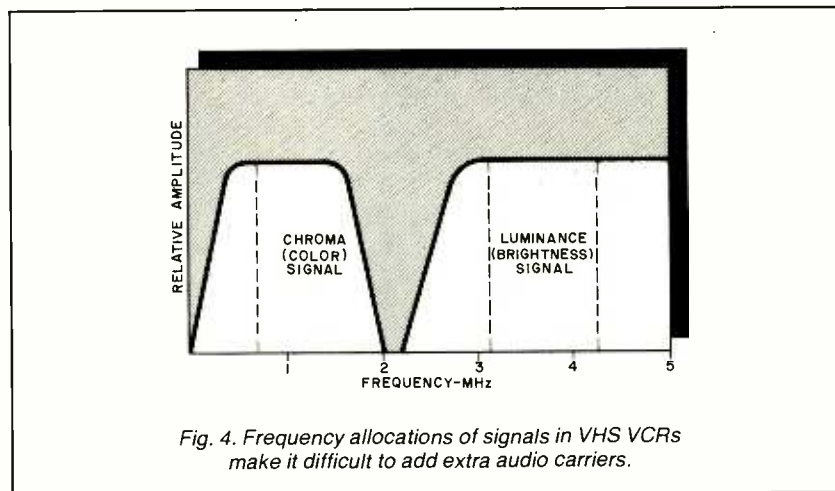
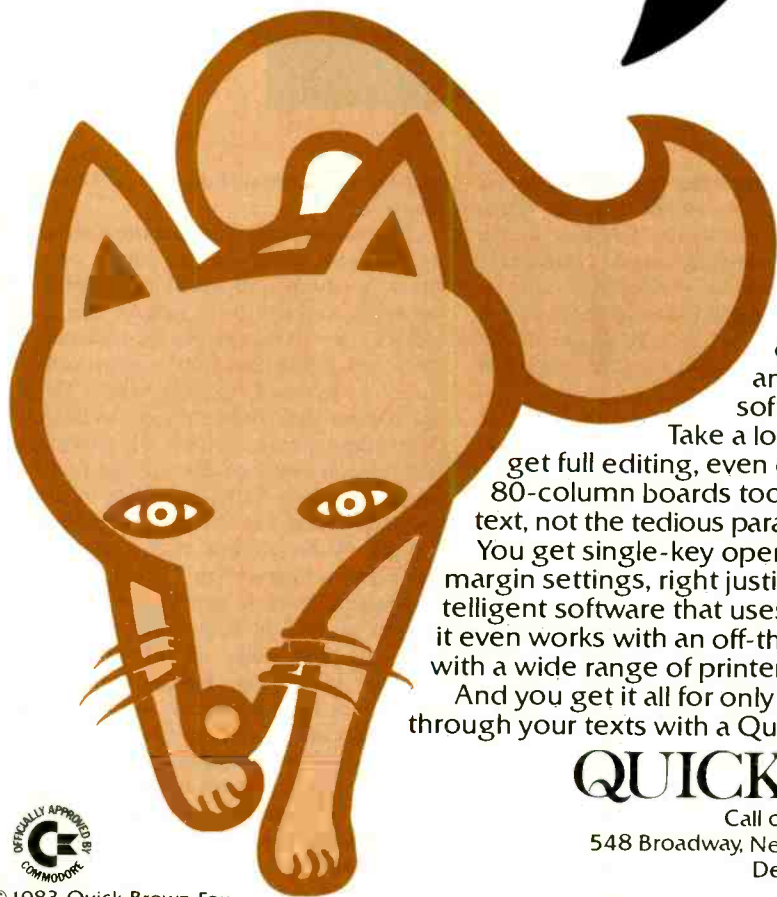

Fig. 4. Frequency allocations of signals in VHS VCRs make it difficult to add extra audio carriers.

# TURN YOUR COMPUTER INTO A FULL-BLOODED WORD PROCESSOR.



VIC 20™ and Commodore 64™ users, something very clever is lying in wait for you. It's called Quick Brown Fox.™

Quite simply, Quick Brown Fox is the quickest, easiest to learn, user-friendliest—and most versatile—word processing software running.

Take a look at some of these crafty features. You get full editing, even on standard displays. (The Fox supports most 80-column boards too.) You get automatic reformatting of edited text, not the tedious paragraph-by-paragraph runaround. There's more. You get single-key operation, text moving, boilerplating, tab and margin settings, right justification, proportional spacing. You get intelligent software that uses less computer memory. (That's how come it even works with an off-the-shelf VIC 20.) You also get compatibility with a wide range of printers—plus plenty more.

And you get it all for only \$65. Doesn't that make you want to trot through your texts with a Quick Brown Fox?

## QUICK BROWN FOX™

Call or write for more details:

548 Broadway, New York, NY 10012 (212) 925-8290

Dealer Inquiries Invited



© 1983 Quick Brown Fox

CIRCLE NO. 15 ON FREE INFORMATION CARD

# KYOCERA'S MODEL R-651 Stereo Receiver with MOSFET POWER OUTPUT



CYBERNET's Kyocera Model R-651 AM/FM-stereo receiver combines a digitally synthesized tuner with a high-quality MOSFET-output amplifier. Output power is conservatively rated at 65 watts/channel into 8 ohms, 20 to 20,000 Hz, at no more than 0.015% THD. The preamplifier section features a highly flexible tone control system described in Cybernet's literature as a "parametric equalizer."

Including its walnut wooden side panels, the receiver measures 18" W  $\times$  14 $\frac{3}{16}$ " D  $\times$  5 $\frac{3}{16}$ " H and weighs 25 lb. Suggested retail price is \$740.

**General Description.** Most of the receiver's less frequently used controls are located behind a full-width door that hinges downward at the bottom of the front panel. Pressing one end of the door allows it to unlatch and provide access to the hidden controls.

In the center of the gunmetal grey satin-finished control panel is a display window. Behind this window are a digital-numeric display for tuned frequency; bargraph displays for monitoring signal strength and peak audio output

power (separate for each channel); and STEREO, IF NARROW, and STATION LOCK indicators. The left half of the panel is relatively blank, containing only the pushbutton POWER switch and a smaller pushbutton DISPLAY switch for selecting  $\times 1$  or  $\times 10$  sensitivity for the audio output power bargraph meters.

Directly to the right of the display window are seven flush-with-the-panel touch switches that provide instant access to any one of up to seven each user-programmable AM and FM stations. (A separate MEMORY PROGRAM switch is provided for actual programming.) A memory system in the tuner section can store the user-selected station frequencies for instant recall.

Other touch panels are provided for UP/DOWN scan tuning, SCAN HOLD tuning, and AUTO/MANUAL tuning modes. At the extreme right of the front panel are similar touch panels for selecting program source—PHONO, AM, FM, AUX, TAPE1, and TAPE2; COPY switches for dubbing from either tape deck to the other; and a  $-20$ -dB AUDIO MUTING switch. Between the two banks of touch

panels is a vertical slide-type VOLUME control.

Behind the hinged door at the bottom of the front panel are five rotary controls, a number of small pushbutton switches, and a PHONES jack. A pair of rotary controls is provided for adjusting bass and treble characteristics according to LEVEL and frequency (HZ). The 11-position detented LEVEL controls act like ordinary tone controls, whereas the HZ controls continuously vary the turnover frequencies (100 to 500 Hz in the bass range and 2 to 10 kHz in the treble range). Although this is not, strictly speaking, a "parametric" equalizer arrangement (which provides independent control of the boost/cut frequency and the amplitude of the response change), it's far more flexible than conventional tone controls—including those that offer a choice of two or three different turnover frequencies. The remaining rotary control is for adjusting channel balance.

Switching functions include: SUBSONIC and HIGH frequency filters, LOUDNESS compensation, STEREO/MONO mode, and EQUALIZER IN/OUT



No wonder they call it the SUPERFONE!

# At Last—a Cordless Phone with TWICE the Range, Sound Fidelity to Rival Phones with Cords, and a Privacy Code System—All This in a Phone Less Than an Inch Thick!

*The Super Fone is less than 1" thick. The base unit has a built-in speaker phone, a fully independent intercom and is 110 volt-220 volt switchable.*



Until now, cordless phones have given you wonderful convenience. But they've had two problems:

1. The range is limited to 600 to 700 feet.
2. Some of them sound as though you're talking inside a barrel.

As cordless phones have become enormously popular, another problem has arisen: two people, living near each other, can have the same channel. Not only is there line confusion, but someone else can literally make a long distance call on your phone.

No more. Never again.

## Range: 1500 Feet OR MORE!

The SuperFone 650 uses state-of-the-art electronics to bring you the **ultimate cordless phone**. Sound quality is superb — and it stays superb, 1500 feet or more from the base station. That's **more than twice the distance** of standard cordless phones.

Only SuperFone 650 has a secret code system to prevent interference and false operation of the phone. You choose from 512 possible "code" combinations. Both the base unit and the phone are **locked** onto that code, which you can change when you want to.

No other phone can interfere. No other unit can share the signal. No one else can hear or speak on your carrier-wave.

## Enormous Range

We say the SuperFone 650 has a range of 1500 feet.

Notice we didn't say "up to" or "as far as" 1500 feet. There's no hedging, because this seems to be the **minimum**, not the maximum range.

Users report 1800 and 2000 feet. That's nearly half a mile. SuperFone 650 is a radiophone, not a toy, and that's why its signal doesn't break up or start hissing or crackling when you get half a block away.

You can tell when you heft it. It's a Little Giant. You can feel the power inside. What a marvel of electronic engineering it is! And it's tough, too. It fits into your shirt pocket, and you can bounce it around all day without damaging it.

## Speakerphone, Intercom — Everything!

SuperFone 650 is The Everything Phone. Anything any phone can do, it can do.

First, the base station is a speaker phone. Touch a button and you can have a hands-free conference conversation in the room in which the base station sits.

Next, it's an intercom. You can page the handset from the base unit and have a private conversation. You have a **true wireless intercom**, not just a signal.

Third, you have a privacy button. Push that button and you'll still be able to hear anything the other party says, but he or she won't be able to hear you until you take the button off "hold."

Fourth, you have an automatic redial. Touch the key and the SuperFone will redial the last complete number.

What else? A **security switch** which makes it impossible for anyone to call out on the remote phone, without changing the ability to receive calls. A **volume control** for the speaker on the base unit. A **call button** to page the base from the cordless phone. **THIS PHONE HAS EVERYTHING!**

## 30-Second Installation

Plug your SuperFone 650 into any wall AC outlet. Push its standard modular terminal into the telephone plug. You're in business.

Every component is heavy-duty, from the built-in condenser microphone (with automatic gain control) to the LED indicator lights. This phone is designed for hard use.

The SuperFone 650 is yours for \$249.95. If you want the SuperAntenna with it, giving you a range of a mile — or even more — you can have **both** for \$319.95. (Or you can get the Super-Antenna alone for \$79.95.)

## We Absolutely Guarantee!

Use the SuperFone 650 (or any electronic instrument you acquire from us) for up to 30 days. If for any reason you decide not to keep it, return it for a 100% refund.

The SuperFone 650 — **\$249.95**

The SuperAntenna — **\$79.95**

BOTH Phone and Antenna — **\$319.95**

Adapter for Multi-Line phone — **\$39.95**

Add \$4.50 per total order for shipping.

CIRCLE NO. 17 ON FREE INFORMATION CARD

[www.americanradiohistory.com](http://www.americanradiohistory.com)

## New! MULTILINE ADAPTER FOR BUSINESS PHONES

If you have several lines, you can plug them into your SuperFone with this single adapter.

The adapter costs \$39.95. Nothing else is required to attach multi-line phones to one SuperFone 650.

## TRIPLE THE RANGE OF ANY CORDLESS PHONE!

The **SuperAntenna** will give your cordless phone, **regardless of make or model**, three times the range it has now.

If the range is 700 feet, it'll leap to over 2,000. If it's 1500 feet, it could be as far as one mile!

Easy to install. Only \$79.95 complete. Add \$4.50 for shipping.

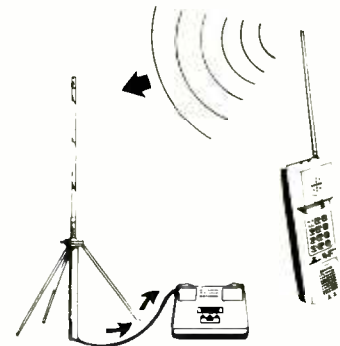

For instant service, if you have a VISA or MasterCard, call toll-free 24 hours a day, seven days a week:

**1-800-824-7888**

Ask for Operator 551.  
(in California: 1-800-852-7777)

The SuperFone 650, SuperAntenna, and Multi-Line Adapter are more electronic marvels from

# NEW HORIZONS

Dept. CE6, 1 Penn Plaza, Suite 100  
New York, NY 10119

## ...KYOCERA RECEIVER

switching. FM tuner buttons control muting, high blend, and NORMAL/NARROW i-f bandwidth selection. Each of the two sets of speaker systems that can be accommodated by this receiver is controlled by its own pushbutton switch.

On the rear apron of the receiver are the various signal inputs and outputs, insulated spring connectors for two pairs of speaker systems, two unswitched and one switched accessory ac outlets, and the antenna terminals. Binding posts are provided for an external AM antenna, supplementing the built-in hinged ferrite-rod antenna. The only FM antenna input on the receiver is a Type F 75-ohm coaxial connector. A supplied matching transformer press-fits onto this connector and has screw terminals for a 300-ohm twin-lead line.

All cooling is performed inside the cabinet, leaving no external heat sinks visible. The MOSFETs in the output stages make intimate contact with a copper pipe that contains a refrigerant that transfers heat to a number of large fins. Ventilation openings in the top and bottom of the receiver permit free convection air flow to carry off the heat collected.

**Laboratory Measurements.** The conservative power ratings of the Model R-651 65 watts/channel receiver were evidenced by its output power at clipping, which was about 81 watts/channel with both channels driving 8-ohm loads at 1000 Hz. The measurements into 4- and 2-ohm loads yielded readings of greater than 89 and 43.3 watts, respectively. Harmonic distortion at 1000 Hz into 8 ohms measured about 0.006% to

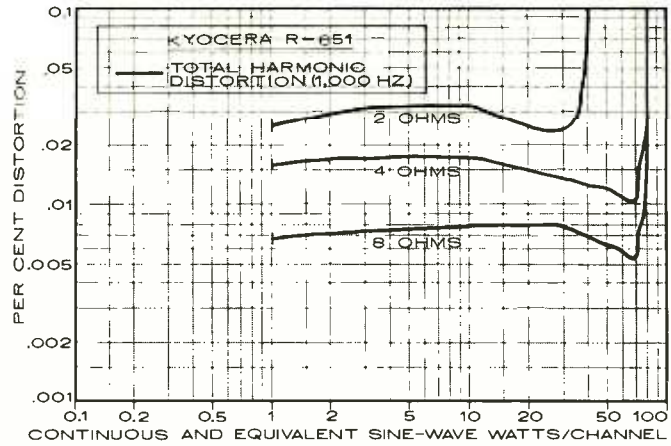

Percent THD into three different loads at 1000 Hz.

0.008% from 1 to more than 70 watts and 0.012% at 80 watts, just before the onset of clipping. At 4 ohms, the distortion was 0.01% to 0.02% up to and beyond 70 watts, reaching a maximum of 0.027% at 80 watts. Into 2 ohms, the measurements were about 0.02% to 0.03% up to 30 watts and 0.5% at 40 watts.

Dynamic power tests with a 20-ms tone burst at 1000 Hz produced clipping outputs of 101, 133, and 80 watts into 8-, 4-, and 2-ohm loads. The 8-ohm clipping headroom measured 0.94 dB, while dynamic headroom was 1.91 dB.

MOSFETs are noted for their high-speed operation. This was reflected in a slew factor greater than 25 and very low IHF intermodulation distortion. With a mixed 18/19-kHz test signal driving the amplifier to 65 watts, second- and third-order distortion components (1000 Hz and 17 or 20 kHz) were barely detectable at the  $-97$ -dB measurement "floor" of our test instruments.

At rated output power, amplifier distortion was in the range of 0.005% to 0.01% over much of the audio band. It

reached 0.017% at 20 Hz and 0.014% at 20,000 Hz. Very similar results were obtained at half and one-tenth power. A 1-watt reference output level was achieved with inputs of 19 and 0.28 mV through the AUX and PHONO inputs, respectively, with A-weighted noise levels of  $-79$  and  $-78$  dB referred to 1 watt. Phono overload occurred at a high 175 mV at low and middle frequencies and 147 mV at 20,000 Hz. RIAA phono equalization was flat within 0.5 dB overall from 60 to 20,000 Hz and was  $+1$  dB at 20 Hz.

The tone controls provided substantial response correction at the frequency extremes without affecting the mid-range. They could also be set to provide a more typical response adjustment in which much of the audible range was modified. Measured response curves confirmed the expected capabilities of this system.

The loudness compensation boosted low frequencies only moderately and high frequencies hardly at all at reduced volume levels. Both audio filters had gradual slopes of 6 dB/octave, with  $-3$ -dB responses at 50 and 2000 Hz.

FM usable sensitivity measured 12 dBf (2.2  $\mu$ V) in mono. The stereo switching (and muting) threshold was about 28 dBf (13  $\mu$ V) and, in its high setting, 42 dBf (70  $\mu$ V). We measured 50-dB quieting sensitivities of 13.8 dBf (2.7  $\mu$ V) in mono and 37 dBf (39  $\mu$ V) in stereo.

At a 65-dBf (1000- $\mu$ V) input, tuner noise level was  $-77$  dB in mono and  $-70.5$  dB in stereo. Corresponding distortion readings were 0.072% and 0.19%. Using 14- and 15-kHz modulating frequencies, our IHF IM distortion measurements for second- and third-order components were  $-68$  and  $-65$  dB in mono and stereo were  $-55$  and  $-56$  dB.

Frequency response in the FM section was flat within 1 dB overall from 30

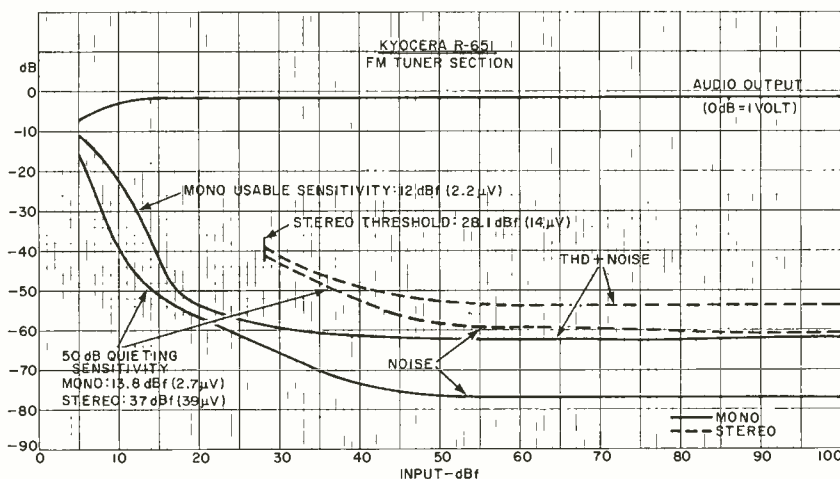

Sensitivity and noise for the FM tuner section.

to 15,000 Hz. Channel separation was nearly constant 50 dB  $\pm$  2 dB, 30 to 1000 Hz, and reduced smoothly to 27.5 dB at 15,000 Hz. Capture ratio measured about 1.5 dB, AM rejection a good 66 dB at a 45-dBf (100- $\mu$ V) input, and image rejection 65 dB. The 19-kHz pilot carrier leakage was a low -76 dB, and tuner hum level was -74 dB. In the NORMAL bandwidth mode, alternate-channel selectivity was only 37 dB, while adjacent-channel selectivity was 2.8 dB. Signal-strength lights for the FM tuner came on at irregular spacings of 6 to 16 dB over a range of 16 to 1200  $\mu$ V, which encompasses most of the useful range of signal levels.

In the NARROW bandwidth mode, alternate-and adjacent-channel selectivity dramatically improved to 74 and 9.4 dB, respectively. Capture ratio in this mode was somewhat degraded at 2.6 dB, and IHF IM distortion was slightly greater at -60 to -65 dB in mono and -43 to -49 dB in stereo. Other aspects of tuner performance weren't affected by the change in bandwidth.

Frequency response of the AM tuner was down 6 dB at 40 and 2800 Hz.

**User Comment.** This receiver proved itself to be above average in both performance and features. Although no single aspect of its design or performance is necessarily beyond that of other contemporary receivers, the total effect is one of excellence. In our view, this reflects a balanced design that ensures best performance for the largest number of potential users.

A good example of this is the switchable FM i-f bandwidth feature that makes the Model R-651 as useful under adverse reception conditions as in a more ideal situation. In our metropolitan New York location, NORMAL bandwidth (actually, quite broad compared to most tuners) was always adequate in rejecting alternate-channel interferences. Significantly, degradation of tuner performance in the NARROW mode was inaudible and insignificant.

The receiver's tone controls are among the best we've ever encountered. If you know what you want to hear and have the patience to experiment, these versatile controls are very likely to provide the desired results.

The Kyocera line of audio components from Cybernet is a relatively new name in the U.S. marketplace, though the company was founded almost a quarter-century ago. If our experience is any gauge, it won't be one of those names that fails to achieve prominence as a supplier of high-quality components.

—Julian D. Hirsch

CIRCLE NO. 101 ON FREE INFORMATION CARD

## How to use computers to teach math!

# COMPUTERS IN MATHEMATICS:

## A SOURCE BOOK OF IDEAS

Now that more and more math departments have access to a micro-computer, the problem becomes: How to use the computer effectively as a teaching aid?

Here's where COMPUTERS IN MATHEMATICS can help you. This 224-page book of reprints from *Creative Computing* magazine is a goldmine of learning ideas, problem-solving strategies, programming hints, puzzles, brain teasers, and much more!

COMPUTERS IN MATHEMATICS covers nine subject areas:

- Computer literacy and computers in society.
- Thinking strategies and how to solve problems.
- Computer simulations and how to write them.
- Probability.
- Mathematical miscellany, from circular functions to differential equations.
- Art and graphics and their relation to mathematics.
- Computer Assisted Instruction (CAI).
- Programming style.
- Puzzles, problems and programming ideas.

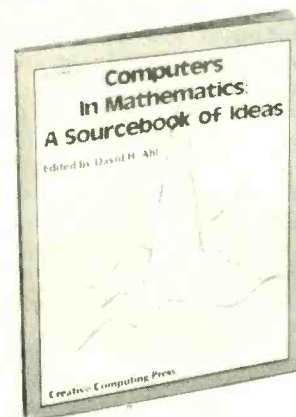

8 1/4" x 11", softcover,  
hundreds of black-and-white  
diagrams and illustrations.  
224 pp.

In all, COMPUTERS IN MATHEMATICS contains 77 fascinating articles, over 200 problems for assignment, and nearly 100 programs. Edited and with a preface by David H. Ahl, Editor-in-Chief of *Creative Computing*, this immensely practical volume is an invaluable classroom tool for teachers and students of all grades.

### USE THE COUPON TO ORDER YOUR COPY TODAY!

**creative computing** Dept. NA6B, 39 East Hanover Avenue  
Morris Plains, New Jersey 07950

Please send me \_\_\_\_\_ copies of COMPUTERS IN MATHEMATICS:  
A Sourcebook of Ideas, at \$15.95, plus \$2.00 postage & handling,\* each #12D  
CHECK ONE:  Payment enclosed \$\_\_\_\_\_ (NJ residents add 5% sales tax.)

Charge my:  American Express  MasterCard  Visa

Card No. \_\_\_\_\_ Expire Date \_\_\_\_\_

Signature \_\_\_\_\_

Mr./Mrs./Ms. \_\_\_\_\_  
(please print full name)

Address \_\_\_\_\_ Apt. \_\_\_\_\_

City \_\_\_\_\_ State \_\_\_\_\_ Zip \_\_\_\_\_

\*All foreign orders (except Canada and Mexico) add \$3 to postage and handling shown. Shipped air mail only. Purchase orders under \$50 not accepted.

For faster service, call TOLL FREE 800-631-8112. (In NJ call 201-540-0445.)

# COMPUTER VIDEO GAMES

## Hands-on Reviews of the latest Computer Game Software

**U**SING a "home" computer, you've likely already come to grips with the mass storage options. This generally means a choice or mix of tape cassette, mini-floppy disk, solid-state board, or even a hard disk. The cassette method has the virtue of being very affordable, of course, and is often employed with low-cost "starter" computers. Floppies, on the other hand, come higher, with disk drives costing as much or even double the price of the computer itself.

Audio cassettes are cheap, but awfully slow. Typically, they take four or five minutes to load 32K of program material—if you're lucky and no error messages pop up on line 895 or wherever. When error messages do appear, you have to rewind and start the loading process all over again. So they're a real turnoff. In contrast, diskettes can load 32K in a matter of six to eight seconds, and with a high degree of reliability and accuracy. But, oh, that first hardware cost if the computer itself is a cheapy.

The news now is that you will soon have an alternative. The new format is called a "wafer," and it's a very distant cousin of the microcassette. The difference is that it has been designed specifically for use with home computers and,

as such, has a lot of very special features.

The medium is an endless-loop tape  $\frac{1}{16}$ " wide and housed in a minuscule cassette case that's a little smaller than a credit-card calculator (see photo below). The tape currently being used, according to Entrepo, Inc., the manufacturer, is high-grade video tape slit to less-than-shoestring width. The oxide formulation may change in the future, but the size and convenience won't.

Tape is available in lengths from 5 to 50 ft., in 5-ft. increments, and it's all certified. It whizzes past the record/playback head at 10 ips, and a 50-footer can hold up to 128K, says the manufacturer. Here's the best part: suggested retail price for a data recorder for these wafers will be about \$100—only slightly more than the \$75 or so that companies are asking for their house-branded data-cassette machines.

Entrepo calls the hardware "Microdrive," and the tapes are "Micro-wafers." They will retail in the \$3-to-\$5 range for blanks, and the hope is that a lot of software houses will adopt the Microwafer as another storage medium for their products so that the format has a chance to catch on. That 32K program mentioned will load in about 15 seconds from a Microwafer—pretty impressive when compared with the 6-to-8-second loading time for a floppy disk.

Companies already committed to the wafer concept are Texas Instruments and Coleco. TI will be hitting the market soon with an add-on Microdrive as a companion piece for its Compact Computer 40 (possibly under a different

name). Coleco recently introduced its "Super Game Expansion Module #3" with Microdrive built-in and two free games on wafers—Super Donkey Kong and Super Gorf. The advertising claims that this module will provide "realistic arcade game play." Maybe it will, working with the ColecoVision's basic 32K of RAM, which admittedly is a lot for a dedicated game-playing machine.

Should you run out and buy one right now? Chances are, you can't! But be patient. The drives will soon appear on dealer shelves.

### CHOPLIFTER!

Diskette for Atari 400/800.  
Broderbund Software, Inc., 1938  
Fourth St., San Rafael, CA 94901  
(415-456-6424). \$34.95.

Graphics ★★★★★

Gameplay ★★★★★

Sustained Interest ★★★★★

Type: Joystick action game.

Memory required: 48K

You're a helicopter pilot and have to rescue a number of hostages (or prisoners, if you will) being held in various barracks buildings behind enemy lines. Take off in your trusty, heavily armed

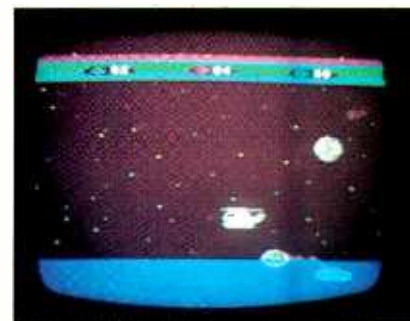

helicopter and try to save these men. The ones who can get out of their blasted-open barracks run to the chopper and climb on board with little urging when you land.

But watch out! There are enemy tanks shooting at the chopper and at your hostages. Take off and turn through 90 degrees so you can drop bombs. You have to be low enough for the bombs to have any effect—but at this low altitude, the tank's fire can get you, too. It's an aggravating scenario, and those tanks are awfully hard to hit.

The enemy fire does come in handy at one point. Explosions from enemy tank shellfire rip open other barracks buildings, allowing the prisoners to escape and run for your chopper. Other enemies to be contended with are jet fight-

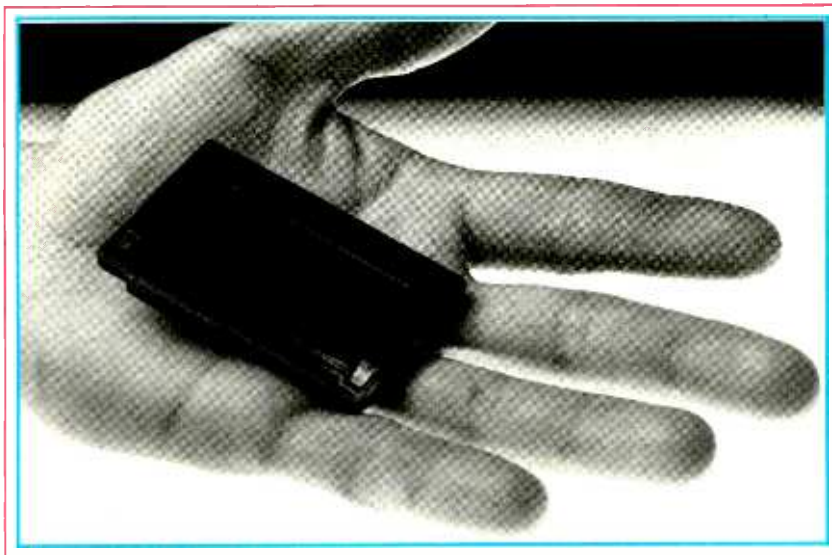

ers, which you can shoot back at, and next are drone air mines which home in on your chopper. They can also follow you back to your home base.

This game is strictly joystick controlled with eye-hand coordination an important part of gameplay. If you hit the "BREAK" key, the game will pause so you can answer the telephone or nature's call, or just go get a cup of coffee. This is a feature that more and more computer games provide—but unfortunately, not all of them do. It's very disconcerting to be deeply involved in a game—especially when you're racking up a good score—and have to abort it to answer the telephone.

The difficulty level is quite high, and it will take a fair amount of practice to get through the tank and jet fighter waves to the point where you have to be concerned about the air-drone mines. Perhaps it also takes a certain amount of patience, because like all games, practice is needed to get you into the expert category. Gameplay is interesting and frustrating. Just when you have a dozen or so hostages safely loaded on your helicopter, you take an unlucky hit from a tank cannon and crash, losing all on board.

## DEMON ATTACK

ROM Cartridge for Atari  
400/800.

Imagic, 981 University Ave., Los  
Gatos, CA 95030 (408-399-2200).  
\$39.95.

**Graphics** ★★★

**Gameplay** ★★★★★

**Sustained Interest** ★★★★★

**Type:** Joystick action game.

**Memory required:** 16K resident  
memory.

This game won all kinds of awards last year in its Atari VCS game machine version, and it has lost none of the inter-



est and excitement in its translation into Atari computer format. What is missing, however, is any kind of improvement in graphics or addition of special features. After all, this is a *computer*, not a dumb game machine that has no

built-in RAM or graphics capabilities to speak of.

Yet it is part of the genius of the designers that the game graphics and gameplay were so good in the VCS version that unless you had already played that one extensively, you'd be enthralled by what this game has to offer in the way of visuals and excitement. It can be played by one or two people—each with his own cannons and reserve supply of spare shooters. The attacking waves of demons get progressively more difficult to destroy, and you get an extra cannon for each wave that you eliminate. Earn as many as you can; you'll need them later on as the demons get more demonic.

Demon Attack has the ability to captivate and hold interest for hours. There's even a version—like the classic Space Invaders—that lets you and your second player team up to destroy the attacking demons. You busily dodge demon bombs, and in later waves, laser blasts, as these super-stealthy creatures fly back and forth in random patterns that seem to defy your ability to lead them with your cannon fire and shoot them down. After a little practice, you'll find yourself starting to get their range, but just when you least expect, you'll get clobbered by a lucky demon hit.

And with all this going on, there's also an electronic musical beat that keeps time to the demon wing-flapping—with a tempo that gets increasingly intense as the action heats up. Beware! This game is habit-forming.

## SOCCER

ROM cartridge for Atari 400/800.

Thorn EMI, 1370 Ave. of the Americas,  
New York, NY 10019 (212-  
977-8990). \$49.95.

**Graphics** ★★★

**Gameplay** ★★★

**Sustained Interest** ★★★

**Type:** Joystick strategy/action game

**Memory Required:** Minimum resident  
(16K)

Our British cousins have brought us a typically European game that is currently enjoying a vogue on this side of the Atlantic as well. It's one of those realistic sports games that can be very fast and a lot of fun. It can be played by zero, one, two, three, or four players.

If one person plays, you try to beat the computer (it's invariably better than you are). Two people can play against each other, and if you feel really lazy, you can set it so the computer plays against itself. I imagine that this last choice would be very good for parties and betting pools—not just betting on

the first team to score, but also betting on how long it takes either team to make a goal. There are also nine difficulty levels available, but even the easiest one is darned tough!

The game consists of two standard soccer teams of 11 players each. The screen is shown with a slight tilt toward the far side of the playing field to add a three-dimensional quality to the graphics. You play until the final buzzer sounds at the end of the time period that



you select in advance: 10, 45, or 90 minutes. We haven't graduated beyond the 10-minute game length yet; maybe this tells you something about the frustration level of the game.

The playing field is too wide for the TV screen, so just one-third of it appears at any one time. The screen field scrolls horizontally to follow the action—much the same way a TV camera pans on a real playing field. This provides a nice, realistic touch to the gameplay.

At first, it's hellishly difficult to learn how to keep your players from overrunning the soccer ball and how to kick it. Your joystick can control only one player at any one time, and when you press the "fire" button, control passes to the player nearest to the ball (in the computer's judgment). You may not always agree, and you may want to run some other player, but you have no choice in making this selection—a feature that I consider a definite drawback in the game program.

Sound effects consist of just two things: the sound of the ball being kicked and the referee's whistle when a goal is scored or the ball goes out of bounds. Selection of the various game options is from a computer-like menu that appears at the start of the game. The cursor on the menu is joystick controlled, making selections easy and straightforward.

For the uninitiated, the instruction booklet even includes a special section that explains the rules of soccer, the most popular sport on a worldwide basis. Overall, this appears to be one of the better sports-type computer games on the market. It's incredibly realistic, and is just difficult enough to be a challenge. ◇



# Inside Apple

Apple Computer Inc., 20525 Mariani Avenue, Cupertino, California 95014

Vol. 1 No. 2

For the authorized Apple dealer nearest you, call 800-538-9696 (800-662-9238 in California.)

## Fruitful Connections.

There are more people in more places making more accessories and peripherals for Apples than for any other personal computer in the world.

Thanks to those people — in hundreds of independent companies — you can make the humblest 1978 Apple II turn tricks that are still on IBM's Wish List for 1984.

But now we're coming out with our very own line of peripherals and accessories for Apple® Personal Computers.

For two very good reasons.

First, compatibility. We've created a totally kluge-free family of products designed to take full advantage of all the advantages built into every Apple.

Second, service and support.



Now the same kindly dealer who keeps your Apple PC in the pink can do the same competent job for your Apple hard-disk and your Apple daisywheel printer.

So if you're looking to expand the capabilities of your Apple II or III, remember:

Now you can add Apples to Apples.

## A joy to behold.

The new Apple Joystick II is the ultimate hand control device for the Apple II.

Why is it such a joy to use?

With two firing buttons, it's the first ambidextrous joystick — just as comfortable for lefties as righties.

Of course, it gives you 360° cursor control (not just 8-way like some game-oriented devices) and full X/Y coordinate control.

And the Joystick II contains high-quality components and switches tested to over 1,000,000 life cycles.

Which makes it a thing of beauty. And a joystick forever.



## Gutenberg would be proud.

Old Faithful Silentype® has now been joined by New Faithfuls, the Apple Dot Matrix Printer and the Apple Letter Quality Printer.

So now, whatever your budget and your needs, you can hook your Apple to a printer that's specifically designed to take advantage of all the features built into your Apple. With no compromises.

The 7x9 Apple Dot Matrix Printer is redefining "correspondence quality" with exceptional legibility. With 144x160 dots per square inch, it can also create high resolution graphics.

The Apple Letter Quality Printer, which gets the words out about 33% faster than other daisywheel printers in its price range, also offers graphics capabilities. See your authorized Apple dealer for more information and demonstrations. Because, unfortunately, all the news fit to print simply doesn't fit.





## Up the creek without a paddle?

Or lost in space? Or down in the dungeons?

Whatever your games, you'll be happy to know that someone has finally come out with game paddles built to hold up under blistering fire. Without giving you blisters.

Apple Hand Controller II game paddles were designed with one recent discovery in mind:

People playing games get excited and can squeeze very, very hard.

So we made the cases extra rugged. We used switches tested to 3,000,000 life cycles. We shaped them for holding hands and placed the firing button on the right rear side for maximum comfort.

So you'll never miss a shot.

## A storehouse of knowledge.

If you work with so much data or so many programs that you find yourself shuffling diskettes constantly, you should take a look at Apple's ProFile™, the personal mass storage system for the Apple III Personal Computer.

This Winchester-based 5-megabyte hard disk can handle as much data as 35 floppies. Even more important for some, it can access that data about 10-times faster than a standard floppy drive.

So now your Apple III can handle jobs once reserved for computers costing thousands more.

As for quality

and reliability, you need only store one word of wisdom:  
Apple.

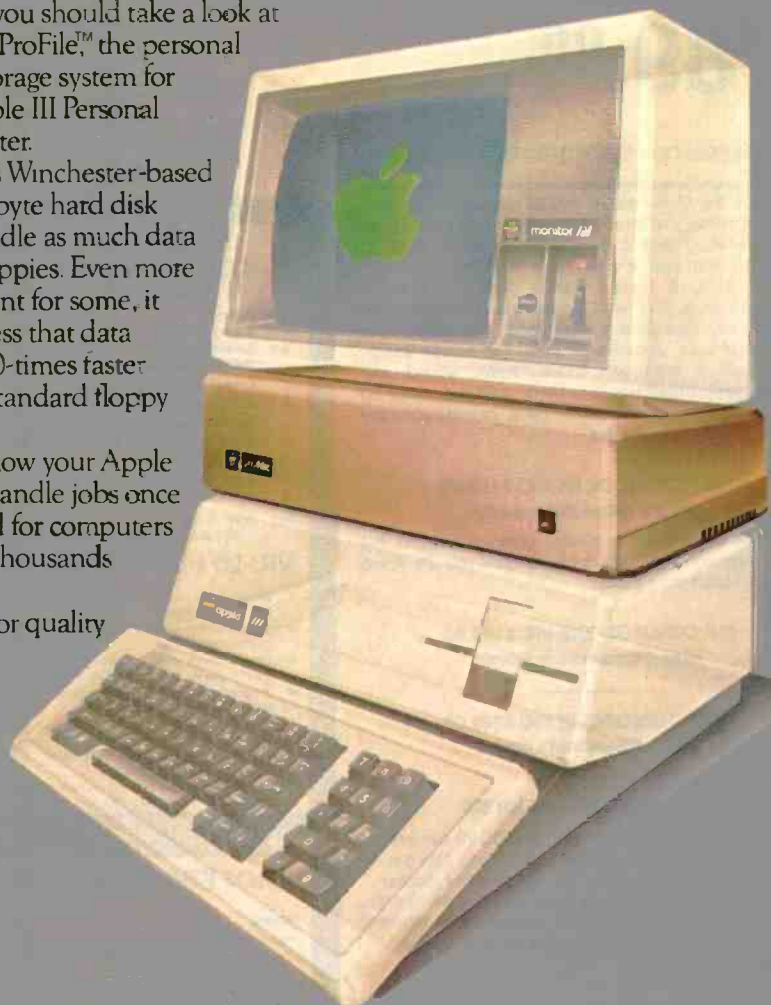

## Launching pad for numeric data.

Good tidings for crunchers of numerous numbers:

Apple now offers a numeric keypad that's electronically and aesthetically compatible with the Apple II Personal Computer. So you can enter numeric data faster than ever before.

The Apple Numeric Keypad II has a standard calculator-style layout. Appropriate,

because unlike some other keypads, it can actually function as a calculator.

The four function keys to the left of the numeric pad should be of special interest to people who use VisiCalc®. Because they let you zip around your work sheet more easily than ever, adding and deleting entries.

With one hand tied behind your back.

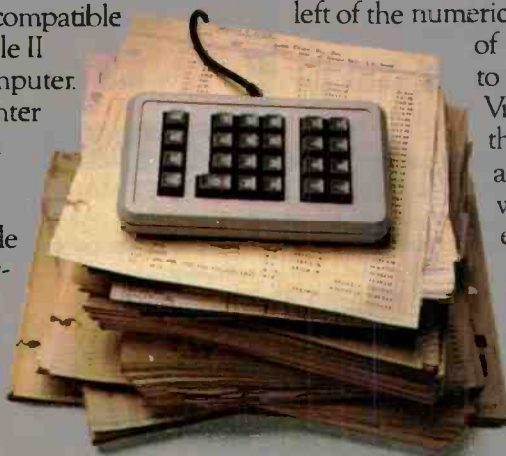

# VIC-20

(a real computer at the price of a toy)

## \$89.00

(when you buy 6 programs)

You get the Commodore VIC-20 computer for only \$134.00 when you buy 6 tape programs on sale for only \$59.00. These 6 programs list for \$100.00 to \$89.00. You can choose one of three packs: 6 games pack, 6 home finance pack, or 6 small business pack. The VIC-20 computer includes a full size 66 key typewriter professional keyboard, color command keys, upper/lower case, full screen editor, 16K level II microsoft basic, color, sound and music, real time, floating point decimal, easy to read self teaching instruction book, connects to any TV, includes console case.

**33K COMMODORE VIC \$159.00**  
with 2½ times more power

You get the VIC-20 computer plus we expand the total memory to 33,000 bytes to give you 2½ times more programming power.

**41K COMMODORE VIC \$199.00**  
with 4 times more power

**49K COMMODORE VIC \$249.00**  
with 6 times more power

**40-80 COLUMN BOARD \$99.**

A fantastic price breakthrough for VIC-20 owners on this most wanted accessory!! "Now you can get 40 or 80 Columns on your T.V. or Monitor Screen." Plus we add a word processor with mail merge, electronic spread sheet, time manager and terminal emulator!! These PLUS programs require only 8K RAM memory.

### TRACTION FRICTION PRINTER \$299.00

Comstar F/T deluxe line printer, prints 8½x11 full size, single sheet, roll or fan fold paper, labels etc. 40, 66, 80, 132 columns. Impact dot matrix, bi-directional, 80 CPS.

### 60K MEMORY EXPANDER \$69.00

Sixslot — Switch selectable — Reset button — Ribbon cable. A must to get the most out of your VIC-20 computer.

### VOICE SYNTHESIZER \$79.00

Makes your VIC-20 talk, VOTRAX based plus features found only in \$295 versions. GREAT BUY — DON'T MISS THIS SALE!!

# COMPUTER AND SOFTWARE SALE

# COMMODORE 64

(more power than Apple II at half the price)

WE HAVE THE LOWEST PRICES — CALL US!

## \$197.00

(with factory rebate and software savings applied)

## VIC20 PERSONAL COMPUTER

### TOP 10 ARCADE GAMES

VIC-20 TAPE PROGRAM SALE!!

Rank	Name	Sale
1.	Super Paratrooper (Fantastic)	\$19.95
2.	Exterminator-Plus (Better than Centipede)	\$19.95
3.	Cricket (Better than Frogger)	\$19.95
4.	Snackman (Better than Pacman)	\$15.95
5.	Galactic Crossfire (you in the middle)	\$16.95
6.	Anti-Matter Splatter (Nuclear Disaster)	\$19.95
7.	Bug Blast (Creepy)	\$16.95
8.	Bombs Away (Great)	\$15.95
9.	3-D Maze Escape	\$14.95
10.	Krazy Kong	\$14.95

BUY ANY FOUR — DEDUCT 10% MORE

### VIC-20 PROGRAMMING AIDS!!

	Sale
• Introduction to basic programming (manual and tapes)	\$22.95
• Advanced basic programming (manual and tapes)	22.95
• Programmers reference manual (288 pages — you must have this!)	15.95
• Programmers easy reference card (tables-lists-drawings)	3.95
• VIC-20 Revealed (267 pages of VIC secrets)	11.95
• 6502 Machine Language Assembler	24.95
• 16K Programming cartridge (gives 400% more programming power — get \$24.95 16K adventure game free!)	60.00

## Commodore 64 Computer

### PROFESSIONAL SOFTWARE

Name	Sale
word processing pack	\$69.00
complete Data Base pack (includes Mailmerge)	\$69.00
Electronic spreadsheet pack (like visicalc)	\$69.00
Accounting pack (personal & business)	\$49.00
Programmers Helper	\$59.00
Programming Reference guide	\$16.95
Basic Tutor	\$19.95
Typing Tutor	\$19.95

## 80 column BOARD

80 characters per line on the screen at one time. Includes word processing pack (list \$89.00), complete data base pack (list \$89.00), Electronic spreadsheet pack (list \$89.00). ALL FOR ONLY \$179

We have over 300 Programs for the Commodore 64 Computer

WE LOVE OUR CUSTOMERS

You pay only \$397.00 when you order the powerful 84K Commodore 64 computer! We pack with your computer a VOUCHER good for \$100 rebate from the factory when you send in your old Atari, Mattel, Coleco electronic game or computer. This includes Sinclair, Timex, Texas Instruments, VIC-20 computers and others!! PLUS we also include a \$100 software COUPON FREE that allows you to buy PROFESSIONAL SOFTWARE from the items shown in the center column of this ad! Call us today (312) 382-5244 for best prices and best service.

### PROFESSIONAL WORDPROCESSING PACKAGE

This wordprocessor is specially designed for the Commodore-64 utilizing the latest techniques. Allows powerful text editing capabilities without long hours of orientation or training. Complete cursor and insert/delete key controls are used. Block movement and/or duplication, line insertion and/or deletion, automatic centering, margin settings, tab settings, copy, disk or tape handling, and all printer types. Up to 99 continuous pages of text can be output to the printer. List \$89.00.

### COMPLETE DATABASE PACKAGE

A user friendly data base system that makes information easy to find and store. You can add, change, delete, and search for data. Print the information on a printer in any format desired. When combined with the word processor pack you have a powerful merge program that allows custom documents and personalized mailing lists. List \$89.00.

### COMPLETE ACCOUNTING PACKAGE (Home or Small Business)

This general ledger program is perfect for small business as well as home. It utilizes a double entry bookkeeping system. You only need enter one transaction and the computer will handle the other. All accounts are user definable and will build for 1 year, resulting in a file of all transactions by account number, month and year to date. Each month a current month's transactions can be viewed at any time (99 accounts 187 entries per month). With this accounting program you will be able to monitor your financial growth as well as your expenses. List \$59.00.

### COMMODORE-64 PROGRAMMERS REFERENCE GUIDE

This is the in-depth guide that goes into the heart of the 64. All aspects of the basic and machine language are covered. (A must for anyone wishing to program the Commodore-64). Sale \$16.95.

• LOWEST PRICES • 15 DAY FREE TRIAL • 90 DAY FREE REPLACEMENT WARRANTY  
• BEST SERVICE IN U.S.A. • ONE DAY EXPRESS MAIL • OVER 500 PROGRAMS • FREE CATALOGS

Add \$10.00 for shipping, handling and insurance. Illinois residents please add 6% tax. Add \$20.00 for CANADA, PUERTO RICO, HAWAII orders. WE DO NOT EXPORT TO OTHER COUNTRIES.

Enclose Cashiers Check, Money Order or Personal Check. Allow 14 days for delivery, 2 to 7 days for phone orders, 1 day express mail!! Canada orders must be in U.S. dollars.

CIRCLE NO. 40 ON FREE INFORMATION CARD

# PROTECTO ENTERPRISES (WE LOVE OUR CUSTOMERS)

BOX 550, BARRINGTON, ILLINOIS 60010  
Phone 312/382-5244 to order



# SOLID-STATE "DISKS"

1. *A user's hands-on experience  
with lightning-fast RAM memory drives*

*By Craig Anderton*

**O**F THE various mass storage media available for microcomputers, magnetic floppy diskettes have proved to be the most popular. However, while floppy diskettes offer large storage capacity for a relatively modest cost, they are by no means perfect. The most information an 8" diskette can store is about 1.2 megabytes—and that assumes the data is stored on both sides of the diskette, in double-density format (with single-density, the potential storage is halved). Though 1.2 megabytes is a lot of storage, for large data

bases (or even for holding contents of a long book), more storage may be necessary. In recent years, the problem of the floppy diskette's limited storage has been addressed very well by the hard disk, which can store 10, 20, 30, or more megabytes of information.

Another problem associated with floppy diskettes is media wear: in other words, the more you use a diskette, the faster it deteriorates. Little pieces of oxide flake off periodically, and if this happens often enough, drop-outs in the magnetic medium can occur, thus



## ...SOLID-STATE DISKS

interfering with the integrity of the stored data.

Still another problem is speed of operation. While floppy diskettes are hundreds of times faster than cassette interfaces, to retrieve data from a diskette (or to send data to the diskette), a head assembly must position itself over the correct section of the diskette. The diskette then rotates as the head reads (or writes) the information from various parts of the diskette. All this takes a certain amount of time, so during disk-intensive operations, the computer has to take a break while the disk system catches up. A "disk wait" or similar notice usually appears at the terminal under these conditions, and you generally need to refrain from working with the computer during disk waits. (Controllers using direct memory access or DMA techniques are faster, but still require occasional disk waits.)

A few seconds may not seem like too much time, but over the course of a few weeks, disk waits definitely add up. And during long compiles, it's not uncommon to have a disk drive whirring away for 30 minutes or more at a time.

Enter the solid-state disk drive (also called memory drive, or MD

the popular CP/M operating system. The advantages claimed were lower media wear, virtual elimination of the disk wait, and greatly increased speed of operation.

But the spring of 1981 was a long time ago by computer industry standards—and if the solid-state disk drive is so useful, why doesn't every computer incorporate one by now? There are two main reasons: the first is that the MD is *volatile*, meaning that it loses its data when power is removed. Therefore, at the end of a computing session it's necessary to copy any files you want to keep from the MD over to a standard floppy diskette or hard disk, since these mass storage devices retain their data even after power is turned off. The second reason is cost, since lots of memory costs lots of money.

The first problem can be solved by using low-power memory with battery backup to implement the MD, and as the price of CMOS memory declines, this option will become more economically attractive. The second problem is becoming less relevant as memory prices decline. So before too long, it's likely that solid-state disk drives will become available at prices that will be tempting to any microcomputer user. As a result, most computer owners will sooner or later have to

tem to the computer. With this configuration, the M-Drive RAM could also be used as regular system RAM when M-Drive was not in use; however, the original M-Drive only worked with CompuPro computers.

Shortly thereafter, SemiDisk marketed a competing product for S-100 computers which was similar—but not identical to—M-Drive. The main difference was that SemiDisk was a dedicated I/O device and could not be used as general-purpose memory. Now CompuPro has replaced its original M-Drive package with the newer M-Drive/H, a 512K memory board using dynamic chips and it is conceptually closer to the SemiDisk. CompuPro M-Drive/H boards can be cascaded for up to 4 megabytes of storage, while the SemiDisk boards can be cascaded for up to 8 megabytes of storage. SemiDisk also makes MD packages for the IBM-PC and TRS-80 Model II. Another company, PION, makes MDs for Apple, TRS-80, SS-50, and S-100 systems; and there are also MD packages available from other companies for other computers (such as the Atari 800).

The Disk-Less™ computer from SD Systems, Dallas, TX, is a Z80A-based, S-100 (IEEE 696) computer that has 256K bytes of main memory and from 256K bytes to 1M byte of MD. No floppy disk is usually provided with this machine. (However one can be used for software loading.) Normally, the programs are contained in ROMs. These ROM "firmware" chips are mounted on a ROM board that can hold a total of 16 2764s or 16 2723s EPROMS. This so-called Romdisk contains the program material.

At this time SD Systems has only provided the CP/M-Plus system and BASIC. However they are now contracting to provide a full range of applications such as word processing, accounting, and electronic spreadsheet programs in ROM. Another major application of MD is for the briefcase and handheld computers. These use CMOS memory which is kept "alive" because the memory is not de-energized when the computer is "shutoff". Instead, the re-chargable NiCd batteries

“...make it look like a disk drive to the computer.”

for short). At the 1981 West Coast Computer Faire, G & G Engineering ran a CompuPro S-100 system with 1 megabyte of RAM. Shortly thereafter, they developed some software, based on a concept originated by CompuPro, which formatted the system RAM to make it look just like a disk drive to the computer. You could read to it, write to it, copy files from it to a regular floppy diskette, and generally treat it exactly like a disk drive running under

face the question, *does the increase in performance of the solid-state disk drive justify the cost?* As we'll see, the answer depends mostly on how much you use your computer.

**Typical MD Products.** My first MD was the CompuPro "M-Drive" package. This included 128K of CMOS RAM and a modified version of CP/M (supplied on diskette) that made it possible to format the RAM to look like a floppy-disk sys-

keep the program material in RAM until the machine is turned on.

This is a form of MD that will be very popular as the use of portable computers increases.

**MD Computing Session.** First, the RAM must be formatted to look like a disk drive. This is done either manually by the operator or automatically by the computer when booted, depending on the particular model of MD.

Second, the files to be worked with must be copied from floppy diskette to the MD. I typically copy over word-processing and spelling checker software, along with any text files I want to process.

Third, standard CP/M commands are used to make the MD the current drive. Applications software can then be called, and computing can begin.

Finally, when a computing session is complete, any text files are saved back over to floppy diskette.

Before continuing, I should explain a little bit about how I use my computer. Being a free-lance writer, virtually all my time at the computer is spent processing words. So, in some ways my work is not as disk-intensive as other ways of using a computer. But that doesn't mean I don't get a little irritated when disk waits do occur. For example, with my high-speed system, it takes about 8.5 seconds to save five pages of double-spaced text onto disk. This event usually occurs every five to ten minutes or so while writing. Thus, during the approximate hour it takes to write those five pages, I'll have spent at least one minute in disk saves. That may not sound like much, but then consider the time it takes to jump from the beginning of a text file to somewhere else. The process of saving a piece of text, and then getting back to where I left off writing, takes about 11 seconds. This also occurs several times during the course of writing, adding up to about another minute.

Block moves also take a fair amount of time, and some instructions must be fetched from the disk. If your software displays "help"

messages on the screen, these require more disk waits as they are read from the diskette. Rejustifying text often requires disk waits as well.

When you add up all of these operations, you find you can easily spend 5% or more of your time watching the disk wait message—even with a fast disk controller. What's more, toward the end of an editing session, changes typically become smaller, where you're simply altering a word or two here and there. It can be very frustrating to take a second or less to enter a change, and then wait much longer for the disk drive to register that change onto the diskette.

With an MD, though, these waits become a thing of the past. When I invoke my word processor, there's no delay—no wait at all. Before you can even blink your eyes, the no-file menu is up on the screen. The only limiting factor on your system speed at this point is the transfer rate of your terminal (the rate in kilobaud), since everything in the computer happens, for all practical purposes, instantaneously.

Believe me, it takes a little while to get used to this instant response. You call up a file to edit and—it's right there! No delay, no disk sounds, no disk wait. Save the file, and you're right back at the begin-

ning again. Jump to the end of a file or a place marker, and you're there *immediately*. When you want to move a block of text, it's moved as soon as your fingers are off the keyboard.

Since I also edit a magazine where all text is entered into either my computer (or its clone in another location), I'm a devotee of proofing programs. These run *much* more efficiently with an MD. For example, SuperSpellguard has a message on the screen that lets you know how much of the text has been compared with its internal dictionary. With a standard disk drive, you hear the disk whirr around and watch the "percentage of text read" increase until the entire text has been proofed. With an MD, those percentages just fly by—it seems to take only a second or two to read a lengthy text file. And, you not only save time while the computer proofs, but the time required to invoke the program (and the time required to mark changes in the text file) are cut drastically. Thus, you can easily save a minute or two while proofing a document, and save even more time if you need to proof it several times.

**Cost-Effectiveness.** As of this writing, the CompuPro 512K M-Drive/H lists for \$1895, while the SemiDisk 512K board (which includes battery backup capability) lists for \$1995 (1-megabyte model for \$2995). Axlon's Ramdisk (reviewed in this issue) is priced at \$1395. Since we're talking about a significant financial investment, the question arises whether an MD is cost-effective.

As far as I'm concerned, the real question of whether or not something is worth its cost is whether it can pay for itself. If adding some-

---

**“ You spend 5% of time watching the disk wait message. ”**

---

thing to a computer saves you enough time to justify the cost of the addition, it's worth investigating. For example, since using an MD saves about 5% to 10% of each hour, and if your time is worth \$50 an hour, that translates to a savings of about \$3 to \$4 per hour. Thus, in 500 hours of operation the MD essentially pays for itself. Note that 500 hours isn't that much when you spend four to five hours daily in front of a computer (around four

ing again. Jump to the end of a file or a place marker, and you're there *immediately*. When you want to move a block of text, it's moved as soon as your fingers are off the keyboard.

Since I also edit a magazine where all text is entered into either my computer (or its clone in another location), I'm a devotee of proofing programs. These run *much* more efficiently with an MD. For example, SuperSpellguard has a

## ...SOLID-STATE DISKS

months of operation, in my case). For those who use lots of disk-intensive operations, the time (and money) savings would be that much more substantial.

Once you have a solid-state drive, you begin to understand how those seconds tend to add up—especially when you don't have to watch them adding up any more! Of course, you do have to spend some time doing things you normally wouldn't have to do with a floppy diskette (formatting the memory, saving on to disk at the end of a session), but that

amount of time, compared to the overall amount of time saved, is negligible.

Media wear is also a consideration. I have noticed that my post-MD diskettes look a lot newer than my pre-MD diskettes.

Finally, there's something psychologically satisfying about not having to wait for the computer. Computers should be transparent. When you say "save," it should save, not say "Let's see now . . . flash the disk wait message on the screen . . . just a moment here . . . let me position my head . . . okay, there we go . . . all right now, back to work." The less

interference there is between operator and machine, the better.

To this author, the solid-state disk drive is definitely the wave of the future. It's probably only a matter of time before most computers have some kind of solid-state disk drive, if for no other reason than that memory costs are going to drop faster than disk drive costs. In the meantime, if you thought the MD was too expensive to justify, think again. I was amazed at how many seconds an MD can save, and how fast those "few" seconds add up. In fact, it's entirely possible that your business application can't afford *not* to have a solid-state disk drive. ◇

## 2. A hard look at Axlon's Ramdisk 320

By Alexander Marx

**T**HE Ramdisk 320™ is a new product for the Apple computer from Axlon, Inc. (170 Wolfe Rd., Sunnyvale, CA 94086), a manufacturer of products for the Atari computer for several years. The Ramdisk 320 uses solid-state memory to emulate a disk drive. Since this eliminates any mechanical or moving parts, the speed of doing any disk operations is dramatically increased. There are also no floppy diskettes and reliability is thereby improved.

**General Description.** The Ramdisk includes a box about the size of

a standard Apple disk drive, painted to match the Apple's color scheme. This small package contains 40 64K memory ICs and provides 327,680 bytes of RAM (320K bytes of user memory). It also contains a battery backup system to protect memory against blackouts or brownouts. The battery, which is automatically recharged when the Ramdisk is on, will supply power for about three hours. A memory interface card with controller chips and a static RAM connects the system to the Apple.

The memory is configured to look like two conventional Apple disk

drives. There are some differences, however. An Apple drive is divided into 35 tracks. (A track is like a record groove, as you know, but is laid out in concentric circle rather than in one long spiral.) Each track is divided into 16 sectors (in DOS 3.2 there are only 13 sectors) and each sector can hold 256 bytes of data.

The Ramdisk is set up the same as a disk drive except that there are 40 tracks. The capacities of the Ramdisk and the Apple disk drive are compared in Table I. The Ramdisk system normally allows use of just 35 of the 40 tracks. This is to maintain compatibility with Apple's DOS. A utility program is supplied, however, to permit use of the extra space.

A three-ring binder contains a 63-page manual and two floppy disks. One disk is for normal BASIC use on an Apple with DOS 3.3. The other disk contains programs to allow an Apple Pascal system to interface with the Ramdisk.

Included on the standard disk are two limited data-base programs. One is a small directory program and the other is a small file-card-type program. Each program has its own separate manual, which is included in the binder.



The Ramdisk requires the following equipment:

- Apple II or Apple II+.
- Apple Disk II with controller.
- Apple DOS 3.3.

The Ramdisk can be used with only one disk drive in the system. A second disk drive is required only if Pascal is being run.

Installation of the Ramdisk System Interface is straightforward and is outlined in the manual. The instructions, however, may be too technical for the neophyte. In this case, a person unfamiliar with the ways of the Apple slots would be wise to seek the assistance of someone who is.

The card installs in slot 4, and the cable, which has been connected to the card at the factory, is lead out the back of the Apple. The controller for the normal Apple drive or drives remains in slot 6. After the initial setup, however, the Ramdisk can be configured to go in any slot, including 6.

The entire Ramdisk system, including the interface card, is powered from the Ramdisk's main unit, which is plugged into a standard ac outlet. There are instructions in the manual for converting the system to 220 V ac. A small slide switch in the back of the Ramdisk turns on the power for the unit.

On the front panel there are five LEDs (three on the left and two on

TABLE I—COMPARATIVE CAPACITIES

	Ramdisk		Apple	
	Drive 1	Drive 2	Drive 1	Drive 2
Tracks	40	40	35	35
Sectors	16	16	16	16
Bytes	163,840	163,840	143,680	143,680

USE lights on the standard Apple drives.

To initialize the Ramdisk, the System Disk is inserted in the Apple drive connected to slot 6 and boot-ed. This, in turn, loads a modified DOS into the Apple and copies the entire disk (including DOS) into drive 1 on the Ramdisk. The user is then asked if he wants to initialize the second drive on the Ramdisk.

The Ramdisk is now active and can be used as a pair of normal disk drives.

**Operation.** The Ramdisk card normally is installed in slot 4 and is accessed by using the standard DOS commands. DOS can be booted from the Ramdisk by typing PR #4.

Running some simple benchmarks on the system showed the Ramdisk to be unbelievably fast in certain disk operations, but it also has some marginal differences in other ways. Commands like CATALOG, DELETE, LOCK, and UNLOCK are so fast as to appear to be instantaneous. The speed even rivals a hard disk.

I timed how long it took to LOAD and SAVE a 51-sector BASIC (ap-

proximately 13K bytes) and a 51-sector binary file. Table II gives the results for the BASIC files. Times for the binary file were almost the same.

There is a 3-to-1 speed difference with the Ramdisk. I took advantage of this speed to assemble some long programs with an Apple Toolkit Assembler, which uses the disks extensively. I was very pleased with

the high speed at which the assembly took place.

Running benchmarks with data files, though, was a different story. I ran both random access and sequential file timings and found that the speeds were not as different as they were in LOAD and SAVE. My programs wrote 1000 records to the disk and then read them back into the Apple. The time differences between reading and writing were negligible as shown in Table III. The ratio in both cases is close to 1.2 to 1, less than half the speed advantage of the other operations. The manual observes that the sequential file operations would be slow and it gives a demonstration program using a fast loader program supplied on the System Disk. Using the fast

TABLE II—LOAD AND SAVE TIMES FOR BASIC

	Floppy disk (seconds)	Ramdisk (seconds)
Load	14	5.0
Save	17	4.5

loader yielded a read time of 2 seconds for 1000 sequential records. That's correct, 2 seconds!

**The Software.** The software supplied on the Ramdisk DOS System Master diskette provides several utilities to make it more useful. The Select utility permits modifying the Ramdisk operating system so that it can automatically transfer files from a floppy disk onto the Ramdisk upon booting. To create a turn-key disk, it is necessary to place a binary file on a disk called "Ramdisk1." When this program is BRUN, it connects the Ramdisk to the Apple's DOS. Otherwise DOS will not recognize the Ramdisk. Other utilities permit testing the Ramdisk's memory either a byte at a time or at the sector level.

“The speed rivals a hard disk.”

the right) to show the status of the system at all times. On the left, the LEDs are labeled POWER (to indicate when the power is on), BATTERY (ostensibly to indicate when the battery is switched on), and CHARGE (to show that the battery is being charged). On the right, the lights are labeled 1 IN USE and 2 IN USE, to indicate which drive is being accessed. These are similar to the IN

proximately 13K bytes) and a 51-sector binary file. Table II gives the results for the BASIC files. Times for the binary file were almost the same.

There is a 3-to-1 speed difference with the Ramdisk. I took advantage of this speed to assemble some long programs with an Apple Toolkit Assembler, which uses the disks extensively. I was very pleased with

If the user has the programming skills, the Extra40K utility gives five extra tracks on each drive (an extra 20K per drive). The utility does not provide standard access to the extra memory, but requires that the user be able to specify the area of memory to save and the location in the extra space to be used. This might be useful to those doing custom programming, but is fairly useless in general.

When the Apple's DOS is modified to accept the Ramdisk system, it also gets some added functions. These include one that will copy an entire disk form, either the Ramdisk to a floppy or vice versa. It can be called from BASIC by typing "&"

**TABLE III—WRITE AND READ TIMES**

	Floppy Disk (seconds)	Ramdisk (seconds)
Random	66	55
Sequential	38	30

or CALL 1013. The slot and drives for each device can then be specified and the utility runs quickly through the disk. This function is available off the Ramdisk System Disk with full prompting under the name RDCOPY. But the version in DOS could be used in a user-written program.

Another built-in function is the ability to toggle the Ramdisk DOS on and off. This is useful in initializing a floppy without having it contain the Ramdisk modified DOS.

The other two useful programs on the System Master are the Directory and the Mini-Base Phone Book. The former permits storing, retrieving, and sorting over 3200 records. The system works at lightning speed and can find any record in about two seconds. The system could be easily used as a replacement for a rotary type of card file in a small office. What's more, the system can print and sort the entries. The sorting works very well and is also very fast.

An entry can be searched by doing an exact match on a given field

or by using wild cards to make broad matches. On exiting the system, the program provides the option of saving the files onto a floppy disk for backup. The system can also be set to boot from floppies and load both the program and the data into the Ramdisk.

The program is limited, though, not only by its capacity, but also because the fields are preset and not really changeable. Moreover, the entry is filed by the first letter of the first field. These "groups" are fixed at a pre-defined number. That is, "A" can have 128 entries, while "J" can only have 84.

The Mini-Base Phone Book is a similar program. It provides features such as report generation and the ability to use multiple files. However, the records are limited to six fields and 200 records per file. Up to five files can be stored on a disk. This program seems to be better suited as an example of how to use the features of Ramdisk. A tutorial is even provided on how the program works with a function-by-function breakdown.

A second disk is supplied to allow the Ramdisk to interface with Pascal. Since I am not overly fluent in Pascal, I did not do much timing of the Ramdisk using this language. In fact, the manual does not really go beyond installing the drivers needed to have Pascal access the Ramdisk. The Pascal disk contains a program that's menu-driven. This makes it fairly simple to modify the Pascal disks for Ramdisk operation. Some quick checks indicated that the Pascal system also gained the same benefits as the DOS 3.3 system.

Although the Ramdisk performed flawlessly and even better than expected, I found one large defect in the whole system. It isn't a fault in the Ramdisk or its software—rather in what it might be used for. A perfect use would be storing large electronic spreadsheet files (such as Visicalc). Unfortunately, this can't even be attempted. Visicalc is sold as a "protected" program, which means that not only can't it be copied, it can't be modified. As Visicalc loads its own DOS into memory, it clobbers the Ramdisk DOS. Since the Visicalc DOS can't be modified to accept the

Ramdisk, it sits idly by. The only way to use protected programs on the Ramdisk is to make an unprotected copy or use a hardware copy device.

**Conclusions.** I found the Ramdisk to be a well-engineered product as well as one that functioned flawlessly. Using the Ramdisk on a few programs that were very slow because they were disk bound, like my assembler, convinced me that the product has genuine value. For the first time, I enjoyed writing and assembling programs, knowing that the Ramdisk would make it run like greased lightning without a lot of disk waiting time.

The software supplied with the system performed well and was generally user friendly.

The manual was not completely satisfactory, though. I felt that it was on the skimpy side in many places, like the Pascal section, and bogged down in others. The manual does have good points. It includes information on interfacing the Ramdisk into DOS, what memory locations it uses, and program listing of some of the utilities supplied. It's also largely written in English rather than the Computereze that is used in so many of today's instruction manuals.

The Axlon Ramdisk's suggested retail price (\$1395) puts it near the range of a 5-megabyte Winchester hard disk. This may make it seem expensive, especially since it has only 320K, but there are no worries about head crashes and data loss trying to back up 5 megabytes of hard disk onto 36 floppies. A personal complaint of mine is not with the Ramdisk but with today's software, which won't recognize the Ramdisk (or a hard disk) or allow easy modification to do so. I can only hope that the software authors will at least allow the option of using a Ramdisk.

In conclusion, if I were writing assembly language programs for a living, I certainly would feel more than justified in investing in the Ramdisk, which is an excellent product. The same would be true in using or writing software that can be easily modified to accept Ramdisk. ◇

# GUARD PRECIOUS COMPONENTS from Overload Damage

*A single IC provides extra protection for a variety of electronic circuit devices*

*By Harold Wright*

**V**OLTAGE regulators such as those used in many electronic circuits require a much higher source voltage than what they deliver as a regulated output. If such a regulator fails, it is quite possible that its output will increase to a disastrously high voltage for the components it is supplying. For in-



## ...OVERVOLTAGE

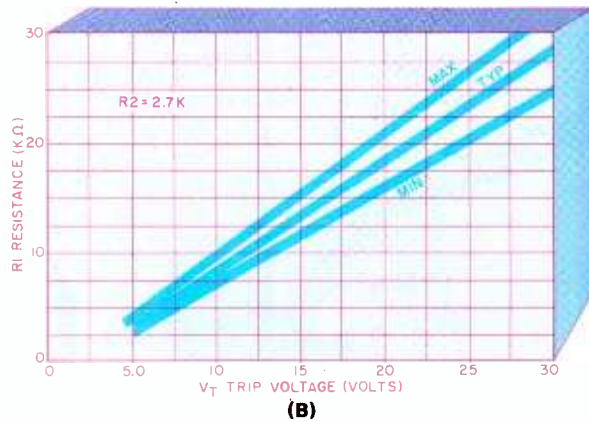
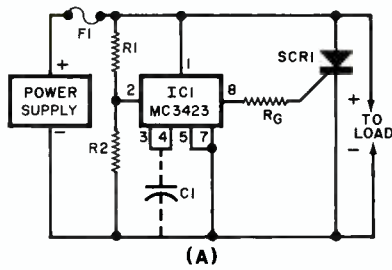

Fig. 1. The basic overvoltage circuit (A) using an MC3423 for power supplies between 4.5 and 36 V. The curves at (B) show how  $R1$  can be used to adjust the trip point.

stance, such components as the Intersil 7107 V/F converter is rated to operate normally at  $\pm 5$  V, with  $\pm 6$  V being an absolute maximum. Thus, if the power supply fails and the voltage rises above the maximum, this expensive chip will be destroyed. Consequently, it is advisable to check the spec sheets of the ICs you are using. Then check your power supply; and, if necessary, provide some means of overvoltage protection.

Very few experimenter circuits (and not much commercial equipment) have overvoltage protection; and except for having fuses, not many automotive electronic items are protected in this manner. The overvoltage protection schemes shown in this article can be applied to existing (or planned) circuits and will work with both line-powered and mobile equipment, including those operating from the vehicle battery/alternator system.

The circuits to be discussed are

designed around the MC3423 Overvoltage Protector (OVP). The basic circuit, used for power supplies between 4.5 and 36 V, is shown in Fig. 1A. When IC1 is triggered through pin 2, pin 8 goes high. This triggers SCR1 through resistor  $R_g$ . The SCR then acts as a short circuit across the power supply, causing the fuse to blow and remove power from the load. This approach is called a "crowbar."

The trigger level is determined by the ratio of  $R1$  to  $R2$ . As shown in Fig. 1B,  $R2$  is fixed at 2.7 kilohms and the value of  $R1$  can be scaled from the graph. To permit precise adjustment of the trip point,  $R1$  can be divided into two components—one a fixed resistor and the other a multi-turn trimmer potentiometer. The total value of the fixed resistor and half the value of the trimmer potentiometer add up to the value of  $R1$  as determined by Fig. 1B. Thus, the trimmer potentiometer can be set slightly above or

below the desired trip point. To protect a 5-V TTL supply, for example, make the variable trimmer 1 kilohm and the fixed portion 3.3 kilohms. Set the trip point to 6 V, a safe value for TTL.

No type number is given for SCR1, since it depends on the value of the protective fuse,  $F1$ . Select an SCR whose turn-on current exceeds the value of the fuse so that, when the SCR is turned on, it will take sufficient current to blow  $F1$ . Gate-current limiting resistor,  $R_g$ , is selected by the graph in Fig. 2A. For voltages below 11 V, omit  $R_g$ .

To avoid tripping the protector when line transients occur, pins 3 and 4 (connected together as shown in Fig. 1A) can be connected to the negative (common) line through a bypass capacitor ( $C1$ ). This sets the minimum duration of overvoltage allowed before IC1 triggers. When the voltage rises above the trip point,  $C1$  starts to charge. If the voltage is transient and is over be-

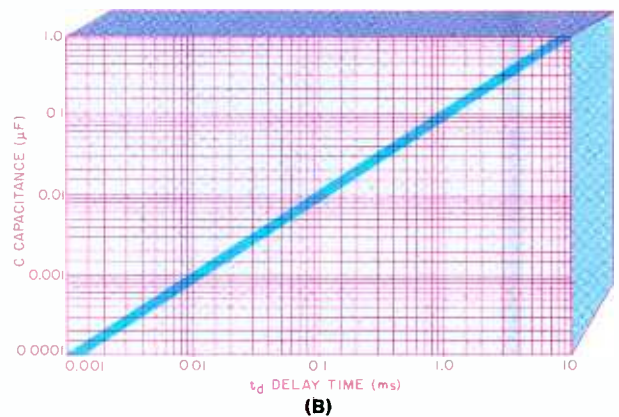
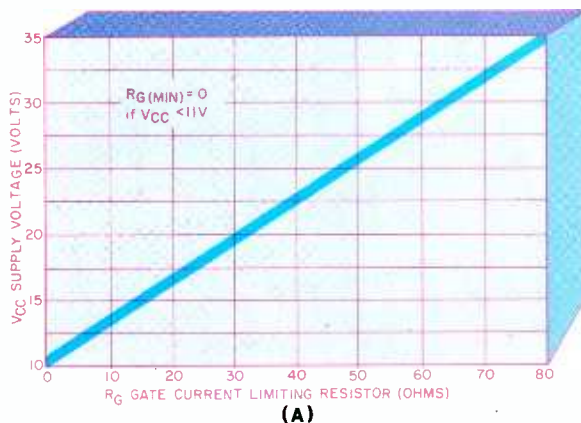

Fig. 2. The curve at (A) is used to select a value of  $R_g$  for the SCR and (B) is to choose a bypass capacitor for IC1.



# "I built this 16-bit computer and saved money. Learned a lot, too."

Save now by building the Heathkit H-100 yourself. Save later because your computer investment won't become obsolete for many years to come.

Save by building it yourself. You can save hundreds of dollars over assembled prices when you choose the new H-100 16-Bit/8-Bit Computer Kit — money you can use to buy the peripherals and software of your choice.

## H-100 SERIES COMPUTER SPECIFICATIONS:

**USER MEMORY:**  
128K-768K bytes\*

**MICROPROCESSORS:**  
16-bit: 8088  
8-bit: 8085

**DISK STORAGE:**  
Built-in standard  
5.25" disk drive,  
320K bytes/cisk

**KEYBOARD:**  
Typewriter-style,  
108 keys, 13  
function keys,  
18-key numeric pad

**GRAPHICS:**  
Always in graphics mode.  
640h/225v resolution;  
up to eight colors  
are available\*\*

**COMMUNICATIONS:**  
Two RS-232C Serial  
Interface Ports and  
one parallel port

\*128K bytes standard.  
\*\*Optional.

**DIAGNOSTICS:**  
Memory self-test  
on power-up

**AVAILABLE SOFTWARE:**  
Z-DOS (MS-DOS)  
CP/M-85  
Z-BASIC Language  
Microsoft BASIC  
Multiplan  
SuperCalc  
WordStar  
MailMerge  
Data Base  
Manager  
Most  
standard  
8-bit CP/M  
Software

The H-100 is easy to build — the step-by-step Heathkit manual shows you how. And every step of the way, you have our pledge — "We won't let you fail." Help is as close as your phone, or the nearest Heathkit Electronic Center.†

And what better way to learn state-of-the-art computing techniques than to build the world's only 16-bit/8-bit computer kit? To run today's higher-speed, higher-performance 16-bit software, you need an H-100. It makes a big difference by processing more data faster.

Dual microprocessors for power and compatibility. The H-100 handles both high-performance 16-bit software and most current Heath/Zenith 8-bit software.

Want room to grow? The H-100's standard 128K byte Random Access Memory complement can be expanded to 768K bytes — compared to a 64K standard for many desktop computers.

And the industry-standard S-100 card slots support memory expansion and additional peripheral devices, increasing future upgradability of the H-100.

High-capacity disk storage, too. The H-100's 5.25" floppy disk drive can store 320K bytes on a single disk. The computer also supports an optional second 5.25" and external 8" floppy disk drives. And an optional internal Winchester disk drive will be available soon.

For more information, circle the reader service number below. Better yet, visit your Heathkit Electronic Center for a demonstration!

*The H-100 gives me the most for my computer dollar!*



**Heathkit®**  
Heath  
Company

†Heathkit Electronic Centers are units of Veritechnology Electronics Corporation.  
Heath Company and Veritechnology Electronics Corporation are subsidiaries of Zenith Radio Corporation.

CIRCLE NO. 24 ON FREE INFORMATION CARD

# If you have put off learning more electronics for any of these reasons, act now!

- I don't have the time.
- High school was hard for me and electronics sounds like it may be hard to learn.
- I can't afford any more education.
- I have a family now.
- I'm here. You're there. I've never learned that way before. I'm not sure it will work for me.

**Read the opposite page and see how you can get started today!**

**Be honest with yourself. Are the reasons really excuses? You already know enough about electronics to be interested in reading this magazine. So why not learn more? If you need encouragement, read on and see how excuses can be turned into results.**

**You don't have the time.** Be realistic. All you have in life is a period of time. Use it. Try to know more tomorrow than you do today. That's the proven way to success. CIE studies require just about 12 hours of your time a week, two hours a day. You probably do have the time.

**Electronics sounds like it may be hard to learn.** You already know something about electronics or you wouldn't be reading this. Now, build on that. CIE Auto-Programmed® Lessons help you learn. Topics are presented in simple, logical sequence. All text is clear and concise for quick, easy understanding. You learn step by step, at your own pace. No classes to attend. Nobody pressures you. You can learn.

**You can't afford any more education.** Actually, you can't afford NOT to gain the skills that can put you ahead of the others. You know what inflation is doing to you now. Education—learning a skill—is an inflation-fighter that can be yours. If you are not able to pay full tuition now, CIE will lend you funds on a monthly payment plan.

**You have a family now.** All the more reason why you have the responsibility to advance yourself. For the sake of your family. Do you want them to have what you had or have more than you had? The choice is yours. Electronics is a rewarding career choice. CIE can help you to get started on that career.

**You're there. We're here. How does CIE help you learn?** First, we want you to succeed. You may study at home, but you are not alone. When you have a question about a lesson, a postage stamp gets you your answer fast. You may find this even better than having a classroom teacher. CIE understands people need to learn at their own pace. When CIE receives your completed lesson before noon any day of the week, it will be graded and mailed back the same day with appropriate instructional help. Your satisfaction with your progress comes by return mail. That's how CIE helps you learn.

**NOW, IF YOU AGREE CIE TRAINING CAN WORK FOR YOU, HOW ELSE CAN CIE HELP YOU?**

Cleveland Institute of Electronics is the largest independent home study school in the world that specializes exclusively in electronics. Although "big" does not always mean "best," it is evidence that CIE is a strong, successful institution with the people and resources to help you succeed.

June 1983

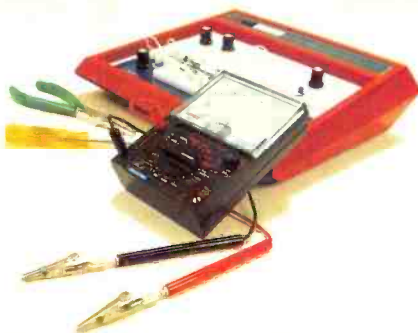

**Step-by-step learning includes "hands-on" training.**

The kind of professional you want to be needs more than theory. That's why some of our courses include the Personal Training Laboratory, which helps you put lesson theory into actual practice. Other courses train you to use tools of the trade such as a 5MHz triggered-sweep, solid-state oscilloscope you build yourself—and use to practice troubleshooting. Or a Digital Learning Laboratory to let you apply the digital theory that's essential today for anyone who wants to keep pace with electronics in the eighties.



**Your FCC License can impress employers.**

For some electronics jobs, you must have your FCC License. For others, employers usually consider it a mark in your favor. Either way, your License is government-certified proof of your knowledge and skills. More than half of CIE's courses prepare you to pass this exam. Surveys show that some 80% of CIE graduates who take the exam are successful.

**Find out more! Today. Now.**

There's a card with this ad. Fill it in and return. If some other ambitious person has already removed it, use the coupon.

You'll get a copy of CIE's free school catalog, along with a complete package of personal home study information.

For your convenience, we'll try to arrange for a CIE representative to contact you to answer any questions you may have.

If you are serious about a rewarding career, about learning electronics or building on your present skills, your best bet is to go with the electronics specialists—CIE. Mail the card or coupon today or write CIE (please mention the name and date of this magazine), 1776 East 17th Street, Cleveland, Ohio 44114.

This could be the best decision you've made all year.

**Associate Degree**

Now, CIE offers an Associate in Applied Science Degree in Electronics Engineering Technology. In fact, all or most of every CIE Career Course is directly creditable towards the Associate Degree.

**"If you're going to learn electronics, you might as well learn it right!"**

*John Cunningham  
Senior Technical Director*



PE89

**CIE Cleveland Institute of Electronics, Inc.**

1776 East 17th Street, Cleveland, Ohio 44114  
Accredited Member National Home Study Council

**YES...** I want to learn from the specialists in electronics—CIE. Send me my FREE CIE school catalog...including details about the Associate Degree program...plus my FREE package of home study information.

Print Name \_\_\_\_\_

Address \_\_\_\_\_ Apt. \_\_\_\_\_

City \_\_\_\_\_

State \_\_\_\_\_ Zip \_\_\_\_\_

Age \_\_\_\_\_ Phone (area code) \_\_\_\_\_

Check box for G.I. Bill bulletin on Educational Benefits:  Veteran  Active Duty

**MAIL TODAY!**

## ...OVERVOLTAGE

fore the capacitor charges, *IC1* does not trip. Figure 2B shows the relationship between the value of *C1* and the duration of the delay. For example, with a value of 0.01  $\mu\text{F}$ , the delay is 0.1 millisecond. The partial circuit shown in Fig. 3 is a modification that does not blow fuses. Instead, when turned on, the SCR operates relay *K1* to remove power from the load. Diode *D1* protects the SCR from the back emf generated when the coil inductance is removed from the circuit. Capacitor *C2* reduces sparking at the relay contacts when they open, thus improving relay life.

If a two-pole relay is used, the second pole can provide power to a LED or operate a warning device such as a Sonalert. Resistor *R3* is selected for safe LED current.

To protect a negative power supply, use the circuit shown in Fig. 4., an inverted version of Fig. 1A.

Both sides of a dual supply can be protected by the circuit shown in Fig. 5. In a  $\pm 5\text{-V}$  supply, the total voltage across the two outputs is 10 V. Any increase in voltage in either side of the supply (such as the negative voltage becoming more negative or the positive more positive) will increase the total voltage across *R1/R2* and *IC1*. If *IC1* is set to trip at 11 V, then a negative increase to  $-6\text{ V}$  or a positive increase to  $+6\text{ V}$  will cause triggering. When *IC1* triggers, pin 8 goes high relative to both ground (common) and the negative side of the supply. It will reach a voltage slightly less than half the tripping level when referenced to the common. In a dual  $\pm 5\text{-V}$  supply set to trip at 11 volts, pin 8 would reach a high of about 5.5 V to ground. This is enough to trip the SCR. The voltage across the SCR load can be used to operate a relay to shut down the power.

If an inhibiting high signal is needed from a negative output supply, use the circuit shown in Fig. 6.

Note that an opto-coupler is used as the load instead of the SCR. Before *IC1* triggers, pin 8 is negative with respect to ground and when *IC1* triggers, pin 8 drops to ground. When this occurs, the LED in the opto-coupler is properly biased and turns on. Resistor *R3* limits the LED current to the required value. The other side of the opto-coupler is connected between an external positive supply and ground through *R4*. When the LED glows, a high will be present across *R4* and it can be used for inhibiting purposes.

**Mobile Use.** Much expensive electronic equipment is used in vehicles and boats. These also require protection. One of the problems can be

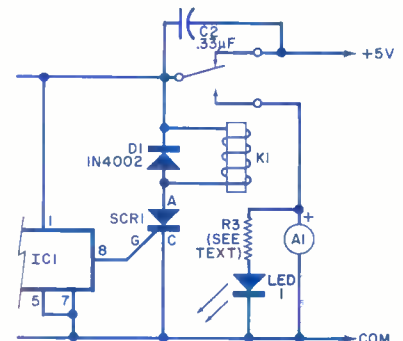

Fig. 3. Circuit to remove power from the load and sound an alarm.

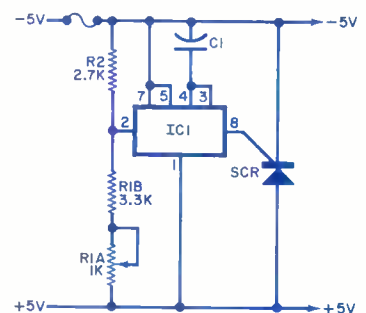

Fig. 4. Use this circuit instead of Fig. 1A for a negative supply.

a type of overvoltage peculiar to battery/alternator/regulator systems. Alternator regulators can fail in such a way that the alternator is allowed to run out of control or wide open. In this situation, as much as 20 to 22 V can be present on the 12-V system of the vehicle.

In the circuit shown in Fig. 7, the trip point can be set to about 15 V. In this case the load is fed from the relay contacts; and, if an overvoltage occurs, the relay operates to remove the damaging voltage from

# The Safe Video Head Cleaner is Dry.



Yes, dry!

The Discwasher® Video Head Cleaner is the only truly nonabrasive dry head cleaner on the market today.

Its superior cleaning action is the result of its textured fabric matrix, not the result of abrasive properties (like those often utilized in aluminum oxide cleaners). This exclusive matrix safely cleans not only the video heads, but the audio and sync heads as well.

The Discwasher Video Head Cleaner is less abrasive than both the video head and video drum. In fact, it's even less abrasive than video tapes themselves. And best of all...it works. Easily, safely, and quickly.

The graph below represents approximate hardness ratings of individual VCR components and various tapes and cleaners using the Temper scale, developed by industry to measure materials. A diamond, one of the hardest materials known, rates T-10.

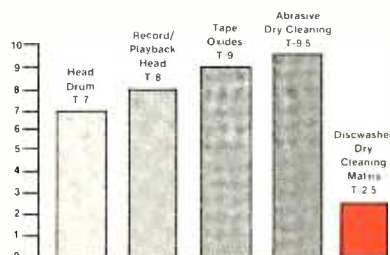

## discwasher

1407 N. PROVIDENCE RD., P.O. BOX 6021, DEPT. CE, COLUMBIA, MO 65205 USA  
A DIVISION OF JENSEN an ESMARK Company

CIRCLE NO. 66 ON FREE INFORMATION CARD

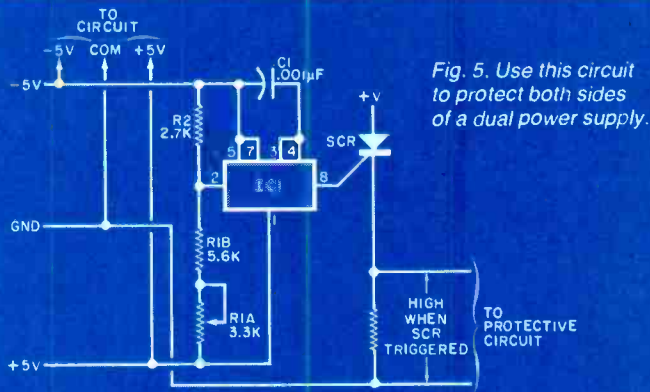

Fig. 5. Use this circuit to protect both sides of a dual power supply.

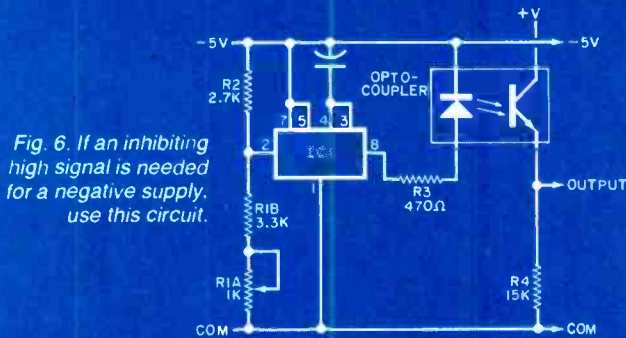

Fig. 6. If an inhibiting high signal is needed for a negative supply, use this circuit.

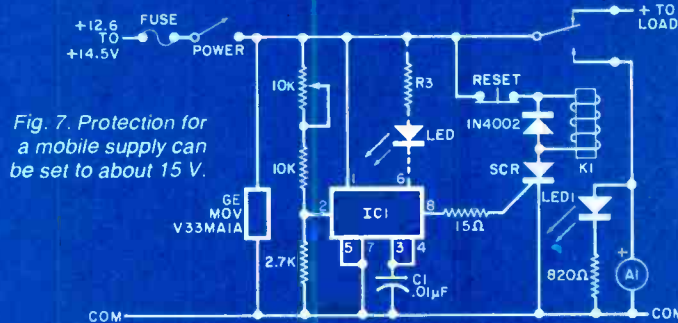

Fig. 7. Protection for a mobile supply can be set to about 15 V.

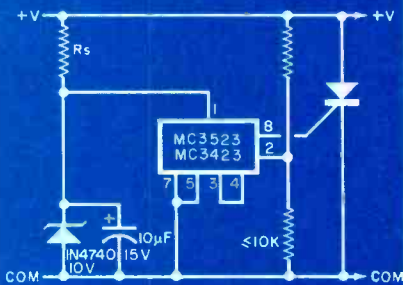
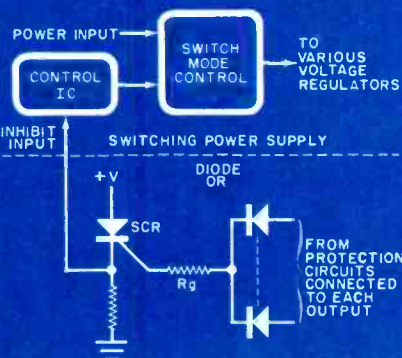

Fig. 9. Outputs from various protection circuits can be ORed to control the IC.



the load and activate the alarm.

Since mobile systems tend to have more voltage transients than power-line systems, if a number of false alarms are encountered (system shutting down often), the value of CI must be increased. However, excessive tripping may indicate that the vehicle electrical system needs cleaning up. Sparking brushes in alternators, windshield wipers, bilge pumps, blower motors, etc. can be the main culprits.

The optional GE MOV varistor transient protector for 15 V will catch most transients, while the MC3423 circuit will catch the rest. The normally closed RESET switch is used to reset the SCR after trip (if the fuse does not blow) and should not be held open for any reason, otherwise the damaging voltage can get to the load.

If you want to have only a transient monitor, remove the circuit coming from pin 8. Internally, IC1 has an uncommitted npn transistor collector tied to pin 6; and, when IC1 trips, this transistor turns on. You can connect a LED and current-limiting resistor (shown dotted in Fig. 7) to this pin.

For voltages higher than 36 V, Motorola recommends the following SCRs: for 50 V—2N6504; 100 V—2N6505; 200 V—2N6506; 400 V—2N6507; 600 V—2N6508; and 800 V—2N6509. Either an MC3523 or MC3423 can be used for IC1, if it is powered from a zener-regulated 10-V source (Fig. 8).

**Switching Supplies.** The protection circuit can also be used with pulse-width modulated switching power supplies. Most of these are provided with an inhibit input that shuts the supply down when a high is applied.

A protection circuit, such as those shown here, can be connected to each dc output of a switching supply. Each output from the various protection circuits can be applied to a diode-OR circuit, such as that shown in Fig. 9, with the OR driving an SCR gate. When the SCR triggers on, the voltage developed across its load resistor is applied to the inhibit input of the control chip of the switching supply, thus shutting it down. ◇

# IN THIS CORNER...

*The battle for supremacy among very-low-cost microcomputers heats up as Texas Instruments' 99/2 goes head to head with the Timex Sinclair 1000; and the TS2000 and Mattel's Aquarius square off against the Commodore VIC-20 and the TI 99/4A*



TEXAS INSTRUMENTS BASIC COMPUTER 99/2

*By Joe Desposito*

The microcomputer world, much like the boxing world, has champs and contenders at all different levels. Lately there has been fierce competition at the low end of the microcomputer spectrum with current champs such as the Timex Sinclair 1000, Commodore VIC-20, and Texas Instruments 99/4A facing stern competition from a host of new challengers. Very-low-cost micros can be conveniently classed into two groups: those that cost less than \$100 (we'll call them featherweights) and those that cost between \$100 and \$200 (we'll call them lightweights). Let's review the champs of each of these divisions here and take a close, hard look at the new contenders.

*(Continued overleaf)*

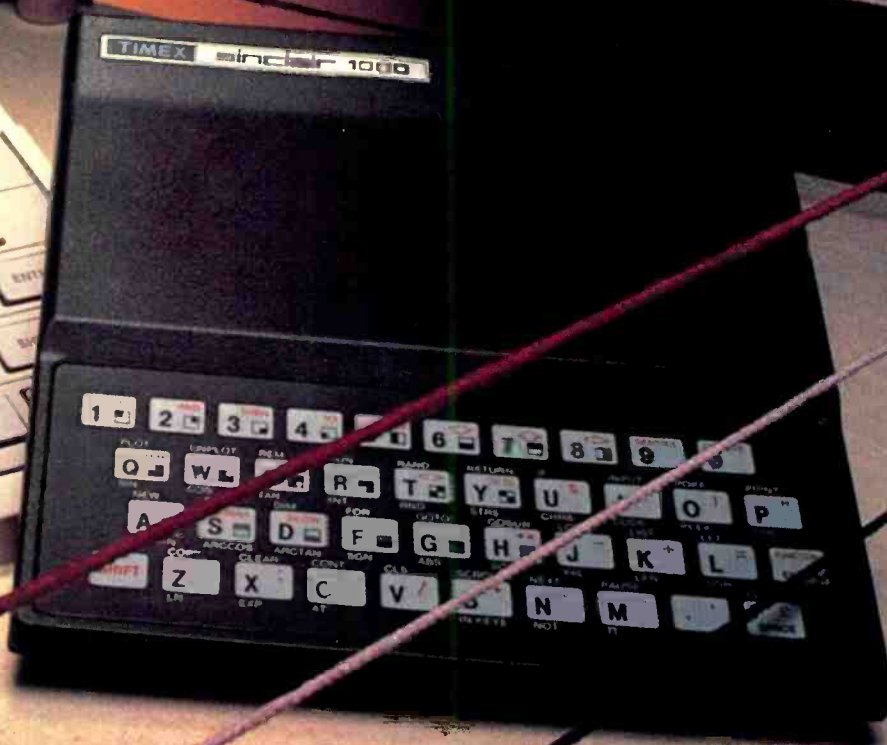

## Featherweight

**T**HE clash for the microcomputer "featherweight" crown promises to provide as much excitement as a title bout at Caesar's Palace. The reigning champ, trained in Britain for more than a year before arriving in the States, is the Timex Sinclair 1000 (formerly competing as the ZX81). Although it has some drawbacks, this scrappy performer is the undisputed champ of its division. And undisputed is not used lightly here. Until recently there has not been one challenger in the featherweight (under \$100) class.

But a formidable challenger has arrived. Known in some circles as the "Great White Hope" because of its cream-colored appearance, the 99/2 from Texas Instruments seems to have everything it takes to dethrone the current champ. It is bigger, faster, classier looking, and (thank goodness) has a keyboard with movable keys. These obvious strengths, however, do not guarantee success. Sometimes it takes more than impressive stats to become a champ. Sometimes intangibles like guts or heart make the champion (witness Rocky Balboa's comeback win over Clubber Lang).

What are the intangibles the older TS1000 has going for it? First off, this computer is an open book—for a long time it could be bought as a kit under its former name. With so many fans knowing the ins and outs

HEX-BUS peripherals  
for the  
Texas Instruments 99/2.



of its makeup, the wealth of support it receives from outside suppliers is not surprising. Peripherals available for use with it include such devices as printers, memory expansion modules, and modems. Keyboards for the TS1000 are being sold to correct its major deficiency, the membrane keyboard. Thousands of business programs, educational programs, and games have been written for the TS1000. Even additional languages such as Forth and Assembler are available through third-party vendors. This humble number cruncher even has a magazine named *Sync* devoted to it. Another point in the TS1000's favor is that it has been the champion for a long time. People are used to it, they love it. On top of all this, it has a secret weapon in its arsenal (which we'll reveal later on in this article).

But enough about the champ, what about the challenger, the TI 99/2? As we said before, this newcomer is impressive looking. It's substantially bigger than the

TS1000, measuring in at 10" × 9½" × 1½".

Its elastomeric keyboard sports 48 pushbutton-type keys in a standard typewriter format. Listed above the keyboard are nine functions. To engage one, the FCTN (function) key plus a key on the top row just below the desired function label must be pressed.

The 99/2 only uses upper-case letters and each key has no more than two legends (whereas the TS1000 uses up to five legends on one key). There is a built-in r-f modulator so that the 99/2 can be hooked right to the TV.

The basic unit comes with 4.2K of user RAM. This can be expanded to 36.2K by plugging in extra RAM housed in "cradles" that hold the RAM chips and permit additional cartridges to "piggy-back" on the RAM cradle. The operating system and program are contained in 32K of ROM, of which 24K is in the permanent memory map. The remaining 8K bytes are bank switched to preserve a 32K-byte expansion port capability.

As with most other TI computers, the microprocessor is part of the 9900 family. It's the 16-bit TMS9995 that has a 10.7-MHz clock—mighty fast for this class—and DMA (direct memory access) video processing. The 99/2 has a flicker-free black-and-white display of 27 characters by 24 lines (whereas the TS1000 still flickers in the slow mode). The 99/2 is designed with an operating system that is a subset of TI-BASIC but the system does not support GROMs (Graphics Read Only Memory) or GROM programming language, joysticks, color, sound, or speech (as the

Timex Sinclair 2040 printer works with either TS1000 or TS2000.





## FEATHERWEIGHTS AT A GLANCE

	Timex Sinclair 1000	Texas Instruments 99/2
Microprocessor	Z80A (3.5 MHz, 8 bits)	TMS 9995 (10.7 MHz, 16 bits)
Resident language	Sinclair BASIC	TI BASIC subset
Memory: ROM	8K	32K
RAM (Std)	2K	4.2K
RAM (Exp)	64K	36.2K
Text display	32 char. × 24 lines	28 char. × 24 lines
Keyboard	40 keys (membrane)	48 keys (elastomeric, movable)
Dimensions	6½" × 6" × 1½"	10" × 9¼" × 1¼"
Weight	12 oz	33 oz

99/4A does). You may have guessed by now that any program written for the 99/2 is compatible with its big brother, the popular 99/4A. However, this is only a one-way street as software for the big guy won't return the favor.

At the rear of the 99/2 is a port that will accept solid-state software cartridges (not compatible with the 99/4A). But so far there's very little in the way of this kind of support. This port does have a great deal of significance, however. It is the spot where the real power of this featherweight will be displayed.

The 99/2 has a team available for the expansion port that is ultra-sophisticated. This team, known as the HEX-BUS peripherals, will surely be the envy of anyone who owns a computer in this class. Let's take a closer look at this HEX-BUS group, as it may be the key factor in establishing the 99/2 as king of the featherweight class.

First there is the Wafertape™ Drive. Of course, the 99/2 can save to a standard cassette recorder, but the Wafertape adds finesse to the operation. This digital tape drive unit uses continuous-loop tape cartridges that store up to 48K. An ordinary cassette recorder cannot move the tape back and forth and, therefore, it is difficult to use this type of recorder for a true computer-file system. The Wafertape, using a continuous loop, can employ a real tape file system with all the programs on the tape listed in a directory. The tape can then be moved to locate any of the named program files. The tape must first be initialized just like a diskette, so the Wafertape system can be thought of as a "stringy floppy." This system is somewhat slower than a floppy disk, but it is much better than the

ordinary cassette tape system used in most home computers. A 4K-byte program can be loaded fast—about 10 seconds.

Another power-packed peripheral is a four-color printer/plotter. Ten different type sizes are available, with print speeds up to 11 characters per second. Printing is done on 2¼" paper in either red, blue, green or black.

An RS232 communications interface rounds out the HEX-BUS group. With this handy peripheral, you can interface the 99/2 to an 80-column printer. It also allows you to hook up a modem for communications with real heavyweight computers like those used by CompuServe.

In all fairness we must mention that HEX-BUS support doesn't come cheap. Suggested retail prices for the peripherals are: Wafertape, \$139.95; Printer/Plotter, \$199.95; and RS232 interface, \$99.95 (with parallel interface option, \$124.95). But still, the support is there if desired.

What's our opinion of the challenger's chances? At first glance, the 99/2 is certainly impressive. But will it suffer the same fate as the 99/4A, which gets software and hardware support almost exclusively from the parent company? (No cottage industry has blossomed here.) It took many years and many price reductions before the 99/4A was embraced by the general public. Will anyone try to take the 99/2 apart and have some fun with it? A polished featherweight can tarnish quickly waiting in the locker room (inside the locker?) for something exciting to do.

Another factor that has to be considered is the current champ's secret weapon. What is it? The

TS1000 has the awesome power to shed price almost at will. At the beginning of 1983, a \$15 rebate was announced, evidence enough of this raw power. But then in mid-March, the champ plummeted from \$99.95 to \$69.95, and kept the rebate going, too. What all this means is that the champ may eventually establish a new class—a "flyweight" division at less than \$50. Can TI's 99/2 meet this challenge? Our guess is that the 99/2 has enough class to make a strong showing, but not enough to dethrone the champ. But this will also be influenced by promotional money behind it.

## Lightweight

THE "lightweight" division (between \$100 and \$200) had just two brawlers during 1982, the Commodore VIC-20 and Texas Instruments 99/4A. The Commodore VIC-20 is a true champion that offers a real moving-key keyboard, excellent memory-expansion capability, a host of low-cost peripherals, and a vast library of programs on cartridges, tapes, and disks. The VIC-20's price has shrunk to less than \$140 in some stores, a value that is hard to beat. Last year the Commodore management wanted to replace VIC with a new entry in its stable named MAX. However, the public would not stand for it; and now it is learned that MAX will only appear in Far East events.

The 99/4A from Texas Instruments originally sold for more than \$1000. The machine has been improved, and the price lowered to less than \$150 by eliminating the color monitor and utilizing mass production. The 99/4A offers an upward expansion path to a full disk system and a vast library of cartridges containing programs and additional memory.

It had been hoped that the VIC-20 and TI 99/4A would battle it out so that we would have a clear champion. Now there are two major newcomers to the class that promise to give the leaders a real run for the money. On one hand, we have the Timex Sinclair 2000 (called Spectrum in Europe), a British challenger, kin to the TS1000 (featherweight

...IN THIS CORNER

champ). As was the case with its predecessor, the TS2000 has spent over a year training in England for its American debut. On the other hand, we have a homegrown product out of Hawthorne, California, with the jazzy moniker, Aquarius™. It arrives on the scene as a virtual unknown to the microcomputer fraternity, but is backed by the powerful Mattel Electronics family. Both entrants are highly regarded and appear genuine threats to ascend to division supremacy. Let's examine each one's qualifications.

**Timex Sinclair 2000.** Like Ingemar Johanssen, the Swede with the knockout right, the TS2000 arrives on these shores packing "thunder and lightning" in the form of a 48K RAM memory standard for the \$199.95 suggested list price. This is at least 32K more than other computers in this class offer in their standard package. This is just the beginning of a set of statistics so impressive that you'll think this computer is a ringer for sure.

Talk about color and it's there. Blue, red, magenta, green, cyan, yellow, white, and black are available for foreground, background, and border areas at the press of a single key. Talk about sound and you've got that, too. An internal loudspeaker can emit 130 semitones (10 octaves) using a BEEP command. Since pitch and duration can be varied, selections such as "Rocky's Theme" can be composed at the keyboard. You can even run the sound to an external amplifier/

speaker from jacks at the rear of the unit.

The machine is compact, measuring 9½" × 5½" × 1¼". This is attributable to the TS2000's elegant 14-chip design. Besides the 48K RAM, there is a 16K ROM that contains the operating system and a BASIC interpreter. The extended BASIC has a unique syntax check-and-report feature that identifies mistakes instantly. The heart of the TS2000 is the Z80A microprocessor running at 3.5 MHz.

The keyboard features 40 rubber pushbutton keys in a standard typewriter format. But you'll need some fancy footwork (fingerwork?) to hit all the options available here. Each key provides at least five functions, while six keys provide six each. All BASIC keywords can be entered with a single keystroke; and, in addition, there are 16 graphics characters, 22 color control codes, and 21 user-definable graphics characters. Both upper- and lower-case letters are supported, and all keys feature auto repeat. A close look at this intricate keyboard will give the ringsider an indication of the championship quality of this computer.

The TS2000 has a memory-mapped video display of 256 × 192 pixels, giving quality high-resolution graphics. The text display is 24 lines of 32 characters. Both can be freely mixed on the screen. Graphics commands such as point, line, and circle are available at the touch of a key. Editing functions such as cursor left, cursor right, insert, and delete are available for the program line currently being edited. This line(s) normally resides at the bottom two lines of the 24-line display.

Timex Sinclair 2000



Commodore VIC-20



The unit has a built-in r-f modulator and cassette interface. The cassette interface, which runs at 1500 baud, can load or save 48K of memory in less than two minutes. All information saved to tape is started with a header containing information as to its type, title, length, and address information. Programs, screens, blocks of memory, and string and character arrays can all be saved separately, as well as verified if desired. Programs and arrays

LIGHTWEIGHTS AT A GLANCE

	Commodore VIC-20	Texas Instruments 99/4A	Timex Sinclair 2000	Mattel Aquarius
Microprocessor	6502A (2 MHz, 8 bit)	TMS 9900 (3 MHz, 16 bit)	Z80A (3.5 MHz, 8 bits)	Z80A (3.5 MHz, 8 bits)
Resident language	Microsoft BASIC	T1 BASIC	Sinclair Extended BASIC	Microsoft BASIC
Memory: ROM	20K	26K	16K	8K
RAM (Std)	5K	16K	48K	4K
RAM (Exp)	32K	48K	48K	52K
Display: Text	22 char. × 23 lines	32 char. × 24 lines	32 char. × 24 lines	40 char. × 24 lines
HiRes Graphics	176 × 184 pixels	192 × 256 pixels	192 × 256 pixels	192 × 320 pixels
Keyboard	66 keys (typewriter quality)	48 keys (typewriter quality)	40 keys (movable)	49 keys (movable)
Colors	16	16	8	16
Sound	4 voices	3 voices & 1 sp. eff.	1 voice	1 voice
Dimensions	15¾" × 8" × 2¾"	15" × 10½" × 2¼"	9½" × 5½" × 1¼"	13" × 6" × 2"
Weight	72 oz	78 oz	20 oz	68 oz

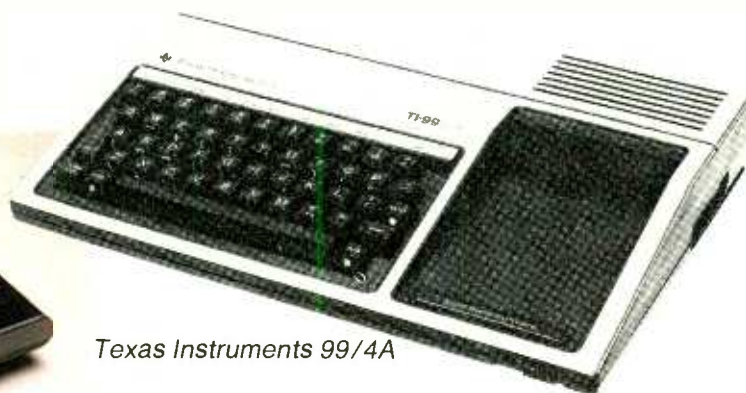

Texas Instruments 99/4A



Mattel Aquarius

can be merged from tape with existing contents of memory, but if line numbers or variable names are repeated, the one in memory is overwritten.

There is an expansion port at the rear of the TS2000 that has the full data, address and control busses from the Z80A. Solid-state software cartridges plug right into this port. The port is also used for plug-in peripherals such as the Timex-Sinclair 2040, a 32-column dot-matrix printer for \$99.95. IN and OUT commands give the I/O port equivalents of PEEK and POKE.

To help fans become better acquainted with the TS2000, a comprehensive step-by-step instruction manual is included. It is divided into two parts. The first part contains complete instructions on setting up and using the computer, and includes a fundamental course in BASIC programming. The second part includes an advanced programming guide for experienced users to develop custom applications.

Sinclair is committed to the intro-

duction of a ZX Expansion Module that will direct and control its new microdisk drive. This module will permit TS2000 computers to communicate with each other and to interface with many commercial printers. In addition, it will permit the connection of a modem for communication over the telephone line. The microdisk itself will store 100K bytes per disk and the TS2000 will support up to eight drives. These peripherals will be offered in the U.K. in the spring of 1983 and they should be available from Timex in the U.S. shortly after that time. The introduction of a disk system and the expansion module will greatly enhance the position of the TS2000 in its fight to the top.

**Mattel Aquarius.** This contender for honors in the lightweight division appears to be just a 98-pound weakling at first glance. It is a modest (13" × 6" × 2") unit with an unassuming keyboard. A total of 49 light-blue, pushbutton keys with one letter per key makes one won-

der whether this is a computer or a Tom Thumb typewriter. But beware the feint and jab, and the old peek-a-boo. With one or another overlay, the keyboard is immediately transformed to match a particular computing need.

If you're programming, keywords are indicated for one-stroke entry. If you're playing a game, up and down, right and left indicators are shown. If you're running a word-processing program, commands such as insert and delete make the task a snap. What we really have, then, is a keyboard that is simple yet powerful. Granted, the keys are not the classiest, but first-time users will not be intimidated either.

The standard Aquarius comes with 4K RAM, expandable to 52K, and 8K ROM that includes Microsoft™ BASIC. The system can be expanded to use plug-in-memory cartridges, expansion devices, and a whole line of compatible peripherals. CP/M® is available when the system is expanded enough to support it.

Aquarius offers a 320 × 192 high-resolution graphics display and a 40 character × 24 line text display. There are 256 total characters, which include the complete ASCII set with upper- and lowercase letters, numbers, and graphics symbols. Sixteen colors are available. A built-in r-f modulator is standard, as well as an RS232 port. Sound can be generated, but only through the speaker on a television receiver.

The real strength of this contender lies in the meaningful software support that Mattel has provided. Three programs, Aquarius LOGO, Fileform, and Finform offer sophisticated software at a reasonable price. LOGO is a popular graphics-oriented language that helps develop problem-solving skills. (LOGO is available on the TI 99/4A, too, but costs several hundred dollars to implement.)

Fileform is a combination file management and word-processing program. The file management features enable you to store and retrieve information such as addresses, phone numbers, correspondence, etc. Word-processing fea-

tures enable you to insert, delete, move blocks of copy, etc.

Finform is the Aquarius version of a spreadsheet program. It has a capacity of 63 columns and 255 rows, and can perform the usual "what if?" operations. Just change a value in one of its cells and the program recalculates all values instantly.

Mattel Electronics has provided an ingenious multi-step system for expanding the Aquarius. First you can plug memory modules of either 4K or 16K capacity directly into the cartridge slot on the computer. Though increasing memory capacity, it does not let you run software cartridges because the cartridge slot is filled. To get around this problem, Mattel has provided the Mini Expander Module. This peripheral has two slots, one for either a 4K or 16K memory module and the other for a software cartridge. In addition, the Mini Expander has two detachable game controllers with six pushbuttons and a 16-position control disk such as that used on the Mattel Intellivision. The Mini Expander also provides three full sound channels for audio effects.

The third level of Aquarius expansion is the Master Expansion Module. This has provisions for 16K memory boards and a disk controller that operates two floppy disk drives. When the Aquarius is fully expanded, it can use CP/M; and the conversion from a starter system to a powerful personal computer is complete.

Mattel Electronics has also provided a cassette Data Recorder unit and a dot matrix printer that will print anything that appears on the screen, including graphics. This is a non-impact printer and requires thermal paper. It prints up to 40 columns and includes upper/lower-case characters and all the Aquarius graphics characters.

Unfortunately, game cartridges for Mattel's Intellivision are not compatible with Aquarius, although a selection of video games is available for the computer.

There are two manuals that come with Aquarius. One is a standard

manual that describes the system and how to use it. The other is meant to get a person into programming immediately. Each page is like a flash card, with simple instructions to perform a specific action. A particular card may give a short program to display various colors on the screen. The goal here is to make a novice's transition into computing as painless as possible.

**Our Opinion.** Each of the two new entrants to the microcomputer lightweight division (between \$100 and \$200) has a unique style. The Timex Sinclair 2000 offers raw power, and indeed looks like a monster

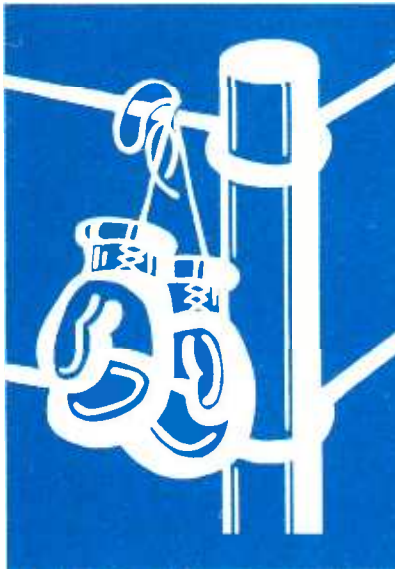

entry to us. If the computer had a professional keyboard, there would be no doubt that it would sweep the division with ease. Even so, we predict that this computer shows enough to send it skyrocketing to the top of the division within a year. In this case, it's likely that the Commodore VIC 20 and the TI 99/4A will go into the sweatbox and lower their prices enough to qualify for the under \$100 featherweight division. After all, the big bucks are in the peripherals and software.

The Aquarius offers simplicity rather than power although the system can be expanded and good software is available. But overall we think that the Aquarius strategy of strength through simplicity will not be enough to make it the dominant micro in this division, though such a good contender will likely gather a significant following.

**Up and Coming.** What's on the horizon in the featherweight and lightweight divisions? There are two novices that have been training well and are expected to take a shot at the big time this year. One is the PHC 20 Personal Computer, a \$99.95 model from Sanyo that was introduced at a recent industry show. But the backers of this Japanese performer have been somewhat secretive since the show, so we'll have to wait and see what develops.

Another interesting candidate is the Humdinger color computer (Venture Micro, Inc., 10090 N. Blaney Ave. Suite #6, Cupertino, CA 95014). With a suggested retail of \$129.95 and impressive stats, too, this exciting youngster was the hit of the 1983 West Coast Computer Faire. The Humdinger, although talent laden, will need to find a well-heeled backer to handle promotions before it can be considered a serious threat in the pro ranks.

There are other computers around that fit into the price classes suggested here, but for one reason or another have not been considered. First, there are the pocket computers from Sharp Electronics and Radio Shack. The new Sharp 1250, nicknamed the "Student Computer," and the Radio Shack PC-4 have suggested retail prices of \$110 and \$69.95, respectively. These models offer increased portability at the cost of decreased expandability and are not really in the same class as the models that were described here.

A second set of opponents at the low end of the personal computer spectrum are the "tag team" models. These are the micros that consist of a keyboard connected to a video game such as the Atari 2600 or Mattel Intellelevision. Although the expansion unit falls into the price range of the micros discussed here, the total cost of the package is usually above \$200.

This wraps up our report on the micros battling for supremacy in the low end of the personal computer market. It's obvious that the divisions we've covered here are very competitive and will provide much excitement as each entrant follows Rocky's advice to "go for it" in coming months. ◇

# FRANKLIN



Call on FRANKLIN Computers. Disk Drives, Software and System Specials!

## MICRO-SCI

### DISK DRIVES FOR APPLE & FRANKLIN

A2	\$269.00
A40	\$349.00
A70	\$459.00
C2 Controller	\$79.00
C47 Controller	\$89.00

## VISICORP

for Apple, IBM & Franklin

Visidex	\$189.00
Visifile	\$189.00
Visiplot	\$159.00
Visiterm	\$89.00
Visitrend/Plot	\$229.00
VisiSchedule	\$229.00
Desktop Plan	\$189.00
Visicalc (Apple, CBM, IBM)	\$179.00

Visicorp prices for IBM may vary slightly.

## CONTINENTAL

Tax Advantage (Apple, Atari)	\$45.00
Home Acct. (Apple, Atari)	\$59.00
1st Class Mail/Form Letter (Ap)	\$79.00
The Book of Apple	\$14.95
The Book of Apple Graphics	\$14.95
The Book of Atari	\$14.95

## FLOPPY DISKS

### MAXELL

MD I (Box of 10)	\$32.00
MD II (Box of 10)	\$44.00
FD I (8")	\$40.00
FD II (8" DD)	\$50.00

### VERBATUM

5 1/4" SS DD	\$26.00
5 1/4" DS DD	\$36.00

### ELEPHANT

5 1/4" SS SD	\$19.99
5 1/4" SS DD	\$24.99
5 1/4" DS DD	\$29.99

## HEWLETT PACKARD



41CV

\$209.



## HP75... \$749.00

HP 41C (Free Memory Mod.)	\$149.00
HP 10C	\$59.00
HP 11C	\$72.00
HP 12C	\$99.00
HP 15C	\$99.00
HP 16C	\$99.00

810 Disk Drive	\$429.00
Visicalc	\$159.00
Inhome Keyboard (400)	\$89.00
1010 Recorder	74.00
1020 Color Printer/Plotter	\$269.00
1025 80 Column Printer	\$469.00
1027 Letter Quality Printer	\$299.00
1050 Double Density Drive	\$379.00
830 Modem	\$159.00
850 Interface	\$169.00
One Year Extended Warranty	\$70.00
CX40 Joysticks (pair)	\$18.00
CX418 Home Manager Kit	\$69.00
CX419 Bookkeeper Kit	\$195.00
CX482 Educator Kit	\$129.00
CX483 Programmer Kit	\$54.00
CX488 Communicator Kit	\$229.00
CX7101 Entertainer Kit	\$69.00

## TIMEX SINCLAIR 1000

Call for information on TIMEX REBATE!



\$64.95

16K Memory Module	\$44.95
Vu-Calc	\$17.95
Check Book Manager	\$13.95
The Organizer	\$14.95
The Budgeter	\$13.95
Stock Option	\$14.95
Loan & Mortgage Amortizer	\$12.95
Mindware Printer	\$109.00

## ORBYTE SOFTWARE

Graphics	\$12.99
Home Budgeter	\$12.99
Home Inventory	\$12.99
Income Tax	\$14.99
Mega Mind	\$15.99
Salvo	\$12.99
The Quiz	\$12.99
Words	\$12.99

## PC-1500 POCKET COMPUTER



\$169.

PC-1250...	\$89.00
PC 150 Printer Plotter and Cass. Interface Unit	\$172.00
PC 152 Cass. Recorder	\$62.00
CE 155 8K Ram Exp. Mod.	\$40.00
CE 125 Print/Micro Cass.	\$129.00

No risk, no deposit on C.O.D. orders. Pre-paid orders receive free shipping within the UPS Continental United States with no waiting period for certified checks or money orders. Add 3% (minimum \$3.00) shipping and handling on all C.O.D. orders and credit card orders. Larger shipments may require additional charges. NV and PA residents add sales tax. All items subject to availability and price change. NOTE: We stock manufacturer's and third party software for most all computers on the market. Call today for our new catalog.



800™ 48K

\$489.

ATARI 1200... CALL

ATARI 600 .. \$199.

## PERCOM

### DISK DRIVES FOR ATARI

AT88-S1	\$399.00
AT88-A1	\$299.00
AT88-S2	\$649.00
RFD40-S1	\$549.00
RFD40-A1	\$349.00
RFD40-S2	\$889.00
RFD44-S1	\$679.00
RFD44-S2	\$999.00

## MONITORS

### AMOEK

300G	\$159.00
300A	\$169.00
310G	\$179.00
310A	\$169.00
Color I	\$299.00
Color II	\$599.00
Color IIIA	\$799.00
Color III	\$349.00

### BMC

12 AU 12" Green	\$79.99
1401 13" Color (Mid-Res)	\$369.00
9191U 13" Color Composite	\$329.00

### TAXAN

RGBI (Hi-Res)	\$299.00
RGBII	\$499.00
12N Green	\$119.00
12A Amber	\$125.00

### ZENITH

13" Color TV	\$269.00
19" Color TV	\$339.00

### U.S.I.

Pi 1, 9" Green	\$99.00
Pi 2, 12" Green	\$119.00
Pi 3, 12" Amber	\$159.00
Pi 4, 9" Amber	\$139.00
1400C 14" Color	\$299.00

## commodore

VIC20

\$139.



CBM 64

\$399.



400

16K..... \$149.\*

32K..... \$224.\*

48K..... \$249.\*

64K..... \$299.\*

\*Prices reflect \$50.00 rebate from ATARI!  
\*Non-Atari Ram

## MODEMS

### HAYES

Smart	\$219.00
Smart 1200 (1200 Baud)	\$549.00
Chronograph	\$199.00
Micromodem 100	\$309.00
Micromodem II	\$279.00
Micromodem II (with Term)	\$299.00

### NOVATION

J-Cat	\$119.00
Cat	\$144.00
D-Cat	\$159.00
103 Smart Cat	\$189.00
Apple Cat II	\$279.00
103/212 Smart Cat	\$439.00
212 Apple Cat II	\$609.00
Apple Cat II 212 Upgrade	\$309.00

### ANCHOR

Mark I (RS232)	\$79.00
Mark II (Atari)	\$79.00
Mark III (T.I. 99)	\$109.00
Mark IV (CBM-PRT)	\$125.00
Mark V (Osborne)	\$95.00
Mark VI (IBM-PC)	\$179.00
Mark VII (Auto Answer Call)	\$119.00
TRS-80 Color Computer	\$99.00
9 Volt Power Supply	\$9.00
Mark VIII	CALL

1520 Color Printer/Plotter	\$169.00
1525 80 Column Printer	\$339.00
1530 Datasette	\$69.00
1541 Single Disk Drive	\$339.00
1600 VIC Modem	\$95.00
1610 VIC Term 40	\$49.00
1650 AD/AA Modem	\$159.00
1701 14" Color Monitor	\$269.00
1311 Joysticks (each)	\$6.99
1312 Paddles	\$11.99
1110 VIC 8K	\$42.00
1111 VIC 16K	\$69.00
1011 RS232 Interface	\$42.00
1211 Super Expander	\$53.00
1906 Super Alien	\$23.00
1910 Radar Rat Race	\$23.00
1917 Voo Doo Castle	\$29.00
*922 Cosmic Cruncher	\$35.00
1923 Golf	\$29.00
1924 Omega Race	\$30.00
1*OVIC 20 Reference Guide	\$15.00
CBM 64 Reference Guide	\$18.00

east computer mail order west

800-233-8950

Dept.607, In PA Call (717)327-9575

477 E. Third St., Williamsport, PA 17701



800-648-3311

Dept.607, In NV Call (702)588-5654

P.O. Box 6689, Stateline, NV 89449

# The Ingenious SWITCHABLE TEST SOCKET

Decreases IC circuit design and debugging time

By Nathan Moskowitz

**T**HE Switchable Test Socket, details of which are shown in the drawing, can help cut down time spent in designing, debugging, and troubleshooting circuits using ICs and/or component carriers. A simple but ingenious device, the STS can be used to isolate or monitor a signal at any selected IC or carrier pin and provide a convenient means for selectively injecting test signals. There's no need to flip over the board or cut circuit traces to perform these operations with the STS.

As shown in the drawing, the STS consists of a 14- or 16-pin Wire Wrap DIP (dual in-line package) socket to the pins of which are soldered in series 7- or 8-section DIP switches. The free pins of the DIP switches, in turn, connect to a 14- or 16-pin solder socket.

To use the STS, you simply unplug the IC or component carrier

from its socket, install the STS in the vacated socket, and plug the removed device—properly oriented—back into the circuit via the Wire Wrap socket atop the STS. With the STS installed, you can switch in and out device pins as desired, using the DIP switches. Additionally, the long, rigid bare-metal leads of the Wire Wrap socket permit easy connection of meter, logic-probe, and oscilloscope test leads for voltage and signal monitoring, or the probes of a signal generator or other signal-injection instrument for performing operating tests.

**Fabrication.** Using the drawing as a guide, tin about  $\frac{1}{8}$ " of the free ends of the Wire Wrap socket leads with solder. Next, bend the pins of two DIP switches so that they project away from the sides of the cases at a 90° angle and tin about

$\frac{1}{16}$ " of the free ends of each pin. Use heat judiciously when tinning and soldering pins on the DIP switches to avoid damaging their potting compounds.

Gently clamp the Wire Wrap socket in a vise or other clamp/support device, arranging it so that its leads are accessible. Making sure of proper orientation, carefully solder one row of DIP-switch pins to one row of the Wrap socket leads, using only enough heat and solder to assure good electrical and mechanical joints. Solder first one end pin and then the other, squaring the assembly for neatness, and finish up with the remaining pins. Then file smooth each soldered connection. Repeat this procedure for the second DIP switch and remaining Wire Wrap socket leads.

After soldering both DIP switches to the Wire Wrap socket, insert the free pins of the switches into a 14- or 16-pin (depending on configuration of socket and DIP switches) solder socket.

**In Closing.** If you routinely design or work with circuits in which many 14- and 16-pin ICs or component carriers are used, you might want to have two or more Switchable Test Sockets available. By installing them in several critical locations in a circuit, the STSs will further reduce design, debugging, and troubleshooting time by permitting you to connect several instruments simultaneously. Using a multi-channel scope, for example, you can compare the timing waveforms at selected points in a digital circuit or observe the levels of amplification obtained at various points in an analog circuit with a given input signal level.  $\diamond$

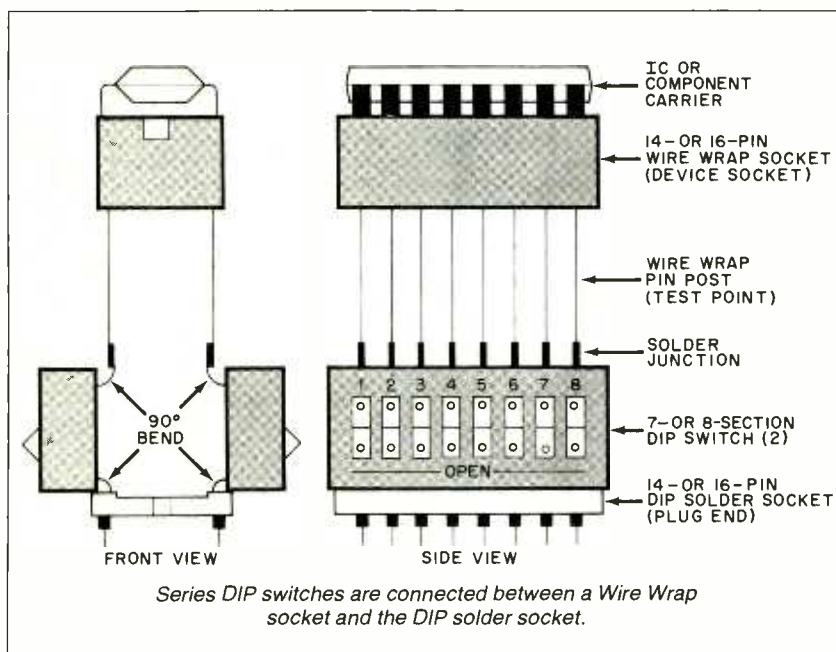

# Off and Running with THE KAYPRO II

**T**HE INTRODUCTION of the Osborne I Portable Computer opened a door on a new generation of portable machines. The Kaypro II is one of this new breed—right down to the originator's selling price (\$1795) and the inclusion of a spate of software that costs more separately than the computer itself.

The biggest difference between the Osborne and the Kaypro II is that the latter features a 9"-diagonal CRT, and the Osborne's is 5". Also,

the Kaypro has a pair of dual-density disk drives while the Osborne uses dual, single-density drives, with double-density available as an option for an additional \$200. Dimensions are similar, but the Kaypro, at 26 lb, is 2 lb heavier.

Like the Osborne, the Kaypro II is a general-purpose computer for business and personal applications using CP/M, and both are somewhat like two-suiter cases (when closed) for easy travel.

**Description.** The Kaypro II Portable Computer is made by Non-Linear Systems and comes in a protective gray-painted metal enclosure (the Osborne is plastic) that measures 18" W × 8" H × 15½" D. The Kaypro has a more squared-off shape than the Osborne, permitting it to stand more evenly on the floor. The end opposite the carrying handle is detachable and contains the keyboard. The line cord is wrapped around four corner lugs and is not



*An integrated carrying case, all-in-one design with 9" screen, dual-density drives, 64K memory, bundled software, and a modest price are hallmarks of this new portable/desktop microcomputer*

Photo: Ed Gallucci

concealed as it is on the Osborne. When detached, the keyboard is connected to the computer through a plug-in telephone-type coiled cable. For travelling overseas, the Kaypro can be set to operate from 220 V ac.

The keyboard consists of 62 sculptured keys, including four "arrow" keys for controlling the position of the cursor. To the right of the QWERTY keyboard is a 14-key numeric cluster that includes its own ENTER key. With the exception of the control keys, all others, including the cursor controls, have an auto-repeat function. The keys have an excellent "feel" and a slight electronic "tick" from an internal transducer lets you know when a key is activated. A red LED under the key indicates when the CAPS LOCK key has been activated. The keyboard is a wedge-shaped platform with the front side 1" high and the rear 3" high.

The manual suggests that the computer can be arranged with the main enclosure's front rubber feet resting on the top rear edge of the keyboard. This makes the unit look like a conventional video terminal. Of course, the keyboard and computer can be separated the distance of the coiled connector cable.

On the front panel, the major difference between the Osborne and the Kaypro II is the layout. The Osborne has each disk drive mounted horizontally, one on each side of the CRT, with a "sleeve" for diskette storage below each drive, while the Kaypro has both disk drives mounted as a vertical pair on one side of the enclosure to the right of the CRT.

The Kaypro uses a Z80A CPU and has 64K bytes of user memory. The display has a green phosphor

screen and is 80 columns by 24 rows, with both upper- and lower-case characters.

Data storage is provided by a pair of double-density 5¼" floppy disk drives. These have a capacity of 195K bytes each (compared with the 92K-byte single- or 184K-byte double-density disk drives on the Osborne for an additional \$200). The Kaypro can also use the Xerox 820 single-density disk format. This is important because there is much software of this type available. The memory map of the system shows two banks. One is 64K of RAM forming the usual CP/M setup, with the second bank forming the video display RAM and the system PROM. Only the lowest 16K of memory will change with the bank-select bit. Addresses above 3FFF (hex) are always available for either bank.

In use, the software on the Xerox 820 format disk is transferred to a Kaypro II diskette, which can hold the contents of several Xerox 820 single-density disks. (It should be noted that the Kaypro II is not compatible with the Xerox 820 II.)

The Kaypro II has two I/O connectors on the rear panel. One is a Centronics-type parallel connector for output to a parallel printer. The

other is a standard DB25 for connection to serial devices. The Kaypro II serial port is an RS232C configured as Data Terminal Equipment (DTE) so it can be directly connected to a modem via an unmodified RS232C cable. The instruction manual details the CP/M instructions to configure the serial I/O. Actually, the Kaypro II has six I/O port addresses: port 0 sets the RS232 baud rate; port 4 is the actual RS232 serial port; port 5 carries the 8-bit data from the keyboard; port 6 is the RS232 status (control and status for the Z80 PIO); port 8 is the 8-bit parallel printer port; while port 1CH is the R/W system port for system control. (The various bits are used for memory bank selection, disk drive control, and printer handshaking.) Unlike the Osborne, the Kaypro II does not have an IEEE-488 connector, nor does it have provisions for battery operation.

The 1920 characters that can be displayed on-screen include standard ASCII plus some extra characters, all mapped on a 5 × 7 display cell. Unlike the Osborne, whose 5" CRT can only display a "window" of 24 rows of 52 characters out of a generated 32 lines of 128 characters, the Kaypro II can display all of its





1920 characters at one time. A front-panel BRIGHTNESS control is provided to adjust the display as desired, while the 25-MHz video monitor bandwidth enhances viewing of the display. Although the computer has 64K of RAM, a bank separate from the user-RAM area has the 2K system ROM and the 2K video display RAM.

Once the Kaypro is opened and the keyboard is connected, starting the computer is a simple matter of inserting the CP/M diskette in drive A (both drives are clearly identified) and operating the rear-apron power switch. A manual RESET button is also available on the rear apron.

When a drive has been activated, its red LED indicator glows and continues to glow after disk activity has ceased and until either the system is turned off or the other drive is selected. In this way, the user always knows which is the active drive. The only other LED is the POWER indicator.

The software package (which costs \$2475 if bought separately) provided with the Kaypro II is based upon standard CP/M-80, version 2.2. The Kaypro II is supplied with MBASIC from Micro-soft; and, in addition, S-BASIC is

available. This is a structured form of the language that resembles Pascal rather than the more familiar forms of BASIC. It is compiled and must be entered by using the word processor as a screen editor. After the program is written, it is saved with an extension of .BAS. This source file is then compiled using the S-BASIC compiler and the result is a .COM file which can be run directly.

This type of BASIC program runs much faster than either an MBASIC (an interpreter) or a CBASIC (an intermediate compiler type).

The rest of the software provided with the Kaypro II consists of the Perfect family of application programs. This includes the Perfect Writer word processor, and PerfectCalc (an electronic spreadsheet). These are all good programs, but by themselves they are nothing exceptional. When used together as an integrated system, though, there is a synergism that makes this package into a data-processing system that everyone will enjoy using. To get this system as part of a computer package is a powerful inducement to buy.

*Perfect Filer* is a data base that enables the user to create his own files of records containing the information required for his use. It lets the user input the data and then to retrieve it, to use it in a variety of ways such as printing address labels to everyone in the data base, to supply information for form letters composed with the Perfect Writer, to print invoices for records entered today, and to produce specialized sales reports and lists.

The system allows you to compose and personalize letters to everyone on a mailing list in the data base. You can also include financial information developed within the electronic spreadsheet. It is this capability to utilize the data among all the parts of the family that make the Perfect software so powerful.

The *PerfectCalc* is an electronic spreadsheet that is similar to Supercalc. But its principal feature is that it interfaces with the other programs in the system. It also features the virtual memory feature common to the Perfect family.

The *Perfect Writer* word processor includes a split screen that enables manipulation of up to seven files in memory at a time. For example, you can be composing a manuscript on the lower half (or three quarters) of the screen while searching another document in the upper portion for a paragraph to insert in that manuscript. You can then construct the paragraph to your liking, restore the document to storage in its original form, and return to full-screen editing.

Perfect Writer also produces an index, creates footnotes, and can even produce its own table of contents—something that only very expensive word processors generally can do. In addition, the word processor will also automatically format more than 30 different entry styles for final printing, such as set-off quotations within a body of text, or numbered and/or lettered lists and sublists. If you run out of memory while writing a long manuscript, Perfect Writer provides “virtual memory” where data is swapped back and forth with a diskette. This feature permits very long manuscripts that would exceed the RAM available. In use, the major difference between the Perfect Writer and the previously offered Select word processor is that Select used one-letter commands to select functions, while Perfect Writer requires the use of the CTRL or ESC keys in conjunction with another key to change functions. Up to four keys might be needed for some commands, although the bulk of them require only two keystrokes.

*Perfect Speller*, a companion dictionary to the word processor, has a 50,000-word dictionary and can process 4000 words per minutes.

**User Comments.** Booting the Kaypro II is conventional. Once the CP/M prompt is displayed, any CP/M 2.2 diskette can be used. With some alphanumerics on the CRT screen, the BRIGHTNESS control is adjusted for the desired appearance. A small “hood” formed by the top cover of the enclosure shields the screen from much of the overhead lighting. The 80 x 24 display is almost exactly the same size as the finished printed product in a



10-character/inch (10-pitch) mode.

The Kaypro II User's Guide is a well-written, well-illustrated manual slanted at the first-time user. It is very readable and goes through all the steps required to get the system up and running. Each of the software elements provided with the computer has its own manual. All of them are excellent and spell out all the details of how to get the maximum benefits from that piece of software.

The Kaypro II and similar computers with all-in-one portability are treading ground smoothed by the Osborne 1, or course, right down to bundling of software with the machine for greater value. Not being a pioneer gives such companies an opportunity to introduce improvements such as Kaypro's larger-size CRT, which is a pleasure to use for its size and its green tint, and standard double-density drives.

Savvy pioneers often meet the new challenges, though, as Osborne has by introducing a green-phosphor screen, optional double-density drives, and a plug-in modem for current models. And users do claim that the smaller screen represents no problem after working with the machine for awhile.

Moreover, Kaypro's software, though good, is not as widely familiar as is Osborne's, whose WordStar and SuperCalc software packages are household names among computerists. And though Kaypro's S-BASIC is faster than a streak of lightning, it has, to my mind, several serious drawbacks. First S-BASIC is as hard to learn as Pascal or C. So why not use these other structured languages, which have the advantage of being portable? Second, and more important, some of the applications written to run under CP/M are for MBASIC or CBASIC-2, or for some form of Pascal. Therefore, to run them you may have to go out and buy the sup-

porting language. However, today many BASIC applications are supplied as compiled object code. This makes S-BASIC useless for supporting packaged software applications in BASIC. So what good is it? Well, it is a rather nice exercise in structured programming. That is all it is, and I urge people buying the Kaypro II to also buy the real BASIC of their choice. The CBASIC package for the Kaypro II retails for \$150, while MBASIC-80 is \$320.

For those interested in manufacturer support (and you always should be), Osborne's pioneering has resulted in wider and deeper distribution of its product. Non-Linear Systems, the Kaypro's maker, cannot be easily dismissed as the typical newcomer, though, since it has been an established, reputable company in the instrument field for decades.

Given the foregoing conclusions and considering the tradeoffs, Kaypro is a solid competitor in this modestly priced portable/desktop computer field. —Leslie Solomon

**CALCULATOR SAVINGS**

<b>HEWLETT PACKARD</b>	
HP-10C Scientific .. \$57.99	82161A Cassette Drive .. \$347.99
HP-11C Programmable .. 74.99	HP-41CV Full Memory .. 207.99
HP-12C Financial .. 95.99	HP-41 System Case .. 79.99
HP-15C Programmable .. 95.99	Port-X-Tender to 10 pts .. 146.99
HP-16C Hexadecimal .. 99.99	82104A Card Reader .. 149.99
HP-41C Alpha Prog .. 149.99	82143A Printer .. 289.99
82162A HP-IL Printer .. 347.99	82153A Wand .. 99.99
82183A Video Interface .. 169.99	HP-75C Computer .. 739.99
82189A HP-IB Interface .. 349.99	82700A 8K Mem for 75C .. 149.99
82180A Extnd Functns .. 59.99	82184A Plotter ROM .. 59.99
82181A Extnd Memory .. 59.99	HP-97 Desk Progrmble .. 599.99
82182A Time Module .. 59.99	
82183A Extnd I/O .. 59.99	
82184A Plotter ROM .. 59.99	
HP-97 Desk Progrmble .. 599.99	

Call for Low Prices on all Accessories and Software

Texas Instruments 99/4A Computer .. \$249.99	LCD Prog .. \$29.99
Extended BASIC Module .. 74.99	TI-55-II .. 39.99
Peripheral Expansion Box .. 189.99	TI-58C .. 89.99
Disk Controller Card .. 189.99	TI-59 .. 189.99
Expansion Box Disk Drive .. 294.99	PC-100C .. 169.99
RS 232 Card .. 134.99	Compact 40 CALL

Olivetti Praxis 35 Triple-pitch Electronic Typewriter .... \$349.99

Sharp	PC-1250 Pocket Extended BASIC Computer .. 89.99
	CE-125 Printer/Microcassette for PC-1250 .. 149.99
	PC-1500 Advanced Handheld Computer .. 179.99
	CE-150 Cassette Intfrc/ 4-color Printer-Plotter .. 179.99
	CE-151 4K Memory Expansion for PC-1500 .. 49.99
	CE-155 8K Memory Expansion for PC-1500 .. 104.99
	CE-158 RS-232C & Parallel Interface for PC-1500 .. 179.99
	CE-159 8K Memory Expans with Battery Back-up .. 139.99

Casio	FX-702P Handheld Computer, 1680 Steps .. 499.99
	FA-2 Cassette Interface for FX-702P .. 75.99
	FP-10 Printer for FX-702P .. 59.99
	FX-602P Alphanumeric Programmable, 512 Steps .. 69.99
	MT-45 Keyboard with Chords, Bass, Rhythms .. 159.99
	MT-65 Home Entertainment Keyboard .. 249.99
	MT-70 Advanced Memory Keyboard .. 299.99
	CT-701 Advanced Electronic Memory Organ .. 599.99

Call us for low prices on famous Casio digital watches!

Pearl-corder	S904 Two-speed, Two-hour Recorder .. 449.99
	S901 Two-speed, Two-hour, Tape Counter .. 99.99
	S801 Two-speed, Compact, Memory Hewind .. 149.99
	X-01 Ultra-thin All Electronic .. 99.99
	SR-11 FM Stereo Microcassette w/Headphones .. 99.99
	Olympus Pearl-corder Microcassettes .. 10 for 24.99

Use cashier's check, postal money order, M.A. or M/C. Free checks take five weeks to clear. Add shipping 1% of your order (\$3.95 minimum). East of Missp. Rv extra 11.50 CA res add 6%. Subject to availability. USA prices.

ORDER TOLL-FREE **800-421-5188** Outside CA AK HI  
Information line (213) 633-3262  
**tam's** Tam's Inc, Dept CE-6  
14932 Garfield Ave.  
Paramount, CA 90723  
(213) 633-3262

CIRCLE NO. 42 ON FREE INFORMATION CARD

**SUPER BARGAIN SPECIALS!**

**Powerful Permanent Magnet Motor/Generator**



ITEM 10-1023 \$14.95  
Prepaid in Continental U.S.A.

With Bridge Rectifier \$16.50

\* ITEM 10-1023 - - Runs on 12 to 120-v. AC or DC. (Rectifier req. for AC). Very powerful for its size. Torque 50 in./oz. at 6500-RPM. 5.5-amps. No load speed, as motor, 1,000 to 10,000-RPM. Reversible rotation. As generator, use wind, pedal, water power to produce 12-volts at 950-RPM, 24-volts at 2000-RPM. Ball bearing equipped. Shaft 15/32" diam., 2-3/4" long, threaded end. O'all size 3" diam. x 7-1/4" including shaft. ( 3-1/2 lbs )  
Brand New

**Waterproof All-Steel .50 Cal. Ammo Boxes**



ITEM 1-1038 \$8.49

Prepaid in Cont. U.S.A.

\* ITEM 1-1038 - - Genuine U.S. Gov't. issue, heavy gauge steel ammo boxes. Not imported, lightweight copies. Tight sealing lid with rubber gasket. Waterproof protection for tools, camera gear, fishing tackle, valuables, ammo, important papers, etc. Carry handle folds flush. 11-3/4" x 7-1/4" x 6-1/8" ( 6 lbs )

Send \$1.00 For 124 Page Equipment Catalog  
SURPLUS CENTER  
Dept. CE-063 Lincoln, NE 68501  
OUR TELEPHONE: ( 402 ) 474-4366

**The world of electronics gee-wizardry**



**-YOURS FREE.**

32-pages of test instruments — from the latest digital multimeters to the famous EICO scopes. Security systems. Automotive and hobbyist products. Kits and assembled. EICO quality. EICO value. For FREE catalog, check reader service card or send 50¢ for first class mail.

**EICO** 108 New South Road  
Hicksville, N.Y. 11801

CIRCLE NO. 43 ON FREE INFORMATION CARD  
Computers & Electronics



# A WATER-LEAK DETECTOR

*Circuit senses presence of water and sounds an alarm when probe resistance drops*

*By Mitchell Lee*

**W**ATER leaks are costly nuisances for any homeowner, especially when they go unnoticed for one or more days. A leak in a refrigerator ice maker, dish washer, hot water heater, evaporative cooler, or plumbing can spell disaster for cabinets, floors, and any items stored in the immediate vicinity. What every homeowner needs to avoid disaster is a device that will alert him of leaks when they first occur, *before* they have a chance to do extensive damage.

The leak detector circuit shown

schematically in Fig. 1 senses the presence of water by monitoring the resistance between two probes that are placed so that the resistance is affected by the amount of moisture present. When this resistance drops below about 0.5 megohm, an alarm sounds to draw attention to the situation.

At the heart of the circuit is a National Semiconductor LM180 battery-operated alarm, which contains a comparator, 500-mA output stage, low-battery detector, and two internal voltage sources.

The positive input of

the comparator at pin 5 of *IC1* is connected to an internal 5.8-volt source via pin 2; the negative input at pin 4 is pulled low by *R1*, with the probe connected between pin 4 and the positive supply line.

Under dry conditions, resistance across the probe is fairly high (greater than 5 megohms) and no output to alarm *A1* is present at pin 8 of *IC1*. When probe resistance drops below about 500,000 ohms, pin 4 of *IC1* is pulled higher than pin 5 and pin 8 goes low, at which point, *A1* sounds.

The on-chip low-battery detector alerts you whenever the potential at pin 12 of *IC1* falls below 6 volts by sounding *A1* for 30 ms every 45 seconds. Voltage divider *R2/R3* determines the low-voltage alarm point. With the values specified, *A1* will sound when battery potential drops below 8.2 volts.

Total standby current drain of the leak detector is less than 7  $\mu$ A, allowing up to a year of operating life from a 9-volt alkaline battery. The alarm can be tested by closing *SI* to emulate a low-resistance across the probes.

**Construction.** The leak detector can be assembled on perforated board, using point-to-point wiring, or on a small home-brewed printed-circuit board. Whichever approach you elect to use, the only constraint is that you take care in component arrangement since all resistors have very high values and should not be shunted by any type of conducting material.

Once assembled, the electronic part of the project can be housed in any enclosure that will accommodate it and battery *B1*. If desired, probe connections can be made via banana jacks mounted on the enclosure.

Probe construction depends on the nature of the leak being detected. A pattern of interdigitated "fingers" (Fig. 2A) can be placed beneath an anticipated drip or on the floor beneath an appliance where leaking water usually occurs. This type of sensor can readily be fabricated from a printed-circuit board

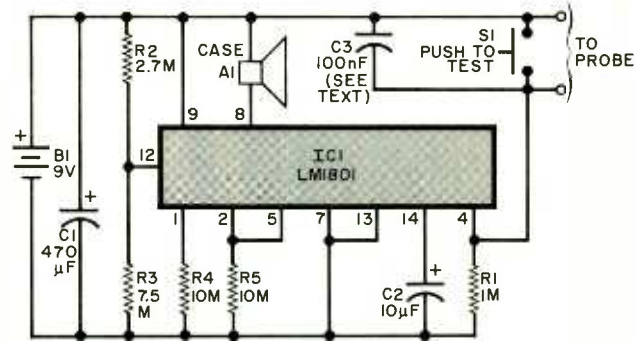

Fig. 1. The heart of the circuit is the LM1801 battery-operated alarm.

**PARTS LIST**

- A1—Buzzer (Radio Shack Cat. No. 273-049 or similar)
- B1—9-V alkaline battery with connector
- C1—470- $\mu$ F, 10-V electrolytic
- C2—10- $\mu$ F, 10-V electrolytic
- C3—100- $\mu$ F disc capacitor (optional—see text)
- IC1—LM1801 battery-operated alarm
- R1—1-megohm resistor
- R2—2.7-megohm resistor
- R3—7.5-megohm resistor

- R4, R5—10-megohm resistor
- S1—Normally open pushbutton switch
- Misc.—Perforated or printed-circuit board; suitable enclosure; materials for sensor(s) (see text); IC socket; hookup wire; solder; etc.

**Note:** The LM1801 integrated circuit is available for \$1.79 from Digi-Key Corp., Highway 32 South, PO Box 677, Thief River Falls, MN 56701 (800-346-5144).

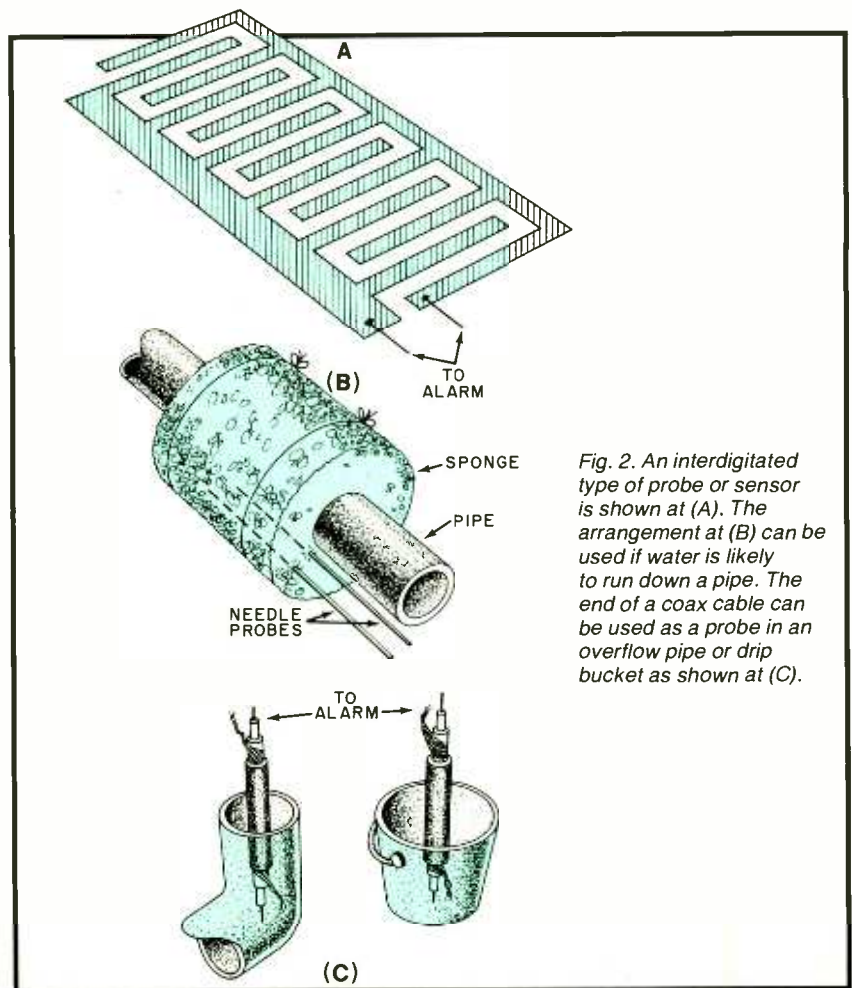

Fig. 2. An interdigitated type of probe or sensor is shown at (A). The arrangement at (B) can be used if water is likely to run down a pipe. The end of a coax cable can be used as a probe in an overflow pipe or drip bucket as shown at (C).

## ...LEAK DETECTOR

edge connector by soldering together alternate traces.

Where leaking water might run down the underside of a pipe, the probe arrangement shown in Fig. 2B would prove most useful. To fabricate it, first wrap a dry sponge around the pipe and tie it in place. Then push two lengths of heavy bus wire (the "probes") into the sponge parallel to and along the underside of the pipe. Using this arrangement, water running down the underside of the pipe will be intercepted and absorbed by the sponge. When the sponge gets wet, it will create a relatively low-resistance path between the probe wires, tripping the alarm.

As shown in Fig. 2C, the unterminated end of a length of coaxial cable makes an excellent leakage probe for a drip bucket or an overflow pipe. The probe tips are formed from the exposed braid and center conductor of the cable.

Multiple probes can be connected to the leak detector simply by tying them into the input circuit in parallel, to permit monitoring of several different locations simultaneously. If a sensor is to be located remotely from the electronic package, it is a good idea to wire a capacitor (*C3* in Fig. 1) across the probe input at the electronic package to reduce noise pickup. In most cases, remotely located sensors can be interconnected with the electronic package via twisted-pair 20-to-30-gauge insulated hookup wire.

A final note: probes and other sensors subject to oxidation (for example, copper) should be periodically cleaned. ◇

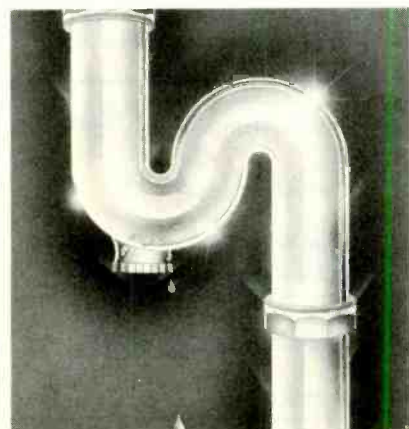

# A COMPLETE SOFTWARE GUIDE ...FREE?

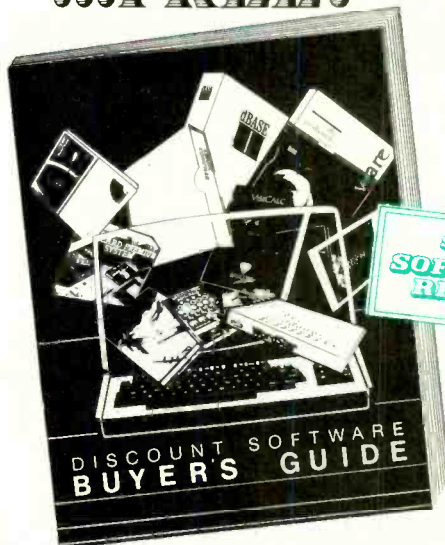

**A** **Discount Software Buyer's Guide**, crammed with useful facts, can be yours for only \$5.00. But you get every penny back when you order your next low-priced program from Discount Software!

Mail the coupon and you'll discover descriptions, features, system requirements, and solid advice on scores and scores of programs. Look at all you get:

1. Step-by-step guide to software shopping.
2. Hardware buyer's guide.
3. System requirements for each package.
4. Glossary of software categories.
5. Directories of software for CP/M, Apple, and 16-bit machines.
6. Thorough product descriptions.
7. Selection of games.
8. Fast-find table of contents and index.

Send for your guide today. Only \$5.00 now, it might well turn out to be free.

### \$5.00 REBATE OFFER

Yes—rush me the useful **Discount Software Buyer's Guide**. My enclosed \$5 check is made out to "Discount Software." I understand that this sum will be rebated to me when I make my next purchase.

Name \_\_\_\_\_ (Please print)

Company \_\_\_\_\_

Address \_\_\_\_\_

City \_\_\_\_\_ State \_\_\_\_\_ Zip \_\_\_\_\_

Mail \$5 check to: Discount Software, 6520 Selma Ave.,  
Los Angeles, CA 90028

CE:683

## DISCOUNT SOFTWARE

They'll never know you're doing it.

# Take High-Quality Photographs With the World's Tiniest Cameras. Change Your Telephone Voice So Your Own Mother Would Be Fooled.

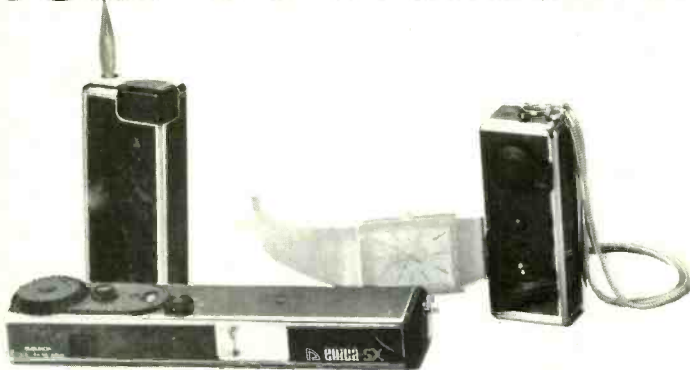

## The Spy Cameras

Surprise your friends with sharp, brilliant photographs they'll never suspect you took.

Minuscule in size but giant in performance, these precision cameras use standard universal miniature cartridges for one-touch loading. Shoot a whole roll without ever looking at your camera: fingertip control automatically resets the shutter as you fire each shot.

Precision optics give results rivalling expensive 35mm cameras.

Genuine Suzunon 3-element fixed focus lens means razor-sharp images without constant fiddling. Aperture adjusts manually from f/3.8 to f/11. 1/120 second shutter has a safety lock so the camera can't accidentally shoot your vest pocket or purse.

Pick the one you want. Each has its own astounding unique advantages. Until you use your SPY CAMERA you won't believe the picture-quality. Custom soft carrying case, roll of film, and neck strap included with each camera.

### We Absolutely Guarantee

Use the VOICE CHANGER or any of the miraculous SPY CAMERAS for up to 30 days. If you decide for any reason you don't want to keep it, return it for a 100% refund.

### Order TOLL-FREE

For fast delivery on credit card orders  
call toll-free 24 hours a day, 7 days a week:

**1-800-824-7888**

Ask for Operator 551  
(in California call 1-800-852-7777)

Or send check or money order.  
Please add indicated shipping cost.

# NEW HORIZONS

Dept. CE6, 1 Penn Plaza, Suite 100, New York, NY 10119



## The Telephone Voice Changer

(New, Improved Model)

It's right out of James Bond. Push a button and the VOICE CHANGER gives your voice completely different characteristics; the person on the other end won't know it's you.

Not an "electronic handkerchief" that muffles or filters your voice, the VOICE CHANGER completely restructures the tone and timber. It literally changes the quality of sound.

This is the new, improved model that completely eliminates distortion as it changes your voice. Your own mother would swear it's a stranger calling.

Choose from two separate, distinct Changer Channels. Pushing "Channel 1" changes timber and texture. Pushing "Channel 2" creates a second set of different characteristics. Pushing "Ordinary" sends your own voice through the line.

If you're alone in an office, it'll sound like an employee answering. Use the VOICE CHANGER to reach that doctor, lawyer, or business executive whose secretary knows your voice and who always is "out" when you call. Use it to screen your own incoming calls. Use it for just plain fun. Anytime you like, during a conversation, push the "Ordinary" button and the other person will hear your normal voice.

The SX-FLASHER  
Sub-Miniature Camera with Strobe/Flash \$99.95.

The SX-LIGHTER  
Sub-Miniature Camera with Lighter \$79.95

The MINIMAX  
World's Smallest Camera \$79.95.  
(+\$1.75 shipping per total camera order)

The VOICE CHANGER  
Telephone Voice Timber Changer \$129.95  
two for only \$119.95  
(+ \$2.50 shipping per total order).

# The SOUL OF CP/M

*This series of articles is condensed from a forthcoming book, Soul of CP/M,\* by Mitchell Waite and Robert Lafore*

## PART 2

**L**AST month, in Part 1 of a series, we introduced the structure of CP/M, basic console system calls, and how to use DDT to write assembly-language programs using single characters. Now, we'll look at some console I/O system calls that will allow you to enter whole words and lines at a time to simplify programming. We'll also describe "Direct Console I/O," which allows much more direct interaction with the screen and keyboard than with previous system calls. Finally, we'll cover a number of functions that deal with unusual I/O equipment.

**Print String.** The way to send complete words and sentences to the screen from inside CP/M is via the Print String function. In programming, a series of characters like a word or sentence is called a "string." We can send strings to the screen and accept strings from the keyboard. Print String sends a string to the console display screen. It's an advanced version of Console Out, which sends to the screen only one character at a time.

Print String expects to find the string you want to send to the screen in a continuous area of memory as a sequence of ASCII bytes. The end of the string must be a 24 hex (ASCII value for the "S" end-string identifier). To print it, put the address where the string starts in register pair DE, a 9 in register C, and do a BONSAI TO BDOS (an excited call 5).

We'll now demonstrate how to type a message in DDT. First, get into DDT and use the Set command (s) to put the hex value for "ABCDE" into memory, starting at location 010A. This command first displays the current contents of the memory location you're about to fill. In this case, these numbers are of no interest to us. Each time you type a two-digit (one-byte) value and hit carriage return, your number is stored in the memory location shown, overwriting the old value:

\*Copyright © 1983 The Waite Group, Inc. All rights reserved. To be published in 1983 by Howard W. Sams & Co., 4300 W. 62 St., Indianapolis, IN 46206. \$18.95. Cat. No. 22030. Reproduced with permission of the publisher.

```
-s10a
010A 53 41
010B 49 42
010C 47 43
010D 48 44
010E 54 45
010F 20 24 $ ends string
0110 28 . period ends set command
-
```

The "s10a" puts DDT in "set" at location 10A. The only information you key in is shown in light-face type.

Now use the "d" command to display what you've entered:

```
-d10a,10f
010A 41 42 43 44 45 24 ABCDES
-
```

As you can see, the numbers are just as you entered them, and the ASCII characters they represent are shown in the right-hand column. Enter the program that will actually print the string:

```
-a100
0100 mvi c,9      set up for print
                    string
0102 lxi d,010a   start string at 10A
0105 call 5       BDOS call
0108 rst 7        return to DDT
-
```

Save this program as "test5.ddt."

**LXI Instruction.** This instruction is similar to mvi except that it puts a two-byte constant into the indicated register pair. This constant is stored in the program in two bytes immediately following the lxi instruction in memory.

As in mvi, the *i* in lxi means that the constant to be stored *immediately* follows the instruction in memory. The *x* indicates that the instruction operates on a register *pair*, instead of a single 8-bit register.

When using lxi, you must type in *four* hex digits, not just the two required for mvi.

Execute the program:

```
-g100
ABCDE*101B
```

There's almost no limit to the size of the string you can print. To observe this, use the "fill" (f) command, followed by the address where you want to start filling, address where you want to stop filling, and the constant you want to fill in. Use DDT:

```
-f10f,400,41
```

This will fill from memory 10f to 400 with ASCII As. Don't forget to end the string with \$ (24 hex) using the s function:

```
-s401
401 FD 24 ASCII $
402 DO . period terminates "s"
-
```

Try running your program with this new string by typing "g100." The screen will simply fill with the letter A continuously until it reaches the end. (*Don't turn on your printer!*)

**Read Console Buffer.** This is one of CP/M's most useful functions. It accepts a string of charac-

ters typed from the keyboard and puts them in a memory "buffer" so your program can use them. Similar to Console Input, Read Console Buffer accepts information typed at the keyboard, except that the read-buffer function allows you to type a string of up to 255 characters at the keyboard. It's also a little more complicated to set up than Console Input.

One feature that makes Read Console Buffer especially useful is that it responds to the set of CP/M control-character commands and, thus, can be edited while you're typing it in. Perhaps the most important of these commands is ctrl-c, which when typed at the beginning of the string causes CP/M to do a warm boot. By using Read Console Buffer, ctrl-c allows a user to reboot the program during input. Read Console Buffer offers a host of other useful line-editing features:

*ctrl-h*—backspaces one character position

*ctrl-x*—backspaces to beginning of line and erases all characters (start over, erase).

*ctrl-u*—moves cursor down to beginning of next line and *ignores previously typed-in line* (start over but still view old line).

*ctrl-r*—retypes current line after new line. Useful when you over-use DEL key and can't figure out what line means.

*ctrl-e*—causes "physical end of line"; cursor returns to left margin one line down.

*ctrl-j*—line feed; terminates input line (as if carriage return were typed).

*ctrl-m*—carriage return; terminates input line.

*ctrl-DEL*—removes and echoes last character typed.

*ctrl-c*—performs warm boot.

Read Console Buffer "reads" a line of edited console input into a buffer addressed by the contents of register pair DE. You must use lxi to set up the buffer address in register DE before making the call. In addition, you must set up in the beginning of the buffer a number that represents the maximum number of characters you want to accept. For example, if you put 20 hex in the buffer, as soon as the user types more than 32 characters (decimal),





the function will terminate or "end by overflow." The user can also terminate the string by hitting carriage return or ctrl-j or ctrl-m.

The buffer we set up is shown in Fig. 5. DE +0 is shorthand for the address set to the function in register DE, DE +1 is the next address, and so on. Hence, if you put 400 in register DE when you call this function, DE +1 will be at 401, DE +2 will be at 402, and so on up to DE +n, which will depend on the length of your message.

The *mx* indicates the maximum number of characters (1 to ff hex) the function will allow you to type into the buffer. The *nc* is the number of characters typed in by the user and is set by FDOS when the function returns to your program. This number is useful for determining actual length of the input string, found at DE +1. Following *nc* are the actual characters read from the keyboard. If the number of characters typed is less than the number set by *mx*, remaining positions in the buffer are whatever they were before the function was called and have no meaning; they're identified by "??" in Fig. 5.

Our Read Console Buffer example is really quite simple. Let's assume we're going to start our buffer at 200 hex. Using DDT, enter:

```
-a100
0100 mvi a,20    set maximum
                 characters to 32
                 decimal
0102 sta 200     and put in first
                 buffer position
0105 mvi c,a     set up register C for
                 Read Console Buffer
0107 lxi d,200   load DE with location
                 of buffer start
010A call 5      call BDOS
010D rst 7      return to DDT
```

Store this program as "test6.ddt"

As you can see, a new instruction, "sta," has been added.

**STA Instruction.** This new instruction takes the 8-bit value in register A and stores it anywhere in memory. Where this value will be stored is determined by the address in the operand field of the instruction. For example, "sta 2000" takes the 8-bit value in register A, which might be anything from 00 to FF, and stores it in memory location 2000. In DDT, this address is represented by a four-digit number.



Notice the difference between this instruction and others we've used so far. For instance, mov b,a takes an 8-bit value from register A and stores it in register B, not in memory as sta does. An instruction like mvi a,7f is different from sta in two ways. First, it's loading an 8-bit value from memory into register A, not taking it from register A and transferring it into memory as sta does. Second, mvi a,7f refers to a constant at a location in memory immediately following the mvi instruction, while sta refers to a location in memory that can be located far away from the sta instruction itself. For this reason, sta uses an *address* in the operand field, while mvi uses the actual 8-bit value.

Our program first puts 20 hex into register A and stores it at the

beginning of our buffer at 200H, represented by *mx*. The program then calls Read Console Buffer, using address 200 as the start of the buffer. It then waits for you to type something in:

```
-g100          start program
Now is the time type this in
*019D         overwrites first part
              of the input
```

Note that there's a small glitch in that \*019D, which DDT prints when the program is over, overwrites part of the typed-in line. For now, dump (display) the buffer at 200H. (See Fig. 6A.)

The 20 at location 200 is *mx*, which you put there with sta. The 10 (16 decimal) at 0201 is the actual number of typed-in characters. The rest of the buffer, from 0212 on, is filled with whatever was in it before.

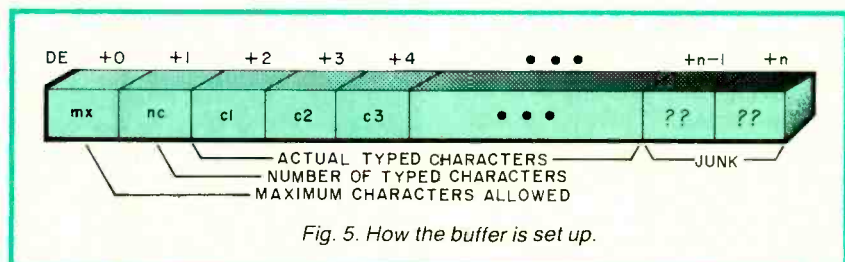

Fig. 5. How the buffer is set up.

```
-d200,21f          A
0100 20 10 4E 6F 77 20 69 73 20 74 68 65 20 74 59 6D .Now is the tim
0210 65 2E CD 05 00 F5 79 CD 8F 06 F1 C9 FE 20 C8 FE e.....y.....

-d200,22f          B
0200 20 20 4E 6F 77 20 69 73 20 74 68 65 20 74 69 6D Now is the tim
0210 65 20 66 6F 72 20 61 6C 6C 20 67 6F 6F 64 20 6D e for all good m
0220 65 6E FE 2C C8 FE 0D C8 FE 7F CA 24 05 C9 0E 0D en.....$....
```

Fig. 6. Two dumps of buffer at 200H.

Here's what happens if you type in more characters than are specified by mx:

```
-g100
Now is the time
for all good men type this in on one
                    line; keep typing. After
                    "men," the function
                    took over and returned
                    to DDT
```

**\*010D**

Dump the buffer again. (See Fig. 6B.) This time, the number of characters typed is the same as the maximum, mx.

**Echo Program.** Let's put together the two string-handling system calls you've just learned into a single program:

```
-a100
0100 mvi a,20 put max. characters
                at start of buffer

0102 sta 1fe
0105 mvi c,0a call Read Console
                Buffer

0107 lxi d,1fe
010A call 5
010D mvi c,2 use Console Out to
                print linefeed

010F mvi e,0a
0111 call 5
0114 mvi c,9 Print String
0116 lxi d,200
0119 call 5
011C rst 7 back to DDT
011D
```

Save this program as "test7.ddt."

This program will accept input typed by you, store it in a buffer, and then print it out on the screen, echoing every character typed. Note that a section is added to the program to print a linefeed to keep Print String from printing over the typed-in string. This is accomplished with Console Out at 010D and a 0A ASCII character (linefeed) at 010F.

We also tell Read Console Buffer and Print String different addresses for the start of the buffer, 1fe at 0107 for Read Console Buffer and 200 at 0116 for Print String. We do this because Read Console Buffer needs two extra bytes at the start of the buffer in which to put mx and nc. These go into 1fe and 1ff, respectively, so that actual typed characters start at 200H.

**List Output To Printer.** This system call is used to send a character to the *list* device, usually a printer, in the same way Console Output sends a character to the console screen. There are, of course, some differences in the way a printer operates, as compared to a video screen.

First, the printer will usually absorb a number of characters, such as a line, without doing anything. Characters sent are stored in a buffer in the printer until the printer's line length is exceeded or a carriage return or other terminating character is sent. At this point, the entire line of characters is printed. Hence, if you want to ensure that what your program sends gets printed, a carriage return must be the last character sent.

Some printers automatically supply a linefeed upon receipt of a carriage return, others don't. If yours doesn't, you must send one following the carriage return to keep the printer from overprinting the previous line.

Secondly, keep in mind that some characters look different on the screen than they do on the printer. Control characters, for example, may appear as characters preceded by a caret on-screen but may generate strange nonprinting actions on the printer, such as changing printing pitch.

Here's a program that will accept a line of input from the keyboard, using Read Console Buffer, and then send the string to the printer using

List Output:

```
-a100
0100 mvi a,50 Get input string. Max.
                line length
0102 sta 01fe into buffer
0105 mvi c,a Read Console Buffer
                buffer address
0107 lxi d,1fe
010A call 5
010D lxi h,200 Set up HL and B. HL is
                buffer address
                number of characters
                typed
0110 lda 01ff goes into B
                number of characters
                typed
0113 mov b,a Send char. to printer
0114 mvi c,5 get character from
0116 mov e,m buffer
                increment pointer
0117 inx h save H
0118 push h save B
0119 push b save B
011A call 5 perform operation
011D pop b restore B
011E pop h restore H
011F dcr b Check if done.
                Decrement count
0120 jnz 114 not done. Print next
                character
                Done. Print linefeed

0123 mvi c,5
0125 mvi e,a
0127 call 5
012A mvi c,5 Print carriage return
012C mvi e,d
012E call 5
0131 rst 7 return to DDT
```

Save this program as "test8.ddt."

We've introduced a couple of new instructions here:

**Phantom "M" Register.** The "m" in "mov e,m" in line 116 refers to a "phantom" register that doesn't really exist. This m is nothing more than a convenient abbreviation for the memory address pointed to by register HL. This register in the 8080 has the useful ability to *indirectly* address a memory location



# CREATIVE COMPUTING

# WIN AN ATARI® SWEEPSTAKE

Save up to 33% on *Creative Computing*, too!

**T**he Creative Computing Sweepstakes is open to all our readers. No purchase is necessary—and you'll receive a fantastic Atari home computer system worth over \$1600 if you're the lucky winner!

## How the Sweepstakes works

Just mail the attached card or the coupon below after filling in your name and address. Be sure to indicate whether you're also subscribing to *Creative Computing* at the special rates shown—you can save as much as 33%.

Then, if you win, you'll get a superb Atari personal computer system: the Atari 800 with 16K RAM and 10K ROM... an 810 Disk Drive... a 16K RAM Memory Module for extra memory... a pair of Joystick Controllers for game interaction. Use the Atari to handle small business and professional applications as well as sophisticated home processing functions—and, of course, for entertainment. Analyze your investments, learn languages, do



business accounting, play video games. Programmable in Basic or Assembly, the 800 can use all Atari peripherals and can control up to four disk drives and a 60 lpm printer. In all, the 800 and its accessories form a package worth a full \$1620 at retail!

## You're sure to win with *Creative Computing*!

Whether you win our Sweepstakes or not, the hours you spend with a computer are certain to be winners when you subscribe to *Creative Computing*. It's the Number One magazine of computer applications and software—filled with in-depth evaluations of computers, peripherals and software, plus applications and software that you can run directly on your computer.

Why not enjoy a year or more of *Creative Computing* at our low introductory prices? You'll save up to 33% if you subscribe at the same time you enter our Sweepstakes!

*Atari is a registered trademark of Atari, Inc.*



## OFFICIAL RULES

### No Purchase Necessary

- On an official entry form or a 3" x 5" piece of paper, hand print your name, address and zip code. Enter as often as you wish, but mail each entry separately to Creative Computing Sweepstakes, P.O. Box 5212, Boulder, Colorado 80322. Entries must be received no later than August 31, 1983, and the drawing will be held by September 21, 1983. All entries become the property of Creative Computing, which reserves the right to reprint the name and address of the winner.
- The winner will be selected in a random drawing from among all entries received, under the supervision of the publishers of Creative Computing, whose decision will be final. Only one prize will be awarded in this Sweepstakes. Winner will be notified by mail and may be required to execute affidavit of eligibility and release. Odds of winning will depend on the number of entries received. Creative Computing will arrange delivery of prize. Taxes are the responsibility of the winner. Any manufacturer's claims and warranties will apply, but Creative Computing makes no claims or warranties with regard to any prizes. Prize is not transferable. No substitutions for prizes.
- Sweepstakes open to all residents of the U.S., its territories and possessions, except employees (and their families) of Creative Computing, its affiliates, and its advertising and promotion agencies. Void wherever prohibited or restricted by law.
- For the winner's name, send a stamped, self-addressed envelope to Creative Computing Sweepstakes, Circulation Department, One Park Avenue, New York, NY 10016.

## OFFICIAL ENTRY FORM

Mail to: Creative Computing Sweepstakes  
P.O. Box 5212, Boulder, Colorado 80322

**YES!** Enter my name in the Creative Computing Sweepstakes and start my subscription to *Creative Computing* for the term checked:

- One year (12 issues) only \$19.97—20% off!
- Two years only \$36.97—26% off!
- Three years only \$49.97—33% off!

Savings based on full one-year subscription price of \$24.97.

**NO** I don't wish to subscribe now, but tell me if I've won the Creative Computing Sweepstakes.

Mr./Mrs./Ms. \_\_\_\_\_ (please print full name) \_\_\_\_\_ 811401

Address \_\_\_\_\_ Apt. \_\_\_\_\_

City \_\_\_\_\_ State \_\_\_\_\_ Zip \_\_\_\_\_

Offer valid only in the U.S., its territories and possessions. Please allow 30 to 60 days for delivery of first issue if you subscribe.

such that other 8-bit instructions—*mvi* and *mov*—can “pretend” there is an “m” register. What we really do when following an instruction with *m* is to have the program first look at *HL* to get the address it holds and then operate on the memory location pointed to by this address as though the memory location were a register. This is useful when we want to store a series of data items in sequential memory locations.

Our program uses two different registers to keep track of two different things: *HL* (16 bits) for the address in the buffer of the current character, and *B* (8 bits) for the number of characters remaining to be printed out.

We'll put the actual typed characters into the buffer starting at 200H. The first location in the buffer (1fe) holds the maximum character count, set at 50H or 80 decimal, to avoid getting more than one line of characters. The second address of the buffer (1ff) will be filled with the number of characters actually typed; this quantity is put into register *B*, which then uses it as the count when sending the characters to the printer. Typed input will be stored in the buffer starting at 200H, which is the address we put into register pair *HL*, the pointer to the current character.

**INX Instruction.** This instruction increments a register pair in the same way *inr* increments a single 8-bit register, adding 1 to the 16-bit number in the register pair. If you started with a zero and just kept incrementing, the register pair would count all the way up to FFFF (65535 decimal) before starting over again at zero.

**DCX Instruction.** Instruction *inx* works on all register pairs. A similar instruction, *dcx*, decrements these register pairs. An important and frequently annoying difference between these 16-bit increment and decrement instructions and 8-bit instructions *inr* and *dcr* is that the 16-bit instructions do *not* set the zero flag when the count gets to zero.

**LDA Instruction.** This instruc-

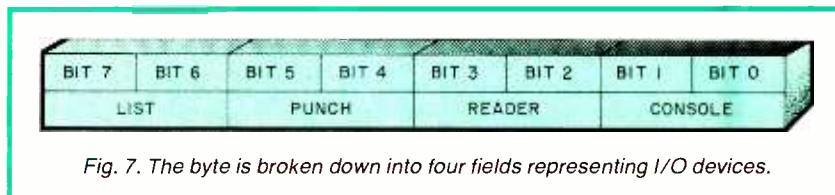

Fig. 7. The byte is broken down into four fields representing I/O devices.

tion is the opposite of *sta*. It loads register *A* with an 8-bit value taken from the memory address specified in the operand field of the instruction.

The program loops between 0114 and 0120, fetching a character from the buffer (line 0116), incrementing the pointer to the next character (line 0117), sending the character (line 011A, set up in line 0114), and decrementing the count (line 01ff) to see if all characters have been sent.

Notice how we must save *both* *HL* and *B* on the stack to keep them from being destroyed by Read Console Buffer in line 011A. The important thing to notice here is that the order in which we save the registers is in the *opposite* order in which we restore them. This is because the stack is last in, first out.

It's easy to get confused in using the stack, popping things off into the wrong registers. Our program presents a relatively simple use of the stack, but when the stack is used extensively in a program, it's important that you pay close attention to its use. Program bugs involving the stack can cause more than usually bizarre results and always seem to be particularly difficult to track down.

**Get I/O Byte.** Get I/O Byte and Set I/O Byte can be very useful when nonstandard devices, such as a modem, are connected into a system. These calls make possible assignment of different physical I/O devices to the logical devices to which the program thinks it's talking. “Physical” simply means the actual device itself, such as keyboard, video screen, or printer.

Oddly enough, in CP/M, a system call to, say, the keyboard (such as Console Output) doesn't necessarily have to go to the keyboard. By setting a group of four software switches, you can cause the charac-

ter sent to the keyboard with Console Output to end up at the printer, or you can cause what you send to the printer to end up on the console device. The destination of the character is the “physical” device, whereas the device the program thinks it's sending the character to is the “logical” device.

CP/M's Stat utility can be used to make a system perform the tasks called upon by Get I/O Byte and Set I/O Byte, but they must be performed by the user from the keyboard. Get I/O Byte and Set I/O Byte let your program change device assignments without human intervention. “I/O Byte” in these system calls has a memory location of 0003H in a typical CP/M system. The byte is broken up into four fields, each of which represents a logical I/O device (Fig. 7).

Each of the four logical devices is assigned two bits: the console gets bits 0 and 1; the list device gets bits 6 and 7; and so on. Each of these 2-bit fields can represent four numbers (00=0, 01=1, 10=2, 11=3). Each of the resulting four numbers is assigned to a physical device as follows:

- CONSOLE FIELD (bits 0,1)
- 0—printer device (TTY:)
  - 1—CRT device (CRT:)
  - 2—batch mode: READER is CONSOLE input, LIST is CONSOLE output (BAT:)
  - 3—user-defined device (UC1:)
- READER FIELD (bits 2,3)
- 0—teletype device (TTY:)
  - 1—high-speed reader device (RDR:)
  - 2—user-defined reader device # 1 (UR1:)
  - 3—user-defined reader device # 2 (UR2:)
- PUNCH FIELD (bits 4,5)
- 0—teletype device (TTY:)
  - 1—high-speed punch (PUN:)
  - 2—user-defined punch # 1 (UP1:)
  - 3—user-defined punch # 2 (UP2:)
- LIST FIELD (bits 6,7)
- 0—teletype device (TTY:)

- 1—CRT device (CRT:)
- 2—line printer device (LPT:)
- 3—user-defined list device (UL1:)

The three-letter mnemonics following each device are used in the STAT function. Note that many of the devices listed are no longer used in a typical CP/M system. Usually, CONSOLE is assigned to the "console printer device," which CP/M thinks of as the teletype (TTY). Although your console uses a CRT (cathode-ray tube), the device name CRT: isn't usually used for the console.

By bringing up DDT and typing "d0,f," the contents of the first 16 bytes of memory will be displayed. Look at the byte in location 0003; it will typically have a value of 94 hex. Taking the binary of 94H and separating it into groups of two bits results in 10,01,01,00. The first two bits (10), show from the above that the LIST function has been assigned to the line-printer device; the next two bits (01), that the punch device has been assigned to the high-speed punch; the next two bits (01), that the READER device has been assigned to the high-speed reader; and the last two bits (00), the CONSOLE device has been assigned to the console printer device.

Here's a program that uses Get I/O Byte to display the I/O byte in a form you can read:

```
-a100
0100 mvi c,7    call Get I/O Byte
0102 call 5
0105 mvi b,4    set count of 4 in B
0107 rlc       rotate A
0108 rlc       2 bits left
```



```
0109 mov c,a    save result in C
010A ani 3      mask off all but lower
                  2 bits
010C adi 30     add ASCII value of 0
010E mov e,a    store result in E for
                  printing
010F push b     save BC
0110 mvi c,2    call Console Out
0112 call 5
0115 pop b      get BC back
0116 mov a,c    put number back in A
0117 dcr b      done 4 digits yet?
0118 jnz 107    no
011B rst 7      yes; back to DDT
```

Save the program as "test9.ddt."

This program displays the contents of the IOBYTE. The first two instructions are the Get I/O Byte system call, which returns the IOBYTE in register A. Next, we take each of the four 2-bit numbers and display them separately on the screen as ASCII characters by *rotating* to the left the contents of register A. The two bits that are now on the right end of the IOBYTE are converted to ASCII, printed, and then rotated and printed again a total of four times. We accomplish

this with three new instructions:

**RLC (rotate-left) Instruction.** There are eight bits in register A. Think of them as bins lined up side by side, each containing a 0 or a 1 (Fig. 8). When rlc is executed, the bits in each bin move one bin to the left. In doing so, the bit in bin 7, having no place to move to the left, loops ("rotates") to the right and occupies the far-right bin (0). The value of the bit in bin 7 is copied into bin 0 and also into a special 1-byte register called the "carry flag." This can be useful in many circumstances, such as when you want to rotate 16-bit numbers.

**ANI Instruction.** This instruction means "AND immediate," where immediate means that the value to be ANDed with the content in register A is part of the instruction, rather than being stored someplace else in memory. The logical AND instruction is somewhat like the OR instruction, except that when you AND two numbers together, *both* bits in the corresponding locations in the operands must be set for the result to be set:

$$\begin{aligned}
 0 \text{ AND } 0 &= 0 \\
 0 \text{ AND } 1 &= 0 \\
 1 \text{ AND } 0 &= 0 \\
 1 \text{ AND } 1 &= 1
 \end{aligned}$$

Here's an example of two 8-bit numbers being ANDed together:

```
First number: 0 1 1 0 1 0 0 1
Second number: 1 0 1 1 0 0 1 0
AND result:   0 0 1 0 0 0 0 0
```

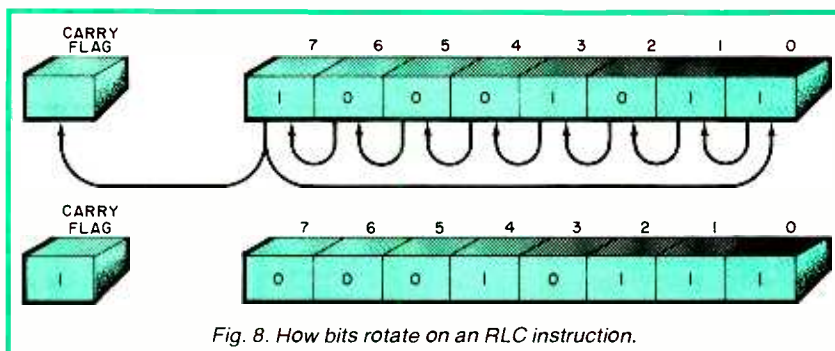

Fig. 8. How bits rotate on an RLC instruction.

One useful application of ani is to "mask off" unwanted bits in a particular byte. ANDing a bit with 0 always results in 0, regardless of whether the bit was 1 or 0. So if we want to get rid of some bits in a particular quantity, we can AND them with 0. In our program, we want to get rid of all bits in register A except the two on the right (positions 0 and 1). Therefore, we "AND immediate" a 3, which is the number with the two right-most bits set: 00000011. All bits in register A that match up with a 0 will be set to 0, and all bits that match up with a 1 will be preserved (set to 1 if they're already 1, cleared to 0 if they're 0).

**ADI (add-immediate) Instruction.** This instruction is similar to ani, except that the contents in register A are added to the number following the instruction, using simple arithmetic addition of two hex numbers. If there's a carry (resulting sum greater than FF hex or 255 decimal), the carry flag is set. The other flags are also set. In particular, if the result of addition is zero, the zero flag will be set; otherwise, it will be cleared.

In the above program, we want a 2-bit value of 0 (00) to print out ASCII 0, 2-bit value of 1 (01) to print ASCII 1, etc. However, the ASCII code for 0 is 30 hex (not 0), 1 is 31 hex, 2 is 32 hex, and 3 is 33 hex. Hence, we must add 30 hex to each of our 2-bit numbers before printing them out. This is where the adi instruction comes into play.

The program uses register B to hold the count of how many 2-bit numbers remain to be printed. This starts at four (set in line 0105) and counts down to zero, at which point, the program returns to DDT (lines 0117 through 011B). Register C is used to keep all eight bits of the IOBYTE—rotated two, four, six, or eight times—as the program progresses.

Since registers B and C can be saved on the stack with "push b" (line 010F), we can save both the count and the current rotated state of the I/O byte simultaneously and similarly restore them with "pop b" in line 0115. They must be saved be-

cause Console Out, used to print out the 2-bit numbers, destroys the contents of registers B and C when called.

Try running the program. It should give you the same value of the IOBYTE you found using the "d" function in DDT.

**Set I/O Byte.** This is a straightforward system call that sets the IOBYTE. Bear in mind that, unless you have some unusual I/O devices in your CP/M system, there's not really too much you can do by changing the IOBYTE. However, here's an experiment you can perform to see if everything is working as advertised. It changes the IOBYTE from 94 hex (10010100) to 14 hex (00010100), which changes the leftmost two bits from 10 to 00. In doing so, we've changed the destination of the LIST device from line printer to TTY: console printer. Use DDT to enter the following program:

```
-a100
0100 mvi c,8 set I/O Byte system call
0102 mvi e,14 new IOBYTE makes LIST the console device
0104 call 5
0107 rst 7 return to DDT
```

Run the program by typing "g100." Then use ctrl-p to turn on your printer. Now, type something on the keyboard and observe the video screen. You will note that whatever you type gets printed twice on the screen, once because the screen is simply echoing the keyboard as it normally does and a second time because ctrl-p turned on the printer echo. The characters that would normally go to the printer are rerouted to the console device because we put a 0 instead of a 2 in the LIST field of the IOBYTE.

**Coming Up.** We've now covered the most important of the nondisk system calls. Additionally, you've learned a lot about how CP/M works and how to program in 8080 assembly language. In the concluding parts of this series, we'll present CP/M disk calls and finish up with some basic BIOS information, including how to change BIOS to use of any peripheral. ♦

# OUR ISOLATORS FOR YOUR PROTECTION



Prevents:

- disk drive woes,
- printer interaction,
- memory loss and damage due to lightning or AC power line disturbances.

**Commercial Grade Isolator**  
ISO-1 3 Isolated Sockets... \$76.95

**Industrial Grade Isolator**  
ISO-3 3 Double Isolated Sockets... 115.95

**Laboratory Grade Isolator**  
ISO-17 4 Quad Isolated Sockets... 200.95

**Circuit Breaker**  
any model (Add-CB)... Add 10.00  
**Remote Switch**  
any model (Add-RS)... Add 18.00

**ESP Electronic Specialists, Inc.**  
171 S. Main St., Box 389, Natick, MA 01760  
Toll Free Order Desk 1-800-225-4876  
MasterCard, VISA, American Express

CIRCLE NO. 51 ON FREE INFORMATION CARD

★ FOR ORDERS ONLY! TOLL FREE (800)221-0828 ★

IBM  
EPSON  
AMDEK  
APPLE  
TI  
SHARP  
OLIVETTI  
COMAMODE  
BASIS  
BSR  
PANASONIC  
PEARL CONDER

# FOCUS

The Largest Authorized Computer Dealer in Brooklyn  
Our 18th year in Electronics!  
Our policy: lowest prices, prompt service, satisfaction guaranteed!

**Computers Peripherals & Software**

**ATARI**

Atari 1200XL 64K	653.95
Atari 800 w/48K	496.95
810 Disk Drive	439.90
850 Interface	call
NEW! Panasonic Computer w/32K R.G.B.	199.90
color	298.98
410 Recorder	73.95
Programmer Kit	45.90
Atari joystick	1.95

**EPSON**

NEW! HX-20 Portable  
In stock for immediate pickup

NEW! FX 80 printer	call
MX 80 II	99.95
MX 80 III F/T	special
MX 100 III	deal
Compress 12" green monitor	99.95

**NEW! HP 15C** \$789.95  
HP 41CV 204.95  
HP 41C 144.90  
HP 15C Programmer 89.95  
HP 15C Scientific 89.95

HP & Accessories low price

**COMMODORE 64 complete** 399.95  
VIC 20 with RF 138.95  
1541 Disk Drive 324.90  
1510 Recorder 63.90

**NEW! TI 99/4A** (after rebate) 149.95  
32K RAM card (PMP 1260) 219.95  
TI Munchman 29.95

Full line of TI software in stock

Times TS 1000	63.99
16K RAM - Original Times	44.44
Times Printer	call
Times Frogat	14.44

Full line of Times software in stock

**SHARP**

PC 1500 with CE 150	299.95
CE 158 RS-232 (for 1500)	159.95
CE 158 BK w/battery	119.95
NEW! PC1250	call
PC CE-125 Printer and micro cassette	call
PC 1211 with CE 122	99.90

**Video & Entertainment**

**Original Daisey Dish Microwave Receiver**  
reg. 71.74  
**\$99.80**  
with Box & 50 ft. of cable 39.00  
36 Channel Cable Converter with fine tuner

NEW! Alan CX 5200	call
Alan CX 2600 w/Combat	110.90
Mattel Intellivision II	149.95
Colovision	179.95
Vectrex	147.95

For information and all N.Y. State orders please dial (212)671-7800. All items subject to availability and price change. Mail and phone orders C.O.D. Master Charge, Visa OK. Shipping extra. Everything Factory Fresh 10 day Money Back Guarantee (less shipping) FOCUS ELECTRONICS 4523 13th Ave. Brooklyn NY 11219

PAGE  
MATTTEL  
NINTA  
FRANKLIN  
HEWLETT PACKARD  
TIMEX  
BSR  
ATARI  
SONY  
NCA  
VIDEONET

★ FOR ORDERS ONLY! TOLL FREE - 1-800-221-0828 ★

CIRCLE NO. 18 ON FREE INFORMATION CARD



# Micro The Computer Book Club®

"The ONLY Book Club for micro users"

Play games . . . develop new programming skills  
. . . organize your finances . . . earn extra income  
. . . even build your own microcomputer!

## HAVE IT ALL FOR ONLY \$2.95

### Select any 5 books (values to \$94.80) for only \$2.95 when you join!

 1455 List \$15.95	 1423 List \$17.95	 1108 List \$14.95	 1422 List \$14.95	 1205 List \$16.95	 1330 List \$16.95	 1513 List \$19.95	 1391 List \$17.95
 1396 List \$13.95	 1526 List \$18.95	 1195 List \$13.95	 1521 List \$17.95	 1277 List \$19.95	 1506 List \$12.95	 1496 List \$17.95	 1295 List \$16.95
 1228 List \$14.95	 1160 List \$13.95	 1480 List \$22.95	 1251 List \$16.95	 1045 List \$13.95	 1485 List \$21.95	 1055 List \$10.95	 1276 List \$15.95

### Ready-To-Run Software

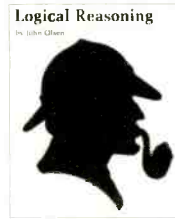
 No. 7113 Tape for TRS-80 Models I or III List \$24.95 No. 7114 Disk for TRS-80 Models I or III List \$29.95	 No. 7122 Tape for TRS-80 Models I or III List \$14.95 No. 7123 Disk for TRS-80 Models I or III List \$19.95 No. 7503 Tape for TS-1000, ZX81 List \$14.95
--	---

## 7 very good reasons to try Micro The Computer Book Club®

Blue Ridge Summit, PA 17214

- **Reduced Member Prices.** Save 20% to 75% on books sure to increase your computer know-how
- **Satisfaction Guaranteed.** All books returnable within 10 days without obligation
- **Club News Bulletins.** All about current selections—mains, alternates, extras—plus bonus offers. Comes 13 times a year with dozens of up-to-the-minute titles you can pick from
- **"Automatic Order."** Do nothing, and the Main selection will be shipped automatically! But . . . if you want an Alternate Selection—or no books at all—we'll follow the instructions you give on the reply form provided with every News Bulletin
- **Continuing Benefits.** Get a Dividend Certificate with every book purchased after fulfilling membership obligation, and qualify for discounts on many other volumes
- **Extra Bonuses.** Take advantage of added-value promotions, plus special discounts; on software, games, and more
- **Exceptional Quality.** All books are first-rate publisher's editions, filled with useful, up-to-the-minute information



## Micro The Computer Book Club®

Blue Ridge Summit, PA 17214

Please accept my membership in The Computer Book Club® and send the 5 volumes circled below, billing me \$2.95 plus shipping and handling charges. If not satisfied, I may return the books within ten days without obligation and have my membership cancelled. I agree to purchase 4 or more books at reduced Club prices (plus shipping/handling) during the next 12 months, and may resign any time thereafter.

1045 1055 1108 1160 1195 1205 1228 1251  
 1276 1277 1295 1330 1391 1396 1422 1423  
 1455 1480 1485 1496 1506 1513 1521  
 1526 7113 7114 7122 7123 7503

Name \_\_\_\_\_ Phone \_\_\_\_\_  
 Address \_\_\_\_\_  
 City \_\_\_\_\_  
 State \_\_\_\_\_ Zip \_\_\_\_\_

Valid for new members only. (Orders outside U.S. or Canada must be prepaid in International Money Orders in U.S. dollars. Canada must remit in U.S. dollars.) This order subject to acceptance by The Computer Book Club®

PECC-683

# Learning

# 16-BIT MICROCOMPUTER TECHNOLOGY

## Part 4: The Programmable Interval Timer and Programmable Peripheral Interface

By George Meyerle

**T**HE fourth part of this series on the construction of an 8088-based microcomputer compatible with the IBM-PC examines two circuit elements in detail—the 8253-5 Programmable Interval Timer and the 8255A-5 Programmable Peripheral Interface (PPI).

**8253-5 Programmable Interval Timer.** The 8253-5 consists of three independent 16-bit counters under software control (Fig. 21). The 1.19-MHz clock inputs (pins 9, 15, 18) are fed from IC29 (Fig. 4) which divides PCLK (2.38 MHz) by two. (Note: Figs. 1 through 9 and Tables I through III appeared in Part 1 of this series.)

To cause a DMA memory refresh cycle every 15  $\mu$ s, the monitor program initializes channel one as follows. During an initialization phase, it outputs a mode-control word to port 43 (see I/O map, Table II). This word selects the channel and type of counting operation desired. In this case, we have selected the "rate generator" mode of channel one. This simply means that the

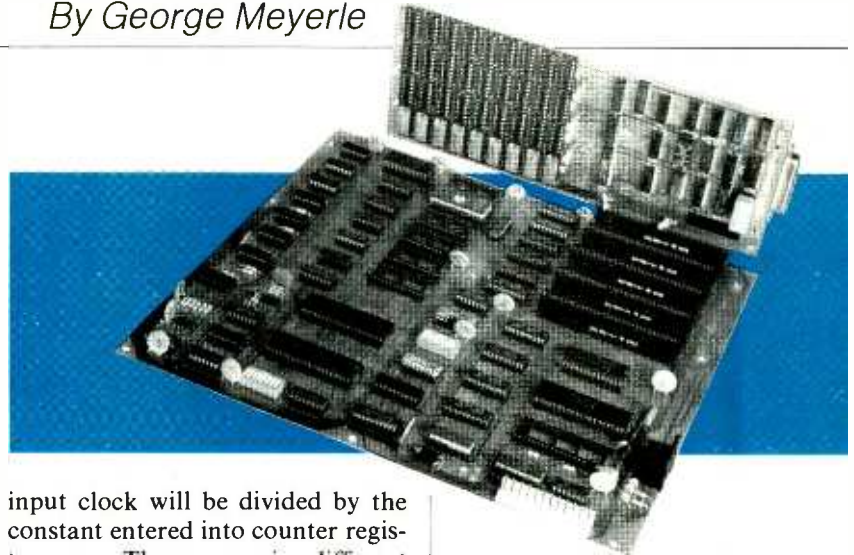

input clock will be divided by the constant entered into counter register one. There are six different modes of operation possible as listed in Table IV.

The program then loads a hexadecimal 12 (decimal 18) into count register one. This results in a pulse train output at pin 13 with a period of 15  $\mu$ s (1/1.19/18). The RAM requires refreshing of the 128 row addresses (RAS) every 2 ms. This is done by the DMA controller, which has been initialized to perform dummy reads at one of the required 128 addresses every time

the timer issues a pulse. The product of 15  $\mu$ s and 128 is 1.92 ms, which is within the time required by the memory.

Channel two is used by both the speaker and cassette outputs. When used by the speaker, channel two is initialized in mode 3 (square-wave output). To get a 1-kHz tone, a 1-ms period is needed. We obtain this count by loading hexadecimal 0533 into count register two. This gives us a 1-kHz square wave at pin 17. To get the tone to the speaker, we have to output a logic 1 to the speaker data line (I/O port 8255 port B, bit 1, pin 19). While this line is high, the output from the timer is gated to the speaker through the 75477 buffer. The frequency and duration of the tone generated are programmable by both the timer and the 8255.

The cassette write routine also uses the channel two counter set for mode 3 (square-wave output). The count register is modified by the software program as follows. If a zero bit is to be outputted, a 500- $\mu$ s square wave is generated. If a one bit is to be outputted, a 1000- $\mu$ s square wave is generated. When the program is writing to cassette, it first turns the motor on by setting the MOTOR OFF line low (8255 port

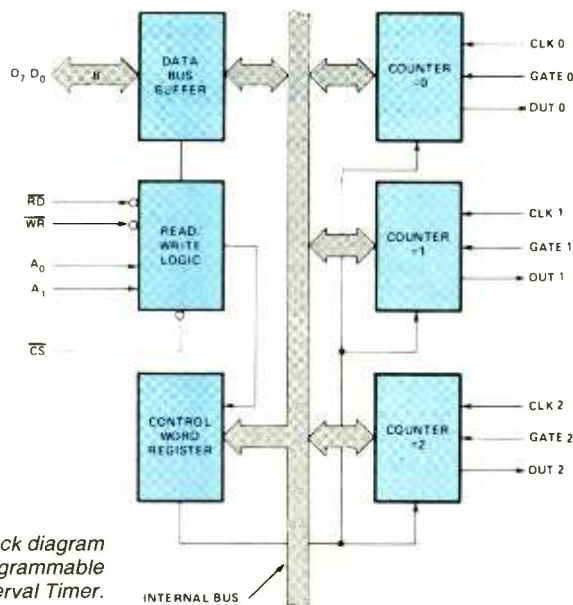

Fig. 21. Block diagram of the 8253 Programmable Interval Timer.



**TABLE IV—8235-5 OPERATION MODES**

B, bit 3). This sets pin 3 of the 75477 low, energizing the relay. Then, using the timer, it generates a leader of 256 bytes of ones. This is followed by two sync bytes, 256 bytes of data, two bytes of error-checking code, 256 bytes of data, etc. until all the data specified is saved. After the last data block, a trailer string of four bytes of ones is written. The cassette motor is then turned off by setting the MOTOR OFF bit high. Although the cassette write program sounds busy, it is simply modifying the counter register to provide the tones that represent the data stored on tape. The cassette read is handled by the I/O port directly and will be discussed later.

Channel zero is not used in the basic Explorer 88. However, when the optional IBM keyboard is added, the program is changed to program the channel zero timer to interrupt the CPU at regular intervals. This allows keeping track of the "time of day" or other time-dependent programs. Channel zero is disabled during cassette operations.

MODE	OPERATION	MODE	OPERATION
1	<b>Interrupt on Terminal Count</b> After count bytes are loaded into selected count register, output goes low and remains low during the countdown. When terminal count is reached, output goes (and stays) high until selected count register is reloaded.	4	<b>Software-Triggered Strobe</b> Output remains high until terminal count has been reached. Then output goes low for one period of input clock. Count is inhibited while gate input is low and begins only after gate is brought high.
2	<b>Programmable One-Shot</b> Output goes low on count following a gate input. Output will go high again on the terminal count. Since one-shot is triggerable, output is low for full count after gate input.	5	<b>Hardware-Triggered Strobe</b> Output remains high until gate input is brought high. Then output goes low when count register terminal count is reached. Output remains low for one period of clock cycle.
3	<b>Rate Generator</b> Generates a square-wave out-		

**8255A-5 Programmable Peripheral Interface.** The 8255, although used in a relatively straightforward manner in this design, is a very versatile CPU interface. It consists of 24 I/O lines that can be individually programmed in two groups of 12 and used in three different modes of operation (Fig. 22). In

mode 0 (Fig. 23A), each group of 12 I/O pins can be programmed in sets of four to be either inputs or outputs. In mode 1 (Fig. 23B), each group can be programmed to have eight lines of input or output, with the remaining lines used for handshaking and interrupt control signals. In mode 2 (Fig. 23C), eight

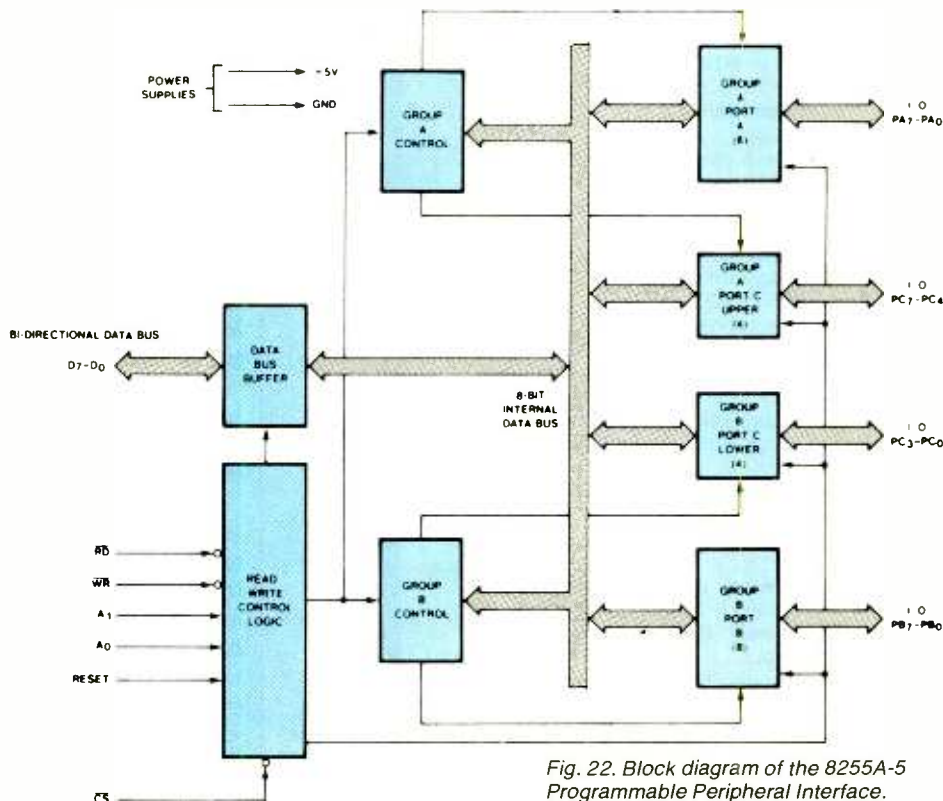
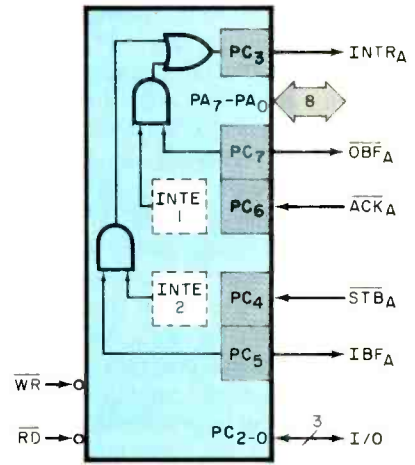
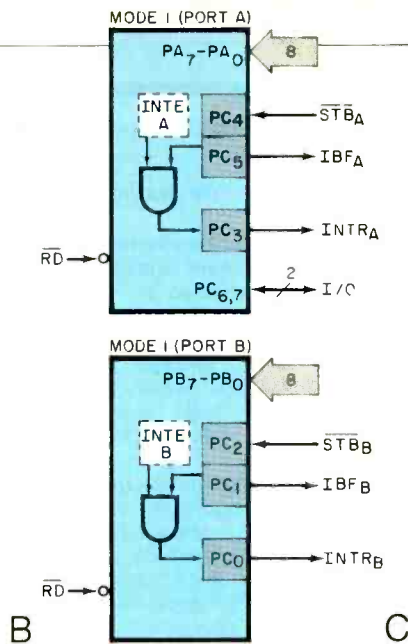
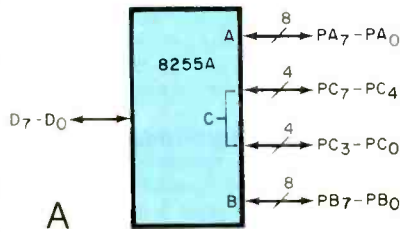

Fig. 22. Block diagram of the 8255A-5 Programmable Peripheral Interface.

Fig. 23. Three modes of operation of the I/O lines of the 8255: (A) mode 0, (B) mode 1, (C) mode 2.



lines are used for a bidirectional bus and five lines for handshaking (borrowing one line from the other group).

The PPI is used here in mode 0 only. By writing a 99 hex to I/O port 63 hex, it is initialized so that ports A and C are inputs and port B is an output. (Complete programming details are available in the 8255 spec sheet.) Referring to Fig.

5, let's examine how the two 8-position mode switches are connected. The switches advise the system monitor what hardware or memory has been connected to the system. Mode switch *S1* is connected to port A, which is configured to be an input port, through buffer *IC19*. Port A is also connected to *IC20*, which is a shift register used by the optional IBM compatible keyboard to en-

ter data. The status of port B bit 7 determines whether switch *S1* or the shift register is to be read. Port B (set up to be an output port) and port C (set up to be an input port) have bit assignments as shown in Table V.

The optional keyboard generates serial data that is loaded into *IC20*. When the data is ready to be read, an interrupt request is generated at *IC40*. The keyboard service routines then read the data via PPI port A and use PPI port B bits 6 and 7 to generate the signals that reset the interrupt and provide for proper keyboard clock operation.

The cassette read function is handled completely by the PPI. When a read is requested, the cassette motor is turned on and the data is read into memory via *IC37* (Fig. 4) and bit 4 on PPI input port C. The read program tests bit 4 continuously to check for a change in level. If the level changes in less than about 700  $\mu$ s, a "one" is assumed; if not, a "zero" is read. In this way, the entire tape is entered into memory complete with an error test after each 256 bytes.

The relay used to control the cassette motor includes an extra switch pole that is used to test the cassette logic function without actually having to make a recording. This is made possible by the extra pole connecting the cassette output to the input whenever the relay is not activated. Software then tests that the cassette loop is complete.

(To be continued.)

TABLE V—8255A-5 PORT ASSIGNMENTS

PORT B	
Bit	Function
0	Timer channel 2 gate input.
1	Speaker data.
2	Selects reading of either <i>S2</i> positions 1 through 4 or <i>S2</i> position 5 when reading port C bits 0 through 3.
3	Motor off.
4	No connection.
5	Enables I/O check input from external bus, which is used to check for parity errors.
6	Hold keyboard clock low.
7	<i>S1</i> /keyboard sense line.

PORT C	
Bit	Function
0-3	Report amount of memory above 64K.
4	Reads data from cassette input.
5	Reads status of timer out channel 2.
6	Reads status of I/O check line.
7	Not used.

# COMPUTER SOURCES

## Hardware

**NCR Comes In.** The NCR Corporation recently announced its entry into the personal computer field with a Decision Mate V series of microcomputer and with Decision Net, a local area network for linking personal computers. The new family features either 8- or  $\frac{16}{8}$ -bit processors, 64K of RAM upgradable to 512K, 4K of ROM, and a graphics memory of 32K for monochrome and 96K for color. The video display is a 12" monochrome green/black or color, having a display of 80 characters on 24 lines. There are 640 x 400 addressable dots. The keyboard has 20 programmable keys, while the disk drive is formed from two 5 $\frac{1}{4}$ " floppy disks or one floppy disk and a hard disk. The floppy disk is double-density, double-sided while hard disks of 12.76M bytes unformatted are available. The system also has RS232 I/O, a parallel interface, and an NCR Omninet local area network interface. The operating system is CP/M-80 for the 8-bit (Z80A), CP/M-86 or MS-DOS for the 16-bit 8088 system. Prices for the 8-bit version with monochrome graphics start at \$2800. The dual ( $\frac{16}{8}$  bit) model sells for \$3340. **Address:** NCR Corporation, Dayton, OH 45479 (513-445-2075).

**CP/M For TI Computer.** The Baby Tex is both hardware (plug-in board) and software (on a 5 $\frac{1}{4}$ " diskette) and allows the user to run CP/M-80 programs on a TI Professional Computer. The Convert utility program allows transfer of files back-and-forth between the Professional Computer and nine types of computers. Keyfix, another utility, provides a simple way to set the special FUNCTION and ARROW keys for any CP/M program. Baby Tex includes 64K bytes of additional system memory which is accessible to the user even when the board is not in use. The system contains 64K bytes of RAM, Z-80B operating at 5 MHz, with fully transparent operation. \$600. Bundled with Wordstar-Mail-Merge-Personal Pearl-WonderCalc, the price is \$995. Bundled with Personal Pearl-WonderCalc, the price is \$650. **Address:** Xedex Corp., 222 Route 59, Suffern, NY 10901 (914-368-0353).

**6502 Analyzer.** The DA6502-A is a stand-alone clip-on microprocessor analyzer for the 6502 that allows the user to examine processor registers, read and modify memory locations, halt a pro-

gram, and stop a program at a location after a number of loops have been completed. The analyzer features an 8-digit hex display; the first two display the contents of the accumulator, the middle four refer to the address, and the re-



maining two display the data found at the displayed address. The microprocessor is accessed via a keyboard containing 24 switches. \$279. **Address:** DA-TECH Corp., 92 Steamwhistle Dr., Ivyland, PA 18974 (215-322-9410).

**Atari Printer.** Interface No. 1 allows connecting any printer having a Centronix-compatible parallel interface (Anadex, C. Itoh, Epson, Microline, Okidata, etc.) to an Atari 400 or 800

computer via controller jacks J3 and J4. A printer handler is provided by cassette or diskette that replaces the resident printer handler, occupies less than 128 bytes of user program area, and is compatible with all Atari cartridges and programs. \$85. **Address:** Looking Glass Microproducts, PO Box 5084, Loveland, CO 80537 (Tel: 303-669-2681).

**ZX81 Cassette Interface.** The Winky Board II is a cassette interface for Timex Sinclair computers that filters electrical interference to yield clean easy loading tapes, has a LED volume level indicator, can save a program on two tape recorders simultaneously, and contains a program duplicating system. It requires no power or hardware modifications. \$24. **Address:** G. Russell Electronics, RD 1, Box 539, Centre Hall, PA 16828.

**Apple Diagnostics.** The APPLEsurance II is an automatic diagnostic package for the Apple II computer. The first part is on a disk controller card and operates at turn-on to check the motherboard RAM, language card RAM, processor, address, motherboard ROM, ROM card, and refresh test. Descriptive error messages even indicate which chip is bad. The second part is disk-based and covers the 16K RAM card, 80-column card, disk controller, printer, color, ROM card, disk drive, keyboard,

**IBM-PC Controller.** This dual-channel asynchronous communications controller for the IBM-PC features a rotating jumper plug to ease communications cabling by switching the transmit and receive signals in the connector. It has programmable baud rates from 50 to 19,200, and supports 5-, 6-, 7-, or 8-bit characters with 1, 1 $\frac{1}{2}$ , or 2 stop bits. Even, odd, or no parity bit generation and detection is also included. A full

prioritized interrupt system controls transmit, receive, error, and modem status change interrupts while diagnostics provide loopback functions for transmit/receive and input/output signals. Full duplex is supported with double buffering. Measure Boards 4" x 5". Single channel is \$130; dual channel, \$195. **Address:** Personal System Tech., Inc., 22957 La Cadena, Laguna Hills, CA 92653 (714-859-8871).

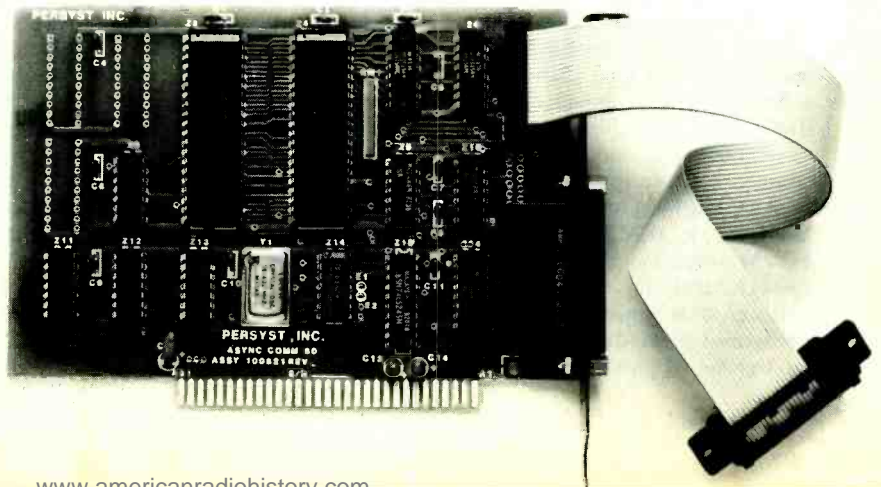

Z80 tests, 64/128K RAM card, serial card, multifunction card, monitor tests, and a series of miscellaneous tests. \$150. Address: Prometheus Products Inc., 45277 Fremont Blvd., Fremont, CA 94538 (415-490-2370).

## Software

**Software for New IBM-XT.** The new IBM-XT uses PC-DOS Version 2.0 (MS-DOS Version 2.0) which supports the hard disks used in this new version of the Personal Computer. In addition, it supports many additional features not included in previous versions. These include (but are not limited to): a full screen editor, piping output from program "A" to be used as input for program "B," sequential and direct access of data files, current data and time used in directory entries and graphics screen dump to printer, and chaining a series of programs in a pre-defined "job stream" that may be designated for automatic execution when the system is first turned on. Also, formatted capacity has been increased to 180K for single-sided or 360K for double-sided drive.

Concurrently with the IBM-XT announcement, IBM also released the Peachtree Software word processor called "PeachText." This system is not only an advanced word processor, but can also use logical commands such as IF/THEN/ELSE and data variables such as NAME. PeachText can make decisions and pull in the appropriate information in the right place while printing.

The Accounting System by Peachtree has also been configured for the IBM-XT. This consists of five packages: General Ledger, Accounts Payable, Accounts Receivable, Inventory Control, and Payroll. This software will be available from IBM Product Centers and dealers.

**Mini/Micro/Network Link.** Blocked Asynchronous Transmission (BLAST) is a software system for linking computers of different manufacturers. This software employs a pipelined system to transfer computer files from computer to computer via standard dial-up, direct contact, satellite links, and networks. BLAST has been announced for DEC VAX, Apple, IBM-PC, all CP/M and MP/M products, and the full range of Data General equipment.

It transmits either binary or text files (from one system to another) and allows for transfer of parts of files as well as

complete files. BLAST also can monitor and report phone-line quality and message traffic. Address: Communications Research Group Inc., 8938 Jefferson Highway, Baton Rouge, LA. 70809 (504-923-0888).

**Seven MS-DOS Programming Languages.** Microsoft has released seven new language versions for the MS-DOS operating system. This is the most popular operating system for 8088 and 8086 16-bit computers. The new language versions include a BASIC interpreter, a Compiled BASIC, Business BASIC Compiler, Pascal, FORTRAN, COBOL, and a C Compiler. All of these languages include common features that make it easier for the user to work with.

Common features include relocatable format, linker format, utilities, and calling conventions. They also feature compatible user interface characteristics so the programmer does not have to relearn the system when switching to a different language. In addition, application programs written in one language can be easily transported to any personal computer that supports the MS-DOS system. These include IBM, Wang, Texas Instruments, DEC, and Zenith. Both Microsoft's BASIC Interpreter and BASIC Compiler allow users to write larger programs and include extensions that make effective use of the MS-DOS environment.

The new Business BASIC Compiler has a 14-digit precision decimal math package for very accurate calculations. In addition, this Compiler includes special features like dynamic arrays, multiline functions, and full alphanumeric labels and references. Business BASIC also includes support for linking separately compiled BASIC programs and a utility that allows a user to translate CBASIC source programs into the Microsoft compiler format.

The new 16-bit MS-Pascal Compiler is the first Pascal that Microsoft has ever offered on the market. It complies with the ISO (International Standards Organization) level 0 standard with many extensions. MS-Pascal also includes support for the 8087 floating-point coprocessor along with the 8087 emulation capability. Therefore, on systems that do not use an 8087, an application program does not have to be modified to work. MS-Pascal also generates native code rather than P-code and includes features such as dynamic array handling capability.

Microsoft's FORTRAN is compatible with the ANSI FORTRAN 77 standard at the subset level, with many full language features. It is also compatible

with MS-Pascal even to the point where FORTRAN subroutines can be linked with a Pascal program.

The new MS-COBOL Compiler includes advanced screen-handling features and highlighting. It also handles with ease sequential, line sequential, and relative multi-key indexed sequential files. A powerful debugger is also included.

The C Compiler is another new language product from Microsoft. It is a full implementation of the language, as described in Kernighan and Richie's textbook, *The C Programming Language*. Address: Microsoft Corp., 10700 Northup Way, Bellevue, WA 98004 (206-828-8080).

**Free Computer Education Program for Teachers.** Tandy Corporation/Radio Shack has produced a computer education program for teachers to give them a basic understanding of computers and their applications in education. This includes an educator's handbook describing how computers are used in schools, a basic computer literacy package to teach elementary computer concepts, a secondary-level textbook to illustrate programming concepts, and a certificate for three free classes on Basic programming and educational uses of computers.

In addition to the teachers' material, a comic book entitled *The Computer Masters of Metropolis*, featuring "Superman" and "Wonder Woman," will be available to schools on a continuing basis. Over 14 million of these comic books have been distributed to promote computer literacy. Address: Tandy Corporation/Radio Shack, 1800 One Tandy Center, Ft. Worth, TX 76102 (817-390-3832).

**Physics Courseware for Apple II.** Harmonic Motion Workshop, Projectile Motion Workshop, and Charged Particle Workshop are new courseware programs for the Apple II Computers. Developed by a former college professor, The Harmonic Motion Workshop visually presents the concepts associated with harmonic motion by the use of hi-resolution graphics. The Projectile Motion workshop illustrates projectile motion under the influence of a uniform force of gravity. Charged Particle Workshop simulates the motion of a charged particle under the influence of various combinations of electric and magnetic fields. Packages require a 48K Apple II with Applesoft in ROM, Disk II. \$75 each. Address: High Technology Software Products Inc., 1611 N.W. 23rd St., PO Box 60406, Oklahoma City, OK 73106 (405-525-4359). ◇

# NEC 25" Component Color TV

**R**EPRESENTING the latest, top-of-the-line, component TV system of NEC Home Electronics (U.S.A.) Inc., the model C25-900A 25" color monitor and TU-831EN 133-channel tuner compares in all essential aspects to the previously reviewed Sony Profeel, Teknika, and Sears systems, as well as the RCA VGM 2023S combination TV set and monitor. Like each of these systems, the NEC equipment has a number of special features that may be of importance to some consumers and not to others. Price, for example, will narrow the buyer's choice to features that are important.

The NEC 25" video monitor has a suggested retail price of \$850, while its

accompanying tuner, including the remote control system, is priced at \$550. A video cassette recorder's tuner can substitute for NEC's tuner, of course. This compares to \$1500 for the Sony 25" monitor and \$520 for the Sony tuner, which, however, covers "only" 105 channels. RCA offers its VGM 2023S, which includes a 25" monitor and a 127-channel tuner, for \$1080. Performance and detailed features differ among all these systems so you can analyze, compare, and decide what is most important and worthwhile for you.

Like other component TV systems reviewed so far, the NEC model offers both mono and stereo audio, with provision for optional external speakers.

NEC also includes a 4" monitor speaker, together with a phone jack, which, when connected, disables this speaker. Separate volume controls for the internal and external speakers are provided on the NEC monitor control panel.

**General Description.** The NEC tuner model TU-831EN front panel contains the channel number display, which doubles as clock/timer, and LED indicators for TV, CATV, TIMER ON and AUX (auxiliary antenna). Separate LEDs are located on its MODE pushbuttons, which control whether TV, Line 1 or Line 2 video/audio inputs are being processed. Another LED is located on the front-panel power pushbutton. The master power switch is located on the back panel. With this master switch on, the clock/timer is provided with a small current even when the front panel power is turned off. The ac outlet on the back panel is controlled by the front-panel power pushbutton, which is also controlled by the clock/timer. In this way, it is possible to program the turn-on or off time of the tuner and another piece of equipment, such as a VCR.

Channel selection can be performed directly by the proper combination of the ten channel number keys or by the scanning action of the channel up/down pushbutton. This scanning can be either in the manual or automatic mode, which is selected by the "search" button that's located under a hinged panel, which is part of the front-panel controls. In the AUTO mode, only those channels on which a TV signal is received will be selected, while in the manual mode, all channels will be scanned, whether a signal is present or not.

The volume control for all audio signals passing through the tuner is another up/down pushbutton. A note in the operating instructions reminds the user that the volume controls (internal and external) at the video monitor must be set for acceptable volume, since they can override the volume control at the tuner.

Bass, treble, and balance potentiometers are located under the hinged front-panel portion as well as six pushbuttons that control operation of the clock/timer. Another pushbutton selects TV or CATV operation. The auxiliary r-f input is used for CATV, including the



use of a possible pay TV decoder box.

An unusual feature that may be important is the aft on/off pushbutton operation. NEC's tuner is a typical microprocessor controlled, frequency synthesizer, electronic tuning system, based on a crystal-controlled PLL (phase-locked loop). With the aft off, normal TV stations are received, based on the crystal control of the PLL. When CATV, VCR, TV game, or home computer r-f signals are received, their carrier frequencies may not be as accurate as the crystal-controlled PLL. For these applications the aft is turned on, disabling the crystal control and allowing the aft circuit to "pull-in" these off-frequency signals. To accomplish the same "pull-in" the Sears tuner, for example, provides two keys for manual up/down fine tuning.

Like most high-performance tuners, the NEC unit uses a SAW (Surface Acoustic Wave) filter for the i-f signal, which is then amplified in a single IC. All age, noise-cancelling and i-f circuits, as well as the sound i-f amplifier, are included in this IC. Another IC provides sound FM detection and preamplification. As with the Sears tuner, the NEC version also uses analog switching ICs, controlled by dc signals from the front-panel controls. Power is provided through a transformer with multiple secondaries, and four bridge rectifiers drive five separate voltage regulators.

NEC's remote control uses two AA batteries and duplicates the tuner's front-panel controls. There are ten numbered keys, a channel up/down control, a volume up/down control, a mode selection pushbutton that changes mode (TV, Line 1 or Line 2) each time it is depressed, a power switch, a timer/channel display selector pushbutton, and a mute button to turn audio off temporarily. In each instance the remote control overrides the front panel control.

On the rear panel of NEC's tuner there are the standard 300-ohm uhf terminals and the 75-ohm coax terminals for the vhf antenna and the CATV inputs. An adapter for 300-ohm twin lead is supplied with the tuner. There are two BNC-type coax connectors for video inputs on Line 1 and Line 2, together with two RCA-type audio jacks for each line. Similarly, there are BNC connectors and audio jacks for one output line and for the TV video output line. As already mentioned, the switched ac outlet and the master power switch are located here, too. Screwdriver controls for r-f

age, video, and audio level are accessible from the rear panel.

NEC provides the typical table matching the TV and the CATV channel numbers. This means that the user must either memorize those CATV channels available or note them in a handy place. Sears included an adhesive-backed chart that the user could paste on the back of the remote control unit. While not an essential feature, it's certainly handier than a printed table.

NEC's monitor appears quite compact, measuring 23 $\frac{3}{8}$ " H  $\times$  26 $\frac{1}{4}$ " W  $\times$  20 $\frac{1}{2}$ " D. It is not as compact or as light, however, as the RCA VGM 2023S. That 25" model measures 21 $\frac{3}{4}$ " H  $\times$  24 $\frac{1}{4}$ " W  $\times$  18 $\frac{3}{4}$ " D, almost two inches less in each dimension, and includes a tuner that's very much the equivalent of the separate NEC tuner. The NEC monitor weighs 92.4 lb, plus 14.5 lb for the NEC tuner, while the RCA unit weighs only 78 lb, including the tuner. Of course, few people buy a TV system because of size or weight. Moreover, heavier is sometimes better if it is the result of better shielding.

The NEC monitor has a removable safety glass, with all front-panel controls under a narrow hinged panel at the bottom of the screen. In addition to the power switch and the usual video controls—tint, color, contrast, brightness, sharpness—this subassembly also contains the internal and external volume controls and the VCR/line-selector switch. This pushbutton control determines whether the video and audio

output signals at the back of the monitor go through the special 8-pin VCR plug or the BNC video and phono jack audio line outputs. Two LEDs on the main front panel of the monitor indicate which connection has been selected.

At the rear of the monitor is an interconnection panel for video and audio input and output signals. There is a single video/audio input channel and a total of three outputs. One is the monitor video/audio output, another is the line video/audio output (a tap-off from the line input) and the third is the 8-pin special VCR connector, which provides video/audio inputs and outputs. There is also an earphone jack that overrides the internal speaker, if connected, and terminals for two external 8-ohm speakers. One screwdriver adjustment permits setting the video input level and another the vertical-hold control. Three slide switches set mono/stereo, 75-ohm or high impedance (video), and connect the 3.58-MHz trap that is normally not connected. If this type of interference is observed, however, the user is instructed to set this switch to "on." With the trap in the circuit, the luminance bandwidth is, of course, greatly reduced.

All of the essential circuits, five ICs and 36 transistors, are located on three pc boards—the sound output, the video/CRT, and the main boards. A three-secondary power transformer provides full ac isolation, but the chassis is connected to the ground pin of the ac plug. While three B+ voltages are obtained from the power transformer,

**NEC MODEL TU-83 1EC TUNER & C25-900A MONITOR  
LABORATORY MEASUREMENTS**

Parameter	Measurement
Sensitivity, vhf (Ch. 3)	58 dBm
Sensitivity, uhf (Ch. 20)	-56 dBm
Noise figure, vhf (Ch. 3)	9 dB
Noise figure, uhf (Ch. 20)	11 dB
Video bandwidth to CRT (-6 dB): (Monitor only)	4.05 MHz* 4.15 MHz
Horizontal resolution (including tuner):	330 lines
Oscillator stability (Ch. 3):	0.05 MHz
(105 to 130 V ac, 2 hr) (Ch. 20):	0.05 MHz
Aft on pull-in range	0.12 MHz
Agc dynamic range:	67 dB
Dc restoration	100%
Horizontal linearity:	100% left; 100% right
Vertical linearity:	100% top; 100% bottom
Convergence	85% at worst (right side)
Pin-cushion effect:	None
Voltage regulation, B+; tuner:	96%
(105 to 130 V ac) monitor:	95%
High-voltage regulation:	95%
(105 to 130 V ac)	
Power rating; tuner:	18 W
monitor:	130 W

\*Switching the 3.58-MHz trap "on" reduces bandwidth to 3.4 MHz

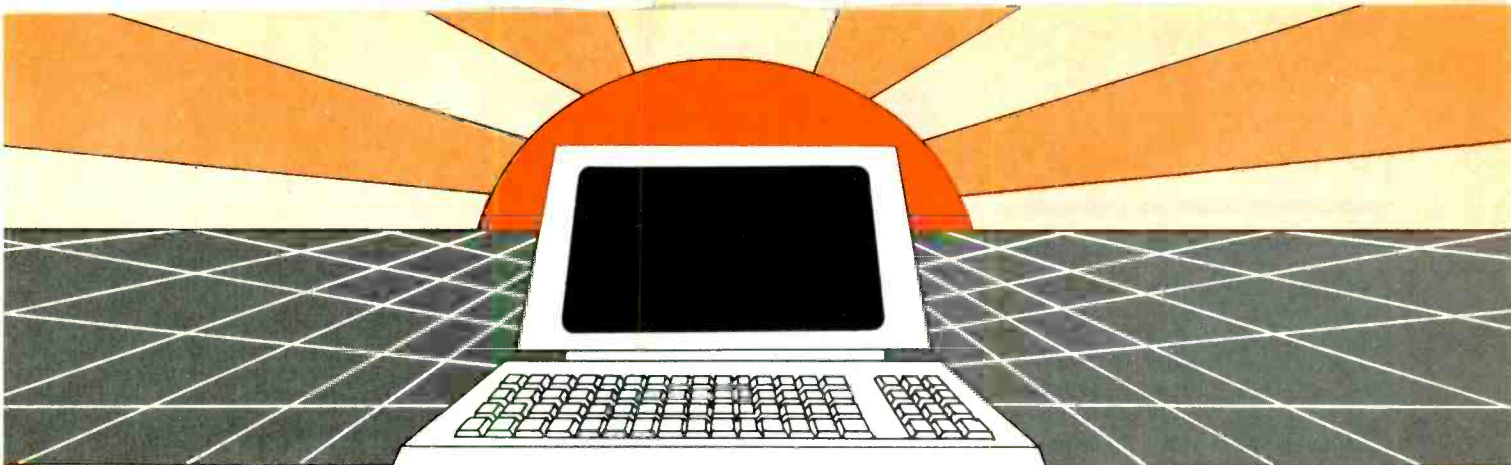

# DISCOVER THE MAGAZINE THAT HELPED LAUNCH THE MICROCOMPUTER INDUSTRY

Incredible as it may seem, *Popular Electronics* helped launch the microcomputer industry. Back in 1975, we published plans for building the first powerful microcomputer based on the 8080 cpu. These plans generated incredible excitement—and started the world thinking about personal computing.

Since then, we've added more coverage of personal computing. Today, so much of the magazine is devoted to microcomputers that we've changed our name to...

## Computers & Electronics

*Computers & Electronics* continues the *Popular Electronics* tradition of helping our readers experience the advances of the future—today. We do it with clearly written, in-depth articles explaining each innovation... plans for building useful, money-saving projects incorporating the newest technology... reviews of the latest mass-produced equipment. Whether it's microcomputer equipment, audio, video, or personal electronics, *Computers & Electronics* will make it possible for you to enjoy the newest, the most sophisticated, the most innovative technology around.

## Helpful buying guides

*Computers & Electronics* compares and contrasts computers and other electronics gear in meaningful buyer's guide articles. We discuss features and options, what to look for, and how to get the best value. Recent buyer's guides have covered computer printers, pocket computers, sophisticated telephones, video cassette recorders and high-tech audio cassettes.

## World-famous test reports

In every issue of *Computers & Electronics* you'll find our famous in-depth test reports. We take a new product, test it and analyze the results. Recently we've tested the Radio Shack TRS-80 Model III, the IBM Personal Computer, and the Sinclair ZX-81. Microcomputers by Apple, Atari, Hewlett-Packard, Intelligent Systems and Netronics. Plus an interactive data terminal, software,

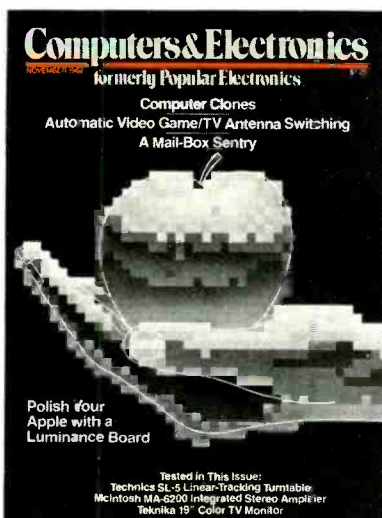

and a variety of audio, video and testing equipment.

## Innovative construction projects

If you're a do-it-yourselfer, you'll love the construction projects in *Computers & Electronics*. Not only did we bring the world the first successful microcomputer kit, but also projects for building the first low-cost modem. The first computer keyboard integrated with the computer (SOL)

The first low-cost voice synthesizer. The first low-cost logic analyzer. The first 1802-based microcomputer (ELF). The first low-cost function generator. The first gas-laser communicator (awarded a place in the Smithsonian Institution). The first low-cost color graphics computer module. An interface to transfer narrow line listings from your TRS-80 Pocket Computer to either a printer or CRT screen....

As you can see, our construction projects, while not necessarily complex (thanks to multifunction IC chips), will keep you at the forefront of technological development—at remarkably low cost. And in the future, we'll be bringing you construction projects to help you make your microcomputer more useful—whether it's an enhancement, an application, or a merging of technology with external controls and products.

## Get the leader in the field— at up to 33% off!

*Computers & Electronics* is the world's most widely read computer and personal electronics magazine. Now you can subscribe at big savings: up to 33% off. At our New Subscriber rates, a one-year subscription is only \$12.97. Take advantage of this offer—complete and return the coupon or postage-paid reply card today!

## Computers & Electronics

P.O. Box 2774, Boulder, Colorado 80322

- YES!** Send me one year (12 issues) of *Computers & Electronics* at \$12.97—I save 19%.  
 I prefer two years for \$22.97—I save 28%.  
 Make that three years for \$31.97—I save 33%.

Savings based on full one-year subscription price of \$15.97

Mr./Mrs./Ms. \_\_\_\_\_ (please print full name) 4N120

Address \_\_\_\_\_ Apt. \_\_\_\_\_

City \_\_\_\_\_ State \_\_\_\_\_ Zip \_\_\_\_\_

CHECK ONE:  Payment enclosed.  Bill me later.

Offer valid in U.S. and possessions only. Please allow 30 to 60 days for delivery of first issue.

with the usual filtering and regulation, three other dc voltages are derived from the flyback transformer.

The actual circuits of the NEC monitor are quite standard, except that some of the special features found in the Sony, RCA, and some other systems are absent. The NEC monitor, for example, does not use a dual sync system to accommodate the accurately interlaced TV broadcast system as well as the less accurate sync signals usually obtained from video games, VCRs, and other accessories. Automatic fleshtone correction circuits are not included and the high-voltage protection circuit is not very sophisticated. NEC's monitor includes stereo audio amplifiers, but does not offer enhanced audio for the TV sound.

The rear-panel video/audio connectors permit a variety of interconnections similar to those of the Sony, Teknika, and RCA systems. When the tuner and its three input channels are used—antenna and lines 1 and 2—a VCR and a color camera can be interconnected as input, and two video monitors and stereo audio system as outputs. Without the tuner, the VCR can provide both input and output for the monitor. An arrangement in which the monitor is used together with a color camera and VCR is another possibility.

The ability of the NEC monitor to operate either on 75-ohm or high-impedance video, depending on the setting of a slide switch at the rear panel, permits a unique "looping" feature. It is possible, for example, to use a tuner, camera, or VCR video signal as input line to one monitor and connect the output line to the next monitor, and so on. All monitors, except the last, are set to high impedance, and the last monitor is set to 75 ohms.

**Laboratory Measurements.** As indicated in the Table, the critical tuner performance characteristics, sensitivity and noise figure, are excellent and almost identical to those of the previously tested high-performance, microprocessor controlled, electronic tuning systems. On the NEC tuner tested, we found the vhf noise figure at 9 dB a little higher than the RCA (5 dB), the Sears (7 dB) and the Sony (6 dB). For practical purposes, however, all of these measurements indicate excellent fringe-area operation.

The luminance (brightness) bandwidth was measured at 4.05 MHz when passing through the tuner and at 4.15

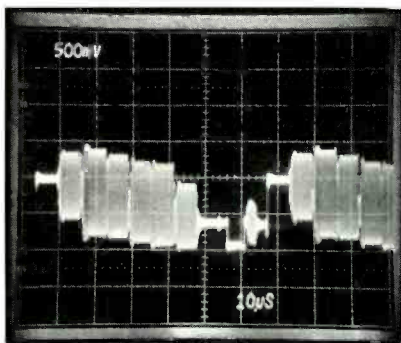
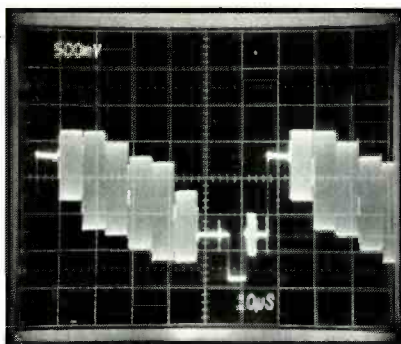

Color-bar signal input at tuner (top) and output at monitor (bottom).

MHz when going through the monitor only. We observed the same amount of bandwidth reduction in the Sears system, but this 100-kHz difference is not really significant. Much more apparent was the effect of switching the 3.58-MHz trap into the monitor's video output amplifier section. The bandwidth dropped to 3.4 MHz and the change in horizontal resolution to about 300 lines was easily seen on a test pattern.

Oscillator stability with the aft off was perfect, clearly due to the crystal-controlled PLL in the frequency synthesizer. The aft pull-in range of 0.12 MHz should be adequate for most off-frequency signals. Age range and dc restoration were excellent.

All of the remaining measurements, except for convergence, were excellent and almost identical to those made on the previously tested component TV systems. For some reason, possibly a slight movement of the deflection-yoke mounting in shipping, the entire right side of the screen was not properly converged. This was not apparent on moving scenes, but our test includes a rigid side-by-side comparison with a studio-type monitor and a color test picture obtained from a studio camera, and the misconvergence was clearly visible on this test.

Bandwidth and color fidelity were excellent, as verified by the oscilloscope photos of a color-bar signal illustrated here. These pictures also prove the good dc characteristics of the NEC monitor. Our group of sophisticated observers,

TV studio technicians, agreed that the colors of the NEC monitor were just as excellent as those of the Sony and RCA, which they had previously considered tops. Some felt that NEC's blues and reds were a little overemphasized, but that may be due to personal preferences and is, of course, adjustable. In summary, the NEC component TV system was found to be an excellent performer.

**User Comments.** Now that component TV systems are becoming popular, the competition in the market place is making itself felt in terms of features, performance, and price.

If you want a 25-inch monitor, top-of-the-line component TV system, you may find that price and features are the main consideration because most of them (at least those we have tested to date) perform about equally well. For example, Sony's price is clearly the highest, and its performance is great. It also features an RGB input for use with computers having RGB outputs. So there are some interesting considerations for one to weigh.

Enhanced audio on regular TV sound is available in most recent top-of-the-line TV equipment, but it is missing from the NEC system. Is that important to you? On the other hand, neither the Sony, Teknika or Sears monitors include, a built-in speaker, in case you don't want to use external speakers. Is that an important feature for you?

NEC has a very flexible interconnection ability due to the monitor's rear panel. Sony, Teknika and, to some extent RCA, have a similar feature, but Sears does not. As a matter of fact, you can mix and match components of most manufacturers, but the Sears equipment is only sold in a combination tuner-monitor arrangement, and the RCA has the tuner and monitor in the same cabinet. Do you have a good VCR that you want to use as a TV tuner? You may only want to buy a monitor and speakers. Again, a decision for doing this would leave out the Sears and RCA as far as you are concerned.

Finally, compare prices. We always mention only the manufacturer's suggested retail price, but you may be able to get a better price at your local dealer on a particular model. Local service availability, manufacturer's reputation, and your own experience with a particular manufacturer's equipment are also important considerations. As the market for component TV systems continues to grow, the choice becomes greater and the consumer can really select just the equipment that suits him best.

—Walter H. Buchsbaum

CIRCLE NO. 102 ON FREE INFORMATION CARD



# Soar Model ME-531 3½-Digit Multimeter

**T**HE Soar Model ME-531 3½-digit multimeter is a classical example of how an excellent and low-cost measuring instrument can arise from the use of new semiconductor technology. Although at the low end of today's test instrument range, the Model ME-531 would have been a relatively high-level instrument only a few short years ago.

Physically, the ME-531 is a mere 3" wide, 6¼" long, and slightly less than 1¼" thick. Power is from two AA cells, and weight is 8 oz. Suggested retail price is \$79.95.

**General Description.** The ME-531 has four input connectors: 10A, mA/ohm/diode, COM and V. The function switch has four color-coded and very clearly identified positions, while a pair of small pushbuttons is used to make subdivision selections. Power is controlled from a small switch on the left side of the front panel. The 3½-digit LCD is mounted under a protective rim. No carrying handle is provided.

Dc voltage ranges are from 200 mV to 1000 V full scale with ac voltage ranges from 2 V to 750 V full scale between 40 and 500 Hz. Resistances can be measured between 200 ohms and 2000 kilohms full scale and the Lo-Ohm function between 2 kilohms and 2000 kilohms full scale. Both ac and dc current can be measured at 200 mA and 10 A (ac current can be measured between 40 and 500 Hz).

Input impedances are greater than 100 megohms on the 200-mV range with 10 megohms on the other voltage ranges. In the 200-mA range, the insertion resistance is about one ohm, reducing to about 20 milliohms on the 10-A range.

**Comments.** The Soar Model ME-531 Digital Multimeter was checked by the



Lockheed Electronics Instrumentation Measurements Laboratory (Plainfield, NJ) against standards traceable to the National Bureau of Standards. After the tests, the IML issued a certificate attesting that the Model ME-531 met its claimed specifications in all respects.

Like all instruments that pass through here, the Model ME-531 was put to work on the bench to see just what it could do.

The instrument was well received. As a "pocket portable" DMM, the ME-531 was used both on the bench and in the field, and was found to be an excel-



lent instrument. Its relatively small size and lack of protruding knobs made it easy to slip in a pocket, and its single-control "front panel" made it convenient to operate.

Its most important feature—full autoranging—makes this instrument easy to use. All you have to do is select from voltage, resistance, or current via the single rotary switch, (and make sure that the red test lead is in the correct connector), and the multimeter does the rest. All ranges are automatically selected, with the range (V/mV, or ohms/kohms) indicated on the 3/8" high LCD display.

If the measured range is less than 19 displayed digits, an internal beeper sounds off. This enables the user to make "eyes off" continuity measurements. This latter feature has usually been found only on the more expensive instruments.

Overload protection is provided, and overload is indicated by the blanking of all but the most significant (left) digit. Polarity is assumed to be positive unless a minus sign appears on the display. The maximum indication is 999. A special low-battery annunciator appears on the LCD readout panel when this condition occurs.

Unlike the more expensive instruments, the low-cost ME-531 does not have an operation manual. It does come with a small "spec sheet" that covers the main specifications, and shows basic operation. Although written and printed in Japan, the English is excellent and, after a few minutes perusal, the spec sheet is no longer required.

After several weeks of use, we can recommend the Model ME-531 if you are looking for a low-cost, reliable, digital multimeter that can be used on the bench or in the field. —Les Solomon

CIRCLE NO. 104 ON FREE INFORMATION CARD



## Ultrasonic Sound Polaroid Rangefinder LM3905 Ap Note Lower Supply Voltages Device Developments By Forrest M. Mims, III

### Use of Ultrasonic Sound

SEVERAL years ago I walked blindfolded through the grounds of the Arkansas Enterprises for the Blind wearing a unique pair of spectacles. On the bridge of the spectacles were three ultrasonic transducers connected by cable to a pocket-sized electronics package.

As I scanned my surroundings, a sequence of strange and exotic swept-frequency tone bursts were fed into my ears by plastic tubes. Depending upon the target's distance and surface texture, the sounds ranged from drzzz...drzzz...drzzz to whoosh...whoosh...whoosh.

Although not nearly a substitute for eyesight, the spectacles highlight the application of ultrasonics in our everyday lives. There are many other interesting applications as well. One of the most recent is the ultrasonic ranging system developed by Polaroid for its SX-70 camera. We'll be discussing the design and operation of Polaroid's system here, but first let's find out more about ultrasonic sound.

Sound waves that have frequencies below and above the limits of normal human hearing are termed, respectively, *infrasound* and *ultrasound*. In-

frasonic sound has a frequency less than a few hertz. It is generated by earthquakes, machinery, and moving air. Ultrasonic sound has a frequency greater than 20 kHz. It is generated by mechanical and electronic sources, jingling keys, rustling leaves, and animals such as bats.

Applications for low-intensity ultrasonic sound include measurement of mechanical stress, flaw detection, and non-optical imaging devices such as those used to view the fetus of a pregnant woman. High-intensity ultrasonic sound is used for soldering, surgery, mixing liquids such as water and oil, and forcing dirt and oil from objects immersed in an ultrasonically agitated liquid.

Though all these applications are important, none has generated as much interest as two of the very first applications for ultrasonic sound: distance measuring and object detection. As early as 1918, scientists had developed practical systems for detecting submarines by reflected waves of ultrasonic sound. In World War II, this technology became widely known as *sonar*, an acronym for *sound navigation and ranging*. Today military applications for sonar range from detection of submarines over a range of 10 km or more, mine detection, and guidance and control of various homing weapons.

The best-known civilian applications for sonar include the detection of fish

and depth sounders. Detection applications in which the sound waves are propagated through air include ultrasonic intrusion alarms and, as described, travel aids for use by the blind and automatic focusing systems for cameras.

**Polaroid's Ranging System.** When Polaroid introduced its automatically focused SX-70 instant picture camera, more interest was expressed in the product's ultrasonic rangefinding system than in the camera itself. A few years ago Polaroid responded to this interest by introducing its Ultrasonic Ranging System Designer's Kit. The kit contains two preassembled circuit boards, two instrument-grade electrostatic transducers, two 6-V Polapulse<sup>®</sup> batteries, a battery holder, and an instruction manual. The kit is available for \$150 from Polaroid Corporation (Battery Division, 784 Memorial Drive, Cambridge, MA 02139).

This remarkable kit requires only that the battery holder leads be clipped or soldered to one of the two circuit boards. It can then be used as an ultrasonic rangefinder, complete with a 3-digit LED display. It can detect and indicate the distance to objects within a range of 0.9' to 35.2'. It has a resolution of  $\pm 0.12''$  at distances out to 10' and  $\pm 1\%$  over the entire detection range.

Since I've had considerable experience designing and testing infrared travel aids for the blind, I was particularly interested in experimenting with Polaroid's ultrasonic ranging system. The unit is much more sensitive than I had expected. For example, it will reliably detect a 1" diameter unfinished wood pole at 18'; it will detect a 9" diameter utility pole at 28'; and it will detect power lines 19' overhead.

The only major drawback of the system is its inability to reliably detect targets having a surface that is smooth with respect to the wavelength of the ultrasonic sound. Borrowing from optical terminology, such targets can be termed *specular reflectors*. If the surface texture of the target is rough with respect to the wavelength of the ultrasonic waves, the target can be termed a *diffuse reflector*.

Flat, specular targets whose surface is normal (perpendicular) to the oncoming sound waves are readily detected. When the target is off-axis to the beam of sound, however, the ultrasonic waves are reflected at an angle away from the source.

This can give rise to anomalous readings if the diverted off-axis beam even-

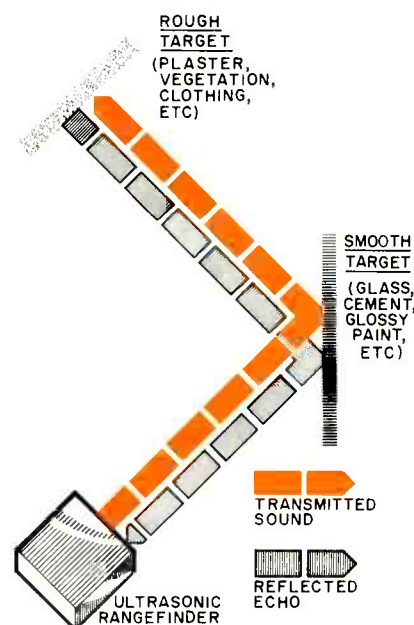

Fig. 1. A smooth target can cause false distance readings.

tually strikes a second surface having acceptable target characteristics. The sound will reflect back to the intended target and from there to the ranging system. The range measurement displayed by the readout, will, therefore, be the two-path distance to the second, unintended target. The intended target will be ignored. This phenomenon is illustrated in Fig. 1.

Infrared rangefinders that use LEDs and diode lasers exhibit this same problem when used to detect specular reflectors such as glass, polished marble, and automobiles with a high-gloss surface. Therefore, I was not surprised when the ultrasonic system could not detect these targets at an off-axis angle.

What was astonishing was the wide range of targets having relatively rough surfaces which, in fact, appear specular to an ultrasonic beam. Typical targets that are difficult or impossible to detect at other than the normal angle include smooth cement walls and driveways, plywood, painted surfaces, automobiles, flat metal plates, etc.

Fortunately, most targets include diffusely reflecting features that make detection possible even at off-axis angles. For example, the curved surfaces of most cars usually cause some of the ultrasonic beam to be reflected back toward the source. Overall, there are more diffusely reflecting targets (fabric, vegetation, shingles, people, posts, carpets, etc.) than specular targets. Nevertheless, it's prudent to be aware of the difficulties posed by specular reflectors when using an ultrasonic ranging system, particularly since Polaroid's otherwise excellent rangefinder manual fails to discuss the subject.

**The Transducer.** The key component of the Polaroid system is an instrument-grade electrostatic transducer that doubles as both an ultrasonic speaker and microphone. A foil diaphragm is stretched tightly over the concentrically grooved metallic backplate to form a capacitor. In receive mode, capacitance of the transducer is altered by incoming sound waves. In transmit mode, the electrostatic force of a charge placed across the capacitor causes the foil to move.

The transducer emits a relatively narrow sound cone (nominally 20° in divergence at the -20-dB points). The best operating frequency for the unit falls between 50 and 60 kHz. These parameters are clearly summarized in the plots, adapted from Polaroid's manual, which are shown in Fig. 2.

**The Ultrasonic Circuit Board.** The transducer is connected directly to the

Ultrasonic Circuit Board, a slightly modified version of the board found in the SX-70 camera. Figure 3 is a block diagram showing the major sections of this board. These functions are implemented by three custom chips.

When activated, the Ultrasonic Circuit Board applies to the transducer, at intervals of about 200 ms a 1-ms, chirped sequence of 14 pulses at 60 kHz, 57 kHz, 53 kHz, and 50 kHz. The pulses have an amplitude of 300 V. Four different frequencies are used to minimize the possibility that the reflection characteristics of the target and, perhaps, its surroundings might cause destructive interference, thus cancelling the reflected sound wave.

The received signal, which may represent a single reflected echo or a series of echoes from various targets, is boosted by a cleverly designed amplifier that incorporates 16 levels of time-dependent gain control. The echo from a nearby target is generally stronger and ar-

rives sooner than the much weaker echo from a more distant target. Therefore, the automatic gain control feature provides substantially more gain for distant targets. As gain is increased, the amplifier's frequency response is simultaneously narrowed. This improves the receiver's noise immunity at very high gain levels.

Figure 4 is a graph showing the theoretical gain for the first eight steps. Steps 10 through 16 resemble step nine as shown in Fig. 5, with each successive step having a 4-dB gain increase.

Figure 5 also shows the binary gain control signals (GCA, GCB and GCC) generated by the timing and control circuitry on the Ultrasonic Circuit Board. Also shown in Fig. 5 is the narrowing of the amplifier's bandwidth at and beyond the eighth gain step. Note the parallel listing of echo times and distances to the target.

Figure 6 summarizes the entire transmission and reception sequence for a

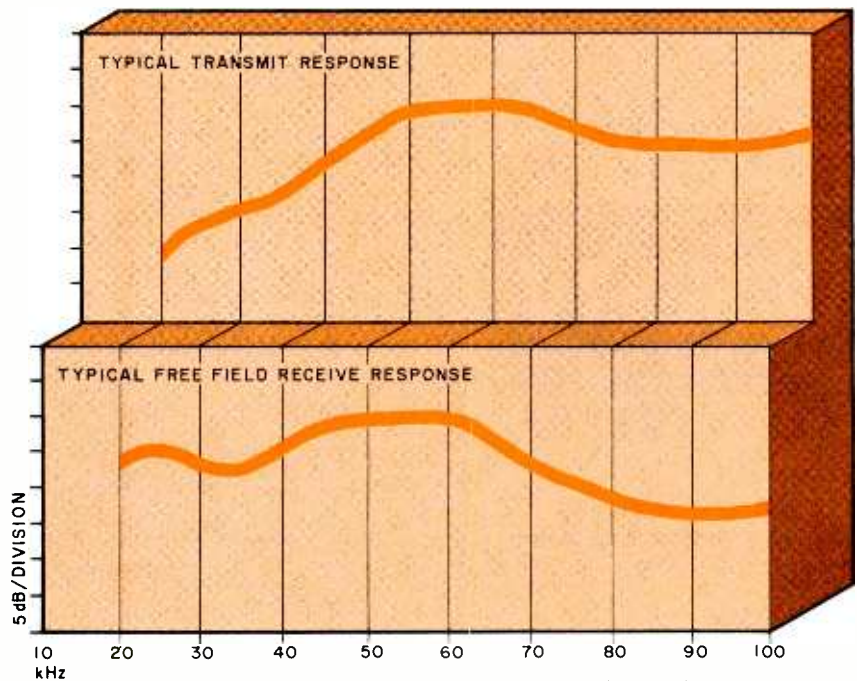

Fig. 2. Transmit and receive response of Polaroid's transducer.

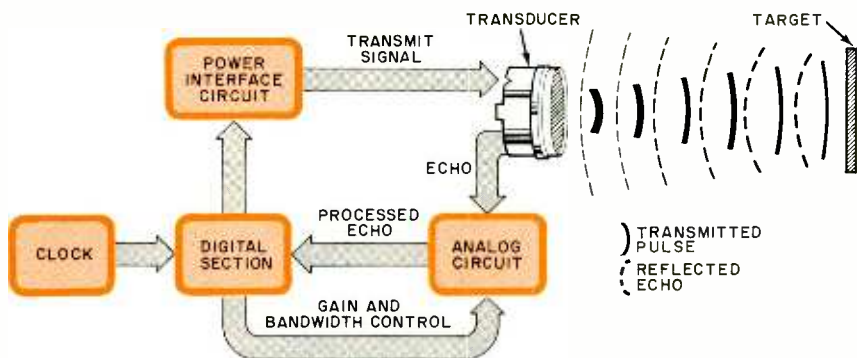

Fig. 3. Block diagram of Ultrasonic Circuit Board.

## AMAZING DEVICES

**LASERS**

**RUBY LASER RAY GUN** — Intense visible red beam, burns and welds the hardest metals. HAZARDOUS device. Kits available. RUB3 PLANS includes part sources \$15.00

**CARBON DIOXIDE BURNING AND CUTTING LASER** — produces a continuous beam of energy. HAZARDOUS device — Kits available. LC5 PLANS includes part sources \$15.00

**VISIBLE LASER LIGHT GUN** — produces intense red beam for special effects and other various optical applications. Hand-held enclosure houses batteries. LGU3 PLANS \$10.00 LGU3K KIT/PLANS (minus tube) \$99.50

**IR PULSED LASER RIFLE** — produces 15-30 watt pulses at 9000A at 200-2000 per second. LRG3 PLANS \$10.00 LRG3K KIT/PLANS (minus diode) \$119.50

**BEGINNER POCKET LASER** — visible red simulated device produces an excellent monochromatic source of light. LHC PLANS \$5.00 LHC2K KIT/PLANS \$24.50

**PHASORS**

**HIGH ENERGY VARIABLE AND PROGRAMMABLE PAIN FIELD GENERATORS, REQUIRE NO CONTACT** — Recently developed device produces directional fields of moderate to high SPL capable of producing intense pain and discomfort. HAZARDOUS IF NOT USED WITH DISCRETION. SOLD FOR ANIMAL CONTROL — MAY BE USED IN CERTAIN INSTANCES TO DISCOURAGE UNWANTED ENCOUNTERS. PPF1 PROG/VAR PLANS \$15.00 PPF1K KIT/PLANS \$175.00

**PSP3 VAR HAND-HELD PLANS \$7.00 PSP3K KIT/PLANS \$44.50**

**PHASOR BURNING WAND** — capable of burning flesh, generates 3500 volts of continuous DC power. PSW3 PLANS \$8.00 PSW3K KIT/PLANS \$59.50

**PARALYZING SHOCKING WAND** — produces 100,000 watt pulses of stunning power. PG1W PLANS \$10.00 PG1WK KIT/PLANS \$79.50

Above electrical devices are hand-held and may be used for **PERSONAL DEFENSE**.

**SECURITY**

**SNOOPER PHONE** — allows user to call his premises and listen in without the phone ever ringing. SNP2 PLANS \$7.00 SNP2K KIT/PLANS \$49.50

**LONG RANGE WIRELESS MIKE** — miniature device clearly transmits over 1 mile. FB19 PLANS \$7.00 FB19K KIT/PLANS \$34.50

**WIRELESS TELEPHONE TRANSMITTER** — long range all automatic, undetectable. VWPM5 PLANS \$7.00 VWPM5K KIT/PLANS \$34.50

**TALK AND TELL** — clearly and automatically records both sides of a telephone conversation when phone is being used. TAT2K KIT/PLANS \$14.50 TAT20 READY TO USE \$24.50

Our order phone is available 24 HOURS, 7 DAYS A WEEK  
Write for **FREE** catalog of our many products  
We accept Master Charge or Visa. Please allow 10% for shipping. On orders OVER \$50.00 **WE PAY** freight!

**SEND TO: SCIENTIFIC SYSTEMS**  
DEPT. Q1, P.O. BOX 716, AMHERST, NH 03031  
OR CALL FOR ORDERING ONLY: 1-603-673-4730

# CABLE TV

## CONVERTERS

**Largest Selection of Equipment Available**  
*\$ Buy Warehouse Direct & Save \$*



**36 channel converter**  
**\$45<sup>95</sup>**



**36 channel wired remote converter only**  
**\$88<sup>95</sup>**

*Send \$2 for complete catalog of converters and equipment*  
Quantity Discounts • Visa • Master Charge  
Add 5% shipping — Mich. residents add 4% sales tax

**C&D Electronics, Inc.**  
P.O. Box 21, Jenison, MI 49428  
(616) 669-2440

## ...ELECTRONICS SCIENTIST

single chirp directed against three targets within the detection field. Note how the circuit shapes each echo and then generates a clean, square pulse representing only the first echo. This signal is designated MFLOG, and is available at pin 15 of the Ultrasonic Circuit Board. The transmitted chirp signal is available at pin 16 on the board. The time duration between these signals represents twice the distance to the target.

**The Experimental Demonstration Board.** The utility of Polaroid's Ultrasonic Ranging System kit is greatly enhanced by the Experimental Demonstration Board. This board is essentially a custom 3-digit counter that converts the echo time signals from the Ultrasonic Circuit Board into distance to the target to the nearest tenth of a foot. CMOS IC's are used throughout, and the range is displayed on a 3-digit LED readout. A red filter is included to increase the visibility of the display in the presence of bright ambient light.

**Testing the System.** The kit is supplied with the two boards connected by a 6-conductor ribbon cable. Therefore, all that's necessary to use the kit as a 0.9'-to-35.2' rangefinder is to solder the two battery leads to the Experimental Demonstration Board.

The boards, transducer, and battery holder should be installed in a suitable

enclosure. Temporarily I have used a compact 7" x 6" x 1" wood cigar box. Holes for the display and power switch were cut through the box top, and a cir-

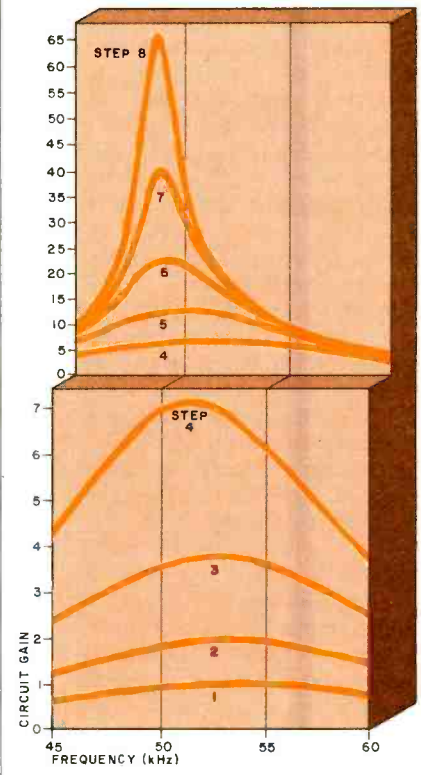

Fig. 4. First eight steps of receiver gain.

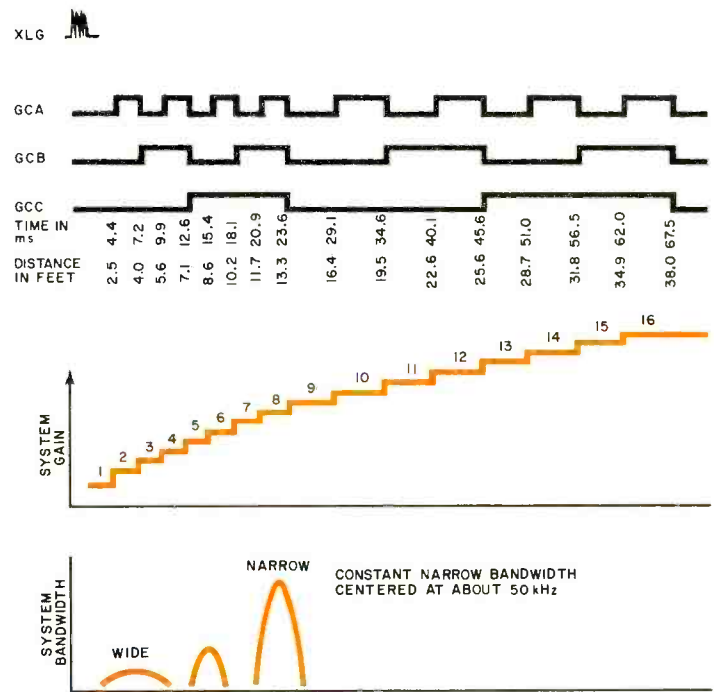

Fig. 5. Operation of gain control logic circuit.

Artwork adapted from Polaroid Operation Manual.

cular aperture for the transducer was made in the bottom of the box. An arrangement like this allows you to view range measurements while pointing the unit away from your face and other objects so that you're pointing toward targets of interest. Make sure the transducer leads do *not* become disconnected and that exposed metal parts of the transducer, including its connections, do *not* touch either board. For best results, of course, install the boards in a permanent metal or plastic enclosure.

Incidentally, Polaroid warns that the transducer *must* be properly connected to the Ultrasonic Circuit Board before power is applied. Otherwise, the high-voltage chirps may damage the board. One of the two transducers supplied with the kit is connected to the Ultrasonic Circuit Board by a short, shielded cable. If the cable connections are flexed frequently, be sure to inspect the solder connections at regular intervals to make sure they are secure.

**Commercial Applications.** One of the most interesting applications for Polaroid's rangefinder technology to reach the market is Tailmate™, a sophisticated detection system for trucks and trailers developed by Gregson Holdings Ltd. (382 Blackpool Road, Preston, Lancashire, PR2 2DS, England).

When a Tailmate-equipped vehicle is placed in reverse, the system is actuated, and the driver can then view a readout installed in the cab, which gives the distance to a loading dock or other object. If the driver wants to stop the vehicle a specific distance from an object, he can enter the distance into the Tailmate unit. Three feet before the pre-

set distance is reached, the system emits a pulsed warning tone. When the desired distance is reached, a continuous tone is sounded. The system can also measure the distance to overhead objects.

Another application is the Sona Switch™, an indoor-outdoor object detection system designed for automatic door openers, vehicle detection, and security systems. The Sona Switch is a product of Electronic Design and Packaging Company (17425 Ecorse Road, Allen Park, MI 48101).

Other applications include robotics, vehicle height detectors, automatic controls for agricultural equipment, and measurement of the product level in silos and storage tanks. A particularly interesting application is a wheelchair guidance system that helps quadriplegics maneuver a motor-driven chair through narrow passages like doorways and halls.

### Experimenting with the Rangefinder

**T**HE Polaroid rangefinder can be used with little or no modification for many applications. You can even interface the device with a computer bus. If you want to try a specific application, details on how to convert the distance reading from the rangefinder into audible chirps are given in the following experiment.

**An Audible Output.** Some of the many useful applications for Polaroid's Ranging System can be enhanced by the addition of an output tone whose frequency

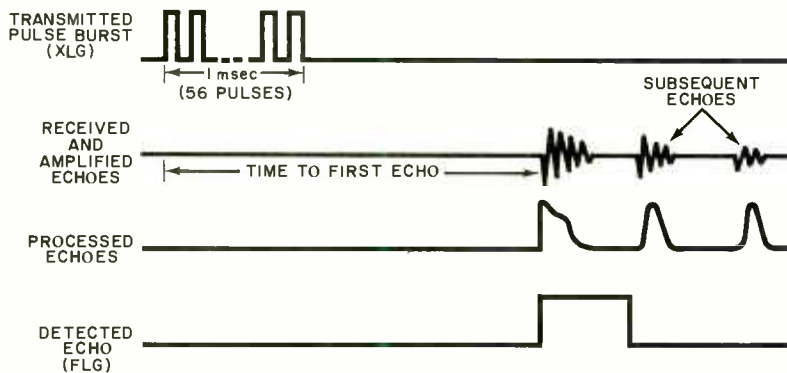

Fig. 6. Waveforms of the transmission and target detection sequence.

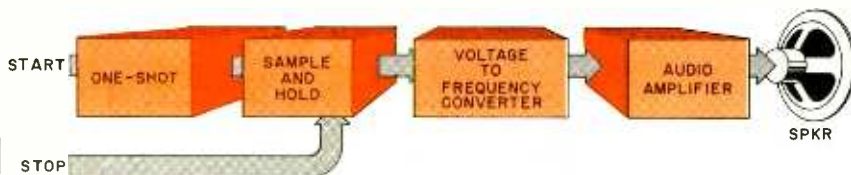

Fig. 7. Block diagram of audible output circuit.

## FIVE FOREIGN BANK NOTES-25¢



Money! Money! Money! It makes the world go around-and here's a collection of real foreign money that will bring you around to the exciting world of Foreign Bank Note collecting. You'll travel back in time to World War II with a Japanese occupation note of Malaya. You'll get a strange little note from Hong Kong. You'll also receive three other notes from Indonesia, China and Bulgaria-all for only 25¢. Also Fine Bank Notes from our approval service. Buy only what you like. **Return balance promptly!** Thank you. Order now!

Jamestown Stamp Co., B63PE  
Jamestown, NY 14701

MEMBER ASDA • APS • SPA

CIRCLE NO. 80 ON FREE INFORMATION CARD

### SEE YOUR DEALER TODAY

FROM



HERE'S A TIP  
THAT'S PERFECT!

AM/FM AUTO RADIO  
AND CB

**'Firestik'® II**  
GOLDEN SERIES

BARE-HANDS TUNABLE  
"NO TOOLS NEEDED"  
HIGH PERFORMANCE ANTENNAS

ALSO ANTENNAS FOR  
CORDLESS TELEPHONES  
MONITOR SCANNERS

Dealer & Distributor Inquiries Invited  
SEND FOR FREE CATALOG

'Firestik' Antenna Company  
2614 East Adams/Phoenix, AZ 85034

Name \_\_\_\_\_  
Street \_\_\_\_\_  
City \_\_\_\_\_  
State \_\_\_\_\_ Zip \_\_\_\_\_

Serving the CB and  
Communications Market Since 1962.

**5-YEAR REPLACEMENT WARRANTY**

CIRCLE NO. 26 ON FREE INFORMATION CARD

varies with the range to the detected target. Figure 7 shows in block diagram form an experimental circuit I've designed that converts the echo time to this rangefinder into a chirped tone. A single chirp is produced for each ranging cycle.

Briefly, an ultrasonic burst from the ranging system triggers a one-shot that, in turn, causes the capacitor in a sample-and-hold circuit to begin charging. When the echo is received, the capacitor stops charging and is immediately discharged by an analog switch. During the time before the echo is received, a voltage-to-frequency converter produces a tone whose frequency increases with the charge on the capacitor. The result is a series of chirps. Nearby targets (short echo time) give low-pitched chirps, while distant targets (long echo time) give high-pitched chirps.

**Circuit Operation.** Figure 8 shows the complete circuit for the chirper. In operation, *Q1* and *Q2* serve as input buffers for the XLG (start) and MFLOG (echo time) signals from the Ultrasonic Circuit Board. The XLG signal triggers a 555 timer (*IC1*) configured as an astable multivibrator. The output from *IC1* (pin 3) remains high for a time determined by *R7* and *C2*.

The MFLOG signal is ANDed by *IC2A* and *IC2B*, and, when both signals are present, analog switch *IC3A* is closed. This allows *C4* to be charged through *IC3A* and *R8*.

The 555 timer, *IC4*, is configured as a voltage-to-frequency converter tone generator. Its control input is connected directly to *C4*. Therefore, as *C4* begins to charge, the oscillation frequency of *IC4* begins to rise.

When the echo arrives, the MFLOG signal goes low and the AND gate out-

put also goes low. This opens *IC3A* so that *C4* is no longer charged. Simultaneously, *IC3B* is closed by *IC2A* and the voltage on *C4* is dumped to ground. The voltage-to-frequency converter immediately stops oscillating. Depending upon adjustments of *R7*, *R8* and *R9*, the audio output from the circuit ranges from low-pitched thumps (nearby objects) to high-pitched chirps (distant objects).

You can better understand the circuit's operation by referring to the oscilloscope waveforms in Figs. 9 and 10. The upper trace in Fig. 9 shows the 1 ms tone burst that is applied to the ultrasonic transducer by pin 16 of the Ultrasonic Circuit Board. The lower trace shows the square wave that begins with the transmitted tone burst and ends when the first echo is received. It appears at pin 15 of the Board.

Figure 10 shows the critical waveforms in the chirp generator circuit for three different target ranges (2.4', 6.3' and 9.5'). The upper trace shows how

the echo time is increased for each of these ranges. In one millisecond, sound travels approximately 0.89'. Therefore, the round trip time for the 9.5' range should be  $9.5' \times 2' \times 0.89'$  or 16.9 ms. This is in close agreement with the indication of about 16.75 ms on the lower trace in Fig. 12.

**Using the Circuit.** Operation of this circuit is very much dependent upon the settings of potentiometers *R7*, *R8*, and *R9*. Potentiometer *R7* controls the one-shot's pulse duration. If it is set to produce a pulse whose duration exceeds the time between range cycles (about 200 ms), the output sound will be a series of double or triple thumps or beeps.

Potentiometer *R8* controls the charging time of *C4*. If its resistance is too low, the voltage-to-frequency converter will produce a steady tone. If its resistance is too high, the voltage of *C4* may take too long to reach the levels required to alter the tone from *IC4*.

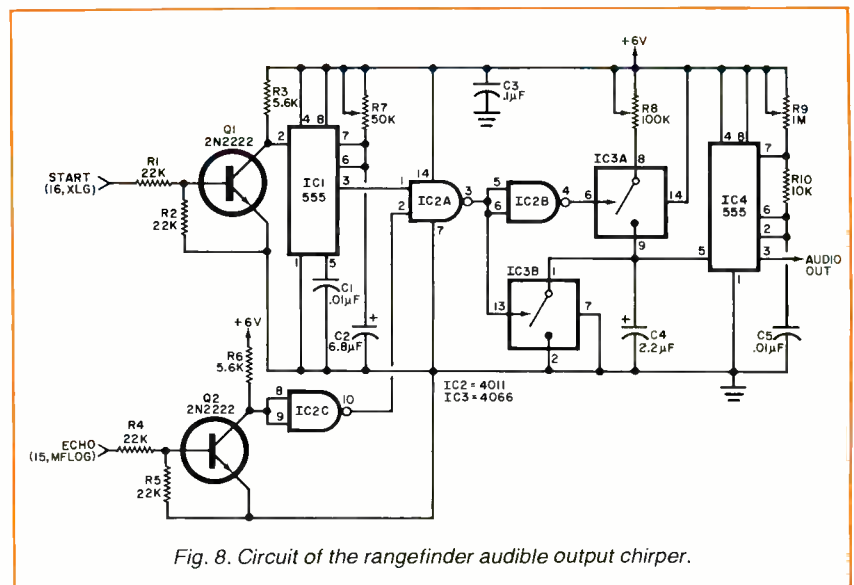

Fig. 8. Circuit of the rangefinder audible output chirper.

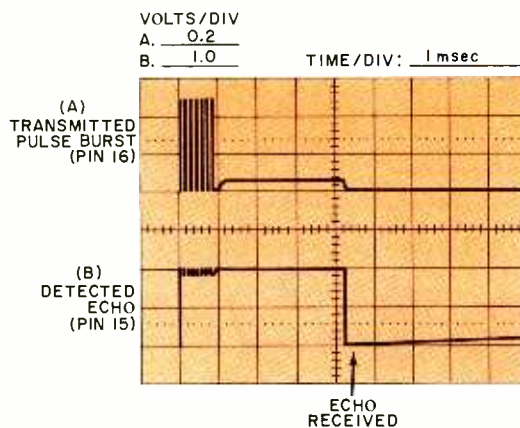

Fig. 9. Waveforms at target detection.

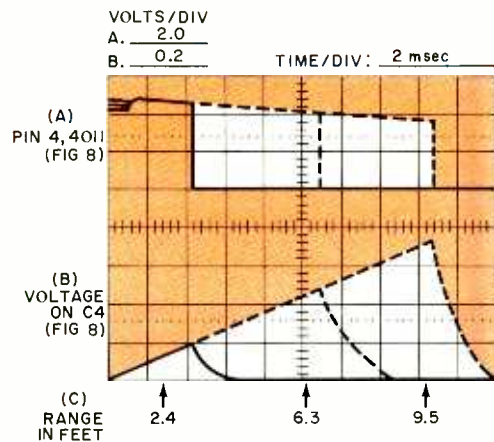

Fig. 10. Waveforms of audible output circuit.

If you own a Timex Sinclair, a ZX81, or any other Sinclair computer, you've probably discovered that the big microcomputer magazines cover only the bigger computers. Where can you find helpful articles on the Sinclair? In *Sync!*

*Sync* is the one magazine that's written exclusively about Clive Sinclair's marvelous inventions, the Sinclair computers. And it's the one magazine to read if you want to get more from your Sinclair.

You'll find program listings for games, helpful programming techniques, hardware upgrades, math and science programs, news of new products for the Sinclair—in short, everything you need to use and enjoy your Sinclair to the fullest.

In just two recent issues, for example, we covered:

- Putting a Reverse Character in a String
- How to Double Your Memory
- Least Squares Data Analysis With the ZX80/81
- Space Warp: A Graphics Space Game
- How to Reduce "Blank Screen Time"

- Storing Three-Letter Words in an Array
- Software Review: ZX Galaxians
- An Introduction to Expression Evaluation
- Short Programs Just for Fun
- The ZX81 Parser and User-Defined Commands
- Understanding Floating Point Arithmetic
- Handling Strings from Another Dimension
- Book Review: Understanding Your ZX81 ROM
- How to Add a Keyboard to Your Sinclair
- Translating Other Basics: DEF on the ZX81
- Six Outer Space Games—With Program Listings
- Hardware Review: Sinclair ZX Spectrum High Resolution Color/Sound Computer

If you own a Sinclair microcomputer, *Sync* is the only computer magazine you really need. Subscribe now to *Sync*, and you can save up to 33%! Just complete and return the postage-paid reply card or the coupon at right.

**SAVE UP TO 33%  
ON SYNC!**

**SYNC**

CN 1986 • Morristown, NJ 07960

**YES!** Please send me *Sync* for:

- One year (6 issues) for \$12.97—I save 19%.
- Two years (12 issues) for \$22.97—I save 28%.
- Three years (18 issues) for \$31.97—I save 33%.

Savings based on full 1-year subscription price of \$16.

Mr. \_\_\_\_\_  
Mrs. \_\_\_\_\_  
Ms. \_\_\_\_\_  
(please print full name) 8H10

Address \_\_\_\_\_ Apt. \_\_\_\_\_

City \_\_\_\_\_

State \_\_\_\_\_ Zip \_\_\_\_\_

**CHECK ONE:**

- Payment enclosed.  Bill me later.

Offer valid in U.S. and possessions only. Please allow 60 to 90 days for delivery of first issue.

**NEW SUBSCRIBERS ONLY**

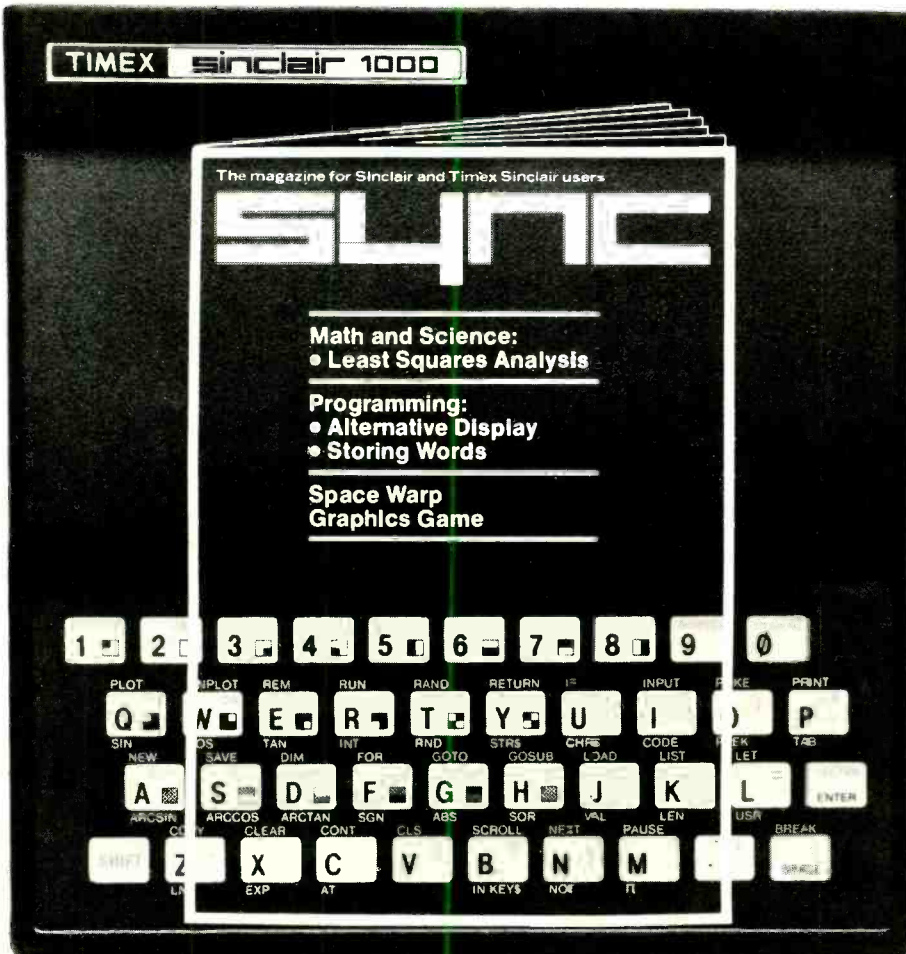

**FOR  
SINCLAIR  
AND  
TIMEX  
SINCLAIR  
OWNERS  
ONLY**

Finally,  $R9$  controls the pitch of the chirps. For best results, set  $R9$  to produce very-high-pitched chirps when the system is detecting very distant targets. Nearby targets will then give a characteristic thump . . . thump . . . thump . . .

**Going Further.** The circuit in Fig. 8 is not optimized, and many variations are possible. For example, you can replace  $C4$  with a piezoelectric alerter (Radio Shack part #273-065 or similar). The alerter will emit tone bursts whose duration is perceptibly longer when distant targets are being detected. Since all the bursts are brief, no matter what the range, longer pulses from the alerter seem louder than very short pulses. The overall effect provides an interesting alternative to the voltage-to-frequency converter chirped tone output.

### LM3905 Ap Note

**T**HOUGH less well-known than its 555 predecessor, the LM3905 is a precision timer with a host of applications. Capable of operating from unreg-

ulated supplies of 4.5 to 40 V, the LM3905 and its LM122/LM222/-LM322/LM2905 counterparts can provide constant timing periods ranging from microseconds to hours. Variations in the supply voltage alter the timing period by less than 0.005% per volt. Therefore, poorly or unregulated supplies with considerable ripple can be used. The chip typically consumes only 2.5 mA in the quiescent state (that is, no external load being driven).

Figure 11 is a straightforward on-after-delay timer given in National Semiconductor's data sheet on the LM3905. This circuit nicely simulates a thermal time-delay relay of the kind often used to apply power to a circuit at a fixed interval after a main switch is closed.

Operation of the circuit in Fig. 11 is straightforward. When  $S1$  is closed, the LM3905 enters a timing cycle with a duration of  $R1C1$  seconds. After the cycle is completed, the relay is actuated. Diode  $D1$  protects the LM3905 from back emf produced by the relay coil when  $S1$  is opened.

For variable delays, use a 1-megohm potentiometer for  $R1$ . For very long de-

lays, use large values for  $C1$ .

Incidentally, the circuit can be easily modified as shown in Fig. 12 to operate in the converse manner. In this configuration, which is also given in the LM3905 data sheet, the relay is closed when  $S1$  is closed. After a time interval of  $R1C1$  seconds, the relay is opened.

For those of you who are skeptical about circuits given in application notes, such as the two discussed here, you can be assured I've breadboarded both these timers. They work just as described.

## The Move to Lower Supply Voltages

**B**EFORE the end of this decade, 5-V logic systems may be as scarce as RTL chips and watches with LED displays. That's because a major move is now underway to standardize logic circuits for operation at 3 V.

Already most CMOS chips are specified for a minimum supply voltage of 3 V. A major impetus for the proposed new standard is that even this minimum is appreciably close to breakdown ratings as low as 5 V that characterize new smaller ICs.

Warren Andrews has reported in *Electronic Engineering Times* that the proposed new 3-V supply standard is slated to apply to both MOS and bipolar linear and digital chips (January 3, 1983). A committee of the Joint Electronic Devices Council (JEDEC) has already approved a 3.3-V ( $\pm 0.3$  V) standard for line-operated regulated supplies and a 2-to-3.6-V standard for battery powered operation.

Two supply standards will satisfy both TTL and MOS manufacturers. The tolerance margin of the 3.3-V standard for regulated supplies will guarantee that TTL circuits are powered by at least 3 V and, therefore, provide a comfortable margin above TTL's guaranteed minimum high-state output ( $V_{OH}$ ) of 2.4 V.

The battery supply standard covers a wider voltage range to allow for the great variety of battery chemistries and discharge characteristics. The 2-V minimum is within 10% of the 2.2-V potential of single lead-acid storage cells. The 3.6-V maximum matches the maximum for the recommended regulated supply voltage and leaves room for a single lithium cell (2.8 V), two mercury cells in series (2.7 V), two alkaline or carbon-zinc cells in series (3 V), or two nickel-cadmium storage cells in series (2.4 V).

The proposed new voltage standards must be approved by several additional

## Put Professional Knowledge and a COLLEGE DEGREE in your Electronics Career through HOME STUDY

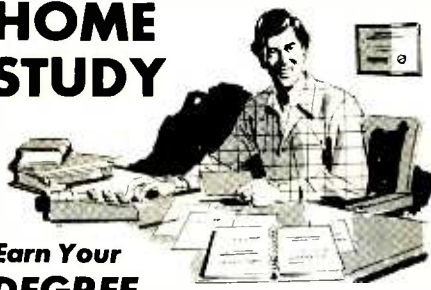

### Earn Your DEGREE

No commuting to class. Study at your own pace, while continuing your present job. Learn from easy-to-understand lessons, with help from your home-study instructors whenever you need it.

In the Grantham electronics program, you first earn your A.S.E.T. degree, and then your B.S.E.T. These degrees are accredited by the Accrediting Commission of the National Home Study Council.

Our free bulletin gives full details of the home-study program, the degrees awarded, and the requirements for each degree. Write for *Bulletin ET-83*.

**Grantham College of Engineering**  
2500 So. LaCienega Blvd.  
Los Angeles, California 90034

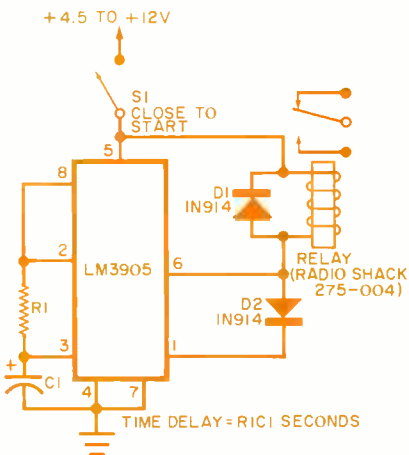

Fig. 11. On-after-delay timer.

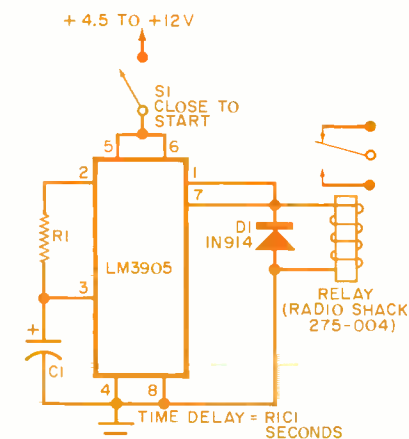

Fig. 12. Off-after-delay timer.



JEDEC committees before final consideration by the JEDEC council. David Ford, chairman of the JEDEC committee that proposed and approved the new standards, was quoted by *Electronic Engineering Times* as having said, "The reaction to the proposed standards is basically positive."

Adoption of the new standard will have several important long-term impacts on solid-state electronics. For example, line-powered supplies will require the development of 3-V regulator chips and low secondary voltage transformers. Three-volt zener diodes will become more widely available.

The most important result of the new standards will be even more growth in the variety and availability of portable battery-powered electronic devices. Certainly, single lithium 2.8-V power cells will become the battery of choice for nearly all such devices. We can therefore expect to see better availability and important price reductions for lithium cells.

Conventional mercury, alkaline, and carbon-zinc chemistries can also be used to meet the new standard, but only in a series arrangement of two cells. Meanwhile, the familiar 9-V transistor radio battery will eventually be relegated to older equipment and special-purpose applications. If competition drives prices down, single lithium cells might even capture a big share of the market that now exists for standard cells.

These speculations should be tempered with the knowledge that a continued reduction in IC fabrication dimensions may eventually require an even lower power supply standard of about 2 V or even less. If this occurs, new or modified battery chemistries may be required. In any event, the rapid advances in IC fabrication technology and the move to lower voltage standards are sure to bring many important changes.

## Device Developments

**The Iso-Gate™ Optoisolator.** Dionics, Inc. (65 Rushmore St., Westbury, NY 11590) announced more than a year ago the development of miniature integrated photovoltaic diode arrays. The company has recently introduced a series of novel optoisolators that employ an infrared-emitting diode and one or two of the new photovoltaic diode arrays to directly drive the gates of power MOSFETs. According to Bernard L. Kravitz, Dionics' president, "Since the output voltage of the Iso-Gate is self-limited by its very construction, it becomes physically impossible for an Iso-Gate to deliver a harmful voltage to the MOSFET."

Iso-Gates can enhance the design and reliability of both switching (for example, a solid-state relay) and analog MOSFET circuits. Kravitz observes, "Some examples of these non-relay MOSFET functions are amplification stages, motor-control circuits, and switching power regulators. In all of those, there is a great advantage in driving the delicate gate of the MOSFET with an optoisolated, self-generated, and self-limited voltage source that is truly 'floating.'" Since the output of the photovoltaic half of the new optoisolators is highly linear with respect to the forward bias applied to the infrared emitter, the new optoisolators may find applications in such linear roles as isolation amplifiers and frequency-to-voltage converters.

Figure 13 shows a typical Iso-Gate MOSFET driver circuit. The resistor  $R_{shunt}$  discharges the residual voltage

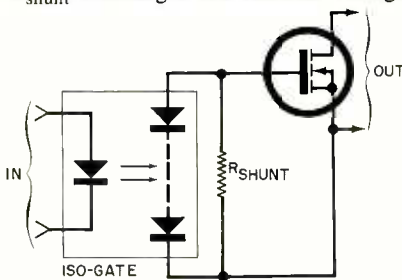

Fig. 13. Iso-Gate MOSFET driver.

remaining in the photovoltaic array (by virtue of its parasitic capacitance) when illumination from the infrared-emitting diode is suddenly removed. Depending upon the device, optimum values of  $R_{shunt}$  range from 1 to 10 megohms. For faster switching speeds, Dionics recommends paralleling the Iso-Gate with a phototransistor optoisolator or a second Iso-Gate.

Dionics now sells five Iso-Gates. The three devices in the DIG-11 series are installed in 6-pin DIPs. Included is a single infrared-emitting diode and photovoltaic diode array. They deliver a minimum self-generated, fully-floating, open-circuit output of 6 V when their infrared-emitting diodes are driven with a forward current of 30 mA. Depending upon the device, the short circuit output current ranges from 2 to 30  $\mu$ A. Prices in 1000-lot quantities range from \$1.32 to \$1.87.

The DIG-122 series includes two devices housed in 8-pin DIPs. These devices include two independent photovoltaic diode arrays which, when connected in series, deliver from 12 to 17 open-circuit volts. The short-circuit output current ranges from 1.5 to 9  $\mu$ A. In 1000-lot orders they are \$1.82 and \$2.13. (Continued overleaf)

# WE TAKE YOU BY THE HAND!

You'll learn all about computers: how to build, program, service, even play TV games—without knowing the first thing about it!



## The New ELF II "Beginners" Package

Your own Logic expandable micro-computer kit, 5 diagnostic analyzers plus circuit, programming, diagnostic manuals, even games you can play on TV. All only \$139.95.

Even if you don't know bits from bytes, now it's easy and inexpensive to build your own micro-computer. Learn how it works, program it, service it—even play games with it on your TV! It's here in the New ELF II "Beginners" Package, only from Netronics. Only \$139.95. Here's the package: 1. your own micro-computer, the famous ELF II (featuring the RCA 1802 CMOS microprocessor) in kit form with step-by-step instructions on how to build it. Diagnostic Analyzers including 2. your own Logic Probe. 3. Pulse Catcher. 4. 8 bit Test Register. 5. Logic Analyzer. 6. Gate Arrays. 7. Non-Technical Manuals on how to use analyzers, how to get into the guts of the computer, what makes it tick, how to service it. 8. Sample Programs that teach you machine language programming plus how to correct or "debug" any programming mistakes. 9. TV games you can play. If your TV set has no video input, an optional converter (RF Modulator), is available. Then, once you've got this "Beginners" Package under your belt, keep on expanding your ELF II with additions like the Typewriter Key Board, added RAM, Full Basic Interpreter, Electric Mouth Talking Board, Color/Music, A/D-D/A Boards for Robot Controls and much, much more. We'll take you by the hand with the New ELF II "Beginners" Package. Only \$139.95. Mail or phone in your order today and begin.

**Specifications ELF II "Beginners" Package**  
The computer features an RCA CMOS 1802 8 bit microprocessor addressable to 64K bytes with DMA, interrupt, 18 Registers, ALU, 256 byte RAM expandable to 64K bytes, Professional-Hex keyboard, fully decoded so there's no need to waste memory with keyboard scanning circuits, built-in power regulator, 5 slot plug-in expansion BUS (less connectors), stable crystal clock for timing purposes and a double sided, plated through PCB Board plus RCA 1861 video IC to display any segment of memory on a video monitor or TV screen along with the logic and support circuitry you need to learn every one of the RCA 1802's capabilities. The diagnostic analyzers add in understanding and trouble shooting your ELF II, as well as other computer and microprocessor products.

Continental U.S.A. Credit Card Buyers Outside Connecticut

**CALL TOLL FREE 800-243-7428**

To Order From Connecticut or For Technical Assistance, Etc..

Call (203) 354-9375

**NETRONICS R&D LTD.** Dept. C1-6  
333 Litchfield Road, New Milford, CT 06776

Please send the items checked below:

- ELF II "Beginners" Kit ..... \$139.95  
 RF Modulator ..... \$ 8.95

Plus \$3.00 for postage, handling and insurance  
(\$6.00 Canada)

Connecticut Residents add sales tax

**Total Enclosed \$** \_\_\_\_\_

- Personal Check  Cashier's Check/Money Order  
 Visa  Master Charge (Bank No. \_\_\_\_\_)

Acct. No. \_\_\_\_\_

Signature \_\_\_\_\_ Exp. Date \_\_\_\_\_

Print \_\_\_\_\_

Name \_\_\_\_\_

Address \_\_\_\_\_

City \_\_\_\_\_

State \_\_\_\_\_ Zip \_\_\_\_\_

**New Peripheral Controller Chips.**

Rockwell International's Electronic Devices Division (4311 Jamboree Rd., PO Box C, Newport Beach, CA 92660) has introduced four new single-chip, 8-bit intelligent peripheral controllers (IPC). These new controllers are actually 6502 microprocessors with on-chip hardware designed specifically to enhance their role as controllers of motors, printers, typewriters, robots, instruments, and communications equipment.

All four of the new IPCs include a parallel-host data bus compatible with the 6500/6800 and 8080/Z80 microprocessor families. They also include on-chip input, output, and status and control registers for data transfer functions. All four chips have on-chip 64 x 8 bit RAMs. Three of the chips have on-chip ROMs, thus making them well suited for motor and keyboard control, small printer line buffering, and many other peripheral control functions.

**New CMOS A/D Converters.** Texas Instruments has introduced a series of four analog-to-digital converter chips that are claimed to simplify the task of interfacing analog signals with 8- and 16-bit microprocessors. The new chips, designated TL530, TL531, TL532 and TL533, feature an 8-line TTL compatible bidirectional data bus. Also included are on-chip multiplexers and 16-bit analog and digital data registers. According to Texas Instruments, these features make it relatively simple for a microprocessor to collect multiple analog and digital inputs with a minimum of hardware and processing time.

Figure 14 shows these new chips and a block diagram summarizing their operation. The TL530 and TL531 are 40-pin units that can accept up to 15 analog

inputs and 12 digital inputs. The TL532 and TL533 are 28-pin chips that accept up to 11 analog and 6 digital inputs. Six of the inputs of all four chips are multipurpose and can accept either analog or digital signals. If some of these specifications seem familiar to experienced A/D users, it's because the TL530 and TL531 can be used as functional replacements for the 74C924 and MC144444; and the TL532 and TL533 for the 74C934.

These new chips feature maximum conversion times of 300 μs. They typically consume 15 mW and require a single 5-V supply. In 100-lot quantities, the TL533 sells for as little as \$4.32. Write Texas Instruments' Literature Response Center (SC-389, PO Box 202129, Dallas, TX 75220).

**A Fast CMOS UART.** Though CMOS consumes considerably less power than NMOS, CMOS has traditionally been slower. For this reason, CMOS is not yet widely used in fast data communications and interface applications.

Recently, National Semiconductor (2900 Semiconductor Drive, Santa Clara, CA 95051) introduced a new CMOS Universal Asynchronous Receiver-Transmitter (UART) fabricated with the firm's proprietary double-poly CMOS process, p<sup>2</sup>CMOS-11". The new chip, which is designated the NSC858, operates at up to 1 million bits per second. The chip typically consumes 50 mW. It includes a programmable on-chip baud-rate generator that can accept clock rates up to 3.1 MHz and divide them by 1 to 216.

In addition to various standard UART features, the NSC858 includes each of the five standard MODEM control functions, a processor interrupt system to minimize processing time required to control the UART, and complete hardware and software power-down capabilities. ◇

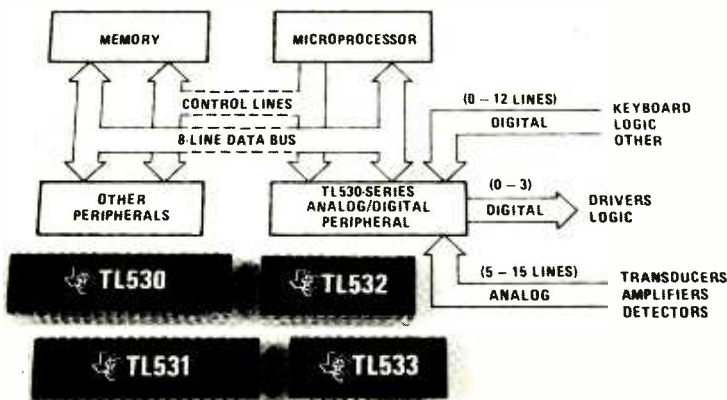

Fig. 14. Block diagram shows operation of TI's CMOS A/D converters.

# OPERATION ASSIST

If you need information on outdated or rare equipment—a schematic, parts list, etc.—another reader might be able to assist. Simply send a postcard to Operation Assist. COMPUTERS & ELECTRONICS, 1 Park Ave., New York, NY 10016. For those who can help readers, please respond directly to them. They'll appreciate it. (Only those items regarding equipment not available from normal sources are published.)

**Philco Model 46-1226-122** record player. Need schematic or out of print Sams Photofact 15-24. Lee Stirm, 3230 Collins, Garland, TX 75042.

**Measurements Model 80-R** signal generator. Need schematic. D. Boone, Box 330, Valley Mills, TX 76689.

**Rapid Printer Model 2001** printing calculator. Need schematic and service manual. Fred Feaver, 105 Townsend Ave., Burlington, Ontario, CAN L7T1Y8.

**Western Electric Model 300** data phone modem. Need schematics or technical information. Harold Wright, 7144 Center St., Highland, CA 92346.

**Dumont Type 274-A** cathode ray oscillograph. Need schematic and operating instructions. T. J. Laube, 6834 Alpert Dr., Orlando, FL 32810.

**Scott Marine Radio Model SLRM.** Need schematic and manual. Mike Curry, 3 Parnly St., Rumson, NJ 07760.

**Panasonic Model CT-702** television. Need schematic or any technical information available. Mike Adams, Box 411, Mt. Vernon, WA 98273.

**Aerotron Model 500** vhf transceiver. Need operating manual and schematic. Gerald Stephens, 1212 N. Monroe, Decatur, IL 62522.

**RCA tube manual.** Need manual printed in early 1940's. Alvin Smith, 1940 S. Dorh St., Ukiah, CA 95482.

**Lafayette Model RK-815** tape recorder. Need drive motor belt, operating manual and schematic. Michel Placias, 2029 Ala Wai PH2, Honolulu, HI 96815.

**General Radio Model 916A** bridge. Need generator and detector cable connectors. Ronald Dement, 755 Quincy Avenue, Bronx, NY 10465.

**Monsanto Type 105A** frequency counter. Need service manual and schematic. Jerry Barnes, 637 Pinehurst Drive., Richardson, TX 75080.

**Philips Model PR 9400** pH meter/voltmeter. Need schematic diagrams. Ignacio L. Aliaga, Apartado 299, Chiclayo, PERU

**RCA Model T7-5** radio. Need parts list and schematic. Garrard Model 6-300 turntable. Need parts and manual. Ron R. Backen, Box # 51, Lake Elsinore, CA 92330.

**Clegg Labs Model 99,** 6 meter transceiver. Need schematic and operating manual. Jimmy J. Cheek, 2202 Windover Dr., N.E., Huntsville, AL 35811.

**Hallcrafters Model S-120** receiver. Need schematic and operating manual. Bob Barteau, 4200 Vaile, Florissant, MO 63034.

**Knight Model KG-625** VTVM. Need schematic and manual. Bill Johnson, 8156 E. 31st Court, Tulsa, OK 74145.

**Hollingsworth Model P U-33/G** military 10 kw generator. Need schematic and service manual. Stan Lovingfoss, Crafton Hills College, 11711 Sand Canyon Rd., Yucaipa, CA 92399.

**Simpson Model 488** TV Field Strength Meter. **Deforest's Training Inc.** Model 101 2" oscilloscope panel. Need instruction manuals and schematics. H.E. Thompson, Box 15, Stouts Mills, WV 26439.

**RCA Model AR 8506 B** Radiomarine receiver and Model BC 474 A Receiver Transmitter. **Simpson Model 415** Signal Generator. **Dumont Model 247** Oscilloscope. Need schematics and service manuals. William D. Eramo, 51 Suffolk Ave., Revere, Mass. 02151.

... OPERATION ASSIST

**Realist Model TM/8 FM/AM tuner.** Need power transformer. N.P. Forcier, Haynes Ave., Middleton, MA 01949.

**Zenith Model 1600 transceiver.** Need schematic and manual. Ronald Slota, 38 Rhinestrip Ave., Wanaque, NJ 07645.

**Hickok Model 209-A VTVM.** Need calibration procedures. Howard Adams, 209 West Shadywood Dr., Midwest City, OK 73110.

**Packard Bell Model 98C32 TV.** Need transformer # 29985. **Accurate Instruments Model 257 tube tester.** Need panel meter. W. H. Voight, 60 Russell Rd., Albany, NY 12203.

**Galaxy Model R-530 receiver.** Need schematic. C. Baylor, 1222 E. Harrison, Wheaton, IL 60187.

**Hy-Gain Model GT550-A SSB transceiver.** Need schematic and service manual. Jose R. Sanabrais, Quintana Roo No. 31, Queretaro, Qro., 76000 MEXICO.

**Gonset Model GI50 FM communicator.** Need service data. Sam J. Esposito, 1961 Sunset Ave., Vineland, NJ 08360.

**Hallcrafters Model S-77-A receiver.** Need manual, schematic and troubleshooting information. Fernando Vioria, 1130 Conley St., Apt. D, Winston, Salem, NC 27105.

**Hallcrafters Model S-38B and S-77A receiver.** Need alignment information. Ronald Hotston, R.R. #2, Picton, Ontario, CAN K0K 2T0.

**Eico Model 435 oscilloscope.** Need schematic and technical manual. Bill Hendron, 581 Iroquois Terrace, Carol Stream, IL 60187.

**Heathkit Model IO-18 oscilloscope.** Need assembly and service manuals. Nick B. Troulinos, 129 B. Vas. Olgas St., Thessaloniki, Greece.

**Cornell-Dublier Model BF60 capacitance resistance bridge checker.** Robert Harsho, 1222 Leland Ave., Lima, OH 45805.

**Simpson Model 466 oscilloscope and Heathkit Model SQ-1 generator.** Need operating and service manuals. Richard L. Kincaid, 5572 Cedonia Ave., Baltimore, MD 21206.

**Knight Model KG-650 r-f generator and Precision Apparatus Corp., Series 600 electrometer tube analyzer.** Need schematics and operating manuals. Bob Niholson, 3423 Long St., Topeka, KS 66605.

**Tektronix Model RM45A oscilloscope.** Need plug-in unit for vertical amplifier. G. Bradley, 325 Dunbeath Ave., Winnipeg, Manitoba, Canada R2K0H2.

**General Electric Model 66B3 refrigerator.** Need schematic or any information available. Jerry Hockers, Route 5, Lost Lane, DePere, WI 54115.

**Hallcrafters Model S-38D radio.** Need schematic. Stan Messers, 530 Grassdale, Cartersville, GA 30120.

**ITT Model 3104/8B computer.** Need manuals and schematics. Kenneth Rimmel, 85 Windemere, Des Peres, MO 63131.

**Fanon Model TR1-35 amplifier.** Need schematic. Spencer Sedlmayr, Rural Route 1, Stoddard, WI 54658.

**Wang Model 629 cassette deck.** Need schematic. Dave Overton, 1709 W. 30, Austin, TX 78703.

**Pyramid Electric Co., Modl RC-1 ratio bridge.** Need schematic and user's manual. R. W. Beck, 466 Sharon, San Antonio, TX 78216.

**Knight-Kit Model KG-988 stereo receiver.** Need schematic and manual. Dan Witt, 45 E. Duck Lake Drive, Gobles, MI 49055.

**Datel Model 30-21-017 computer terminal.** Need manual and schematic. Marc H. Tofsted, 210 W. Beaver Ave., State College, PA 16801.

**Realistic Model 13-1180 tuner, catalog # 40-217 amplifier and RA-193 tuner amp.** Need schematics. J. L. Orysen, 2025 Sunkist Ave., Waukesha, WI 53186.

WHILE OTHERS PROMISE.... WE DELIVER

ORDER TOLL FREE (800) 221-8180 IN NEW YORK (212) 732-8600



**ATARI 800 (16K RAM) \$489**

**ATARI COMPUTERS**  
ATARI 400 \$239.95  
ATARI 1200XL 16K \$639

**ATARI HARDWARE**  
ATARI 1010 (Program Recorder) \$79.95  
ATARI 810 Disk Drive \$429.95  
ATARI 850 Acoustic Modem \$149.95  
ATARI 850 Interface Module \$169.95  
TARA C-52 32K Board \$64.95  
ALLEN GROUP Index Book \$99.95

**SOFTWARE LISTED BELOW COMPATIBLE WITH ATARI HOME COMPUTER SYSTEMS**  
**ATARI SOFTWARE**  
CX-4011 STAR RAIDERS \$34.95  
CX-4020 CENTIPEDS \$34.95  
CX-4022 PAC-MAN \$34.95  
CX-4024 GALAXIAN \$34.95  
CX-4027 DDK \$34.95

**ATARI PROGRAM EXCHANGE SOFTWARE**  
WORD PROCESSOR (Disk) \$44.95  
EASTERN FRONT (Disk) \$29.95  
747 LANDING SIMULATOR (Disk) \$19.95  
MAPWARE (Disk) \$21.90  
OUTLAW HOTTWIRE (Cass) \$19.90

**ON LINE SOFTWARE**  
CROSSFIRE (Disk) \$25.90  
FRODOG (Disk/Disk) \$25.90  
ULYSSES (Disk) \$25.95  
THRESHOLD (Disk 480) \$25.95  
MOUSE ATTACK (Disk 32K) \$31.90

**THORN EMI SOFTWARE**  
BRITISH HERITAGE PT. 1 (Cassette) \$24.90  
SUPERCLUES & SUP \$24.90  
FIGURE FLY (Cassette) \$24.90  
JUNIOR JET PILOT (Cartridge) \$24.90  
SUBMARINE \$39.95

**VIDEO GAMES**  
ATARI CX-5200 Video Game \$199.95  
VECTRIX VIDEO GAME \$159.95  
ATARI VIDEO GAME CX-2600 \$99.95  
MATEL INTELLIVISION II \$149.95  
MATEL INTELLIVISION \$69.95  
COLLISION (Video Game) \$179.95  
ODYSSEY VIDEO GAME \$84.95

**BLANK TAPES**  
MINIMUM ORDER 12 AUDIO TAPES  
MAXELL UDELTA C-90 \$2.79  
MAXELL XLI S-90 \$5.49  
SONY FCR-90 \$1.99  
TDK SA-90 \$2.58  
TDK SA-X-90 \$3.48

**STEREO-TO-GO**  
SONY WMS C-95 Stereo \$84.95  
SONY WMT J-18 Cass Stereo \$124.95  
SANYO MC-8 Cass Stereo \$29.95  
SANYO MC-160 Cass Stereo \$39.95  
ALWA HSP-02 Cass/Stereo/Auto Rec \$89  
ALWA HSP-02 FM/Cass/Stereo Rec \$129  
TOSHIBA KTR-1 FM/Cass/Stereo Rec \$149  
TOSHIBA KTR-3 FM/Cass/Stereo \$65  
TOSHIBA KTR-5 FM/FM/Cass/Stereo \$89  
PANASONIC RQ-220 Cass Dtdo \$124.95  
JVC PC-14 Sport Stereo \$245  
SONY KF-7600 Portable 9Band Short Wave \$95

**TEXAS INSTRUMENTS T199/4A (16K RAM) \$269.95**

**TI HARDWARE**  
PHP 1500 (Speech Synthesizer) \$114.95  
PHP 1500 (Telephone Modem) \$169.95  
PHP 1200 (Peripheral Expansion) \$179.95  
PHP 1220 (RS232 Card) \$129.95  
PHP 1850 (Disk Memory Drive) \$359.95  
PHP 1260 (32K RAM Card) \$219.95

**TIMEX SINCLAIR COMPUTER**  
TIMEX 1016 (16K RAM Expanded) \$64.95  
TIMEX SINCLAIR PRINTER 2040 \$89.95

**TIMEX SINCLAIR MEMOPAK**  
MEMOTECH 16K exp for Timex \$49.95  
MEMOTECH 32K exp for Timex \$89.95  
MEMOTECH 64K exp for Timex \$129.95  
MEMOTECH PERIPHERALS DESIGNED TO FIT TOGETHER IN PICGY-BACK FASHION

**TIMEX SINCLAIR SOFTWARE**  
TIMEX Flight Simulator \$18.95  
TIMEX FOOTER \$19.95  
TYRENT Arithmetic Baseball \$11.95  
SOFTSYNC Space Commando \$14.95  
SOFTSYNC Shark's Treasure \$14.95  
TIMESWORKS ROO. of Lost Tomb \$13.95  
TIMESWORKS Banana Game \$19.95  
XIBMC Cubik \$12.95  
XIBMC Battle \$12.95

**SHARP COMPUTERS**  
SHARP PC-1500 \$209.95  
PC-1250 (Pocket Computer) \$89.95  
PC-122 (Printer 1211) \$39.95  
PC-150 (Printer) \$174.95  
PC-151 (16K RAM Expansion) \$49.95  
PC-155 (16K RAM Expansion) \$99.95

**FLOPPY DISKS**  
MAXELL MD-1 (Box of 10) \$34.90  
SCOTCH 7450 (Box of 10) \$39.90  
ELEPHANT GOLD (Box of 10) \$34.90  
ELEPHANT YELLOW (Box of 10) \$29.90  
BASF FD-10 (Box of 10) \$29.90

**EDUWARE SOFTWARE**  
COMPMATH \$44.90  
PIAT WORD ATTACK \$29.90  
ALGEBRA \$29.90  
COMPUPELL LEVEL 4 \$17.90

**ON LINE SOFTWARE**  
MOUSEATTACK \$29.90  
CRUSH CRUMBLE CHOMP \$24.90  
FRODOG \$29.90  
ULTRAK \$44.90  
WIZARD AND PRINCESS \$26.90

**DEALER/INSTITUTIONAL INQUIRIES CALL (800) 221-3191 'OUR NAME MEANS A GREAT DEAL'**



**23 PARK ROW, DEPT. CE6, NYC, NY 10038**

**HOW TO ORDER BY MAIL:** FOR PROMPT AND COURTEOUS SHIPMENT SEND MONEY ORDER CERTIFIED CHECK CASHIER'S CHECK MASTERCARD VISA INCLUDE CARD NUMBER. INTERBANK EXPIRATION DATE AND SIGNATURE. DO NOT SEND CASH. PERSONAL AND BUSINESS CHECKS MUST CLEAR OUR BANK BEFORE PROCESSING. \$25 MINIMUM ORDER. Shipping, handling & insurance charge is 5% of total order with a \$3.95 minimum. We ship to continental U.S. ALASKA HAWAII PUERTO RICO AND CANADA ONLY (Canadian Orders Add 10% Shipping with a 7.95 minimum charge). For shipments by air, please double these charges. SORRY NO C.O.D.'S NEW YORK STATE RESIDENTS PLEASE ADD SALES TAX. ALL MERCHANDISE SHIPPED BRAND NEW. FACTORY FRESH AND 100% GUARANTEED.

**SEND FOR FREE 240 PAGE AUDIO/VIDEO CATALOG**

**STAR MICROCOMS GEMINI-10 \$329.95**

**STAR MICROCOMS GEMINI-10**  
+Friction Feed  
+100 CPS

**PRINTERS**  
EPSON FX-60 (Impact Feed 160 CPS) CALL  
EPSON MX-80 (8) CALL  
EPSON MX-100 (8) CALL  
SMITH CORONA Letter Quality Printer  
TP-110P (10/prec) \$599.95  
TP-112 (12/prec) \$599.95  
NEC PC-8023 (Impact Feed) \$449.95  
STAR MICROCOMS GEMINI-15 (100 CPS Full Size) \$449.95

**TYPEWRITERS**  
SMITH CORONA ULTRASONIC TYPEWRITER \$439  
NEC PC-8001A (32K RAM) \$689  
NEC PC-8031A (40K mini disk drive) \$685

**MULTITEK MPF-II \$349**  
16K RAM Color Apple Software Compatible

**APPLE & FRANKLIN SOFTWARE**  
ADVENTURE INTERNATIONAL SOFTWARE  
PREPARE (Disk) \$27.90  
PLANETOPS (Disk/Disk) \$27.90  
REAR GUARD (Disk/Disk) \$27.90  
SEA DRAGON (Disk) \$27.90  
TUNNEL TERROR (48K Disk) \$27.90

**BRODERBUND SOFTWARE**  
GENETIC DRIFT \$26.90  
SERPENTINE \$29.90  
STAR BLAZER \$26.90  
TRUCK ATTACK \$26.90

**EDUWARE SOFTWARE**  
COMPMATH \$44.90  
PIAT WORD ATTACK \$29.90  
ALGEBRA \$29.90  
COMPUPELL LEVEL 4 \$17.90

**ON LINE SOFTWARE**  
MOUSEATTACK \$29.90  
CRUSH CRUMBLE CHOMP \$24.90  
FRODOG \$29.90  
ULTRAK \$44.90  
WIZARD AND PRINCESS \$26.90

**DEALER/INSTITUTIONAL INQUIRIES CALL (800) 221-3191 'OUR NAME MEANS A GREAT DEAL'**



**23 PARK ROW, DEPT. CE6, NYC, NY 10038**

**HOW TO ORDER BY MAIL:** FOR PROMPT AND COURTEOUS SHIPMENT SEND MONEY ORDER CERTIFIED CHECK CASHIER'S CHECK MASTERCARD VISA INCLUDE CARD NUMBER. INTERBANK EXPIRATION DATE AND SIGNATURE. DO NOT SEND CASH. PERSONAL AND BUSINESS CHECKS MUST CLEAR OUR BANK BEFORE PROCESSING. \$25 MINIMUM ORDER. Shipping, handling & insurance charge is 5% of total order with a \$3.95 minimum. We ship to continental U.S. ALASKA HAWAII PUERTO RICO AND CANADA ONLY (Canadian Orders Add 10% Shipping with a 7.95 minimum charge). For shipments by air, please double these charges. SORRY NO C.O.D.'S NEW YORK STATE RESIDENTS PLEASE ADD SALES TAX. ALL MERCHANDISE SHIPPED BRAND NEW. FACTORY FRESH AND 100% GUARANTEED.

**SEND FOR FREE 240 PAGE AUDIO/VIDEO CATALOG**

**COMMODORE VIC-20 \$149**

**COMMODORE VIC-20**  
+5K RAM  
+Home Computer

**VIC-20 SOFTWARE**  
VIC 102 (Intro to Basic Pt. 1) \$33.90  
VIC 103 (Intro to Basic Pt. 2) \$33.90  
VIC 110 (Program Ref Guide) \$14.90  
VIC 1901 (Adventure) \$23.95  
VIC 1904 (SuperDoc) \$23.95  
VIC 1915 (Isador Art Race) \$24.95  
VIC 1914 (Adventure Land) \$23.95  
VIC 1915 (Isador Art Race) \$24.95  
VIC 1916 (Adventure Cover) \$28.95  
VIC 1919 (Sargon II Chess) \$28.95  
VIC 1920 (Sargon II Chess) \$28.95  
VIC 1923 (Golf) \$28.95  
VIC 1937 (Sea Wolf) \$24.95

**COMMODORE 64 HARDWARE**  
VIC 1211 (Super Expander) \$49.90  
VIC 1530 (Data Cassette) \$59.95  
VIC 1541 (Single Disk Drive) \$299.95  
VIC 1525 (Cable Printer) \$51.90  
VIC 1600 (Telephone Interface) \$94.95  
VIC 1111 (16K RAM Expander) \$34.95  
VIC 1011A (RS-232) \$44.95  
CARDBOARD & 40K Expander \$84.95

**COMMODORE 64 SOFTWARE**  
VIC 1211 (Super Expander) \$49.90  
VIC 1530 (Data Cassette) \$59.95  
VIC 1541 (Single Disk Drive) \$299.95  
VIC 1525 (Cable Printer) \$51.90  
VIC 1600 (Telephone Interface) \$94.95  
VIC 1111 (16K RAM Expander) \$34.95  
VIC 1011A (RS-232) \$44.95  
CARDBOARD & 40K Expander \$84.95

**KOSMIC KOMIKAZE (Cassette req) \$19.95**  
AMOK (Cartridge) \$29.95  
CLOUD BURST (Cartridge) \$29.95  
VERMIN (Cartridge) \$34.95  
OUTWORLD (Cartridge) \$34.95  
METEOR RUN (Cartridge) \$34.95  
SATILLITES (Cartridge) \$34.95  
VSI CAT. (Printer Req) \$19.95

**NUFECOP SOFTWARE FOR VIC-20**  
ALLEN PANK (Cassette) \$9.95  
ANTH-MATTER (Printer Cass) \$19.95  
DEFENDER ON TRI (Box 3K Equivalent) \$11.95

**EXTERMINATOR (Req VIC 1350) \$19.95**  
INVASION (Cassette) \$9.95  
JOURNEY (Cassette) \$9.95  
KRAZY KONG (Cassette) \$9.95  
DARK (Cassette) \$9.95  
RESCUE (Cassette) \$9.95  
SEARCH (Cassette) \$9.95  
SPACE QUEST (Cassette) \$14.95  
TARGET (Cassette) \$9.95  
VIC MAN (Cassette) \$9.95

**HES SOFTWARE FOR VIC-20**  
AGGRESSOR (Cartridge) \$29.95  
CONCENTRATION (Cassette) \$19.95  
GRID RUNNER (Cartridge) \$29.95  
PAK BOMBER (Cassette) \$44.95  
SYNTHESOUND \$14.95  
LASER BLITZ (Cassette) \$14.95  
HESSWRITER (Word Proc) \$34.95  
VICTREX (Cassette) \$14.95

**NEC C1202A +12 Color Monitor \$299**



**MONITORS**

TI PHA 4100 (10" Color) \$119  
SONY BX-1211 (12" Color) \$639  
QUASAR UP-1762 (7" Color) \$319  
NEC C1202A (12" Color) \$299  
PANASONIC CT-160 (10" Color) \$299  
PANASONIC CT-7711 (7" Color) \$449  
USI PI-119 (Green) \$129.95

**FREE McIntosh STEREO CATALOG and FM DIRECTORY**

Get all the newest and latest information on the new McIntosh stereo equipment in the McIntosh catalog. In addition you will receive an FM station directory that covers all of North America.

McIntosh Laboratory Inc. CE  
East Side Station P.O. Box 96  
Binghamton, N.Y. 13904-0096

NAME \_\_\_\_\_  
ADDRESS \_\_\_\_\_  
CITY \_\_\_\_\_ STATE \_\_\_\_\_ ZIP \_\_\_\_\_

**SEND TODAY!**

If you are in a hurry for your catalog please send the coupon to McIntosh. For non rush service send the Reader Service Card to the magazine.

CIRCLE NO. 31 ON FREE INFORMATION CARD

## Wall Transformers AC and DC Types

Part No.	Input	Output	Price
AC 250 (Pictured)			
AC 250 (above)	117V/60Hz	12VAC 250mA	\$3.95
AC 500	117V/60Hz	12VAC 500mA	\$4.95
AC1000	117V/60Hz	12VAC 1 amp	\$5.95
AC9004	117V/60Hz	9.2VAC 2.5 amp	\$3.95
DC 800	120V/60Hz	8VDC 400mA	\$1.95
DC6912	120V/60Hz	6.9VDC 300mA	\$6.95
DC5490	117V/60Hz	9.5VDC 275mA	\$2.95
DC590	120V/60Hz	9VDC 500mA	\$2.95
DC1200	120V/60Hz	9.5VDC 300mA	\$2.95
DV9200	117V/60Hz	9VDC 200mA	\$3.25

## PCB-3 Makes Circuit Assembly A Breeze!

Lets you work with both hands. Sturdy aluminum construction. Clamp "3rd Hand" on edge of bench table or workboard. Insert circuit board, position components. Notice convenient working angle. Flip circuit board to flat position for soldering and clipping. Reverse procedure for double-sided boards.

PCB-3 ..... \$13.95  
 Extension to hold PCB-3 2" from bench and 6" from front edge. PCB-X ..... \$6.95

## Mostek DC/DC Converter +5 VOLTS TO -9 VOLTS

Input: +5V Output: 9V (regulated) @ 30mA  
 Printed circuit mounting. Specifications incl.  
 DC10 ..... \$2.95 ea. or 2/\$4.95

## Jameco Digital Thermometer Kit

Dual sensors - switch controls for indoor/outdoor or dual monitoring - can be extended to 500 feet. Continuous LED 8" int. display. Range: 40°F to 199°F, 40°C to 100°C. Accuracy ±1° nominal. Calibrate for Fahrenheit/Celsius. Simulated without case. AC wall adapter included. Size: 6 1/2" x 3 1/2" x 1 1/2".  
 JE300 ..... \$39.95

## RADIO CONTROL CIRCUITS

Ideal to use for:  
 • Toys, hobby crafts, robots, trains  
 • Burglar alarms • IR data links  
 • Remote slide projector control  
 • Consumer remote data links  
 • Energy-saving, remotely switched lighting systems

A complete 6-channel digital encoder and RF transmitter; low power, at frequency of 27MHz or 49MHz, or field strength of 10,000V meter at 3 meters. 9V operation on chip RF oscillator/transmitter, on chip 4.6 regulator. Up to 800MHz carrier frequency operation.

LM1871N	RC Encoder/Transmitter Chip	\$1.95
A complete RF receiver/decoder	as at either 27MHz, 49MHz or 72MHz. It provides 4 independent channels when used with LM1871 (2 analog, 2 dig.) operates from four 1.5V cells. Crystal controlled.	
LM1872N	RC Receiver/Decoder Chip	\$2.49
SRX1504	49.435MHz Crystal (LM1872N)	\$3.95
SRX1505	49.890MHz Crystal (LM1871N)	\$3.95

## ATARI

**ATARI PADDLES**  
 JSP (2) ..... \$4.95 pair

**ATARI DRIVER**  
 JSD (1) ..... \$2.95 ea.

**TV GAME SWITCH**  
 Used on Atari. Cosmetically blemished. 100% functional.

TGS-1 ..... \$2.95 ea.

## BOOKS

NATIONAL SEMICONDUCTOR — INTERSIL — INTEL		
30002	National Interface Data Book (1980). (704 pages) DP, DS9001, DS3000, DS5700, etc.	\$6.95
30003	National Linear Data Book (1982). (1376 pages) LM, LF, DAC, ADC, LH Series	\$11.95
30005	National TTL Logic Data Book (1981). (624 pages) 7400, LS, L, S, and DM8000 Series	\$9.95
30008	National Memory Data Book (1980). (464 pages) RAMs, ROMs, PROMs, EPROMs Series	\$6.95
30009	Intersil Data Book (1983). (1356 pages) Complete line.	\$9.95
30010	National Audio/Radio Handbook (1980). (240 pages) Pre-amps, AM, FM & FM Stereo, Power Amps	\$5.95
30011	National Linear Application Handbook (1980). (736 pages) Application Notes, Linear Briefs, etc.	\$15.95
30012	National PAL Data Book (1982). (176 pages) Application Notes, Linear Briefs, etc.	\$5.95
30013	Zilog Data Book (1983). (641 pages) Microprocessors and Support Chips	\$7.95
210830	Intel Memory Components Handbook (1983). (796 pages) Contains all Application Notes, Article Reprints, Data Sheets, and other design information on Intel's RAMs, EPROMs, EEPROMs & Bubble Memories	\$14.95
210844	Intel Microprocessor & Peripheral Handbook (1983). (1027 pages) Contains Data Sheets on all of Intel's Microprocessors and Peripherals.	\$14.95

## Universal Computer Keyboard Enclosures

UTE Blank Desk-Top Enclosures are designed for easy modification. High strength epoxy molded end pieces in macho brown finish. Sliding rear/bottom panel for service/component access. Top/bottom panels: 100% thick alum. die-cast type 1200 finish (gold trim color) for best paint adhesion after modification. Ventured top & bottom panels for cooling efficiency. Rigid construction provides unlimited applications. Assembly instructions included.

DTE-8 Panel Width 7.5" ..... \$24.95  
 DTE-11 Panel Width 10.13" ..... \$27.95  
 DTE-14 Panel Width 13.5" ..... \$29.95  
 DTE-20 Panel Width 19.25" ..... \$34.95

# TIMEX sinclair 1000

• Powerful - fully programmable 2K memory • Portable - 6 1/2" x 6 1/2" x 1 1/2" oz. • Expandable - Optional 16K RAM module • Single-key entry commands • Educational • Unique syntax-check report codes for error identity • Accurate to 9 1/2 decimal places for full range math and scientific functions • Graph drawing and animated display • Advanced 4-chip design combining power, portability and affordable price.



TS1000 ..... \$69.95

## ACCESSORIES FOR TIMEX sinclair 1000 and ZX81

TIMEX sinclair 1016 Expansion from 2K to 16K. Size: 3" x 2 1/2" x 1 1/2" Ser TS1016 \$49.95

Keyboard Mask for Your ZX81/1000\* Computer ..... \$9.95 each  
 ZX81/1000\* Keyboard Conversion Kit ..... \$59.95 ea.

**Keyboard Mask for Your ZX81/1000\* Computer**  
 The JE681 Keyboard Mask provides users of the ZX81/1000 Series computer the individual feel of each keypad on the keyboard. The mask has a raised outline around each keypad allowing the user to feel and correctly position their fingers onto the keyboard.  
 JE681 KEYBOARD MASK ..... \$9.95 each

**ZX81/1000\* Keyboard Conversion Kit**  
 The JE682 Kit provides users of the ZX81/1000 Series computer a full size in dual in-line package home use keyboard. The JE682 Kit allows the use of either the full size keyboard or the Sinclair/1000 keyboard. The Kit also permits the simple disconnection of the Sinclair/1000 keyboard. The JE682 Kit consists of a full size industrial grade keyboard with 62 keys & 2 1/2 boards 24" ribbon cable, DIP socket and ribbon level. The keyboard conversion kit can easily be mounted onto the DTE kit enclosure. This enclosure is large enough to contain the ZX81/1000 computer, and the full size keyboard together. A handy label representing the ZX81/1000 keyboard layout is placed on the enclosure.  
 JE682 Keyboard Conversion Kit ..... \$59.95 ea.  
 (WITH DTE CASE) ..... \$49.95 each  
 DTE AK CASE ONLY ..... \$99.95 ea.  
 JE682 AK Keyboard Conversion Kit ..... \$59.95 ea.  
 (WITH DTE AK CASE - AS PICTURED)

## 80-Key Keyboard CONTROL DATA KEYBOARDS

★ Parallel ASCII  
 ★ SPST Switching  
 ★ FTZ Shielded Base  
 ★ N-Key Rollover  
 ★ 128 Character ASCII  
 ★ Non-Slip, Non-Glare Keycaps  
 ★ CDC752 Terminal Keyboards  
 ★ Attractive Case

These Control Data Keyboards consist of a base, cover, the keyboard assembly, and an interface cable. (Color case): Harvest gold and black. Color (keycaps): Black, blue, and red. Electrical requirements: +5V @ 600mA, -12V @ 50mA. Weight: 6 lbs. All units brand new in original boxes, specifications included.

CA150C	80-Key Keyboard	\$69.95
CA153A	84-Key Keyboard	\$69.95
CA154A	95-Key Keyboard	\$79.95

## Keytronics 90-Key Soft-Programmable Keyboard

WITH SECURITY KEYLOCK SWITCH

Made for Visual Technology, this keyboard features: a security keylock (includes two keys) to guard against unauthorized use; an 11-key numeric keypad; cursor controls; and 10 user-programmable keys. Electrical requirements: +5VDC. Color (case): White. Color (keycaps): Black. Complete with case, keyboard assembly, 40-inch interface cable, and schematics.

Part No. KB270 ..... \$109.95 each

**MICRO SWITCH 85-KEY KEYBOARD**  
 World Packaged Keyboard, 28 Pin Edge Card Connection, Supply Voltage +5VDC. Main Keyboard is DWERTY. Additional Key Pads for Cursor and word processing functions.  
 Part No. 85SD18-1 ..... \$29.95 each

**HI-TEK 14-KEY NUMERIC KEYPAD**  
 SPST switching. Charcoal grey keycaps. Mounted on printed circuit board.  
 Part No. K-14 ..... \$9.95 each

**ALPS 29-KEY CALCULATOR KEYBOARD**  
 Features one 8-position decimal select switch, one 3-position switch, and two 2-position switches; mechanical SPST switching; 22-pin edge card connection. Pin-out included.  
 Part No. KB297040 (Fits DTE-11 Enclosure) ..... \$4.95 each

**POWER SUPPLY +5VDC @ 1 AMP REGULATED**  
 Output: +5VDC @ 1A (also +30VDC) reg. Input: 115VAC 60Hz. 2-tone (black/beige) self-enclosed case. 6 1/2" x 3 1/2" x 2 1/2" cabinet power cord. 6 1/2" x 7 1/2" x 2 1/2". Wt. 3 lbs. Data sheet incl.  
 Part No. PS5119AS ..... \$14.95 each

**POWER SUPPLY +5VDC @ 3 AMP REGULATED**  
 Output: 115VAC, 47-440Hz. Output: 5VDC @ 3 amp. 5VDC @ 2.5 amp. Adjustable current limit. Ripple & Noise: 10mV rms, 5MV p-p @ 2 mounting surfaces. UL recognized. Size: 4" W x 4 1/2" L x 2 1/2" H. Wt. 6 lbs. Data sheet included.  
 Part No. QPS1 ..... \$29.95 each

**POWER SUPPLY +5VDC @ 7.5 AMP, 12VDC @ 1.5 AMP SWITCHING**  
 Input: 115VAC 50-60Hz @ 3 amp. Output: 5VDC @ 7.5 amp. 12VDC @ 1.5 amp. 8 1/2" h. 10" w. 1 1/2" d. 13 1/2" x 13 1/2" x 3 1/2" H. Wt. 6 lbs.  
 Part No. PS94V05 ..... \$39.95 each

**POWER SUPPLY 4-Channel Switching - Apple Compatible**  
 Microprocessor, mini-computer, terminal, medical equipment and process control applications. Input: 90-120VAC, 47-440Hz. Output: +5VDC @ 5A, -5VDC @ 1A, +12VDC @ 1A, -12VDC @ 1A. Line reg. ±0.2%. Ripple 30mV p-p. Load reg. ±1%. Overcurrent protection. Adj. 5V main output ±10%. 6 3/8" x 1 7/8" W x 4 1/8" H. 1 1/2" lbs.  
 Part No. FCS-604A ..... \$69.95 each

\$10.00 Minimum Order - U.S. Funds Only  
 California Residents Add 6 1/2% Sales Tax  
 Shipping - Add 5% plus \$1.50 Insurance  
 Send S.A.S.E. for Monthly Sales Flyer!

Spec Sheets - 30c each  
 Send \$1.00 Postage for your  
 FREE 1983 JAMECO CATALOG  
 Prices Subject to Change

Call for Quantity Discounts

**Jameco ELECTRONICS**  
 NEW! Telex Number Telex 176043

1355 SHOREWAY ROAD, BELMONT, CA 94002  
 6/83 PHONE ORDERS WELCOME - (415) 592-8097 Telex: 176043

## 5 1/4" Mini-Floppy Disk Drive

FOR TRS-80 MODEL II Industry Standard  
 Features: single or double density. Recording mode: FM single, MFM double density. Power: +12VDC (±0.6V) 1.5A max. -5VDC (±0.25V) 0.8A max. Unit as pic. at right (does not include case, power supply, cables). 30 page data book incl. Wt. 3 1/2 lbs. Size: 5 1/4" W x 8 1/2" x 3 1/4" H.  
 Part No. Limited Quantity! Price

FD200 ..... \$179.95  
 Single-sided, 40 tracks, 250K bytes capacity

FD250 ..... \$199.95  
 Double-sided, 35 tracks, 438K bytes capacity

## Siemens 8" Floppy Disk Drive

• Shugart 801R compatible  
 • Single-Sided  
 • 77 Tracks  
 • 400/800 Bytes/Track  
 • Industry Standard

The FDD100-8" Floppy Disk Drive (Industry Standard) features single or double density. Recording mode: FM single, MFM double density. Transfer rate: 250K bits/sec. single density, 500K bits/sec. double density. The FDD100-8" is designed to work with the single-sided soft sector IBM Quikrete 1 or 8" disk cartridge. Power: +15VAC @ 50/60Hz, +24VDC @ 1.7 amp max., +5VDC @ 1.2 amp max. (Unit as pictured above does not include case, power supply, or cables). Size: 8.55" W x 14 1/4" x 4.5" H. Weights 12 lbs. Incl. 96 pg. manual.

Part No. Price  
 FDD100-8 Buy 1 for ..... \$269.95 each  
 FDD100-8 Buy 2 for ..... \$259.95 each  
 FDD100-8 Buy 10 for ..... \$249.95 each



## 7208, 2716, 2732 & 2764 EPROM Programmer

**JE664 EPROM PROGRAMMER**  
 8K TO 64K EPROMS - 24 AND 28 PIN PACKAGES  
 Self-Contained - Requires No Additional Systems for Operation

• Programs, validates, and checks for properly erased EPROMs • Emulates PROMs or EPROMs • RS232C Computer Interface for adding/program loading • Loads data into RAM by keyboard • Changes data in RAM by keyboard • Loads RAM from an EPROM • Compares EPROMs for content differences • Copies EPROMs • Power input: 115VAC, 60Hz, ±10% power consumption • Enclosure, Color-coordinated, light tan plastic w/molded macho brown end pieces • Size: 15-5/8" x 8-3/4" x 3 1/2" • Wt. 5 1/2 lbs.

JE664-A EPROM Programmer ..... \$995.00  
 Assembly & Test Kit included, JM 15A Module

**JE665 - RS232C INTERFACE OPTION** - The JE665 RS232C interface option implements complete access to the JE664's RAM. Sample software written in BASIC provided for TRS-80 Model I/II. Level II Computer. Baud rate 9600 Word (8 bits) odd parity. Stop bits: 2. Option may be adapted to other computers.

**JE664-ARS EPROM prog. w/ JE665 Option** ..... \$1195.00  
 JUMPER MODULE - The JE664 JUMPER MODULE (Personal Module) is a plug-in Module that pre-sets JE664 for proper programming pulses to the EPROM & configures EPROM socket connections for that particular EPROM Part.

No.	EPROM	EPROM MANUFACTURER	PRICE
JM08A	2708	AMD Motorola, National, Intel, TI	\$14.95
JM16A	2716, TMS2516	Intel, Motorola, National, NEC, TI	\$14.95
JM16B	TMS2716	Motorola, TI (+5, -12 +12)	\$14.95
JM32A	TMS2532	Motorola, TI	\$14.95
JM32B	2732	AMD, Fujitsu, NEC, Hitachi, Intel	\$14.95
JM32C	2732A(21V)	Fujitsu, Intel	\$14.95
JM4A	MC68B76A	Motorola	\$14.95
JM4B	MC68B76A	Intel	\$14.95
JM4C	TMS2564	TI	\$14.95
JM4D	HM482764G-4	Hatch (21V)	\$14.95

## UV-EPROM Eraser

8 Chips - 51 Minutes  
 1 Chip - 37 Minutes

Erases 2708, 2716, 2732, 2764, 2516, 2532, 2564. Erases up to 8 chips within 51 minutes (1 chip in 37 minutes). Maintains constant exposure distance of one inch. Special conductive foam liner eliminates static build-up. Built-in safety lock to prevent UV exposure. Compact - only 9.00" x 3.70" x 2.60". Complete with holding tray for 8 chips.

UVS-11EL Replacement Bulb ..... \$16.95  
**DE-4 UV-EPROM Eraser** ..... \$79.95

## EXPAND YOUR MEMORY

TRS-80 to 16K, 32K, or 48K  
 \*\*Model 1 = From 4K to 16K Requires (1) One Kit  
 Model 3 = From 4K to 48K Requires (3) Three Kits  
 Color = From 4K to 16K Requires (1) One Kit

\*\*Model 1 equipped with Expansion Board up to 48K Two Kits Required  
 One Kit Required for each 16K or Expansion

TRS-16K3 \*200ns for Color & Model III ..... \$12.95  
 TRS-16K4 \*250ns for Model I ..... \$10.95

## TRS-80 Color 32K or 64K Conversion Kit

Kit comes complete with 8 each 4164-2 (200ns) 64K dynamic RAMs and conversion documentation. Converts TRS-80 color computers with D and C circuit boards and all new color computers to 32K. Minor modifications of 32K memory will allow the use of all 64K of the dynamic RAM providing you have a FLEX DOS operating system.

TRS-64K2 ..... \$54.95

## JOYSTICKS

JS-5K	5K Linear Taper Pots	\$5.25
JS-100K	100K Linear Taper Pots	\$4.95
JS-150K	150K Linear Taper Pots	\$4.75
JVC-40	40K (2) Video Controller in Case	\$4.95
JS-5K (Pictured)		
JS KNOB	Knob for JS5K, 100K, 150K	\$9.95 ea.
JVC KNOB	Knob for JVC-40	\$9.95 ea.

# NEW—THE BEST OF SYNC

Here's an all-new collection of articles and programs that appeared in the first six issues (now out of print) of *Sync* magazine. Chapters include: *Games, Math and Math Graphics, Software Programming Techniques, Translation, Graphics, Machine Language, Hardware, Resources, Reviews, Glossary*—and more!

In *The Best of Sync, Volume One*, you'll find games like "Forest Treasure"...plans for a "Key Click Generator"...techniques for "Handling Character Strings in the ZX80" and "Converting from other BASICs"—and many other hard-to-find programs, reviews and procedures.

If you own a Sinclair ZX80, ZX81 or Timex Sinclair 1000, this is one book you can't afford to miss. Order your copy now!

8½" x 11", softcover **ONLY \$9.95!**

For faster service,  
PHONE TOLL FREE: 800-631-8112  
(In NJ only: 201-540-0445)



Also available at your local bookstore or computer store.

## CREATIVE COMPUTING PRESS

Dept NB4Q 39 East Hanover Avenue, Morris Plains, NJ 07950

Please send me \_\_\_\_\_ *The Best of Sync, Volume One*, at \$9.95\* plus \$2.00 postage and handling each. Outside USA add \$3.00 per order. #6M

PAYMENT ENCLOSED \$ \_\_\_\_\_ \*Residents of CA, NJ and NY State add applicable sales tax.

CHARGE MY:  American Express  MasterCard  Visa

Card No. \_\_\_\_\_ Exp. Date \_\_\_\_\_

Signature \_\_\_\_\_

Mr./Mrs./Ms. \_\_\_\_\_ (please print full name)

Address \_\_\_\_\_ Apt. \_\_\_\_\_

City/State/Zip \_\_\_\_\_

Send me a FREE *Creative Computing Catalog*.

QUALITY  
SERVICE  
AVAILABILITY



ACTIVE, YOUR  
NUMBER ONE  
CHOICE

# Active Electronics

WE ARE THE LARGEST BECAUSE WE ARE THE BEST.  
Over \$40 million in stock. The world's most complete hobbyist inventory.

Active Electronics is your one stop source for the widest variety of top quality semiconductors, microprocessors, memories, microcomputer systems, peripherals and electronic components.

## NEW — 1983 IC MASTER

The FIRST add ONLY complete guide to IC's, Microcomputer Boards and Development Systems.

Deluxe 2 volume set  
3300 pages  
Regular Price: \$95.00



Call or write for our FREE comprehensive catalogue. If you work with electronics you shouldn't be without it!

ACTIVE'S PRICE  
ONLY \$79.95

Circle No. 50 on free information card or write:  
P.O. Box 8000, Westboro, Mass. 01581

CALL TOLL FREE: 1-800-343-0874  
MASS. customers call (617) 366-0500

CIRCLE NO. 50 ON FREE INFORMATION CARD

# FIREWORKS

**FIRE CRACKERS** *Rocket's*  
**Sparklers**  
**FOUNTAINS**

MAJOR CREDIT CARDS ACCEPTED

WE SHIP TO ALL 50 STATES

**THOUSANDS OF ITEMS TO CHOOSE FROM**

Full Color Catalog Kit—\$2.00  
REFUNDABLE WITH YOUR FIRST ORDER

Toll Free Nationwide  
**1-800-321-6001**

Name \_\_\_\_\_  
Address \_\_\_\_\_  
City \_\_\_\_\_  
State \_\_\_\_\_ Zip \_\_\_\_\_

PLEASE PRINT TO ASSURE PROMPT CATALOG DELIVERY!

**FIREWORKS UNLIMITED**



8550 ROUTE 224 \* DEERFIELD, OHIO 44411

CIRCLE NO. 74 ON FREE INFORMATION CARD

**NOW!**

## GET IBM-PC Capacity at a Fraction of IBM's Price!

New NETRONICS 16 Bit EXPLORER 88-PC Kit  
Starts at Just \$399.95 - Accepts All IBM Peripherals.

It's true! Now you can enjoy the power of the Intel 8088—the same microprocessor which powers the IBM-PC—and run any program compiled for the IBM-PC...starting at only \$399.95!

Take this easy, low cost way to learn 16-bit technology! Two-board system features:

1. 8088 mother board with 5-slot expansion bus; accepts any hardware designed for IBM-PC; and
2. 64K memory board, expandable to 256K; with IBM compatible RS232 communications port.

Any disk-operating system which works on the IBM will work directly on the EXPLORER 88-PC, and all programs compiled for the IBM will run on it.

The system monitor ROM included in the Starter system features a user-friendly operating system that allows easy program generation and debugging. The commands include display/modify memory...display/modify registers...input/output data to 1/0 ports...block moves...single-step trace mode...go/run with optional breakpoint and register reports...cassette load/save with file labels...plus a complete system test program that tests and reports condition of ROM, RAM, cassette interface, timer, OMA controller, interrupt controller, and the communications port. These test programs not only allow easy debugging of software but they serve as hardware and software learning tools.

The EXPLORER 88-PC STARTER KIT includes a mother board, memory/I/O board, all components needed, sockets for IC's used, one 62-pin bus connector and complete assembly/test instructions. All you need is a soldering iron, solder, a power supply, and a standard RS232 terminal (Netronics has 2 low-cost ones to choose from).

- Explorer 88-PC Starter Kit...\$399.95 + 1.00 p&i  
 wired & tested, add \$100.00  
 Extra 62-pin connectors at \$4.25 ea. + 1.00 p&i.

Use your own terminal with the EXPLORER 88-PC or, if you plan to expand it to be fully IBM compatible, we offer our IBM compatible keyboard and an IBM compatible color graphics board (only available wired and tested).

- IBM compatible keyboard...\$299.95 + 10.00 p&i.
- IBM compatible color board...\$299.95 + 10.00 p&i.
- Additional ROM required...\$35.00.

Set your own pace! Invest and learn, at the rate YOU want! Add to your EXPLORER 88-PC:

- Deluxe heavy-duty steel cabinet that houses either two 5¼" floppies or a 5¼" hard disk with one floppy. This cabinet features a brush-finish front panel and a wood-grained sleeve.
- EXPLORER 88-PC Cabinet...\$199.95 + 18.00 p&i.

A heavy-duty open frame power supply with fan that can be used in your own cabinet or installed into the Netronics cabinet is available as follows:

- 10 amp power supply for system + 2 floppies...\$149.95 + 8.00 p&i.
- As above + extra power for 1 hard disk...\$169.95 + 8.00 p&i.
- IBM compatible disk controller board. Controls four 5¼" floppy drives (w/2 drive cable). Available wired and tested only...\$250.00 + 8.00 p&i.
- Monitors and BIOS source listings: available on either disk or hard copy at \$35.00. Please specify format and system required.
- INTEL 8086/8088 user manual...\$15.00 + 1.50 p&i.
- THE 8086 BOOK by RECTOR & ALEX...\$16.00 + 1.50 p&i.

Special IBM compatible system: with keyboard, color graphics board, floppy disk controller, 64K RAM, cabinet, standard power supply and a single 5¼" floppy drive...\$1899.95 + 25.00 p&i.

IBM compatible hard disks, built-in modern board, eprom burner, print buffer system plus more will be available shortly.

Over 100 EXCLUSIVE Products and Kits—including the 'Speak Easy' universal voice synthesizer, a Diagnostic card with built-in logic probe for the IBM-PC, terminals, monitors, the ELF and EXPLORER 85 computers, and much more, are described in our upcoming catalog. It's yours FREE if you check here

For Canadian orders please double the amount of p&i shown. IBM-PC is a registered trademark of IBM Corporation.



"p&i" stands for "postage and insurance".

CALL TOLL FREE 1-800-243-7428 for Charge Card Orders.  
In Conn., call 203-354-9375, Conn. res. add sales tax.

TO ORDER BY MAIL, CHECK BOXES FOR PRODUCTS DESIRED AND MAIL ENTIRE AD TO:

**NETRONICS R & D LTD.**

333 Litchfield Rd., New Milford, CT 06776

Amount enclosed  OR Charge my  VISA  MASTERCARD  
Acct. No. \_\_\_\_\_ OR \_\_\_\_\_ Exp. Date \_\_\_\_\_

Signature \_\_\_\_\_

PRINT NAME \_\_\_\_\_

Address \_\_\_\_\_ City \_\_\_\_\_ State \_\_\_\_\_ Zip \_\_\_\_\_

# 4164

64K DYNAMIC  
200 NS

# \$595

# TMM2016

2KX8 STATIC  
200 NS

# \$415

## STATIC RAMS

2101	256 x 4 (450ns)	1.95
5101	256 x 4 (450ns) (cmos)	3.95
2102-1	1024 x 1 (450ns)	.89
2102L-4	1024 x 1 (450ns) (LP)	.99
2102L-2	1024 x 1 (250ns) (LP)	1.49
2111	256 x 4 (450ns)	2.49
2112	256 x 4 (450ns)	2.99
2114	1024 x 4 (450ns)	8/9.95
2114L-4	1024 x 4 (450ns) (LP)	8/12.95
2114L-3	1024 x 4 (300ns) (LP)	8/13.45
2114L-2	1024 x 4 (200ns) (LP)	8/13.95
2147	4096 x 1 (55ns)	4.95
TMS4044-4	4096 x 1 (450ns)	3.49
TMS4044-3	4096 x 1 (300ns)	3.99
TMS4044-2	4096 x 1 (200ns)	4.49
MK4118	1024 x 8 (250ns)	9.95
TMM2016-200	2048 x 8 (200ns)	4.15
TMM2016-150	2048 x 8 (150ns)	4.95
TMM2016-100	2048 x 8 (100ns)	6.15
HM6116-4	2048 x 8 (200ns) (cmos)	4.75
HM6116-3	2048 x 8 (150ns) (cmos)	4.95
HM6116-2	2048 x 8 (120ns) (cmos)	8.95
HM6116LP-4	2048 x 8 (200ns) (cmos)(LP)	5.95
HM6116LP-3	2048 x 8 (150ns) (cmos)(LP)	6.95
HM6116LP-2	2048 x 8 (120ns) (cmos)(LP)	10.95
Z-6132	4096 x 8 (300ns) (Qstat)	34.95

LP = Low Power      Qstat = Quasi-Static

## DYNAMIC RAMS

TMS4027	4096 x 1 (250ns)	1.99
UPD411	4096 x 1 (300ns)	3.00
MMS280	4096 x 1 (300ns)	3.00
MK4108	8192 x 1 (200ns)	1.95
MMS298	8192 x 1 (250ns)	1.85
4116-300	16384 x 1 (300ns)	8/11.75
4116-250	16384 x 1 (250ns)	8/11.95
4116-200	16384 x 1 (200ns)	8/12.95
4116-150	16384 x 1 (150ns)	8/14.95
4116-120	16384 x 1 (120ns)	8/29.95
2118	16384 x 1 (150ns) (5v)	4.95
4164-200	65536 x 1 (200ns) (5v)	5.95
4164-150	65536 x 1 (150ns) (5v)	6.95

5V = single 5 volt supply

## EPROMS

1702	256 x 8 (1us)	4.50
2708	1024 x 8 (450ns)	3.95
2758	1024 x 8 (450ns) (5v)	5.95
2716	2048 x 8 (450ns) (5v)	3.95
2716-1	2048 x 8 (350ns) (5v)	5.95
TMS2516	2048 x 8 (450ns) (5v)	5.50
TMS2716	2048 x 8 (450ns)	7.95
TMS2532	4096 x 8 (450ns) (5v)	5.95
2732	4096 x 8 (450ns) (5v)	4.95
2732-250	4096 x 8 (250ns) (5v)	8.95
2732-200	4096 x 8 (200ns) (5v)	11.95
2764	8192 x 8 (450ns) (5v)	9.95
2764-250	8192 x 8 (250ns) (5v)	14.95
2764-200	8192 x 8 (200ns) (5v)	24.95
TMS2564	8192 x 8 (450ns) (5v)	17.95
MC68764	8192 x 8 (450ns) (5v) (24 pin)	39.95

5v = Single 5 Volt Supply

## EPROM ERASERS

	Timer	Capacity Chlp	Intensity (uW/Cm <sup>2</sup> )	
PE-14		6	5,200	83.00
PE-14T	X	6	5,200	119.00
PE-24T	X	9	6,700	175.00
PL-265T	X	20	6,700	255.00
PR-125T	X	16	15,000	349.00
PR-320	X	32	15,000	595.00

## Z-80

2.5 Mhz

Z80-CPU	3.95
Z80-CTC	4.49
Z80-DART	10.95
Z80-DMA	14.95
Z80-PIO	4.49
Z80-SIO/0	16.95
Z80-SIO/1	16.95
Z80-SIO/2	16.95
Z80-SIO/9	16.95

4.0 Mhz

Z80A-CPU	4.95
Z80A-CTC	4.95
Z80A-DART	11.95
Z80A-DMA	16.95
Z80A-PIO	4.95
Z80A-SIO/0	16.95
Z80A-SIO/1	16.95
Z80A-SIO/2	16.95
Z80A-SIO/9	16.95

6.0 Mhz

Z80B-CPU	11.95
Z80B-CTC	13.95
Z80B-PIO	13.95
Z80B-DART	19.95

## ZILOG

Z6132	34.95
Z8671	39.95

## CRYSTALS

32.768 khz	1.95
1.0 mhz	4.95
1.8432	4.95
2.0	3.95
2.097152	3.95
2.4576	3.95
3.2768	3.95
3.579535	3.95
4.0	3.95
5.0	3.95
5.0688	3.95
5.185	3.95
5.7143	3.95
6.0	3.95
6.144	3.95
6.5536	3.95
8.0	3.95
10.0	3.95
10.738635	3.95
14.31818	3.95
15.0	3.95
16.0	3.95
17.430	3.95
18.0	3.95
18.432	3.95
20.0	3.95
22.1184	3.95
32.0	3.95

## CRT CONTROLLERS

6845	14.95
68B45	19.95
HD46505SP	15.95
6847	11.95
MC1372	6.95
68047	24.95
8275	29.95
7220	99.95
CRT5027	39.95
CRT5037	49.95
TMS9918A	39.95
DP8350	49.95

## KEYBOARD CHIPS

AY5-2376	11.95
AY5-3600	11.95

## 8000

8035	5.95
8039	6.95
INS-8060	17.95
INS-8073	24.95
8080	3.95
8085	5.95
8085A-2	11.95
8086	29.95
8087	CALL
8088	39.95
8089	89.95
8155	6.95
8155-2	7.95
8156	6.95
8185	29.95
8185-2	39.95
8741	39.95
8748	24.95
8755	24.95

## 8200

8202	24.95
8203	39.95
8205	3.50
8212	1.80
8214	3.85
8216	1.75
8224	2.25
8226	1.80
8228	3.49
8231	call
8237	19.95
8237-5	21.95
8238	4.49
8243	4.45
8250	10.95
8251	4.49
8253	6.95
8253-5	7.95
8255	4.49
8255-5	5.25
8257	7.95
8257-5	8.95
8259	6.90
8259-5	7.50
8271	39.95
8272	39.95
8275	29.95
8279	8.95
8279-5	10.00
8282	6.50
8283	6.50
8284	5.50
8286	6.50
8287	6.50
8288	25.00
8289	49.95

## DISC CONTROLLERS

1771	16.95
1791	24.95
1793	26.95
1795	49.95
1797	49.95
2791	54.95
2793	54.95
2795	59.95
2797	59.95
6843	34.95
8272	39.95
UPD765	39.95
1691	17.95
2143	18.95

## CONNECTORS

RS232 MALE	2.50
RS232 FEMALE	3.25
RS232 HOOD	1.25
S-100 ST	3.95

## 6800

68000	59.95
6800	3.95
6802	7.95
6808	13.90
6809E	19.95
6809	11.95
6810	2.95
6820	4.35
6821	3.25
6828	14.95
6840	12.95
6843	34.95
6844	25.95
6845	14.95
6847	11.95
6850	3.25
6852	5.75
6860	9.95
6862	11.95
6875	6.95
6880	2.25
6883	22.95
68047	24.95
68488	19.95

6800 = 1MHZ

68B00	10.95
68B02	22.25
68B09E	29.95
68B09	29.95
68B10	6.95
68B21	6.95
68B45	19.95
68B50	5.95

68B00 = 2MHZ

## 6500

6502	4.95
6504	6.95
6505	8.95
6507	9.95
6520	4.35
6522	7.95
6532	9.95
6545	22.50
6551	11.85

6502A 2MHZ

6502A	6.95
6522A	9.95
6532A	11.95
6545A	27.95
6551A	11.95

6502B 3MHZ

6502B	14.95
-------	-------

## UARTS

AY3-1014	6.95
AY5-1013	3.95
AY3-1015	6.95
PT1472	9.95
TR1602	3.95
2350	9.95
2651	8.95
TMS6011	5.95
IM6402	7.95
IM6403	8.95
INS8250	10.95

## GENERATORS BIT-RATE

MC14411	11.95
BR1941	11.95
4702	12.95
COM5016	16.95
COM8116	10.95
MM5307	10.95

## FUNCTION

MC4024	3.95
LM566	1.49
XR2206	3.75
8038	3.95

## 74LS00

74LS00	24	74LS173	69
74LS01	25	74LS174	55
74LS02	25	74LS175	55
74LS03	25	74LS181	2.15
74LS04	24	74LS189	8.95
74LS05	25	74LS190	.89
74LS08	28	74LS191	.89
74LS09	29	74LS192	.79
74LS10	25	74LS193	.79
74LS11	35	74LS194	.69
74LS12	35	74LS195	.69
74LS13	45	74LS196	.79
74LS14	59	74LS197	.79
74LS15	35	74LS221	.89
74LS20	25	74LS240	.95
74LS21	29	74LS241	.99
74LS22	25	74LS242	.99
74LS26	29	74LS243	.99
74LS27	29	74LS244	.99
74LS28	35	74LS245	1.49
74LS30	25	74LS247	.75
74LS32	29	74LS248	.99
74LS33	55	74LS249	.99
74LS37	35	74LS251	.59
74LS38	35	74LS253	.59
74LS40	25	74LS257	.59
74LS42	49	74LS258	.59
74LS47	75	74LS259	2.75
74LS48	75	74LS260	.59
74LS49	75	74LS266	.55
74LS51	25	74LS273	1.49
74LS54	29	74LS275	3.35
74LS55	29	74LS279	.49
74LS63	1.25	74LS280	1.98
74LS73	39	74LS283	.69
74LS74	35	74LS290	.89
74LS75	39	74LS293	.89
74LS76	39	74LS295	.99
74LS78	49	74LS298	.89
74LS83	60	74LS299	1.75
74LS85	69	74LS323	3.50
74LS86	39	74LS324	1.75
74LS90	55	74LS352	1.29
74LS91	.89	74LS353	1.29
74LS92	55	74LS363	1.35
74LS93	55	74LS364	1.95
74LS95	75	74LS365	.49
74LS96	.89	74LS366	.49
74LS107	.39	74LS367	.45
74LS109	.39	74LS368	.45
74LS112	.39	74LS373	.99
74LS113	.39	74LS374	.99
74LS114	.39</		

2114 450 NS 8/\$995

2114 250 NS 8/\$1095

7400

7400	.19	74132	.45
7401	.19	74136	.50
7402	.19	74141	.65
7403	.19	74142	2.95
7404	.19	74143	2.95
7405	.25	74145	.60
7406	.29	74147	1.75
7407	.29	74148	1.20
7408	.24	74150	1.20
7409	.19	74151	.35
7410	.19	74152	.65
7411	.25	74153	.55
7412	.30	74154	1.25
7413	.35	74155	.75
7414	.49	74156	.65
7416	.25	74157	.55
7417	.25	74159	1.65
7420	.19	74160	.85
7421	.35	74161	.69
7422	.35	74162	.85
7423	.29	74163	.69
7425	.29	74164	.85
7426	.29	74165	.85
7427	.29	74166	1.00
7428	.45	74167	2.95
7430	.19	74170	1.65
7432	.29	74172	5.95
7433	.45	74173	.75
7437	.29	74174	.89
7438	.29	74175	.89
7440	.19	74176	.89
7442	.49	74177	.75
7443	.65	74178	1.15
7444	.69	74179	1.75
7445	.69	74180	.75
7446	.69	74181	2.25
7447	.69	74182	.75
7448	.69	74184	2.00
7450	.19	74185	2.00
7451	.23	74190	1.15
7453	.23	74191	1.15
7454	.23	74192	.79
7460	.23	74193	.79
7470	.35	74194	.85
7472	.29	74195	.85
7473	.34	74196	.75
7474	.33	74197	.75
7475	.45	74198	1.35
7476	.35	74199	1.35
7480	.59	74221	1.35
7481	1.10	74246	1.35
7482	.95	74247	1.25
7483	.50	74248	1.85
7485	.59	74249	1.95
7486	.35	74251	.75
7489	2.15	74259	2.25
7490	.35	74265	1.35
7491	.40	74273	1.95
7492	.50	74276	1.25
7493	.35	74279	.75
7494	.65	74283	2.00
7495	.55	74284	3.75
7496	.70	74285	3.75
7497	2.75	74290	.95
74100	1.75	74293	.75
74107	.30	74298	.85
74109	.45	74351	2.25
74110	.45	74365	.65
74111	.55	74366	.65
74116	1.55	74367	.65
74120	1.20	74368	.65
74121	.29	74376	2.20
74122	.45	74390	1.75
74123	.49	74393	1.35
74125	.45	74425	3.15
74126	.45	74426	.85
74128	.55	74490	2.55

LINEAR

LM301	.34	LM340 (see 7800)	LM566	1.49	LM1800	2.37
LM301H	.79	LM348	LM567	.89	LM1812	8.25
LM307	.45	LM350K	NE570	3.95	LM1830	3.50
LM308	.69	LM350T	NE571	2.95	LM1871	5.49
LM308H	1.15	LM358	NE592	2.75	LM1872	5.49
LM309H	1.95	LM359	LM709	.59	LM1877	3.25
LM309K	1.25	LM376	LM710	.75	LM1889	1.95
LM310	1.75	LM377	LM711	.79	LM1896	1.75
LM311	.64	LM378	LM723	.49	ULN2003	2.49
LM311H	.89	LM379	LM723H	.55	LM2877	2.05
LM312H	1.75	LM380	LM733	.98	LM2878	2.25
LM317K	3.95	LM380N-8	LM741	.35	LM2900	.85
LM317T	1.19	LM381	LM741N-14	.35	LM2901	1.00
LM318	1.49	LM382	LM741H	.40	LM3900	.59
LM318H	1.59	LM383	LM747	.69	LM3905	1.25
LM319H	1.90	LM384	LM748	.59	LM3909	.98
LM319	1.25	LM386	LM1014	1.19	LM3911	2.25
LM320 (see 7900)	LM387	1.40	LM1303	1.95	LM3914	3.95
LM322	1.65	LM389	LM1310	1.49	LM3915	3.95
LM323K	4.95	LM390	MC1330	1.69	LM3916	3.95
LM324	.59	LM392	MC1349	1.89	MC4024	3.95
LM329	.65	LM394H	MC1350	1.19	MC4044	4.50
LM331	3.95	LM399H	MC1358	1.69	RC4136	1.25
LM334	1.19	NE531	MC1372	6.95	RC4151	3.95
LM335	1.40	NE555	LM1414	1.59	LM4250	1.75
LM336	1.75	NE556	LM1458	.59	LM4500	3.25
LM337K	3.95	NE558	LM1488	.69	RC4558	.69
LM337T	1.95	NE561	LM1489	.69	LM13080	1.29
LM338K	6.95	NE564	LM1496	.85	LM13600	1.49
LM339	.99	LM565	LM1558H	3.10	LM13700	1.49

H = TO-5 CAN      T = TO-220      K = TO-3

RCA

CA 3023	2.75	CA 3082	1.65
CA 3039	1.29	CA 3083	1.55
CA 3046	1.25	CA 3086	.80
CA 3059	2.90	CA 3089	2.90
CA 3060	2.90	CA 3096	3.49
CA 3065	1.75	CA 3130	1.30
CA 3080	1.10	CA 3140	1.15
CA 3081	1.65	CA 3146	1.85
CA 3160	1.19		

TI

TL494	4.20	75365	1.95
TL496	1.65	75450	.59
TL497	3.25	75451	.39
75107	1.49	75452	.39
75110	1.95	75453	.39
75150	1.95	75454	.39
75154	1.95	75491	.79
75188	1.25	75492	.79
75189	1.25	75493	.89
75494	.89		

BI FET

TL071	.79	TL084	2.19
TL072	1.19	LF347	2.19
TL074	2.19	LF351	.60
TL081	.79	LF353	1.00
TL082	1.19	LF355	1.10
TL083	1.19	LF356	1.10
LF357	1.40		

CMOS

4000	.29	4527	1.95
4001	.25	4528	1.19
4002	.25	4531	.95
4006	.89	4532	1.95
4007	.29	4538	1.95
4008	.95	4539	1.95
4009	.39	4541	2.64
4010	.45	4543	1.19
4011	.25	4553	5.79
4012	.25	4555	.95
4013	.38	4556	.95
4014	.79	4581	1.95
4015	.39	4582	1.95
4016	.39	4584	.75
4017	.69	4585	.75
4018	.79	4702	12.95
4019	.39	74C00	.35
4020	.75	74C02	.35
4021	.79	74C04	.35
4022	.79	74C08	.35
4023	.29	74C10	.35
4024	.65	74C14	.59
4025	.29	74C20	.35
4026	1.65	74C30	.35
4027	.45	74C32	.39
4028	.69	74C42	1.29
4029	.79	74C48	1.99
4030	.39	74C73	.65
4034	1.95	74C74	.65
4035	.85	74C76	.80
4040	.75	74C83	1.95
4041	.75	74C85	1.95
4042	.69	74C86	.39
4043	.85	74C89	4.50
4044	.79	74C90	1.19
4046	.85	74C93	1.75
4047	.95	74C95	.99
4049	.35	74C107	.89
4050	.35	74C150	5.75
4051	.79	74C151	2.25
4053	.79	74C154	3.25
4060	.89	74C157	1.75
4066	.39	74C160	1.19
4068	.39	74C161	1.19
4069	.29	74C162	1.19
4070	.35	74C163	1.19
4071	.29	74C164	1.39
4072	.29	74C165	2.00
4073	.29	74C173	.79
4075	.29	74C174	1.19
4076	.79	74C175	1.19
4078	.29	74C192	1.49
4081	.29	74C193	1.49
4082	.29	74C195	1.39
4085	.95	74C200	5.75
4086	.95	74C221	1.75
4093	.49	74C373	2.45
4098	2.49	74C374	2.45
4099	1.95	74C901	3.99
14409	12.95	74C902	.85
14410	12.95	74C903	.85
14411	11.95	74C905	10.95
14412	12.95	74C906	.95
14419	7.95	74C907	1.00
14433	4.18	74C908	2.00
4502	.95	74C909	2.75
4503	.65	74C910	9.95
4508	1.95	74C911	8.95
4510	.85	74C912	8.95
4511	.85	74C914	1.95
4512	.85	74C915	1.19
4514	1.25	74C918	2.75
4515	1.79	74C920	17.95
4516	1.55	74C921	15.95
4518	.89	74C922	4.49
4519	.39	74C923	4.95
4520	.79	74C925	5.95
4522	1.25	74C926	7.95
4526	1.25	74C928	7.95
		74C929	19.95

74S00

74S00	.32	74S163	1.95
74S02	.35	74S168	3.95
74S03	.35	74S169	3.95
74S04	.35	74S174	.95
74S05	.35	74S175	.95
74S08	.35	74S181	3.95
74S09	.40	74S182	2.95
74S10	.35	74S188	1.95
74S11	.35	74S189	6.95
74S15	.35	74S194	1.49
74S20	.35	74S195	1.49
74S22	.35	74S196	1.49
74S30	.35	74S197	1.49
74S32	.40	74S201	6.95
74S37	.88	74S225	7.95
74S38	.85	74S240	2.20
74S40	.35	74S241	2.20
74S51	.35	74S244	2.20
74S64	.40	74S251	.95
74S65	.40	74S253	.95
74S74	.50	74S257	.95
74S85	1.99	74S258	.95
74S86	.50	74S260	.79
74S112	.50	74S274	19.95
74S113	.50	74S275	19.95
74S124	2.75	74S287	1.90
74S132	1.24	74S288	1.90
74S133	.45	74S289	6.89
74S134	.50	74S301	6.95
74S135	.89	74S373	2.45
74S138	.85	74S374	2.45
74S139	.85	74S381	7.95
74S140	.55	74S387	1.95
74S151	.95	74S412	2.98
74S153	.95	74S471	4.95
74S157	.95	74S472	4.95
74S158	.95	74S474	4.95
74S161	1.95	74S482	15.25
74S162	1.95	74S570	2.95
		74S571	2.95

IC SOCKETS

8 pin ST	1.99	100
14 pin ST	.13	.11
16 pin ST	.15	.12
18 pin ST	.17	.08
20 pin ST	.20	.18
22 pin ST	.29	.27
24 pin ST	.30	.27
28 pin ST	.40	.32
40 pin ST	.49	.39
64 pin ST	4.25	call
ST = SOLDER TAIL		
8 pin WW	.59	.49
14 pin WW	.69	.52
16 pin WW	.49	.49
18 pin WW	.99	.90
20 pin WW	1.09	.98
22 pin WW	1.39	1.28
24 pin WW	1.49	1.35

# SUMMERTIME IS BUILD-IT, FIX-IT TIME

And the Place to Start Your Projects is Radio Shack!

Put the Sun to Work With Our Portable Solar Panel

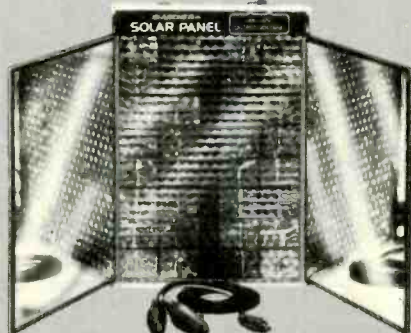

Radio Shack Exclusive!

- Ready to Use
- 12 or 6VDC Output
- 32 Full-Spec Cells

**2495**

Converts bright sunlight into approximately 1/2-watt of "free" electrical power. Ideal for charging batteries, it also will power many radios, calculators and small devices directly. Output with full sun: 80 milliamps at 6V, 40 mA at 12V. Includes detachable 5 x 4" reflector panels and 48" plug-in leads with clips. 5 3/4 x 4 1/8 x 5/8". Not for permanent outdoor installation. 277-1250 ..... 24.95

Compact AC Cooling Fan

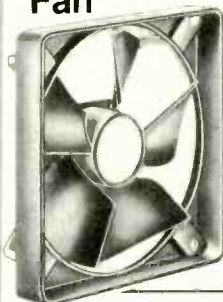

**1595**

Quiet & Efficient

Perfect for computers, power supplies, ham and hi-fi equipment. Delivers up to 65 CFM. Leads for easy hookup. For 120VAC, 11 watts, U.L. listed. 4 1/16 x 2 1/2". 273-241 ..... 15.95

50WVDC, Non-Polarized Electrolytics



Low As **79c**

For speaker crossover networks, audio filters and much more. Long axial leads.

µF	Approx. Crossover Frequency (8 ohms)	Cat. No.	Each
1.0	10 kHz	272-996	.79
2.2	8 kHz	272-997	.79
4.7	4 kHz	272-998	.89
10.0	2 kHz	272-999	.99

Sale! Communicator ICs



Now Low As

**99c**

Up to **45% Off!**

Connect Your Microcomputer To The Real World at Low Cost!

1488 RS232 Quad Line Driver. Makes it easy to interface data terminal equipment with data communications devices. Can interconnect different logic families. Protected, current-limited output. Will withstand short to any conductor in interconnecting cable. Split supply, 15VDC maximum. 14-pin DIP with data. Reg. 1.79. 276-2520 ..... Sale 99c

1489 RS232 Quad Line Receiver. Use with above. Will perform logic level translation. Sections can be paralleled to obtain multiple outputs from one input. Input signal range ± 30V. Built-in input threshold hysteresis. Single supply, 10VDC maximum. 14-pin DIP with data. Reg. 1.79. 276-2521 ..... Sale 99c

SN75446 Dual Peripheral Driver. Can take a logic-level signal and drive a relay, solenoid or other device directly, up to 350 mA, 50VDC. TTL/MOS compatible diode-clamped inputs. Very low input current. Single 5.5VDC supply. 8-pin DIP with data. Reg. 2.79. 276-2530 ..... Sale 1.99

Mercury Switch



**89c**

Gravity-Actuated

Submini position-detecting switch, rated 100 mA at 24VDC. Ideal for models, "motion detector" alarms and more. 275-025 ..... 89c

12-Volt DC Buzzer



**189**

Super-Loud!

Low current—great for battery powered security. Metal case with leads. 273-051 ..... 1.89

MOV Transient Protector

**159**

- Easy to Install
- Fast Response

V130LA10A. Guards 120VAC equipment against voltage spikes. 35 ns response! With ap notes 276-570 ..... 1.59

Replacement Cords



Low As **79c**

- 6 Feet Long
- U.L. Listed



[A] Line Cord. 18-gauge wire, molded 2-prong plug, stripped leads. 278-1255 ..... 79c  
[B] AC Power Cord. Fits most cassette portables, radios. 278-1256 ..... 1.59

Snap-In LEDs



Low As **179**

Pkg. Of 2

Extra-High Brightness

T-1 3/4 size. Black holders mount instantly in 5/16" holes.

Color	Cat. No.	Pkg. of 2
Red	276-018	1.79
Green	276-019	1.89

1/4-Watt Resistors



100-Piece Assortment **299**

5% Tolerance. 13 popular values, Ten each: 10, 1k, 10k, 100k; eight each: 47, 100, 470, 2.2k, 4.7k, 1 meg; four each: 150, 220, 15k. 271-308 ..... Set, 2.99

5VDC DIP Relay

**299**



DPDT contacts: 2 A at 125VAC, 5VDC, 72 mA, 70-ohm coil. For 14-pin DIP socket or PC mounting. 275-243 ..... 2.99

On Radio Shack's Book Shelf

**60% Off!**

Reg. **195**

4.95

By William Barden, Jr.

**NEW!**  
**395**

Developed by TI Learning Center

[A] Programming Techniques for Level II BASIC. Provides many practical examples of BASIC routines. 224 pages. 62-2062 ..... Sale 1.95

[B] Understanding Electronic Control of Energy Systems. Principles of controlling motors, generators, combustion engines and more. Illustrated. 256 pages. 62-1386 ..... 3.95

16-Pin DIP Header

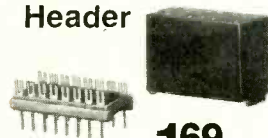

**169**

Mounts resistors, capacitors and more for plug-in use with 16-pin sockets.

276-1980 ..... 1.69

Knobs for 1/4" Shafts



**189**

Brass Set-Screw

Perfect for replacement or projects. Smart metal-over-plastic styling. 274-424 ..... Pkg. of 2/1.89

6VAC Transformer

**Cut 33%**

Reg. 2.99

**199**

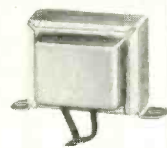

Build a Supply!

Shielded. 120VAC primary, 6.3VAC at 450 mA secondary. 1 7/8 x 2 9/8 x 1 1/2". 273-1364 ..... Sale 1.99

# Radio Shack®

A DIVISION OF TANDY CORPORATION • OVER 8500 LOCATIONS WORLDWIDE  
Retail prices may vary at individual stores and dealers



# FIRST QUALITY COMPONENTS - NOT MAIL ORDER "SECONDS"

Send for Free Catalog - over 1100 parts.

## ARIES ZERO INSERTION FORCE SOCKETS



cam actuated, true zero insertion - tin plated solder tail pins - capable of being plugged into dip sockets, including wire wrap.

Stock No.	No. of Pins	1-9	10-49	50
11055	24	4.98	\$4.35	\$3.90
11056	28	5.15	4.50	4.05
11057	40	6.81	5.95	5.35
11058	64	12.02	10.50	9.45

## IC-KOOLERS™ from UNITRACK™

passive over 2 watt of heat from IC's, producing longer life and better performance. Just push IC-Kooler on heat is collected from top and bottom of IC and dissipated. Won't shake loose!

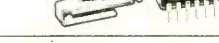

Stock No.	No. Pins	IC Price	IC Price
22225	14	\$9.29	
22226	16	2.29	
22227	18	2.29	
22228	20	2.29	

## DIGITAL MULTIMETER

Single rotary switch operation. Large easy to read 5 1/2 digit display. 800 hours operating life with single battery. Seven functions - DC Volts, DC Amps, Ohms, AC Volts, AC Amps, Diode and Resistor Junction, Audible Continuity Check.



Stock No. 82503 \$79.95 (For 1 year warranty)  
 Stock No. 82504 Carrying case with belt loop \$9.95

## TI WIRE WRAP SOCKETS

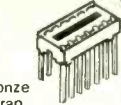

Tin plated phosphor bronze contact - 3 wrap

Stock No.	No. Pins	1-99	100-499	500
11301	8	\$4.00	\$3.36	\$3.30
11302	14	.59	.54	.45
11303	16	.64	.58	.48
11304	18	.73	.66	.55
11305	20	.90	.75	.75
11306	22	1.12	1.02	.85
11307	24	1.25	1.14	.95
11308	28	1.52	1.38	1.15
11309	40	2.05	1.86	1.55

## TIN LOW PROFILE SOCKETS



Tin plated copper alloy 688 contact pins with gas tight seal.

Stock No.	No. Pins	1-24	25-99	999
11201	8	\$1.00	\$0.90	\$0.80
11202	14	.14	.13	.12
11203	16	.16	.15	.14
11204	18	.18	.17	.15
11205	20	.20	.18	.16
11206	22	.22	.20	.18
11207	24	.24	.22	.20
11208	28	.28	.26	.25
11209	40	.40	.37	.33

## WILD ROVER

Touch switch capsule. Operating motion is .005" without the use of a levered arm. Extremely fast on and off with low noise. Normally operated 115 VAC, 1.6 amp. 30 millihm resistance - 615 radius by .160 thick.

Stock No.	1-9	10 & Up
12098	\$1.42	\$1.28

## 60/40 ROSIN CORE SOLDER

Stock No.	Length	Weight	Price
50075	0.62	9 1/5	\$1.16
50076	0.62	25	4
50077	0.62	50	8
50078	0.32	33	1.5
50079	0.32	86.5	4
50080	0.32	175	8

## ELPAC POWER SUPPLIES - DC/DC CONVERTERS

SINTEC Stock No.	ELPAC Part No.	Input Voltage (VDC)	Output Voltage (VDC)	Output Current (mA)	Dimensions (HxWxD) in inches	Price
13825	CB3801	3-0-7.0	12.0-6.0	0-25	.48x.51x3.05	\$ 7.95
13826	CB3811	3-0-7.0	12.0-0.6	0-25	.48x.51x3.05	7.95
13827	CB3802	3-0-7.0	15.0-0.7	0-20	.48x.51x3.05	7.95
13828	CB3812	3-0-7.0	15.0-0.7	0-20	.48x.51x3.05	7.95
13829	CB3804	3-0-7.0	28.0-0.7	0-10	.48x.51x3.05	7.95
13830	CB3814	3-0-7.0	28.0-0.7	0-10	.48x.51x3.05	7.95

1.5 W TYPE:

SINTEC Stock No.	ELPAC Part No.	Input Voltage (VDC)	Output Voltage (VDC)	Output Current (mA)	Dimensions (HxWxD) in inches	Price
13831	CL3801	4-0-7.0	12.0-6.0	125	.651x1.2x1.77	\$24.95
13832	CL3811	4-0-7.0	12.0-0.6	125	.651x1.2x1.77	24.95
13833	CL3802	4-0-7.0	15.0-0.7	100	.651x1.2x1.77	24.95
13834	CL3812	4-0-7.0	15.0-0.7	100	.651x1.2x1.77	24.95
13835	CL3804	4-0-7.0	28.0-1.4	50	.651x1.2x1.77	24.95
13836	CL3814	4-0-7.0	28.0-1.4	50	.651x1.2x1.77	24.95
13825-1	DATA SHEET FOR DC/DC CONVERTERS..... 25					

## ELPAC POWER SUPPLIES - SOLV SERIES FULLY REGULATED

SINTEC Stock No.	ELPAC Part No.	Output Voltage (VDC)	Output Current (mA)	Dimensions (HxWxD) in inches	OVP	Price
13802	SOLV15-5	5	3.0A	4.71/6.4x4.2	Fixed included	\$39.95
13803	SOLV15-12	12	1.5A	4.71/6.4x4.2	Fixed included	39.95
13804	SOLV15-15	15	1.2A	4.71/6.4x4.2	Fixed included	39.95
13805	SOLV15-24	24	0.75A	4.71/6.4x4.2	Fixed included	39.95
13806	SOLV30-5	5	6.0A	5.5/8x4.7/8x3-1/8	DVP-4	59.95
13809	SOLV30-12	12	4.0A	5.5/8x4.7/8x3-1/8	DVP-4	59.95
13810	SOLV30-15	15	3.3A	5.5/8x4.7/8x3-1/8	DVP-4	59.95
13812	SOLV30-24	24	2.0A	5.5/8x4.7/8x3-1/8	DVP-4	59.95
13802-1	Data Sheet for SOLV Series..... 25					

## Special of the Month!

### MICRO-MIKE

Precision Pocket Microscope

Features: Professional quality optics • always in focus • precise measurements (readings to .001), accurate to .001 • ideal size (under 5") • special beveled opening • durable aluminum case

Stock No. Power Price  
 51058 10X \$9.95  
 51059 20X 9.95

## MODUTEC

### Miniclamp AC Volt-Ammeter

allows singling one conductor out of many without disarrangement.

Stock No. AC Amperes Price  
 13730 0-25A \$39.50  
 13731 0-50A 39.50  
 13732 0-100A 39.50

SET OF THREE \$99.00

### ACCESSORY LINE SPLITTER

allows fast readings of AC power consumption of plug in equipment without separation of leads

Stock No. 13727 \$9.95

### POCKET SIZED BATTERY TESTER

for all types of small batteries from 1.35v to 4.5v

Stock No. 13733 \$13.95

### VOLT-CATOR

automotive diagnostic meter plugs into lighter socket and indicates battery condition and charging rates.

Stock No. 13736 \$15.95

### AC VOLTAGE TESTER

plugs into any 110v service receptacle to check line voltage over 50-150 VAC

Stock No. 13735 \$14.95

### VOM-MULTIESTER

versatile Volt-Ohm-Milliammeter in small package

Stock No. 13729 \$13.95

## PIN FORMING TOOL

puts IC's on their true low low spacing. One side for 300 centers. Flips tool over for devices on 600 centers. Put device in tool and squeeze. NEW! Stock No. 10200 \$14.95 (ANTI-STATIC MODEL)

ONE TOOL DOES 8 thru 40 PINS! Stock No. 11059 \$12.95

## OK MACHINE AND TOOL

### IC INSERTION/EXTRACTION KIT

Includes DIP IC extractors and inserters to accommodate all IC's from 14 to 40 pins. Tools that engage conductive surfaces in a CMOS safe and include grounding tips. Stock No. 13309 \$37.74

## SOCKET WRAP ID

DIP socket sized plastic panels with numbered holes in pin locations. Slip into socket before wire wrapping to identify pins. Also write on them for location. IC part number function etc. Samples. Install wire wrapping trouble shooting and repair.

13295 14 pin \$1.82 per pack  
 13296 16 pin  
 13297 18 pin  
 13298 20 pin  
 13299 22 pin  
 13300 24 pin  
 13301 26 pin  
 13302 28 pin  
 13303 30 pin

## IC EXTRACTOR

One-piece, spring steel construction. Will extract all LSI, MSI and SSL devices with 8 to 24 pins.

Stock No. 13313 \$2.10

# SINTEC

Drawer Q Milford co. NJ 08848-9990

VISA MasterCard

TOLL 800-526-5960 FREE in NJ (201) 996-4093

We accept VISA, MC, C.O.D., G.C.H.E. or M.O. INCLUDE SHIPPING CHARGES - 0 to \$100 - \$3.00 \$100 to \$250 - \$4.00 over \$250 - \$5.00

FREE! FREE! free! SEND FOR OUR NEW 40 PAGE CATALOG free! FREE! FREE!

## 2-WAY CAR STEREO SPEAKER SYSTEM

THESE SPEAKERS COME IN HEAT RESISTANT ABS PLASTIC CABINETS. IDEAL FOR CAR INTERIORS WHERE HEAT CHANGING OCCURS. POWER RATING: 15 WATT NOM. 45 WATT MAX. EACH SYSTEM CONTAINS A 4 INCH 10 OZ. WOOFER AND 2 INCH TWEETER

SPECIAL PRICE \$36.00 PER PAIR

## RELAYS

### 6 VDC RELAY

MINIATURE D.P.D.T. 3 AMP CONTACTS FUJITSU # FBR321D006 \$1.75 EA 10 / 16.00

### MINIATURE 6 VDC RELAY

SUPER SMALL SPDT RELAY: GOLD COBALT CONTACTS. RATED 1 AMP AT 30 VDC. HIGHLY SENSITIVE. TTL DIRECT DRIVE POSSIBLE. OPERATES FROM 4.3 TO 6 V. COIL RES. 220 OHM.

1 3/16" x 13/32" x 7/16" AROMAT # RSD-6V \$1.50 EACH 10 FOR \$13.50

## COMPUTER GRADE CAPACITORS

1700 mfd. 150 VDC \$2.00  
 2 1/2" DIA x 4 3/4" HIGH  
 3,600 mfd. 40VDC \$1.00  
 1 3/8" DIA x 3" HIGH  
 6,400 mfd. 60VDC \$2.50  
 1 3/8" DIA x 4 1/4" HIGH  
 18,000 mfd. 75 VDC \$4.00  
 2 1/2" DIA x 4 1/2" HIGH  
 22,000 mfd. 15 VDC 2" DIA. x 2 1/2" HIGH \$2.00  
 22,000 mfd. 40 VDC 2" DIA. x 6" HIGH \$3.00  
 24,000 mfd. 30 VDC 1 3/4" DIA. x 4" HIGH \$3.50  
 31,000 mfd. 15 VDC 1 3/4" DIA. x 4" HIGH \$2.50  
 72,000 mfd. 15 VDC 2" DIA. x 4" HIGH \$3.50  
 180,000 mfd. at 6V 2 1/2" DIA. x 4 1/2" HIGH \$1.50  
 CLAMPS TO FIT CAPACITORS 50¢ ea.

## EDGE CONNECTORS

ALL ARE .156" SPACING

15 PIN GOLD SOLDER EYELET \$1.75 EACH

15/30 GOLD SOLDER EYELET \$2.00 EACH

18/36 GOLD SOLDER EYELET \$2.00 EACH

22/44 GOLD SOLDER TAIL (P.C. STYLE) \$2.50 EA 10 FOR \$22.50

## SOLID STATE RELAY

CONTROL: 3-32VDC LOAD: 10 AMP 1-0 VAC \$9.50 EACH

## L.E.D.'S STANDARD JUMBO DIFFUSED

RED 10 FOR \$1.50  
 GREEN 10 FOR \$2.00  
 YELLOW 10 FOR \$2.00

FLASHER LED 5 VOLT OPERATION RED JUMBO SIZE \$1.00 EACH

BI POLAR LED 2 FOR \$1.70

## SUB-MINI LED

079" x .098" 20 MA AT 1.75V  
 RED 10 FOR \$1.00  
 200 FOR \$18.00  
 GREEN 10 FOR \$1.50

LED HOLDERS  
 TWO PIECE HOLDER FOR JUMBO LED 10 FOR 65¢ 200 FOR \$10.00

## KEY ASSEMBLY 5 KEY

CONTAINS 5 SINGLE-POLE NORMALLY OPEN SWITCHES. MEASURES 3 3/4" LONG \$1.00 EACH

## 6 KEY

CONTAINS 6 SINGLE-POLE NORMALLY OPEN SWITCHES. MEASURES 4 1/4" LONG \$1.25 EACH

## SLIDE POTS

100K linear taper 2" LONG 1 5/8" TRAVEL 75¢ EACH

500K linear taper 2 7/8" LONG 1 3/4" TRAVEL 75¢ EACH

DUAL 100K audio taper 3 1/2" LONG 2 1/2" TRAVEL \$1.50 EACH

## 13 VDC RELAY

CONTACT: S.P.N.C. 10 AMP @ 120 VAC ENERGIZE COIL TO OPEN CONTACT. COIL: 13 VDC 650 OHMS SPECIAL PRICE \$1.00 EACH

## POWER SUPPLY W/ PRE-AMP

THIS SUPPLY WAS USED TO POWER AN 8 TRACK/CASSETTE UNIT. IT WILL SUPPLY APPROX. 18 VDC AND INCLUDES A SMALL PRE-AMP TO BOOST SIGNAL LEVEL. RCA PLUGS FOR LINE IN/OUT. \$4.50 EACH

## 4 PDT RELAY

14 pin style • 3 amp contacts • 24 volt d.c. or 120 volt a.c. coil • Used but fully tested \$1.70 EACH specify coil voltage LARGE QUANTITIES AVAILABLE SOCKETS FOR RELAY 50¢ each

## MINIATURE TOGGLE SWITCHES

AVAILABLE IN EITHER P.C. OR SOLDER LUG PLEASE SPECIFY TERMINAL STYLE DESIRED ALL ARE RATED 5 AMPS @ 125 VAC

SPDT \$1.00 EACH 10 FOR \$9.00 100 FOR \$80.00

DPDT \$2.00 EACH 10 FOR \$18.00 100 FOR \$175.00

SPDT CENTER OFF \$1.00 EACH 10 FOR \$9.00 100 FOR \$80.00

CALL FOR LARGER QUANTITY QUOTES

## PHOTO-FLASH CAPACITORS

35 MFD 330 VOLT 1" x 5/8" DIA. 45¢ EACH... 10 FOR \$4.00

170 MFD 330 VOLT 1 1/8" x 7/8" 2-FOR \$1.50 10 FOR \$7.00

750 MFD 330 VOLT 2" HIGH x 1 1/4" DIA. \$1.25 EACH 10 FOR \$11.00

# ALL ELECTRONICS CORP.

TOLL FREE ORDERS ONLY 1-800-826-5432 (ORDER ONLY)

ALASKA, HAWAII, CALIF OR INFORMATION. (213) 380-8000

905 S. Vermont Ave. P.C. BOX 20406 Los Angeles, Calif. 90006

CIRCLE NO. 3 ON FREE INFORMATION CARD

www.americanradiohistory.com

QUANTITIES LIMITED MINIMUM ORDER \$10.00 USA: \$2.50 SHIPPING FOREIGN ORDERS: INCLUDE SUFFICIENT SHIPPING CALIF. RES. ADD 6% NO C.O.D.

# AMERICAN RADIO

INCORPORATED In Minn., Ak., Ill. Call 218-681-6674

NATIONAL SEMICONDUCTOR \* PANASONI  
AAVDP \* CHEMVAL \* BISHOP GRAPHICS \*  
MCKEY \* ALLEY \* MCKEY \* MCKEY \*  
OK MACHINE \* UNGAR \* GC CHEMICALS \*  
NATIONAL SEMICONDUCTOR \* PANASONI

★ COMING IN MAY ★  
1% Metal Film Resistors at a Low DIGI-KEY Price

CHEMICALS \* ARIES \* PLESSEY \* MOLEX \* E.  
ICMINE \* DIAMOND TOOL \* UNGAR \* GC CH.  
INSTRUMENTS \* ITT \* CHEMICALS \*  
D.TOLL \* UNGAR \* GC CHEMICALS \* ARIES  
CHEMICALS \* ARIES \* PLESSEY \* MOLEX \* E.

Integrating Circuits

Part No.	Price	Part No.	Price	Part No.	Price	Part No.	Price
7400 TTL	1.00	74150 TTL	1.00	4000 CMOS	1.00	Linear	1.00
7401N	30	74150N	30	4001	30	LM741	30
7402N	30	74150N	30	4002	30	LM742	30
7403N	30	74150N	30	4003	30	LM743	30
7404N	30	74150N	30	4004	30	LM744	30
7405N	30	74150N	30	4005	30	LM745	30
7406N	30	74150N	30	4006	30	LM746	30
7407N	30	74150N	30	4007	30	LM747	30
7408N	30	74150N	30	4008	30	LM748	30
7409N	30	74150N	30	4009	30	LM749	30
7410N	30	74150N	30	4010	30	LM750	30
7411N	30	74150N	30	4011	30	LM751	30
7412N	30	74150N	30	4012	30	LM752	30
7413N	30	74150N	30	4013	30	LM753	30
7414N	30	74150N	30	4014	30	LM754	30
7415N	30	74150N	30	4015	30	LM755	30
7416N	30	74150N	30	4016	30	LM756	30
7417N	30	74150N	30	4017	30	LM757	30
7418N	30	74150N	30	4018	30	LM758	30
7419N	30	74150N	30	4019	30	LM759	30
7420N	30	74150N	30	4020	30	LM760	30
7421N	30	74150N	30	4021	30	LM761	30
7422N	30	74150N	30	4022	30	LM762	30
7423N	30	74150N	30	4023	30	LM763	30
7424N	30	74150N	30	4024	30	LM764	30
7425N	30	74150N	30	4025	30	LM765	30
7426N	30	74150N	30	4026	30	LM766	30
7427N	30	74150N	30	4027	30	LM767	30
7428N	30	74150N	30	4028	30	LM768	30
7429N	30	74150N	30	4029	30	LM769	30
7430N	30	74150N	30	4030	30	LM770	30
7431N	30	74150N	30	4031	30	LM771	30
7432N	30	74150N	30	4032	30	LM772	30
7433N	30	74150N	30	4033	30	LM773	30
7434N	30	74150N	30	4034	30	LM774	30
7435N	30	74150N	30	4035	30	LM775	30
7436N	30	74150N	30	4036	30	LM776	30
7437N	30	74150N	30	4037	30	LM777	30
7438N	30	74150N	30	4038	30	LM778	30
7439N	30	74150N	30	4039	30	LM779	30
7440N	30	74150N	30	4040	30	LM780	30
7441N	30	74150N	30	4041	30	LM781	30
7442N	30	74150N	30	4042	30	LM782	30
7443N	30	74150N	30	4043	30	LM783	30
7444N	30	74150N	30	4044	30	LM784	30
7445N	30	74150N	30	4045	30	LM785	30
7446N	30	74150N	30	4046	30	LM786	30
7447N	30	74150N	30	4047	30	LM787	30
7448N	30	74150N	30	4048	30	LM788	30
7449N	30	74150N	30	4049	30	LM789	30
7450N	30	74150N	30	4050	30	LM790	30
7451N	30	74150N	30	4051	30	LM791	30
7452N	30	74150N	30	4052	30	LM792	30
7453N	30	74150N	30	4053	30	LM793	30
7454N	30	74150N	30	4054	30	LM794	30
7455N	30	74150N	30	4055	30	LM795	30
7456N	30	74150N	30	4056	30	LM796	30
7457N	30	74150N	30	4057	30	LM797	30
7458N	30	74150N	30	4058	30	LM798	30
7459N	30	74150N	30	4059	30	LM799	30
7460N	30	74150N	30	4060	30	LM800	30
7461N	30	74150N	30	4061	30	LM801	30
7462N	30	74150N	30	4062	30	LM802	30
7463N	30	74150N	30	4063	30	LM803	30
7464N	30	74150N	30	4064	30	LM804	30
7465N	30	74150N	30	4065	30	LM805	30
7466N	30	74150N	30	4066	30	LM806	30
7467N	30	74150N	30	4067	30	LM807	30
7468N	30	74150N	30	4068	30	LM808	30
7469N	30	74150N	30	4069	30	LM809	30
7470N	30	74150N	30	4070	30	LM810	30
7471N	30	74150N	30	4071	30	LM811	30
7472N	30	74150N	30	4072	30	LM812	30
7473N	30	74150N	30	4073	30	LM813	30
7474N	30	74150N	30	4074	30	LM814	30
7475N	30	74150N	30	4075	30	LM815	30
7476N	30	74150N	30	4076	30	LM816	30
7477N	30	74150N	30	4077	30	LM817	30
7478N	30	74150N	30	4078	30	LM818	30
7479N	30	74150N	30	4079	30	LM819	30
7480N	30	74150N	30	4080	30	LM820	30
7481N	30	74150N	30	4081	30	LM821	30
7482N	30	74150N	30	4082	30	LM822	30
7483N	30	74150N	30	4083	30	LM823	30
7484N	30	74150N	30	4084	30	LM824	30
7485N	30	74150N	30	4085	30	LM825	30
7486N	30	74150N	30	4086	30	LM826	30
7487N	30	74150N	30	4087	30	LM827	30
7488N	30	74150N	30	4088	30	LM828	30
7489N	30	74150N	30	4089	30	LM829	30
7490N	30	74150N	30	4090	30	LM830	30
7491N	30	74150N	30	4091	30	LM831	30
7492N	30	74150N	30	4092	30	LM832	30
7493N	30	74150N	30	4093	30	LM833	30
7494N	30	74150N	30	4094	30	LM834	30
7495N	30	74150N	30	4095	30	LM835	30
7496N	30	74150N	30	4096	30	LM836	30
7497N	30	74150N	30	4097	30	LM837	30
7498N	30	74150N	30	4098	30	LM838	30
7499N	30	74150N	30	4099	30	LM839	30
7500N	30	74150N	30	4100	30	LM840	30

TEXAS INSTRUMENTS I.C. SOCKETS

92 Pin DIP Socket with 0.100 inch Pitch  
Accommodates standard ICs up to 0.100 inch thick  
(0.05 inch) - Contact in design and oriented to the  
customer's preference. Meet all IC socket standards  
for low insertion and high retention force. Socket is  
designed for maximum density on boards.

SOLDER TAIL DIP SOCKETS

• Single beam  
• Low profile  
• YOUR CHOICE: TIN OR GOLD

TIN PLATED WIRE WRAP

• Standard profile  
• Universal mounting and  
• pack-off design  
• Contacts accommodate 0.075  
inch diameter wire  
• Round dual in line leads

WIRE WRAP DIP SOCKETS

• Standard profile  
• Universal mounting and  
• pack-off design  
• Contacts accommodate 0.075  
inch diameter wire  
• Round dual in line leads

GOLD INLAY WIRE WRAP

• Standard profile  
• Universal mounting and  
• pack-off design  
• Contacts accommodate 0.075  
inch diameter wire  
• Round dual in line leads

TIN PLATED WIRE WRAP

• Standard profile  
• Universal mounting and  
• pack-off design  
• Contacts accommodate 0.075  
inch diameter wire  
• Round dual in line leads

GOLD INLAY WIRE WRAP

• Standard profile  
• Universal mounting and  
• pack-off design  
• Contacts accommodate 0.075  
inch diameter wire  
• Round dual in line leads

TIN PLATED WIRE WRAP

• Standard profile  
• Universal mounting and  
• pack-off design  
• Contacts accommodate 0.075  
inch diameter wire  
• Round dual in line leads

GOLD INLAY WIRE WRAP

• Standard profile  
• Universal mounting and  
• pack-off design  
• Contacts accommodate 0.075  
inch diameter wire  
• Round dual in line leads

TIN PLATED WIRE WRAP

• Standard profile  
• Universal mounting and  
• pack-off design  
• Contacts accommodate 0.075  
inch diameter wire  
• Round dual in line leads

GOLD INLAY WIRE WRAP

• Standard profile  
• Universal mounting and  
• pack-off design  
• Contacts accommodate 0.075  
inch diameter wire  
• Round dual in line leads

TIN PLATED WIRE WRAP

• Standard profile  
• Universal mounting and  
• pack-off design  
• Contacts accommodate 0.075  
inch diameter wire  
• Round dual in line leads

GOLD INLAY WIRE WRAP

• Standard profile  
• Universal mounting and  
• pack-off design  
• Contacts accommodate 0.075  
inch diameter wire  
• Round dual in line leads

TIN PLATED WIRE WRAP

• Standard profile  
• Universal mounting and  
• pack-off design  
• Contacts accommodate 0.075  
inch diameter wire  
• Round dual in line leads

GOLD INLAY WIRE WRAP

• Standard profile  
• Universal mounting and  
• pack-off design  
• Contacts accommodate 0.075  
inch diameter wire  
• Round dual in line leads

TIN PLATED WIRE WRAP

• Standard profile  
• Universal mounting and  
• pack-off design  
• Contacts accommodate 0.075  
inch diameter wire  
• Round dual in line leads

GOLD INLAY WIRE WRAP

• Standard profile  
• Universal mounting and  
• pack-off design  
• Contacts accommodate 0.075  
inch diameter wire  
• Round dual in line leads

TIN PLATED WIRE WRAP

• Standard profile  
• Universal mounting and  
• pack-off design  
• Contacts accommodate 0.075  
inch diameter wire  
• Round dual in line leads

GOLD INLAY WIRE WRAP

• Standard profile  
• Universal mounting and  
• pack-off design  
• Contacts accommodate 0.075  
inch diameter wire  
• Round dual in line leads

TIN PLATED WIRE WRAP

• Standard profile  
• Universal mounting and  
• pack-off design  
• Contacts accommodate 0.075  
inch diameter wire  
• Round dual in line leads

GOLD INLAY WIRE WRAP

• Standard profile  
• Universal mounting and  
• pack-off design  
• Contacts accommodate 0.075  
inch diameter wire  
• Round dual in line leads

TIN PLATED WIRE WRAP

• Standard profile  
• Universal mounting and  
• pack-off design  
• Contacts accommodate 0.075  
inch diameter wire  
• Round dual in line leads

GOLD INLAY WIRE WRAP

• Standard profile  
• Universal mounting and  
• pack-off design  
• Contacts accommodate 0.075  
inch diameter wire  
• Round dual in line leads

TIN PLATED WIRE WRAP

• Standard profile  
• Universal mounting and  
• pack-off design  
• Contacts accommodate 0.075  
inch diameter wire  
• Round dual in line leads

GOLD INLAY WIRE WRAP

• Standard profile  
• Universal mounting and  
• pack-off design  
• Contacts accommodate 0.075  
inch diameter wire  
• Round dual in line leads

TIN PLATED WIRE WRAP

• Standard profile  
• Universal mounting and  
• pack-off design  
• Contacts accommodate 0.075  
inch diameter wire  
• Round dual in line leads

GOLD INLAY WIRE WRAP

• Standard profile  
• Universal mounting and  
• pack-off design  
• Contacts accommodate 0.075  
inch diameter wire  
• Round dual in line leads

TIN PLATED WIRE WRAP

• Standard profile  
• Universal mounting and  
• pack-off design  
• Contacts accommodate 0.075  
inch diameter wire  
• Round dual in line leads

NEW! KIT

310 DISC CAPACITORS

NEW! KIT

310 DISC CAPACITORS

NEW! KIT

310 DISC CAPACITORS

NEW! KIT

310 DISC CAPACITORS

NEW! KIT

310 DISC CAPACITORS

NEW! KIT

310 DISC CAPACITORS

NEW! KIT

310 DISC CAPACITORS

NEW! KIT

310 DISC CAPACITORS

NEW! KIT

310 DISC CAPACITORS

NEW! KIT

310 DISC CAPACITORS

NEW! KIT

310 DISC CAPACITORS

NEW! KIT

310 DISC CAPACITORS

NEW! KIT

310 DISC CAPACITORS

NEW! KIT

310 DISC CAPACITORS

NEW! KIT

310 DISC CAPACITORS

NEW! KIT

310 DISC CAPACITORS

NEW! KIT

310 DISC CAPACITORS

NEW! KIT

310 DISC CAPACITORS

NEW! KIT

310 DISC CAPACITORS

NEW! KIT

NATIONAL SEMICONDUCTOR • PANASONIC • AVIC • CHEMVAL • BISHOP GRAPHICS • ARIES • MOLEX • AVIDO • E • G • O MACHINE • UNGAR • GC CHEMICALS • NATIONAL SEMICONDUCTOR • PANASONIC

3 AMP SILICON RECTIFIERS ZENER DIODES 3 AMP SILICON RECTIFIER

IT SILICON ZENER DIODES

Programmable Clock Modules 0.7 or 0.8" Red 4-Digit LED Display

5-Digit LED Clock Modules

3AG NORMAL-BLO FUSES

DIGI-CLOCK KIT

3AG SLO-BLO FUSES

3AG PANEL FUSEHOLDER

Digi-Key volume discount and handling charges are simple to apply.

★ —★ COMING IN MAY ★ —★ 1% Metal Film Resistors at a Low DIGI-KEY Price

Silicon Transistors

TERMINATION JUMPEERS

PCB Transformers

5% Carbon Film Resistors

5% Carbon Film Resistor Values in Ohms

1% WATT 5% CARBON FILM RESISTOR ASSORTMENT

1% WATT 5% CARBON FILM RESISTOR ASSORTMENT

1% WATT 5% CARBON FILM RESISTOR ASSORTMENT

EMICALS • ARIES • PLESSEY • MOLEX • E CHINE • DIAMOND TOOL • UNGAR • GC CH INSTRUMENTS • IT • A • P PRODUCTS • OI T • O • L • U • N • G • A • R • G • C • H • E • M • I • C • A • L • S • P • L • E • S • S • E • Y • M • O • L • E • X • E •

alpha wire cable tubing

Hookup Wire Solid PVC Insulated

DIP Jumper Cable Assembly Standard Assembly Styles

Shrinkable Tubing, Polyolefin Block

Adhesive Tack Shrinkable Tubing Block

Self-Encapsulating Conduits

D-Subminiature Connectors

Handling Charges

Volume Discount

# Computers & Electronics Marketplace

**CLASSIFIED RATES:** Per Word, 15 Word Minimum. **COMMERCIAL:** \$4.00. **PERSONAL:** \$2.30. **EXPAND-AD®:** \$6.00. Ads set in all bold type @ 20% premium. Ads set with background screen @ 25% premium. **DISPLAY:** 1" x 2 1/4", \$485.00. 2" x 2 1/4", \$970.00. 3" x 2 1/4", \$1,450.00. **GENERAL INFORMATION:** Frequency rates and prepayment discounts available. Payment must accompany order except credit card—Am. Ex., Diners, MC, VISA (include exp. date)—or accredited ad agency insertions. Copy subject to publisher's approval; must be typewritten or printed. First word set in caps. Advertisers using P.O. Boxes **MUST** supply permanent address and telephone number. Orders not acknowledged. They will appear in next available issue after receipt. Closing date: 1st of the 2nd month preceding cover date (e.g., Mar. issue closes Jan. 1). Send order & remittance to: Classified Advertising, **COMPUTERS & ELECTRONICS Magazine**, 1 Park Avenue, New York, NY 10016. Direct inquiries to Rose Lynch, (212) 725-7686.

## FOR SALE

**GOVERNMENT** and industrial surplus receivers, transmitters, snooper scopes, electronic parts, Picture Catalog 25 cents. Meshna, Nahant, Mass. 01908.

**ELECTRONIC PARTS**, semiconductors, kits. **FREE FLYER.** Large catalog \$1.00 deposit. **BIGELOW ELECTRONICS**, Bluffton, Ohio 45817.

**BUILD AND SAVE.** TV EARTH STATION. **DETECTIVE ELECTRONICS.** Video Recorders, Color Cameras, advanced Telephone Projects. **BROADCAST ELECTRONICS.** 50 page color catalog of unusual electronic projects **AIR MAILED \$3.00**; with 3 hour audio cassette dramatization of our catalog \$5.00. Don Britton Enterprises, PO Drawer G, Waikiki, Hawaii 96815.

**RECONDITIONED TEST EQUIPMENT \$1.00** for catalog. **WALTER'S TEST EQUIPMENT**, 2697 Nickel, San Pablo, CA 94806, (415) 724-0587.

**ELECTRONIC PARTS.** Stamp for flyer, \$1.00 deposit for catalog. **DAYTAPRO ELECTRONICS**, 3029 N. Wilshire, Arlington Hts., IL 60004.

**ELECTRONIC CATALOG.** Over 4,500 items. Parts, & components. Everything needed by the hobbyist or technician. \$2.00 postage & handling (United States Only), refundable with first \$15.00 order. T & M Electronics, 472 East Main St., Patchogue, NY 11772. (516) 289-2520.

**PRINTED CIRCUIT BOARDS**, your artwork. Quick delivery. Reasonable. **Atlas Circuits**, Box 892, Lincolnton, NC 28092. (704) 735-3943.

### Telephone Listening Device

Record telephone conversations in your office or home. Connects between any cassette or tape recorder and your telephone or telephone LINE. Starts automatically when phone is answered. Records both sides of phone conversation. Stops recorder when phone is hung up. This device is not an answering service.



Each  
**\$19.95**  
Qty. Disc Avail.

---

### Super Powerful Wireless Mic

10 times more powerful than other mics. Transmits up to 1/4 mile to any FM radio. Easy to assemble kit. 15V battery (not incl.)

Call (305) 725-1000 or send \$19.95 + \$1.00 shipping per item to **USI Corp.**, P.O. Box CE-2002, Melbourne, FL 32901. COD's accept. For catalog of Transmitters, voice scramblers and other specialty items, enclose \$2.00 to USI Corp.



Size 2" x 3" x 1/2"

**SATELLITE TELEVISION...HOWARD/COLEMAN** boards to build your own receiver. For more information write...**ROBERT COLEMAN**, Rt. 3, Box 58-APE, Travelers Rest, S.C. 29690.

**SOUND SYNTHESIZER KITS**—Surf \$19.95, Wind \$19.95, Wind Chimes \$24.95, Musical Accessories, many more. Catalog free. **PAIA Electronics**, Box J14359, Oklahoma City, OK 73114.

FREE SBCOM IN YOUR HOME WITH AIRD MAILING

## SATELLITE TV

### FANTASTIC 80 TV CHANNELS

New antenna construction plans plus big 8x11 book loaded with aiming info, kits, LNAs and receivers at wholesale prices. Far better than cable TV! Enjoy crystal clear reception. Send \$9.95 today. Add \$2.00 for 1st class (air mail) or call our 24 hr. COD order line (305) 862-5068 Now.

Global TV Electronics, P.O. Box 219-E, Maitland, FL 32751

**RF MODULATORS** for **SATELLITE TELEVISION**, **MICROCOMPUTERS** CCTV. Also monitors, cameras, kits. **FREE VIDEO CATALOG.** Phone (402) 987-3771. Dealers Welcomed. **ATV RESEARCH**, 13-P Broadway, Dakota City, NE 68731.

**CABLE TV CONVERTERS & EQUIPMENT.** Plans and parts. Build or buy. For more information send \$2.00; **C & D ELECTRONICS INC.**, P.O. Box 21, Jenison, MI 49428.

**FREE FLYER!** IC's, resistors, capacitors, jacks, etc., plus SSM music synthesizer/audio IC's, power amp modules, analog delay IC's, computer books, and more. Also plans for analog delay/chorus unit! **PGS Electronics**, Route 25, Box 304 Terre Haute, IN 47802.

## SATELLITE TV

• SYSTEMS • COMPONENTS • LNA'S •  
• ANTENNAS • RECEIVERS •  
WE CAN HELP YOU!

### HIGH FRONTIER

2230 E. Indian School Rd., Phoenix, AZ 85016  
(602) 954-6008

**TELETYPE EQUIPMENT:** Copy Military, Press, Weather, Amateur, Commercial Transmissions. Catalog \$1.00. **WEATHER-MAP RECORDERS:** Copy Satellite Photographs, National-Local Weather Maps. Learn How! \$1.00. **Atlantic Sales**, 3730 Nautilus Ave., Brooklyn, NY 11224. Phone: (212) 372-0349.

## CABLE TV CONVERTERS VIDEO ACCESSORIES

BUY DIRECT & SAVE

	40 CHANNEL CONVERTER <b>\$38</b> Regular \$69
Advanced Solid State design and circuitry allows you to receive mpeg & super band channels Restores missing programming to Video Recorders	
	36 CHANNEL REMOTE CONTROL CABLE CONVERTER <b>\$88.00</b>
DIAMOND D-56 WIRELESS THE ULTIMATE CABLE T.V. CONVERTER	
	56 CHANNEL INFRARED REMOTE CONTROL <b>\$139.00</b>

Send \$1 for Complete Catalog VISA • MASTERCARD • COD

### DIRECT VIDEO SALES

P.O. BOX 1329  
JEFFERSONVILLE, INDIANA 47130  
CALL 1-812-282-4766

**POLICE CODE UNSCRABLERS**, lets you hear the coded messages of Police, Fire and Medical channels; magnetic mobile scanner antennas and other scanner accessories, satisfaction guaranteed. **DNE Inc.**, Rt. 7, Box 257-A, Hot Springs, AR 71901. (501) 623-6027.

## REPAIR ATARI GAMES AT HOME

Complete repair course on 3 hour video tape (Beta or VHS) plus schematics and technical literature enables you to start earning money right away. All popular repair parts in stock for immediate shipment. \$1.00 for parts/price list and additional information refundable with order. Exclusive National Distributor.

**ELECTRONICS WAREHOUSE CORP.**  
1910 Coney Island Avenue  
Brooklyn, N.Y. 11230 (212) 375-2700

**FREE FLYER** 99 cent kits. Parts. Bargains Galore! **ALLKIT**, 434 West 4th St., West Islip, New York 11795.

**RESISTORS**, 1/4W 5% C.F., 3¢ ea., 1% Metalfilms. NO MINIMUMS. Quantity Discounts. Write: **JR INDUSTRIES**, 5834-A Swancreek, Toledo, OH 43614.

**NEW UHF CONVERTERS** and Cable units Sound out TV CH3 antenna connections Model A Gated. Pulse Suppressed, Model B Computerized Addressable, Model C Cable computerized Addressable. Send \$2, for information: **J&D Engineering**, P.O. Box 469, Boston, MA 02186. 1-617-837-8431.

**FAST, DEPENDABLE MAIL-ORDER! PRIME** semiconductors, parts, accessories. Free 54 page catalog. The Parts Store, Dept. 180,999 44th St., Marion, IA 52302.

Call or Send for Free **SINTEC**  
**ELECTRONIC PARTS CATALOG**

Thousands of Quality Components No Mail Order "Seconds"  
Call Toll Free **800-526-5960**  
NJ Residents call 201-996-4093  
Sintec, Drawer Q, Milford, NJ 08848

SPEAKER KITS.



From the worlds oldest and largest speaker kit manufacturer, **SPEAKERLAB**. Save up to 30% on the speaker designs critics rave about. From tiny bookshelf speakers to slender, floor-standing models to massive folded corner horns. PLUS the latest in state-of-the-art car speakers. All in Speakerlab's 1983 catalog. Send for it today. (Allow 4 - 6 weeks for delivery. Send \$1.25 for faster, first class postage.)

## speakerlab

Dept. CE63 735 N. Northlake Way  
Seattle, Washington 98103

**IF YOU ARE READY TO BUY OR SELL GAMES OR SOFTWARE, YOU NEED...**

## COMPUTER SHOPPER

Over 100 pages each month. Deal with individuals nationwide. Low ad rate, only 12¢ a word. Subscription: \$10/year. MC & VISA Money back guarantee. P.D. Box 7596 Titusville, FL 32780. (305) 269-3211.

## CABLE TV KITS

We have all 3 types of Cable TV Kits. Prices start at \$37. Send for our "informative catalog" \$2, and find out what type you need.

**J & W Electronics, Inc.**  
P.O. Box 61-K  
Cumberland, RI 02864

**PRINTED CIRCUIT BOARDS. "QUICK PROTOTYPES"**, production, design, reflow solder. Send print or description for quote to: **KIT CIRCUITS**, Box 235, Clawson, MI 48017.

**S-100 POWER SUPPLY KIT**—\$29.95 (plus shipping). IC's, FANS, CRT's. Catalog: 40¢ SASE. **DEALIN' ELECTRONICS**, 735 Loma Verde, Palo Alto, CA 94303.

**PRINTED CIRCUIT BOARDS** and Artwork. Fast turn around, quality service, E.C.E., 3620 Spring Garden St., Greensboro, NC 27407.

**"LOW LOW COMPONENT PRICES!** Ask for free flyer. Write: **EET**, 11 Revere Place, Tappan, NY 10983.

**CABLE TV SECRETS**, the informative publication the cable companies are trying to ban. **HBO, Movie Channel, Showtime** converters, etc. Send \$8.95 to: **CABLE FACTS**, Box 711-PE, Pataskala, Ohio 43062.

## A SINGER'S DREAM!

**REMOVES VOCAL FROM MOST STEREO DISCS**

The Thompson Vocal Eliminator can actually remove most or virtually all of a solo vocalist from a standard stereo record and yet leave most of the background music untouched! Not an equalizer! We can prove it works over the phone. Write or call for a 24 page brochure and demo record.

Write to: **L.T. Sosand**, Dept. CE, P.O. Box 338, Stone Mountain, GA 30086. Phone: (404) 493-1258

**RELIABLE MICROWAVE TV ANTENNAS**  
**2.1 to 2.6 GHz**  
**Frequency Range**  
**34db System Gain (or Greater)**  
 Complete System (pictured) \$119.95  
 Down Converter Probe Style  
 (Assembled & Tested) \$49.95  
 Power Supply (12V to 16V DC)  
 (Assembled & Tested) \$39.95

**PETERSON ELECTRONICS**  
 4558 Auburn Blvd  
 Sacramento, CA 95841  
 (916) 486-9071

**SPECIAL QUANTITY PRICING**  
 Dealers Wanted · COD'S

1 YEAR WARRANTY  
 PARTS & LABOR



TELEPHONES and ACCESSORIES FCC registered. Send \$2.00 for 72 page catalog (refundable). UNIQUE COMMUNICATIONS, 6335 SR, 97 Galion, Ohio 44833.

HI-FI SPEAKER KITS and SR, 97 drivers from the world's finest manufacturers. For beginners and audiophiles. Free information. A&S SPEAKERS, Box 7462C, Denver, CO 80207, (303) 399-8609.

SATELLITE TV RECEIVER BREAKTHROUGH! Build your own commercial quality receiver now! Instruction manuals, schematics, circuit boards! Send stamped envelope: XANDI, Box 25647, Dept 22L, Tempe, AZ 85282.

BIG SAVINGS ON CONY TRANSMITTERS—Up to 30% OFF! Send two stamps for catalog. S.E. Corp., Box 1132-PC, Yorba Linda, CA 92686.

EPROM ERASER—Convert ordinary 18" fluorescent desk lamp. Send \$29.95 for special tube. Bit Bucket, Box 92514, Rochester, NY 14692.

WHOLESALE: MATV/CATV/VCR equipment, Antennas, Audio, Cables, Adapters, Original and Replacement Cartridges, Stylis, Telephone Accessories, Radios, Cassette Recorders, Speakers, etc. Send letterhead for catalog. 212-897-0509, D&WP, 66-19 Booth, Rego Park, NY 11374.

PREVENT—RELIEVE Allergies, Colds, Computeritis, Headaches, infections ten years!! Negative Ionizers \$49.95!!! Climatologist!!!, 3045 (CE) Troy, Chicago, 60618. (312) 478-9526

MITSUMI UHF-TV Varactor tuner UES-ASSF only \$19.95. Minimum per order \$25.00. P.O. Box 246, Montebello, CA 90640.

SATELLITE TELEVISION: Receivers \$300, Dishes \$100, LNA's, microwave equipment. Catalog \$5.00. Satellite Systems, Box 184, Milpitas, CA 95035.

FREE CATALOG. Large selection of electronic kits and parts. Chaney Electronics, Box 27038, Denver, Colorado 80227. (303) 781-5750.

CABLE TV and UHF converter manual only \$12.95, covers the three major systems. VIDEO GAME CARTRIDGES are easy and inexpensive to duplicate. Plans \$9.95. Information \$2.00, refundable. Random Access (formerly D&S Enterprises), Box 41770C, Phoenix, AZ 85080.

TRANSPOSERS, DIGITAL RHYTHM DISPLAYS, Super cymbal, many more inexpensive accessories. All organs. Send for free brochure. Sacha International, 943 Archer Street, San Diego, California 92109.

TV/FM (antimultipath antenna. Patented fringes VHF/UHF/FM reception without need of splitter. Everything furnished (twin-lead, etc.), outside/inside use, and hangs flat on any wall. Sent COD, VISA, Mastchq, or for \$20 cash (add \$4.00 for insured airmail shipping) by SADC0, 11621 Hughes NE, Albuquerque, NM 87112. (USA).

SATELLITE ANTENNAS—Build wood or metal from \$98. Send \$2: Prototype Engineers, Box 1812, Deming, NM 88030.

**Satellite Earth Station**  
**Complete systems from \$1,899.00**  
 Call or write for our latest brochure.  
**TENNESSEE ELECTRONICS**  
 P.O. Box 181108  
 Memphis, TN 38118  
 (901) 795-4504

TELEQUEST CATALOG—Filled with over 350 exciting state-of-the-art electronic products. Latest in high-tech engineering and design. To order dial toll free 1-800-327-TELE. Or send \$4.95 plus \$1.40 for shipping and handling (Fla residents include 5% sales tax) to: TeleQuest: 3015 North Ocean Blvd, Fort Lauderdale, Florida 33308.

SATELLITE TV—Before you buy get this video cassette tape explaining operation set-up and troubleshooting. Save up to \$500.00 on installation fees, \$49.95 VHS or Beta. Free system price list enclosed. Information booklet \$4.95. Gatorvision, Box 313, Hardin, IL 62047.

TELEPHONE TEST SET. Fault isolate telephone problems. Assembled for use. Send \$14.75. Tele-Tale, Box SES 7310 Ritchie Highway, Glen Burnie, Maryland 21061.

GATED PULSE WAVE UHF (speaker box type), has true A.G.C., parts \$125. The following have sound out of the TV like normal with only an antenna connection to the TV or VCR. Deluxe IIB Cos Wave UHF, has true A.G.C., parts \$150. Digital Sync Suppression/Active Video Inversion VHF/UHF FV-4, has true A.G.C., parts \$225. Quantity discounts. Plans: large SASE (54¢ postage). Free shipping/handling. 1-312-267-3455. LSR Engineering, Dept. CE, P.O. Box 6075, Chicago, Illinois 60680.

WILL TRADE FACTORY SEALED COMPUTER EQUIPMENT for your McIntosh, Marantz and other quality audio equipment. Martin Gasman, 779 Worcester St., Wellesley, MA 02181, (617) CEL-TICS.

CABLE T.V. EQUIPMENT and UHF converters. Send \$2.00 for catalog. Mean Electronics, P.O. Box 347, Boston MA 02188.

PCB 15¢ sq-in. FREE DRILLING. Quantity Discounts. International Enterprise, 6452 Hazel Circle, Simi-Valley, CA 93063.

DELUXE UHF Converters: Sinewave, gated pulse, computerized addressable. We've got them all! Low, low prices! Catalog \$2.00. TCE, Dept. C6, Box 343, Brooklyn, NY 11230.

### COMPUTER EQUIPMENT/PARTS

SAVE 90% Build Your own Minicomputer. Free Details. Digatek, 2723 West Butler Dr., Suite 20C, Phoenix, AZ 85021.

WANT A PLEASANT SURPRISE! Call or write for our quotes: Atari, Commodore, Timex, Franklin, TI, Okidata and more. ACCESSORIES, SOFTWARE. Factory sealed with full manufacturer warranty. HARDWARE, SOFTWARE, ANYWARE, 10 Coles Street, Brooklyn, NY 11231, (212) 596-3592.

APPLE COMPUTER BUILDERS—Apple cabinets, power supplies, keyboards, PC boards and peripherals. Call or write for lowest prices. Xicom Computer Products, Inc., 801 E. Ogden, Suite 1085, Naperville, IL 60566, (312) 369-6125.

USED COMPUTER TERMINALS, PRINTERS, MODEMS, CABLES, SURPLUS ELECTRONIC PARTS. SPECIALS: DAISY WHEEL PRINTERS (will interface to various computers) \$300.00. XEROX 820 CPU BOARD (single board computer, new, assembled & tested) \$425.00, CATALOG \$1.00. RONDURE COMPANY, "The Computer Room" PE, 2522 BUTLER STREET, DALLAS, TX 75235. (214) 630-4621.

VIDEO SELECTOR: Permits convenient switching of up to four different inputs to your T.V. VHF terminal. Send \$29.95 plus \$2.50 shipping to: TVI Co., P.O. Box 2613, Redmond, WA 98052. Washington residents add 8.1% sales tax.

NEW! COLOR YOUR COMPUTER'S SCREEN! Videoflex Color Transparencies transform harsh B&W into stimulating — Laser Red, Cybernetic Blue, Phosphor Green. Boosts fun and efficiency for all computer users. Easy installation on all B&W screens to 13". Order now receive FREE Amber Eyesaver. Send \$6.00 per kit, Videoflex-2A, Box 149, Netcong, New Jersey 07857. Money back.

APPLE Computer, Disk Drive \$195.00, Resistors, 0.25W5%, Voltage Regulator, 74XX series, Memory, CPU. Presto Enterprise, Box 9060, S.J., CA 95157.

### COMPUTER SOFTWARE

VIC-20 USERS GROUP, receive newsletter, programs, discounts and more. Send SASE for information. P.O. Box 459, Dept 7, Ladson, South Carolina 29456.

FREE CATALOG—PET, VIC, Commodore 64 Software, Books. TIS, Box 921, Dept. CE5, Los Alamos, NM 87544.

VIC-20: Eighty Software Programs on cassette, \$10.00 check or money order, includes postage. Public Domain. FANFARE SOFTWARE, 120 E. Main St., El Cajon, CA 92020.

TI-99/4A PROGRAMMERS: 6 programs plus list, \$6.95, cash, check, M.O., or \$1 for list. PROGRAMS, 1435 Burnley Square North, Columbus, Ohio 43229.

APPLE, TRS-80. Stock market software. Free information. Stock Market Computers, 235 Mesa Avenue, Newbury Park, CA 91320, (213) 884-6900.

COMPREHENSIVE INVENTORY MANAGEMENT SYSTEM with included CASH REGISTER function. Requires CP/M, dBase-11 or runtime package. \$119.95. Colonie Computech Corp, 438N Karner, Albany, NY 12205.

XFORTH—Forth-79 standard sub-set plus extra utilities. 10K+ available for user code. On cassette for 16K ZX-81 \$25.00 +\$1.00 P&H. Arkansas residents add \$1.00. HAWG WILD Software, Box 7668-E, Little Rock, AR 72207.

TI-99/4A CASSETTE SOFTWARE. Each cassette includes 4 games. Submarine Hunt, Hammurabi, Scramble, Nim: order CAS1 \$14.95. Hangman, Mastermind, Moon Landing, Simon Sez: order CAS2 \$14.95. Add \$1.50 p/h. Write for more. TI-99/4A Cassette Software, 4129 Abercorn Road, Knoxville, TN 37921.

SINCLAIR ZX81/TS1000 Software. Send for free Catalog. Midwest Software, 9922 Harwich, Crestwood, MO 63126.

TI-99/4A OWNERS! Send for free list of new and exciting, low cost software. D.E., Box 124, Hicksville, NY 11801.

VIC-20 USERS GROUP, Programs, discounts, reviews, SASE National VIC-20 Program Exchange, 102 Hickory Court, Portland, Indiana 47371.

TIMEX-SINCLAIR USERS: Join the group of newsletter subscribers who receive free programs every month! Software discounts, Free program, issue and catalog. Z-WEST, Box 2411, Vista, CA 92083.

T99/4A MOON TRIP animated graphic program on cassette. Guide module through asteroid belt. Then land on moon. Speech synthesizer and joyst capability. \$12.00 postpaid. JAG Software, P.O. Box 2225, Dept 1CE, Ocean, New Jersey 07712.

VIC-20 PROGRAMS \$1.50 each. Catalog \$2.00. Cooperative Computer, 21630 W. McNichols, Detroit, MI 48219.

FREE DISCOUNT SOFTWARE CATALOG for your home computer. Fastrack, Box 456-A, Columbus, OH 43216, (614) 863-1699.

VIC-20/COMMODORE 64—quality software. Low prices. Free catalog. RAK Electronics, Box 1585, Orange Park, Florida 32067-1585.

COMPUTER PAPER—SAVE\$\$\$; Lowest single carton prices. Free samples. Bob's Charts, 405 East Third, Long Beach, CA 90802.

ZX 81/TS 1000 16K PROGRAMS: Super File, Phone/Address List, and EZ-Filter (op-amp filter design) \$12.95 each. Electro Research, P.O. Box 12380, Columbus, Ohio 43212.

COMPUTER SOFTWARE (Business, Educational and Games) Atari, VIC-20, TRS-80, etc. Lowest Prices. Free price list. Surburban Quality, P.O. Box 908, Duncan, SC 29334. (803) 439-7289.

ATARI, APPLE, IBM-PC: Extensive line educational, entertainment, business. FREE BROCHURE. New Dimension Software, 39010 Baroque, Mt. Clemens, Michigan 48044.

SINCLAIR-ZX81/TIMEX FREE CATALOG of over 80 programs. UAS, Box 612, Haddonfield, NJ 08033.

COMMODORE 64 OWNERS. Send for free list of recreational, educational and home finance programs. Gator Software, 3803 Arabella St., Long Beach, CA 90805.

ATTN: VIC-20 OWNERS! Vegas style poker on cassette, only \$9.95 8K REQ. Catalog \$1.00 applied to first order. TWILIGHT ENTERPRISES, P.O. Box 1958, Camp Verde, AZ 86322.

### COMPUTER PUBLICATIONS

FREE Catalog of special function IC's and quality components. Goldsmith Scientific, Box 318M, Commack, New York 11725.

COMPUTER CURIOUS? Beginner's pamphlet on basic computer terms, \$4.00. Basic, P.O. Box 9254, Bakersfield, CA 93389.

HUMOROUS "ADULT" Color video cassettes catalog, \$1. ROSETRONIX, P.O. B. 801, Baldwin Park, CA 91706.

HOW to buy your second computer first! Free information. Write: C&M, P.O. Box 4091, Wilmington, NC 28406.

### AMATEUR RADIO

RADIO AMATEUR CALLBOOKS: 1983 Directories of Radio Amateurs around the world. U.S. Callbook \$23.00; Foreign Callbook \$22.00, shipping included. See your Dealer or write for FREE catalog. RADIO AMATEUR CALLBOOK, Dept CE, 925 Sherwood Dr., Lake Bluff, IL 60044.

VIDEOSCAN 1000 Slow Scan TV — HIGH RESOLUTION (amateur, phone line, monitoring, teleconferencing). CODE\*STAR — DECODE Morse, RTTY, ASCII. LARGE LEDs or connect computer/printer. MORSE-AKEYER — CW Keyboard. TRI-VOLTAGE POWER SUPPLY. Kits/Assembled. FREE brochures. MICROCRAFT CORPORATION, Box 513-PE, Thiensville, WI 53092. (414) 241-8144.

### TIMEX/SINCLAIR

ZX81/TS1000 Accessories! Catalog \$1.00 (Refundable). SKELGRAF, 4415 Basswood Lane, Bellaire, TX 77401.

KROPK., STAR SEARCH, NOAH'S ARK, finest programs available. Machine Language action, graphics. SASE Brown Cottage, 5486 Bright Hawk, Columbia, MD 21045.

PROFESSIONAL KEYBOARD PLANS \$5.00. M.O. Smuk Enterprises, Box 555, Orleans, Ontario, Canada K1C 1S9. U.S. Inquiries.

FREE SOFTWARE/HARDWARE CATALOG for your TS/ZX-81 16K: New programs. JPR SOFTWARE, Box 4155, Winter Park, FL 32793.

"MUST-HAVE"! Utility SOFTWARE. Cassettes-relocatable machine language. SASE for information. SIRIUS WARE, 6 Turning Mill Rd., Lexington, MA 02173.

ANTI-SLIP COMPUTER CUSHION. Insures accurate, vibration free typing. \$4.95 complete. EDCOMPCO, 998 Farmington Ave., West Hartford, CT 06107.

TIMEX/SINCLAIR KITS: Color Graphics and Sound W/16K RAM \$179.95. 4 Port I/O board \$69.95. CW/TTY and Disk Controller soon available. All plug into ST-50 Buffered Motherboard \$149.95. Brochure \$1 (refundable). Sigma-Technology, Dept. L, Box 971, Va. Beach, VA 23451.

TIMEX/SINCLAIR 1000/ZX81. HOW-TO Hardware upgrade book. Covering: Buffered expansion interface, Serial output, Std. printer interface and more. \$5.95. Inner Knowledge Computers & Peripherals, 5944 N.E. Sandy Blvd., Portland, Oregon 97213.

TIMEX/SINCLAIR SOFTWARE CHEAP! Special programs plus catalog \$1.00 and large SASE. SMART, Box 493, Groves, TX 77619.

### C.B. EQUIPMENT

IMPROVE CB PERFORMANCE! Modification hardware, books, plans, Catalog \$2. CBC INTERNATIONAL, Box 31500PE, Phoenix, AZ 85046.

### CABLE TV

CHANNEL 3—60db notch filter. 63.5MHz. \$32. Crosley, Dept. 607, Box 840, Champlain, NY 12919.

### PLANS AND KITS

SATELLITE RECEIVERS, LNA's, ANTENNAS—Build and save—Send stamp for details, Matco Electronics, Box 316CE, Cadillac, MI 49601.

ELECTRONIC Combination Lock. Patented. Plans available. \$3.00 and SASE. JINN, Box 764, Herndon, VA 22070.

### ALARMS

BETTER EQUIPMENT, Longer Guarantee. You'll save! Catalog 50¢, refundable. AAS, 414A Lorna Square, B'ham, AL 35216.

PROTECT MICROCOMPUTERS AND ELECTRONICS! Free Catalog of systems for SCHOOLS AND STORES. SGM Corporation, 6 West Main, Bound Brook, NJ 08805, (201) 496-8585.

### HIGH FIDELITY

**DIAMOND NEEDLES and STEREO CARTRIDGES at DISCOUNT PRICES for SHURE, PICKERING, STANTON, EMPIRE, GRADO, AUDIO TECHNICA, ORTOFON, ADC, SONUS and MICRO-ACOUSTIC.** Send S.A.S.E. free catalog. LYLE CARTRIDGES. Dept. P., Box 69, Brooklyn, NY 11218. For fast COD service Toll Free 800-221-0906. N.Y. State (212) 871-3303. 9AM-8PM except Sunday.

### WANTED

GOLD, Silver, Platinum, Mercury, Tantalum wanted. Highest prices paid by refinery. Ores assayed. Free circular. Mercury Terminal, Box 191, Norwood, MA 02062.

### GOVERNMENT SURPLUS

IS IT TRUE YOU CAN BUY JEEPS FOR \$44 THROUGH THE U.S. GOVERNMENT? Get the facts today! Call (312) 742-1142 Ext. 4649.

### TUBES

TUBES: "Oldies". Latest. Supplies, components, schematics. Catalog Free (stamp appreciated). Steinmetz, 7519-PE Maplewood, Hammond, Ind. 46324.

HUGE INVENTORY! Thousands of types. Wholesale prices. FREE CATALOG! ETCO Electronics, DEPT. 290, Plattsburgh, NY 12901.

### PERSONALS

MAKE FRIENDS WORLDWIDE through international correspondence, illustrated brochure free. Hermes-Verlag, Box 110660/Z, D-1000 Berlin 11, W. Germany.

CORRESPONDENCE FOR FRIENDSHIP IN PHILIPPINES, MALAYSIA. Free information. AAWS-(PE), Box 2777, Orcutt, California 93455-0777.

PENFRIENDS—ENGLAND—USA, through correspondence. Send age, interests. Free reply. Harmony, Box 89PE, Brooklyn, New York, 11235.

UNIVERSITY DEGREES BY MAIL! Bachelors, Masters, Ph.D.'s...Free revealing details, Counseling, Box 317-EP06, Tustin, California 92680.

SCANDINAVIAN LADIES, sincere, seek correspondence for friendship. Details—Send stamp: Scannaclub, Box 4-(CE), Pittsford, NY 14534.

ORIENTAL SINGLES seeking cultural exchange, friendship, sharing, marriage. Write: CHERRY BLOSSOMS, Box 1021P, Honolulu, Hawaii 96727.

SUNBELT SINGLES looking for a person of quality. Check our group. Details Box 83395, Oklahoma City, OK 73148.

FREE: WORLD'S LARGEST PARTNER-PHOTO-CATALOG for friendship and marriage. Personalized introductions. INTERCONTACT, Box 12, Toronto, Canada M4A 2M8. U.S. Inquiries.

WHY TRAVEL ALONE? We help singles, couples find compatible partners, new friends, travel inexpensively. TRAVEL COMPANION EXCHANGE, Box 833-CE, Amityville, New York 11701.

DISCOVER! Oriental Paradise, Box 12710, Rochester, New York 14612. Representing Christian, Educated Ladies Desiring Correspondence. Members Information Guide, saves hundreds. (Enclose Stamps).

ASIAN GIRLS seek lasting friendship. Free illustrated details: International Introductions, Box 82922-E, San Diego, California 92138.

### INSTRUCTION

UNIVERSITY DEGREES BY MAIL! Bachelors, Masters, Ph.D.'s. Free revealing details. Counseling, Box 317-PE06, Tustin, California 92680.

LEARN WHILE ASLEEP! HYPNOTIZE! Astonishing details, strange catalog free! Autosuggestion, Box 24-ZD, Olympia, Washington 98507.

MEDICAL ELECTRONICS TECHNOLOGY, home study. Troubleshoot medical instruments. WTI, P.O. Box 3124, Fresno, CA 93650-3124.

UNIVERSITY DEGREES BY SPECIAL EVALUATION of existing credits and Job Experience. Fast, inexpensive. Call (614) 863-1791. Or write: EVALUATION, Box 13151-A6, Columbus, Ohio 43213.

COMPUTER REPAIR, PROGRAMMING, WORD PROCESSING Courses. Exciting "Hands On" training in 4 months, lifetime placement assistance. Systems Technology Institute, 6442 Edgewater Drive, Orlando, FL 32810. (305) 299-6535.

REPAIR ELECTRONIC ORGANS—Revised home study course covers all current makes and models. Free booklet. Niles Bryant School, P.O. Box 20153, Sacramento, CA 95820.

F.C.C. COMMERCIAL RADIOTELEPHONE LICENSE. Home Study. Fast, Inexpensive! Free details. COMMAND, Box 26348-P, San Francisco 94126.

UNIVERSITY DEGREES without classes. Bachelors, Masters, Doctorates. Accredited, inexpensive, fast. Dr. John Bear, P.O. Box 11447-C6, Marina Del Rey, CA 90291.

YOUR OWN RADIO STATION AM, FM, Cable, licensed, unlicensed, low cost transmitter! Free information. BROADCASTING, Box 130-R4, Paradise, CA 95969.

IF YOU NEED, (or would like to be) a Video Technician...The finest school in America is in Dallas, Texas. Video Technical Institute, 1806 Royal Lane, Dallas, Texas 75229, 214-263-2613.

SLEEP-LEARNING BREAKTHROUGH! Discover 21st Century ERSP™ "Audio" Tapes-Dynamic Self-Improvement. Exciting FREE catalogue. ADVANCE SYSTEMS—CE1, 13906 Ventura, Sherman Oaks, CA 91423.

### FOR INVENTORS

#### INVENTORS! IDEAS HAVE VALUE!

Ever think of an idea, forget it and see it later on the market? Many people don't forget, act quickly and are rewarded by American Industry. Write down your ideal! We offer free disclosure registration and initial consultation regarding your idea's potential value. Call or write without delay for your free information package.

AMERICAN INVENTORS CORPORATION  
82 Broad St., Dept. CE  
Westfield, MA 01086  
(413) 737-5376

A fee Based Marketing Company  
Offices Coast to Coast

PATENT AND DEVELOP your invention. FREE PATENT INFORMATION. Richard L. Miller, P.E., 3612-E, Woolworth Building, New York, NY 10007, (212) 267-5252.

INVENTIONS, IDEAS, NEW PRODUCTS wanted for presentation to industry and exhibition at national technology exposition. Call 1-800-528-6050. Arizona, 1-800-352-0458. Ext. 831.

PATENTWRITER™ and MARKWRITER™ COMPUTER PROGRAMS. Prepare U.S. patent and trademark applications on your personal or business computer. For information write: Codelco Incorporated, 599 Mathilda, Suite 210-3, Sunnyvale, California 94086; or call toll free 1-800-227-9600. In California call 408-773-9600.

### BUSINESS OPPORTUNITIES

FREE CATALOGS. Repair air conditioning, refrigeration. Tools, supplies, full instructions. Doolin, 2016 Canton, Dallas, Texas 75201.

MECHANICALLY INCLINED individuals desiring ownership of Small Electronics Manufacturing Business—without investment. Write: BUSINESSES, 92-K6 Brighton 11th, Brooklyn, New York 11235.

ERASE DEBTS with little-known law—create wealth! Details FREE—Wealth Kit, No. EE6, Billings, NY 12510.

MAILORDER OPPORTUNITY! Start profitable home business without experience or capital. Information free. Mail Order Associates, Dept 488, Montvale, NJ 07645.

ONE MAN CRT FACTORY. T.V.'s, Business machines, Monitors, Scopes, VDT's. \$3.00 rebuilding nets \$100-\$500 each tube. Higher profits overseas. New/used. FACTORY, 1909 Louise, Crystal Lake, IL 60014. (815) 459-0666.

MAKE MONEY SELLING ELECTRONICS. Wholesale dealer catalog \$5. (redeemable). ETCO, Dept. 532, Box 840, Champlain, N.Y. 12919.

LIFETIME PROSPERITIES. Plan beats envelope stuffing anyway! Cancels debts: free sample. Elliott, Box 7206-PE6, Columbia, MO 65205.

BORROW \$300-\$30,000 INTEREST FREE! Keep indefinitely! Free Details. Write: American, 1601 Main, Plainfield, Indiana 46168.

I HAVE MADE A FORTUNE in Mail Order, selling information. Let me show you how. Write Kash CE701, Box 31051, Indianapolis, IN 46241.

BORROW \$30,000 without interest! All eligible. Reply anytime. Free details! Infohouse—508CE, 533 Sutter, San Francisco, CA 94102.

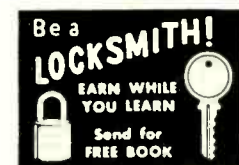

Locksmithing Institute, Dept. 73063  
Div. Technical Home Study Schools, Little Falls, N. J. 07424

Big opportunities. Big profits. Earn quickly. Full or part time. Learn at home, it's easy. Do real jobs. All Tools — Materials Supplied. Lic. State of NJ — Appd. for Veterans. Send Name and address for FREE book.

PICTURE TUBE REBUILDING EQUIPMENT—new and used. ATOLL TELEVISION, 6425 Irving Park, Chicago, Illinois 60634, (312) 545-6667.

BUMPER STICKER PRINTING DEVICE. Cheap, Simple, Portable. Free details, Bumper, POB 22791 (PE), Tampa, FL 33622.

MAKING MONEY WITH PERSONAL COMPUTERS! 3 cassette package \$19.95, with book \$25.00. Computer Resources, 1659 Mills Street, Chula Vista, CA 92010.

HOME BURGLAR ALARMS—Fantastic business. Information \$2.00 (Redeemable). Security Electronics International, P.O. Box 1456-Z, Grand Rapids, Michigan 49501.

MAKE MONEY FROM HOME—Excellent opportunities! Details \$1.00. Chamberlin, 4166 Almond Street, Riverside, CA 92501.

**EMPLOYMENT OPPORTUNITIES**

ELECTRONICS/AVIONICS EMPLOYMENT OPPORTUNITIES. Report on jobs now open. Details FREE. Aviation Employment Information Service, Box 240E, Northport, New York 11768.

JOBS OVERSEAS - Big money fast. \$20,000 to \$50,000 plus per year. Call 1-216-494-2900, ext. 4605.

**BOOKS & MAGAZINES**

PUBLISHERS' OVERSTOCKS. BARGAIN BOOKS 2,000 titles, all subjects! Free catalog: Hamilton's, 98-85 Clapboard, Danbury, CT 06810.

TINKERTRON: Write for summer 1983 Electronics Catalog. Includes Voltage and Current Variable Power supplies, Audio Amp Modules, Remote Wireless switches and Electronic Parts. LOWEST PRICES—SAVE UP TO 50% or MORE! Send 25¢ to: TinkerTron, Department C, P.O. Box 53128, Lubbock, Texas 79453.

**REAL ESTATE**

NEW...FREE CATALOG! Top real estate values coast to coast! Please specify types, property and location desired. UNITED FARM AGENCY, 612-EP West 47th, Kansas City, MO 64112.

**RUBBER STAMPS**

RUBBER STAMPS, BUSINESS CARDS. Free catalog 1-800-851-4945, Jackson's, E-100, Brownsville Rd., Mt. Vernon, Ill. 62864.

**RETAIL ROSTER**

**ALASKA**

JUNEAU ELECTRONICS—1000 Harbor Way, 99801, (907) 586-2260. Apple, Osborne Hardware/Software/Peripherals. Full service and support.

**CALIFORNIA**

P.C. COMPUTERS, 10166 San Pablo Ave., El Cerrito 94530. (415) 527-6044. Commodore 64, VIC-20, Pet Specialists. In-House Maintenance.

**LOUISIANA**

THE COMPUTER PEOPLE—Apple, NEC, Osborne, Corvus Concept—Seminars, Sales, Service. Houma, Morgan City, Lafayette—1-800-352-5828.

**MASSACHUSETTS**

SAUGUS—ROUTE 1. LAND OF ELECTRONICS. Walnut Place Shopping Center, (617) 581-3133. Apple, Altos—Hardware! Software/Peripherals. Service, Classes, Seminars.

**NEW HAMPSHIRE**

COMPUTER MART of NEW HAMPSHIRE, 170 Main Street, Nashua 03060. 603-883-2386. THE APPLE SPECIALISTS. Full line Hardware/Software. Training/Service.

**OHIO**

COLUMBUS—HEATHKIT ELECTRONIC CENTER, 2500 Morse Rd., (614) 475-7200. Heath/Zenith Computers, Software, Peripherals, Robotics, Training.

**PENNSYLVANIA**

MARKETLINE SYSTEMS INC., 975 Jaymor, Southampton 18966, 215-355-5400. Microcomputers, terminals, printers, supplies, monitors, modems, diskettes, etc.

**WASHINGTON**

TACOMA—COMPUTERS +, 2504 Jefferson Avenue 98402. (206) 272-2329. Atari/Commodore computers. Atari/Commodore/TRS-80 Training.

**WISCONSIN**

MILWAUKEE—HEATHKIT ELECTRONIC CENTER, 5215 W. Fond du Lac. (414) 873-8250. Heath/Zenith Computers, Software, peripherals, robotics.

.....CLASSIFIED ADVERTISING ORDER FORM.....

1	2	3	4	5
6	7	8	9	10
11	12	13	14	15 (MINIMUM)
16	17	18	19	20
21	22	23	24	25
26	27	28	29	30
31	32	33	34	35
36	37	38	39	40
41	42	43	44	45
46	47	48	49	50

Please refer to heading on first page of this section for ad placement information

**COMMERCIAL: \$4.00. PERSONAL: \$2.30. EXPAND-AD®: \$6.00**

# OF WORDS \_\_\_\_\_ # OF INSERTIONS \_\_\_\_\_

PAYMENT ENCLOSED \$ \_\_\_\_\_

CHARGE You will be billed monthly.  American Express  Diners  Visa  MasterCharge-Interbank # \_\_\_\_\_

Account # \_\_\_\_\_ Exp Date \_\_\_\_\_

SIGNATURE \_\_\_\_\_

PRINT NAME \_\_\_\_\_

ADDRESS \_\_\_\_\_

CITY \_\_\_\_\_ STATE \_\_\_\_\_ ZIP \_\_\_\_\_

CE-683

**Computer Mart**

RATE: Ads are 2" by 3". 1 insertion: \$625.00. 6 insertions: \$600.00 ea. 12 insertions, \$575.00 ea. Closing date: 1st of the 2nd mo. preceding cover date. Send order and remittance to Computer Mart, Computers & Electronics, 1 Park Ave., N.Y., N.Y. 10016. Direct inquiries to (212) 725-4216.

**KEYBOARD for ATARI 400™**

Replace standard membrane keyboard with an easily installed and color matched pushbutton keyboard. Complete with instructions ..... \$119.95

---

**SECRETS of SATELLITE TV®**

New manual explores the purchase and installation of satellite TV receivers ..... \$17.95

---

**TV IF & RF MODULE**

Includes TUNERS, IF AMP, video and sound detectors ..... \$85.00

---

Catalog includes information on VIDEO products, experimenters KITS, and interesting manuals: ..... \$2.00  
 VISA and MasterCard accepted by phone (415) 439-7470. Include 5% shipping. Calif. residents add tax.

**Abex**  
 P.O. BOX 26601-C2  
 SAN FRANCISCO, CA 94126

CIRCLE NO. 96 ON FREE INFORMATION CARD

**TRS-80 DISCOUNT COMPUTERS**

**CALL US LAST** for the **LOWEST** price!

**918-825-4844**  
 it will be worth the call!

  
**AMERICAN Small BUSINESS COMPUTERS**  
 118 S. MILL ST. PRYOR, OK. 74361

CIRCLE NO. 97 ON FREE INFORMATION CARD

**Wasting Money! We Have the World's Most Cost Effective Development System.**



- Includes HexKit 1.0, a powerful 100% machine code editor/debugger utility program that makes coding for 8-bit Micros a snap
- Program from Commodore VIC-20 Keyboard into built-in 4K ROM emulator
- Jumper to target ROM socket
- Test programs in circuit
- Built-in EPROM programmer and power supply

Send for Free Brochure

**PROMQUEEN CARTRIDGE: \$199, U.S.; \$269, CAN.**

Distributed in U.S. by **Arbutus Total Soft, Inc.**, 4202 Meridian, Suite 214, Bellingham, WA 98226. Phone 800-426-1253, in Washington 206-733-0404  
 Distributed in Canada by **IBC/DISTRIBUTION CANADA**, 4047 Cambie St. Vancouver, BC V5Z 2x9. Phone 604-879-7812 Visa/MC accepted

Promqueen 64 \$299  
 8K board/w 1 Eprom \$29.95  
 16K board/w 1 Eprom \$39.95  
 C-64 board/w 1 Eprom \$39.95

CIRCLE NO. 98 ON FREE INFORMATION CARD

**SPEECH SYNTHESIS** **NEW!** SAVE \$5 ONLY **\$69** KIT

TS85  
ZX81  
TIMEX  
VIC20  
APPLE II

● UNLIMITED VOCABULARY  
● AMPLIFIER + SPEAKER BUILT  
● INPUT FOR EAR-MUSIC UNITS

**SMART EARS!** **SPEECH RECOGNITION** **\$99**

SPEECH INPUT FOR ABOVE LISTED COMPUTERS & OTHERS CALL (SOME NEED P.O.)

**MUSIC** **STEREO 16 LINE CONTROL PORT**  
PLAY 3 PART MUSIC, EFFECT DRUMS ETC.  
1/0 PORT TO CONTROL ROBOT, \$49.95  
HOME SECURITY BARRIERS, BUILT \$59

AUDIO VISION  
1279 N. NORMAN  
LOS ANGELES, CA 90027

**SPEECH CHIP SX-01** \$36  
ADD \$3 SHIPPING Charge \$5.00  
(213) 6605217

CIRCLE NO. 99 ON FREE INFORMATION CARD

**\$450<sup>00</sup> WEEKLY**

working one or two hours a day with your personal computer. **GUARANTEED.** Simple program process. No special skills or experience. **Free details/application.**

**BOND INDUSTRIES**  
7115 Blanco Road  
Dept. 114-178  
San Antonio, TX 78216

CIRCLE NO. 100 ON FREE INFORMATION CARD

**TIMEX-SINCLAIR**  
**MEMOCALC** Spreadsheet Calculator  
**MEMOTEXT** Word Processor

ZX81 TS1000 TS1500

MEMOCALC Spreadsheet (16-64K) \$ 48.95  
Up to 99 cols X 250 rows  
MEMOTEXT Word Processor (16-64K) \$ 48.95  
TIMEX Sinclair "1500" Computer \$ 94.95  
TIMEX Sinclair "2040" Printer \$ 89.95  
Seikosha 80 Char. Printer Pkg. \$339.95  
(Incl. Parallel Interface & Cable)  
Memopak 64K \$138.95  
32K \$89.95 16K \$54.95  
Memotech Keyboard \$89.95  
TIMEX Sinclair 1983 Directory \$ 5.00

**WE Pay Shipping on all USA Orders**  
**To Order:** Send check, money order or VISA/MC number and exp date. MN res add 6% sales tax. Foreign: Get shipping estimate from your post office and include with your payment.  
**Write For Our Free Descriptive Catalog**

**E. Arthur Brown Company**  
Dept. 1702 Oak Knoll Drive  
Alexandria, MN 56308 Ph: 612/762-8847

**IBM® DISKETTES**

5 1/4" Diskette 1D Single Side Double Density **\$29<sup>90</sup>**  
5 1/4" Diskette 2D Double Side Double Density **\$39<sup>90</sup>**  
Soft\* Box of 10 Soft\* Box of 10

\* Add \$1.75 for Plastic Library Case 8" and other brands also available.

**COD ACCEPTED**  
**DEALER INQUIRIES INVITED**

**CALL TOLL FREE 800-848-1101**  
In N.Y.S. (716) 631-3925  
**BETSY BYTES Division**  
BB International, Inc.  
P.O. Box 564  
Buffalo, N.Y. 14221

TERMS: Prepaid orders receive free shipping within continental U.S.A. Add 3% (\$2.00 minimum) shipping and handling charge on all COD and credit card orders. N.Y. res. add 7% tax.

CIRCLE NO. 101 ON FREE INFORMATION CARD

**UNIPROM**

THE VERSATILE EPROM HANDLER

- Reads programs 2704, 2708, 2758, 2508, 2516, 2716 (1 supply) 2532, 2732, INTEL'S 2732A and the 8755A (INTEL/NEC)
- Reads/erases/programs Hitachi 48016 EEPROM'S
- No personality modules required
- All signals are 5-10V compatible (can adapt to most other buses)
- Port mapping occupies NO memory space
- Bus clock rates exceeding 6mhz.
- All software is 8080/8085/280 compatible.
- Software "user" friendly
- All software is fully CP/M & CDOS compatible

Board (A&T) with extensive documentation \$199.00  
Disk software (8" or NORTHSTAR 5.25") \$38.00  
EPROM-based software with source listing \$55.00  
Expansion console, 24 pin \$50.00

Featured in July, August '82 Microsystems

**CER-TEK**  
6020 Doniphan (915) 581-6697 El Paso, TX 79932  
**ELECTRONICS MANUFACTURING SINCE 1975**

CIRCLE NO. 102 ON FREE INFORMATION CARD

**A/D 8 channels + D/A 8 channels**

**Fast 1.6 μs A/D conversion time** 100 ns acquisition window 1 μs D/A settling time 8 bits 0-5V or 0-2.5V full scales. Board allows re-arrangement of the pins and other features for easy interfacing to many types of host computers including Sinclair Apple, TRS80 others. Switches set address. Address pins channel. Inquire about KITS and software. Assembled and tested **\$195**. Aluminum box and ribbon cable **\$15**.

**Computer Continuum**  
301-16th Ave  
San Francisco, CA. 94118 (415) 752-6294

Radio Shack and TDP-100

**COLOR COMPUTER**  
★ GAMES ★  
★ HOME & WORK ★  
★ PROGRAMMER AIDS ★  
Dealer Inquiries Invited

**COMPUTERWARE®**  
Box 668 •  
6809 Specialists Enchitas, CA 92024  
(619) 436-3512  
Computerware is a trademark of Computerware

**SAVE 90%**

YES you can save up to 90% on a computer system for home or office.

68000 microsystem (8MHz) with 128KB & three RS-232C ports, \$252.00

8086 microcomputer with 128KB & three RS-232C ports, \$204.00

Z80A 4MHz micro with 64KB & two RS-232C ports, \$110.00

Floppy Interface as little as \$60.00

**FREE BROCHURE TODAY**

**DIGATEK CORPORATION**  
Suite 7  
2723 West Butler Drive  
Phoenix, Az. 85021

**ROLL-YOUR-OWN TECHNOLOGY AND SAVE A BUNDLE**

CIRCLE NO. 103 ON FREE INFORMATION CARD

TS 1000 ZX81

**VOTEM** \$39.95 (kit) \$59.95 (A&T)

**THE ANALOG INTERFACE FOR TIMEX Sinclair**

VOTEM is a complete package of hardware and software to enable your computer to measure, display and record voltage and temperature. Use your computer to monitor any physical phenomenon (pressure, light, temperature, etc.) that can be represented by a DC voltage. A probe is provided for temperature measurements. Use VOTEM as a smart voltmeter/thermometer with storage.

VOTEM also amplifies and cleans up the tape signal to help you overcome LOADING problems experienced by many TS1000 owners.

- \* Connects to tape input of TS-1000/ZX81/80
- \* Requires no modifications to computer
- \* Easily adapted to other computer systems
- \* Operate with 1K or more memory
- \* Resolution: > 14-bit 0.00005V 0.02° F 50ppm
- \* Input Range: 0 to +1 Volts (easily expanded)
- \* Documentation: 35pp manual available separately
- \* Price: \$59.95/Assembled & Tested or \$39.95/kit
- \* Warranty: 15-day unconditional (A&T units only)

Send check or money order plus \$3 shipping (US currency). Manual alone: \$5pp (applied to first purchase). Write for a FREE detailed product description.

Down East Computers  
P.O. Box 3096  
Greenville, NC 27834  
We accept major institutional POs

CIRCLE NO. 104 ON FREE INFORMATION CARD



## TIMEX-SINCLAIR ZX81 1000



### 1983 Directory

- Where to find: Disk Drives, RAM Extensions, Printers, Modems, Keyboards, Game & Serious Software, Books, Periodicals, Programming Aids, and other Exciting Accessories!
- Articles on: Special applications like Control Circuitry, Enhanced Graphics, Voice Generation, Music Synthesis, Video Inversion, Light Pens, Joysticks, etc.
- Complete Descriptions: We'll tell you what it is, what it does, how much it costs, and where to buy it.
- Jam-packed w/photographs: We knew you'd want to see what these products look like. So, we got pictures and put them in!

**Only \$5.95 ... Postpaid!**  
Sent First Class in the U.S.A.

**To Order:** Send check, money order, or VISA/MC number and expiration date. MN residents add 6% sales tax.

Dealer Inquiries Welcome.  
**E. Arthur Brown Company**  
Dept. 1702 Oak Knoll Drive  
Alexandria, MN 56308 Ph 612/762-8847

MODULES FOR:

## TIMEX-Sinclair

**64K MEMORY \$119.<sup>95</sup> KIT**  
\$129.<sup>95</sup> W&T **WHY PAY MORE?**

**MODEM \$119.<sup>95</sup> KIT \$149.<sup>95</sup> W&T**  
(RS-232 Port & Software Included)

**RS-232 PRINTER INTERFACE**  
Only **\$59.<sup>95</sup> KIT \$69.<sup>95</sup> W&T**

**CONTROL MODULE \$59.<sup>95</sup> KIT**  
8 Relays, 8 Inputs, 8 LED's \$69.<sup>95</sup> W&T

Expand your 16K to 32K with our M-16  
\$59.<sup>95</sup> KIT \$69.<sup>95</sup> W&T

90-Day Warranty On All Modules.  
10-Day Return Privilege

**ORDER PHONE 803-532-5812**  
Add \$4.95 shipping & handling to all orders.

CHECKS  
Rt. 3 Box 147 Brodie Rd.  
Leesville, S.C. 29070

THOUSANDS IN USE WITH PROVEN RELIABILITY.  
ALL MODULES IN STOCK.

TRS-80

## COLOR COMPUTER

Quality Software on:

- DISK
- CARTRIDGE
- CASSETTE

Send for our free catalog  
-----clip and mail-----

**Eigen Systems** Box 10234  
Austin, TX 78766  
(512) 837-4665

Name \_\_\_\_\_  
Address \_\_\_\_\_  
Zip \_\_\_\_\_

## IT'S HERE!!

### The keyboard you have been waiting for!

A LARGE 80 KEY TACTILE FEEL KEYBOARD (MEASURES 10" x 4") THAT PLUGS INTO THE SAME CONNECTORS AS EXISTING KEYBOARD ON YOUR ZX81 OR TIMEX SINCLAIR 1000. IT HAS ALL SILKSCREENED LEGENDS IN 3 COLORS ON THE BASE, MOLDED LEGENDS & GRAPHICS ON KEY TOPS; 8 AUTOMATIC SHIFT KEYS (NO SHIFTING REQUIRED) FOR EDIT, DELETE, SINGLE & DOUBLE QUOTES, COLON, SEMI-COLON, FUNCTION & STOP; 5" SPACE BAR; 2 SHIFT KEYS; NUMERIC KEY PAD.

**ONLY \$84.95**

MASS. RESIDENTS ADD 5% SALES TAX  
SHIPPING & HANDLING \$4.00/UNIT

DELIVERY 4 - 6 WEEKS. QUANTITY DISCOUNTS. WE WILL ACCEPT MC/VISA. PLEASE INCLUDE #S, EXP. DATE AND SIGNATURE. FOR MORE INFORMATION SEND SASE. SEND INQUIRIES, CHECK OR MONEY ORDER TO:

**E-Z KEY**  
SUITE 75 E. 711 SOUTHERN ARTERY  
QUINCY, MASSACHUSETTS 02169  
(617) 773-1187

## COMPLETE CONTROL FROM YOUR TIMEX-SINCLAIR 1000



- 12 Unbuffered TTL Digital I/O Lines
- 8 Unbuffered Analog Inputs (0 - 5V.)
- 8-Bit Analog To Digital Converter
- LED Status Indicators
- Clock/Calendar
- Buffered Digital Outputs (500 ma.)
- TRIAC Outputs - 400 V. 2 Amp Zero-Crossing Optically Isolated (IOC 24-4 has 4 TRIAC Outputs, IOC 24-12 has 12 TRIAC Outputs)
- Regulated 5V. Power Source Using The Power Supply Of The Computer
- Programmable Peripheral Interface
- Simple Program Included

**GCM Electronics, Inc.**  
P.O. Box 6152  
Ft. Smith, AR 72906  
Phone: 501-646-2100

Description	Price
IOC 24-4	189.95
IOC 24-12	249.95
CABLE	12.95

Checks VISA  
MasterCard  
Sorry no C.O.D.s

## Home Control System for the VIC 20



Control up to 256 lights & appliances  
ON OFF ALLOFF ALLOFF Commands  
9 levels of Brightness  
Manual & Time Control Software  
Uses BSR remote switches  
Plugs into User Port

only **\$59.95**  
MasterCard or VISA Accepted  
Call 215-961-0850 to Order

**GENESIS COMPUTER CORP.**  
1444 Linden Street  
Bethlehem, PA 18018

# VICcontroller

## FULL-FEATURED SPREADSHEET

# NOVACALC

Every micro user should have one.  
And now, every micro user can afford one.

**\$24.95** \$5 shipping/handling \$3.95 opt vinyl binder

Remarkable, but true, NOVACALC includes all standard features plus: consolidation, internal rate of return, trig and depreciation. for IBM PC and CP/M formats. TO ORDER TODAY, CALL:

**(312) 690-1855**

**HOURLASS SYSTEMS**  
P.O. BOX 312, Glen Ellyn, IL 60137

## SINCLAIR / REAL TIME CLOCK

ZX80/1  
TIMEX 1000

I/O Board with our Real Time Clock/Calendar

Time	Month	Date	Year	Day of Week
23:59:59	12	31	99	7

Features

- 8 Outputs capable of driving relays
- 8 TTL Inputs
- Feed through Sinclair Bus connector to allow normal expansion
- Battery back-up for clock
- Expandable Ports
- All software included
- 90 day warranty

Future Products

- Touch Tone™ encoder/decoder
- Speech and Sound synthesizer

MODEL	Built & Tested	Bare PCB & Manual	DESCRIPTION	PRICE
310	315		MASTER I/O WITH CLOCK	\$59.95 \$24.95
MODEL 310 ACCESSORY BOARDS				
320	325		A to D and D to A converter	\$47.95 \$19.95
330			Wireless control system (BSR™)	\$69.95
340			Solid State AC Relay	\$19.95
SPECIALIZED PARTS FOR MODEL 315				
316			Sinclair edge connector, 46 pin w/key	\$12.95
317			Clock IC and crystal (tested)	\$ 4.95

California residents add 6% Shipping and handling \$ 3.95

Send self addressed stamped envelope for catalog.

**JK AUDIO**  
P.O. Box 3295  
Escondido, CA 92025-0580  
(619) 741-5132 (24 Hr. Order Line)

VISA/MASTERCARD

## POWER LINE PROBLEMS?



### SPIKE-SPIKERS™...The Solution!

Minimize equipment damaging spikes and conducted RF noise to or from sensitive equipment. Transient surge protection plus low pass RFI hash filtering. All units 120V 15A.

**MINI II \$44.95**  
Wall Mount  
3-stage filter  
2 sockets

**QUAD II \$59.95**  
Wall mount. Dual 3-stage filter  
4 sockets & light

**DELUXE \$79.95**  
Dual 5-stage filtered ckt's  
8 switch sockets  
moin switch, fuse, light

**Koigo Electronics Co., Inc.**  
65 84 Ruch Rd., Dept. "C.E."  
Bethlehem, PA 18017

Order Factory Direct  
**215-837-0700**  
Out of State  
**800-523-9685**

DEALERS INVITED  
PA Res. Add 6% + COD add \$3.00 + Shipping

# A REAL KEYBOARD FOR YOUR TIMEX-SINCLAIR.

- Many features not found in other keyboards
- Full-size contoured keyboard
- Sturdy aluminum chassis
- 46 Sculptured keys
- No soldering

**PRE-PRODUCTION OFFER \$69.95**  
 Price will nearly double when production is complete.  
 + \$5.50 P&H

**KOPAK**  
 KEYBOARDS INC.  
 119 Peter St.  
 Union City, NJ 07087  
 (201) 864-4410

CIRCLE NO. 112 ON FREE INFORMATION CARD



**LEO ELECTRONICS, INC.**  
 8921 S. Sepulveda # 208  
 Los Angeles, CA 90045  
 (213) 641-3101 (800) 421-2418  
 TLX: 664-688 Interline LSA

## LOOK!! LOW PRICES

RAMS		EPROMS	
4116 (200ns)	1.10	2708	2.50
4116 (150ns)	1.25	2716	3.20
4164 (200ns)	4.65	2716-1	5.00
4164 (150ns)	4.85	TMS 2716	4.75
2114 (200ns)	1.50	2732	3.95
6116P-3	4.25	2532	4.50
		2764	8.00

MICROPROCESSORS		REGULATORS	
Z-80A	4.50	ALL	.75
8080A	2.75	TO-220	
8085A	6.00		

TERMS: Check, Visa, Mastercard. Call for C.O.D.  
 U.S. Funds only. California residents add 6% sales tax.  
 SHIPPING: Add \$2.00 for Ground and \$5.00 for Air.  
**ALL MAJOR MANUFACTURERS  
 ALL PARTS 100% GUARANTEED**

CIRCLE NO. 113 ON FREE INFORMATION CARD

## UV EPROM ERASER

- Erases over 15 EPROMS - 15 minutes erase time
- Element #s 7700, 7400
- Intensity 1700 mW/cm<sup>2</sup> at 1"
- Erases all UV EPROMS (2716, 2732, 2516, 2532, etc.)

**\$49.95**



• HOBBY MODEL  
**INDUSTRIAL MODEL**  
 QUJ-18 / 2N  
**\$68.95**  
 WITH TIMER AND  
 SAFETY SWITCH  
 QUJ-18 / 2T  
**\$97.50**

### INTELLIGENT PROGRAMMER STAND ALONE RS-232

★ RELIABLE  
 ★ EASY COPY (no external equipment needed)  
 COMPATIBLE  
 IBM PC, TRS-80, APPLE, CP/M, FLEX, TEKTRONICS, MDS  
**(MCS-48)**  
 PROGRAMMING  
 PRICE INCLUDES  
 PERSONALITY MODULE  
**\$489.00**

PROGRAMS: 2508, 2516, 2532, 2716, 27C16, 27C32, 2732A, 2758, 8748, 8749H, 8748H  
 OPTIONAL MODULES: 2564, 2764, 8755A, 8741  
 • STAND ALONE CRT OR COMPUTER CONTROL  
 • UNLOAD/DOWNLOAD IN MICROLOG OR INTL HEX FORMAT  
 • MICROPROCESSOR BASED • 8 K INTERNAL RAM  
 • 80 UV PORTS & LABOR WARRANTY ON ALL PRODUCTS  
 SOON TO BE RELEASED  
**PROMPRO-8 128K Version \$689.**

CIRCLE NO. 114 ON FREE INFORMATION CARD

## Put 64K CP/M 2.2 in your TRS-80 Model III.

Our plug-in Shuffleboard III comes with 16K and gives you the full power of 64K CP/M 2.2, the industry standard operating system.



Tap into over 2,000 off-the-shelf business programs such as dBASE II, SuperCalc, WordStar, etc.

READ/WRITE and RUN software from Osborne, Xerox, Superbrain, Kaypro II, HP 125 and TeleVideo. You can even READ/WRITE IBM PC software for CP/M 86.

Simple to install. Shuffleboard III plugs into two existing sockets inside your Model III. No permanent modifications, no cut traces, no soldering. You'll be up and running in minutes. For only \$299. Includes MBASIC Interpreter, a software manual and a first class user's manual. Coming soon: an 80 x 24 Video Board and a Floppy Disk Controller.

See the Shuffleboard at your local computer store or order directly from us. Credit card orders shipped directly from stock. Sorry, no COD's. Free 12 page brochure. Call (415) 483-1008

**\$299.**

**Memory Marchant** 1468 Doolittle Drive San Leandro, CA 94577

CIRCLE NO. 115 ON FREE INFORMATION CARD

## PUT YOUR TIMEX/SINCLAIR COMPUTER TO WORK!

### TIMEX/SINCLAIR SOURCEBOOK™

- SOFTWARE
- HARDWARE ADD-ONS
- BOOKS/CATALOGS

Maximize your ZX80, ZX81 or TS1000 computer investment with the TIMEX/SINCLAIR SOURCEBOOK which lists programs, hardware accessories and reference books.

The SOURCEBOOK allows you to quickly identify the ZX computer products you need from a wide variety of sources to put your computer to work. Order your copy today — over 600 listings — only \$6.95 P&H (\$2.50 outside the U.S.)

**TIMEX/SINCLAIR SOURCEBOOK™**  
 Micro Design Concepts  
 Dept. CE-6  
 P.O. Box 280  
 Carrollton, TX 75006

Send for an application for free listings.

CIRCLE NO. 116 ON FREE INFORMATION CARD



**Micro Management  
Systems, Inc.**

2803 Thomasville Road East • Cairo, Georgia 31728

## COMPUTERS & EQUIPMENT

### DISCOUNT PRICES - BUY DIRECT

### TOLL FREE 1-800-841-0860

WRITE FOR FREE PRICE LIST  
 GA. & INFO 912-377-7120

- TRS-80 COMPUTERS**  
**COMMODORE COMPUTERS**  
**EPSON • OKIDATA • C. ITOH**  
**SMITH CORONA • STAR GEMINI**  
**ATARI • BROTHER • FRANKLIN**  
**NOVATION • HAYES • VERBATIM**  
**PANASONIC • AMDEK • COMREX**  
**QUADRAM • CARDCO • MORE**

CIRCLE NO. 117 ON FREE INFORMATION CARD

## Votrax® SC-01A SPEECH SYNTHESIZER



**\$50 Each**  
 (\$40 in  
 hundreds)

### Order in Ones or Thousands

The SC-01A Speech Synthesizer is a completely self-contained solid state device. This single chip phonetically synthesizes continuous speech of unlimited vocabulary.

Computer interfaces and text-to-speech algorithms also available for product development.

Micromint is the largest U.S. distributor of the SC-01A. Call us for a price quote.

Call 1-800-645-3479, in N.Y. 1-516-374-6793

**MICROMINT INC.**  
 561 Willow Avenue  
 Cedarhurst, NY 11516



Add \$2.00 for shipping & handling

CIRCLE NO. 118 ON FREE INFORMATION CARD

I WILL BEAT ANY COMPETITOR'S PRICE PROVIDED IT IS NOT BELOW MY COST. TRY TO BEAT THESE IC PRICES:

DYNAMIC RAM		
64K	200 ns	\$4.79
64K	150 ns	4.99
64K	120 ns	5.90
16K	200 ns	1.25

EPROM		
2764	250 ns	\$7.50
2732	450 ns	4.15
2716	450 ns	3.25
2532	450 ns	4.70

STATIC RAM		
6116P-3	150 ns	\$4.24
2016	100 ns	4.00
2114	200 ns	1.60

Z80A FAMILY		
CPU, CTC, or PIO		\$3.39
DART		8.25
DMA or SiO <sub>2</sub>		12.50

MasterCard/VISA or UPS CASH COD  
 Factory New, Prime Parts  
**MICROPROCESSORS UNLIMITED**  
 24 000 South Peoria Ave  
 BEGGS, OK 74421  
 (918) 267-4961

Prices subject to change. Call for volume prices. Subject to available quantities. Shipping & insurance extra. Cash discount prices shown.

CIRCLE NO. 119 ON FREE INFORMATION CARD

# FREE CATALOG!

Just let us know and we'll mail you a FREE *Creative Computing* Catalog—16 pages filled with books, buyer's guides, magazines, and more!

To get your FREE catalog, write to: *Creative Computing* Catalog, Dept NA1X 39 East Hanover Ave., Morris Plains, NJ 07950.

# VIC-20

## VIC-20 INTERFACING BLUE BOOK

Did you know that your VIC can be used to control a 99c toy motor so effectively that it runs like a precision machine? Or that you can build an accurate digital thermometer using the VIC and four parts costing less than \$5?

These and other 18 interfacing projects selected for usefulness, ease of construction and low cost are detailed in the VIC-20 Interfacing Blue Book, a veritable gold mine of practical information on how to build a variety of interfaces for your computer.

Projects include: Connecting VIC to your stereo; Pickproof digital lock; Capacitance meter; Liquid level sensor; Telephone dialer; Voice output; 8K/16K RAM/ROM expansion; 128K RAM expansion; 8-bit precision D/A; 8-bit A/D converter; MX-80 interface and more.

Written by a college professor in a friendly and informative style, the Blue Book gives you theory of operation, schematics, program listings, parts list, construction hints and sources of materials for each one of the 20 projects.

If you want to get the most out of your VIC this book is a must. Cost is \$14.95 (less than 75c per project!). Price includes postage.

**microsignal** Dept. B1  
P.O. Box 22  
MILLWOOD NY 10548

VIC-20

VIC-20 VIC-20 VIC-20 VIC-20 VIC-20

VIC-20 VIC-20 VIC-20 VIC-20 VIC-20

MICRO

SOLUTIONS

## 8 TO 16 BIT UPGRADE

### TRUE 16 BIT PROCESSING

- Z8001 Microprocessor (upgradable to Z8003)
- 2 Kx16 Eprom with Monitor Program (E-Rom optional)
- 16 Vectored Interrupts
- Full IEEE-696 (S100) Compliance
- All Z8001 Features available
- Battery backup time of day clock
- Requires ram capable of word transfers

\*Model M8000 CPU Board \$425.00  
\*Model M8000 EE optional E-Rom \$ 75.00

\*6 month limited warranty

To Order  
Call 1-800-821-8858, in New Mexico 1-505-523-0975  
or write  
Micro Solutions Inc. Include check or money order.  
Suite 191 A New Mexico residents add  
1608 El Paseo Rd. 4.6% sales tax  
Las Cruces, NM 88001 Visa and Master Card welcome

CIRCLE NO. 120 ON FREE INFORMATION CARD

Now we can make any computer sing as well as talk, for only \$219.



As featured in Garcia's Circuit Cellar, BYTE Magazine, September, October 1982.

### Microvox.

MICROVOX is a completely self contained professional voice quality text-to-speech synthesizer. MICROVOX may be easily interfaced to any computer/modem RS-232C serial or parallel output device.

- 6502 Microprocessor based text-to-speech algorithm
- SG-01A phoneme based speech synthesizer
- 6c crystal controlled inflection levels
- 3000 character buffer
- RS-232C and parallel port interfaces
- On board power supply
- Music and sound effects capability

MVD1 Microvox Assembled & Tested ..... \$299.00  
MVD2 Microvox complete kit ..... \$219.00

To Order: Call Toll Free 1-800-645-3479  
In N.Y. 1-516-374-6793  
**MICROMINT, INC.**  
561 Willow Avenue  
Cedarhurst NY 11516

CIRCLE NO. 121 ON FREE INFORMATION CARD

# Commodore 64 & VIC 20 Software

## FREE CATALOGUE

DEALER INQUIRIES WELCOME

Fill out reader service card or write:

**ORBYTE**™  
SOFTWARE  
The Creative Force™

P.O. Box 948, Waterbury, CT 06720  
203-753-8308

CIRCLE NO. 122 ON FREE INFORMATION CARD

## ARBITRARY WAVEFORM GENERATOR ONLY \$345!

Generate any custom waveform with the Apple Computer.

- analog and digital outputs
- up to 20 volts p-p output
- 125 ns/pt — 1 sec/pt
- up to 2048 points
- 8 bit resolution

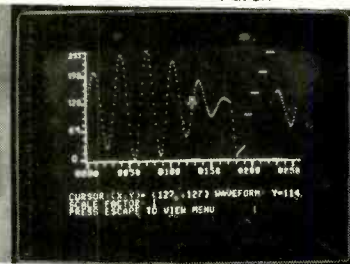

**Pacific Micro Systems**

160 GATE 5 ROAD • SAUSALITO, CA. 94965 • (415) 331-2525

CIRCLE NO. 123 ON FREE INFORMATION CARD



## RADIO SHACK TRS-80's™

We offer Special Discounts, Free Shipping and a Toll Free Order Number

1-800-531-7466 TOLL FREE

## Pan American Electronics

Dept. P.E. 1117 Conway Avenue  
Mission, Texas 78572  
(512) 581-2766 Telex 767339

CIRCLE NO. 124 ON FREE INFORMATION CARD

## THE PEOPLE'S COMPUTER SUPPLY



YOUR TIMEX SINCLAIR ZX801 IS A FOOLER. IT LOOKS LIKE A TOY. BUT DON'T LET LOOKS FOOL YOU! TRY SOME OF OUR ADONS & SEE WHAT YOU CAN REALLY DO WITH THE FOOLER.

HERE ARE JUST A FEW OF OUR HARDWARE ITEMS. MEMOTECH PRODUCTS

- 1 64K MEMOPAK \$144
- 2 32K MEMOPAK \$95
- 3 16K MEMOPAK \$58
- 4 HIGH RESOLUTION GRAPHICS \$95
- 5 FULL SIZE DIRECT CONNECT KEYBOARD \$99
- 6 MAKE IT TALK TO YOU. WILLIAM STUART SYSTEMS SPEECH SYNTHESIS \$99

WE ALSO SELL MONITORS & PRINTERS FOR THE TIMEX SINCLAIR ZX801/81  
VISA MASTER CARD & AMEX Foreign Order Please Add \$5.50  
& MONEY ORDERS U.S. Orders Please Add \$3.00  
PERSONAL CHECK Printer & Monitor Orders add \$7.50  
ALLOW 2 WEEKS

THE PEOPLE'S COMPUTER SUPPLY  
P.O. Box 664, Sidney, Nebraska 68162  
Order Phone: Tel. 308-254-3208

CIRCLE NO. 125 ON FREE INFORMATION CARD

## TIMEX/SINCLAIR ZX/81 KEYBOARD



ONLY \$59.95  
built & tested

Full Size 43 Keyboard + \$5.00/s/h

### SINGLE KEY SHIFT LOCK FUNCTIONS & GRAPHICS

LED Mode Indicators  
Simple Plug In Installation

Send Check or Money Order To:

**RAMEX INTERNATIONAL**  
P.O. Box 50, Utica, MI 48087  
Please Allow 6-8 Weeks Delivery

Name \_\_\_\_\_  
Address \_\_\_\_\_  
City \_\_\_\_\_  
State/Zip \_\_\_\_\_

Michigan Residents Add 4%

CIRCLE NO. 126 ON FREE INFORMATION CARD

## FREE SOFTWARE for the KAYPRO 2 or VECTOR 3 & 4

Lots of games, CP/M utilities and other programs are in public domain.

Now you can order copies from 90 disks of well-known user group on 5 inch disk.

Copy fee of \$10 per disk includes postage.

Either Kaypro 2 (46 lpi sdd) format or Vector 3 & 4 (100 lpi ddd) format.

Other 5 inch formats also available. (Sorry, not for Apple II, North Star, or Vector 9000.)

- The 90 disk library includes these favorites:
- #3 and #5 EBASIC games and compiler
  - #12 PILOT programming; early version
  - #21 star trek and other games; requires MBASIC
  - #23 STOIC stack language; similar to FORTH
  - #28 simple ALGOL compiler with games
  - #37 arithmetic CAL games; requires CBASIC
  - #41 HAM radio programs; requires MBASIC
  - #42, #44, and #45 Osborne business; requires CBASIC
  - #51 PASCAL compiler written in PASCAL
  - #51 or #57 original or extended adventure game
  - #68 a 6502 simulator runs on Z80
  - #61 HELP for novices on BASIC, CP/M, PASCAL, etc.
  - #7b or #84 SMODEM37 or MODEM765; requires MAC
- (No representations implied on any public domain software.)

Send \$10 (check or MO) for each disk, specify format. List of 90 disks for \$2, or free with order of 3 disks.

Sheephead Software™  
P.O. Box 486  
Boonville, CA 95415  
(707) 463-1833

VISA/Master Card OK No COD No refunds  
† CP/M trademark of Digital Research  
‡ Apple trademark of Apple Computer Co

CIRCLE NO. 127 ON FREE INFORMATION CARD

# RAM

For ATARI  
with Lifetime Warranty

64K Board	(400)	\$150
48K Board	(400)	\$115
32K Board	(400/800)	\$ 90
Real Time Clock	(800)	\$ 50
16K Board	(VIC-20)	\$ 80

FREE SHIPPING ANYWHERE IN U.S.A.

**INTEC**  
**PERIPHERALS**  
**CORP**

906 E. Highland Ave.  
San Bernardino, CA 92404  
(714) 881-1533



VIC 20 is a Trademark of Commodore Inc  
ATARI 400 800 are Trademarks of ATARI Inc

CIRCLE NO. 126 ON FREE INFORMATION CARD



*Now!* ZX81  
KEY-TOP  
SYMBOLS IN  
3 COLORS

ZX81 keyboard symbols in red, blue and black on white background; covered with 8 mils of tough clear vinyl; backed with 3-M press-sensitive adhesive. When trimmed and sealed per instructions, edges disappear, key caps look and feel custom-made.

Includes extra FUNCTION/ENTER and two SHIFT's for normal or over-size caps, and SHIFT LOCK.

Includes instructions and diagrams for keyboard conversion; money-back guarantee.

**MULE Electronics**  
Dept. 310 \$9.95  
444 Lincoln Bl.  
Venice, CA 90291

\*Please add \$1.50 for postage and handling, and 6% tax in California.

CIRCLE NO. 129 ON FREE INFORMATION CARD

# SELL THIS MAGAZINE

in your store for  
BIG PROFITS!

FOR DETAILS:

**CALL COLLECT**  
**(212) 725-6851**

**DIRECT RETAIL SALES DEPT.**  
4th FLOOR, ONE PARK AVENUE  
NEW YORK, NY 10016

# COMPUTER MART FORMAT 2" X 3"

PICTURE YOUR AD HERE!

NEXT CLOSING DATE:  
MAY 3

PERK UP YOUR DAISY



WARN INTELLIGENT PRINTER INTERFACE  
MODEL II

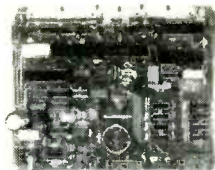

For Daisy Wheel Printers  
Standard Features: 16K Buffer • Serial/Parallel Input • Graphics • Standard ASCII Keyboard Input • Wordstar™ Compatible • Many Others! Optional 60K Buffer  
Available in A&T or Bare Board/PROM from \$200  
MasterCard and VISA Accepted  
\*WordStar is Micropro's registered trademark  
WARN ELECTRONICS LTD.  
P.O. Box 526, Knightdale, NC 27545  
(919) 266-9411

CIRCLE NO. 131 ON FREE INFORMATION CARD

## EDGE CARD CONNECTORS

S-100		APPLE BUS	
125 X 250 (100 PIN)		100 X 2 (50 PIN)	
PC MOUNT	QTY WIREWRAP	PC MOUNT	QTY WIREWRAP
\$5.25	1 to 9 Pieces	\$3.20	1 to 9 Pieces
4.97	10 to 49 Pieces	3.05	10 to 49 Pieces
4.66	50 to 99 Pieces	2.56	50 to 99 Pieces
4.24	100 to 249 Pieces	4.95	100 to 249 Pieces
		2.80	2.80

WESTLAND ELECTRONICS has a complete line of Texas Instruments Edge Card Connectors

### MEMORY

4164	200 ns	8/\$39.75
4116	300 ns	8/\$12.95 each
4116	250 ns	8/\$13.95
4116	200 ns	8/\$15.95
4116	150 ns	8/\$17.95
6116	P3 2K X 8 CMOS RAM	\$ 5.95
2716	2K X 8 EPROM	\$ 3.95
2732	4K X 8 EPROM	\$ 5.49
2764	16K X 8	\$12.00

SC-01 VOICE SYNTHESIZER CHIP \$39.50  
WESTLAND ELECTRONICS now stocks all standard values of 1% metal film resistors from 10 OHMS to 1 MEG OHMS  
SEND FOR A COMPLETE CATALOG  
CALL OR WRITE:  
**WESTLAND ELECTRONICS**  
37387 FORD ROAD  
WESTLAND, MI. 48185  
313-728-0650 in Michigan  
1-800-521-0664 outside Michigan

CIRCLE NO. 132 ON FREE INFORMATION CARD

# COMPUTER CASSETTES



**BASF**  
**-DPS**

THE WORLD'S FINEST  
Data media for all microcomputers. Used nationwide by software manufacturers, hobbyists, schools and businesses. Premium 5-screw shell with leader fits all standard recorders.

SATISFACTION GUARANTEED OR MONEY BACK.

ITEM	1 DOZ.	2 DOZ.
C-05	<input type="checkbox"/> 7.50 <input type="checkbox"/> 13.50	
C-10	<input type="checkbox"/> 8.00 <input type="checkbox"/> 14.40	
C-20	<input type="checkbox"/> 10.00 <input type="checkbox"/> 18.00	
Hard Box	<input type="checkbox"/> 2.50 <input type="checkbox"/> 4.00	

Send for free brochure. Ask for quantity discounts. Calif. residents add sales tax. SHIPPING: HANDLING (UPS) 1 doz. \$2; 2 doz. \$3.50; 3 doz. \$4.50; ea. additional doz. \$1.50. For parcel post instead of UPS add \$1. Outside Continental USA, add \$2.

FOR IMMEDIATE SHIPMENT USE YOUR VISA OR MASTERCARD CALL 213/710-1430

**YORK 10™ Computerware**  
24573 Kilridge St., P1 Canoga Park, CA 91307

CIRCLE NO. 133 ON FREE INFORMATION CARD

*2-Bit Software*  
**FATHERS DAY GIFT**  
KEYSTROKE MANAGEMENT \$14.95  
FOUR 2K GAMES FOR  
TIMEX/SINCLAIR COMPUTERS  
**FREE**  
COLOR CATALOG

2-BIT™ SOFTWARE, P.O. Box 2036  
Dept. CED2, Del Mar, CA 92014  
(619) 481-3629

DEALER INQUIRIES INVITED

CIRCLE NO. 134 ON FREE INFORMATION CARD

# ★MICROCOMPUTER★ BUSINESS SOFTWARE

MEDICAL MGMT...  
DENTAL MGMT...  
INSURANCE AGENT  
LEGAL BILLING.....  
PROPERTY MGMT..  
AND MUCH MORE !

**UNIVAIR INTERNATIONAL**  
9024 St. Charles Rock Road  
ST. LOUIS, MISSOURI U.S.A. 63114

(314) 426-1099

CIRCLE NO. 135 ON FREE INFORMATION CARD

**DISC DRIVE HEAD CLEANER DISCS**  
**MAIN FEATURES:**

- \*Non-abrasive dry cleaner; no liquid, no mess.
- \*Easy to use . . . insert as a regular disc.
- \*Cleans automatically without chemicals.
- \*Protective plastic folder—prevents contamination of cleaner.
- \*For use with single or double sided drives.
- \*Available for 5¼" and 8" flexible disc drives.
- \*Two discs per box;
  - \*\*Thirty cleanings for sided drives
  - \*\*Fifteen cleanings for double sided drives

**RETAIL PRICE**  
**\$24.95**

**ZOLMAN INTERNATIONAL, INC.**  
 600 Montgomery St. 45th Fl.  
 San Francisco, CA. 94111  
 Dept. E  
 or Call (415) 421-5340

CIRCLE NO. 136 ON FREE INFORMATION CARD

**FLY BOARD**  
 Programable  
**INTERFACE**  
 for the Apple II

The FLY BOARD is an interfacing system designed for Apple Owners who want to learn computer interfacing. The FLY BOARD is programmable through BASIC or Assembly.

**Fly Board's Hardware:**

- 6522 VIA:
  - 16 bidirectional I/O lines
  - 4 control lines
  - 2 - 15-bit timers
  - interrupt ability
- 2K bytes RAM:
  - accepts 80x commands
  - replaceable with an EPROM not used by monitor, BASIC, or DOS
- 2 - 36" DIP Jumper Cables
  - connect to your projects

**Support Materials Included:**

- User's Manual expertly written to guide the novice and intrigue the expert
- Summary Card details at a glance
- Engineer's Notebook (28 page electronic cookbook)
- 6522 Data Sheet explains advanced features

only **129<sup>95</sup>** Ready to use add \$2 for shipping

**SNAVE SYSTEMS**  
 P.O. Box 957  
 Niles, IL 60048 (312) 966-4505

Visa, M.C. or check

CIRCLE NO. 137 ON FREE INFORMATION CARD

**\$1,295.00**  
**FRANKLIN SYSTEM**  
 DISK DRIVE, DRIVE CARD,  
 MONITOR

-----

MX80	\$400.00
80 col. card	\$125.00
Z80 card	\$110.00
Super Text 40-80	\$125.00
BMC 12" Monitor	\$ 90.00

-----

**!!WE WILL BEAT ANY PRICE!!**

**SOFTSELL SYSTEMS**  
 9600 Roosevelt Blvd.,  
 Suite 100, LL  
 Philadelphia, Pa. 19115  
 (215) 665-5639

Visa, Mastercard preferred or C.O.D.

CIRCLE NO. 138 ON FREE INFORMATION CARD

**TIMEX SINCLAIR 1000**  
**SINCLAIR ZX81 SOFTWARE**  
 CALL OR WRITE FOR FREE CATALOG

**SOFTSYNC, INC.**  
 14 E. 34th St. NY, NY 10016  
 212-685-2080

CIRCLE NO. 139 ON FREE INFORMATION CARD

**Get more out of your Apple with the MICRO on the Apple Series**

Vols. 1, 2, & 3 **\$24.95**  
 + \$2.00 shipping each volume

Each book includes more than 30 programs —  
**all on DISKETTE**

Machine Language Aids  
 I/O Enhancements  
 Runtime Utilities  
 Graphics & Games  
 Hardware & Reference Information

To order toll free:  
 1-800-345-8112  
 In PA 1-800-662-2444  
**MICRO INK, Dept. CE**  
**P.O. Box 6502**  
**Amherst, NH 03301**  
**603-889-4330**

**Full Size Keyboard Conversion**

For Your ZX81/TS1000

SUN KD-81  
**\$69<sup>95</sup>**

Easy To Install  
 No Soldering - No Modifications

41 Keys with Full Size Space Bar • Allows Touch Typing  
 Same Key Layouts as Sinclair • Two Color Keypops  
 Keyboard Case Holds Both Keyboard and Computer  
 Commands and Graphics Spelled Out on Keypops

16K Piggyback RAM Module P/N MX-18 \$49.95

**SUNTRONICS CO., INC.**  
 In Calif Call 213-644-1149  
 Outside Calif Call 1-800-421-5775  
 Or send Check or M.O. to:  
 P.O. Box 1957 Hawthorne CA 90250  
 California residents add 6½% sales tax  
 Add \$4.00 shipping handling VISA/Mastercard include expiration date

**ADVERTISERS INDEX**

RS no.	ADVERTISER	PAGE no.			
50	Active Electronics	95	26	Firestik Antenna Corp.	87
3	All Electronics Corp.	99	74	Fireworks Unlimited	95
4	Apple Computer	30-31	18	Focus	72
55	Artec Electronics	10	59	Franklin Computers	Cover 3
	C & D Electronics	86		Grantham College of Engineering	90
	Classified Advertising	102-111	24	Heath Co.	41
	Cleveland Institute of Electronics, Inc	42-45	65	Hewlett-Packard	5
29	Commodore Computer	3	41	IBM Corporation	11
60	CompuServe	15	21	Jameco Electronics	94
11	Computer Mail Order	55	80	Jamestown Stamp Co.	87
			22	JDR Microdevices	96-97
14	Digi-Key Corp.	100-101	23	J & R Music World	93
	Discount Software	63		Leading Edge	Cover 4
66 84	Discwasher	1,46	30	Maxell	Cover 2
			31	McIntosh Laboratory, Inc.	93
51	Electronic Specialists	72	32	MFJ Enterprises	21
25	Epson America	7		National Computer Products	21
				Netronics, R & D Ltd.	93,95
				New Horizons	25,64
				NRI Schools	16-19
				Protecto Enterprises	32
				Quick Brown Fox	23
				Radio Shack	98
				The Right Answer	112
				Scientific Systems	86
				Sintec Co	99
				Surplus Center	60
				Tab Books	73
				TAMS, Inc.	60
				Tektronix	13

# Answering Machine Price Breakthrough!

## THE "EVERYTHING MACHINE" FROM COBRA—NOW AT AN INCREDIBLE LOW PRICE PLUS A FREE

## PUSH-BUTTON TELEPHONE

**Full One-Year Warranty  
and Ten-Day Trial Period  
on this Exclusive Offer**



If you're like most busy people and haven't gotten around to picking up a telephone answering machine or if you're waiting for prices to come down, we think we can make it easy for you to decide. The Cobra Remote probably has every feature you could ever use. And you won't have to spend \$250 or \$300 to get those features. Plus, as a completely free bonus, you get a Cobra push-button telephone. Total price: \$149.95. ←

### LOOK AT ALL YOU GET:

**FULL REMOTE OPERATION SO YOU CAN CALL IN FOR YOUR MESSAGES ANYTIME FROM ANYWHERE.** Simply call your own phone number from any telephone in the world, "beep" your pocket-size remote device into the mouthpiece, and hear your messages played back to you.

**"VOX" VOICE ACTUATION CIRCUIT TAKES ANY LENGTH MESSAGE.** Your Cobra Remote begins recording an incoming message when it "hears" the caller's voice. It continues to record for as long as the caller talks or until he or she hangs up. And Cobra will take an unlimited number of messages.

**TWO CASSETTES FOR CONVENIENCE AND EASE IN CHANGING YOUR MESSAGE.** Your "hello" message is recorded on one cassette (just by pushing a button and speaking into the built-in microphone). Incoming messages from callers are taken on a second cassette. This gives you three advantages: 1. You need to record your announcement only once, not thirty

times as with some machines. 2. You can change your message at will—push a button and speak. 3. You can erase the messages you've already heard and re-use the cassette, or you can file cassettes away to keep a permanent record of your messages.

**EXCLUSIVE 'DISCONNECT DIRECTOR' MEANS NO ANNOYING DIAL TONES TO LISTEN TO.** If a caller hangs up without leaving a message, and a dial tone comes on, your Cobra will know the difference between a dial tone and a voice, and immediately stop recording.

**ADJUSTABLE NUMBER OF RINGS.** You can set the Cobra to answer your phone after four rings or two rings to give you the chance to answer the phone before the machine does.

**FREEDOM-OF-CHOICE CALL MONITORING.** If you're busy or not in the mood to talk, let Cobra answer the phone for you while you listen to the caller over the built-in loudspeaker. Then if you do decide to talk, simply pick up the phone yourself.

**RED L.E.D. LIGHT FOR CALLS RECEIVED.** Light will flash if messages have come in while you were away.

**FULL-FEATURED KEYBOARD** Simple and convenient, the Cobra Remote is the only all-push-button machine with all the luxury features including fast forward, fast rewind, and remote rewind.

**FAMOUS COBRA QUALITY AND FULL-YEAR WARRANTY.** We guarantee both the Cobra Remote and telephone for a full year because it is highly unlikely that anything will go wrong. Cobra manufactures these units with the same precision that goes into their famous CBs and cordless phones.

**ABOUT YOUR FREE COBRA PHONE.** You get easy push-button dialing whether you now have Touch-Tone or rotary phones...Automatically re-dials number if busy...Has built-in "HOLD" button...On/off switch for ringer. No wiring needed—just plug in...Save the Telephone Company rental charge—own your phone FREE!

**P. S.** If you think you've found a better value than this, let us know and we'll beat it. We love the Cobra for quality and price, but also carry every brand of phone equipment. Call or write us with your best price.

# THE RIGHT ANSWER

111 Third Avenue  
New York, NY 10003

**SAME-DAY SHIPPING**  
...If you pay by money order, certified check, or credit card. Outside USA, add First Class postage for 7 pounds, plus insurance.



Call collect for "Order Dept."

**ORDER BY PHONE**  
Call 24 hours a day  
**212/734-4455**

**TO: THE RIGHT ANSWER, 111 Third Avenue, New York, NY 10003**

Enclosed is \$\_\_\_\_\_ for \_\_\_\_\_ COBRA REMOTES WITH PHONES  
QTY \_\_\_\_\_

@ \$149.95 including FREE phone (Additional phones \$29.95 each.)  
(Additional remote beepers only \$19.95 each.)

CE-3

Shipping & insurance \$2.95 per order. N.Y. residents add tax.

Charge my: VISA  MC  DC  AM EX  Phone # \_\_\_\_\_

Card# \_\_\_\_\_ Exp Date \_\_\_\_\_

Name \_\_\_\_\_ Signature \_\_\_\_\_

Address (Not P.O. Box) \_\_\_\_\_

City \_\_\_\_\_ State \_\_\_\_\_ Zip \_\_\_\_\_

# Franklin's ACE1000 Runs With The Best!

VisiCalc®, DB Master®, Desktop Plan®—they are all running on the Franklin ACE 1000. Cash flow, budgets, word processing or data base management, business or pleasure, the ACE 1000 runs with the best.

The Franklin ACE 1000 is hardware and software compatible with the Apple® II. Franklin users can choose from an enormous selection of programs—programs that run better on the ACE because it includes 64K of RAM, upper and lower case, VisiCalc keys, a numeric pad and an alpha lock key.

Run with the best. Call or write today for the name of your local authorized Franklin dealer.

CIRCLE NO. 59 ON FREE INFORMATION CARD

Franklin ACE is a trademark of Franklin Computer Corporation.  
Apple is a registered trademark of Apple Computer, Inc.  
VisiCalc and Desktop Plan are registered trademarks of Visi Corp.  
DB Master is a registered trademark of Stoneware.



**FRANKLIN**  
COMPUTER CORPORATION

2138 Route 38  
Cherry Hill, NJ 08002  
609-482-5900  
Telex: 837-385



**BUY A BANANA.  
SAVE A BUNCH.  
MORE TO COME.**



Leading Edge Products, Inc., 225 Turnpike Street, Canton, Massachusetts 02021.  
Call: toll-free 1-800-343-6833, or in Massachusetts call collect (617) 828-8150. Telex 951-624.

CIRCLE NO. 20 ON FREE INFORMATION CARD