

# Computers & Electronics

MARCH 1983

\$1.25

formerly Popular Electronics

## How Video Recordists Tap Cable TV Programs

**A PRACTICAL GUIDE:**

## “Working” the Computer Networks

## Learning 16-Bit Microcomputer Technology

The  
British  
Are  
Coming!

First-hand  
examination  
of BBC and  
Torch Micro-  
computers



**Tested in This Issue:**

- Zenith “System 3” Color TV Receiver  
(with outgoing and incoming wireless telephone control)
- Marantz 46 watts/channel Stereo FM/AM Receiver



# THE LEADING EDGE IN PRINTERS

ONE GREAT LINE. ONE GREAT WARRANTY.

Finally, there's one full family of printers that covers every business or word processing application—all from C. Itoh, a company known for packing more product into less price, and all distributed exclusively by Leading Edge, a company known for searching out and providing that very thing. Which means that one call to one source can get you any printer, any time you need it, for any purpose. All backed by a full year's warranty from Leading Edge. (Try *that* on any other line of printers.)

## THE PRO'S.

**The Prowriters: business printers—and more.** The "more" is a dot-matrix process with more dots. It gives you denser, correspondence quality copy (as opposed to business quality copy, which looks like a bad job of spray-painting).

**Prowriter:** 120 cps. 80 columns dot matrix compressible to 136. 10" carriage. Parallel or serial interface.

**Prowriter 2:** Same as Prowriter, except 15" carriage allows full 136 columns in normal print mode. Parallel or serial interface.

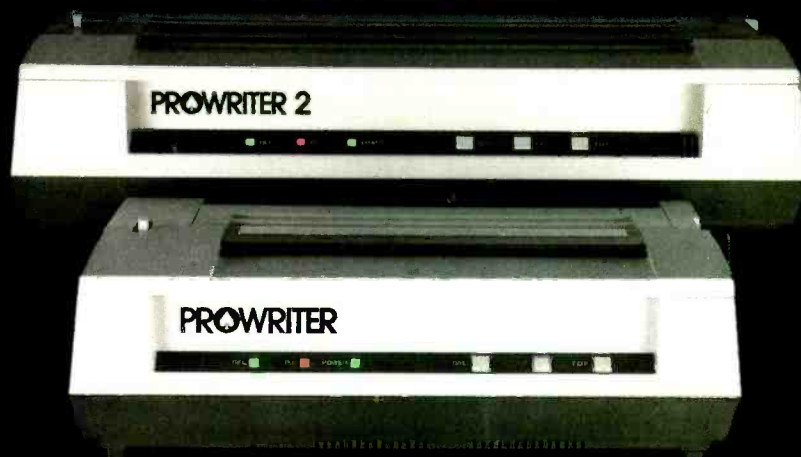

## THE STAR.

**The Starwriter F-10.** In short (or more precisely, in a sleek 6" high, 30-pound unit), it gives you more of just about everything—except bulk and noise—than any other printer in its price range. It's a 40 cps letter-quality daisy-wheel with a bunch of built-in functions to simplify and speed up word processing. It plugs into almost any micro on the market, serial or parallel.



## THE MASTER.

**The Printmaster F-10.** Does all the same good stuff as the Starwriter except, at 55 cps, the Master does it faster.



Distributed Exclusively by Leading Edge Products, Inc., 225 Turnpike Street, Canton, Massachusetts 02021.  
Call: toll-free 1-800-343-6833; or in Massachusetts call collect (617) 828-8150. Telex 951-624.

CIRCLE NO. 20 ON FREE INFORMATION CARD





# The \$7 Push Button Phone

**Plug in and start pushing. Now you can have highly automated phones with no monthly service charges for just \$7 each. But, there's a catch.**

Send back your dumb phones. Now instead of paying monthly service charges you can have push button dialing, last number redial, mute, and ringer off.

You can forget big clunky phones. You can also forget dials. This phone works perfectly whether you now have rotary or push button phones.

Now for just \$7 you'll have the latest technology at a price that'll let you have a phone in every room in your home. But, don't forget there's a catch.

## NOTHING TO INSTALL

Simply plug this phone into any standard modular phone jack and start talking. If you don't already have jacks, call your phone company.

They may even put them in free for

quality speaker instead of the old diaphragm 'thing' that's been in phones for 20 years. Even the electronic ring is new.

But, the nicest part of all are the push buttons. Once you've started using buttons you'll hate dialing the old way.

With this phone you can push the buttons as fast as you want. Then the phone sends out pulses on your line that work with virtually any phone system.

So this phone works anywhere. You can unplug it and move it from room to room or house to house in seconds.

The phone automatically hangs up when you set it down or you can push its 'hang up' button. It comes complete with an 8 foot cord, coiled at the phone end, and a limited warranty.

We challenge you to compare the frequency response, dynamic range and signal to noise ratio of our new Gold Label MLX to Maxell UDXL or TDK SA. If they win, we'll not only give you back your money, we'll give you a free gift for your trouble. And, DAK's come with a deluxe hard plastic box, index insert card and a limited 1 year warranty.

## WHY, YOU MAY BE ASKING?

You're very valuable to us in the form of future business. Over 150,000 customers have responded to bonuses like this. We find most of you keep buying once you've tried our cassettes and our prices; and that's a gamble worth taking.

## NOT A BAD CATCH

DAK manufactures a cassette with no problems and great sound. We've been hot on the heels of the frequency responses of Maxell and TDK. The tape we made last year had a great frequency response up to 14,000hz.

Now our new Gold Label MLX is second to none. We have a frequency response to 19,500hz and we'll go head to head against any tape on the market.

## TRY NEW DAK MLX90 CASSETTES RISK FREE

To get the automated phone for just \$7, try 10 MLX high energy cassettes. If you aren't 100% satisfied, return only 9 of the 10 cassettes and the phone in its original box within 30 days for a refund. The 10th cassette is a gift for your time.

To order your 10 Gold Label DAK MLX 90 minute cassettes and get the automated phone for only \$7 with your credit card, call the DAK toll free hot line or send your check for only \$24.90 for the tapes, plus \$7 for the phone and \$3 for postage and handling for each group. Order No. 9416. CA res add 6%.

An automated Phone for \$7 and DAK's new improved MLX. Time to stock up.

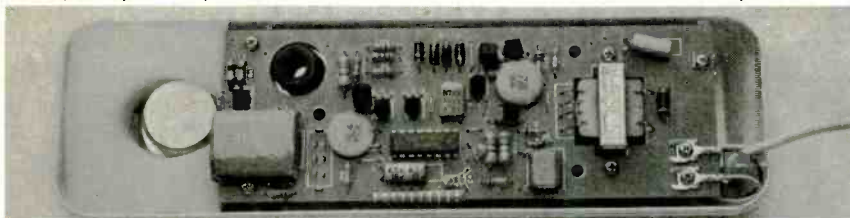

It's built more like a HiFi than a telephone. Modern electronics have finally come to phones.

you. Due to the recent Supreme Court ruling, soon they'll probably be selling you your own phones anyway. And, at worst, there's just a small one time fee.

## LAST NUMBER REDIAL PLUS

It's really neat. If you call a number and it's busy this phone will automatically redial the number for you each time you touch 'redial'. There's no need to keep dialing over and over again.

When you need to speak privately to someone with you, you don't have to cover the mouth piece. Just press the mute button and the person on the line will be cut off for privacy.

When you want to take a nap, just switch the ring off and the phone won't ring. There's never a need to take your phone off the hook again.

The quality is great. A high quality condenser microphone lets the person you talk to hear you loud and clear.

And you hear them through a high

## THE CATCH

Frankly we are losing our shirts on the automated phone, but we're looking for audiophiles who use audio cassettes.

If you buy top name TDK and Maxell cassettes, you probably pay \$3.50 to \$4.50 each for a 90 minute cassette.

We want you to try DAK's new Gold Label MLX ultra high energy, normal bias cassettes. Not at \$4.50 or even at \$3.50 each, but at a factory direct price of just \$2.49 for a 90 minute cassette.



CIRCLE NO. 67 ON FREE INFORMATION CARD

**DAK**  
INDUSTRIES INCORPORATED  
TOLL-FREE 1-800-423-2636  
If busy, after hours, on weekends or in CA  
CALL TOLL-FREE . . . 1-800-228-1234  
10845 Vanowen St., N. Hollywood CA 91605



The new HX-20 Notebook Computer.  
Where was it when I was a kid?

# Epson.

The new Epson HX-20 Notebook Computer is perfect for kids. But it's not just for kids.

The HX-20 has as much total memory as most popular desktop computers. And, like a desktop, you can connect it to a monitor, add extra memory, use a cassette or microcassette to load and store programs, play games, even interface with other computers through a telephone modem.

But that's where the similarity ends. Because, unlike a desktop, the HX-20 has the hardware you need to do word and data processing anywhere. Built in. It has enough internal power to run for 50-plus hours, a full-size keyboard, a scrollable LCD screen, even a handy little microprinter.

But more importantly, it has something that no comparable personal computer can match: a price tag of under \$800. You can have *everything* you need to do real computing for a lot less than the cost of most desktop computers. A lot less.

The new Epson HX-20 Notebook Computer. It's perfect for kids, salespeople, business executives, students — anyone who's looking for an affordable way into serious computing.

For the Epson computer dealer nearest you, just call (800) 421-5426, or in California (213) 539-9140.

Try it out. After all, why should kids have all the fun?



**EPSON**  
EPSON AMERICA, INC.  
COMPUTER PRODUCTS DIVISION

3415 Kashiwa Street • Torrance, California • (213) 539-9140

CIRCLE NO. 25 ON FREE INFORMATION CARD



# Computers & Electronics

MARCH 1983

VOLUME 21, NUMBER 3

## FEATURE ARTICLES

- 39 **THE BRITISH ARE COMING!**  
*Stan Veit/Evaluation of the BBC and Torch microcomputers.*
- 59 **CROSSED SIGNALS**  
*B.K. Roberts/A logic quiz.*
- 60 **THE COMPUTER NETWORK MAZE, Part 1**  
*Stan Veit/How to use the various communication networks available on your microcomputer.*
- 69 **THE VIDEO CONNECTION**  
*Dave Trowbridge/An equipment and hook-up guide for cable-TV viewers and VCR recordists.*
- 81 **16-BIT MICROCOMPUTER TECHNOLOGY**  
*George Meyerle/Part 1: The first in a series on learning about an 8088-based computer.*

## CONSTRUCTION ARTICLES

- 52 **MICROCOMPUTER JOYSTICK INTERFACING METHODS**  
*Randy Carlstrom and Ralph Tenny/Two ways to interface a joystick or paddle to your computer.*
- 92 **A PSEUDO CURSOR FOR OSCILLOSCOPES**  
*D.E. Patrick/Add a calibrated time base to dual-trace scopes.*
- 95 **USE A TRIPLE-THREAT IC**  
*Sami A. Shakir/Versatile uses of the CD4040 CMOS IC.*
- 98 **AUTOMOBILE IDIOT LIGHTS**  
*Richard M. Hilbert/Circuit monitors your car's electrical system*

## EQUIPMENT REVIEWS

- 16 **ZENITH SYSTEM 3 MODEL SY1963W 19" COLOR TV RECEIVER**
- 22 **MARANTZ SR620CX AM/FM STEREO RECEIVER**

## COLUMNS

- 31 **LES SOLOMON ON COMPUTER HARDWARE**  
*Adding a Video Monitor To Your Sinclair ZX81.*
- 35 **STAN VEIT ON COMPUTER SOFTWARE**  
*Software for Mass Markets and Integrated Packages.*
- 100 **PROGRAMMER'S NOTEBOOK/Jim Keogh**  
*How to Use Subroutines.*
- 102 **COMPUTER VIDEO GAMES**
- 103 **SOLID-STATE DEVELOPMENTS/Forrest M. Mims**  
*New Peripheral Transforms Apple II into a Computerized Oscilloscope.*
- 107 **COMPUTER HOTLINE**
- 109 **DX LISTENING/Glenn Hauser**  
*Around the World.*
- 111 **EXPERIMENTER'S CORNER/Forrest M. Mims**  
*Experimenting with VMOS Power Transistors.*
- 114 **PROJECT OF THE MONTH/Forrest M. Mims**  
*A Digitally Programmable VMOS Variable Resistor.*

## DEPARTMENTS

- 6 **EDITORIAL/Art Salsberg**  
*The Calculator Connection.*
- 7 **LETTERS**
- 12 **NEW PRODUCTS**
- 99 **LITERATURE**
- 106 **OPERATION ASSIST**
- 115 **ADVERTISERS' INDEX**
- 128 **COMPUTER MART/ELECTRONICS CLASSIFIED**

COVER PHOTO BY JAY BRENNER

COPYRIGHT © 1983 BY ZIFF-DAVIS PUBLISHING COMPANY. All rights reserved. Computers & Electronics (ISSN 0032-4485) March 1983, Volume 21, Number 3. Published monthly by Ziff-Davis Publishing Co., at One Park Ave., New York, NY 10016. Richard P. Friese, President; Selwyn Taubman, Treasurer; Bertram A. Abrams, Secretary. One year subscription rate for U.S. and Possessions, \$15.97; Canada, \$20.97; all other countries, \$23.97 (cash orders only, payable in U.S. currency). Second Class Postage Paid at New York, N.Y. 10016 and at additional mailing offices. Authorized as second class mail by the Post Office Dept., Ottawa, Canada, and for payment of postage in cash. POPULAR ELECTRONICS including ELECTRONICS WORLD trademark registered. Indexed in the Reader's Guide to Periodical Literature. Ziff-Davis also publishes Boating, Car and Driver, Cycle, Flying, Popular Photography, Skiing, Stereo Review, Electronic Experimenter's Handbook, and Tape Recording & Buying Guide. **POSTMASTER:** Send address changes to COMPUTERS & ELECTRONICS, Circulation Dept., P.O. Box 2774, Boulder, CO 80302. Please allow at least eight weeks for change of address, enclosing, if possible, an address label from a recent issue. **Permissions.** Material in this publication may not be reproduced in any form without permission. Requests for permission should be directed to John Babcock, Rights and Permissions, Ziff-Davis Publishing Co., One Park Ave., New York, NY 10016.

# It's the same old Apple II.

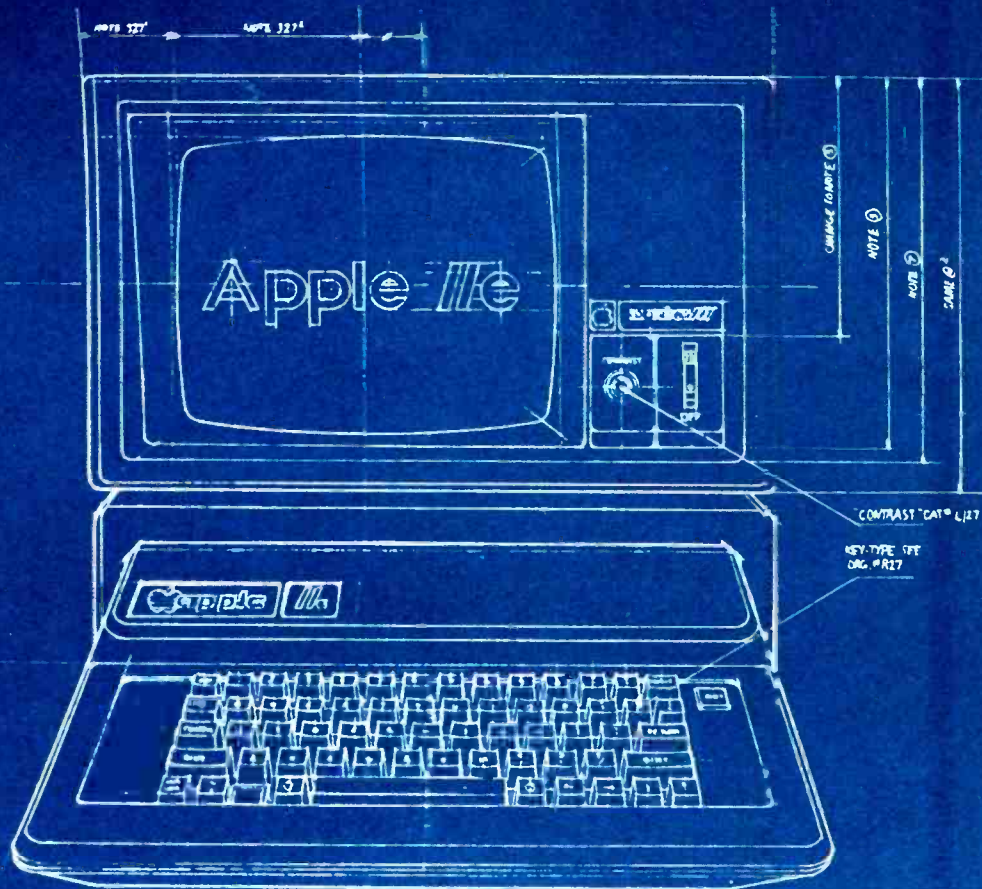

For years, people have been trying to build a better Apple® II. It finally happened.

Meet the Apple IIe, an impressive new version of a most impressive machine.

The "e" means enhanced. Which means a bundle of new features:

A standard memory of 64K (versus 48K) that's easily

expandable. So you can create fatter files and crunch larger numbers of numbers.

A new, improved keyboard, with a complete set of ASCII standard characters. Plus full cursor controls, programmable function keys, and a rapid auto-repeat feature built into every key on the board.

Both upper and lower case

characters. (And if you want to see more of them on the screen at one time, a low cost 80-column text card is available.)

Improved peripheral ports. Which make it a lot easier to connect and disconnect game controllers, printers and all those other wonderful things that go with an Apple Personal Computer.



# Except for the front, back and inside.

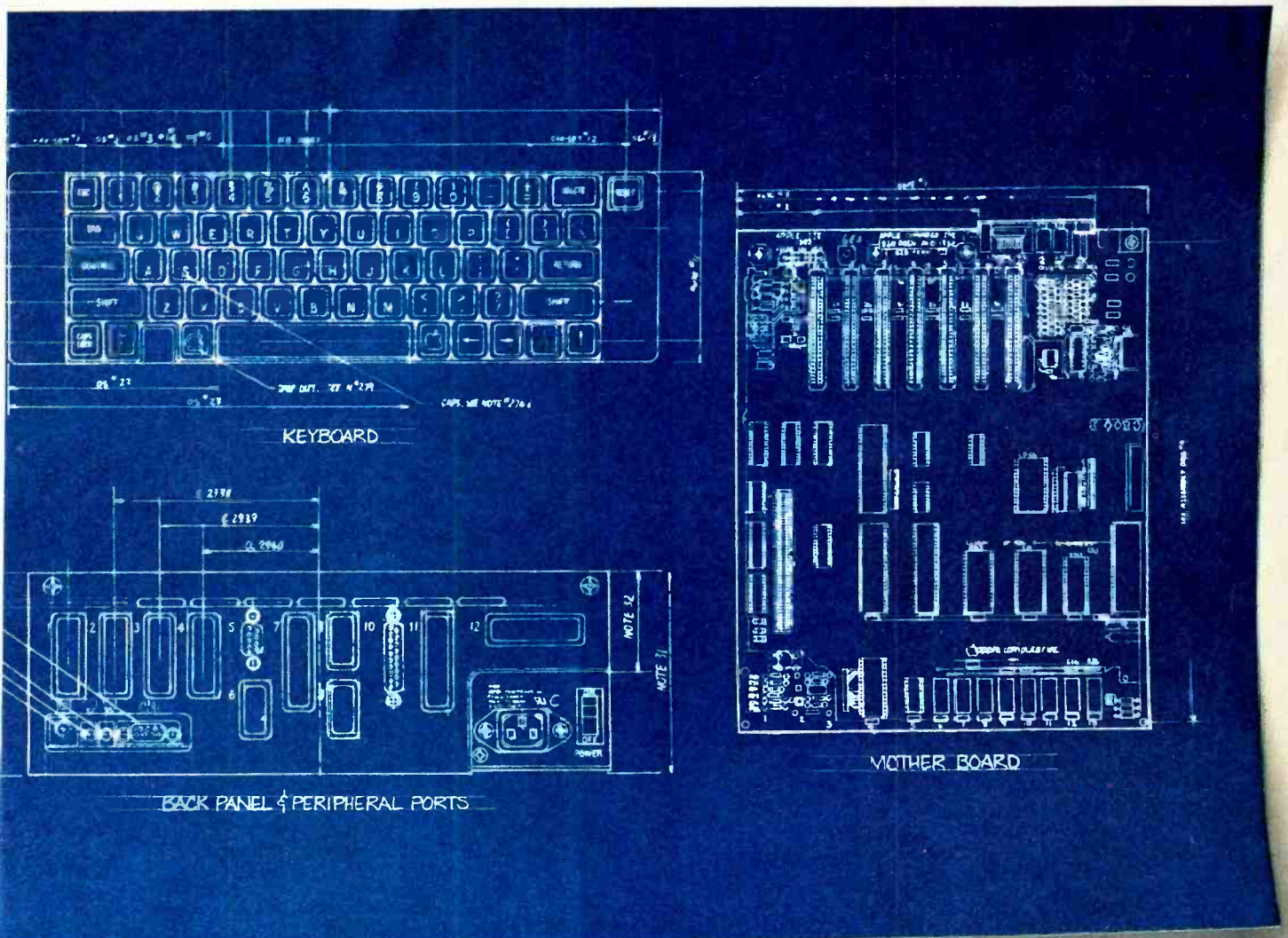

Self-diagnostics. That's a special feature that makes it easy to give your computer a thorough check-up.

Plus an even more reliable design. Achieved by reducing the number of components — which is to say, the number of things that could go wrong.

And bear in mind, the IIe still has all those other virtues that made the Apple II so very popular. Including access to more accessories, peripheral devices and software than any other personal computer you can buy.

So visit any of our over 1300

authorized dealers, and see the newest Apple for yourself.

Like the original, it's rather extraordinary. But then some things never change.



The most personal computer.

Call (800) 538-9696 for the location of the authorized Apple dealer nearest you, or for information regarding corporate purchases through our National Account Program. In California (800) 662-9238. Or write Apple Computer Inc., Advertising and Promotion Dept., 20525 Mariani Ave., Cupertino, CA 95014. ©1983 Apple Computer Inc.

CIRCLE NO. 35 ON FREE INFORMATION CARD



## The Calculator Connection

About 14 years ago a new company, Intel (a contraction of INTEgrated ELEctronics), got a contract from a Japanese firm to produce integrated circuits for a new calculator. It called for almost a dozen ICs. The project head, Ted Hoff, combined this need with Yankee savvy into a monolithic chip called the Intel 4004, which was the first microprocessor.

The world hasn't been the same since.

A few years later Intel introduced the first 8-bit microprocessor, aptly named the 8008. The pMOS CPU was super-

seded rather quickly owing to its limited instruction set and an inability to address more than 16K bytes by the nMOS 8080. This 8-bit device was able to access 65K of memory and had over 50% more instructions.

Again, a calculator maker came into the picture: MITS. The company's calculator business was in a nose dive, together with a host of others, and the owner, Ed Roberts, sought to enter the computer field using Intel's new device. The new computer, named Altair, was introduced to the world in our January 1975 issue. The calculator connection was made once again. A byproduct of the new computer was a bus with 100 connections, called the standard-100 or S-100 for short, which served as the impetus for a host of manufacturers to latch onto it with various peripherals and to establish a sort of mini (micro?) universal system that was recently standardized as the IEEE-696 bus.

Other companies developed and marketed their own microprocessors, including Motorola with its 6800 CPU, MOS Technology with its 6502, and Zilog with its Z80 (an improved outgrowth of the 8080 that spurred Intel to develop its 8085 CPU), among others.

The horsepower race continues today with the introduction of a number of 16-bit microprocessors. Actually, a 16-bit microprocessor from National Semiconductor was on the market before an 8-bit one was, but 16-biters did not come into prominence until a later time.

Even the early Texas Instruments 16-bit TMS-9900 didn't gain popularity, perhaps owing to its uniqueness. It really took Intel's 8088 16-bit CPU to dramatize the effectiveness of 16-bit devices for small computers. This "chip" is actually a modified 8086 that uses an 8-bit data bus instead of 16-bits, and programs written for it are upward compatible with the earlier 8080 CPU. Moreover, it is incorporated into the popular IBM-PC personal computer.

Furthermore, support chips must draw from the 8088 in order to work. Given all this, COMPUTERS & ELECTRONICS has chosen the 8088 as the heart of a microcomputer course initiated in this issue. As the course unfolds, you'll doubtlessly observe that it isn't pure electronics; nor is it software. It's logic-oriented, with the "electronics" in black-box devices that essentially consist of solid-state on-off switches that are often packaged as thousands to a device.

The final calculator connection here appears to have been made recently when IBM, which had a hand in developing an early general-purpose calculator, the Harvard Mark I, bought a piece of the (silicon) rock—Intel.

**ARTHUR P. SALSBERG**  
Editorial Director

**LESLIE SOLOMON**  
Technical Director

**JOHN R. RIGGS**  
Managing Editor

**EDWARD I. BUXBAUM**  
Art Director

**JOSEPH DESPOSITO**  
Technical Editor

**STANLEY VEIT**  
Technical Editor

**DAVID M. WEBER**  
Features Editor

**ANDRE DUZANT**  
Technical Illustrator

**CARMEN ROBLES**  
Production Editor

**JEFF NEWMAN**  
Editorial Assistant

Contributing Editors:

Walter Buchsbaum, Len Feldman,

Glenn Hauser, Julian Hirsch

Jim Keogh, Forrest Mims

**MARIE MAESTRI**  
Executive Assistant

## Computers & Electronics

formerly Popular Electronics

Editorial and Executive Offices  
One Park Avenue  
New York, New York 10016  
212 725-3500

New York Office  
Advertising Director:  
Richard Govatski 212 725-7460

Sales:  
Tom Ballou 212 725-3578  
Ken Lipka 212 725-3580

Midwestern Office  
Suite 1400, 180 N. Michigan Ave.,  
Chicago, IL 60601 312 346-2600  
Sales: Robert Vanek

Western Office  
3460 Wilshire Blvd.  
Los Angeles, CA 90010 213 387-2100  
Sales: Ted Welch

Representation in Japan  
J.S. Yagi  
Iwai Trading Co., Ltd.  
603 Ginza Sky Heights Bldg.  
18-13, Ginza 7-Chome  
Tokyo, Japan 104

Consumer Computers & Electronics Magazine Division

Larry Sporn President  
J. Scott Briggs, Marketing Vice Presidents  
Carole Mandel, Circulation  
Eileen G. Markowitz, General Manager

Ziff-Davis Publishing Company

Richard P. Friebe President  
Albert S. Traina President, Consumer Magazine Division  
Furman Hebb Executive Vice President  
Paul H. Chook Executive Vice President  
Marketing and Circulation  
Senior Vice Presidents

Phillip T. Heffernan  
Sidney Holtz  
Edward D. Muhlfeld  
Philip Sine  
Robert Bavier Vice Presidents  
Baird Davis  
George Morrissey  
Selwyn Taubman Treasurer  
Bertram A. Abrams Secretary

Editorial correspondence: COMPUTERS & ELECTRONICS, 1 Park Ave., New York, NY 10016. Editorial contributions must be accompanied by return postage and will be handled with reasonable care; however, publisher assumes no responsibility for return or safety of manuscripts, art work, or models submitted.

The publisher has no knowledge of any proprietary rights which will be violated by the making or using of any items disclosed in this issue.





## LETTERS

### PARALLEL PAIRS

The "Calculating Parallel Resistance Pairs" article in the December 1982 issue gives a simple shortcut for finding two or more resistance values to substitute for one that is not available. However, it should have been pointed out that the choice of the number used as the multiplier for finding the values of  $R1$  and  $R2$  is a random choice. The author used 4—it could have been 8 or 9. However, once the number is chosen for the multiplier, then the number used for the divisor must be one less, or 3 in the example—*Mack D. Baxter, Granite Shoals, TX.*

### LINE SPIKES SET OFF ALARM

I built the "New, Effective Anti-Burglary System" (June 1982) and found that sometimes disturbances (spikes) on the power line will set off the alarm. The problem can be corrected to an extent by placing capacitors across the power transformer leads. However, in some cases, a capacitor must be applied across the source of the disturbance—refrigerator, fluorescent light, etc.—*David Crotty, Highland Park, MI.*

### PRINTING COLOR GRAPHICS

With regard to the article "Printing Computer Graphics" (November, 1982), please note the following concerning the TRS-80 Color Computer. The early versions of the Color Computer had 7-bit printer drivers, limiting the values transmitted to 127. A cassette 8-bit driver program is available free to bring the machine to 8 bits out. Machines manufactured after April 1981, (Ver. 1.1) have had 8-bit drives built-in, and can transmit the 8-bit values needed for graphic printing. The screen print program (26-3021), which dumps a high-resolution screen to TRS-80 graphic printers also has an 8-bit output driver. The TRS-LP VIII also includes graphic capabilities.—*Roy J. Irvine, Radio Shack, Fort Worth, TX.*

# How to move a paragraph.

For memos or manuscripts, sales reports or book reports, a person could use the IBM Personal Computer.

Because, with the EasyWriter\* software program, creating, revising and storing text is just that. Easy.

With ten function keys that help save time on repetitious tasks and "menus" that guide you along, the IBM Personal Computer can insert a clause. Delete a line. Move a paragraph from one page to another. Transfer text from file to file. Even merge words from your EasyWriter program with numbers generated by your VisiCalc† program.

And when you're done, a copy of the finished product can be printed out at 80 characters a second.

So if you do any kind of writing, try it on the IBM Personal Computer at your nearest authorized dealer. You'll see that the performance, quality and price are really something to write home about.

**IBM**<sup>®</sup>



## The IBM Personal Computer A tool for modern times

For more information on where to buy the IBM Personal Computer, call 800-447-4700. In Alaska or Hawaii, 800-447-0890.  
†VisiCalc is a trademark of VisiCorp      \*EasyWriter is a trademark of Information Unlimited Software, Inc.

CIRCLE NO. 41 ON FREE INFORMATION CARD

MASTER THE "NEW ELECTRONICS" WITH MCGRAW-HILL'S

# Contemporary

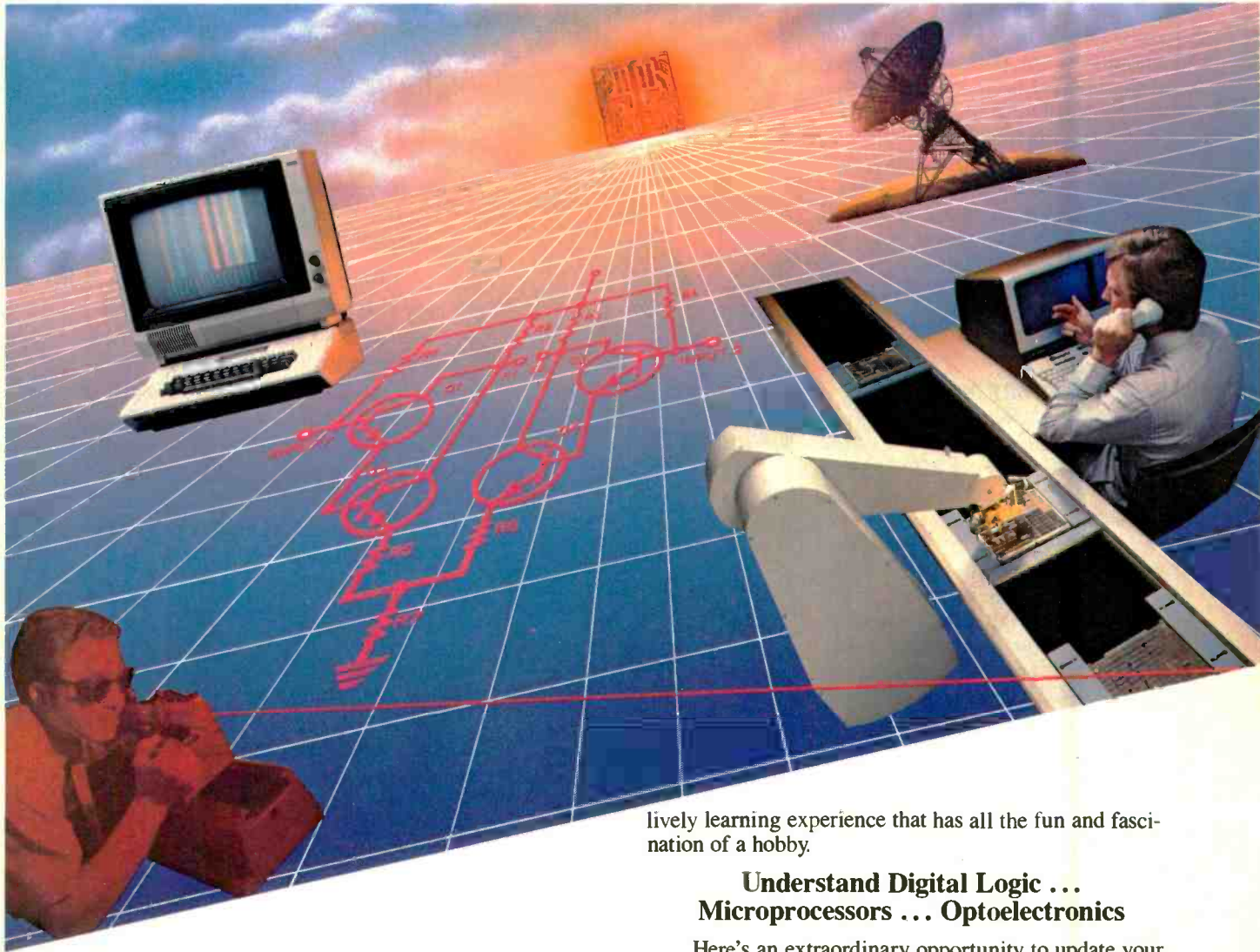

Now you can meet the challenges of today's incredibly rapid changes in electronics quickly and easily. This professional level electronics learning series is as innovative as the circuitry it explains and as fascinating as the experiments you build and explore!

From digital logic to the latest 16-bit microprocessor, you master one subject at a time with McGraw-Hill Concept Modules sent to you one at a time, once a month, to make up the complete CONTEMPORARY ELECTRONICS SERIES. Each module of the fifteen in the Series is a unique blend of "hands-on" experience, interactive audio cassettes, and vividly illustrated printed support materials. Together they will prepare you for tomorrow's better jobs or advancement in your present position by staying current with today's electronics revolution. Professional in every respect, yet it's a

lively learning experience that has all the fun and fascination of a hobby.

### Understand Digital Logic ... Microprocessors ... Optoelectronics

Here's an extraordinary opportunity to update your understanding of today's most important technological changes in electronics. You can start from scratch or use the Series to update yourself. You cover the latest integrated circuits, including TTL, CMOS, and ECL digital circuits; op-amps; phase-locked loops; microprocessors; and opto devices such as LEDs and LCDs.

### Perform Electronic Experiments

With your first module you'll use the latest digital integrated circuits to build an oscillator circuit that demonstrates digital signals—verified visually by the flash of light emitting diodes (LEDs) and audibly by tones produced through the mini-speaker that is provided.

You'll know the differences (and similarities) between electronics and electricity, learn the concepts applicable to all electronic circuits. With the first module, you will be able to identify the major passive components, like resistors, capacitors, inductors, diodes and



# Electronics Series

transformers, and active components such as transistors and integrated circuits.

Each **Concept Module** goes right to the heart of the matter. You waste no time on extraneous material or outdated history. It's a fast, efficient, and lively learning experience, a nontraditional approach to the most modern of subject matter.

## Construct and Use a Prototyping/Design Laboratory

What's more, when you reach the midpoint of your

### YOU COVER EVERY SUBJECT IN CONTEMPORARY ELECTRONICS

- Digital logic
- Digital gates (TTL, CMOS, ECL, NMOS)
- Flip flops, counters and registers. Op-amps and applications
- Power supplies (plus IC and switching regulators)
- Combinational logic circuits (ROMs, PLAs, decoders, etc.)
- Circuit analysis. AC theory. LCR networks
- Transistors (bipolar and FETs), diodes, thyristors
- Integrated circuits (linear and digital)
- Oscillators and function generators
- Modulation and demodulation
- Optoelectronics
- Digital multimeters and scopes
- Microprocessors

Series, you will have constructed a professional Prototyping/Design Laboratory which will become a valuable learning tool throughout the remainder of your studies. This Prototyping/Design Lab contains a signal generator, logic switches, pushbuttons, and LED indicators. It rivals professional instruments that are widely used in industrial laboratories for electronic design and development as well as testing and measuring. Because of its versatility, it is an instrument that you will use again and again, even after you have completed your Contemporary Electronics Series.

With each new module you'll receive a McGraw-Hill Action-Audio Cassette, a proven successful method of programmed, interactive instruction. Each tape creates a dynamic dialogue that not only quickly communicates the facts, but makes you feel that you're participating, as you respond to questions and listen to problems being solved.

Your ability to rapidly make this knowledge your own is further aided by a strikingly original technique for using diagrams, illustrations, and schematics to drive home points made as you listen to the cassette. The same carefully indexed binder that contains this material also includes the instructions

to guide you through hands-on experiments. Finally, having completed the Series, you can be awarded a Certificate of Achievement from the McGraw-Hill Continuing Education Center upon passing an optional final examination.

## Update Your Knowledge of the New Electronics

This program is for you whether you're a scientist who can use electronics to improve or speed up your investigations... a teacher who'd benefit from a refresher in contemporary components, circuits and applications... a manager or supervisor in an electronics related industry or business... an engineer in another field who finds electronics playing an ever more important role in your work... someone looking to find new direction in this wide open field... or the kind of person who wants to understand what's going on in the world around you.

McGraw-Hill's Contemporary Electronics Series offers you the quickest and probably least expensive learning method available today, and the only one with "hands-on" experience.

## No Risk, No Obligation

And we invite you to prove all this to your own satisfaction—without risk and without committing yourself in any way.

Return the reply card and we'll send you the first module and other materials for a free 14-day examination. If you're not absolutely satisfied, and certain that this is an enjoyable as well as highly effective way to learn, simply return the module to us along with the unpaid bill and that will be the end of it.

If you wish to continue, we'll ship the remaining modules automatically, about once a month, for only \$19.95 each plus \$2.25 for shipping and handling. Remember, each module comes on the same 14-day free examination basis, with no obligation to pay for any module you don't want to keep.

Return the reply card now. It'll bring you the first module Contemporary Electronic Components and Circuits... your first step in becoming an expert in the "new electronics." There's no risk or obligation.

If the card is missing write to:



Contemporary Electronics Series  
McGraw-Hill Continuing Education Center  
3939 Wisconsin Avenue, NW  
Washington, DC 20016

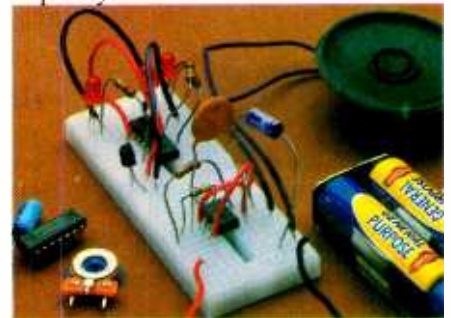

*With your first module you'll receive this professional solderless breadboarding system. It enables you to connect components and build electronic circuits easily and quickly. It's used throughout the series and can be used later to design, build and test your own circuits.*



## NEW PRODUCTS

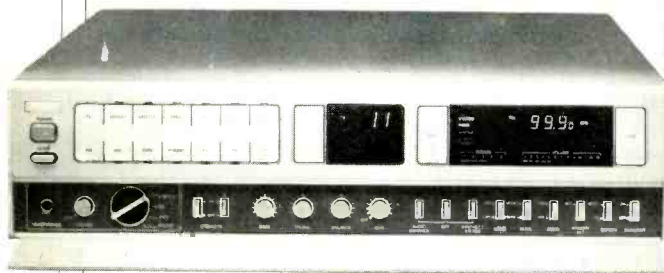

### AUDIO/VIDEO RECEIVER

Combined in Jensen's Model AVS-1500 receiver are a synthesizer AM/FM tuner, 50-W/ch amplifier, cable-ready 133-channel video tuner, and microprocessor-controlled input/output switcher. The receiver can simulate stereo sound from mono video sources and has Dynamic Noise Reduction to enhance audio performance. Headphone listening to audio is possible while the main outputs are used for listening to video programs. \$990.

Circle No. 92 on Free Information Card

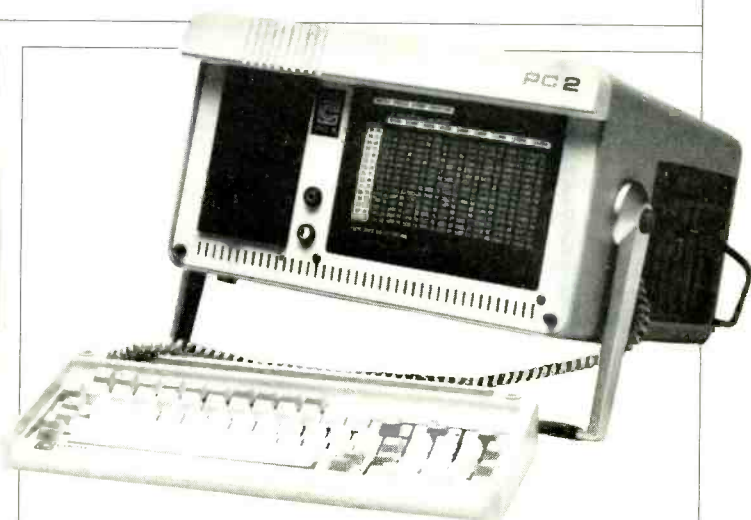

### IBM-PC COMPUTER GOES PORTABLE

Colby Computer's Model PC-1 kit allows the IBM-PC to go portable. It consists of a 9" high-resolution video monitor, switching power supply, wiring harness, and interface boards in a 17" x 15" x 8½" Cyclac® carrying case with room for IBM-PC elements. It's specifically designed to work with IBM-PC disk drive, system and plug-in boards, and keyboard. Total system weight is 26 lb. \$899.

Circle No. 99 on Free Information Card



### HANDHELD DMM

The Model LX-306 is a new Hickok 3½-digit handheld multimeter with LCD display and "Vari-Pitch" tone. In addition to measuring and displaying up to 1000 V dc (750 V ac to 5 kHz), to 10 A ac/dc, and from 200 ohms to 20 megohms, the meter's tone frequency varies proportionally with signal input. Basic instrument accuracy is 0.25%. A diode test function is included. \$139.

Circle No. 95 on Free Information Card

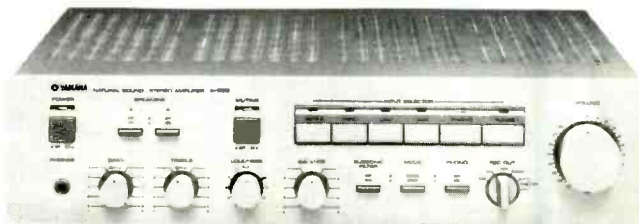

### DIGITAL AUDIO STEREO AMPLIFIER

Yamaha has just released a stereo amplifier designed to meet the demanding requirements of digital audio discs. Rated at 70 W/ch, the Model A-500 features Zero Distortion Rule (ZDR) circuitry for super-low distortion, moving-coil head amp, digital input, independent record out/source in to permit recording from one source while listening to another, variable loudness control, and -20-dB mute switch. \$300.

Circle No. 100 on Free Information Card

### COMMUNICATIONS RECEIVER

The Model R-200 communications receiver from Trio-Kenwood covers 150 kHz to 30 MHz on AM/SSB/CW/FM in 30 bands. Features include: fluorescent frequency display; digital vfo's; 10 memories (store frequency, band, and mode); memory and programmable band scan modes; switchable i-f filters; S meter; noise blanker; r-f attenuator; dual 24-hour clock; with ac or battery operation. A lithium battery provides memory backup. \$600.

Circle No. 93 on Free Information Card



(More on page 14)



# INTRODUCING the world's first, affordable teaching robot...

**HERO<sup>1</sup>** the  
most sophisticated  
microprocessor-  
controlled device  
since the  
microcomputer.

HERO 1 is a completely self-contained, electro-mechanical robot capable of interacting with its environment. Controlled by an on-board, programmable computer, it has electronic sensors to detect light, sound, motion and obstruction in its path.

Capable of seven axes of mo-

tion, the robot can be programmed to pick up small objects with its arm. It will also speak in complete sentences, using its voice synthesizer.

**Remarkable though the robot is, its companion Robotics Education Course**

is an even more significant "first." It provides a thorough understanding of robot technologies, including robotics programming. Course features self-test unit reviews, experiments and final exam.

Designed to be used with

HERO 1, this 1200 page course is the most complete introduction to robotics available today.

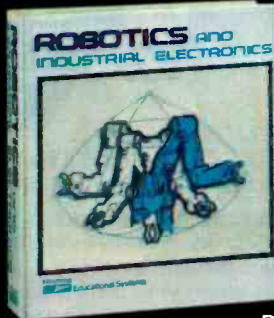

**HERO 1 is a computer on wheels.**

HERO 1 uses a 6808 microprocessor that controls 13 functions and sense boards. Its on-board processor can take it through complex maneuvers. The programming process is straightforward with provision for step-by-step debugging, enforcement and other corrections.

HERO 1 senses include: sound detection (frequency range 200-5000 Hz); light detection; ultrasonic ranging; ultrasonic motion detection; speech synthesis; and real time, four year calendar clock.

A completely mobile platform robot, HERO 1's motion abilities permit head rotation and arm rotation of 350°, shoulder rotation of 150°, arm extension of 5 inches, wrist pivot of 180° and wrist rotation of 350°. Gripper will open to a maximum of 3½ inches and rotate 90° at extreme extension. Payload capacity of arm is 8 oz. at maximum extension and 16 oz. at normal.

The remarkable HERO 1 robot is in production now, ready for you. Buy assembled or build it from a kit. Kit price is \$1500 and the assembled robot is \$2500, FOB Benton Harbor, or through your nearest Heathkit Electronic Center.

**For full information on HERO 1 call 800-253-0570 toll-free. (In Alaska, Hawaii and Michigan, call 616-982-3411.) We'll give you the address of the nearest Heathkit Electronic Center and send you a booklet that gives details about the robot, the content of this course, and other information.**



Please send details on the HERO 1 robot and robotics course.

Mail to: Heath Company, Dept. 010-998  
Benton Harbor, MI 49022

Name \_\_\_\_\_

Address \_\_\_\_\_

City \_\_\_\_\_

State \_\_\_\_\_ Zip \_\_\_\_\_

Heathkit / Zenith Educational Systems is a division of Heath Company,  
Benton Harbor, Michigan 49022. RO-100A

**Heathkit**  
Heathkit / Zenith  
Educational Systems

### PANASONIC HOME COMPUTER

Panasonic's new Model JR-200 8-color/3-tone (in five octaves) home computer comes with 32K bytes of user RAM and 16K bytes of ROM with BASIC and can be used with color TV receivers or RGB monitors. It features typewriter keyboard, ac power supply, r-f modulator, cassette I/O, Atari-compatible joystick and printer interfaces.

Circle No. 96 on Free Information Card



### REMOVABLE CASSETTE PLAYER CAR STEREO

"Music Shuttle" Model XRM-10 from Sony Autosound is an in-dash AM/FM-stereo receiver with removable cassette player that can double as a carry-along personal stereo player. A battery pack, headphones, and carrying case are provided for Walkman-like operation of the cassette player. The system has outputs for two and four speakers, built-in fader control, metal-tape capability, and variable tape bias. System price is \$380.

Circle No. 94 on Free Information Card

### OLIVETTI TYPEWRITER COMPUTER INTERFACES

Olivetti Praxis series electronic portable typewriters can be used as letter-quality computer printers with "Micro-Type" interface kits from Computer Products Division of Selectone. Available are separate RS232C serial (Model OP-140S) and Centronics parallel (Model OP-150P) versions for interfacing with most personal microcomputers. Interface kits install inside the Praxis typewriters and have no effect on normal typewriter-only operation. Supplied with each kit are step-by-step instruction manual, application notes with connect points for configuration, and operating tips for many popular personal computers. \$195 for each model.

Circle No. 98 on Free Information Card



### NEW HOME COMPUTER FROM ATARI

Now at the top of Atari's line of home computers is the Model 1200XL, with 64K bytes of user RAM and an improved typewriter keyboard. It can be used with existing Atari software and peripherals and includes 256 colors and four sound "voices" that cover 2½ octaves. Provided are HELP and four user-definable function keys, one applications/games cartridge slot, two controller and one serial I/O port, and an operating system compatible with previous Atari systems but modified to take advantage of the 64K memory. A built-in r-f modulator allows output to be displayed on TV channel 2 or 3. Under \$1200.

Circle No. 97 on Free Information Card





# COMPUTER BOOKS FOR BEGINNERS

Everything you need to get started programming your own personal computer. These handy books of programs, and about programming, are loaded with easy-to-understand info for beginners. The books include hundreds of ready-to-type-and-run programs as well as hundreds of program-writing tips, tricks, hints, shortcuts, secrets, techniques. We offer books covering the most popular computers for beginners: TRS-80 Color Computer, Atari 400, Atari 800, Apple II, Sinclair ZX-81, Timex 1000, Micro Ace, IBM Personal Computer, Casio FX-702P pocket computer, Sharp PC-1211 and PC-1500 pocket computers and TRS-80 PC-1 and PC-2 pocket computers, TI-99/4A, VIC-20, and Commodore 64.

## Timex 1000/Sinclair ZX-81

**101 TIMEX 1000/Sinclair ZX-81 Programming Tips & Tricks**, secrets, hints, shortcuts, learn-by-doing instruction, techniques for the ZX-81, MicroAce and Timex 1000 computers, includes 101 ready-to-run programs, 128 pages **\$7.95**

**37 TIMEX 1000/Sinclair ZX-81 Computer Programs for Home, School & Office**, practical type-and-run software for ZX-81, Timex 1000 and MicroAce, 96 pages **\$8.95**

**Practical TIMEX/Sinclair Computer Programs for Beginners**, by Edward Page, three-dozen ready-to-run new programs for home, school & office, 96 pages **\$7.95**

**TIMEX/Sinclair Computer Games Programs**, by Edward Page, two-dozen all-new fun game programs, 96 pages **\$7.95**

**TIMEX/Sinclair Computer Program Writing Workbook**, by Edward Page, a handy supply of program-writing worksheets, graphics grids, and BASIC instruction, 96 pages **\$4.95**

## TRS-80/Sharp/Casio Pocket Computers

**99 Tips & Tricks for the New Pocket Computers**, all new programs, using tremendous power of TRS-80, PC-2/Sharp PC-1500, LCD graphics, printer/plotter graphics, useful business and home software, includes 99 complete type-and-run programs, learn full range of expanded BASIC, 128 pages **\$7.95**

**Pocket Computer Programming Made Easy**, fast new, easy read-and-learn way to quickly understand the BASIC programming language, how to make TRS-80 PC-1/PC-2, Sharp PC-1211/PC-1500 & Casio FX-702P computers work for you, 128 pages **\$8.95**

**101 Pocket Computer Programming Tips & Tricks**, secrets, hints, shortcuts, techniques from a master programmer, includes 101 ready-to-run programs, for TRS-80 PC-1 and PC-2 and Sharp PC-1211 and PC-1500, 128 pages **\$7.95**

**50 Programs in BASIC for Home, School & Office**, useful ready-to-run software for PC-1/PC-2/PC-1211/PC-1500, 96 pages **\$9.95**

**50 MORE Programs in BASIC for Home, School & Office**, book of tested software for PC-1/PC-2/PC-1211/PC-1500, 96 pages **\$9.95**

**Murder In The Mansion and Other Computer Adventures**, mystery, space adventure, games, 24 programs for PC-1/PC-2/PC-1211/PC-1500, 96 pages **\$6.95**

**35 Practical Programs for the Casio Pocket Computer**, useful type-and-run software for the FX-702P, 96 pages **\$8.95**

**Pocket Computer Program Writing Workbook**, by Jim Cole, 96 pages, 8 1/2x11 **\$4.95**

## Atari 400/800 Computers

**101 ATARI Computer Programming Tips & Tricks**, learn-by-doing instruction, hints, secrets, shortcuts, techniques for Atari 400 and 800 computers, includes 101 ready-to-run programs, 128 pages **\$8.95**

**31 New ATARI Computer Programs for Home, School & Office**, practical type-and-run software for Atari 400 and 800, 96 pages **\$8.95**  
**ATARI Computer Program Writing Workbook**, 96 pages, 8 1/2x11 **\$4.95**

## Texas Instruments

**101 Programming Tips & Tricks for the Texas Instruments TI-99/4A Home Computer**, learn-by-doing instructions, shortcuts, hints, secrets, includes 101 ready-to-run programs, 128 pages, **\$8.95**

**36 Texas Instruments TI-99/4A Programs for Home, School & Office**, by Len Turner, practical type-and-run software for home, classroom and small-business office, 96 pages **\$8.95**

**Texas Instruments Computer Program Writing Workbook**, by Len Turner, handy supply of program-writing worksheets, graphics grids, BASIC instruction, for TI-99/4A, 96 pages, **\$4.95**

## Apple Computer

**101 APPLE Computer Programming Tips & Tricks**, secrets, hints, insights, 101 ready-to-run programs for Apple II, 128 pages **\$8.95**

**33 New APPLE Computer Programs for Home, School & Office**, practical type-and-run software for Apple II, 96 pages **\$8.95**

**APPLE Computer Program Writing Workbook**, by Fred White, 96 pages, 8 1/2x11 **\$4.95**

## TRS-80 Color Computer

**Color Computer Graphics**, complete guide loaded with instruction, how to make the most of TRS-80 Color Computer video graphics, many complete programs, 128 pages **\$9.95**

**101 Color Computer Programming Tips & Tricks**, learn-by-doing instructions, hints, secrets, techniques, insights, for TRS-80 Color Computer, includes 101 programs, 128 pages **\$7.95**

**55 Color Computer Programs for Home, School & Office**, practical ready-to-run software, colorful graphics, for TRS-80 Color Computer, 128 pages **\$9.95**

**55 MORE Color Computer Programs for Home, School & Office**, handy companion volume packed with different useful type-and-run software, colorful graphics, for TRS-80 Color Computer, 112 pages **\$9.95**

**The Color Computer Songbook**, 40 favorite pop, folk, classical, seasonal songs arranged for play on TRS-80 Color Computer, type-and-run music programs, 96 pages **\$7.95**

**My Buttons Are Blue and Other Love Poems from the Digital Heart of An Electronic Computer**, a high-tech classic, 96 pages **\$4.95**

**TRS-80 Color Computer Program Writing Workbook**, by Ron Clark, 96 pages, 8 1/2x11 **\$4.95**

Order direct from this ad. Send check, money order, or MasterCard or VISA account number and expiration date. Include \$1 shipping for each item ordered up to a maximum of \$3. Mail to:

# ARCsoft Publishers

Post Office Box 132A  
Woodsboro, Maryland 21798



Foreign customers wanting airmail send \$4 postage per item ordered, pay in U.S. dollars. Maryland residents add 5% sales tax. Sorry, no COD.

## TEST REPORT: VIDEO

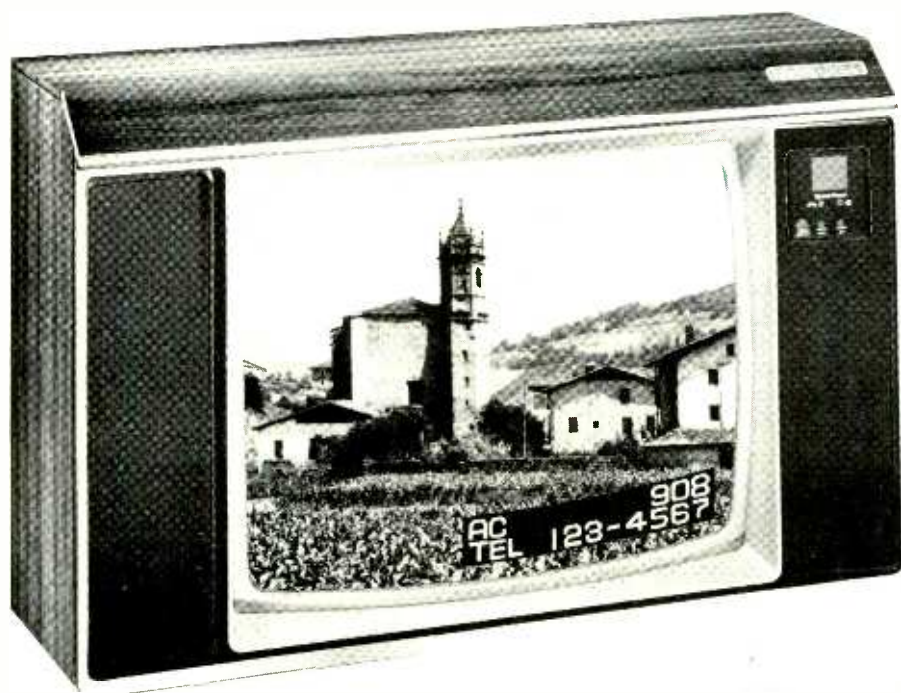

### Zenith System 3 Model SY1963W 19" Color TV Receiver

In 1980, Zenith introduced an "answer-only" telephone as part of a TV receiver, following this "first" with a digital "dial-out" phone in 1981. In some of its latest sets, such as the Zenith System 3 Model SY1963W 19" color TV receiver examined here, an "Advanced Space Phone" is incorporated (Computer Space Phone Model 4100) that stores two phone numbers in memory and can automatically dial them through the TV receiver. Interestingly, the cost is only \$30 more than Zenith's comparable model (Model SY161) that does not include this function.

This high-quality 19-incher features electronic tuning, remote control, 112-channel tuning capability, an on-off timer, and a number of worthwhile technical features. The new receiver utilizes the company's familiar modular construction with highly reliable "key-lock" connectors. Dimensions are 18" H × 27" W × 17" D, and weight is 56 lb.

**General Description.** The all-electronic, crystal-controlled, mi-

croprocessor operated vhf and uhf tuner covers 42 cable channels, including midband, superband and hyperband, as well as vhf and uhf channels. With the afc (automatic frequency control) switch in the NORMAL position the electronic fine-tuning circuit locks in on standard broadcast station signals, but when the switch is set to "special," the phase-lock loop (PLL) control voltage pulls in slightly off-frequency signals, such as those that might come from some video games, computers, VCRs, or master antenna systems.

Zenith's Computer Space Command 4100 remote control system uses infrared, digital signalling that includes not only channel selection, picture and volume control, but also the telephone operation. Channel selection is by up/down scanning of pre-programmed TV channels or by pressing the buttons representing the selected channel number. On-screen display of the TV channel, together with the time-of-day, persists for about five seconds, but pressing the "recall" button or se-

lecting another channel brings the display back. A time control programmer can turn the set on or off once every 24 hours.

For Advanced Space Phone operation, a standard phone cable with snap-in plug is provided. When the phone rings, the viewer simply depresses the "phone" button on the remote control and the caller's voice comes from the TV receiver's two 5" oval speakers. A sensitive microphone mounted in the receiver lets anyone in the room answer, but if you want to discuss something without the caller hearing it, you press the "mute/privacy" button on the remote control. Pressing that button again restores microphone operation.

To dial out, there are a number of options. You can simply press the "phone" button, hear the dial tone over the TV speakers, and dial the number by pressing buttons on the remote control, just as on any pushbutton phone. As numbers are dialed, they appear superimposed on the TV screen. If you dial a 7-digit number, the display will just read





To get the most from today's new VCRs, we created the finest tape we ever made. Fuji Super High Grade. For the ultimate in slow-speed and stop-action performance, as well as incredible richness of color and detail. Bring home the excitement and see for yourself.

**IF IT'S WORTH TAPING, IT'S WORTH FUJI.**

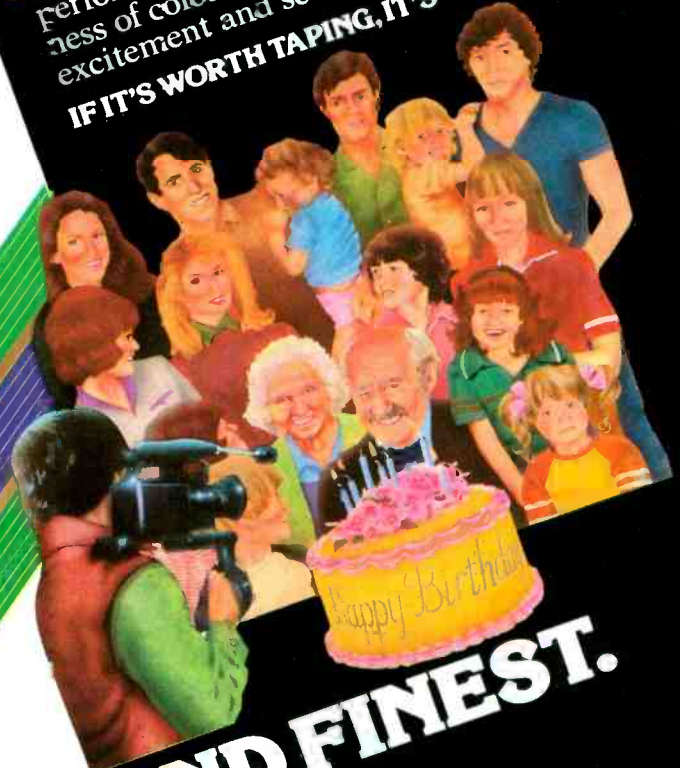

**FUJI SHG. THE FIRST AND FINEST.**

# FRANKLIN'S BAKER'S DOZEN!



## 13 Good Reasons to Buy the **ACE 1200**

1. **Apple® II-compatible**
2. **CP/M®-compatible**
3. **128K of RAM**
4. **Built-in floppy disk drive**
5. **Disk controller**
6. **80 column card**
7. **Serial interface**
8. **Parallel interface**
9. **Upper and lower case**
10. **VisiCalc® keys**
11. **Cursor control pad**
12. **Numeric pad**
13. **Auto repeat keys**

Extras can more than double the price of your personal computer. Not so with the Franklin ACE 1200. It's the professional computer system that includes the extras—and a long list of exclusive Franklin features that make it the most extraordinary value on the market today.

The ACE 1200 has everything you'll need to add a color or black and white monitor, modem, printer, back-up disk drive and other accessories. You can choose from the enormous selection of Apple programs and peripherals because the ACE 1200 is hardware- and software-compatible with

the Apple II. And, with the built-in CP/M card, you can run both Apple II and CP/M programs. Franklin's CP/M operates three times as fast as many competing systems, drastically reducing processing time for most business applications.

The Franklin ACE 1200—the most extraordinary value on the market today. Call or write today for the name of your local authorized Franklin dealer.

Franklin ACE is a trademark of Franklin Computer Corporation. Apple is a registered trademark of Apple Computer Inc. CP/M is a registered trademark of Digital Research Inc. VisiCalc is a registered trademark of Visi Corp.



**FRANKLIN**  
COMPUTER CORPORATION

7030 Colonial Highway, Pennsauken, NJ 08109 609-488-1700

CIRCLE NO. 59 ON FREE INFORMATION CARD



"TEL 123-4567," but if you dial an area code, say 201, the display will run two lines, with the top reading "AC 201" and the bottom the same as before. Up to 13 digits can be displayed, and the display is on-screen for about 30 seconds. After the dial-tone, you will hear the ring-back, busy, or voice over the speakers. If you want to repeat the call, just press the "phone" button for the dial tone and then press the "enter" key on the remote control. This automatically redials the last phone number. In addition to the nonvolatile memory for the last number dialed, the Space Phone has memory for automatic dialing of two preprogrammed 13-digit numbers. The "autodial" mode is programmed by pressing the "autodial" button on the remote control and numbers are stored by means of the "enter" key. When "autodial" is used, the on-screen display will show AUTODIAL 1 (or 2), together with the number that has been programmed into that location.

The heart of the auto dial/dial-out system is a microprocessor, combined with a character generator and MNOS memory. As the transmitter's digit keys are pressed for dialing, the microprocessor decodes IR signals received and causes a relay to open and close on the Space Phone module in accordance with the signals. Sound is muted automatically to eliminate audio "clicks" when this occurs. There's a 90-ms delay between digits to compensate for slower phone equipment in some areas. To assure valid entry of signals, digits should not be "dialed" faster than three digits per second.

The i-f section of the Zenith SY1963W contains a SAW (Surface Acoustic Wave) filter and, as a special feature, Zenith's PRP (Peak Resolution Picture) circuit. It consists of a ceramic filter in the fourth stage of the i-f amplifier that is controlled by the agc (automatic gain control). When weak TV signals are received, this circuit changes the i-f response curve so that the video carrier, normally 6 dB below the top of the curve, moves to the top. In other

words, on weak signals, the video carrier gets an extra 6-dB gain, but the high-frequency portion of the video signal loses about 4 dB.

As in most modern, high-performance color TV sets, the horizontal and vertical sync are counted down from a crystal-controlled, PLL oscillator. When the special circuit in the sync section detects at least nine serrated horizontal pulses during the vertical sync interval, standard, interlaced operation is assumed. When six consecutive noncoincidences are detected during the vertical sync interval, nonstandard sync is assumed and, instead of the count-down system, a conventional sync system takes over.

Zenith's "Color Sentry" consists of eight different, well-established, automatic circuits for color correction, flesh-tone, brightness, color sync, etc.

The sweep and high voltage sections of the Model SY1963W are very similar to most recent color TV sets. Most of the voltages are rectified from taps on the flyback transformer, with filtering and regulation done at the horizontal sweep frequency. This means that only the well-regulated B+ power to the horizontal sweep comes from the line, with the chassis "hot" and requiring an isolation transformer for all trouble-shooting or testing.

The audio portion of this receiver has a tone control and includes an output jack for connection to an external hi-fi system.

**Laboratory Measurements.** The r-f/i-f performance of the SY1963W was quite satisfactory, even without the special PRP circuit in the fourth i-f stage. By monitoring the signal down to a vhf input of -54 dBm, we obtained full bandwidth. At that point the agc voltage switched the ceramic filter and we were able to get another 3 dBm of sensitivity. As indicated in the table of test results, the same increase was obtained in the uhf band. The noise figure in both vhf and uhf certainly recommends this set for deep fringe area reception. The video bandwidth (luminance bandwidth) measured an excellent 3.90 MHz, but when we activated the PRP ceramic filter in the fourth i-f stage, the over-

all bandwidth dropped to 3.50 MHz. This was obviously due to the shift in the i-f response curve.

The scope pictures show the overall response to the color bar signal. The frequency of the sine wave comprising each color bar is that of the color subcarrier at 3.58 MHz. If the video bandwidth were less, the color bar output would be reduced greatly.

R-f oscillator stability and frequency error were typical of other crystal-controlled, microprocessor-operated, electronic tuners we have tested. When we set the switch to "special"—simulating reception of an inaccurate r-f signal from a TV game, computer or VCR—we measured a capture range of 1.2 MHz on channel 3, certainly adequate for all but grossly mistuned r-f signal sources.

Agc dynamic range and dc restoration were good and typical of most of our previously tested '82 and '83 color sets. In the specific unit that we tested the horizontal linearity was off at both sides, but the vertical sweep was almost perfectly linear. A slight misconvergence at the right side and a clearly visible pin-cushion effect on all four edges was found when using the grid test pattern. However, none of these relatively minor problems could be observed on a normal TV picture. Regulation of both B+ and high voltage were adequate and typical of recent color TVs.

**Comments.** From the test results, the Zenith model SY1963W emerges as a very good color receiver

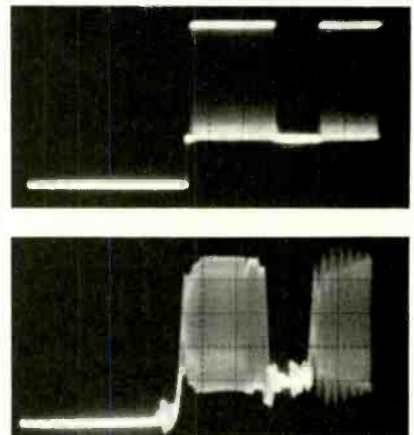

Scope photos show color bar signal response: input (top) and output.

# Become a Recording Engineer.



## Learn in

- Control Room & Console Labs
- Studio Synthesizer Lab
- Audio Fundamentals Lab
- Digital Logic Lab
- Disc Cutting Lab

Obtain your Diploma in

## Multi-track Recording Technology

in one year, or credit toward a B.S. Degree.

Spring '83 Quarter starts  
Thursday, March 24th.

Summer '83 Quarter starts  
Tuesday, July 5th.

Call or write for 24-pg. illustrated brochure

**212/677-7580** or

**1-800/847-4187**

(Toll-free outside of N.Y. State)



**Institute  
of Audio  
Research**

64 University Place  
Greenwich Village  
New York, N.Y. 10003

Established  
1969

Licensed by N.Y. State Dept. of Education  
Approved for Veterans Training

CIRCLE NO. 64 ON FREE INFORMATION CARD

...ZENITH

## ZENITH MODEL SY1963W 19" COLOR TV LABORATORY MEASUREMENTS

Parameter	Measurement
Sensitivity, vhf (Ch. 3):	-54 dBm (-57 dBm*)
Sensitivity, uhf (Ch. 20):	-50 dB, (-53 dBm*)
Noise figure, vhf (Ch. 3):	8 dB
Noise figure, uhf (Ch. 20):	15 dB
Video bandwidth to CRT (-6 dB):	3.90 MHz (3.50 MHz*)
Oscillator stability (Ch. 3):	0.05 MHz
(105 to 130 V ac, 2 hr)	
Oscillator error (Ch. 3):	0.05 MHz
Afc pull-in range (Ch.3):	1.20 MHz
Agc dynamic range:	64 dB
Dc restoration:	95%
Horizontal linearity:	95% left, 95% right
Vertical linearity:	98% top, 100% bottom
Convergence:	95% at worst
Pin-cushion effect:	5% at worst
Voltage regulation, B+:	96%
(105 to 130 V ac)	
High-voltage regulation:	95%
(105 to 130 V ac)	
Power rating:	70 W
*Effect of Peak Resolution Picture (PRP) circuit.	

with a host of desirable, advanced features. Color reproduction was very good, but when we asked the same observers who had been so enthusiastic over the Sony Profeel TV monitor and the RCA VGM 2023 monitor/TV set, they agreed unanimously that these two units had a degree of "naturalness"—a "true" pastel color reproduction—that was lacking in the Zenith set; color bar patterns were reproduced very well, faces appeared reasonably natural, but landscapes seemed to suffer from overemphasis of the primary colors (RGB). Zenith has an excellent, long-standing reputation, an active, nationwide network of service centers and parts suppliers, and enjoys a following of loyal customers. If you do buy the model SY1963W, you should consider the following.

In theory, any direct video connection can provide better resolution and color fidelity than a connection via an r-f signal that must be demodulated into a video signal (with the attendant possibility for degradation). If you plan to use your color TV set as a display for TV games, computers, VCR and video camera outputs, you might consider purchasing either a video monitor or a TV set that has direct video input capabilities. (Zenith, like other manufacturers, offers sev-

eral 19-inch and 25-inch receivers that include video input jacks and can operate as video monitors.)

If, however, you are primarily looking for a color TV set for broadcast and cable reception (with the use of video accessories as a secondary consideration) you will find the SY1963W most satisfactory. The set provides many advanced features, such as the Computer Space Command 4100 remote control system, very well designed electronic tuning, SAW filter, etc. In addition, it has two circuits specially designed to improve operation with the inexpensive r-f modulators found in TV games, computers, VCR and video camera outputs. Automatic switch-over between standard TV broadcast 525-line interlaced sync, and nonstandard sync helps greatly in this respect. Also, switching from the normal, crystal-controlled operation for broadcast channels to the special "pull-in" tuner often overcomes the lack of an accurate carrier frequency from inexpensive r-f modulators.

In short, the Zenith SY1963W is a very good, 19" table-model color set, well worth considering for your home, including use with various video accessories. The Advanced Space Phone is an additional attraction. —Walter Buchsbaum.

CIRCLE NO. 102 ON FREE INFORMATION CARD



# Games that challenge you at a price that won't.

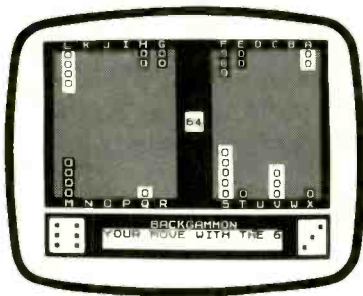

BACKGAMMON

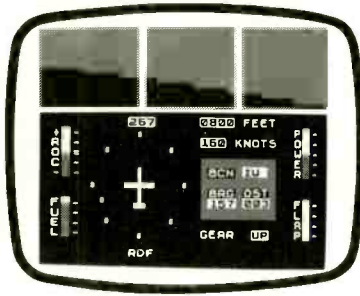

FLIGHT SIMULATOR

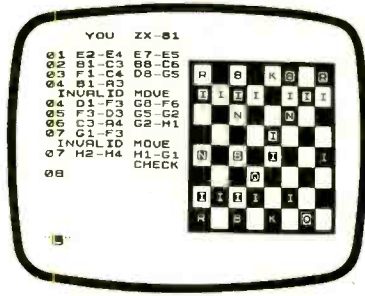

CHESS

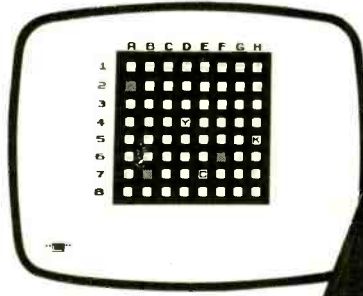

MIXED GAME BAG

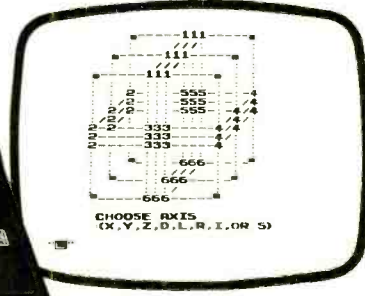

CUBE GAME

**\$79.95** Look to Sinclair for the only \$79.95 computer and the first Serious Games Package. A special limited time offer. Call toll free today.

What could be more challenging than creating your own games on a personal computer? Or being intellectually challenged by serious games where you match wits with a computer or another opponent in a fierce trial of skills?

The Timex/Sinclair 1000\* is a fully programmable computer with a powerful BASIC language and complete instruction manual, all for only \$79.95. The moment you sit down with the TS1000 you can learn how to program your own games. Maybe you want to create a stock market game, a word game, a mathematical game. The challenges are endless.

For this one low price, the TS1000 comes with everything you need for connecting the computer to your color or black-and-white TV.

Of course, you might also want pre-programmed software cassettes for your \$79.95 computer. You'll have a wide choice with our free software catalog which comes with the TS1000. And the software cassettes play in any cassette recorder.

### The 16K Memory Module. More power to you.

Let's say you want to go one step further. The 16K Memory Module allows you and your family to be challenged by even more sophisticated games. Not mindless arcade games, but serious, intellectually stimulating games which are both fun and educational.

The Memory Module costs only \$49.95 and plugs onto the back of the TS1000 for 8 times more memory capacity. A whole new world of software is available to those with the 16K Memory Module.

### The Serious Games Package. A \$75 value for only \$50.

For those who want a lot of serious 16K games, Sinclair announces a special software offering with a \$25 savings! Now, for the first time, you can receive all five games shown above at the reduced price of only \$50.

Chess: You can play with another opponent or you can match wits with the computer.

Flight Simulator: Maneuver and land a light aircraft with full cockpit controls, instrumentation and navigational aids. You have to allow for wind velocity and direction, rate of descent and mountainous terrain.

Cube Game: Every bit as mind-baffling as Rubik's Cube.

Backgammon: Everyone's favorite. Again, you can play against another opponent or against the computer. Complete with a doubling cube.

Mixed Game Bag: A series of memory and concentration tests including Robot Wars, a version of "Master Mind"

There's never been a better value on a serious games package. And to think it all starts on a \$79.95 computer!

### Why order today?

In addition to saving \$25 on software, there are other reasons to buy your TS1000 today. Computers costing hundreds and even thousands of dollars rarely offer you games this serious or challenging.

Another reason to order today is convenience, by toll-free phone. No crowds, no waiting lines, no parking worries. It's never been easier to get started in the world of computers. Or more worthwhile.

### How to order today!

Just call our toll-free number and use your MasterCard or VISA. Or send the coupon with a check or money order. Then try out the Timex/Sinclair 1000 for 10 days at no risk. If you're not entirely satisfied, we will refund your money. It's as easy as that. (Sorry, no refunds on software.)

Call toll-free: 800-543-3000. Ask for operator 509. In Ohio call: 800-582-1364. Ask for operator 509. In Canada call 513-729-4300, operator 509. Have your MasterCard or VISA ready when calling. Phones open 24 hours a day, 7 days a week. These numbers are for orders only.

If you simply want information, please don't call, write Sinclair Research, Ltd., 2 Sinclair Plaza, Nashua, NH 03061.

**Call toll free 800-543-3000**  
(operator 509)

Ad code: B3PE	Mail to: Sinclair Research, Ltd. One Sinclair Plaza, Nashua, NH 03061		
<input type="checkbox"/> Check or Money Order enclosed			
	Price**	Qty.	Amount
TS1000	\$79.95		
16K Memory Module	\$49.95		
16K Cassettes	\$15.00 each		
Special Serious Games Package (5 games valued at \$75.00)	\$50.00		
Shipping/Handling	\$ 5.00		\$ 5.00
**U.S. Dollars			Total:
Cassettes for 16K Memory Module: \$15.00 each. Check the boxes of all the cassettes you want.			
<input type="checkbox"/> Flight Simulator #6		<input type="checkbox"/> Mixed Game Bag #26	
<input type="checkbox"/> Chess #7		<input type="checkbox"/> I'll take all 5 cassettes included in Sinclair's Special Serious Games Package.	
<input type="checkbox"/> Backgammon #8			
<input type="checkbox"/> Cube Game #9			
Name _____			
Street _____			
City _____			
State _____		Zip _____	
*Sinclair technology is the heart of both the ZX81 and the Timex/Sinclair 1000 computer.			

**sinclair**

# Marantz SR620CX AM/FM Stereo Receiver

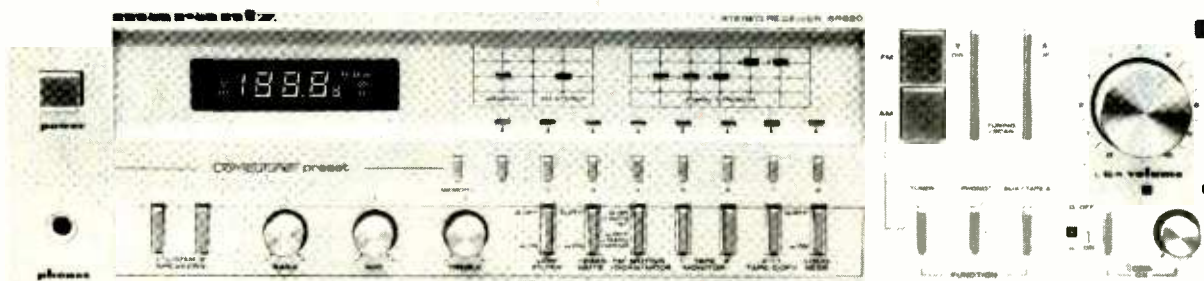

**T**HE new SR620CX stereo receiver is part of the Marantz "Solid Gold" line of stereo components. Although the exterior finish of the products in this line (a pale satin gold for all visible metal surfaces, including knobs and push-buttons) would seem to justify the name, there is actually a more substantial basis for the choice than mere color. According to Marantz, the 24-karat gold plating on the input and output phono jacks on the rear apron ensures corrosion-free contacts.

The Marantz SR620CX contains a PLL (phase locked loop) synthesized AM/FM tuner, covering those bands in steps of 10 and 100 kHz, respectively (switchable to 9 and 50 kHz for use in other parts of the world). Its phono preamplifier, designed for use with a moving magnet cartridge, includes a CX decoder that provides a 20-dB noise reduction when playing CX-encoded records. The audio power amplifier is rated to deliver 46 watts per channel to 8-ohm loads, from 20 to 20,000 Hz, with no more than 0.03% total harmonic distortion. It also carries a 4-ohm output rating of 55 watts per channel, with no more than 0.06% distortion.

The Marantz SR620CX is 16 $\frac{3}{8}$ " W  $\times$  12"D  $\times$  4"H, and it weighs 13 $\frac{3}{4}$  lb. The suggested retail price is \$495.

**General Description.** Most of the operating controls of the Marantz SR620CX are pushbuttons, with small knobs being used for the three tone controls and the CX calibra-

tion. A large knob controls the volume. To match the threshold level of the decoder to the output of the cartridge, the CX calibration is adjusted until the two red LEDs above it flash alternately when playing a CX-encoded record. A more accurate calibration can be made with the aid of a special record supplied with the receiver. This has 1000-Hz tones recorded at the standard level of 3.54 cm/s. When playing it, the control is set so that both of the LEDs are extinguished. However, proper operation of the CX system does not require a critical adjustment.

The SR620CX has 8 buttons for instant recall of station frequencies previously stored in its memories. Each button can serve for an FM

## *... CX decoding provides 20-dB noise reduction*

and AM channel, for a total of 16 stored frequencies. A long-life lithium battery in the receiver retains the memories for as long as 7 years. In normal operation, a touch on one of the narrow scanning buttons causes the tuner to step up or down in frequency until it comes to a signal whose strength exceeds the muting threshold. At this point, tuning stops and the receiver unmuters. Mono/stereo operation is automatically determined by the presence or

absence of a pilot carrier in the received signal. Pressing one of the control buttons on the front panel simultaneously switches the receiver to mono, disables the muting, and changes the tuning mode so that it advances by one frequency interval each time the scanning button is pressed. However, pressing a button for more than a couple of seconds causes the tuner to scan rapidly until it is released (regardless of the presence of a signal on the tuned frequency).

The display window on the panel contains the numerical frequency readout, LEDs that show relative signal strength (in five steps) and the presence of a stereo pilot carrier, and other LEDs that identify the selected memory and when the MEMORY button has been pressed in preparation for storing a received frequency.

The rear apron of the Marantz SR620CX contains the gold-plated phono jacks for the inputs, a single high-level input identified as VIDEO/CD/TAPE 3/AUX, and input and output jacks for two tape decks. There are insulated spring connectors for two sets of speakers and binding post terminals for 300- or 75-ohm FM antennas and an external AM wire antenna. The pivoted AM loop antenna that normally connects to the AM antenna terminals can be removed and positioned or oriented for best AM reception. The scan step selector slide switch is also on the rear of the receiver (its setting is retained by a plastic strip to prevent accidental changes). One of the two ac outlets is switched.



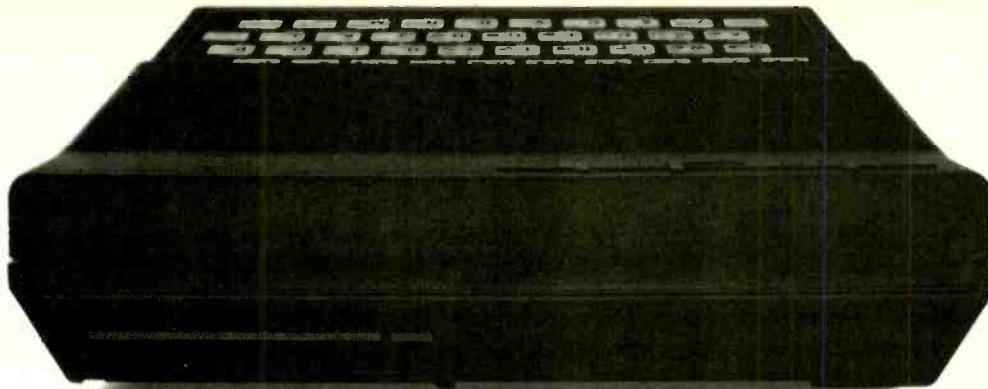

# BEHIND EVERY GOOD SINCLAIR IS A MEMOPAK

If you own a Timex-Sinclair 1000 or ZX81 computer, you should have a Memopak behind it. From increased memory to high resolution graphics, Memotech has a Memopak to boost your system's capabilities. Every Memopak peripheral comes in a black anodised aluminum case and is designed to fit together in "piggy back" fashion to enable you to continue to add on and still keep an integrated system look.

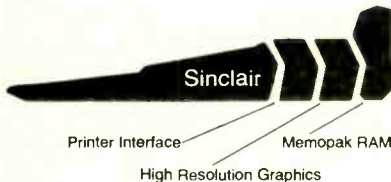

## Order at no risk

All Memotech products carry our 10 day money back guarantee. If you're not completely satisfied, return it in ten days and we will give you a full refund. And every Memotech product comes with a six month warranty. Should anything be defective with your Memopak, return it to us and we will repair or replace it free of charge. Dealer inquiries welcome. To order any Memotech product call our toll-free number **800/662-0949** or use the order coupon.

**MEMOTECH**  
CORPORATION

7550 West Yale Avenue  
Denver, Colorado 80227  
(303) 986-1516  
TWX 910-320-2917



**Memopak 64K RAM** The 64K RAM extends the memory of your Sinclair by 56K to a full 64K. It is directly addressable, user transparent, is neither switched nor paged and accepts such BASIC commands as 10 DIM A (9000). The Memopak 64K turns your Sinclair into a powerful computer suitable for business, recreational and educational use. No additional power supply is required.

**Memopak 32K RAM** The 32K RAM Memopak offers your Sinclair a full 32K of directly addressable RAM. Like the 64K Memopak, it is neither switched nor paged and enables you to execute sophisticated programs and store large data bases. It is also fully compatible with Sinclair's or Memotech's 16K RAM to give you a full 48K of RAM.

**Memopak 16K RAM** The Memopak 16K RAM provides an economical way to increase the capabilities of your Sinclair. And at the same time, it enables you to continue to add on other features with its "piggy back" connectors. It is compatible with the Sinclair 16K or a second Memopak 16K or Memopak 32K to give 32K or 48K of RAM respectively.

**Memopak High Resolution Graphics** The Memopak HRG contains a 2K EPROM monitor and is fully programmable for high resolution graphics. The HRG provides for up to 192 by 248 pixel resolution.

**Memopak Printer Interface** The Memopak Centronics Parallel or RS232 Interface paks enable your Sinclair to use a wide range of compatible printers (major manufacturers' printers available through Memotech at significant savings). The resident software in the units gives the ASCII set of characters. Both Memopak printer interfaces provide lower case character capabilities. The RS232 Interface is also compatible with modems.

**New products coming soon** Memotech will soon be introducing four new Sinclair compatible products: a high quality, direct connection keyboard, a digitizing tablet, a 16K EPROM and a disk drive. Watch for our future advertisements.

Mail to: Memotech Corporation, 7550 West Yale Ave., Denver, CO 80227

Code: CE-03	*Price	Qty.	Total
64K RAM	\$179.95		
32K RAM	109.95		
16K RAM	59.95		
Centronics Parallel Printer Interface	104.95		
RS232 Printer Interface	139.95		
High Resolution Graphics	144.95		
Shipping and handling	4.95		\$4.95
* All prices quoted in U.S. dollars			Tax**
** Colorado residents please add sales tax			Total
<input type="checkbox"/> Check <input type="checkbox"/> MasterCard <input type="checkbox"/> Visa			
Account No. _____		Exp. _____	
Name _____			
Address _____			
City _____		State _____ Zip _____	

**Laboratory Measurements.** The Marantz SR620CX, though a receiver of moderate power, is quite compact. For that reason it became warm over the output transistor heat sinks (which are inside the cabinet) as a result of the one hour pre-conditioning operation at one-third rated power. This was followed by five minutes at full power, and, finally, the actual measurements. In normal operation, however, the receiver remained quite cool to the touch.

The output waveform clipped at 60.5 watts per channel when both channels were driving 8-ohm loads. The 4-ohm clipping power was 61.6 watts, and the 2-ohm power was 65 watts per channel. (The receiver is not rated for 2-ohm operation, but it withstood this severe treatment without shutting off, overheating, or even distorting significantly.) The Clipping Headroom rating was 1.19 dB at 8 ohms and 0.49 dB at 4 ohms. Using the pulsed (tone burst) 20-millisecond test signals of the Dynamic Headroom measurement, we measured maximum power outputs of 79 W, 78 W, and 90 W for load impedances of 8, 4, and 2 ohms. The corresponding Dynamic Headroom ratings (for 8 and 4 ohms) were 2.34 dB and 1.52 dB.

Since the maximum power output was very nearly the same for all

three load impedances, the most obvious difference between them was the distortion, which increased slightly as the load impedance was reduced. With 8-ohm loads, the total harmonic distortion was a constant 0.0028% from 1 to 50 W, rising steeply as the clipping point was approached. With 4 ohms, the distortion was a constant 0.004% at most power outputs, and with 2 ohms it was typically 0.008 to 0.009%.

At rated power (8 ohms) or less, the distortion was less than 0.002% in the midrange, increasing to 0.01 to 0.02% at the extremes of 20 and 20,000 Hz. The IHF-IM distortion (using two equal-amplitude input signals at 18 and 19 kHz, whose peak amplitude was equal to that of a 46-watt sine-wave signal) produced a second order component at 1000 Hz with an amplitude of -78 dB, and third-order distortion at 17 and 20 kHz at a -82-dB level.

Input sensitivity for a reference output of 1 watt was 83 mV at the high-level AUX input, and 0.43 mV at the PHONO input. The respective A-weighted S/N measurements were 81.4 and 77.2 dB. The PHONO input overloaded at levels between 147 and 157 mV over the 20-to-20,000-Hz range. The amplifier was stable with reactive simulated speakers loads, its IHF Reactive Load Factor was 1.03 dB at 63 Hz. (This is a measure of an amplifier's ability to develop at least its rated output into the complex impedance

of a loudspeaker woofer near its resonance frequency.) The amplifier Slew Factor was 3.8. (A full-power sine wave developed a triangular shape at 76 kHz.) This measurement shows that the amplifier of the SR620CX can deliver its rated output power with low distortion at frequencies well above the audio range.

Tone controls of the Marantz SR620CX had conventional response characteristics, with the bass turnover frequency shifting between about 200 Hz and 400 to 500 Hz as the control knob was turned from its center. The bass control range was about  $\pm 10$  dB at 100 Hz. The treble curves were hinged at about 3500 Hz. The midrange control action affected most frequencies between 100 and 4000 Hz, with a maximum boost or cut of about 5 dB, which is adequate for most conditions without undue risk of excessive modification of the tonal balance.

The loudness contours boosted both low and high frequencies at control settings below -10 dB. (The amount of boost did not change over most of the range of volume control movement, below -20 dB.) The LOW filter had a good cutoff slope of 12 dB per octave, with a -3 dB response frequency of about 35 Hz. The RIAA phono equalization was very accurate, almost perfectly flat from 100 to 20,000 Hz, rising to +1.5 dB in the 20-to-40-Hz octave. It was not affected significantly by the inductance of a phono cartridge connected to the input jacks.

The FM tuner section had a mono usable sensitivity of 11.6 dBf (2.1  $\mu$ V). Stereo sensitivity was set by the stereo switching/muting threshold of 28.7 dBf (15  $\mu$ V). The 50-dB quieting sensitivity was 13 dBf (2.4  $\mu$ V) in mono and 36.8 dBf (38  $\mu$ V) in stereo. The distortion at a 65-dBf (1000  $\mu$ V) input was 0.22% in mono and 0.28% in stereo, and the respective S/N measurements were 76 dB and 70 dB. The mono IHF-IM distortion (with the signal generator modulated by equal amplitude signals at 14 and 15 kHz, whose combined peak level corresponded to 100% modulation) was -48 dB for second order (1000

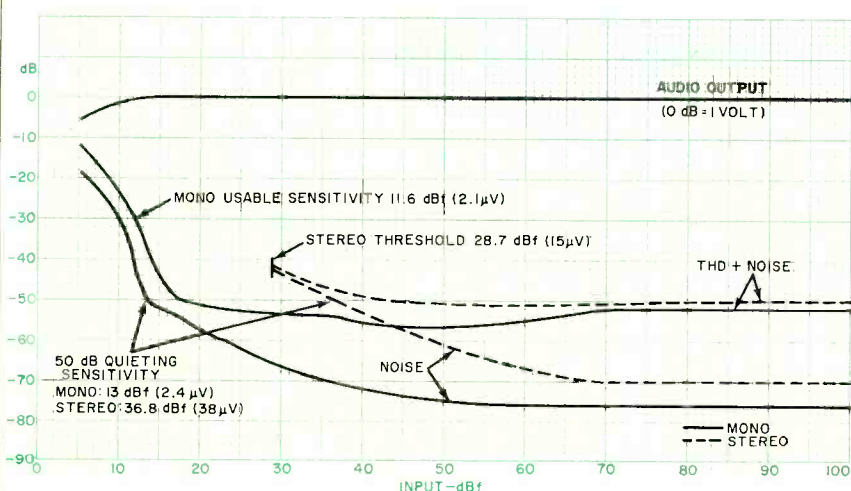

Noise and sensitivity curves for FM section of the SR620CX.





# Bionic "Ears"

Tiny, powerful electronic sensors give you superhearing — through walls, up to 1/2 mile away.

## The Dyna-Mike Transmitter

It's smaller than a quarter. But DYNA-MIKE will transmit every sound in the room to an FM radio tuned to the proper unused frequency, up to half a mile away.

If you're at a neighbor's home a block from your own, you can hear your baby's cry, or you can tell the instant your spouse comes home. If two of you are driving tandem in two cars, one or both of you can communicate with the other even if other cars drive between you.



DYNA-MIKE has as many uses as your imagination can think of. For a business conference, let the tiny microphone sit unobtrusively on the table or concealed on a shelf, and you'll be able to record every word. For businesses, put an FM receiver in a warehouse or remote office and "broadcast" instructions or orders to be filed.

Public speakers never had a better friend than the DYNA-MIKE. No wires or setup — just turn on one or more radios and your speech will come through with perfect fidelity. Put one on the front porch. If you hear a suspicious sound, turn on the radio and you'll hear the doorbell or even a muttered conversation.

### Choose Your Model

New Horizons is introducing three models of the DYNA-MIKE supersensitive broadcast microphone. Model AR-7 is the world's smallest microphone, it's a miracle of electronic miniaturization, with a range of 750 feet and a battery life of 90 hours. Introductory price is \$129.95 (two for \$119.95 each).

Model 9-DX is a long-range microphone, broadcasting an unbelievable half-mile distance. This miniaturized wonder is \$149.95 (two for only \$139.95 each). Normal battery life is 25 hours, or you can have the special Power-Pak, which operates 200 hours, for \$19.95.

The AR-7 and 9-DX are sensitive. They'll pick up sounds from 40 feet away. But for super-sensitivity, nothing beats the A-5.

The A-5 will pick up a whisper from more than 60 feet away and broadcast it to a receiver 750 feet distant. The A-5 comes with a special 200-hour long-life battery and is introductory-priced at \$99.95 (two for only \$89.95 each).

## The Telephone Voice Changer

It's right out of James Bond! Push a button and the VOICE CHANGER gives your voice completely different characteristics. The person on the other end of the phone won't know it's you.



The VOICE CHANGER is more than an "electronic handkerchief" — it doesn't cause your voice to sound filtered. It literally changes tone and timbre.

Choose from two separate, distinct Changer Channels. If you're alone in a business office, it'll sound like an employee answering. If you live alone, you can get rid of pesky calls by pushing Channel 1 or Channel 2 and saying, "Sorry, that person isn't in."

### How It Works

The VOICE CHANGER is powered by two ordinary penlight batteries. One set of lead-in wires connects to your telephone base; the other clips to the wires leading to the handset.

Pushing the button labeled "Ordinary" puts your normal voice through the line. Pushing "Channel 1" changes timbre and texture. Pushing "Channel 2" creates different characteristics from Channel 1. Thus you have three voice options — your own, plus two changed voices.

MAKE NO MISTAKE! THE VOICE CHANGER DOESN'T MUFFLE YOUR VOICE OR MAKE IT UNINTELLIGIBLE. It literally changes the quality of sound — space-age electronics at work.

Use the VOICE CHANGER to reach that doctor, lawyer, or business executive whose secretary knows your voice and who always is "out" when you call. Use it to screen your own incoming calls. Use it for just plain fun. Any time you like, during a conversation, push the "Ordinary" button and your regular voice returns to the wire.

The VOICE CHANGER is yours for \$99.95 — two for \$89.95 each (plus \$2.50 shipping per total order). When you consider the many uses of this brilliant electronic instrument, it's a real bargain. Of course it has the standard New Horizons guarantee.

## The Super Ear

You'll hear it all.

Effortlessly, you can hear not just a baby's cries, but quiet breathing — through a concrete wall a foot thick. Put the earphone in your ear and place the SUPER-EAR on the wall. That's all there is to it.

SUPER-EAR hears everything — and, even more astounding, hears it clearly. It's as though the wall weren't there. If you're coming home late at night and think intruders are in your residence, let SUPER-EAR find out for you. Want to know if the meeting is over in the room with the closed door? SUPER-EAR will tell you in a second.

SUPER-EAR is undetectable from the other side of the wall. The quality of sound has amazing fidelity — good enough to record, and SUPER-EAR has its own built-in recorder jack.

Because SUPER-EAR is the ultimate listening device, you can use it to pinpoint hidden squeaks in your car or the source of mysterious engine noises. Construction experts use it to check for flaws or cracks in buildings.

### It Works Anywhere!

Ever put your ear to a railroad track to try to hear the train? Try it with SUPER-EAR. You'll hear that train many miles away. Use it as a powerful stethoscope on yourself, a friend, or a pet. You can even hear a bird's breathing.

The only source for SUPER-EAR is New Horizons. Choose from two models — Model SB-5, with ultrasensitive microphone, \$139.95 (two for only \$129.95 each); or Model SB-1, with suction-type microphone, \$99.95 (two for only \$89.95 each).



## The Private Transmitter/Receiver

The NCZ-10 broadcasts on a special radio band. No one without equipment can hear your transmitted messages.

The reception is unbelievably clear and bright — commercial broadcast quality.



Your receiver clicks into any of three separate channels. In the suburbs the range is up to 2000 feet, and in the city 850 feet.

With your special receiver is an inconspicuous high fidelity earphone. You can put three transmitters in three locations and then switch back and forth, monitoring all three. Someone with an FM or police band receiver can tune his dial all day, but he won't pick up these signals.

With two receivers, you can have a complete two-way system without the inconvenience and annoyance of the semi-public CB channels. The NCZ-10 channels are private.

This professional-quality electronic miracle is easy to use and completely dependable. Monitor your baby's room. Leave a transmitter in an inconspicuous place in your office or your home, and you'll hear anything going on in that room.

One NCZ-10 receiver with one transmitter is \$279.95; with two transmitters (two separate bands), it's \$379.95; with three transmitters (three separate bands), it's \$479.95.

For a complete private communications system, order two receivers, each with a transmitter (we'll send them with different bands). Special high-performance batteries enable you to operate the receiver for 40 hours continuously, the transmitter for 35 hours.

### We Absolutely Guarantee!

Use any electronic instrument acquired from us for up to 30 days. If you decide for any reason you don't want to keep it, return it for a 100% refund.

ORDER TOLL-FREE

For fast delivery on credit card orders, call toll-free 24 hours a day, seven days a week:

**800-824-7888**

Ask for Operator no. 551  
(in California, call 800-852-7777)

Or send check or money order. Please add \$2.50 per total order for shipping. Order any or all these state-of-the-art electronic instruments:

- Dyna-Mike AR-7, \$129.95 (two for \$119.95 each)
- Dyna-Mike 9-DX, \$149.95 (two for \$139.95 each)
- 9-DX rechargeable power-pak, \$19.95
- Dyna-Mike A-5, \$99.95 (two for \$89.95 each)
- Super-Ear Model SB-5 microphone, \$139.95 (two for \$129.95 each)
- Super-Ear Model SB-1 microphone, \$99.95 (two for \$89.95 each)
- Voice Changer, \$99.95 (two for \$89.95 each)
- NCZ-10 transmitter and receiver, \$279.95 (two transmitters, one receiver, \$379.95) (three transmitters, one receiver \$479.95)

**NEW HORIZONS**

CIRCLE NO. 17 ON FREE INFORMATION CARD

DEPT. CE 3 1 Penn Plaza, Suite 100 • New York, NY 10119

For information, call 201-370-8029

# Now NRI takes you inside the new TRS-80 Model III microcomputer to train you at home as the new breed of computer specialist!

NRI teams up with Radio Shack advanced technology to teach you how to use, program, and service state-of-the-art microcomputers.





It's no longer enough to be just a programmer or a technician. With microcomputers moving into the fabric of our lives (over 250,000 of the TRS-80™ alone have been sold), interdisciplinary skills are demanded. And NRI can prepare you with the first course of its kind, covering the complete world of the microcomputer.

### Learn at Home in Your Spare Time

With NRI training, the programmer gains practical knowledge of hardware, enabling him to design simpler, more effective programs. And, with advanced programming skills, the technician can test and debug systems quickly and easily.

Only NRI gives you both kinds of training with the convenience of home study. No classroom pressures, no night school, no gasoline wasted. You learn at your convenience, at your own pace. Yet you're always backed by the NRI staff and your instructor, answering questions, giving you guidance, and available for special help if you need it.

### You Explore the New TRS-80 Model III Inside and Out

NRI training is hands-on training, with practical experiments and demonstrations as the very foundation of your knowledge. You not only learn to program your computer, you learn all about it . . . how circuits interact . . . interface with other systems . . .

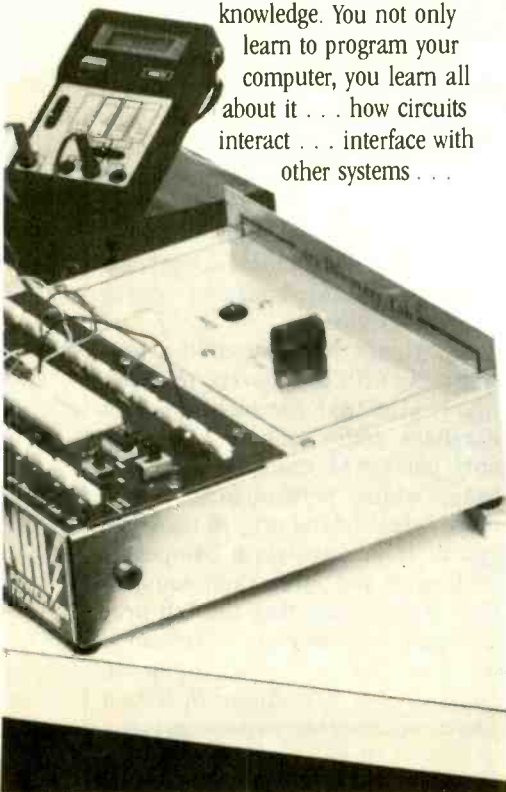

gain a real insight into its nature.

You also work with a professional 4-function multimeter, featuring full portability and a 3½-digit liquid crystal display. Using it along with the exclusive NRI



Training includes the TRS-80 Model III microcomputer, professional LCD multimeter, the NRI Discovery Lab, Computer Assisted Instruction programs and hundreds of demonstrations and experiments.

Discovery Lab® and your TRS-80, you perform over 60 separate experiments. You learn how to troubleshoot and gain greater understanding of the information your testing procedures give you.

### Advanced Technology Microcomputer Is Yours to Keep

As part of your training, NRI sends you the new, state-of-the-art TRS-80 Model III microcomputer. This functional unit is complete with 65-key keyboard and 12" display in one desk-top unit. It features high-speed cassette loading, built-in interface for parallel printer, and provisions for optional disk drive. Its 16K RAM is internally expandable to 48K and its BASIC language is compatible with most Model I software.

Along with your multimeter and the NRI Discovery Lab, this latest concept in

advanced microcomputers is yours to learn with, yours to keep and use for your own personal programs, business use, and other applications.

### Computer Assisted Instruction

Your TRS-80 even helps train you. You receive 8 special lesson tapes in BASIC computer language. Using them in your microcomputer, you "talk" to it as you progress. Errors are explained, graphics and animation drive home key points. Within a matter of minutes, you'll be able to write simple programs yourself.

### Send for Free Catalog...No Salesman Will Call

Get all the details on this exciting course in NRI's free, 100-page catalog.

It shows all equipment, lesson outlines, and facts on other electronics courses such as Electronic Design, Industrial Electronics, TV/Audio/Video Servicing...11 different career opportunities in all.

Send today, no salesman will ever bother you. Keep up with the latest technology as you learn on the world's most popular computer. If postcard has been used, write to NRI Schools, 3939 Wisconsin Ave., Washington, D.C. 20016.

1-033



**NRI Schools**  
McGraw-Hill Continuing  
Education Center  
3939 Wisconsin Ave.  
Washington, D.C. 20016

**We'll give you tomorrow.**

(TRS-80 is a trademark of the Radio Shack division of Tandy Corp.)

## Comparing the SR620CX to Marantz's Costliest Model

**T**HE SR620CX is approximately in the middle of the Marantz receiver lineup. Having also examined its top receiver, the SR8100DC, we found it interesting to compare the two, both with respect to their audio specifications (rated and tested), and to their various features.

The SR8100DC is 50% more expensive than the SR620CX (about \$750 versus \$500). It is quite similar in styling and general features, with the additional power one would expect from a high-end receiver (rated 75 and 90 watts for 8 and 4 ohms, respectively). But the power difference, it must be realized, is only about 2 dB, and hardly likely to be noticed by a listener. In fact the major difference between the re-

ceivers in this regard was the superior current delivering capability of the SR620CX, which can actually deliver more power to 2 ohms than its larger relative.

The SR8100DC has considerably higher amplifier gain, roughly the same distortion (negligible in both cases), and a Slew Factor of 1.7 compared to the 3.8 of the SR620CX. (Neither is exceptional, but both are adequate.)

The FM tuners of both receivers have identical features, and very nearly the same performance ratings. For the most part, both met their ratings; and in fact, the SR620 had marginally better sensitivity and S/N performance than the SR8100. (The differences were in all probability due

to sample-to-sample variations).

All in all, we would judge the two to be equivalent in performance, leaving the real differences to be in their features. The SR8100DC has a five-band graphic equalizer instead of the three tone controls of the SR620CX. Instead of the CX decoder of the SR620, it has a built-in digital clock (24-hour) that controls a number of timing functions for the receiver. It can be set to turn it on and off at preset times over a 24-hour cycle, repetitively if one desires. Aside from that convenience feature, we would have to say that the lower-priced SR620CX offers about the same listening performance, plus the ability to decode CX records. ◇

The Marantz top-of-the-line Model SR8100DC.

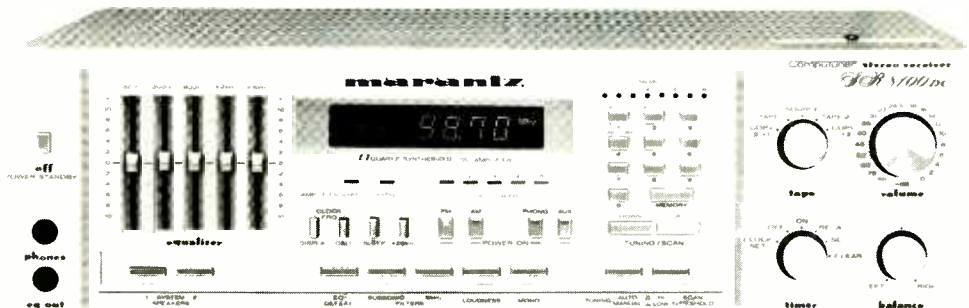

Hz) and  $-51$  dB for third order (13 and 16 kHz). In stereo, the corresponding readings were  $-50$  and  $-41$  dB.

The FM frequency response was within  $\pm 0.5$  dB from 30 to 15,000 Hz, and the stereo channel separation was between 45 and 52 dB from 80 to 8000 Hz, reducing to 39 dB at 30 Hz and 35 dB at 15,000 Hz. The FM capture ratio was an exceptionally good (low) 0.92 dB at 45 dBf (100  $\mu$ V) input. The AM rejection was 61 dB at the same signal level. Image rejection was a fairly good 56 dB, as was the alternate channel selectivity of 60 dB and the adjacent channel selectivity of 4 dB. The 19-kHz pilot carrier in the audio output was at a  $-65$ -dB level, and the power line hum in the tuner output was extremely low at  $-78$  dB. The five signal-strength lights came on at input levels of 17.7 to 48.7 dBf (4.2 to 150  $\mu$ V), indicating that one cannot expect to realize full performance of the FM tuner unless all the lights are lit. The only measurement made of the AM tuner section

was of its frequency response, which was down 6 dB at 20 and 3100 Hz, relative to the 1000 Hz output.

**User Comment.** The Marantz SR620CX was a very easy receiver to use, with all of its controls marked logically and operating smoothly.

The sound, from either FM or records, was excellent. It had no difficulty driving low-efficiency speakers to the highest levels we find enjoyable. The gain of the audio amplifier is somewhat lower than that of most receivers we have tested, though; and, as a result, it may be necessary to set the volume control a bit higher than usual in some cases. The CX decoder worked very well, and the dual LED calibration indicator, used with the supplied test record, made it possible to calibrate in a matter of seconds. (It has to be repeated only if the cartridge, is changed.) We found, however, that proper calibration was possible only with cartridges delivering at least 2 mV from a 3.54 cm/s record-

ed velocity, but this covers almost all moving-magnet cartridges currently available. Some high output moving-coil types, otherwise suitable for use with this amplifier, may not be fully compatible with its CX decoder. Even though the CX system may operate satisfactorily without the proper input level, it normally reduces the overall gain of the phono system (at least in this receiver) and did not produce sufficient listening level with moving-coil cartridges whose rated outputs were in the 2-mV range.

All things considered, the Marantz SR620CX proved to be a highly attractive combination of an excellent audio section, a reasonably good AM tuner, and an FM tuner whose performance, if not quite "state of the art" in some respects, is nonetheless a competent performer and more than equal to the task of extracting the full program quality from any broadcast it is likely to be called upon to receive.

—Julian D. Hirsch

CIRCLE NO. 101 ON FREE INFORMATION CARD





## Adding a Video Monitor to your Sinclair ZX81

**L**IKE some other computers, a large "cottage industry" has grown up around the low-cost Sinclair ZX81 and its American cousin, the Timex 1000.

Almost every kind of peripheral imaginable—from disk systems to printers—is currently available for this small computer. However, the only type of video output from this import is r-f switch selectable between channels 3 or 4.

The problem with using a TV receiver as the video monitor for a computer is the lack of sufficient bandwidth to display good-quality alphanumeric and graphics. Also,

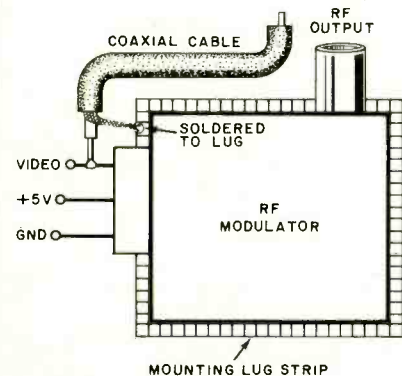

Connecting a monitor to your ZX81.

adjacent-channel interference produces disturbing moire patterns that can cause more eyestrain than the program is worth.

There is no question that a video monitor is far superior to a TV receiver, and such a monitor may be used with the ZX81 by the simple addition of a short length of coaxial cable. If the addition is made, the warranty is likely voided. If you do make it, though, the ZX81 will have both r-f and direct video output. Here's how it's done.

Turn the ZX81 upside down, and remove the five Philips-head screws securing the bottom half of the computer to the top half. Gently remove the bottom half, taking care not to lose the screws. Just as gently, remove the two screws securing the pc board to the top half of the assembly, noting which holes contained the mounting screws.

Carefully turn the pc board over to expose the metal enclosure that surrounds the r-f modulator as shown in the diagram. Note that there are three bare leads coming from the pc board to a plastic grommet on the side of the metal enclosure. The lead nearest the edge of the pc board carries the baseband video used to modulate the carrier; the other two leads carry +5 volts and ground. If desired, a scope can be used to observe the video, which is at TTL level.

Trim the end of a length of slender coaxial cable, exposing both the outer braid and the center conductor. Carefully solder the inner conductor to the bare video lead, and the braid to the metal enclosure (the bottom grips can be used as the enclosure is solder-proof aluminum). Make sure that there are no solder bridges, then carefully re-assemble the pc board to the top half of the assembly.

Using a sharp knife, carefully enlarge the hole in the plastic case that surrounds the RCA r-f connector. Press the slender coaxial cable into this slot. Carefully re-assemble the bottom half of the case to the top half, using the five Philips-head screws. Affix a suitable connector to the loose end of the slender coaxial

cable (it should mate with the cable coming from the video monitor).

Connect the r-f connector, as usual, to the antenna inputs of a monochrome TV receiver, then connect the new coaxial cable connector to the video monitor. Turn all power on. Note that no matter how well you can tune the TV receiver, the display on the video monitor is considerably better.

**New HP Computers.** A couple of new computers are now available from Hewlett Packard. The first is the Series 200 Model 16, a 16-bit machine based on a MC68000 operating at 8 MHz. The Series 200 also includes the Model 26 and Model 36 desktop computers, formerly called the HP 9826 and 9836. Its features include a 9-inch CRT, a detached ASCII keyboard, and a choice of single or dual 3.5" microfloppies (Sony approach). These provide 270K bytes of storage per diskette. A single 3.5" microfloppy also is available with a 4.6M-byte Winchester disk. The standard 128K bytes of main memory can be increased to 768K bytes and with an external expander to as much as 4.6M. The Model 16 has built-in graphics and has an 80 column by 25 line display with each character formed by a 9 × 15 matrix. Resolution is 300 by 400 pixels.

The keyboard includes 5 user-definable keys (10 with shift), and a special rotary control knob for fast editing of programs, cursor positioning, analog control of instruments, and other applications requiring a linear input.

Interfaces include the HP-IB (IEEE-488) and RS232C for serial communications.

Software includes BASIC, HPL, and Pascal. The BASIC includes enhancements of some powerful languages like FORTRAN or ALGOL including subprograms, multi-dimensional arrays, unified I/O and mass storage, labelled COMMON blocks, and external program control. HP is investigating the possibility of offering CP/M and an HP version of Unix.

(Continued on p. 34)

# \$1790



Full size smart terminal with detachable keyboard

4MHz, Z80A™ CPU  
64K RAM main memory  
200 Kbyte 5¼" floppy disk  
(Osborne, Xerox, IBM formats)  
Two serial ports

Complete software package  
including:

CP/M Operating System  
WordStar® Word Processing  
Microsoft® BASIC 80  
NorthStar compatible BAZIC®  
Spelling Checker  
Electronic Spreadsheet



# You can't buy more computer for less.

\$1790 is the total retail price of the complete Micro Decision™ System you see in this ad. And that includes the computer with a disk drive, a full size smart terminal, and over \$1800 worth of software. No other business computer available today offers so much for so little (a comparable Apple system costs almost twice as much).

The Micro Decision is a bargain any way you look at it. The computer alone, with all that software and one disk drive is only \$1195. If you want to add another disk drive, the price is still great: just \$1545. And the smart terminal is only \$595. Retail. As for the microcomputer itself, our Micro Decision

includes a 64K CP/M® 2.2 Operating System. That's the industry standard operating system that gives you access to over 2000 business programs (available right now—right off the shelf).

If you'd like more information, or to find out about our substantial quantity discounts, call us at (415) 430-1970. We'll introduce you to more Morrow. And less price.

**LOOK TO MORROW FOR ANSWERS TODAY**  
**MORROW DESIGNS**

600 McCormick St.  
San Leandro, CA 94577  
(415) 430-1970

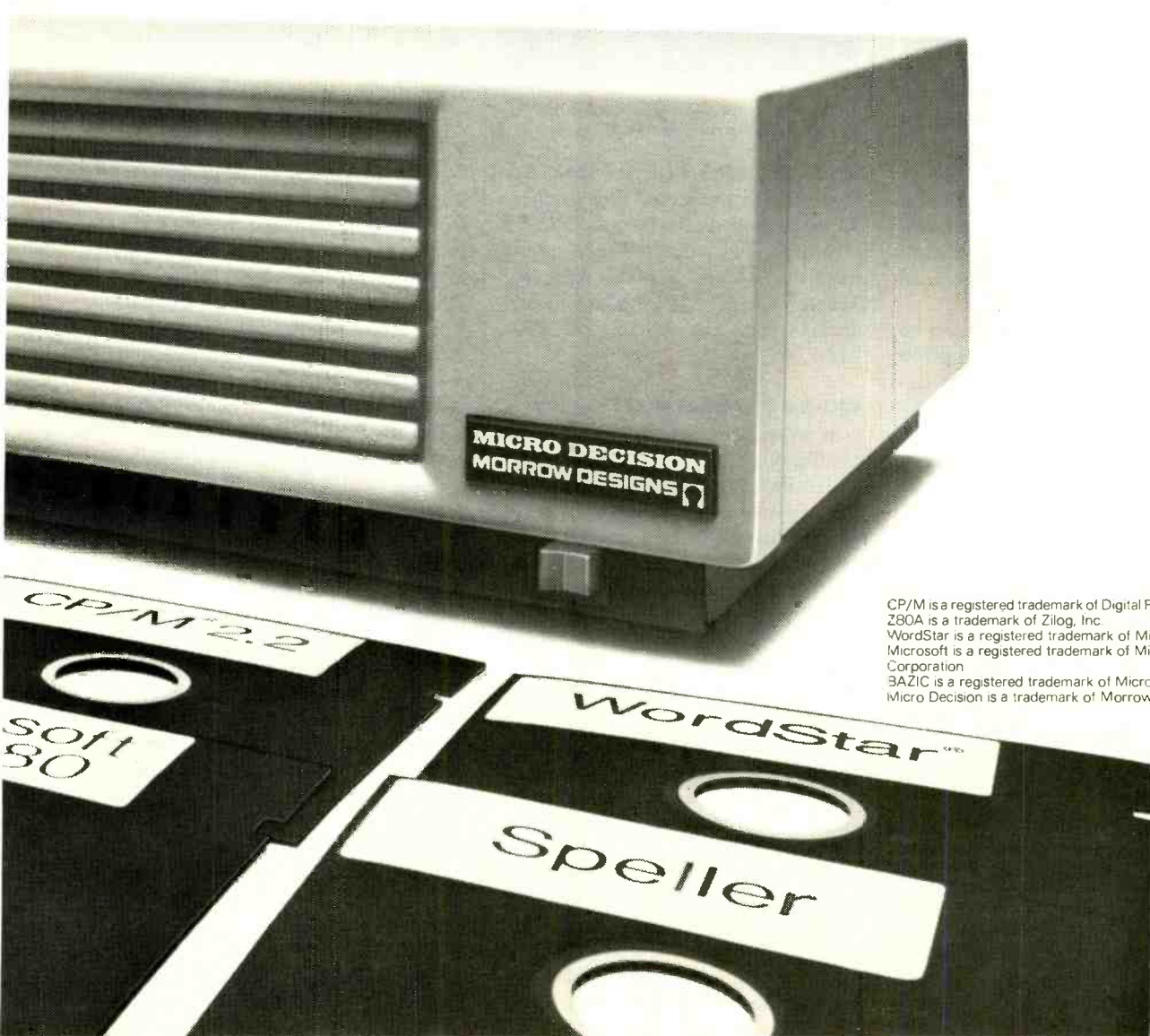

CP/M is a registered trademark of Digital Research, Inc.  
Z80A is a trademark of Zilog, Inc.  
WordStar is a registered trademark of MicroPro, Inc.  
MicroSoft is a registered trademark of Microsoft Corporation  
BAZIC is a registered trademark of Micro Mike's, Inc.  
Micro Decision is a trademark of Morrow Designs

CIRCLE NO. 63 ON FREE INFORMATION CARD

(Continued from p. 31)

Other software packages include computer-aided engineering tools, mathematics modules, and a broad variety of business aids including VisiCalc.

Several Model 16's can be linked together to share disc drives and printers in what is called Shared Resource Management. The SRM network can also incorporate other HP computers including Series 200 and HP9845 that includes color graphics.

The second computer, the Series 100 Model 120 is a personal office computer that includes word processing, decision support, presentation graphics, programming and accounting. It has all the computing power of the HP 125 in a smaller package (1.7 square feet of desk space), and can be used as an intelligent terminal when the demand requires.

The Series 100 uses dual Z80A CPU's and have 64K bytes of main memory, 16K bytes of screen display memory, and 32K bytes of ROM. The operating system is CP/M.

The 9-inch video monitor can be mounted on a tilt-and-swivel option to locate the screen as the user desires. It features the same high-resolution display as the HP 125 including true descenders in lower case. Character format is on a  $9 \times 15$  matrix.

Each Series 100 computer has an IEEE-488 connector allowing as many as 14 peripherals to be attached, and a pair of RS232C ports. Single or dual 3.5-inch disc drives are available with each providing 248K bytes of formatted storage. A single 3.5-inch and a companion 4.6M byte Winchester are also available, although 5.25 and 8 inch floppies continue to be offered.

Software includes WordStar (with companions SpellStar and MailMerge), VisiCalc and CONDOR database and report generators, and BPI payroll packages. Because of the CP/M, program packages from third-party suppliers are also available.

**140M-byte 5 1/4" Drive.** The MX-1000 family of 5 1/4" Winchester drives now includes an 8-disk, 140M byte 5 1/4" drive. Average access time is 30 milliseconds, and the drive is compatible with standard ST506/412 interface, and has a data transfer rate of 5M bytes/s. The drives use plated media for storage



Maxtor's new 5 1/4" Winchester has 140M bytes on eight plated disks.

capacities of 9.57M-bytes/disk surface and 918 tracks per disk surface. Recording density is 11,155 bits/inch. The price in OEM quantities is about \$2600. **Address:** Maxtor Corp., 5201 Lafayette St., Santa Clara, CA 95050 (Tel. 408-748-7740).

**VIC-20 Peripherals.** This firm is now producing four new peripherals for the VIC-20. The first is the Video Pak cartridge that plugs into the expansion port and produces a 24-line display with a choice of 40 or 80 upper/lower case characters, at the same time increasing the memory from 5K to 20 or even 70K. It also includes a terminal emulator and has screen print feature. Price is \$299.95 for 16K, and \$399.95 with 64K.

The second add-on is a Printer Interface that adapts the VIC-20 to most printers and has continuous visual monitoring of the data transfer functions via two LEDs. These status monitors indicate if the printer is hooked up, if the buffer is full, and if data is being transmitted. \$69.95.

The third item is an Expansion Chassis that allows use of any four

compatible cartridges simultaneously. These can be memory, software, or games. It plugs into the 22-pin edge connector and has its own protective fuse. \$64.95.

The fourth item is a 16K Memory Cartridge that increases the VIC-20 memory to 20K, and uses 200-nano-second RAMs. \$99.95. **Address:** Data 20 Corp., 20311 Moulton Parkway, Suite B10, Laguna Hills, CA 92653 (Tel: 714-770-2366).

**Hitachi 16-Bit Personal Computer.** Due in the very near future is the 16-bit Personal Computer from Hitachi. This three-piece—keyboard, video display, and disk system—office computer, features an 8088 processor, 64K bytes of RAM (with parity) expandable to 256K, and a video display of 80 by 25 or 40 by 25 in a choice of 15 colors or monochrome. In the graphics mode,  $640 \times 200$  (noninterlaced) or  $640 \times 400$  (interlaced) pixels in eight different colors are provided. Text and graphics can be overlaid with each having their own colors. A double-sided, double-density mini floppy is built in and can be supported by external drives. Interfaces that can connect with CRT displays, printers, light pens, and RS232 are also built in. Five expansion slots having an IBM-style structure are provided. Software includes MS-DOS (Microsoft) and a BASIC interpreter, FORTRAN, COBOL, PASCAL, and an assembler are optional.

**Timex Add-Ons.** VOTEM is a package of hardware and software that enables a Timex/Sinclair to monitor almost any physical phenomena that can be represented by a dc voltage. It requires no modification to the computer and does not use the expansion port. Voltage measurements have resolution to 0.000044 V with an accuracy of 0.2%, and linearity of 0.1%. Temperature measurements can be made from  $-25$  to  $+125^\circ\text{C}$  with a resolution of better than 0.05%: and the power supply requirements are  $+8$  to  $+15$  V at 25 mA. Will also work on ZX80 with an 8K ROM. Kit is \$39.95. **Address:** Down East Computers, POB 3096, Greenville, NC 27834.  $\diamond$



## STAN VEIT ON COMPUTER SOFTWARE

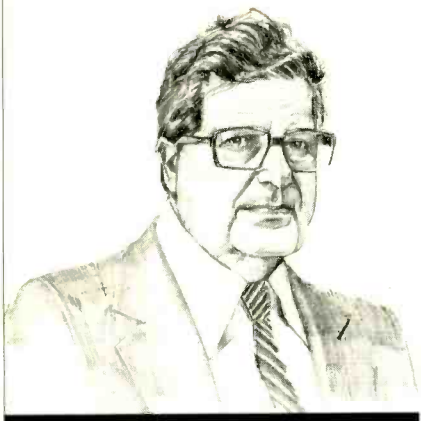

### Software for Mass Markets and Integrated Packages

**A**S I walked through the aisles at Comdex, the big Fall computer industry show in Las Vegas, I was impressed by two trends in the software industry. First is the development of good, low-cost software systems designed for the mass market. The second is the offering of integrated packages by several companies. This trend was started by the Context MBA package and taken up by Lotus 1-2-3, previously reported on in this column. At Comdex, there were several new entries by both new and established companies.

Although these trends may seem to be opposites, they are both signs of the growing maturity of the software market.

Initially, let's consider the excellent low-cost software I saw at Comdex. The outstanding example of this was Wordvision from Bruce & James. This is a word-processing program designed for the IBM-PC and priced at \$49.95! Jim Edlin, president of Bruce & James, is a long-time advocate of mass-market and "people literate" software. Wordvision is designed for the first-time user of word-processing software. It provides all the necessary features, but omits most of the "bells and whistles" that make a word processor difficult to learn

and are therefore used only by a relatively small group of people. (Bruce & James, 4500 Tuller Road, Dublin, OH 43017. Tel: 614-766-0110. Compuserve Number, 71435,1040.)

Other low-cost software I noted was Budget Master for the Timex/Sinclair and the 6502 Professional Development System (\$29.95) for the Commodore 64. (Human Engineered Software (HES), 71 Parl Lane, Brisbane, CA 94005. Tel: 415-468-4900.) The company also proffers Heswriter, a word processor for the VIC-20, and Heswriter 64, a word processor for the Commodore 64 at \$44.95.

It should be noted that the IBM-PC owner has the best selection of low-cost software of any computer. The IBM-PC DOS costs \$40 including the manuals and BASIC. Then there is the Freeware software, including PC-Talk for \$25 and PC-File for \$35. Now Wordvision for \$49.95 extends the concept. In spite of this, we notice that some software publishers price their IBM-PC software above versions for other computers. We wonder about the reason for this practice.

The second trend toward integrated software systems was represented at Comdex by Context MBA, Lotus 1-2-3, and Visicorp's VisiOn. VisiOn, unlike Lotus 1-2-3 is not really a system, but an Operation Environment. With VisiOn, applications are displayed on a screen that corresponds to the desk of the user. Each application appears on the screen in a separate window. The user accesses one or more of them by moving a cursor controlled by a peripheral called a "Mouse." The Mouse cursor acts as if it were an extension of the user's arm. As a result, it is claimed that a new user can learn to employ the system in 30-minutes.

One may show a word-processing draft in one window, while a second may display an electronic spreadsheet calculation. A user can view both applications and, while working on one, move the Mouse to an-

other and push the button. This opens the related window and its application. To open new windows, or close existing windows, the user moves the cursor to the command line located on the bottom of the screen. Multiple windows can be sized and re-located on the screen using the Frame command, and data can be moved from one window to another using the Mouse and the Transfer command.

Although VisiOn was shown at Comdex, operating on an IBM-PC, and was one of the most exciting software concepts there, it will not be ready for release until the summer of 1983. Visicorp announced that a contract had been signed to install the system into the Digital Equipment Corp. personal computers, and it is expected that VisiOn will also be installed on other memory-mapped video computers made by others.

Power Base from GMS Systems (12 West 37th St., New York, NY 10018. (Tel: 212-947-3500) is a relational data-base system that attracted a lot of attention at the show. This system is very simple to set up and operate, yet it is powerful, accommodating up to 65K records of 1760 bytes of length containing 32 fields each. Each field can be 80 bytes in length. Power Base was also shown on the IBM-PC, but will be extended to other computers.

The long-established Condor and dBase2 data bases were also represented at the show with new revisions of their proven software.

Not all of the new software systems were shown in the exhibit hall. At other areas around the convention site, we were greatly impressed by products such as MicroMate III, a complete business package from Megaware Systems (2581G Alicia Parkway, Laguna Hills, CA 92653. Tel: 714-855-4733). This package contained all of the usual business accounting modules, plus report programs.

What impressed us the most was the coordination between On-Line Helps and the manuals. *There were*

*references to the exact manual pages with each help shown on the screen!* It is just this type of user-friendly application that is needed to support first time computer users. The system sells for about \$250 per module, bringing the complete system to a user for \$1995, which is not an excessive price for high-grade business accounting software.

In the field of operating system software, Digital Research Inc. of CP/M fame announced "CP/M Plus," its new name for version 3 of CP/M-80. The company also will release its extensive Graphics Software to work with CP/M. There were many questions about the development of a CP/M for the M68000 microprocessor. DRI spokesman said that CP/M-68K was being written in the C-language to provide portability to the many different types of M68000 computers now appearing on the market. This is the first important announcement of a non-Unix operating environment for the M68000 computers. Heretofore, only RM Cobol and Unix were offered as M68000 operating systems. The use of a CP/M type of environment for the M68000 will please a lot of users who are accustomed to this system.

**Two-Dimensional Graphics.** The entry of Digital Research Inc. into the graphics field was one of the important trends announced at the fall session of Comdex in Las Vegas. The initial product from DRI that provides a base for CP/M Graphics is called "GSS-Kernel." This tool provides software authors with an established library of two-dimensional graphic primitives such as lines and coordinate points needed to include graphic routines into application packages. By using GSS-Kernel software, authors no longer have to write graphics application code from scratch. They can simply call the established primitive from within GSS-Kernel.

Its use requires installation of the GSX extension of graphics to the CP/M system. (GSX is a graphics system extension that gives CP/M

the ability to interface with many graphics hardware devices, from plotters to CRTs.) Writing graphics programs with the GSS-Kernel linkable run-time library will provide source-code portability to all micros with CP/M operating systems that have been extended with GSX. GSS-Kernel can be used with several popular computer languages, such as FORTRAN, Pascal MT+, and PL/1-80.

While to some the announcements may make it seem as if DRI is only playing "catch-up" in the graphics field. But I think that incorporating graphics into CP/M will profoundly affect the way application software appears to the user. It is all part of the development of user friendly software that is necessary if it is to be widely accepted.

**Attention Programmers.** Osborne Computer Co. has a new promotion plan for software authors. They are looking for programs to run on their machine and are offering a liberal royalty to authors. For additional information, contact Bob Moody at Osborne Computer Co., 26500 Corporate Ave., Haywood, CA 94545 and ask for an Author's Pack. If your programs were originally written for another CP/M machine, they will do the translation for you. Since their installed base is about 70,000 and they expect 200,000 by the end of next year, this sounds like a good deal for software authors.

**C-Language Compiler for TRS-80.** MISOSYS has developed LC, a C-compiler for TRS-80 Mod I and Mod III. Selling for \$175, plus \$4 shipping, the program produces ROM-able Z80 assembler source code compatible with EDAS IV, a full macro assembler that is included. LC supports I/O redirection, command line arguments, dynamic memory management and many C-statements. It is, however, an integer-only compiler. **Address:** MISOSYS, PO Box 4848, Alexandria, VA.

**Apple Reference Cards.** These pocket reference cards for the Apple II and Apple II Plus are accor-

dion-foldup style on 80-pound Beckett antique cover stock. There are two cards, one for BASIC only, and one for BASIC and 6502 machine language. They are complete summaries of the Reference Manual, Integer BASIC Programming Manual, Applesoft BASIC Programming Manual, and the 6502 programming manual. BASIC only is \$3.95, BASIC + 6502 is \$4.95. **Address:** Nanos Systems Corp., Post Office Box 24344, Speedway, IN 46224.

**Slides From Apple II Disks.** Visual Horizons has developed one of the most exciting services to be offered in a long time. It is called Computer Slide Express, and it offers to convert the graphics from any Apple II diskette into a color slide.

The disk can have up to 35 graphic programs on it and the cost is \$6 per slide. The turn-around time is said to be 48 hours from receipt of the disk. Once the slide is made, other photographic media can be produced, such as overhead projection transparencies and black-and-white prints. To start, the service is offered only from Apple II diskettes. Reportedly, the service will be extended later to IBM-PC and other computers with graphic capabilities. **Address:** Visual Horizons, 180 Metro Park, Rochester, NY 14623.

**Condor Data Base.** Condor Computer Corp. publishes the Condor Relational Data Base System which is a completely self-contained data language permitting users to define their own data storage and retrieval system. The Condor DMS is relational and easier to understand and use than network systems or hierarchical data bases. Condor DBMS has been adopted by most of the major microcomputer companies and is available on Digital Equipment Corp., IBM-PC, Hewlett-Packard 125, BMC Computer, Apple II, Zenith Data Systems, and NEC Computers. All of these will market and support the data base system for their respective computers. **Address:** Condor Computer Corp., 2051 S. State, Ann Arbor, MI 48104. ◇



# VIC20™ PERSONAL COMPUTER

(List Price \$299)

## SALE!

# \$139<sup>00</sup>

(when you buy 6 tape programs at sale prices)

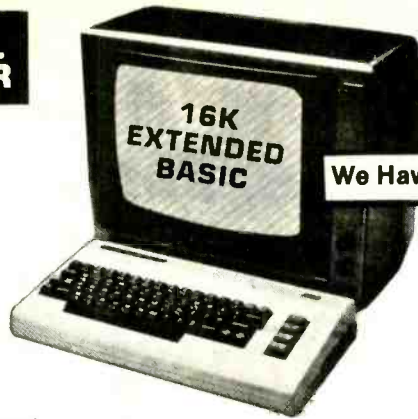

**We Have Commodore 64 Computers In Stock**

- We Love Our Customers Our Prices and Service Prove It!
- One Day Delivery Express Mail

- Commodore 64 Programmers Reference Guides Free With Purchase
- Over 500 Programs To Choose From
- Free Catalogs

You get the COMMODORE VIC-20 Computer for only \$139.00 when you buy 6 tape programs on sale for only \$59.00. These 6 tape programs list for \$96.00 to \$132.00! You can choose one of these three tape program packs: 6 GAME program pack \$59.00 (Allen Invasion, Target Command, Artillery, Chase, Snake Out, Cattle Round Up). 6 HOME FINANCE program pack \$59.00 (Check Book, Calculator, The Budgeter, Home Inventory, Income Tax, Utility Bill Saver). 6 SMALL BUSINESS program pack \$59.00 (Accountant, Accounts Receivable and Payable, Inventory, Order Tracker, Estimating and Bidding, Appointments).

### 33K COMMODORE VIC \$199 WITH 2½ TIMES MORE POWER

For only \$199.00 you get the COMMODORE VIC-20 Computer plus WE ADD 8,000 BYTES OF USER MEMORY to give you 2½ TIMES MORE PROGRAMMING POWER! This powerful full-sized extra featured computer includes the 6502 microprocessor (LIKE APPLE) 20,000 bytes ROM with a 16K extended LEVEL II Microsoft BASIC, 13,000 bytes RAM, a total of 33,000 bytes memory, plug in expandable to 60,000 bytes, 66 key typewriter professional expanded keyboard with graphic symbols on keys, color command keys, high resolution graphics, 512 displayable characters, text display is 22 lines 23 characters, sound and music, real time, upper lower case, full screen editing cursor, floating point decimal and trig functions, string arrays, scrolling, multi statement lines, file management, PEEK AND POKE. Assembly machine language is available. We have easy to use self teaching books and programs. Accepts TAPE-DISK AND PLUG IN CARTRIDGES, connects to any TV, includes AD adaptor, R.F. modulator, switch box, self teaching instruction book, comes in a beautiful console case.

### 41K COMMODORE VIC \$249 WITH FOUR TIMES MORE POWER

For only \$249.00 you get the 41K COMMODORE VIC with 400% MORE PROGRAMMING POWER THAN VIC-20! We add 16,000 bytes user memory to the VIC-20. You get a total of 41,000 bytes memory (20,000 bytes ROM, 21,000 bytes RAM and extended LEVEL II BASIC) plus all the extra features listed!

### 49K COMMODORE VIC \$299 WITH SIX TIMES MORE POWER

For only \$299.00 you get the SUPER POWERED 49K COMMODORE VIC with 600% MORE PROGRAMMING POWER than VIC-20! We add 24,000 bytes user memory to the VIC-20. You get a total of 49,000 bytes memory (20,000 bytes ROM, 29,000 bytes RAM and extended LEVEL II BASIC) plus all the extra features listed!

### TRACTOR-FRICTION PRINTER \$399

This all new COM-STAR deluxe line printer, prints 8½" x 11" letter quality full size, single sheet, roll or fan fold computer paper, labels, etc. 40, 66, 80, 132 columns. Impact dot matrix, bi-directional, 80 CPS. Includes special cable that plugs direct into the VIC-20 printer port — no other costly interface is needed! List \$599.00 Sale \$399.00.

### SUPER 10" COM-STAR PRINTER \$499

Has all the features of the COM-STAR printer shown above, PLUS! 10" carriage 100 CPS, Dot addressable bit image graphics, 2.3 buffer, 18 character sets, 40, 48, 66, 80, 96, 132 columns, prints true descender, super and subscript, underlining. Includes special cable to plug into the VIC-20 printer port. List \$699. Sale \$499.

### 60K MEMORY EXPANDER \$79

Allows memory expansion to 60K total (20K ROM and 40K RAM). Has six slots to add six cartridges — you can switch select any combination of memory or programs. Stop and start any program with reset button, you don't have to remove cartridges or turn off computer. This expander is a must to get the most out of your VIC-20 Computer!

### PLAY ATARI GAMES ON VIC-20 \$79

WOW!! Plug in our new "GAME LOADER" and you can play all ATARI video game cartridges, Activision, Imagic M-Network on your VIC-20 computer. List \$99. Sale \$79.

### LOW COST PLUG IN EXPANSION

Accessories plug in direct to this computer, extra RAM memory, data cassette, telephone modem \$99.00, deluxe 80 column printer \$399.00, 170K disk drive \$349.00 all plug in direct! You do not have to buy an expensive expansion interface!!

### WE HAVE THE LOWEST PRICES

We sell direct to customers and you save the profit margin normally made by computer stores, department stores and distributors, we are willing to take a smaller margin to develop volume. WE LOVE OUR CUSTOMERS — OUR PRICES PROVE IT!

### IMMEDIATE REPLACEMENT WARRANTY

If your computer fails because of warranty defect within 90 days from date of purchase, you simply send your computer to us via United Parcel Service prepaid. We will "immediately" send you a replacement computer at no charge via United Parcel Service prepaid. This warranty applies to all products we sell because WE LOVE OUR CUSTOMERS!!

### 15 DAY FREE TRIAL

#### DON'T MISS THIS SALE-ORDER NOW

- VIC-20 for only \$139. plus \$59. for 6 pack of programs Specify pack wanted \_\_\_\_\_
- 33K-VIC for only \$199.
- 41K-VIC for only \$249.
- 49K-VIC for only \$299.
- Tractor Friction Printer \$399.
- Super 10" Printer \$499.
- 60K Memory Expander \$79.
- Game Loader—Atari \$79.

We ship C.O.D. and honor Visa and Master Card.

Name \_\_\_\_\_

Address \_\_\_\_\_

City \_\_\_\_\_

State \_\_\_\_\_ Zip Code \_\_\_\_\_

VISA  MASTER CARD  C.O.D.

Credit Card No. \_\_\_\_\_

Expiration Date \_\_\_\_\_

Add \$10.00 for shipping, handling and insurance. Illinois residents please add 6% tax. Add \$20.00 for CANADA, PUERTO RICO, HAWAII orders. WE DO NOT EXPORT TO OTHER COUNTRIES.

Enclose Cashiers Check, Money Order or Personal Check. Allow 14 days for delivery, 2 to 7 days for phone orders, 1 day express mail!

Canada orders must be in U.S. dollars.

**GET \$150 FREE SOFTWARE WHEN YOU BUY A COMMODORE 64 COMPUTER!!**

# PROTECTO ENTERPRIZES

(FACTORY-DIRECT)

BOX 550, BARRINGTON, ILLINOIS 60010  
Phone 312/382-5244 to order

CIRCLE NO. 40 ON FREE INFORMATION CARD

# Tek's most successful scope series ever: At \$1200-\$1450, it's easy to see why!

**Wide-range vertical sensitivity:**  
Scale factors from 100 V/div (10X probe) to 2 mV/div (1X probe). Accurate to  $\pm 3\%$ . Ac or dc coupling.

**Two high-sensitivity channels:** dc to 60 MHz bandwidth from 10 V/div to 20 mV/div; extended sensitivity of 2 mV/div at  $> 50$  MHz.

**Sweep speeds:**  
from 0.5 s to 50 ns. To 5 ns/div with X10 magnification.

**Delayed sweep measurements:**  
Accurate to  $\pm 3\%$  with single time-base 2213; to  $\pm 1.5\%$  with dual time-base 2215.

**Complete trigger system.** Includes TV field, normal, vertical mode, and automatic; internal, external and line sources; variable holdoff.

**Probes included.** High-performance, positive attachment 10-14 pF and 60 MHz at the probe tip.

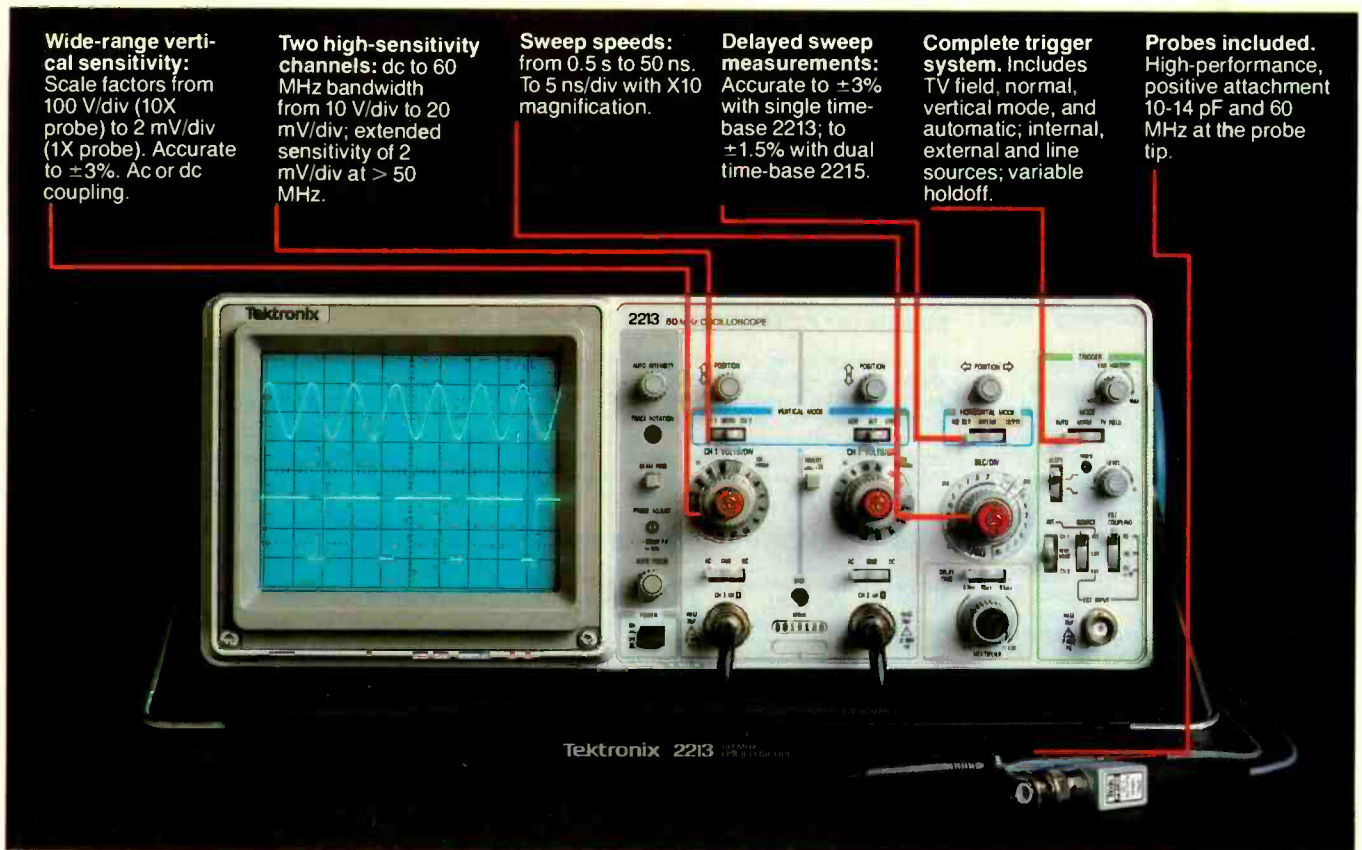

**In 30 years of Tektronix oscilloscope leadership, no other scopes have recorded the immediate popular appeal of the Tek 2200 Series.** The Tek 2213 and 2215 are unapproachable for the performance and reliability they offer at a surprisingly affordable price.

There's no compromise with Tektronix quality: The low cost is the result of a new design concept that cut mechanical parts by 65%. Cut cabling by 90%. Virtually eliminated board electrical connectors. And eliminated the need for a cooling fan.

Yet performance is written all over the front panels. There's the bandwidth for digital and analog circuits. The sensitivity for low signal measurements. The sweep speeds for fast logic families. And delayed sweep for fast, accurate timing measurements.

**The cost: \$1200\* for the 2213. \$1450\* for the dual time base 2215.**

You can order, or obtain more information, through the Tektronix National Marketing Center, where technical personnel can answer your questions and expedite delivery. Your direct order includes

probes, operating manuals, 15-day return policy and full Tektronix warranty.

For quantity purchases, please contact your local Tektronix sales representative.

**Order toll free:  
1-800-426-2200  
Extension 46**

In Oregon call collect:  
(503) 627-9000 Ext. 46

\*Price F.O.B. Beaverton, OR. Price subject to change.



# THE BRITISH ARE COMING!

*Hands-on evaluation of the BBC and Torch Microcomputers*

*By Stan Veit*

**T**HE British government has launched a campaign to encourage computer literacy among the country's children and young adults. The principal vehicles for this campaign are two Computer Literacy Programmes broadcast by the BBC. These are used by both individuals and schools throughout

the United Kingdom. To support this program, a standard computer was specified. The resulting machine, called the BBC Computer (built by Acorn Computers) is the most versatile, small general-purpose computer I've seen.

The BBC micro is capable of having all kinds of enhancements and

peripheral modules added to it until it grows into one of the most powerful microcomputers on the market. In fact, that is what the Torch Computer is: a BBC Computer with every possible hardware upgrade device and peripheral packaged in one cabinet and supported by a host of operating and application software.



**Computers & Electronics**

MARCH 1983

**Learning  
electronics  
is no picnic.**

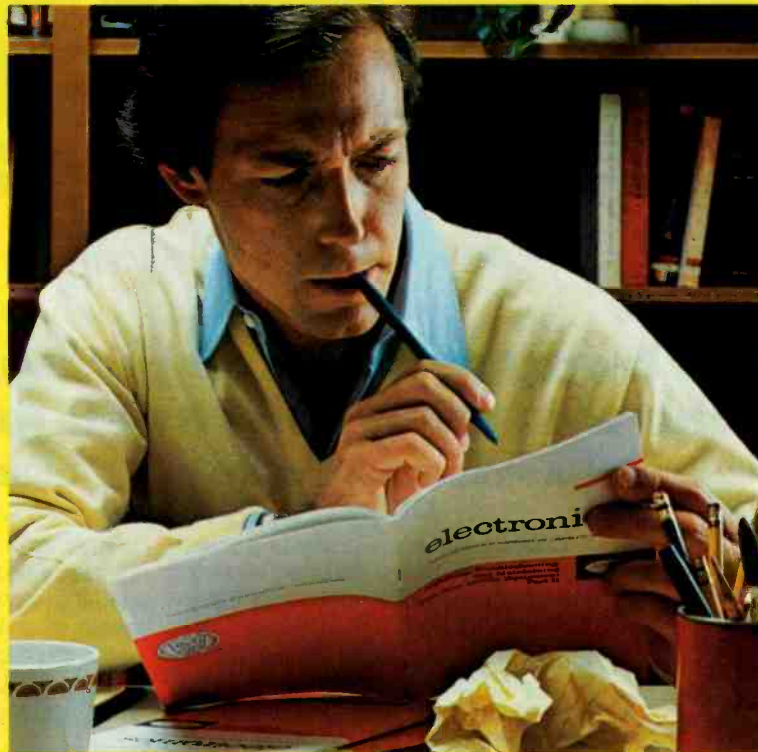

**At any level it  
takes work and  
a few sacrifices.  
But with CIE,  
it's worth it.**



Whoever said, "The best things in life are free," was writing a song, not living a life. Life is not just a bowl of cherries, and we all know it.

You fight for what you get. You get what you fight for. If you want a thorough, practical, working knowledge of electronics, come to CIE.

You can learn electronics at home by spending just 12 hard-working hours a week, two hours a day. Or, would you rather go bowling? Your success is up to you.

At CIE, you *earn* your diploma. It is not handed to you simply for putting in hours. But the hours you do put in will be on your schedule, not ours. You don't have to go to a classroom. The classroom comes to you.

### Why electronics training?

Today the world depends on technology. And the "brain" of technology is electronics. Every year, companies the world over are finding new ways to apply the wonders of electronics to control and program manufacturing, processing...even to create new leisure-time products and services. And the more electronics applications there are, the greater the need will be for trained technicians to keep sophisticated equipment finely tuned and operating efficiently. That means career opportunities in the eighties and beyond.

### Which CIE training fits you?

Beginner? Intermediate? Advanced? CIE home study courses are designed for ambitious people at all entry levels. People who may have:

1. No previous electronics knowledge, but do have an interest in it;
2. Some basic knowledge or experience electronics;

In-depth working experience or or training in electronics.

You can start where you fit and fit ere you start, then go on from there your Diploma, FCC License and cer.

### any people can be taught rronics.

There is no mystery to learning electronics. At CIE you simply start with at you know and build on it to elop the knowledge and techniques t make you a specialist. Thousands CIE graduates have learned to ster the simple principles of elec- ics and operate or maintain even most sophisticated electronics pment.

### specializes exclusively in rronics.

Why CIE? CIE is the largest ndent home study school that izes exclusively in electronics. g else. CIE has the electronics hat's right for you. nging electronics is a lot more norizing a laundry list of

facts about circuits and transistors. Electronics is interesting! It is based on recent developments in the industry. It's built on ideas. So, look for a program that starts with ideas and builds on them. Look to CIE.

### Programmed learning.

That's exactly what happens with CIE's Auto-Programmed® Lessons. Each lesson uses famous "programmed learning" methods to teach you important principles. You explore them, master them completely, before you start to apply them. You thoroughly understand each step before you go on to the next. You learn at your own pace.

And, beyond theory, some courses come fully equipped with electronics gear (the things you see in technical magazines) to actually let you perform hundreds of checking, testing, and analyzing projects.

### Experienced specialists work closely with you.

Even though you study at home, you are not alone! Each time you return a completed lesson, you can be sure it will be reviewed, graded and returned with appropriate instructional help. When you need additional individual help, you get it fast and in writing from the faculty technical specialist best qualified to

answer your question in terms you can understand.

### CIE prepares you for your FCC License.

For some jobs in electronics, you must have a Federal Communications Commission (FCC) License. For others, some employers tend to consider your license a mark in your favor. Either way, your license is government-certified proof of your knowledge and skills. It sets you apart from the crowd.

More than half of CIE's courses prepare you to pass the government-administered exam. In continuing surveys, nearly 4 out of 5 graduates who take the exam get their licenses! You can be among the winners.

### Associate Degree

Now, CIE offers an Associate in Applied Science Degree in Electronics Engineering Technology. In fact, all or most of every CIE Career Course is directly creditable towards the Associate Degree.

### Today is the day. Send now.

Fill in and return the postage-free card attached. If some other ambitious person has removed it, cut out and mail the coupon. You'll get a FREE school catalog plus complete information on independent home study. For your convenience, we'll try to have a CIE representative contact you to answer any questions you may have.

Mail the card or the coupon or write CIE (mentioning name and date of this magazine) at: 1776 East 17th Street, Cleveland, Ohio 44114.



Pattern shown on oscilloscope screen is simulated.

# CIE Cleveland Institute of Electronics, Inc.

1776 East 17th Street, Cleveland, Ohio 44114

PE 82

YES...I want to learn from the specialists in electronics — CIE. Send me my FREE CIE school catalog...including details about the Associate Degree program...plus my FREE package of home study information.

Print Name \_\_\_\_\_

Address \_\_\_\_\_ Apt. \_\_\_\_\_

City \_\_\_\_\_

State \_\_\_\_\_ Zip \_\_\_\_\_

Age \_\_\_\_\_ Phone (area code) \_\_\_\_\_

Check box for G.I. Bill bulletin on Educational Benefits:  Veteran  Active Duty

**MAIL TODAY!**

(Continued from p. 42)

However, the disk drives are of the latest slim-line design. This represents the general situation in the UK, where most people who buy a moderately priced computer like the BBC Model "A" Computer will use cassette storage rather than disks. There is a huge amount of packaged software for the BBC Computer, but we were not supplied with anything but demos. The games we had are of Arcade quality though, and we are told that there are excellent business applications available.

The Torch is the best illustration of the BBC Computer's potential. It is truly a computer owner's dream. We ran WordStar, Supercalc, and the special Executive Aid System that contains the Typewriter Word Processor, Cardex Data Base, and Diary memo programs. This is a very friendly system, as is all the packaged software we used. Even in WordStar, the great speed of the system cut the time lost in changing menu screens so much that we forgot how annoying it can be on a slow computer. The recalculation time in Supercalc was dazzling! What really impressed us was the Prestel demonstration. We sat in our office in New York and selected items on a menu. The Torch automatically called the Prestel computer in Boston, made the connection, and in a few minutes we were looking at the Prestel pages in London,

England! All in full color with graphics! We read all the post-Christmas ads for the London department stores and the Lonely Hearts Column. All our experience on the networks in this country had not prepared us for this technological wonder!

We also had a demo of the Torchmail system. In this electronic mail program, the Torch in New York automatically dialed the Torch in Boston, made the connection, announced it on the screen, and presented us with a menu.

**TABLE I—BBC COMPUTER VIDEO DISPLAY MODES**

**Model B only:**

- Mode 0 640 × 256, 2-color graphics, 80 × 24 text
- Mode 1 320 × 256, 4-color graphics, 40 × 32 text
- Mode 2 160 × 256, 16-color graphics, 20 × 32 text
- Mode 3 380 × 25, 2-color text

**Models A & B:**

- Mode 4 320 × 256, 2-color graphics and 40 × 32 text
- Mode 5 160 × 256, 4-color graphics and 20 × 32 text
- Mode 6 40 × 25, 2-color text
- Mode 7 40 × 25 Teletext display

We requested that a file be downloaded and presto, there it was, saved on our disk, forever ours. We have seen a lot of network operation, but this is the most-user friendly transfer we have ever experienced. A Torch spokesman told us that many international firms buy the computer just for this feature. We can believe it.

**Conclusions.** The BBC Computer is a wonder for the money in the UK. It costs about 300£ for the Model A and 400£ for the Model B. The disk drive costs 235£ for the single 100K unit and 389£ for the 200K double unit. The 14-inch RGB Monitor sells for 279£. (The exchange rate around the first of the year was about \$1.63 to the pound.) These prices are for the British models. The BBC Computer will be imported into this country during 1983, but since there are technical modifications to be made because of the power and video differences, do

not expect the price to be equivalent. Since this machine will have to compete with the same machines as it does in the UK, namely the Commodore, Apple, and TI Computers, the price will have to be competitive, though. With the price wars going on in the low-end computer industry, that will not be easy.

In any event, the design of the BBC Computer shows that original thought is going on in the UK at a time when so many of the American computer companies are building clones of one or another popular computers.

Some of the features of the BBC should be copied by our computer manufacturers. The idea of having different video modes, giving the owner a choice of display size, is certainly one that should be copied in this country. The option of NTSC or RGB color is another, and the built-in modem should also be considered. After all, it only requires a few extra chips added to existing circuits.

I predict that operating systems in ROM will become much more common in U.S. computers, thus providing more use of the complete RAM memory. As competition in price becomes sharper, we will likely see computers designed like the BBC. The initial purchase model will be inexpensive and there will be lots of add-on modules, increasing the power and cost of the computer to match the increasing skill of the user.

The Torch Computer is priced at \$6,500 in this country which is not a high price for a machine with all its features. Nothing else in the market place offers the same kind of features for anywhere near this price. However, it is not everybody's computer.

While everyone will admire the Torch, not many people will find justification for the price. For those that need it, however, the Torch will find a welcome place in the market.

It certainly shows that the BBC Computer and all its expansion modules can be adapted for use in the U.S. No other computer for sale anywhere can match the Torch feature for feature in the same price range. It certainly gives U.S. designers a target to aim for. ♦





# Get serious about ZX81 & TS 1000 Computing

## DATA STORAGE SYSTEM

### MULTIFILE PLUS

For 16K or greater ZX81

#### PRICE INCLUDES:

1. PROGRAM TAPE
2. 8-PAGE BOOKLET
3. THREE DATA STORAGE TAPES
4. STORAGE CASE

**\$34.95**

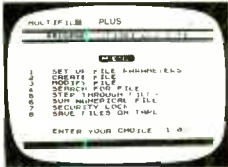

ACTUAL SCREEN PRINT.

An amazingly versatile multi-purpose filing system for the 16K ZX81. The program is menu-driven, and number, size and headings of files are user-definable. Both string and numerical files are catered for. Files may be created, modified, replaced, and searched, and are protected by an ingenious foolproof security system. Output to the ZX printer is also provided. The program comes on cassette, together with three quality data cassettes for file storage, and comprehensive documentation, describing a host of applications for both business and personal use. Supplied in an attractive storage case. If your ZX81 is bored with playing games, then this program will give it plenty to think about!

## The Complete ZX81 and TS1000 Library!

### BOOKS

The Complete ZX81 Basic Course	\$34.95
Basic Course Cassettes (2)	7.50
Getting Acquainted with your ZX81	8.95
ZX81 Pocket Book	10.95
Making the Most of Your ZX81	10.95
Computer for Kids, ZX81 Edition	3.95
Explorers Guide to the ZX81	10.95
ZX81 Companion	8.95
49 Exploding Games for the ZX81	10.95
Not Only 30 Programs for ZX81 : 1K	14.95
Machine Language Made Simple for Sinclair	19.95
Mastering Machine Code on your ZX81	12.95
ZX81 Rom Disassembly: Part A	14.95
ZX81 Rom Disassembly: Part B	14.95
Understanding your ZX81 ROM	19.95



### SPEECH PACK

**\$119.95**

Add high quality solid-state speech to your ZX81 or TS1000. Many applications in personal computing, education, and industry. DCP Speech Pack contains all the letters of the alphabet, numbers zero to over a million, and some other general words. Easy to use under ZX81/TS1000 control using POKE commands (fully explained in manual). The DCP Speech Pack connects directly onto rear of ZX81. It can be used in addition to a RAM Pack, Printer, or other accessories. Contains its own speaker and volume control, and allows an external extension to be added. Additional Word Pack ROMs are available and simply plug into sockets inside the Speech Pack to extend the vocabulary of the unit.

#### TOLL-FREE ORDER LINE

800-833-8400

Have Visa or Mastercard ready

## ZX FORTH

Simplicity of BASIC with the Speed of Machine Code

A complete implementation of the FORTH language for the ZX81 and TS1000 computer. FORTH's most distinctive feature is its flexibility. The basic unit is the word — the programmer uses existing words to define his own which can then be used in further definitions. FORTH is a compiled language so programs run very fast (typically five times faster than BASIC). ZX-FORTH is supplied on cassette and is accompanied by extensive documentation:

56-page Users Manual  
8-page Editor Manual **\$29.95**

## ASSEMBLER

This Machine Code program occupies 7K of memory and locates itself at the top of memory. The program is a full Editor/Assembler and Monitor. Labels may be used instead of any string. The features include Line Insertion/Delete, Insert Characters, Auto Repeat on all keys. The monitor has facilities to inspect memory, registers and run machine code programs. **\$14.95**

## ZX BUG Machine Code Monitor & Disassembler

ZXBUG is a powerful tool for machine language programming. It is 4K long and uses memory from 71E0 to the top memory. ZX BUG works in hexa-decimal (base 16), not decimal, so all addresses are a maximum of 4 Hex bits long. Provides a total of 28 commands. **\$14.95**

## TOOLKIT 9 Powerful New Functions!

RENUMBER. This routine renumbers a program in any step and from any line up to 9999  
DELETE. This command deletes a group of lines in a program.  
MEMORY. Prints how much spare memory is available.  
DUMP. Displays current values of string and numerical values, except arrays.  
FIND. Will find any string of up to 255 characters and list each line containing that string.  
REPLACE. Replaces any string of up to 255 characters by any other string.  
SAVE. Transfers program in computer to below RAM-TOP.  
APPEND. Allows two programs to be joined.  
REMKILL. Removes all REM statements from a program, otherwise leaving it unchanged, preserving memory. **\$14.95**

# GLADSTONE ELECTRONICS

NY Residents call (716) 874-5510

1585 Kenmore Ave., Buffalo NY 14217

Mail to: Gladstone Electronics, 1585 Kenmore Ave., Buffalo, NY 14217

( ) Check ( ) Mastercard ( ) Visa

Acct No \_\_\_\_\_ Exp \_\_\_\_\_

Name \_\_\_\_\_

Address \_\_\_\_\_

City \_\_\_\_\_ State \_\_\_\_\_ Zip \_\_\_\_\_

\*Add shipping: \$3.00 first hardware item, \$1.50 each additional. \$1.50 first software item, 50¢ each additional. 90 day limited warranty all items. Dealer inquiries are invited

Ave., Buffalo, NY 14217

Please rush me:

Item	Qty	Price	Total

Shipping and handling\* \_\_\_\_\_

NY residents add 7% tax \_\_\_\_\_

Total \_\_\_\_\_

with Quality Hardware and Software from Gladstone Electronics

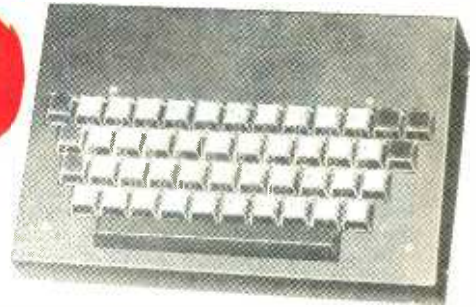

## Professional Keyboard & Case

A full-sized professional keyboard for the ZX81 Features 47 keys and a full-sized space bar. Connects to the ZX81 with no soldering required, via a plug-in flexible connector. You can purchase the keyboard only, or the optional metal case that holds both keyboard and ZX81. Expansion devices (i.e. RAM packs, etc) connect to the ZX81 edge-connector which extends from the rear of the cabinet.

A professional keyboard makes program entry easier and less error-prone.

Assembled Keyboard **\$85.00**  
Optional metal case **\$25.00**

## 32K RAM



## \$89.95 with "piggy-back" feature

A sensible choice for 16K RAM owners. Jigsaw 32K RAM 'piggy-backs' onto your 16K RAM to give a total memory of 48K! If you do not own a 16K RAM, you may use a 32K RAM instead. At a later date you may add the ZX81, TS1000, or Jigsaw 16K RAM, should you decide you require more memory.

Larger memory enables longer programs and greater data bases, enhancing the value of your personal computer.

## 64K RAM

Expands the ZX81's memory capacity to its maximum. **\$149.95**

## 16K RAM

Equivalent to ZX81 or TS1000 16K RAM. **\$49.95**



# Introducing the portable computer for professionals on the move. Hewlett-Packard's new HP-75.

A decade ago, we introduced the world's first scientific pocket calculator and rendered the time-honored slide rule obsolete.

Now we're introducing the HP-75 portable computer. And if press reaction is any indication, history is about to repeat itself.

## As small as a book. As powerful as a personal.

Desktop-computer power in a handsome 26-ounce package. That's the HP-75. It's just 10 inches by 5 inches by 1¼ inches.

But don't let the compactness fool you. Inside its rugged case lies a 48K-byte, ROM-based operating system. With a comprehensive, 147-command instruction set that helps you write hard-working, memory-efficient BASIC programs.



Plug-in ROM ports let you add up to three 32K-byte software modules — modules that solve tough problems *without* sacrificing user memory.

And that user memory gives you up to 24K bytes of program and data storage.

It all adds up. A fully loaded HP-75 is a 168K-byte computing powerhouse in calculator clothing.

Want more? A built-in magnetic card reader provides a convenient, inexpensive way to store and retrieve programs or data.

The HP-75's typewriter-like keyboard means rapid, accurate entry of text or data. And when we say you can touch type on it, we *mean* you can touch type on it.

Those keys, by the way, can be redefined with your favorite commands or programs. Up to 196 unique key combinations in all.

## Immediate, convenient access to your most frequently used programs.

Thanks to the HP-75's multiple-file

structure, programs, data and text can be named, simultaneously stored in memory, and programmed to interact with each other.

Add continuous memory, and you've got a computer that's designed to solve problems on the go. Simply load your favorite files and enjoy immediate access to any or all of them. The files are retained in memory until you decide to delete them — even when the machine is turned off.

## Time and appointments to keep you on schedule.

The TIME key brings to display the day of the week, date and time to the nearest second.

The APPOINTMENT feature reminds you — an hour from now or a year from now — of things you have to do. You can have a silent message on the display, any one of six alarms, or a combination of both.

Even if the machine is turned off, it will "wake up" and alert you of an appointment. Or it will execute programs or control peripherals according to predetermined schedules.

In an environmental test, for instance, where readings are taken every half hour, the HP-75 can make sure its owner gets the weekend off.

## Software tailored to solve your specific problems.

HP-75 software is now available in areas such as math, engineering, finance, and statistics. With spreadsheet analysis\* on the way.

Our plug-in math module,\* for instance, solves polynomial roots, evaluates integrals, and performs finite Fourier transforms.

With our text-formatter module,\*\* you'll compose memos, letters, and short documents virtually anywhere; then print them out when you return to your home or office.

In addition, our third-party software program assures you of ever-expanding software variety.

If you're a volume purchaser or OEM, give us a call. We can help you create custom HP-75 systems with special plug-in modules, magnetic cards, digital cassettes, and keyboard overlays.

## Peripherals for a total computing package.

The HP-75 is equipped with the Hewlett-Packard Interface Loop, giving you a choice of 15 peripherals. (And that choice is expanding. The HP-75 can work simultaneously with up to 30.)

In a battery-powered briefcase system weighing about seven pounds, you might have the 24-character printer, digital cassette drive and acoustic modem\*\*\*

A desktop system might include the 80-column impact printer, full-color graphics plotter, and 12-inch video monitor.

And the HP-75 can "talk to" other computers, peripherals, and instruments with our HP-IB (IEEE-488)\*\* RS-232C\* and

GPIO interfaces.

In summary, the HP-75 is the heart of an extremely versatile system, in addition to its stand-alone capabilities.



## Manuals to make sure you get the most from your machine.

Chock-full of examples and helpful hints, our owner's manual will get you up and running in short order. And it's organized to help you access the information you need to get on with the job at hand.

A supplementary reference guide provides a concise summary of the computer's operating protocol and instruction set.

## The value you're looking for.

What is the price of all this power in this compact package? \$995\*\*\*\* A lot less than you might pay for a personal computer you can't take with you.

See the HP-75 today. It's the smart choice for professionals on the move.

For the authorized HP dealer or HP sales office nearest you, call TOLL-FREE 800-547-3400 (Oregon, Alaska, Hawaii: 503-758-1010). TTY users with hearing or speech impairments, dial 503-758-5566.

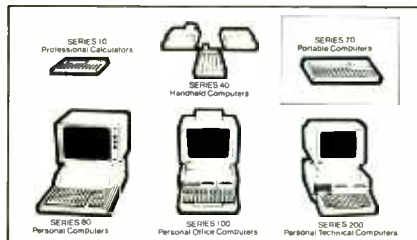

\*Available May 1, 1983.

\*\*Available March 1, 1983.

\*\*\*Call our toll-free number for availability.

\*\*\*\*Suggested retail price. May vary outside U.S. Peripherals and software not included.



# HEWLETT PACKARD

CIRCLE NO. 54 ON FREE INFORMATION CARD





**HP-75 SPECIFICATIONS**  
**Size and weight:** 10" X 5" X 1 1/4" 26 oz.  
**48K byte, ROM-based operating system:**  
 • 8-bit CMOS CPU • Multiple file structure in continuous memory • Instruction set: 52 system commands, 43 BASIC commands, 41 numeric functions, 7 string functions, 6 time mode commands, 16 arithmetic/logical/

**relational operators**  
**Numeric precision:**  
 • Real—12 digits ( $\pm 9.999999999999 \times 10^{-99}$ )  
 • Short—5 digits ( $\pm 9.9999 \times 10^{-99}$ )  
 • Integer—5 digits ( $\pm 99999$ )  
**Time/appointments:**  
 • Perpetual clock/calendar • 12- or 24-hour format • Appointment control of command/

**program execution**  
**Memory:**  
 • User (RAM) — 16K bytes, expandable to 24K bytes • Operating system (ROM) — 48K bytes  
 • Plug-in software (ROM) — up to 96K bytes (3 32K-byte modules)  
**Typewriter-like QWERTY keyboard:**  
 • 65 keys • 194 redefinable key combinations

• "Hidden" numeric keypad  
 Integral mass storage: hand-pulled card reader (1.3K bytes per card)  
**Built-in interface:** HP-I; choice of 15 peripherals  
**Power supply:** 3 AA NiCad batteries (AC adapter/charger included)  
**Liquid-crystal display:** 32-character window on 96-character line  
 PG02308 209 B

1 1/4"



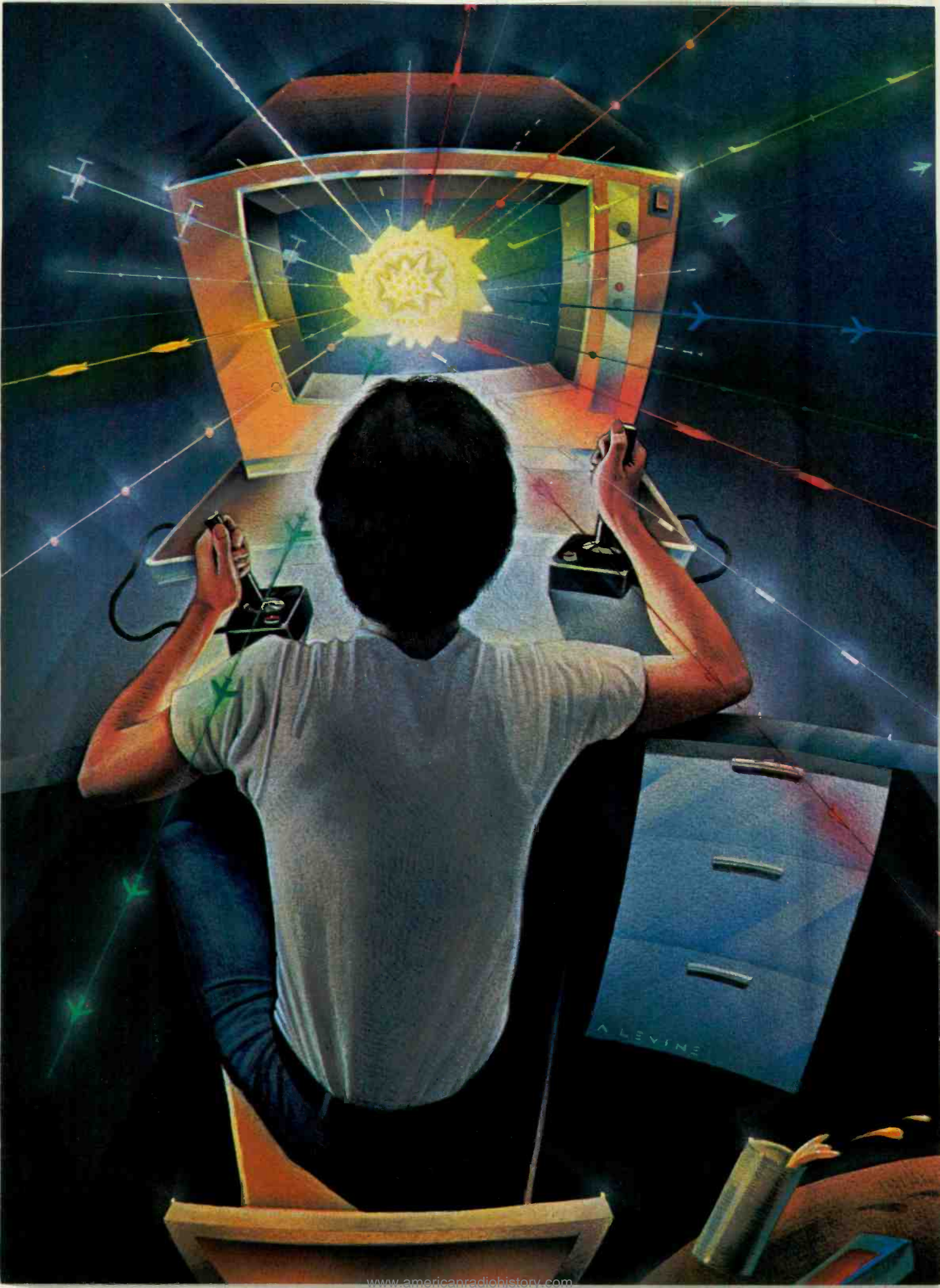





# MICROCOMPUTER *JOYSTICK* INTERFACING METHODS

*Two ways to add a joystick or paddle*

*ONE: By Randy Carlstrom*

**T**HE USUAL way a microcomputer detects a joystick's position is through an A/D converter and an input port of the computer. If the joystick has two degrees of freedom (vertical and horizontal), two A/D converters and input ports are required. Presented here, however, is a simple and inexpensive method of interfacing joysticks to your computer using only one TTL IC and a few bytes of program memory.

*(Continued on page 56)*

# "I built this 16-bit computer and saved money. Learned a lot, too."

Save now by building the Heathkit H-100 yourself. Save later because your computer investment won't become obsolete for many years to come.

Save by building it yourself. You can save hundreds of dollars over assembled prices when you choose the new H-100 16-Bit/8-Bit Computer Kit — money you can use to buy the peripherals and software of your choice.

## H-100 SERIES COMPUTER SPECIFICATIONS:

**USER MEMORY:**  
128K-768K bytes

**MICROPROCESSORS:**  
16-bit: 8088  
8-bit: 8085

**DISK STORAGE:**  
Built-in standard  
5.25" disk drive,  
320K bytes/disk

**KEYBOARD:**  
Typewriter-style,  
108 keys, 13  
function keys,  
18-key numeric pad

**GRAPHICS:**  
Always in graphics mode.  
640h/225v resolution;  
up to eight colors  
are available

**COMMUNICATIONS:**  
Two RS-232C Serial  
Interface Ports and  
one parallel port

**DIAGNOSTICS:**  
Memory self-test  
on power-up

**AVAILABLE SOFTWARE:**  
Z-DOS (MS-DOS)  
CP/M-85  
Z-BASIC Language  
Microsoft BASIC  
Multiplan  
SuperCalc  
WordStar  
MailMerge  
Data Base  
Manager  
Most standard  
8-bit CP/M  
Software

128K bytes standard.    Optional.

The H-100 is easy to build — the step-by-step Heathkit manual shows you how. And every step of the way, you have our pledge — "We won't let you fail." Help is as close as your phone, or the nearest Heathkit Electronic Center.

And what better way to learn state-of-the-art computing techniques than to build the world's only 16-bit/8-bit computer kit? To run today's higher-speed, higher-performance 16-bit software, you need an H-100. It makes a significant difference by processing more information at faster speeds.

Dual microprocessors for power and compatibility. The H-100 handles both high-performance 16-bit software and most current Heath/Zenith 8-bit software.

Want room to grow? The H-100's standard 128K byte Random Access Memory complement can be expanded to 768K bytes — compared to a 64K standard for many desktop computers.

And the industry-standard S-100 card slots support memory expansion and additional peripheral devices, increasing future upgradability of the H-100.

High-capacity disk storage, too. The H-100's 5.25" floppy disk drive can store 320K bytes on a single disk. The computer also supports an optional second 5.25" and external 8" floppy disk drives. And an optional multi-megabyte internal Winchester disk drive will be available in the near future.

*The H-100 gives me the most for my computer dollar!*





Critical circuits are pre-assembled, making the H-100 easier and faster to build!

Want beautiful high-resolution graphics? You can create extensive charts, drawings, graphs and symbols to meet your needs – using the H-100's bit-mapped graphics and its 640 x 225 pixel video display.

The H-100 gives you total communications flexibility. Three interface ports let you plug in dot-matrix and letter-quality printers, as well as other peripherals.

Compare the H-100's exceptional capabilities with other desktop computers:

COMPUTER:	Heathkit H-100	IBM Personal Computer	Apple III
<b>MICROPROCESSORS:</b>			
16-bit:	8088	8088	—
8-bit:	8085	—	6502
<b>RANDOM ACCESS MEMORY:</b>			
Minimum:	128KB	16KB	128KB
Maximum:	768KB	576KB	256KB
<b>FLOPPY DISK STORAGE:</b>			
Per Diskette:	320KB	320KB	140KB
Maximum Internal:	640KB	640KB	140KB
8" Floppy Support:	Standard	—	—
<b>EXPANSION SLOTS:</b>	Five S-100 (four available)	Five (three available)	Eight
<b>I/O PORTS:</b>			
Parallel:	1	Optional	—
Serial:	2	Optional	1
<b>VIDEO DISPLAY:</b>			
Line Columns:	25 x 80	25 x 80	24 x 80
Pixels Colors:	640 x 225 (8 colors)	640 x 200 (2 colors) 320 x 200 (4 colors)	560 x 192 (16 colors)
<b>OPERATING SYSTEMS:</b>	CP/M-85, Z-DOS (MS-DOS)	CP/M-86, PC-DOS (MS-DOS), UCSO P-System	Apple SOS

Information current as of 8/31/82. External disk storage available soon.

Learn by building. When you build and operate the H-100, you learn more about this sophisticated computer system and its unique 16-bit/8-bit software capabilities.

Learn from outstanding documentation. One of the most important parts of any computer system is documentation – and Heathkit documentation is among the industry's best. Our instruction and operating manuals are fully detailed, in the world-famous Heathkit tradition.

Learn by doing. Many of our software programs come with a complete set-up and operating manual. More complete than most other software documentation, each manual not only tells you what the program will do – it shows you the easiest way to accomplish each task.

We back you all the way. With Heathkit computer products, technical assistance and expertise is as close as your telephone – or the nearest Heathkit Electronic Center. Complete technical assistance and service is available at over 60 locations nationwide.

Buy from a leader. When you choose a Heathkit computer, you get the backing and reliability of the world's leader in quality electronic kits for over 50 years! You can count on us for quality, service, reliability and value – at kit prices that give you more computer for your dollar!

See the H-100 in action. Visit your nearby Heathkit Electronic Center, which has the world's first 16-bit/8-bit computer kit, peripherals and software programs on display. See your telephone white pages for the nearest store location. Or mail the coupon today for a FREE, full-color Heathkit computer catalog.

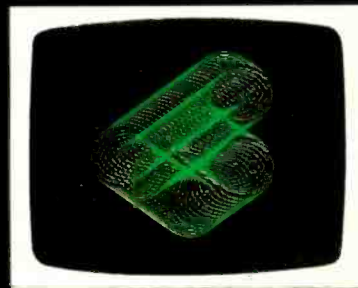

Always in graphics mode, you can control each of the H-100's 144,000 screen dots! (Color graphics optional)

CLIP COUPON AND MAIL TODAY TO:

Heath Company, Dept. 310-994  
Benton Harbor, MI 49022

Please send my FREE Computer Catalog, with details on the new 16-bit/8-bit H-100 Computer Kit, today!

Name

Address

City  State

CP-218  Zip

Heathkit Electronic Centers are units of Veritechnology Electronics Corporation. Heath Company and Veritechnology Electronics Corporation are subsidiaries of Zenith Radio Corporation. Prices, product availability and specifications are subject to change without notice.

**Heathkit**  
Heath  
Company

**Circuit Operation.** The circuit of Fig. 1 shows IC1A, which is one-half of a dual non-retriggerable monostable multivibrator ("one-shot"). The output pulse width is determined by the values of C1, R1, and Rx. The circuit is triggered at pin 1 of IC1A by an "input read" pulse. This pulse is generated from the system's input interface logic during the execution of an input instruction. Circuit details are omitted since the decoding circuitry is system and CPU dependent. The input read signal is usually found connected to an "enable" input of the input buffers of the interface. Pin 13 of IC1A should be connected to one bit of the input port for sampling by the CPU. This scheme allows up to eight joystick potentiometers to be interfaced to an 8-bit computer using only one parallel input port and very simple hardware.

When IC1A times out, C2 begins charging through R2. Multivibrator IC1A is prevented from triggering again until C2 charges to about 1 V which enables IC1A. This delay is necessary to provide sufficient "recovery time" for IC1A, to make sure its maximum rated duty cycle is not exceeded.

**Software.** The second half of the joystick interface is the driver software. Basically, a program measures the length of time one-shot IC1A is fired, which is a function of the joystick position (the setting of Rx). The pulse width, tx, of IC1A can be calculated from the formula:

$$t_x = 0.7C1(R1 + Rx).$$

In the 8080 implementation of the driver software shown in Table I, register B is used as a counter for measuring the pulse length. (The choice of register B is completely arbitrary.)

The value that will be returned in register B can be determined by the following method. The execution time for loop "XLOOP" is 18.5 μs for an 8080 CPU running at 2 MHz. (This can be calculated by adding up the individual execution times for each subroutine instruction, as

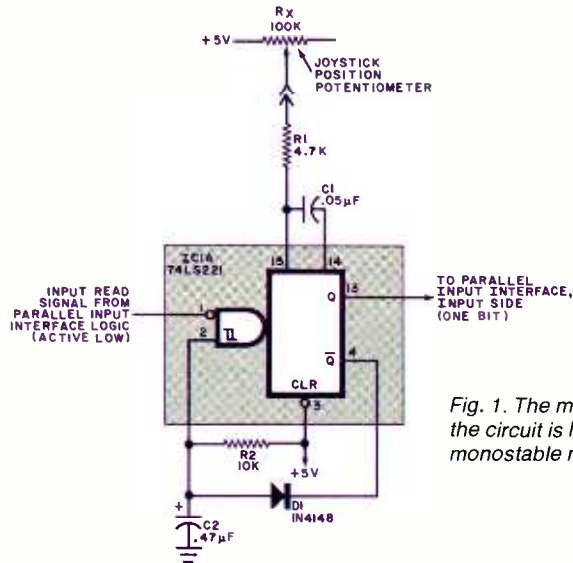
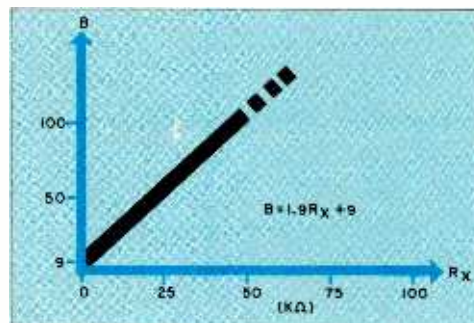
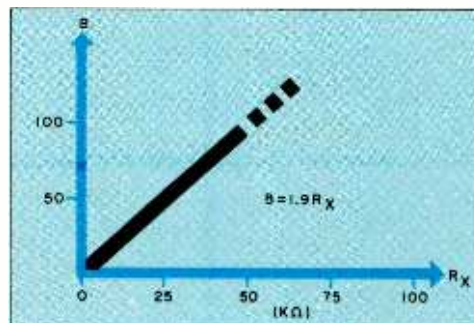

Fig. 1. The main part of the circuit is half of a dual monostable multivibrator.



(A)



(B)

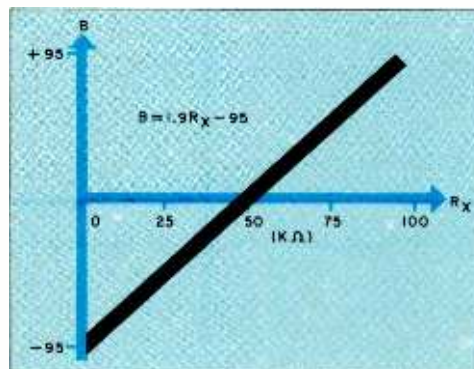

(C)

Fig. 2. Three plots of B vs Rx with different amounts of vertical offset.



## ...JOYSTICK

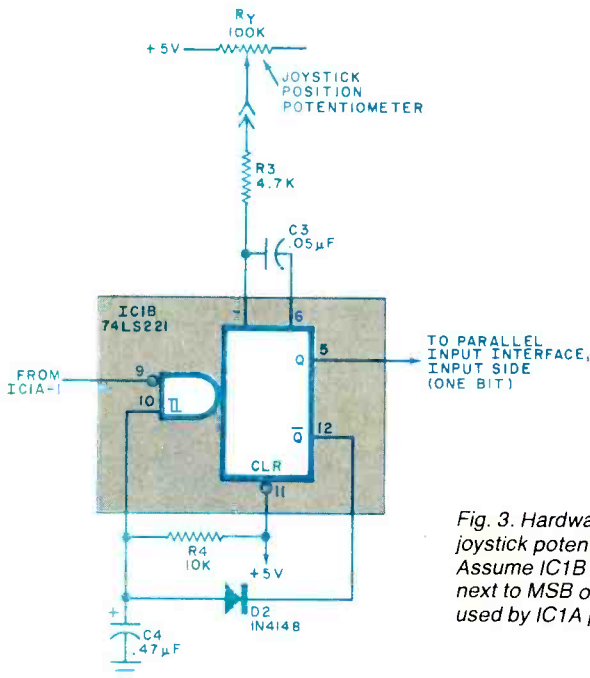

Fig. 3. Hardware for second joystick potentiometer interface. Assume IC1B pin 5 is connected next to MSB of same interface used by IC1A pin 13.

given in the 8080 data sheets.) Therefore, as long as the one-shot is fired, register B is incremented by one count every  $18.5 \mu\text{s}$ . Clearly, then, the value returned in register B is

$$\begin{aligned} B &= t_x / 18.5 \mu\text{s} \\ &= 0.7CI(R1 + Rx) / 18.5 \mu\text{s} \\ &= 0.7CI R1 / 18.5 \mu\text{s} + \\ &\quad 0.7CI Rx / 18.5 \mu\text{s} \end{aligned}$$

Using

$$CI = 0.05 \mu\text{F}$$

and

$$R1 = 4.7 \text{ kilohms}$$

from Fig. 1,

$$B = 8.9 + 1.9Rx \quad (Rx \text{ expressed in kilohms}).$$

A plot of B vs. Rx would be a straight line of slope 1.9 and B-intercept of 9. (The value of B must be an integer; the closest integer to 8.9 is 9). See Fig. 2A. The experimental result of B vs. Rx is given in Table II.

If the program calling the subroutine in Table I required the register B count corresponding to  $Rx = 0$  to be zero, the curve in Fig. 2 could be "shifted down" to make the B-intercept zero by subtracting nine from register B (Fig. 2B). Similarly, if joystick displacements to

the left of the neutral (center) position were to represent negative displacements, and displacements to the right positive displacements, subtracting the B value corresponding to  $Rx = 50$  kilohms (which corresponds to the joystick neutral position) will shift the curve by the appropriate amount (Fig. 2C). (This is assuming that Rx increases as the stick's position is moved from left to right).

It should be noted that, if the subroutine shown in Table I is called again before the one-shot's "recovery time" has elapsed, register B will be returned with a value of zero. Because of this, the calling program should check for this condition before it processes register B any further. (Register B = 0 may be interpreted as "hardware not ready" by the calling program.)

If the joystick has two degrees of freedom (and therefore two position potentiometers), the second potentiometer Ry may be interfaced as shown in Fig. 3. More joysticks may be interfaced to the input port in like manner.

If your CPU runs at a speed other than 2 MHz, CI should be scaled by

### TABLE I—8080 SUBROUTINE

START	MVI B,00	Initialize counter
XLOOP	IN XCORD	Trigger one-shot
		Has one-shot
		timed out?
	ANI 80H	(Mask one-shot
		status)
	RZ	Yes: return with
		count in register B
	INR B	No: bump count
		in register B and
	JMP XLOOP	continue measur-
		ing pulse length

Note: Assumes IC1A pin 13 is connected to MSB of input interface. XCORD represents actual port number, dependent on system input interface hardware.

### TABLE II—EXPERIMENTAL RESULTS OF B VS. Rx

Rx (kilohms)	B Count	Calculated value
0	9	9
10	27	28
20	47	47
30	65	66
40	86	85
50	106	104
60	125	123
70	143	142
80	162	161
90	180	180
100	201	199

the appropriate amount to keep the value returned in register B in the range 0 to 255. For instance, if your CPU is a Z80 running at 4 MHz and the subroutine in Table I is used, CI should be scaled by 1/2, or  $CI = 0.025 \mu\text{F}$ . Or, compensation can be provided by increasing the execution time of XLOOP by imbedding NOP instructions in the loop, each of which adds  $1 \mu\text{s}$  to the execution time (for a Z80 running at 4 MHz).  $\diamond$

(Authors note: For more information on 8080 I/O interfacing and machine language programming, refer to "Designing with the 8080 Microprocessor," Parts 2 and 3, which appeared in POPULAR ELECTRONICS, October and November, 1981.)

(See next page for second interfacing method.)

TWO: By Ralph Tenny

**U**SING a new low-cost A/D (analog to digital) converter, you can design a joystick interface for your personal computer. Originally developed for automotive control circuits, the TL507 A/D converter offers features not even available in more costly ICs.

The internal logic for this IC is shown in Fig. 1. It features a counter driving a resistive ladder, a set of comparators, and an internal voltage regulator.

After a reset signal is applied to pin 8, the internal counter is set to zero. With the voltage being measured applied to pin 5, and a clock signal applied to pin 2, the internal counter begins counting. The voltage output of the resistive ladder is compared against the input voltage. When the ladder voltage equals the input voltage, the output at pin 4 switches low and remains low as long as the reference is high. The counter can then be reset to start again. If the clock signals continue, the counter will continue to count until it "wraps around" to zero. When it reaches this point, the output at pin 4 switches high. The internal voltage regulator generates +5 V at pin 7 if needed.

**Joystick Interface.** The TL507 can be used to create a joystick interface, as shown in the schematic of Fig. 2. The actual joystick potentiometer, *R2*, is connected in a voltage divider formed by *R1* and *R3* across the regulated output coming from pin 5 of *IC1*.

If the computer generates clock pulses while counting the pulses, then stores the count when the output (pin 4 of *IC1*) switches low, the count of pulses represents the input voltage at pin 4. When this circuit is driven from a computer port, a program using the flowchart shown in Fig. 3 will generate a binary number proportional to the joystick position. ♦

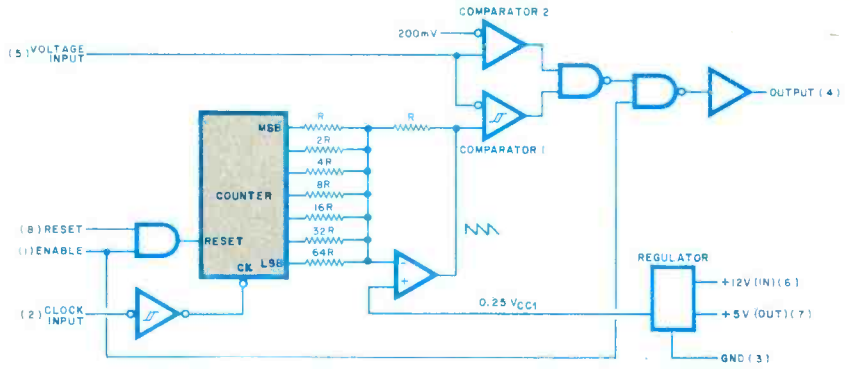

Fig. 1. Internal block diagram of the TL507.

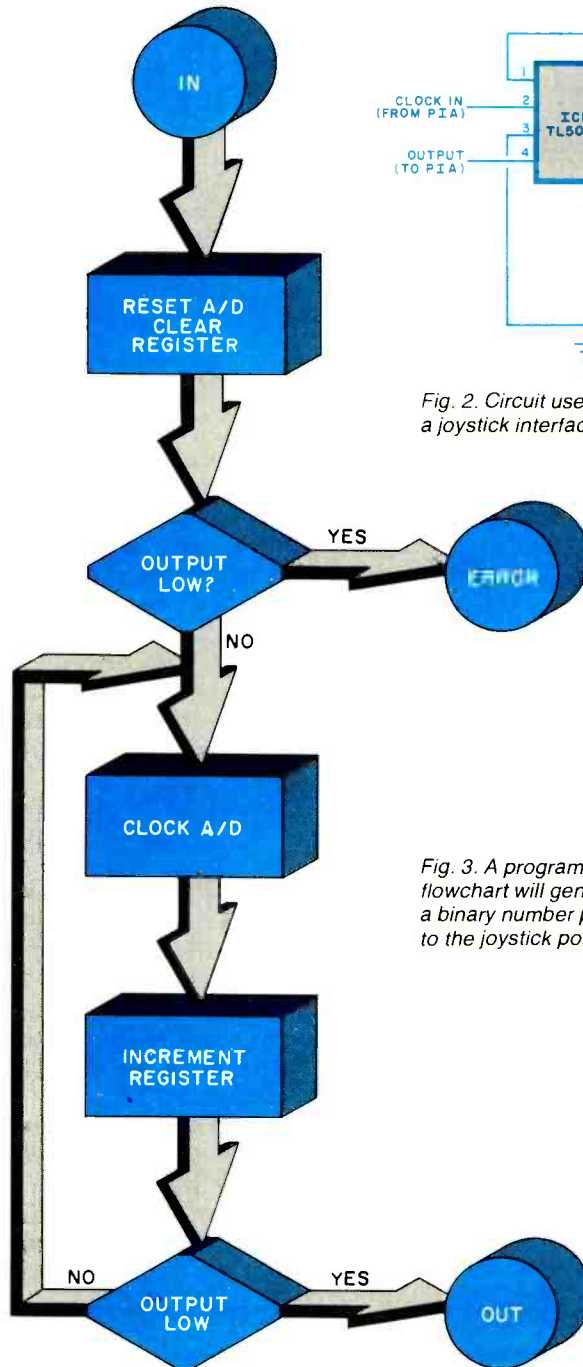
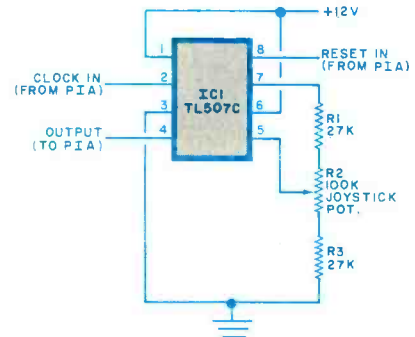

Fig. 2. Circuit used to create a joystick interface with TL507.

Fig. 3. A program using this flowchart will generate a binary number proportional to the joystick position.





# CROSSED SIGNALS

By B. K. Roberts

ONE of the basic elements of computer circuitry and digital logic is the *gate*. There are three fundamental types of gates: (A) the AND gate, whose output is a 1 if and only if both inputs are 1 (Fig. 1A); (B) the OR gate (also known as an Inclusive OR), whose output is a 1 if either or both inputs are 1 (Fig. 1B); and the Exclusive OR gate, whose output is a 1 if either, but not both, inputs are 1 (Fig. 1C).

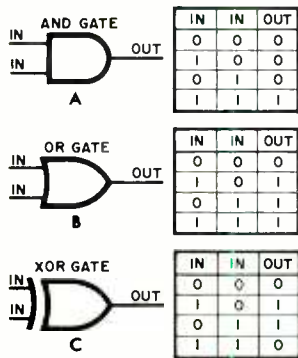

Fig. 1. Three types of gates.

To learn how to use these logic elements in designing a circuit, try the following quiz. Starting with the simple box layout in Fig. 2, connect  $X_{in}$  to  $X_{out}$  and  $Y_{in}$  to  $Y_{out}$  with logic gates so that the effect will be the same as if two simple wires had been used to make the connections. That is, a logic 1 applied to  $X_{in}$  should appear at  $X_{out}$  and a logic 1 at  $Y_{in}$  should appear at  $Y_{out}$ . The problem would be trivial except for one small consideration: *no lines may cross on the diagram*. You may use as many gates as you like—of any type. ◇

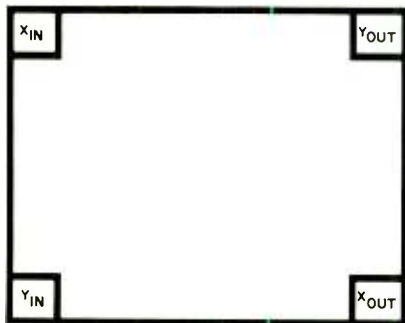

Fig. 2. Simple box layout.

## ANSWER

The problem is solved by using three Exclusive OR gates, connected as shown here. The truth table shows what happens with any possible combination of inputs.

$X_{in}$	$Y_{in}$	Z	$X_{out}$	$Y_{out}$
0	0	0	0	0
1	0	1	1	0
0	1	1	0	1
1	1	0	1	1

TRUTH TABLE

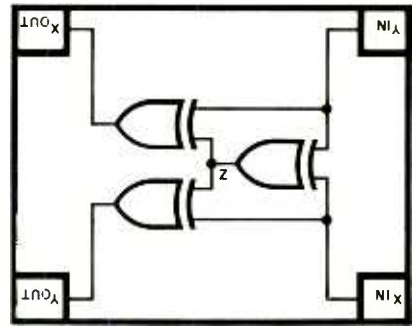

# For people who take their games seriously.

\*Atari® is a registered trademark of Atari, Inc.  
 \*\*Tele-Games® is a registered trademark of Sears, Roebuck and Co.  
 \*\*\*Vic-20® is a registered trademark of Commodore International, Ltd.



- Rugged design for durability.
- Contoured hand grip for comfort.
- High-speed performance for quick maneuvering.
- Fast action thumb trigger fire button for right or left handed play.

- Compatible with your Atari\* Sears Tele-Games\*\* Commodore Vic-20\*\*\* and other game systems.
- Extra long cord for convenience.

discwasher®  
**POINTMASTER™**  
 competition joystick

DISCWASHER 1407 NORTH PROVIDENCE ROAD, P.O. BOX 6021, COLUMBIA, MO 65205 USA  
 A DIVISION OF JENSEN an ESMARK Company

CIRCLE NO. 66 ON FREE INFORMATION CARD

# The COMPUTER NETWORK MAZE

Part 1: Helpful hints on how to use the various communication networks that are available on your microcomputer

By Stan Veit



**T**HERE is a whole new subculture evolving on the computer networks. It consists of members of computer Special Interest Groups, investors, writers, game players, and just people who seek friends or information by communicating electronically. This subculture has its own languages, customs, and manners, all influenced by the nature of an electronic medium. However, signing on to a network and "working" it can be a frustrating experience. Here is a guide to help you avoid getting lost in the network. While it cannot teach you *all* of the customs and protocols used by the networks and the Special Interest Groups, it is a neat introduction to an interesting and informative experience.

When the computer networks were originally founded, they were envisioned as a transmission medium for electronic mail and as bulletin

A LEVINE



boards where people could post messages to each other. As they evolved, they became electronic newspapers, magazines, entertainment centers, and trading posts. Complete encyclopedias such as *The World Book* are available for reference, as well as theatre and travel reservations, current news, and financial information. In addition, a subscriber can send or receive electronic mail and participate in electronic conferences on every conceivable subject.

There are two principal general information networks available to the public. These are "The Source," owned by Reader's Digest, and "CompuServe Information Services," a division of H&R Block. In addition, there are several smaller services with specialized services, including the "Dow Jones News/Retrieval Service," Lockheed's "Dialog," and "BRS After Dark" from Biographical Research Service. The Source and CompuServe started out at the same time, but CompuServe has far outstripped The Source both in the number of members and the quality of the services offered. Since The Source was bought by Reader's Digest, it has a new computer center and is offering many new services and features to attract new customers.

In any event, before you can get on one of the networks and enjoy the host of features offered, you must learn how to sign on to the network and how to find your way through the maze of menus to your section of interest.

Most people communicate with the networks through the major common carriers such as Telenet and Tymnet. However, CompuServe has a growing number of direct-connect nodes where the user can dial a direct CompuServe access number. The Source only has such direct-connect facilities in the Washington, D.C. area. To sign on any of the networks you must have an ID number assigned by the network and a secret password, which you choose. Often, the network assigns you a password generated by random selection for your initial contact. Once you have signed on, you select a new password known only to yourself and the computer.

To start, you must buy a sign-on package from the network. These are sold by computer stores and other places where computer equipment is sold. In case you do not have such a facility available, you can call the network directly to sign up for the service. Dialog and BRS After Dark offer direct subscription service. For most of the networks there is an initiation fee and an hourly fee for the use of the service.

Some networks offer a special package in conjunction with the manufacturer of modems, computers or software. This special offer includes a sign-on contract package with the purchase of the equipment, and includes the initial fee plus a minimum number of hours on the network. Upon receipt, the new member fills out the papers so that he can charge future time to an approved credit card. By the time the sample hours are used up, the credit

is approved and the normal membership starts. The Source charges a minimum charge each month if the service is used or not. CompuServe does not make this charge.

The equipment needed to use the networks varies from a "dumb terminal" with a modem to a personal computer with a modem and a videotext or communication program. The more elaborate equipment can print the conversations and record programs from the network to a disk storage system or from the personal computer disk to the network disk storage. Most communications over the telephone line to and from the networks are transmitted at 300 characters per second (300 baud). However, today's equipment often can work at speeds up to 1200 baud. Though this is four times as fast, the networks charge a much higher fee for this rapid communication facility.

## CompuServe Information Service

**T**O illustrate connection to the networks I'll use the example of direct connect to CompuServe—the simplest case. The user turns on his computer and loads the communication program. If he is using a terminal, no special software is needed. The telephone number of the nearest access port is then dialed and, when a high-pitched tone is heard, the connection is made. If an acoustic coupler modem is being used, the telephone instrument is placed in the rubber cups on the coupler. The telephone cord end is usually marked on the acoustic modem. If a direct-connect modem is used, the connection is made automatically or a light goes on indicating that the user should throw a switch. Once the connection is made, the system prints out the word CONNECT, then the number of users on the node and the initials of the node. It then asks for the name of the host network.

CONNECT—Indicates that a connection has been made.

02NYC—Second person on the New York City node.

Host Name—The name of the host net is CompuServe Information Service so you enter CIS.

The request for the ID# appears on the screen. The user enters the number supplied by CompuServe and hits CARRIAGE RETURN. There is a short pause and a request for the user's password is made.

User ID—User enters his ID number

Password—User enters password which is invisible on screen.

If the password is accepted, the user is on the network and the following appears:

CompuServe Information Service  
21:00 EST Tuesday 14-Dec-82

If the correct password is not accepted, the system asks for it several times and then signs off if it is not received.

**Main Menu.** What happens next is the result of a choice made by the user when he first joins the net. There are several options available, but most users choose to receive the top level menu of the service. Before the top level menu appears, there is a series of announcements called "Whats New." If a user wants additional information about any of the

announcement subjects, at the (!) prompt, he enters "Go New" and receives additional information.

As shown in Illustration I, the top menu lists the major sections of the network and allows a selection from them.

When you enter your selection number, you are transferred to the section you have selected and presented with another menu for sub-sections. The entire network is a tree structure of menus, each taking the user from the general classification to the specific information you are seeking.

The tree of menus, however, is only for the user who does not know where to go. Once you have been to a section of the network, you can directly return there by using the GO command at the ! prompt. For instance, type:

!GO CEM-450

This will take you directly to the Computers & Electronics Special Interest Groups, bypassing the hierarchical structure of menus usually needed to get there. When you use this method, the system will respond with "Request Recorded," and after a short pause you will be at page CEM-450.

Everything on CompuServe is divided into pages that are 32 characters wide by 12 lines long, plus a header line with the page identifier. This accommodates the personal computers with 32- or 40-character lines. If the information is longer than 12 lines, it is divided among as many pages as necessary to contain the information. On some pages you can enter an "S" in answer to a prompt. This will give you a screen as wide as you have indicated your terminal to be. You enter this information in a special terminal default section in the User section.

**Electronic Mail.** One of the most useful features of the networks is some type of electronic mail system. Each network has some version of electronic mail. In CompuServe, you can either send or receive mail

from anyone who has a registered user number on the network. One of the options you make when you first sign on the network is to receive notice of any mail that is in your "mailbox" at the time you sign on the network. If you have made this option, you are informed, at the prompt, "You Have EMAIL Waiting." The system then automatically puts you into the EMAIL area. You have the option at the EMAIL prompt to:

1. Read Mail
  2. Compose and send mail.
- Last page menu page. Key digit or M for previous menu.

Suppose you prompt:

! 1

The following message might appear:

CompuServe Page EMA-5

14- DEC-82 00:22 FR (703421,4561)  
Thanks for the information. I will act on it soon.  
Cheers.  
Bill

Then, if you key ENTER to continue

!

Then:

CompuServe EMA-5

1. File this message, then delete it from mailbox
2. Delete from mailbox
3. Display the message again

Last menu page. Key digit or M for previous page.

!2

CompuServe EMA-10

Message Deleted.  
Last page. Key M for menu.

The user selects one of the options, and the system either files or deletes the message. If the message is filed, it is recorded on the user's personal block of data storage allocated by the system.

If the person receiving the message wants to send a message in response, he enters an M and is returned to the main EMAIL menu. He can then select the option of composing an EMAIL message. All messages must be composed using one of the system Editor programs and then sent via the EMAIL Menu

by selecting it from the file. Instruction on use of the System Editor programs can be obtained from manuals purchased from CompuServe, or from Help screens.

**Using the Menus.** Once sign-on procedures are completed and the EMAIL messages have been read and answered, the user is returned or sent to the main menu.

From this main menu the user can move through the network by following the chain of menus. Help messages are available at almost any point to aid the user. In addition, there are human guides called System Operators or SYSOPS available to help users on the Special Interest Groups that exist on the network.

Though the SYSOPS may not be on-line at the time the user needs aid beyond that provided by the normal help messages, a confused person can leave a message addressed to the SYSOP in the appropriate Special Interest Group (SIG) area (Illustration II). It will be answered by a message referenced by number to the questioning message. If the question is deemed to be of general interest to the membership by the SYSOP, it will be left on the bulletin board for all to read. Other members may also answer the question and the result will become a general discussion based on the question. Most of the SYSOPS are specialists in the area they manage, in addition to being experts in the management of the network.

**CB on the Network.** No discussion of the CompuServe network would be complete without covering the "CB" channels, which is part of the Communications menu under Home Services (Illustration III). This is a simulation of citizens band radio on the network. It works about the same way except instead of being limited to an area of 5 to 20 miles (the range of CB transceivers) the CBers can talk with others across the United States and Canada. The interest range of CBers is wide and the conversations sometimes can become heated. CompuServe only requires that the CBers observe the same kind of rules that the FCC requires for CB radio.

(Text continues on page 68)



# WORD PROCESSOR?



You bet! Quick Brown Fox word processing software has more features than Word Star and runs on your VIC or Commodore 64. And it can grow and grow. Add memory, 80 column display, disks, even a letter quality printer. We'll show you how a 1st-class word processor can be yours for less than \$2000! You can even have a "student" system for less than \$700!

It all starts with the Quick Brown Fox at \$65.

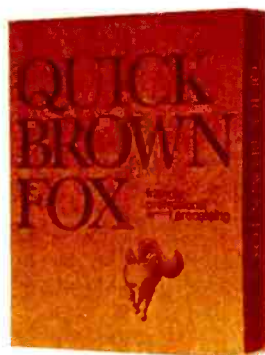

Call or write for our free brochure  
Quick Brown Fox 548 Broadway New York NY 10012  
Dealer Inquiries Invited (212) 925-8290

... NETWORK  
MAZE

I

CompuServe Page CIS-1

CompuServe Information Service

- 1 Home Services
- 2 Business & Financial
- 3 Personal Computing
- 4 Services for Professionals

- 5 User Information
- 6 Index
- 7 Reduced Holiday Rates

Enter your selection number,  
or H for more information.

!4

←  
SIGN-ON

CompuServe Page HOM-1

HOME SERVICES

- 1 News/Weather/Sports
- 2 Reference Library
- 3 Communications
- 4 Home Shopping/Banking
- 5 Groups and Clubs
- 6 Games and Entertainment
- 7 Education
- 8 Home Management
- 9 Travel

Last menu page. Key digit  
or M for previous menu.

!6

PERSONAL COMPUTING SERVICES

- 1 News
- 2 Reference
- 3 Communications
- 4 Shop at Home
- 5 Groups and Clubs
- 6 Programmer's Area

Last menu page. Key digit  
or M for previous menu.

!6

CompuServe Page FIN-1

BUSINESS AND FINANCIAL SERVICES

- 1 News/Reports
- 2 Reference Databases
- 3 Communications
- 4 Brokerage Services
- 5 Banking Services
- 6 Discussion Forum
- 7 Travel Services

- 8 Personal Finance

Last menu page. Key digit  
or M for previous menu.

!m

CompuServe Page SFP-1

Services for Professionals

- 1 Aviation
- 2 Engineering/Technical
- 3 Environmental
- 4 Legal
- 5 Medical

Last menu page. Key digit  
or M for previous menu.

CompuServe Page CIS-4

USER INFORMATION

- 1 What's New
- 2 Command Summary & Usage Tips
- 3 FEEDBACK, Manuals, Products
- 4 Changing Terminal Defaults
- 5 Changing Your Password
- 6 Reviewing Your Charges
- 7 Changing Credit Card Info
- 8 Telephone Access Numbers
- 9 Current Rates
- 10 CompuServe Viewpoint

Last menu page. Key digit  
or M for previous menu.



... NETWORK MAZE

II

CompuServe Page PCS-1

PERSONAL COMPUTING SERVICES

- 1 News
- 2 Reference
- 3 Communications
- 4 Shop at Home
- 5 Groups and Clubs
- 6 Programmer's Area

Last menu page. Key digit or M for previous menu.

From Main Menu CIS-1

CompuServe Page PCS-10

NEWS

- 1 Atari Newsletter
- 2 RCA Newsletter
- 3 Tandy Newsletter
- 4 Microsoft Newsletter
- 5 The Micro Advisor
- 6 Computers & Electronics
- 7 Commodore Newsletter

Last menu page. Key digit or M for previous menu.

CompuServe Page PCS-60

PROGRAMMER'S AREA

If you proceed to the next page you will enter the Programmer's

Area. If you don't have a Personal Computing Guide, we suggest that you return to the previous menu by keying M.

Once in the Programmer's Area you can return to the main menu by typing: R DISPLA

The next page will take you into Programmer's Area.

<ENTER> to proceed; M for Menu

CompuServe Page PCS-50

COMPUTER GROUPS AND CLUBS

- 1 CP/M Group
- 2 HUG (Heath)
- 3 MAUG (Apple)
- 4 MNET-11(H11)
- 5 MUSUS=PASCAL
- 6 RCA Group
- 7 TRS80 Color
- 8 Panasonic
- 9 MNET80 TRS80
- 10 LDD3 TRS80
- 11 VTOS ST80
- 12 TeleComm Now
- 13 CEMSIG
- 14 ALT-10R'S SIG
- 15 Commodore
- 16 Atari Forum
- 17 Instructions
- 18 Descriptions

Last menu page. Key digit or M for previous menu.

To SIGS

CompuServe Page CEM-1

Computers & Electronics Magazine On CompuServe (Formerly Popular Electronics) Computers & Electronics Magazine sponsors this electronic magazine for the benefit of it's readers. The opinions expressed herein are those of the individual making them and not those of the magazine.

Key S or <ENTER> to continue

CompuServe Page CEM-6

CEMSIG - The Computers & Electronics Users Group. This is the area where people with an interest in any branch of Computers, or Electronics can ask questions, or have interactive contact with experts, or other hobbyists. To get into the CEMSIG area, type Go CEM-450 or Press <ENTER>.

CompuServe Page CEM-5

- Computers & Electronics Menu
- 1. New Products Roundup
  - 2. Coming Attractions
  - 3. CEMSIG- The User's Group
  - 4. The Sysop Speaks
  - 5. Letters to The Editor

Last menu page. Key digit or M for previous menu.

CompuServe Page CEM-7

- New Developments Roundup
- 1. Computer Hardware
  - 2. Computer Software
  - 3. Audio Equipment
  - 4. Video, Recording Equipment
  - 5. Semiconductors and IC's
  - 6. Robotics
  - 7. General Products

Last menu page. Key digit or M for previous menu.

To CEM-450 (CEMSIG)

To Feedback

To SYSOP



...NETWORK  
MAZE

# III

From Main Menu CIS-1

CompuServe Page HOM-1

## HOME SERVICES

- 1 News/Weather/Sports
- 2 Reference Library
- 3 Communications
- 4 Home Shopping/Banking
- 5 Groups and Clubs
- 6 Games and Entertainment
- 7 Education
- 8 Home Management
- 9 Travel

Last menu page. Key digit or M for previous menu.

!!

CompuServe Page HOM-10

## NEWS/WEATHER/SPORTS

### News Services

- 1 The Washington Post
- 2 St. Louis Post-Dispatch
- 3 Middlesex Daily News
- 4 AP Viewdata Wire

- 5 NOAA Weather Wire

- 6 Official PGA Tour Guide

Last menu page. Key digit or M for previous menu.

To News Service

CompuServe Page HOM-80

## HOME MANAGEMENT

- 1 Balance Your Checkbook
- 2 Calculate Your Next Raise
- 3 Calculate Your Net Worth
- 4 Amortize A Loan

Last menu page. Key digit or M for previous menu.

To Programs

CompuServe Page HOM-20

## REFERENCE LIBRARY

- 1 Better Homes & Gardens
- 2 Popular Science
- 3 Movie Reviews
- 4 U.S. Government Publications

- 5 Gandolf's Report
- 6 Health-Tex
- 7 The Victory Garden
- 8 Video Information
- 9 National Satirist
- 10 Belmont's Golf Association
- 11 Parenting and Family Life

Last menu page. Key digit or M for previous menu.

To SIGS & Data Bases

CompuServe Page HOM-50

## GROUPS AND CLUBS

- |                           |                   |
|---------------------------|-------------------|
| 1 CBIG                    | 9 NIP SIG         |
| 2 Hamnet                  | 10 Literary       |
| 3 Netwits                 | 11 Educators'     |
| 4 Photo-80                | 12 Arcade SIG     |
| 5 Sports                  | 13 Games          |
| 6 Cooks' SIG              | 14 Family Matters |
| 7 Golf                    | 15 Good Earth     |
| 8 Space                   | 16 Communications |
| 17 Instructions           |                   |
| 18 Descriptions of Groups |                   |

Last menu page. Key digit or M for previous menu.

To SIGS

CompuServe Page HOM-30

## COMMUNICATIONS

- 1 Electronic Mail (user to user messages)
- 2 CB Simulation
- 3 National Bulletin Board (public messages)
- 4 User Directory
- 5 Talk to Us
- 6 Lobby Letters of America
- 7 Ask Aunt Nettie
- 8 CB Society

Last menu page. Key digit or M for previous menu.

CompuServe Page HOM-40

## HOME SHOPPING/BANKING

- 1 Comp-U-Store
- 2 Electronic Banking
- 3 NPR Cassette Gazette
- 4 The Athlete's Outfitter
- 5 Documentation and Art Gallery
- 6 Music Information Service

Last menu page. Key digit or M for previous menu.



# IV

Entry From  
A-PCS-50  
B-CEM-6  
C-With "GO"  
Command at  
any ! Prompt

CompuServe Page CEM-450

Request Recorded,  
One Moment, Please  
Thank You for Waiting

Welcome to CEMSIG, v. 1A(45)

SYSOP on-line  
CompuServe sponsor: BILL LOUDEN 70006,11

Name: SYSOP/STAN 70001,760  
Last or: 26-Dec-82 21:06:46  
High msg#: 6519

You are user number 16375  
System contains messages  
6237 to 6558

Help  
(Available at  
any point)

Section 0 - GENERAL  
Function: sn  
0 - GENERAL  
1 - NEW PRODUCTS  
2 - TI  
3 - IEMPC  
4 - TIMEX/SINCLAIR  
5 - PORTABLE COMPUTERS  
6 - EFSOY COMPUTERS  
7 - SYSOPS  
8 - NEWMEM  
9 - NCRTH STAR  
10 - SOFTWARE INFO.

### Sections

### Messages & Answers

.....  
WELCOME TO THE CEMSIG CD AREA!

REGULARLY SCHEDULED EVENTS  
(Updated 12/17/82)  
-----

Mondays 10:00 pm EST  
SOFTWARE CONFERENCE  
with SYSOP/Randy

Tuesdays 10:00 pm EST  
TI CONFERENCE  
with SYSOP/JIM  
(and/or SYSOP/Randy)

.....

CD Helpful hints-----

/HEL -> List CD Commands  
/EXI -> Exit CD & Return to SIG  
/UST -> Lists CD Users

---> ANNOUNCE YOUR ARRIVAL <---  
---> DON'T BE A LURKER! <---

SYSOP/Stam      SYSOP/Barry  
      SYSOP/Ron  
SYSOP/Jim      SYSOP/Randy

.....

### Conference Area

Function: xa3  
SIG Database Access System  
Use ? for help

SIG Access: cat

[70001,1052]  
VTQC.SUB      11-Dec-82 1725      Accesses: 4    12-Dec-82

[70205,1217]  
FKHEX.IBM      02-Nov-82 4720      Accesses: 25    09-Dec-82  
MODEPH.IBM    02-Nov-82 21305     Accesses: 21    13-Dec-82  
PC-JCS.MOD     04-Sep-82 7545      Accesses: 28    14-Dec-82  
SD4E.IBM       02-Nov-82 2795      Accesses: 21    09-Dec-82

[70215,1017]  
GRAF.FIX       01-Dec-82 375        Accesses: 10    12-Dec-82  
GRAPH.FIX      01-Dec-82 16020     Accesses: 13    12-Dec-82  
HIDUE.IBM       01-Dec-82 520        Accesses: 16    09-Dec-82  
IBLB.R          12-Oct-82 18990     Accesses: 41    09-Dec-82  
IBMD.R.FIX     15-Nov-82 550        Accesses: 23    09-Dec-82  
SWITCH.IBM     01-Dec-82 5875       Accesses: 11    13-Dec-82

[70273,127]  
PELG.FIX       07-Sep-82 4C75      Accesses: 30    13-Dec-82

### SIG Data Base

There are even "outlaws" who violate the rules and delight in taking advantage of the unwary. For example, most of the CB fans use "handles" in place of their real names. They become very attached to these handles and become very upset when one of the "outlaws" uses somebody else's handle to insult someone. An expert can find out the user number of the party he is talking to (which should match the known "handle"), but a newcomer does not have the experience to do this.

Another "outlaw" trick is to get a newcomer to give out his secret password. The outlaw then uses the number and password to charge time on the network to the victim's account. This can go on for over a month, or at least until the victim gets the huge bill for time and services. So, never give anyone your password on the network even if he claims to work for the network. That is a common outlaw trick. Change your password every once in a while just to be cautious, but don't forget it! If you forget your password, even CompuServe can't get it for you. Only you and the computer know your password, and it is stored in the computer in a coded form that none can decode. All they can do is issue you a new one, and that can take a couple of weeks. There are also pranksters on the network who delight in playing tricks on others. One of these is the notorious Ninja 4 who can blank his victim's screen or even blast him off the network! Sometimes he just causes the victim's computer to sound its horn or bell without control of the user!

**SIGS and Conferences.** Conference areas on the SIGS are a very interesting place to "visit." The conference areas are like the CB channels except that they are channels devoted just to the Special Interest Groups (Illustration IV). They are used by SIG members who want instant communication with other members rather than leaving messages to be answered in the future. They are also used for general

scheduled conferences attended by all the members of the SIG who care to participate. Usually they are moderated by one or more of the SYSOPs who keep things going.

Often the conference will start at 9 p.m. Eastern Time and people across the country join in as the time zone moves to Central, Mountain and Pacific times. Sometimes there will be a SYSOP in each time zone to conduct the meeting, but more likely people just stay up late to talk to others across the nation. There are special protocols used to control the conference. If these controls did not exist, the conference would be like a room full of people all talking at the same time. When a person is typing a message, it appears on his screen. At the same time, the messages sent by the others appear interleaved with his text. This can be a little difficult to get used to when several people take turns sending messages while you are typing.

The important thing to realize is that your message does not appear on anyone else's screen until you hit RETURN (CR). When you do, your message is sent to all those signed on to the conference. If you have more to say than can be typed in one line, you end your line with a series of dots. This tells all the other members that you have more to send. When you are finished, you indicate it by sending GA (for Go Ahead). Then someone else picks up the conversation.

One of the newest features on the Conference Areas of the SIGS is the interview with a well-known person. This is usually scheduled in advance so that everyone knows about it. In fact, notices are put on all the various SIGS that so-and-so is going to appear at a certain time and SIG. The interview is conducted by the SYSOP with all members getting a chance to ask questions. For those who can not attend, a recorded conversation is stored in the SIG Data Base.

Each Special Interest Group has an area of disk storage used for the storage of text or program material. This is one of the most useful features of CompuServe. The collection of public-domain software on the SIGS attracts more people than

almost anything else. For example, the CP/M Users Group software is available on the CP/M SIG and quite a lot of excellent IBM-PC, and TI software is on CEMSIG. In addition to software in the SIGS, there is a lot of software in the Public Access Areas in the Programmers Section (formerly Micronet) of CompuServe.

It is the contribution of the SYSOPs that sets CompuServe apart from other networks. They bring a sense of human participation that mere contact with a computer cannot duplicate. When the network's primary purpose is to allow access to various data bases, human intervention is not necessary; but in interactive areas, there is no substitute for the SYSOPs.

When CompuServe first started, the hobbyist (nonprime-time) area was called Micronet, and it consisted of Bulletin Boards where people could post messages of all kinds. It also had a programming area with computer languages and word processors that could be used in place of a subscriber's home computer. With the development of the SIGS and game areas, this type of usage became less important and, today, it is used mainly by the "experts." Once a subscriber becomes experienced he should try using these areas for programming and mass data storage capabilities.

**Games.** No mention of the networks would be complete without a discussion of the Games area. There are three types. First are conventional games like Blackjack and Hangman. Second, come the interactive adventure and role-playing games. Finally, there are the interactive war games like DecWars, where you fight against both the computer and other gamers. The biggest game feature on CompuServe is Megawars, a super-role-playing/war game that a subscriber can join and become a character that fights for either side.

Not to become too one sided, CompuServe does not neglect the arts. It has a Literary SIG for serious writers and poets. ◇

*(In Part 2 of this article, we will continue with The Source, Dow Jones Network, BRS After Dark, and others.)*



# THE VIDEO CONNECTION

*An equipment hookup guide  
for using video cassette recorders  
with cable TV*

*By Dave Trowbridge*

**C**ABLE television is becoming a major factor in the "video revolution." To a video recording enthusiast, it looks like a dream come true: a seemingly limitless video "library" at one's fingertips. As a result, video equipment manufacturers are scrambling to add cable-oriented features to their products. There are now cable-ready TV and VCR tuners that promise the ability to "browse" through 127 or more channels with a handheld remote control. Some video recorders can be programmed to automatically record up to eight "events" on different channels over a 21-day period, and all video recorders offer the option of recording one channel while watching a different one.

Unfortunately for many videophiles, much of the video gear now available is still not wholly compatible with most modern cable systems. Consequently, if you subscribe to cable and are planning to buy a new television receiver or a video recorder, you should consider your purchase carefully. Otherwise, you may find that your cable system offers more channels than your "cable-ready" set will tune; that it has "offset" channels that your PLL tuner ignores; or that some of the channels on it are scrambled, which can compromise or eliminate important features of your video system. You may even find that you cannot record the channels you pay extra for!

If you already own equipment that is limited by the design of your cable system, don't despair. The

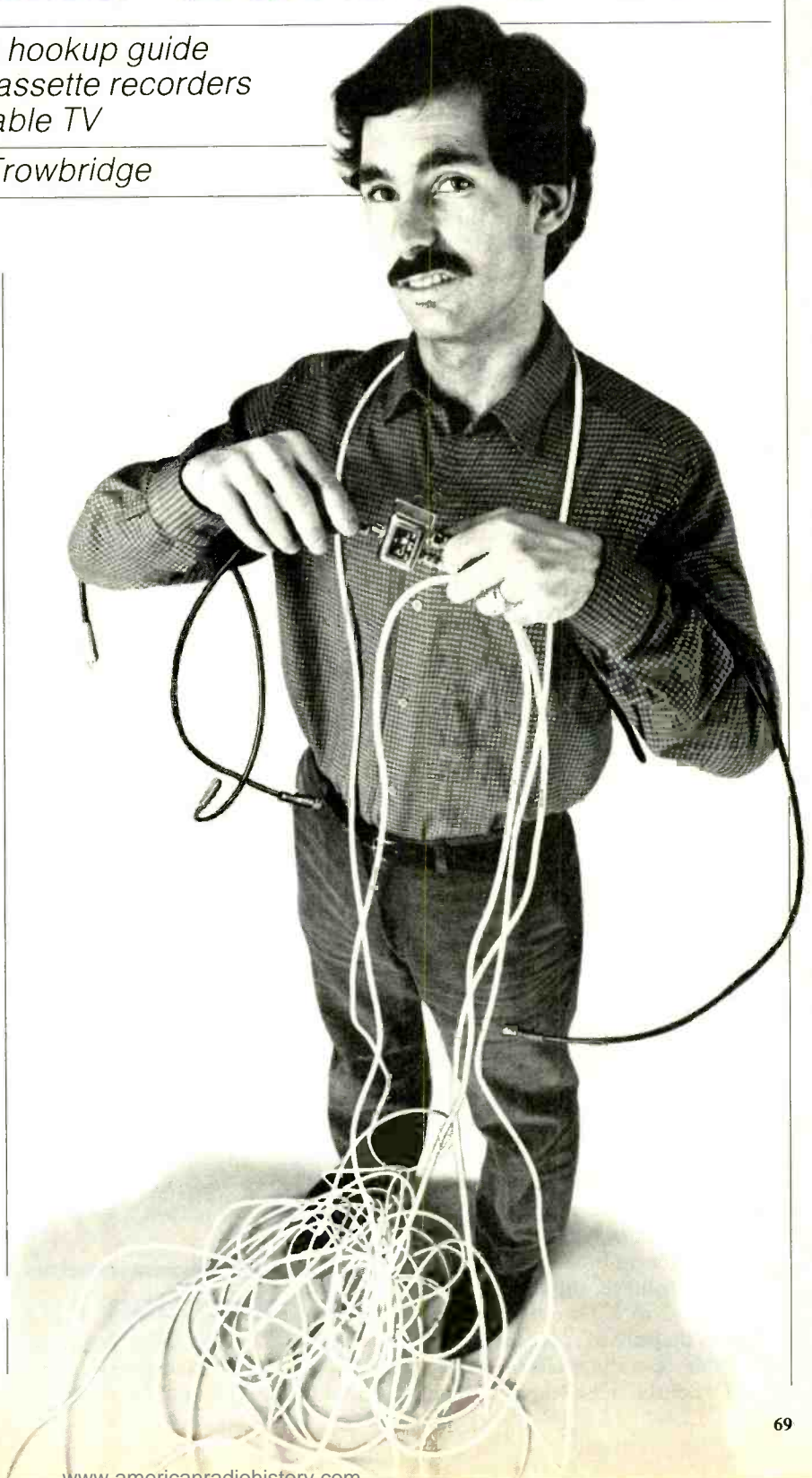

“block converter,” a device that converts a whole “block” of vhf channels into uhf channels, may be all you need. On many cable systems (though not all) this versatile video accessory can restore remote channel control, multi-channel programmability, and watch/record versatility to your equipment—features eliminated entirely on many cable systems. It can even be used to deliver the output of a video component or r-f switcher to every television in your home over the existing cable wiring, without interfering with a TV set’s remote control function.

**Cables and Recording.** Though there are many aspects of cable system design that can affect your television or video recorder, three in particular are most likely to limit the usefulness of your video system: the number of channels carried, the presence of “off-set” (off-frequency) channels, and the use of “programming security systems” to prevent unauthorized (free) reception of certain channels.

Although 60% of all cable systems still have twelve channels or fewer, a state-of-the-art system can transmit frequencies as high as 450 MHz, giving it a 66-channel capacity. A “dual-cable” system, one which runs two trunk lines to each neighborhood and two drops to each subscriber, can carry 132 channels. Extending a cable system’s bandwidth beyond this point would be quite expensive, and would be liable to interference from broadcast uhf stations (470 MHz and higher), especially since most televisions have unshielded uhf tuners (not to mention the fact that there’s not even enough programming available yet for the existing channels!).

Some of the problems encountered in cable use result from the frequencies allocated to cable and their relation to broadcast frequencies. For instance, the standard vhf channels (2 to 13) are the same on cable as they are over the air, unless the cable operator “offsets” them. Until recently, most televisions had

**CABLE CHANNEL CONVERSION CHART**

VHF BANDS	Low-band (Standard)	Mid-band (Special)
Numeric Designation	2 3 4 5 6	14 15 16 17 18 19 20 21 22
Appears on UHF Channel	42 43 44 45 47	54 55 56 57 58 59 60 61 62
Alphanumeric Designation	2 3 4 5 6	A B C D E F G H I

VHF BANDS	High-band (Standard)	Super-band (Special)
Numeric Designation	7 8 9 10 11 12 13	23 24 25 26 27 28 29 30 31 32 33 34 35 36
Appears on UHF Channel	83 84 85 86 87 88 89	70 71 72 73 74 75 76 77 78 79 80 81 82 83
Alphanumeric Designation	7 8 9 10 11 12 13	J K L M N O P Q R S T U V W

unshielded tuner sections. Since there can be only one station broadcasting on a channel in a given area, there was nothing to shield against. On a cable system, however, the off-the-air channel 7, for example, can interfere with cable channel 7, causing “herringbone” or moire patterns in the picture. Some television sets, even “cable-ready” ones, still don’t have shielded tuners, however, and are subject to this “co-channel interference.”

Another related problem is caused by cable use of many of the same frequencies allocated to land mobile services, such as fire and police departments, and aeronautical radio. This is a source of intermittent “herringbone” on some cable channels, and sometimes you can even hear police calls on your TV set. This, too, can be due to a poorly shielded tuner, or, like co-channel interference, a result of deficiencies in the cable system itself (corroded connections, defective coaxial cables, etc.).

Until recently, all television receivers were equipped with 82-channel tuners capable of tuning the 12 standard vhf channels and 70 uhf channels (Congress mandated the inclusion of all uhf channels in 1964). Since cable television systems do not use the uhf band, once they began expanding beyond a 12-channel capacity some form of converter became necessary to enable their subscribers to tune in the additional channels.

connection No. 1. The channel conversion chart at the top of this page shows where the special vhf channels end up on the uhf band on one block converter.

This is still a useful hookup in some cases, but a block converter has certain channel and performance limitations so the cable industry turned to set-top tuner-converters.

A settop converter selects channels one-by-one and converts them to a single vhf channel, usually channel 3 or 4. Since the converter only delivers one channel at a time, it eliminates the remote channel control feature of any television set connected to it because the television must be tuned only to the out-

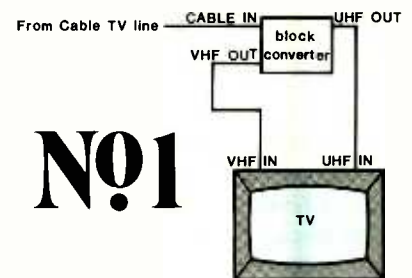

put channel of the converter. The cable industry has gradually introduced remote-control set-top converters. However, television receiver manufacturers have also been building so-called “cable-ready” tuners that can receive cable channels without the use of an external converter, thus retaining remote control.

The first cable-ready sets had 91-channel tuners (12 standard vhf, 9 special vhf and 70 uhf). Later sets had a 105-channel capability (12 standard vhf, 23 special vhf, and 70

**Connection 1**

At first the cable industry used a block converter to change the additional channels to uhf as shown in



# Get all the facts about the IBM Personal Computer.

## Get PC™ Magazine!

**W**hether you already own an IBM Personal Computer or you're thinking about buying one, you need *PC Magazine*.

*PC Magazine* is the independent guide to IBM Personal Computers. Each monthly issue is packed with the latest information for everyone who's interested in IBM Personal Computers.

This is *the* magazine for finding out how to put together the best IBM "PC" system... and how to get the most out of it. Every month you'll receive hundreds of colorful pages of evaluations, insights, and straight talk from respected experts—professionals in computer science as well as lawyers, businessmen, writers, educators and many others.

*PC* covers software, hardware, applications, and every other topic of importance to the thousands of IBM Personal Computer users who read it. To make sure that we give you the facts you need, we include a special "User-to-User" section, a "PC Wish List," and news about IBM Personal Computer clubs, events and publications.

Right now you can save up to 33% on an introductory subscription. And if you're ever dissatisfied with *PC*, just write and tell us—you'll receive a prompt refund for all the unmailed issues remaining in your subscription.

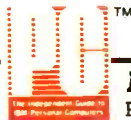

### PC™ Magazine

P.O. Box 598, Morris Plains, NJ 07950

**Yes!** I want to subscribe to *PC*, the independent guide to IBM Personal Computers:

- One year (12 issues) only \$19.97—20% off!
- Two years only \$36.97—26% off!
- Three years only \$49.97—33% off!

Savings based on full one-year subscription price of \$24.97.

**CHECK ONE:**  Payment enclosed.  Bill me later.

8H01

Mr./Mrs./Ms. \_\_\_\_\_  
(please print full name)

Company \_\_\_\_\_

Address \_\_\_\_\_

City \_\_\_\_\_ State \_\_\_\_\_ Zip \_\_\_\_\_

Offer valid only in the U.S. its territories and possessions. Please allow 30 to 60 days for delivery of first issue.

uhf), and now some televisions can tune as many as 142 channels. While certainly useful, the cable-ready feature is somewhat over-rated, for the use of offset channels and scrambling can often render such a tuner unusable.

As channels are added to a cable system, it becomes increasingly difficult to avoid intermodulation distortion from trunk amplifiers and other active components in the system. These distortion products can cause "herringbone" or moire patterns on the screen. In systems with fewer than 35 channels these effects can be greatly diminished by offsetting the frequencies of selected channels in a way that eliminates the worst intermodulations. In systems with more than 35 channels it is usually necessary to install an HRC (Harmonically Related Carrier) headend. In an HRC system all visual carriers are coherent (in phase) and are harmonics of a 6-MHz master oscillator. This means that any distortion generated in the system will fall "zero-beat" on a visual carrier. Thus, it will look like a harmonic of that carrier and will be ignored by the tuner circuitry. An HRC system offers a minimum 6-dB improvement in distortion levels, but all of its channels are 1.25 MHz lower than their "normal" frequencies, except for channels 4 and 5, which are 0.75 MHz higher. Some cable systems may use an IRC (Incrementally Related Carrier) system. This is similar to HRC but lacks the master oscillator and has fewer offset channels.

Offset channels are not a problem if you have a television receiver or video recorder with manual fine-tuning, but many of the latest advanced sets have PLL (phase-lock loop) tuners. Such a tuner generally has a "capture range" (the range within which it will look for a channel) of only  $\pm 125$  kHz around the nominal frequency of a channel, and no fine-tuning adjustment. Therefore, it cannot tune-in an offset channel. However, some PLL tuners are now equipped with a variable-range aft (automatic fine tuning) circuit (usually a switch la-

belled AFT: NORM/CABLE) that can be set for a wider capture-range. Many do not, though, and cannot tune-in offset channels.

If you have a set with a PLL tuner that does not have a variable aft range, and your cable system is an IRC type, you will have to use the set-top converter supplied by the cable company whether or not your set is cable-ready, and you will lose the use of the remote channel control on your TV set (or VCR).

## Connection 2

If your cable system is HRC or has only a few offset channels, you can connect a block converter as shown in connection No. 2 to maintain a measure of remote channel control.

On a HRC system, adjust the local oscillator of the block converter to bring the up-converted channels back to viewable frequencies on uhf, but channels 4 and 5 will have to be selected on the set-top converter because of their different offset.

**Programming Security.** Many cable systems offer several levels of service, called tiers. Some may offer up to ten tiers, but two or three-tier systems are most common. A tier may consist of just one additional channel (such as a movie channel) or of several. Each tier that you add to your cable subscription costs additional money.

The first tier, usually called "basic," often consists of just the 12 standard vhf channels that any TV set can receive. Additional tiers may add services such as ESPN or CNN, the superstations like WTBS and WGN, or movie services such as HBO and Showtime, and may require the use of a set-top converter.

Since so many TV sets and video recorders now have cable-ready tuners (over half the televisions sold this year will), and because a block converter can make any set cable-ready, many cable operators protect their higher tiers with some sort of programming security to prevent free reception. There are many different security systems available. A cable operator will choose one based on three parameters: cost, se-

curity (how easy is it to "cheat"?), and transparency (how much does it affect the channel it protects?).

There are two basic types of programming security: trapping and scrambling. Trapping involves the use of a notch filter tuned to suppress a specific channel. If a subscriber decides to add a trapped channel to his service, the cable company sends an installer out to remove the trap, which must be re-installed if the subscriber later cancels that channel. Traps are completely transparent, moderately secure, and best of all from a videophile's standpoint, have no effect on the operation of a video system.

If your equipment is cable-ready, then once the trap is removed, you get the channel. Unfortunately, traps are somewhat more expensive than the alternative (scrambling) due to the labor costs incurred every time a trap must be removed or re-installed. To get around this problem, some companies have developed "addressable" traps that can be turned on and off at the headend.

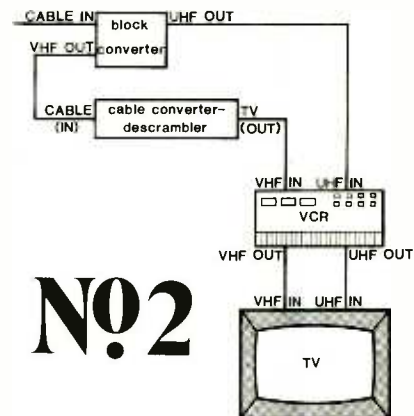

A scrambling system electronically distorts a pay channel in the headend while a set-top converter-descrambler in the subscriber's home descrambles it for viewing. A cable-ready tuner cannot tune a scrambled channel, of course. The number of cable systems using a scrambling system is growing rapidly because the cost of the electronics needed has fallen drastically in the past few years.

Scrambling methods can be divided into three basic types: video inversion, line switching, and sync-pulse modification. In the first, the



## ...CABLE CONNECTION

video signal is inverted with respect to the sync pulse. Line switching is a rather esoteric system in which the headend actually scrambles the order of the scanning lines in each video field.

Sync-pulse modification is the most popular type of scrambling. There are four methods: the sync pulse may be inverted; it may be suppressed (reduced in level 6 dB or so); its width may be reduced to make it too "fast" for the receiver to detect; or pseudo-random sync pulses may be added. Some systems use a combination of these methods.

In almost all scrambling systems a decoding signal (called a "tag") is sent out by the headend to tell the converter-descrambler how to descramble the picture; and on most cable systems, the tag is amplitude-modulated onto the FM audio carrier of the scrambled channel. Since the limiter in an FM tuner strips the carrier of any AM, this tag cannot affect sound quality.

The transparency of these systems varies. One scrambling system uses an analog decoding signal on the audio carrier, and any number of problems in the cable system, from the headend to the line amplifiers, can induce unwanted AM onto that FM carrier. The decoder circuit interprets this as part of the decoding tag and generates a misshapen sync pulse that your television receiver or video recorder cannot lock to. Ironically, it is often older sets that are least affected by this problem, while newer sets are generally affected, especially those without manual vertical and horizontal-hold controls. There is very little you can do about this particular problem except wait for your cable operator to find the source of the unwanted AM. (If the problem affects only your VCR, so that you can watch movies but not record them, your request for service may be assigned a very low priority on the repair schedule.)

More modern scrambling systems use a digital tag on the audio carrier that cannot be influenced by extraneous AM. Not only is such a system more transparent, but a ca-

ble operator can assign a different digital code to any or all channels and control the availability of each channel in each home by means of a computer interfaced with the headend. Such a system, called "addressable," can even be combined with interactive circuitry to create a "pay-per-view" system, where the subscriber pays only for those programs he or she selects on the set-top converter/decrambler. The "addressable" concept is so attractive to the cable industry that more and more operators are making every channel addressable (every channel scrambled).

To understand how the presence of even one scrambled channel eliminates several important features of your video system, let's look at three ways a VCR and a TV set can interface with a cable system with some (not all) scrambled channels.

### Connection 3

The television and the video recorder can receive only the channel selected on the converter/decrambler, whether they're cable-ready or not in connection No. 3. You can record any channel, scrambled or not, but you can't watch a different channel from the one you're recording. You can automatically record several events on a single channel, but you can't program your VCR to record different channels at different times unless someone is present to select the channels

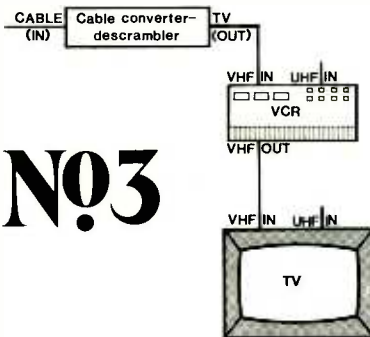

# No.3

on the settop converter. If your television has a remote channel control, it won't work.

### Connection 4

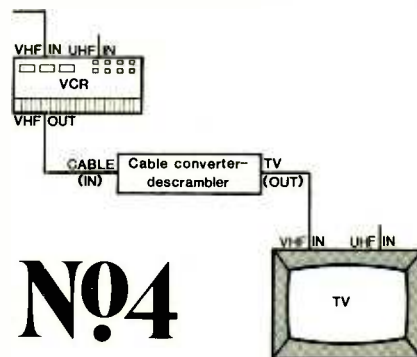

# No.4

In connection No. 4, the video recorder can record any *non*-scrambled channel that it can tune-in, and it can program any combination of those channels. The television can tune in any channel, but its remote channel control still doesn't work. You can watch any channel while recording any non-scrambled channel, but you can't record the channels you're paying extra for. If your VCR is not cable-ready, this hookup is particularly limiting.

### Connection 5

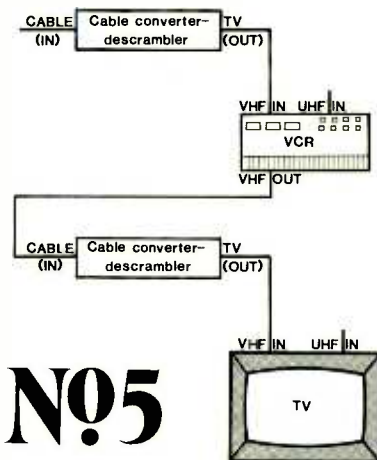

# No.5

An additional converter/decrambler rented from the cable company and used as shown in connection No. 5 can give you full watch/record versatility *and* the ability to record scrambled channels. You still won't have full, multi-channel programmability (and you're paying \$3 to \$5 a month for the extra converter). But if you subscribe to a fully addressable system with every channel scrambled, this is the best you can do, although you'll still be doing without remote control.

**The Block Converter.** The three connections above have one thing in common: the uhf inputs of both the television and the video recorder are

unused. On an 82-channel set this means that more than 85% of the tuner's channel capacity is left out. It is this fact that makes the block converter such a good accessory. Not only can it be used to make any 82-channel television set or VCR

cable-ready by up-converting the cable frequencies to uhf, it can also give your video system access to both scrambled and nonscrambled channels at the same time, thus restoring a measure of multi-channel programmability, remote channel

## How A Block Converter Works

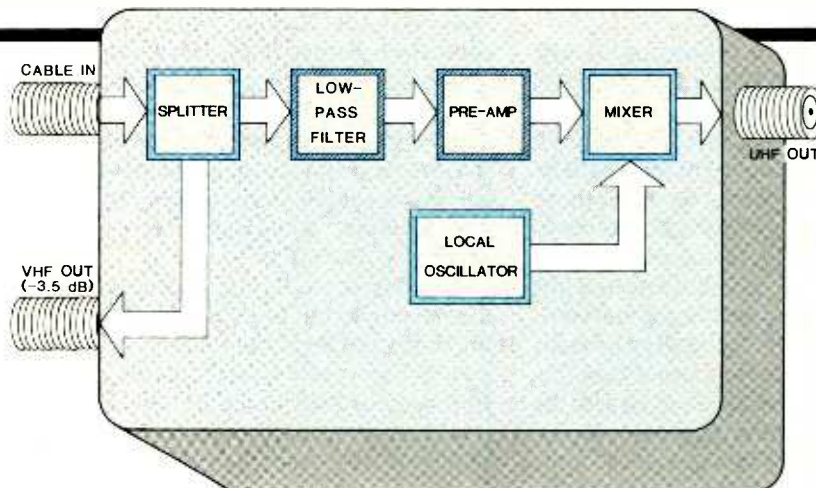

A block converter "beats" an internally generated frequency against a "block" of incoming vhf channels in order to up-convert them to uhf channels. Circuits in solid outlines in the block diagram are found in all block converters; those in dotted outlines only in more advanced models.

As the signal enters the block converter it is split, and a portion is returned to the VHF OUT port so that standard vhf channels can be tuned in their normal positions (as in connection No. 1), or so that a converter/descrambler can be used to access scrambled channels (as in connection No. 2).

After the splitter, some block converters use a low-pass filter, generally at a frequency around 330 MHz. This helps prevent or limit intermodulation distortion caused by the presence of channels higher than the block converter can handle. (The second harmonic of the local oscillator beats against the higher channels, generating a frequency that interferes with the lower channels.)

After the filter, some block converters have a preamp to compensate for the loss caused in the mixer section. This is quite an important feature because the uhf output of a block converter, if it is converting many channels, cannot be amplified; there is no uhf amplifier that can handle twenty to thirty adjacent channels without incurring unacceptable intermodulation distortion in the picture.

The local oscillator generates the frequency to be beat against the incoming vhf channels. This frequency is generally between 540 and 590 MHz. For instance, if channel 2 (54 to 60 MHz) is beat against a 584-MHz oscillator, the result is uhf channel 42 (638 to 644 MHz). The lower the frequency, the more channels the block converter can up-convert before it runs into the limit imposed by the size of the uhf

band. (You can't up-convert to a channel higher than 83.) However, intermodulation effects limit any block converter to about 36 channels no matter what oscillator frequency is chosen.

The local oscillator should be tuneable over a range of at least  $\pm 6$  MHz in order to compensate for offset channels and to allow re-tuning to avoid co-channel interference on a specific channel from a local uhf station.

Finally, in the mixer section, the actual heterodyne conversion takes place. Its output is the UHF OUT port of the block converter. The outputs of a typical block converter are shown in the cable conversion chart.

**Disadvantages.** As useful as a block converter can be, it has several limitations that can prevent it from operating satisfactorily in some situations. First, it has a limited "dynamic range." Most block converters can accept signal input levels over a range of only about 10 to 15 dB. Less than the rated input range yields a noisy (grainy) picture and intermodulation distortion (herringbone); more generates even worse intermodulation.

Second, its uhf output, as mentioned above, cannot be amplified unless it is handling only one channel at a time. This, taken with the dynamic range limitation, means that a single block converter can rarely be used to supply an up-converted multi-channel signal to more than two VCRs or televisions simultaneously. Of course, you can use separate block converters for each set, but that runs into money!

Third, a block converter is not completely compatible with some PLL tuners. In the frequency allocations, there is a space between channels 4 and 5. This space is less than one channel (6 MHz) wide. When a

block converter up-converts the low-vhf band it reproduces this spacing, but there is no corresponding space in the uhf band. This creates offset uhf channels that some PLL tuners cannot manage. The only (partial) solution is to tune the local oscillator of the block converter so that channels 5 and above are on-frequency, and use the set-top converter to tune channels 2, 3, and 4 (connection No. 2).

Last, but not least, the noise generated by the up-conversion process increases with the number of channels converted, due to unavoidable nonlinearities in the circuitry. If you are most concerned with the image quality of your recordings, it is best to sacrifice some convenience and up-convert only a single channel at a time (connection No. 6).

**Selecting a Block Converter.** Since a block converter can increase the versatility of your video system enormously, it's important to choose a good one. As discussed above, a block converter should have a preamp and a low-pass filter on the input especially if your cable system has more than 36 channels.

It should be temperature and voltage stabilized, a feature of extreme importance for programmed recordings. If the block converter drifts off frequency due to a voltage brown-out or a temperature change (many people turn their thermostats down when going out), your VCR, which you set to record two movies and an important football game, may end up recording only noise, or an entirely different channel!

A block converter should be FCC and UL approved. All converters require what is called Part 15 approval since they generate an r-f signal. Some cable operators will not let you use an unapproved block converter.  $\diamond$



control, as well as watch/record versatility.

There are many ways to connect a block converter to accomplish this. The best way for you will depend on the nature of your cable system, which of the features of your video system are most important, and what kind of tuner your television set or VCR recorder has. In the following hookups we'll consider two kinds of tuner: "direct-access" and "preset."

A "direct-access" tuner is one that can tune-in any channel in its range directly without presetting. The old-fashioned "two-knob" mechanical tuners and the latest electronic tuners with "calculator keyboard" or "ten key" controls are both direct access. A cable-ready direct-access tuner (105 or more channels) *cannot* tune uhf and special vhf cable channels at the same time, unfortunately. Such tuners have a switch on the control panel (generally labeled CATV/NORM) that defeats the cable-ready feature when uhf reception is desired. (Remember to use this switch when employing a block converter with this kind of tuner.) Almost all cable-ready televisions have direct-access tuners. A few of the most recent VCRs do, too, giving them greater programming versatility than VCRs with "preset" tuners.

A "preset" tuner is one that must be preset to the channels you want to receive. These generally have 12 or 14 tuning positions, each of which can be set to any channel within the tuner's capability. Channels not preset cannot be received without manually re-tuning the set. Unlike a direct-access tuner, a cable-ready preset tuner *can* receive uhf and special vhf cable channels at the same time. Up until very recently all programmable video recorders had preset tuners.

The most commonly used block converter installation however, was illustrated by connection No. 2. It is best for the following situations: (1) if you have a programmable video recorder, noncable-ready or direct-access cable-ready, and programmability is the most important fea-

ture to you; or (2) if you have a direct-access television (cable-ready or not) or a noncable-ready preset television, and you want the maximum number of channels available for remote control and maximum watch/record versatility.

When this hookup is used with a preset tuner, one of the tuner's positions should be set to the vhf output channel of the converter/descrambler so that you can watch or record the scrambled channel (s). The remaining positions should be tuned to the nonscrambled channels of your choice on their up-converted uhf equivalents. You'll have to make some choices here, since your cable system will likely have more nonscrambled channels than your preset tuner has tuning positions. Of course, any channel can be tuned-in by selecting it on the converter/descrambler.

As an example of what this hookup can do, assume you have a programmable VCR with a 14-position preset tuner and a remote-control TV with a direct-access tuner. With connection No. 2, you will be able to program any combination of 13 nonscrambled channels you've preset on the VCR's tuner *plus* one scrambled channel from the converter/descrambler. You cannot program two different scrambled channels. You can watch any non-scrambled channel or one of the scrambled channels while recording that same scrambled channel or one of the 13 preset channels, and you have all of the nonscrambled channels plus one scrambled channel at a time available for remote channel control.

Note that in this hookup, if your cable system has more channels than your block converter can han-

dle, those channels beyond its range will count as scrambled, since the only way to tune them is through the converter/descrambler.

Some video recorders have a single, combined vhf and uhf input and output (Sanyo, Sears, and Toshiba, among them). If you have this kind of VCR you will have to use a vhf/uhf separator/joiner to combine the vhf and uhf lines before the video recorder. The use of this separator/joiner does not change the operation of the block converter installation in any way.

## Connection 6

Use connection No. 6 in the following situations: (1) if you have a cable-ready preset VCR and programmability is the most important feature, (2) if you have a single-knob preset television and you want the maximum number of channels available for remote control or watch/record versatility or (3) if your cable system has only the 12 standard vhf channels plus the scrambled channel (s).

Since a cable-ready preset tuner can tune uhf and special vhf simultaneously, you can record any non-scrambled channel directly on vhf, and any scrambled channel up-converted to uhf after it has passed through both the descrambler and the block converter. A significant advantage of this installation is that you get cleaner recordings because the block converter is up-converting only one channel at a time and is less subject to intermodulation distortion.

Connection No. 6 is used with a single-knob preset television when remote control is important because

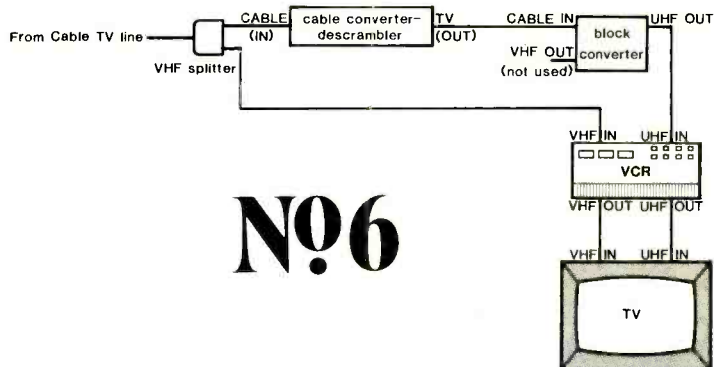

**No. 6**



**400**  
**16K.....\$199**  
**32K.....\$274\***  
**48K.....\$359\***

**800**  
**48K.....\$499**

\*Non-Atari Ram

410 Recorder.....	\$74.00
810 Disk Drive.....	\$429.00
822 Printer.....	\$269.00
825 Printer.....	\$589.00
830 Modem.....	\$159.00
820 Printer.....	\$259.00
850 Interface.....	\$169.00
CX40 Joysticks (Pair).....	\$ 18.00
CX853 Atari 16K Ram.....	\$ 77.95

Axlon Ramdisk (128K).....	\$429.95
Intec 48K Board.....	\$159.00
Intec 32K Board.....	\$ 74.00
One Year Extended Warranty.....	\$ 70.00
CX481 Entertainer Package.....	\$ 69.00
CX482 Educator Package.....	\$130.00
CX 483 Programmer Package.....	\$54.00
CX 484 Communicator Package.....	\$344.00
Atari 800 Dust Cover.....	\$6.99
Atari 400 Dust Cover.....	\$6.99
Atari 810 Dust Cover.....	\$6.99

# PERCOM

## Disk Drives

AT 88-S1.....	\$399.00
AT 88-A1.....	\$289.00
RFD 40-S1.....	\$539.00
RFD 40-A1.....	\$329.00
RFD 40-S2.....	\$869.00
RFD 44-S1.....	\$659.00
RFD 44-S2.....	\$999.00



## μ-SCI

### MICRO-SCI

#### Disk Drives For Franklin & Apple



A2.....	\$299.00
A40.....	\$349.00
A70.....	\$459.00
C2 Controller.....	\$79.00
C47 Controller.....	\$89.00

### ATARI

Pac Man.....	\$33.00
Centipede.....	\$33.00
Caverns of Mars.....	\$32.00
Asteroids.....	\$29.00
Missile Command.....	\$29.00
Star Raiders.....	\$35.00

### DATASOFT

Pacific Coast Highway.....	\$25.00
Canyon Climber.....	\$25.00
Tumble Bugs.....	\$25.00
Shooting Arcade.....	\$25.00
Clowns and Balloons.....	\$25.00
Graphic Master.....	\$30.00
Graphic Generator.....	\$13.00
Micro Painter.....	\$25.00
Text Wizard.....	\$79.00
Spell Wizard.....	\$64.00
Bishop's Square.....	\$25.00

### ON-LINE

Jawbreaker.....	\$27.00
Softporn.....	\$27.00
Wizard and the Princess.....	\$29.00
The Next Step.....	\$34.00
Mission Asteroid.....	\$22.00
Mouskattack.....	\$31.00

### SYNAPSE

File Manager 800.....	\$69.00
Chicken.....	\$26.00
Dodge Racer.....	\$26.00
Synassembler.....	\$30.00
Page 6.....	\$19.00
Shamus.....	\$26.00
Protector.....	\$26.00
Nautilus.....	\$26.00
Slime.....	\$26.00
Disk Manager.....	\$24.00

### K-BYTE

Krazy Shoot Out.....	\$32.00
Krazy Kritters.....	\$32.00
Krazy Antics.....	\$32.00
K-star Patrol.....	\$32.00

**STICK STAND**  
**\$6<sup>99</sup>**



## VISICORP

### For Apple, IBM, Franklin

Visidex.....	\$189.00
Visifile.....	\$189.00
Visipilot.....	\$159.00
Visiterm.....	\$89.00
Visitrend/Plot.....	\$229.00
VisiSchedule.....	\$229.00
Desktop Plan.....	\$189.00
VISICALC.....	\$179.00

for Apple II plus, Atari, CBM & IBM

### Continental

The Home Accountant (Apple/Franklin).....	\$59.00
The Home Accountant (IBM).....	\$119.00
1st Class Mail.....	\$59.00

## FLOPPY DISKS

### Maxell

MD I (Box of 10).....	\$32.00
MD II (Box of 10).....	\$44.00
MFD I (8").....	\$40.00
MFD II (8" Double Density).....	\$50.00

### Verbatim

5 1/4" SS DD.....	\$26.00
5 1/4" DS DD.....	\$36.00

### Elephant

5 1/4" SS SD.....	\$19.99
-------------------	---------

## TIMEX

**TIMEX SINCLAIR 1000**

**LOWEST PRICE EVER!**  
**\$89.99**

### ALIEN VOICE BOX

Apple/Franklin (Disk).....	\$159.00
Atari (Disk or Cassette).....	\$129.00

## FRANKLIN ACE1000



64K Personal Computer  
 Hardware, Software and peripheral compatible with the Apple II and even has some features not found on the Apple.

## MONITORS

### AMDEK

100 B & W.....	\$74.95
300A.....	\$179.00
300G.....	\$169.00
Color I.....	\$339.00
Color II.....	\$399.00
Color III.....	\$429.00

### BMC

12" Green.....	\$79.00
13" Color 1400.....	\$279.00
13" Color 1401 (Mid Res).....	\$369.00

### ZENITH

ZVM 121.....	\$ 99.00
--------------	----------

### SHARP

Sharp 13" Color TV.....	\$275.00
-------------------------	----------

### PANASONIC

TR-120 MIP (High Res. Green).....	\$159.00
CT-160 Dual Mode Color.....	\$299.00

**west**  
**800-648-3311**

IN NV. CALL (702)588-5654  
 P.O. BOX 6689, STATELINE, NV. 89449

**east**  
**800-233-8950**

IN PA. CALL (717)327-9575  
 477 E. THIRD STREET, WILLIAMSPORT, PA. 17701

In-stock items shipped same day you call. No risk, no deposit on C.O.D. orders. Pre-paid orders receive free shipping within the continental United States with no waiting period for certified checks or money orders. Add 3% (minimum \$3.00) shipping and handling on all C.O.D. and Credit Card orders. NV and PA residents add sales tax. All items subject to availability and price change. **NOTE:** We stock manufacturer's and third party software for most all computers on the market! Call today for our new catalogue.



...CABLE CONNECTION

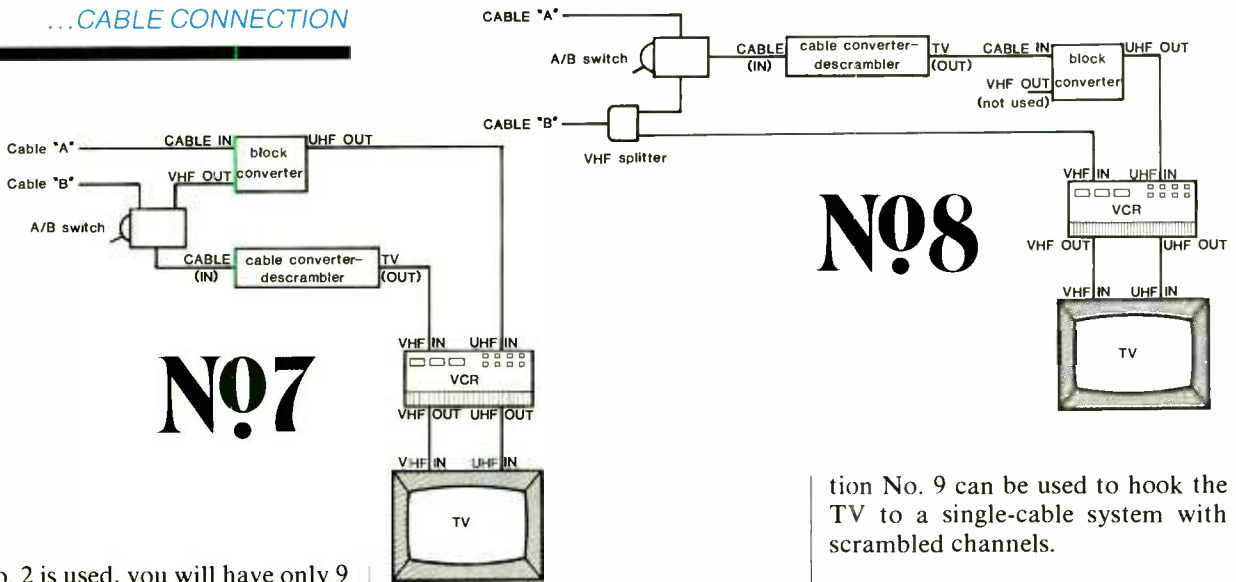

if No. 2 is used, you will have only 9 channels available for remote selection: 8 uhf plus one vhf (the vhf can't be re-tuned to uhf). With connection No. 6, you get 13 channels for remote control: 12 vhf plus one uhf. The watch/record versatility of the system is improved for the same reason.

Finally, if your cable system has only the 12 standard vhf channels plus the scrambled channel(s), it doesn't make sense to up-convert channels that your tuner can receive directly, so use connection No. 6.

**Dual Cable Systems.** A dual-cable system is no more than two single-cable systems combined into one, with an A/B switch to select which of the two will be accessed by the converter/descrambler. In the following hookups the A/B switch is shown separately for clarity. The hookups that follow are variants of Nos. 2 and 6, except that here we must consider the distribution of the channels on two cables. Some dual-cable systems put all the scrambled channels on one line and the rest on the other. Other systems may put the basic tier on one cable and all remaining tiers on the other. Space prohibits listing all the possible combinations, but here are two installations that will be useful with most dual-cable systems.

**Connection 7**

Connection No. 7 is a variation of No. 2. You can program or remotely control any combination of

nonscrambled channels from Cable A plus any one channel (scrambled or not) from A or B and watch or record any channel. If A has no scrambled channels, the A/B switch is unnecessary.

**Connection 8**

Connection No. 8 is a variation of No. 6, and is likewise most useful with cable-ready preset tuners. With this installation you can tune-in any nonscrambled channel from Cable B plus any one channel (whether scrambled or not) from either Cable A or B. Since this hookup is usually used with preset tuners, the addition of another A/B switch wouldn't be of any help.

**Double-Input TV.** Some recent cable-ready televisions and component video tuners are equipped with a built-in A/B switch to allow accessing both scrambled and nonscrambled channels with your remote control. In this case, connec-

**No. 8**

tion No. 9 can be used to hook the TV to a single-cable system with scrambled channels.

**Connection 9**

Note that a "double-input" television doesn't need a block converter. No VCR is yet equipped with this feature, though, so a block converter will still be necessary for programmability and full watch-record versatility. Now, however, you can hook up the block converter in the way that best suits your particular VCR without worrying about how the hookup will affect your TV.

**Connection 10**

Use connection No. 10 with a non-cable-ready VCR or any direct-access VCR, and a double input television. The block converter and descrambler are positioned as in connection No. 2 with respect to the VCR.

**Connection 11**

With a cable-ready preset VCR and a double-input TV, use connection No. 11. Here the block convert-

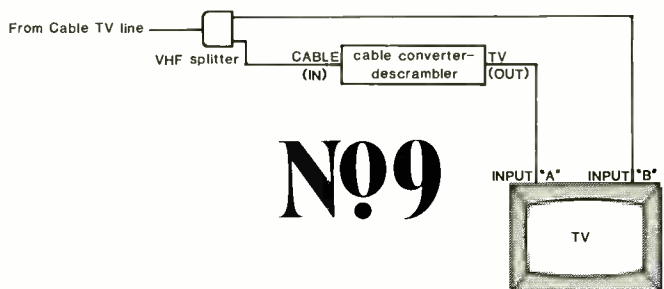

The does-everything phone that fits in your pocket!

# The Maxcall Cordless Phone has a 1000-foot range, a built in speaker phone, a nine-call memory, an intercom, and incredible audio quality.

By now everyone has seen the cordless phone. What you haven't seen is one that thinks it has a cord. The MAXCALL delivers high-quality sound that defies the listener to believe he's hearing your voice over a cordless phone. One reason is the engineering, which delivers audio frequencies from 200 to 3000 Hz. Another is the power, which enables the MAXCALL to operate efficiently up to 1000 feet from the base station 300 to 400 feet farther than most cordless phones.

## True Hands-Free Conversation

The base station is a speaker-phone that's a pleasant surprise if you've been using one of those hollow-sounding units. It picks up the voices of a roomful of people; a fine-quality speaker brings you the voice on the other end. The base station also is a perfect platform for your existing phone. It has the paging button that doubles as a full-conversation intercom.

Base unit holds your regular phone and doubles as a hands-free speaker-phone.

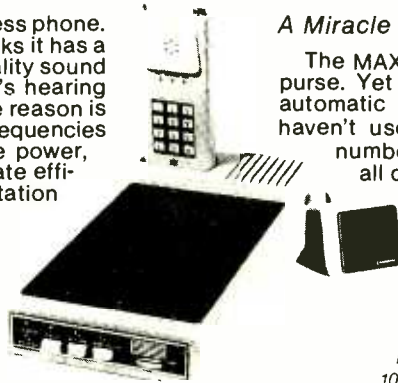

## A Miracle of Precision Engineering

The MAXCALL is thin enough to fit into your pocket or purse. Yet its sound rivals any conventional telephone. For automatic redialing just push the "★" key. Even if you haven't used the phone for weeks, it remembers the last number you dialed. Use your MAXCALL all day. Its nickel cadmium rechargeable batteries have the strength of Hercules. Overnight, in its slot on the base unit, it recharges to full power.

MAXCALL is so thin it fits in your pocket, but it has an incredible 1000-foot range.



## A Nine-Number Memory!

As befits the ultimate state-of-the-art cordless phone, the MAXCALL "remembers" any nine phone numbers. In seconds, you can enter a number into its memory. Then, pushing just two buttons will dial that number, even if it's outside your own area code. Change memorized numbers whenever you like. We even supply an attached card to enable you to see which numbers are in memory.

On this card you can list 9 numbers, stored in the unit memory bank.



## More, More, More!

You have a "secure" option on your MAXCALL. Kids can't play with it, because when you push a button, the portable phone becomes inoperative until you release it. Your MAXCALL can take plenty of abuse. Every component is designed to stand up against the shaking and pounding it can get in your shirt pocket or briefcase. The outer case is a high-impact material that won't show wear (color is attractive ivory). MAXCALL is incredibly thin - 7/8". It weighs only 10 1/2 oz. Even a year ago, no one could pack so much engineering and sound fidelity into a phone this compact. Now you can be among the first to own it.



**\$199.95 complete**

"Call" button activates intercom on every phone on the line. "Secure" button makes portable phone inoperative.

For \$199.95 you'll own the most advanced cordless phone on the market, with 1000-foot range, speaker-phone, a nine number memory, a "secure" button, and sound fidelity rivalling any conventional phone. No matter what kind of phone you've been using, you can't imagine the convenience of MAXCALL until you own one.

Multi-line adaptor for business phone \$39.95. (Shpg. \$1.75)

**We Absolutely Guarantee!** Use the MAXCALL (or any electronic instrument acquired from us) for up to 30 days. If you decide for any reason that you don't want to keep it, return it for a full 100% refund. For immediate service on credit card orders, call toll-free 24 hours a day, seven days a week:

**800-824-7888**

Ask for operator NO. 551  
In Cal. Call 1-800-852-7777

**NEW HORIZONS**

## Cordless Phone Antenna System

This specially designed system increases the operational range of all cordless telephones 10 to 20 times. The Antenna System is composed of an Omni directional 49 MHz transponder receiving antenna and a 1.7 MHz 60-foot transponder long wire transmitting antenna. Installation is quick and easy to all cordless phones utilizing 49 MHz band.

Enjoy increased freedom of movement with this long cordless telephone antenna system  
Only \$79.95 (Shpg. \$4.50)



Also available: Ultra long range cordless phone, range up to 2 miles. Intercom ability compatible with any American telephone system, touch tone or rotary. For export only. \$399.95. (Shpg. \$4.50).

## PHONE OR USE THIS COUPON

**NEW HORIZONS** 1 Penn Plaza Suite 100 New York, NY 10119

Please ship at once, with 30-day money-back guarantee, a complete MAXCALL portable telephone including base unit with built-in speaker-phone and nine number memory capacity. CE3

- MAXCALL \$199.95 & \$3.75 shpg., total \$203.70
- CORDLESS ANTENNA SYSTEM \$79.95 & \$4.50 shpg., total \$84.45
- MULTI-LINE ADAPTOR \$39.95 & \$1.75 shpg., total \$41.70
- LONG RANGE PHONE \$399.95 & \$4.50 shpg., total \$404.45

### Indicate payment method:

Check enclosed  
 VISA MasterCard card no. \_\_\_\_\_ exp. date \_\_\_\_\_  
 Name \_\_\_\_\_  
 Address \_\_\_\_\_  
 City \_\_\_\_\_ State \_\_\_\_\_ Zip \_\_\_\_\_

CIRCLE NO. 27 ON FREE INFORMATION CARD



...CABLE CONNECTION

er and descrambler are positioned as in connection No. 6.

All double-input televisions and tuners are direct-access types, and both inputs on these sets are either cable-ready or not, depending on the setting of the "defeat" switch. An exception is a tuner made by the Proton Corp., which has one uhf/vhf and one cable-ready input, selectable by a front-panel switch.

There is one more hookup for a block converter that may well be the most useful one we have discussed. If you have several television receivers that are all connected to the cable system and you have access to the distribution splitter that feeds the signal to them, you can use a block converter to distribute the r-f output of any video component to every TV set or VCR in your home, using the existing cable wiring. This includes your video recorder or videodisc player, a home computer (which then becomes an electronic memo board that can be read from any TV), or a surveillance camera in a security system.

## Connection 12

Assuming there is an r-f output, use connection No. 12. A program on any video component can be watched or recorded on every TV receiver in your home on the up-converted uhf equivalent of its vhf

output channel, leaving the remote controls on your video equipment unimpaired. Be sure the distribution splitter will pass uhf (many CATV splitters won't); and don't attempt to use a combined uhf/vhf amplifier in this setup. No uhf/vhf amplifier can handle more than about 7 vhf channels. The thirty or so adjacent channels on your cable system can drive such an amplifier into gross distortion and give you a pretty bum picture.

**Conclusion.** As effective as a block converter can be, it is not always the video panacea that one might hope for. Some things can impair its operation, from defects in a cable system to subtle oversights on the user's part. For example, there could be a weak signal at the input of the converter that might require use of a CATV amplifier, a grainy or snowy picture on a few channels that requires tuning higher in the band to

avoid spurious images, co-channel interference from a uhf channel that requires re-tuning of the converter's local oscillator, distorted pictures as a result of too high a signal that requires insertion of an r-f attenuator, and other causes and effects. In most cases these problems will not occur, however.

More importantly, VCR owners have an opportunity to enjoy a host of advantages, from obtaining more channels to watching one channel while recording another one, by following the guidelines presented here. Most VCR instruction manuals ignore the fact that there are cable-TV connections to be made, and even when they do, the common setup presented does not make it possible to watch a channel while recording another one, which is achievable without a block converter, though remote-control facilities and reception of extra channels are not garnered. ♦

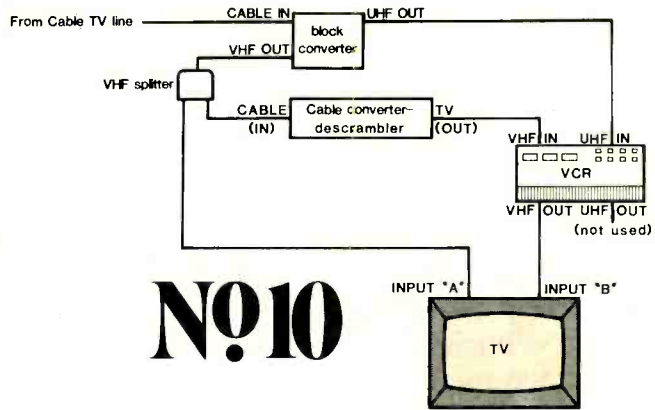

# No. 10

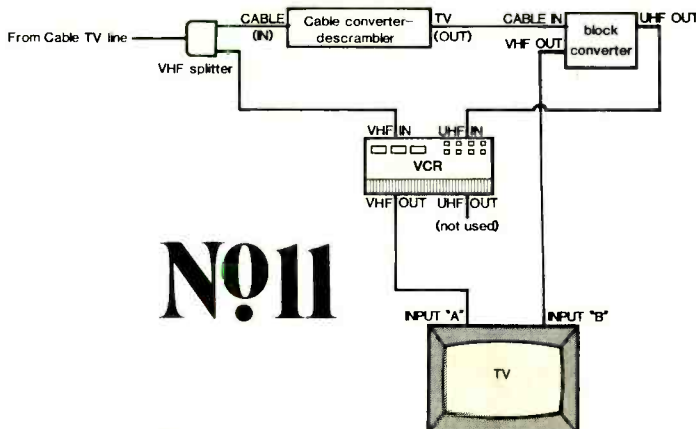

# No. 11

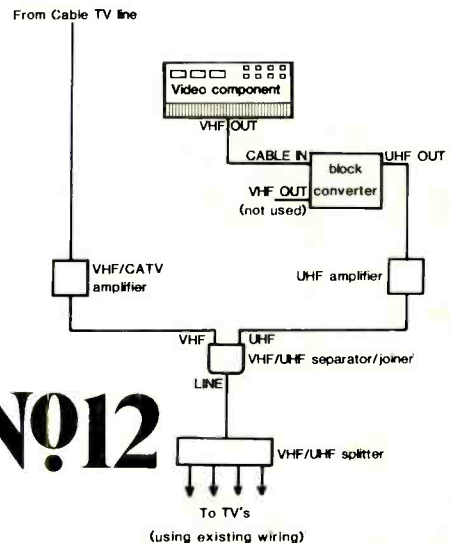

# No. 12

# There are five good reasons to buy the new HP-86.

And they're all solutions.

- Spreadsheet analysis solutions.
- Letter, memo, and report solutions.
- Information management solutions.
- Presentation graphics solutions.
- Data communications solutions.

If you need

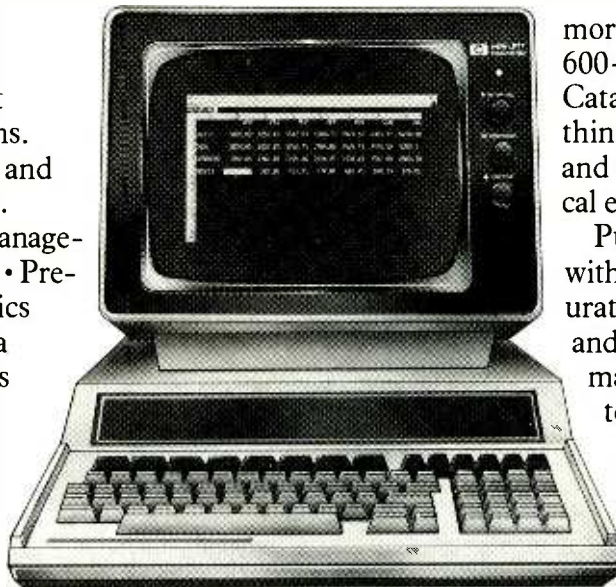

more, check out our 600-page Software Catalog, for everything from accounting and finance to electrical engineering.

Put that together with the modular configuration of the HP-86, and you've got a machine designed to expand as your needs expand.

# And 500 good reasons to buy it now.

**SAVE \$500** on software with our three-for-one software sale through **April 30.**

Our Personal Productivity Pac includes VisiCalc<sup>®</sup> PLUS, WORD/80, and FILE/80. It's a \$750 value (suggested retail price), for only \$250\*.

**VisiCalc<sup>®</sup> PLUS** is a powerful analytical tool for making quick work of worksheets. And once you do your "what-if" planning, you can turn the result into graphics immediately. (That's the PLUS.)

**WORD/80** software lets you create, type, print, lay out, reproduce, and store memos, letters, and reports.

**FILE/80** software lets you store and

VisiCalc is a registered trademark of VisiCorp.  
\*Suggested retail price. May vary outside U.S.



**Personal Productivity Pac**  
*A \$750 value for \$250.*

retrieve information quickly, add to your records, delete or modify them, and maintain lists easily. Without paperwork.

All in all, this is an offer designed to meet your essential software needs. And it's the perfect complement to the new HP-86, a personal computer we're really proud of.

Ask your dealer or sales rep about the Personal Productivity Pac, and do some serious comparison shopping.

We're so convinced you'll prefer the HP-86, the software offer stands. Whether or not you buy the computer.

For the authorized HP dealer or HP sales office nearest you, call TOLL-FREE 800-547-3400 (Oregon, Alaska, Hawaii: 503-758-1010).

TTY users with hearing or speech impairments, dial 503-758-5566.

**For professionals on the move.**

CIRCLE NO. 65 ON FREE INFORMATION CARD

 **HEWLETT  
PACKARD**



# *Learning* 16-BIT MICROCOMPUTER TECHNOLOGY

*Part 1: First of a series of articles on how an Intel 8088 CPU-based computer works. This unique microcomputer course is supported by plans to assemble and expand hardware that is compatible with the IBM-PC personal computer, starting here with circuits that will be discussed in subsequent articles.*

*By George Meyerle*

**D**ESIGN of computers has been revolutionized by the development of single-chip microprocessors. Starting with 4-bit types, these ICs quickly evolved to those that use 8-bit data words. Now there is a new generation of 16-bit microprocessors that provides awe-

somely greater power than 8-bit types.

Among the 16-bit microprocessors is Intel's 8088, which promises to be a leader for a variety of reasons. These include the use of this CPU in the popular IBM-PC machine and similar personal com-

puters; IBM's 62-pin bus structure is supported by hundreds of manufacturers; and the 8088 represents the most cost-effective scheme to date because it is internally structured as both an 8-bit and a 16-bit processor, and externally as an 8-bitter.

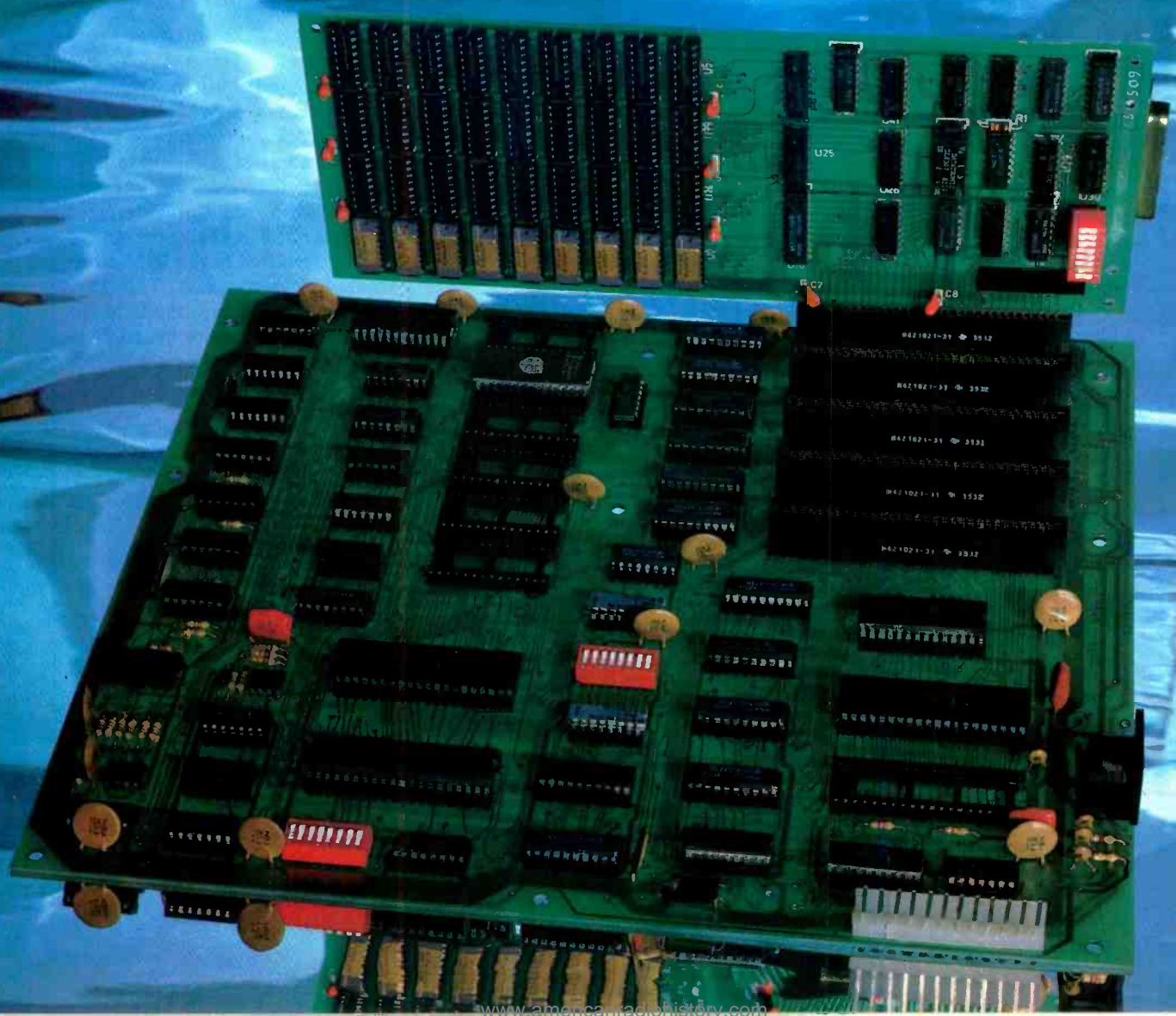

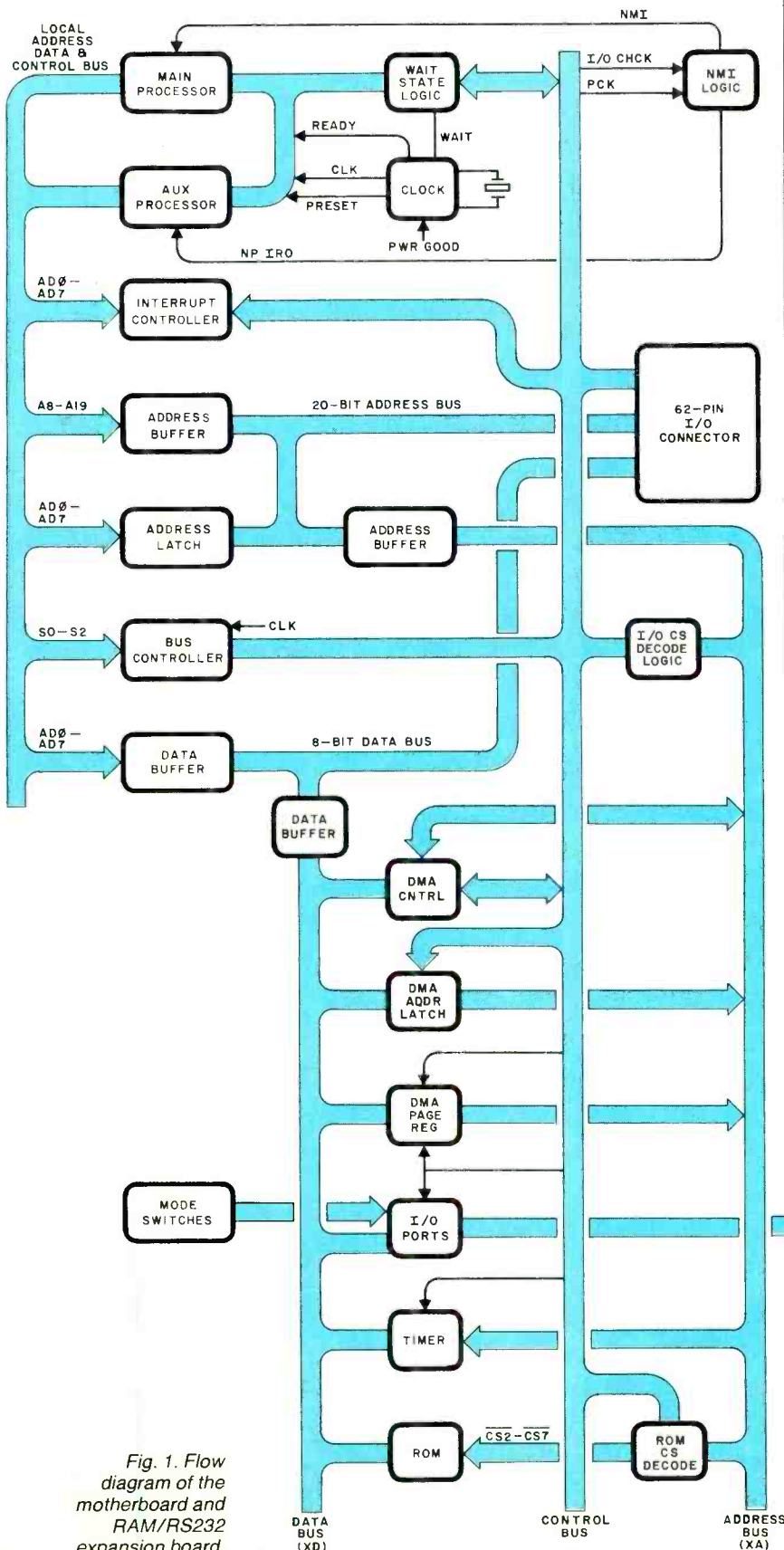
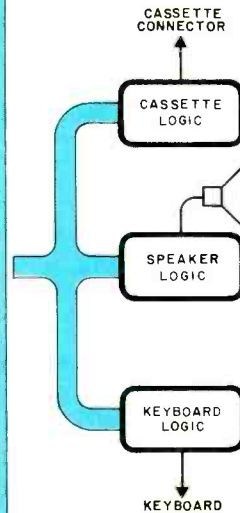

Fig. 1. Flow diagram of the motherboard and RAM/RS232 expansion board.

Thus, the 8088 has been chosen as the heart of a 16-bit microcomputer course that represents a unique hands-on learning experience. With this course, one can learn all about 16-bit microcomputers and, starting with only a modest hardware investment, have a complete IBM-compatible machine at the end if one wishes. You'll also have the knowledge to service and add to this type of machine and the basis for understanding an important technology in a broad sense. The Explorer 88PC project allows a person with a moderate budget (around \$400) to build the 88PC motherboard, plus a 64K RAM/RS232 expansion board. A flow diagram of the system is shown in Fig. 1.

The hardware includes the 8088 microprocessor, programmable interrupt controller, programmable DMA controller, timer, I/O ports, 64K of parity-checked memory (on board expandable to 256K), programmable RS232 interface, cassette interface, system clock, bus controller, and system monitor. Also, there are provisions for an 8087 co-processor (soon to be available) and an IBM-compatible keyboard interface.

The system monitor interfaces with either the RS232 port and a standard terminal or the IBM-compatible keyboard port. The keyboard can be used with the IBM (or other compatible) color board. System monitor commands are shown





in Table I. Note that the monitor program in ROM includes a section that tests most of the system hardware and reports status, all under user control. This feature not only tests the 88PC hardware but also teaches a user the fundamental procedures to test, section by section, any peripherals compatible with the IBM PC's 62-pin bus structure (hereafter described as the S-62 bus).

The basic project (motherboard/64K board) can be expanded by adding an IBM compatible BIOS, floppy and hard disks, color boards, EPROM burners, A/D-D/A boards, game adapters, modem boards, an IBM compatible keyboard, and most disk operating systems offered by IBM and others. The Explorer 88PC is not compatible with the IBM-PC in one respect. Some IBM disk BASIC commands imbedded in the IBM cassette BA-

SIC ROMs are not available on the 88PC. This can be overcome either by compiling programs designed for the IBM-PC or by purchasing a compiled version (which is normally how software is sold anyway).

The following section describes in more detail the various components of the motherboard and 64K RAM/RS232 expansion board.

**The 8088 Microprocessor.** The 8088 microprocessor (Fig. 2) represents a major breakthrough in CPU architecture. Previous generation devices generally executed a program in the following way: first, fetch an instruction from memory; second, read an operand (if required); third, execute the instruction; and fourth, write the result (if required). These steps had to be performed serially. The 8088 performs the same steps but uses two separate processing units within the CPU: the execution unit (EU) executes the instructions, reads operands, and writes results. The two units can operate independently of one

another and are able in most cases to overlap instruction fetches with execution. The result is that most of the time required to fetch instructions disappears. The registers and instruction pointer are somewhat more complicated to understand than previous processors due to the fact that a 20-bit address bus is generated by combining two 16-bit registers. From a hardware point of view the 8-bit data bus is multiplexed with the low-order address lines AD0 to AD7. (Addresses A8 to A19 are available on their own pins.)

The clock is 4.77 MHz and RESET and READY lines are handled in a standard fashion. This design configures the 8088 in the maximum (multiprocessor) mode, which requires two signals (bus LOCK and TEST) not found in single-processor CPUs. The bus LOCK pin is an information signal to other processors on the bus utilizing common resources, and the TEST pin is used in conjunction with the WAIT instruction to synchronize an external event. The

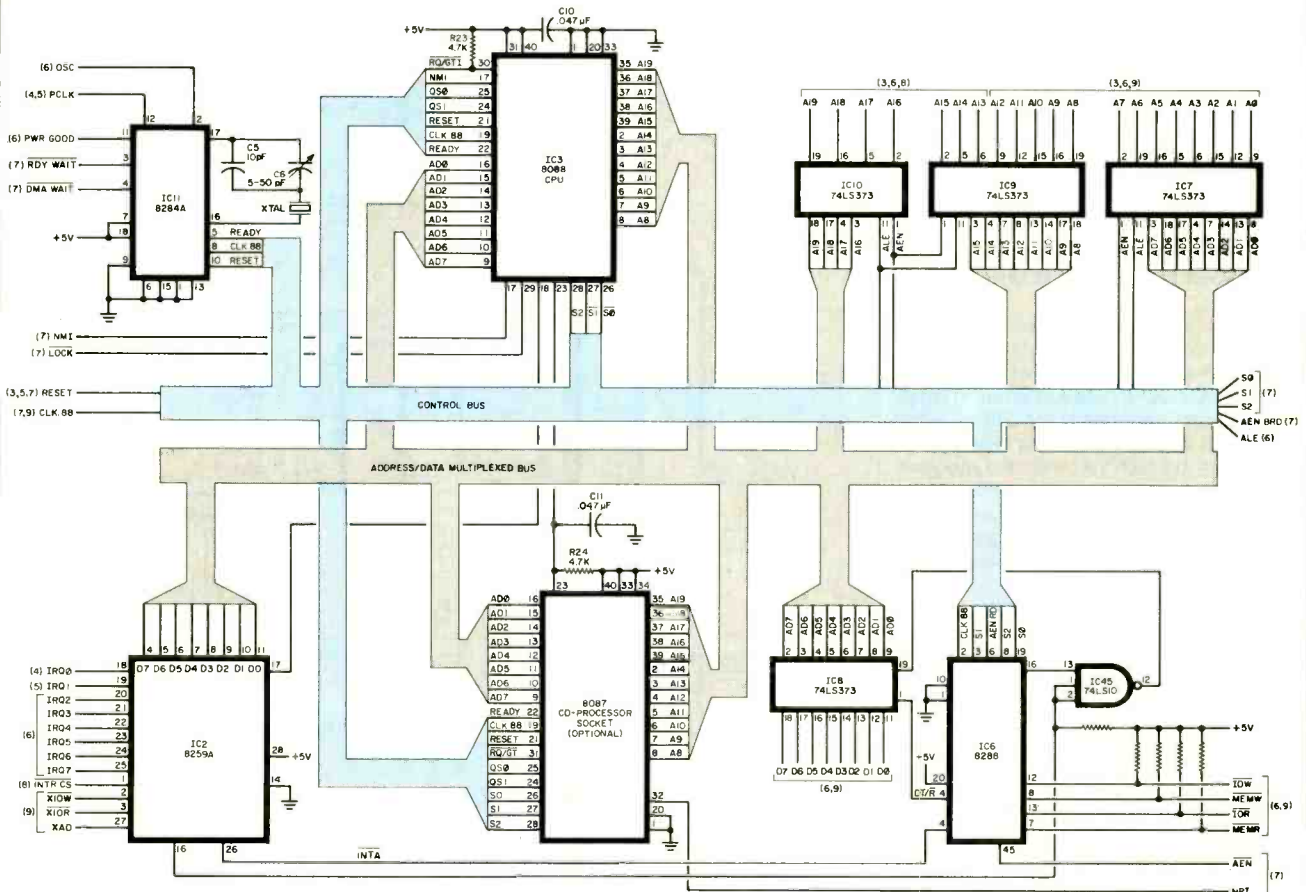

Fig. 2. The microprocessor, buses, and support circuits.

NMI (non-maskable interrupt) input is used to report memory parity errors.

**8284A Clock Generator and Driver.** Clock generator *IC11* provides CLK88, the CPU clock signal, READY synchronization, RESET logic, a 14.31818-MHz OSC signal for the expansion bus and a PCLK (clock ÷ 2) TTL level signal for peripherals (in this case an input to the timer). Variable capacitor *C6* is connected in series with the crystal to allow trimming the oscillator when using a color board. The RESET line (pin 11) is connected to the "power good/reset" (PWRGOOD) input that resets the CPU in the event of a power-supply failure.

**8288 Bus Controller.** Bus controller *IC6* provides command and

### TABLE I—SYSTEM MONITOR COMMANDS

**EXAMINE/CHANGE MEMORY CONTENTS:** Load or change programs in memory. These commands also allow entering short programs that test your understanding of 8088 programming.

**EXAMINE/CHANGE REGISTER CONTENTS:** Load or change the contents of any of the 8088 registers.

**DISPLAY BLOCK OF MEMORY:** Allows any block of memory to be displayed.

**MOVE BLOCK OF MEMORY:** Allows user to move contents of memory to new boundary.

**INPUT DATA FROM A PORT:** Allows any active input port to be read and tested by the monitor.

**OUTPUT DATA TO A PORT:** Allows data to be output to any active output port.

**EXECUTE PROGRAM WITH OR WITHOUT BREAK POINTS:** Allows running a program in small segments. Very handy for software debugging when all you do is indicate the address at which you want the program to stop.

**EXECUTE PROGRAM IN SINGLE/STEP MODE:** Runs a program one step at a time and allows user to examine contents of the 8088 registers at each step.

**SAVE PROGRAMS ON CASSETTE:** Saves your programs on an ordinary cassette recorder.

**LOAD PROGRAMS FROM CASSETTE:** Load saved programs back into memory.

**EXECUTE DIAGNOSTICS:** 64K MEMORY & ROM SELF TEST: Checks RAM with a walking bit test and ROM with a check sum tests.

**DMA TEST:** Tests the DMA controller.

**INTERRUPT CONTROLLER TEST:** Tests operation of interrupt controller.

**TIMER TEST:** Tests timer vs. instruction times.

control timing generation as well as bipolar bus drive. CPU status lines *S0*, *S1*, and *S2* provide status information to the control bus.

**8259A Programmable Interrupt Controller.** Controller *IC2* allows 8 I/O devices to signal the CPU, via interrupts, that they re-

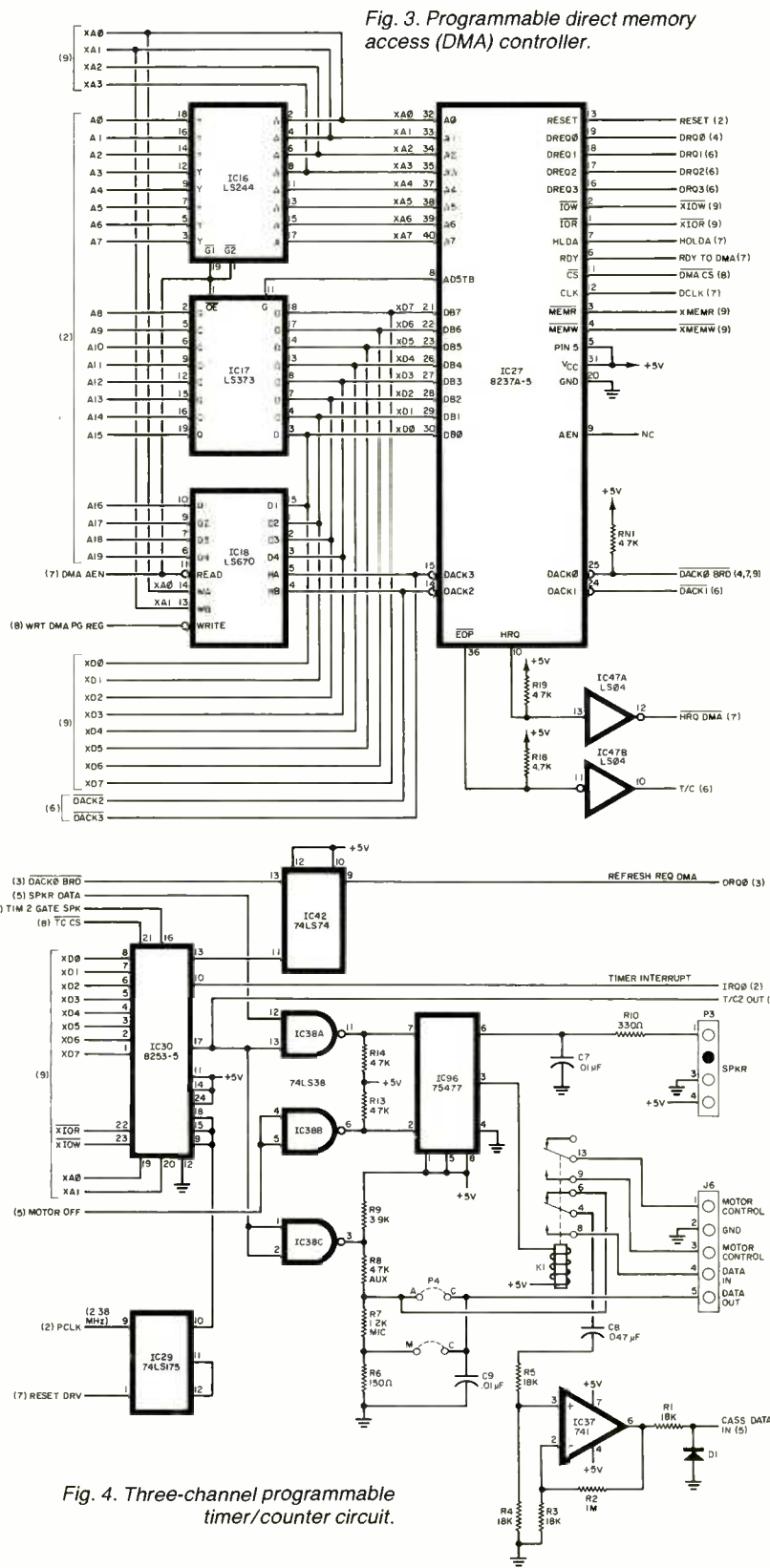



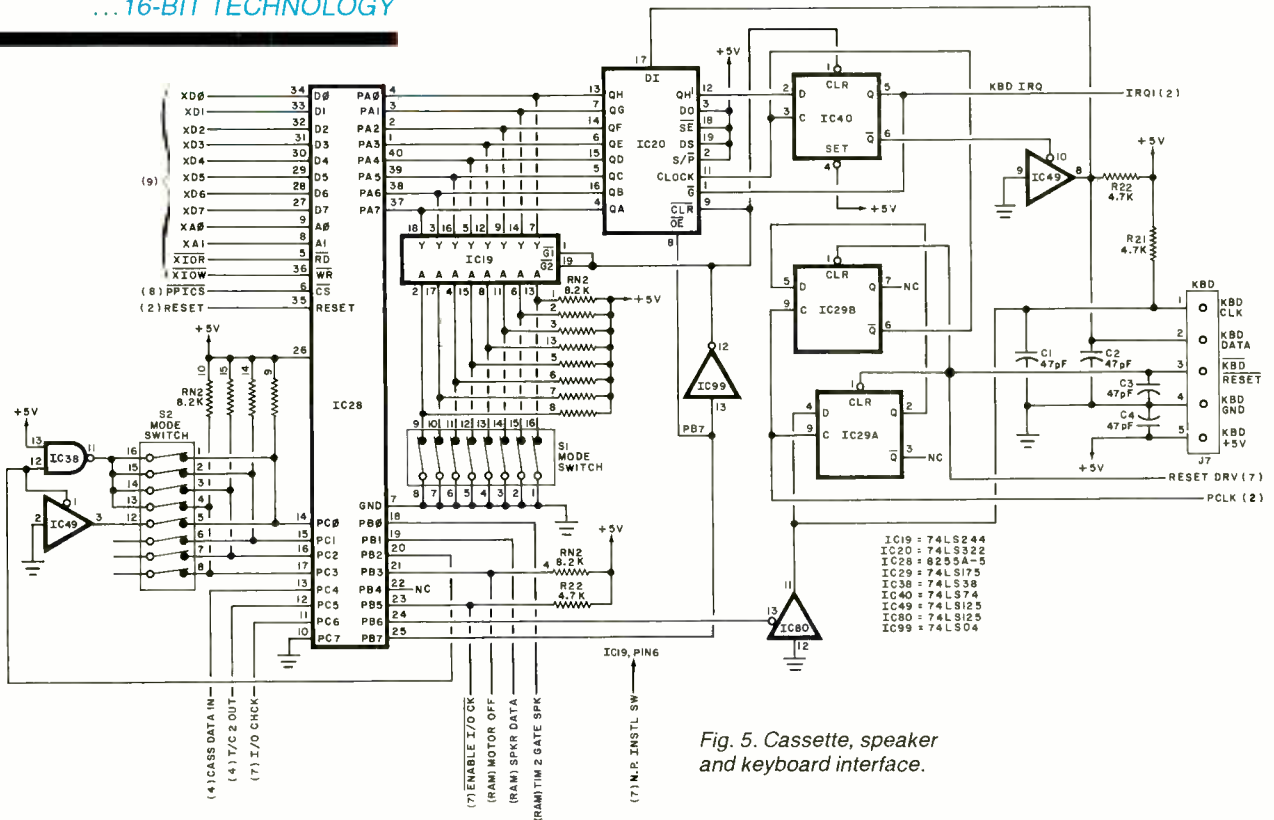

Fig. 5. Cassette, speaker and keyboard interface.

quire service. Without an interrupt controller, the CPU would have to check the status of all the I/O ports in service by repeatedly polling each port. Using the 8259A bypasses that programming step completely (improving throughput considerably). If a device requires attention, the following steps occur:

1. The device signals the 8259A by raising its interrupt line (IRQ0-IRQ7) high.
2. The 8259A evaluates the priority of the request and notifies the CPU via the INTA line if appropriate.
3. The 8259A will then issue a CALL instruction to the CPU via the D0-D7 bus.
4. After the CALL instruction is received by the CPU, it will issue two INTA pulses to the 8259A. This allows the 8259A to release its preprogrammed subroutine address to the CPU via the data bus. The CPU then will call the appropriate service routine.

Level 0, the highest priority interrupt, is connected to channel 1 of the timer/counter (IC30, Fig. 4) and provides a periodic interrupt. Level 1 is connected to the optional IBM keyboard input (IC40, Fig. 5)

which transmits an interrupt for each keyboard input. The remaining six interrupt inputs are tied to the expansion bus (Fig. 6) for use by other I/O devices.

**8237A Programmable Direct Memory Access (DMA) Controller** (Fig. 3). This chip (IC27) allows external devices to cause the transfer of data to or from the system memory at rates to 1.6 megabytes/second. It contains four indepen-

dent channels, each having a full 64K address and word count capability. The operation is as follows:

1. The I/O device requesting a data transfer signals the 8237A.
2. The 8237A then signals the CPU. After receiving an acknowledge signal from the CPU, the DMA controller begins the transfer. Each channel has registers that are programmed by the system monitor to control the transfers. They include information regarding

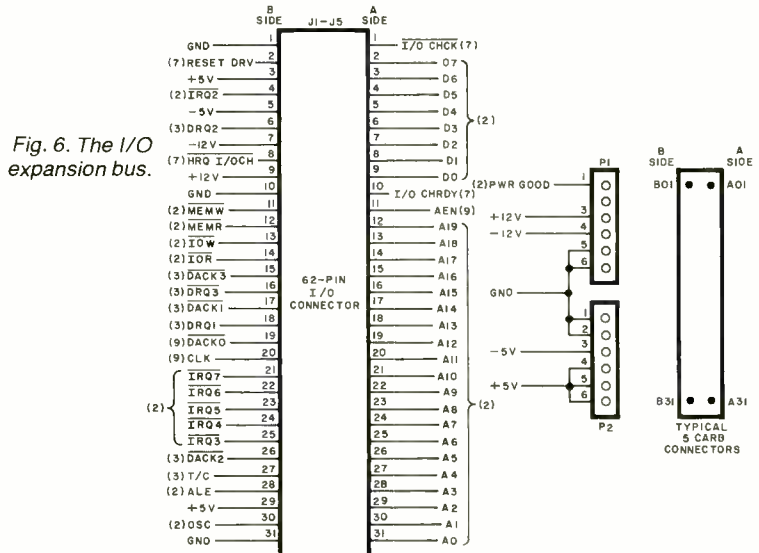

Fig. 6. The I/O expansion bus.

**TABLE II—I/O ADDRESS MAP**

the starting address, number of transfers to be performed, type of transfers, etc.

The first DMA channel is programmed to refresh the system memory. This is done by programming channel 0 of the timer to periodically request a DMA transfer. This generates a memory read cycle which is available to refresh the dynamic RAMs. The three remaining DMA channels are available on the expansion bus.

**8253-5 Three-Channel Programmable Timer/Counter.** Timer IC30 (Fig. 4) is organized as eight independent 16-bit software

Hex. Range	9	8	7	6	5	4	3	2	1	0	Device***	Device****
00-0F	0	0	0	0	0	Z**	A3	A2	A1	A0	DMA 8237-2	Same
20-21	0	0	0	0	1	Z	Z	Z	Z	A0	Interrupt 8259A	"
40-43	0	0	0	1	0	Z	Z	Z	A1	A0	Timer 8253-5	"
60-63	0	0	0	1	1	Z	Z	Z	A1	A0	PPI 8255A-5	"
80-83	0	0	1	0	0	Z	Z	Z	A1	A0	DMA regs	"
AX*	0	0	1	0	1						NMI mask reg	"
CX	0	0	1	1	0						Reserved	"
EX	0	0	1	1	1						Reserved	"
3F8-3FF	1	1	1	1	1	1	1	A2	A1	A0	TP RS232C	RS232C
3F0-3F7	1	1	1	1	1	1	0	A2	A1	A0	5 1/4" DRV	Reserved
3F8-2FF	1	0	1	1	1	1	1	A2	A1	A0	Reserved	"
378-37F	1	1	0	1	1	1	1	Z	A1	A0	Par. Prtr Prt	"
3DD-3DF	1	1	1	1	0	1	A3	A2	A1	A0	Color/graph.	"
278-27F	1	0	0	1	1	1	1	Z	A1	A0	Reserved	"
200-20F	1	0	0	0	0	0	A3	A2	A1	A0	Game I/O	"
380-38F	1	1	1	0	1	1	A3	A2	A1	A0	IBM Mono Dis	"

\*At power-on time, the Non Mask Interrupt (NMI) into the 8088 is masked off. This mask bit can be set and reset via system software as follows: Set mask—write (80) to I/O Address (A0) (enable NMI). Clear mask—write (00) to I/O Address (A0) (disable NMI).

\*\*Z = don't care; that is, not in decode.

\*\*\*With IBM compatible keyboard ROMs.

\*\*\*\*With Explorer 88PC monitor ROMs.

**8255 I/O BIT MAP**

(When equipped with Explorer 88PC ROM)

**Hex 0060: Input**

- PA0 Baud rate select†
- PA1 "
- PA2 "
- PA3 Parity ON/OFF
- PA4 Parity EVEN/ODD
- PA5 Not used
- PA6 "
- PA7 "

**Hex 0061: Output**

- PB0 Timer 2 gate speaker
- PB1 Speaker data
- PB2 Note used
- PB3 Cassette motor off
- PB4 Not used
- PB5 Enable I/O CH CK
- PB6 Not used
- PB7 Enable KBD or CLR KBD & enable sense SW's

**Hex 0062: Input**

- PC0 I/O Read/Write memory (SW2-1)††
- PC1 I/O Read/Write memory (SW2-2)††
- PC2 I/O Read/Write memory (SW2-3)††
- PC3 I/O Read/Write memory (SW2-4)††
- PC4 Cassette data in
- PC5 Timer channel 2 out
- PC6 I/O Channel Check
- PC7 Not used

**Hex 0063: CMD/Mode Register**

Mode Reg. Value 7 6 5 4 3 2 1 0  
(Hex 99) 1 0 0 1 1 0 0 1

†PA0	PA1	PA2	RS232C Port
SW1-1	SW1-2	SW1-3	Baud rate
0	0	0	110
1	0	0	150
0	1	0	300
1	1	0	600
0	0	1	1200
1	0	1	2400
0	1	1	4800
1	1	1	9600

††Binary value X32KB

**8255 I/O BIT MAP** (With optional IBM Compatible Keyboard ROM)

**Hex 0060: Input**

- PA0 + KBD scan code 0 or IPL 5 1/4" DRV (SW1-1)
- PA1 + KBD scan code 1 or Reserved (SW1-2)
- PA2 + KBD scan code 2 or Reserved
- PA3 + KBD scan code 3 or Reserved
- PA4 + KBD scan code 4 or + Display type 1 # (SW1-5)
- PA5 + KBD scan code 5 or + Display type 2 # (SW1-6)
- PA6 + KBD scan code 6 or No. of 5 1/4" drvs # # (SW1-7)
- PA7 + KBD scan code 7 or No. of 5 1/4" drvs # # (SW1-8)

**Hex 0061: Output**

- PB0 + Timer 2 gate speaker
- PB1 + Speaker data
- PB2 +(Read Read/Write Memory Size) or (Read Spare Key)
- PB3 +Cassette motor off
- PB4 Not used
- PB5 - Enable I/O CH CK
- PB6 - Hold KBD CLK low
- PB7 -(Enable KBD) or +(CLR KDB & Enable Sense SWs)

**Hex 0062: Input**

- PC0 I/O Read/Write Memory (SW2-1) Binary value X32KB
- PC1 I/O Read/Write Memory (SW2-2) Binary value X32KB
- PC2 I/O Read/Write Memory (SW2-3) Binary value X32KB
- PC3 I/O Read/Write Memory (SW2-4) Binary value X32KB
- PC4 + Cassette data in
- PC5 + Timer channel 2 out
- PC6 +I/O channel check
- PC7 Not used

**Hex 0063: CMD/Mode Register**

Mode reg. value 7 6 5 4 3 2 1 0  
(Hex 99) 1 0 0 1 1 0 0 1

# PA5	PA4	Type of Display
S1-6	S1-5	
0	0	Reserved
0	1	Color card 40X25 (BW mode)
1	0	Color card 80X25 (BW mode)
1	1	IBM mono display (80X25)
# # PA7	PA6	No. of 5 1/4" Drvs. in system
S1-8	S1-7	
0	0	1
0	1	2
1	0	3
1	1	4

**Note:** PA bit = 0 implies switch is on.  
PA bit = 1 implies switch is off.



# Microsystems

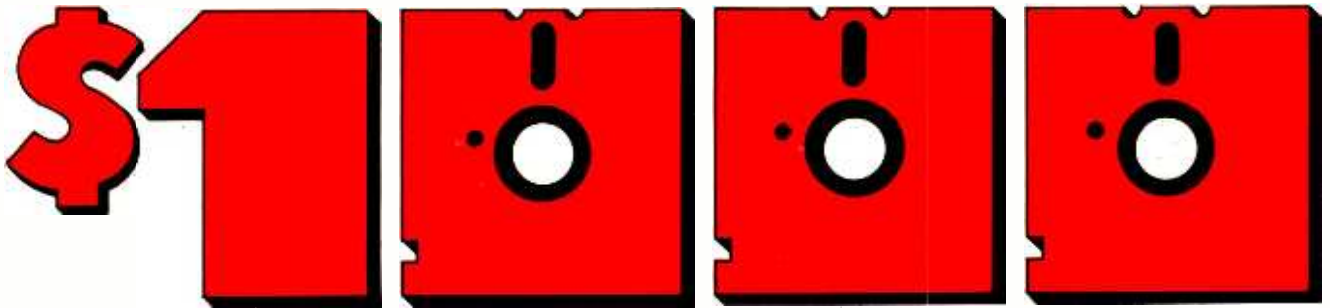

## SOFTWARE SWEEPSTAKES

Save up to 33% on *Microsystems*, too!

**T**he Microsystems Sweepstakes is open to all our readers. No purchase is necessary—and you can choose \$1000 worth of software if you're the lucky winner!

### Here's how the Sweepstakes works

Just mail the attached card or the coupon below after filling in your name and address. Be sure to indicate whether you're also subscribing to *Microsystems* at the special rates shown—you can save as much as 33%.

Then if you win, you may choose up to \$1,000 worth (at retail prices) of any software you like. What you select is entirely up to you. Business, games, educational programs—it's your choice!



**You're sure to win with *Microsystems*!**

Whether or not you win our Sweepstakes, the hours you devote to computing are sure to be more profitable when you subscribe to *Microsystems*. It's the Number One journal for advanced microcomputer users—filled with state-of-the-art information on CP/M®, MP/M®, CP/Net®, UNIX®-like systems, and the hardware that supports them.

Why not enjoy a year or more of *Microsystems* at our low introductory prices? You'll save up to 33% if you subscribe at the same time you enter our Sweepstakes!

*Registered trademarks: CP/M, MP/M and CP/Net—Digital Research. UNIX—Bell Laboratories.*

### OFFICIAL RULES No Purchase Required

1. On an official entry form or a 3" x 5" piece of paper, hand print your name, address and zip code. Enter as often as you wish, but mail each entry separately to Microsystems Sweepstakes, CN 1987, Morristown, New Jersey 07960. Entries must be received no later than April 30, 1983, and the drawing will be held by May 31, 1983. All entries become the property of Microsystems, which reserves the right to reprint the name and address of the winner.
2. Winner will be selected in a random drawing from among all entries received, under the supervision of the publishers of *Microsystems*, whose decision will be final. Only one prize will be awarded in this Sweepstakes. Winner will be notified by mail and may be required to execute affidavit of eligibility and release. Odds of winning will depend on the number of entries received. *Microsystems* will arrange delivery of prize. Taxes are the responsibility of the winner. Any manufacturer's claims and warranties will apply, but *Microsystems* makes no claims or warranties with regard to any prizes. Prize is not transferable. No substitutions or exchanges for prizes.
3. Sweepstakes open to all residents of the U.S., its territories and possessions, except employees (and their families) of *Microsystems*, its affiliates, and its advertising and promotion agencies. Void wherever prohibited or restricted by law.
4. For the winner's name, send a stamped, self-addressed envelope to Microsystems Sweepstakes, Circulation Department, *Microsystems*, One Park Avenue, New York, N.Y. 10016.

### OFFICIAL ENTRY FORM

Mail to: **Microsystems Sweepstakes**  
CN 1987, Morristown, New Jersey 07960

**YES!** Enter my name in the Microsystems Sweepstakes and start my subscription to *Microsystems* for the term checked:

- One year (12 issues) only \$19.97—20% off!
- Two years (24 issues) only \$36.97—26% off!
- Three years (36 issues) only \$49.97—33% off!

**CHECK ONE:**

- Payment enclosed.
- Bill me later.

Savings based on full one-year subscription price of \$24.97.

**NO** I don't wish to subscribe now, but tell me if I've won the Microsystems Sweepstakes.

8H17

Mr./Mrs./Ms. \_\_\_\_\_ (please print full name)

Address \_\_\_\_\_ Apt. \_\_\_\_\_

City \_\_\_\_\_ State \_\_\_\_\_ Zip \_\_\_\_\_

Offer valid only in the U.S., its territories and possessions. Please allow 30 to 60 days for delivery of first issue if you subscribe.

programmable counters. Channel 0 is programmed to time and request the refresh signals from DMA channel 0. Channel 1 is used by the system as a general-purpose timer providing a time base for implementing a time-of-day clock. Channel 2 is used to support the tone generation for the speaker output plus the signals for the cassette output. Each channel has a minimum timing resolution of 1.05  $\mu$ s.

**Cassette Interface.** Cassette operation is all under software control. Channel 2 of timer IC30 is used to control the data transfer to the cassette recorder. The cassette input is read by a bit on the 8255 I/O port (IC28, Fig. 5). The motor is controlled by an output-port bit on the 8255. (Also see I/O address map, Table II).

**Speaker Output.** The audio output can be driven from either the I/O output bit from IC28 (see Fig. 5 and Table II) or the timer IC30 channel 2 clock output. Note that the timer gate is also controlled by an IC28 I/O port bit (see I/O address map).

**Keyboard Interface and I/O Port (Fig. 5).** Provisions have been made to upgrade the Explorer 88PC to include an IBM-compatible keyboard when used with an IBM-compatible color or monochrome board. To implement this upgrade, the 88PC system monitor ROM must be changed to provide the necessary IBM-compatible keyboard decoding routines (see Ordering Information). This ROM set also includes an IBM-compatible BIOS so that other IBM-compatible options, such as a disk controller, can be used. The optional IBM-compatible interface generates an interrupt that

reads the input port (pin 5) on IC28. This port transfers the data from the keyboard to the computer. Note that the IBM keyboard connects to the computer through a 5-wire cable and transmits data serially. The keyboard does not use standard ASCII code.

**8255 System I/O Port.** Programmable I/O port IC28 is used to test the inputs from mode switches S1 and S2. The operating system tests how the switches have been set and configures the system to the hardware being used (number of drives, display, memory size, etc.). This IC also supplies data to the cassette and audio outputs (see Table II for details).

**The I/O Expansion Bus.** The S-62 (62-line) I/O expansion bus (Fig. 6) is an extension of the 8088 microprocessor bus. It is, however, demultiplexed and includes inter-

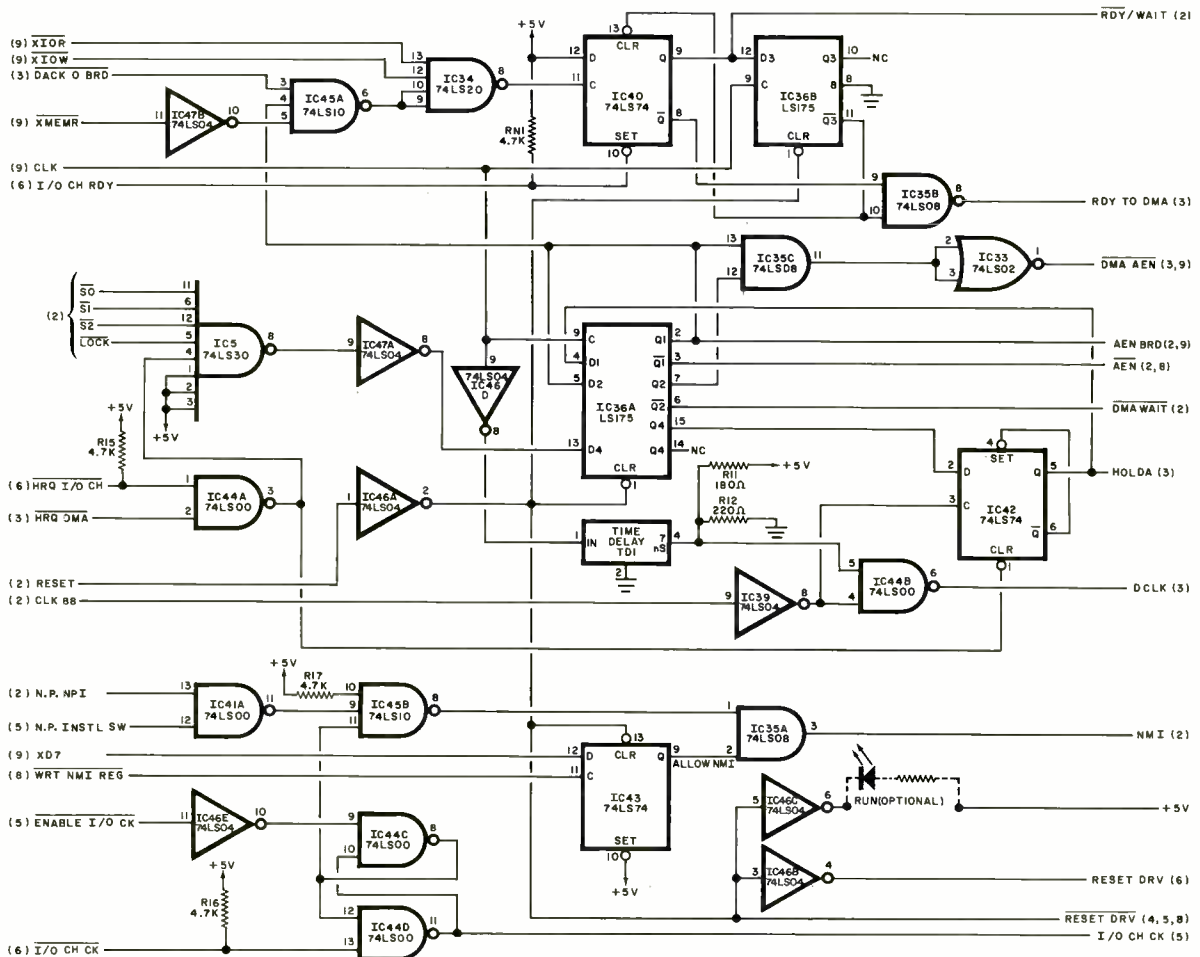

Fig. 7. Motherboard bus arbitration and wait-state generator.



rupts, DMA, and I/O functions. The expansion bus contains an 8-bit bidirectional data bus, 20 address lines, six levels of interrupt, memory and I/O read or write control signals, clock and timing lines, three channels of DMA control lines, memory refresh timing control lines, a channel check lines, and power and ground for the plug-in cards. Four voltage levels are supplied:  $\pm 5$  and  $\pm 12$  V dc.

I/O devices are addressed using I/O-mapped address space. The system is designed so that 512 I/O device addresses are available to the plug-in cards. A channel check line is used for reporting error conditions to the processor. Activating this line results in an NMI (non-maskable interrupt). Memory expansion options use this line to report parity errors. (A complete description of the pinouts for this expansion bus is shown in Table III.)

**Motherboard Bus Arbitration and Wait-State Generator.**

Figure 7 shows the bus arbitration and wait-state generator. If a device on the bus is too slow to respond to the system, IC40 will generate a WAIT signal, delaying the processor until the device can respond. The balance of the circuits shown are used to coordinate or arbitrate bus and processor activity and will be explained more fully in future articles.

**Motherboard System ROM and Other Device Address Decoders.**

Each system peripheral has been mapped into special memory or I/O address. This section provides the chip- or device-select signals to the DMA and interrupt controllers, timer, on-board I/O ports, and the six system ROM sockets (Fig. 8).

**System Board ROM and Bus Drivers.** The motherboard has provisions for 48K of ROM. This is divided into six 8K  $\times$  8 2564 EPROMs. At this time, IC26 is the only one used. It houses the system monitor, test routines, and BIOS.

As a system is expanded, these sockets will house such utilities as look-up tables for multiprocessor schemes and an expanded BIOS, as well as serve as hardware for specific types of programs. (For example, IBM disc BASIC uses look-up tables plus additional information contained in these ROMs.) In addition to the ROM, Fig. 9 includes bus drivers. They are necessary because the number of circuits connected to the bus exceeds the drive capability of the microprocessor and/or other peripherals.

**System RAM/RS232 Port.** The discussions of the plug-in RAM board/RS232 port and system power supply are given without figure references, since they will appear in the next installment of this article.

The System RAM/RS232 Port is a plug-in board containing a 64K-byte parity-checking memory (expandable to 256K) and an RS232 port. The RAM address decoding allows its use at the bottom of memory. The RS232 port uses a programmable UART, whose mode, baud rate, parity, etc. have to be

Fig. 8. Device address decoding circuits.

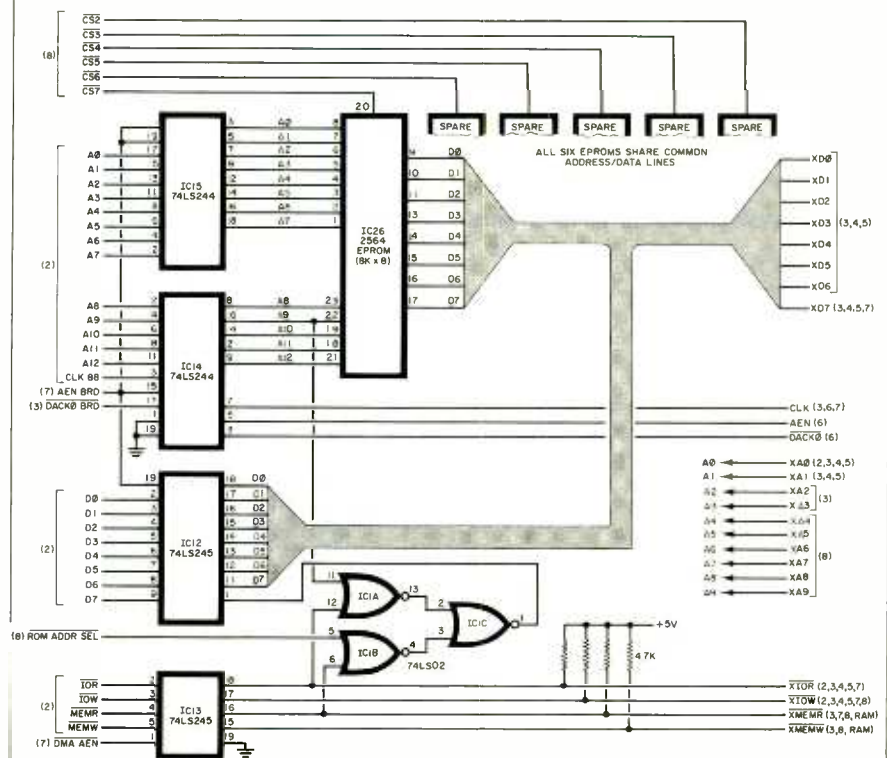
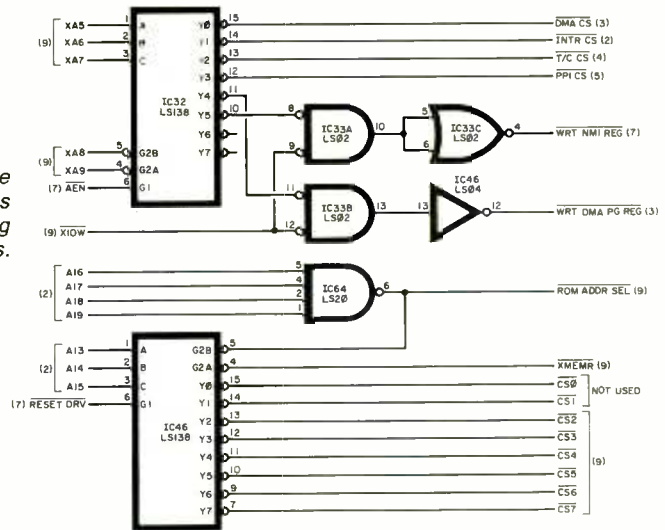

Fig. 9. System board ROM and bus drivers.

programmed by the operating system on power up or reset. In the case of the Explorer 88PC monitor, the initialization is controlled by the setting of the mode switches. The baud rate is selectable from 150 to 9600 baud. When using the optional IBM-compatible keyboard, this port becomes the COMM-1 port which can be used to drive a printer, modem, etc.

**Power Supply.** The power supply is often the most critical yet least considered part of a computer. The suggested supply is a straight-forward design using heat sinks and of course, a fan. A switching supply could be used but keep in mind that, if the output voltage is not stable, you risk destroying the chip set. The suggested supply provides for an additional 5 A on the 5-V line in the event the builder wants to add a hard disk into the same cabinet as the CPU. This addition is not necessary for the beginner system.

**Building the System.** The printed circuit boards are so compact and complex that the foil patterns will not be offered. (The boards can be purchased separately if desired.) The system can be wire-wrapped if you have the patience. There are a few suppliers that provide a prototyping board for the expansion bus so that the memory and RS232 port

### KIT INFORMATION

The following items are available from Netronics R&D Ltd., 333 Litchfield Rd., New Milford, CT 06776: complete kit including motherboard and plug-in RAM with I/O port with 64K bytes of RAM \$399.95 (with 128K bytes, \$479.95; with 192K bytes, \$659.95, 256K bytes \$739.95). Please add \$10 for shipping and handling (s/h).

Also available separately are an IBM-compatible keyboard with cable at \$299.95; IBM-compatible color board at \$299.95 (both with \$10 s/h); extra 8K ROM required with IBM-compatible at \$35; 62-pin bus connectors at \$4.25 each (plus \$1 s/h); monitor and keyboard BIOS source listing at \$35 (plus \$2 s/h); motherboard pc at \$75 (plus \$2 s/h); RAM-I/O pc board at \$30 (plus \$2 s/h); and power supply with fan at \$149.95 (plus \$8 s/h), with extra power for hard disk \$169.95 (plus \$8 s/h).

could be constructed that way. Make sure that the power supply you choose is reliable and stable. Remember, if the voltage exceeds 5 V, you risk blowing a few hundred dollars worth of chips.

After building and testing the hardware, a user should learn the function and operation of all the 8088/8086 instructions (if he does not already). The software monitor included is a convenient way to learn the architecture of the system.

The Intel 8086 users manual and a new book written by Russell Rector and George Alexy entitled *The 8086 Book Includes the 8088* is sufficient to give a good understanding of both the hardware and software principles. The IBM technical reference manual (available at most IBM retail outlets) is also a handy reference book. It includes information about a cassette BASIC and a system BIOS that is, of course, not supplied with this project. ♦

### TABLE III—S-62 BUS DESCRIPTION

(as set forth by IBM)

OSC (Oscillator): A high-speed clock with a 70-ns period (14.31818 MHz). Has a 50% duty cycle.	IRQ2-IRQ7 (Interrupt Request 2 to 7): Used to signal the processor that an I/O device requires attention. They are prioritized with IRQ2 as the highest priority and IRQ7 as the lowest. An Interrupt Request is generated by raising an IRQ line (low to high) and holding it high until acknowledged by the processor (Interrupt Service Routine).
CLK (Clock): Divide-by-three of the oscillator with a period of 210 ns (4.77 MHz). Has a 33% duty cycle.	$\overline{\text{IOR}}$ (I/O Read Command): Instructs an I/O device to drive its data onto the data bus. It may be driven by the processor or the DMA Controller. Active low.
RESET DRV (Reset Drive): Used to reset or initialize system logic upon power-up or during a low line voltage outage. Signal is synchronized to the falling edge of clock. Active high.	$\overline{\text{IOW}}$ (I/O Write Command): Instructs an I/O device to read the data on the data bus. It may be driven by the processor or DMA Controller. Active low.
A0-A19 (Address Bits 0 to 19): Used to address memory and I/O devices within the system. The 20 address lines allow access of up to 1 megabyte of memory. A0 is the Least Significant Bit (LSB) while A19 is the Most Significant Bit (MSB). These lines are generated by either the processor or the DMA Controller. Active high.	MEMR (Memory Read Command): This command line instructs the memory to drive its data onto the data bus. It may be driven by the processor or the DMA controller. Active low.
D0-D7 (Data Bits 0 to 7): Provide data bus bits 0 to 7 for the processor, memory, and I/O Devices. D0 is the Least Significant Bit (LSB) and D7 is the Most Significant Bit (MSB). Active high.	MEMW (Memory Write Command): Instructs the memory to store the data present on the data bus. It may be driven by processor or the DMA Controller. Active low.
ALE (Address Latch Enable): Provided by the 8288 Bus Controller and used on the System Board to latch valid addresses from the processor. Available to the I/O Channel as an indicator of a valid processor address (when used in conjunction with AEN). Processor addresses are latched with the falling edge of ALE.	DRQ1-DRQ3 (DMA Request 1 to 3): Asynchronous channel requests used by peripheral devices to gain DMA service. They are prioritized with DRQ1 having highest priority and DRQ3 the lowest. A request is generated by bringing a DRQ line to an active level (high). A DRQ line must be held high until the corresponding DACK line goes active.
$\overline{\text{I/O CH CK}}$ (I/O Channel Check): Provides the CPU with parity (error) information on memory or devices in the I/O Channel. When this signal is active Low, a parity error is indicated.	DACK0-DACK3 (DMA Acknowledge 0 to 3): Used to acknowledge DMA requests (DRQ1-DRQ3) and to refresh system dynamic memory (DACK0). Active low.
$\overline{\text{I/O CH RDY}}$ (I/O Channel Ready): This line (normally high or "READY") is pulled low ("NOT READY") by a memory or I/O device to lengthen I/O or memory cycles. Allows slower devices to attach to the I/O Channel with a minimum of difficulty. Any slow device using this line should drive it low immediately upon detecting a valid address and a READ or WRITE command. This line should never be held low for any period in excess of 10 clock cycles (2.1 $\mu$ s). Machine cycles (I/O or memory) are extended by an integral number of CLK cycles (210 ns).	AEN (Address Enable): Used to degate the processor and other devices from the I/O Channel to allow Direct Memory Access (DMA) transfers to take place. When this line is active (high), the DMA Controller has control of the address bus, data bus, read command lines, (memory and I/O), and the write command lines, (memory and I/O).
	T/C (Terminal Count): Provides a pulse when the terminal count for any DMA channel is reached. This signal is active high.



## Deciding Which Computer to Buy

Of the 1.9 million people who bought small computers last year, over 20,000 of them bought the wrong computer for their needs. And no wonder. New products are introduced into the market at a breathtaking pace. The language question. The terminology problem -RAMs, ROMs, bits, bytes, bauds, protocols and processors. What's important? What's standard and what's optional? Even the dealers are confused.

To help you tackle this problem, we pulled together many of our sources -including leading experts in the field, manufacturers, marketing analysts, computer dealers and customers. In addition, we utilized computer user groups, clubs and associations throughout the United States, contacts in Japan and numerous industry and business publications. **COMPUTER GUIDE 1983** is the natural result of learning from the knowledge and mistakes of more than one million people.

The following steps will help you with your computer shopping -whether you're buying your first computer, or updating the one you have. **COMPUTER GUIDE 1983** can help you make the right decision.

### 1. What is the computer to be used for?

You may want to use it for entertainment, financial planning, learning how to speak a foreign language, office work, drawing and many other tasks a computer does well. The possible uses of a computer are as varied as human activities.

### 2. Which program will do the best job?

There are thousands of application programs on the market to consider. It is the program that gives you the power to control the actions of the computer. You must choose the right application program.

The first section of **COMPUTER GUIDE 1983** surveys each of the application programs available with computers today. Similar programs are grouped together and compared -one against another. **COMPUTER GUIDE 1983** contains over 2,000 application programs, grouped in over 100 categories -including programs for accounting, management, professional uses, word processing, graphics, research, games, learning and special applications. Programs are described using comparison charts -listing for each application program: the program name, computer(s) and system configuration(s) required, the documentation available and the price.

**COMPUTER GUIDE 1983** provides you with a quick and efficient way of deciding which application program and which computer and options for that computer can do the right job for you.

### 3. The language?

You cannot get a computer to do anything useful unless you know how to talk to it. This is no easy task. But, **COMPUTER GUIDE 1983** can help.

The second section of **COMPUTER GUIDE 1983** guides you in selecting the right language. Different dialects of languages are grouped in their generic category. The BASIC language, for example, is a generic name and has many dialects -including Microsoft Basic, Atari Basic, Basic Plus and Basic-80.

Each of these languages have their own machine requirements. **COMPUTER GUIDE 1983** provides the name, machine and machine requirements, documentation and price of over 500 dialects, for over 50 languages. **COMPUTER GUIDE 1983** helps you solve the language problem.

### 4. What about the machine?

Depending on your needs, there will probably be several computers still in the running. Now the decision is based on the guts of the machines (hardware). **COMPUTER GUIDE 1983** compares machine characteristics in an easy to follow format. You don't have to be an electrical engineer to make an intelligent decision.

The solution is to work top down and not to go any further down than is needed. Your uses for the computer determines which machine characteristics are important. **COMPUTER GUIDE 1983** divides the machine into five areas -the keyboard, video display, printer, other peripherals and I/O, processor and memory and direct access storage. These five areas correspond to your basic machine needs. For example, an accountant needs a keyboard with a numeric keypad; word processing requires a printer; games utilize a video display; a mathematician wants a very fast machine; lots of memory is best when using the LISP language; and so on, as the hardware combines with the application program to develop a complete computer system.

**COMPUTER GUIDE 1983** contains machine descriptions for over 250 computer systems, produced by over 150 manufacturers. Information is displayed in spreadsheets -allowing you to get the information you need. You don't have to bother with extraneous details and cumbersome text. **COMPUTER GUIDE 1983** can accommodate millions of people in making the right decision, as varied as those decisions will be.

### 5. Where to buy the chosen computer system.

**COMPUTER GUIDE 1983** lists hundreds of vendors, by geographical location, and by the products they sell. It also provides additional consumer information. The first ship date, the ship rate, the number installed to date, prices and what that includes, purchasing terms and warranties. **COMPUTER GUIDE 1983** contains the names, addresses and phone numbers of hundreds of manufacturers, dealers and stores throughout the United States.

No one wins when you buy the wrong computer or computer product. Make the right decision. Use **COMPUTER GUIDE 1983**.

Send me **COMPUTER GUIDE 1983**  
The complete computer buyer's guide.

*I'm enclosing my check for \$32.75 plus \$1.50 for shipping.*  
(Mass. residents add 5% sales tax.)

Mail to: **CESS**  
P.O. Box 345, MIT Branch P.O.  
Cambridge, MA 02139  
(617) 491-8925

Name \_\_\_\_\_

Address \_\_\_\_\_

City, State and Zip \_\_\_\_\_

Please allow six to eight weeks for delivery.

COMPUTER GUIDE and CESS are trademarks of Computer & Electronic Supply Services. P.O. Box 345, MIT Branch P.O. Cambridge, MA 02139.

# *A Pseudo Cursor* FOR OSCILLOSCOPES

*Add a calibrated time base to dual-trace scopes*

*By D. E. Patrick*

**K**NOWING the exact timing relationships between points on a signal displayed on a dual-trace scope is a function of the accuracy (linearity) of the sweep used. In most cases, this can reach 3% or so, dropping to much higher percentages in older and uncalibrated instruments. Unfortunately, most electronics experimenters seem to have uncalibrated scopes in daily operation. As a result, the graticule markings are almost relative.

The "Pseudo Cursor" described in this article can overcome this problem. It's the second trace of a dual-trace instrument and will display a "picket-fence" of narrow, spiked pulses, with each pulse an accurately known time interval from its neighbor. The pulses can be arranged so that every alternate, or every fifth pulse, is emphasized to

make timing interpolation easy. Since the pulses are derived from a crystal-controlled oscillator, pulse interval spacing and thus, timing accuracy can be known to (typically) 0.002%.

**Circuit Operation.** As shown in the block diagram of Fig. 1, the dual-trace scope is set up so that one trace is synchronized with the signal of interest. Since a common time base is used, the second trace is also synchronized. The second trace vertical amplifier is connected to the output of the Pulse Generator.

The Pulse Generator, in turn, accepts pulses from a crystal-controlled time base, then converts them into very spiked pulses that

are applied to the second trace of the scope. Since the Pulse Generator is synchronized to the scope sweep circuit (via the sweep gate signal), the "picket fence" generated on the second trace is locked with the signal under observation. If the time interval between pulses on the picket fence is known, any interval on the signal under observation can be measured. Since the pulse interval timing is based on a crystal-controlled oscillator, their spacing interval can be as accurate as the crystal used—typically 0.002% or better.

A circuit within the Pulse Gener-

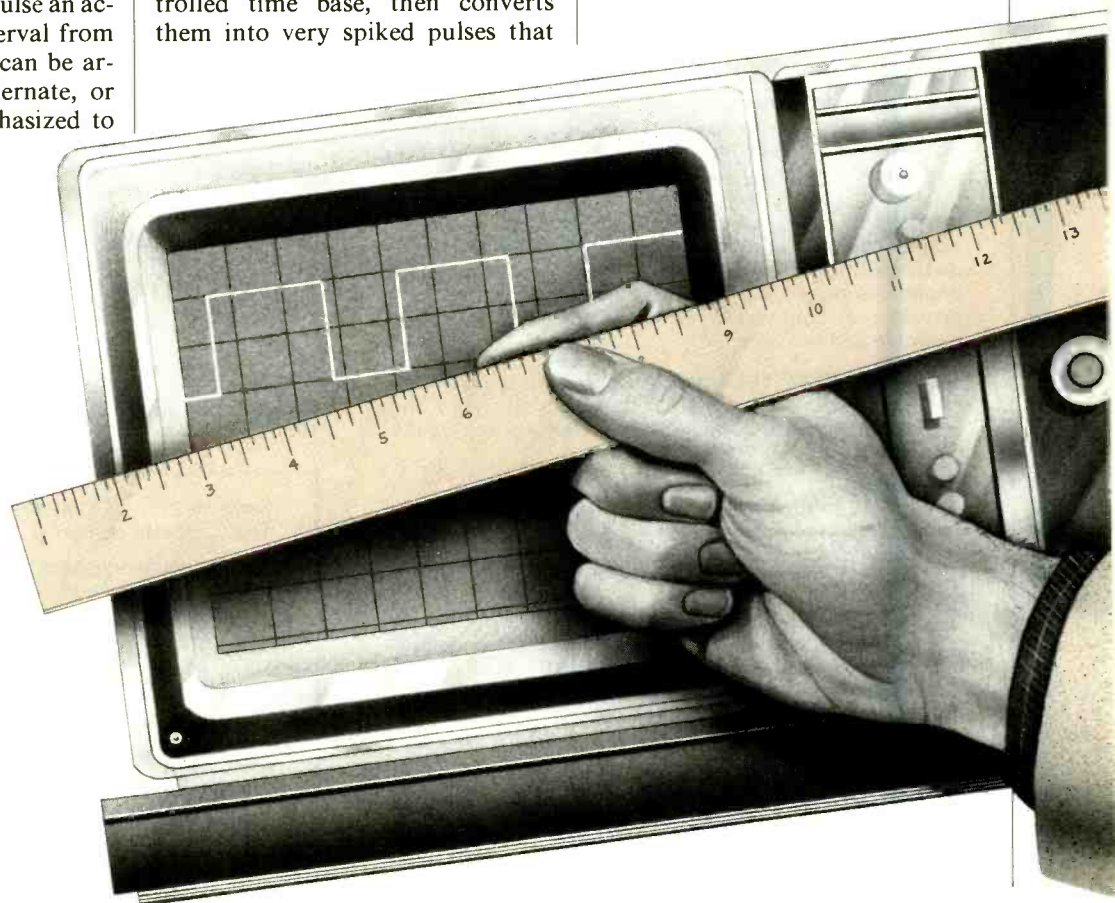



## PSEUDO CURSOR

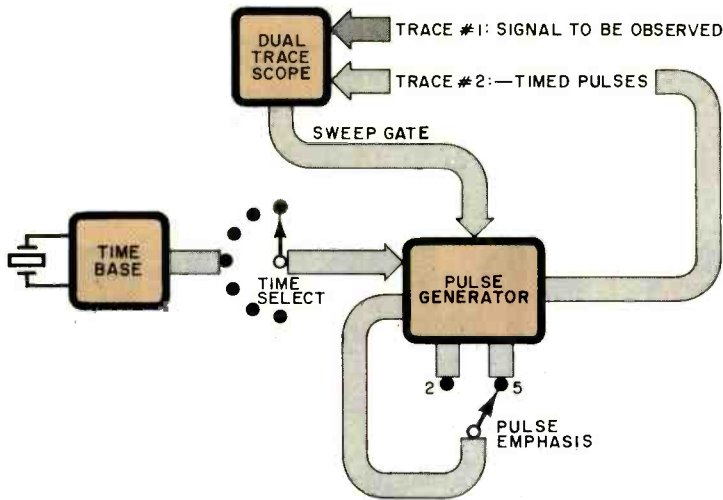

Fig. 1. One trace is synchronized with the signal of interest. The second is connected to the output of a pulse generator.

## PARTS LIST

- C1—10-to-40-pF capacitor. Can be eliminated (along with R9) above 1 MHz  
 IC1, IC2—7490 decade counter  
 IC3—7406 open-collector hex inverter  
 IC4—7400 quad 2-input NAND gate  
 Q1—2N3904 or similar  
 Q2—2N3906 or similar  
 R1—100-kilohm to 1-megohm resistor (see text)  
 R2, R5, R7, R8—1-kilohm resistor  
 R3—470-ohm resistor  
 R4—4.7-kilohm resistor  
 R6—820-ohm resistor  
 R9—100-kilohm potentiometer (see C1 above)  
 S1—Four-pole, double-throw switch  
 S2—Spdt switch
- Note**—The following is available from Electronic Technical Consultants, POB 29278, Denver, CO 80229): complete kit of parts at \$34.95 plus \$3.50 for shipping and handling. Also available separately are the pc board at \$8.00 and the power supply at \$10.00.

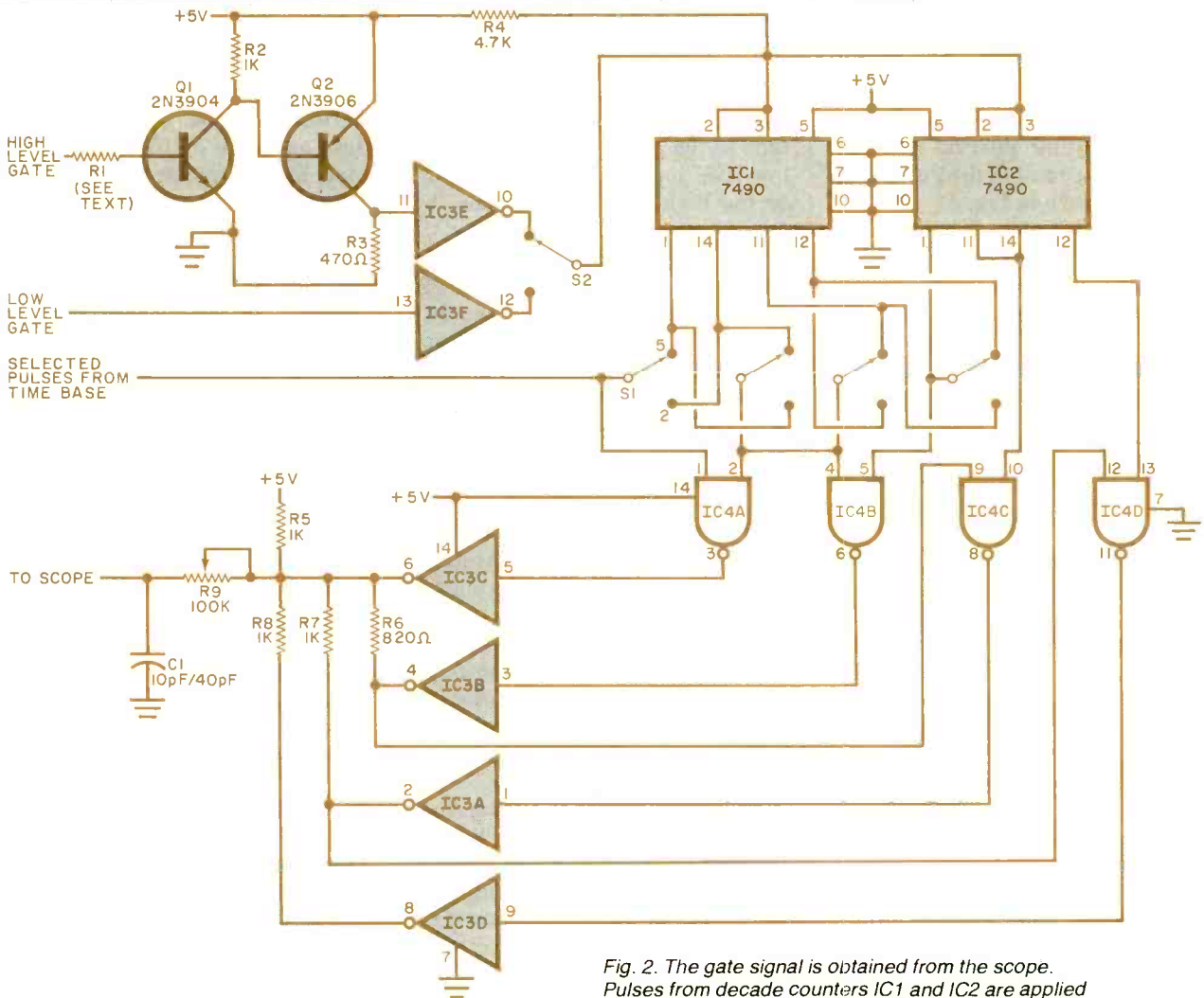

Fig. 2. The gate signal is obtained from the scope. Pulses from decade counters IC1 and IC2 are applied to a D/A converter formed by R5 and R8. Potentiometer R9 and capacitor C1 can be omitted for clock pulses above 1 MHz.

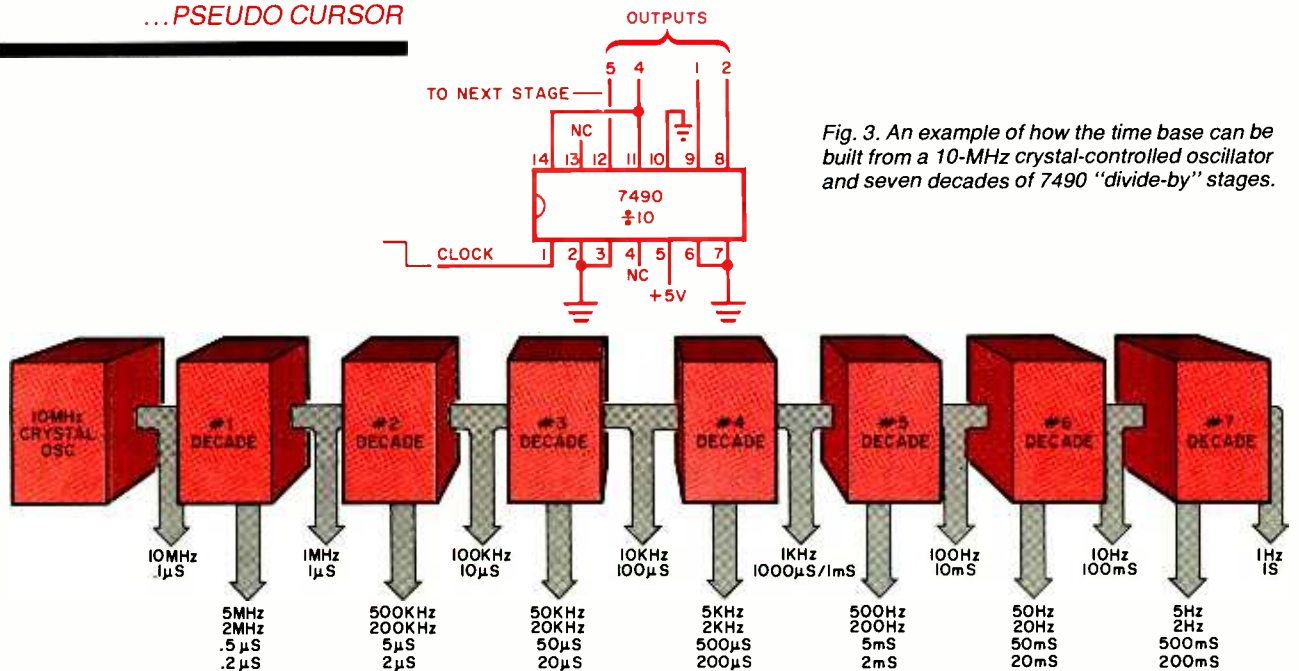

Fig. 3. An example of how the time base can be built from a 10-MHz crystal-controlled oscillator and seven decades of 7490 "divide-by" stages.

ator allows emphasis of either each alternate or each fifth pulse to ease timing interpolations. A selector switch within the time base allows almost any time interval to be selected. The circuit of the Pulse Generator is shown in Fig. 2.

In operation, decade counter *IC1* continuously accepts the selected timing pulses from the time base at its counting (pin 1) input. Both *IC1* and *IC2* have their outputs set to all zeroes if their 0 SET (pins 2 and 3) is high and will start counting when these pins are made low. This is how both decade counters are forced to start from zero at the beginning of each sweep, and count up during the sweep.

The gate signal used to turn *IC1* and *IC2* on must be in existence as long as the sweep is crossing the CRT. In a triggered sweep scope, such a gate is available from the sweep horizontal circuit and can be applied to pin 13 of inverter *IC3F*. For example, such a signal is available in a Heath IO-4510 at *IC404*, pin 9 or pin 8, while in the Tektronix T922 it is available at pin 3 of *U2334A*.

In some cases, the actual sweep ramp voltage can be applied to the base of *Q1* which will remain on as long as the ramp voltage is higher than the *Q1* turn-on voltage. Resistor *R1* in series with the base of *Q1*

can range from 100,000 ohms to a megohm or so, depending on the level of the ramp.

Thus, contingent on the amplitude of the gating signal, either the low-level input consisting of *IC3F*, or the high-level input formed by *Q1*, *Q2*, and *IC3E* is selected.

The output at pin 12 of *IC1* can be used as the trigger for the second decade counter, *IC2*. Since the ICs used for *IC1* and *IC2* are biquinary (divide-by-2/divide-by-5) decade counters, switch *S1* can be used to select either of these division modes. With switch *S1* in the position shown, each fifth pulse on the second trace will be emphasized. If the user prefers one or the other of these emphasis modes, *S1* can be removed from the circuit and the pins of *IC1*, *IC2*, and *IC4* can be wired accordingly.

NAND gates *IC4A* through *IC4D* accept the various division outputs of the two decade counters, and apply their NAND outputs via inverter elements within *IC3* to a rudimentary digital-to-analog converter formed by resistors *R5* through *R8*. The composite signal is applied to the second trace input of the scope via an optional low-pass filter produced by potentiometer *R9* and capacitor *C1*. This filter can be deleted when clock pulses above 1 MHz are being used. In use, *R9* is

adjusted for a clean "picket fence" display on the second trace of the scope.

The time base can be built up from any type of 10-MHz crystal-controlled oscillator capable of driving a TTL load, and followed by as many "divide-by" stages as desired. In the example shown in Fig. 3, note that, with a 10-MHz oscillator and seven decades of 7490 countdown, intervals from 0.1 microsecond to 1 second can be measured with crystal accuracy. If desired, other counting chains can be used. For example, a 7492 can produce a divide-by-2/divide-by-6; a 7493 can produce a divide-by-2/divide-by-8; etc. Any TTL handbook will show how to build almost any modulo counting chain desired for almost any application.

**Construction.** Since the circuits are not critical, any type of construction can be used from point-to-point wiring to the design, etching, and drilling of a small pc board. As previously mentioned, selector switch *S1* may be removed after a choice is made to whether every alternate or every fifth pulse is to be emphasized. Likewise, switch *S2* and the unused gating circuit may be eliminated once the correct gating signal is found within the scope being used. ◇



# Use a TRIPLE-THREAT IC

How a CD4040's 12 flip-flops can be used to make a frequency divider, counter, or meter

By Sami A. Shakir

**A** MAJOR advantage in using state-of-the-art semiconductors is that a number of transistors and several conventional ICs often can be replaced by a single IC. A case in point is the CD4040 CMOS 12-stage ripple binary up-counter. This versatile IC can be used to make a low-cost frequency divider, long-term counter or even a simple frequency meter. In this article, we'll discuss how you can go about doing all three inexpensively and with minimum parts count.

**Technical Details.** All 12 of the CD4040's cascaded flip-flops are

capable of being reset to zero by applying a high (+V) at the RESET input. For normal counting however, the RESET input is held low.

If an input signal is applied to the clock input, each stage will divide the frequency of the signal by 2, the last stage dividing the frequency by  $2^{12}$  (4096). Cascading two counters as shown provides 24 stages that each divide by two, for a grand total of 16,777,216 divisions. In general, stage  $n$  will divide the input by  $2^n$ , where  $n$  is the stage number.

Maximum input frequency to the circuit depends upon supply voltage. For example, with 5-, 10-, and

12-volt supplies, maximum input signals are about 4, 10, and 12 MHz, respectively. Since the 4040 is a CMOS device, it has the advantage of low power consumption, wide 1-to-15-volt power supply range and high noise immunity.

**Possible Applications.** The circuit shown here can be used as a frequency divider, timer, and simple form of frequency meter as follows:

**Frequency Divider.** Twelve-position switch  $S2$  permits a selection of every other counting stage. In this configuration, each position permits division by 4 of the input frequency. Thus, for any selected position of  $S2$ , the circuit will divide the input frequency by  $4^n$ , where  $n$  is the number of the switch position selected. Of course, a 24-pole switch can be substituted to obtain every divide-by capability of the two-chip circuit. In the frequency-divider mode, any signal within the maximum range of the IC can be divided down as desired. One possible application of the frequency-divider mode is to allow an r-f generator to cover the audio range. If an accurate oscillator is used as the input, you will end up with a precision audio source.

**Timer.** If the power line-frequency of 60 (or 50) Hz is used as the input signal, the circuit can be used as a timer that can be reset using  $S1$ . A 60-Hz input has a period of 0.01667 second (16.667 ms), which means the first stage will change state every 0.01667 second, the second stage will double this time, and so on to the last stage, which changes state every 139,809.57 seconds (1.618 days). Since the selected

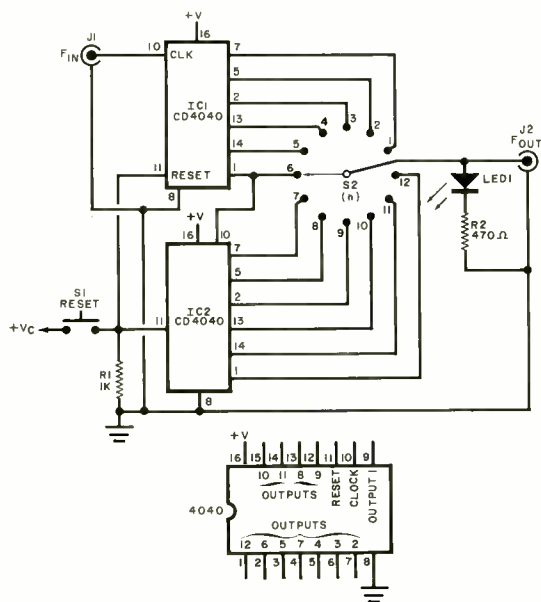

## PARTS LIST

IC1, IC2—CD4040 12-stage counter  
LED1—Any light-emitting diode  
J1, J2—Miniature open-circuit phone jack  
R1—1-kilohm, 1/4-W resistor  
R2—470-ohm, 1/4-W resistor

S1—Spst normally open pushbutton switch (Radio Shack 275-1547)  
S2—Single-pole, 12-position (or 24-position) nonshorting rotary switch (Radio Shack 275-1385 or similar)

# Diskettes For Less!

**MEMOREX**  
AS LOW AS  
**\$2<sup>10</sup>**

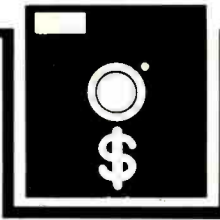

**MAXELL**  
AS LOW AS  
**\$2<sup>74</sup>**

Part #	100 Quantity Price per Disk
<b>8" DISKS</b>	
SSDD IBM Compatible (128 B/S, 26 Sectors)	3062 \$2.10
SSDD Shugart Compatible, 32 Hard Sector	3015 2.10
SSDD IBM Compatible (128 B/S, 26 Sectors)	3090 2.75
DSDD Soft Sector (Unformatted)	3102 3.35
DSDD Soft Sector (128 B/S, 26 Sectors)	3115 3.40
DSDD Soft Sector (256 B/S, 26 Sectors)	3103 3.40
DSDD Soft Sector (512 B/S, 15 Sectors)	3114 3.40
DSDD Soft Sector (1024 B/S, 8 Sectors)	3104 3.40
<b>5 1/4" MINI DISKS</b>	
SSDD Soft Sector w/Hub Ring	3481 2.35
SSDD 10 Hard Sector w/Hub Ring	3483 2.35
SSDD 16 Hard Sector w/Hub Ring	3485 2.35
DSDD Soft Sector w/Hub Ring	3491 3.10
DSDD 10 Hard Sector w/Hub Ring	3493 3.10
DSDD 16 Hard Sector w/Hub Ring	3495 3.10
SSDD Soft Sector w/Hub Ring (96TPI)	3504 3.00
DSDD Soft Sector w/Hub Ring (96TPI)	3501 4.00

Part #	100 Quantity Price per Disk
<b>8" DISKS (single and double density)</b>	
<b>Single Sided</b>	
MODEL NO	
FDI-128M-1100	\$3.56
FDI-128M-1200	
FHI-32M-1200	
<b>Double Sided</b>	
FD2-X-DM-1100	\$4.37
FD2-X-DM-1200	
FH2-32-DM-1200	
<b>5 1/4" MINI DISKS (single and double density)</b>	
<b>Single Sided</b>	
MD1-M	\$2.74
MH1-10M	
MH1-16M	
<b>Double Sided</b>	
MD2-DM	\$3.87
MH2-10DM	
MH2-16DM	
<b>Quadsensity</b>	
MD1-DDM (96TPI)	\$3.56
MD2-DDM (96TPI)	\$4.37

Quantities less than 100 units available at 10% surcharge, prepaid or C.O.D. Minimum order \$50.00.

ALL PRICES C.O.D. SHIPPING NOT INCLUDED

WATCH FOR OUR NEW WEST COAST OFFICE OPENING SOON!

**MAGTEK MEDIA  
DATA SUPPLIES LTD.**

5916 Eighteenth Avenue  
Brooklyn, N.Y. 11204

ORDER TOLL FREE: 1-800-221-0869  
MasterCard and Visa Accepted.

In New York (212) 232-7166

CIRCLE NO. 37 ON FREE INFORMATION CARD

position of  $S_2$  will be high after  $4^n$  (0.01667) seconds,  $LED_1$  will turn on to indicate that the output is high. This high can then be used to control other circuits, the only precaution here being that the input voltage of the circuit being controlled must be about equal to the supply voltage for the timer circuit.

**Frequency Meter.** This mode is just the reverse of the timer mode, because here the input frequency is not known. If we assume the period of the input signal is  $T$ , the first stage will change state every  $2 \times T$  seconds and, hence, will come back to its state after  $4 \times T$  seconds. Therefore, any position of  $S_2$  will yield a period of  $4^n \times T$  ( $n$  being the switch selected). The output is monitored by  $LED_1$ . Hence a period is measured from the time the LED turns off until it turns on again. If you use a stop watch or wristwatch to measure the period, you can calculate the unknown frequency from  $f = 4^n/T$ , where  $T$  is the time measured, for position  $n$ , to turn off  $LED_1$  and then turn it on again.

Frequency measurement accuracy depends upon time-measurement accuracy. Consequently, accuracy is greater for large values of  $T$  since the percentage error due to human reflexes in the measuring process decreases. You should choose the highest possible position for  $S_2$  for greatest accuracy. However, to avoid making the measurement process a lengthy one, an optimum choice for  $S_2$  is the position in which an extinguish/turn-on period is a few seconds. (Note: If the input signal level is low, a suitable amplifier should be used to increase it to where it will reliably drive the circuit.)

**Construction.** Since the circuit has so few components, perforated-board construction can be conveniently used. Selector switch  $S_2$ 's positions can be numbered from 0 to 11 (or 0-23 if you substitute a 24-position switch as described above). Any LED with the appropriate current-limiting resistor ( $R_1$ ) can be used to monitor the output. The board can be installed in almost any metallic or plastic box. Finally, any 3-to-15-volt source can be used to supply power to the circuit.  $\diamond$

**SEE YOUR DEALER TODAY**

FROM

**Firestik®**  
ANTENNAS  
ACCESSORIES

HERE'S A TIP THAT'S PERFECT!  
AM/FM AUTO RADIO AND CB

**Firestik® II**  
GOLDEN SERIES

BARE-HANDS TUNABLE  
"NO TOOLS NEEDED"  
HIGH PERFORMANCE ANTENNAS

ALSO ANTENNAS FOR  
CORDLESS TELEPHONES  
MONITOR SCANNERS

Dealer & Distributor Inquiries Invited  
SEND FOR FREE CATALOG

Firestik® Antenna Company  
2614 East Adams/Phoenix, AZ 85034

Name \_\_\_\_\_  
Street \_\_\_\_\_  
City \_\_\_\_\_  
State \_\_\_\_\_ Zip \_\_\_\_\_

Serving the CB and  
Communications Market Since 1962.

**5-YEAR REPLACEMENT WARRANTY**

CIRCLE NO. 26 ON FREE INFORMATION CARD

**NEW INDOOR ACTIVE ANTENNA**

Covers 300 KHz - 30 MHz.  
For SWL, BCL, VLF DXers.

Rivals long wires

**\$79.95**  
(+ \$4.00 shipping)

**MFJ-1020 NEW INDOOR ACTIVE ANTENNA** sits on your desk ready to listen to the world. Rivals, can often exceed, reception of outside long wire. Unique **Tuned Active Antenna** minimizes intermod, provides RF selectivity, reduces noise outside tuned band. Also use as preselector for external antenna. Covers 300 KHz to 30 MHz in 5 bands. Adjustable telescoping antenna. Controls: Tune, Band Selector, Gain, On-Off/Bypass. LED. FET, bipolar circuitry. Phono jack for external ant. 6x2x6 in. 9-12 VDC or 9 V battery for portable use. 110 VAC with optional AC adapter, MFJ-1312, \$9.95.

Order from MFJ and try it. If not delighted, return it within 30 days for refund (less shipping). **One year unconditional guarantee.**

Order today. Call TOLL FREE 800-647-1800. Charge VISA, MC. Or mail check, money order. Write for free catalog.

**CALL TOLL FREE ... 800-647-1800**  
601-323-5869 in MS, outside continental USA.

**MFJ ENTERPRISES, INCORPORATED**  
921 Louisville Road, Starkville, MS 39759

CIRCLE NO. 32 ON FREE INFORMATION CARD



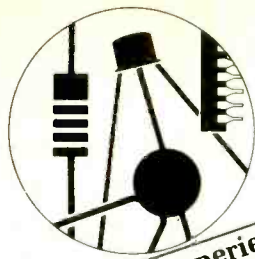

18 years experience

# The ELECTRONICS BOOK CLUB

Exciting projects, troubleshooting and repair tips, and hands-on, do-it-yourself info . . . plus hundreds of time- and money-saving ideas!

Select 5 fact-filled volumes for only \$2.95 (total value up to \$94.75)

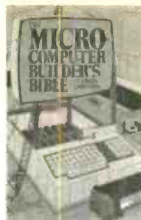

1473 List \$18.95

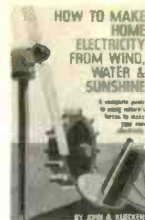

1128 List \$17.95



1225 List \$16.95



1465 List \$15.95



338 List \$14.95



1474 List \$15.95



1486 List \$17.95



1475 List \$14.95

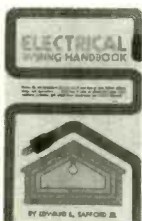

1245 List \$15.95 (paper)



1050 List \$12.95



1113 List \$14.95



1113 List \$10.95



1337 List \$9.95



1332 List \$16.95

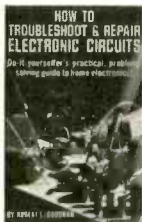

1218 List \$16.95



1169 List \$17.95

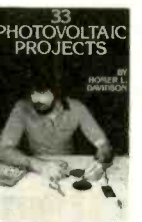

1467 List \$16.95



1402 List \$14.95

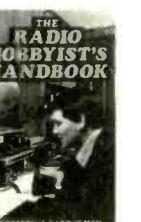

1346 List \$14.95



1233 List \$9.95 (paper)



1108 List \$14.95



1406 List \$17.95



1451 List \$18.95



1283 List \$12.95 (paper)



1435 List \$15.95



1160 List \$13.95



1420 List \$17.95



1296 List \$18.95



1276 List \$15.95



1436 List \$16.95

## 7 very good reasons to try Electronics Book Club

Blue Ridge Summit, PA 17214

- **Reduced Member Prices.** Save 20% to 75% on books sure to increase your know-how
- **Satisfaction Guaranteed.** All books returnable within 10 days without obligation
- **Club News Bulletins.** All about current selections—mains, alternates, extras—plus bonus offers. Comes 13 times a year with dozens of up-to-the-minute titles you can pick from
- **"Automatic Order."** Do nothing, and the Main selection will be shipped automatically! But . . . if you want an Alternate selection—or no books at all—we'll follow the instructions you give on the reply form provided with every News Bulletin
- **Continuing Benefits.** Get a Dividend Certificate with every book purchased after fulfilling membership obligation, and qualify for discounts on many other volumes
- **Bonus Specials.** Take advantage of sales, events, and added-value promotions
- **Exceptional Quality.** All books are first-rate publisher's editions, filled with useful, up-to-the-minute information



## ELECTRONICS BOOK CLUB

Blue Ridge Summit, PA 17214

Please accept my membership in Electronics Book Club and send the 5 volumes circled below, billing me \$2.95 plus shipping and handling charges. If not satisfied, I may return the books within ten days without obligation and have my membership cancelled. I agree to purchase 4 or more books at reduced Club prices (plus shipping/handling) during the next 12 months, and may resign any time thereafter.

338 1050 1108 1113 1128 1160 1169  
1183 1218 1225 1233 1245 1276 1283 1296  
1332 1337 1346 1402 1406 1420 1435  
1436 1451 1465 1467 1473 1474 1475 1486

Name \_\_\_\_\_ Phone \_\_\_\_\_  
Address \_\_\_\_\_  
City \_\_\_\_\_  
State \_\_\_\_\_ Zip \_\_\_\_\_

(Valid for new members only. Foreign and Canada add 20%. Orders outside U.S. or Canada must be prepaid with international money orders in U.S. dollars.) This order subject to acceptance by Electronics Book Club. PE-383

# Automobile IDIOT LIGHTS

Very low-cost circuit monitors your car's electrical system with high-low voltage indicators

By Richard M. Hilbert

Many people think "idiot" lights are just that. But how often do we really look at gauges and how many motorists really know when an instrument indicates a normal reading or a potential problem? On the other hand, a bright red light attracts attention immediately and warns of a malfunction.

The high-low voltage unit described here monitors a vehicle's electrical system for a preset high and low voltage. For instance, a 12-volt system normally operates between 12 and 14.5 volts. Any drop below 12 volts turns on *I1* and any increase above 14.5 volts turns on *I2*. Either indicates a problem.

**Construction.** Construction of the unit is not critical and neither are parts. Many substitutions can be made. All components fit nicely on a 1¾" × 2¼" piece of phenolic perf board. Components *D6*, *D7*, and *S1* can be eliminated if desired. They were added to the original circuit to test the lamps because only the low-voltage lamp comes on during engine cranking (which is perfectly normal). Helitrim potentiometers do not have to be used, but they are easier to "fine tune" than regular potentiometers.

**Calibration and Use.** The circuit as shown is accurate to ±10 milli-

volts. A variable dc-power supply and a digital voltmeter were used to set up the unit. To calibrate, adjust the power supply to the desired low-limit voltage, hook up as shown on the schematic, and adjust *R3* until *I1* just goes out. Then increase power supply voltage to the desired high limit and adjust *R4* until *I2* turns on. All that is left to do is connect the unit to its permanent location.

In the prototype, *I1*, *I2*, *D6*, *D7*, and *S1* were mounted on a remote panel. However, all components could be installed in a minibox and mounted in, on, or under the dashboard. ♦

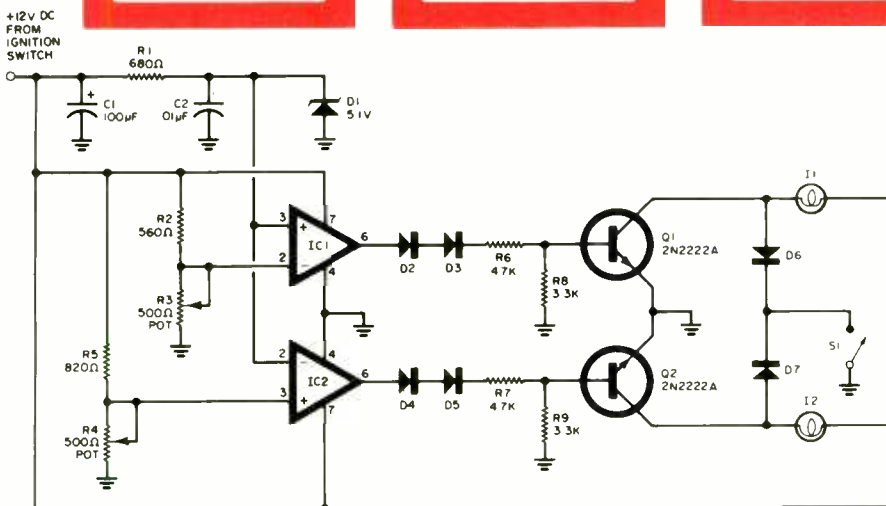
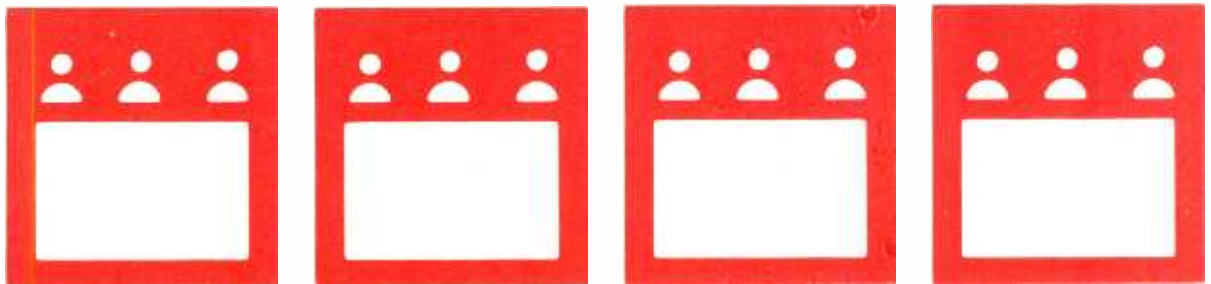

## PARTS LIST

- C1—100- $\mu$ F, 25-V electrolytic
- C2—0.01- $\mu$ F, 50-V capacitor
- D1—5.1-V, 1-watt zener diode
- D2-D7—1N4001 silicon diode
- I1, I2—# 382, 12-V indicator lamp or equivalent with socket
- IC1, IC2—LM-741 op amp
- Q1, Q2—2N2222A transistor
- R1—680-ohm, ½-W resistor
- R2—560-ohm, ¼-W resistor
- R3, R4—500-ohm potentiometer
- R5—820-ohm, ¼-W resistor
- R6, R7—4.7-kilohm, ¼-W resistor
- R8, R9—3.3-kilohm, ¼-W resistor
- S1—Spst momentary, normally open switch



## AMAZING DEVICES

**RUBY LASER RAY GUN** — Intense visible red beam, burns and welds the hardest metals. HAZARDOUS device. Kits available RUB3 PLANS includes part sources \$15.00

**CARBON DIOXIDE BURNING AND CUTTING LASER** — produces a continuous beam of energy. HAZARDOUS device — Kits available LC5 PLANS includes part sources \$15.00

**VISIBLE LASER LIGHT GUN** — produces intense red beam for special effects and other various optical applications. Hand-held enclosure houses batteries.

LGU3 PLANS \$10.00 LGU3K KIT/PLANS (minus tube) \$99.50

LRG3 PLANS \$10.00 LRG3K KIT/PLANS (minus diode) \$119.50

**BEGINNER POCKET LASER** — visible red simulated device produces an excellent monochromatic source of light

LHC2 PLANS \$5.00 LHC2K KIT/PLANS \$24.50

**HIGH ENERGY VARIABLE AND PROGRAMMABLE PAIN FIELD GENERATORS REQUIRE NO CONTACT** — Recently developed device produces directional fields of moderate to high SPL capable of producing intense pain and discomfort. HAZARDOUS IF NOT USED WITH DISCRETION. SOLD FOR ANIMAL CONTROL — MAY BE USED IN CERTAIN INSTANCES TO DISCOURAGE UNWANTED ENCOUNTERS.

PPF1 PROG/VAR PLANS \$15.00 PPF1K KIT/PLANS \$175.00

PPS3 VAR HAND-HELD PLANS \$7.00 PPS3K KIT/PLANS \$44.50

**PHASOR BURNING WAND** — capable of burning flesh, generates 3500 volts of continuous DC power

PSW3 PLANS \$8.00 PSW3K KIT/PLANS \$59.50

**PARALYZING SHOCKING WAND** — produces 100,000 watt pulses of stunning power

PG1W PLANS \$10.00 PG1WK KIT/PLANS \$79.50

Above electrical devices are hand-held and may be used for PERSONAL DEFENSE

**SNOOPER PHONE** — allows user to call his premises and listen in without the phone ever ringing

SNP2 PLANS \$7.00 SNP2K KIT/PLANS \$49.50

**LONG RANGE WIRELESS MIKE** — miniature device clearly transmits over 1 mile

FB19 PLANS \$7.00 FB19K KIT/PLANS \$34.50

**WIRELESS TELEPHONE TRANSMITTER** — long range all automatic, undetectable

VWPM5 PLANS \$7.00 VWPM5K KIT/PLANS \$34.50

**TALK AND TELL** — clearly and automatically records both sides of a telephone conversation when phone is being used

TA12K KIT/PLANS \$14.50 TA120 READY TO USE \$24.50

Our order phone is available 24 HOURS, 7 DAYS A WEEK. Write for FREE catalog of our many products.

We accept Master Charge or Visa. Please allow 10% for shipping. On orders OVER \$50.00 WE PAY freight.

SEND TO: SCIENTIFIC SYSTEMS  
DEPT. 01, P.O. BOX 716, AMHERST, NH 03031  
OR CALL FOR ORDERING ONLY: 1-603-673-4730

## LITERATURE

### MICRO CATALOG FROM ROCKWELL

A new publication, designated "Short-Form Catalog, part number D-2" is now available from the Electronic Devices Division of Rockwell International. The 16-page, four-color brochure covers microcomputers, development systems, modems, and expansion devices. Included are summaries of Rockwell's 4-, 8- and 16-bit microprocessors, the R6500 AIM 65 and AIM 65/40 board-level computers with their associated support products, and LSI-based 2400 and 9600 bps modems. A separate chart compares the performance of the Rockwell R6500 family to competitive microprocessor families. Address: Sales Support Services, Electronic Devices Division, Rockwell International, Box 3669, RC 55, Anaheim, CA 92803.

### A/D CONVERTERS

A six-page application note discussing some common pitfalls in using and testing A/D converters is available from ILC Data Device Corporation. Entitled "Getting the Best from A/D Converters", it describes common problems encountered by system designers such as track-and-hold timing, noisy grounds, and T/H output drive limitations. Suggestions are made for achieving specified converter performance, and for eliminating time-consuming debugging procedures. Attention is given to output impedance problems, grounding difficulties, and ADC summing point sensitivities. Address: Marketing Dept., ILC Data Device Corporation, 105 Wilbur Place, Bohemia, NY 11716.

### WIRING AND PC BOARD TOOLS

The new 65-A-1982 is a 24-page full-color catalog of wire wrapping tools and other electronic assembly tools and parts from OK Machine and Tool Corporation. It features a new line of PC boards, IC dispensers, circuit troubleshooting kits, etc. Address: O.K. Machine and Tool Corporation, 3455 Conner St., Bronx, NY 10475.

## TS1000-ZX81

OWNERS



## WIN \$20,000 or more

KRAKIT™ is an adventure and a treasure hunt for the ZX81 and TS1000 computers. The bank account and prize money actually exist. Be the first to crack the puzzle and the prize is yours. Only one prize will be awarded.

### SOLVE 12 CLUES LIKE THIS!

*Where it all began. Where the torch was first lit. Where muscles and sinews strain. Where our heroes win acclaim. Where the symbols hold the key.*

KRAKIT™ consists of 12 clues on a ready-to-run ZX81 or TS1000 cassette tape (16K RAM). The answer to each clue is the name of a country, a city or town, and a number. If you are the first qualified entrant to solve all 12 clues and declared the winner, you receive two tickets to the city of the secret KRAKIT™ vault location. When you arrive at that location, a check for a minimum amount of \$20,000.00 (U.S.) will be presented to you. The amount of the prize money is augmented weekly.

## TS1000-ZX81

### RULES

1. The first qualified entrant to be confirmed by the judges to have completed all the clues correctly is the winner.
2. There will be one winner only.
3. No persons connected to International Publishing & Software Inc. or their families are eligible to enter KRAKIT™.
4. This offer is not valid where prohibited by law.
5. Due to the confidential nature of KRAKIT™ we regret we are unable to enter into any individual correspondence. All the required information, including how to claim the prize, is on the computer tape.
6. The winner will be required to sign an affidavit of compliance with these rules.



INTERNATIONAL PUBLISHING & SOFTWARE INC.  
P.O. BOX 1654, BUFFALO, N.Y. 14216



Mail to:  
INTERNATIONAL PUBLISHING & SOFTWARE INC.  
P.O. BOX 1654, BUFFALO, N.Y. 14216

Please send \_\_\_\_\_ copies of KRAKIT™ at \$19.95 plus \$1.50 shipping.

Total \_\_\_\_\_ enclosed is  check  money order

Charge to  Visa  Mastercard

Number \_\_\_\_\_

Expiry \_\_\_\_\_ Signature \_\_\_\_\_  
*Please Print*

Name \_\_\_\_\_

Address \_\_\_\_\_

City \_\_\_\_\_ State \_\_\_\_\_ Zip \_\_\_\_\_

*Allow 2 weeks for personal checks.*

*Dealer inquiries welcome.*

CIRCLE NO. 13 ON FREE INFORMATION CARD

# FOCUS

**FOR ORDERS ONLY! TOLL - FREE (800)221-0620**

Electronic/Computer VIDEO LARGEST AUTHORIZED  
GAMES NEW UCHTEX ARCADE w/Screen \$16990 SONY DEALER IN BROOKLYN

**Atari \$11495**  
Sold w/Combat Cartridge \$119.90  
Pacman Cartridge \$25.90

**Intellivision II by Mattel \$14990**

Intellivision Make your Mattel talk \$99.95  
Buy 10 Cart. for Mattel or Atari & get 1 free \$24.95

Pacman Game \$43.90  
Donkey Kong Game \$24.95

**FIDELITY: CHESS**  
Sensory Voice Chess \$179.90  
Mini-Sensory \$339.95  
Sensory 6 \$84.95  
Chess Challenger 7 \$66.90  
Champion Sensory \$264.95  
Chess Sensory 8 \$119.90

**Computers**  
Call  
Atari 400 w/16K \$139.95  
Atari 800 w/48K \$499.90  
Commodore 64 in stock CALL  
Commodore Vic 20 expands to 32K  
Sharp PC 1211 w/Printer \$169.95  
CE 122 \$108.99  
Sharp PC 1500 w/CE 122 probe \$269.95  
Times Sinclair Computer \$14.95  
TI 99/4A Comp \$294.90  
1100 Mhz rebate \$99.98  
Amdek 12" Green Monitor \$139.90  
Sanyo 12" Green Monitor \$89.99

**Original Daisey Dish Microwave Receiver**  
Fig. 21 24 pin \$9990  
w/ 60 & 90 ft. of cable  
2x Channel Cable Converter \$79.90  
w/ AC Power & 72 300 ohm disc

For information and all N.Y. State orders, please dial (212)871-7600. All items subject to availability and price change. Mail and phone orders C.O.D. Master Charge, Visa O.K. Shipping extra. Everything Factory Fresh 10 day Money Back Guarantee (less shipping) FOCUS ELECTRONICS 4523 13th Ave. Brooklyn, NY 11219

CIRCLE NO. 18 ON FREE INFORMATION CARD

## How to Use Subroutines

By Jim Keogh

**I**N THE PAST, we have presented several useful subroutines in this column. Some readers have asked for more information on how to use these subroutines to develop their own programs. Here are some ideas on combining subroutines with your own system.

A subroutine is a group of computer commands that have the computer perform a certain function when the commands are executed. Building a program or system from a group of subroutines is called module programming. Each subroutine or module is linked to other modules in a manner similar to the construction of a building.

Let us take a look at a rather simple program that analyzes data and presents it in the form of a bar graph on the display screen. The program receives data, manipulates the data, and then displays the results. The modules that make up the program are:

*Input.* The first module is for the input of data. A set of commands must be written that enable the data to be received into the program. Input modules can be designed to handle data coming directly from the keyboard, from a data tape, from a disk, or even from another program.

*Manipulation.* The next module accepts the data from the first module and performs the necessary analysis. There are countless ways to analyze data and each method may produce an independent module.

*Display.* The display module takes the results of the manipulation and displays them. As with the other modules, it can take one of a variety of forms.

In our example, the programmer will have to develop three modules or subroutines before the input data can be displayed in the form of a bar graph. Although we said the programmer must develop each module, that is not necessarily the case. There are other techniques that can

be used to acquire the modules needed for the program.

A programmer can review other programs he or she has developed and borrow a module that has the same function. A programmer can also review the work of others (such as those presented in this column) and pick up some tips.

There is really no need to rethink the logical commands for each function within a program unless the programmer is designing a piece of unique software. Just as electronic devices are built from existing circuit designs, programs can be built up from existing subroutines.

In our example, all the programmer has to do is develop or locate two of the three modules required: the input module and the manipulation module. The display module is a subroutine presented here a few months ago. With the three modules (subroutines) available, the only task is to combine them.

**The Connection.** Unfortunately, building a program from subroutines or modules is not like constructing a building in every way. You can't just nail one module to another. At this point it is more like combining off-the-shelf electronic circuits. The circuits may be adequate for your project, but additional circuits are needed for the interconnections.

Software subroutines also need a few commands to connect subroutines. Before you set out to connect subroutines, you must have a thorough understanding of each one's function. You must be able to follow the logic and the commands of each module before you are ready to connect them.

To develop this understanding, you must read the subroutine line by line and determine how the computer will function after each command. Don't try to shortcut this approach! Without it, you can easily become lost when modifying and linking modules. It is much less time-consuming to review the logic of the module before developing a large program containing several modules. After you run the pro-

gram, you might find yourself spending hours trying to find bugs in the software that could have been avoided by taking the necessary precautions at the subroutine stage.

Once the logic of each module is known, it will become obvious as to where one is in conflict with the other. Conflict in the logic flow of subroutines can come when each subroutine uses a different variable for the same data. Other problems can arise from the size of the dimension commands. These situations can be corrected by modifying a command statement in the module.

The programmer may also find that he has to modify subroutines that do not involve a problem of connecting modules. For example, the programmer may want to have certain portions of the display printed in a position different from that contained in a subroutine. As long as the programmer has a thorough understanding of how the subroutine functions, this modification can probably be made in a short time.

Of course, an entire subroutine does not have to be used just as it was written. It can always be enhanced by using some original additional ideas. For example, a subroutine that draws a game board could be enhanced by adding color and sound (assuming your computer has color and sound). In this case, you would have adjusted the function of the subroutine to suit your own taste.

When you see a subroutine you would like to use, remember it is just a guide that can be either used intact or greatly modified to suit your needs.

**Subroutines as Learning Tools.** So far we have concentrated on how to select a software subroutine and combine it with others to develop a program. You do not have to have a program in mind to find a use for a subroutine. Subroutines show you how to have a computer perform a specific function, and they can also be used as material to increase your own knowledge of programming.

For example, suppose you wanted to develop a program to have



your computer keep score in a game. In a recent column, we discussed how to program registers so that the computer could keep track of several events. The register is the logic used to develop a subroutine to keep score. You might not develop a program containing a register module, but you might learn the logic behind such a subroutine.

Subroutines can be used as lessons in BASIC programming. They are advanced material for the newcomer to programming. To use subroutines as learning tools, you must have a good understanding of the command statements in the BASIC language. Without this knowledge, you will have a difficult time trying to follow the logic of the module. Once you speak and understand the language of programming, you can quickly increase your understanding by reviewing how a subroutine was able to present a certain function on the computer.

For example, one reader pointed out that, after developing a good foundation in the BASIC language, she still felt that developing a simple target game was too difficult to attempt. However, after reviewing, in detail, the subroutines in the target game, she realized she was "reading" more into the program than was actually there.

The projectile moving from the bottom to the top of the screen was a routine she thought was well above her ability and understanding. However, when she studied such a subroutine, she realized that the movement of the projectile was nothing more than turning on and off a series of lights on the display screen. She already knew how to light up portions of the screen and was soon developing her own target games.

Let us review some of the more common techniques used to dissect a subroutine. First, when you look at the program list, don't try to review the entire program in one glance. Looking at a program in that manner can overwhelm even the best programmer.

A good approach is to study ten lines at a time. Try to identify com-

mands and routines (that is, loops) contained within the ten lines. Make sure you have a clear understanding of what the computer will do using those ten lines.

If the function of the instructions on the lines is not clear, key them into the computer and run the program. Finally, if the logic still escapes you, key the program into the computer and have it trace it for you.

Be sure that you also follow commands that send the computer to different lines in the program (GOTO, GOSUB, etc.). Don't take the shortcut and skip following the branches. Remember when you are programming, you either know how to program a certain function or you don't know how. The computer will not let you program half a program.

Whenever you pick up a program or subroutine written by someone else, take a few moments to study what it was designed to do. You'd be surprised what tips and hints about programming you will discover. The more time you spend investigating programming logic, the more often you will be saying, "So that's how they do it!" Then you will be developing your own creations and others will be saying, "How does he do it?"



"I don't care if it is your Pet, get it out of the bed."

# Put Professional Knowledge and a COLLEGE DEGREE in your Electronics Career through HOME STUDY

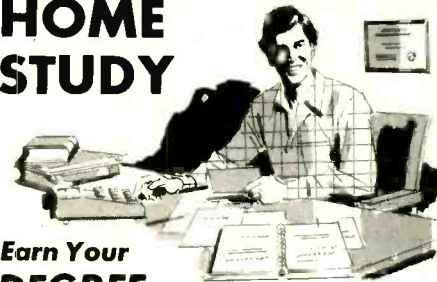

## Earn Your DEGREE

No commuting to class. Study at your own pace, while continuing your present job. Learn from easy-to-understand lessons, with help from your home-study instructors whenever you need it.

In the Grantham electronics program, you first earn your A.S.E.T. degree, and then your B.S.E.T. These degrees are *accredited* by the Accrediting Commission of the National Home Study Council.

Our *free* bulletin gives full details of the home-study program, the degrees awarded, and the requirements for each degree. Write for *Bulletin ET-83*.

**Grantham College of Engineering**  
2500 So. LaCienega Blvd.  
Los Angeles, California 90034

### CALCULATOR SAVINGS

HEWLETT PACKARD		TI-35	
HP-10C Scientific	\$57.99	TI-35	\$19.99
HP-11C Programmable	74.99	TI-55-II	39.99
HP-12C Financial	99.99	TI-58C	89.99
HP-15C Programmable	99.99	TI-59	189.99
HP-16C Hexadecimal	99.99	PC-100C	169.99
HP-41C Alpha Prog.	149.99	HP-97 Desk Programmable	599.99
HP-41CV Full Memory	207.99		
HP-41 System Case	79.99	82161A Cassette Drive	369.99
Port-X-Tender to 10 pins	146.99	82162A HP-IL Printer	369.99
82104A Card Reader	154.99	82163A Video Interface	189.99
82143A Printer	289.99	82165A GP-IO Interface	249.99
82153A Wand	99.99	82180A Extnd Functns	59.99
Gordon Battery System	34.99	82181A Extnd Memory	59.99
HP-41 Pacs	26.99 to 64.99	82182A Time Module	59.99
82180A HP-IL Module	94.99	82183A Extnd I/O	59.99
		82184A Plotter ROM	59.99

Call for Low Prices on all Accessories and Software

Texas Instruments 99/4A Computer	\$329.99	TI-35	\$19.99
Extended BASIC Module	74.99	TI-55-II	39.99
Peripheral Expansion Box	189.99	TI-58C	89.99
Disk Controller Card	189.99	TI-59	189.99
Expansion Box Disk Drive	294.99	PC-100C	169.99
*100 rebate from TI on TI-99/4A purchase		HP-97 Desk Programmable	599.99

Call us for low prices on Casio digital watches

Olivetti Praxis 35 Triple-pitch Electronic Typewriter	\$399.99
Sharp PC-1250 Pocket Extended BASIC Computer	989.99
CE-125 Printer/Microcassette for PC-1250	149.99
PC-1500 Advanced Handheld Computer	179.99
CE-150 Cassette Interf./4-color Printer-Plotter	179.99
CE-151 4K Memory Expansion for PC-1500	49.99
CE-155 8K Memory Expansion for PC-1500	104.99
CE-158 RS-232C & Parallel Interface for PC-1500	179.99
CE-159 8K Memory Expans with Battery Back-up	139.99
Casio FX-702P Handheld Computer, 1680 Steps	999.99
FA-2 Cassette Interface for FX-702P	42.99
FP-10 Printer for FX-702P	79.99
FX-602P Alphanumeric Programmable, 512 Steps	69.99
MT-45 Keyboard with Chords, Bass, Rhythms	159.99
MT-65 Home Entertainment Keyboard	249.99
MT-70 Advanced Memory Keyboard	299.99
CT-701 Advanced Electronic Memory Organ	629.99
Call us for low prices on Casio digital watches	
Pearl-corder S904 Two-speed, Two-hour Recorder	49.99
S901 Two-speed, Two-hour, Tape Counter	99.99
S801 Two-speed, Compact, Memory Hewing	149.99
X-01 Ultra-thin All Electronic	199.99
XR Advanced Tiny Recorder/AM/FM	299.99
Olympus Pearl-corder Microcassettes	10 for 24.99

We accept cashier's checks, money orders, VISA, and M/C. Personal checks take 5 weeks to clear. Add shipping: 1% of your order (\$3.95 minimum). East of Missp Rvr add \$1.50. CA res add 6%. Subject to availability. USA prices.

ORDER 800-421-5188 Outside  
TOLL-FREE Information line (213) 633-3262 CA, AK, HI

**tam's**  
INCORPORATED

Tam's Inc, Dept CE-3  
14932 Garfield Ave.  
Paramount, CA 90723  
(213) 633-3262

CIRCLE NO. 42 ON FREE INFORMATION CARD

# COMPUTER VIDEO GAMES

## Reviews of the Latest Computer Game Software

### PRINCESS AND THE FROG

*Romox Inc., 64K ROM cartridge.*

As a person who is "less than gentle" on floppy disks, I eagerly rushed to my Atari with this new ROM cartridge from Romox. However, I must admit it was a disappointment when I ran the program.

It was readily apparent from the packaging that this was another of the many "Frogger" clones, but this game didn't even try to vary the elements much. The instructions were limited to a few incomplete statements printed on the reverse side of the packaging. As they were printed in dark letters on a black background and extremely difficult to read, I saw why Romox didn't bother to make them very extensive.

Nonetheless, proceeding with every intention of forgiving all these minute details if the game was an interesting variation, or a challenge to the player, I loaded the cartridge, grasped the joystick and proceeded to play.

The first feature (or lack of) that came to the forefront, was the absence of the usual theme music that comes with nearly every game. While this music adds to the overall atmosphere, I do confess to approving of its absence, as cute jingles can quickly become very annoying after a very short time. The game sounds that were part of the play, while



"If it's still possible,  
I'd like to place a  
human-being-to-human-being call!"

nothing spectacular, were more than adequate.

On my 12-inch Sony TV screen, the graphics were marginally acceptable. It took some pretty close observation to distinguish the jousting knights that were the first obstacles to be evaded. After just 2 or 3 tries, this became quite easy to do. Then it was on to the second section. Here, the player (frog) must cross a moving moat by hopping upon the backs of snakes and alligators and landing safely on the far side. Bonus points are awarded for connecting with female frogs along the way.

All in all, the "Princess and the Frog" is another in an endless series of unimaginative copies of successful arcade and computer games. It is very quickly mastered by a novice game player and offers little that would allow a favorable recommendation. Save your money.

### PREPPIE

*Adventure International. 16K disk.*

This game by Russ Wetmore had come highly recommended, and I'm very happy to report, that I was not disappointed in the least. This is one of the more imaginative variations of the Frogger style of action games, with graphics and sound that rival the original.

In this 2-player game, each player controls a "Preppie" (complete with matching designer shirt), through 2 obstacles in pursuit of wayward golf balls. In the first section, our Preppie must dodge golf carts, lawnmowers, tractors, and similar moving vehicles to reach the safe zone in the center of the screen.

The second challenge finds him crossing a moving stream by hopping from logs to canoes to the backs of that familiar alligator, that sometimes takes a dive below the surface.

Each successive difficulty level is truly a step up from the previous one and more than adequately accommodates the beginner yet challenges the experienced player.

The author is to be commended for the catchy soundtrack and his

excellent use of the Atari superior color graphics capabilities. The instructions were complete and very readable. While the disk version is copy-protected, and cannot be backed up by the purchaser for his own purposes, AI does have what is probably one of the most reasonable policies in the industry. A free replacement is offered for a full year in the event the original disk fails to boot, and a modest \$5 handling fee levied after that. Should the purchaser want a backup available on hand at all times, a coupon is enclosed that allows an additional copy to be ordered immediately without the documentation for \$3.99.

Preppie provided hours of fun without losing its appeal and I recommend it without reservation to all game players.

### SHAMUS

*Synapse Software*

It's difficult to talk about "Shamus," by Wm. Malaga, without using lots of superlatives and expressing a level of excitement not generated by most new games. "Shamus" is an arcade game requiring fast reflexes, a nimble touch on the joystick, and thought and planning to succeed.

The object of this game is to maneuver your SHAMUS through 4 maze-like levels of 36 rooms to find the secret and defeat the dreaded foe, the "Shadow." Equipped only with the powerful Ion-shivs, Shamus must battle hoards of opponents every step of the way.

As if all this weren't enough to challenge players, the author has included 4 selectable skill levels that range from challenging to outright impossible. As stated in the instructions, you better not expect to master this game in 1 or 2 sittings but rather enjoy it for quite a while.

If there were an award for the outstanding computer game of the year, my vote would be cast for "Shamus." I recommend it without reservation to every Atari owner who isn't satisfied by the mediocre fare that is all too commonplace. Get one for a friend, too! ◇



## SOLID-STATE DEVELOPMENTS

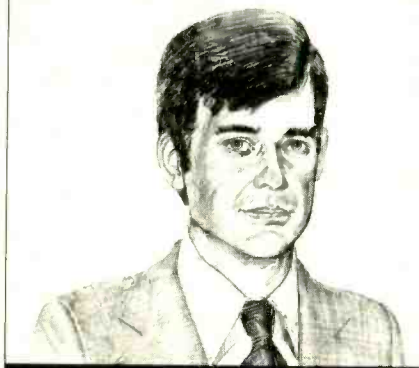

### New Peripheral Transforms Apple II into A Computerized Oscilloscope

By Forrest M. Mims

**I**F EVER there was an important technological breakthrough in peripherals for personal computers, it's the Model 85 aScope™ from Northwest Instrument Systems, Inc. Briefly introduced in this column last month, the aScope is a compact, modular accessory that transforms the Apple II computer into a powerful, programmable, dual-trace oscilloscope with memory capability and a 50-MHz bandwidth.

The aScope module has two BNC connectors and two rows of edge connectors (Fig. 1). The \$995 price for the module and its operating software might at first seem rather steep; but when plugged into an Apple II, the combination provides the capabilities of a highly sophisticated laboratory oscilloscope worth over \$10,000.

The most important circuit components of the aScope are a high-speed sample-and-hold system and an 8-bit analog-to-digital converter. The aScope provides real-time processing and digitization for sweep speeds of 1 ms/div and slower. For sweep speeds of 10 ns/div to 500  $\mu$ s/div, the inherent speed limitation of the A/D converter is overcome by employing a sampling method called *equivalent time digitization*.

The aScope provides both normal and automatic triggering. The trigger level is programmable in 10 mV steps from 5 mV/div to 200 mV/div, and 200-mV steps from 500 mV/div to 5 V/div. Both the slope (plus or minus) and source (channel 1 or 2) are programmable.

The rise time of the aScope is 40  $\mu$ s or less in the real-time mode and 7 ns or less in the equivalent time digitizing mode. The vertical sensitivity ranges from 5 mV/div to 5 V/div, programmable in the standard 1-2-5 sequence.

The features that distinguish the aScope from conventional oscilloscopes are made possible by the Apple II. For example, a software-generated graticule can be displayed upon command. A movable cursor and an on-screen digital-voltmeter readout permits the amplitude of any selected point on a waveform to be accurately measured with or without a graticule.

Waveforms can be stored and later recalled for comparison with other waveforms. They can be printed on an Epson MX-80 printer with graphics option or an Apple Silentype.

Figure 2 is a screen photograph

from an Apple II/aScope display showing a dual-trace rendition of a sine wave and a square wave. Note the convenient on-screen calibration information on the bottom left side of the photo. Also note the cursors near the center of each waveform. The information on the bottom right side of the screen provides the amplitude of each signal at the respective cursor locations.

Another screen photo of an Apple II/aScope combination is shown in Fig. 3. Here the graticule has been selected to permit two waveforms to be visually compared. The upper waveform (channel 1) is being displayed by means of equivalent time digitization (note the 10-ns/div sweep speed). The lower waveform is designated as the reference, apparently because it has been recalled from memory.

The aScope is an outstanding example of what can be achieved by combining a personal computer with a sophisticated semiconductor subsystem. The aScope also illustrates what can be accomplished by considering a personal computer as an advanced, programmable processing system for test equipment peripherals. Perhaps we will next see additional peripherals that convert computers into fully program-



Fig. 1. The aScope converts an Apple II into a digital oscilloscope.

mable spectrum analyzers, automotive tune-up analyzers, digital multimeters, and even function generators.

The aScope is supplied with a user's manual (available separately) and all necessary software on a 5¼ inch diskette. It requires an Apple II with 48K RAM, a video display, Disk II drive, and DOS 3.3. For more information, write Northwest Instrument Systems, Inc. (PO Box 1309, Beaverton, OR 97075), or call 800-547-4445.

**A 7-Bit Flash A/D Converter.** In last month's discussion about flash A/D converters, Motorola's MC10315L/MC10317L 7-bit flash A/D converter was mentioned briefly. I have since received a data sheet for this new device.

The only difference between the MC10315L and MC10317L is the method of overranging. When the MC10315L is overranged, all output bits remain high and the overrange output goes high. When the MC10317L is overranged, all output bits go low and the overrange output goes high. This permits the MC10317L to be paired with an MC10315L to provide an 8-bit A/D flash converter.

The MC10315L/MC10317L employs a string of resistors that provides an ascending series of reference voltages to each of 128 latched comparators. The input signal is applied to a pin that is common to the inputs of all the comparators.

The comparator outputs are fed into a 128-to-7-bit encoder. The output from the encoder goes to a clocked output latch that stores between samples the digitized input signal. The maximum sampling frequency is 15 MHz. The device typically has a non-linearity of just  $\pm 0.16\%$ .

The MC10315L/MC10317L is supplied in a 24-pin ceramic DIP. Though it's price may be too high for many experimenters, it is substantially cheaper than previous flash A/D converters. Its applications include digital oscilloscopes, fast A/D conversion for microcomputers operated in a "real time"

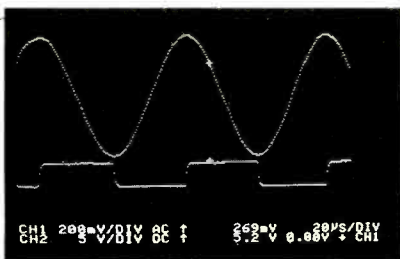

Fig. 2. Results of use of aScope in the digital voltmeter mode.

mode, high-speed instrumentation, video special effects and encoding, and radar signal processing. For more information, contact Motorola Semiconductor Products, Inc. (Box 20912, Phoenix, AZ 85036).

**A Piezoelectric Cooling Fan.**

Piezo Electric Products, Inc. has formally introduced a family of miniature piezoelectric blowers. These remarkable new fans are designed to cool components such as power semiconductors. They incorporate a pair of piezoelectric benders formed by sandwiching a thin metal tab between a pair of piezoceramic layers. When powered directly by the ac line (115 volts at 60 Hz), each bender waves a rectangular Mylar "blade" back and forth. A molded plastic housing directs the resultant flow of air into a highly directional stream.

Since the piezoelectric benders are operated well within their elas-

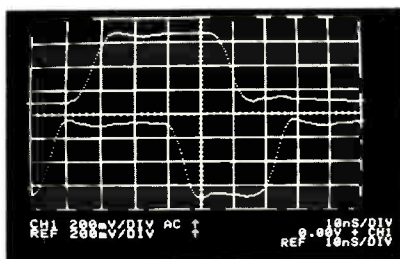

Fig. 3. The aScope/Apple II providing graticule and a pair of traces.

tic limits, the fans are expected to have much longer operating lives than the 10,000 hours of typical electromagnetic rotary fans. In fact, Piezo Electric Products has operated a piezoelectric bender for more than three years with no detectable degradation in performance.

Two of the new fans are now available. Module A is a miniature piezoelectric blower designed for printed-circuit board mounting. It

weighs only 0.7 oz. and consumes 25 mW. Module B is a more powerful fan that consumes 150 mW and delivers an air flow of 300 ft./min. A module C fan that is more powerful than the other two is not yet available.

The Module A is \$96 per dozen, while the Module B is \$120 per dozen. For more information about these fans and other novel piezoelectric products, write Piezo Electric Products (212 Durham Ave., Metuchen, NJ 08840). You may also wish to refer to this column in the June 1982 POPULAR ELECTRONICS ("New Piezoelectric Products," p. 73).

**A High Speed Z80.** Zilog, Inc., the company that developed the Z80 microprocessor, has now introduced an 8-MHz version of this popular chip. Earlier versions of the Z80 operate at 2.5, 4.0, and 6.0 MHz.

Designated the Z80H, the new microprocessor is supported by Zilog's Z8500 family of peripheral circuits designed for more powerful 16-bit microprocessors. This increases system throughput of the Z80H by four to six times over comparable systems based on the 4-MHz Z80A. The Z8500 peripherals include the Z8530 Serial Communications Controller (SCC), the Z8531 Asynchronous Serial Communication Controller (ASCC), the Z8536 Counter/Timer and Parallel I/O Unit (CIO), the Z8538 Bus Control Interface Unit (F10), the Z8060 FIFO Expander, and the Z8516 Direct Memory Access Unit (DTC).

The Z80H is priced at \$19.95 in 1,000-unit quantities. It is supplied in a 40-pin plastic DIP. For more information, write Zilog, Inc. (1315 Dell Avenue, Campbell, CA 95008).

**New Liquid-Crystal Display Developments.**

Liquid-crystal displays continue to become more versatile and popular. Driving such displays formerly presented several circuit design difficulties, but now a range of driver ICs is available. The latest liquid-crystal display drivers is a family of three CMOS chips announced by National Semiconductor Corporation (2900 Semiconductor



...SOLID-STATE

tor Dr., Santa Clara, CA 95051).

National's MM74C945 and MM74C947 are 4-digit up/down counters complete with latches and decoders. The MM74C946 is a 4½ digit counter. All three chips include the backplane oscillator/driver necessary to drive liquid-crystal displays. The internal oscillator/driver can be disabled by grounding the output pin. This permits an external oscillator to drive the display and therefore facilitates the cascading of multiple displays and counters.

Each of these new counter chips sells for \$6.95 in 100-unit quantities. Considering the complexity of these counters, this price represents a real bargain. But if RCA has its way, National and every other maker of liquid crystal driver circuits will have to add a dollar to the price of their drivers and devices that use liquid-crystal display drivers. That's the royalty fee RCA has just set for the non-exclusive use of its 1972 patent "Circuits for Driving Loads such as Liquid Crystal Displays" (U.S. Patent 3,653,745).

Executives of many firms that make devices that use liquid-crystal displays were surprised to receive a certified letter from RCA offering a nonexclusive license for the use of its liquid-crystal driver patent in return for a one dollar royalty for each use. The term of the license will expire when the patent expires on April 4, 1989.

Considering the enormous number of digital watches, clocks, instruments, chips, displays, and other devices that use or incorporate liquid crystal drivers, the potential return to RCA is substantial. But companies making use of the patented technology are sure to resist paying royalties now that the patent holder has waited more than ten years to collect them.

As you might expect, RCA's action is attracting considerable attention in the electronics industry. However, at this stage, it's impossible to predict whether RCA or the affected companies will win what may become a major series of lawsuits. ♦

# WHILE OTHERS PROMISE.... WE DELIVER

ORDER TOLL FREE (800) 221-8180  
IN NEW YORK (212) 732-8600



**COMMODORE VIC-20**  
(16K RAM) **\$159.95**

COMMODORE HARDWARE  
VIC 102 (Intro to Basic Pt 1) \$29.90  
VIC 103 (Intro to Basic Pt 2) \$29.90  
VIC 110 (Program Ref Guide) \$14.90  
VIC 121 (Super Expander) \$49.90  
VIC 1530 (Data Cassette) \$59.95  
VIC 1541 (Single Disk Drive) \$299.95  
VIC 1525 (Graphic Printer) \$319.95  
VIC 1600 (Telephone Interface) \$94.95  
VIC 1111 (16K Memory Expander) \$84.95  
VIC 1011A (RS-232) \$44.95  
CARDBOARD & 40K Expander \$84.95

COMMODORE SOFTWARE  
VIC 1901 (Adventure) \$29.95  
VIC 1904 (SuperStar) \$29.95  
VIC 1911 (The Sky Is Falling) \$29.95  
VIC 1914 (Adventure Land) \$29.95  
VIC 1915 (Private Cove) \$29.95  
VIC 1916 (Mission Impossible) \$29.95  
VIC 1919 (Gargun 1 Chess) \$29.95  
VIC 1922 (Cosmic Cruncher) \$29.95  
VIC 1923 (Golf) \$29.95  
VIC 1924 (Omega Race) \$29.95

UMI SOFTWARE FOR COMMODORE  
3-D MAZE (Dataset Rec.) \$19.95  
ALLEN BLITZ (Cartridge) \$29.95  
CLOUD BURST (Cartridge) \$29.95  
SUPER HANGMAN (Dataset Rec.) \$19.95  
OUTWORLD (Cartridge) \$34.95  
METEOR RUN (Cartridge) \$34.95  
RACEWAY (Dataset Rec.) \$19.95  
VSI CAT (Dataset Rec.) \$19.95

MUSIC SOFTWARE FOR COMMODORE  
ALIEN PANIC (Cassette) \$9.95  
BOMBER (Cassette) \$9.95  
DEFENSE ON THE BRQ (Cassette) \$19.95  
EXTERMINATOR (Req. VIC 1530) \$19.95  
INVASION (Cassette) \$9.95  
JOURNEY (Cassette) \$9.95  
KRAZY KING (Cassette) \$9.95  
QUIRK (Cassette) \$9.95  
RACEWAY (Cassette) \$9.95  
SEARCH (Cassette) \$9.95  
SIX GUNNER (Cassette) \$9.95  
TANK (Cassette) \$9.95  
VIC MAN (Cassette) \$9.95

MES SOFTWARE FOR COMMODORE  
ACROSSER (Cartridge) \$29.95  
CONCENTRATION (Cassette) \$14.49  
DAM BOMBER (Cassette) \$14.49  
GRID RUNNER (Cartridge) \$34.95  
SYN THE SOUND Cartridge \$44.95  
TANK TRAP (Cassette) \$14.49  
HESWRITER (Word Proc.) \$34.95  
VICTREK (Cassette) \$14.95



**COMMODORE 64**  
(16K RAM) **\$499**

**MONITORS**

TI PHA 4100 (10" Color) \$309  
NEC C-12202A (12" Color) \$299  
SONY XE-1211 (12" Color) \$399  
SONY XE-1901 (18" Color) \$179.95  
PANASONIC TR-120 (12" Green) \$179.95  
PANASONIC CT-160 (10" Color w/Tuner) \$299  
PANASONIC CT-7717 (17" Color) \$349  
USI PT-1 (9" Green) \$129.95



**TEXAS INSTRUMENTS TI-99/4A**  
(16K RAM) **\$299.95**

TI HARDWARE  
PHP 1500 (Speech Synthesizer) \$114.95  
PHP 1600 (Telephone Modem) \$168.95  
PHP 1700S-232 (Interface) \$168.95  
PHP 1800 (Disk Drive Controller) \$218.95  
PHP 1850 (RAM Memory Drive) \$359.95  
PHP 1260 (2K RAM Card) \$219.95  
TIME'S SINCLAIR COMPUTER  
TIME'S SINCLAIR HARDWARE  
TIME'S SINCLAIR 1000 \$85  
TIME'S 1016 (16K Expander) \$49.95

TIME'S SINCLAIR MEMOPAK  
MEMOTECH 16K Exp. for Times \$54.95  
MEMOTECH 32K Exp. for Times \$84.95  
MEMOTECH 64K Exp. for Times \$164.95  
MEMOTECH 128K Exp. for Times \$324.95  
FIT TOGETHER IN PICCY-BACK FASHION  
TIME'S SINCLAIR SOFTWARE  
SOFTSYNC INC. HAZOOS \$17.95  
SOFTSYNC INC. METEORITES \$14.95  
SOFTSYNC INC. RED ALERT \$14.95  
TIMETWORK'S MONEY MANAGER \$16.95  
TIMETWORK'S STAR BATTLE \$14.95  
TIMETWORK'S DATA MASTER \$13.95  
XIBMC SNAKEBITE \$12.95  
XIBMC CALLY VOYAGER \$12.95  
XIBMC CRAZY CARDS \$12.95  
XIBMC FUNGALCIDS \$12.95

**SHARP COMPUTERS**

SHARP PC-1500 \$299.95  
PC-1211 (Pocket Computer) \$89.95  
CE-122 (Printer '12") \$39.95  
CE-140 (Printer for PC 1500) \$174.95  
CE-151 (4K RAM Expansion) \$49.95  
CE-155 (8K RAM Expansion) \$99.95  
MAXELL MD-1 (Box of 10) \$34.90  
SCOTCH 745 (Box of 10) \$39.90  
ELEPHANT GOLD (Box of 10) \$34.90  
ELEPHANT YELLOW (Box of 10) \$34.90  
BASE FD-10 (Box of 10) \$32.90

PC-8001A NEC  
IMC-8001 (Computer with 32K RAM) \$689  
PC-8013A (4K Mini-Disk Drive Unit) \$689

DEALER/INSTITUTIONAL INQUIRIES CALL (800) 221-3191

"OUR NAME MEANS A GREAT DEAL"



23 PARK ROW, DEPT. CE3, NYC NY 10038

HOW TO ORDER BY MAIL: FOR PROMPT AND COURTEOUS SHIPMENT SEND MONEY ORDER (CERTIFIED CHECK, CASHIER'S CHECK, VISA, M/C, or DISC. include card number, Interbank No., expiration date and signature). DO NOT SEND CASH, PERSONAL AND BUSINESS CHECKS. MUST CLEAR OUR BANK BEFORE PROCESSING. \$25 MINIMUM ORDER. Shipping, handling & insurance charges: 1% of total order with a \$2.95 minimum. WE SHIP TO CONTINENTAL U.S., ALASKA, HAWAII, PUERTO RICO, AND CANADA ONLY. Canadian Orders Add 10% (GST). Shipping with a 15% minimum charge. For shipments by air, please double these charges. SOBBY, NO C.O.D.'s. NEW YORK RESIDENTS PLEASE ADD SALES TAX. ALL MERCHANDISE SHIPPED BRAND NEW, FACTORY FRESH, AND 100% GUARANTEED.  
SEND FOR FREE 240 PAGE AUDIO/VIDEO CATALOG



**FRANKLIN ACE 1000**  
CALL

Apple II (80K) \$995  
DISC II DRIVE \$519  
APPLE & FRANKLIN SOFTWARE  
ADVENTURE INTERNATIONAL SOFTWARE  
ELIMINATOR (80K Disk) \$27.90  
PLANET ODDS (80K Disk) \$22.90  
HEAD GUARD (80K Disk) \$27.90  
SEA DRAGON (Disk) \$29.90  
TUNNEL TERROR (80K Disk) \$27.90  
TIME'S SINCLAIR SOFTWARE  
CHOPFLUTTER \$29.90  
SERPENTINE \$29.90  
STAR BLAZER \$26.90  
TRACK ATTACK \$26.90  
EDUWARE SOFTWARE  
COMPUARTH \$44.90  
SAT WORD ATTACK \$44.90  
SAT WORD ATTACK \$44.90  
COMUSPELL LEVEL 4 \$17.90  
ONLINE SOFTWARE  
CANNONBALL BLITZ \$26.90  
CRUSH CRUMBLE CHOMP \$29.90  
FRODOG \$29.90  
ULTRA II \$44.90  
WIZARD AND PRINCESS \$26.90

**SMITH CORONA TP-1 LETTER PRINTER**  
**\$599**

**PRINTERS**

EPSON MX 80-III CALL  
EPSON MX 80-III (Friction Feed) CALL  
EPSON MX 100-III CALL  
NEC PC 8023 (Friction Feed) \$499  
OKIDATA B2A \$429  
OKIDATA B3A (8" Directional) \$689  
OKIDATA B4S (Serial Printer) \$1189

DEALER/INSTITUTIONAL INQUIRIES CALL (800) 221-3191

"OUR NAME MEANS A GREAT DEAL"



23 PARK ROW, DEPT. CE3, NYC NY 10038

HOW TO ORDER BY MAIL: FOR PROMPT AND COURTEOUS SHIPMENT SEND MONEY ORDER (CERTIFIED CHECK, CASHIER'S CHECK, VISA, M/C, or DISC. include card number, Interbank No., expiration date and signature). DO NOT SEND CASH, PERSONAL AND BUSINESS CHECKS. MUST CLEAR OUR BANK BEFORE PROCESSING. \$25 MINIMUM ORDER. Shipping, handling & insurance charges: 1% of total order with a \$2.95 minimum. WE SHIP TO CONTINENTAL U.S., ALASKA, HAWAII, PUERTO RICO, AND CANADA ONLY. Canadian Orders Add 10% (GST). Shipping with a 15% minimum charge. For shipments by air, please double these charges. SOBBY, NO C.O.D.'s. NEW YORK RESIDENTS PLEASE ADD SALES TAX. ALL MERCHANDISE SHIPPED BRAND NEW, FACTORY FRESH, AND 100% GUARANTEED.  
SEND FOR FREE 240 PAGE AUDIO/VIDEO CATALOG



**ATARI 800**  
(16K RAM) **\$499**

**ATARI COMPUTERS**  
ATARI 400 (16K RAM) \$239.95

ATARI HARDWARE  
ATARI 400 (Program Recorder) \$79.95  
ATARI 810 (Disk Drive) \$429  
ATARI 830 (Acoustic Modem) \$149.95  
ATARI 8 Interface Module \$169.95  
TARA C-32 (32K Board) \$64.95  
ALIEN GROUP Movie Box \$104.95  
SOFTWARE LISTED BELOW COMPATIBLE WITH ATARI 800 AND 400

ADVENTURE INT'L SOFTWARE  
ADVENTURE AND AD \$14.90  
SALVAGE ISLAND PT. 1 \$14.90  
GOLDEN VOYAGE \$24.90  
MISSION IMPOSSIBLE (2Disk) \$14.90  
VOODOO CASTLE (2Disk) \$14.90  
ATARI PROGRAM EXCHANGE SOFTWARE  
BABEL (Disk) \$19.90  
COCOA (Disk) \$19.90  
DKS FIXER (2Disk) \$21.90  
HAWWAAR (Disk) \$21.90  
OUTLAW HONOLULU (Cass) \$19.90

ON LINE SOFTWARE  
CROSSFIRE (Disk) \$25.90  
PROCCER (2Disk) \$19.90  
MISSION ASTEROID (Cass) \$19.90  
MOUSE ATTACK (Disk 32K) \$31.90  
GLYPSES (Disk 40K) \$29.90

THORN EMI SOFTWARE  
BRITISH HERITAGE PT. 1 (Cassette) \$24.90  
DARTS (Cassette) \$24.90  
PICTURE FUN (Cassette) \$24.90  
JUMBO JET PILOT (Cartridge) \$39.90  
RIVER RESCUE (Cartridge) \$24.90  
SOCCER (Cartridge) \$34.90

**VIDEO GAMES**

ATARI CX-5200 (Video Game) \$199.95  
RETRIEVE VIDEO GAME \$24.90  
ATARI VIDEO GAME CX-2600 \$99.95  
MATEL INTELLIVISION II \$149.95  
COLECOVISION (Video Game) \$179

**BLANK TAPES**

MINIMUM ORDER 12 AUDIO TAPES

MAXELL UD-XL C-90 \$2.99  
TDK SA-X90 \$2.59  
TDK SA-X90 \$3.49

**STEREO-TO-GO**

SONY WALKMAN 4 (cass. Stereo) \$59  
SONY WALKMAN 5 (cass. Stereo) \$59  
SONY MC-9 (cass. Stereo) \$55  
SANYO MC-30 (AM-FM Cass. Ster.) \$58  
AIWA HSP-02 (Cass. Ster. Auto Rev.) \$89  
AIWA HSP-03 (AM-FM Cass. Ster. Rec.) \$129  
TECHNICS SC-07 (SB-F7 (Port. Ster.) \$339  
TOSHIBA KTR-1 (FM Cass. Ster.) \$75  
AIWA HSP-03 (AM-FM Cass. Stereo) \$89  
TOSHIBA KTR-51 (AM-FM Cass. Ster.) \$89  
TOSHIBA RPS-1 (AM-FM Cass./Ster.) \$55  
JVC PC-11 (Port. Stereo) \$279  
SONY IC-F600 (Portable 9-Band Short Wave) \$99

CIRCLE NO. 23 ON FREE INFORMATION CARD

# POCKET SCANNER CLOSE OUT

Thanks to a European Distributor's overstock, you can get a great deal on a pocket scanner.

It's a six channel, three band unit that is actually the smallest scanner available on the market. You'll hear your choice of police, fire and emergency calls and get extra features like channel lock-outs, manual control, two antennas plus an AC

**\$79.95**

Includes TWO FREE frequency crystals. Additional crystals \$4.95 ea., other accessories available.

charger/adaptor. Coverage includes UHF bands, VHF high bands and mid-band.

We've taken what is already a good value and made it a steal! From the original price — the equivalent of \$190 — we've lowered the price a full \$110. Plus you get two frequency crystals of your choice at absolutely no charge. And, you'll have our 25 day no-hassle refund privilege so you can try it out before making your decision. Don't Delay. Supplies are limited. Call Today. 24 hrs. a day 7-days a week.

Order product 1050. Visa/Master Charge or COD customers may call toll free. Or send check for \$79.95 plus \$2.00 shipping and handling. 90 day warranty.

**MTN 800-528-6050 Ext. 1035**

P.O. Box 215 Yankton, S.D. 57078 In AZ 800-352-0458 Ext. 1035

CIRCLE NO. 48 ON FREE INFORMATION CARD

OF THE EIGHT MAJOR  
CAPACITANCE INSTRUMENTS  
MADE; ONLY THE CM-100...

# DETECTS LEAKAGE

(and at half the price!)

**\$89<sup>95</sup>**

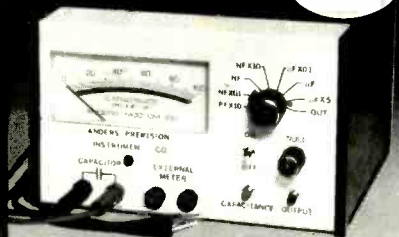

**Usefulness** — Measure capacitors 10pF — 500µF; leakage 1 nA or .005 C.V., whichever is greater. **Accuracy** — To 2% depending on range. **Dependability** — Ruggedized construction; 1 yr. warranty. **Versatility** — In circuit measurement of capacitance and leakage. Output signal proportionate to measurement. **Portability** — 350 Hr. Battery Life.

\* To 25,000µF with external voltmeter

Send check, address (NO P.O. BOX) plus \$3.50 Handling. CT res. add 7½% tax.

Phone orders: (203) 423-7940

**ANDERS PRECISION INSTRUMENT CO., INC.**  
4 Bridge St. Plaza, P. O. Box 75 Willimantic, CT 06226

CIRCLE NO. 6 ON FREE INFORMATION CARD

# CABLE TV

## CONVERTERS DESCRAMBLERS

Largest Selection  
of Equipment Available  
\$ Buy Warehouse Direct & Save \$



36 channel  
converter  
**\$45<sup>95</sup>**

36 channel  
wired remote  
converter  
only  
**\$88<sup>95</sup>**



Send \$2 for complete catalog  
of converters and unscramblers

Quantity Discounts • Visa • Master Charge  
Add 5% shipping—Mich. residents add 4% sales tax

**C&D Electronics, Inc.**  
P.O. Box 21, Jenison, MI 49428  
(616) 669-2440

# OPERATION ASSIST

If you need information on outdated or rare equipment—a schematic, parts list, etc.—another reader might be able to assist. Simply send a postcard to Operation Assist. COMPUTERS & ELECTRONICS, 1 Park Ave., New York, NY 10016. For those who can help readers, please respond directly to them. They'll appreciate it. (Only those items regarding equipment not available from normal sources are published.)

**Thomas Model 145L**, Serial # 1853216 electronic organ. Need service manual. Eugene L. Evanoff, Box 33, Casa Grande, AZ 85222.

**Amcomm Model S 225** two meter amateur transceiver. Need schematic and technical information. Bob Duckworth, 331 4th St., NE, Apt. 1, Atlanta, GA 30308.

**MSI source 2102** data terminal and **Microswitch** keyboard # 54SW1. Need any information available. Harold Howard, Star Route, Box 87, Mineral Wells, TX 76067.

**Seeburg Model 600** stereo console. Need any information available. John Clayton, 207 Elizabeth, Cleburne, TX 76031.

**Princeton Applied Research Model CR-4** low noise amplifier, **Perkin Electronics** MTVR 040-1 power supply, **International Centronics, Inc.**, CPG 200-3 lochpule generator and **Computer Measurements Co.**, 1144A counter. Need service manuals for all the items listed. Jim Powell, 300 Collier Blvd., Napa, CA 94558.

**Hallcrafters Model TW-2000** receiver. Need name and address of parts supplier. C. Mansell, 10556-48 St., Edmonton, Alta, CAN.

**RCA #34392** meter. Need owner's manual. Gino M. Salvadori, 8313 Bardwell Ave., Van Nuys, CA 91402.

**Microdot** FM signal generator. Need service literature and schematic. Robert Haskett, 5657 Navy Road, Millington, TN 38053.

**Knight Model KG854** amplifier. Need schematic or any additional information. Edward L. Metzger, 20 Elm Estates, Corbin, KY 40701.

**Teleprinter Model GGC-15**. Need schematic, manual and parts. Marcel Trottier, Oneida Acres, Williston, VT 05495.

**Kirby Model 98** flyback transformer tester and **Solar Model CE** capacitor analyzer. Need operating manuals and schematics. Leland H. Bates, 39 Radcliff Rd., Springfield, IL 62703.

**Lafayette Model SSB-140** CB radio. Need owner's manual and schematic. Gary Kawamote, 1141 W. 3rd St., Cleveland, OH 44113.

**Magnavox Model T944** chassis B&W TV. Need part # 250526. **Zenith** transoceanic radio GA40 chassis. Need tubes 1U4 and 50A1. Henry Ludzus, 23 Monroe St., Oakville, CT 06779.

**Remington Rand EDC III** calculator. Need schematic diagram and instructions. Luis Piris, Box 1714, Christiansted, St. Croix, Virgin Islands 00820.

**Jackson Model CRO-3** oscilloscope. Need schematic or any information available. Don Longacre, 16 North St., Caledonia, NY 14423.

**Hallcrafters Model S-38B** receiver. Need schematic, manual and trouble shooting information. Gary Howell, 571 W. Champion Ave., Warren, OH 44483.

**Commercial Trades Institute Model VT-20** VTOM. Need schematic, manual and troubleshooting information. Al Clark, 4799-3 Locks Road, Chillicothe, OH 45601.

**Heathkit Model HX-11** transmitter and **Hallcrafters Model CB-7** transceiver. Need service manuals, technical operating instructions or any information available. Mr. Sam Sussman, 87 Cumberland Cr., London, Ontario N5X 1B7, CAN.

**FREE**

# McIntosh STEREO CATALOG and FM DIRECTORY

Get all the newest and latest information on the new McIntosh stereo equipment in the McIntosh catalog. In addition you will receive an FM station directory that covers all of North America.



**SEND  
TODAY!**

McIntosh Laboratory Inc. CE  
East Side Station P.O. Box 96  
Binghamton, N.Y. 13904-0096

NAME \_\_\_\_\_

ADDRESS \_\_\_\_\_

CITY \_\_\_\_\_ STATE \_\_\_\_\_ ZIP \_\_\_\_\_

If you are in a hurry for your catalog please send the coupon to McIntosh.  
For non rush service send the Reader Service Card to the magazine.

CIRCLE NO. 31 ON FREE INFORMATION CARD



## COMPUTER HOTLINE

### The C & E Staff Answers Your Questions About Computers

#### COMMODORE RECORDING

**Q:** How can I build a cable to use an ordinary cassette recorder with a VIC-20 in place of the VIC1530 Dataset? Where can I get information to connect an Epson MX-80 printer to a VIC-20 and software if necessary?—Larry Stempnik, Warren, MI.

**A:** The Commodore VIC-20, like all other Commodore computers, uses digital recording rather than the audio recording used in other cassette-operated computer data storage systems. You cannot use an ordinary cassette recorder for this purpose. The VIC1530 Dataset is the least expensive digital recorder built, but it works very well. Buy it if you want to have full use of your VIC-20. It is a bargain!

#### APPLE MAINTENANCE

**Q:** I have an Apple II Computer, which I selected because of its large number of accessories and modifications. I expected that Apple would be friendly to its customers who are interested in "do it yourself maintenance." Now I find that Apple will not sell me parts or service manuals! This is the first time that I have ever encountered this from a manufacturer. I have had problems with the disk drives and controller which so far I have been unable to repair without a service manual. I would be grateful for technical information from a second source.

—Arthur Thompson, Hereford, AZ.

**A:** This is a problem that we will hear much more about as more computers become appliances rather than hobbyist devices.

Apple has one of the most exten-

# Put your ideas in our box.

Meet the Idea Box. The shortest distance between idea and working prototype or one-of-a-kind instrument.

It's a great time-saver! You design the circuit, we provide the power supplies... assembled and tested... and the right case to house it all.

The Idea Box comes complete with three highly regulated low-ripple power supplies (fixed 5VDC @ 1A; + and -15VDC, variable, @0.5A). Plus your choice of a solderless breadboard; a pre-etched, pre-drilled PCB which emulates the hole connection of the solderless breadboard's pattern; or a blank foil board you can use for existing PCB designs. All,

housed in our attractive, high-impact case (4"H x 10"W x 7"D), complete with aluminum front panel and hardware. Priced from just \$149.95\*

The Idea Box has the capacity for big ideas as well as small ones. You can stack any of the three circuit cards, in any combination.

So, before you tackle your next project, get a head start with a little help from us: have an Idea Box on hand. After all, good ideas shouldn't be kept waiting.

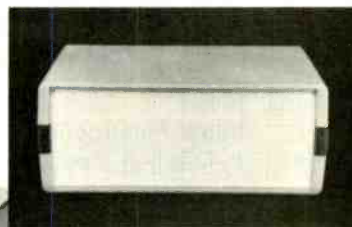

## GLOBAL SPECIALTIES CORPORATION

70 Fulton Terr. New Haven, CT 06509 (203) 624-3103 TWX 710-465-1227  
OTHER OFFICES: San Francisco (415) 648-0611, TWX 910-372-7992 Europe: Phone Saffron-Walden 0799-21682, TLX 817477  
Canada: Len Finkler Ltd., Downsview, Ontario

Call toll-free for details **1-800-243-6077**  
During business hours

\*Suggested U.S. resale. Prices, specifications subject to change without notice.  
© Copyright 1981 Global Specialties Corporation.

sive maintenance programs of any manufacturer. Every dealer must have technicians trained in an Apple School. They provide very large and complete manuals and diagnostic software to their dealer service people. Their parts distribution is entirely through the dealers. Every dealer must maintain a full parts in-

ventory. When a defective part is sent back to Apple, a replacement is sent to the dealer's service department to fill his parts kit.

This is the reason that they have no way to handle parts sales to individuals. They also do not want to have their repair parts end up in the hands of the "unauthorized" dealers. (Although I don't think they will admit this!) My advice to you is make friends with your local dealer

and try to use his services to get parts and technical information.

**PRINTER GLITCHING**

**Q:** *I have a parallel printer that runs very well when it is located next to my computer. If I move the printer to the other side of the room, it prints incorrect characters. What is wrong with it?—Tony Davis, Rockaway, IL.*

**A:** There is probably nothing wrong with either your printer or your computer. The problem is likely caused by moving a parallel interface cable more than 10 ft. from the data source. When this happens, the cable picks up the ambient electrical noise in the room and induces noise on the lines. You only have to change one bit from a "zero" to a "one," for example, to change a character into something else or just "garbage."

As a rule, you can go from 0 to 10 ft. with a parallel interface cable (depending upon noise level at the location). You can go up to 50-ft with an RS232C serial interface. A 20 mA current loop serial interface extends this to a few hundred feet. For longer cable runs, you will need a "short haul" modem and a private line.

**MORE ON TI 99/4A**

**Q:** *Why aren't there more articles on the TI 99/4A Computer? At its current low price, it is a very popular machine. What is the outlook for future software and peripherals for it?—George Reynolds, Virginia Beach, VA.*

**A:** Texas Instruments sent us a complete TI 99/4A Computer with an Expansion Box, Memory Module, and LOGO and Pascal modules. We want to do a complete review and test of this equipment, but we are missing two important parts of the system—the disk drive and controller in the Expansion Unit. They have promised to send us these components as soon as they can. We will then write a feature on this popular computer. We want to report on the new features since there is no point in considering the TI 99/4A as a cartridge operated "video computer." ♦

**VIC20 PERSONAL COMPUTER**

**TOP 10 ARCADE GAMES**

**VIC-20 TAPE PROGRAM SALE!!**

Rank	Name	List	Sale
1.	Super Paratrooper (Fantastic)	\$24.95	\$19.95
2.	Exterminator-Plus (Better than Centipede)	\$24.95	\$19.95
3.	Cricket (Better than Frogger)	\$24.95	\$19.95
4.	Snackman (Better than Packman)	\$19.95	\$15.95
5.	Galactic Crossfire (you in the middle)	\$19.95	\$16.95
6.	Anti Matter Splatter (Nuclear Disaster)	\$24.95	\$19.95
7.	Bug Blast (Creepy)	\$19.95	\$16.95
8.	Bombs Away (Great)	\$18.95	\$15.95
9.	3-D Maze-Escape	\$16.95	\$14.95
10.	Krazy Kong	\$16.95	\$14.95

**BUY ANY FOUR — DEDUCT 10% MORE**

**VIC-20 PROGRAMMING AIDS!!**

- Introduction to basic programming (manual and tapes) **Sale \$22.95**
- Advanced basic programming (manual and tapes) **22.95**
- Programmers reference manual (288 pages — you must have this!) **15.95**
- Programmers easy reference card (tables-lists-drawings) **3.95**
- VIC-20 Revealed (267 pages of VIC secrets) **11.95**
- 6502 Machine Language Assembler **24.95**
- 16K Programming cartridge (gives 400% more programming power — get \$24.95 16K adventure game free!) **89.00**

- 10 DAY FREE TRIAL
- WE HAVE THE LOWEST PRICES
- ONE DAY DELIVERY EXPRESS MAIL
- FREE CATALOGS
- WE LOVE OUR CUSTOMERS!

**PROTECTO ENTERPRIZES (FACTORY-DIRECT)**

BOX 550, BARRINGTON, ILLINOIS 60010  
Phone 312/382-5244 to order

CIRCLE NO. 47 ON FREE INFORMATION CARD



## DX LISTENING

### News of Stations and Programs Around the World

By Glenn Hauser

**Alaska.** The World Christian Broadcasting Corp. continues its project to build a shortwave station to reach the USSR from Anchor Point on the Kenai Peninsula. A target date of May 1983 is foreseen, providing WCBC can show that r-f from the transmitters will not endanger the environment.

**Antarctica.** LRA-36, operated by the Argentine army from Esperanza Base at the tip of Palmer Peninsula, has been widely heard in North America on 15474 kHz between 2200 and a variable closing between 0030 and 0100. The station, also known as *Radio Nacional Arcangel San Gabriel*, has been running IDs in several languages including English, and asking for reports.

**Australia.** *Radio Australia* has reached a nadir in its service, as more and more transmitters have had to be retired for lack of spare parts before new transmitters can go on line. However, the future looks bright, as *Radio Australia* is to be funded separately from its parent body, the ABC. In November, *Radio Australia* moved into its own studio complex in the Melbourne suburb of Burwood. Several BBC sites unexpectedly relayed *Radio Australia* briefly during the Commonwealth Games. The DX program *Spectrum*, with Dick Speakman, former host of Radio Nederland's *DX Jukebox*, has become a weekly feature, Sundays at 0612, 0810, 1612, 2112, and GMT Mondays at 0330.

**Austria.** *Austrian Radio* has installed some new antennas, resulting in much stronger signals into North America. A new high-power transmitter should also be in use.

**Bolivia.** Here are some program recommendations from a New Zealand listener, Barry Hartley; they can also be heard by early-rising North Americans. *Radio Panamericana*, La Paz on 6105 kHz, opens the day at 1030 GMT with "Bolivia en Antena," a combination musical travelogue and mailbag program which in effect is an external service. Another La Paz station, *Radio Illimani*, on 6025 and 4945 kHz, runs Altiplano music for peasants at 1000, followed at 1100 Sundays by another mailbag show, "El Club de la Amistad."

**Brazil.** We learn from Takayuki Inoue in Japan that the 17815-kHz transmitter of Radio Cultura, Sao Paulo, on the air at 0900-0500 GMT, is directional with an azimuth of 342°. This just happens to be right on New Bedford, Massachusetts, a major Portuguese-speaking area. It may be, however, that the 342° beam was actually chosen for general coverage of the Amazon.

**Burma.** Isao Ugusa, a Japanese DX listener who speaks Burmese and publishes *DX Front Line*, specializing in Southeast Asia, reports that the Karen National Union, a minority group based on race rather than politics, planned to reactivate its clandestine station *Voice of Kawthoolei*. It formerly operated on 4880 kHz at 1130-1330 GMT, extended to 1400 on Saturday and Sunday.

**Canada.** Radio Canada International has held preliminary talks with Swiss Radio International about the possibility of exchanging relay facilities in order to improve each other's coverage. A government commission has also called for RCI to immediately expand its target areas to improve Asia and the Pacific. However, to do this effectively, new transmitters in the Vancouver area would be needed to supplement those in New Brunswick.

(To be continued next month)

## Learn how to Program and Use PERSONAL COMPUTERS



Now at Home in Spare Time, you can learn everything you always wanted to know about personal computers. How to program in BASIC. How to understand and use more than 80 BASIC commands and functions. How to write and run your own programs... for both personal and business applications. How to use pre-packaged software and change it to meet your special needs. How to make sense of the overwhelming maze of books, information and advice available at your local computer store.



### More Than Just A Computer Manual

This is more than just another programming manual... it's an entire comprehensive course written by experts. Yet, because it was especially developed for home study, you learn everything right in your own home, without changing your job or lifestyle, without attending a single class.



### Plus You Get Your Own Computer

To give you practical hands-on experience, this course includes your own personal computer—the Timex 1000 with 16K memory module—plus a cassette recorder that lets you save your programs on tape. Get all the facts.

MAIL COUPON TODAY!

ICS  
SINCE 1981

COMPUTER TRAINING, Dept. PD023  
Scranton, PA 18515

Name  Age

Address

City/State/Zip

## BACK ISSUES AVAILABLE...



If you've missed any of the previously published issues of *Computers & Electronics* (formerly *Popular Electronics*), a wide selection is still available. Copies may be ordered for issues published during the past 12 months. In the event a particular issue ordered is out of print your payment will be returned promptly.

Order by mailing \$3.00 per copy (postage & handling included) to *Computers & Electronics*, P.O. Box 555, Morris Plains, NJ 07950

(Outside U.S.A. copies are \$4.00 each.)

Please be sure to enclose payment and identify the specific issues you wish to receive.

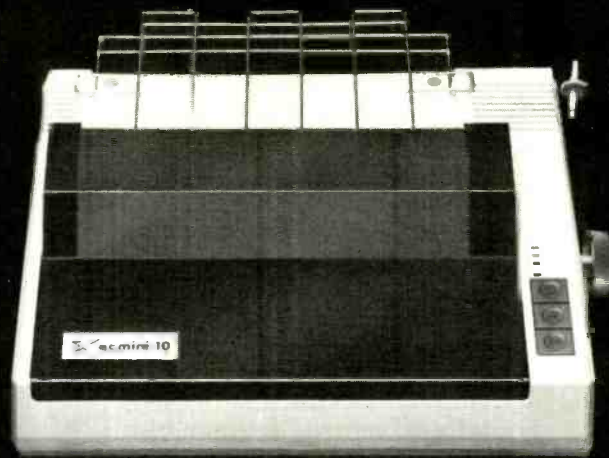

## GEMINI— FOR PRINTER VALUE THAT'S OUT OF THIS WORLD

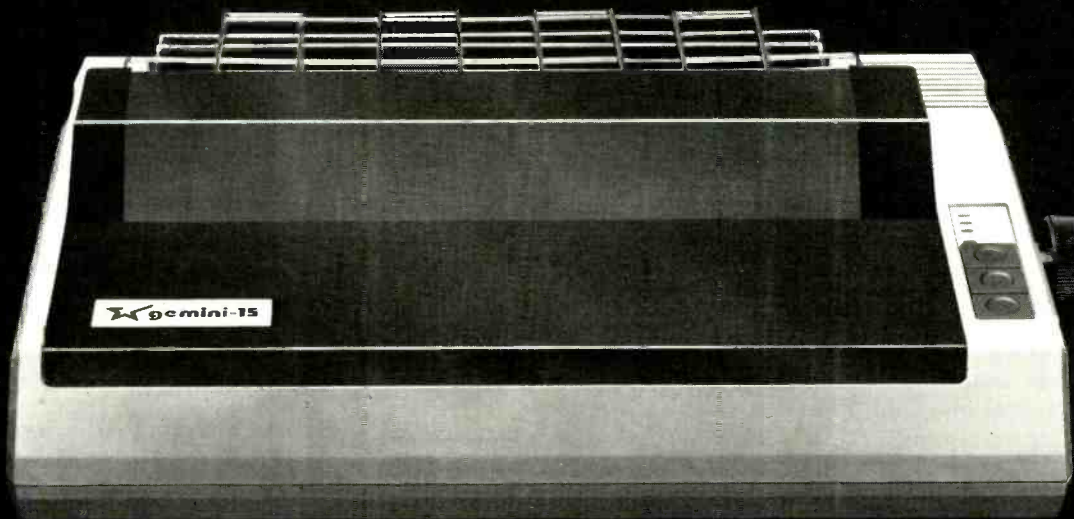

Over thirty years of down-to-earth experience as a precision parts manufacturer has enabled Star to produce the Gemini series of dot matrix printers—a stellar combination of printer quality, flexibility, and reliability. And for a list price of nearly 25% less than the best selling competitor.

The Gemini 10 has a 10" carriage and the Gemini 15 a 15½" carriage. Plus, the Gemini 15 has the added capability of a bottom paper feed. In both models, Gemini quality means a print speed of 100 cps, high-resolution bit image and block graphics, and extra fast forms feed.

Gemini's flexibility is embodied in its diverse specialized printing capabilities such as super/sub script, underlining, back-spacing, double strike mode and emphasized print mode. Another extraordinary standard

feature is a 2.3K buffer. An additional 4K is optional. That's twice the memory of leading, comparable printers. And Gemini is compatible with most software packages that support the leading printers.

Gemini reliability is more than just a promise. It's as concrete as a 180 day warranty (90 days for ribbon and print head), a mean time between failure rate of 5 million lines, a print head life of over 100 million characters, and a 100% duty cycle that allows the Gemini to print continuously. Plus, prompt, nationwide service is readily available.

So if you're looking for an incredibly high-quality, low-cost printer that's out of this world, look to the manufacturer with its feet on the ground—Star and the Gemini 10, Gemini 15 dot matrix printers.

# star

MICRONICS • INC

MAKING A NAME FOR OURSELVES

1120 Empire Central Place, Suite 216, Dallas, TX 75247

CIRCLE NO. 38 ON FREE INFORMATION CARD



# EXPERIMENTER'S CORNER

## Experimenting with VMOS Power Transistors

By Forrest M. Mims

**A**BOUT a year ago, in a "Solid-State Developments" column, I discussed the design, fabrication, and operating advantages of various kinds of VMOS field-effect transistors ("The New Power FETs," POPULAR ELECTRONICS, February 1982, p. 94). The key advantages of these VMOS devices include ultra-low "on" resistance, ultra-high input impedance, nanosecond switching time, high power capability, and both linear- and switching-mode operation. I also described practical circuits for a linear VMOS lamp dimmer, a pulse-modulated lamp dimmer, and a variable-rate lamp flasher.

This month, we'll examine in some detail the design and operation of a basic common-source VMOS amplifier. We'll also experiment with both unidirectional and bidirectional VMOS analog switches. Then we'll conclude with a brief look at a VMOS high-power variable resistor.

**Where to Get Them.** When I first wrote about VMOS power transistors, Radio Shack was the only major hobby dealer that carried the new devices. That still holds true today. They sell two Siliconix products, the VN20KM (\$1.59) and the VN67AF (\$2.49), both of which can be used in all the circuits that follow. Figure 1 gives the pin outlines for the transistors and lists some of their key specifications. (Additional

SPECIFICATION	VN10KM	VN67AF
MAXIMUM DRAIN-SOURCE VOLTAGE	60 V	60 V
MAXIMUM DRAIN CURRENT	0.5 A	2.0 A
DRAIN-SOURCE ON RESISTANCE	5 $\Omega$	3.5 $\Omega$
TURN-ON DELAY TIME	2 ns	2 ns
RISE TIME	5 ns	2 ns



Fig. 1. VMOS pin outlines.

information on the devices is available in the data sheets.)

Although Radio Shack remains the only major hobby source of VMOS transistors, the devices are available through industrial distributors who represent VMOS manufacturers. In addition to Siliconix, major domestic manufacturers of VMOS transistors include International Rectifier, Intersil, and Motorola.

**Operating Precautions.** Though the drain-source channel of a VMOS transistor can safely handle very high currents and voltages, the gate connection retains the usual vulnerability of MOSFET devices to electrostatic discharge damage. To avoid this problem, handle VMOS FETs like any other MOS device, and make sure to store loose components in conductive foam. Some VMOS power FETs include a protective zener diode between the gate and the source. Although the diode protects the input from static electricity, it can also impair the performance of the device.

If you use VMOS power FETs in high-power applications, be sure to observe all appropriate temperature and power ratings. In some cases a heat sink may be necessary. See the manufacturer's specifications for detailed information.

**A Basic VMOS Amplifier.** Figure 2 shows a basic VMOS common-source amplifier. The amplifier is so named because  $Q1$ 's source is common to both the input and the output of the circuit. It is therefore the MOSFET counterpart to the bipolar transistor common-emitter amplifier.

In operation,  $R1$  and  $R2$  form a

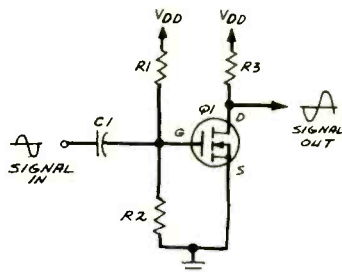

Fig. 2. Basic common-source amplifier.

voltage divider that biases  $Q1$ 's gate to a point where the drain-source voltage ( $V_{DS}$ ) is half the supply voltage ( $V_{DD}$ ). The required gate voltage ( $V_{GS}$ ) can be measured with the help of a test circuit, or it can be found by referring to the family of curves that shows the output characteristics for individual power MOSFETs as a function of drain current ( $I_D$ ) and  $V_{DS}$ .

Let's assume we wish to use the circuit in Fig. 2 as a tone amplifier that directly drives a small 8-ohm speaker. If  $V_{DD}$  is 9 V and if the speaker is rated at 2 W, then the maximum forward current ( $I_D$ ) through  $Q1$  and the speaker is, from Ohm's law, the power divided by the voltage (2/9) or 222 mA.

Incidentally, knowing  $I_D$  and  $V_{DD}$ , we can apply Ohm's law to find the necessary resistance for  $R3$ . Discounting the channel resistance of the VMOS FET (typically 0.5 to 5 ohms when fully on) to provide a safety margin, it is  $V_{DD}$  divided by  $I_D$  (9/0.222) or 40.5 ohms.

Now that we know  $I_D$  and  $V_{DS}$ , we can refer to the manufacturer's output characteristics curves for  $Q1$  to find the required  $V_{GS}$ . For Siliconix's VN10KM,  $V_{GS}$  is typically about 3.5 V when  $I_D$  is 222 mA and  $V_{DS}$  is 4.5 V. (The output characteristics curves are printed in Siliconix's *VMOS Power FETs Design Catalog* and in the 1982 and 1983 editions of Radio Shack's *Semiconductor Reference Guide*.)

Knowing the  $V_{GS}$  required to bias  $Q1$  so that  $V_{DS}$  is one-half  $V_{DD}$  means that the values for  $R1$  and  $R2$  can now be selected. Since  $V_{GS}$  is 3.5

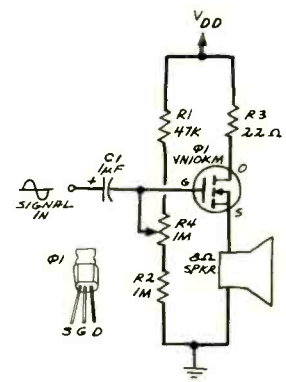

Fig. 3. VMOS audio amplifier.

$V$  and  $V_{DD}$  is 9 V,  $V_{GS}$  is 0.39  $V_{DD}$ . Therefore, the resistance of  $R2$  should be  $0.39(R1 + R2)$ . Assuming we wish to keep the circuit's input resistance high, a reasonable approximation using standard resistance values would be to use 750 kilohms for  $R2$  and 1.2 megohms for  $R1$ . This will provide a  $V_{GS}$  of 3.46 V.

We can calculate the voltage gain ( $A_v$ ) of the basic amplifier by multiplying load resistor  $R3$  times  $Q1$ 's transconductance ( $g_{fs}$ ). The typical  $g_{fs}$  of Siliconix's VN10KM is 200 millimhos. Therefore,  $A_v$  is  $40.5 \times 0.2$  or 8.1.

Though a voltage gain of 8.1 may seem very small, the amplifier's power gain can be considerably higher. For example, assume the input signal is a 1-V peak-to-peak sine wave originating from a source having an output impedance of 10 kilohms. The equivalent input power ( $P_i$ ) of this ac signal is found by dividing the square of the signal's rms voltage by the source's resistance. The rms value of the signal is 0.3535 times its peak-to-peak amplitude (or 0.707 times the peak amplitude). For the values given above,  $P_i$  is  $(1 \times 0.3535)^2 / 10,000$  or 12.5  $\mu$ W.

The output power ( $P_o$ ) is found by dividing the square of the rms output voltage by the load resistance ( $R3$ ). Since the voltage gain ( $A_v$ ) of the amplifier is 8.1, then the output voltage is  $1 \times 8.1$  V peak-to-peak. Therefore,  $P_o$  is  $(8.1 \times 0.3535)^2 / 40.5$  or 0.202 W. The power gain is  $P_o/P_i$  or 16,195.

Incidentally, since the speaker in Fig. 3 is directly coupled to the VMOS transistor, it receives a dc bias even with no input signal. The resultant displacement of the speaker's cone will cause distortion of

high-level audio signals. This distortion can be eliminated by inserting a transformer between the circuit and the speaker at  $R3$ . It may then be necessary to recalculate the circuit parameters.

For more information about predicting the performance of a common-source power MOSFET amplifier, see *Design of VMOS Circuits* by Robert Stone and Howard Berlin (Howard Sams & Co., 1980). This excellent book provides detailed step-by-step design procedures in chapter 4. It also contains a wealth of information about various VMOS circuits. Incidentally, the examples given on pp. 39-40 of this book multiply peak-to-peak signal values by 0.707 instead of 0.3535. While this gives incorrect values for  $P_i$  and  $P_o$ , it does not affect the example calculation of power gain.

**A Real VMOS Amplifier.** If you enjoy working with numbers, the preceding discussion probably makes the design of a common-source MOSFET amplifier seem relatively straightforward. But for those of us who also enjoy experimenting with real circuits, the mathematical approach has a serious drawback since the predictions are based on "typical" values of transconductance ( $g_{fs}$ ) and gate voltage ( $V_{GS}$ ).

Since the voltage gain ( $A_v$ ) of the amplifier is the product of the load resistance ( $R3$ ) and  $g_{fs}$  ( $g_{fs} = A_v/R3$ ).  $A_v$  can be found by measuring the voltage at the input and output and dividing the latter by the former. Now  $g_{fs}$  can be easily determined for individual MOSFETs under specific operating conditions. (Incidentally,  $g_{fs}$  is sometimes designated  $g_m$ .)

$V_{GS}$  can be found by injecting a sine wave into the amplifier while

watching the waveforms at the input and output of the amplifier on a dual-trace scope. The voltage divider network ( $R1$  and  $R2$ ) should be trimmed until the output waveform is a maximum-amplitude, undistorted version of the input waveform.

Figure 3 shows a practical version of the amplifier that works quite well. Note the addition of  $R4$  to permit quick adjustment of  $V_{GS}$ . The data sheet specifies for the VN10KM used in the circuit minimum and typical values of  $g_{fs}$  (or  $g_m$ ) of, respectively, 100 and 200 millimhos. The typical value gives a predicted  $A_v$  of 4.4 ( $A_v = R3g_{fs}$ ).

I measured an  $A_v$  of only 3.0 when the speaker was shorted to leave a load resistance of 22 ohms. This corresponds to a  $g_{fs}$  of 140 millimhos. As you can see, using the "typical" data sheet value can be misleading.

**Applications for the VMOS Amplifier.** The simple circuit in Fig. 3 is well suited for use as a high input impedance small speaker driver. The input impedance can be increased by increasing  $R1$  and  $R2$  in the proper proportion to permit  $R4$  to determine  $V_{GS}$ .

In audio applications a scope is not always necessary to adjust  $R4$ . Simply feed a tone or a voice signal into the input and listen to the speaker while adjusting  $R4$  for maximum undistorted volume.

The circuit in Fig. 3 also makes an excellent LED driver for an amplitude-modulated lightwave communications transmitter. Simply replace the speaker with a LED and increase  $R3$ 's resistance to limit the current through the LED to a safe value. For maximum optical power output, select an AlGaAs or GaAs:Si LED.

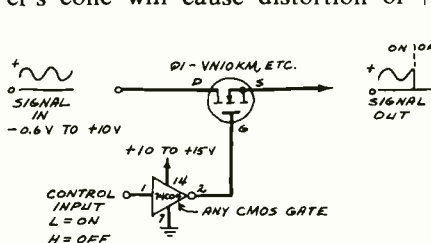

Fig. 4. Basic unidirectional analog switch.

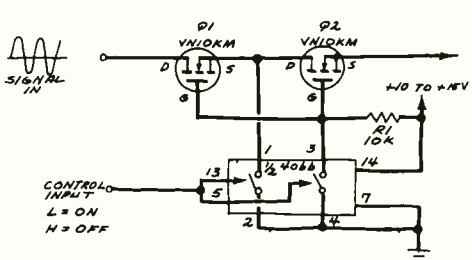

Fig. 5. Simple analog switch.

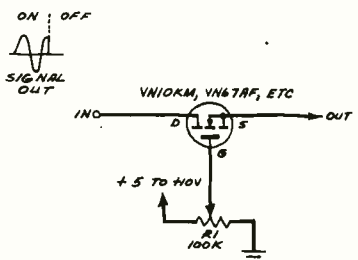

Fig. 6. High-current pot.





# PROJECT OF THE MONTH

## A Digitally Programmable VMOS Variable Resistor

By Forrest M. Mims

**M**ICROPROCESSORS and computers can be readily interfaced to power switching devices like SCRs, triacs and VMOS FETs. But of all these on/off switching devices, the VMOS FET is the only one that can also be used in a variable resistor mode. This is done by varying the voltage ( $V_{GS}$ ) at the gate of the transistor, which in turn controls, in a nearly linear fashion, the resistance of the transistor's drain-source channel.

A digital-to-analog converter provides a convenient means for allowing a computer to generate a variable voltage. Figure 1 shows a very simple, low-cost, 4-bit D/A converter that applies (under digital control) a variable voltage to the gate of a VMOS FET.

The D/A converter is made from an R-2R resistor ladder network and two op amps. Of course, a single-chip D/A converter such as the DAC801 can be used to provide higher resolution (8 bits or 256 voltage levels) as well as better accuracy.

**How It Works.** The D/A conversion is accomplished by the resistor ladder network. When all inputs are low, the network output is 0 V. When all inputs are high, the output is nearly +V. Intermediate binary inputs provide directly proportional output voltages.

The first 741 op amp buffers, inverts, and gives dual polarity to the output from the ladder network. The second 741 provides a means of adjusting the baseline of the output voltage (above, below, or at ground). This is achieved by adjusting  $R_{11}$ , which permits the output voltage applied to the gate of  $Q_1$  to be set to any point.

**Testing the Circuit.** Interfacing the circuit in Fig. 1 to the computer's data bus is best accomplished by interposing buffers between the data bus and the D/A converter.

If you want to test the circuit *without* a computer, the nibble generator circuit in Fig. 2 provides a convenient source of a stepped, automatically recycled binary count (0000 to 1111 and repeat). The count is controlled by  $R_1$ . Capacitor  $C_1$  can be increased to a few tens of microfarads for much slower count rates.

When the circuit in Fig. 1 is connected to a data bus or nibble generator that provides a repetitive series of ascending binary counts, you can test  $Q_1$ 's opera-

tion. Just connect a small lamp (with a rating equal to the power supply) at  $R_L$ . When  $R_{11}$  is properly adjusted, the lamp will respond to an ascending count by gradually brightening. It will then suddenly turn off and again begin to brighten as the cycle repeats.

Be sure to connect a voltmeter to pin 6 of the second 741 while performing the lamp test. You can then monitor  $V_{GS}$  while adjusting  $R_{11}$ . For best results, slow the count rate when you are making voltage readings.

**Going Further.** This circuit has many interesting applications. For example,  $Q_1$  can be used as the frequency control resistor for a 555 tone generator circuit. Use the basic 555 clock circuit in Fig. 2, but omit  $R_1$  and connect  $Q_1$ 's drain to +V. Connect its source through a 50-kilohm trimmer resistor to pin 7 of the 555. Reduce  $C_1$ 's value to 0.01  $\mu$ F. Connect a small speaker through a 200-ohm resistor from pin 3 of the 555 to +V. Adjusting  $R_{11}$ , the tone generator trimmer, and  $R_1$  of the clock will provide a repetitive series of stepped frequency tones.

For more information about using VMOS FETs as variable resistors, see this month's "Experimenter's Corner." Also, refer to application notes published by the various VMOS FET manufacturers.  $\diamond$

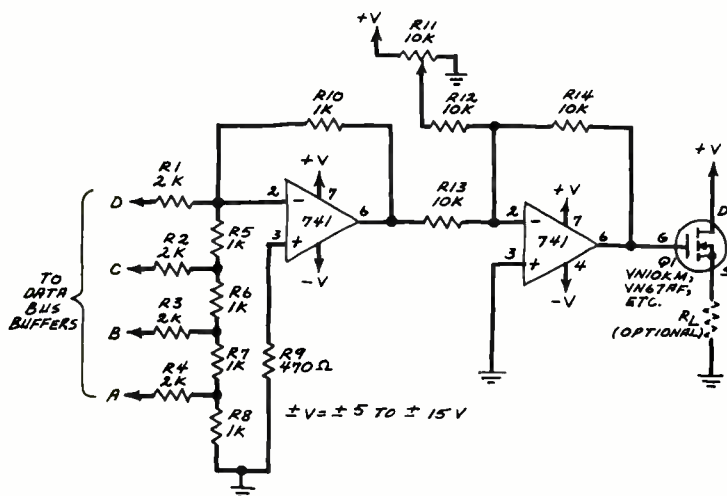

Fig. 1. Digitally programmable VMOS variable resistor.

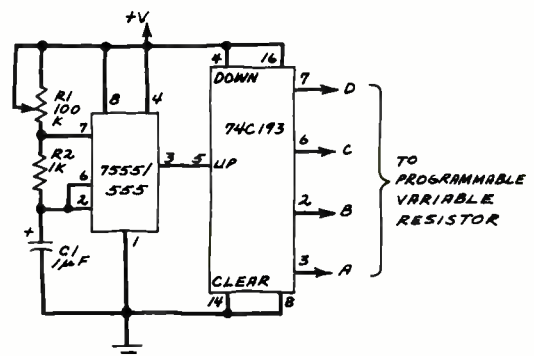

Fig. 2. Nibble generator for testing programmable variable resistor.



## ADVERTISERS INDEX

RS no.	ADVERTISER	PAGE no.
50	Active Electronics	113
2	Albia Electronics	125
57	Alco	126
3	All Electronics Corp.	124
6	Anders Precision Instruments	106
35	Apple Computer	4,5
	ARCsoft Publishing	15
62	Bishop Graphics	115
7	Bottom Line, The	113
	C & D Electronics	106
	Classified Advertising	128-136
	Cleveland Institute of Electronics, Inc.	44-47
29	Commodore Computer	Cover 4
60	CompuServe	Cover 3
8	Computers & Electronics Supply Co.	91
11	Computer Mail Order	76
67	DAK Industries Inc.	1
14	Digi-Key Corp.	122,123
66	Discwasher	59
25	Epson America	2
26	Firestik	96
18	Focus	99
59	Franklin Computers	18
	Fuji Photo Film USA, Inc.	17
19	Gladstone Electronics	49
58	Global Specialties	107
	Grantham College of Engineering	101
28,61	Heath Co.	13,54-55
54,65	Hewlett-Packard	50-51,80
41	IBM Corporation	7
	ICS Computer Programming	109
64	Institute of Audio Research	20
13	International Publishing & Software, Inc.	99
21	Jameco Electronics	118
22	JDR Microdevices	116,117
23	J & R Music World	105
20	Leading Edge	Cover 2
	McGraw-Hill Book Club	8-11
31	McIntosh Laboratory, Inc.	106
32	MFJ Enterprises	96
37	Magtek Media	96
	Memotech	23
63	Morrow Designs	32-33
	Netronics, R & D Ltd.	121,124
17,27	New Horizons	25,78
	NRI Schools	26-29
40,47	Protecto Enterprises	37,108
15	Quick Brown Fox	63
	Radio Shack	127
48	Regency Electronics	104
	Scientific Systems	99
	Sinclair Research Ltd	21
36	Sintec Co.	126
38	Star Micronics, Inc.	110
39	Tab Books	97
42	TAMS, Inc.	101
	Tektronix	38

THE SMARTER COMPUTER STARTS HERE!



The smarter computer starts with your imagination & E-Z CIRCUIT's Professional Printed Circuit Design Kit... "The Anything Board Kit."

Use "The Anything Board Kit" to design & build real-time clocks, GPU's, voice synthesizers, A/D converters, serial I/O's, memory boards, game boards & more. With E-Z CIRCUIT, the possibilities are unlimited.

Designed especially for small systems computers, "The Anything Board Kit" contains a complete assortment of E-Z CIRCUIT pressure-sensitive copper products. Included in every kit are copper donut pads, tape, transistor mounting patterns, DIP patterns, discrete component patterns, power & ground distribution lines, the appropriate E-Z Bus board & more... OVER 200 PIECES IN ALL\*...virtually everything you need to design & build professional quality PC boards without artwork, photography, screening or etching. Simply peel, press & solder.

Available in four popular configurations. Standard Bus, S-100, Apple II\*\* & EuroKit (for metric and general purpose applications), "The Anything Board Kit" has total small systems compatibility.

**The Smarter Computer Starts Here!**



Don't Delay... Get "The Anything Board Kit" TODAY... to find your local E-Z CIRCUIT Distributor or to order directly from Bishop... CALL TOLL FREE

**(800)782-8766**

Mon. - Fri. 8:00 am to 5:00 pm P.S.T.

In California, Hawaii and Alaska call (213) 991-2600

Standard Bus (\$62.80) + . Order No. EZ8952 Apple II (\$63.20) + . . . Order No. EZ8954  
S-100 (\$68.20) + . . . . . Order No. EZ8953 EuroKit (\$67.50) + . . . Order No. EZ8951  
+ Include \$4.00 shipping and handling, per kit. California residents add 6% sales tax.

\*Kit does not include components \*\*Apple II is a trademark of Apple Computer, Inc.



**E-Z CIRCUIT**  
by Bishop Graphics, Inc.

5388 Sterling Center Drive  
P.O. Box 5007CE  
Westlake Village, CA 91359  
(213) 991-2600 Telex: 66-2400

# 4164 64K DYNAMIC \$625

200 NS

# TMM2016 2KX8 STATIC \$415

200 NS

ALL MERCHANDISE 100% GUARANTEED!

CALL US FOR VOLUME QUOTES

## STATIC RAMS

2101	256 x 4 (450ns)	1.95
5101	256 x 4 (450ns) (cmos)	3.95
2102-1	1024 x 1 (450ns)	.89
2102L-4	1024 x 1 (450ns) (LP)	1.29
2102L-2	1024 x 1 (250ns) (LP)	1.69
2111	256 x 4 (450ns)	2.99
2112	256 x 4 (450ns)	2.99
2114	1024 x 4 (450ns)	8/14.95
2114L-4	1024 x 4 (450ns) (LP)	8/15.25
2114L-3	1024 x 4 (300ns) (LP)	8/15.45
2114L-2	1024 x 4 (200ns) (LP)	8/15.95
2147	4096 x 1 (55ns)	4.95
TMS4044-4	4096 x 1 (450ns)	3.49
TMS4044-3	4096 x 1 (300ns)	3.99
TMS4044-2	4096 x 1 (200ns)	4.49
MK4118	1024 x 8 (250ns)	9.95
TMM2016-200	2048 x 8 (200ns)	4.15
TMM2016-150	2048 x 8 (150ns)	4.95
TMM2016-100	2048 x 8 (100ns)	6.15
HM6116-4	2048 x 8 (200ns) (cmos)	4.95
HM6116-3	2048 x 8 (150ns) (cmos)	5.95
HM6116-2	2048 x 8 (120ns) (cmos)	8.95
HM6116LP-4	2048 x 8 (200ns) (cmos)(LP)	6.95
HM6116LP-3	2048 x 8 (150ns) (cmos)(LP)	8.95
HM6116LP-2	2048 x 8 (120ns) (cmos)(LP)	10.95
Z-6132	4096 x 8 (300ns) (Qstat)	34.95

LP = Low Power Qstat = Quasi-Static

## DISC CONTROLLERS

1771	16.95
1791	29.95
1793	38.95
1795	54.95
1797	54.95
6843	34.95
8272	39.95
UPD765	39.95
1691	18.95
2143	18.95

## INTERFACE

8T26	1.69
8T28	2.49
8T95	.99
8T96	.99
8T97	.99
8T98	.99
DM8131	2.95
DP8304	2.29
D58835	1.99
D58836	.99

## MISC.

3242	7.95
3341	4.95
MC3470	4.95
MC3480	9.00
111C90	13.95
95H90	7.95
2513-001 UP	9.95
2513-002 LOW	9.95

## SOUND CHIPS

76477	3.95
76489	8.95
AY3-8910	12.95
MC3340	1.49

## CRT CONTROLLERS

6845	14.95
68B45	35.95
HD46505SP	15.95
6847	12.25
MC1372	6.95
68047	24.95
8275	29.95
7220	99.95
CRT5027	39.95
CRT5037	49.95
TMS9918A	39.95
DP8350	49.95

## BIT-RATE GENERATORS

MC14411	11.95
BR1941	11.95
4702	12.95
COM5016	16.95
COM8116	10.95
MM5307	10.95

## UARTS

AY3-1014	6.95
AY5-1013	3.95
AY3-1015	6.95
PT1472	9.95
TR1602	3.95
2350	9.95
2651	8.95
TMS6011	5.95
IM6402	7.95
IM6403	8.95
INS8250	14.95

## KEYBOARD CHIPS

AY5-2376	11.95
AY5-3600	11.95

## CLOCK CIRCUITS

MM5314	4.95
MM5369	3.95
MM5375	4.95
MM58167	8.95
MM58174	11.95
MSM5832	6.95

## Z-80

### 2.5 Mhz

Z80-CPU	3.95
Z80-CTC	5.95
Z80-DART	15.25
Z80-DMA	17.50
Z80-PIO	5.75
Z80-SIO/0	18.50
Z80-SIO/1	18.50
Z80-SIO/2	18.50
Z80-SIO/9	16.95

### 4.0 Mhz

Z80A-CPU	6.00
Z80A-CTC	8.65
Z80A-DART	18.75
Z80A-DMA	27.50
Z80A-PIO	6.00
Z80A-SIO/0	22.50
Z80A-SIO/1	22.50
Z80A-SIO/2	22.50
Z80A-SIO/9	19.95

### 6.0 Mhz

Z80B-CPU	17.95
Z80B-CTC	15.50
Z80B-PIO	15.50

## ZILOG

Z6132	34.95
Z8671	39.95

## CRYSTALS

32.768 khz	1.95
1.0 mhz	4.95
1.8432	4.95
2.0	3.95
2.097152	3.95
2.4576	3.95
3.2768	3.95
3.579535	3.95
4.0	3.95
5.0	3.95
5.0688	3.95
5.185	3.95
5.7143	3.95
6.0	3.95
6.144	3.95
6.5536	3.95
8.0	3.95
10.738635	3.95
14.31818	3.95
15.0	3.95
16.0	3.95
17.430	3.95
18.0	3.95
18.432	3.95
20.0	3.95
22.1184	3.95
32.0	3.95

## DATA ACQUISITION

ADC0800	15.55
ADC0804	3.49
ADC0809	4.49
ADC0817	9.95
DAC0800	4.95
DAC0806	1.95
DAC0808	2.95
DAC1020	8.25
DAC1022	5.95
MC1408L6	1.95
MC1408L8	2.95

## 8000

8035	5.95
8039	6.95
INS-8060	17.95
INS-8073	24.95
8080	3.95
8085	5.95
8085A-2	11.95
8086	29.95
8087	CALL
8088	39.95
8089	89.95
8155	7.95
8156	8.95
8185	29.95
8185-2	39.95
8741	39.95
8748	29.95
8755	32.00

## 8200

8202	29.95
8203	39.95
8205	3.50
8212	1.80
8214	3.85
8216	1.75
8224	2.25
8226	1.80
8228	3.49
8237	19.95
8238	4.49
8243	4.45
8250	10.95
8251	4.49
8253	6.95
8253-5	7.95
8255	4.49
8255-5	5.25
8257	7.95
8257-5	8.95
8259	6.90
8259-5	7.50
8271	39.95
8272	39.95
8275	29.95
8279	8.95
8279-5	10.00
8282	6.50
8283	6.50
8284	5.50
8286	6.50
8287	6.50
8288	25.00
8289	49.95

## FUNCTION GENERATORS

MC4024	3.95
LM566	1.49
XR2206	3.75
8038	3.95

## INTERSIL

ICL7103	9.50
ICL7106	9.95
ICL7107	12.95
ICL7660	2.95
ICL8038	3.95
ICM7207A	5.59
ICM7208	15.95

## 6800

68000	59.95
6800	4.95
6802	7.95
6808	13.90
6809E	19.95
6809	12.95
6810	2.95
6820	4.95
6821	3.25
6828	14.95
6840	12.95
6843	34.95
6844	25.95
6845	14.95
6847	12.25
6850	3.45
6852	5.75
6860	9.95
6862	11.95
6875	6.95
6880	2.25
6883	24.95
68047	24.95
68488	19.95

## 6800 1MHZ

68B00	10.95
68B02	22.25
68B09E	29.95
68B09	29.95
68B10	7.95
68B21	12.95
68B45	35.95
68B50	12.95

## 6500 1 MHZ

6502	5.95
6504	6.95
6505	8.95
6507	9.95
6520	4.35
6522	8.75
6532	11.25
6545	22.50
6551	11.85

## 2 MHZ

6502A	9.95
6522A	11.70
6532A	12.40
6545A	28.50
6551A	12.95

## 3 MHZ

6502B	14.95
-------	-------

## EXAR

XR 2206	3.75
XR 2207	3.85
XR 2208	3.90
XR 2211	5.25
XR 2240	3.25

## 9000 SERIES

9316	1.00
9334	2.50
9368	3.95
9401	9.95
9601	7.75
9602	1.50
96S02	1.95

## DYNAMIC RAMS

TMS4027	4096 x 1 (250ns)	1.99
UPD411	4096 x 1 (300ns)	3.00
MMS280	4096 x 1 (300ns)	3.00
MK4108	8192 x 1 (200ns)	1.95
MMS298	8192 x 1 (250ns)	1.85
4116-300	16384 x 1 (300ns)	8/11.75
4116-250	16384 x 1 (250ns)	8/11.95
4116-200	16384 x 1 (200ns)	8/13.95
4116-150	16384 x 1 (150ns)	8/15.95
4116-120	16384 x 1 (120ns)	8/29.95
2118	16384 x 1 (150ns) (5v)	4.95
4164-200	65536 x 1 (200ns) (5v)	6.25
4164-150	65536 x 1 (150ns) (5v)	7.25

5V = single 5 volt supply

## EPROMS

1702	256 x 8 (1us)	4.50
2708	1024 x 8 (450ns)	3.95
2758	1024 x 8 (450ns)(5v)	5.95
2716	2048 x 8 (450ns)(5v)	3.95
2716-1	2048 x 8 (350ns)(5v)	6.25
TMS2516	2048 x 8 (450ns)(5v)	5.50
TMS2716	2048 x 8 (450ns)	7.95
TMS2532	4096 x 8 (450ns)(5v)	7.95
2732	4096 x 8 (450ns)(5v)	4.95
2732-250	4096 x 8 (250ns)(5v)	12.95
2732-200	4096 x 8 (200ns)(5v)	16.95
2764	8192 x 8 (450ns)(5v)	16.95
2764-250	8192 x 8 (250ns)(5v)	18.95
2764-200	8192 x 8 (200ns)(5v)	24.95
TMS2564	8192 x 8 (450ns)(5v)	24.95
MC68764	8192 x 8 (450ns)(5v)(24 pin)	39.95

5v = Single 5 Volt Supply

## EPROM ERASERS

PE-14	Timer	Capacity Chip	Intensity (uW/Cm <sup>2</sup> )	
PE-14		6	5,200	83.00
PE-14T	X	6	5,200	119.00
PE-24T	X	9	6,700	175.00
PL-265T	X	20	6,700	255.00
PR-125T	X	16	15,000	349.00
PR-320	X	32	15,000	595.00

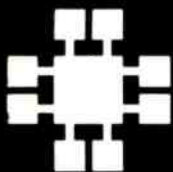

# JDR MICRODEVICES, INC.

1224 S. Bascom Avenue  
San Jose, CA 95128

800-538-5000 • 800-662-6279 (CA)  
(408) 995-5430 • Telex 171-110

© 1982 JDR MICRODEVICES, INC.

— NEW HOURS —  
M-W-F, 9-5  
T-Th., 9-9 Sat. 11-3

PLEASE USE YOUR CUSTOMER NUMBER WHEN ORDERING

TERMS:



### 74LS00

74LS00	.24	74LS86	.39	74LS169	1.75	74LS323	3.50
74LS01	.25	74LS90	.55	74LS170	1.49	74LS324	1.75
74LS02	.25	74LS91	.89	74LS173	.69	74LS352	1.29
74LS03	.25	74LS92	.55	74LS174	.55	74LS353	1.29
74LS04	.24	74LS93	.55	74LS175	.55	74LS363	1.35
74LS05	.25	74LS95	.75	74LS181	2.15	74LS364	1.95
74LS08	.28	74LS96	.89	74LS189	8.95	74LS365	.49
74LS09	.29	74LS107	.39	74LS190	.89	74LS366	.49
74LS10	.25	74LS109	.39	74LS191	.89	74LS367	.45
74LS11	.35	74LS112	.39	74LS192	.79	74LS368	.45
74LS12	.35	74LS113	.39	74LS193	.79	74LS373	.99
74LS13	.45	74LS114	.39	74LS194	.69	74LS374	.99
74LS14	.59	74LS122	.45	74LS195	.69	74LS377	1.39
74LS15	.35	74LS123	.79	74LS196	.79	74LS378	1.18
74LS20	.25	74LS124	2.90	74LS197	.79	74LS379	1.35
74LS21	.29	74LS125	.49	74LS221	.89	74LS385	1.90
74LS22	.25	74LS126	.49	74LS240	.95	74LS386	.45
74LS26	.29	74LS132	.59	74LS241	.99	74LS390	1.19
74LS27	.29	74LS133	.59	74LS242	.99	74LS393	1.19
74LS28	.35	74LS136	.39	74LS243	.99	74LS395	1.19
74LS30	.25	74LS137	.99	74LS244	.99	74LS399	1.49
74LS32	.29	74LS138	.55	74LS245	1.49	74LS424	2.95
74LS33	.55	74LS139	.55	74LS247	.75	74LS447	.37
74LS37	.35	74LS145	1.20	74LS248	.99	74LS490	1.95
74LS38	.35	74LS147	2.49	74LS249	.99	74LS624	3.99
74LS40	.25	74LS148	1.35	74LS251	.59	74LS668	1.69
74LS42	.49	74LS151	.55	74LS253	.59	74LS669	1.89
74LS47	.75	74LS153	.55	74LS257	.59	74LS670	1.49
74LS48	.75	74LS154	1.90	74LS258	.59	74LS674	9.65
74LS49	.75	74LS155	.69	74LS259	2.75	74LS682	3.20
74LS51	.25	74LS156	.69	74LS260	.59	74LS683	3.20
74LS54	.29	74LS157	.65	74LS266	.55	74LS684	3.20
74LS55	.29	74LS158	.59	74LS273	1.49	74LS685	3.20
74LS63	1.25	74LS160	.69	74LS275	3.35	74LS688	2.40
74LS73	.39	74LS161	.65	74LS279	.49	74LS689	3.20
74LS74	.35	74LS162	.69	74LS280	1.98	74LS783	24.95
74LS75	.39	74LS163	.65	74LS283	.69	81LS95	1.49
74LS76	.39	74LS164	.69	74LS290	.89	81LS96	1.49
74LS78	.49	74LS165	.95	74LS293	.89	81LS97	1.49
74LS83	.60	74LS166	1.95	74LS295	.99	81LS98	1.49
74LS85	.69	74LS168	1.75	74LS298	.89	25LS2521	2.80
				74LS299	1.75	25LS2569	4.25

### IC SOCKETS

1-99	100
8 pin ST	.13 .11
14 pin ST	.15 .12
16 pin ST	.17 .13
18 pin ST	.20 .18
20 pin ST	.29 .27
22 pin ST	.30 .27
24 pin ST	.30 .27
28 pin ST	.40 .32
40 pin ST	.49 .39
64 pin ST	4.25 call
ST = SOLDERTAIL	
8 pin WW	.59 .49
14 pin WW	.69 .52
16 pin WW	.69 .58
18 pin WW	.99 .90
20 pin WW	1.09 .98
22 pin WW	1.39 1.28
24 pin WW	1.49 1.35
28 pin WW	1.69 1.49
40 pin WW	1.99 1.80
WW = WIREWRAP	
16 pin ZIF	6.75 call
24 pin ZIF	9.95 call
28 pin ZIF	10.95 call
ZIF TEXTTOOL (Zero Insertion Force)	

### 7400

7400	.19	74132	.45
7401	.19	74136	.50
7402	.19	74141	.65
7403	.19	74142	2.95
7404	.19	74143	2.95
7405	.25	74145	6.00
7406	.29	74147	1.75
7407	.29	74148	1.20
7408	.24	74150	1.35
7409	.19	74151	.55
7410	.19	74152	.65
7411	.25	74153	.55
7412	.30	74154	1.25
7413	.35	74155	.75
7414	.49	74156	.65
7416	.25	74157	.55
7417	.25	74159	1.65
7420	.19	74160	8.5
7421	.35	74161	6.9
7422	.35	74162	8.5
7423	.29	74163	6.9
7425	.29	74164	8.5
7426	.29	74165	8.5
7427	.29	74166	1.00
7428	.45	74167	2.95
7430	.19	74170	1.65
7432	.29	74172	5.95
7433	.45	74173	.75
7437	.29	74174	8.9
7438	.29	74175	8.9
7440	.19	74176	8.9
7442	.49	74177	.75
7443	.65	74178	1.15
7444	.69	74179	1.75
7445	.69	74180	.75
7446	.69	74181	2.25
7447	.69	74182	.75
7448	.69	74184	2.00
7450	.19	74185	2.00
7451	.23	74186	18.50
7453	.23	74190	1.15
7454	.23	74191	1.15
7460	.23	74192	.79
7470	.35	74193	.79
7472	.29	74194	8.5
7473	.34	74195	8.5
7474	.33	74196	.79
7475	.45	74197	.75
7476	.35	74198	1.35
7480	.59	74199	1.35
7481	1.10	74221	1.35
7482	.95	74246	1.35
7483	.50	74247	1.85
7485	.59	74248	1.25
7486	.35	74249	1.95
7489	2.15	74251	.75
7490	.35	74259	2.25
7491	.40	74265	1.35
7492	.50	74273	1.95
7493	.35	74276	1.25
7494	.65	74279	.75
7495	.55	74283	2.00
7496	.70	74284	3.75
7497	2.75	74285	3.75
74100	1.75	74290	.95
74107	.30	74293	.75
74109	.45	74298	.85
74110	.45	74351	2.25
74111	.55	74365	.65
74116	1.55	74366	.65
74120	1.20	74367	.65
74121	.29	74368	.65
74122	.45	74376	2.20
74123	.49	74390	1.75
74125	.45	74393	1.35
74126	.45	74425	3.15
74128	.55	74426	.85
		74490	2.55

### CMOS

4000	.29	4527	1.95
4001	.25	4528	1.19
4002	.25	4531	.95
4006	.89	4532	1.95
4007	.29	4538	1.95
4008	.95	4539	1.95
4009	.39	4541	2.64
4010	.45	4543	1.19
4011	.25	4553	5.79
4012	.25	4555	.95
4013	.38	4556	.95
4014	.39	4581	1.95
4015	.39	4582	1.95
4016	.39	4584	.75
4017	.69	4585	.75
4018	.79	4702	12.95
4019	.39	74C00	.35
4020	.75	74C02	.35
4021	.79	74C04	.35
4022	.79	74C08	.35
4023	.29	74C10	.35
4024	.65	74C14	.35
4025	.29	74C20	.35
4026	1.65	74C30	.35
4027	.45	74C32	.39
4028	.69	74C42	1.29
4029	.79	74C48	1.99
4030	.39	74C73	.65
4034	1.95	74C74	.65
4035	.85	74C76	.80
4040	.75	74C83	1.95
4041	.75	74C85	1.95
4042	.69	74C86	.39
4043	.85	74C89	4.50
4044	.79	74C90	1.19
4046	.85	74C93	1.75
4047	.95	74C95	.99
4049	.35	74C107	.89
4050	.35	74C150	5.75
4051	.79	74C151	2.25
4053	.79	74C154	3.25
4060	.89	74C157	1.75
4066	.39	74C160	1.19
4068	.39	74C161	1.19
4069	.29	74C162	1.19
4070	.35	74C163	1.19
4071	.29	74C164	1.39
4072	.29	74C165	2.00
4073	.29	74C173	.79
4075	.29	74C174	1.19
4076	.79	74C175	1.19
4078	.29	74C192	1.49
4081	.29	74C193	1.49
4082	.29	74C195	1.39
4085	.95	74C200	5.75
4086	.95	74C221	1.75
4093	.49	74C374	2.45
4098	2.49	74C374	2.45
4099	1.95	74C901	.39
14409	12.95	74C902	.85
14410	12.95	74C903	.85
14411	11.95	74C905	10.95
14412	12.95	74C906	.95
14419	7.95	74C907	1.00
14433	4.18	74C908	2.00
4502	.95	74C909	2.75
4503	.65	74C910	9.95
4508	1.95	74C911	8.95
4510	.85	74C912	8.95
4511	.85	74C914	1.95
4512	.85	74C915	1.19
4514	1.25	74C918	2.75
4515	1.79	74C920	1.95
4516	1.55	74C921	15.95
4518	.89	74C922	4.49
4519	.39	74C923	4.95
4520	.79	74C925	5.95
4522	1.25	74C926	7.95
4526	1.25	74C928	7.95
		74C929	19.95

## Prices Slashed! 74S00

74S00	.32	74S163	1.95
74S02	.35	74S168	3.95
74S03	.35	74S169	3.95
74S04	.35	74S174	.95
74S05	.35	74S175	.95
74S08	.35	74S181	3.95
74S09	.40	74S182	2.95
74S10	.35	74S188	1.95
74S11	.35	74S189	6.95
74S15	.35	74S194	1.49
74S20	.35	74S195	1.49
74S22	.35	74S196	1.49
74S30	.35	74S197	1.49
74S32	.40	74S201	6.95
74S37	.88	74S225	7.95
74S38	.85	74S240	2.20
74S40	.35	74S241	2.20
74S51	.35	74S244	2.20
74S64	.40	74S251	.95
74S65	.40	74S253	.95
74S74	.50	74S257	.95
74S85	1.99	74S258	.95
74S86	.50	74S260	.79
74S112	.50	74S274	19.95
74S113	.50	74S275	19.95
74S114	.55	74S280	1.95
74S124	2.75	74S287	1.90
74S132	1.24	74S288	1.90
74S133	.45	74S289	6.89
74S134	.50	74S301	6.95
74S135	.89	74S373	2.45
74S138	.85	74S374	2.45
74S139	.85	74S381	7.95
74S140	.55	74S387	1.95
74S151	.95	74S412	2.98
74S153	.95	74S471	4.95
74S157	.95	74S472	4.95
74S158	.95	74S474	4.95
74S161	1.95	74S482	15.25
74S162	1.95	74S570	2.95
		74S571	2.95



## ORDER TOLL FREE 800-538-5000 800-662-6279 (CALIFORNIA RESIDENTS)







# ANNOUNCING TWO NEW TERMINALS

Smart • Fast • Graphics • Matching Modem and \$295 Printer

Netronics announces a state of the art breakthrough in terminals, now at prices you can afford, you can go on-line with data-bank and computer phone-line services. It's all yours... "electronic newspapers," educational services, Dow-Jones stock reports, games, recipes, personal computing with any level language, program exchanges, electronic bulletin boards... and more every day!!!



Netronics offers two new terminals, both feature a full 56 key/128 character typewriter-style keyboard, baud rates to 19.2 Kbaud, a rugged steel cabinet and power supply. The simplest one, FASTERM-64, is a 16 line by 64 or 32 character per line unit, with a serial printer port for making hard copy of all incoming data, and optional provisions for block and special character graphics. The "smart" version, SMARTERM-80, features either 24 line by 80 characters per line or 16 by 40 characters per line. It offers on-screen editing with page-at-a-time printing, 12,000 pixel graphics, line graphics, absolute cursor addressing, underlining, reverse video, one-half intensity and much more... simply plug them into your computer or phone modem and be on-line instantly. Use your TV set (RF modulator required) or our deluxe green-phosphor monitor pictured above. For hard copy just add our matched printer.

Price breakthrough!!! Own the FASTERM-64, a complete terminal kit, ready to plug in for just \$199.95 or order the SMARTERM-80 kit for just \$299.95, (both available wired and tested.) Be on-line with the million-dollar computers and data services today... we even supply the necessary subscription forms.

More good news: All the components in our terminals are available separately (see coupon), so you buy only what you need!!!

**FASTERM-64** DISPLAY FORMAT: 64 or 32 characters/line by 16 lines... 96 displayable ASCII characters (upper & lower case) 8 baud rates: 150, 300, 600, 1200, 2400, 4800, 9600, 19,200 (switch select) LINE OUTPUT: RS232C or 20 ma current loop VIDEO OUTPUT: 1V PIP (EIA RS-170) CURSOR MODES: home & clear screen, erase to end of line, erase cursor line, cursor up & down, auto carriage return/line feed at end of line & auto scrolling REVERSE VIDEO BLINKING CURSOR PARITY: off, even or odd STOP BITS: 1, 1.5, 2 DATA BITS PER CHARACTER: 5, 6, 7 or 8 CHARACTER OUTPUT: 5 by 7 dot matrix in a 7 by 12 cell PRINTER OUTPUT: prints all incoming data 1K ON BOARD RAM 2K ON BOARD ROM CRYSTAL CONTROLLED COMPLETE WITH POWER SUPPLY OPTIONAL GRAPHICS MODE: includes 34 Greek & math characters plus 30 special graphics characters... ASCII ENCODED KEYBOARD: 56 key/128 characters

**SMARTERM-80** DISPLAY FORMAT: 80 characters by 24 lines or 40 characters by 16 lines 128 displayable ASCII characters (upper & lower case) 8 baud rates: 110, 300, 600, 1200, 2400, 4800, 9600, 19,200... LINE OUTPUT: RS232C or 20 ma current loop VIDEO OUTPUT: 1V PIP (EIA RS-170) EDITING FEATURES: insert/delete line, insert/delete character, forward/back tab LINE OR PAGE TRANSMIT PAGE PRINT FUNCTION CURSOR POSITIONING: up, down, right, left, plus absolute cursor positioning with read back VISUAL ATTRIBUTES: underline, blink, reverse video, half intensity & blank GRAPHICS: 12,000 pixel resolution block plus line graphics ON-SCREEN PARITY INDICATOR PARITY: off, even or odd STOP BITS: 1 to 2, all others 1 CHAR OUTPUT: 7 by 11 character in a 9 by 12 block PRINTER OUTPUT: 60 OR 50 Hz VERTICAL REFRESH BLINKING BLOCK CURSOR CRYSTAL CONTROLLED 2K ON BOARD RAM ASCII ENCODED KEYBOARD: 56 key/128 character 4K ON BOARD ROM COMPLETE WITH POWER SUPPLY

**TELEPHONE MODEM 103 O/A** FULL DUPLEX, FCC APPROVED DATA RATE 300 baud INTERFACE: RS232C and TTY CONTROLS: talk/data switch (no need to connect and disconnect phone), original/answer switch on rear panel... NO POWER SUPPLY REQUIRED

**ASCII KEYBOARD ASCII-3** 56 KEY/128 CHARACTER ASCII ENCODED UPPER & LOWER CASE FULLY DEBOUNCED 2 KEY ROLLOVER POS OR NEG LOGIC WITH POS STROBE REQUIRES +5 & -12V DC (SUPPLIED FROM VIDEO BOARDS)

**PRINTER COMET I** SERIAL I/O TO 9600 BAUD 80 CHARACTER COLUMN (132 COMPRESSED) 10" TRACTOR FEED UPPER/LOWER CASE INDUSTRY STANDARD RIBBONS 4 CHARACTER SIZES 9 BY 7 DOT MATRIX BI-DIRECTIONAL PRINTING



Continental U.S.A. Credit Card Buyers Outside Connecticut  
CALL TOLL FREE 800-243-7428

To Order From Connecticut Or For Tech. Assist. Call (203) 354-9375

**NETRONICS R&D LTD.** Dept. CE

333 Litchfield Road, New Milford, CT 06776

Please send the items checked below:

- COMPLETE FASTERM-64 TERMINAL (includes FASTVID-64 video board ASCII-3 keyboard, steel cabinet and power supply) ... kit \$199.95 plus \$3 P&I ... wired & tested \$249.95 plus \$3 P&I... graphics option: add \$19.95 to each of above
- COMPLETE SMARTERM-80 TERMINAL (includes SMARTVID-80 video board, ASCII-3 keyboard, steel cabinet and power supply) ... kit \$299.95 plus \$3 P&I ... wired & tested \$369.95 plus \$3 P&I
- FASTVID-64 VIDEO BOARD (requires +5 & -12V DC) ... kit \$99.95 plus \$3 P&I ... graphics option add \$19.95
- SMARTVID-80 VIDEO BOARD (requires +5 & +/-12V DC) ... kit \$199.95 plus \$3 P&I ... wired & tested \$249.95 plus \$3 P&I
- DELUXE STEEL TERMINAL CABINET ... \$19.95 plus \$3 P&I
- ASCII-3 KEYBOARD (requires +5 & -12VDC) ... kit \$69.95 plus \$3 P&I ... wired and tested \$89.95 plus \$3 P&I
- POWER SUPPLY (powers ASCII-3 keyboard & video boards) ... kit only \$19.95 plus \$2 P&I
- ZENITH VIDEO MONITOR (high resolution green phosphor) ... wired & tested \$149.95 plus \$6 P&I
- TELEPHONE MODEM MODEL 103 O/A ... wired & tested \$189.95 plus \$3 P&I
- DOT MATRIX PRINTER Comet I ... wired & tested \$299.95 plus \$10 P&I
- RF MODULATOR MOD RF-1 ... kit only \$8.95 plus \$1 P&I
- 3FT-25 LEAD WIRE/TERMINAL OR PRINTER/TERMINAL CONNECTOR CABLE ... \$14.95 ea plus \$2 P&I

For Canadian orders, double the postage Conn. res. add sales tax.

Total Enclosed \$

Personal Check  Cashier's Check/Money Order

VISA  MasterCard (Bank No. \_\_\_\_\_)

Acct. No. \_\_\_\_\_ Exp. Date \_\_\_\_\_

Signature \_\_\_\_\_

Print Name \_\_\_\_\_

Address \_\_\_\_\_

City \_\_\_\_\_ State \_\_\_\_\_ Zip \_\_\_\_\_

# FOR ONLY \$129.95 Learn Computing From The Ground Up

Build a Computer kit that grows with you, and can expand to 64K RAM, Microsoft BASIC, Text Editor/Assembler, Word Processor, Floppy Disks and more.

## EXPLORER/85

Here's the low cost way to learn the fundamentals of computing, the all-important basics you'll need more and more as you advance in computer skills. For just \$129.95 you get the advanced design Explorer/85 motherboard, with all the features you need to learn how to write and use programs... and an easy-to-use system that is a match for any personal computer on the market. Look at these features: **8085 Central Processing Unit**, the microprocessor "heart" of the Explorer/85 (Join the millions who will buy and use the 8080/8085 this year alone!) **Four 8-bit power supply and terminal ports** from which you can input and output your programs, as well as control exterior switches, relays, lights, etc. a cassette interface that lets you store and reload programs you've learned to write... **deluxe 2,000 byte operating system/monitor**, makes it easy to learn computing in several important ways... It allows simpler, faster writing and entering of programs... It permits access by you to all parts of the system so you can check on the status of any point in the program... It allows tracing each program step by step with provision for displaying all the contents of the CPU registers (flags, etc.)... and it does much more!

You get all this in the starting level (Level A) of the Explorer/85 for only \$129.95. Incredible! To see: just plug in your 8V power supply and terminal or keyboard/display... if you don't have them, see our special offers below.

Level A computer kit (Terminal Version) \$129.95 plus \$3 P&I \*  
 Level A kit (Hex Keypad/Display Version) \$129.95 plus \$3 P&I \*

**LEVEL B** - This "building block" converts the motherboard into a two-slot S100 bus industry standard computer. Now you can plug in any of the hundreds of S100 cards available.

Level B kit \$49.95 plus \$2 P&I \*  
 S100 bus connectors (two required) \$4.85 each, postpaid.

**LEVEL C** - Add still more computing power, this "building block" mounts directly on the motherboard and expands the S100 bus to six slots.

Level C kit \$36.95 plus \$2 P&I \*  
 S100 bus connectors (five required) \$4.85 each, postpaid.

**LEVEL D** - When you reach the point in learning that requires more memory, we offer two choices: either add 4K of memory directly on the motherboard, or add 16K to the memory by means of a single S100 card, our famous "JAWS"...

**Level D kit (CHECK ONE)**...  4K on-board \$49.95 plus \$2 P&I \*  16K S100 "JAWS" \$149.95 plus \$2 P&I \*  32K S100 "JAWS" \$199.95 plus \$2 P&I \*  48K S100 "JAWS" \$249.95 plus \$2 P&I \*  64K S100 "JAWS" \$299.95 plus \$2 P&I \*

**LEVEL E** - An important "building block" that activates the 8K ROM/EPROM space on the motherboard. Now just plug in our 8K Microsoft BASIC or your own custom programs.

Level E kit \$5.95 plus \$1 P&I \*  
**Microsoft BASIC** - It's the language that allows you to talk English to your computer! It is available three ways:

8K cassette version of Microsoft BASIC (requires Level B & 12K of RAM minimum; we suggest a 16K S100 "JAWS" - see above) \$64.95 plus \$2 P&I \*  
 8K ROM version of Microsoft BASIC (requires Level B & Level D and 4K RAM, just plug into your Level E sockets. We suggest either the 4K Level D RAM expansion or a 16K S100 "JAWS")... \$99.95 plus \$2 P&I \*  
 Disk version of Microsoft BASIC (requires Level B, 32K of RAM, floppy disk controller, 8" floppy disk drive) \$325 postpaid.

**TEXT EDITOR/ASSEMBLER** - The editor/assembler is a software tool (a program) designed to simplify the task of writing programs. As your programs become longer and more complex, the assembler can save you many hours of programming time. This software includes an editor program that enters the programs you write, makes changes, and saves the programs on cassettes. The assembler performs the clerical task of translating symbolic code into the computer readable object code. The editor/assembler program is available either in cassette or a ROM version.

Editor/Assembler (Cassette version) requires Level B & 8K (min) of RAM... we suggest 16K "JAWS" - see above) \$59.95 plus \$2 P&I \*  
 Editor/Assembler (ROM version) supplied on an S100 card; requires Level B and 4K RAM (min) - we suggest either Level D or 16K "JAWS" \$96.95 plus \$2 P&I \*

**8" FLOPPY DISK** - A remarkable "building block" that our 8" floppy disk when you need faster operation, more convenient program storage, perhaps a business application, and access to the literally thousands of programs and program languages available today. You simply plug them into your Explorer/85 disk system - it accepts all IBM formatted programs.

8" Floppy Disk Drive \$499.95 plus \$12 P&I \*  
 Floppy Controller Card \$199.95 plus \$2 P&I \*  
 Disk Drive Cabinet & Power Supply \$69.95 plus \$3 P&I \*

Drive Cables (set up for two drives) \$25.00 plus \$1.50 P&I \*

CP/M 2.2 Disk Operating System, includes Text Editor/Assembler, dynamic debugger, and other features that give your Explorer/85 access to thousands of existing CP/M-based programs. \$150.00 postpaid.

**NEED A POWER SUPPLY?** Gensat our AP-1. It can supply all the power you need for a fully expanded Explorer/85 (note: disk drives have their own power supply). Plus the AP-1 fits neatly into the attractive Explorer steel cabinet! (see below).

AP-1 Power Supply kit (HV @ 5 amps) in deluxe steel cabinet \$39.95 plus \$2 P&I \*

**NEED A TERMINAL?** We offer you choices: the least expensive one is our Hex Keypad/Display kit that displays the information on a calculator-type screen. The other choice is our ASCII Keyboard/Computer Terminal kit that can be used with either

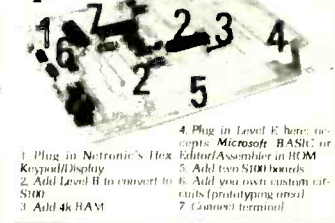

a CRT monitor or a TV set (if you have an RF modulator).

Hex Keypad/Display kit \$69.95 plus \$2 P&I \*

FASTERM - 64 TERMINAL KIT - Featuring a 56 key ASCII Keyboard, 128 character set upper and lower case, 75 ohm output, 8 baud rates, 150 to 19,200 (switch select) RS232C or 20 MA output, 32 or 64 character by 16 line formats, complete with Deluxe Steel Cabinet and Power Supply \$199.95 plus \$3 P&I \*

RF Modulator kit (allows you to use your TV set as a monitor) \$6.95 postpaid

12" Video Monitor (10MHz bandwidth) \$139.95 plus \$5 P&I \*

Deluxe Steel Cabinet for the Explorer/85 \$49.95 plus \$3 P&I \*

Fan for cabinet \$15.00 plus \$1.50 P&I \*

AP-1 Power Supply kit (HV @ 5 amps) in deluxe steel cabinet \$39.95 plus \$2 P&I \*

8" Floppy Disk Drive \$499.95 plus \$12 P&I \*

Floppy Controller Card \$199.95 plus \$2 P&I \*

Disk Drive Cabinet & Power Supply \$69.95 plus \$3 P&I \*

Drive Cables (set up for two drives) \$25.00 plus \$1.50 P&I \*

CP/M 2.2 Disk Operating System, includes Text Editor/Assembler, dynamic debugger, and other features that give your Explorer/85 access to thousands of existing CP/M-based programs. \$150.00 postpaid.

NEED A POWER SUPPLY? Gensat our AP-1. It can supply all the power you need for a fully expanded Explorer/85 (note: disk drives have their own power supply). Plus the AP-1 fits neatly into the attractive Explorer steel cabinet! (see below).

AP-1 Power Supply kit (HV @ 5 amps) in deluxe steel cabinet \$39.95 plus \$2 P&I \*

8" Floppy Disk Drive \$499.95 plus \$12 P&I \*

Floppy Controller Card \$199.95 plus \$2 P&I \*

Disk Drive Cabinet & Power Supply \$69.95 plus \$3 P&I \*

Drive Cables (set up for two drives) \$25.00 plus \$1.50 P&I \*

CP/M 2.2 Disk Operating System, includes Text Editor/Assembler, dynamic debugger, and other features that give your Explorer/85 access to thousands of existing CP/M-based programs. \$150.00 postpaid.

NEED A POWER SUPPLY? Gensat our AP-1. It can supply all the power you need for a fully expanded Explorer/85 (note: disk drives have their own power supply). Plus the AP-1 fits neatly into the attractive Explorer steel cabinet! (see below).

AP-1 Power Supply kit (HV @ 5 amps) in deluxe steel cabinet \$39.95 plus \$2 P&I \*

8" Floppy Disk Drive \$499.95 plus \$12 P&I \*

Floppy Controller Card \$199.95 plus \$2 P&I \*

Disk Drive Cabinet & Power Supply \$69.95 plus \$3 P&I \*

Drive Cables (set up for two drives) \$25.00 plus \$1.50 P&I \*

CP/M 2.2 Disk Operating System, includes Text Editor/Assembler, dynamic debugger, and other features that give your Explorer/85 access to thousands of existing CP/M-based programs. \$150.00 postpaid.

NEED A POWER SUPPLY? Gensat our AP-1. It can supply all the power you need for a fully expanded Explorer/85 (note: disk drives have their own power supply). Plus the AP-1 fits neatly into the attractive Explorer steel cabinet! (see below).

AP-1 Power Supply kit (HV @ 5 amps) in deluxe steel cabinet \$39.95 plus \$2 P&I \*

8" Floppy Disk Drive \$499.95 plus \$12 P&I \*

Floppy Controller Card \$199.95 plus \$2 P&I \*

Disk Drive Cabinet & Power Supply \$69.95 plus \$3 P&I \*

Drive Cables (set up for two drives) \$25.00 plus \$1.50 P&I \*

CP/M 2.2 Disk Operating System, includes Text Editor/Assembler, dynamic debugger, and other features that give your Explorer/85 access to thousands of existing CP/M-based programs. \$150.00 postpaid.

NEED A POWER SUPPLY? Gensat our AP-1. It can supply all the power you need for a fully expanded Explorer/85 (note: disk drives have their own power supply). Plus the AP-1 fits neatly into the attractive Explorer steel cabinet! (see below).

AP-1 Power Supply kit (HV @ 5 amps) in deluxe steel cabinet \$39.95 plus \$2 P&I \*

8" Floppy Disk Drive \$499.95 plus \$12 P&I \*

Floppy Controller Card \$199.95 plus \$2 P&I \*

Disk Drive Cabinet & Power Supply \$69.95 plus \$3 P&I \*

Drive Cables (set up for two drives) \$25.00 plus \$1.50 P&I \*

CP/M 2.2 Disk Operating System, includes Text Editor/Assembler, dynamic debugger, and other features that give your Explorer/85 access to thousands of existing CP/M-based programs. \$150.00 postpaid.

NEED A POWER SUPPLY? Gensat our AP-1. It can supply all the power you need for a fully expanded Explorer/85 (note: disk drives have their own power supply). Plus the AP-1 fits neatly into the attractive Explorer steel cabinet! (see below).

AP-1 Power Supply kit (HV @ 5 amps) in deluxe steel cabinet \$39.95 plus \$2 P&I \*

8" Floppy Disk Drive \$499.95 plus \$12 P&I \*

Floppy Controller Card \$199.95 plus \$2 P&I \*

Disk Drive Cabinet & Power Supply \$69.95 plus \$3 P&I \*

Drive Cables (set up for two drives) \$25.00 plus \$1.50 P&I \*

CP/M 2.2 Disk Operating System, includes Text Editor/Assembler, dynamic debugger, and other features that give your Explorer/85 access to thousands of existing CP/M-based programs. \$150.00 postpaid.

NEED A POWER SUPPLY? Gensat our AP-1. It can supply all the power you need for a fully expanded Explorer/85 (note: disk drives have their own power supply). Plus the AP-1 fits neatly into the attractive Explorer steel cabinet! (see below).

AP-1 Power Supply kit (HV @ 5 amps) in deluxe steel cabinet \$39.95 plus \$2 P&I \*

8" Floppy Disk Drive \$499.95 plus \$12 P&I \*

Floppy Controller Card \$199.95 plus \$2 P&I \*

Disk Drive Cabinet & Power Supply \$69.95 plus \$3 P&I \*

Drive Cables (set up for two drives) \$25.00 plus \$1.50 P&I \*

CP/M 2.2 Disk Operating System, includes Text Editor/Assembler, dynamic debugger, and other features that give your Explorer/85 access to thousands of existing CP/M-based programs. \$150.00 postpaid.

NEED A POWER SUPPLY? Gensat our AP-1. It can supply all the power you need for a fully expanded Explorer/85 (note: disk drives have their own power supply). Plus the AP-1 fits neatly into the attractive Explorer steel cabinet! (see below).

AP-1 Power Supply kit (HV @ 5 amps) in deluxe steel cabinet \$39.95 plus \$2 P&I \*

8" Floppy Disk Drive \$499.95 plus \$12 P&I \*

Floppy Controller Card \$199.95 plus \$2 P&I \*

Disk Drive Cabinet & Power Supply \$69.95 plus \$3 P&I \*

Drive Cables (set up for two drives) \$25.00 plus \$1.50 P&I \*

CP/M 2.2 Disk Operating System, includes Text Editor/Assembler, dynamic debugger, and other features that give your Explorer/85 access to thousands of existing CP/M-based programs. \$150.00 postpaid.

NEED A POWER SUPPLY? Gensat our AP-1. It can supply all the power you need for a fully expanded Explorer/85 (note: disk drives have their own power supply). Plus the AP-1 fits neatly into the attractive Explorer steel cabinet! (see below).

AP-1 Power Supply kit (HV @ 5 amps) in deluxe steel cabinet \$39.95 plus \$2 P&I \*

8" Floppy Disk Drive \$499.95 plus \$12 P&I \*

Floppy Controller Card \$199.95 plus \$2 P&I \*

Disk Drive Cabinet & Power Supply \$69.95 plus \$3 P&I \*

Drive Cables (set up for two drives) \$25.00 plus \$1.50 P&I \*

CP/M 2.2 Disk Operating System, includes Text Editor/Assembler, dynamic debugger, and other features that give your Explorer/85 access to thousands of existing CP/M-based programs. \$150.00 postpaid.

NEED A POWER SUPPLY? Gensat our AP-1. It can supply all the power you need for a fully expanded Explorer/85 (note: disk drives have their own power supply). Plus the AP-1 fits neatly into the attractive Explorer steel cabinet! (see below).

AP-1 Power Supply kit (HV @ 5 amps) in deluxe steel cabinet \$39.95 plus \$2 P&I \*

8" Floppy Disk Drive \$499.95 plus \$12 P&I \*

Floppy Controller Card \$199.95 plus \$2 P&I \*

Disk Drive Cabinet & Power Supply \$69.95 plus \$3 P&I \*

Drive Cables (set up for two drives) \$25.00 plus \$1.50 P&I \*

CP/M 2.2 Disk Operating System, includes Text Editor/Assembler, dynamic debugger, and other features that give your Explorer/85 access to thousands of existing CP/M-based programs. \$150.00 postpaid.

NEED A POWER SUPPLY? Gensat our AP-1. It can supply all the power you need for a fully expanded Explorer/85 (note: disk drives have their own power supply). Plus the AP-1 fits neatly into the attractive Explorer steel cabinet! (see below).

AP-1 Power Supply kit (HV @ 5 amps) in deluxe steel cabinet \$39.95 plus \$2 P&I \*

8" Floppy Disk Drive \$499.95 plus \$12 P&I \*

Floppy Controller Card \$199.95 plus \$2 P&I \*

Disk Drive Cabinet & Power Supply \$69.95 plus \$3 P&I \*

Drive Cables (set up for two drives) \$25.00 plus \$1.50 P&I \*

CP/M 2.2 Disk Operating System, includes Text Editor/Assembler, dynamic debugger, and other features that give your Explorer/85 access to thousands of existing CP/M-based programs. \$150.00 postpaid.

NEED A POWER SUPPLY? Gensat our AP-1. It can supply all the power you need for a fully expanded Explorer/85 (note: disk drives have their own power supply). Plus the AP-1 fits neatly into the attractive Explorer steel cabinet! (see below).

AP-1 Power Supply kit (HV @ 5 amps) in deluxe steel cabinet \$39.95 plus \$2 P&I \*

8" Floppy Disk Drive \$499.95 plus \$12 P&I \*

Floppy Controller Card \$199.95 plus \$2 P&I \*

Disk Drive Cabinet & Power Supply \$69.95 plus \$3 P&I \*

Drive Cables (set up for two drives) \$25.0











# WE TAKE YOU BY THE HAND!

You'll learn all about computers: how to build, program, service, even play TV games—without knowing the first thing about it!

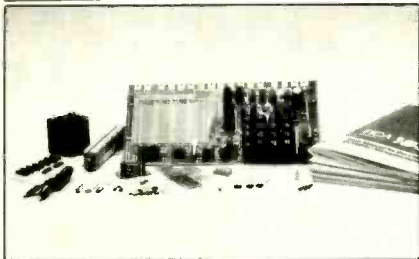

## The New ELF II "Beginners" Package

Your own expandable micro-computer kit, 5 diagnostic analyzers plus circuit, programming, diagnostic manuals, even games you can play on TV. All only \$139.95.

Even if you don't know bits from bytes, now it's easy and inexpensive to build your own micro-computer. Learn how it works, program it, service it—even play games with it on your TV! It's here in the New ELF II "Beginners" Package, only from Netronics. Only \$139.95. Here's the package: 1. Your own micro-computer, the famous ELF II (featuring the RCA 1802 CMOS microprocessor) in kit form with step-by-step instructions on how to build it. Diagnostic Analyzers including 2. your own Logic Probe. 3. Pulse Catcher. 4. 8 bit Test Register. 5. Logic Analyzer. 6. Gate Arrays. 7. Non-Technical Manuals on how to use analyzers, how to get into the guts of the computer, what makes it tick, how to service it. 8. Sample Programs that teach you machine language programming plus how to correct or "debug" any programming mistakes. 9. TV games you can play. If your TV set has no video input, an optional converter (RF Modulator), is available. Then, once you've got this "Beginners" Package under your belt, keep on expanding your ELF II with additions like the Typewriter Key Board, added RAM, Full Basic Interpreter, Electric Mouth Talking Board, Color/Music, A/D-D/A Boards for Robot Controls and much, much more. We'll take you by the hand with the New ELF II "Beginners" Package. Only \$139.95. Mail or phone in your order today and begin.

Specifications: ELF II "Beginners" Package. The computer features an RCA CMOS 1802 8 bit microprocessor, addressable to 64K bytes with DMA, interrupt, 18 Registers, ALU, 256 byte RAM expandable to 64K bytes. Professional-flex keyboard, fully decoded so there's no need to waste memory with keyboard scanning circuits, built-in power regulator, 5 slot plug-in expansion BUS (less connectors), stable crystal clock, formatting purposes and a double-sided, plated through PC Board plus RCA 1861 video IC to display any segment of memory on a video monitor or TV screen along with the logic and support circuitry you need to learn every one of the RCA 1802's capabilities. The diagnostic analyzers aid in understanding and trouble shooting your ELF II, as well as other computer and microprocessor products.

Continental U.S.A. Credit Card Buyers Outside Connecticut  
**CALL TOLL FREE 800-243-7428**  
 To Order From Connecticut or For Technical Assistance, Etc.,  
 Call (203) 354-9375

**NETRONICS R&D LTD.** Dept. CE-3  
 333 Litchfield Road, New Milford, CT 06776  
 Please send the items checked below:

- ELF II "Beginners" Kit ..... \$139.95
- RF Modulator ..... \$ 8.95

Plus \$3.00 for postage, handling and insurance  
 (\$6.00 Canada)

Connecticut Residents add sales tax

Total Enclosed \$

- Personal Check  Cashier's Check/Money Order
- Visa  Master Charge (Bank No. \_\_\_\_\_)

Acct. No. \_\_\_\_\_

Signature \_\_\_\_\_ Exp. Date \_\_\_\_\_

Print \_\_\_\_\_

Name \_\_\_\_\_

Address \_\_\_\_\_

City \_\_\_\_\_

State \_\_\_\_\_ Zip \_\_\_\_\_

# QUALITY parts at DISCOUNT PRICES



## 2-WAY CAR STEREO SPEAKER SYSTEM

THESE SPEAKERS COME IN HEAT RESISTANT ABS CABINETS...EACH CONTAIN A 4" 10 OZ WOOFER AND 2" TWEETER, 15 WATT NOM., 45 WATT MAX. POWER RATING. COMPARE TO \$80.00 VALUE... SPECIAL PRICE... \$36.00 PER PAIR.....

LIMITED NUMBER AVAILABLE.

## JOYSTICK

PRECISION DEVICE... CONTAINS 4 50K CENTER TAPPED ALPS POTS. \$4.75 ea

## VARACTOR DIODE

16 PF MV2205 3 FOR \$1.00 100 FOR \$30.00 BB-103 4 FOR \$1.00 100 FOR \$22.50

## 120V INDICATOR

NEON INDICATOR. RATED 120V 1/3W. MOUNTS IN 5/16" HOLES. RED LENS. 75¢ EACH 10 FOR \$7.00 100 FOR \$65.00

## 0-15 VDC METER

THIS 2 1/4" SQUARE METER MEASURES 0-15 VDC. \$4.50 EACH

## BLACK PLASTIC CASE

PAC-TEC SERIES C BLACK PLASTIC ENCLOSURE ADJUSTABLE HEIGHT FROM 1.63" TO 2.93"; WIDTH 6.85"; DEPTH 8". BUILT-IN STAND OFFS FOR P.C. BOARDS. FRONT AND BACK PANELS NOT INCLUDED.. \$5.25 PER CASE

## PHOTO-FLASH CAPACITORS

35 MFD 330 VOLT 1" X 5/8" DIA. 45¢ EACH.. 10 FOR \$4.00 170 MFD 330 VOLT 1 1/8" X 7/8" 2 FOR \$1.50/10 FOR \$7.00 600 MFD 360 VOLT 3 1/2" HIGH X 1" DIA. \$1.00 EA. 10 FOR \$9.00 750 MFD 330 VOLT 2" HIGH X 1 1/4" DIA. \$1.25 EACH 10 FOR \$11.00

## COMPUTER GRADE CAPACITOR

1700 mfd. 150VDC \$2.00 2 1/2" DIA X 4 3/4" HIGH 3,600 mfd. 40VDC \$1.00 1 3/8" DIA. X 3" HI 6,400 mfd. 60VDC \$2.50 1 3/8" dia X 4 1/4" 12,000 mfd. 40 VDC \$3.00 2" DIA X 4 1/4" HIGH 18,000 mfd. 75 VDC \$4.00 2 1/2" DIA X 4 1/2" HIGH 22,000 mfd. 15 VDC 2" dia X 2 1/2" HIGH \$2.00 22,000 mfd. 40VDC 2" DIA. X 6" HIGH \$3.00 24,000 mfd. 30 VDC 1 3/4" DIA X 4" HI \$3.50 31,000 mfd. 15 VDC 1 3/4" DIA X 4" HI \$2.50 72,000 mfd. 15 VDC 2" DIA. X 4" HIGH \$3.50

## COMPUTER GRADE CAPACITOR SPECIAL

180,000 mfd. at 6V 2 1/2" DIA X 4 1/2" HIGH \$1.50 CLAMPS TO FIT CAPACITORS 50¢ ea. DC WALL TRANSFORMER ALL ARE 115 VAC PLUG IN 4 VDC at 70 MA \$2.50 9 VDC at 100 MA \$2.00 9 VDC at 225 MA \$3.00 16.5 VAC 10VA \$3.50 22 VDC at 60 MA \$2.50

## TRANSFORMERS

120 volt primaries 5.6 VOLTS at 750 MA \$3.00 6 VOLTS at 150 MA \$1.25 16.5 V. at 3 AMPS \$6.50 18 VOLTS at 1 AMP \$4.50 18 V.C.T. at 2 AMP \$5.50 24 VOLTS at 250 ma \$2.50 24 VCT at 1 AMP \$4.50 42 V.C.T. at 1.2 AMP \$4.50 65 V.C.T. at 2 AMP \$5.50

## L.E.D.'s

STANDARD JUMBO DIFFUSED RED 10 FOR \$1.50 GREEN 10 FOR \$2.00 YELLOW 10 FOR \$2.00 FLASHER LED 5 VOLT OPERATION RED JUMBO SIZE \$1.00 EACH BI POLAR LED 2 FOR \$1.70 SUB MINI LED RED .079" X .098" 10 FOR 20mA at 1.75V \$1.00 200 FOR \$18.00

## LED HOLDERS

TWO PIECE HOLDER FOR JUMBO LED 10 FOR 65¢ 200 FOR \$10.00

## CRYSTALS

CASE STYLE HC33/U COLORBURST 3579, 545 KC \$3.50 EACH \$1.00 EACH

FREE! SEND FOR OUR NEW 1983 40 PAGE CATALOG FREE!

## MINIATURE 6VDC RELAY

SUPER SMALL SPDT RELAY; GOLD COBALT CONTACTS. RATED 1 AMP AT 30 VDC; HIGHLY SENSITIVE, TTL DIRECT DRIVE POSSIBLE, OPERATES FROM 4.3 TO 6 V, COIL RES. 220 OHM. 1 3/16" X 13/32" X 7/16" AROMAT X RSD-6V \$1.50 EACH 10 FOR \$13.50

## EDGE CONNECTOR

ALL ARE .156" SPACING 15 PIN GOLD SOLDER EYELET \$1.75 EACH 15/30 GOLD SOLDER EYELET \$2.00 EACH 18/36 GOLD SOLDER EYELET \$2.00 EACH 22/44 GOLD SOLDER TAIL (P.C. STYLE) \$2.50 EA 10 FOR \$22.50 22/44 GOLD SOLDER EYELET \$2.50 EACH

## BLACK LIGHT (ULTRAVIOLET)

G.E. # F6T5BL \$2.50 each

## 4PDT RELAY

14 pin style 3 amp contacts 24 volt d.c. or 120 volt a.c. coil Used but fully tested \$1.70 EACH specify coil voltage LARGE QUANTITIES AVAILABLE SOCKETS FOR RELAY 50¢ each

## 6 VDC RELAY

MINIATURE D.P.D.T. 3 AMP CONTACTS FUJITSU # FBR321D006 \$1.75 EA 10 / 16.00

## 2 CHANNEL LIGHT ORGAN

EASILY HOOKS INTO STEREO SPEAKERS AND ALLOWS 110 VAC LIGHTS TO DANCE WITH MUSIC. TWO SEPARATE 110 VAC OUTPUTS FOR HIGH AND LOW FREQUENCY AUDIO SIGNALS. USE TWO ORGANS FOR STEREO... \$6.50 PER UNIT COLOR LIGHT STRING AVAILABLE \$1.75 EA

## FOOT CONTROL WITH SIDE SWITCH

MEASURES 4 3/4" X 9 3/4" WITH 100 K LINEAR POT AND MOMENTARY S.P.D.T. SWITCH. \$6.50 EACH

## 4 WATT STEREO AMP

ASSEMBLY INCLUDES VOLUME, BALANCE AND TONE CONTROLS, CERAMIC PHONE INPUT, LINE INPUT AND 8 OHM OUTPUT FOR SPEAKER OR HEADPHONES. OPERATES ON 12 VAC @ 500MA. OUR ABOVE 12 VOLT TRANSFORMER IS IDEAL FOR THIS APPLICATION \$4.50 EACH

## 13 VDC RELAY

CONTACT: S.P.N.C. 10 AMP @ 120 VAC ENERGIZE COIL TO OPEN CONTACT... 1V COIL: 13 VDC 650 OHMS SPECIAL PRICE \$1.00 EACH

## MINI-PUSH BUTTON

S.P.S.T. MOMENTARY NORMALLY OPEN 1/4" BUSHING 35¢ EACH 10 FOR \$3.25 100 FOR \$30.00 SPECIFY COLOR: RED, BLACK, WHITE, GREEN, YELLOW.

## KEY SWITCH

S.P.S.T. 4 AMPS @ 125 VAC KEY REMOVES BOTH POSITIONS \$2.50 EA

## LIGHTED PUSH BUTTON

RED LIGHTED 120 VAC 10 AMP, S.P.S.T. "POWER" PRINTED ON FACE. MOUNTS IN 7/8" SQUARE HOLE.. \$1.50 EA 10/ \$13.50

## SLIDE POTS

500K linear taper 2 7/8" LG.. 1 3/4" TRAVEL 75¢ EACH DUAL 100 K AUDIO TAPER SLIDEPOT 3 1/2" LONG 2 1/2" TRAVEL. \$1.50 EACH

## AM/FM/MPX CHASSIS

THIS AM / FM / STEREO CHASSIS IS COMPLETE AND READY TO PLUG IN EXCEPT FOR THE SPEAKERS... HAS CONNECTIONS FOR UP TO 4 SPEAKERS, A TURNABLE, RECORDING OUTPUT AND HEADPHONES. IDEAL FOR MOUNTING INTO YOUR CUSTOM CABINET... \$12.50 EACH

## EQUIPMENT SLIDES CHASSIS-TRAK MODEL C3005

3 SECTION. LENGTH 22" CLOSED. HOLDS TO 85 LBS., EXTENDS 23" \$5.00 PER PAIR SOME HARDWARE INCLUDED

## METAL OXIDE VARISTOR

G.E. # V82Z12 50 VOLTS, NOMINAL D.C. VOLTAGE. 5/8" DIAMETER. 2 FOR \$1.50

- Quantities limited
- Min. Order \$10.00
- Add \$ 2.50 Shipping USA
- Calif. Res. Add 6 1/2%
- Prompt Shipping NO COD.

TOLL FREE ORDERS ONLY 1-800-826-5432 (ORDER ONLY) ALASKA, HAWAII, CALIF OR INFORMATION (213) 380-8000

# ALL ELECTRONICS CORP.

905 S. Vermont Ave. P.O. BOX 20406 Los Angeles, Calif. 90006

CIRCLE NO. 3 ON FREE INFORMATION CARD



Mention this magazine and get a free gift

## REGULATED TRIPLE POWER SUPPLY, LOW PRICED! DM-6

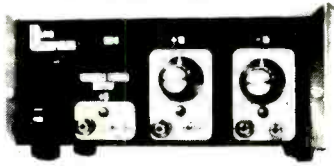

A fully assembled and tested triple benchtop power supply. Includes fixed 5V @ 1 Amp, 5V to 15V @ 0.5 Amp and -5V to -15V @ 0.5 Amp—all supplies regulated, short proof. Each supply has a power on indicator LED. Complete and ready for use in a durable (8" x 6" x 3 1/2") metal case.

**\$99<sup>95</sup>**

## LOW OHM METER MODULE, DM-10

Measure resistance from 10 milliOhms to 20 Ohms. Now you can measure resistance down to 10 milliOhms with this low cost easy to use DVM module. Check out resistance transformers, relays, chokes, printed circuit board copper finishes and ground cables. Special zero balance control nulls out input cable resistance to insure accurate readings. Your DVM has to be set to 2V range during operation.

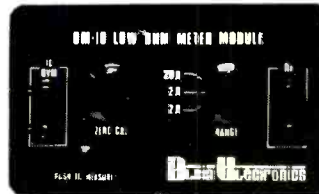

Resistance range 10 milliOhms to 20 Ohms. Zero Calibration control. Battery powered (push to read battery saver circuit). Requires 9 Volt Battery (not included). Size 6.25" x 3.75" x 2". Incl. Model 336 Test Clips.

**\$55<sup>95</sup>**

## 8 CHANNEL SCOPE MULTIPLEXER, DM-12

Convert your single channel scope into a 4 or 8 channel instrument, just connect the DM-12 8 channel scope multiplexer to your scope, clip the 8 input probes to the signals you want to view. Simple, easy, fast—can handle logic level TTL signals from DC to 3MHz. Features separate spacing and trace amplitude controls and selectable sampling rate—all to insure easy clear scope display.



COMPLETELY ASSEMBLED AND TESTED! READY TO USE!

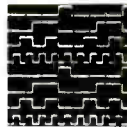

VIEW 8 CHANNELS AT ONCE!

**\$74<sup>95</sup>**

- 8 TTL compatible input channels (1 TTL load per channel) can drive 50 Ohm scope cable
- Maximum full screen amplitude 1.6 Volts adjustable
- Trace amplitude and spacing controls
- 4 or 8 channel selector switch
- 8 color coded input cable, 24" long with insulated alligator clips
- External 9 VDC power supply included (Model MMAC-2)
- Size 6.25" x 3.75" x 2"
- BNC Output Cable Accessory (Model PSA-2 add \$14.95)

## LOW COST CAPACITANCE METER MODULE, DM-8

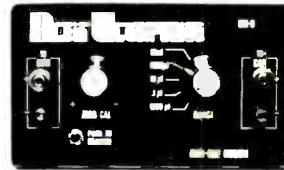

Connect this high quality low cost Capacitance Meter Module, DM-8 to your digital Volt Meter and turn it into a Digital Capacitance Meter—the Low Cost Way!

COMPLETELY ASSEMBLED AND TESTED! READY TO USE!

**\$79<sup>95</sup>**

- 2V Output
- Accuracy better than 5%
- Push to read range (button) from 1 pF to 20,000 μF
- Zero Calibration control
- In one easy to use self-contained package
- Battery powered, with "push to read" battery saver circuit (9V batteries not included)
- Size 6.25" x 3.75" x 2"
- Includes Model 336 Test Clips

## PORTABLE SELF-CONTAINED CIRCUIT DESIGNER, DM-5

Contains 8 LEDs and 8 logic switches.

- Control switches and buffered LED logic indicators
- Plug your ICs into solderless breadboards, tie in power and ground, connect your logic switches and LED indicators

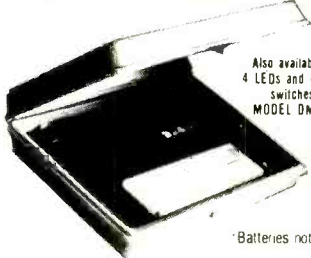

Also available in 4 LEDs and 4 logic switches MODEL DM-5A

- All interconnections between LEDs, switches and circuits via 22-26 solid wire
- Self-powered, in compact, durable carrying case
- Battery (4 1 1/2 Volt C cells) or AC powered providing economical bench use or convenient portable use. Available in two models.

**\$69<sup>95</sup>**

\*Batteries not included

## LOW COST HIGH FREQUENCY COUNTER



MODEL NO. DM-7

The Albia Model DM-7 8 Digit High Frequency Counter is easy to use, switch selectable time base input by a single BNC, nothing to build!

- 5 Hz to 550 MHz
- 8 big easy-to-read 43" high intensity LED display
- Crystal (±3 ppm @ 25 C) controlled 0.1 or 1.0 sec. gate times
- Convenient benchtop size 17" x 10" x 3" durable attractive case

COMPLETELY ASSEMBLED PRE-CALIBRATED PRE-TESTED

**\$149<sup>95</sup>**

PRICES & SPECIFICATIONS SUBJECT TO CHANGE • SPECIAL ENDS APRIL 30th



FOR FASTER SERVICE USE YOUR CREDIT CARD.

**Albia Electronics**  
44 KENDALL STREET  
NEW HAVEN, CT. 06512



MOST ORDERS SHIPPED NEXT DAY.

BACKED BY ALBIA'S FAMOUS WARRANTY.

**CALL TOLL FREE 1-800-243-6953**

9 AM  
5 PM  
EST

We accept VISA, MC, C.O.D., CHECK or M.O.

# FIRST QUALITY COMPONENTS - NOT MAIL ORDER "SECONDS"

Min. order \$10.00 - add 5% Shpg and \$1.00 Ins

## ARIES ZERO INSERTION FORCE SOCKETS



cam actuated, true zero insertion - tin plated solder fair pins - capable of being plugged into dip sockets, including wire wrap

Stock No.	No. Pins	1-9	10-49	50
11055	24	4.98	\$4.35	\$3.90
11056	28	5.15	4.50	4.05
11057	40	6.81	5.95	5.35
11058	64	12.02	10.50	9.45

## RESISTOR ASSORTMENT

82508 - 700 pcs (1 each below assort'd) **\$22.50**  
 Stock No. 82501 10 ea. of 10-12-15-18-22-27-33-39-47-56 OHM  
 Stock No. 83502 10 ea. of 68-82-100-120-150-180-220-270-330-390 OHM  
 Stock No. 82503 10 ea. of 470-560-680-820-1K-1.2K-1.5K-1.8K-2.2K-2.7 OHM  
 Stock No. 82504 10 ea. of 3.3K-3.9K-4.7K-5.6K-6.8K-8.2K-10K-12K-15K-18K OHM  
 Stock No. 82505 10 ea. of 22K-27K-33K-39K-47K-56K-68K-82K-100K-120K OHM  
 Stock No. 82506 10 ea. of 150K-180K-220K-270K-330K-390K-470K-560K-680K-820K OHM  
 Stock No. 82507 10 ea. of 1M-1.2M-1.5M-1.8M-2.2M-2.7M-3.3M-3.9M-4.7M-5.6M-OHM

## TI WIRE WRAP SOCKETS



Tin plated phosphor bronze contact - 3 wrap

Stock No.	No. Pins	1-24	25-100
11301	8	\$ 4.53	4.08
11302	14	6.68	5.94
11303	16	7.24	6.58
11304	18	8.22	7.38
11305	20	1.11	99
11306	22	1.26	1.12
11307	24	1.41	1.25
11308	28	1.71	1.52
11309	40	2.31	2.05

## TI LOW PROFILE SOCKETS



Tin plated phosphor bronze con. 1cl pins with gas tight seal.

Stock No.	No. Pins	1-24	25-100
11201	8	\$1.15	\$1.13
11202	14	.18	.15
11203	16	.21	.18
11204	18	.24	.21
11205	20	.27	.24
11206	22	.30	.28
11207	24	.33	.30
11208	28	.38	.34
11209	40	.53	.45

## WILD ROVER

Touch switch Capsule. Operating motion is .005" without the use of a levered arm. Extremely fast on and off with low noise. Normally operated 115 VAC, 1.5 amp-30 millihm resistance - 615 radius by .180 thick.



Stock No.	1-9	10-25
12098	\$ 1.28	\$ 1.12
12099	\$ 1.12	\$ .95

## 60/40 ROSIN CORE SOLDER

Stock No.	Dia. (feet)	Length (feet)	Price
50075	.062	9	1.5
50076	.062	25	4
50077	.062	50	8
50078	.032	33	1.5
50079	.032	88.5	4
50080	.032	175	8

## ELPAC POWER SUPPLIES - DC/DC CONVERTERS

SINTEC Stock No.	ELPAC No.	Input Voltage (VDC)	Output Voltage (VDC)	Output Current (mA)	Dimensions (HxWxD) in inches	Price
13823	CB3801	3.0-7.0	12.0	0.25	48x51x3.05	7.95
13828	CB3811	3.0-7.0	12.0	0.25	48x51x3.05	7.95
13827	CB3802	3.0-7.0	15.0	0.20	48x51x3.05	7.95
13828	CB3812	3.0-7.0	15.0	0.20	48x51x3.05	7.95
13829	CB3804	3.0-7.0	28.0	0.10	48x51x3.05	7.95
13830	CB3814	3.0-7.0	28.0	0.10	48x51x3.05	7.95
13831	CL3801	4.0-7.0	12.0	0.6	85x11.2x1.77	\$24.95
13832	CL3811	4.0-7.0	12.0	0.6	85x11.2x1.77	24.95
13833	CL3802	4.0-7.0	15.0	0.7	85x11.2x1.77	24.95
13834	CL3812	4.0-7.0	15.0	0.7	85x11.2x1.77	24.95
13835	CL3804	4.0-7.0	28.0	0.10	85x11.2x1.77	24.95
13836	CL3814	4.0-7.0	28.0	0.10	85x11.2x1.77	24.95

## ELPAC POWER SUPPLIES - SOLV SERIES FULLY REGULATED

SINTEC Stock No.	ELPAC Part No.	Output Voltage	Output Current Rating	Dimensions (HxWxD) in inches	OVP	Price
13802	SOLV1-5	5	3.0A	4.71/6x4.2	Fixed included	\$39.95
13803	SOLV1-12	12	1.5A	4.71/6x4.2	Fixed included	39.95
13804	SOLV1-15	15	1.2A	4.71/6x4.2	Fixed included	39.95
13805	SOLV1-24	24	0.75A	4.71/6x4.2	Fixed included	39.95
13806	SOLV3-5	5	6.0A	5.5/8x4.7/8x3.3/16	OVP-4	59.95
13809	SOLV3-12	12	3.0A	5.5/8x4.7/8x3.3/16	OVP-4	59.95
13810	SOLV3-15	15	3.3A	5.5/8x4.7/8x3.3/16	OVP-4	59.95
13812	SOLV3-24	24	2.0A	5.5/8x4.7/8x3.3/16	OVP-4	59.95

## OK MACHINE AND TOOL

### IC INSERTION/EXTRACTION KIT

Includes DIP IC extractors and inserters to accommodate all ICs from 14 to 40 pins. Tools that engage conductive surfaces are CMOS safe and include ground and logic. Stock No. 13309 **\$37.74**

### SOCKET WRAP ID

DIP socket-sized plastic panels with numbered holes in pin locations. Slip on socket before wire wrapping to identify pins. Also write on them for location, IC part number, function, etc. Simplifies initial wire wrapping, troubleshooting and repair. **\$.82 per pack**

## Special of the Month!

### DIGITAL MULTIMETER

Single rotary switch operation. Large, easy to read 5 1/2 digit display. 800 hours operating life with single 9v battery. Seven functions - (DC Volts, DC Amps, Ohms, AC Volts, AC Amps, Diode and Resistor Junction, Audible Continuity Check). Stock No. 82503 **\$75.00** Full 1 year warranty. Stock No. Carrying case with belt loop 82504 **\$7.50**

## MODUTEC

### Miniclamp AC Volt-Ammeter

allows singling one conductor out of many without disarrangement. Stock No. AC Amperes Price  
 13730 0-25A \$39.50  
 13731 0-50A 39.50  
 13732 0-100A 39.50

### ACCESSORY LINE SPLITTER

allows fast readings of AC power consumption of plug in equipment without separation of leads. Stock No. 13727 **\$9.95**

### POCKET SIZED BATTERY TESTER

for all types of small batteries from 1.35v to 4.5v. Stock No. 13733 **\$13.95**

### VOLT-ICATOR

automotive diagnostic meter plugs into lighter socket and indicates battery condition and charging rates. Stock No. 13736 **\$15.95**

### AC VOLTAGE TESTER

plugs into any 110v service receptacle to check time voltage over 50-150 VAC. Stock No. 13735 **\$14.95**

### VOM-MULTITESTER

versatile Volt-Ohm-Milliammeter in small package. Stock No. 13729 **\$13.95**

# SINTEC CO.



Drawer Q Milford NJ 08848-9990  
**TOLL 800-526-5960**  
**FREE in NJ (201) 996-4093**

Send for Free Catalog - over 1100 parts

CIRCLE NO. 36 ON FREE INFORMATION CARD

## YOUR OWN Personal Switcher

# POWER SUPPLY

### For Lab or Original Equipment

**save 20%**

**FEATURES:** Efficient 30kHz switching frequency • Four Models satisfy most applications • Years of trouble-free service • Each side AC line fuse protected • Tele-Tale LED "Pwr-On" Panel Indicator • Three separate voltage outputs • Metal enclosure provides physical and EMI protection • For experimental use or permanent power source • Soft start feature protects critical circuits • Parallel operation acceptable for higher current needs • Push-in terminals, accept wire or test lead • Light-weight, easy to use • AC line cord permanently attached • Most reliable power source for a variety of uses and applications • 48 hour burn-in assures MTBF of 3 1/2 years, reasonably priced at \$1.90/watt • Full one year guarantee • 2-tone audiozied case • Custom volt/current outputs on special order • Input surge protection • Automatic short circuit protection • restoration • UL recognized components • Handy Service Aid

**SPECIFICATIONS:** Input: 90-132VAC, 47-440Hz • Dual AC Input Fuses • Line Regulation: ±0.1% Max. for 10% input change • Load Regulation: ±0.2% Max. on #1 Output • Ripple Noise: Typ. 1% PP Max. • Over Voltage Protection • Reverse Polarity Protection • Compact, only 7 1/2" x 4" x 2 1/4" • Fast load transient response • 5 volt adj. ±10% • DC Output: 42 Watts continuous • 70% Efficiency • New Push-On type terminations.

SCHOOLS - LABS: QUANTITY PRICING ON REQUEST

**Com inc** 1545 Osgood St. Unit 11Y, No. Andover, MA 01845

Name (Please Print) \_\_\_\_\_  
 Address \_\_\_\_\_  
 City \_\_\_\_\_ State \_\_\_\_\_ Zip \_\_\_\_\_

**ORDER INFORMATION**  
 Order First Unit - \$99.50  
 Second or More - \$79.00  
 OFFER EXPIRES April 30, 1983

Qty.	Model	Output #1	Output #2	Output #3	Total
	PS-1	5V-6A	+12V-0.5A	-12V-0.5A	
	PS-2	5V-6A	+15V-0.4A	-15V-0.4A	
	PS-3	5V-6A	+12V-0.5A	-5V-1A	
	PS-4	5V-3A	+24V-0.6A	-24V-0.6A	

Information on other switcher models: NC

Charge No:  MasterCard  Visa  American Express  Check/Money Order  
 Card # \_\_\_\_\_ Exp. Date \_\_\_\_\_  
 Signature \_\_\_\_\_

Call Toll Free - 1-800-373-1455; Within Massachusetts - 617/682-6936.

CIRCLE NO. 57 ON FREE INFORMATION CARD

## NEW - THE BEST OF SYNC

Here's an all-new collection of articles and programs that appeared in the first six issues (now out of print) of Sync magazine. Chapters include: Games, Math and Math Graphics, Software Programming Techniques, Translation, Graphics, Machine Language, Hardware, Resources, Reviews, Glossary - and more!

In *The Best of Sync, Volume One*, you'll find games like "Forest Treasure"...plans for a "Key Click Generator"...techniques for "Handling Character Strings in the ZX80" and "Converting from other BASICs" - and many other hard-to-find programs, reviews and procedures.

If you own a Sinclair ZX80, ZX81 or Timex Sinclair 1000, this is one book you can't afford to miss. Order your copy now!

8 1/2" x 11", softcover. **ONLY \$9.95!**

For faster service,  
**PHONE TOLL FREE: 800-631-8112**  
 (in NJ only: 201-540-0445)

Also available at your local bookstore or computer store.



## CREATIVE COMPUTING PRESS

Dept. NA4Q, 39 East Hanover Avenue, Morris Plains, NJ 07950

Please send me \_\_\_\_\_ *The Best of Sync, Volume One*, at \$9.95\* plus \$2.00 postage and handling each. Outside USA add \$3.00 per order. #6M

PAYMENT ENCLOSED \$ \_\_\_\_\_ \*Residents of CA, NJ and NY State add applicable sales tax.

CHARGE MY:  American Express  MasterCard  Visa

Card No. \_\_\_\_\_ Exp. Date \_\_\_\_\_

Signature \_\_\_\_\_

Mr./Mrs./Ms. \_\_\_\_\_ (please print full name)

Address \_\_\_\_\_ Apt. \_\_\_\_\_

City/State/Zip \_\_\_\_\_

Send me a FREE Creative Computing Catalog.



# WHY PAY MORE? SHOP AMERICA'S PARTS PLACE™

## Low Prices! High Quality! Wide Selection! In Stock!

### Audio Compressor/ Expander

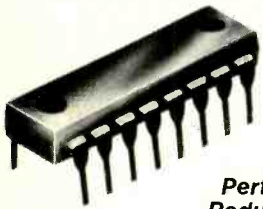

**699**

*Perfect for Noise  
Reduction Systems*

NE572. Dual channel—can be used either for dynamic range compression or expansion. Independent attack and recovery control. 6 to 22VDC single supply. 16-pin DIP with data. 276-1781 ..... 6.99

### Sound Switch Module

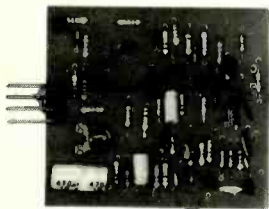

**199**

*Up to 25-Ft.  
Range*

Just whistle—once for on, again for off! Remote-control a relay, motor, radio or TV. 6-9VDC. With data. 277-1011 ..... 1.99

### 43-Range Multitester 38% Off



**2488**

Reg. 39.95

*50,000 Ohms  
Per Volt*

Measures AC and DC volts, DC milliamps, resistance and dB. Range-Doubler switch. Requires one "AA", one 9V battery. With leads. 22-204 ..... Sale 24.88

### 150 Disc Capacitors

**Cut  
31%**

Reg. 9.95

**688**

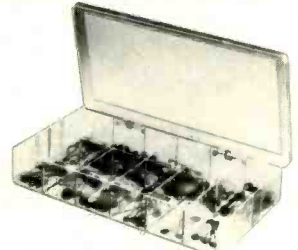

\$30.25 Individual Parts Value. 50WVDC. Contains 15 .005µF, ten each of 100, 220 and 470pF; .001, .002, .01, .02, .05, .1µF. 29 other assorted values. With chart. 272-601 ..... Sale 6.88

### Waveform Generator

**595**

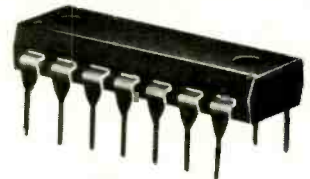

ICL8038. Produces precise sine, square, triangle, sawtooth and pulse waves with minimum external parts. Simultaneous high-level sine, square and triangle outputs. Range: .001 Hz to 300 kHz+. Single/split supply. 14-pin DIP. 276-2334 ..... 5.95

### Mini 12VDC Buzzer

**169**



Small enough to hide, loud enough to call attention. 1 1/16" mounting centers. With leads. 273-055 ..... 1.69



### Precision Panel Meters

**895** *Monitor Your  
Critical DC Circuits*

Jeweled movements. Accuracy: ± 5% full scale. 2 3/4 x 2 1/4 x 1 1/4". Require 17/8" round mounting holes.

0-50 µA DC. 270-1751 ..... 8.95

0-1 mA DC. 270-1752 ..... 8.95

0-15VDC. 270-1754 ..... 8.95

### Submini Toggle Switches

**Low  
As 199**



- 10 Amps at 125VAC
- 1/4" Mounting Holes

### CdS Photocell

**129**



3 megohms in darkness to 100 ohms in bright light. 200 mW at 170V, max. 276-116 ..... 1.29

### Books to Program Your TRS-80®



**54%  
Off**

**Both For  
Only**

**588**



**Save \$702**

**A** Programming Techniques for Level II BASIC. Reg. \$4.95. A "cookbook" of program applications for the TRS-80 line. Describes Level II commands, data search, string manipulation, high-speed graphics and much more. Everything you need to write BASIC computer programs. 224 pages. Softbound. 62-2062

**B** TRS-80 Graphics. Reg. \$7.95. Explores the computer's aptitude for graphic displays, particularly line printer, character and pixel graphics. With sample programs and suggested problems and solutions. 132 pages. Softbound. 62-2073

Description	Cat. No.	Each
SPST	275-324	1.99
SPDT	275-326	2.19
SPDT Center Off	275-325	2.39
DPDT	275-1546	2.69
DPDT Center Off	275-1545	2.89

### SPST Toggle

Red LED lights when "on". 5A. For 12VDC use only. 7/16" mounting hole. 275-680 ..... 2.99



### Electret Mike Element

**119**



Omnidirectional. PC board mounting. 2 to 10VDC, 1 mA max. 20 to 15,000 kHz. 270-090 ..... 1.19

### 12V Snap-In Lamps

**189**

*Panel Mounting*



Assemblies have one amber, one blue lens. Mounting tabs for 1/2" dia. hole. 4" leads. With bulbs. 272-335 ..... Pkg. of 2/1.89

### Metal Project Enclosure

**28%  
Off**

Reg. 10.95

**788**



Heavy-duty. Vented steel top, aluminum front/bottom. Handles. 5 1/4 x 9 1/2 x 6 3/4". 270-270 ..... Sale 7.88

# Radio Shack®

A DIVISION OF TANDY CORPORATION • OVER 8500 LOCATIONS WORLDWIDE

Retail prices may vary at individual stores and dealers



# Computer Mart

RATE: Ads are 2" by 3". 1 insertion: \$625.00. 6 insertions: \$600.00 ea. 12 insertions, \$575.00 ea. Closing date: 1st of the 2nd mo. preceding cover date. Send order and remittance to Computer Mart, Computers & Electronics, 1 Park Ave., N.Y., N.Y. 10016. Direct inquiries to (212) 725-4216.



**NEW! PLUG-IN MEMORY-X-TENDER**

Expand your HP-41C/CV to 10.6k (1600 registers) with the AME DESIGN Memory-X-Tender. Requires no modification to the calculator. Card Reader remains in place. One switch selects Bank A or B. Each bank can hold one X-FUNCTION and two X-MEMORY Modules. Additional slot for HP-IL Module. Built-in Lithium battery to maintain memory.

**SPECIAL INTRODUCTORY PRICE!!**  
\$99.00

**AME DESIGN**  
Box 373  
13450 Maxella, G185  
Marina del Rey, CA 90291  
(213) 306-1249

Please add \$2.00 for shipping, include 6% sales tax in California.  
© 1982 AME DESIGN

CIRCLE NO. 100 ON FREE INFORMATION CARD

**SECRETS of SATELLITE TV**  
How to install your own Satellite TV System. Written from "The Trenches". Avoid costly mistakes! . . . . .  
**\$19.95 TELEVISION SIGNAL PROCESSING MANUAL** explores standard and nonstandard television. Includes theory and circuits . . . . .  
. . . . . **\$15.95 Both Above Manuals**  
. . . only **\$29.95** Catalog features Video and Computer products and exciting **KITS: \$2.00**  
Include **5% shipping**. Calif. residents add Tax, Order by Phone or Mail.  
**VISA or MasterCard** (include number and exp. date), Check or Money Order.

**ABEX** (415) 439-7470  
**P.O. Box 26601-CT**  
**San Francisco, CA 94126**

CIRCLE NO. 101 ON FREE INFORMATION CARD

**Parallel, TTL Input I/O TYPEWRITER/PRINTER**



\*Excellent for Word Processing  
\*Use as a Computer Printer  
\*Use as a Typewriter  
\*Takes Std. "Golf Ball" Element

**399.00**

**"SELECTRIC"®**

**Flash Unit Assembly**

Same Flash Unit as Described By Forrest Mims of this Mag., Nov, Dec, Jan, '82-'83 Issues.  
Can be Flashed Every 1-1/3 sec.

Use Order No. D2DS0502 ONLY **6.99**

Call or Write for **Free!**  
40 Page Catalog of Illustrated Electronic & Computer Equipment!

**BNF Enterprises**  
119r FOSTER St.  
Peabody MA 01960  
(617) 531-5774

Accepted

**Customer Pays All Shipping Charges.**

CIRCLE NO. 102 ON FREE INFORMATION CARD

**\$450<sup>00</sup> WEEKLY**  
working one or two hours a day with your personal computer. **GUARANTEED.** Simple program process. No special skills or experience. **Free details/application.**

**BOND INDUSTRIES**  
7115 Blanco Road  
Dept. 114-178  
San Antonio, TX 78216

CIRCLE NO. 103 ON FREE INFORMATION CARD

**TIMEX**  
**TS 1000 Computer**

**\$87.50**

**CONDITIONAL SALE**

We must receive at least 100 orders to qualify for a special purchase price. If less than 100 orders are received, all payments will be returned within 30 days.

**How To Order:** Make checks and money orders in the amount of \$87.50 payable to E. Arthur Brown Co. MN residents add \$4.38 for sales tax. VISA & Mastercard: Give card name, number, expiration date, and sign your order. Finally, print or type your name, address, and zip code on a blank sheet of paper and mail it along with your method of payment to the address below.

**E. Arthur Brown Company**  
Dept TC-3  
1702 Oak Knoll Drive  
Alexandria, MN 56308

CIRCLE NO. 104 ON FREE INFORMATION CARD

**TIMEX-SINCLAIR**  
ZX81 1000



**1983 Directory**

- Where to find: Disk Drives, RAM Extensions, Printers, Modems, Key Boards, Game and Serious Software, Books, Programming Aids, and Other Exciting Accessories!
- Articles on: Timex Sinclair 1000, History & Development, New Accessories, How-To-Projects.
- Reviews of: Books & Monthly Publications

No ZX81 or Timex 1000 owner should be without this valuable resource book!

**Only \$5.00 ... postpaid**

How to order: Make checks and money orders in the amount of \$5.00 payable to E. Arthur Brown Company. MN residents add 5% sales tax. VISA & Mastercard: Give card name, number, expiration date, and sign your order. Finally, print or type your name, address, and zip code on a blank sheet of paper and send it, along with your method of payment, to the address below.

**E. Arthur Brown Company**  
Department ZC-3  
1702 Oak Knoll Drive  
Alexandria, MN 56308

CIRCLE NO. 105 ON FREE INFORMATION CARD

MODULES FOR:

**TIMEX-Sinclair**

**64K MEMORY \$119.95 KIT**  
\$129.95 W&T **WHY PAY MORE?**

**MODEM \$119.95 KIT \$149.95 W&T**  
(RS-232 Port & Software Included)

**RS-232 PRINTER INTERFACE**  
Only **\$59.95 KIT \$69.95 W&T**

**CONTROL MODULE \$59.95 KIT**  
8 Relays, 8 Inputs, 8 LED's **\$69.95 W&T**

Expand your 16K to 32K with our M-16  
**\$59.95 KIT \$69.95 W&T**

90-Day Warranty On All Modules.  
10-Day Return Privilege

**ORDER PHONE 803-532-5812**  
Add \$4.95 shipping & handling to all orders.

BYTE-BACK CO.  
Rt. 3 Box 147 Brodie Rd.  
Leesville, S.C. 29070

CHECKS  
VISA

THOUSANDS IN USE WITH PROVEN RELIABILITY.  
ALL MODULES IN STOCK.

CIRCLE NO. 104 ON FREE INFORMATION CARD

**A ZX-81 breakthrough!**



**The CAI/ESF mass storage device**

- Load or store 27K bytes in less than 30 seconds.
- Your existing cassette-stored programs transfer easily.
- Menu-driven, access by keyboard command.
- Second drive easily added for greater flexibility.
- For T/S 1000, ZX-81 and ZX-80.

**\$119.95\***

\*Requires CAI/O Board for interface **\$69.95**

Order by phone or mail. Check, money order, VISA or MasterCard (include number and exp. date). Post. in U.S. \$5

**CAI Instruments**  
PO Box 2032, Midland, MI 48640  
© Copyright 1982 CAI Instruments, Inc.

**517-687-7343**

CIRCLE NO. 105 ON FREE INFORMATION CARD

**CAROLINA MICRO**

It's not a bargain if it doesn't work!  
We support and service what we sell!

Free 18 month extended warranty by cm on orders placed in February and March for:

**FRANKLIN ACE 1000**  
**RANA ELITE DRIVES and CONTROLLERS**  
**EPSON PRINTERS**  
**OKIDATA PRINTERS**

For pricing, information, and credit card orders on these and other fine products,  
Call

**1-803-781-8081**  
**1-803-781-8082**

CIRCLE NO. 106 ON FREE INFORMATION CARD



**SINGLE BOARD CONTROL COMPUTERS**

BOTH FEATURING  
8085 CPU  
CRYSTAL TIME BASE  
ON-BOARD REGULATOR

TIMER COUNTER  
256 BYTES OF RAM

SB-85-1  
★ Has 2K/4K ROM/EPROM (ROM's are not supplied),  
★ 16 I/O Lines (Parallel/Serial/Handshake) and  
★ 5 levels of interrupt Price: \$129 (A&T)

SB-85-2  
★ Has 2 K ROM/EPROM (ROM's are not supplied)  
★ 22 I/O Lines- Parallel/Serial/Handshake) and  
★ 2 levels of interrupt Price: \$99

**CER-TEK**  
ELECTRONICS  
6020 Doniphan 3B El Paso, Tx 79932 (915) 581-6697  
ELECTRONICS MANUFACTURING SINCE 1975

CIRCLE NO. 107 ON FREE INFORMATION CARD

A/D 8 channels + D/A 8 channels

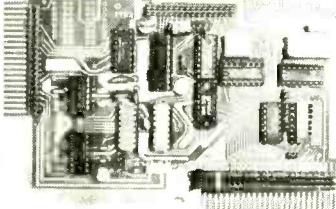

**Fast 1.6µs A/D CONVERSION TIME.**  
100 NS ACQUISITION WINDOW. 1 µs D/A  
SETTLING TIME. 8 BITS OF RESOLUTION.  
0V-5V OR 0V-2.5V FULL SCALE OPTIONS.  
PIN RE-ARRANGEMENT FEATURE AND OTHERS  
ALLOW EASY INTERFACING TO Z80 &  
OTHER FAMILIES. FITS ON SINCLEAR ZX81.  
SWITCHES CHOOSE PORT-OR-MEMORY-MAPPED  
AND ADDRESS-BLOCK. ADDRESS PICKS  
CHANNEL. ASSEMBLED AND TESTED \$230.  
INQUIRE ABOUT KITS AND SOFTWARE.

**Computer Continuum**  
301-16th Ave  
San Francisco, CA. 94118 (415) 752-6294

CIRCLE NO. 108 ON FREE INFORMATION CARD

Why pay more for  
**TRS-80** ATARI  
FRANKLIN  
APPLE  
EPSON  
OKIDATA  
C. ITOH

Color Computer  
Model II  
Model III  
Model 16  
Printers

Our prices  
are so low we  
aren't allowed  
to print  
them!

We have cables to  
interface our printers  
with Commodore,  
IBM, and  
Osborne  
computers.

Most items in stock for immediate shipment.  
Call or write for Free 40 page catalog.

**Computer Discount of America**  
15 Marshall Hill Road  
West Milford Mall  
West Milford, NJ  
07480-2198  
In New Jersey call  
201-728-8080  
**CALL TOLL FREE: 800-526-5313**

CIRCLE NO. 109 ON FREE INFORMATION CARD

**5 Meg Hard Disk \$600.00**

High reliability Shugart 8" SA1002 hard disk drives.  
\$400 each. Quantity 10

**Computer DYNAMICS**  
(803) 877-7471  
105 S. Main St. Greer, S.C. 29651

We have interface kits for IBM PC, Heath 89/90/Z100, S-100, STD BUS, Apple II, 6809 Systems, w/Flex and others. Kits start at \$350. Computer Subsystems from \$1500.

CIRCLE NO. 110 ON FREE INFORMATION CARD

**YOU CAN PAY MORE BUT YOU CAN'T GET MORE!**



Color Computer 16K  
**\$235**  
w/16K Ext. Basic  
**\$305**  
w/32K Ext. Basic  
**\$420**

Model III 16K  
**\$799**  
Model III 48K  
2 disk & RS232 c  
**\$1899**

**BUY DIRECT.** These are just a few of our great offers which include Printers, Modems, Computers, Peripherals, Disc Drives. Software and more. call TOLL FREE 1-800-343-8124

We have the lowest possible fully warranted prices and a full complement of Radio Shack Software.

**computer plus**  
Write for your free catalog  
480 King Street  
Littleton, MA 01460  
617-486-3193

CIRCLE NO. 111 ON FREE INFORMATION CARD

SINCLAIR ZX81

**FORM FITTING DUST COVER ONLY \$11.95\***



Protect your ZX81 from dust, grime and spills with a quality dust cover from The Computer Trader. The form fitted cover provides protection during storage or transport. Available colors: black, tan, royal blue, brown, navy blue and burgundy.  
DEALER & DISTRIBUTOR INQUIRIES WELCOME  
\*California residents add 6% sales tax. Please include \$1 postage and handling. Allow 1-3 weeks for delivery. Specify color and amount.

The Computer Trader  
P.O. Box 20976  
San Diego, CA 92120 (619) 283-9273

CIRCLE NO. 112 ON FREE INFORMATION CARD

Radio Shack and TDP-100

**COLOR COMPUTER**  
★ GAMES ★  
★ HOME & WORK ★  
★ PROGRAMMER AIDS ★  
Dealer Inquiries Invited



**COMPUTERWARE®**  
Box 668  
6809 Specialists Encinitas, CA 92024  
(714) 436-3512  
Computerware is a trademark of Computerware

March 1983

**SAVE 90%**

YES you can save up to 90% on a computer system for home or office.

68000 microsystem (8MHz) with 128KB & three RS-232C ports, \$252.00

8086 microcomputer with 128KB & three RS-232C ports, \$204.00

Z80A 4MHz micro with 64KB & two RS-232C ports, \$110.00

Floppy Interface as little as \$60.00

**FREE BROCHURE TODAY**

**DIGATEK CORPORATION**  
Suite 7  
2723 West Butler Drive  
Phoenix, Az. 85021

**ROLL-YOUR-OWN TECHNOLOGY AND SAVE A BUNDLE**

CIRCLE NO. 113 ON FREE INFORMATION CARD

**NEW! M-68000 SINGLE BOARD COMPUTER**



**FEATURES:**  
16-bit Motorola 68000 CPU operating at 10MHz. 28K bytes of on-board fast static RAM. 16K bytes of on-board EPROM space. 7 levels of prioritized auto-vector interrupts. 2 memory expansion buses (up to 256K). 2 serial communication ports (RS-232C). 16-bit bidirectional parallel port. 6800 peripheral accommodation bus. 5x 16-bit counter/timers with vectored interrupts. on-board real time clock. software compatible with Motorola M68KRD board.

**PRICE:**  
Bare board with documentation \$99.95  
M68KRD compatible monitor in 2744 EPROM \$128.00  
M68000 CPU & memory map PROM \$115.00  
Shipping and handling (Domestic) \$3.00  
(Foreign) \$15.99  
CALIFORNIA RESIDENTS ADD SALES TAX

**EMS** Electronic Mail Service  
P.O. BOX 1815 IRVINE CA 92713  
(714) 553-0133

CIRCLE NO. 114 ON FREE INFORMATION CARD

**NEW! S-100 BUS COMPATIBLE**  
SINGLE BOARD COMPUTER WITH VIDEO OUTPUT

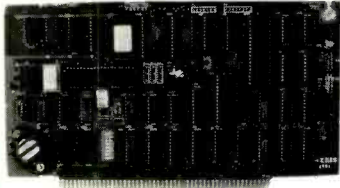

**USES:**  
This card can function as a stand alone single board computer or a S-100 intelligent video interface card

**FEATURES:**  
4 MHz 7.80A\*, up to 8K of EPROM, up to 4K Static RAM, two 8 BIT input ports, one 8 BIT output port, one 8 BIT sense input port with interrupt, composite video output (80x24), video attributes (reverse video, underline, blinking), graphic capabilities using SML CRT 507 and CRT 8002

**PRICE:**  
Bare board with documentation ..... \$49.95  
Monitor and video terminal software (in EPROM) ..... \$45.00  
Source listing (with Monitor purchase) ..... \$15.00  
Hard to find Parts Kit (crystal and fuse link PROMs) ..... \$15.00

**EMS Educational Microcomputer Systems**  
P.O. BOX 16119 IRVINE, CA 92713-1119 (714) 553-0133  
CALIFORNIA RESIDENTS ADD 6% TAX  
\*Registered trademark of Intel, Inc.

CIRCLE NO. 115 ON FREE INFORMATION CARD

TRS-80

**COLOR COMPUTER**

Quality Software on:

- DISK
- CARTRIDGE
- CASSETTE

Send for our free catalog

----- clip and mail -----

**Eigen Systems** Box 10234  
Austin, TX 78766  
(512) 837-4665

Name \_\_\_\_\_

Address \_\_\_\_\_

Zip \_\_\_\_\_

CIRCLE NO. 116 ON FREE INFORMATION CARD

**SCOTCH® QUALITY PLUS A FREE LIBRARY CASE AT A BUDGET PRICE!**

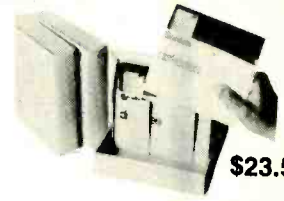

\$23.50

Double density, single sided, soft sectored diskettes with reinforced holes in a protective storage case for easy filing.

10 SCOTCH® Diskettes w/ protective case \$23.50

Protective Storage case only \$2.00  
Send your order to: **FUTRA COMPANY, P.O. Box 4380, Dept. PE, Torrance, CA 90510**

For Mastercard and Visa orders call 1-800-421-5006 or 213-328-8951. Add \$1.50 handling per every 3 cases (or boxes of disks). Calif. residents add 6% (LA county 6.5%) sales tax. Continental USA orders only please.

CIRCLE NO. 117 ON FREE INFORMATION CARD

**DISC DRIVE HEAD CLEANER DISCS**  
MAIN FEATURES:

- \*Non-abrasive *dry* cleaner; no liquid, no mess.
- \*Easy to use . . . insert as a regular disc.
- \*Cleans automatically without chemicals.
- \*Protective plastic folder—prevents contamination of cleaner.
- \*For use with single or double sided drives.
- \*Available for 5¼" and 8" flexible disc drives.
- \*Two discs per box;
  - \*\*Thirty cleanings for sided drives
  - \*\*Fifteen cleanings for double sided drives

**RETAIL PRICE**  
\$24.95

**ZOLMAN INTERNATIONAL, INC.**  
600 Montgomery St. 45th Fl.  
San Francisco, CA. 94111  
Dept. E

or Call (415) 421-5340

CIRCLE NO. 118 ON FREE INFORMATION CARD

**STOP**

Wasting Money! We Have the World's Most Cost Effective Development System.



Send for Free Brochure

- Includes Hexkit 1.0, a powerful 100% machine code editor/ debugger utility program that makes coding for 8-bit Micro a snap.
- Program from Commodore VIC-20 keyboard into built-in 4K ROM emulator
- Jumper to target ROM socket
- Test programs in circuit
- Built-in EPROM programmer and power supply
- Burns & runs EPROMs for the Commodore VIC-20, too
- Comprehensive manuals
- Fits EXPANSION PORT

**PROMQUEEN CARTRIDGE ONLY \$199**



**Gloucester Computer Bus Co.**  
6 Brooks Rd.  
Gloucester, MA 01930  
617-283-7719  
VISA AND MASTERCARD ACCEPTED

CIRCLE NO. 119 ON FREE INFORMATION CARD

**RAM**

For ATARI  
**48K RAM BOARD FOR THE 400**  
with Lifetime Warranty

- Highest quality available
- Reduces power consumption
- Reduces heat

**48K Board (400) \$150**

**32K Board (400/800) \$ 90**

**16K Board (800) \$ 60**

FREE SHIPPING ANYWHERE IN U.S.A.

**INTEC PERIPHERALS CORP**

906 E. Highland Ave.  
San Bernardino, CA 92404  
(714) 881-1533



ATARI, 400, 800 are Trademarks of ATARI, Inc.

CIRCLE NO. 120 ON FREE INFORMATION CARD

**SINCLAIR ZX80/1**  
TIME X 1000

I/O Board with our Real Time Clock/Calendar

Time	Month	Date	Year	Day of wk
23:59:59	12	31	99	7

- 8 Outputs capable of driving relays
- 8 TTL Compatible inputs
- Battery back-up for clock
- All software included
- Feed through Sinclair Bus connector to allow normal expansion
- Output lines expandable through Multiplexing
- 5 volt regulator
- 90 day warranty
- Future products used with I/O board:
- Touch Tone™ encoder/decoder
- Speech and Sound synthesizer

Model	Description	price
310	I/O port with real time clock*	\$59.95
315	PC board and manual of #310	\$24.95
320	A to D and D to A converter*	\$27.95
330	PC board and manual of #320	\$19.95
330	Wireless control system (BSR™)	\$64.95
340	Solidstate 25amp sw. modules*	\$19.95
317	Clock IC and crystal (tested)	\$12.95
	Shipping and handling	\$3.95

\*Built and tested. Calif. residents add 6% tax  
Mail order, check/money orders Foreign orders in US money Visa/Mastercard

**JK AUDIO**

P O Box 3295, Escondido, CA 92025 - 0580  
Info. (619) 741-5132  
24 hour order line only **NATL 800-227-1617**  
Calif. Res 800-772-3545 Ext. 367

CIRCLE NO. 121 ON FREE INFORMATION CARD

**POWER LINE PROBLEMS?**



**SPIKE-SPIKERS™... The Solution!**

Minimize equipment damaging spikes and conducted RF noise to or from sensitive equipment. Transient surge protection plus low pass RFI hash filtering. All units 120V 15A.

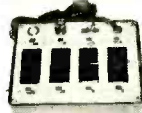

**MINI II \$44.95**  
Wall Mount  
3-stage filter  
2 sockets

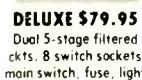

**QUAD II \$59.95**  
Wall mount. Dual 3-stage filter  
4 sockets & light

**DELUXE \$79.95**  
Dual 5-stage filtered ckt. 8 switch sockets main switch, fuse, light

**Kalglo Electronics Co., Inc.** Order Factory Direct  
65 84 Ruch Rd., Dept. C E **215-865-0006**  
Bethlehem, PA 18017

Out of State **800-523-9685**  
DEALERS INVITED  
PA Res. Add 6% • COD add \$3.00 + Shipping

CIRCLE NO. 122 ON FREE INFORMATION CARD

**SINCLAIR/TIMEX ZX81/TIMEX 1000**

**TouchaMatic™ Overlay**

\$9.95 plus \$1.50

Postage/Handling

Call or send for FREE Catalog.

**SIGNALMAN MODEM**

- Direct Connect
- 300 Baud
- Easy to use
- Accurate

\$89.95 Plus \$3.00 Postage/Handling.

**KOPAK Creations, Inc.**

Dept. CE1

448 W. 55th St.

New York, N.Y. 10019

(212) 757-8698

24 Hours MasterCard/Visa

CIRCLE NO. 123 ON FREE INFORMATION CARD





**LEO ELECTRONICS, INC.**  
8921 S. Sepulveda #208  
Los Angeles, CA 90045  
(213) 641-3101 (800) 421-2418

**WHY PAY MORE? SAVE MONEY!**  
**LOWEST PRICES ON PARTS!**

EPROMS		REGULATORS	
2708	3.00	7805	.75
2716	3.75	7812	.75
2716	6.00	7815	.75
TMS 2716	6.00	7905	.85
2732	7.00	7912	.85
2532	7.00	7915	.85
2764	9.00		

RAMS		MICROPROCESSORS	
4116(200ns)	8/12.00	Z-80A-CPU	5.00
4116(150ns)	8/16.00	8080A	3.00
4164(200ns)	8/52.00	8085A	7.00
4164(150ns)	8/54.00		
6116P-3	6.00		

**TERMS:** Check, Visa, Mastercard. Call for C.O.D.  
U.S. Funds only. California Residents add 6.5% Tax.  
**SHIPPING:** Add \$2.00 for Ground \$5.00 for Air.  
**ALL MAJOR MANUFACTURERS**  
**ALL PARTS 100% GUARANTEED**

CIRCLE NO. 124 ON FREE INFORMATION CARD

## UV EPROM ERASER



PROGRAMS: 2508, 2516, 2532, 2716, 27C16, 27C32, 2732A, 2758, 8748, 8749H, 8748H  
OPTIONAL MODULES: 7564, 2754, 8755A, 8741

\* STAND ALONE CRT. OR COMPUTER CONTROL  
\* UPLOAD/DOWNLOAD BY ANTENNA OR INTELEX FORMER  
\* MICROPROCESSOR BASED w/ 8 INTERNAL RAM  
\* 90 DAY PRICE & LABOR WARRANTY ON ALL PRODUCTS

SOON TO BE RELEASED:  
**PROMPRO-8 128K Version \$689.**

**LOGICAL DEVICES INC.**  
781 N. OAKLAND PARK BLVD. • FT. LAUDERDALE, FL 33311  
Phone Orders (305) 776-5870 • Tel. # as of 1/11/1983 (305) 974-0967  
TWX: 510-955-9496

**\$49.95\***

\*HOBBY MODEL  
**INDUSTRIAL MODEL**  
QUV-18 / 2N  
\$68.95  
WITH TIMER AND SAFETY SWITCH  
QUV-18 / 2T  
\$97.50

**INTELLIGENT PROGRAMMER STAND ALONE RS-232**

\* RELIABLE  
\* EASY COPY (no external equipment needed)  
\* COMPATIBLE: IBM PC, TRS-80, APPLE, CP/M, FLEX, TEXTRONICS, MDS

**(MCS-48) PROGRAMMING PRICE INCLUDES PERSONALITY MODULE**

CIRCLE NO. 125 ON FREE INFORMATION CARD

## PUT YOUR TIMEX/SINCLAIR COMPUTER TO WORK!

**TIMEX/SINCLAIR SOURCEBOOK™**

- SOFTWARE
- HARDWARE ADD-ONS
- BOOKS/CATALOGS

Maximize your ZX80, ZX81 or TS1000 computer investment with the TIMEX/SINCLAIR SOURCEBOOK which lists programs, hardware accessories and reference books.

The SOURCEBOOK allows you to quickly identify the ZX computer products you need from a wide variety of sources to put your computer to work. Order your copy today — over 600 listings — only \$6.95 plus \$1.25 P&H (\$2.50 outside the U.S.)

**TIMEX/SINCLAIR SOURCEBOOK™**

Micro Design Concepts  
Dept. CE-1  
P.O. Box 280  
Carrollton, TX 75006

CIRCLE NO. 126 ON FREE INFORMATION CARD

## COMPUTERS Buy By Direct Mail

**1-800-841-0860**

**Call For Your Discount Prices**

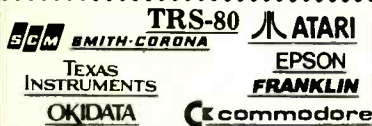

## MICRO MANAGEMENT SYSTEMS, INC.

PARCEL DIVISION DEPT. NO. 12  
2803 Thomasville Rd. East  
Cairo, Georgia 31728  
**912-377-7120**

CIRCLE NO. 127 ON FREE INFORMATION CARD

## Votrax SC-01A SPEECH SYNTHESIZER



\$50. Each  
40 in 100's

**Order in Ones or Thousands**

The SC-01A Speech Synthesizer is a completely self-contained solid state device. This single chip phonetically synthesizes continuous speech of unlimited vocabulary.

The SC-01A contains 64 different phonemes which are accessed by a 6-bit code. Computer interfaces and text-to-speech algorithms also available for product development. Largest U.S. Distributor Of Votrax Chips

Votrax is a trademark of Federal Screw Works  
Call 1-800-645-3479, in N.Y. 1-516-374-6793

MICROMINT INC.  
917 Midway  
Woodmere, N.Y. 11598



Call for quantity pricing.

CIRCLE NO. 128 ON FREE INFORMATION CARD

I WILL BEAT ANY COMPETITOR'S PRICE PROVIDED IT IS NOT BELOW MY COST. TRY TO BEAT THESE IC PRICES:

### DYNAMIC RAM

64K	200 ns	\$5.75
64K	150 ns	6.25
16K	150 ns	1.25

### EPROM

2764	250 ns	\$10.00
2732	450 ns	4.15
2716	450 ns	3.43
2532	450 ns	4.94

### STATIC RAM

6116P-3	150 ns	\$4.75
6116LP-3	150 ns	5.50
2114	200 ns	1.60

### Z80A FAMILY

CPU, CTC, or PIO	\$ 3.50
DART	7.50
DMA or SIO/0	13.50

MasterCard/VISA or UPS CASH COD

All Prime Parts

**MICROPROCESSORS UNLIMITED**

24,000 South Peoria Ave.

BEGGS, OK 74421

(918) 267-4796

Jan. 1983

Prices subject to change. Call for volume prices. Subject to available quantities. Shipping & insurance extra.

CIRCLE NO. 129 ON FREE INFORMATION CARD

## VIC-20

### VIC-20 INTERFACING BLUE BOOK

Did you know that your VIC can be used to control a 99c toy motor so effectively that it runs like a precision machine? Or that you can build an accurate digital thermometer using the VIC and four parts costing less than \$5?

These and other 18 interfacing projects selected for usefulness, ease of construction and low cost are detailed in the VIC-20 Interfacing Blue Book, a veritable gold mine of practical information on how to build a variety of interfaces for your computer.

Projects include: Connecting VIC to your stereo; Pickproof digital lock; Capacitance meter; Liquid level sensor; Telephone dialer; Voice output; 8K/16K RAM/ROM expansion; 128K RAM expansion; 8-bit precision D/A; 8-bit A/D converter; MX-80 interface and more.

Written by a college professor in a friendly and informative style, the Blue Book gives you theory of operation, schematics, program listings, parts list, construction hints and sources of materials for each one of the 20 projects.

If you want to get the most out of your VIC this book is a must. Cost is \$14.95 (less than 75¢ per project!). Price includes postage.

**microsignal** Dept. B1  
P.O. BOX 22  
MILLWOOD NY 10548

VIC-20



## STEP UP!

Quality Software for  
Apple II, Apple III, IBM PC.

Medical, Dental, Office  
And Educational Software

For further information  
call  
**(619) 365-6668**

**Memmen**  
COMPUTER SERVICE  
Village Data Center • P.O. Box 603  
Joshua Tree California 92522

CIRCLE NO. 130 ON FREE INFORMATION CARD

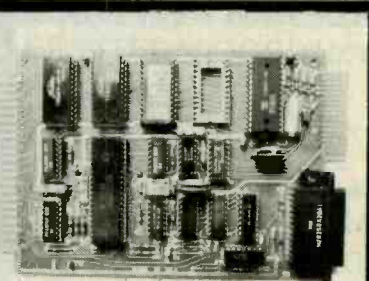

## CONTROL THE WORLD!

A/D conversion, high current outputs, switch closure and logic inputs, BASIC language, RS-232 and cassette interfaces, and EPROM programmer are only some of the features of this family of single board computers. The lowest cost unit can control more than 2000 external devices. Programmed learning text, software, and other support available. Industrial, educational, and home uses. Prices start below \$150.

Octagon Systems Corporation  
5150 West 80th Avenue Suite B  
Westminster, CO 80020  
(303) 426-9780

CIRCLE NO. 131 ON FREE INFORMATION CARD



# TIMEX SINCLAIR 1000 SOFTWARE

ALSO COMPATIBLE WITH ZX81

## FREE CATALOGUE

Fill out reader service card or write:

# ORBYTE

SOFTWARE  
THE CREATIVE FORCE™

P.O. Box 948, Waterbury, CT 06720  
203-753-8308

CIRCLE NO. 132 ON FREE INFORMATION CARD

## ARBITRARY WAVEFORM GENERATOR ONLY \$345!

Generate any custom waveform  
with the Apple Computer.

- analog and digital outputs
- up to 20 volts p-p output
- 7 thru 10 MHz
- 64 words
- 18 channels
- Interval timer
- Delayed triggering
- Sequential triggers
- State and timing display
- 125 ns/pt. - 1 sec/pt
- up to 2048 points
- 8 bit resolution

Use the Apple Computer to  
capture and display digital data

## LOGIC ANALYZER • ONLY \$995.00!

PACIFIC MICROSYSTEMS INC.  
160 GATE 5 ROAD • SAUSALITO,  
CA 94965 (415) 331-2525

CIRCLE NO. 133 ON FREE INFORMATION CARD



## RADIO SHACK TRS-80's™

We offer Special Discounts, Free Shipping  
and a Toll Free Order Number

1-800-531-7466 TOLL FREE

## Pan American Electronics

Dept. P.E. - 1117 Conway Avenue  
Mission, Texas 78572  
(512) 581-2766 Telex 767339

CIRCLE NO. 134 ON FREE INFORMATION CARD

## SYNCHRO SETTE

The Subscription Magazine for the  
**Sinclair ZX-81/TS-1000**  
Microcomputers

Games, Educational, Business, Graphics  
Tutorial, 1K, 2K, 16K, Etc.

12 Mo. Issues — 6 Bi-Month  
CASSETTES  
AT LEAST 6 PROGRAMS EACH



\$39.50



Ill. Residents add \$2.07 tax  
outside USA add \$10.00

Ask for operator # 383  
24 Hr. Hot Line 800-543-1300

THE S & S COMPANY  
388 W. Lake Street, Dept. CE  
Addison, IL 60101  
(312) 628-8955

CIRCLE NO. 135 ON FREE INFORMATION CARD

# TIMEX SINCLAIR 1000 SINCLAIR ZX81 SOFTWARE

CALL OR WRITE FOR  
FREE CATALOG

## SOFTSYNC, INC.

14 E. 34th St. NY, NY 10016  
212-685-2080

CIRCLE NO. 136 ON FREE INFORMATION CARD

# TRS-80 COMPUTERS

Model II 64k .....	\$3288
Model III 16k .....	\$825
Model III 48k 2 Drives RS232 .....	\$2069
Color Computer 4k Level I .....	\$308
Color Computer 16k Extended Basic .....	\$459

## EPSON Printers \$CALL

All printers and accessories in stock.

### Discount Prices

on full line of Radio Shack & TCS Custom  
Computers and Accessories. Call for catalog

## Texas Computer Systems

P.O. Box 1327 Arlington, Texas 76004-1327

TOLL FREE 800-433-5184

Texas Residents 817-274-5625

PAYMENT: Money order, cashier's check or  
certified check. Prices reflect 3% cash discount.  
Call for VISA and Mastercard prices.

CIRCLE NO. 137 ON FREE INFORMATION CARD

## ★MICROCOMPUTER★ BUSINESS SOFTWARE

MEDICAL MGMT...  
DENTAL MGMT...  
INSURANCE AGENT  
LEGAL BILLING.....  
PROPERTY MGMT..  
AND MUCH MORE!

## UNIVAIR INTERNATIONAL

9024 St. Charles Rock Road  
ST. LOUIS, MISSOURI U.S.A. 63114

(314) 426-1099

CIRCLE NO. 138 ON FREE INFORMATION CARD

## EDGE CARD CONNECTORS

S-100		APPLE BUS	
PC MOUNT	QTY WIREWRAP	PC MOUNT	QTY WIREWRAP
\$5.25	1 to 9 Pieces	\$6.25	1 to 9 Pieces
4.97	10 to 49 Pieces	5.82	10 to 49 Pieces
4.66	50 to 99 Pieces	5.45	50 to 99 Pieces
4.24	100 to 249 Pieces	4.95	100 to 249 Pieces
		\$3.20	1 to 9 Pieces
		3.05	10 to 49 Pieces
		2.56	50 to 99 Pieces
		2.40	100 to 249 Pieces

WESTLAND ELECTRONICS has a complete line of Texas Instruments  
Edge Card Connectors

### MEMORY

4116	300 ns	8/	\$12.95 each
4116	250 ns	8/	\$13.95
4116	200 ns	8/	\$15.95
4116	150 ns	8/	\$17.95
6116	P3 2K X 8 CMOS RAM		\$ 7.25
2716	2K X 8 EPROM		\$ 4.49
2732	4K X 8 EPROM		\$ 6.95
2764	HK X 8		\$18.00

### SC-01 VOICE SYNTHESIZER CHIP \$55.00

WESTLAND ELECTRONICS now stocks  
all standard values of 1% metal film resistors from  
10 OHMS to 1 MEG OHMS.

SEND FOR A COMPLETE CATALOG

CALL OR WRITE:

WESTLAND ELECTRONICS

37387 FORD ROAD

WESTLAND, MI. 48185

313-728-0650 in Michigan

1-800-521-0664 outside Michigan

CIRCLE NO. 139 ON FREE INFORMATION CARD

# COMPUTER CASSETTES



## BASF -DPS

THE WORLD'S FINEST  
Data media for all microcomputers.  
Used nationwide by software manufac-  
turers, hobbyists, schools and busi-  
nesses. Premium 5-screw shell with  
leader fits all standard recorders.

SATISFACTION GUARANTEED OR MONEY BACK.

ITEM	1 DOZ.	2 DOZ.
C-05	<input type="checkbox"/> 7.50 <input type="checkbox"/> 13.50	
C-10	<input type="checkbox"/> 8.00 <input type="checkbox"/> 14.40	
C-20	<input type="checkbox"/> 10.00 <input type="checkbox"/> 18.00	
Hard Box	<input type="checkbox"/> 2.50 <input type="checkbox"/> 4.00	

Send for free brochure. Ask for  
quantity discounts. Calif. resi-  
dents add sales tax. SHIPPING/  
HANDLING (UPS) 1 doz. \$2.  
2 doz. \$3.50. 3 doz. \$4.50. ea.  
additional doz. \$5.00. For parcel  
post instead of UPS add \$1.  
Outside Continental USA. add \$2.

FOR IMMEDIATE SHIPMENT  
USE YOUR VISA OR MASTERCARD CALL 213/710-1430

## YORK 10™ Computerware

24573 Killridge St., P.1 Canoga Park, CA 91307

CIRCLE NO. 140 ON FREE INFORMATION CARD



# Computers & Electronics Marketplace

**CLASSIFIED RATES:** Per Word, 15 Word Minimum. **COMMERCIAL:** \$4.00. **PERSONAL:** \$2.30. **EXPAND-AD\*:** \$6.00. Ads set in all bold type @ 20% premium. Ads set with background screen @ 25% premium. **DISPLAY:** 1" x 2 1/4", \$485.00. 2" x 2 1/4", \$970.00 3" x 2 1/4", \$1,450.00. **GENERAL INFORMATION:** Frequency rates and prepayment discounts available. Payment must accompany order except credit card—Am. Ex., Diners, MC, VISA (include exp. date)—or accredited ad agency insertions. Copy subject to publisher's approval; must be typewritten or printed. First word set in caps. Advertisers using P.O. Boxes MUST supply permanent address and telephone number. Orders not acknowledged. They will appear in next available issue after receipt. Closing date: 1st of the 2nd month preceding cover date (e.g., Mar. issue closes Jan. 1). Send order & remittance to: Classified Advertising, **COMPUTERS & ELECTRONICS Magazine**, 1 Park Avenue, New York, NY 10016. Direct inquiries to Rose Lynch, (212) 725-7686.

## FOR SALE

GOVERNMENT and industrial surplus receivers, transmitters, snooper scopes, electronic parts, Picture Catalog 25 cents. Meshna, Nahant, Mass. 01908.

ELECTRONIC PARTS, semiconductors, kits. **FREE FLYER.** Large catalog \$1.00 deposit. **BIGELOW ELECTRONICS**, Bluffton, Ohio 45817.

SAVE UP TO 50% on name brand test equipment. Free catalog and price list. Salen Electronics, Box 82, Skokie, IL 60077.

BUILD AND SAVE. TV EARTH STATION. DETECTIVE ELECTRONICS. Video Recorders, Color Cameras, advanced Telephone Projects. **BROADCAST ELECTRONICS**. 50 page color catalog of unusual electronic projects **AIR MAILED \$3.00**; with 3 hour audio cassette dramatization of our catalog \$5.00. Don Britton Enterprises, PO Drawer G, Waikiki, Hawaii 96815.

POLICE/FIRE SCANNERS, crystals, antennas, CBs, Radar Detectors. HPR, Box 19224, Denver, CO 80219.

RECONDITIONED TEST EQUIPMENT \$1.00 for catalog. **WALTER'S TEST EQUIPMENT**, 2697 Nickel, San Pablo, CA 94806, (415) 724-0587.

ELECTRONIC PARTS. Stamp for flyer. \$1.00 deposit for catalog. **DAYTAPRO ELECTRONICS**, 3029 N. Wilshire, Arlington Hts., IL 60004.

ELECTRONIC CATALOG. Over 4,500 items. Parts, & components. Everything needed by the hobbyist or technician. \$2.00 postage & handling (United States Only), refundable with first \$15.00 order. T & M Electronics, 472 East Main St., Patchogue, NY 11772. (516) 289-2520.

PRINTED CIRCUIT BOARDS, your artwork. Quick delivery. Reasonable. Atlas Circuits, Box 892, Lincolnton, NC 28092. (704) 735-3943.

### Telephone Listening Device

Record telephone conversations in your office or home. Connects between any cassette or tape recorder and your telephone or telephone LINE. Starts automatically when phone is answered. Records both sides of phone conversation. Stops recorder when phone is hung up. This device is not an answering service.



size 100"

**Each**

**\$19.95**

Qty. Disc. Avail.



size 2" x 3" x 3/4"

### Super Powerful Wireless Mic

10 times more powerful than other mics. Transmits up to 1/4 mile to any FM radio. Easy to assemble kit. 15V battery (not incl.) Call (305) 725-1000 or send \$19.95+ \$1.00 shipping per item to USI Corp., P.O. Box CE-2052, Melbourne, FL 32901. COD's accept. For catalog of transmitters, voice scramblers and other specialty items, enclose \$2.00 to USI Corp.

SATELLITE TELEVISION... HOWARD/COLEMAN boards to build your own receiver. For more information write... **ROBERT COLEMAN**, Rt. 3, Box 58-AP, Travelers Rest, S.C. 29690.

## SAVE UP TO 85%

### GOV'T SURPLUS and NEW EQUIP'T



**Blower/Fan**  
100-CFM  
115-VAC  
LAST OVER \$24.99  
**\$8.79**  
F.O.B. Lincoln

• (ITEM #16-940) - Use for intake, exhaust, cool electronic gear. 4" diam. blade, mounts in 6-1/2" diam. opening. 4-1/4" deep. (2-1/2 lbs.)



**1/4-HP Electric Motor**  
G.E., 115-VAC  
1725 RPM  
5-AMPS.  
(13 lbs.) **\$19.95** F.O.B. Lincoln

• ITEM 10-996 - Split ph., cont. duty for moderate torque use. Rotation reversible. Thermal protection. Res. mt. Shaft 1/2" diam. Pulley incl. 9" x 6" x 6".

• Many other motors shown in our catalog. Write for it!

100-Page Catalog Send \$1.00  
Contains 100's Of Terrific Bargains

**SURPLUS CENTER CE-033** Lincoln, Ne. 68501  
(402) 474-4366

SATELLITE TELEVISION INFORMATION \$4. Build or buy your Earth Station. Satellite Television, RD 3, Oxford, NY 13830.

SOUND SYNTHESIZER KITS—Surf \$19.95, Wind \$19.95, Wind Chimes \$24.95, Musical Accessories, many more. Catalog free. PAIA Electronics, Box J14359, Oklahoma City, OK 73114.

**FREE SATELLITE TV KIT**  
IN YOUR HOME  
NEW AND IMPROVING

## SATELLITE TV

### FANTASTIC 80 TV CHANNELS

New antenna construction plans plus big 8 x 11 book loaded with aiming info, kits, LNAs and receivers at wholesale prices. Far better than cable TV! Enjoy crystal clear reception. Send **\$9.95 today**. Add \$2.00 for 1st class (air mail) or call our 24 hr. COD order line (305) 862-5068 Now.

Global TV Electronics, P.O. Box 219-E, Maitland, FL 32751

RF MODULATORS for SATELLITE TELEVISION, MICROCOUNTERS CCTV. Also monitors, cameras, kits. **FREE VIDEO CATALOG.** Phone (402) 987-3771. Dealers Welcomed. **ATV RESEARCH**, 13-P Broadway, Dakota City, NE 68731.

CABLE TV CONVERTERS & EQUIPMENT. Plans and parts. Build or buy. For more information send \$2.00: **C & D ELECTRONICS INC.**, P.O. Box 21, Jenison, MI 49428.

FREE FLYER! IC's, resistors, capacitors, jacks, etc., plus SSM music synthesizer/audio IC's, power amp modules, analog delay IC's, computer books, and more. Also plans for analog delay/chorus unit! **PGS Electronics**, P.O. Box 749-A, Terre Haute, IN 47808.

### Satellite Earth Station

Complete systems from \$1,899.00  
Call or write for our latest brochure.

## TENNESSEE ELECTRONICS

P.O. Box 181108  
Memphis, TN 38118  
(901) 795-4504

## SATELLITE TV

• SYSTEMS • COMPONENTS • LNA's •  
• ANTENNAS • RECEIVERS •

WE CAN HELP YOU!

### HIGH FRONTIER

2230 E. Indian School Rd., Phoenix, AZ 85016  
(602) 954-6008

TELETYPE EQUIPMENT: Copy Military, Press, Weather, Amateur, Commercial Transmissions. Catalog \$1.00. **WEATHER-MAP RECORDERS:** Copy Satellite Photographs, National-Local Weather Maps. Learn How! \$1.00. Atlantic Sales, 3730 Nautilus Ave., Brooklyn, NY 11224. Phone: (212) 372-0349.

MICRO TOPOLOGY EXPOSED! Discover the incredible detail of a microprocessor chip enlarged over 20,000 times into a large full color poster. See how an LSI circuit, the 6502 CPU, is built. Poster only \$4.50 with free 6502 fact sheet. **OMICRON DIGITAL SYSTEMS LTD.**, Box 3055-PE, Falls Church, VA 22043.



### DESIGN, ANALYZE & REPAIR BASIC CIRCUITS

Step by step PROCEDURE calculates Voltage, Impedance, Reactance, etc. w/ SCHEMATICS & examples. Color Coded. Includes Formulas, THEORY, Tables & P. Supplies. **ELECTRONICS-VISUALIZER WALL CHART** shpd. in tube \$10.95 ppd. **ELECTRONICS REFERENCE Inc.**, P.O. Box 312, Brooklyn, N.Y. 11214

SAVE!!! (KITS) 2.5 GHZ Downconverter \$29.95, P/S less Transformer \$15.00. Plans \$7.50. **Hoptronix**, Box 402183, Garland, TX 75040.

### SHORTWAVE AND SCANNER LISTENERS

Tune in spies, smugglers, secret satellites, undercover agents, pirate stations, foreign broadcasts. Choose the proper equipment to hear more, hear farther. Discover listening excitement beyond your dreams by reading **MONITORING TIMES**, respected authority on monitoring. For your **FREE SAMPLE** call toll-free TODAY! 1-800-438-8155 or 1-704-837-2216, or write:

**GROVE ENTERPRISES**  
Dept. A, 140 Dog Branch Road  
Brasstown, NC 28902

## CABLE TV CONVERTERS DESCRAMBLERS

BUY DIRECT & SAVE



36 CHANNEL REMOTE CONTROL CABLE CONVERTER  
\$88.00

### AMATEUR MICROWAVE ANTENNA

• 26 DB Gain  
• Advanced Down Converter  
• Complete-Ready to install  
\$119.00



### LINDSEY JET I WIRELESS THE ULTIMATE CABLE TV CONVERTER

56 CHANNEL INFRARED REMOTE CONTROL COMPLETELY PROGRAMMABLE  
\$149.95

Send \$1 for Complete Catalog  
VISA • MASTERCARD • COD



### DIRECT VIDEO SALES

P.O. BOX 1329  
JEFFERSONVILLE INDIANA 47130  
CALL TOLL FREE  
1-800-626-5533

MICROWAVE TELEVISION "DOWN CONVERTERS." Exclusive new five stage design. Easily assembled. Catalogue: \$2.00 (refundable). **NDS**, Box 12652-E, Dallas, 75225.

RESISTORS, 1/4W-1/2W 5% C.F., 3/8ea., 1% Metallfilms. NO MINIMUMS. Quantity Discounts. Write: **JR INDUSTRIES**, 5834-A Swancreek, Toledo, OH 43614.

### REPAIR ATARI GAMES AT HOME

Complete repair course on 3 hour video tape (Beta or VHS) plus schematics and technical literature enables you to start earning money right away. All popular repair parts in stock for immediate shipment. \$1.00 for parts/price list and additional information refundable with order. Exclusive National Distributor.

**ELECTRONICS WAREHOUSE CORP.**  
1910 Coney Island Avenue  
Brooklyn, N.Y. 11230 (212) 375-2700

FREE FLYER 99 cent kits. Parts. Bargains Galore! **ALLKIT**, 434 West 4th St., West Islip, New York 11795.

TRANSISTORS, IC's, RF Power, LED's and Sanyo rechargeable batteries. For best buys plus service call TOLL FREE 800-458-6053. PA call 800-672-7100. MC/VISA honored. Savings. Service. Quality. At: **B&D** we do it better. **B&D ENTERPRISES**, Box 305, Kane, PA 16735.

POLICE CODE UNSCRAMBLERS, lets you hear the coded messages of Police, Fire and Medical channels; magnetic mobile scanner antennas and other scanner accessories, satisfaction guaranteed. **DNE Inc.**, Rt. 7, Box 257-A, Hot Springs, AR 71901. (501) 623-0071.

FAST, DEPENDABLE MAIL-ORDER! Prime semiconductors, parts, accessories. Free 54 page catalog. The Parts Store, Dept. 180, 999 44th St., Marion, IA 52302.



Call or Send for Free **SINTEC**  
ELECTRONIC PARTS CATALOG

Thousands of Quality Components  
No Mail Order Seconds! Call Toll Free  
**800-526-5960**  
NJ Residents call 201-996-4093  
Sintec, Drawer Q, Milford, NJ 08848

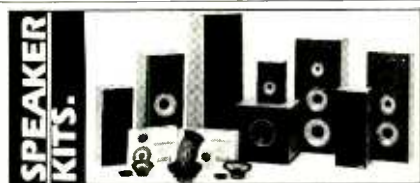

**SPEAKER KITS.**

From the worlds oldest and largest speaker kit manufacturer, **SPEAKERLAB**. Save up to 30% on the speaker designs critics rave about. From tiny bookshelf speakers to slender, floor-standing models to massive folded corner horns. PLUS the latest in state-of-the-art car speakers. All in Speakerlab's 1983 catalog. Send for it today. (Allow 4 - 6 weeks for delivery. Send \$1.25 for faster, first class postage.)

**speakerlab**  
Dept. CE33 735 N. Northlake Way  
Seattle, Washington 98103

**LOW NOISE AMP**

Check or Money Order \$495.  
Call residents add 6% tax

110°K noise temp. The LNA used in commercial satellite earth stations. Immediate delivery Military quality. 12 month guarantee. Factory repair service

**MICROWAVE SUPPLY CENTER**  
8223 Manchester, Playa Del Rey CA 90291

NEW UHF CONVERTERS and Cable units Sound out TV CH3 antenna connections Model A Gated, Pulse Suppressed, Model B Computerized Addressable, Model C Cable computerized Addressable. Send \$2, for information: J&D Engineering, P.O. Box 469, Boston, MA 02186. 1-617-837-8431.

HOW TO BUILD A SATELLITE TV LNA OR DOWNCONVERTER! Save Hundreds! Free Information! XANDI, Box 25647, Dept. 22G, Tempe, AZ 85282.

SATELLITE ANTENNA BUILD OR BUY from \$160. Approved leading Electronics magazine. Prototype Engineers, Box 1812 Deming, NM 88030.

TELEVISION SIGNAL PROCESSING MANUAL, \$12.95. Includes theory, circuits, waveforms and trouble shooting hints. Information \$2.00, refundable. D&S Enterprises, Box 09292, Cleveland, Ohio 44109.

LOWEST PRICES—Atari 400 \$265.00/Atari 800 \$609.00/Vic-20 \$179.00/TimeX \$88.00/NEC/Diablo/TI 99-4A. HARDWARE SOFTWARE ANYWARE, 10 Coles Street, Brooklyn, NY 11231, (212) 596-3592.

E-PROM BOARDS FOR ATARI® VICS. For 25/2716, 21/2732 E-PROM. Build your own cartridge, Bare Board—\$14.95, Assembled—\$25.00. SPECIALTY SERVICES, 511 Martha, Euless, TX 76039.

SINCLAIR ZX81/TIMEX FREE CATALOG of over 80 programs. UAS, Box 612, Haddonfield, NJ 08033.

**IF YOU ARE READY TO BUY OR SELL GAMES OR SOFTWARE, YOU NEED...**

**COMPUTER SHOPPER**

Over 100 pages each month. Deal with individuals nationwide. Low ad rate, only 12¢ a word. Subscription, \$10/year MC & VISA Money back guarantee P.O. Box F593, Titusville, FL 32780. (305) 269-3211

**CABLE TV KITS**

We have all 3 types of Cable TV Kits. Prices start at \$37. Send for our "informative catalog" \$2, and find out what type you need.

J & W Electronics, Inc.  
P.O. Box 61-K  
Cumberland, RI 02864

MICROWAVE ANTENNA SYSTEMS \$49.95, factory direct 24 hour shipping, CODS, GUARANTEED. NEVADA SATELLITE CORPORATION (702) 367-0333.

**RELIABLE MICROWAVE TV ANTENNAS**  
2.1 to 2.6 GHz  
Frequency Range  
34db System Gain (or Greater)

Complete System (pictured) \$149.95  
Down Converter: Probe Style (Assembled & Tested) \$ 64.95  
Power Supply (12V to 16V DC) (Assembled & Tested) \$ 59.95

**PETERSON ELECTRONICS**  
4558 Auburn Blvd  
Sacramento CA 95841  
(916) 486-9071

SPECIAL QUANTITY PRICING  
Dealers Wanted - COD'S

1 YEAR WARRANTY PARTS & LABOR

MasterCard VISA

**SEE THE WEATHER AND SAVE \$1,000!**

A leading manufacturer of commercial weather chart recorders has developed a facsimile Weather Chart Recorder Kit for use by hobbyists, amateurs, pilots, and educators.

All you need is a stable HF general-coverage receiver to tune in weather facsimile frequencies—your recorder will print out accurate weather charts. Major components in this easy-to-build kit are pre-assembled and tested. And the recorder is backed by a limited warranty against defects. Special kit price is \$995. Add \$5 for shipping and handling in the U.S. and Canada. (For Massachusetts delivery, add \$49.75 sales tax.) MasterCard and Visa accepted. Call or write for more information.

**ALDENELECTRONICS**  
Washington Street, Westborough, MA 01581  
(617)366-8851

RESISTORS, ¼W5% C.F., 1-9/type \$0.03, 10/type \$0.025, 100/type \$0.015, 500/type \$0.013. Presto Enterprise, Box 9060, San Jose, CA 95157.

**ZX81 16K MEMORY PACKS—\$44.95 assembled, \$39.95 kit, \$2.95 shipping. High reliability. LASERSCAN ELECTRONICS, 441 Westwind Drive, North Palm Beach, Florida 33408.**

**COMPUTER EQUIPMENT/PARTS**

SAVE 90% Build Your own Minicomputer. Free Details. Digatek, 2723 West Butler Dr., Suite 20C, Phoenix, AZ 85021.

PLUGS-INS AND ADD-ONS FOR THE IBM PERSONAL COMPUTER. Available in kit form as well as assembled. Build it yourself and save. Free information. Compatible Computer Corp., Dept CE 9, Box 51102, Seattle, WA 98115.

APPLE BUILDERS—Send stamp for our flyer of Apple parts. IC sets, ROM sets, connectors, Shugart drive to Apple modification kits etc. Electrovalue Industrial Inc., Box 157-P, Morris Plains, NJ 07950.

NEW: SINGLE BOARD CONTROLLER uses Z8671. Eight A/D inputs. Triac outputs. 16K. RS232C. Write: H.H.S. Microcontrollers, 5876 Old State, Edinboro, PA 16412.

ITS EASY TO MAKE YOUR OWN video game cartridges, average cost is only \$10 per game. Complete, detailed plans \$9.95. Random Access, Box 41770C, Phoenix, AZ 85080.

**COMPUTER SOFTWARE**

SINCLAIR ZX81/TS-1000/TRS-80 COLOR COMPUTER PROGRAMS. Wide selection/High quality. Catalog \$1.00. Zeta Software, Box 3522, Greenville, SC 29608.

DISCOUNT SOFTWARE—Available for Apple, TRS-80 and TI 99/4 Personal Computers. Professional applications for the doctor, dentist, attorney, school administrator, teacher, contractor and general office personnel. Catalog, \$1.00. Creative Discount Software, 256 S. Robertson Blvd., Suite 2156, Beverly Hills, CA 90211.

THE CRITICAL CONNECTION! Now you can buy an inexpensive ATARI-400, and have it use the disk drives, printer and keyboard on your CP/M computer. Complete package \$147.00. DEALER INQUIRIES WELCOME. USS ENTERPRISES, 6708 Landerwood Lane, San Jose, CA 95120. (408) 997-0264.

TAX PROGRAM to assist you in organizing/preparing an accurate return. 1040 Schedule A-B on 16x Cassette. For Timex-Sinclair, Texas Instruments, Commodore, Apple, Tandy (Color, Lill), Bonus 1983 H&R Block Tax Workbook (\$5.95 value) included. Tax deductible. \$29.75. Specify machine. Eugene Bock, Associates, 135 Heartwood Dr., Lansdale, PA 19446, (215) 362-6082.

VIC-20 USERS GROUP, receive newsletter, programs, discounts and more. Send SASE for information. P.O. Box 459, Dept 7, Ladson, South Carolina 29456.

TIMEX/SINCLAIR software catalog, one program free. Dealers welcome. Panwar, 2035C, Kentland, Houston, Texas 77067, (713) 537-8453.

ZX81, TS1000 SOFTWARE. Many programs and games including chess. Send \$9.95 to: JPM Enterprises, 2841 N. 117th St., Wauwatosa, WI 53222.

TS-1000, 2K PROGRAMS! Four games \$9.95. Free catalog. SASE. 2-BIT SOFTWARE, CE1, 13674 Boquita, DelMar, CA 92014.

TIMEX COMPUTER FAMILY SOURCEBOOK 2ed. describes over 1000 programs and accessories for the TS1000 and ZX80/1. Send \$8.95 + \$1.25 postage to: Atlantic Computer, Box 936, Norfolk, VA 23501. Send for our free discount software catalog.

1982 INCOME TAX PROGRAM for unexpanded VIC 20 and ZX81. Form 1040 and Schedule A. Cassette \$15 postpaid. UC Software, 1236 Abbotsbury, Universal City, TX 78148.

TI-99/4A OWNERS. Send for free list of new and exciting software. D.E., Box 124, Hicksville, NY 11801.

ZX81-T/S 1000 Quality Programs. CATALOGUE \$2.00. LARSOF, P.O. Box 255. Waterloo, Illinois 62298.

COMMODORE 64/VIC-20 SOFTWARE—Amateur Radio/Utility/Games/Educational—Specify computer! RAK Electronics, Box 1585, Orange Park, Florida 32067-1585.

**COMPUTER PUBLICATIONS**

COMPUCOLOR/INTECOLOR — Basic/Graphic Books, Disks. Write/call for information. CHARLES PUBLISHING, 130 Sherwood Drive, Dept CE, Hilton, New York 14468, (716) 392-8152.

**AMATEUR RADIO**

RADIO AMATEUR CALLBOOKS: 1983 Directories of Radio Amateurs around the world. U.S. Callbook \$23.00; Foreign Callbook \$20.00, shipping included. See your Dealer or write for FREE catalog. RADIO AMATEUR CALLBOOK, Dept CE, 925 Sherwood Dr., Lake Bluff, IL 60044.

CALL AND ORDER NOW. SPECIALS: Yaesu FT-102, \$999.; Kenwood TS-530S, \$600. DISCOUNTS! DISCOUNTS on many more! Fast shipping. MADISON ELECTRONICS, Houston, TX call: (713) 658-0268.

VIDEOSCAN 1000 Slow Scan TV — HIGH RESOLUTION (amateur, phone line, monitoring, teleconferencing). CODE-STAR — DECODE Morse, RTTY, ASCII. LARGE LEDs or connect computer/printer. MORSE-A-KEYER—CW Keyboard. TRI-VOLTAGE POWER SUPPLY. Kits/Assembled. FREE brochures. MICROCRAFT CORPORATION, Box 513-PE, Thiensville, WI 53092. (414) 241-8144.

NO SALES TAX IN MONTANA! The New ICOM IC-R70 general coverage commercial grade receiver; List \$749, Cash \$649. Trades welcome. Catalog \$1. CONLEY RADIO, 318-P N. 16th, Billings, MT 59101. (406) 259-9554.

"AMATEUR RADIO, SUPER HOBBY!" Guaranteed easy reading primer. Literature: Cologne Press, Box 682A, Cologne, NJ 08213.

**TIMEX/SINCLAIR**

16K (ZX81), Dominos plus new games. Free brochure. \$9.95 cassette. check/M.O.: JPR SOFTWARE, Box 4155, Winter Park, Florida 32793.

**CABLE TV**

**FREE** THE GREAT ELECTRONIC THINGS & IDEAS BOOK!

HUNDREDS OF UNUSUAL PARTS, GADGETS & IDEA ITEMS. UNAVAILABLE IN STORES OR CATALOGS ANYWHERE! Bargain prices on everything! New items in every issue! Rush postcard for your copy!

**ETCO** ELECTRONICS  
Dept. 310  
Plattsburgh, N.Y. 12901

CHANNEL 3—60db notch filter. 63.5MHz. \$32. Crosley, Dept. 607, Box 840, Champlain, NY 12919.



**C.B. EQUIPMENT**

**IMPROVE CB PERFORMANCE!** Modification hardware, books plans, Catalog \$2. **CBC INTERNATIONAL**, Box 31500PE, Phoenix, AZ 85046.

**PLANS AND KITS**

**GIANT SCREEN TV** projection system converts any television into 7-foot picture. Lens & instructions \$14.95. (Dealers welcome). Bell Video, 4616 Belair Rd., Baltimore, MD 21206.

"PROFESSIONAL" **GIANT SCREEN PROJECTION TV** — "Don't be fooled with cheap imitations!" "Build the best!" Use **EXACT SAME TYPE LENSES** and **SCREENS** utilized by Sony, Zenith, Pioneer, and Magnavox! Simple construction! Profitable! Illustrated information and complete parts catalog \$2.00. Money back guarantee! **POLI-VISION**, 168-F Dunmore St., Throop, PA 18512.

**FM TRANSMITTER KIT.** Great for experimenters. Instructions and parts only \$19.95. **TUCKER ENTERPRISES**, P.O. Box 10120, Alex., VA 22310-0120.

**PROJECTION TV...** Convert your TV to project 7 Foot picture... Results equal to \$2,500 projector... Total cost less than \$20.00. **PLANS & LENS** \$17.50. Illustrated information **FREE**. Macrocomg, Washington Crossing, Pennsylvania 18977. Creditcard orders 24 hours. 215-736-3979.

**ATARI GAME KIT, BUILD YOUR OWN AND SAVE.** Plans, diagram, resistors, transistors and diodes included. Also where to get other parts. \$10.00 name and address to: **NU-TRITRONICS**, 212 W. Hill #2, Chicago, IL 60610.

**ALARMS**

**BETTER EQUIPMENT, Longer Guarantee.** You'll save! Catalog 50¢, refundable. **AAS**, 414A Lorna Square, B'ham, AL 35216.

**PROTECT PERSONAL COMPUTERS AND ELECTRONICS.** Free catalog of systems for schools and stores. **SGM Corporation**, 6 West Main, Bound Brook, NJ 08805.

**BURGLAR ALARM BUSINESS BOOMING.** Learn Now. Information \$1.00. **Security Electronics International**, P.O. Box 1456-JN, Grand Rapids, Michigan 49501.

**HIGH FIDELITY**

**DIAMOND NEEDLES and STEREO CARTRIDGES at DISCOUNT PRICES for SHURE, PICKERING, STANTON, EMPIRE, GRADO, AUDIO TECHNICA, ORTOFDN, ADC, SONUS and Micro-Acoustics.** Send **S.A.S.E.** free catalog. **LYLE CARTRIDGES**, Dept. P., Box 69, Brooklyn, NY 11218. For fast **CDD service Toll Free 800-221-0906**. N.Y. State (212) 871-3303. **9AM-8PM except Sunday.**

**WANTED**

**GOLD, Silver, Platinum, Mercury, Tantalum** wanted. Highest prices paid by refinery. Ores assayed. **Free circular.** **Mercury Terminal**, Box 191, Norwood, MA 02062.

**TUBES**

**TUBES: "Oldies".** Latest. Supplies, components, schematics. Catalog **Free** (stamp appreciated). **Steinmetz**, 7519-PE Maplewood, Hammond, Ind. 46324.

**HUGE INVENTORY!** Thousands of types. Wholesale prices. **FREE CATALOG!** **ETCO Electronics**, DEPT. 290, Plattsburgh, NY 12901.

**PERSONALS**

**MAKE FRIENDS WORLDWIDE** through international correspondence, illustrated brochure free. **Hermes-Verlag**, Box 110666/Z, D-1000 Berlin 11, W. Germany.

**CORRESPONDENCE FOR FRIENDSHIP IN PHILIPPINES, MALAYSIA.** Free information. **AAWS-(PE)**, Box 2777, Orcutt, California 93455-0777.

**PENFRIENDS—ENGLAND—USA,** through correspondence. Send age, interests. **Free reply.** **Harmony**, Box 89PE, Brooklyn, New York, 11235.

**UNIVERSITY DEGREES BY MAIL! Bachelors, Masters, Ph.D.'s ...** Free revealing details, **Counseling**, Box 317-EP03, Tustin, California 92680.

**SCANDINAVIAN LADIES,** sincere, seek correspondence for friendship. Details—Send stamp: **Scannaclub**, Box 4-(CE), Pittsford, NY 14534.

**VITAMINS DIRECT FROM MANUFACTURER.** 14 years quality service, unbelievable savings. **FREE Catalog.** **LIFE CYCLE VITAMINS**, 6354 Van Nuys Blvd., Dept 136CE, Van Nuys, CA 91401.

**ORIENTAL SINGLES** seeking cultural exchange, friendship, sharing, marriage. Write: **CHERRY BLOSSOMS**, Box 1021P, Honokaa, Hawaii 96727.

**BEAUTIFUL PHILIPPINE ladies** seek nice friendship, correspondence! Photos, information, free! **Transcor-B** Box 2321, Manila, Philippines 2801.

**SUNBELT SINGLES** looking for a person of quality. Check our group. Details Box 83395, Oklahoma City, OK 73148.

**FREE: WORLD'S LARGEST PARTNER-PHOTO-CATALOG** for friendship and marriage. Personalized introductions. **INTERCONTACT**, Box 12, Toronto, Canada M4A 2M8.

**INSTRUCTION**

**UNIVERSITY DEGREES BY MAIL! Bachelors, Masters, Ph.D.'s.** Free revealing details. **Counseling**, Box 317-PE03, Tustin, California 92680.

**LEARN WHILE ASLEEP! HYPNOTIZE!** Astonishing details, strange catalog free! **Autosuggestion**, Box 24-ZD, Olympia, Washington 98507.

**MEDICAL ELECTRONICS TECHNOLOGY,** home study. Troubleshoot medical instruments. **WTI**, P.O. Box 3124, Fresno, CA 93650-3124.

**UNIVERSITY DEGREES BY SPECIAL EVALUATION of existing credits and Job Experience.** Fast, inexpensive. Call (614) 863-1791. Or write: **EVALUATION**, Box 13151-A3, Columbus, Ohio 43213.

**Be an ELECTRONICS TECHNICIAN! Get your 2-Year ASSOCIATE DEGREE Train at home in spare time.**



Choose from exciting opportunities in the fast-growing space-age industries...Automation, Aerospace, Cable-TV, Missile Design, Electronic Circuitry, Computers, Telemetry and much, much more. No previous experience necessary. No need to quit your job. Your Associate Degree gives you everything you need to qualify for an Electronics Technician Position. Instructors are as close as your telephone. Use our 24-hour home-study hot line—we pay the bill. Send for free facts. No obligation. No salesman will call. Mail coupon today!

**ICS** Center for Degree Studies, Dept. PD023  
(SINCE 1991) ICS Electronics Center, Scranton, PA 18515

Rush free facts telling how I can train to be an Electronics Technician and get my 2-year Associate Degree at home in spare time.

NAME \_\_\_\_\_ AGE \_\_\_\_\_  
 ADDRESS \_\_\_\_\_  
 CITY/STATE/ZIP \_\_\_\_\_

**ATTENTION ELECTRONIC TECHNICIANS**



Highly Effective Home Study BSEE Degree Program for Experienced Electronic Technicians  
 Our New Advanced Placement Program grants Credit for previous Schooling & Professional Experience. Advance Rapidly! Our 30th Year!  
 FREE DESCRIPTIVE LITERATURE!  
**Cook's Institute of Electronics Engineering**  
 DESK 15 . P.O. BOX 20345. JACKSON, MS 39209

**COMPUTER REPAIR, PROGRAMMING, WORD PROCESSING Courses.** Exciting "Hands On" training in 4 months, lifetime placement assistance. **Systems Technology Institute**, 6442 Edgewater Drive, Orlando, FL 32810. (305) 299-6535.

**HANDLE YOUR OWN LEGAL AFFAIRS—** Be a Paralegal. Accredited Attorney Instruction. Home Study. **FREE CATALOG.** **Southern Career Institute**, Drawer 33E-2158, Boca Raton, FL 33427. (305) 368-2522.

**REPAIR ELECTRONIC ORGANS—** Revised home study course covers all current makes and models. Free booklet. **Niles Bryant School**, P.O. Box 20153, Sacramento, CA 95820.

**GET YOUR ASSOCIATE DEGREE AT HOME Be an ELECTRICAL ENGINEERING TECHNICIAN ...**



Learn at home in spare time. No previous experience needed—just a high school diploma. Associate degree awarded with major in Electrical Engineering Technology. Graduate in as little as two years. No need to quit your job or school. Approved for G.I.'s and Veterans. Write for free facts. No obligation. No salesman will call.

**ICS** CENTER FOR DEGREE STUDIES  
(SINCE 1991) Electrical Eng. Tech., Dept. PD023 Scranton, PA 18515

**F.C.C. COMMERCIAL RADIOTELEPHONE LICENSE.** Home Study. Fast, Inexpensive! Free details. **COMMAND**, Box 26348-P, San Francisco 94126.

**UNIVERSITY DEGREES** without classes. Bachelors, Masters, Doctorates. Accredited, inexpensive, fast. **Dr. John Bear**, P.O. Box 11447-C2, Marina Del Rey, CA 90291.

**FAST!** Want to pass FCC General License? I will tell you what books to study, list of formulas and a plan to follow. Best advice from retired Instructor. Send \$4.98 cash or M.O. **F&M Enterprise**, P.O. Box 1328, Pasco, WA 99301.

**YOUR OWN RADIO STATION** AM, FM, Cable, licensed, unlicensed, low cost transmitters! Free information. **BROADCASTING**, Box 130-R3, Paradise, CA 95969.

**TEXAS INSTRUMENTS COMPUTER ADVANTAGE CLUB (TICAC)** announces computer awareness classes for adults and children. Offerings for children include general micro-computer operation, TI LOGO and TI BASIC. Offerings for adults include general microcomputer operation and TI BASIC. Classes available in over 100 cities across the USA. For schedules and locations nearest you call toll free: 1-800-858-4069 (inside Texas 1-800-692-1318). Special rates for large groups.

.....CLASSIFIED ADVERTISING ORDER FORM.....

1	2	3	4	5
6	7	8	9	10
11	12	13	14	15 (MINIMUM)
16	17	18	19	20
21	22	23	24	25
26	27	28	29	30
31	32	33	34	35
36	37	38	39	40
41	42	43	44	45
46	47	48	49	50

Please refer to heading on first page of this section for ad placement information:

**COMMERCIAL: \$4.00. PERSONAL: \$2.30, EXPAND-AD\*: \$6.00.**

# OF WORDS \_\_\_\_\_ # OF INSERTIONS \_\_\_\_\_

PAYMENT ENCLOSED \$ \_\_\_\_\_

CHARGE: You will be billed monthly.  American Express  Diners  Visa  MasterCard-Interbank # \_\_\_\_\_

Account # \_\_\_\_\_ Exp. Date \_\_\_\_\_

SIGNATURE \_\_\_\_\_

PRINT NAME \_\_\_\_\_

ADDRESS \_\_\_\_\_

CITY \_\_\_\_\_ STATE \_\_\_\_\_ ZIP \_\_\_\_\_

CE-383

## GOVERNMENT SURPLUS

IS IT TRUE YOU CAN BUY JEEPS for \$44 through the U.S. Government? Get the facts today! Call 312-742-1142 Ext. 4649.

## FOR INVENTORS

### INVENTORS! IDEAS HAVE VALUE!

Ever think of an idea, forget it and see it later on the market? Many people don't forget, act quickly and are rewarded by American Industry. Write down your idea! We offer free disclosure registration and initial consultation regarding your idea's potential value. Call or write without delay for your free information package.

AMERICAN INVENTORS CORPORATION  
59 Interstate Drive, Dept. CE  
West Springfield, MA 01089  
(413) 737-5376

A fee Based Marketing Company  
Offices Coast to Coast

IDEAS, inventions, new products wanted! Call toll free 1-800-528-6050, in Arizona, 1-800-352-0458. Extension 831.

PATENT AND DEVELOP your invention. FREE PATENT INFORMATION. Richard L. Miller, P.E., 3612-E, Woolworth Building, New York, NY 10007, (212) 267-5252.

BUILD A BETTER MOUSETRAP? We will buy or jointly develop your ideas, inventions, new products, etc., patented or not. Confidentiality assured. Call Mr. Florio at: (914) 632-9201. Leave your telephone number and a brief description or write to: HBI Inc., P.O. Box 1020, Wykagyl Station, New Rochelle, NY 10804.

## BUSINESS OPPORTUNITIES

FREE CATALOGS. Repair air conditioning, refrigeration. Tools, supplies, full instructions. Doolin, 2016 Canton, Dallas, Texas 75201.

MECHANICALLY INCLINED individuals desiring ownership of Small Electronics Manufacturing Business—without investment. Write: BUSINESSSES, 92-K2 Brighton 11th, Brooklyn, New York 11235.

ERASE DEBTS with little-known law—create wealth! Details FREE—Moneywise, No. EE3, LaGrange, NY 12540.

MAILORDER OPPORTUNITY! Start profitable home business without experience or capital. Information free. Mail Order Associates, Dept 664, Montvale, NJ 07645.

ONE MAN CRT FACTORY. T.V.'s, Business machines, Monitors, Scopes, VDT's. \$3.00 rebuilding nets \$100-\$500 each tube. Higher profits overseas. New/used. FACTORY, 1909 Louise, Crystal Lake, IL 60014. (815) 459-0666.

MAKE MONEY SELLING ELECTRONICS. Wholesale dealer catalog \$5. (redeemable). ETCO, Dept. 532, Box 840, Champlain, N.Y. 12919.

BORROW \$25,000 "OVERNIGHT." Any purpose, Keep indefinitely! Free Report! Success Research, Box 19739-GB, Indianapolis, IN 46219.

FREE BOOK "2042 Unique Proven Enterprises." Fabulous "unknowns," second inflation income. Haylings-M, Carlsbad, CA 92008.

LIFETIME PROSPERITY. Plan beats envelope stuffing any day! Cancels debts; free sample. Elliott, Box 7206-PE3, Columbia, MO 65205.

BORROW \$300-\$30,000 INTEREST FREE! Keep indefinitely! Free Details. Write: American, 1601 Main, Plainfield, Indiana 46168.

I HAVE MADE A FORTUNE in Mail Order, selling information. Let me show you how. Write Kash CE701, Box 31051, Indianapolis, IN 46241.

BORROW \$30,000 without interest! All eligible. Repay anytime. Free details! Infohouse, 533 Sutter, Suite 508-CE3, San Francisco, CA 94102.

AMAZING PROFITS SELLING How to Make Money Books! Details \$1.00. Tom, 298-E, Sandbug Lane, North Bend, Oregon 97459.

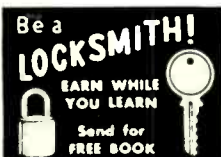

Locksmithing Institute, Dept. 73-023  
Live Technical Home Study Schools, Little Falls, N. J. 07424

Big opportunities. Big profits. Earn quickly Full or part time. Learn at home, it's easy. Do real jobs: All Tools — Materials Supplied. Lic. State of NJ — Appd for Veterans. Send Name and address for FREE book.

Little Falls, N. J. 07424

BUMPER STICKER PRINTING DEVICE. Cheap, Simple, Portable. Free details. Bumper, POB 22791 (PE). Tampa, FL 33622.

PROJECTION TV ... Make \$\$\$'s assembling Projectors ... Easy ... Results comparable to \$2,500 projectors ... Your total cost less than \$17.00—PLANS, LENS & Dealers Information \$15.50 ... Illustrated information FREE ... Macrocomcgx, Washington Crossing, Pennsylvania 18977. Creditcard orders 24 hours 215-736-2880.

LEARN TO MAKE \$100,000 PER YEAR. Send \$2.50: Troy Systems, P.O. Box P, Independence, KS 67301.

EARN \$35.-\$50. per hour—Start your own personal computer repair service. Be part of the fast growing PC repair industry. Packages include; sample business plan, how to target markets, and how to become factory trained, etc. Send \$5.95 to: VSI Inc., Dept. RTC, P.O. Box 76848, Atlanta, GA 30328.

## EMPLOYMENT OPPORTUNITIES

ELECTRONICS/AVIONICS EMPLOYMENT OPPORTUNITIES. Report on jobs now open. Details FREE. Aviation Employment Information Service, Box 240E, Northport, New York 11768.

JOBS OVERSEAS - Big money fast. \$20,000 to \$50,000 plus per year. Call 716-842-6000, ext. 4602.

ELECTRONICS FIRM is looking for assemblers interested in working at home. Send \$3.00 application fee. I.R.D.C., Dept. B, Joppa Hill Road, Manchester, NH 03102.

SECURITY ALARM INDUSTRY BOOMING. Get in now. Tremendous demand. Employment-Business Terrific. Information \$1.00. Security Electronics International, P.O. Box 1456-RG, Grand Rapids, Michigan 49501.

## BOOKS & MAGAZINES

 FREE OFFER FREE  
NOW you can get a FREE electronic kit when you order our HOW TO UNDERSTAND BASIC ELECTRONICS booklet packed with illustrations and simple explanations. Send \$10.00: HOW TO COMPANY, P.O. Box 2592, Newport Beach, California, 92663-1592  
10 Day Money back guarantee.

PUBLISHERS' OVERSTOCKS. BARGAIN BOOKS 2,000 titles, all subjects! Free catalog: Hamilton's, 98-58 Clapboard, Danbury, CT 06810.

## MOVIE FILMS/VIDEO TAPES

VIDEO MOVIES. Adult. Family. Sold. Exchanged. Membership (no obligations), catalogs—mail \$10.00. Tower, Dunkirk, MD 20754-0213.

## REAL ESTATE

NEW... FREE CATALOG! Top real estate values coast to coast! Please specify types, property and location desired. UNITED FARM AGENCY, 612-EP West 47th, Kansas City, MO 64112.

## RUBBER STAMPS

RUBBER STAMPS, BUSINESS CARDS. Free catalog 1-800-851-4945, Jackson's, E-100, Brownsville Rd., Mt. Vernon, Ill. 62864.

## MISCELLANEOUS

MPG INCREASED! Bypass Pollution Devices easily REVERSIBLY!! Free details—Posco GEE3, LaGrangeville, NY 12540.

NEED CREDIT? Get MasterCard, others, w/no credit check. Guaranteed! Simple, Legal. Plus other credit secrets. Free details! Inflation Reports, PE-D, Box 60148, Los Angeles, CA 90060.

## RETAIL ROSTER

### CALIFORNIA

P.C. COMPUTERS, 10166 San Pablo Ave., El Cerrito 94530. (415) 527-6044. Commodore 64, VIC-20, Pet Specialists. In-House Maintenance.

### LOUISIANA

THE COMPUTER PEOPLE — Apple, NEC, Osborne, Corvus Concept—Seminars, Sales, Service. Houma, Morgan City, Lafayette—1-800-352-5828.

## MONTANA

THE COMPUTER STORE—BILLINGS—1216-CE 16th Street, 59102. (406) 245-0092: Apple, Commodore, Hewlett—Packard: Software, Peripherals, Service.

## NEW HAMPSHIRE

COMPUTER MART of NEW HAMPSHIRE, 170 Main Street, Nashua 03060. 603-883-2386. THE APPLE SPECIALISTS. Full line Hardware/Software. Training/Service.

## OHIO

COMPUTERLAND/CLEVELAND: 4 convenient locations! Columbia Plaza, N. Olmsted, (216) 777-1433; Som Center, Mayfield Hgts., 461-1200; Belden Village, Akron-Canton, 493-7786; E. 9th St., Cleveland, 621-7262; IBM, Apple, Osborne, Altos, Fortune, peripherals. APPLICATIONS SOFTWARE TO FIT MOST NEEDS. FULL PROFESSIONAL SUPPORT. We know small computers.

## WASHINGTON

TACOMA—COMPUTERS +. 2504 Jefferson Avenue, 98402. (206) 272-2329. Atari/VIC Computers. Atari/Apple/TRS-80/Commodore software. Supplies.

# SELL COMPUTERS & ELECTRONICS IN YOUR STORE!

### Computers & Electronics

Formerly Popular Electronics

Simple Audio Gate Reduces Noise  
An EPROM Programmer for Small Computers  
Scope Switch Provides Multi-Channel Traces

FORREST NIMS COMPANY  
The New Handheld Computers



Big profits on sales

We pay shipping

Minimum order 8 copies per issue.



FOR DETAILS CALL COLLECT:  
LYNN KUJAWA  
(212) 725-7679

ZIFF-DAVIS PUBLISHING COMPANY

# FREE CATALOG!

Just let us know and we'll mail you a FREE Creative Computing Catalog — 166 pages filled with books, buyer's guides, magazines, and more!

To get your FREE catalog, write to Creative Computing Catalog, Dept NB5X39 East Hanover Ave., Morris Plains, NJ 07950.



# We don't care which computer you buy. We'll help you get the most out of it.

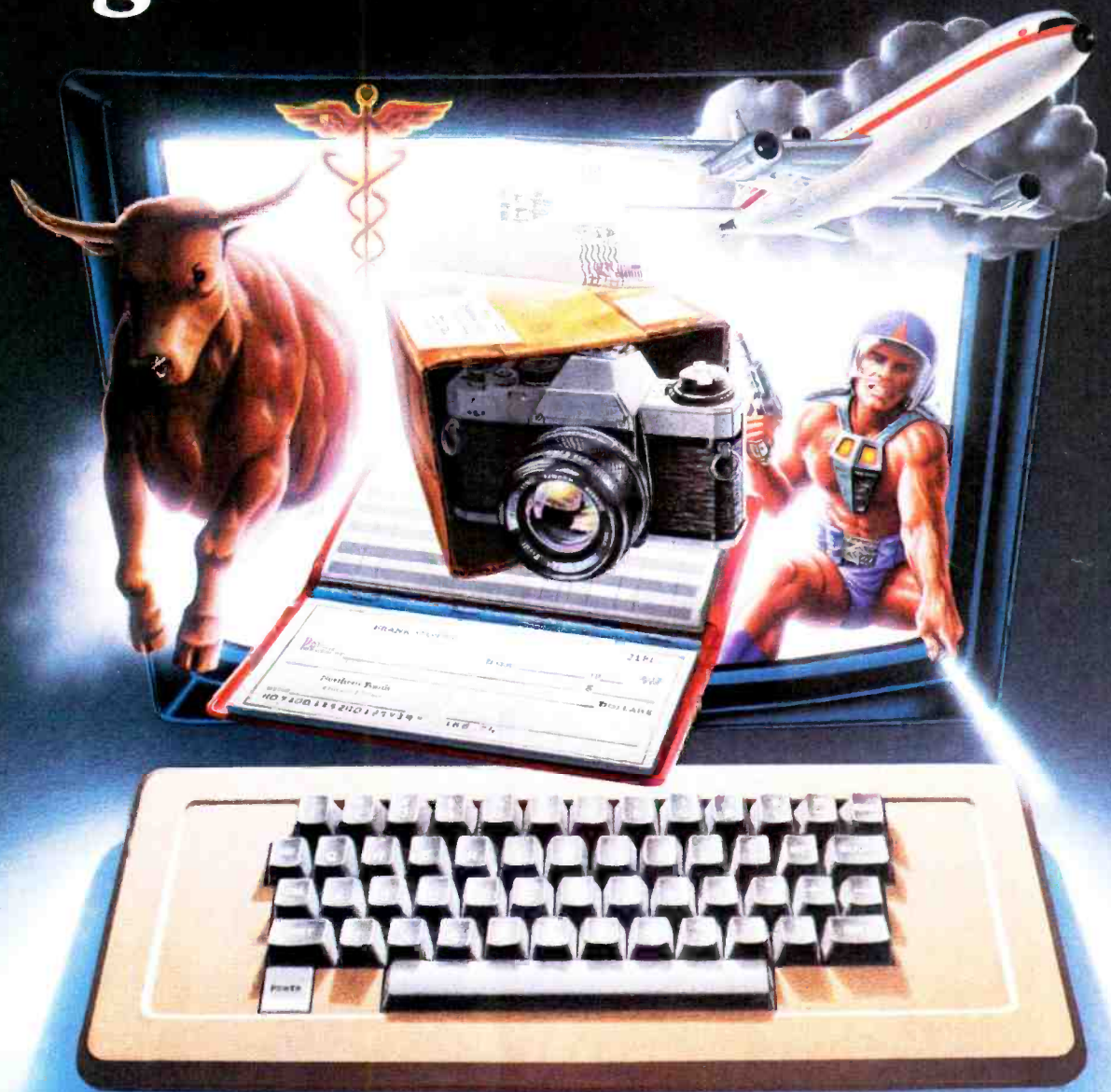

## CompuServe puts a world of information, communications, and entertainment at your fingertips.

CompuServe is the easy to use videotex service designed for the personal computer user and managed by the communications professionals who provide business information services to over one fourth of the FORTUNE 500 companies.

Subscribers get a wealth of useful, profitable, or just plain interesting information like national news wires, electronic banking and shop at home services, and

sophisticated financial data. Plus, a communications network for electronic mail, a bulletin board for selling, swapping, and personal notices and a multi-channel CB simulator.

You get games on CompuServe, too. Classic puzzlers, educational, sports and adventure games and fantastic space games featuring MegaWars, the "ultimate computer conflict."

To learn more about CompuServe, call toll free, 800-848-8990, for an illustrated guide to the CompuServe Information Service. The videotex service for you, no matter which computer you buy.

## CompuServe

P.O. Box 20212  
5030 Arlington Centre Blvd., Columbus, OH 43220

**800-848-8990**

In Ohio call 614-457-8650

An H&R Elock Company

CIRCLE NO. 60 ON FREE INFORMATION CARD



# HOME IS THE LAST PLACE YOU SHOULD LEARN ABOUT A HOME COMPUTER.

WANT TO LEARN SOMETHING ABOUT HOME COMPUTERS? HERE, IT'S FREE.

AT HOME, IT COULD COST YOU.

No one expects you to know everything about a home computer before you buy it. A fact

which is not lost on our

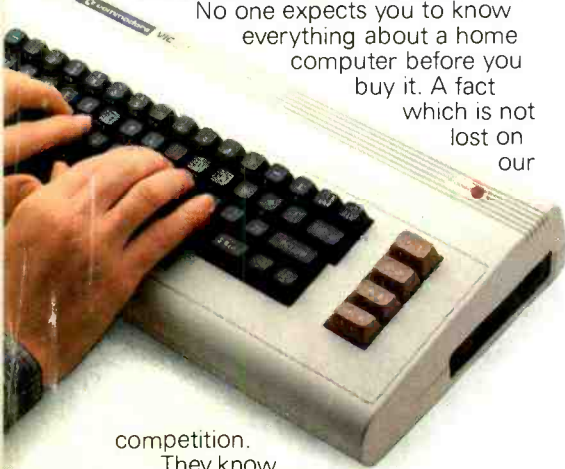

competition.

They know

that an impressively low price can divert your attention from some depressingly cheap features. So that you won't know what you may be missing with their home computer until after it's been in your home for a while.

At which point, naturally, it'll cost you to change your mind.

IT'S EASY TO TELL THE DIFFERENCE.

Fortunately, you don't have to be a computer engineer to tell

what makes the

Commodore VIC 20™ superior to the competition.

All you have to do is take advantage of three of your five senses.

Use your sense of

vision and read this comparison chart. You can see in black and white where two of our major



competitors have skimped. Use your sense of touch in the store. You'll feel the VIC 20's superiority immediately. It feels a lot more expensive than it is.

If these two senses don't convince you that the VIC 20 offers more for the money than any other home computer, simply rely on common sense.

**NOW THAT YOU KNOW HOW EASY A COMMODORE HOME COMPUTER IS TO OWN, FIND OUT HOW EASY IT IS TO EXPAND.**

One thing about home computers that you're bound to discover at home is that, once you learn what they can do, you'll want them to do more and more. To do this, you may need accessories called peripherals. These let you



early to start planning to add peripherals. If that's what you think, you're once again playing right into the hands of our competitors.

Because once they've gotten you to buy their home computer, for what seems to be a reasonable price, they have you hooked on their system.

The costs of which, if you'll examine the chart below, can really start getting unreasonable. For example, while these computers may seem to be close to the same price to start, an expanded system

EXPANSION COSTS	VIC 20™ or COMMODORE 64™	TI99/4A®	ATARI 400®
<b>BASIC</b>	Included	Included	\$59.95
<b>Peripheral Expansion System</b>	Not Necessary	\$249.95	Not Necessary
<b>Disk Drive</b>	\$399.00	399.95	599.95
<b>Disk Controller Card</b>	Included	249.95	Included
<b>Modem</b>	109.95	224.95	199.95
<b>Modem Interface</b>	Included	174.95	219.95
<b>TOTAL</b>	<b>\$508.95</b>	<b>\$1299.75</b>	<b>\$1079.80</b>

Manufacturer's suggested list prices. Prices per TI June-December 1982 U.S. Consumer Products Suggested Price List. Atari prices effective July 1, 1982 Suggested Retail Price List.

get more out of a home computer by letting you put more into it.

They include items like cassette recorders and disk drives to input data, modems for telecomputing and printers. And all VIC 20 peripherals are fully compatible with the powerful Commodore 64™ personal computer.

**PLAN AHEAD.**

When you start looking at your first home computer, you may think it's too

can cost you twice as much with TI or Atari as with the Commodore VIC 20 or Commodore 64.

**THINK OF IT AS BUYING A TOASTER.**

It's easy to fill up a computer ad with RAM's and ROM's, numbers and technical jargon. But when it comes right



down to it, buying a home computer is just like buying anything else. It's important to know just what you're getting for your hard-earned money.

And we hope we've accomplished that here by telling you about the cost of expanding your Commodore VIC 20 or Commodore 64 computer.

COMPUTER FEATURES	VIC 20	TI 99/4A	ATARI 400
Typewriter Keys	Yes	Yes	No
Typewriter Feel	Yes	No	No
Color Control Keys	Yes	No	No
Graphics on Keys	Yes	No	No
Reverse Letters	Yes	No	Yes
Programmable Function Keys	Yes	No	No
Works with TV or Monitor	Yes	Yes	No
True Lower Case Letters	Yes	No	Yes
<b>DISK FEATURES</b>			
Capacity	170K	90K	88K

**commodore**  
COMPUTER

CIRCLE NO. 29 ON FREE INFORMATION CARD