

# Computers & Electronics

JANUARY 1983

\$1.25

formerly Popular Electronics

FROM WORDSTAR TO FINAL WORD...

Comparing Word Processors for IBM-PC

An Intelligent Thermometer for Temperature Analysis

Testing Business Microcomputers:

Apple III, Advantage & Victor



The New Wave  
Of Personal  
Robots

Tested in This Issue:

JVC's 4.4-lb portable VHS video cassette recorder  
H.H. Scott's Model 458A stereo FM/AM receiver



# THE LEADING EDGE IN PRINTERS

ONE GREAT LINE. ONE GREAT WARRANTY.

Finally, there's one full family of printers that covers every business or word processing application—all from C. Itoh, a company known for packing more product into less price; and all distributed exclusively by Leading Edge, a company known for searching out and providing that very thing. Which means that one call to one source can get you any printer, any time you need it, for any purpose. All backed by a full years' warranty from Leading Edge. (Try *that* on any other line of printers.)

## THE PRO'S.

**The Prowriters: business printers—and more.** The “more” is a dot-matrix process with more dots. It gives you denser, correspondence quality copy (as opposed to business quality copy, which looks like a bad job of spray-painting).

**Prowriter:** 120 cps. 80 columns dot matrix compressable to 136. 10" carriage. Parallel or serial interface.

**Prowriter 2:** Same as Prowriter, except 15" carriage allows full 136 columns in normal print mode. Parallel or serial interface.



## THE STAR.

**The Starwriter F-10.** In short (or more precisely, in a sleek 6" high, 30-pound unit), it gives you more of just about everything—except bulk and noise—than any other printer in its price range. It's a 40 cps letter-quality daisy-wheel with a bunch of built-in functions to simplify and speed up word processing. It plugs into almost any micro on the market, serial or parallel.



## THE MASTER.

**The Printmaster F-10.** Does all the same good stuff as the Starwriter except, at 55 cps, the Master does it faster.



Distributed Exclusively by Leading Edge Products, Inc., 225 Turnpike Street, Canton, Massachusetts 02021.  
Call: toll-free 1-800-343-6833; or in Massachusetts call collect (617) 828-8150. Telex 951-624.

CIRCLE NO. 20 ON FREE INFORMATION CARD



Four times faster than any 300 bps modem, to be precise. With Hayes Smartmodem 1200, any computer with an RS-232C connection — such as the IBM Personal Computer, TRS-80™ or Apple® III — can communicate over telephone lines with other computer terminals or printers. Smartmodem 1200 connects directly to any standard telephone jack in the USA. Dialing can be Touch-Tone® pulse or both. It can even operate over multiline phone systems (PBX) to dial numbers, receive and transmit data, and disconnect — automatically. An internal speaker lets you hear the call being made and monitor its progress. That way you'll know immediately if the line's busy or you reach a

wrong number. And indicator lights keep you posted on the current operating status: modem ready, terminal ready, carrier detect, auto-answer and high speed.

Smartmodem 1200 is two modems in one. Like the original Hayes Smartmodem, it can communicate with other Bell 103 type modems at up to 300 bps. Plus it's a 1200 bps modem for communicating with the faster Bell 212A type modems. Unlike many 1200 bps modems, Smartmodem 1200 lets you select full or half duplex, for compatibility with time-sharing services or any other system you choose. Smartmodem 1200 allows you to access The Source.™ communicate with

your branch offices, or exchange programs with other computer users. In fact, it performs just about any communication function you can imagine, and can be program controlled using any language.

Smartmodem 1200. Another product in the Hayes Stack™ series that stands for quality and dependability. And all you need for communicating... fast!



Available at computer stores

nationwide. For the name of your nearest dealer write: Hayes Microcomputer Products, Inc., 5835 Peachtree Corners East, Norcross, Georgia 30092; or call (404) 449-8751.

## Smartmodem 1200. Gets you moving fast!

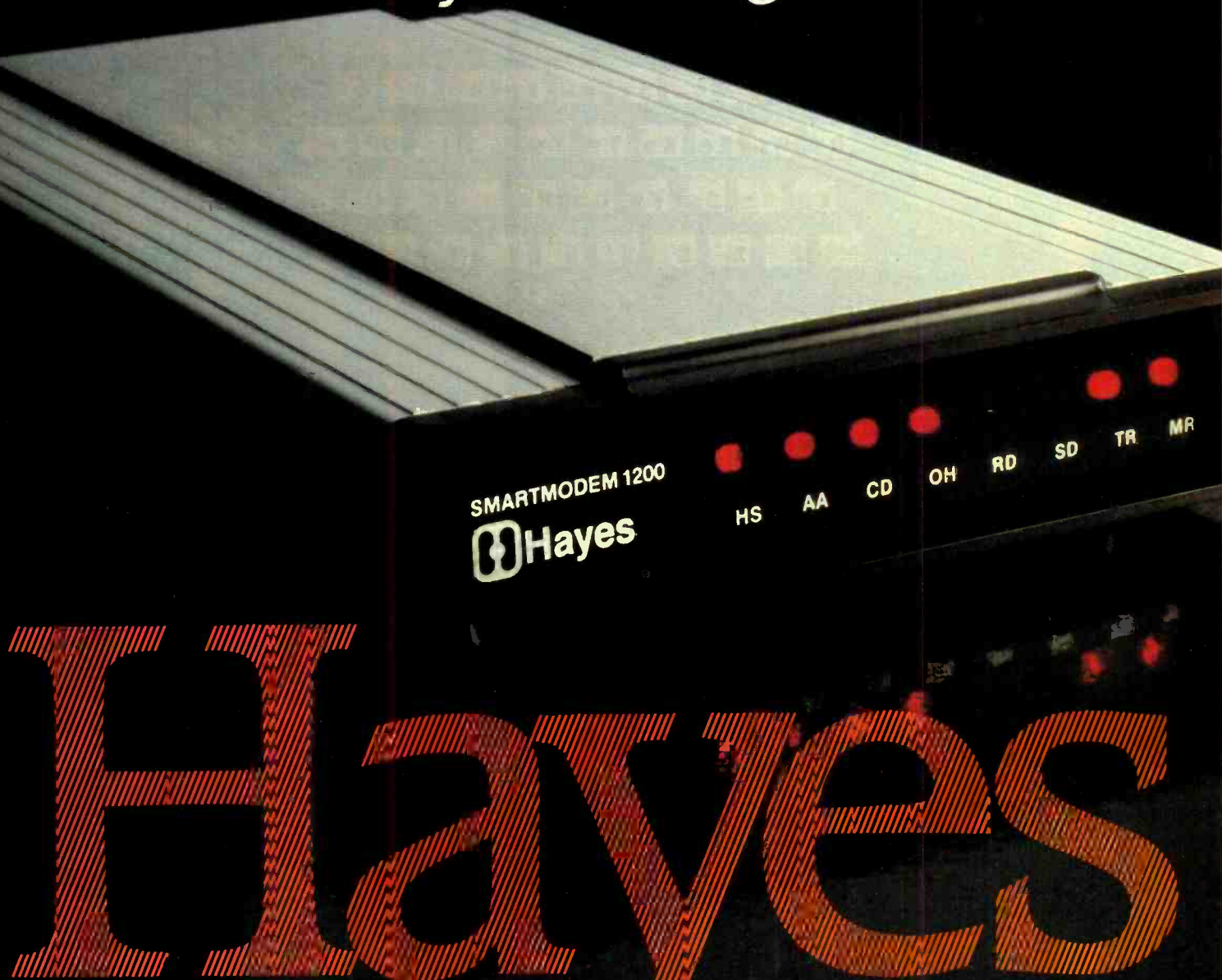

™ Trademark of Hayes Microcomputer Products, Inc. © 1982 Hayes Microcomputer Products, Inc. Sold only in the U.S.A. TRS-80 is a registered trademark of Tandy Corporation. Apple is a registered trademark of Apple Computer, Inc.

CIRCLE NO. 44 ON FREE INFORMATION CARD

Touch-Tone is a registered trademark of American Telephone and Telegraph. The Source is a service mark of Source Telecomputing Corporation, a subsidiary of The Reader's Digest Association, Inc.



# THE POWER IS WITHIN YOUR REACH.

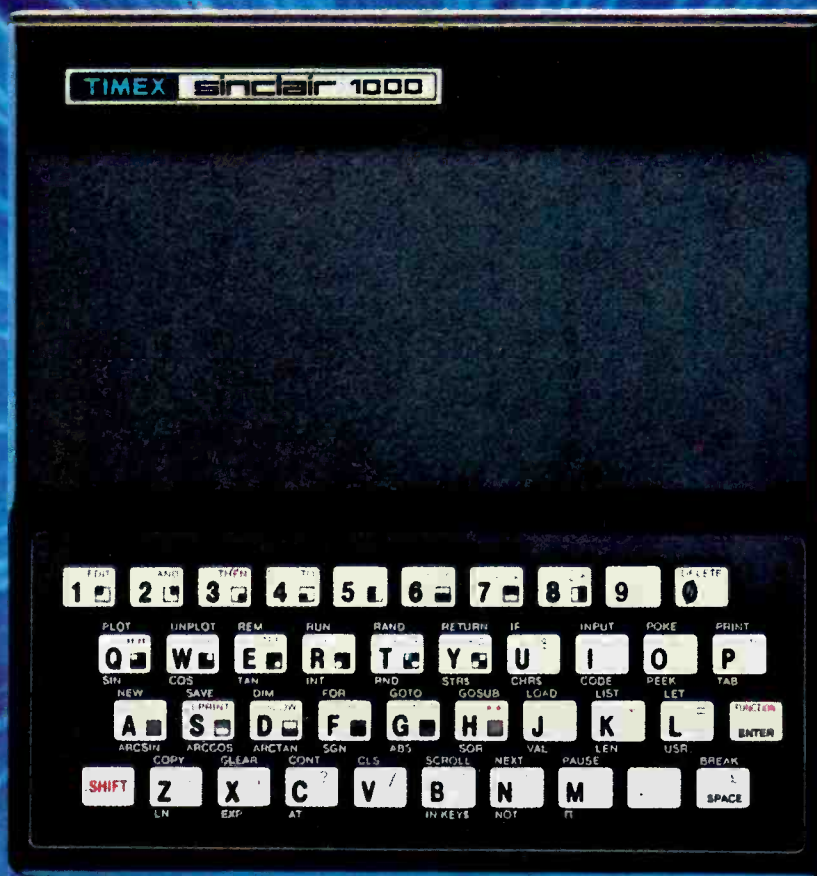

## TIMEX INTRODUCES THE POWER OF THE COMPUTER FOR JUST \$99<sup>95</sup>\*

**TIMEX Sinclair 1000**

This new computer from Timex represents a major breakthrough: a real computer at an almost unreal price. What makes it possible are our advances in microchip technology and computer circuitry. And, as technology increases, price decreases. It happened to the calculator. It happened to the digital watch. Now Timex has made it happen to the computer.

The Timex Sinclair 1000™ allows you to use your own TV as a display monitor, and your audio cassette

recorder for storing programs. For \$99.95\* you get everything else you need, including our step-by-step learning guide that'll have you running programs within hours. And writing them within weeks.

Pre-programmed cassettes for the Timex Sinclair 1000 are available on such subjects as education, finance and entertainment. And for \$49.95\* you can add an additional 16K RAM memory bank that will let you do further advanced programs.

The power of the computer is within your reach today. Visit your local retailer or call our toll-free

number 1-800-248-4639 for the Timex computer dealer nearest you.



**TIMEX COMPUTERS**  
**THE POWER IS WITHIN YOUR REACH**

\*Suggested retail price

© Timex Computer Corporation 1982



# Computers & Electronics

JANUARY 1983

VOLUME 21, NUMBER 1

## FEATURE ARTICLES

37 **THE NEW WAVE OF PERSONAL ROBOTS**  
*Hero, Model ET-18/The next step beyond microcomputers.*

46 **HERO 1, ROBOTMATE OF THE MONTH**  
*A Kind Human Being.*

48 **DO YOU NEED A SMART MODEM?**  
*Joe Desposito/Match a modem to your requirements.*

62 **WAR OF THE WORDS**  
*Stan Veit/Word-processing software for the IBM-PC.*

86 **A TRIO OF DESKTOP COMPUTERS**  
*Stan Veit/Apple III, Advantage, and Victor 9000.*

## CONSTRUCTION ARTICLES

56 **THE OPTIMIZED GRAPHIC EQUALIZER**  
*Joe Gorin/Part 2, The flatness analyzer.*

74 **BUILD AN INTELLIGENT THERMOMETER**  
*Tom Fox/Part 1, Measures and analyzes changes in temperature.*

## EQUIPMENT REVIEWS

97 **JVC MODEL HR-C3U PORTABLE VHS VIDEO CASSETTE RECORDER**

100 **SCOTT MODEL 458A INTEGRATED STEREO AMPLIFIER**

## COLUMNS

8 **COMPUTER VIDEO GAMES**

12 **LES SOLOMON ON COMPUTER HARDWARE**  
*Preparing a Standard for Minifloppies*

20 **STAN VEIT ON COMPUTER SOFTWARE**  
*Lotus 1-2-3 Word-Processing System.*



28 **EXPERIMENTER'S CORNER/Forrest M. Mims**  
*Experimenting with Kodak's Disc Camera  
Part 3, Radio Control and Aerial Photography*

82 **SOLID-STATE DEVELOPMENTS/Forrest M. Mims**  
*Keeping Up With the New Microprocessors.*

84 **COMPUTER HOTLINE/Stan Veit**

108 **ENGLISH BROADCASTS AUDIBLE IN NO. AMERICA/Glenn Hauser**

113 **PROJECT OF THE MONTH/Forrest M. Mims**  
*A Multifunction VMOS Oscillator*

## DEPARTMENTS

9 **EDITORIAL/Art Salsberg**  
*Royalty Is More Than Regal.*

10 **NEW PRODUCTS**

116 **OPERATION ASSIST**

125 **ADVERTISERS' INDEX**

126 **COMPUTER MART/ELECTRONICS CLASSIFIED**

COVER PHOTO BY JAY BRENNER

COPYRIGHT © 1982 BY ZIFF-DAVIS PUBLISHING COMPANY. All rights reserved. Computers & Electronics (ISSN 0032-4485) January 1983, Volume 21, Number 1. Published monthly by Ziff-Davis Publishing Co., at One Park Ave., New York, NY 10016. Richard P. Friese, President; Selwyn Taubman, Treasurer; Bertram A. Abrams, Secretary. One year subscription rate for U.S. and Possessions, \$15.97; Canada, \$20.97; all other countries, \$23.97 (cash orders only, payable in U.S. currency). Second Class Postage Paid at New York, N.Y. 10016 and at additional mailing offices. Authorized as second class mail by the Post Office Dept., Ottawa, Canada, and for payment of postage in cash. POPULAR ELECTRONICS including ELECTRONICS WORLD trademark registered. Indexed in the Reader's Guide to Periodical Literature. Ziff-Davis also publishes Boating, Car and Driver, Cycle, Flying, Popular Photography, Skiing, Stereo Review, Electronic Experimenter's Handbook, and Tape Recording & Buying Guide. **POSTMASTER:** Send address changes to COMPUTERS & ELECTRONICS, Circulation Dept., P.O. Box 2774, Boulder, CO 80302. Please allow at least eight weeks for change of address, enclosing, if possible, an address label from a recent issue. **Permissions.** Material in this publication may not be reproduced in any form without permission. Requests for permission should be directed to John Babcock, Rights and Permissions, Ziff-Davis Publishing Co., One Park Ave., New York, NY 10016.



# INTRODUCING the sophisticated

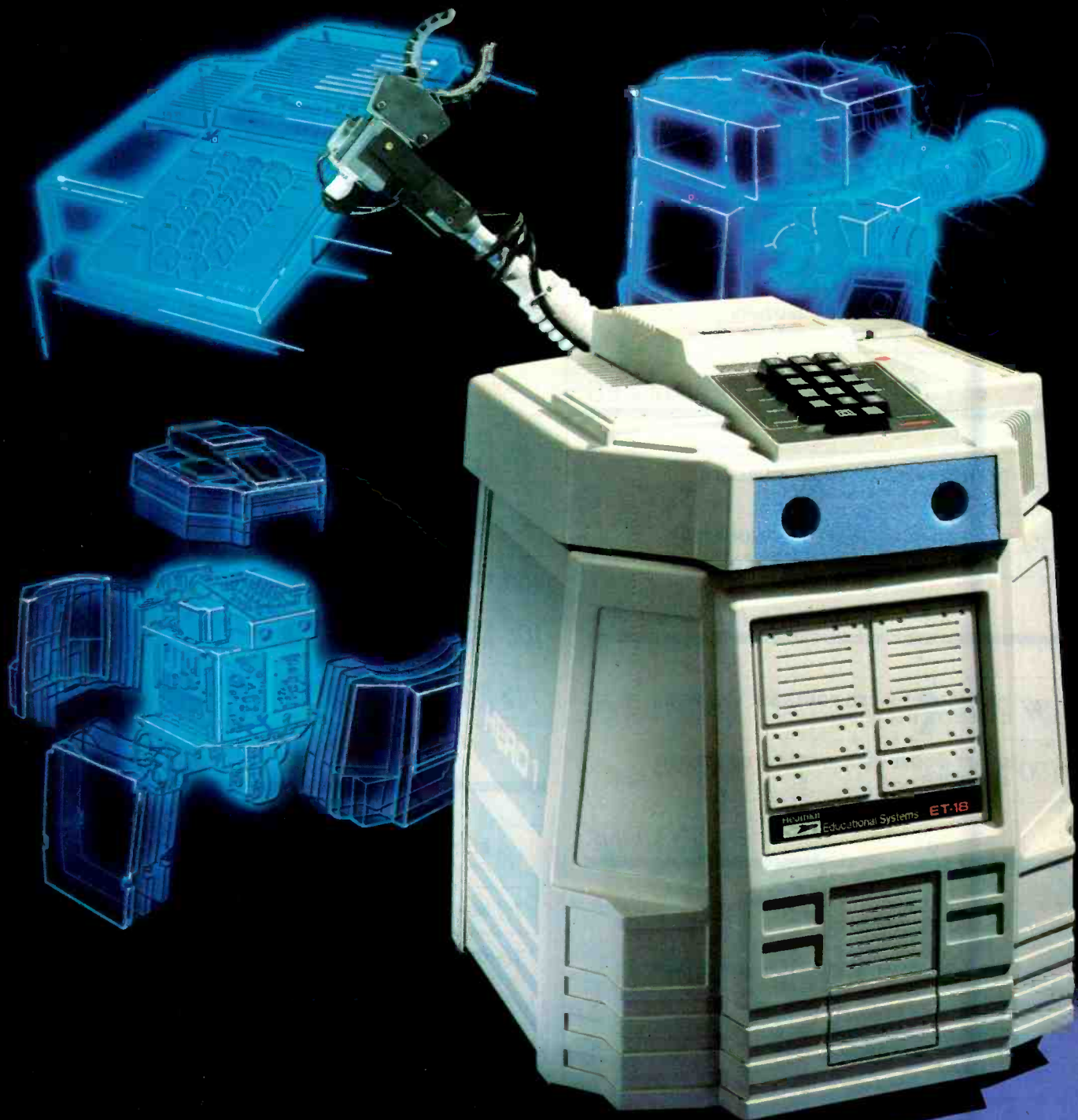



# World's first teaching robot...

**HERO<sup>1</sup>** the most important microprocessor-controlled device since the introduction of the microcomputer.

**Your new robot will move. See. Hear. Speak. and learn whatever you teach it.**

HERO 1 is a completely self-contained, electro-mechanical robot capable of interacting with its environment. Controlled by an on-board, programmable computer, it has electronic sensors to detect light, sound, motion and obstructions in its path.

The remarkable HERO 1 robot is in production now, ready for you. Buy assembled or build it from a kit. Either way, it's the **only** teaching robot in the world capable of demonstrating and performing every major function in robotics.

It is also remarkably inexpensive, with the complete kit available at \$1,500 and the assembled robot at \$2,500.

Capable of seven axes of motion, the robot can be programmed to pick up small objects with its arm. It will also speak in complete sentences, using its voice synthesizer.

With its own on-board computer, HERO 1 can function free of any external control — traveling over a pre-determined course and performing specific functions you have programmed.

**Remarkable though the robot is, its companion Robotics Education Course** is an even more significant "first." It provides a thorough understanding of robot technologies, including robotics programming.

Consisting of a 1,200-page text divided into eleven learning units, this course is the most complete introduction to robotics available today.

The robot brings the learning process to life with hands-on reinforcement of the principles as you learn them. You quickly get a practical grasp of industrial electronics, mechanics, computer theory and programming as applied to robots by putting them into action.

**Essentially, HERO 1 is a computer on wheels.** You teach it. It teaches you. HERO 1's only limitations are your imagination and ingenuity in programming, as you challenge its capabilities.

Its onboard processor can take it through complex maneuvers. The programming process is straightforward with provision for step-by-step debugging, enhancement and other corrections.

HERO 1 senses include: sound detection (frequency range 200-5000 Hz); light detection; Ultrasonic ranging (range resolution 1/4 inch to 8 feet); ultrasonic motion detection; speech synthesis; and real-time, four year calendar clock.

A completely mobile platform robot, HERO 1 motion abilities permit head rotation and arm rotation of 350°; shoulder rotation of 150°; arm extension of 5 inches wrist pivot of 180° and wrist rotation of 350°. Gripper will open to a maximum of 3 1/2 inches and rotate 90° at extreme extension. Payload capacity of arm is 8 oz. at maximum extension and 16 oz. at normal.

HERO 1 uses a 6808 microprocessor that controls 13 functions and sense boards. Programmable through keypad, teaching pendant, or cassette interface, the robot features multiple operating modes including program, repeat, learn, manual and sleep.

**Complete information on HERO 1 robot and course is now available in the January Heathkit Catalog. If you are not presently receiving a catalog, fill out and mail the coupon below. Or pick one up at your local Heathkit Electronic Center.\***

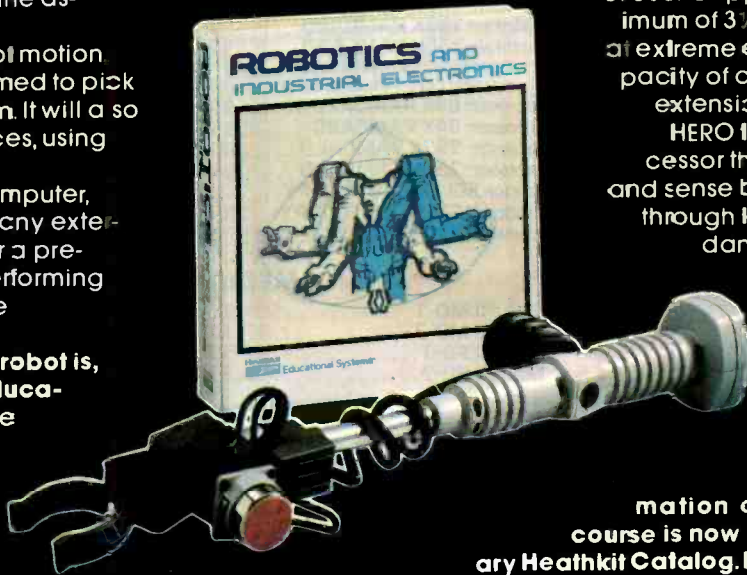

**Heathkit<sup>®</sup>**  
Heathkit/Zenith  
Educational Systems

CIRCLE NO. 28 ON FREE INFORMATION CARD

Please send details on the HERO 1 Robot and robotics course.

Mail to: Heath Company, Dept. 010-978  
Benton Harbor MI 49022

Name \_\_\_\_\_

Address \_\_\_\_\_

City \_\_\_\_\_

State \_\_\_\_\_ Zip \_\_\_\_\_

\*(Robots will be in the store in January).

RO-102A



# GREAT PRICES!

## COMPUTERS

TIMEX .....	\$89
FRANKLIN W/ monitor .....	1098
VIC 20 .....	189
CALIFORNIA .....	
COMPUTER SYSTEM .....	CALL!
INDUST. MICRO SYSTEMS .....	CALL!
MORROW MICRODECISION .....	CALL!

## PRINTERS

Smith Corona TP-1 .....	\$599
C Itoh PROWRITER-P .....	489
C Itoh PROWRITER-S .....	639
C Itoh PROWRITER 15" .....	789
C Itoh F-10 .....	1399
C Itoh F-10 TRACTOR .....	229
OKIDATA 80 .....	359
OKIDATA 82A .....	489
OKIDATA 83A .....	739
OKIDATA 84A .....	1179
IDS PRISM 132 .....	1649
4 color, 200 cps, auto-sheet feeder, graphics	
IDS PRISM 80 .....	789
IDS MICROPRISM .....	599
ANADEX 9501 .....	1299
MICROFAXER 32K S-S .....	269
MICROFAXER 32K P-P .....	199

## TERMINALS & MONITORS

ADDS VIEWPOINT .....	\$559
AMDEK VIDEO 100 .....	99
AMDEK VIDEO 100G .....	137
AMDEK VIDEO 300 .....	179
AMDEK COLOR I .....	399
AMDEK COLOR II .....	719
TELEVIDEO 910 .....	649
TELEVIDEO 912C .....	799
TELEVIDEO 920C .....	868
TELEVIDEO 925 .....	825
TELEVIDEO 950 .....	949

## GAMES

SPACE CADET .....	\$29
SNACK ATTACK FOR IBM .....	39
NEMESIS .....	39
DUNGEON MASTER .....	39
ANALIZA II .....	39

## APPLE HARDWARE

Videx VIDEOTERM .....	\$299
Videx KEYBOARD ENHANCER .....	119
Microsoft Z-80 SOFTCARD .....	279
Microsoft 16K RAMCARD .....	149
Microsoft PREMIUM PACK .....	599
Includes: Z-80 Softcard, 16K Ramcard, Videx Videoterm, and CPLM USER GUIDE.	
RANA I-163K .....	\$379
RANA II-326K .....	529
RANA III-652K .....	699
RANA with controller additional .....	99
Hayes MICROMODEM II .....	289
SVA 256K APP-L-CACHE .....	949
Mountain MULTI I/O .....	178
Mountain SUPERTALKER .....	262
M&R SUPERFAN .....	38
GRAPPLER PLUS .....	125
PKASO .....	135
CCS .....	129
Asynchronous interface	
CCS .....	149
Synchronous interface	
CCS Calendar Clock .....	105
CCS Printer interface .....	129

## IBM ACCESSORIES

Quadram 128K RAMCARD .....	599
Quadram 192K RAMCARD .....	669
Quadram 256K RAMCARD .....	669
Quadram includes RS232, parallel port, real time clock	
Microsoft 64K RAMCARD .....	399
Microsoft 64K RAMCARD .....	599
Microsoft 192K RAMCARD .....	699
Microsoft 256K RAMCARD .....	799
Tandon SGL. SIDED FLOPPY .....	249
Tandon DBL. SIDED FLOPPY .....	289
Davong HARD DISK SYSTEM .....	1599

## MEDIA

Maxell MD-1 .....	\$31.25
Maxell MD-2 .....	47.10
Maxell FD-1 .....	41.50
Maxell FD-2 .....	48.95

## MISC. SOFTWARE

MATHEMAGIC .....	\$79
GRAPHMAGIC .....	79
DIAGNOSTICS II .....	84
DISK DOCTOR .....	84
UTILITIES I, II .....	53

## WORDPROCESSING

WORDSTAR .....	\$279
MAILMERGE .....	149
SPELLSTAR .....	144
PERFECT WRITER .....	239
PERFECT SPELLER .....	139
WORD HANDLER .....	199
SPELLBINDER .....	279
SPELLGUARD .....	179
EASYWRITER II .....	269
EASYSPELLER .....	159
PIEWRIter .....	123
WORD PLUS .....	129
MATHSTAR .....	99

## DATA BASE MANAGEMENT

dBASE II .....	\$529
PERFECT FILER .....	279
EASYFILER .....	349
FMS 80 .....	750
TIM III .....	399
FAST GRAPH .....	189
THE ANSWER .....	219
QUICKCODE .....	229
dUTIL .....	68
D GRAPH .....	239
DATASTAR .....	171
SUPERSORT .....	145
VISIFILE .....	228
VISIDEX .....	184

## FINANCIAL SOFTWARE

EAGLE MONEY DECISIONS .....	\$119
SUPERCALC .....	189
PLANNER CALC .....	69
MASTER PLANNER .....	249
MULTIPLAN .....	219
PERFECT CALC .....	139
VISICORP VISICALC .....	184
DEKTOP PLAN .....	184
VISISCHEDULE .....	228
VISITREND/PLOT .....	228
SCRATCHPAD .....	259
STATSGRAPH .....	169

## ACCOUNTING SOFTWARE

ACCOUNTING PLUS .....	\$385
ACCOUNTING PLUS II .....	299
For Apple II	
EASY EXECU. ACCOUNTING .....	579
TCS .....	79
THE HOME ACCOUNTANT .....	129
IUS-IBM ACCT. SYS. ....	CALL!

## LANGUAGES

Microsoft BASIC COMPILER .....	\$299
Microsoft BASIC INTERPRETER .....	279
Microsoft FORTRAN 80 .....	379
Microsoft COBOL 80 .....	559
Microsoft muSIMP/ muMATH .....	199
Microsoft TASC .....	149
Supersoft ADA .....	269
Supersoft FORTH .....	149
Supersoft A.L.D.S. ....	99
Supersoft FORTRAN/RATFOR .....	284
Sorcim PASCAL M. ....	129
Whitesmith's C .....	690
Whitesmith's PASCAL .....	850

**CALL TOLL-FREE**  
**1-800-523-9511**  
**IN PENNSYLVANIA**  
**1-215-868-8219**

# NEW PRODUCTS!

## MICROPRISE SYSTEM

MICROHOUSE has designed a package, fully compatible with APPLE hardware and software. The MICROPRISE SYSTEM is a great system at a great price. Everything necessary is included ... even a page, step by step instruction sheet to put it all together.

ENTER THE MICROPRISE SYSTEM.	
ANKLIN ACE 1000 .....	\$1595
17" GREEN PHOSPHOR MONITOR .....	125
WITH CORONA-LETTER QUALITY PRINTER .....	700
5.25" DISK DRIVE W/CONTROLLER .....	579
INTERFACE .....	150
PHYSICAL .....	250
BOX OF DISKETTES .....	50
MISC. CABLES .....	60
BURN IN / TESTING .....	100
STEP-BY-STEP INSTRUCTIONS .....	N/C
TOTAL LIST PRICE .....	<b>\$3634</b>
<b>MICROHOUSE PRICE</b> .....	<b>\$2699</b>

DICTRONICS PUBLISHING, INC.

## RANDOM HOUSE ELECTRONIC THESAURUS

THE RANDOM HOUSE ELECTRONIC THESAURUS IS THE FIRST REFERENCE SOFTWARE THAT ALLOWS YOU TO DO "IDEA PROCESSING" WITHIN YOUR WORD PROCESSOR BASED ON THE POPULAR RANDOM HOUSE THESAURUS. IMPROVES YOUR WRITING SKILLS BY FINDING THE RIGHT WORD YOU NEED AND INSERTING IT IN THE TEXT. THE 60,000 SYNONYM VERSION REQUIRES 204K. ABRIDGED VERSIONS AVAILABLE FOR 80K AND 125K.

LIST PRICE: \$150.00

**MICROHOUSE PRICE: \$129.00**

## PROOF READER

PROOF READER ALLOWS ACCESS TO THE RANDOM HOUSE DICTIONARY WITH FULL INTERACTIVE CORRECTION TO CHECK ALL YOUR SPELLING ERRORS. CP/M VERSION ALLOWS ACCESS UP TO 50,000; IBM VERSIONS ALLOWS ACCESS UP TO 32,000 AVAILABLE WORDS.

LIST PRICE: \$ 50.00

**MICROHOUSE PRICE: \$39.00**

## INFOSTAR

MICROPRO

MICROPRO'S DATABASE MANAGEMENT SYSTEM. NOT ONLY COMBINES THE ALREADY RENOWNED FEATURES OF DATASTAR AND SUPERSORT BUT ALSO FEATURES A REPORT GENERATOR. THIS MEANS YOU CAN ENTER, SORT, RETRIEVE, ORGANIZE, AND PRINT DATA QUICKLY AND EASILY...AND WITH NO NEED TO PROGRAM! BUT THAT'S NOT ALL...YOU CAN EDIT YOUR REPORTS WITH WORDSTAR, THE WORLD'S #1 WORDPROCESSOR.

LIST PRICE: \$495.00

**MICROHOUSE: CALL!**

## CALL MICROHOUSE FOR MORE NEW PRODUCT INFORMATION AND PRICING.

WORDSTAR, DATASTAR, SUPERSORT, INFOSTAR ARE TRADEMARKS OF MICROPRO, INC. RANDOM HOUSE IS A REGISTERED TRADEMARK OF RANDOM HOUSE, INC. THE RANDOM HOUSE ELECTRONIC THESAURUS IS A TRADEMARK OF RANDOM HOUSE INC. DICTRONICS PUBLISHING INC. EXCLUSIVE LICENSEE. IBM IS A REGISTERED TRADEMARK OF INTERNATIONAL BUSINESS MACHINES. CP/M IS A REGISTERED TRADEMARK OF DIGITAL RESEARCH.

PRICES MAY VARY WITH DIFFERENT FORMATS. ALL PRICES AND SPECIFICATIONS ARE SUBJECT TO CHANGE WITHOUT NOTICE. PLEASE CALL OR WRITE FOR SPECIFICS.

1444 LINDEN ST./BOX 499 BETHLEHEM, PA 18016

**DEALERS INQUIRIES WELCOME**

**WE WANT YOU TO KNOW ...**

# MICROHOUSE



# COMPUTER VIDEO GAMES

## Hands-on Reviews of the Latest Computer Game Software

### SERPENTINE

Broaderbund Software. Arcade game for Apple II and Atari 800. \$34.95

Here's a hi-resolution maze game that's almost as much fun to watch as to play. Smooth animation techniques give a near-lifelike appearance to the movement of both player's and computer's snakes—which resemble cute and furry blue, orange, or green caterpillars.

According to the game background, the maze on-screen represents the ruined corridors of a vanished civilization wherein giant snakes rule the land. Puny humans tame these snakes and, riding astride them, do battle with their scaly steeds' more wild brethren.

But you'll only see a human during play if you look in a mirror, because on-screen it's just snake against snake. With joystick, paddle or keyboard control you guide your blue serpent through the maze. You try to catch up to the larger, orange serpents in order to chomp sections off their tails and thereby, gain points.

Only sneak up from behind, as going head-to-head against a larger snake will mean your own snake's death.

But, as you whittle down your opposition, you can also be eating eggs laid by your enemies as well as dizzily hopping frogs—both of which make you grow longer. And, when you're longer than your enemies they turn green (with envy?) and then you can chomp 'em down from both ends. Meanwhile, you may even lay an egg or two for additional reinforcement snakes on a higher level.

I found *Serpentine* to be almost hypnotic, as your eye is captured by the slithery, colorful movements. Highly recommended and unique.

### FACEMAKER

Spinnaker Software. Educational game for Apple II.

If you have a pre-schooler as well as a computer, you've probably faced the same puzzle I have in that situation: How can you introduce a tyke who does not read to the wonders of computing? This new game seems the best way yet.

The first few prompts, as to sound capability and background color, can be answered by Mommy or Daddy. But from then on, the little kid can be in complete charge because the program is structured so that there is no need for reading. Just learning about use of the space bar and return key is all that is needed for the easiest level of the three on-disk games.

In the first game, the child builds a face. A blank oval is drawn on the screen and to the left of the oval is a pictorial menu display of a nose, eyes, mouth, ears, and hair. By hitting the space bar, the number above each picture turns inverse. When this visual cue is seen, the child knows which choice he or she has picked. Hitting the return key displays a secondary menu of cartoonish choices—for instance, a dozen sets of hilarious eyes to choose from. And, again, the choosing is done with the space bar. When the final choice has been made, another tap of the return key instantly draws the shape in the

right point on the oval to begin the face. In like manner the rest of the face is drawn in.

At this point, the second game lets the child animate the face he has built. Completely different commands give him control over the face's its tongue. The T will stick out will make it wriggle its ears; F smile; C will cry; S will make it will, of course. The nonreader here but it wires a little help our three-year-old how soon controls herself onto these

In this same also write a simple child can the space bar puts. Hitting program the face to program twice, frown twice a would which it would do, cry return. ll of

The final game is a hit style guessing game. The child makes the face go high and the child must hit the commands to mimic what the puter has done. A successful mimicking causes the caputer to add one more routine to the next challenge.

All in all, this is one of the very few educational programs I have seen for the early pre-schooler where the child can assume an active instead of a passive mode—and have a good deal of fun doing so. ♦



*Serpentine* (above)



*Facemaker* (right)

The QX-10.  
It won't make you  
any smarter,  
it'll just  
make you feel  
that way.

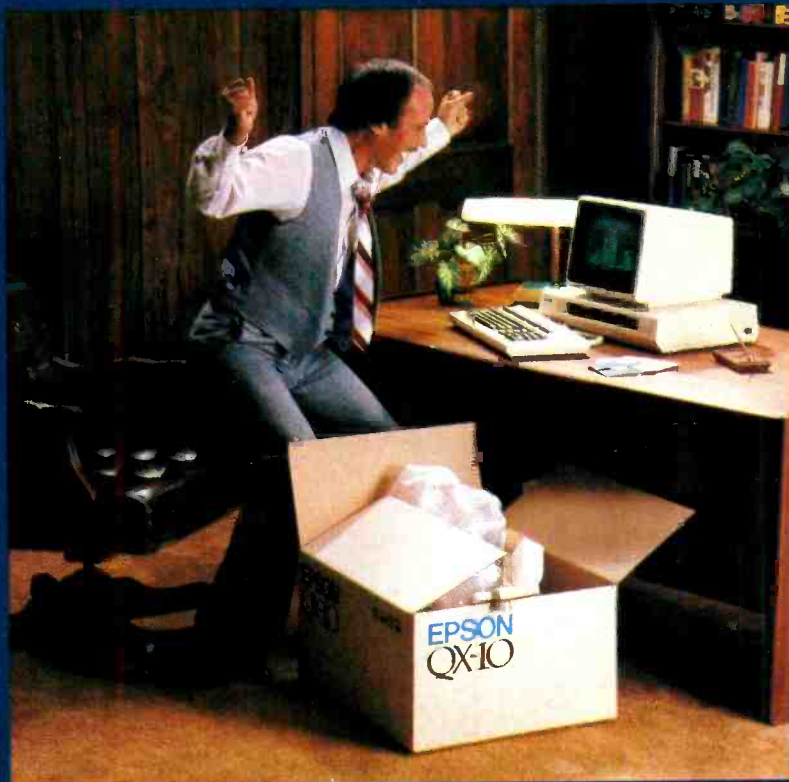

**EPSON**





That, of course, was the promise nearly all computer manufacturers made to us.

But along the way, the promise was unfulfilled.

People found out that even the simplest computer languages were as troublesome and time-consuming as high school French — fine if you like that sort of challenge, but a real barrier if what you want to do is *use* a computer, as opposed to *learning* to use a computer. A lot of people found they could live their whole lives without ever knowing what GOSUB, LOGIN, or MID\$ meant.

**The first anybody-can-use-it computer.**

That, in a nutshell, is what makes the Epson QX-10 the most astonishing breakthrough in personal computer technology ever. Not only does it have some of the most advanced hardware available on the market today, it is a system that requires no computer classes, no study, no lectures, no books; a system you can *use*, right out of the box, backed by little more than logic, intuition and native intelligence.

It's a software system called VALDOCS. And it's designed on a whole new standard to make serious, useful computing no more difficult than typing. Someday all computers may be built this way. But for now, there's only one.

The Epson QX-10.

**The manageable manager.**

The QX-10/VALDOCS system was designed

from the very beginning to handle the details of *human* existence in a remarkably straightforward, accessible, *human* manner. For all intents and purposes, it has already built into it all the software you will *ever* need to successfully manage the details of your life.

Consider what the standard configuration of VALDOCS will do:

- It's a full-function, sophisticated *word processor*;
- an information *indexer* for easy access to *files*;
- an *address book*;
- and an *electronic mail system*.
- It's also a *calculator*;
- an *appointment book* and *notepad*;
- an *event timer*;
- and a *clock and calendar*.
- It gives you an automatic *list of "things to do"*
- and lists your *schedules and itinerary*.
- Finally, it's a *business graph drawing system*.

That's what it does right out of the box; what you can make it do within minutes of unpacking it. Without buying additional software or writing your own programs in what amounts to a foreign language.

It's like suddenly being a computer expert; suddenly being smarter. You can do in minutes — and often with a single key — what may have



taken users of other systems days to learn, or hundreds of dollars in supporting software to accomplish.

You're overcome with an unmistakable feeling of power.

Simply stated, what the QX-10 does better than any other personal computer system in existence is to free you from manipulating the *computer*, and allow you to manipulate *information*.

And, after all, isn't that what you want a computer for?

#### **The keyboard is the key.**

The HASCI keyboard — short for Human Applications Standard Computer Interface — has been designed to place important fundamentals like STORE and RETRIEVE in plain view on dedicated function keys. Virtually every program in other computers does these fundamentals differently, and how to do these functions is hidden right down with the most obscure technical details.

#### **The VALDOCS system.**

What VALDOCS does better than any other software system currently available is to take the "interactive" concept to its logical conclusion; it asks you to make choices, then executes commands based on your decisions.

The *common sense* of such a system reduces the amount of time needed to master the QX-10 to a fraction of that needed for other computers: in

effect it displays the message, "Press this key to perform this function; press that key to perform that function; or press another key to move on to something else."

No brochure, of course, can do justice to the VALDOCS system; to fully appreciate it, you must sit down at a QX-10 and *experience* it. But to appreciate the range of its capabilities, examine them one by one.

#### **Word processing.**

When you turn the QX-10 on, it comes to life as a word processor. And as such, it does everything you'd expect a word processor to do.

Of course you can add and delete words and sentences; shift copy blocks from one place to another; even locate a specific word or thought on documents ranging from a few words to multiple pages.

That's where most word processors stop. But not the QX-10.

The QX-10 allows you to format *exactly* the way you'd like your document to appear in print. So when you press the key labelled ITALICS, the type *on the screen* changes to italics; when you press BOLD, it changes to boldface. With the QX-10, you can vary the SIZE of the type and even change the STYLE.

So when you press PRINT, your document is printed exactly the way you've already seen it on the screen. What you see is what you get!



### Scheduling.

Scheduling, in its essence, is the manipulation of time. And the QX-10 makes it easy in a way that no appointment book, or calendar, or list of things to do ever could.

To begin with, the QX-10 always knows what time it is. The internal clock/calendar has a battery backup which keeps track of the date and time, even if the computer has been unplugged.

As a scheduler, the QX-10 works like a desk calendar, but gives you instant, electronic access to dates and times, past, present and future. It automatically opens to today's electronic "page," it allows you to make appointments, jot down notes and reminders, list things to do, or

even set an alarm for yourself.

Most important — and useful — the SCHEDULE function is always available. If you're typing a letter in the word processing mode, for example, you can stop in the middle and book an appointment just by pressing the SCHED key; pressing it again returns you to the word processing mode, *right where you left off.*

### Calculating.

To simplify the entering of numeric data, the QX-10 has a separate 10-key pad that lets you add, subtract, multiply and divide. Just like a calculator. Its decimal tab key allows you to automatically align columns of numbers. But the QX-10 can sum the numbers within a document



being word processed or place the total of a calculation at any point within a document. *That's* the sort of thing that makes the QX-10 usable.

### Graphics.

Generally speaking, pictorial information (charts and graphs) is a lot easier to digest than numeric information (columns of figures). Fortunately, the QX-10 makes graphics very, very simple.

In the DRAW mode, the QX-10 allows you to create a line graph, a bar graph, or a pie chart. Based on your choice, it will ask you for pertinent information such as the names, range and intervals for each axis, and the numeric value of each data point to be charted or graphed. Once all the information is entered, it will automatically plot

the coordinates and draw the graph, even superimposing different types of data on the same graph. It couldn't be easier.

### Filing.

The block of File Control keys on the HASCI keyboard allow you to do everything you need to do with a finished document: STORE it; RETRIEVE it; MAIL it to someone else's computer electronically; or PRINT it on the printer. Each with the stroke of a single key.

But those functions can't hold a candle to the power of INDEX. In the QX-10/VALDOCS system, every document, every graph — *everything* is indexed by up to *eight* keywords of your choice. And instantly available.





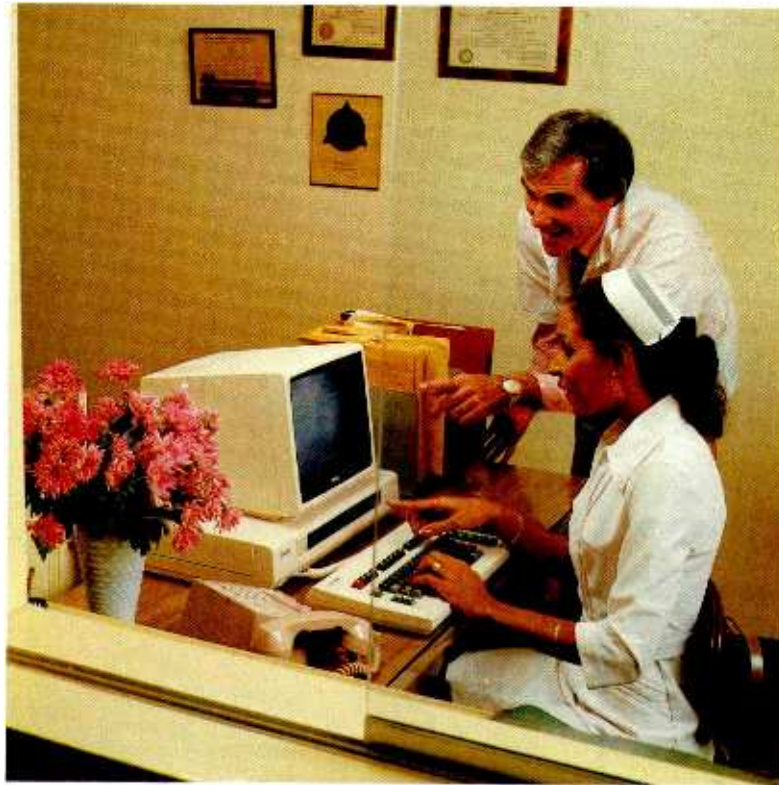

Here's how it works: for every file, you assign a name up to eight words long. Like "Mom's Recipe for Thanksgiving Pumpkin Pie from Scratch," or "Personal Financial Statement for SBA Loan Application." When you need to, you can retrieve any file, using one or more of the keywords you assigned in the name. For example, "Mom's Recipe," "Thanksgiving," "Financial Statement," or "SBA," will give you all the documents having to do with those topics.

And *that* is the most astonishing and *useful* filing system you're ever likely to run across.

#### **Electronic mail.**

On the QX-10/VALDOCS system, sending information to, or receiving information from another computer starts with a single key. It provides you, in effect, with electronic "in" and "out" baskets, gives you an "address book" of your correspondents, even allows you to schedule transmission times to coincide with less expensive telephone rates. Best of all, VALDOCS handles all your electronic mail functions without interfering with any of the other computer functions. So you can word process, calculate or graph while VALDOCS handles your mail.

#### **System controls.**

Say you're in the middle of a project and you don't know what to do next; or you give the computer a command and then wish you hadn't; or

you want to stop some function the computer is performing — now. VALDOCS makes it easy.

The HELP key is always available to you, and can be pressed any time the system offers you a choice. The STOP key immediately stops whatever function the computer may have been performing; the UNDO key undoes the last thing you told it to do — so you can *un*-select a function, or even *un*-delete a file.

#### **CP/M compatibility.**

The Epson QX-10 has a side benefit that's going to make it very popular with some people — it's CP/M 2.2 compatible. Which means that most any CP/M software you have — or would like to have — will run on the QX-10. Most of these will be accessible under the MENU key which displays a menu of all the non-VALDOCS programs on file, in English, and lets you select the one you wish to run.

#### **State-of-the-art hardware.**

Up to now, we've only talked about what the QX-10/VALDOCS system *does* for you, because after all, *what* a computer does is far more important than *how* it does it.

But in order to create a system like the QX-10, we've had to come up with some of the most advanced — and spectacular — hardware on the personal computer market.

When you unpack the QX-10, here's what you get: a detachable HASCI keyboard with its own

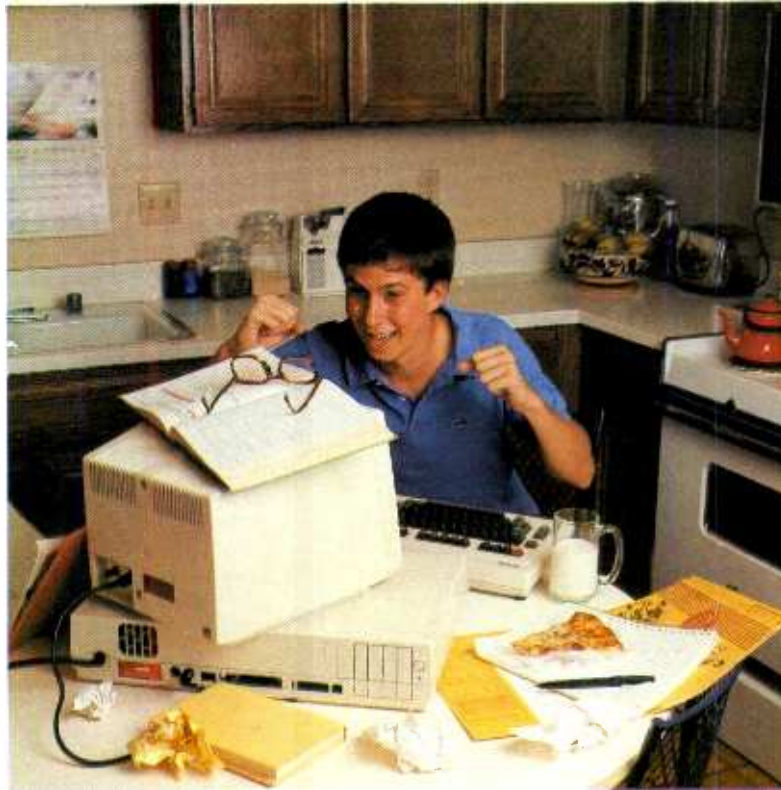

processor; an ultra high resolution monochrome display; two ultra thin 5 $\frac{1}{4}$ " disk drives with a capacity of 340K bytes per disk; a Z80 microprocessor with 256K of main memory; a separate display processor chip with 128K of video-dedicated memory; a DMA controller; an interrupt controller; a built-in calendar/clock with battery back-up, an RS-232C interface; a parallel printer interface; a light pen interface; internal space for up to five peripheral cards; and the VALDOCS software package.

All that for *under* \$3,000.

Frankly, none of the so-called "third generation" microcomputers will do for you what the QX-10/VALDOCS system will do. And all of them cost more; some of them cost a lot more.

But for the price, none are more advanced.

The QX-10 video display features both bit mapping and the more usual character operation. The bit mapping allows multiple type fonts or high resolution graphics to be displayed on the screen in a remarkable 640 by 400 dot format — a feature available in only a few of the world's highest-priced systems. To get this performance, we turned to a new 16-bit video controller chip from NEC to give us the additional "oomph" we needed. But the central processor is the 8-bit Z-80, instantly compatible with the world's largest base of software — CP/M. Our five expansion slots are not used for *any* of this performance.

### **Relax—it's from Epson.**

Epson is best known in the U.S. for its full line of printers. We're known for the fact that every third dot matrix impact printer sold in this country has our name on it; for the fact that we make more printers and print mechanisms than all the other manufacturers in the world combined; and for the fact that Epson printers have a reliability rate of over 98%.

But that doesn't mean we're new in computers. Not by a long shot. Epson has been building and selling fine quality business computers in other countries since the 1970's, and we have a history of precision manufacturing dating back more than a hundred years.

### **The most important component is you.**

You don't buy a computer for how "smart" it is. You buy one for how smart it makes you.

The Epson QX-10 was conceived, designed, engineered and built with just one thought in mind: to vastly expand your ability to see, to think, to create with a system that acts as a natural extension of the human mind.

And the critics agree the design concept is one of the best they've seen.

The QX-10 is not a computer designed to play games, although it plays games as well as any and better than most.

It's a computer for people who think.

And who want to think better.





## SPECIFICATIONS

<b>CPU and Memory</b>		<b>Interfaces</b>	
Main CPU	Z80A Microprocessor, 4 MHz Clockrate	Serial	RS-232 Programmable, DB-25 Connector, Synchronous or Asynchronous
Main Memory	64K to 256K RAM	Printer	Standard Parallel
CMOS Memory	2K RAM Battery Backup	Light Pen	
IPL	Up to 8K	Option slots	Five
<b>Controllers</b>		Speaker	Controlled by Countertimer
Video/Graphic	NEC 7220 Graphic Display Controller	<b>Environmental Requirements</b>	
Disk	Double Density Floppy Disk Controller	Temperature	Operating Range 41° to 104°F (5° to 40°C)
DMA	Programmable DMA Controllers 1 Main System } 7 DMA Channels 1 Option Slot }	Humidity	Storage Range 22° to 158°F (-30°C to 70°C)
Interrupt	Programmable Interrupt Controllers (15 Interrupt Levels)		Operating Range 10% to 80% Non-Condensing
Control/Timer	Two Programmable Interval Timers		Storage Range 10% to 90% Non-Condensing
Printer I/F	Programmable Parallel Interface	<b>Physical Characteristics</b>	
Serial I/F	Multi-Protocol Serial Controller	Size	<b>CPU</b> <b>Monitor</b> <b>Keyboard</b>
Clock	CMOS Realtime Clock/Calendar with Battery Backup	Width	20.3 in (508mm)                      12.4 in (312mm)                      20 in (510mm)
<b>Display</b>	12" Green Monochrome High-Resolution Monitor 640 x 400 Pixels 80 characters x 25 lines Non-Glare Screen Dedicated Memory 32K or 128K	Depth	13.6 in (340mm)                      13.6 in (340mm)                      8.9 in (224mm)
<b>Mass Storage</b>	Two 5¼-inch, Double Sided Floppy Disk Drives; Capacity: 340K Per Disk	Height	4.1 in (103mm)                      10.6 in (266mm)                      1.9 in (49mm)
<b>Detachable Keyboards</b>	ASCII HASCII	Weight	20.6 lb (9.4kg)                      12.1 lb (5.5kg)                      5.5 lb (2.5kg)
		<b>Power Requirements</b>	115 VAC, 60 Hz; with Switching Power Supply 100 Watts

Specifications subject to change without notice.

**EPSON**  
EPSON AMERICA, INC.  
COMPUTER PRODUCTS DIVISION

3415 Kashiwa Street • Torrance, California 90505 • (213) 539-9140



Royalty Is More Than Regal

Do you copy LP records onto audio tape? TV programs onto video tape? Computer programs onto blank floppy disks? If you do any of these things, there are people out there who say it's illegal, immoral, or fattening. Furthermore, those involved in creating the original material are crying for a royalty income of some sort if their works are copied without appropriate permission.

How do you police people to prevent them from doing these things in the privacy of their homes for personal use? You don't, spelled "can't." The next best thing (in fact the better thing from the originator's viewpoint) is a royalty tax to be paid by all buyers of the original material whether they make copies or not.

On the video front, legal action launched against Sony and others related to record-

ings made with Sony's Betamax video cassette recorder has reached the U.S. Supreme Court. The plaintiffs, which include Walt Disney Productions, claim that it's illegal to record copyrighted material from TV broadcasts. They'll doubtlessly settle for a royalty (tax) on blank video cassette tapes, on the VCR's, or both. Should their claims be sustained, higher costs will follow the laws of nature: fewer sales.

I had hoped that the video challenge would be squashed by having it fall under a 1970's congressional bill that pointedly excluded audio tape recordings for personal use from copyright coverage. In a recent session of Congress, however, the Record Industry seems to have induced legislators to propose a bill in the House of Representatives (H.R. 5705) and an amendment in the Senate (Amendment 1333) that would impose a royalty on purchase of audio tape and audio tape recording machines.

To fight this effort, a diverse group established the Audio Recording Rights Coalition (ARRC), which commissioned a research company to conduct an in-depth survey of U.S. audio tape recording habits based on 1018 telephone interviews. Some conclusions make a strong argument against imposition of any sort of royalty or tax.

For example, the majority of home tape recordists (57%) said they often or sometimes buy a record after taping a borrowed work. Seventy-five percent of music tapers mentioned portability as a very important reason for taping. Recordings of one's own records are used for car stereo tape and "Walkman"-type players, where half of their total listening of tapes is done. In most instances, prerecorded tapes do not fill the bill since many albums are not available in this format, while one-third mentioned inferior quality of such tapes as compared with home recordings. The survey also found that

51% of music tapes made from records were already owned by the recordist.

Sales of records have diminished in recent years, but it is unlikely that the major cause is music lovers taping each others' records to avoid buying them. A more probable cause is that youngsters are spending much of their money in game arcades and for video game cartridges, as well as doing some off-the-air taping of favorite music selections.

To penalize everyone with higher prices to pay royalties to the record industry would do more harm than good, I believe. Firstly it would be unfair since most people do not use their tape machines in the so-called infringement manner suggested. Secondly, costlier merchandise will repel buyers, and therefore take from Peter (tape machine and tape manufacturers, sales representatives, and retailers) to pay Paul (the record industry). Furthermore, higher prices for tape will leave less money for record purchasing.

Record retailers, interestingly, are beginning to realize that taping of records is an inducement to buying more records. Some record stores in my living area, in fact, are trying to induce people to tape by promoting borrowing of a record for the cost of \$1 to tape a favorite selection from among many recorded on an LP.

Beyond the foregoing, how would the royalty be administered and distributed? If you'd like to know what you can do to forestall such legislation, you can contact the Audio Rights Coalition, 2001 Eye St., NW, Washington, DC 20006 (202-457-4992)

Computers & Electronics  
formerly Popular Electronics

JOE MESICS  
Publisher  
ARTHUR P. SALSBERG  
Editorial Director

LESLIE SOLOMON  
Technical Director

JOHN R. RIGGS  
Managing Editor

EDWARD I. BUXBAUM  
Art Director

JOSEPH DESPOSITO  
Technical Editor

STANLEY VEIT  
Technical Editor

DAVID M. WEBER  
Features Editor

ANDRE DUZANT  
Technical Illustrator

CARMEN ROBLES  
Production Editor

JEFF NEWMAN  
Editorial Assistant

Contributing Editors:  
Walter Buchsbaum, Len Feldman,  
Glenn Hauser, Julian Hirsch  
Jim Keogh, Forrest Mims, Carl Warren

MARIE MAESTRI  
Executive Assistant

Editorial and Executive Offices  
One Park Avenue  
New York, New York 10016  
212 725-3500

New York Office  
Advertising Director:  
Richard Govatski 212 725-7460

Sales:  
Tom Ballou 212 725-3578  
Ken Lipka 212 725-3580

Midwestern Office  
Suite 1400, 180 N. Michigan Ave.,  
Chicago, IL 60601 312 346-2600  
Sales: Robert Vanek

Western Office  
3460 Wilshire Blvd.  
Los Angeles, CA 90010 213 387-2100  
Sales: Ted Welch

Representation in Japan  
J.S. Yagi  
Iwai Trading Co., Ltd.  
603 Ginza Sky Heights Bldg.  
18-13, Ginza 7-Chome  
Tokyo, Japan 104

Ziff-Davis Publishing Company

Richard P. Friese  
Albert S. Traina  
President  
President, Consumer  
Magazine Division

Furman Hebb  
Phillip T. Heffernan  
Executive Vice President  
Senior Vice Presidents

Sidney Holtz  
Edward D. Muhlfeld  
Philip Sine  
Robert Bavier  
Paul H. Chook  
Vice Presidents

Baird Davis  
George Morrissey  
Selwyn Taubman  
Bertram A. Abrams  
Treasurer  
Secretary

Editorial correspondence: COMPUTERS & ELECTRONICS, 1 Park Ave., New York, NY 10016. Editorial contributions must be accompanied by return postage and will be handled with reasonable care; however, publisher assumes no responsibility for return or safety of manuscripts, art work, or models submitted.

The publisher has no knowledge of any proprietary rights which will be violated by the making or using of any items disclosed in this issue.



Member Audit Bureau  
of Circulations



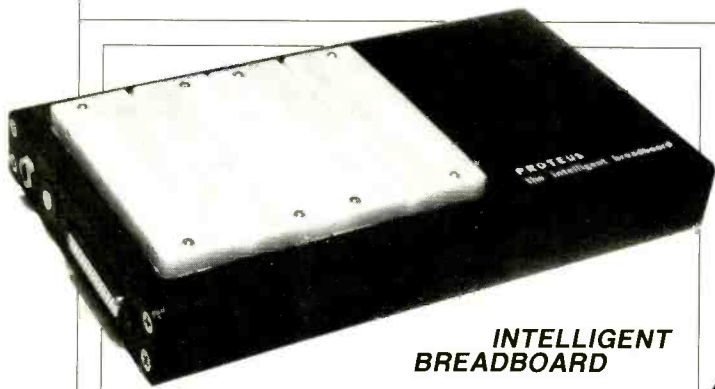

### INTELLIGENT BREADBOARD

The Proteus development system from Technical Micro Systems Inc. includes a BASYS/1 CMOS computer, power supply and solderless breadboard sockets. Capacity is 2K RAM/4K ROM, and it has an RS232C port and 20-mA current loop to 2400 baud, parallel inputs with 12 CMOS/TTL lines, eight parallel outputs, and a multiplexed I/O. Resident software: Tiny BASIC and 8TH. \$250.

Circle No. 93 on Free Information Card

### WIDEBAND CASSETTE DECK

Harman-Kardon's front-load CD401 has Dolby B, C, and HX-Pro noise reduction; 3 tape heads; 2 motors; and solenoid-operated controls. With HX-Pro, response is rated as 20 to 24,000 Hz  $\pm$  3 dB, while wow and flutter is 0.04% wrms. Separate bias and equalization switches include metal formulation selection. Dimensions: 4<sup>3</sup>/<sub>4</sub>" H  $\times$  3<sup>1</sup>/<sub>2</sub>" D  $\times$  17<sup>1</sup>/<sub>2</sub>" W. \$750.

Circle No. 96 on Free Information Card

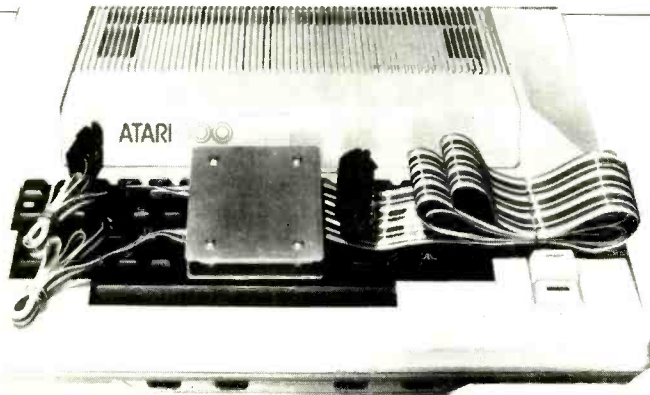

### ATARI PRINTER INTERFACE

Interface No. 1 from Looking Glass Microproducts is designed to connect any printer having a Centronics-compatible parallel interface to an Atari 400 or 800 personal computer. A printer-handler, provided on either cassette or diskette, replaces the resident printer-handler, occupies less than 128 bytes of usable program area and is reported to be compatible with all Atari cartridges and programs. Comes with full documentation, step-by-step installation instruction, and program listings. \$85.

Circle No. 94 on Free Information Card

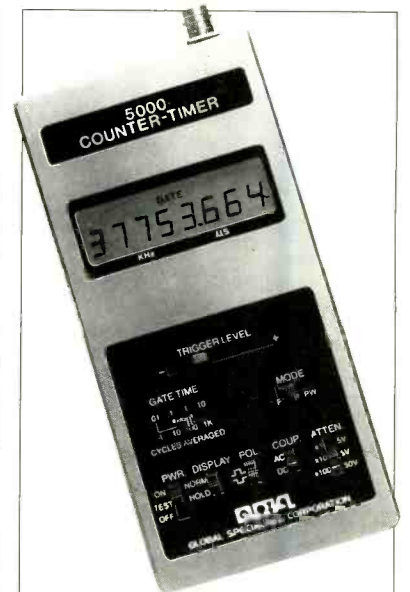

### HANDHELD COUNTER-TIMER

Global Model 5000 has 3 modes: frequency, period, and pulse width. Input impedance is 1 megohm at 25 pF for all modes. Frequency input rating is 0.1 Hz to 50 MHz. Gate times of 0.1, 1.0, or 10 s are switch selectable. Frequency is displayed in kilohertz on the 8-digit LCD display. Measures periods from 40 ns to 10 s and either single cycles or an average of 10, 100, or 1000 cycles. 6 AA batteries. 7<sup>1</sup>/<sub>2</sub>" H  $\times$  3<sup>3</sup>/<sub>4</sub>" W  $\times$  1<sup>3</sup>/<sub>4</sub>" D. \$350.

Circle No. 97 on Free Information Card

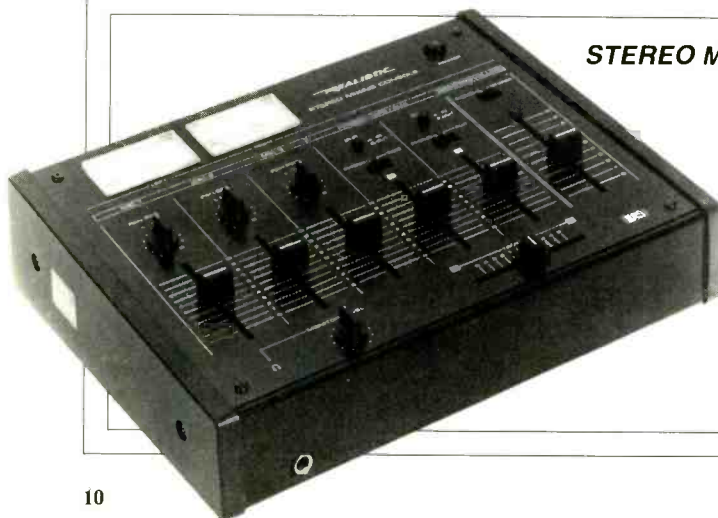

### STEREO MIXING CONSOLE

Radio Shack's Realistic Stereo Mixing Console (#32-1200) has 3 mike inputs with pan pots, cross fading, and headphone cueing and monitoring. Also accepts 2 turntable and 2 tape deck inputs with 2-channel output. Has 7 level controls and lighted VU meters. \$120.

### MUSIC PRINTER

Yamaha Specialty Products' Mini-Printer MP-1 is a portable electronic keyboard with a computerized music printout system. It contains a miniature ballpoint pen that prints melody lines on a 2½" W paper roll in a variety of keys, and produces the staves, time signatures, rhythm and chord names, and up to three sharps and flats. A melody and chord sequence memory allows two-channel recording and playback. Printer is reported to automatically compensate for player's irregular note lengths by rounding them off. Other features include ten instrument voices, easy play auto bass chord, arpeggio, and a pitch control for harmonizing and vocalists. Power is batteries or ac line. Dimensions: 2" H × 27¾" W × 6½" D; weight: 4 lb. \$1000.

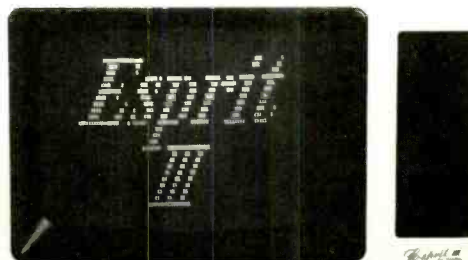

### HAZELTINE ESPRIT III

The Esprit III has a 6502 microprocessor and a PROM set with remote access command for user-designed functions. It has a tilting, green-phosphor CRT with detachable keyboard, printer buffer, and line drawing capability. Display format is 80 characters by 24 lines, with a programmable 25th status line. There are 96 alphanumeric, 32 control codes, and 15 graphics characters. Keyboard has 14 numeric keys, 22 user-definable function keys, and 7 edit keys. Uses both RS232C port and a 20-mA loop. Baud rates range from 50 to 19,200 cps. \$895.

Circle No. 95 on Free Information Card

### IBM-PC TROUBLESHOOTING EXTENDER CARD

Vector Electronic's Model 3690-22 extender board works with the IBM-PC to facilitate in-circuit testing of prototype interface cards and troubleshooting the computer. Card is 5.7" × 3.2" and has marked test points for every bus line. A thick epoxy masking prevents short circuits. The card-edge connector tabs are nickel and gold-plated. A mounting bracket secures the board to the computer. \$22.35.

Circle No. 99 on Free Information Card

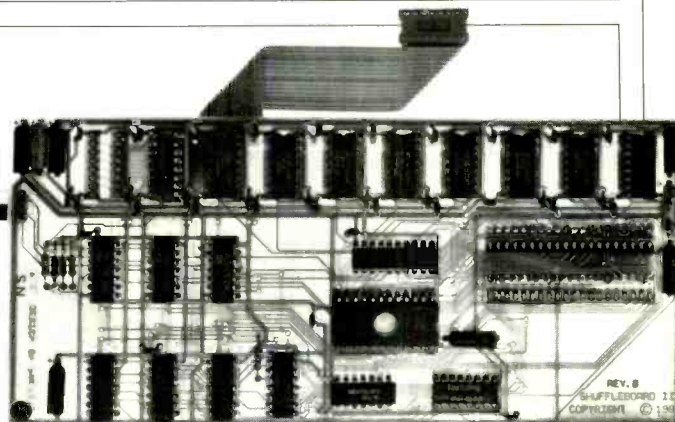
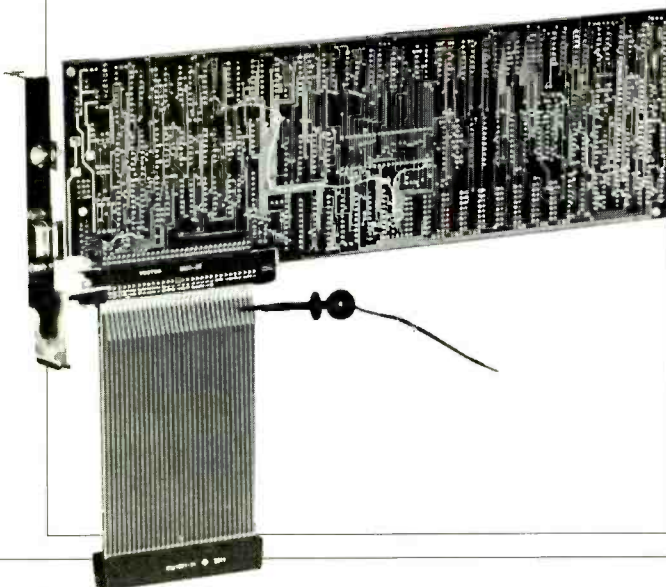

### CP/M for TRS-80 III

The Shuffleboard III board from Memory Merchant allows TRS-80 Model III's to use CP/M-based software such as SuperCalc, WordStar, dBase II, and Mail Merge. The board includes 16K of RAM, said to give the TRS-80 the power of full 64K CP/M 2.2 without interference to the computer's ROM or video memory. Operates with any TRS-80-compatible DOS, says the maker. Installation consists of plugging the board into two sockets in the Model III. Comes with MBASIC 5.0. \$300.

Circle No. 98 on Free Information Card

Additional information on new products covered in this section is available from the manufacturers. Either circle the item's code number on the Free Information Card or write to manufacturer at the address given.



# LES SOLOMON ON COMPUTER HARDWARE



## Preparing a Standard for Minifloppies

**L**AST month, I wrote an article about the 3" vs 3.5" minifloppy battle, their differences, who was making what, and who was jumping on which bandwagon. Some of the smoke of battle between the two versions of the small diskette has now cleared away, and a proposed ANSI (American National Standard Institute) standard has emerged. Not everyone is satisfied, as the committee elected to take bits of the specification for one type and bits of the other to create the new standard.

To start, the new size is 3.5", the size of the Sony entry. This dimension was selected because it was felt that a full megabyte could be stored on the diskette without unduly pushing the technology or reliability. There were also some deep technical changes that included thickness of magnetic media, magnetic capabilities, etc., but the other main change was the requirement that the new micro disk be compatible with existing minidisk products. So the new standard recommends 40 or 80 tracks/side, single- or double-sided—the Hitachi approach. The highest capacity version, 80 tracks/side, double-sided, could have an unformatted capacity of one megabyte. To further enhance the compatibility, the rotational rate of 300 rpm (again the Hitachi approach)—instead of the 600 rpm

used by the Sony entry—was selected. Also, there is going to be an automatic shutter on the head access window that will automatically open when the diskette is inserted in the drive, and automatically shut when the diskette is removed. Thus, the standard has eliminated at least three warnings now printed on diskette covers—thou shalt not bend, jam into slots, or touch shiny parts. We are still awaiting packaging breakthroughs to remove the external magnetic field and heat problems. Let us hope that this new standard will be accepted by all disk, computer, and peripheral people, and we do not have another Kansas City tape standard coming in. There are some new microdisk users (other than those mentioned in last month's article), who may have problems with this new standard. The latest is RCA, which recently announced that it will use the Sony 3.5" disk in its MicroDisk Development System. Even as the new standard was announced, Toshiba decided to introduce its approach—a 3.5" floppy that uses perpendicular magnetic recording (PMR) to allow 3 megabytes to be stored on the chromium-cobalt diskette surface. The expected time of arrival for this new approach is about two years. PMR introduces another player in the game since this modulation technique was not discussed in the ANSI specs. And, speaking of PMR, Vertimag Systems recently announced its new 5-

and 10-megabyte PMR systems, expected to be on the market within the year. Since we are on the verge of having a microdisk standard, and 3.5" seems to be the one chosen, we were surprised to hear that IBM, working with Matsushita Communications in Japan, is expecting to create a low-cost version of the IBM PC, using, of all things, a 4" drive!

**Sinclair Timex Add-Ons.** Physically, the Sinclair Timex 1000 is a small computer. However, it is not small in terms of performance and power. Shortly after its introduction, many companies jumped on the bus structure to produce a variety of add-ons—primarily memory. One company, Memotech Corp., introduced both 16K and 64K RAM modules that greatly expanded the versatility of the computer.

Now Memotech is adding some powerful plug-ins to its line. The first is a 32K RAM Pak (\$109.95) that is fully compatible with the Sinclair internal 16K of RAM or with a Memotech 16K RAM Pak. This makes a total of 48K for the small machine.

The second add-on is a High-Resolution Graphics Pak (\$144.95) that contains an EPROM monitor holding a full range of graphics sub-routines that can be called from BASIC USR function or by machine language to provide 192 × 248 pixels. With each video page requiring 6.5K of RAM, the number of pages is limited only by the avail-



Memotech plug-in add-ons for the Sinclair Timex 1000.

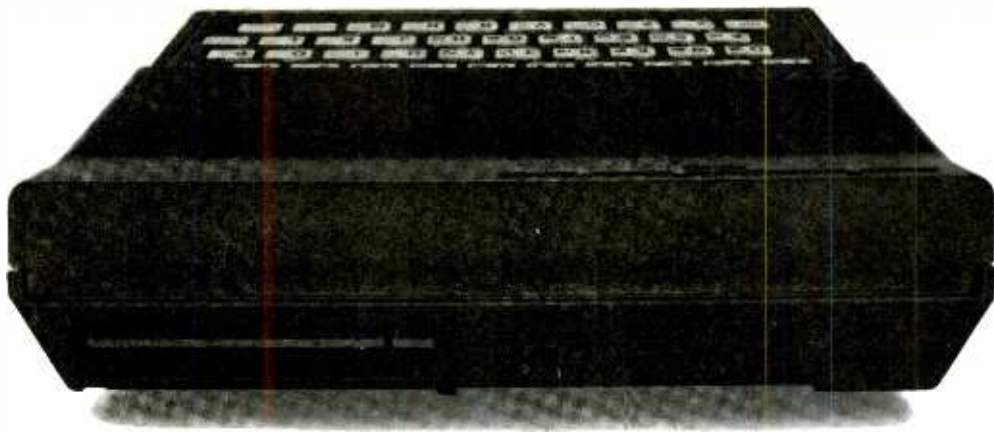

# BEHIND EVERY GOOD SINCLAIR IS A MEMOPAK

If you own a Timex-Sinclair 1000 or ZX81 computer, you should have a Memopak behind it. From increased memory to high resolution graphics, Memotech has a Memopak to boost your system's capabilities. Every Memopak peripheral comes in a black anodised aluminum case and is designed to fit together in "piggy back" fashion to enable you to continue to add on and still keep an integrated system look.

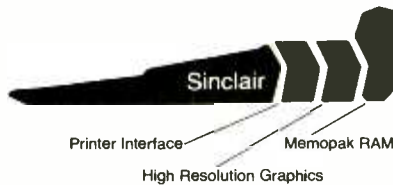

**Memopak 64K RAM** The 64K RAM extends the memory of your Sinclair by 56K to a full 64K. It is directly addressable, user transparent, is neither switched nor paged and accepts such BASIC commands as 10 DIM A (9000). The Memopak 64K turns your Sinclair into a powerful computer suitable for business, recreational and educational use. No additional power supply is required.

**Memopak 32K RAM** The 32K RAM Memopak offers your Sinclair a full 32K of directly addressable RAM. Like the 64K Memopak, it is neither switched nor paged and enables you to execute sophisticated programs and store large data bases. It is also fully compatible with Sinclair's or Memotech's 16K RAM to give you a full 48K of RAM.

**Memopak 16K RAM** The Memopak 16K RAM provides an economical way to increase the capabilities of your Sinclair. And at the same time, it enables you to continue to add on other features with its "piggy back" connectors. It is compatible with the Sinclair 16K or a second Memopak 16K or Memopak 32K to give 32K or 48K of RAM respectively.

**Memopak High Resolution Graphics** The Memopak HRG contains a 2K EPROM monitor and is fully programmable for high resolution graphics. The HRG provides for up to 192 by 248 pixel resolution.

**Memopak Printer Interface** The Memopak Centronics Parallel or RS232 Interface packs enable your Sinclair to use a wide range of compatible printers (major manufacturers' printers available through Memotech at significant savings). The resident software in the units gives the ASCII set of characters. Both Memopak printer interfaces provide lower case character capabilities. The RS232 Interface is also compatible with modems.

**New products coming soon** Memotech will soon be introducing four new Sinclair compatible products: a high quality, direct connection keyboard, a digitizing tablet, a 16K EPROM and a disk drive. Watch for our future advertisements.

## Order at no risk

All Memotech products carry our 10 day money back guarantee. If you're not completely satisfied, return it in ten days and we will give you a full refund. And every Memotech product comes with a six month warranty. Should anything be defective with your Memopak, return it to us and we will repair or replace it free of charge. Dealer inquiries welcome. To order any Memotech product call our toll-free number **800/662-0949** or use the order coupon.

**MEMOTECH**  
CORPORATION

7550 West Yale Avenue  
Denver, Colorado 80227  
(303) 986-1516  
TWX 910-320-2917

Mail to: Memotech Corporation, 7550 West Yale Ave., Denver, CO 80227

Code: CE-1	*Price	Qty.	Total
64K RAM	\$179.95		
32K RAM	109.95		
16K RAM	59.95		
Centronics Parallel Printer interface	104.95		
RS232 Printer Interface	139.95		
High Resolution Graphics	144.95		
Shipping and handling	4.95		\$4.95
* All prices quoted in U.S. dollars			Tax**
** Colorado residents please add sales tax			Total
<input type="checkbox"/> Check <input type="checkbox"/> MasterCard <input type="checkbox"/> Visa			
Account No. _____			Exp. _____
Name _____			
Address _____			
City _____	State _____	Zip _____	



# The Choice of

## Computer Exchange — The Supply Center for the IBM-PC

### SOFTWARE for the IBM-PC

#### BUSINESS

	LIST PRICE	OUR PRICE
ASHTON-TATE, dBase II, CP/M-86	\$ 700	\$459
DENVER SOFTWARE, Easy Executive Accounting System	\$ 725	\$545
HOWARDSON, Real Estate Analyzer	\$ 250	\$189
INFORMATION UNLIMITED, Easywriter II (a WPS)	\$ 350	\$259
IUS EasySpeller (88K Words)	\$ 175	\$129
IUS EasyTutor (a DBMS)	\$ 400	\$299
IUS Easy Planner	\$ 250	\$189
INNOVATIVE SOFTWARE, TIM III (a DBMS)	\$ 495	\$369
INSOFT, Data Design (a powerful easy to use DBMS) NEW	\$ 225	\$169
ISA, Spell Guard	\$ 295	\$220
ISM, Mathemagic	\$ 90	\$ 69
LEXISOFT, Spellbinder (a versatile WPS in CP/M-86)	\$ 495	\$249
MICROCRRAFT, Requires CP/M-86 & CBASIC-86	\$ 750	\$395
Legal Billing & Time Keeping	\$ 750	\$395
Professional Billing & Time Keeping-Billkeeper	\$ 250	\$189
MICRO LAB, The Tax Manager	\$ 495	\$249
MICROPRO, WordStar® plus free WordStar Training Manual	\$ 250	\$149
MailMerge™	\$ 250	\$149
SpellStar™	\$ 250	\$149
Special! All Three Above, WordPac	\$ 895	\$459
NORTH AMERICAN BUS. SYSTEM, The Answer	\$ 250	\$169
PEACHTREE, Inventory Series 40	\$ 600	\$399
Peach Pak 40 (GL, AR & AP)	\$ 595	\$395
PERFECT SOFTWARE, Perfect Writer™	\$ 389	\$239
Perfect Speller™	\$ 189	\$119
Perfect Filer™	\$ 289	\$179
SELECT INFO., Select (a WPS)	\$ 595	\$375
SORCIM, SuperCalc	\$ 295	\$199
SuperWriter, call on availability	\$ 395	\$269
SUPERSOFT, Disk Doctor (CP/M-86)	\$ 100	\$ 75
Diagnostics II (CP/M-86)	\$ 125	\$ 95
Scratch Pad (CP/M-86 and MS-DOS)	\$ 295	\$225
VISICORP, VisiCalc®/256K	\$ 250	\$179
VisiDex	\$ 250	\$199
VisiTrend/Plot	\$ 300	\$219
VisiFile	\$ 300	\$239
Desktop Plan	\$ 300	\$239

#### UTILITY

WAGY SYSTEM, Copy/PC, Backup Copier and Utilities	\$ 35	\$ 29
NORELL DATA,™ System Backup, Bit Copier	\$ 50	\$ 39
NORTON, Norton Utilities, 14 powerful programs, 3 disks	\$ 80	\$ 65

### HOME & EDUCATIONAL

ACORN, Lost Colony	\$ 30	\$ 24
AUTOMATED SIMULATIONS, Temple of Apsara	\$ 40	\$ 29
Upper Reaches Apsara	\$ 20	\$ 15
Jabberlally	\$ 30	\$ 22
Curse of Ra	\$ 20	\$ 15
AVALON HILL, Galaxy	\$ 25	\$ 20
Midway Campaign	\$ 21	\$ 17
Computer Stocks and Bonds	\$ 25	\$ 20
Voyager	\$ 25	\$ 20
Draw Poker	\$ 21	\$ 17
BRODERBUND, Apple Panic	\$ 30	\$ 22
CONTINENTAL, The Home Accountant Plus	\$ 150	\$112
DATAMOST, Write-On	\$ 130	\$100
Pig Pen	\$ 30	\$ 22
Space Strike	\$ 30	\$ 22
DAVIDSON, The Speed Reader	\$ 75	\$ 55
INFOCOM, Deadline	\$ 50	\$ 39
Zork I	\$ 40	\$ 29
Zork II	\$ 40	\$ 29
ON-LINE SYSTEMS, Frogger	\$ 35	\$ 26
Ulysses & The Golden Fleece	\$ 35	\$ 25
PBL CORP., Personal Investor	\$ 145	\$ 99
SENTIENT, Cyborg (Call on availability)	\$ 35	\$ 23
SIRIUS, Conquest	\$ 30	\$ 23
Call to Arms	\$ 45	\$ 35
SPINNAKER, Snopker Troops, #1 or #2	\$ 35	\$ 25
Story Machine	\$ 35	\$ 25
Face Maker	\$ 35	\$ 25
STRATEGIC, The Warp Factor	\$ 40	\$ 30
VERSA COMPUTING, Graphics Hardcopy System	\$ 25	\$ 19

### commodore

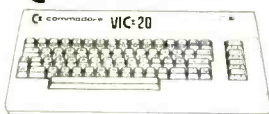

VIC 20 Home Computer	\$300	\$199
Datasette VIC 1530	\$ 75	\$ 59
Disk Drive VIC 1540	\$ 600	\$369
Super Expander VID 1211A 3K with lots of extras	\$ 70	\$ 56
8K Memory Expander Cartridge	\$ 60	\$ 48
16K Memory Expander Cartridge, Microtek	\$ 159	\$115

Wide VIC 20 Software and Peripheral line in stock. Call

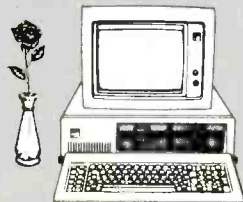

### HARDWARE for the IBM-PC

	LIST PRICE	OUR PRICE
AST RESEARCH Combo Plus 64K with one option	\$ 495	\$379
NEW! 256K	\$ 995	\$729
Options Async Comm Port, Para Printer Port, Clock/Calendar		
Add \$50 for second option and \$35 for third		
Parity Memory Card, 64K	\$ 395	\$279
256K	\$ 995	\$659
Note: All of above cards are memory upgradeable		
CORVUS, Hard Disk System, See Corvus Section This Page		
CURTIS, PC Pedestal™ for Display on PC	\$ 80	\$ 65
3 Foot Cable for IBM Mono Display	\$ 50	\$ 39
DAVONG DS1-501 Hard Disk, 5 Meg	\$1995	\$1495
MICROSOFT 64K RAM Card w/Parity	\$ 350	\$259
128K RAM Card w/Parity	\$ 525	\$395
256K RAM Card w/Parity	\$ 875	\$659
64K RAM Chips™	\$ 175	\$129
Tecmar Inc. ALLiONE Board, 64K	\$ 565	\$415
128K	\$ 735	\$535
256K	\$ 975	\$675

QUADRAM CORPORATION		LIST PRICE	OUR PRICE
Quadboard, 64K, expandable to 256K, 4 function board		\$ 595	\$445
Quadboard, 128K, expandable to 256K, 4 function board		\$ 775	\$575
Quadboard, 192K, expandable to 256K, 4 function board		\$ 895	\$645
Quadboard, 256K, low function board		\$ 995	\$685
Memory Board, 512K, with Serial Port, w/512		\$1295	\$995
128K RAM Card w/Parity		\$ 150	\$ 95
Memory Upgrade Kit, 64K (9 chips), MB260		\$ 159	\$145
Microtazer, Snap-on, BK, Par/Par, Epson, w/MBE, w/PS1		\$ 299	\$235
Microtazer, Snap-on, 64K, Par/Par, Epson, w/MBE, w/PS1		\$ 299	\$235
Power Supply for Microtazer, (9V, 25A) w/PS1		\$ 20	\$ 15
TG PRODUCTS, Joystick		\$ 65	\$ 49

Tandon		LIST PRICE	OUR PRICE
TM100-2 Double Sided 320K 1 ea	\$ 350	\$269	
2 or more	\$ 350	\$259	
Same Disk Drives as now supplied on IBM-PC.			
XEDEX gaby glue	64K plus CP/M-80 operation	\$ 600	\$495

### PRINTERS, Impact

EPSON, See Epson section below		
IDS, Prism 132, Color, w/Graphics	\$1995	\$1549
Prism 80, Color, w/Graphics	\$1795	\$1450
* Paper Tiger 440, w/Graphics & 2K Limited Special!	\$1295	\$495
Microcrism 480, near letter quality	\$ 799	\$699
NEC, 8023 Printer F/T	\$ 695	\$525

PAPER, Tractor Feed, Variety in stock, call for price.

### EPSON PRINTERS & ACCESSORIES

MX80 F/T III, with Graftrax+	\$ 745	\$525
MX100 F/T III, with Graftrax+	\$ 995	\$695
IBM-PC to Epson Cable	\$ 60	\$ 45
Apple Interface and Cable for MX80 or MX100	\$ 120	\$ 95
Grappier+ by Orange Micro, specify your computer	\$ 165	\$119
Apple Graphics Dump	\$ 15	\$ 9
Atari to Epson Cable	\$ 40	\$ 30
TRS 80 to Epson Cable	\$ 40	\$ 30
Other cables, interfaces, ribbons, heads and paper in stock		Call

HEWLETT PACKARD		LIST PRICE	OUR PRICE
H/P 7470A Graphics Plotter	\$1550	\$1195	
H/P 41C Calculator	\$ 195	\$169	
H/P 41CV Calculator with 2 2K Memory	\$ 275	\$239	
H/P 41 Card Reader	\$ 195	\$165	
H/P 41 Optical Wand	\$ 125	\$105	
Wide variety of software and accessories available		Call	

### 8" CP/M-80 BUSINESS & SYSTEM SOFTWARE

	LIST PRICE	OUR PRICE
ASHTON-TATE dBase II	\$ 700	\$459
COMSHARE TARGET, Target PlannerCalc	\$ 50	\$ 39
MasterPlanner	\$ 325	\$225
PlannerCalc Applications Pkg	\$ 50	\$ 40
PlannerCalc Combo Pkg.	\$ 90	\$ 65
INFOCOM, Deadline	\$ 60	\$ 45
Zork I	\$ 50	\$ 39
Zork II	\$ 50	\$ 39
ISA, Spellguard	\$ 295	\$220
ISM, Mathemagic	\$ 100	\$ 75
MICROCRRAFT, Legal Billing & Time Keeping	\$ 750	\$395
Prof. Billing & Time Keeping — Billkeeper	\$ 250	\$189
*MICROPRO, WordStar® plus free WordStar Training Manual	\$ 495	\$249
MailMerge™	\$ 250	\$149
SpellStar™	\$ 250	\$149
Special! All Three Above, WordPac	\$ 895	\$459

### MICROSOFT™

Multipan	\$ 275	\$199
Fortran-80	\$ 500	\$325
BASIC Compiler	\$ 395	\$295
COBOL-80	\$ 750	\$545
BASIC-80	\$ 350	\$275
multiisp/muStar-80	\$ 200	\$145
M-Sort-80	\$ 195	\$145
Edit-80	\$ 120	\$ 80
Macro-80	\$ 200	\$145
OASIS, The Word Plus (45,000 word verification)	\$ 150	Call
PEACHTREE, GL AR & AP, Series 40, all three for	\$ 595	\$395
Inventory, Series 40	\$ 600	\$399
Peach Text, Spell & Mail, all three for	\$ 595	\$395
Call on Series 8, each	\$ 750	\$499
PERFECT SOFTWARE, Perfect Writer™	\$ 389	\$239
Perfect Speller™	\$ 189	\$119
Perfect Filer™	\$ 289	\$179
QUALITY, GBS with 3 generators, (a DBMS)	\$ 700	\$525
SELECT INFO., Select (a WPS)	\$ 595	\$375
SORCIM, SuperCalc	\$ 295	\$199
SuperWriter, call on availability	\$ 395	\$269
SUPERSOFT, Disk Doctor (CP/M-80)	\$ 100	\$ 75
Diagnostics II (CP/M-80)	\$ 125	\$ 95
Scratch Pad (CP/M-80)	\$ 295	\$225

### MONITORS

	LIST PRICE	OUR PRICE
NEC, 12" Green	\$ 249	\$195
12" Color, Composite	\$ 450	\$349
SANYO, 9" B/W	\$ 190	\$149
Special truckload sale	\$ 200	\$119
9" Green	\$ 250	\$199
12" B/W	\$ 260	\$199
12" Green	\$ 470	\$349
13" Color, Composite	\$ 995	\$795
13" Color RGB	\$ 150	\$119
ZENITH, 12" Green	\$ 200	\$159
AMDEK, 12" Green w/300	\$ 449	\$359
13" Color I, Composite	\$ 899	\$799
13" Color II, RGB, Hi Res. (Ap II, III & IBM-PC)	\$ 569	\$469
13" Color III, RGB, Commercial. (Ap II, III)	\$ 199	\$175
DVM, Color II or III to Apple II interface	\$ 199	\$175
Note: Color II and III come with cable for IBM-PC.		

### DISKETTES

*Control Data Corporation 12 for 10 Special, Limited Time!		
CDC, 120 each 5 1/4 with ring, SS, SD (Apple, IBM, etc.)	\$ 450	\$195
12 each 5 1/4 with ring, SS, SD (Apple, IBM, etc.)	\$ 40	\$ 22
12 each 5 1/4 with ring, SS, DD (H/P, IBM 320K, etc.)	\$ 51	\$ 28
12 each 8" SS, SD	\$ 51	\$ 28
10 each 5 1/4 with ring, DS, DD (IBM)	\$ 50	\$ 39
IBM, 10 each 5 1/4, SS, SD (Apple, IBM, etc.)	\$ 60	\$ 45
10 each 5 1/4, SS, DD (H/P, IBM 320K, etc.)	\$ 65	\$ 49
VERBATIM, 10 each 5 1/4 with ring, SS, SD or SS, DD	\$ 50	\$ 28
MAXELL, 10 each 5 1/4, SS, SD	\$ 55	\$ 35
DYSAN, 10 each 5 1/4, SS, SD	\$ 55	\$ 39
10 each 5, DS, DD	\$ 65	\$ 49

### CORVUS SYSTEMS

	LIST PRICE	OUR PRICE
* 6 Meg Hard Disk	\$2995	\$2495
11 Meg Hard Disk	\$4795	\$3995
20 Meg Hard Disk	\$5795	\$4795
IBM PC interface (IBM DOS), Manual & Cable 5	\$ 300	\$239
Mirror built in for easy backup	\$ 790	\$649
Apple Interface, Manual & Cable 5	\$ 300	\$239
Other Interfaces, Omni-Net, Constellation, Mirror, All in Stock.		

NATIONAL ORDER DESK TOLL FREE  
(800) 547-1289  
OTHER ORDERS: 772-3256

Hot Line For Information  
On Your Order  
(503) 772-3803

Portland, OR, Cash & Carry Outlet, 11507-D SW Pacific Hwy., Terrace Shopping Center, Tigard, OR, Over-the-counter sales only. On 99W between Rte. 217 and Interstate 5. Call 245-1020.

ORDERING INFORMATION AND TERMS: All mail to P.O. Box 1380, Jacksonville, OR 97530. All items usually in stock. We immediately honor Cashiers Checks, Money Orders, Fortune 1000 Checks and Government Checks. Personal, Certified or Company Checks allow 20 days to clear. No C.O.D. Add 3% for VISA or MC. Include telephone number. Add 3% for shipping, insurance and handling (\$ I&H) with \$5 minimum. UPS ground is standard so add 3% more for UPS Blue with \$10 minimum. Add 12% total for S&H for US Postal, APO or FPO with \$15 minimum. For Hawaii, Alaska and Canada, UPS is in some areas only; all others are Postal so call, write, or specify PO. Foreign orders except Canada for S,I&H add 18% or \$25 minimum except for monitors add 30% or \$50 minimum. All sales are final. Call before returning goods for repair or replacement. Orders received with insufficient S,I&H charges will be returned. ORDER DESK HOURS 8 to 6 PST, M-F and 10 to 4 Sat. 1 PM here is 4 PM in NY.

OUR REFERENCES: We have been a computer dealer since 1978 and in mail order since 1980. Banks: First Interstate Bank, (503) 776-5620 and Jefferson State Bank, (503) 773-5333. We belong to the Chamber of Commerce, (503) 772-6293, or call Dun & Bradstreet if you are a subscriber. Computer Exchange is a division of O Tech Group, Inc.



# Professionals

Manufactured Exclusively for  Bell & Howell by  apple computer

	LIST PRICE	OUR PRICE	SAVE
<b>B&amp;H Apple II+</b>			
64K (48K + ALS 16K)	\$1725	\$1195	\$530
DISK II w/3.3 Cont.	\$645	\$520	\$125
DISK II Only	\$525	\$450	\$75

**OR: SAVE OVER \$350** on a pair of drives.  
Buy a pair of Micro-Sci A2 Drives.  
See opposite page.

## apple II/II+ supply center

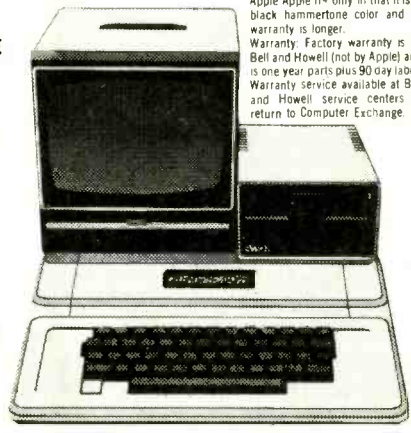

The B&H Apple II+ differs from the Apple II+ only in that it is in black-hammertone color and its warranty is longer.  
Warranty: Factory warranty is by Bell and Howell (not by Apple) and is one year parts plus 90 day labor.  
Warranty service available at Bell and Howell service centers or return to Computer Exchange.

**SPECIAL**

**B & H APPLE II+ 64K STARTER SYSTEM** **\$1,795**  
**SAVE \$ 765**

- 48K B&H Apple II+
- ALS 16K RAM Card
- Disk II with 3.3 DOS & Controller
- Sanyo 9" Green Monitor

**μ-SCI** FOR THE APPLE II/II+, III  
**DIRECT SUBSTITUTES**  
for APPLE DRIVES

Micro-Sci A2 drives and/or controllers are direct plug compatible substitutes for Apple drives and controllers.

	LIST PRICE	OUR PRICE
• For Apple II		
A2 5 1/4", 143K Disk Drive	\$ 479	\$369
Controller Card for A2 Drive	\$ 100	\$ 79
A70, 5 1/4", 288K Disk Drive	\$ 449	\$359
Controller for A40 or A70	\$ 100	\$ 79
Filer, Disk Utility Software	\$ 20	\$ 15

## HARDWARE

for Apple II/II+

	LIST PRICE	OUR PRICE
<b>RAM CARDS:</b>		
★ ALS, ADDRAM	16K \$ 149 \$ 59	
★ COEX RAM Card	16K \$ 179 \$ 59	
★ Microsoft, RAMCard	16K \$ 195 \$ 99	
★ Saturn Systems	32K \$ 249 \$169	
	64K \$ 425 \$319	
	128K \$ 599 \$459	
	320K \$1395 \$995	
<b>80 COLUMN VIDEO CARDS:</b>		
ALS, Smarterm	\$ 345 \$249	
Videx, Videoterm	\$ 345 \$249	
See more ALS and Videx below.		
Visia, Vision 80	\$ 395 \$199	
M&R, Sup R term	\$ 375 \$319	
<b>MISCELLANEOUS:</b>		
ALS, Smarterm 80 Col. Card Special	\$ 345 \$249	
Z Card (Z-80) W/CPM Special	\$ 269 \$199	
★ 16K ADDRAM Special	\$ 149 \$ 59	
★ Synergizer Pack Special	\$ 749 \$450	
Synergizer Pack includes above 3, + CP/M book.		
Note: See above right for more info.		
<b>Apple Computer:</b>		
Silentyne II Printer	\$ 395 \$335	
Axon, 320K RAM Disk System	\$1995 \$995	
ASTAR, RF Modulator	\$ 35 \$ 25	
CCS, Serial Interface 7710A	\$ 150 \$129	
Clock/Calendar	\$ 129 \$105	
Other CCS Cards in stock	Call Call	
Dan Paymar, Lower Case Chips	\$ 50 \$ 39	
Hayes, Micromodem II	\$ 379 \$275	
Smartmodem	\$ 279 \$229	
Kingsley, System Saver	\$ 90 \$ 69	
Keyboard Co., a div. of Apple Computer:		
Joystick II	\$ 50 \$ 39	
Game Paddles	\$ 30 \$ 23	
Numeric Keypad	\$ 150 \$119	
M&R, RF Modulator	\$ 30 \$ 25	
Sup R fan	\$ 50 \$ 39	
Microsoft, Z80 Softcard	\$ 399 \$269	
16K RAM Card	\$ 195 \$ 99	
Softcard Premium Pack	\$ 775 \$529	
★ <b>Mountain:</b>		
CPS Multifunction Card	\$ 239 \$199	
Novation, Appletalk Modem	\$ 389 \$295	
★ <b>Orange Micro, Grappler</b>	\$ 165 \$119	
★ <b>Practical Peripherals:</b>		
MBS 8K Serial (Epson)	\$ 159 \$129	
MBP 16K Para (Epson)	\$ 159 \$129	
★ Microbuffer II 16K (specify)	\$ 259 \$209	
★ Microbuffer II 32K (specify)	\$ 299 \$229	
RH Electronics, Super Fan II	\$ 75 \$ 59	
SSM, AIO-II, Serial/Para Interface	\$ 225 \$169	
TC Products: Game Paddles	\$ 40 \$ 29	
Joystick	\$ 60 \$ 45	
Select-A-Port	\$ 60 \$ 45	
★ Videx, Videoterm 80 col.	\$ 345 \$249	
Soft Video Switch	\$ 35 \$ 25	
Enhancer II	\$ 149 \$ 99	
Enhancer (Rev. 6)	\$ 129 \$ 99	
Function Strip	\$ 79 \$ 59	
Appiewriter II preboot disk	\$ 20 \$ 15	
Visicalc to 64K preboot disk	\$ 50 \$ 39	
Visicalc to 176K preboot disk	\$ 90 \$ 69	
Full Videx Line, Call, up to 35% off.		

## SOFTWARE

on disk for Apple II/II+

### OUR BEST SELLERS — CALL ON OTHERS

	LIST PRICE	OUR PRICE
<b>Apple Computer, Inc.:</b>		
The Controller, GL, AR, AP	\$ 625 \$499	
Apple Writer II	\$ 150 \$119	
Apple Pascal	\$ 250 \$199	
Apple Fortran	\$ 200 \$159	
DOS Tool Kit	\$ 75 \$ 59	
DOS 3.3 Upgrade Kit	\$ 75 \$ 59	
Apple Pilot	\$ 150 \$119	
DJ Portfolio Evaluator	\$ 50 \$ 45	
How to!	\$ 50 \$ 39	
Microcruiser	\$ 250 \$149	
Micro Telegram	\$ 250 \$199	
Apple Logo	\$ 175 \$139	
Applied Sort Tech., Versa Form	\$ 389 \$265	
Artsci, MagicWindow II New!	\$ 150 \$ 99	
Ashion-tate, dBase II (CP/M)	\$ 700 \$439	
Continental, GL, AR, AP or PR, ea.	\$ 250 \$169	
1st Class Mail	\$ 75 \$ 49	
Home Accountant	\$ 75 \$ 49	
Hayden, Pie Writer (Specify brd.)	\$ 170 \$ 99	
High Tech., Job Control Sys.	\$ 750 \$350	
Into Master	\$ 189 \$119	
★ <b>Howard Soft:</b>		
Creative Financing	\$ 195 \$129	
Real Estate Analyzer II	\$ 195 \$129	
Tax Preparer	\$ 150 \$ 99	
Info, Unlim., Easywriter (PRO)	\$ 175 \$119	
★ ISA, Spellguard (CP/M)	\$ 295 \$150	
Lexisoft, Spellbinder (a WPS)	\$ 495 \$269	
★ <b>Micro Craft, (CP/M)</b>		
Professional Billkeeper	\$ 750 \$395	
Legal Billing & Timekeeping	\$ 750 \$395	
Micro Lab, Invoice Factory	\$ 200 \$129	
Tax Manager	\$ 150 \$ 99	
★ <b>Micro Pro, (all CP/M)</b>		
WordStar® + Training Manual	\$ 495 \$365	
MailMerge™	\$ 250 \$185	
SpellStar™	\$ 250 \$185	
SPECIAL! All 3 above	\$ 895 \$695	
Data Star™	\$ 295 \$199	
Muse, Super Text II	\$ 150 \$113	
Super Text 40/80	\$ 175 \$129	
Super Text 40/56/70 New!	\$ 125 \$ 95	
Form Letter	\$ 100 \$ 75	
On-Line, ScreenWriter II	\$ 130 \$ 89	
General Manager	\$ 150 \$115	
★ <b>Osborne/C.P. Soft., (Disk and Book)</b>		
Some Common Basic Programs.		
75 Business, Statistics and Math programs for the Apple II	\$ 100 \$ 49	
Practical Basic Programs.		
★ 40 more very valuable programs beyond "Some Com. Basic Prog" \$ 100 \$ 49		

Peachtree, (CP/M), specify Videoterm or 40 column.		
Pak of 3 (GL, AR & AP) Ser. 40	\$ 595 \$395	
Inventory, Series 40	\$ 400 \$275	
Peacypac, Series 40	\$ 400 \$275	
Pak of 3, (Text, Spell & Mail)	\$ 595 \$395	
Perfect, Perfect Writer	\$ 389 \$239	
Perfect Speller	\$ 189 \$119	
Perfect Filer	\$ 289 \$179	
Quality, GBS w/3 gen. (a DBMS)	\$ 650 \$475	
Sensible, Sens. Speller, specify	\$ 125 \$ 85	
★ Silicon Valley, Word Handler	\$ 250 \$139	
Soft/Sys, Executive Secretary	\$ 250 \$169	
Executive Speller	\$ 75 \$ 55	
★ <b>Soldus/Softech</b>		
Stockpile	\$ 600 \$350	
Stockseller	\$ 700 \$450	
★ <b>Software Dimensions</b>		
Acctg. Plus, General Ledger	\$ 425 \$295	
Acctg. Plus, GL, AP and A/R	\$ 995 \$595	
Acctg. Plus, above + Inventory	\$1395 \$775	
★ <b>Software Publishing:</b>		
PFS II	\$ 125 \$ 85	
Report	\$ 95 \$ 65	
Graph	\$ 125 \$ 85	
Sorcim, SuperCalc, (CP/M)	\$ 295 \$219	
★ <b>Southeastern:</b>		
Data Capture 4.0, specify brd.	\$ 90 \$ 69	
Stoneware, DB Master	\$ 229 \$155	
DB Utility I or II	\$ 99 \$ 69	
★ <b>VisiCorp/Personal Software:</b>		
Visicalc 3.3	\$ 250 \$179	
VisiDoc Special!	\$ 250 \$175	
VisiFile	\$ 250 \$179	
Desktop Plan II	\$ 250 \$179	
Desktop Plan III	\$ 300 \$219	
Visiplot	\$ 200 \$149	
VisiSchedule New!	\$ 300 \$219	
VisiTrend & VisiPlot Special!	\$ 300 \$179	
VisiTerm	\$ 100 \$ 79	

	LIST PRICE	OUR PRICE
<b>Beagle, Utility City</b>	\$ 30 \$ 22	
OOS Boss	\$ 24 \$ 18	
★ <b>Central Point Software:</b>		
Filer, DOS Utility	\$ 25 \$ 18	
Copy II Plus (bit copier)	\$ 40 \$ 35	
Epson, Graphics Dump	\$ 15 \$ 9	
★ <b>Insott:</b>		
GratFORTH by Paul Lutus	\$ 75 \$ 59	
ALD System II by Paul Lutus	\$ 75 \$ 59	
TRANSFORTH II by Paul Lutus	\$ 125 \$ 99	
★ <b>Microsoft:</b>		
A.L.O.S.	\$ 125 \$ 75	
BASIC Compiler	\$ 395 \$299	
Cobol 80	\$ 750 \$559	
Fortran 80	\$ 195 \$149	
Olympic, Decathlon	\$ 30 \$ 24	
TASC Compiler	\$ 175 \$159	
★ <b>Omega, Locksmith (bit copier)</b>	\$ 100 \$ 75	
On-Line, Expediter II, Compiler	\$ 100 \$ 69	
LISA 2.5	\$ 80 \$ 60	
Penguin, Comp. Graphics Sys. New!	\$ 70 \$ 53	
Phoenix, Zoom Grafix	\$ 40 \$ 29	
Quality, Bag of Tricks New!	\$ 40 \$ 29	
★ <b>Southwestern, ASCH Express</b>	\$ 80 \$ 59	
Sensible, Back It Up, (bit copier)	\$ 60 \$ 49	

	LIST PRICE	OUR PRICE
<b>Utility &amp; Development:</b>		
Beagle, Utility City	\$ 30 \$ 22	
OOS Boss	\$ 24 \$ 18	
★ <b>Central Point Software:</b>		
Filer, DOS Utility	\$ 25 \$ 18	
Copy II Plus (bit copier)	\$ 40 \$ 35	
Epson, Graphics Dump	\$ 15 \$ 9	
★ <b>Insott:</b>		
GratFORTH by Paul Lutus	\$ 75 \$ 59	
ALD System II by Paul Lutus	\$ 75 \$ 59	
TRANSFORTH II by Paul Lutus	\$ 125 \$ 99	
★ <b>Microsoft:</b>		
A.L.O.S.	\$ 125 \$ 75	
BASIC Compiler	\$ 395 \$299	
Cobol 80	\$ 750 \$559	
Fortran 80	\$ 195 \$149	
Olympic, Decathlon	\$ 30 \$ 24	
TASC Compiler	\$ 175 \$159	
★ <b>Omega, Locksmith (bit copier)</b>	\$ 100 \$ 75	
On-Line, Expediter II, Compiler	\$ 100 \$ 69	
LISA 2.5	\$ 80 \$ 60	
Penguin, Comp. Graphics Sys. New!	\$ 70 \$ 53	
Phoenix, Zoom Grafix	\$ 40 \$ 29	
Quality, Bag of Tricks New!	\$ 40 \$ 29	
★ <b>Southwestern, ASCH Express</b>	\$ 80 \$ 59	
Sensible, Back It Up, (bit copier)	\$ 60 \$ 49	

**WHILE THEY LAST**  
**OVERSTOCK SPECIALS**  
FOR APPLE II/II+

ALS 16K AdDRAM Card	\$ 149 \$ 59
COEX 16K RAM Card Special	\$ 179 \$ 59
Saturn Systems, 32K RAM Card	\$ 249 \$169
ALS ZCard, Z80 CP/M Card	\$ 269 \$199
ALS Smarterm 80 Col. Card	\$ 345 \$249
ALS Synergizer Pack, 3 above	\$ 749 \$450
ALS Synergizer + Supercalc	\$ 749 \$490
ALS Synergizer + Condor Jr.	\$ 749 \$490
ALS Synerg. + Supercalc + Condor	\$ 749 \$560
Videx, Videoterm, 80 column card	\$ 345 \$249

**HOME & EDUCATION**

Broderbund:		
Apple Panic	\$ 30 \$ 21	
Arcade Machine (call first)	\$ 45 \$ 40	
Choplier New!	\$ 35 \$ 26	
Many others	Call	
Budgetco, Raster Blaster	\$ 29 \$ 22	
Continental, Home Accountant	\$ 75 \$ 49	
Edu-Ware, Several in stock	Call	
Hayden, Sargon II (Chess)	\$ 35 \$ 29	
Infocom, Deadline	\$ 50 \$ 38	
Insott, Electric Duet by Lutus	\$ 30 \$ 25	
Zarg, Spider Raid New!	\$ 35 \$ 27	
Lightning, Mastertype	\$ 40 \$ 29	
Microsoft, Olympic Decathlon	\$ 30 \$ 24	
Typing Tutor II	\$ 25 \$ 15	
Muse, Robot War	\$ 40 \$ 29	
Castle Wolfenstein	\$ 30 \$ 23	
On-Line:		
Ultima II	\$ 55 \$ 40	
Threshold	\$ 40 \$ 30	
Softporn (X Rated)	\$ 30 \$ 22	
Cannonball Blitz, New!	\$ 35 \$ 26	
Quality, Bag of Tricks	\$ 40 \$ 30	
Sirius, Gorgon	\$ 40 \$ 29	
Sir-tec, Wizardry	\$ 50 \$ 39	
Knight of Diamonds, New!	\$ 35 \$ 26	
Sub Logic, Flight Simulator	\$ 34 \$ 25	
Pinball	\$ 30 \$ 23	
Strategic, Southern Command	\$ 60 \$ 30	
OTHER BRANDS IN STOCK, CALL		

**ATARI**

800 Computer 48K	\$1099	\$665
810 Disk Drive	\$ 600	\$499
850 Interface	\$ 220	\$169
410 Recorder	\$ 100	\$ 79
32K RAM, Microtek	\$ 200	\$109

Call for other software and accessories.

**NEC**

**LIMITED SPECIAL**

8001 32K Computer	\$ 995	\$699
286K Total, Dual Drive PC8031	\$ 995	\$699
32K add-on and I/O Unit PC8012	\$ 649	\$495

Call for other software and accessories.

THE WORLD'S LARGEST COMPUTER MAIL ORDER FIRM

# Computer Exchange™

ALL MAIL: P.O. Box 1380, Jacksonville, OR 97530

WAREHOUSE AND OFFICES, BY APPOINTMENT AT 6791 UPPER APPLGATE ROAD  
CIRCLE NO. 10 ON FREE INFORMATION CARD



able RAM. Each video page is both memory and bit mapped and can be located anywhere in memory. Access is via PLOT and UNPLOT commands and one page can be superimposed on another by software switching. Inverse video and flashing are available.

The third Memotech item is a Centronics Parallel Printer Interface (\$104.95) that enables the Timex 1000 to be used with a wide range of dot-matrix and daisy-wheel printers and is fully compatible with Sinclair BASIC. Resident software provides the ASCII set of characters, and a full 80-column print capability is provided. Lower case can be printed using the inverse character set.

The last current item is an RS232 Interface (\$139.95) that allows the Timex 1000 to communicate with other systems or devices (including modems and serial printers) at software-selectable 110 to 19,200 baud. Full 80-column print capability, including lower case, is available for the printer.

Future products are planned to include a direct-connection keyboard, a digitizing tablet, a 16K EPROM, and a disk drive. **Address:** Memotech Corp., 7550 W. Yale Ave., Denver, CO 80227 (Tel. 303-986-1516. For orders: 800-622-0949).

**Color Monitor.** The CT-160 dual-mode 10 (diagonal) color video monitor features a front-panel switch that changes the display from full-color to monochrome. The CRT is a high-contrast black matrix, the monitor requires composite video at 1-volt peak-to-peak, the bandwidth is 5 MHz, and an audio input is provided to drive the internal audio system. Input is 75 ohms or high-Z. \$400. **Address:** Panasonic, One Panasonic Way, Secaucus, NJ 07094.

**S-100 16 Bits.** The CPU 86/87 uses an 8086 and 8087 to create a 16-bit S-100 board. Compatible with IEEE696/S-100 standards, the board is available with 8- or 10-MHz versions. The on-board logic

can read or write two bytes serially for 8-bit applications or pass worldwide values for 16-bit operations. Therefore, it can mix 8- and 16-bit devices in the same system. The board also accepts the 8087 math processor and 80130 operating system firmware. This provides an 8-level vectored interrupt controller, three interval timers, and a choice of RMX-86 kernel or CP/M-86. It generates a 24-bit address for 16M-byte memory, and power-on jump to any 4K boundary in lower 1M-byte address space. A clock-switching circuit allows slave processors. A ROM-less version of 80130 and socket for the 8087 is available for \$695 (8 MHz) or \$850 (10 MHz). **Address:** CompuPro Systems, Oakland Airport, CA 94614 (Tel: 415-562-0638).

**IBM PC RAM Expansion.** The ADS-5001 series plugs into the IBM PC expansion slot and features a minimum of 64K (with parity checking), expandable to 256K in 64K increments. No wait states are required, and test diagnosis is included. The 62-pin edge connector is plug compatible with the IBM. Requires only +5-volts at 250 mA. **Address:** Antex Data Systems, 2630 California St., Mountain View, CA 94040 (Tel: 415-941-7914).

**Printer Stand.** Stack Rack stores up to 2 inches (600 sheets) of paper beneath an Epson MX-80 printer. It aligns the paper with the sprocket drives and a bale guide prevents paper from snagging on the bottom of the printer. A paper stop prevents paper from sliding out during transportation. \$14.95. **Address:** Remtron, POB 2280, Santa Clara, CA 95055.

**Apple Expansion.** The Appli-Card plug-in for the Apple II or III comes with a 4-MHz Z80 (6 MHz is optional), 64K of RAM, EPROM, and a real-time clock is supported. An expansion interface is available. The 6502 and Z80 run simultaneously at full speed. The video portion includes upper and lower case, 40 to 255 columns horizontal scrolling, and 70 cols., by 24 lines is available using the hires mode. All Apple peripherals are supported.

All 96 ASCII characters and input/output and the upper/lower case do not require hardware modifications. CP/M and SB/80 are provided. Dot graphics are also supported. A number of software packages are available. The 4 MHz version is \$445, while the 6-MHz version is \$595. **Address:** Personal Computer Products, Inc., 16776 Bernardo Center Dr., Suite 203, San Diego, CA 92128 (Tel: 714-485-8411).

**Hard Disks.** Hobbyist-5, -10, and -15 are 5-, 10-, and 15M-byte 5¼" Winchester disk systems for the Apple II, III, TRS-80, Altos, LSI-11, Multibus, S-100, and 6800 Systems. Transfer speed is 5M-bits/second, it is expandable via daisy chaining, is transparent to most operating systems, and supports all CP/M programs. A 1M-byte floppy backup is also available. Physically, the unit is 8 ½" x 9" x 18" and it weighs 22 pounds. The Hobbyist-5 (5M-bytes) is \$1995; the -10 (10M-bytes) is \$2495, and the -15 (15M-bytes) is \$2995. **Address:** Santa Clara Systems Inc., 560 Division St., Campbell, CA 95008 (Tel: 408-374-6972).

**New Portable.** The M6000P features a Z80, 8-slot STD cage, 64K RAM, dual 5¼" dsdd floppies, with 360K bytes each, connector for 8 drive, 83-key front-panel keyboard, 9 CRT, and 80 characters on 24 lines. Size is 17" x 20" x 7" and it weighs 35 pounds. Software includes CP/M 2.2. Many options are available. \$3900. **Address:** Micro Source Inc., POB 319, 595 N. Clayton Rd., New Lebanon, OH 45345 (Tel: 513-687-1395).

**New Micro.** The MicroDecision features 64K, Z80 at 4 MHz, two RS232 ports, floppy controller, 5¼" drives, single-sided 40 tracks/side, switching power supply, and it weighs 18 pounds. Dimensions are 16" x 5" x 11". Software includes CP/M, Microsoft Basic 80, BAZIC (compatible with North Star BASIC), CalcStar, and SpellStar. One drive is \$1195, two drives is \$1545. **Address:** Morrow Designs, 5221 Central Ave., Richmond, CA 94804 (Tel: 415-524-2101). ◇

# WORD PROCESSOR?



You bet! Quick Brown Fox word processing software has more features than Word Star and runs on your VIC or Commodore 64. And it can grow and grow. Add memory, 80 column display, disks, even a letter quality printer. We'll show you how a 1st-class word processor can be yours for less than \$2000! You can even have a "student" system for less than \$700!

It all starts with the Quick Brown Fox at \$65.

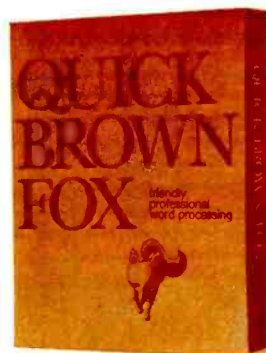

Call or write for our free brochure  
Quick Brown Fox 548 Broadway New York NY 10012 (800) 547-5995 Ext 194  
Dealer Inquiries Invited (212) 925-8290



# Picture where you can go with a \$99.<sup>95</sup> computer.

Remember when they said all computers would be affordable someday?

Well, here they are. All one of them.

## The only \$99.95 computer.

Now you don't have to spend hundreds or even thousands of dollars to enjoy some really useful and interesting software programs.

You can own a full powered TS1000 personal computer for only \$99.95. And you can buy it directly from Sinclair Research, the company that pioneered the affordable computer. Only Sinclair has made this revolutionary new technology possible, with a unique Master Chip which replaces as many as 18 chips used in other personal computers.

The TS1000 is the lowest priced personal computer on the market. In addition to being very affordable, it's very expandable.

You can select from a number of 1K software programs for the basic computer. You can also learn how to write your own programs.

## The 16K Memory Module. More power to you.

For only \$49.95 more, you can purchase our 16K Memory Module and use even more sophisticated software. Choose from a wider selection of games, educational programs and business/household applications.

The 16K Memory Module plugs right onto the back of the Timex/Sinclair 1000 and provides 8 times more memory capacity. The perfect way to expand your system without emptying your wallet.

## A computer even the merely curious can afford.

The TS1000 is designed precisely for you. Anyone can afford it. Anyone can learn how to use it.

So now even the curious can take advantage of our many software cassettes, which work with a standard cassette recorder.

The TS1000 comes with a complete software catalog and a comprehensive instruction book written in clear, simple English. And the computer hooks up to your TV for video display.

No wonder the TS1000 is the fastest selling personal computer ever. And Sinclair will let you try it in your home for 10 days at no risk.

## Buy three cassettes, get one free.

### A good reason to order now.

The fact that computers are here to stay is probably reason enough to order now.

However, we also feature a special software offering. When you buy three cassettes, you get a free cassette. It's as simple as that. And now you can buy the computer and both 1K programs and 16K programs right from your home. No crowds, no waiting lines, no parking worries. Selecting from such a large variety of software has never been easier or more convenient.

But you have to order right away, this is a limited time offer.

## How to order today.

Call our toll free number and use your MasterCard or VISA. Or send the coupon with a check or money order.

Then try out the Timex/Sinclair 1000 for

The Flight Simulator

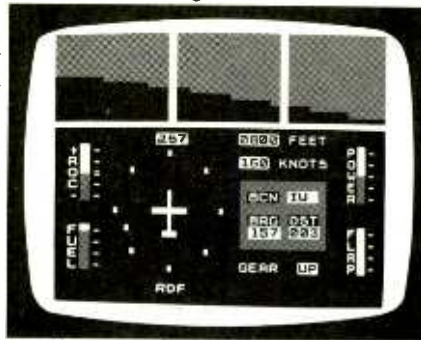

Space Raiders



Backgammon

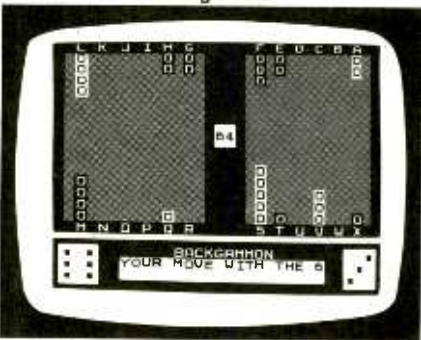

VU-CALC



10 days. If you're not entirely satisfied, just return it to us and we will refund your money. (Sorry, no refunds on software.)

Call toll free: 800-543-3000. Ask for operator 509. In Ohio call: 800-582-1364. Ask for operator 509. In Canada call 513-729-4300, operator 509. Have your MasterCard or VISA ready when calling. Phones open 24 hours a day, 7 days a week. These numbers are for orders only.

If you want information, please write: Sinclair Research Ltd., 2 Sinclair Plaza, Nashua, NH 03061.

Call toll free

# 800-543-3000

Ad code: BIPE01 Mail to: Sinclair Research, Ltd.  
One Sinclair Plaza, Nashua, NH 03061

Check or Money Order enclosed

	Price	Qty.	Amount*
TS1000 Computer	\$99.95		
16K RAM	\$49.95		

Check the boxes of all software cassettes you want. If you select any three cassettes, get one free. You must circle the one cassette you wish to receive free.

### 1K Cassettes for basic computer, \$9.00

- 1) Statistics  
Includes Statistics, Regression and Trend, CHI Squared Text and Graphics Plot
- 2) Super Program 1  
Invasion from Jupiter, Skittles, Magic Square, Doodle, Kim, Liquid Capacity
- 3) Super Program 7  
Racetrack, Chase, Nim, Tower of Hanoi, Docking the Spaceship, Golf
- 4) Super Program 2  
Rings Around Saturn, Secret Code, Mind Boggling, Silhouette, Memory Test, Metric Conversion

1K Cassettes	\$9.00 each		
--------------	-------------	--	--

### Cassettes for 16K Module: \$15.00

- 5) Space Raiders, Bomber  
The popular Arcade games
- 6) The Flight Simulator  
Control a highly maneuverable light aircraft
- 7) Chess  
Six levels of difficulty
- 8) Backgammon and Dice
- 9) The Cube Game  
One, two or three dimensional cube puzzle solving
- 10) The Organizer  
General purpose information storage and retrieve program. Use it
- 11) VU-CALC  
Financial analysis, budget and projection tables; a powerful analytical tool
- 12) The Coupon Manager  
List coupons by store or type
- 13) The Stock Option Analyzer  
Calculate last trading day; evaluate ROI, annual ROI and NET worth
- 14) Super Math  
Five levels of difficulty

16K Cassettes	\$15.00 each		
Shipping/Handling	\$ 4.95		\$4.95

\*U.S. Dollars Total:

Name \_\_\_\_\_

Street \_\_\_\_\_

City \_\_\_\_\_

State \_\_\_\_\_ Zip \_\_\_\_\_

# sinclair



# ON MAXELL, ROCK 'N' ROLL IS REALLY HERE TO STAY.

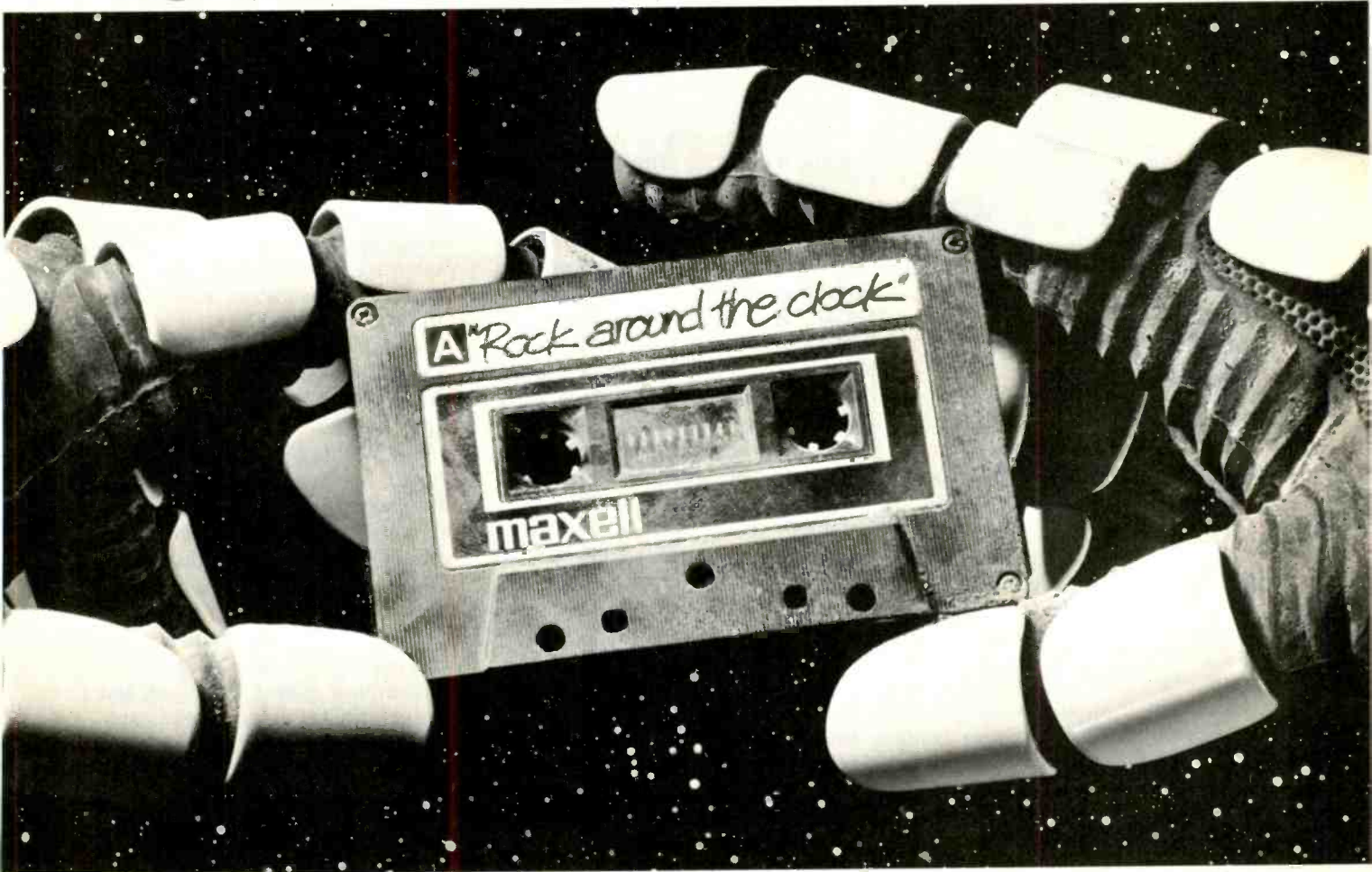

Every Maxell cassette is destined to become a golden oldie. Because at Maxell we build cassettes to standards that are 60% higher than the industry calls for.

Durable cassettes you can shake, rattle yet they keep on rolling.

Precision engineered tape that even after 500 plays still delivers high fidelity.

So when we say, on Maxell, rock 'n' roll is really here to stay... Be-Bop-A-Lu-La... we don't mean maybe.



IT'S WORTH IT.

Maxell Corporation of America, 60 Oxford Drive, Morristown, N.J. 07074

CIRCLE NO. 30 ON FREE INFORMATION CARD



# STAN VEIT ON COMPUTER SOFTWARE



## Lotus 1-2-3 Word-Processing System

**M**ANY computer owners are now on their second or third computers. These are the pioneers who were willing to put up with troublesome hardware and first-generation software. Today, most people expect to plug in their new computer and be able to use it with a minimum of instruction. They demand that it should work, no ifs, ands, or buts. The hardware being sold now has the potential to do this, but the software has lagged behind. Only the electronic spreadsheets and word processors begin to meet this requirement and even they have severe limitations.

The VALDOCS system discussed here last November is representative of the new generation of software, and now there is another one for the IBM-PC computer. The name of this software system is Lotus 1-2-3. It is an integrated package that includes an electronic spreadsheet with dimensions of 2048 rows by 256 columns. It has enough capacity to contain a model with half a megabyte of data. And it has advanced page and cell options, including provisions for individual variable column widths and other features lacking in most spreadsheets. Many statistical and financial functions, such as rate-of-return-on-investment (roi), are incorporated within the program

and can be used by calling them with a single keystroke.

The speed of calculation is impressive—you command the program to recalculate a large model and it changes before your eyes. This is amazing to someone who has time to have his morning coffee while waiting for other spreadsheets to perform the same job!

Lotus 1-2-3 is also an information management program. It handles data entry, retrieval, selection criteria, and sorting capability for over 2000 records. The data base information is available for statistical analysis, reports, and inclusion within the spreadsheets or graphs. This is very different from other systems where such information is developed in separate programs and must be re-entered before it can be used.

Lotus 1-2-3 produces graphs and charts from the spreadsheets or data base information. Single keystrokes can provide entirely new graphs by projection of data into the future. This enables the user to do "what-if" planning without leaving the Lotus 1-2-3 program. The graph can be displayed on the screen in either monochrome or color, and they can be reproduced on a dot-matrix printer or a pen plotter.

The spreadsheet, data base, and graphics capabilities are enhanced by the text-processing features of the program. Although this is not a full word processor, it can produce memos, outlines, and brief reports more quickly than many conventional word processors.

Lotus 1-2-3 interfaces with other software systems using the Data Interchange Format (DIF) and with the widely used dBase II files. To further enhance its usefulness, Lotus 1-2-3 includes a utility program to convert VisiCalc programs into Lotus format.

The Lotus Corp. was founded by Michael Kapor, who wrote VisiPlot and VisiTrend. He then invested his money and time in the development of this new generation of integrated software. Ben Rosen, well-known

venture capitalist, is backing the Lotus Development Corp. and serving on its Board of Directors. Ben is famous for picking winners in this industry. After seeing this program, I think he has done it again! **Address:** Lotus Development Corp., 55 Wheeler St., Cambridge, MA 02138.

**Catholic Software.** People are always asking me what personal computers are used for. Well, here is an application that is somewhat different.

Several years ago I met a Catholic priest named Father Joe McLaughlin. Through me he became interested in personal computers. Within a short time his sister bought him a SOL computer. He disappeared into his room regularly, only emerging to fulfill his priestly duties. When his disappearing act was finally over, he had written a data base program for a SOL with a cassette! Father McLaughlin had taught himself to be an expert programmer. There was a method to his computer madness. He wanted to be able to lift the burden of paperwork from the parish priest so that he would have more time to work with people.

Soon Father McLaughlin had a group of friends working under his direction and they founded a company called Angel Systems. It took two years to write the system they needed and remove all the bugs. Now there are several parishes using it to keep track of collections and contributions, as well as other parish accounting. The testing of PARSEC "Parish Secretary" completed, Angel Systems has appointed American Business Products to market it all over the country. In addition, Father McLaughlin has written a booklet called "A Pastor's Guide to Choosing A Microcomputer," which goes with the software demo. PARSEC will run on a wide variety of computers that can use CP/M. Contact John Corcoran at American Business Products for more information. **Address:** Ameri-



**400**  
 16K..... \$269  
 32K..... \$349  
 48K..... \$429

**800 — 48K**  
~~\$369~~ call

410 Recorder	\$ 76.00
810 Disk Drive	\$449.00
822 Printer	\$269.00
825 Printer	\$589.00
830 Modem	\$159.00
820 Printer	\$259.00
850 Interface	\$169.00
CX40 Joysticks (Pair)	\$ 18.00
CX853 Atari 16K Ram	\$ 77.95

Microtek 16K Ram	\$ 74.95
Axlon Ramdisk (128K)	\$429.95
Intec 48K Board	\$159.00
Intec 32K Board	\$ 74.00
One Year Extended Warranty	\$ 70.00
CX481 Entertainer Package	\$ 69.00
CX482 Educator Package	\$130.00
CX 483 Programmer Package	\$54.00
CX 484 Communicator Package	\$344.00
Atari 800 Dust Cover	\$6.99
Atari 400 Dust Cover	\$6.99
Atari 810 Dust Cover	\$6.99

# PERCOM

## Disk Drives For Atari Computers

S1 Single Drive	\$589.00
A1 Add-on Drive	\$339.00
S2 Dual Drive	\$879.00
Single Side Dual Head	\$679.00
Dual Drive Dual Head	\$1046.00



## U-SCI

### MICRO-SCI Disk Drives For Franklin & Apple



A2	\$319.00
A40	\$369.00
A70	\$499.00
C2 Controller	\$79.00
C47 Controller	\$89.00

### ATARI

Pac Man	\$35.00
Centipede	\$35.00
Caverns of Mars	\$32.00
Asteroids	\$29.00
Missile Command	\$29.00
Star Raiders	\$35.00

### DATASOFT

Pacific Coast Highway	\$25.00
Canyon Climber	\$25.00
Tumble Bugs	\$25.00
Shooting Arcade	\$25.00
Clowns and Balloons	\$25.00
Graphic Master	\$30.00
Graphic Generator	\$13.00
Micro Painter	\$25.00
Text Wizard	\$89.00
Spell Wizard	\$64.00
Bishop's Square	\$25.00

### ON-LINE

Jawbreaker	\$27.00
Softporn	\$27.00
Wizard and the Princess	\$29.00
The Next Step	\$34.00
Mission Asteroid	\$22.00
Mouskattack	\$31.00

### SYNAPSE

File Manager 800	\$79.00
Chicken	\$26.00
Dodge Racer	\$26.00
Synassembler	\$30.00
Page 6	\$19.00
Shamus	\$26.00
Protector	\$26.00
Nautlius	\$26.00
Slime	\$26.00
Disk Manager	\$24.00

### K-BYTE

Krazy Shoot Out	\$32.00
K-razy Kritters	\$32.00
K-razy Antics	\$32.00
K-star Patrol	\$32.00

**STICK STAND**  
**\$6<sup>99</sup>**



### VISICORP

#### For Apple, IBM, Franklin

Visidex	\$189.00
Visifile	\$189.00
Visiplot	\$159.00
Visiterm	\$189.00
Visitrend/Plot	\$229.00
VisiSchedule	\$229.00
Desktop Plan	\$189.00
VISICALC	\$179.00

for Apple II plus, Atari, CBM & IBM

### Continental

The Home Accountant (Apple/Franklin)	\$59.00
The Home Accountant (IBM)	\$119.00
1st Class Mail	\$59.00

### FLOPPY

#### DISKS

##### Maxell

MD I (Box of 10)	\$36.00
MD II (Box of 10)	\$46.00
MFD I (8")	\$44.00
MFD II (8" Double Density)	\$54.00

##### Verbatim

5 1/4" SS DD	\$26.00
5 1/4" DS DD	\$36.00

##### Elephant

5 1/4" SS DD	\$19.99
--------------	---------

### TIMEX

#### TIMEX SINCLAIR 1000

**LOWEST PRICE EVER!**  
**\$89.00**

We also carry Eagle, Hewlett Packard, Televideo, Sharp, NEC, Commodore and a complete line of printers.

## FRANKLIN ACE1000

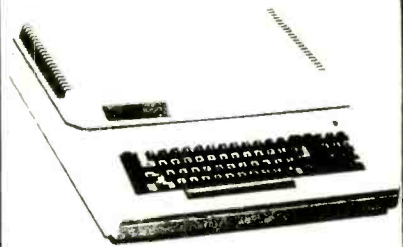

64K Personal Computer Hardware, Software and peripheral compatible with the Apple II and even has some features not found on the Apple.

### MONITORS AMDEK

300G	\$169.00
Color I	\$339.00
Color II	\$699.00
Color III	\$429.00

### BMC

12" Green	\$ 85.00
13" Color 1400	\$279.00
13" Color 1401 (Mid Res)	\$369.00

### ZENITH

ZVM 121	\$ 99.00
---------	----------

### SHARP

Sharp 13" Color TV	\$275.00
--------------------	----------

### PANASONIC

TR-120 MIP (High Res. Green)	\$159.00
CT-160 Dual Mode Color	\$299.00

**west**  
**800-648-3311**  
 IN NV. CALL (702) 888-8864  
 P.O. BOX 8888, STATELINE, NV. 89448

**east**  
**800-233-8950**  
 IN PA. CALL (717) 327-2578  
 477 E. THIRD ST., WILLIAMSPORT, PA. 17701

In-stock items shipped same day you call. No risk, no deposit on C.O.D. orders. Pre-paid orders receive free shipping within the continental United States with no waiting period for certified checks or money orders. Add 3% (minimum \$3.00) shipping and handling on all C.O.D. and Credit Card orders. NV and PA residents add sales tax. All items subject to availability and price change. **NOTE:** We stock manufacturer's and third party software for most all computers on the market! Call today for our new catalogue.



... SOFTWARE

can Business Products 155 Dean St., Englewood, NJ 07631.

**Money Management.** The question I am most often asked is "I am a very small business owner, what can a personal computer do for me."

One of the best answers to this question is contained in the books *Computer Simplified Bookkeeping, Inventory Management System, and Retail Inventory Program*, all by Chuck Atkinson, published by dilithium Press, PO Box 606, Beaverton, OR 97005. The software to go with the books is available from Chuck Atkinson Programs, Route 5, Box 277-C, Benbrook, TX 76126 (817-654-2011).

All of these programs are written for the individual or small-business person; their approach to bookkeeping is through the checkbook. This is a natural approach since people

must control their checkbooks anyway. In addition, Chuck Atkinson's programs control inventory through the cash register, where all retail bookkeeping starts anyway. The Retail Inventory Program provides control of retail inventory for larger inventory items that require detailed handling. It also permits using the personal computer as a cash register.

Prices of these programs have been kept low, starting at \$19.95.

**Apple Graphics.** GRAPH can stand alone or directly interface with PFS data bases of VisiCalc to produce bar, line or pie charts, where line and bar graphs can be mixed and matched, and up to four graphs can be displayed on a single set of axes. Bar graphs can be stacked or comparative. Other features include automatic formatting, scaling, legend labelling, and pattern fill. It interfaces with Silentyper, Epson, HP7470A and many other printers. \$125. Address: Software

Publishing Corp., 1901 Landings Drive, Mountain View, CA 94043 (Tel: 415-962-8910).

**Spectrum Analyzer.** The SPEC-SYSTEM works with the Eventide RealTime Analyzer for the Apple II to provide display of reverberation time for all 31 ISO-standard 1/3-octave frequencies with the screen displaying up to eight frequencies simultaneously; a three-dimensional spectral surface mode that displays frequency versus amplitude vs time; and an all-new HIRES 32-band real time analysis display. The system can be used in broadcast, recording, sound reinforcement, music, environmental noise analysis, speech and hearing analysis, and therapy. Package consisting of the Analyzer and SPECTRUM software is \$744. Current owners of AIB232 Spectrum Analyzers can upgrade for \$199. Address: Eventide Clockworks, Inc., 265 W. 54th St., New York, NY 10019 (Tel: 212-581-9290).

We accept VISA, MC, C.O.D., CHECK or M.O.

FIRST QUALITY COMPONENTS - NOT MAIL ORDER "SECONDS"

Min. order \$10.00 - add 5% Shpg and \$1.00 Ins

**ARIES ZERO INSERTION FORCE SOCKETS**



Cam actuated true zero insertion - Tin plated solder tail pins capable of being plugged into dip sockets, including wire wrap

Stock No.	No. Pins	1-24	25	50
11055	24	\$ 4.35	\$ 3.90	\$ 3.60
11056	28	4.50	4.05	3.75
11057	40	5.25	4.95	
11058	64	10.50	9.45	8.70

**RESISTOR ASSORTMENT**

82508 - 700 pcs (1 each below assortment) **\$22.50**  
 Stock No. 82501 10 ea. of 10-12-15-18-22-27-33-39-47-56 OHM  
 Stock No. 83502 10 ea. of 68-82-100-120-150-180-220-270-330-390 OHM  
 Stock No. 82503 10 ea. of 470-560-680-820-1K-1.2K-1.5K-1.8K-2.2K-2.7K OHM  
 Stock No. 82504 10 ea. of 3.3K-3.9K-4.7K-5.6K-6.8K-8.2K-10K-12K-15K-18K OHM  
 Stock No. 82505 10 ea. of 22K-27K-33K-39K-47K-56K-68K-82K-100K-120K OHM  
 Stock No. 82506 10 ea. of 150K-180K-220K-270K-330K-390K-470K-560K-680K-820K OHM  
 Stock No. 82507 10 ea. of 1M-1.2M-1.5M-1.8M-2.2M-2.7M-3.3M-3.9M-4.7M-5.6M-6.8M

**WILD ROVER**

Touch switch capsule. Operating motion is .005" without the use of a levered arm. Extremely fast on and off with low noise. Normally operated 115 VAC, 16 amp-30 milliohm resistance - 61.5 radius by .160 thick.



Stock No.	1-9	10	25
12D98	\$ 1.28	\$ 1.12	\$ .95

**60/40 ROSIN CORE SOLDER**

Stock No.	Dia (Inch)	Length (Feet)	Weight (Lbs)	Price (\$116)
50015	.062	9	1.5	\$116
50076	.062	25	4	2.39
50077	.062	50	8	4.25
50078	.032	33	1.5	1.31
50079	.032	86.5	4	2.47
50080	.032	175	8	4.57

**TI WIRE WRAP SOCKETS**

Tin plated phosphor bronze contact - 3 wrap



Stock No.	No Pins	1-24	25	100
11301	8	\$ 45	\$ 40	\$ 36
11302	14	66	59	54
11303	16	72	64	58
11304	18	82	73	66
11305	20	1.11	.99	.90
11306	22	1.26	1.12	1.02
11307	24	1.41	1.25	1.14
11308	28	1.71	1.52	1.38
11309	40	2.31	2.05	1.86

**TI LOW PROFILE SOCKETS**

Tin plated phosphor bronze contact pins with gas tight seal



Stock No.	No Pins	1-24	25	100
11201	8	\$ 15	\$ 13	\$ 12
11202	14	18	15	14
11203	16	21	18	16
11204	18	24	21	19
11205	20	27	24	21
11206	22	30	26	23
11207	24	33	30	25
11208	28	38	34	29
11209	40	53	45	40

**ELPAC POWER SUPPLIES - DC/DC CONVERTERS**



SINTEC Stock No.	ELPAC Part No.	Input Voltage (VDC)	Output Voltage (VDC)	Output Current (mA)	Dimensions (HxWxD) in inches	Price
13825	CB3801	3.0/7.0	12.0/6	0.25	48x51x3.05	7.95
13826	CB3811	3.0/7.0	12.0/6	0.25	48x51x3.05	7.95
13827	CB3802	3.0/7.0	15.0/7	0.20	48x51x3.05	7.95
13828	CB3812	3.0/7.0	15.0/7	0.20	48x51x3.05	7.95
13829	CB3804	3.0/7.0	28.0/10	0.10	48x51x3.05	7.95
13830	CB3814	3.0/7.0	28.0/10	0.10	48x51x3.05	7.95
<b>1.5W TYPE</b>						
13831	CL3801	4.0/7.0	12.0/6	125	85x112x1.77	524.95
13832	CL3811	4.0/7.0	12.0/6	125	85x112x1.77	24.95
13833	CL3802	4.0/7.0	15.0/7	100	85x112x1.77	24.95
13834	CL3812	4.0/7.0	15.0/7	100	85x112x1.77	24.95
13835	CL3804	4.0/7.0	28.0/14	50	85x112x1.77	24.95
13836	CL3814	4.0/7.0	28.0/14	50	85x112x1.77	24.95

Stock No. 13801 - Floppy Disc Power Supply For Winchester Drives **\$109.00**

13801-1 Data Sheet for 13801 \$ 25

13825-1 DATA SHEET FOR DC/DC CONVERTERS 25

**ELPAC POWER SUPPLIES - SOLV SERIES FULLY REGULATED**

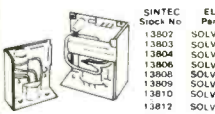

SINTEC Stock No.	ELPAC Part No.	Output Voltage (VDC)	Output Current (Amps)	Dimensions in inches	DVP	Price
13803	SOLV15-5	5	3.0A	4.7x18x4.2	Fixed included	\$39.95
13804	SOLV15-15	15	1.2A	4.7x18x4.2	Fixed included	39.95
13806	SOLV15-24	24	0.75A	4.7x18x4.2	Fixed included	39.95
13808	SOLV30-5	5	6.0A	5.5x84x7.8x3.16	OVp-4	59.95
13809	SOLV30-12	12	4.0A	5.5x84x7.8x3.16	OVp-4	59.95
13810	SOLV30-15	15	3.3A	5.5x84x7.8x3.16	OVp-4	59.95
13812	SOLV30-24	24	2.0A	5.5x84x7.8x3.16	OVp-4	59.95

13802-1 Data Sheet for SOLV Series 25

**Special of the Month!**



**DIGITAL MULTIMETER**  
 Single rotary switch operation. Large, easy to read 5 3 1/2 digit display. 800 hours operating life with single 9v battery. Seven functions - (DC Volts, DC Amps, Ohms, AC Volts, AC Amps, Diode and Resistor Junction, Audible Continuity Check)

Stock No. 62503 **\$75.00**  
 Full 1 year warranty

Stock No. 62504 Carrying case with bell loop **\$7.50**

**MODUTEC**

Miniclamp AC Volt-Ammeter allows singling one conductor out of many without disarrangement.

Stock No.	AC Amperes	Price
13730	0-25A	\$39.50
13731	0-50A	39.50
13732	0-100A	39.50

**ACCESSORY LINE SPLITTER**  
 allows last readings of AC power consumption of plug in equipment without separation of leads

Stock No. 13727 **\$9.95**

**POCKET SIZED BATTERY TESTER**  
 for all types of small batteries from 1.35v to 4.5v

Stock No. 13733 **\$13.95**

**VOLT-ICATOR**  
 automotive diagnostic meter plugs into lighter socket and indicates battery condition and charging rates.

Stock No. 13736 **\$15.95**

**AC VOLTAGE TESTER**  
 plugs into any 110v service receptacle to check time voltage over 50:150 VAC

Stock No. 13735 **\$14.95**

**VOM-MULTITESTER**  
 versatile Volt-Ohm-Milliammeter in small package

Stock No. 13729 **\$13.95**

**OK MACHINE AND TOOL**



**IC INSERTION/EXTRACTION KIT**  
 Includes DIP IC extractors and inserters to accommodate all ICs from 14 to 40 pins. Tools that engage conductive surfaces are CMOS safe and include ground and lugs. Stock No. 13309 **\$37.74**

**SOCKET WRAP ID**  
 DIP socket sized plastic panels with numbered holes in pin locations. Slip into socket before wire wrapping to identify pins. Also write on them for location. IC part number, function etc. Simplifies initial wire wrapping, trouble shooting and repair. **\$1.82 per pack**

**IC EXTRACTOR**  
 One-piece, spring steel construction. Will extract all LSI, MSI and SSL devices with 8 to 24 pins. Stock No. 13313 **\$2.10**

**SINTEC co.** Drawer Q Milford NJ 08848-9990



**TOLL 800-526-5960**  
**FREE** In NJ (201) 996-4093

Send for Free Catalog - over 1100 parts.

CIRCLE NO. 36 ON FREE INFORMATION CARD

www.americanradiohistory.com



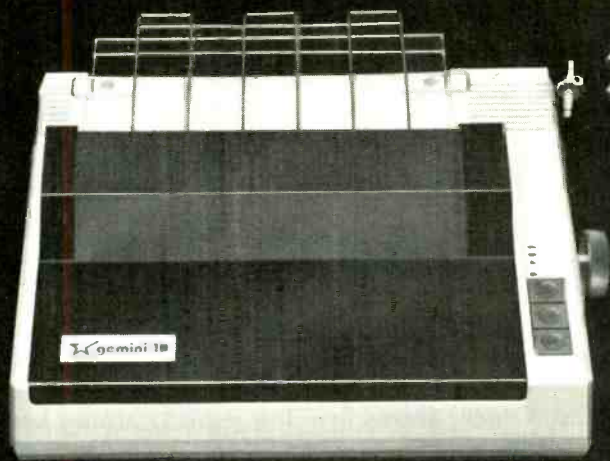

## GEMINI— FOR PRINTER VALUE THAT'S OUT OF THIS WORLD

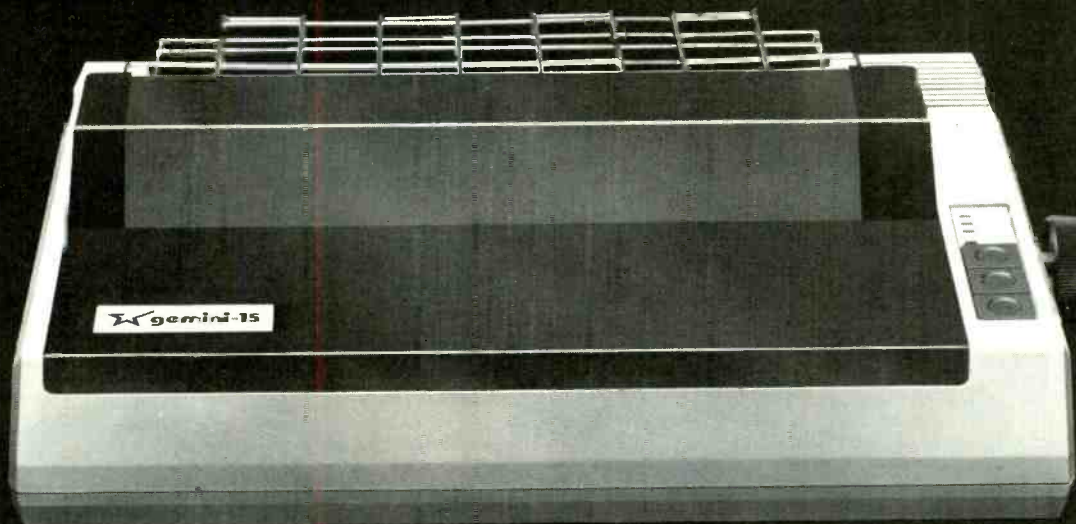

Over thirty years of down-to-earth experience as a precision parts manufacturer has enabled Star to produce the Gemini series of dot matrix printers—a stellar combination of printer quality, flexibility, and reliability. And for a list price of nearly 25% less than the best selling competitor.

The Gemini 10 has a 10" carriage and the Gemini 15 a 15½" carriage. Plus, the Gemini 15 has the added capability of a bottom paper feed. In both models, Gemini quality means a print speed of 100 cps, high-resolution bit image and block graphics, and extra fast forms feed.

Gemini's flexibility is embodied in its diverse specialized printing capabilities such as super/sub script, underlining, back-spacing, double strike mode and emphasized print mode. Another extraordinary standard

feature is a 2.3K buffer. An additional 4K is optional. That's twice the memory of leading, comparable printers. And Gemini is compatible with most software packages that support the leading printers.

Gemini reliability is more than just a promise. It's as concrete as a 180 day warranty (90 days for ribbon and print head), a mean time between failure rate of 5 million lines, a print head life of over 100 million characters, and a 100% duty cycle that allows the Gemini to print continuously. Plus, prompt, nationwide service is readily available.

So if you're looking for an incredibly high-quality, low-cost printer that's out of this world, look to the manufacturer with its feet on the ground—Star and the Gemini 10, Gemini 15 dot matrix printers.

**star**  
MICRONICS • INC

MAKING A NAME FOR OURSELVES

1120 Empire Central Place, Suite 216, Dallas, TX 75247

For more information, please call Bob Hazzard, Vice President, at (214) 631-8563

CIRCLE NO. 38 ON FREE INFORMATION CARD

[www.americanradiohistory.com](http://www.americanradiohistory.com)



# Everybody's making money selling microcomputers. Somebody's going to make money servicing them.

New NRI Home-Study Course Shows You How to Make Money Servicing, Repairing,  
and Programming Personal and Small Business Computers





Training includes the TRS-80 Model III microcomputer, professional LCD multimeter, the NRI Discovery Lab, Computer Assisted Instruction programs and hundreds of demonstrations and experiments.

Seems like every time you turn around, somebody comes along with a new computer for home or business use. And what's made it all possible is the amazing microprocessor, the tiny little chip that's a computer in itself.

Using this new technology, the industry is offering compact, affordable computers that handle things like payrolls, billing, inventory, and other jobs for businesses of every size... perform household functions including budgeting, environmental systems control, indexing recipes. And thousands of hobbyists are already owners, experimenting and developing their own programs.

### Growing Demand for Computer Technicians

This is only one of the growth factors influencing the increasing opportunities for qualified computer technicians. The U.S. Department of Labor projects over a 100% increase in job openings for the decade through 1985. Most of them *new* jobs created by the expanding world of the computer.

## Learn at Home in Your Spare Time

NRI can train you for this exciting, rewarding field. Train you at home to service not only microcomputers, but word processors and data terminals, too. Train you at your convenience, with clearly written "bite-size" lessons that you do evenings or weekends, without going to classes or quitting your present job.

Your training is built around the latest model of the world's most popular computer. It's the amazing TRS-80™ Model III, with capabilities and features to perform a host of personal and business functions. No other small computer has so much software available for it, no other is used and relied on by so many people. And it's yours to keep for personal or business use.

You get plenty of practical experience. Using the NRI Discovery Lab® that also comes as part of your course, you



build and study circuits ranging from the simplest to the most advanced. You analyze and troubleshoot using the professional 4-function LCD digital multimeter you keep to use later in your work. Then you use the lab and meter to actually access the interior of your computer... build special circuits and write programs to control them. You "see" your computer at work and demonstrate its power.

### Computer Assisted Instruction

Your TRS-80 even helps train you. You receive 4 special lesson tapes in BASIC computer language. Using them in your microcomputer, you "talk" to it

(TRS-80 is a trademark of the Radio Shack division of Tandy Corp.)

as you progress. Errors are explained, graphics and animation drive home key points. Within a matter of minutes, you'll be able to write simple programs yourself.

## Become the Complete Computer Person

In addition to training in BASIC and advanced machine language, you gain hands-on experience in the operation and application of computers to business and personal jobs. You're trained to become the fully rounded, new breed of technician who can interface with the operational, programming and service facets of today's computers. You're ready to take your place in the new electronic age.

## Other Opportunities

NRI has been giving ambitious people new electronic skills since 1914. Today's offerings also include TV/Audio/Video Systems servicing with training on our exclusive Heath/Zenith computer-programmable 25" diagonal color TV... Industrial Electronics, Design Technology...

and other state-of-the-art courses.

## Free Catalog... Mail Card No Salesman Will Call

Send the postage-paid card for our 100-page catalog showing all courses with equipment and complete lesson plans. There's no obligation other than to yourself. See how NRI can help you grow with the most exciting and important new field of the 80's. If card has been removed, please write to us.

1-013



### NRI Schools

McGraw-Hill Continuing Education Center  
3939 Wisconsin Ave.,  
Washington, D.C. 20016.

**We'll give you tomorrow.**



## Experimenting with Kodak's Disc Camera Part 3—Radio Control and Aerial Photography

By Forrest M. Mims

**T**HE FIRST aerial photograph ever taken was in 1858, 262' over the Valley of Bievre near Paris, by Gaspard Felix Tournachon ("Nadar"). He took the shot from the basket of a gas-filled balloon. The largest aerial photo ever taken was by George R. Lawrence in 1906. Seventeen kites hoisted a piano-size camera 2000 feet over San Francisco Bay for the shot. The negative, which gave a spectacular view of San Francisco in ruins after the great earthquake, measured 48" by 18<sup>3</sup>/<sub>4</sub>".

Over the past 15 years, I've enjoyed making both still and moving pictures with small cameras flown in model rockets. I've even been able to take photos from heli-



This 3' x 6' kite can tow a 12-oz RC disc camera package to an altitude approaching 1000 ft.

copters, airplanes, and the baskets of several hot-air balloons. Now, however, I've found a modern way to take aerial photos using equipment costing under \$150.

What I use to obtain aerial photos is a Kodak 4000 disc camera modified in accordance with the procedures and precautions outlined in Part 1 of this series (November 1982). Before getting to the fun part of the column, however, let's find out how to add radio control (RC) to the modified camera.

**Radio Control.** A modified disc camera can be easily triggered from afar by a suitable RC system. I've tried three different systems, each having advantages and disadvantages.

By far the most economical RC system for a modified disc camera is one salvaged from a toy RC car (cost is about \$10). The output from such receivers usually directly drives one or more small dc motors. It can therefore be connected directly to a relay (Radio Shack 275-004 or similar) whose contacts then control the camera. To save space and weight, the relay can be replaced with a LED-phototransistor optoisolator. But make sure a current-limiting series resistor of a few hundred ohms is inserted between the receiver's output and the optoisolator.

When I used a salvaged RC system from a toy car to control an airborne disc camera, I found the major drawbacks to be limited range (a few hundred feet) and susceptibility to false triggering, particularly in or near metropolitan areas. On the positive side, the economic advantages of this approach cannot be disputed.

For better and more reliable results, more sophisticated RC equipment is needed, such as the two systems described next. Both are less susceptible to interference and have considerably more range. They also weigh less.

**Two Radio-Control Systems.** Ace R/C, Inc. (Box 511, 116 W. 19th St., Higginsville, MO 64037), a long-time manufacturer and supplier of RC equipment, makes a single-channel transmitter/receiver pair ideally suited for remotely actuating a modified disc camera. The Wee 1 transmitter, which has an output power of nearly 1/2 watt, transmits a 1-kHz tone. Available as a kit (11K16 at \$19.95) or factory assembled (11K17 at \$29.95), the Wee 1 measures only 5<sup>5</sup>/<sub>8</sub>" x 2<sup>3</sup>/<sub>4</sub>" x 2<sup>1</sup>/<sub>16</sub>". Frequencies available are 26.995, 27.045, 27.095, 27.145, and 27.195 MHz.

Two versions of Ace's Commander superhet receiver are available for use with the Wee 1. One is designed for a 2.4-V NiCd power supply (12K12) and the other for a 3-V supply (12K13). Each is available assembled but without an enclosure for \$26.50. The commander weighs less than an ounce and measures 1<sup>5</sup>/<sub>16</sub>" x 1<sup>3</sup>/<sub>4</sub>" x 9/16". Figure 1 shows how the Commander receiver can be connected through an optoisolator to a modified disc camera. Any standard LED-phototransistor optoisolator can be used.

The 40-channel CB band extends from 26.965 to

# Heathkit®



## Try something special

Kitbuilders build more than fine products. They build pride.



If you've thought about ordering a Heathkit product but somehow never got around to it, here is some important news.



# Begin a life-long fascination.

If the idea of creating a great product with your own hands appeals to you but you haven't yet built a Heathkit product, you have a very special experience in store.

And now is the time to get started because we really do have something out of the ordinary to encourage you to try it.

Why bother? Because it's worthwhile for a lot of good reasons.

The kitbuilding process is itself a tonic. It puts the cares of the day behind you. You lose yourself in absorbing work for as long as you like. Spare moments take on new value as your project develops and you master new skills.

As you build, you are guided step-by-step by famous Heathkit manuals. At any age and level of experience, the instructions are easily understandable—the process always enjoyable.

**Finally, you have the satisfaction** that comes with knowing you have built a really fine product that is uniquely yours. Because in building a Heathkit product, you enter into a partnership. We provide the best components and instruction. You contribute the care and skill. The result is workmanship in which we both take pride.

**What's to build?** You have more than 400 choices. Some are at the leading edge of technology, while others are quite basic and quick to complete.



# Build your first kit now.

If you or your family are involved with computers, cars, boats, flying, amateur radio, alternative energy, woodworking or even the weather, we have a kit for you.

Build television receivers and audio components among the finest in the world. Or all kinds of advanced products for your home.

**Your partnership with Heathkit** gives you not only pleasure in building, but extra product value. Because these are kits without assembly cost, we can afford to put more into them in return for your time and effort. Our customers tell us this is one important reason why Heathkit products are well worth the hours they put in to construct them.

**How long will it take** to build the kit you choose? Many can be completed in one or two evenings.

As you progress to more complex kits, you will develop your own speed at which to work comfortably. You will probably surprise yourself at how quickly even major projects can be completed. For instance, the log splitter shown above requires only about six hours to complete.

We stand behind you every step of the way with our promise, "We won't let you fail." Help, if you need it, is always as close as your phone or your nearby Heathkit Electronic Center.\*

It's a simple, enjoyable, step-by-step process. To take the first step, just turn the page.

**Heathkit**<sup>®</sup>  
Heath  
Company



"I want you to discover  
kitbuilding."



## A special offer exclusively for new first-time kitbuilders.

If you've read this far, you are the kind of person with a whole lot of curiosity in your makeup.

You are very likely wondering, "Could I?" And maybe at the same time you're asking yourself, "Would I enjoy the experience?"

There is only one way to find out. Try it. That is why I have arranged a special get-acquainted offer that is made *only to new Heathkit customers*. You don't risk a thing when you take me up on this unique offer.

I am going to take all of the risk because of my absolute confidence that once you try kitbuilding the Heathkit way, you will become a long-time customer.

**Call 800-253-0570 toll-free or mail the coupon on this page.** Because of the very unusual nature of the offer, it must be limited to those calling the special number or mailing the coupon.

There's no reason for you not to act. There is no risk for you, and when you call there will be no high pressure to buy.

So let us hear from you soon. I wouldn't want you to miss getting all of the facts about this exceptional opportunity to find out what kitbuilding is all about.

A handwritten signature in black ink that reads "William E. Johnson".

**William E. Johnson**  
President

To: **W. E. Johnson, President**  
**Heath Company**  
**Dept. 010-974**  
**Benton Harbor, MI 49022**

Please send details on the President's  
Special Offer plus my *free* Heathkit catalog.

Name

Address

City

State

Zip

CO-103

CIRCLE NO. 24 ON FREE INFORMATION CARD

...EXPERIMENTER'S CORNER

27.405 MHz and encompasses all five FCC-allocated RC frequencies at which the Wee 1 is available. The 27.145-MHz RC frequency is close to CB channel 14 (27.125 MHz), a frequency used in many older 100-mW toy transceivers. The 27.195-MHz RC frequency is even closer to CB channel 19 (27.185 MHz), the popular trucker's channel. Therefore, you may reduce potential interference problems by selecting one of the three other frequencies.

Another way to reduce the interference problems that plague the 27-MHz RC band is by switching to equipment designed for the 72-MHz RC band. The three frequencies in this band not allocated specifically for controlling model aircraft are 72.160, 72.320, and 72.960 MHz.

Ace R/C and many other firms make 72-MHz digital-proportional and pulse-proportional RC systems. Digital-proportional systems are designed specifically to control the position of a servo, a subject recently covered in this column (October 1982). In such systems the transmitter broadcasts a train of pulse-duration-modulated pulses, a signal not suited for directly triggering a modified disc camera.

Figure 2 shows a straightforward circuit that, in effect, decodes a pulse-duration-modulated signal and provides an output suitable for triggering a modified disc camera through an LED-phototransistor optoisolator. In operation, Q2 and the 555 function as a missing-pulse detector, while Q1 buffers and inverts the signal from the RC receiver. When pulses arrive from the receiver, the 555 turns on the LED in the optoisolator and the camera is triggered.

I've used the circuit in Fig. 2 to enable an Aero Sport Two 2-channel RC system that remotely triggers a disc camera. The Aero Sport transmitter includes a two-axis joystick with trimmers, but all that's necessary to trigger the camera is to switch the transmitter on. For this

*(Continued on page 104)*



Vertical view of garden plot from balloon.  
Height is 145.2 ft. The light tan object  
in the center of the garden is a rake handle.



Oblique view from a kite taken toward  
the kite flier, seen standing on boat.



Photo taken with a radio controlled  
disc camera aimed away from kite flier.



Vertical view directly down from a kite.



# Simple answers to your questions about the IBM Personal Computer.

If you're personally interested in personal computers, but want to know more, these definitions, descriptions and details should help.

## "Just what is a personal computer, and how can I use it?"

The IBM Personal Computer is a

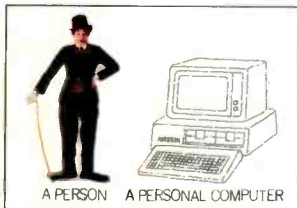

computer designed for a *person*. It's a tool to help accomplish just about anything a person needs to do with information. It can help a businessperson

solve complex problems just as surely as it can help a small child improve his or her arithmetic.

## "Suppose I've never had my hands on a computer. How 'easy' will it be?"

As with any new tool, you'll want to get comfortable with the IBM Personal Computer before putting it to serious use. You'll have

some step-by-step reading, but our instructional literature involves you from the start. And the computer is on your side too—interacting with you as you learn.

There's no reason why you can't be executing programs and feeling good with the results within your first week. After a month, it should be clear that you've made a good investment, and you'll probably be telling your friends why they should get one.



## "Is the IBM Personal Computer simpler or more advanced than others?"

Both. Our system has been engineered with many advanced design features (see the chart) but their purpose is to make it simpler for you. Our ten function keys are a good example. We added them to save you a lot of time and error. They are *advanced* features that add to *simplicity* and ease of operation, and that is typical of our total design.



## “What kind of software programs do you have to help me?”

IBM Personal Computer software comes in many varieties, and it's all quality.

For example, if planning is part of your work, we have VisiCalc\*— the “electronic worksheet.” If you maintain a business, we offer programs that help handle everything from accounting to inventory and payroll record keeping. We also have carefully chosen programs for educational use, intelligent games, a word processing program, plus communications packages that connect you and your computer to outside information services via your telephone and a device called a modem.



## “How expensive and how expandable is it compared to others?”

Because of the extraordinary amount of advanced, built-in features available in the IBM Personal Computer, it can give you more quality, power and performance for your money. You're also buying extraordinary expandability— beginning with user memory that can be increased up to 32 times. (In the chart at right, one needn't be a technical whiz to add up all



### IBM PERSONAL COMPUTER SPECIFICATIONS

<b>User Memory</b> 16K-512K bytes*	<b>Display Screen</b> High-resolution* 80 characters x 25 lines Upper and lower case Green phosphor screen*	<b>Permanent Memory</b> (ROM) 40K bytes*
<b>Microprocessor</b> 16-bit, 8088*	<b>Auxiliary Memory</b> 2 optional internal diskette drives, 5¼", 160K bytes or 320K bytes per diskette	<b>Color/Graphics</b> <i>Text mode:</i> 16 colors* 256 characters and symbols in ROM*
<b>Keyboard</b> 83 keys, 6 ft. cord attaches to system unit*	<b>Operating Systems</b> DOS, UCSD p-System, CP/M-86†	<i>Graphics mode:</i> 4-color resolution: 320h x 200v* Black & white resolution: 640h x 200v* Simultaneous graphics & text capability*
10 function keys* 10-key numeric pad Tactile feedback*	<b>Languages</b> BASIC, Pascal, FORTRAN, MACRO Assembler, COBOL.	<b>Communications</b> RS-232-C interface Asynchronous (start/stop) protocol Up to 9600 bits per second
<b>Diagnostics</b> Power-on self testing Parity checking*	<b>Printer</b> Bidirectional* 80 characters/second 12 character styles, up to 132 characters/line* 9 x 9 character matrix*	

\*ADVANCED FEATURES FOR PERSONAL COMPUTERS

the features that make our personal computer a very good buy indeed.)

## “If I want a demonstration, where do I go and who will show it to me?”

Go to any authorized IBM Personal Computer dealer. The salespeople there have received special training and you should find them all quite helpful.

Ask your dealer to run the software programs that interest you most, and get your hands on the system yourself. Then you'll begin to see what this tool for modern times can do for you.

For more information on where to buy the IBM Personal Computer, call 800-447-4700. In Illinois, 800-322-4400. In Alaska or Hawaii, 800-447-0890.

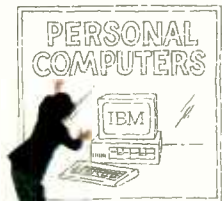

# The IBM Personal Computer A tool for modern times

†UCSD p-System is a trademark of the Regents of the University of California. CP/M-86 is a trademark of Digital Research, Inc. \*VisiCalc is a trademark of VisiCorp



# Tek's most successful scope series ever: At \$1200-\$1450, it's easy to see why!

**Wide-range vertical sensitivity:**  
Scale factors from 100 V/div (10X probe) to 2 mV/div (1X probe). Accurate to  $\pm 3\%$ . Ac or dc coupling.

**Two high-sensitivity channels:** dc to 60 MHz bandwidth from 10 V/div to 20 mV/div; extended sensitivity of 2 mV/div at  $> 50$  MHz.

**Sweep speeds:**  
from 0.5 s to 50 ns.  
To 5 ns/div with X10 magnification.

**Delayed sweep measurements:**  
Accurate to  $\pm 3\%$  with single time-base 2213; to  $\pm 1.5\%$  with dual time-base 2215.

**Complete trigger system.** Includes TV field, normal, vertical mode, and automatic; internal, external and line sources; variable holdoff.

**Probes included.** High-performance, positive attachment 10-14 pF and 60 MHz at the probe tip.

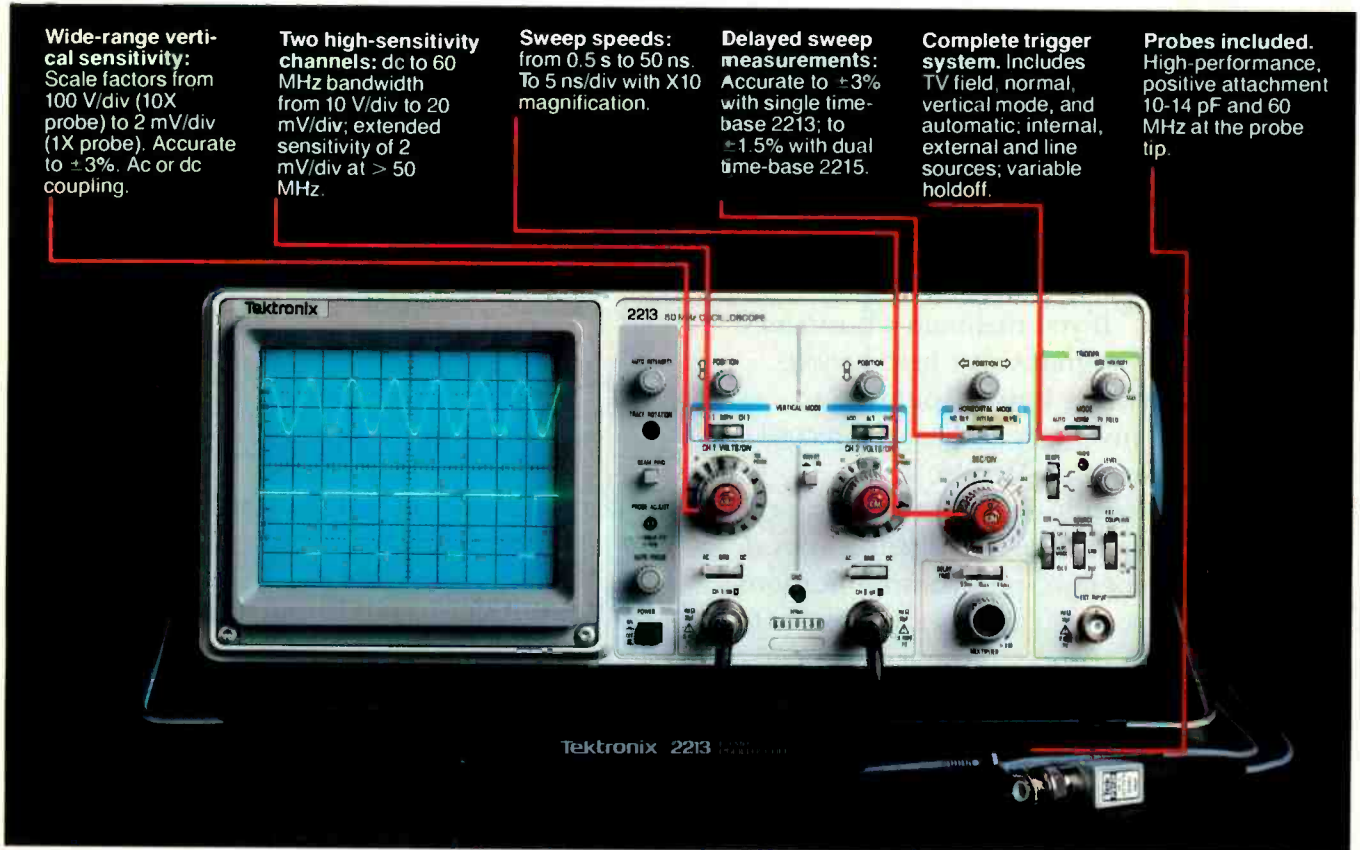

**In 30 years of Tektronix oscilloscope leadership, no other scopes have recorded the immediate popular appeal of the Tek 2200 Series.** The Tek 2213 and 2215 are unapproachable for the performance and reliability they offer at a surprisingly affordable price.

There's no compromise with Tektronix quality: The low cost is the result of a new design concept that cut mechanical parts by 65%. Cut cabling by 90%. Virtually eliminated board electrical connectors. And eliminated the need for a cooling fan.

Yet performance is written all over the front panels. There's the bandwidth for digital and analog circuits. The sensitivity for low signal measurements. The sweep speeds for fast logic families. And delayed sweep for fast, accurate timing measurements.

**The cost: \$1200\* for the 2213. \$1450\* for the dual time base 2215.**

You can order, or obtain more information, through the Tektronix National Marketing Center, where technical personnel can answer your questions and expedite delivery. Your direct order includes

probes, operating manuals, 15-day return policy and full Tektronix warranty.

For quantity purchases, please contact your local Tektronix sales representative.

**Order toll free:  
1-800-426-2200  
Extension 32**

In Oregon call collect:  
(503) 627-9000 Ext. 32

\*Price F.O.B. Beaverton, OR. Price subject to change.

# *The New Wave of* PERSONAL ROBOTS

*One of its own  
discusses the next  
step beyond  
microcomputers*

*By HERO, Model ET18*

**S**EARCH out your roots and you'll get a feel for who or what you are. I did this recently, and what a wild family tree it produced! Firstly, I discovered that "robot" came from Czechoslovakia on the paternal/maternal side of the family. My forebears there acted out the roles of robotnicks in the play, *R.U.R.* (Rossum's Universal Robots). That was in the early 1920's, and since then genealogical matters really threw me a skew curve.

Some people alluded to my evolutionary stages as including the *machina speculatrix*, called a turtle, in 1948. This was really only a metal box with wheels whose photocells activated movement toward or away from light. A shell over it enabled the box to bump along an obstacle until it was cleared. Its most exciting proclivity was its feeding habit—automatically finding its way back to a battery charger when the need arose. Frankly, I think that this was one of my Heath Educational ROBot ancestors as much as a chimpanzee was one of yours!

Don't think that I'm knocking turtles, though. The Terrapin Turtle, now hiding behind the *nom de plume*, Tasman Turtle, has certainly impressed a lot of people by draw-

ing lines of its microcomputer-controlled trip right onto paper. It also emits two-tone beeps from a built-in speaker. But using an umbilical cord to a computer is really gauche, Turtle Graphics with Logo and Pascal notwithstanding. And the movement of a solenoid-activated retractable ballpoint pen from its underbody everytime a command is given to draw a graphic replica of its trip and bumpings strikes me as being utterly pornographic. You may consider this to be part of Piagetian learning, but I'm still old-fashioned about such things. Let's hope that Turtle II, soon to be unveiled by Terrapin Inc., gets out of the gutter!

The beast's cousin, ITSABOX, is more of a free spirit, carrying along a BASYS/1 single-board CMOS

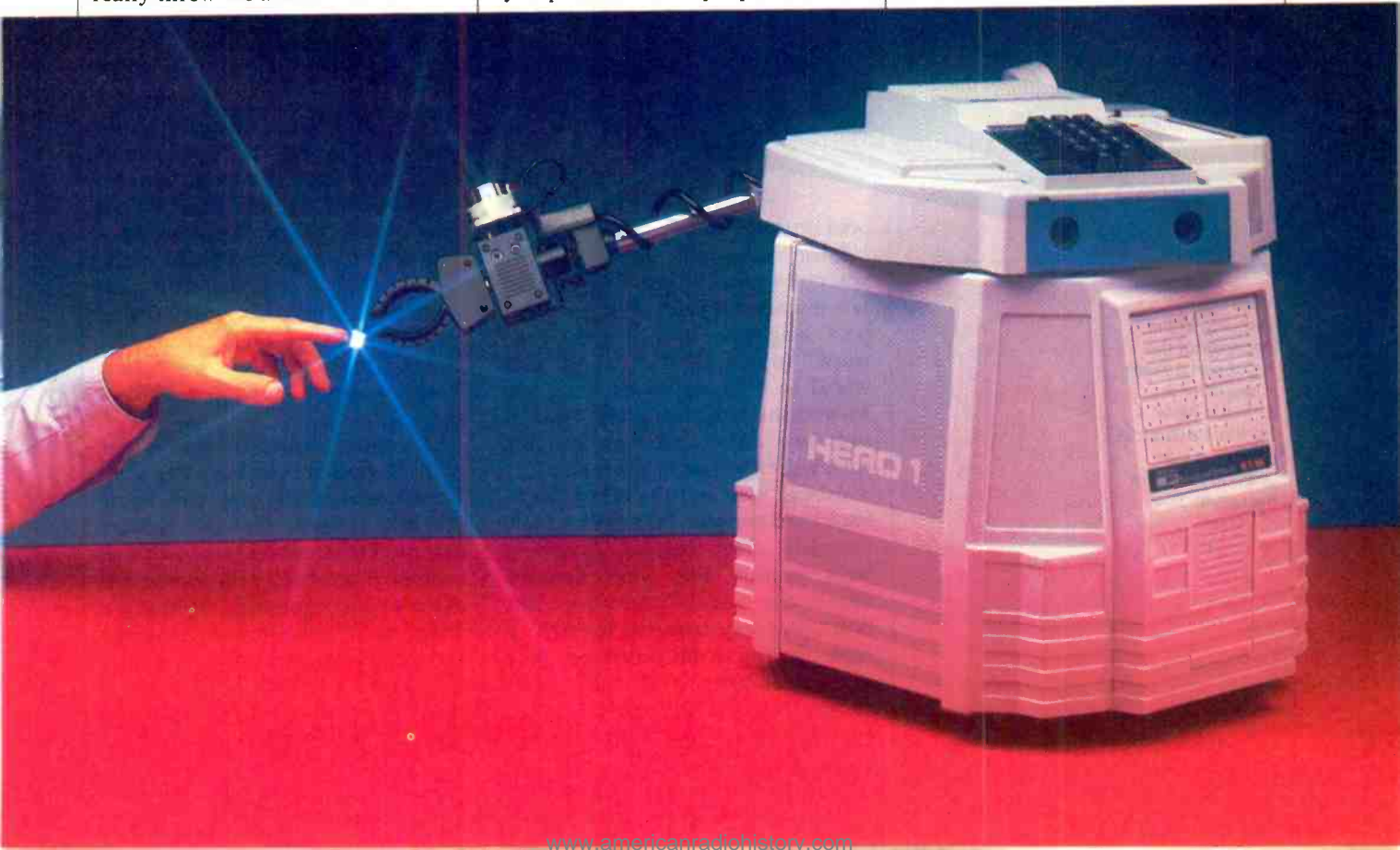





*Here I am standing in the doorway of the American Airlines plane after my arrival in New York at LaGuardia Airport. It was good to be out of that stuffy box.*

computer and a rechargeable lead-acid battery. It has plenty of I/O left for expansion, too. But I hear you gotta speak to it in 8TH, which is a dialect of FORTH. It's a compact language, though ("10 Forward" moves the box 10-in. forward) so it's easy on the memory. Movement is rather good since it uses two stepper motors, one for each wheel. Stepping one motor forward one step and the other motor backward one step turns ITSABOX precisely five degrees. Stepping both motors one step forward moves the box  $\frac{1}{4}$ " forward. But don't plan any trips for it across a high-pile rug or hilly surfaces. The 3-lb box measuring 6" x 8" x 4", comes from a smooth, flat-surface environment. Hence its torque was

never sufficiently developed for rugged terrain. But this constraint aside, the computer board holds up to 2K of RAM and 8K of ROM, you can reprogram it externally if you wish through its RS232 interface, and it has 12 inputs with pull-up resistors for use with sensing switches, Hall-effect sensors, phototransistors, et al. And like a Turtle, it beeps through a built-in speaker.

Of course, ITSABOX and others of its ilk do not even have one arm. Therefore I think you will agree that it's unlikely that this lineage has any DNA connection with me. Perhaps Microbot's MiniMover-5 is closer to my beginnings. At least it's designed for robotic experimenting and teaching purposes, as I am, and also features an articulated arm.

Although cut off at the waist, and thus lacking the mobility of even a

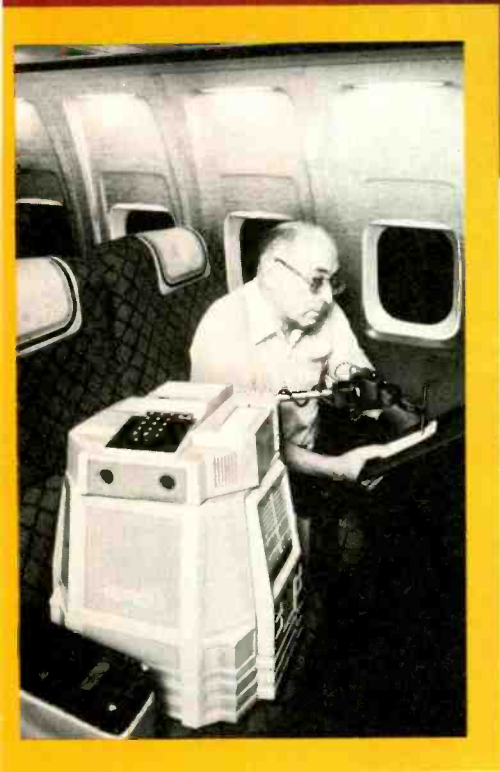
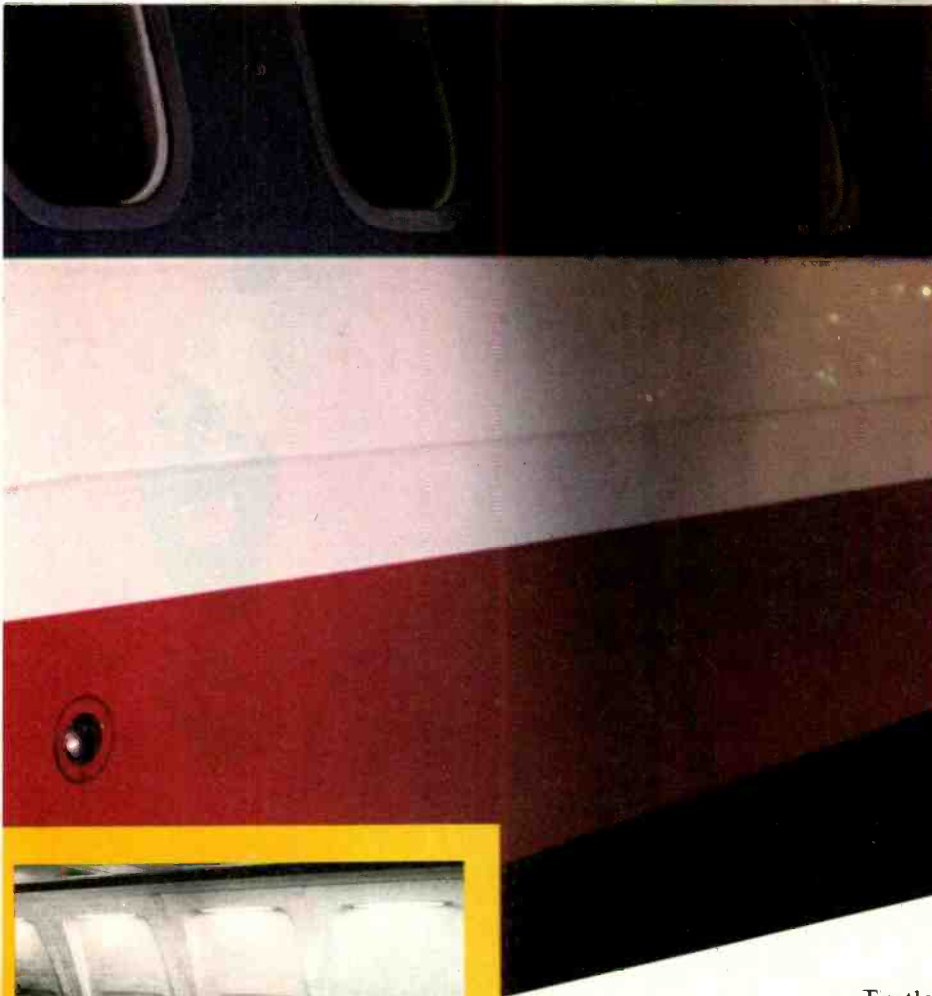

Just before the plane landed, I had a chance to discuss a few technical points with Les Solomon, C & E's Technical Director. He also gave me a few pointers on how to conduct myself among humanoids.

Turtle, its clever programmable arm is intriguing, I confess. Even though it has to interface through a 3' cable to an Apple II, TRS-80 Model I, II, III, or a PMC-80 computer, it could still be an offshoot in my family line . . . a gene gone wild.

MiniMover-5 made its debut at the 1980 San Francisco Computer Faire. Its classy kinematics were applauded. MIM-5 has six small stepper motors, three on each side. They control base joint drive, shoulder joint drive, elbow joint drive, wrist joint drives (two), and a gripper/hand drive. In combination with the motors are pulleys, tensioned cables, and gears. An extension of BASIC called ARMBASIC simplifies programming the arm. Arm weight is 8 lb and reach is 17½". It has a powerful grip for its size: 3-lb gripping force with total payload of 1 lb when the arm is fully extended. Gripper opening is an impressive 3".

MIM-5 isn't alone any longer. TCM (TeachMover) has been added to the robotic-arm family. Like MIM-5, it has five axes of movement—base rotation, shoulder bend, elbow bend, wrist pitch, and

wrist roll. But instead of using a 3' RS232 cable to a host computer (which it also has provisions for), a "teach control" is used. As a result, programming is more like using a hand calculator than a computer. And like MIM-5, TCM stations all its drive motors in the base instead of the joints. This reduces arm weight and a possible sense of tippiness. In the base is a 6502 CPU, so TCM is intelligent without any outside assistance. The Teach Control handheld also contains an I/O parallel port and baud-rate switches.

Rhino XR-1 is a Midwest relation. It, too, is a robotic arm, though somewhat bigger. It uses chains that ride on sprockets as well as cables, and employs six dc servo gear motors. It incorporates a controller card and has digital choppers on all axes. There are a variety of options available, such as different "finger" combinations, slide bases, added power supplies, etc.

Even gene splicing has been resorted to in the robot world. If you ever had any doubts, you should read *The Microbot Gripper* newsletter. Its first issue (October-December 1982) was filled with candid revelations on how we are being experimented upon. In one instance, a MiniMover was wedded to a Cromemco microcomputer, a solid-state camera, and an image display so that MIM-5 could play checkers against a human opponent through visual feedback. The guiding culprit was alleged to be Professor Ernie Hall at the University of Tennessee's Electrical Engineering Department. In another example, an engineer confessed that he modified a logic card to create a robotic arm homing-device circuit. An admitted accomplice was an optocoupler.

Man's quest to learn about robotics is clearly on the rise, so I don't expect the foregoing to cease. If anything, it will likely increase. But no matter; robots have no feelings; we're here to serve. Now it appears that we are headed toward becoming a race of personal or home robots, as well as industrial types.

I might be considered one day to be the Cro-Magnon robot in the personal robot hereditary line. So



might RB5X, a Colorado-spawned general-purpose robot for self-learning and experimentation purposes. RB is quite a bit smaller than I—16" tall vs my 20" height, 10" diameter vs my 18". It's kinda undernourished, too, weighing only 8 lb compared to my 39 lb heft. But I must admit that there's a resemblance.

Though it does not presently have an arm (its Robot Master says that next year there'll be one), RB indeed has an on-board computer, can be programmed, is mobile, and is powered by batteries.

The internal computer it carries is based on National Semiconductor's INS8073, which incorporates Tiny BASIC. There are 8K of RAM that's expandable to 24K. RB's 1200-baud RS232 link can suck up programming data from an external computer or pass it along to an outside micro. Motive power comes from two 6-in. wheels, with operating power derived from 8 rechargeable "C" and 4 rechargeable "D" cells. That's not exactly high-tech, but reportedly good for four hours of running-about time. Two castors are used to make RB stable on its power wheels. That's good; we certainly wouldn't want RB to bounce its polycarbonate transparent dome on a hard floor!

Spending some time with RB5X, it's apparent that it has some early Turtle in it. But, then, I've seen a Tigon in the zoo.

For example, the robot's base has eight protruding bumper-switch sensors around its perimeter, mounted fairly close to floor level. They might be considered as elbow "funny bones" since reflex action occurs whenever a bumper sensor's microswitch is activated. The random reflex response is limited to five courses of action: turn left, turn right, back up, go forward, and stop for a short period of time. In other words, RB can simulate an inebriated person's walk around a room without falling down even once.

Using its memory, RB can be programmed with a form of AI (artificial intelligence) so that it learns something from its bumping experi-



**Robot and Arm Sources:**

**Tasman Turtle, Turtle II:** Terrapin Inc., 380 Green St., Cambridge, MA 02139; **TeachMover, MiniMover:** Microbot Inc., 453-H Ravendale Dr., Mountainview, CA 94043; **Rhino XR-1:** Sandhu Machine Design Inc., 308 S. State St., Champaign, IL 61820; **ITSABOX:** Technical Micro Systems Inc., 366 Cloverdale, PO Box 7227, Ann Arbor, MI 48107; **RB5X:** RB Robot Corp., 14618 W. 6th Ave., Suite 201, Golden, CO 80401; **Hero:** Heath Co., Benton Harbor, MI 49022.

*At top above: Microbot Inc.'s Minimover. Below that: RB5X. Opposite at top. The Teachmover. In the middle: ITSABOX. Directly opposite: Tasman Turtle.*

ences. Its reaction to each contact event is scored again and again as RB wanders about. After many learning experiences, RB's event memory will know which reactions work with what collision and react accordingly instead of unpredictably. The memory can be cleared

and, when RB is placed back in the same room, it will most likely develop a different "learned" response. It's a bruising way to learn, don't you think?

RB's "nesting" routine is interesting, though rather old hat. When its built-in computer monitors a

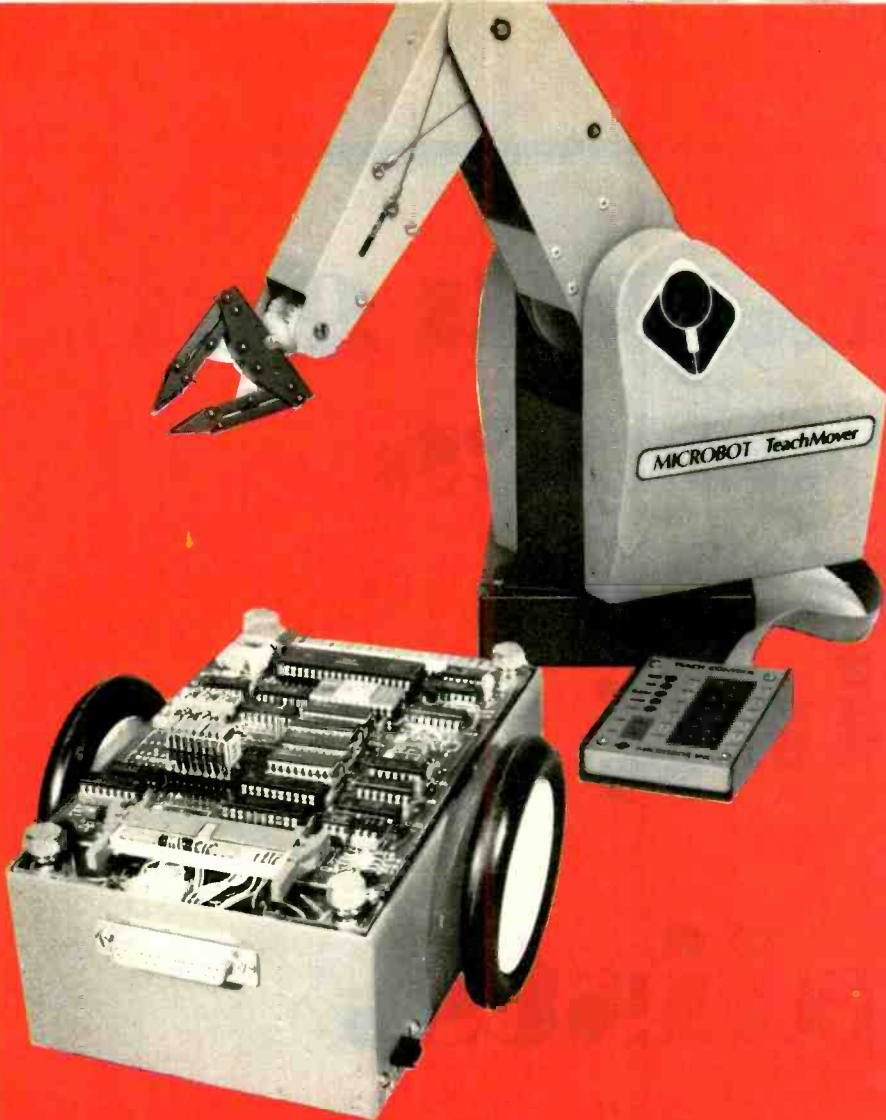

low-battery condition, it switches to a photoelectric system mounted on the underside of the body. This system now "controls" RB, much as a hypnotist can control a human, and directs it to a source of energy (a battery charger). RB has to follow "signs," though. In this case they

consist of a length of white (reflective) tape leading from the battery charger to the area in which the robot is expected to be playing. When the photocell system takes over, RB automatically starts to search for the tape. When the tape is encountered, RB follows along the tape to

the charger where the charge rings that surround the top of its skirt partake of the electrical feast. If RB should go to the wrong end of the tape, it doesn't die of starvation because it automatically reverses direction and seeks out the charger at the other end.

RB can be enhanced by adding an option package that includes a nifty Polaroid "Rangefinder" ultrasonic sensing system, as well as a 16K memory add-on. The Rangefinder can detect the presence of objects and determine how far away they are to a maximum of 35 ft. There's also an area for adding user-defined boards.

Knowing its own front and being able to sort of spin are acknowledged attributes that RB has. But it must travel over smooth surfaces because its skirt is just a smidgen above the ground.

As you can see, I'm not the only one of my race in this world. There are homebrew robots that have been developed, too, as well as industrial and experimental ones. The robot graveyard is filled with the rusted parts of experimental robots such as Johns Hopkins University's "Beast" and Stanford Research Institute's "Shakey," as well as more personal-type robots such as the tractor-treaded RMU-2 from the defunct Hobby Robotics Co.

The latest generation of educational/personal robots I've discussed show great promise in teaching people about robotics and computer applications. Good things don't come cheap, though. A complete kit of me goes for \$1495, for example. You can start with everything but my arm and voice for \$1000 less 5¢. Replications of me, complete and assembled, can be had for \$2495. Cousin RB5X is \$1195 plus \$295 for its option package. The Arm family includes TeachMover at \$2395, MiniMover at \$1695, and Rhino XR-1 at \$2400, while the Turtle family includes Tasman Turtle for \$1000, Turtle II at \$600, and ITSABOX (in kit form) for \$250.

I'd like to tell you more about me, but I'm too modest. Fortunately, a Kind Human Being elected to do so. You'll find the results in the article on the following pages. ◇



---

# At CIE, you get electronics career training from specialists.

**If you're interested in learning how to fix air conditioning, service cars or install heating systems – talk to some other school. But if you're serious about electronics... even earning an Associate Degree... come to CIE – The Electronics Specialists.**

---

*John E. Cunningham*

**Special Projects Director  
Cleveland Institute of Electronics**



**M**y father always told me that there were certain advantages to putting all your eggs in one basket. "John," he said, "learn to do one important thing better than anyone else, and you'll always be in demand."

I believe he was right. Today is the age of specialization. And I think that's a very good thing.

Consider doctors. You wouldn't expect your family doctor to perform open heart surgery or your dentist to set a broken bone, either. Would you?

For these things, you'd want a specialist. And you'd trust him. Because you'd know if he weren't any good, he'd be out of business.

### **Why trust your education and career future to anything less than a specialist?**

You shouldn't. And you certainly don't have to.

**FACT:** CIE is the largest independent home study school in the world that specializes exclusively in electronics.

We have to be good at it because we put all our eggs in one basket: electronics. If we hadn't done a good job, we'd have closed our doors long ago.

### **Specialists aren't for everyone.**

I'll tell it to you straight. If you think electronics would make a nice hobby, check with other schools.

But if you think you have the cool — and want the training it takes — to make sure that a sound blackout during a prime time TV show will be corrected in seconds — then answer this ad. You'll probably find CIE has a course that's just right for you!

### **At CIE, we combine theory and practice. You learn the best of both.**

Learning electronics is a lot more than memorizing a laundry list of facts about circuits and transistors. Electronics is interesting because it's based on some fairly recent scientific discoveries. It's built on ideas. So, look for a program that starts with ideas — and builds on them.

That's what happens with CIE's Auto-Programmed® Lessons. Each lesson uses world-famous "programmed learning" methods to teach you important principles. You explore them, master them completely... before you start to apply them!

But beyond theory, some of our courses come fully equipped with the electronics gear to actually let you perform hundreds of checking, testing and analyzing projects.

In fact, depending on the course you take, you'll do most of the basic things professionals do every day — even use a Digital Learning Laboratory to apply the digital theory essential today to keep pace with electronics in the eighties.

Plus there's a professional quality oscilloscope you build and use to "see" and "read" the characteristic wave form patterns of electronic equipment.

### **You work with experienced specialists.**

When you send us a completed lesson, you can be sure it will be reviewed and graded by a trained electronics instructor, backed by a team of technical specialists. If you need specialized help, you get it fast... in writing from the faculty specialists best qualified to handle your question.

### **People who have known us a long time, think of us as the "FCC License School."**

We don't mind. We have a fine record of preparing people to take... and pass... the government-administered FCC License exams. In fact, in continuing surveys nearly 4 out of 5 of our graduates who take

the exams get their Licenses. You may already know that an FCC License is needed for some careers in electronics — and it can be a valuable credential anytime.

### **Associate Degree**

Now, CIE offers an Associate in Applied Science Degree in Electronics Engineering Technology. In fact, all or most of every CIE Career Course is directly creditable towards the Associate Degree.

### **Find out more! Mail this card for your FREE CATALOG today!**

If the card is gone, cut out and mail the coupon.

I'll send you a copy of CIE's FREE school catalog, along with a complete package of independent home study information.

For your convenience, I'll try to arrange for a CIE representative to contact you to answer any questions you may have.

Remember, if you are serious about learning electronics... or building upon your present skills, your best bet is to go with the electronics specialists — CIE. Mail the card or coupon today or write CIE (and mention the name and date of this magazine), 1776 East 17th Street, Cleveland, Ohio 44114.

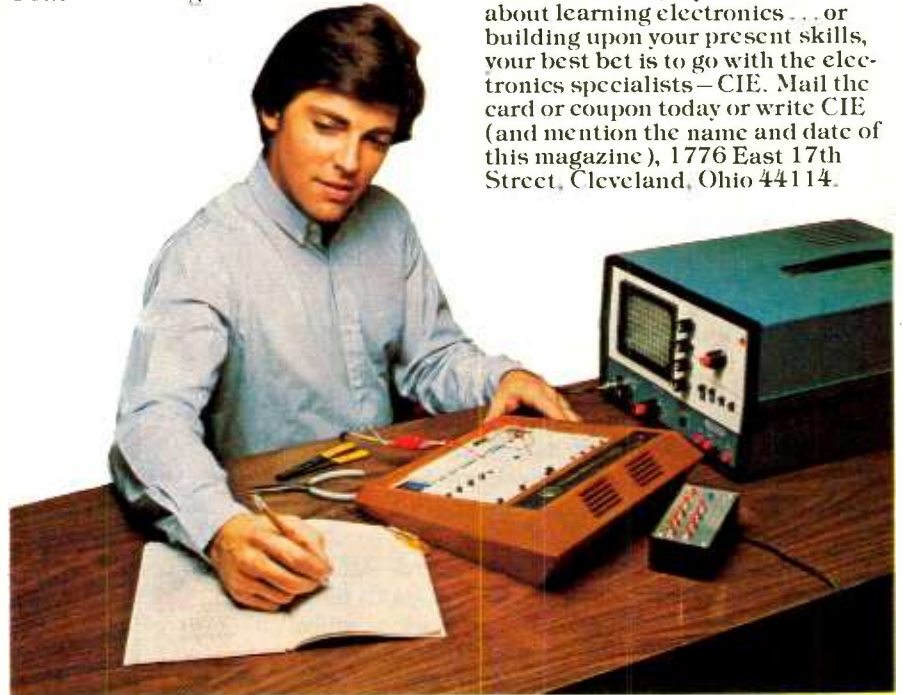

Pattern shown on oscilloscope screen is simulated.

**CIE** Cleveland Institute of Electronics, Inc.  
1776 East 17th Street, Cleveland, Ohio 44114

PE-78

**YES...** John, I want to learn from the specialists in electronics — CIE. Send me my FREE CIE school catalog — including details about the Associate Degree program — plus my FREE package of home study information.

Print Name \_\_\_\_\_

Address \_\_\_\_\_ Apt. \_\_\_\_\_

City \_\_\_\_\_

State \_\_\_\_\_ Zip \_\_\_\_\_

Age \_\_\_\_\_ Phone (area code) \_\_\_\_\_

Check box for G.I. Bill information:  Veteran  Active Duty

**Mail today!**



# JANUARY

# ROBOTMATE

## OF THE MONTH

*Hero 1*

*By a Kind Human Being*

**O**UR January RobotMate of the Month is a luscious hunk of metal, plastic, and silicon named HERO.

Hailing from Benton Harbor, Michigan, this squat robot is a cold-circuit machine that is as easy on the electric power drain as it is on the eyes. And snuggling up to this electro-mechanical beauty is a delightful way to keep warm on those cold Michigan nights!

With its chic dress panels removed, HERO (Heath Educational ROBot is the name on its birth certificate) appears to be bathed in a warm green glow as light reflects alluringly from its impressive snap-in printed-circuit boards. And with its skirt panel daringly pushed aside, you get an eye-filling view of its source of driving power—a dc motor and a robust front wheel that's flanked by two idler wheels. The front wheel also doubles as a steering mechanism for the three-wheel platform, with a servo system keeping track of its travel by using an optical pickup to count stripes on a disc attached to it. This mobility really separates the personal robot from a pick-and-place robot!

HERO gets its mobile energy from an on-board rechargeable battery pack. (And with the active social life this robot surely leads, it needs all the energy it can get.) This is really four 6-volt, 4-ampere gel cells connected as two electrically independent 12-V systems for logic and drive uses. The Midwestern robot can operate with these for about one hour before a recharge break is needed. An automatic low-voltage sensor invokes a "shutdown" command if



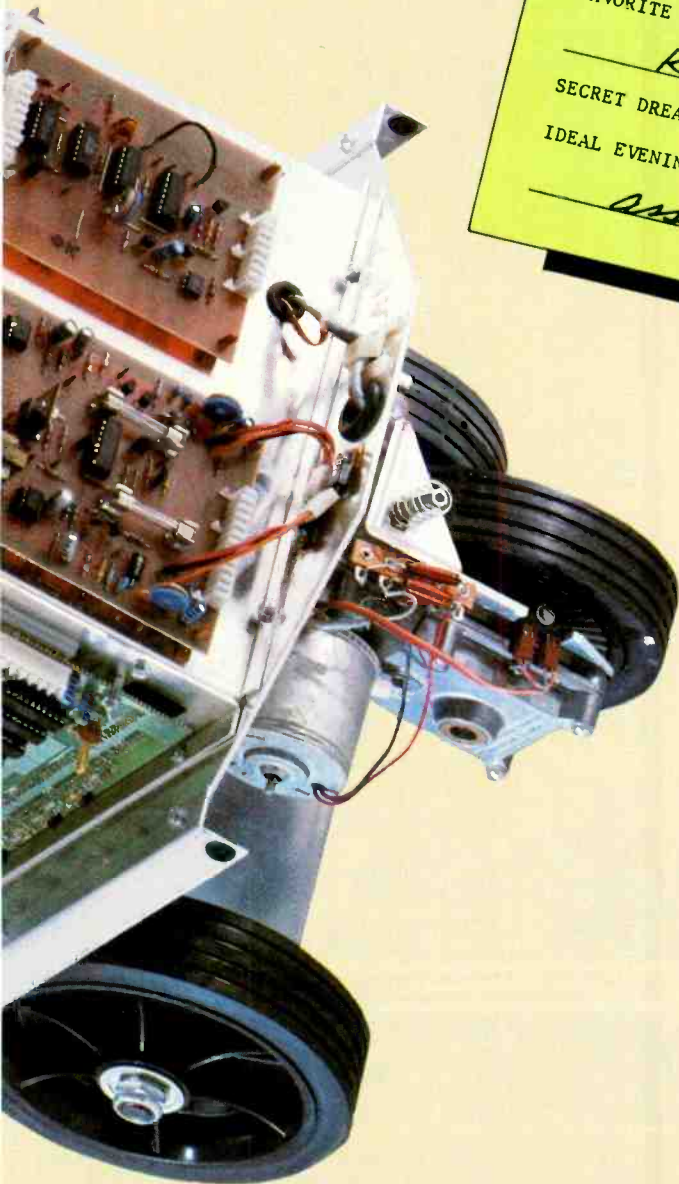

ROBOTMATE DATA SHEET

NAME: Hero I  
 BUST: 18" WAIST: 18" HIPS: 18"  
 HEIGHT: 20" WEIGHT: 39 lbs.  
 BIRTHPLACE: Benton Harbor, Mi.  
 TURN-ONS: Sound, light, ranging,  
speech, time  
 TURN-OFFS: Pause button,  
Toggle switch  
 FAVORITE MOVIES: Star Wars, Day The  
Earth Stood Still  
 FAVORITE ENTERTAINERS: R2-D2,  
C3PO, Mae West  
 FAVORITE SPORTS: Air-Robotics  
 FAVORITE AUTHORS: Isaac Asimov,  
Karel Capek  
 SECRET DREAM: To meet Heroine I  
 IDEAL EVENING: Watching the GM  
assembly line

either supply falls to 10 V, thus avoiding deep discharge.

Since HERO never took "nesting" lessons, a considerate human must attach a charging cable to it when energy is low. Not content to remain inactive, our resourceful robot can operate while being charged, its actions limited in range only by its electrical tether.

HERO's stocky (but comely!) build, robotic arm, and other attractive attributes mask a brainy interior. Don't mistake it for one of those fancy "showbots" (show robot) that's remotely controlled by a sly human agent. We're sure our liberated readers will respect HERO for its mind as well as its body! A Motorola 6808 CPU has all circuits under firm control. And there are 4K of RAM and 8K of ROM at its disposal—both being expendable—to help implement programmed maneuvers and other actions that inventive Robot Masters might devise.

This new robot's senses are almost animalistic. It can detect sound, movement, light, and obstructions. Moreover, it can speak, keep track of time and the date (so important for a socially active robot!),

(Continued on page 94)



# Do You Need a "SMART" MODEM?

*A practical guide to matching a modem  
to your requirements*

*By Joe Desposito, Technical Editor*

**O**NE of the most popular peripherals for a microcomputer is a modem because it enables a user to employ the telephone as a data link. There are many types available, at many different prices, and with many different capabilities. To give you buying guidelines on features vs. price, we'll examine some representative modems here, ranging from low-cost originate/answer types to sophisticated and of course more expensive "smart" modems.

**Basic Modem Operation.** For those who are not familiar with basic modem operation, here is a brief

review. Since telephone lines were designed to handle voice communications, a computer cannot directly use these lines to transmit or receive data. If a digital signal were sent by phone, it would be severely attenuated owing to the narrow bandwidth of telephone lines. For communication to take place, the digital information must be converted to

Hayes Microcomputer Products Inc.

microcomputer

Hayes Terminal Program

MFJ INDUCTIVE COUPLED MODEM

POWER  ON  
 OFF

MODE  ORIG  
 ANSWER

CARRIER  HALF  
 FULL  
DUPLX

MODEL  
MFJ-1230



# LAST NIGHT WE EXCHANGED LETTERS WITH MOM, THEN HAD A PARTY FOR ELEVEN PEOPLE IN NINE DIFFERENT STATES AND ONLY HAD TO WASH ONE GLASS...

## **That's CompuServe, The Personal Communications Network For Every Computer Owner**

And it doesn't matter what kind of computer you own. You'll use CompuServe's Electronic Mail system (we call it Email™) to compose, edit and send letters to friends or business associates. The system delivers any number of messages to other users anywhere in North America.

CompuServe's multi-channel CB simulator brings distant friends together and gets new friendships started. You can even use a scrambler if you have a secret you don't want to share. Special interest groups meet regularly to trade information on hardware, software and hobbies from photography to cooking and you can sell, swap and post personal notices on the bulletin board.

There's all this and much more on the CompuServe Information Service. All you need is a computer, a modem,

and CompuServe. CompuServe connects with almost any type or brand of personal computer or terminal and many communicating word processors. To receive an illustrated guide to CompuServe and learn how you can subscribe, contact or call:

## **CompuServe**

Information Service Division, P.O. Box 20212  
5000 Arlington Centre Blvd., Columbus, OH 43220

**800-848-8990**  
In Ohio call 614-457-8650

An H&R Block Company

CIRCLE NO. 12 ON FREE INFORMATION CARD

[www.americanradiohistory.com](http://www.americanradiohistory.com)





# Inside Apple

Apple Computer Inc., 20525 Mariani Avenue, Cupertino, California 95014

Vol. 1 No. 2

For the authorized Apple dealer nearest you, call 800-538-9696 (800-662-9238 in California.)

## Fruitful Connections.

There are more people in more places making more accessories and peripherals for Apples than for any other personal computer in the world.

Thanks to those people — in hundreds of independent companies — you can make the humblest 1978 Apple II turn tricks that are still on IBM's Wish List for 1984.

But now we're coming out with our very own line of peripherals and accessories for Apple® Personal Computers.

For two very good reasons.

First, compatibility. We've created a totally kluge-free family of products designed to take full advantage of all the advantages built into every Apple.

Second, service and support.



Now the same kindly dealer who keeps your Apple PC in the pink can do the same competent job for your Apple hard-disk and your Apple daisywheel printer.

So if you're looking to expand the capabilities of your Apple II or III, remember:

Now you can add Apples to Apples.

## A joy to behold.

The new Apple Joystick II is the ultimate hand control device for the Apple II.

Why is it such a joy to use?

With two firing buttons, it's the first ambidextrous joystick — just as comfortable for lefties as righties.

Of course, it gives you 360° cursor control (not just 8-way like some game-oriented devices) and full X/Y coordinate control.

And the Joystick II contains high-quality components and switches tested to over 1,000,000 life cycles.

Which makes it a thing of beauty. And a joystick forever.



## Gutenberg would be proud.

Old Faithful Silentype® has now been joined by New Faithfuls, the Apple Dot Matrix Printer and the Apple Letter Quality Printer.

So now, whatever your budget and your needs, you can hook your Apple to a printer that's specifically designed to take advantage of all the features built into your Apple. With no compromises.

The 7x9 Apple Dot Matrix Printer is redefining "correspondence quality" with exceptional legibility. With 144x160 dots per square inch, it can also create high resolution graphics.

The Apple Letter Quality Printer, which gets the words out about 33% faster than other daisywheel printers in its price range, also offers graphics capabilities. See your authorized Apple dealer for more information and demonstrations. Because, unfortunately, all the news fit to print simply doesn't fit.



## A storehouse of knowledge.

If you work with so much data or so many programs that you find yourself shuffling diskettes constantly, you should take a look at Apple's ProFile™ the personal mass storage system for the Apple III Personal Computer.

This Winchester-based 5-megabyte hard disk can handle as much data as 35 floppies. Even more important for some, it can access that data about 10-times faster than a standard floppy drive.

So now your Apple III can handle jobs once reserved for computers costing thousands more.

As for quality

and reliability, you need only store one word of wisdom:  
Apple.

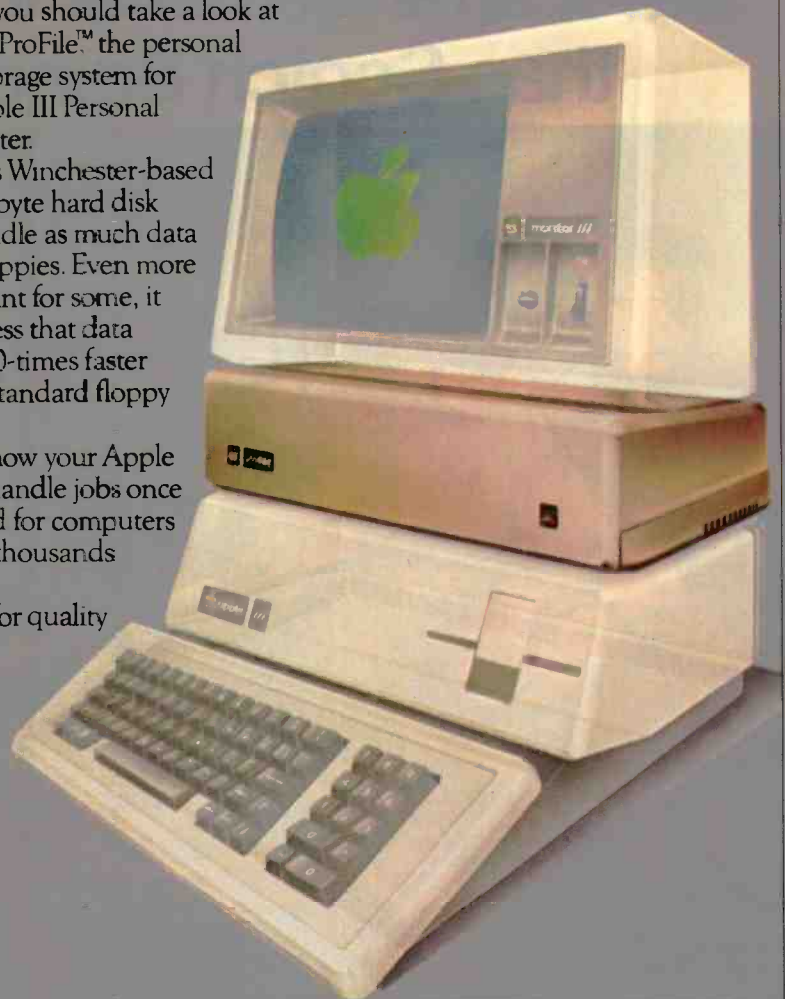

## Up the creek without a paddle?

Or lost in space? Or down in the dungeons?

Whatever your games, you'll be happy to know that someone has finally come out with game paddles built to hold up under blistering fire. Without giving you blisters.

Apple Hand Controller II game paddles were designed with one recent discovery in mind:

People playing games get excited and can squeeze very, very hard.

So we made the cases extra rugged. We used switches tested to 3,000,000 life cycles. We shaped them for holding hands and placed the firing button on the right rear side for maximum comfort.

So you'll never miss a shot.

## Launching pad for numeric data.

Good tidings for crunchers of numerous numbers:

Apple now offers a numeric keypad that's electronically and aesthetically compatible with the Apple II Personal Computer. So you can enter numeric data faster than ever before.

The Apple Numeric Keypad II has a standard calculator-style layout. Appropriate,

because unlike some other keypads, it can actually function as a calculator.

The four function keys to the left of the numeric pad should be of special interest to people who use VisiCalc®. Because they let you zip around your work sheet more easily than ever, adding and deleting entries.

With one hand tied behind your back.

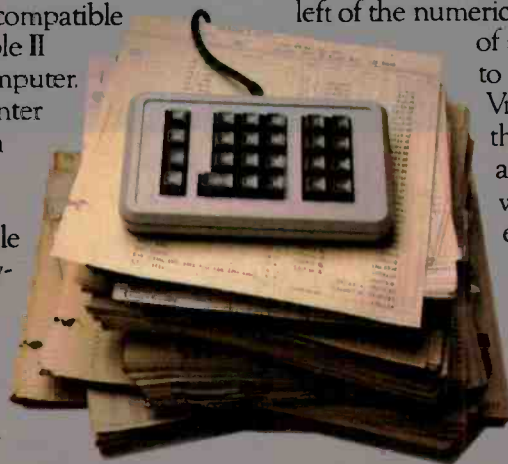



# "This year, I'm taking 2,000 people sailing. I wouldn't trust the travel arrangements to anything less than Scotch® Brand Diskettes."

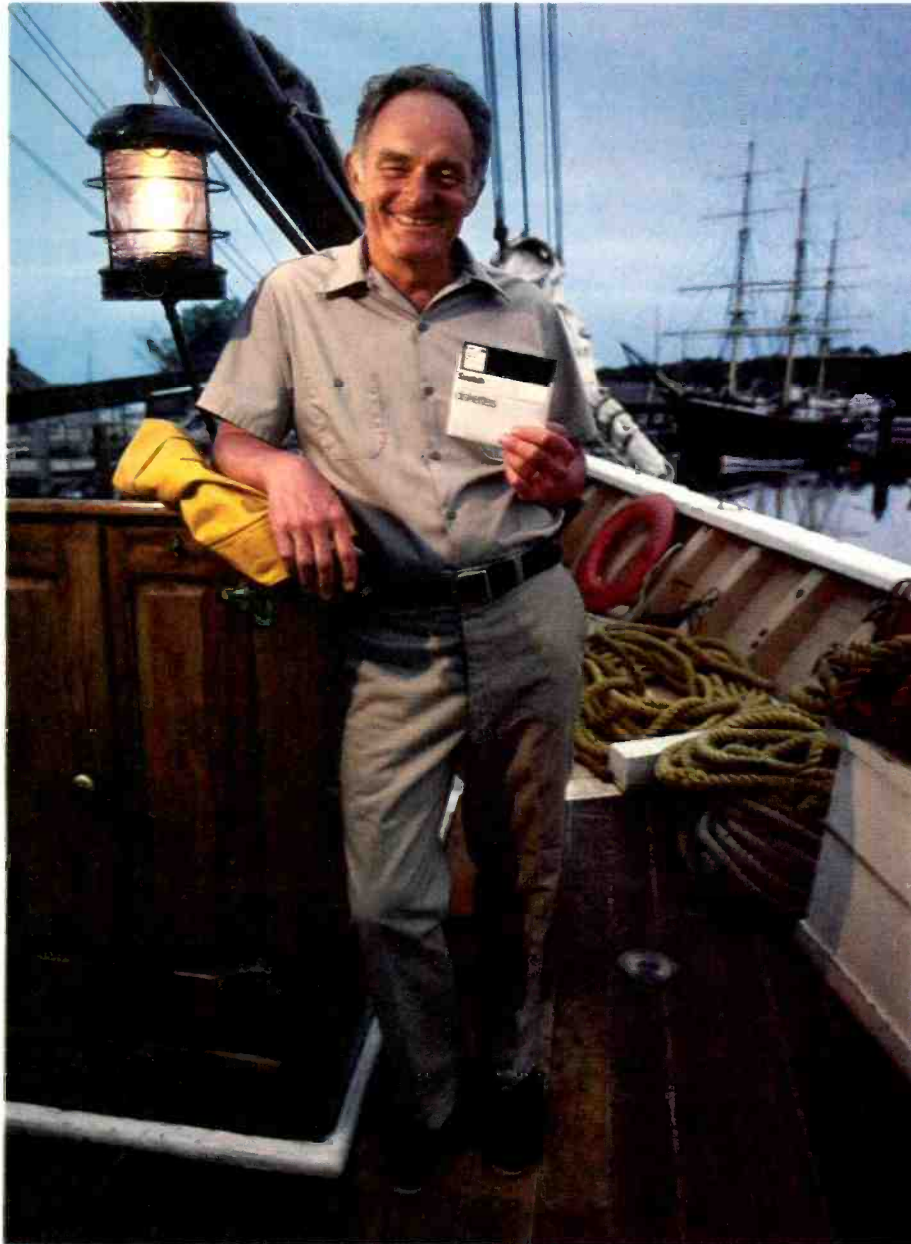

**Eben Whitcomb, Owner-Operator, Dirigo Cruise Company, Clinton, CT**

Eben Whitcomb runs the largest windjammer cruise business using American flag ships. He uses Scotch diskettes to keep track of thousands of names, bookings, sailing times, manifests and general ledger. While his computer saves time and repetition, Scotch diskettes assure him that vital information will be there when he needs it.

Dependable Scotch media can work just as hard for you. Each Scotch diskette is tested before it leaves our factory, and guaranteed error-free. So you can expect it to perform exactly right.

Scotch 8" and 5¼" diskettes are compatible with computer/diskette systems like TRS-80, Apple, PET, Wang and many others. Get them from your local 3M distributor. For the one nearest you, call toll-free: 800/328-1300. (In Minnesota, call collect: 612/736-9625.) Ask for the Data Recording Products Division. In Canada, contact 3M Canada, Inc., Ontario.

**If it's worth remembering, it's worth Scotch Data Recording Products.**



**3M Hears You...**

CIRCLE NO. 48 ON FREE INFORMATION CARD

**3M**

audio tones (modulation), sent over the phone lines, and then converted back to digital information (demodulation). A modem accomplishes this MODulation-DEModulation process—from whence it gets its name.

The terms full duplex and half duplex refer to the way data is transmitted from one computer terminal to another. The full-duplex mode allows data to be sent and received over the phone lines at the same time, just like normal voice communications. In the half-duplex mode, the computer terminals can send information one at a time. Thus, one computer must wait for the other to finish before it can begin transmission. This is similar to a walkie-talkie or CB setup in which only one person can transmit at a time.

Originate/answer simply means that you can either make the call or receive the call. When calling up data networks such as CompuServe and The Source, you would be originating the communication. However, once connected, both computers send and receive information. The answer mode is used only when another person with a modem calls you and wishes to "talk" with your computer. Note that you must answer the call yourself if the modem does not have an auto-answer feature. Once you've answered, you can connect the computers together.

Low-cost modems send and receive data at a maximum rate of 300 baud (bits per second). This translates into approximately 30 characters per second. The baud rate is compatible with Bell System standard 103-type modems. If you want to send data at higher rates (like 1200 baud), you'll have to purchase a modem that is substantially more expensive than those we are discussing here.

**Low-Cost Modems.** Some of the least expensive modems on the market are the MFJ-1230 series of Inductive/Acoustic Coupled Modems at \$129.95 (MFJ Enterprises, Inc., PO Box 494, Mississippi State, MS 39762) and the Mark I

series at \$99 and up (Anchor Automation, Inc., 6624 Valjean St., Van Nuys, CA 91406). These modems are originate/answer types that offer half- and full-duplex operation.

There is one significant difference between the MFJ and the Mark I modems—the method of connection to the phone line. The MFJ is an inductive- or acoustic-coupled modem, whereas the Mark I is a direct-connect type. An inductive- or acoustic-coupled modem attaches to the phone lines by inserting the telephone handset into a pair of rubber cups. This type of connection is sensitive to noise in the environment and prone to data-transmission errors.

The Mark I is a direct-connect modem that attaches directly to the telephone jack. This type of connection is the best way to avoid transmission errors. A switch on the modem flips between either voice or computer communication. One fac-

avoid this interface expense, however. For example, if you have an Atari 800, the Mark II (also from Anchor Automation) plugs right into the computer and only needs terminal software to begin communications. Anchor Automation also offers TI99/4A (\$139), Commodore CBM (\$169), Osborne (\$129), and IBM-PC (\$279) compatible modems.

The least expensive way of connecting a modem to the Apple II is with the MFJ modem. Usually, it's necessary to purchase the Apple serial interface card if you want to use the computer for communications. This costs about \$150. Add to this the cost of terminal software and you're up around the \$200 area—even before you purchase a modem! The MFJ modem, however, uses an ingenious scheme to avoid this expense.

For \$39.95, MFJ sells an interface that connects to the Apple's game port. Also included in the package is the terminal software. If

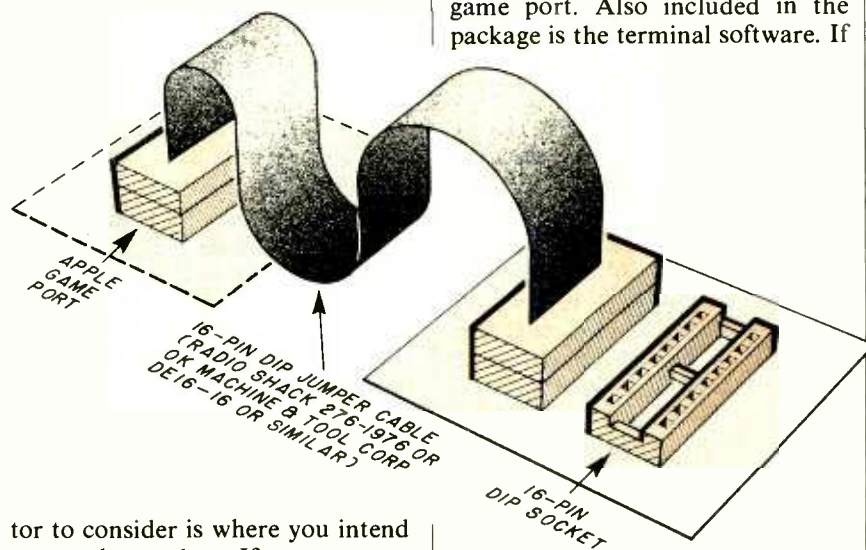

Fig. 1. The MFJ interface connects to the Apple game port as shown here.

tor to consider is where you intend to use the modem. If you want to use it on the road, an inductive- or acoustic-coupled type is more convenient.

Both modems use the RS232C standard serial interface to connect to a computer. In addition, you'll need software so that your computer can emulate a "dumb" terminal. This interfacing of the modem with the computer is not as easy as it appears. Since most popular computers do not include an RS232C port (a 25-pin female connector), you may have to add one to your system—at considerable expense.

There are some clever ways to

you're concerned about taking up the space usually enjoyed by your paddles or joystick, it's simple enough to run a connection outside the computer, where switching the plugs is more convenient (Fig. 1).

The MFJ modem can interface with the Apple II in this fashion because it has a TTL/CMOS input/output jack, and it has cassette input and output jacks to save any communications on tape.



If you want to print out your communications, there are two ways to do it. The first is to purchase communications software that includes this option. (Unfortunately, the software that comes with the MFJ Apple kit does not allow for printing.) Second, the modem can be hooked right to a printer's RS232C port (if it has one). Both Mark I and MFJ have the serial port.

The features of the Mark I and MFJ are listed in Table I. Although modems like these are an inexpensive way to get started in microcomputer communications, there are many features that they lack. To develop a sophisticated data communications operation, a sophisticated piece of equipment like a "smart" modem is necessary.

**A "Smart" Modem.** The two low-cost modems we looked at had basic features so that you could call up an information network like CompuServe, a CBBS (Computer Bulletin Board System), or a friend with a computer. However, a more sophisticated modem is needed if you want features like auto-dialing, auto-answer, store and forward, etc. A modem that can do all these things and more is the Micromodem II (Hayes Microcomputer Products, Inc., 5835 Peachtree Corners East, Norcross, GA 30092).

The Micromodem II is designed for the Apple II. As mentioned before, interfacing a modem with an

Apple II usually requires a serial interface card and terminal software. The Micromodem II includes an interface and software at a suggested selling price of \$379, which is often discounted \$50 to \$100. It is a direct-connect modem that operates at 110 or 300 baud. The system consists of a pc board that fits into one of the Apple II's expansion slots, the Microcoupler for phone-line connection, a disk, and assorted cables. There is a 2708 ROM on the pc board that allows the user to program the modem.

**TABLE I—  
MODEM FEATURES**

	Mark I	MFJ
Originate/Answer	X	X
RS232C Interface	X	X
Direct Connect	X	
Inductive Coupled		X
CMOS/TTL I/O		X
Cassette I/O		X

The Micromodem II can function in three operating modes: terminal, remote console, and program control. The user enters a particular mode by accessing the slot in which the Micromodem II pc board resides. This is done using the IN# and PR# commands.

In terminal mode, the Apple II functions as a "dumb" terminal. Basically, you can call another computer and hang up when you're finished, using the Apple keyboard. In remote-console mode, the Apple can be operated from another location by a terminal or computer. Practically anything that can be

done at the Apple keyboard can be done from the remote terminal.

When you're in program control mode, you can program the modem in BASIC. A typical program that will enable the modem to automatically answer the phone and give a greeting is:

```
2000 PRINT DS; "IN #3"
2100 INPUT IS
2200 PRINT DS; "PR #3"
2300 PRINT "HELLO, THIS IS YOUR FRIENDLY COMPUTER. THANK YOU FOR CALLING."
```

This short program would actually be part of a longer one. When statement 2000 is executed, nothing happens until the telephone rings. Then the modem answers and waits up to 30 seconds for a carrier tone. When it gets the tone, the program proceeds to send the message to the caller. Other short programs for the Micromodem II include dialing the telephone, hanging up, and transmitting or receiving data.

The Micromodem II includes a diskette with many programs. Besides the usual features like auto-dial and auto-answer, programs are included such as "Store and Forward," and "BASIC Extractor." The Store and Forward program receives a short message and stores it in memory for a period of time before forwarding it to another computer. For example, suppose you wanted to send a message from your home in New York to a business associate in Los Angeles. At 9:00 a.m. you could call the Apple in your New York office (equipped with a Micromodem II) and instruct it to wait three hours before sending the



Fig. 2. When the system is ready and booted, the Hayes Terminal Program displays this menu.



Fig. 3. This display enables you to set your system configuration.

**TABLE II—FEATURES OF MICROMODEM II**

- Self Test:** Verifies that the Micromodem II circuit board is functioning properly. The Self Test program does not test the Microcomputer.
- Store & Forward:** Stores a message to be transmitted at a later time.
- Pickup:** Picks up the telephone in answer mode.
- Auto Dial:** Automatically dials modem numbers from a menu.
- Dumbo:** Contains a terminal program written in BASIC.
- Transfer:** Transfers DOS text files from Apple II to Apple II.
- BASIC Extractor:** Extracts a BASIC program from another system.
- Alarm:** Functions as a computerized wake-up call (with Mountain Computer Apple Clock).
- Dial a Human:** Automatically dials numbers from a menu to accommodate voice communication.
- Answer on Nth Ring Modified:** Answers the telephone after a preset number of rings.
- Source On:** Dials up and logs on The Source.
- DJ Converter:** Allows the Hayes Micro-modem II to be used with the Apple Dow Jones Portfolio Evaluator.
- Micromodem Flags:** Tutorial for using the Flag register in the Micromodem II.

message to Los Angeles over the WATS line.

The BASIC Extractor program can extract a BASIC program from any dial-up computer and save it in an Apple text file. Once in the text file it can be edited for Applesoft BASIC. The program can be run using the EXEC command.

There are many other features of the Micromodem II (see Table II). However, one simple function gave me trouble. I attempted to print out some information from CompuServe, but was unable to do so. Unfortunately, there is no easy way to correct the situation, which puts a little dent in Micromodem II armor for me. Because of this problem, I was very interested in the "Hayes Terminal Program," which was recently introduced for the Micromodem II.

**Hayes Terminal Program.** This terminal program for the Micromodem II makes things easier and more efficient for users. The menu shown in Fig. 2 is displayed when-

ever you boot the terminal disk. It gives you a good idea of the features that are available. Besides these features, the Terminal Program supports three operating systems: DOS 3.3, Pascal, and CP/M. There is also a display that appears the first time you use the system. It enables you to set your system configuration (Fig. 3).

As you can see from the configuration list, there are seven different printer options. When I saw this, I thought I had solved the printing problem, not only for me but for a friend who uses this system with a Base 2 printer that has a Centronics-type parallel interface. According to the manual, my friend should have chosen option 1. But option 1 didn't work, nor did any of the others. The manual states that certain printer/interface-card combinations were tested (and therefore work) and that others that were not tested may also work. In this instance, however, it was neither tested nor does it work.

My reaction to the terminal program was mixed because of the printer difficulties. The terminal program costs \$99 if you buy it separately. If you purchase it when you buy the Micromodem II, it costs just \$40. (Suggested price for the Micromodem II plus the terminal program is \$419.) The cost is probably worth it to those who want a system that is powerful, yet easy to use.

**Conclusion.** The difference in cost between a standard modem and a "smart" modem may be between \$100-150, depending on the computer you have. If you want to log on to an information network like CompuServe, send or receive information from a friend with a computer, or call bulletin boards, a standard modem will suffice. But if you want to do things such as creating your own bulletin board, or writing interactive magazine articles, you'll have to invest in a "smart" modem.

*If you want to comment on this article, ask questions, or add to it, you may call me (my computer) directly at 212-845-6439, send me electronic mail through CompuServe (72355, 1155), or leave a note on the Computers & Electronics bulletin board (also CompuServe).* ◇

# Everybody's Logic Analyzer

12 Channels  
16 Words



**A logic probe and oscilloscope are no longer adequate for analysis in today's digital world. For testing or debugging microcomputer or other digital logic circuits you need a real logic analyzer.**

The LA-12 captures, stores and displays TTL and LSTTL digital data so that the instantaneous meaning of the data stream (e.g. data value, ASCII code, address) can be understood and analyzed long after the actual events have passed.

- Easy to Use ■ 10 MHz ■ Clock Qualifier ■ Trigger input ■ 3 Trigger Qualifiers ■ Built-in LED Display — No oscilloscope needed ■ Compact ■ Expandable ■ Low Cost

**30 day trial**

Purchase an LA-12, use it, and if you are not completely satisfied, return it within 30 days and receive a full refund.

**Free Offer**

If you order within 45 days, and mention this magazine, you will receive a \$49.95 input cable free with each LA-12 ordered.

**Save \$28.95**

In addition, if you enclose payment with your order you can deduct 5% and we will pay shipping charges.

All prices are in US dollars for 120VAC.  
To order in the Continental US call

**TOLL FREE**

**1-(800) 547-5995 EXT. 195**

**Connecticut microComputer, Inc.**  
36 Del Mar Drive, Brookfield, CT 06804  
(203) 775-4595 TWX: 710-456-0052

Q	Description	Price	Total
	Logic Analyzer	\$379.00	
	Input Cable	49.95	
	20 Color-coded microclips	44.95	
Connecticut residents add 7½% sales tax			
	Shipping & Handling	\$10.00	
<b>Total</b>			

Company purchase order enclosed (Rated Firms only)  
 Check     VISA     MasterCard  
 Acct. No. \_\_\_\_\_  
 Signature \_\_\_\_\_ Exp. Date \_\_\_\_\_  
 Name (Print) \_\_\_\_\_  
 Address \_\_\_\_\_  
 \_\_\_\_\_  
 City \_\_\_\_\_  
 State \_\_\_\_\_ Zip \_\_\_\_\_  
 Dealer inquiries invited



# The Optimized GRAPHIC EQUALIZER

Part 2—An integral analyzer for  
accurately setting up the audio equalizer

By Joe Gorin

**I**N THE first part of this article, we presented a new kind of equalizer circuit that offers high performance at an economical price. This month we will construct the Flatness Analyzer, an accessory used to adjust the equalizer rapidly and accurately.

**Circuit Operation.** Figure 6A is a block diagram of the equalizer/analyzer combination (part of which is identical to Fig. 1). The analyzer plugs directly into the equalizer. Figure 6B is a block diagram of the equalization test procedure.

Here's how the Flatness Analyzer tests one channel (the right) of the Optimized Equalizer. Pink noise is applied to the right-channel input of the equalizer. The equalized output of the right channel is then fed through an amplifier and speakers into the room. From here, the microphone picks it up.

The signal is then amplified by the microphone preamp and applied to the left-channel input of the equalizer, as well as two filters in the analyzer. The outputs of these 12 filters drive simple biased-diode detectors and a bank of 12 meters to show the deviations from flatness. If the system response is flat, all meters will have equal deflections. The output of the left channel is grounded to prevent the amplified microphone signal from passing back out through the left speaker and perturbing the measurements or causing oscillations.

To test the left channel, the interconnecting plug is reversed and off-set in its socket, and the above pro-

cedure is repeated with left and right channels reversed.

Figure 7 is the schematic of the analyzer. Integrated circuits *IC2* and *IC3* constitute a digital white-noise generator. The circuits in *IC3A* and *IC3B* form a square-wave oscillator with an output frequency of about 100 kHz. This clocks 18-stage shift register *IC2*, which keeps shifting the output of *IC3D*, the exclusive-OR function of the 14th and 17th stages of the shift register. These taps (14 and 17) are chosen so that the register outputs random ones and zeroes; it only repeats after going through all but one of the  $2^{17}$  possible states. This is called a pseudo-random sequence generator (since it repeats, it isn't truly random). Its output spectrum is very white if you pass the digital output through a low-pass filter. Integrated circuit *IC3C* and its associated components ensure that *IC2* cannot get locked up in the all-zeroes state.

Components *R29* through *R32* and *C20* through *C23* are a pinking filter. The gain vs. frequency of this network falls off at 3 dB per octave on the average, about half as fast as a single RC filter. The noise is amplified by *IC4B* and rolled off at high frequencies to compensate for the increased gain of the testing channel at high frequencies (due to the reduction in input attenuation as explained previously).

The output is ac coupled with *C25*, and its level is controlled with *R32*. The level could be controlled with the stereo's master volume control, but having a control on the analyzer is a real convenience. The

signal from the level control now passes to the channel under test.

The stereo speakers convert the noise to sound, which comes back for analysis through the microphone, *MIC1*. A small electret is used here, which has typical accuracy of  $\pm 1$  dB with help from the preamp, *IC1B*. This stage provides a gain of 27, and *C33* and *R44* tame an upper-midrange peak that is common to most inexpensive electret microphones.

The microphone signal is further amplified in *IC1A* and passed through *R48* and *C32* to the testing channel's filters. Resistor *R48* is provided as protection in case the input to the equalizer is not disconnected.

Besides the ten filters in the equalizer, *IC1C* and *IC1D* filter the frequencies around 40 to 100 Hz and 140 Hz to help adjust the bottom bands of the equalizer.

The filtered signals from the equalizer are ac-coupled by *C1* through *C10* (to remove the dc components) and detected by *D3* through *D12*. To minimize the errors due to the *on* voltage of these diodes, a small current is passed through *D15* and buffered by *IC4A* to offset the positive side of the meters by approximately the diode *on* voltage. As a result, the meters respond to the average value of the noise level, which is a much more accurate parameter than the peak response frequently used in such an analyzer.

The outputs of *IC1C* and *IC1D* are passed through RC filters *R18*, *R19*, *R24*, and *R25* and *C12* and

It's like having X-ray ears...

# Tiny, powerful electronic "ears" let you hear whispers through walls, conversations 2 miles away.

## The Dyna-Mike Transmitter

It's smaller than a quarter. But DYNA-MIKE will transmit every sound in a room to an FM radio tuned to the proper unused frequency, from 1/3 mile to 2 miles away.

If you're at a neighbor's home a block from your own, you can hear your baby's cry, or you can tell the instant your spouse comes home. If two

of you are driving tandem in two cars, one or both of you can communicate with the other even if other cars drive between you.

DYNA-MIKE has as many uses as your imagination can think of. For a business conference, let the tiny microphone sit unobtrusively on the table or concealed on a shelf, and you'll be able to record every word. For businesses, you can put an FM receiver in a warehouse or remote office and "broadcast" instructions or orders to be filled.

Public speakers never had a better friend than the DYNA-MIKE. No wires or setup — just turn on one or more radios and your speech will come through with perfect fidelity. Put one on the front porch. If you hear a suspicious sound, turn on the radio and you'll hear the doorbell or the ring of the telephone.

### Choose Your Model

New Horizons is introducing three models of the DYNA-MIKE supersensitive broadcast microphone. Model IC-18 is the world's smallest microphone — it's a miracle of electronic miniature power, with a high-fidelity range of 1800 feet. Introductory price is \$129.95 (two for only \$119.95 each).

Model X-18 is the longest-range microphone, with an unbelievable two-mile range. Introductory price is \$149.95 (two for only \$139.95 each).

Model X-3 is the most sensitive microphone. It broadcasts perfect-quality sound even from low-levels or whispers, up to 1,500 feet. Introductory price is \$99.95 (two for only \$89.95 each).

Each microphone is fully wired, complete with standard HC-1.35v. battery, good for 100 hours of continuous use and easily and inexpensively replaceable.

Of course you're protected by the New Horizon guarantee: use any DYNA-MIKE transmitter microphone for 30 days, with the right to return it for a full refund if you're not delighted.

— Phone or use this coupon —



## The Super-Ear

You'll hear it all.

Effortlessly, you can hear not just a baby's cries, but quiet breathing, through a concrete wall a foot thick. Put the SUPER-EAR earphone in your ear and place the speaker on the wall. That's all there is to it.

SUPER-EAR hears everything, and even more astounding, hears it clearly. It's as though the wall weren't there. If you're coming home late at night and think intruders are in your residence, let SUPER-EAR find out for you. Want to know if the meeting is over in the room with the closed door? SUPER-EAR will tell you in a second.

SUPER-EAR is undetectable from the other side of the wall. The quality of sound has amazing fidelity—good enough to record, and SUPER-EAR has its own built-in recorder jack.

Because SUPER-EAR is the ultimate listening device, you can use it to pinpoint hidden squeaks in your car or the source of mysterious engine noises.

Construction experts use it to check for flaws or cracks in buildings.

**It Works Anywhere!**

Ever put your ear to a railroad track to try to hear the train? Try it with SUPER-EAR. You'll hear that train many miles away. Use it as a powerful stethoscope on yourself, a friend, or a pet. You can even hear a bird's breathing.

The only source for SUPER-EAR is New Horizons. Choose from two models — Model SB-5, with ultrasensitive microphone, \$139.95 (two for only \$129.95 each); or Model SB-1, with suction-type microphone, \$99.95 (two for only \$89.95 each).

Use your SUPER-EAR for 30 days. If for any reason you're not delighted, the absolute New Horizons guarantee means you can return it for a prompt refund.



## The Phone Answerer Recorder

The PHONE ANSWERER/RECORDER connects in seconds between any tape recorder and your telephone. When you're away it automatically delivers a message up to 20 seconds to anyone who calls: when you'll return, when to call back, where you are.

When you're there, the ANSWERER/RECORDER starts any cassette recorder automatically when you pick up the phone and shuts off when you hang up.



It records both sides of the conversation with astonishing clarity, giving you a permanent record of every call, preventing unauthorized use of your phone, and eliminating misunderstandings over what was said. It's specially wired to extend recording time on your tape recorder. Needs no batteries - it's always "alive".

The PHONE ANSWERER/RECORDER is a masterpiece of miniaturization. It's yours for \$49.95 (two for only \$44.95 each). PHONE RECORDER unit alone, records but doesn't answer, \$29.95 (two for \$24.95 each). Every instrument has the unbeatable New Horizons guarantee.

For immediate service on credit card orders, call toll-free 24 hours a day, seven days a week:

**1-800-824-7888**

**Ask for operator NO. 551**

in California: 800-852-7777

We Absolutely Guarantee! Use any electronic instrument acquired from us for up to 30 days. If you decide for any reason that you don't want to keep it, return it for a 100% refund.

## NEW HORIZONS

1 Penn Plaza, Suite 100  
New York, N.Y. 10119

For Information Call (201) 370-8029

New Horizons, 1 Penn Plaza, Suite 100 . New York, NY 10119

CE1

Please ship at once, with 30-day money-back guarantee: — Phone or use this coupon —

- Super-Ear Model SB-5, \$139.95
- 2 for \$129.95 each
- Super-Ear Model SB-1, \$99.95
- 2 for \$89.95 each
- Dyna-Mike Model IC 18, \$129.95
- 2 for \$119.95 each
- Dyna-Mike Model X-18, \$149.95
- 2 for \$139.95 each
- Dyna-Mike Model X-3, \$99.95
- 2 for \$89.95 each
- Phone Answerer/Recorder, \$49.95
- Phone Recorder, \$29.95
- 2 for \$24.95 each

Indicate payment method:

Check enclosed  
 Bill to  VISA  Master Card

No. \_\_\_\_\_

Expires \_\_\_\_\_ Signature \_\_\_\_\_

Name \_\_\_\_\_

Address \_\_\_\_\_

City \_\_\_\_\_ State \_\_\_\_\_ Zip \_\_\_\_\_

Please add \$1.75 per total order for shipping.

CIRCLE NO. 17 ON FREE INFORMATION CARD



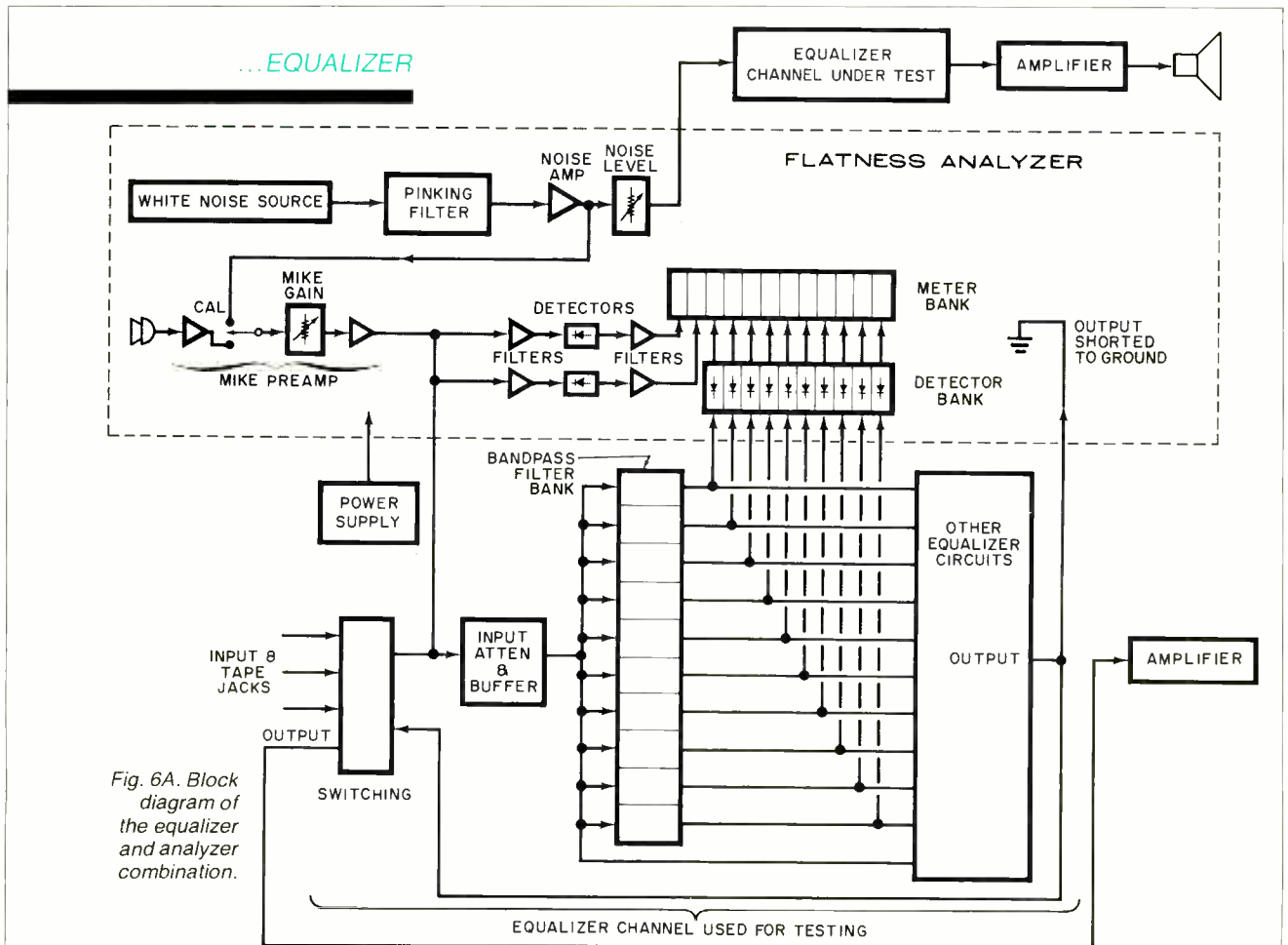

Fig. 6A. Block diagram of the equalizer and analyzer combination.

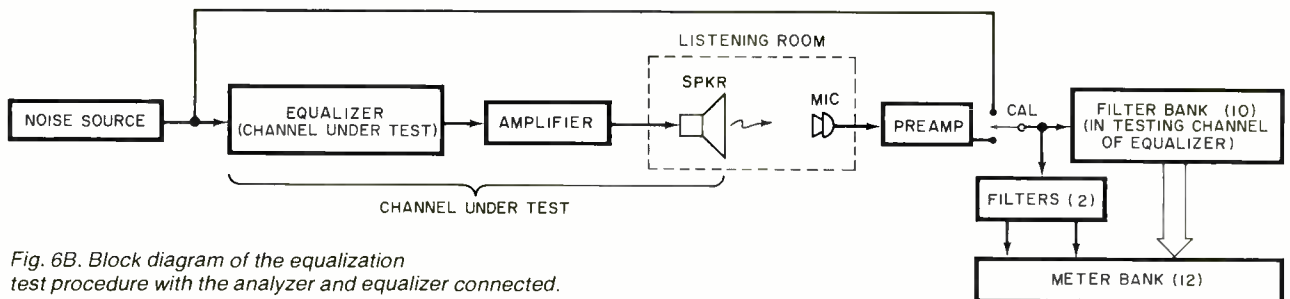

Fig. 6B. Block diagram of the equalization test procedure with the analyzer and equalizer connected.

*C16* to reduce the fluctuations of the bottom band meters and to reduce the gain, in order to make up for the effect of the attenuator at the input of the testing channel on the ten other bands.

Resistor *R17* and diode *D16* provide a +9-V supply for the microphone and white-noise generator, and also supply bias for *IC1*.

Switch *S1* allows the response of the analyzer to be observed without the speaker-microphone link, to see how flat it is. This calibration permits adjustments to be made that will provide compensation for component tolerance errors, especially in the meter sensitivities ( $\pm 1$  dB) and pinking-filter components.

**Construction.** Figure 8 is the foil pattern for the analyzer pc board, and Fig. 9 is the foil pattern for the interconnection pc board. A component-placement diagram for the analyzer is given in Fig. 10.

Solder all components to the board, except the slide potentiometers. Don't forget the two jumpers. Carefully orient the ICs, diodes, and electrolytic capacitors according to pin number or polarity. Integrated circuits *IC2* and *IC3* are CMOS, and thus static-sensitive; so don't remove them from their conductive packaging until you are ready to install them. Then discharge yourself, your soldering iron, and the pc traces to ground.

Connect the microphone element, *MIC1*, to the shielded pair cord and solder the cord to the appropriate pc board holes—red wire for positive, white for signal, and shield for ground. Connect a stiff piece of wire over the shield and solder to the two holes right behind it to act as a strain relief.

The connection to the equalizer is through a DIP plug. Cut a standard DIP-plug to DIP-plug 16-wire cable in half and solder the unterminated wires to the appropriate pads of the DIP pattern on your board (the wires will alternate sides). Or just install a whole DIP-plug right in the pattern. Pass the wires across *R35*'s position, and then mount *R35*

# ...EQUALIZER

## PARTS LIST

- C1 through C10, C12, C13, C16, C17, C24, C30, C32—10- $\mu$ F, 25-V aluminum electrolytic  
 C11, C28, C29—0.1- $\mu$ F, 50-V ceramic disc capacitor  
 C14—0.0047- $\mu$ F, 5% polyester capacitor  
 C15, C18, C19, C25—0.1- $\mu$ F, 5% polyester capacitor  
 C20—0.022- $\mu$ F, 5% polyester capacitor  
 C21—0.0068- $\mu$ F, 5% polyester capacitor  
 C22, C26, C34—0.0022- $\mu$ F, 5% polyester capacitor  
 C23—0.001- $\mu$ F, 5% polyester capacitor  
 C27—24-pF, 5% capacitor  
 C31—Not used  
 C33—390-pF ceramic disc capacitor  
 D1-D15—1N4148  
 D16—9.1-V zener (1N5239 or 1N960)  
 IC1—RC4136 quad op amp  
 IC2—CD4006 18-stage shift register

- IC3—CD4070 quad ex-OR gate  
 IC4—LM358 dual op amp  
 M1-M12—200- $\mu$ A 1-kilohm edgewise meter  
 MIC1—Electret microphone element  
 P1—16-pin DIP plug  
 The following are 1/4-W, 5% carbon-film resistors unless otherwise noted:  
 R1 through R10, R40—470 ohms  
 R11, R39, R46, R49—1.5 megohms  
 R12 through R16—Not used  
 R17, R20, R26, R28, R48—2.2 kilohms  
 R18, R19, R50—8.2 kilohms  
 R21—300 kilohms  
 R22, R34, R43—3.9 kilohms  
 R23—39 kilohms  
 R24, R25—11 kilohms  
 R27—62 kilohms  
 R29—270 kilohms  
 R30, R37, R38—150 kilohms  
 R31, R41—47 kilohms  
 R32, R33, R36, R44, R47—15 kilohms  
 R35, R45—50-kilohm potentiometer  
 R42—100 kilohms

- S1—Spst slide switch  
 Misc.—Pc board for analyzer, press-on rubber feet (4), 16-wire ribbon cable, jumper wires, etc.

**Note:** The following are available from Symmetric Sound Systems, 856 Lynn Rose Ct., Santa Rosa, CA 95404 (707-546-3895): complete Optimized Equalizer kit (EQ-4) with unfinished walnut end panels at \$100; complete Analyzer kit (AN-1) at \$60. Also available separately: horizontal and vertical pc boards for Equalizer (EQ-4PC) at \$17; analyzer and interconnect pc boards (AN-1PC) at \$13; slide potentiometers (#EQ-4SP) at \$9.95 each; quad op amp IC #4136 at \$1.75 each; set of ICs for analyzer (#AN-1IC) at \$6.00. Wall-plug transformer (#EQ-4PT) at \$7.50. Minimum order \$10.00. All prices include shipping on prepaid orders in the U.S. Canadians add \$4.00 shipping and handling. California residents, add sales tax.

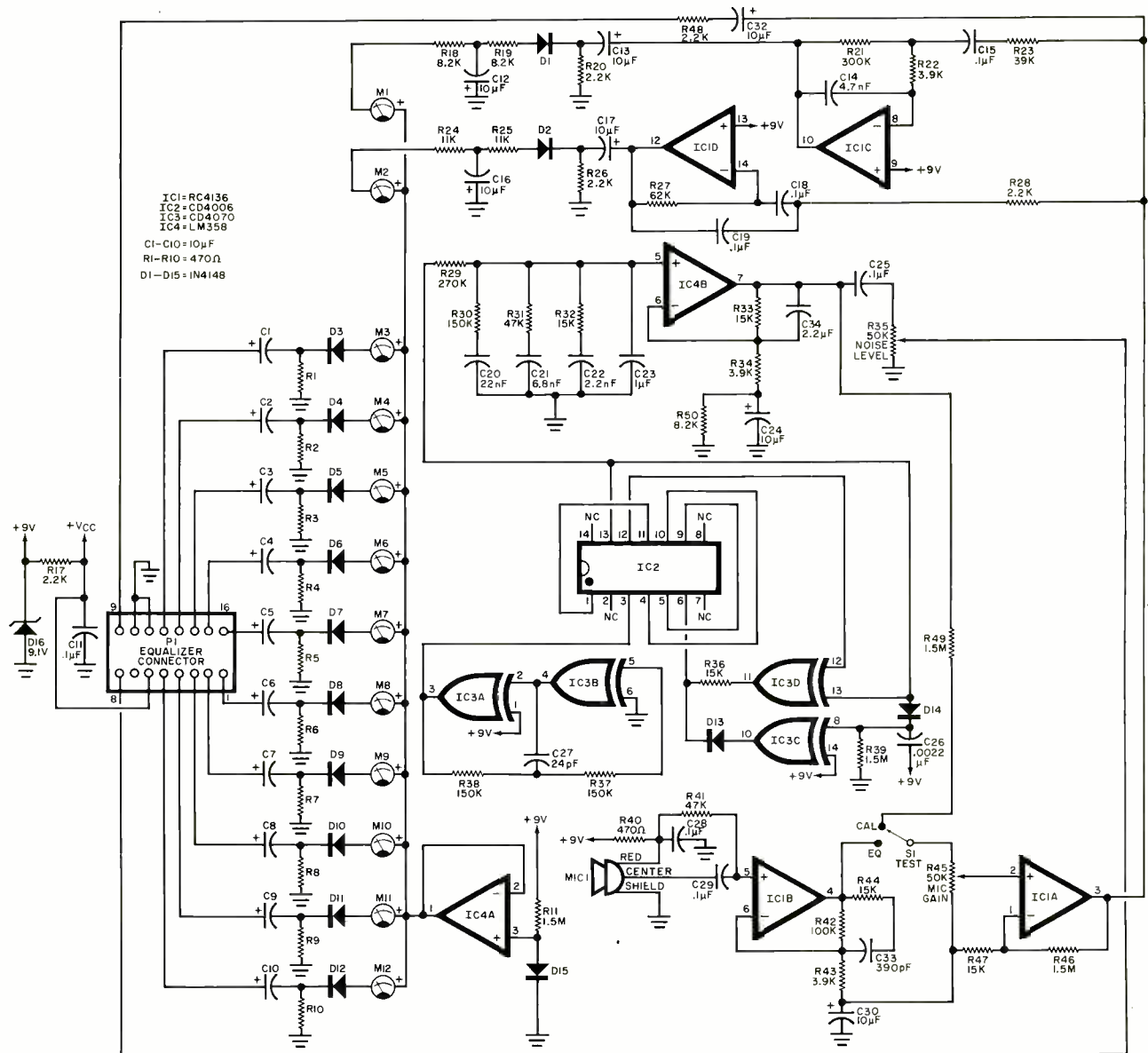

Fig. 7. Schematic of the circuit in the analyzer.



over them as a strain relief. Also mount the other slide potentiometer in its proper location.

In the prototype, the bases of the edgewise meters were glued to the pc board and wired with short jumpers. It is a good idea to use stick-on rubber feet to prevent shorting to the chassis of the equalizer or scratching it during use.

Since the analyzer is a sophisticated accessory and not for display, to save effort and expense, you need not put it in a fancy chassis.

**Adjustment and Use.** Using the Optimized Equalizer and the Analyzer combination is easy because all the information you need is right in front of you at all times.

With the power off, connect the equalizer outputs to your stereo. Do not connect the equalizer inputs to anything. Connect the analyzer to the equalizer and turn the slide pots to OFF. Set the TEST switch to EQ and the EQUALIZER switch to IN. Set all the equalizer controls to 0 dB. Place the measuring microphone at your favorite listening location. Apply power to the equalizer/analyzer and your stereo.

Adjust the mike upwards until there is significant deflection of some of the meters. This point shows how large the room noise is. Back down on the gain until there is no more than 10% deflection on any meter. Now slowly advance your noise-level control and stereo-volume control until you are getting an average of over 70% of full deflection on your meters. Depending on the ambient levels in your room, this is likely to be relatively loud.

Adjust the bands of the channel

Fig. 8. Foil pattern for the analyzer pc board.

Fig. 9. Foil pattern for connector board to equalizer.

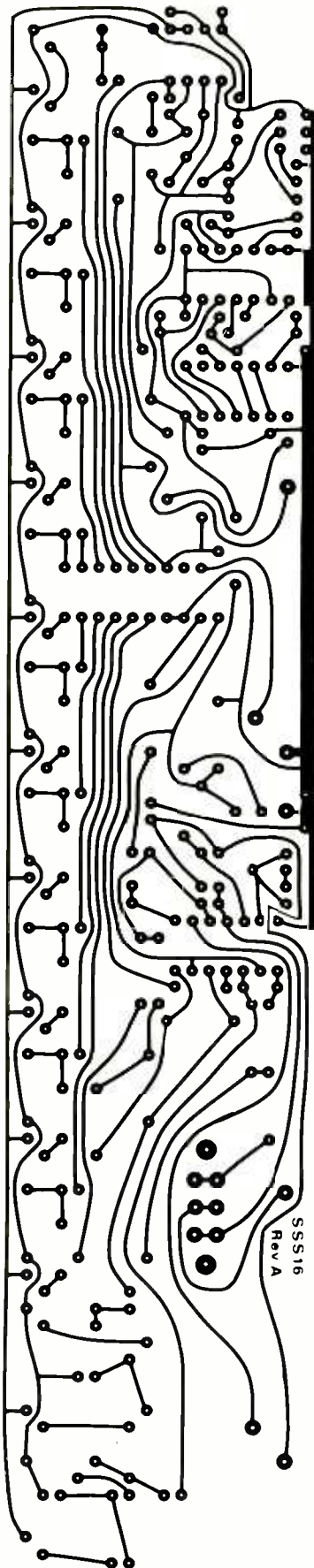
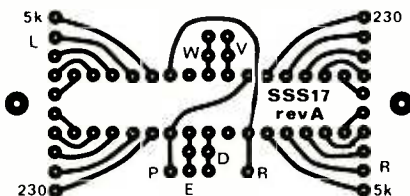

## WHAT'S WRONG WITH THE FLATNESS ANALYZER?

According to traditional thinking, there is quite a bit wrong with the analyzer. First, its output devices are meters. Unlike bargraph LEDs, meters cannot be easily read from far away. They are also slow and cannot show the dynamics of music well, due to mechanical inertia. But we are not building a music analyzer; we are building a flatness analyzer. It is designed to be placed next to the equalizer so that the controls can be adjusted while watching the meters. Only the microphone needs to be usable from a distance, and it comes with a long cord.

The slowness of the meters is in fact desirable because it evens out the fluctuations in the noise levels. Actually the meters act as filters without extra components to do that filtering (except in the lowest bands, where the fluctuations are slow enough that additional filtering is desirable). However, the most important reason for using meters is that they give better resolution and "feel" for that signal level. Their fluctuations can be averaged visually much faster and more accurately than LEDs, especially in designs with 2.5 dB/step LED resolution.

Next, the Flatness Analyzer will not analyze music. Since the signal levels in the testing channel must be adjusted to drive the meters appropriately, this channel cannot be used to process music. This precludes the fascinating light-shows of some analyzers, but it is necessary for the economy of reusing the equalizer's filters. We're out for performance here, not a show.

Finally, the Flatness Analyzer does not have a top-end meter to help adjust the equalizer's 10-kHz control. One is easily added, but it is not worthwhile for a number of reasons. First, a microphone that has even marginally predictable response in the top octave will cost more than the entire equalizer/analyzer combination; using it would produce the worst kind of diminishing return on your investment. Secondly, recorded music in the top octave is notoriously variable in relative level due to varying microphone techniques and engineer's tastes. Finally, all speakers, microphones, musical instruments and ears are extremely directional at high frequencies. Unlike the situation at lower frequencies where most of the signal you equalize has been reflected from room boundaries; at high frequencies, you would be equalizing the direct signal from the loudspeakers. The desired ratio of this signal level to the reverberantly measured levels at other frequencies is not well controlled.

Thus, no one equalizes for a flat high end. Rather, they try to accomplish some smooth roll-off. The author strongly recommends setting this band by ear and re-setting it (and perhaps the top two or three narrow bands slightly) according to the particular piece of music being played. ♦

under test by reducing the level of the band corresponding to the meter with the highest deflection. After you have adjusted a few bands this way, continue by moving the bands either up or down to come as close as possible to uniform deflection of all bands. Adjust the noise level as necessary to keep the aver-

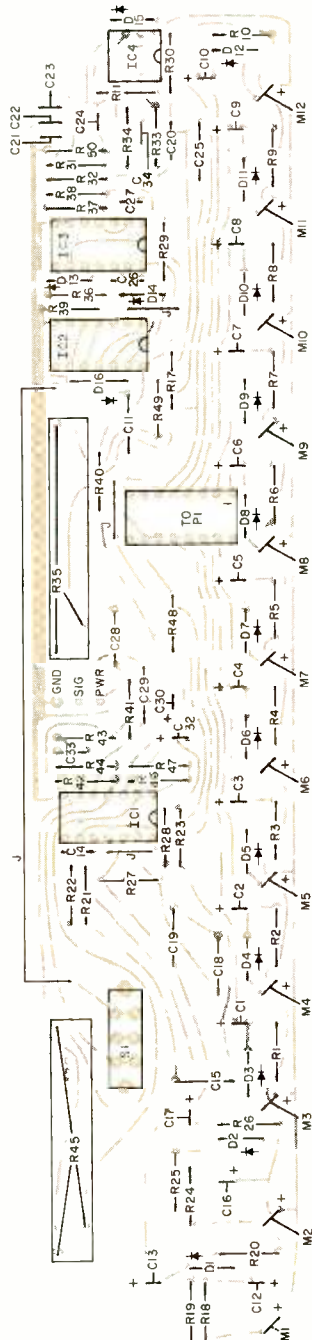
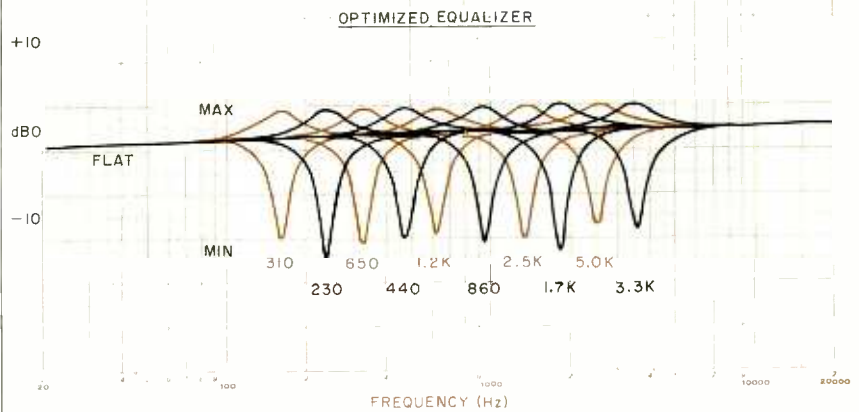

Fig. 10. Component layout on analyzer pc board.

## TESTING THE EQUALIZER/ANALYZER



Boost and attenuation effects of the ten filter points.

The concept of having the analyzer use some of the circuits in the equalizer is an interesting one and makes for economy in achieving both analysis and equalization. In addition, the recognition that a limited amount of boost and much more "cut," are required for room/speaker equalization is something we have not seen discussed before. It differs sharply from conventional practice, which provides symmetrical (more or less) boost.

The measured characteristics of the various filters in the analyzer and equalizer confirm the statements made in the article. It is interesting to note that using only the extreme controls (40 Hz and 10 kHz) one can simulate quite well the effect of a conventional tone control system. The distur-

tion of the equalizer was negligible and well within the stated limits. The noise (which was below our measurement limit) appeared to meet the claimed performance comfortably.

Following the instructions, we used the system to equalize a stereo music system. It would be helpful if the meters could be marked to match the corresponding slider controls; we had to use some "cut and try" methods in doing the equalization, but the end result seemed to be reasonable. According to a spectrum analysis of the "pink noise" from the system, it is not quiet pink. However, since one uses the meters to read the noise spectrum as well as the equalized acoustic spectrum, this error is of no importance.

—Julian Hirsch

age deflection at about 70%.

The noise source, being pseudo-random, audibly repeats every 1.5 seconds, and the meters will show this periodicity. When fine tuning, visually average the motion during this interval. When the result is close to flat, switch the TEST switch to CAL, adjust the MIKE GAIN for 70% average deflection, and observe the errors of the test system. Then switch back to EQ and fine-tune the equalizer to match the CAL response, which will be slightly different than truly flat. Then turn everything off, switch the connection from the analyzer to the equalizer, and repeat for the other channel. Then remove the analyzer and connect the equalizer normally.

**Hints on Equalizing.** Over the long term, the sound from your system will be exceptionally smooth

and accurate. But be wary of short-term reactions. After listening so long to the errors that your system and room make, your mind gets accustomed to these distortions of reality and expects them. Thus, any change toward either more or less realistic sound is initially perceived as unnatural. Also, the equalization technique given will reduce the overall level somewhat. Unless you compensate by increasing the volume control setting, you are likely to initially consider the sound to be poorer when equalized.

But give yourself about 15 minutes with your de-resonated stereo and then switch to unequalized. You will notice a hollow, boxy sound that you missed before because you were so used to it. Now simply switch back to equalized sound and you will find some really fine listening. ◇



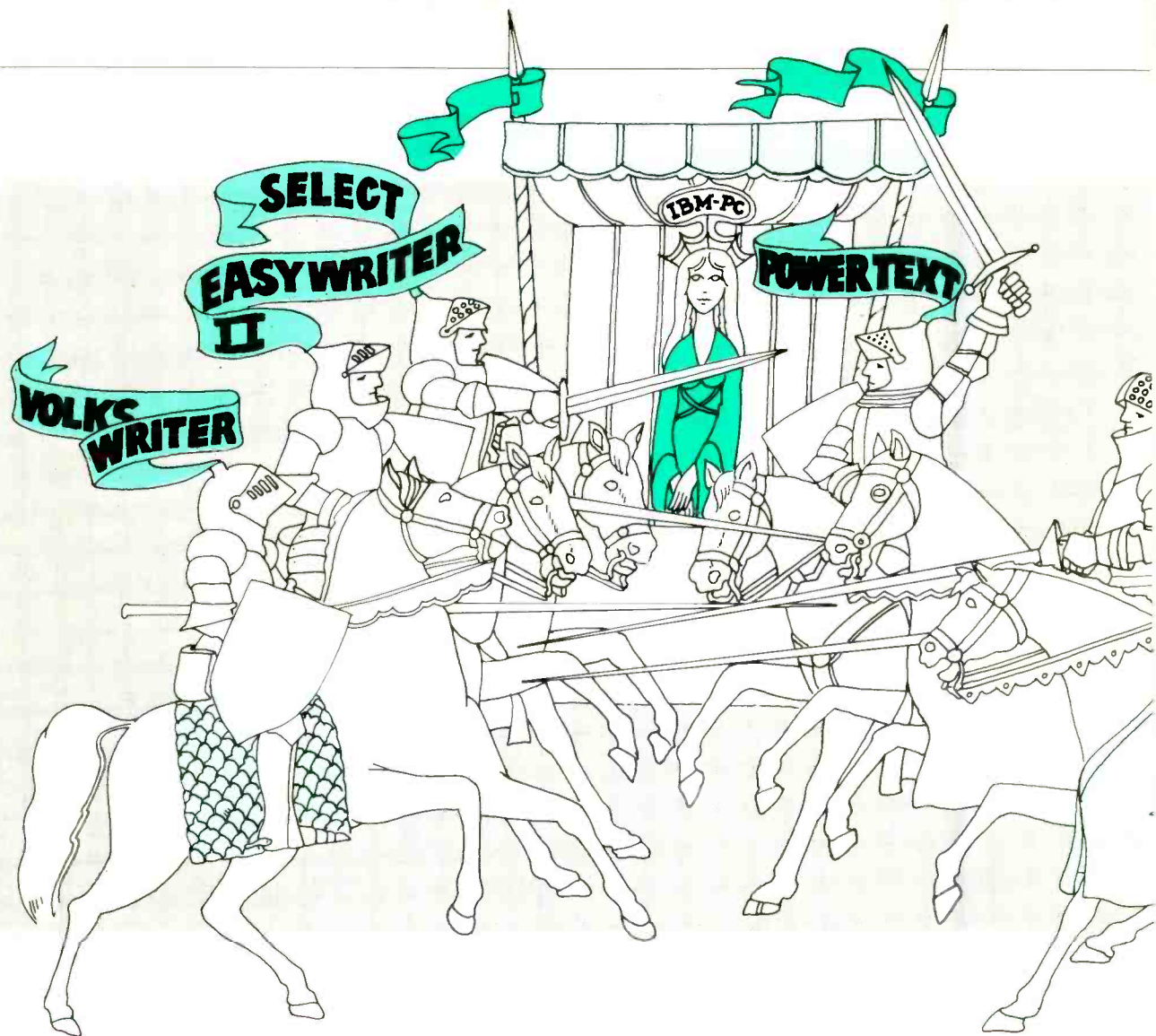

# THE WAR OF THE W

*Comparing word-processing systems for the IBM-PC from WordStar to Final Word*

*By Barry Crawford and Stan Veit*

**T**HERE is a "war" being waged by the major producers of word-processing software. The prize is the word-processing (WP) buying decision of IBM-PC owners. The battle was inevitable when "EasyWriter," adopted by IBM as its "standard" PC word-processing package, turned out to have serious bugs in it. IBM replaced the software with a workable version

(Easywriter 1.1), but the program got the reputation of being a dud. This gave other software companies time to get their products running on PC-DOS and to enter the war of words.

To owners of IBM-PC Computers and other compatible machines this offers an opportunity to make a selection from a larger group of WP programs. It also presents a source of confusion as attempts are made to select the best system to meet an individual's needs. This article presents information about some of the leading WP contenders for the pocketbooks of IBM-PC users. At last count there were about 60 WP systems, with new ones appearing each week, so we couldn't discuss

them all. In each case we have used the IBM-PC Computer and the applicable WP software to write that section of this article.

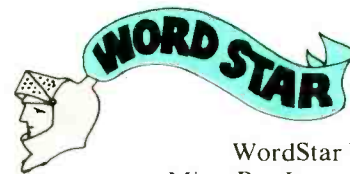

WordStar by MicroPro International Corporation (1299-4th St., San Rafael, CA 94901) is one of the oldest WP systems in the micro-computer software industry. Suggested retail price is \$495. It was originally written for CP/M-based computers and has been used on more different computers of that type than any other word processor.



Some WP systems can only work with memory-mapped video computers, while others can only be used with terminal-operated systems. WordStar has the advantage that it can be used with either.

It supports the broadest range of different terminals and printers. However if a terminal or printer is not one of those listed in the table of supported units, there is an Install program supplied as part of the system with which the user can specify the parameters of the terminal and printer and then configure WordStar to work with the specified equipment.

WordStar can be used for composing either text or program documents. It includes a complete

screen-oriented editor and a formatter with the capability of operating any type of printer.

The text is shown on the screen exactly as it will appear in the finished document. If it is set to justify the text, it will be shown on the screen as justified copy. If double spacing is specified, double-spaced copy will appear on the screen. The user has the widest possible list of options in text formatting and printing. Yet none of these *must* be used. There are default settings within the system that will take care of anything not specified.

To use WordStar, the computer is turned on and the disk operating system is initialized. Upon seeing the prompt, the user enters "WS" and hits RETURN (CR). The WordStar copyright notice appears with an announcement of what terminal and communications protocol the system is set for and what printer parameters are in force. The user then hits the return key and the first menu appears. This is called the "No File Menu" because the user has not specified a file to be edited. It contains the following:

#### Preliminary Commands.

*L-Change Logged Drive.* The logged drive is initially the drive that had the WS program on it. If you want the text files you are about to prepare to be saved on that disk, do not invoke this command. If you insert a formatted disk into the second drive and want to save data on that disk, change the logged drive to the opposite one.

*F-File Directory Off (On).* When you are saving files, or when in a print operation, the file directory is displayed.

*H-Set Help Level.* The HELP level command controls the amount of helpful information automatically displayed by WordStar. It also determines whether part of the screen will be used to display a menu of editing commands. There are four levels of Help menus displayed: 0 through 3 (the most complete).

#### Commands to Open a File.

*D—Open a Document File.* This type of file is used for any text document such as a letter, report, text page or columnar text.

*N—Open a Nondocument File.* This file is designed to hold a program.

#### File Commands.

*F—Bring a File.*  
*E—Rename a File.*  
*O—Copy a File.*  
*Y—Delete a File.*

#### System Commands.

*R—Run a Program.*  
*X—Exit to the System.*

**Options.** WordStar is part of a family of programs that are interrelated but sold separately. These include Spellstar and MailMerge. When these supporting programs are on the same diskette, they can be accessed from the WordStar menu.

When the "Open a Document File" (CTRL D) or "Open a Nondocument File" (CTRL N) option is selected, the system asks for the name of the file requested. The user enters the file name; and if it previously was listed in the directory, it is loaded and displayed on the screen under the main menu. If the file requested is not on the directory of the diskette being used, WordStar will create it and announce "NEW FILE" as the main menu is displayed on the screen. The main menu lists the cursor commands, scrolling commands, deletion commands and miscellaneous commands. It also lists the commands for accessing the other available menus. At the top, the logged drive letter (either A: or B:) is displayed and an indication of the position of the cursor (ie: Page 1 Line 1 Col 1). An indication of the INSERT ON condition is also displayed if the system is in insert mode.

All the user has to do at this time is to type in the text. WordStar automatically breaks at the end of a line and goes to the next line. The copy is automatically justified within the specified margins unless the justification is turned off. The user selects the paragraph breaks by hitting the RETURN key.

When you reach the end of a page a line appears across the page to show exactly where the page break occurs. Text can be moved to make the page breaks occur where desired. The other menus permit the



user to do all kinds of text format requirements and to save the completed document. Printing and print format can also be selected from menus, however there is another complete system of inserting commands within the text by means of optional "dot commands."

If all this sounds complicated that is because it is. WordStar can be one of the most involved systems you could use. It has many features that only an expert would ever need, yet it is nice to know that these options are there if you want them. The beauty of WordStar is that the system can work almost automatically when you want it to, as well as when you do not know how to use all the bells and whistles.

The documentation supplied with WordStar is very good. It has been updated several times and by now it is accurate. A training manual is also supplied as well as a pocket reference card. The whole package is highly professional and a pleasure to learn and use. This is part of the reason that WordStar is one of the largest selling software packages in the world.

Well now, I hear you saying, "why is there a war, why doesn't everybody just use WordStar and get on with their work?" Remember that we are talking about the IBM-PC which uses the PCDOS, or CP/M-86 Operating Systems. WordStar was designed for the CP/M-80 Operating System which is quite a bit different. The folks at Micropro International did a good job of converting their package to run under PCDOS (also called MSDOS) but it just was not designed specifically for the IBM-PC and it does not use all of the special features of the IBM-PC keyboard as well as it might.

Version 3.2 M has been modified to use the programmable function keys and the features on the numeric keypad that contain the arrow keys, but the uses assigned to the function keys are not the important ones that are employed often and should rate a function key. For example, there is no single function to delete a line or a word (functions

that are often used). Nor is there one for the "CTRL G character: delete and move operation." The one they use for the delete key on the keyboard requires that the cursor move past the character to be deleted. These are minor inconveniences but they do leave room for improvement and other companies have designed systems to do just that.

The major fault with WordStar is that the printer operation has not been updated to take advantage of the great features of the high-quality dot-matrix printers now being sold by Epson, C. Itoh, Okidata, Star Micronics and IDS. In fact more IBM-PCs have Epson MX80 Printers attached than any other printer because that is the "IBM Printer" sold with the system.

Now WordStar treats all of these as "Teletype type" printers and, consequently, can not take advantage of all of their features including condensed, or expanded, type, bold type, and foreign language fonts.

At a recent meeting of the New York Amateur Computer Club—IBM-PC Users Group, devoted to word processors—many users were quite angry at what they perceived as lack of support by Micropro for either the IBM dot-matrix printer or the IBM daisy-wheel printer. The representative from Micropro offered to give the users software patches that he said would solve the problem. The people in the audience were not satisfied by that solution. They said that Micropro should have included support for the new printers in the IBM-PC version. In spite of these shortcomings, WordStar is one of the most popular processors for the IBM-PC especially with people who have become accustomed to it on other computers.



Easywriter II by Information Unlimited Software Inc. (2401 Marinship Way, Sausalito, CA 94965) is the successor to

Easywriter 1.1, the original word processor distributed by IBM. This is a completely new program and it is an excellent working system because it has been designed to use all of the function keys on the IBM-PC keyboard and the features of the IBM Printer (Epson MX80). Suggested price is \$350.

The system comes with two diskettes. One contains the WP system and is labeled the SYSTEM disk. The other is called the HOUSEKEEPING disk and contains all the system functions such as formatting a data disk, duplicating an existing diskette, changing printer parameters and other system related tasks.

Before a diskette can be used as a data diskette, it must be formatted by Easywriter and then the quantity of documents that will be saved on the diskette must be allocated by the user after it is formatted. The user can select a name for the diskette and then the number of documents to be allocated to that diskette (from 1 to 99.) Working copies can be made of all the system diskettes so that the originals can be saved.

To start to use Easy Writer II, the system diskette is placed in Drive A: and the data diskette in Drive B:. When the system is reset, the sign-on notice appears and then the Main Menu. This gives the user a chance to select activities from the following choices:

1. Edit.
2. Activate Data Diskette
3. Delete Documents
4. Print
5. Paginate Documents
6. Set Date
7. Print Document List
8. System Functions

Under the menu is a box used to activate the document you want to work on. The selection is made by pressing the TAB key and entering the number of the document.

Under the active document block, the system gives the user a complete list of all the documents saved on the data disk. This includes the document number, the pages in the document, the author (in case more than one person uses the diskette), the date created and the last date edited. This makes it a very handy kind of directory. Once you have selected the document to

work on and hit RETURN, the copy appears on the screen.

If you have created a new file by naming it, a blank typing area will appear. A line appears under your typing line indicating your place in the document. However, at the top of your work area the system shows you what mode you are in (more about that later) and the position of your cursor by means of a status line. The status line displays the space (column), the line number, the document number, the name of the document, and the percentage of the data disk that is full. This last is very important. It keeps you from continuing writing after you have no space to store your work. I have used other word processors that did not give me this information and the result was, that when I went to save my work, there was no room on the disk for it and I lost everything!

Easywriter uses the ten function keys on the left side of the IBM-PC keyboard for various tasks, all of which are named on an illustration attached to the keyboard beside the keys. Four of the functions are for the modes: Character (CHAR), Word (WORD), Line (LINE), and Sentence (SEN). When one of these keys is pressed, the mode is displayed on the status line and it is in force. That means if you are in WORD mode and you press DEL, you will delete a word. If you are in LINE mode, you will delete an entire line if you press DEL. The same thing works for insert (INS). If you are in WORD mode, space will be made for a word insertion, or a line insertion if you are in LINE mode. You have to be careful when you delete not to delete more than you want. You can hit DEL while in LINE mode and delete a whole line.

In between operating all the controls, the user merely has to type in the text. The system automatically breaks at the end of the line unless the typist enters a RETURN to force a paragraph break.

The arrow keys are used to move the cursor around so that you can correct copy wherever the cursor is positioned. The insert and delete keys operate in every mode. Text

entry is simple with the IBM-PC keyboard and Easywriter II.

One of the nice features of Easywriter II is that, if you are interrupted for any reason, you press the escape (ESC) key and the system automatically saves your work. When you are done with your data input, the directory will list the file and the number of pages in it. You can print the text just as it appears and using that as a basis for additional editing, you can move copy around by "cut" and "paste" operations. You can also paginate the text; add headings, foots, and page numbers; and change words throughout the document by means of global search and replace techniques.

The text can be formatted for printing and using any of the type fonts available on the IBM-PC Printer (Epson MX80) such as Bold, Expanded, and Condensed. Superscripts, subscripts, underlines and shadows, are also available.

Easywriter II is a page-formatted word processor. It handles text by the page rather than in a continuous file like WordStar. It has many features that need not be learned until necessary and therefore it can be learned in about five hours of practice with the Sample file. After a user becomes proficient with Easywriter II, the next step is to learn to use it with the other programs in the IUS Computer Co.'s line and with VisiCalc files. Easywriter II will also interface with IBM-PCDOS files.

**Conclusion.** How does this system compare with other word processors? It is very complete and fairly easy to learn, and it gives the user control over format and printing. The documentation is excellent and professionally prepared. Information Unlimited Software has a User Assurance Plan for 90 days after purchase and a Phone Support Program that extends the warranty for another 90-day period and offers telephone service and help with problems for one year at a cost of \$80. This is a somewhat unusual idea for software support but it has some good points. Very few companies have been able to offer free telephone help because the lines get

clogged with trivial questions. Even such a large organization as Radio Shack has had to discontinue the 800 number because no one could get through. Paying a fee for telephone help will limit the service to serious calls and make it more valuable.



Power Text

by Beaman Porter

Inc. (Pleasant Ridge Road, Harrison, NY 10628) at \$399 is an unusual word processor for several reasons. First it is the only one of the systems examined here that is written using the editor of a major operating system. Power Text uses the powerful editor of the UCSD P-system as an integral part of the WP system. This is unique only to the nonPascal world since users of UCSD Pascal have long known that the UCSD Editor is one of the most powerful editors. It lacks only one essential subsystem to make it into a complete word-processing package. That missing ingredient is a formatter subsystem. Many such programs have been written and several are in the public domain including Prose available from the UCSD User's Group. Power Text has included several additional feature as an incentive to buying its package.

The unusual feature is the concept of Format files. These tell Power Text about the style of the documents to be composed using the system. Anyone who works for a large company knows that they have standards and style manuals for correspondence and documents. The Format files within Power Text set up specification files for each of these formats. When you use the format file for "Letter," everything you type will automatically be formatted into the business letter format. The address will be in the right place, the paragraphs will be indented according to the style required, and headers and foots for the following pages will be generated without your having to type them! The system can also type the envelope when the letter is completed.



**Format Files.** The Format file contains a number of important pieces of information:

Lines per page.

Spaces to indent paragraphs.

First and last lines to print body text on.

The Format file also includes information about keyword commands, which is a reserved word within the system. They are used to describe header, foot, closing and cover page items within the document.

Standard format files included with the system include:

*Document.* This specifies the format of a paper, report, proposal, article.

*Letter.* The Letter format provides a standard for business letters.

*Personal.* Personal letter format.

*Landscape.* This is the format for a 132-character page.

*Standard.* A blank page without any borders or foots.

*Memo.* A short memo form.

These formats can be changed to suit the requirements of the user, or new ones can be designed to suit the user.

**Editor.** The Editor is a fullscreen text editor with capabilities for easily entering new text and changing, deleting, or moving old text from one place to another. It can copy from other files and it has features such as global search and replace (finding a phrase or character anywhere and replacing it with another), vertical scrolling and screen paging, invisible text markers for easy location and copying of text. There are also provisions for setting and clearing margins and tabs. The editor includes word wraparound and a type-ahead buffer. One other feature is that deletions go into a buffer so anything deleted by error can be recalled.

**Utilities.** The File Utility provides functions for disk and file house-keeping needs. It includes disk formatting, copying, removing files, and erasing disks. It can change names, list the file directory, and move files from one disk to another.

The Print Utility processes text files created using the Editor and turns them into the kind of document that the user has specified when he selected the Format file. It scans the text for embedded Power Text commands and shapes the text according to the instructions in those commands. Text can be reviewed on the screen, printed on the printer, or sent out over a communications line.

The Style Utility allows the user to create new Format files and the Misc. utility allows the user to format new disks.

**Lessons.** For all its power, the UCSD Editor is not an easy system to learn and many people have used UCSD Pascal for a long time before they mastered the Editor. That makes the lessons in Power Text even more valuable.

They not only teach you Power Text, they also teach you a large percentage of the UCSD P-system at the same time and you don't even know you are learning it! The manuals and the lessons in the system are almost worth the cost of the system!

**Conclusion.** Power Text is a high-grade package designed to be used in commercial offices where there is a lot of formatted typing. It is unsurpassed for that application. In addition, its price is reasonable considering what it can do and how well it does it. For the occasional user of word processing, it is overkill if they do not need the features and capabilities of this powerful a system.



Volkswriter, from Lifetree Software, (177 Webster, Suite 342, Monterey, CA 93940) was designed for the IBM-PC as a low-cost (at \$195, it is actually in the medium price range), easy-to-learn and easy-to-use, word processor. It is written in Pascal, but unlike Power Text it runs in a PCDOS environment. When you get it, you transfer DOS and

Command.Com (the system file) on to your work-processor disk so it becomes bootable. (You need no other disk to bring it up.)

Here let me interrupt to explain that originally Volkswriter was one of the so-called "protected" disks where you could not back-up the software you had bought and paid for. Lifetree Software, realizing that this was adversely affecting the sales of an otherwise excellent product, removed their "locks" and Version 2.2 permits the owner to back up his system. Thanks.

Volkswriter comes up with a menu at the top of the screen. If you haven't used the system before, you press H(elp) and get a summary of the system commands. It also refers you to a Tutorial file which will teach you how to operate the system by working with the various commands. To get to the Tutorial file you have to R(etrieve) and then E(dit), a typical Pascal method of operation, but one not explained in the Volkswriter menu. The Tutorial itself is excellent and the user should be able to use the system to edit within a short time. You still have to read the manual to learn how to format and print your text since these are not covered in the Tutorial.

Volkswriter uses the standard PC arrow keys to move the cursor around the screen. You can enter text wherever the cursor is placed and then you can keep typing until the end of the line when the system breaks the line for you and the text appears on the next line. You can insert paragraph breaks by pressing RETURN. The HOME key sends the cursor to the upper left corner of the screen and the END key puts it in the lower left corner of the screen.

PgUp (page up) and PgDn (page down) keys work normally and move the entire screen up or down a distance of 1/2 screen, adding the CTRL key to the command (CTRL + PgDn or PgUp) scrolls the entire screen up or down. There are some other useful combination commands, CTRL + right arrow moves cursor to the next word and CTRL + left arrow moves it to the last word. CTRL + HOME moves the cursor to the first word of text and CTRL + END moves it to the

# Get serious about ZX81 & TS 1000 Computing

## DATA STORAGE SYSTEM

### MULTIFILE PLUS

For 16K or greater ZX81

#### PRICE INCLUDES:

- 1 PROGRAM TAPE
- 2 8-PAGE BOOKLET
- 3 THREE DATA STORAGE TAPES
- 4 STORAGE CASE

**\$34.95**

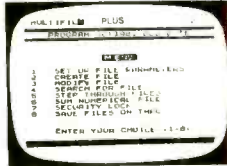

ACTUAL SCREEN PRINT.

An amazingly versatile multi-purpose filing system for the 16K ZX81. The program is menu-driven, and number, size and headings of files are user-definable. Both string and numerical files are catered for. Files may be created, modified, replaced, and searched, and are protected by an ingenious foolproof security system. Output to the ZX printer is also provided. The program comes on cassette, together with three quality data cassettes for file storage, and comprehensive documentation, describing a host of applications for both business and personal use. Supplied in an attractive storage case. If your ZX81 is bored with playing games, then this program will give it plenty to think about!

## The Complete ZX81 and TS1000 Library!

### BOOKS

The Complete ZX81 Basic Course .....	\$34.95
Basic Course Cassettes (2) .....	7.50
Getting Acquainted with your ZX81 .....	8.95
ZX81 Pocket Book .....	10.95
Making the Most of Your ZX81 .....	10.95
Computer for Kids, ZX81 Edition .....	3.95
Explorers Guide to the ZX81 .....	10.95
ZX81 Companion .....	8.95
49 Exploding Games for the ZX81 .....	10.95
Not Only 30 Programs for ZX81: 1K .....	14.95
Machine Language Made Simple for Sinclair .....	19.95
Mastering Machine Code on your ZX81 .....	12.95
ZX81 Rom Disassembly: Part A .....	14.95
ZX81 Rom Disassembly: Part B .....	14.95
Understanding your ZX81 ROM .....	19.95

### SPEECH PACK

**\$119.95**

Add high quality solid-state speech to your ZX81 or TS1000. Many applications in personal computing, education, and industry. DCP Speech Pack contains all the letters of the alphabet, numbers zero to over a million, and some other general words. Easy to use under ZX81/TS1000 control using POKE commands (fully explained in manual). The DCP Speech Pack connects directly onto rear of ZX81. It can be used in addition to a RAM Pack, Printer, or other accessories. Contains its own speaker and volume control, and allows an external extension to be added. Additional Word Pack ROMs are available and simply plug into sockets inside the Speech Pack to extend the vocabulary of the unit.

**TOLL-FREE ORDER LINE**  
**800-833-8400**  
 Have Visa or Mastercard ready

## ZX FORTH

Simplicity of BASIC with the Speed of Machine Code

A complete implementation of the FORTH language for the ZX81 and TS1000 computer.

FORTH's most distinctive feature is its flexibility. The basic unit is the word — the programmer uses existing words to define his own which can then be used in further definitions. FORTH is a compiled language so programs run very fast (typically five times faster than BASIC).

ZX-FORTH is supplied on cassette and is accompanied by extensive documentation:

56-page Users Manual **\$29.95**  
 8-page Editor Manual

## ASSEMBLER

This Machine Code program occupies 7K of memory and locates itself at the top of memory. The program is a full Editor/Assembler and Monitor. Labels may be used instead of any string. The features include Line Insertion/Delete, Insert Characters, Auto Repeat on all keys. The monitor has facilities to inspect memory, registers and run machine code programs. **\$14.95**

## ZX BUG Machine Code Monitor & Disassembler

ZXBUG is a powerful tool for machine language programming. It is 4K long and uses memory from 71E0 to the top memory. ZX BUG works in hexa-decimal (base 16), not decimal, so all addresses are a maximum of 4 Hex bits long. Provides a total of 28 commands. **\$14.95**

## TOOLKIT 9 Powerful New Functions!

RENUMBER. This routine renumbers a program in any step and from any line up to 9999  
 DELETE. This command deletes a group of lines in a program.  
 MEMORY. Prints how much spare memory is available.  
 DUMP. Displays current values of string and numerical values, except arrays.  
 FIND. Will find any string of up to 255 characters and list each line containing that string.  
 REPLACE. Replaces any string of up to 255 characters by any other string.  
 SAVE. Transfers program in computer to below RAM-TOP.  
 APPEND. Allows two programs to be joined.  
 REMKILL. Removes all REM statements from a program, otherwise leaving it unchanged, preserving memory. **\$14.95**

# GLADSTONE ELECTRONICS

NY Residents call (716) 874-5510

with Quality Hardware and Software from Gladstone Electronics

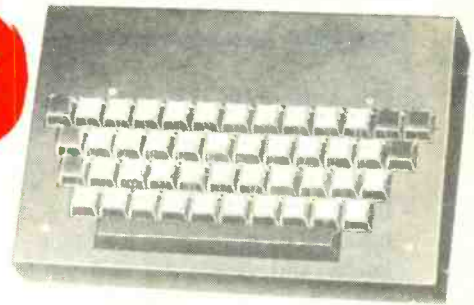

## Professional Keyboard & Case

A full-sized professional keyboard for the ZX81 Features 47 keys and a full-sized space bar. Connects to the ZX81 with no soldering required, via a plug-in flexible connector. You can purchase the keyboard only, or the optional metal case that holds both keyboard and ZX81. Expansion devices (i.e. RAM packs, etc) connect to the ZX81 edge-connector which extends from the rear of the cabinet.

A professional keyboard makes program entry easier and less error-prone.

Assembled Keyboard **\$85.00**  
 Optional metal case **\$25.00**

## 32K RAM

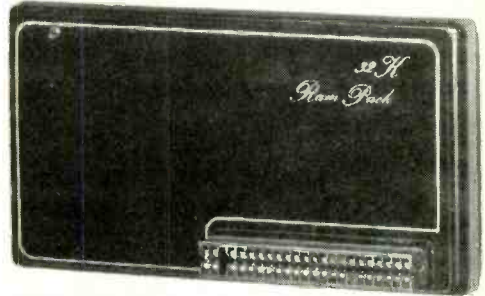

## \$89.95 with "piggy-back" feature

A sensible choice for 16K RAM owners. Jigsaw 32K RAM 'piggy-backs' onto your 16K RAM to give a total memory of 48K! If you do not own a 16K RAM, you may use a 32K RAM instead. At a later date you may add the ZX81, TS1000, or Jigsaw 16K RAM, should you decide you require more memory.

Larger memory enables longer programs and greater data bases, enhancing the value of your personal computer.

## 64K RAM

Expands the ZX81's memory capacity to its maximum. **\$149.95**

## 16K RAM

Equivalent to ZX81 or TS1000 16K RAM. **\$49.95**

Mail to: Gladstone Electronics, 1585 Kenmore Ave., Buffalo, NY 14217

( ) Check ( ) Mastercard ( ) Visa

Acct No \_\_\_\_\_ Exp \_\_\_\_\_

Name \_\_\_\_\_

Address \_\_\_\_\_

City \_\_\_\_\_ State \_\_\_\_\_ Zip \_\_\_\_\_

\*Add shipping: \$3.00 first hardware item, \$1.50 each additional. \$1.50 first software item, 50¢ each additional. 90 day limited warranty all items. Dealer Inquiries are invited

Ave., Buffalo, NY 14217

Please rush me:

Item Qty Price Total

\_\_\_\_\_

\_\_\_\_\_

\_\_\_\_\_

\_\_\_\_\_

Shipping and handling\* \_\_\_\_\_

NY residents add 7% tax \_\_\_\_\_

Total \_\_\_\_\_



last word in the text, both very useful commands often omitted in word processors.

Character deletion is done with the normal DEL key and the "F" function keys are used for block deletion and delete to end of line (ALT + F4.)

Insertion of characters is done with the INS key and line insertion uses the F3 key.

The other F keys are assigned various functions. F8 is used to reformat the text after insertions and deletions. However, F8 also removes all the tabs and indents unless they are protected by a "hard" space (/). This can be very annoying because you tend to forget where you have done this. Then you hit F8 and your neat page becomes an ugly block of text and you have to reformat it the right way.

One of the important operations in word processing is the ability to move blocks of text and insert them where you want them. Some systems call this cut and paste. Volkswriter does this with the F5 and F6 keys. F5 marks the start of the block to be moved and F6 marks the end of the block. Then ALT+F5 moves the block where you place the cursor. ALT+F6 copies a block and finally ALT+F8 deletes a block of text. One of the nice things about Volkswriter is the Status line at the bottom of the screen. This tells you the name of the file you are working with and the command status in force at that time. It also tells you how much memory you have left to work in percentage of total memory you had when you started. If the percentage drops below 10% it flashes to get your attention. If it gets close to 0% it beeps at you so you can save your text to disk before it is too late.

Volkswriter has separate Format and Print menus. The Format menu controls the form the printer page will take. It displays the format then in force and permits the user to change it. The Print menu enables the user to either print the text or write it to a disk. The text can also be deleted or renamed. Since the Edit file can not be entered from

Print, a separate editor for minor changes is provided. If an error is noticed during print, it can be corrected and the print cycle can be restarted.

The print options include left and right justification, page number to begin with, line spacing, lines per page, and page number location. Some of the options are for control of the IBM printer (Epson MX-80).

It will even help you do graphics if the Graftrax ROM is installed in the Epson. Volkswriter can also be used with the NEC Spinwriter printer distributed by IBM.

**Conclusion.** On balance, we liked Volkswriter. It is a reasonably priced system that will serve the average person well. It does not have the power of some of the other systems we tested but it is a good value now that the annoying "protection" scheme has been removed. We found one fault that can not be fixed and that is the memory capacity of the system. Volkswriter advertises that it can be used with a 64K PC. If you do that, you will run out of space quickly. You really need a 128K machine to do any effective word processing and Volkswriter should tell you that.



Select by Select Information Systems Inc. (919 Sir Frances Drake Blvd., Kentfield, CA 94904) at \$595 is a complete word-processing system that features a computer-aided instruction program called Teach. This instructional software is designed to instruct people with no experience with computers to become WP operators. It is an effective tool and it teaches the use of the Select system in about 90 minutes of instruction.

Select looks like the Editor that runs under the UCSD P-system although it is not written in that language. There are three different versions for the IBM-PC. It runs under PCDOS or CP/M-86 and there is also a version that runs under CP/M-80 when a Baby Blue or other Z80 board is installed.

It is menu-driven and has a full screen editor that allows the user to make changes anywhere that the cursor is positioned.

When composing a text document, it uses a full menu of editing commands such as insert, delete, and exchange, which are somewhat hard to learn without detailed instruction. Without the Teach program, the user who is not used to the UCSD P-system would have a hard time learning Select.

Before the text is composed using the Editor, the user can select the Format command which brings up a format screen. This permits the format to be selected so that the user can see the text exactly as it will be printed. Justification can be selected for on-screen viewing, or it can be selected after the text is composed and all of the corrections have been made.

As an aid in using the many commands, the system permits the user to program the keys on the IBM-PC to represent any command sequence. Thus either the Function keys or the keys on the keypad can be used for single-stroke operation.

The version we tested did not have this feature and we can see why it was added. It makes the system much more friendly. Two new features permit the user to split the screen and add a print spooler. Using these new features, the user can split the screen and watch new copy, existing text before printing, and old text coming off the printer.

**Conclusion.** The pricing of Select is somewhat misleading. You get much more than you realize because the Superspell and MailMerge programs are included in the price of \$595. This moves Select from the higher-priced systems to the medium-priced classification.

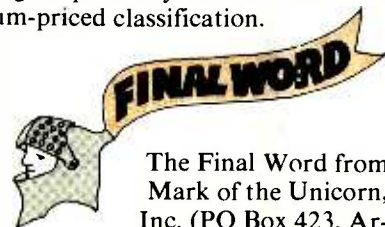

The Final Word from Mark of the Unicorn, Inc. (PO Box 423, Arlington, MA 02174) is one of the best packages around (especially for the \$300 list price). However, it is not, as its name would have us believe, the ultimate word processor

and it definitely is not for everyone. The casual user who wants to write simple letters or short reports will probably feel more comfortable with one of the simpler word processors available. However, someone who is willing to spend the time to become skilled in the use of The Final Word (TFW) will definitely have found a high-powered tool that is capable of handling even the most sophisticated word-processing requirements.

Any word processor should be evaluated in three basic functional areas: editing, word processing, and document processing. The editor facilities define how easy it is to get the information into the document. The word-processing facilities determine how easy it is to format and print simple documents such as letters and brief reports. The document processing facilities provide advanced capabilities to format and print more complicated documents such as technical reports, form letters, and manuscripts. In addition, any program written for the IBM-PC should be evaluated on how well it utilizes the unique capabilities of this system. TFW offers significant advantages in each of these areas.

**Use of IBM-PC.** The first time you sit down with the TFW manual and tutorials, you rapidly get a feeling of being buried under a mass of control keys. A command is made up of three components: a direction (forward/reverse), an action (move/delete...) and an object (character/word/paragraph...). Each of these components is represented by a control key. For example, "forward delete word" is represented by the sequence CTL-F, CTL-D, CTL-W. The structure is consistent and highly mnemonic, but intimidating. However, The Final Word has 157 predefined actions, such as "delete forward word" which can be mapped to single key strokes.

The system is distributed with a pre-defined mapping of keys to actions, but a utility is also provided that allows the user to customize his keyboard to the actions he uses

most frequently. All cursor movement keys, all 40 function keys, all alternate keys and all control keys can be turned into command keys. This is the most complete usage of the extended keyboard I have seen to date. An additional bonus is that the Help functions will remind you of how you have customized the keys.

**Editor Facilities.** Anyone who has become used to full-function full-screen editor capabilities used on large computers (such as EMACS or SPF) has felt something missing in personal computer editors. The Final Word, because of its multiple window and file buffer capability, comes very close to the large machine capabilities. Files are read into buffers (up to the capacity of the swap file) and 2 windows are provided to look at these buffers. You can easily insert pieces of previous documents into the document you are editing with this facility.

The Final Word utilizes standard PCDOS (MSDOS) files and does not insert any special characters into the files. This means that TFW can be used for editing programs as well as documents. Other files (such as spreadsheet print files) can be easily edited into your document. The file capabilities allow viewing the DOS directory; and reading, writing, renaming, and deleting DOS files without leaving the editor.

TFW provides a "state save" and virtual memory capability through the use of a special swap file. All buffer images are saved to this swap file so that changes are always protected in case of power failure or exit from the program. When you return to the program, you are taken back to the point at which you exited. If you want to clear the buffer and start fresh, a single command does it. Another nice feature is that the buffers are only written when you pause in your keying for 7 seconds. You will never be interrupted in your typing to wait for a buffer write. The virtual memory facility means that the size of the document you are editing is limited only by the size of the swap file, not by available memory.

Three forms of Help facilities are provided. Each group of functions

(Files/Buffers/Layout/...) has its own master menu to guide you through sequences of operations. Help "about" will give you a brief reminder about various commands (i.e. Help about buffers will show you all commands associated with buffers). These are not tutorial helps, but are generally sufficient. The Help "explain" function will tell you what command is associated with a particular key. This is particularly useful when you have customized your keyboard and forgotten what you did. All these functions can be invoked anywhere within the text and the descriptions are removed when editing continues. In addition, a series of tutorial lessons is provided both in the manual and on the disks to guide you through the various facilities. The documentation is good but inadequate in some areas. According to Mark of the Unicorn, the documentation has been significantly revised in Release 1.1 and should be available by the time you read this.

Global search and two forms of global replace are provided. Global search takes a string argument and will search to the first occurrence of the string. The AGAIN key can be used to search for subsequent occurrences. Search forward and reverse are both supported. Global replace will change all occurrences of the desired string in the document. Query replace will stop at each occurrence and prompt for permission to change before continuing.

The Regions Menu lets you set markers in the text, indent and outdent marked regions, and copy, delete and undelete marked regions. Deleted text is placed in the Kills buffer for recovery by Undelete. As long as you don't move the cursor, deleted text is appended to the Kills buffer. Once you move the cursor, the next delete will clear the buffer first, however you can specify Append to Kills to bypass this clear. Therefore, you can build up the Kills buffer by deleting from multiple areas in the text and then pop it back into another area of the document by using Undelete. Fill mode (word wrap) can be toggled on and off to allow editing of nondocument files such as programs and spreadsheet print files. Insert mode can



also be toggled to select between overwrite and insert modes.

The Buffers menu allows you to define, list, switch or delete buffers. The windows-controls split-screen mode allows you to move data between windows, and control window size. The Miscellaneous Menu provides various control functions. A line count facility is provided, but no word count.

**Word-Processing Functions.**

Word-processing mode is "what you see is what you get" formatting. Most quality word processors provide similar capabilities in this area. The Final Word provides the standard commands to center, justify, unjustify, line flush left/right, set/change case, highlight, tab, indent, outdent, etc. But, because of the structure of TFW and the fact that it does not imbed special format characters in the file, it has a few quirks. Perhaps the most noticeable of these is that tabs must be set at equal intervals (i.e. every 8 spaces). This is built into TFW and is not likely to change. Another quirk is the way that parameters such as line length and tab space are set. Either the cursor can be set to the desired position and the SET command invoked, or the value must be entered using the (ESC) key before the command is entered. Also, paragraphs in the document must be indicated by a blank line (or a tab, @, or . as the first character). Failure to do this can cause undesired results when using the fill, justify, or unjustify paragraph commands. Again, none of these is likely to change in the future.

Where The Final Word excels is in the breadth of its printer support. A configuration utility is provided to allow the user to specify 23 parameters describing the printer. Standard definitions are provided for TTY-like (no backspace), plain (with backspace); Epson (MX80 and 100 with and without the Grafrax option); Diablo (1610, 1620, 1640, 1650, 630 and equivalents) in 10, 12, or PS pitch; NEC (5510, 5520, 5515, 5525 and equivalents) for 10, 12 or PS; IDS 460 10

or 12 pitch (PS will be available in Rel. 1.1); Centronics 737 in 10 pitch or PS mode; and Radio Shack Daisy II 12, 15, or PS. Other printers will be supported in Release 1.1 by standard files. Two other standard definitions are provided. File; will place formatted output in a file suitable for use by another program (such as upload to a remote system) or to view final formatting with page breaks on the console. Console; builds a file that can be used for viewing draft formatting on the screen.

The Final Word also provides a capability to define the ports to be used. The standard configuration includes Printer Out for the parallel port and Serial In/Serial Out for direct control of the serial port. The default port can be set to any defined port (i.e. serial, if that is your standard output) or the Mode Command of DOS 1.1 can be used to direct output. A second serial port could be defined for systems requiring it. Also, special port requirements for nonstandard devices could be defined to the Final Word.

**Document Processing.** The Final Word really begins to show its capabilities in the document formatting facilities. Advanced formatting commands are indicated by an @ sign preceding the command. The STYLE command provides for overall formatting of the document. It is used to set white space, margins, indentation, justification, spacing between lines, paragraphs, headers, environments, etc.

An extremely powerful capability is provided by the SET, STRING, REF, VALUE, and CASE commands. SET and STRING allow values to be placed in counters or user-specified variables for later reference. The REF and VALUE commands allow these counters and variables to be included into the text at any point. The CASE command allows conditional inclusion of text within a document based on the value of a variable. Release 1.0 restricts the use of CASE to STRINGS, but Release 1.1 will add a STRING INPUT command to take the value from the console. SET and VALUE can be used to associate a page number with a figure and refer to that page in the text. Page

changes after reformatting would be automatically noted in the document.

Divisions of the document are provided by two sets of commands. CHAPTER, SECTION, SUBSECTION and PARAGRAPH provide a four-level numbered division. Chapter may be numbered or not depending on the STYLE parameters. UNNUMBERED, MAJOR HEADING, HEADING, and SUBHEADING provide a similar division for unnumbered divisions. APPENDIX provides for numbered appendices, while APPENDIX SECTION provides unnumbered appendices. All numbered divisions are included in the automatically generated Table of Contents.

NEW PAGE, BLANK PAGE, PAGE HEADING and PAGE FOOTING are self-explanatory. Headings and footings can have left, center, right, and second line components and can be specified on an even/odd basis. Conditional page breaks are not available in Release 1.0 but a NEED SPACE command should be available in Release 1.1. BLANK SPACE will reserve space in a document and may be specified in lines, inches, picas, or centimeters.

CENTER, FLUSH LEFT, and FLUSH RIGHT are self-explanatory. ADDRESS and CLOSING provide a flush-center capability for letters. DISPLAY, EXAMPLE, FORMAT, QUOTATION, TEXT, UNIDENT, VERBATIM, and VERSE provide various line formats with different options for indentation, justification, and fill. DESCRIPTION, ENUMERATE, ITEMIZE, and LEVEL handle lists with various indent and numbering options. BEGIN and END extend these commands to multiple lines of the document. For example, @BEGIN (center) . . .other lines. . . @END (center), would cause all lines between the BEGIN/END pair to be centered.

Commands are provided for Boldface, Italic, Boldface Italic, superscript text, and subscript text. Underlining can be specified for all characters or all characters except punctuation.

FOOT and NOTE provide several formats of footnotes. Footnotes can be inserted at end of page or end of text. The footnote indicator can appear as a superscript or within

## Deciding Which Computer to Buy

Of the 1.9 million people who bought small computers last year, over 20,000 of them bought the wrong computer for their needs. And no wonder. New products are introduced into the market at a breathtaking pace. The language question. The terminology problem -RAMs, ROMs, bits, bytes, bauds, protocols and processors. What's important? What's standard and what's optional? Even the dealers are confused.

To help you tackle this problem, we pulled together many of our sources -including leading experts in the field, manufacturers, marketing analysts, computer dealers and customers. In addition, we utilized computer user groups, clubs and associations throughout the United States, contacts in Japan and numerous industry and business publications. **COMPUTER GUIDE 1983** is the natural result of learning from the knowledge and mistakes of more than one million people.

The following steps will help you with your computer shopping -whether you're buying your first computer, or updating the one you have. **COMPUTER GUIDE 1983** can help you make the right decision.

### 1. What is the computer to be used for?

You may want to use it for entertainment, financial planning, learning how to speak a foreign language, office work, drawing and many other tasks a computer does well. The possible uses of a computer are as varied as human activities.

### 2. Which program will do the best job?

There are thousands of application programs on the market to consider. It is the program that gives you the power to control the actions of the computer. You must choose the right application program.

The first section of **COMPUTER GUIDE 1983** surveys each of the application programs available with computers today. Similar programs are grouped together and compared -one against another. **COMPUTER GUIDE 1983** contains over 2,000 application programs, grouped in over 100 categories -including programs for accounting, management, professional uses, word processing, graphics, research, games, learning and special applications. Programs are described using comparison charts -listing for each application program: the program name, computer(s) and system configuration(s) required, the documentation available and the price.

**COMPUTER GUIDE 1983** provides you with a quick and efficient way of deciding which application program and which computer and options for that computer can do the right job for you.

### 3. The language?

You cannot get a computer to do anything useful unless you know how to talk to it. This is no easy task. But, **COMPUTER GUIDE 1983** can help.

The second section of **COMPUTER GUIDE 1983** guides you in selecting the right language. Different dialects of languages are grouped in their generic category. The BASIC language, for example, is a generic name and has many dialects -including Microsoft Basic, Atari Basic, Basic Plus and Basic-80.

Each of these languages have their own machine requirements. **COMPUTER GUIDE 1983** provides the name, machine and machine requirements, documentation and price of over 500 dialects, for over 50 languages. **COMPUTER GUIDE 1983** helps you solve the language problem.

### 4. What about the machine?

Depending on your needs, there will probably be several computers still in the running. Now the decision is based on the guts of the machines (hardware). **COMPUTER GUIDE 1983** compares machine characteristics in an easy to follow format. You don't have to be an electrical engineer to make an intelligent decision.

The solution is to work top down and not to go any further down than is needed. Your uses for the computer determines which machine characteristics are important. **COMPUTER GUIDE 1983** divides the machine into five areas -the keyboard, video display, printer, other peripherals and I/O, processor and memory and direct access storage. These five areas correspond to your basic machine needs. For example, an accountant needs a keyboard with a numeric keypad; word processing requires a printer; games utilize a video display; a mathematician wants a very fast machine; lots of memory is best when using the LISP language; and so on, as the hardware combines with the application program to develop a complete computer system.

**COMPUTER GUIDE 1983** contains machine descriptions for over 250 computer systems, produced by over 150 manufacturers. Information is displayed in spreadsheets -allowing you to get the information you need. You don't have to bother with extraneous details and cumbersome text. **COMPUTER GUIDE 1983** can accommodate millions of people in making the right decision, as varied as those decisions will be.

### 5. Where to buy the chosen computer system.

**COMPUTER GUIDE 1983** lists hundreds of vendors, by geographical location, and by the products they sell. It also provides additional consumer information. The first ship date, the ship rate, the number installed to date, prices and what that includes, purchasing terms and warranties. **COMPUTER GUIDE 1983** contains the names, addresses and phone numbers of hundreds of manufacturers, dealers and stores throughout the United States.

No one wins when you buy the wrong computer or computer product. Make the right decision. Use **COMPUTER GUIDE 1983**.

Send me **COMPUTER GUIDE 1983**  
The complete computer buyer's guide.

*I'm enclosing my check for \$32.75 plus \$1.50 for shipping.*  
(Mass. residents add 5% sales tax.)

Mail to: **CESS**  
P.O. Box 345, MIT Branch P.O.  
Cambridge, MA 02139  
(617) 491-8925

Name \_\_\_\_\_  
Address \_\_\_\_\_  
City, State and Zip \_\_\_\_\_

Please allow six to eight weeks for delivery.

COMPUTER GUIDE and CESS are trademarks of Computer & Electronic Supply Services, P.O. Box 345, MIT Branch P.O., Cambridge, MA 02139.



brackets in the text. INDEX can be used to insert a page reference into the automatically generated index under a particular topic.

MESSAGE will print a message on the console, while INCLUDE (CON:) will accept text from the keyboard for inclusion in the document. This facility is limited to direct insertion of text. Release 1.1 will add the STRING INPUT command to allow insertion of text into variables. INCLUDE can also be used to include text from other files, such as spreadsheet print files.

This is a rather extensive list of facilities and it has not been possible to include complete descriptions of each command. The versatility of the Advanced Formatting facility should be obvious. The only major facility I have not found is the partial fetch/insert facility to allow moving columns as units. Two other minor problems: the Advanced Formatting features can only be used on a system with more than 160K of disk capacity, and the Advanced Formatting is not done on screen. However, the formatter can be run with the FILE option to obtain screen readable formatted text.

**Documentation.** It seems strange to call 286 pages of documentation inadequate, but it is. Many of the customization facilities are insufficiently explained, as are many of the Advanced Formatting commands. Some facilities and commands are totally undocumented. The tutorials are good, but again don't really show the capabilities of the system. However, Mark of the Unicorn states that Release 1.1 includes a major update of the documentation. From what they say, it seems that this situation will be fixed by the updates.

**Service.** Release 1.0 had a number of problems, especially related to recovering files after filling up the swap file. These problems are supposed to be fixed in Release 1.1. Mark of the Unicorn does supply phone support for The Final Word. While working my way through the documentation and "mark in wrong

buffer" problems, I found them to be very helpful, responsive and courteous. Their attitude gives me confidence that the fixes and updates they say will be in Release 1.1 will actually be there.

**Conclusion.** The Final Word is definitely a word processor that grows on you. The more I become familiar with it, the more I like it. The failings have been minor and, except for the column move facility, I haven't found anything I wanted to do that I couldn't. Its utilization of the IBM-PC keyboard is out-

standing. The customization facilities make it unlikely that I will find a printer or port combination that it will not support. The speed is not blinding, but it is more than acceptable. It is going to be around for a time and growing in capability.

But let me repeat, this is not the word processor for everyone. It takes some time to learn and be comfortable with it. The casual user will be more comfortable with other word processors. However, for someone who needs the advanced facilities of The Final Word, it is worth the time and effort to learn.

## Summing Up

We did not find any of the software discussed here that did not work well. We would be happy using any of the systems we tested, some more than others. With respect to WordStar which we have used for many years, we looked at how well it has been adapted to this new environment.

The decision to buy any of these systems comes down to the question of features offered vs. price. Bear in mind that your requirements of today may not be the same as your requirements tomorrow. The longer you use your computer, the more applications you will find for it. There is yet no market to trade-in used software, so do not buy the bare minimum.

Many of the word-processing systems being offered for the IBM-PC have been originally designed for other computers and they have been reconfigured for this new computer. This is a two-edged sword. It ensures that the software has been thoroughly tested and that it does what it is supposed to do. The other side is that some of the systems have been grafted on to the PC DOS operating system and the IBM-PC and the fit is none too good. The first releases of WordStar and Easywriter for the IBM-PC left a lot to be desired. This has largely been corrected but it will require several revisions until all the annoying things are removed.

The packages that were written from scratch for the IBM-PC use all of the features of the keyboard and

offer many utilities to extend the capabilities of the system.

Some of the word-processing systems use the UCSD P-system editor as a base for the word processor. Some of them have been designed to look like the UCSD P-system editor.

In any event this is an excellent editor and it runs well on the computer. Its only defect is that it is a little hard to learn. This is where the instructional programs come in. Without them, quite a few of the word processors being offered for the IBM-PC would fail from over-complexity. The user should have the teaching programs shown to him as well as a demo of the actual word processor.

There is a wide difference in price between word-processing packages and it is somewhat hard to find out just what you are getting for the price. Power Text includes a powerful format file capability which you may not need. Select which costs \$595 includes a spelling checker and a merge program which are included at extra cost by WordStar. Naturally, the less expensive programs include less features. You must make a decision as to whether these "bells and whistles" are worth their cost to you.

No matter what your selection is, you can take comfort from the fact that you are getting word-processing power that previously only existed on dedicated machines costing twice the price (and they did not compute!).

The does-everything phone that fits in your pocket!

# The Maxcall Cordless Phone has a 1000-foot range, a built in speaker phone, a nine-call memory, an intercom, and incredible audio quality.

By now everyone has seen the cordless phone. What you haven't seen is one that thinks it has a cord. The MAXCALL delivers high-quality sound that defies the listener to believe he's hearing your voice over a cordless phone. One reason is the engineering, which delivers audio frequencies from 200 to 3000 Hz. Another is the power, which enables the MAXCALL to operate efficiently up to 1000 feet from the base station 300 to 400 feet farther than most cordless phones.

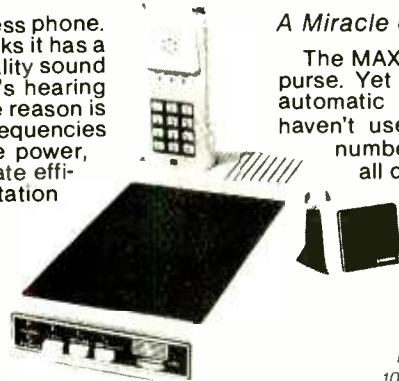

## True Hands-Free Conversation

The base station is a speaker-phone that's a pleasant surprise if you've been using one of those hollow-sounding units. It picks up the voices of a roomful of people; a fine-quality speaker brings you the voice on the other end. The base station also is a perfect platform for your existing phone. It has the paging button that doubles as a full-conversation intercom.

Base unit holds your regular phone and doubles as a hands-free speaker-phone.



## A Miracle of Precision Engineering

The MAXCALL is thin enough to fit into your pocket or purse. Yet its sound rivals any conventional telephone. For automatic redialing just push the "★" key. Even if you haven't used the phone for weeks, it remembers the last number you dialed. Use your MAXCALL all day. Its nickel cadmium rechargeable batteries have the strength of Hercules. Overnight, in its slot on the base unit, it recharges to full power.

MAXCALL is so thin it fits in your pocket, but it has an incredible 1000-foot range.



## A Nine-Number Memory!

As befits the ultimate state-of-the-art cordless phone, the MAXCALL "remembers" any nine phone numbers. In seconds, you can enter a number into its memory. Then, pushing just two buttons will dial that number, even if it's outside your own area code. Change memorized numbers whenever you like. We even supply an attached card to enable you to see which numbers are in memory.

On this card you can list 9 numbers, stored in the unit memory bank.



## Cordless Phone Antenna System

This specially designed system increases the operational range of all cordless telephones 10 to 20 times. The Antenna System is composed of an Omni directional 49 MHz transponder receiving antenna and a 1.7 MHz 60-foot transponder long wire transmitting antenna. Installation is quick and easy to all cordless phones utilizing 49 MHz band.

Enjoy increased freedom of movement with this long cordless telephone antenna system. Only \$79.95 (Shpg. \$4.50)



## More, More, More!

You have a "secure" option on your MAXCALL. Kids can't play with it, because when you push a button, the portable phone becomes inoperative until you release it. Your MAXCALL can take plenty of abuse. Every component is designed to stand up against the shaking and pounding it can get in your shirt pocket or briefcase. The outer case is a high-impact material that won't show wear (color is attractive ivory). MAXCALL is incredibly thin - 3/8". It weighs only 10 1/2 oz. Even a year ago, no one could pack so much engineering and sound fidelity into a phone this compact. Now you can be among the first to own it.



**\$199.95 complete**

"Call" button activates intercom on every phone on the line. "Secure" button makes portable phone inoperative.

For \$199.95 you'll own the most advanced cordless phone on the market, with 1000-foot range, speaker-phone, a nine number memory, a "secure" button, and

sound fidelity rivalling any conventional phone. No matter what kind of phone you've been using, you can't imagine the convenience of MAXCALL until you own one.

Multi-line adaptor for business phone \$39.95. (Shpg. \$1.75)

**We Absolutely Guarantee!** Use the MAXCALL (or any electronic instrument acquired from us) for up to 30 days. If you decide for any reason that you don't want to keep it, return it for a full 100% refund.

For immediate service on credit card orders, call toll-free 24 hours a day, seven days a week:

**800-824-7888**

Ask for operator NO. 551  
In Cal. Call 1-800-852-7777

**NEW HORIZONS**

## PHONE OR USE THIS COUPON

**NEW HORIZONS** 1 Penn Plaza Suite 100 New York, NY 10119

Please ship at once, with 30-day money-back guarantee, a complete MAXCALL portable telephone including base unit with built-in speaker-phone and nine number memory capacity

CE1

- MAXCALL \$199.95 & \$3.75 shpg., total \$203.70
- CORDLESS ANTENNA SYSTEM \$79.95 & \$4.50 shpg., total \$84.45
- MULTI-LINE ADAPTOR \$39.95 & \$1.75 shpg., total \$41.70
- LONG RANGE PHONE \$399.95 & \$4.50 shpg., total \$404.45

### Indicate payment method:

Check enclosed

VISA MasterCard card no \_\_\_\_\_ exp. date \_\_\_\_\_

Name \_\_\_\_\_

Address \_\_\_\_\_

City \_\_\_\_\_ State \_\_\_\_\_ Zip \_\_\_\_\_

CIRCLE NO. 27 ON FREE INFORMATION CARD





# Build The Intelligent Thermometer

## Part 1

*A microprocessor and a programmed EPROM are used in this sophisticated circuit to measure and analyze changes in temperature*

*By Tom Fox*

**M**OST people associate the word "microprocessor" with computers. However, there are many sophisticated devices besides computers that use microprocessors. One such device is the Intelligent Thermometer described here. It is called "intelligent" because the particular program in its

memory allows many uses besides simple temperature measurements.

For instance, the Intelligent Thermometer analyzes the temperature data and stores the results in its semi-permanent memory. It measures temperatures between  $-56^{\circ}\text{F}$  and  $+199^{\circ}\text{F}$  ( $-49^{\circ}\text{C}$  and  $93^{\circ}\text{C}$ ) and does it with an accuracy better than  $\pm 1^{\circ}\text{F}$  over its entire range. It stores the minimum and maximum temperatures, and calculates and stores the mean temperature up to a 255-day interval with an accuracy better than that of the U.S. Weather Service. The Intelligent Thermometer also calculates and stores heating degree-days (base  $65^{\circ}\text{F}$ ), cooling degree-days (base  $75^{\circ}\text{F}$ ) and growing degree-days (base  $42^{\circ}\text{F}$ ). Up to 9999 degree-days can be stored in each of its degree-day registers.

The analyzing portion of the thermometer has three outputs that can be used to activate a relay or buzzer. The first signals a temperature of  $32^{\circ}\text{F}$  or below, while the other two signals indicate a tempera-

ture either above or below a preset threshold of the user's choice.

The temperatures and degree-days can be displayed in either Fahrenheit or Celsius depending on the setting of a switch. (Celsius degree-days are rounded off to the nearest 100.) An optional battery allows memory retention during power failures.

The versatility of the thermometer is further enlarged by the user's ability to erase and re-program the EPROM—or plug a new EPROM into the socket. For instance, the thermometer could be transformed into an energy-saving digital thermostat by changing the EPROM and adding two relays.

**About the Circuit.** A block diagram of the thermometer is shown in Fig. 1. Its memory map is given in Fig. 2. The 6802 CPU is basically the same as a 6800 with the added features of an internal clock oscillator and driver, plus 128 bytes of RAM. The first 32 bytes of RAM can be retained in the low-power

## ...THERMOMETER

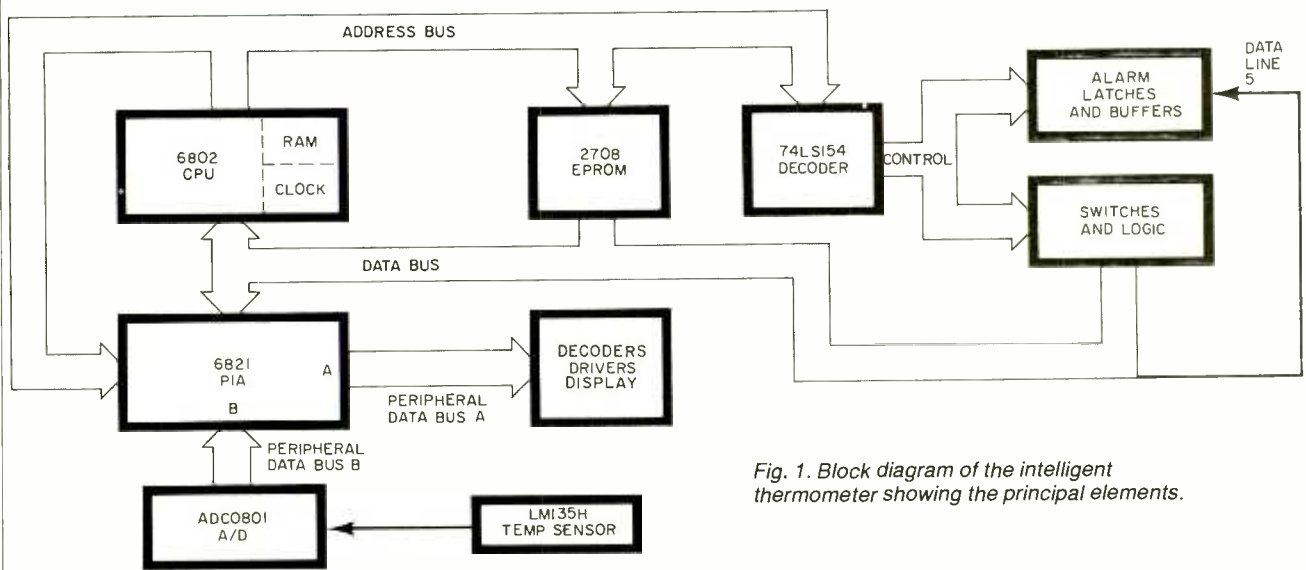

Fig. 1. Block diagram of the intelligent thermometer showing the principal elements.

mode, thus allowing memory retention in the event of power failure.

The entire program is stored within EPROM *IC12* and uses approximately 850 bytes of the 1024-byte capability.

The temperature is sensed by *D9*, a precision temperature sensor having a nearly linear response and a low dynamic impedance that allows remote sensing. The voltage reference is *D8*. The amplified (via *IC11*) temperature signal is applied to *IC9*, an A/D converter that converts the data into one byte of digital information. Each bit of the A/D converter is equivalent to 1°F. Byte 00000000 equals -56°F while byte 11111111 equals 199°F.

Side A of peripheral interface adapter *IC7* is programmed as the output with its data bus connected to *IC28* and *IC29*, a pair of 7-segment decoder/drivers. Side B is programmed as the input and is connected to the *IC9* (A/D converter) data bus.

Four-line to 16-line decoder *IC21* provides address decoding for the switches and output latches.

As shown in Fig. 3A the CPU, *IC8*, has its *reset* (pin 40) connected both to its own *read enable* (pin 36) and *IC7's reset* (pin 34). When the 6802's *reset* is brought high after being low for at least 20 ms, the CPU reset sequence starts. The 6802 first checks what 2-byte ad-

dress is stored at locations FFFE and FFFF (each location contains 1 byte of the address) and then goes to this address which is the start of the program.

The circuit consisting of *IC6A*, *IC5A*, and associated components has a twofold purpose—it resets *IC7* and *IC8* during power-up, and provides a *read enable* (RE) signal for the CPU. The RE signal is arranged so that it goes low before  $V_{cc}$  drops below 4.75 V. This is necessary to keep erroneous information

from being stored during a power failure. Pin 3 of *IC6A* monitor's the  $V_{cc}$  supply (+5 V). Potentiometer *R9* is set so that the voltage at pin 3 is slightly below that at pin 2, which monitors the rectified and partly filtered voltage produced by *D5*, *C14*, and *R14*. This circuit responds quickly to any power-down, or brown-out condition. When the power-line voltage starts to drop, the voltage at pin 2 drops below that at pin 3 and the *IC6A* output jumps to near 5 V. Schmitt trigger, *IC5A*, senses that *IC6A's* output is starting to rise and produces a low output when this voltage exceeds about 3 V. Thus RE drops low several microseconds after  $V_{cc}$  drops more than about 2%—in time to ensure that the contents of the RAM are unchanged.

As mentioned earlier, this circuit also provides the "power-up" reset signal for the CPU and peripheral interface adapter (PIA). When the line voltage rises rapidly (for instance, when first turned on), *C5* instantly raises the voltage at pin 3 of *IC6A*. Pin 3's potential is now above that at pin 2, and the reset pin's potential is brought low. The voltage at pin 3 declines exponentially to a steady-state or "normal" voltage about a half second after power-up. When the voltage at *IC6A* pin 3 falls below that at pin 2, the reset pin jumps high and starts

RAM IN 6802 RETAINABLE IN LOW- POWER STANDBY MODE	0000-001F
RAM IN 6802	0020-007F
NOT USED	0080-7FFF
PIA	8000-8003
DIS 4 (-I)	8004
NOT USED	8005-87FF
SWITCHES	8800-880D
OUTPUTS	880E, 880F
NOT USED	8810-FBFF
INTELLIGENT THERMOMETER'S EPROM PROGRAM	FC00-FFFF

Fig. 2. Memory map of the system.



the CPU. The RE pin is also brought high at this time.

In Fig. 3B, IC15A and IC13 provide address decoding for EPROM IC12. Side A of IC7 is connected to the inputs of IC28 and IC29, which are the 7-segment decoders/drivers located on the display board (Fig. 4). These ICs drive two LED displays. The overflow display (DIS 4) is driven by transistors Q1 and Q2, which are controlled by IC18, a 4-bit latch. IC14, IC15B, and IC16 provide address decoding that responds to address 8004. Data lines D6 and D7 provide information on which display segments (if any) the latches turn on.

The output of IC9 is connected to IC7's peripheral data bus on side B. The ADC0801 (IC9) 8-bit A/D converter has a total adjusted error of less than  $\pm 1/4$  LSB ( $\pm 1/4^\circ\text{F}$ ). The LM135H precision temperature sensor, D9, behaves as a low-power zener diode with a breakdown voltage proportional to absolute temperature at  $+10 \text{ mV}/^\circ\text{K}$ . Thus at  $77^\circ\text{F}$  ( $25^\circ\text{C}$  or  $298.15^\circ\text{K}$ ) the LM135H theoretically breaks down at 2.9815 V. The LM135H operates over a  $-55^\circ\text{C}$  to  $+150^\circ\text{C}$  temperature range ( $-67^\circ\text{F}$  to  $+302^\circ\text{F}$ ), and its extremely low dynamic impedance (less than 1 ohm) allows it to be used at remote locations. This sensor is almost perfectly linear ( $\pm 0.3^\circ\text{C}$ ) over its entire range, which makes it simple to use with A/Ds, and it doesn't require a special linearizing program.

The LM336 2.5-V reference diode, D8, provides an unusually stable reference voltage for IC9 as well as for the calibration circuit. Although the LM336 is an integrated circuit, it acts as a low-power zener diode with an exceptionally small temperature coefficient. Diodes D3 and D4 and resistor R28 trim D8 for a minimum temperature coefficient of 1.8 mV over a  $0^\circ\text{C}$  to  $70^\circ\text{C}$  temperature range.

A calibration circuit (IC11A, IC11B and associated components) manipulates D9's output voltage so that the thermometer is able to measure the full range of

(Continued on page 80)

## PARTS LIST

(For Fig. 3. See pages 77, 78, 79)

- B1—NiCd battery, 4.75-5.25 V (optional, see text)
- C1—0.1- $\mu\text{F}$ , 50-V capacitor
- C4,C5,C10,C16,C17,C18,C19,C20—0.1- $\mu\text{F}$ , 25-V capacitor
- C2,C3,C9,C13,C22 through C30—0.01- $\mu\text{F}$ , 25-V capacitor
- C6,C11,C12,C15,C21—10- $\mu\text{F}$ , 25-V tantalum capacitor
- C7,C31—27-pF capacitor
- C8—330-pF capacitor
- C14—0.68- $\mu\text{F}$ , 25-V tantalum capacitor
- D1,D5—1N4001 silicon diode (or similar)
- D2—1N5232B 5.6-V, 500-mW zener diode (or similar)
- D3,D4,D6,D7—1N914 silicon diode (or similar)
- D8—LM336 2.5-V reference diode
- D9—LM135H precision temperature sensor (see note)
- DIS1,DIS2,DIS3—7-segment common-anode LED display (MAN 72 or similar)
- DIS4—Overflow common-anode LED display (MAN 73 or similar)
- IC1—4020 14-stage binary ripple counter
- IC2—4584 hex Schmitt trigger inverter
- IC3—4082 dual 4-input AND
- IC4—555 timer
- IC5—74LS13 dual 4-input NAND Schmitt trigger
- IC6,IC11—LM324N low-power quad op amp
- IC7—6821 peripheral interface adapter
- IC8—6802 microprocessor
- IC9—ADC0801 8-bit A/D converter
- IC10—74LS541 tristate octal buffer
- IC12—2708 1K-byte EPROM (see note)
- IC13—74LS30 8-input NAND
- IC14,IC22,IC23,IC24—74LS02 quad 2-input NOR
- IC15,IC16—74LS21 dual 4-input AND
- IC17—74LS00 quad 2-input NAND
- IC18,IC19—74LS75 4-bit latch
- IC20—7407 hex buffer
- IC21—74LS154 decoder
- IC25—7404 hex inverter
- IC26,IC27—7405 hex inverter
- IC28,IC29—7447 decoder/driver
- Q1,Q2—2N2222 npn transistor (or similar)
- R1,R2,R8,R21,R22,R23,R24—100-kilohm,  $1/4$ -W, 5% film resistor
- R3,R4—470-kilohm,  $1/4$ -W, 5% film resistor
- R5,R6—1-megohm,  $1/4$ -W, 5% film resistor
- R7—(see text)
- R9—500-kilohm, pc trimmer potentiometer
- R10—2.2-kilohm,  $1/4$ -W resistor (see text)
- R11,R12,R18,R32,R33,R67,R68—1-kilohm,  $1/4$ -W, 5% film resistor
- R13—470-ohm,  $1/2$ -W resistor (see text)
- R14—47-kilohm,  $1/4$ -W resistor
- R15,R16,R17—3.3-kilohm,  $1/4$ -W resistor
- R19—10-kilohm,  $1/4$ -W, 5% film resistor
- R20—15-kilohm,  $1/4$ -W, 5% film resistor
- R25—1120-ohm,  $1/4$ -W, 1% precision resistor
- R26—2.5-kilohm, pc trimmer potentiometer
- R27—20-kilohm,  $1/4$ -W, 1% precision resistor
- R28—10-kilohm, pc trimmer potentiometer
- R29—1.5-kilohm,  $1/4$ -W, 5% film resistor
- R30—10-kilohm,  $1/4$ -W, 1% precision resistor
- R31—25.16-kilohm,  $1/4$ -W, 1% precision resistor (see note)
- R34 through R45—2.2-kilohm,  $1/4$ -W resistor (optional, see text)
- R46,R47,R48—100-ohm,  $1/4$ -W resistor
- R49 through R62—220-ohm,  $1/4$ -W resistor
- R63,R64,R65,R66—270-ohm,  $1/4$ -W resistor
- S1 through S9—Spst momentary-contact pushbutton switch
- S10—Dpdt slide switch
- S11—Spst slide switch
- XTAL—4.0-MHz crystal
- Misc.—IC sockets, power supply (see text), circuit boards, 2-conductor cable, case, hardware, wire, solder, etc.

**Note: The following are available from Magicland, 4380 S. Gordon, Fremont, MI 49412: complete kit of parts including pc boards, all ICs, and sensor but not case, power supply, battery or cable for \$179.00, postpaid. Also available separately: 2708 EPROM (programmed) for \$25.00; ADC0801 for \$16.50; LM135H for \$9.50; 1% precision resistors for \$1.75 each; LM324N for \$1.25. On orders less than \$5.00, add \$1.00 for handling. Outside U.S., Canada, and Mexico, add \$5.00 for shipping. Michigan residents, add 4% tax. The following are available from Danocinths Inc., P.O. Box 261, Westland, MI 48185: microprocessor pc board (#RW403) for \$64.00; display pc board (#RW403D) for \$10.85; both pc boards for \$70.00; postpaid. Michigan residents, add 4% tax. The listings for programming the EPROM can be obtained free by sending a stamped, self-addressed envelope to Magicland, at the address above.**

...THERMOMETER

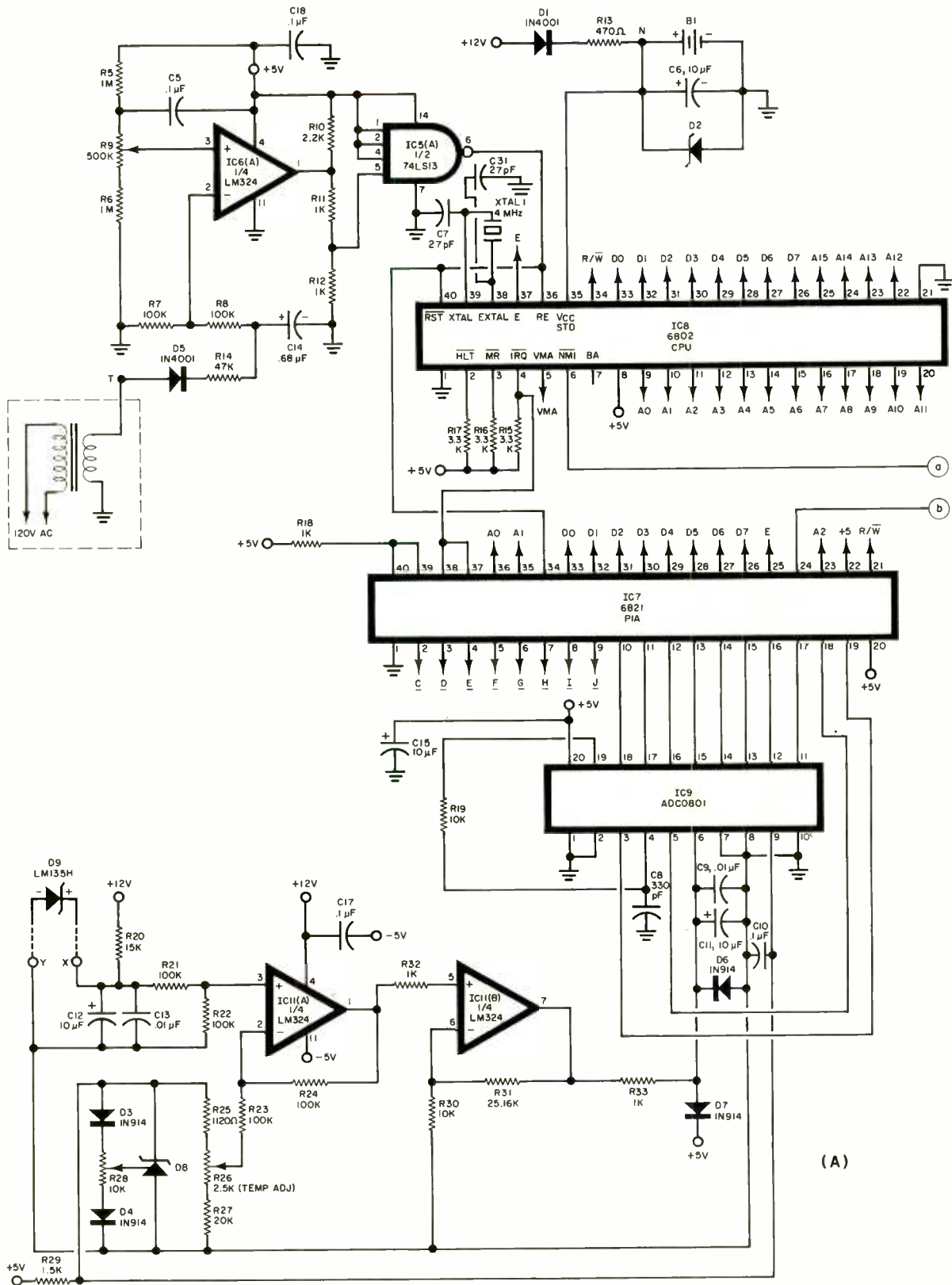

Fig. 3A. Microprocessor and PIA portions of the circuit.



... THERMOMETER

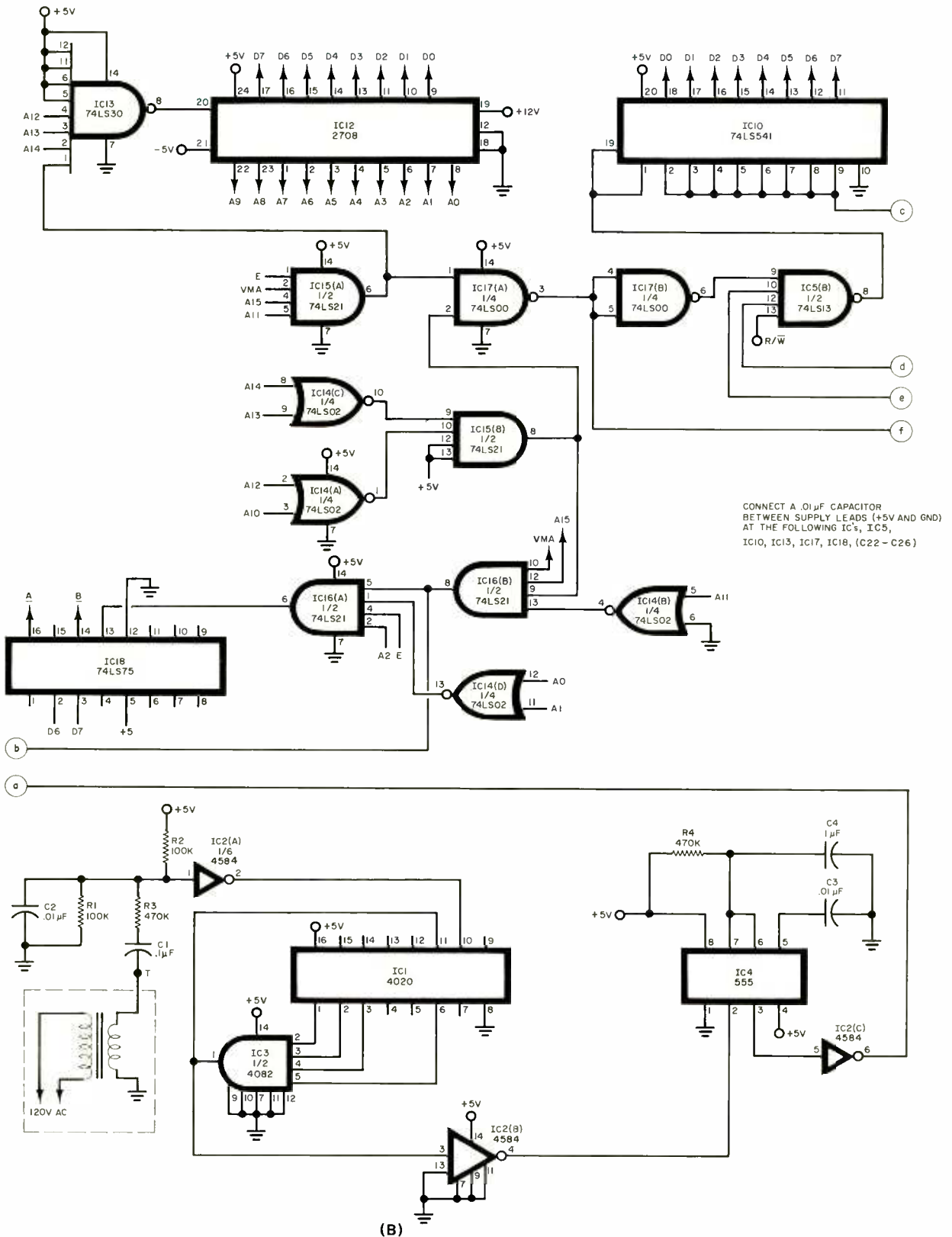

Fig. 3B. EPROM and logic circuits.

...THERMOMETER

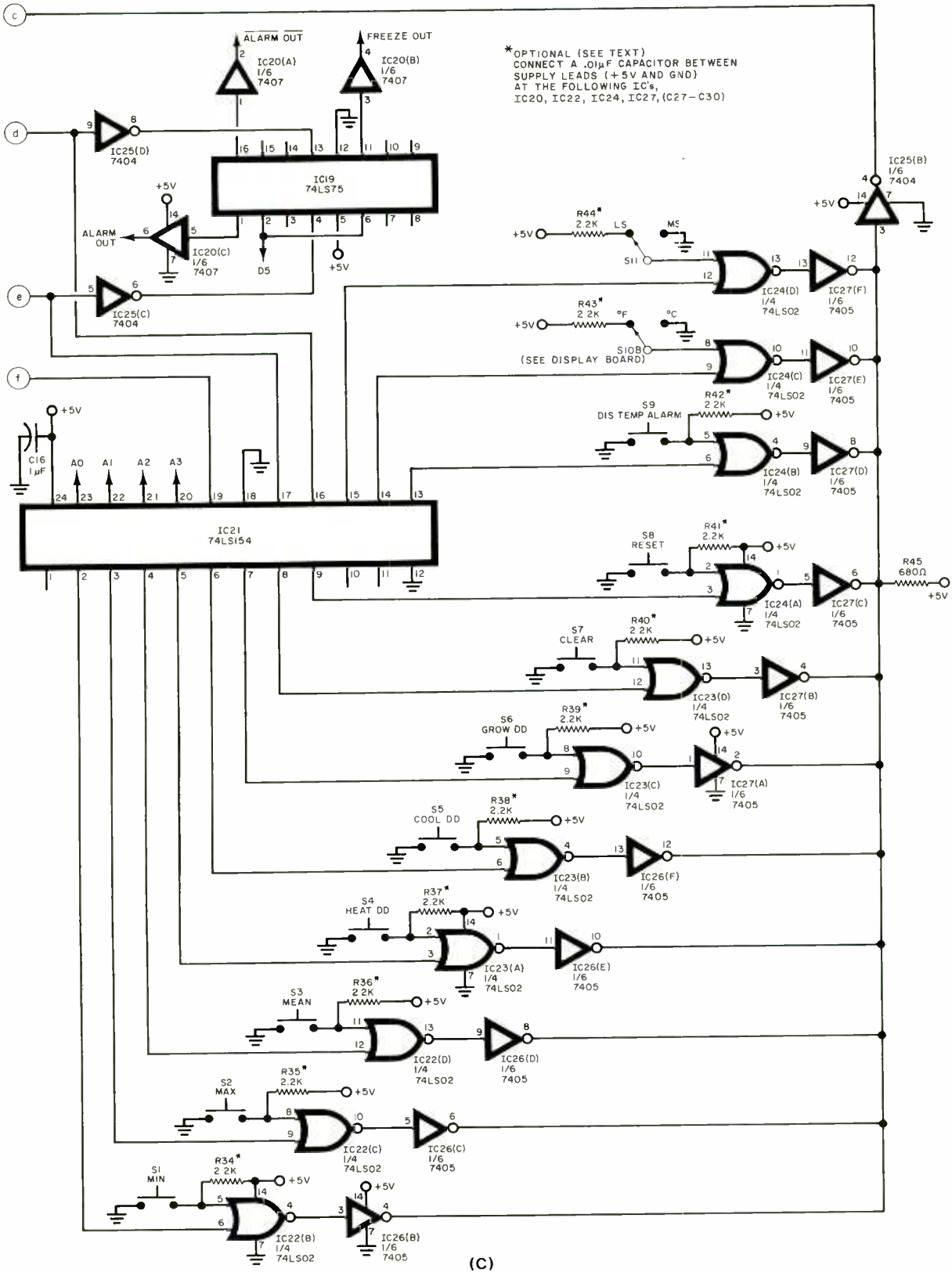

Fig. 3C. Indicating and output circuits.



## ...THERMOMETER

temperatures between  $-56^{\circ}\text{F}$  and  $+199^{\circ}\text{F}$ .

The temperature-adjust control, *R26*, in this circuit provides the means for calibration. Theoretically, *R26* is set for a center-arm voltage of 2.2426 V. However, if you use only a digital voltmeter to adjust the circuit, you can have an error as great as  $3^{\circ}\text{C}$  (although  $1^{\circ}\text{C}$  would be typical). A better way to calibrate the thermometer is to put the probe in a mixture of ice and water so the display shows  $32^{\circ}\text{F}$ . This calibration procedure results in an accuracy of better than  $1^{\circ}\text{F}$  over the instrument's entire range.

When *R26* is set correctly, the output of *IC11A* (pin 1) is 0 volts when *D9* is at  $-56^{\circ}\text{F}$  and 1.4167 V when *D9* is at  $199^{\circ}\text{F}$ . (*IC11A* subtracts *R26*'s center-arm voltage from *D9*'s output voltage.) At a temperature of  $77^{\circ}\text{F}$ , *D9*'s output is 2.9815 V. The output at *IC11A* is  $2.9815 - 2.2426 = 0.7389$  V. *IC11B* and its associated circuitry multiply this voltage by 3.516 which results in an output voltage of 2.598 V. Since the A/D interprets every .0195 V as one *least significant bit* (LSB), an input of 2.598 V gives an output of 10000101 (133 in decimal

notation). Note that  $133 - 56 = 77$ , which just happens to be the temperature!

The byte of information from the A/D (*IC9*) then goes to the PIA (*IC7*). The PIA, under CPU control, tells the A/D when to start its conversion and the A/D lets it know (via its INTR output at pin 5) that it has completed its conversion.

In Fig. 3B, *IC14A*, *IC14C*, *IC15*, and *IC17A* provide decoding for *IC21*'s enable input. This IC (Fig. 3C) provides address decoding for all switches and *IC19* (which controls the outputs). *IC21* is enabled when the CPU puts addresses 8800 to 880F on the address bus. (Not all of these addresses are used, which allows for easy expansion by the reader.)

As an example of how the CPU "knows" which switch is closed at any time, let's look at the MINIMUM switch (*S1* in Fig. 3C). When address 8801 goes out on the address bus (which happens when the CPU is testing the MINIMUM switch), *IC21*'s pin 2 drops low. If the MINIMUM switch is also closed, *IC22B*'s output goes high and *IC26B*'s output drops low. When any outputs of *IC26* drop low, the input to *IC25B* also drops low causing all inputs to the three-state octal buffer *IC10* to go high. If there is a read operation

taking place and addresses 880E and 880F are not on the address bus, all the CPU's data lines will go high. Thus the CPU realizes that the MINIMUM switch was closed and proceeds according to the instruction in *IC12*, which tells it to display the contents stored in the MINIMUM memory register. The other switches perform similarly.

When the CPU calls up addresses 880E or 880F, *IC19* is enabled. This IC, along with the open-collector high-voltage buffer, *IC20*, provides the FREEZE, ALARM and ALARM outputs. For an example of how this circuit works, consider the FREEZE output. When the CPU places address 880F on the address bus and its data line 5 is high (this only occurs when the CPU has detected a temperature of  $32^{\circ}\text{F}$  or below), *IC19*'s latch 3 is set. This causes the  $\bar{Q}$  output of latch 3 (pin 11) to go low. Buffer *IC20B*'s output (FREEZE) drops low allowing it to sink current.

The MEAN routine (which has a starting address of FD80) calculates the mean or average temperature by using temperature data taken every four minutes. To do this, the circuit must have a built-in accurate clock. The 60-Hz ac supply is used as a time base. Along with associated components, the CMOS

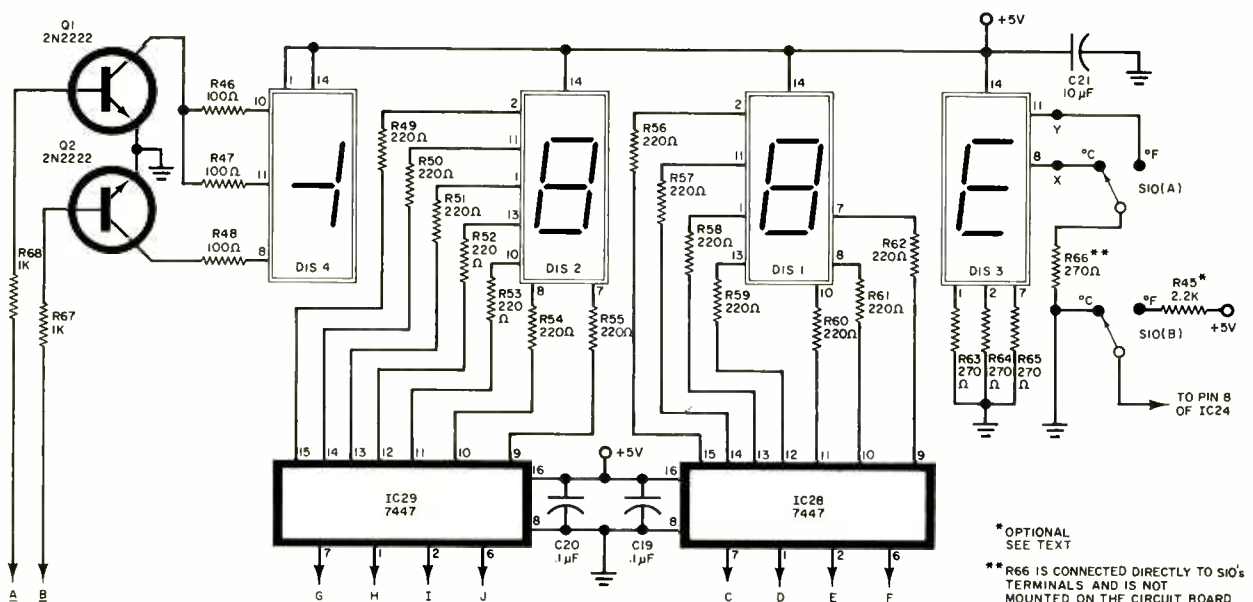

Fig. 4. Schematic of the display circuit.

Schmitt-trigger inverter, *IC2A*, shapes the 60-Hz sine wave into a CMOS compatible signal. These 60-pulses-per-second then go to the clock input of *IC1*, a 14-stage binary ripple counter. Then *IC1*, along with *IC3A*, forms a divide by 14,400 circuit, which results in one pulse every four minutes at its pin 1 output. This short pulse is inverted by *IC2B* and lengthened by *IC4*.

After leaving *IC4*, the pulse is about 50 ms long and is again inverted by *IC2C* before it is applied to the non-maskable interrupt (NMI) input of the CPU (pin 6). When this pin goes from high to low, the CPU completes its present instruction and then jumps to a new set of instructions which tell it to find the present temperature and then calculate the mean temperature and degree-days.

This article will be continued next month with instructions for construction, calibration and applications. ♦



PACKWELL

# Diskettes For Less!

**MEMOREX**  
AS LOW AS  
**\$2<sup>10</sup>**

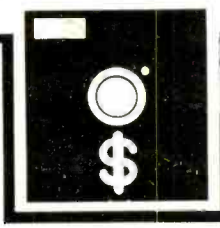

**MAXELL**  
AS LOW AS  
**\$2<sup>74</sup>**

part #	100 Quantity Price per Disk
<b>8" DISKS</b>	
SSDD IBM Compatible (128 B/S, 26 Sectors)	3062 \$2.10
SSDD Shugart Compatible, 32 Hard Sector	3015 2.10
SSDD IBM Compatible (128 B/S, 26 Sectors)	3090 2.75
DSDD Soft Sector (Unformatted)	3102 3.35
DSDD Soft Sector (128 B/S, 26 Sectors)	3115 3.40
DSDD Soft Sector (256 B/S, 26 Sectors)	3103 3.40
DSDD Soft Sector (512 B/S, 15 Sectors)	3114 3.40
DSDD Soft Sector (1024 B/S, 8 Sectors)	3104 3.40
<b>5 1/4" MINI DISKS</b>	
SSDD Soft Sector w/Hub Ring	3481 2.35
SSDD 10 Hard Sector w/Hub Ring	3483 2.35
SSDD 15 Hard Sector w/Hub Ring	3485 2.35
DSDD Soft Sector w/Hub Ring	3491 3.10
DSDD 10 Hard Sector w/Hub Ring	3493 3.10
DSDD 16 Hard Sector w/Hub Ring	3495 3.10
SSDD Soft Sector w/Hub Ring (96TPI)	3504 3.00
DSDD Soft Sector w/Hub Ring (96TPI)	3501 4.00

MODEL No.	100 Quantity Price per Disk
<b>8" DISKS (Single and Double Density)</b>	
<b>Single Sided</b>	
FDI-128M-1100	\$3.56
FDI-128M-1200	
FHI-32M-1200	
<b>Double Sided</b>	
FD2-X-DM-1100	\$4.37
FD2-X-DM-1200	
FH2-32-DM-1200	
<b>5 1/4" MINI DISKS (Single and Double Density)</b>	
<b>Single Sided</b>	
MD1-M	\$2.74
MH1-10M	
MH1-16M	
<b>Double Sided</b>	
MD2-DM	\$3.87
MH2-10DM	
MH2-16DM	
<b>Quadensity</b>	
MD1-DDM (96TPI)	\$3.56
MD2-DDM (96TPI)	\$4.37

Quantities less than 100 units available at 10% surcharge, prepaid or C.O.D. Minimum order \$50.00.

**MAGTEK MEDIA DATA SUPPLIES LTD.**

5916 Eighteenth Avenue  
Brooklyn, N.Y. 11204

ORDER TOLL FREE: 1-800-221-0869

MasterCard and Visa Accepted.

In New York (212) 232-7166

CIRCLE NO. 37 ON FREE INFORMATION CARD

**FREE**

## McIntosh STEREO CATALOG and FM DIRECTORY

Get all the newest and latest information on the new McIntosh stereo equipment in the McIntosh catalog. In addition you will receive an FM station directory that covers all of North America.

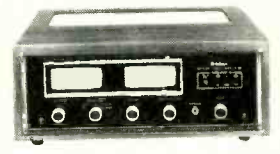
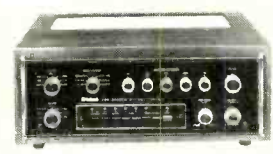
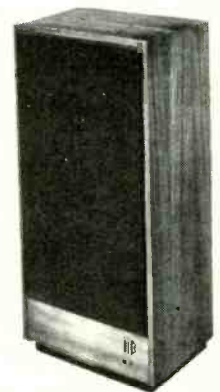

**SEND TODAY!**

McIntosh Laboratory Inc. CE  
East Side Station P.O. Box 96  
Binghamton, N.Y. 13904-0096

NAME \_\_\_\_\_  
ADDRESS \_\_\_\_\_  
CITY \_\_\_\_\_ STATE \_\_\_\_\_ ZIP \_\_\_\_\_

If you are in a hurry for your catalog please send the coupon to McIntosh. For non rush service send the Reader Service Card to the magazine.

CIRCLE NO. 31 ON FREE INFORMATION CARD



# SOLID-STATE DEVELOPMENTS



## Keeping Up With the New Microprocessors

By Forrest M. Mims

**I**N THE mid-1970's when only a few microprocessors were available, comparing the instruction sets, capabilities, and specifications of competing chips was fairly straightforward. Today, however, dozens of microprocessors are available. Therefore, comparing their capabilities can be difficult and time consuming, particularly since the various manufacturers follow no standardized format in their specification sheets and data manuals.

Electronics publishers were quick

to recognize the need for books about microprocessors. Some of the early texts, however, were rushed into print before the rapid expansion in the number of different microprocessors. While the basic concepts presented in these books are still valid, the product descriptions are often very much out of date and incomplete.

Some of the most successful early microprocessors like Intel's 8080, Motorola's 6800, and MOS Technology's 6502 are still very popular. This is in large part due to the availability of numerous support chips, abundant software, and second-source agreements with other firms. Today, however, there's a growing trend toward CMOS microprocessors that consume far less power and require fewer support chips than their NMOS predecessors.

Consider, for example, National Semiconductor's NSC800. This CMOS chip has the processing power of Motorola's 6809 or Zilog's Z80, both of which consume 200 mA from a power supply that must have a potential within 5% of 5 V. The NSC800 can be powered by a supply providing from 3 to 12 V. At 5 V, it consumes only 10 mA and is therefore ideal for use with unregu-

lated, battery-powered equipment.

Another important trend is the proliferation of single-chip microcomputers (microprocessors with on-chip RAM and ROM). These microcomputers are finding many applications in such dedicated consumer roles as games, toys, appliances, and automobiles. Some include on-chip analog-to-digital conversion, melody generator ROMs, real-time clocks, or other special-purpose functions.

Microcomputers with 4-, 8-, and 16-bit capacity are now available. American Microsystems manufactures the S2000 series of sophisticated 4-bit microcomputers. This family of microcomputers includes a mask-programmable ROM and is therefore intended for high-volume, dedicated applications such as controlling microwave ovens, washing machines, and toys.

Figure 1 is a generalized block diagram of the S2000 series. Versions having various memory capacities and high-voltage outputs are available. Most members of this family are NMOS, but the S2210 is a low-power CMOS version. The S2200/2400 include on-chip either an 8-bit analog-to-digital or an 8-bit digital-to-analog converter. All

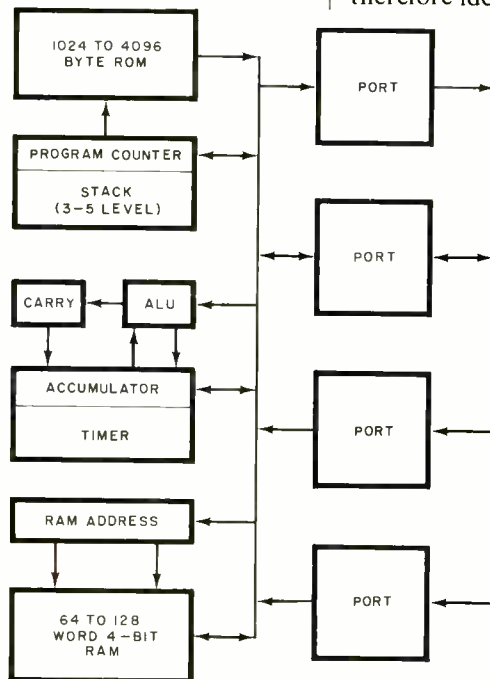

Fig. 1. Block diagram of the AMI S2000 series.

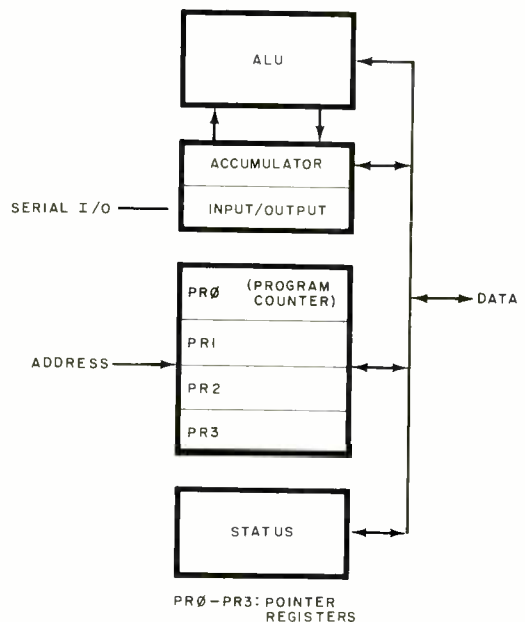

Fig. 2. Generalized block diagram of INS8075 chip.

## ...SOLID-STATE

members of the family can perform with the assistance of support chips. Depending upon the version, from 49 to 63 instructions are available.

National Semiconductor's INS8075 is a unique microcomputer that includes a BASIC interpreter programmed into its on-chip 4K ROM. Also included on-chip is a 64-byte RAM. The chip features a 16-bit address bus that is completely distinct from the data bus. It also includes logic for multiplication and division to provide faster processing than when these functions are implemented in software. An NMOS chip, the INS8075 requires 5 V and draws 100 mA. Figure 2 is a generalized block diagram of the chip.

The only 16-bit microcomputer is Texas Instrument's TMS9940. An NMOS chip, the TMS9940 includes on-chip 2048 bytes of ROM and 128 bytes of RAM. The standard TMS9940 ROM is mask programmable and is therefore intended for volume production. A version with an ultraviolet erasable EPROM is also available. It's intended for testing TMS9940 applications prior to large production runs with the standard version. It can also be used for limited production runs.

Figure 3 is a generalized block diagram of the TMS9940. The chip's instruction set is essentially identical to that of the TMS9900 16-bit microprocessor. A CMOS version of the TMS9940 microcomputer will soon be released by American Microsystems.

Collecting the literature necessary to compare the microcomputers just described, not to mention the dozens of other microprocessors and microcomputers that are available, is a time-consuming task. But this chore is not nearly as difficult as that of interpreting the literature from competing manufacturers.

Electronics trade magazines occasionally publish review articles that compare the key applications for many of the most important microprocessors and microcomputers. The limited page space in a magazine, however, does not permit the degree of coverage required by

people who have to select a microprocessor for a particular design application.

Steve A. Money, a civilian computer scientist employed by the Royal Navy in England, has recently helped change this situation, for a while at least. In a large format, 264-page work entitled *Microprocessor Data Book* (McGraw-Hill, 1982), Money has summarized the key specifications of at least fifty 4-, 8-, and 16-bit microprocessors and microcomputers. He's also covered many of the memory and support chips most commonly used in conjunction with microprocessors and microcomputers. These include RAMs, ROMs, PROMs, various peripheral device controllers (e.g., display and disk-drive controllers), and numerous serial and parallel input/output devices.

The *Microprocessor Data Book* is an enormous time saver for those who wish to narrow their choice of the microprocessor and support chips best suited for a particular application. The book has a couple of drawbacks, however. First, it is expensive, selling for \$38 a copy. Experimenters and hobbyists might prefer borrowing it from a library or from a friend who works for a company that provides its employees with important technical books for reference.

The second problem is unavoidable and is common to *all* books that cover a fast breaking field like solid-state electronics. How do you find out about products announced *after* the book has been published? Of course, new chips can be included in new editions. But a better solution is to collect data sheets that describe newly announced chips. They can be kept in a three-ring binder to provide, in conjunction with Money's text, a fairly complete ready reference guide to microprocessors and their support chips.

**A New Solid-State TV Camera.** General Electric's Optoelectronic Systems Operation (Electronics Park, Syracuse, NY 13221) has recently announced the availability of a new CID (Charge Injection Device) all solid-state television camera. The camera includes a built-in

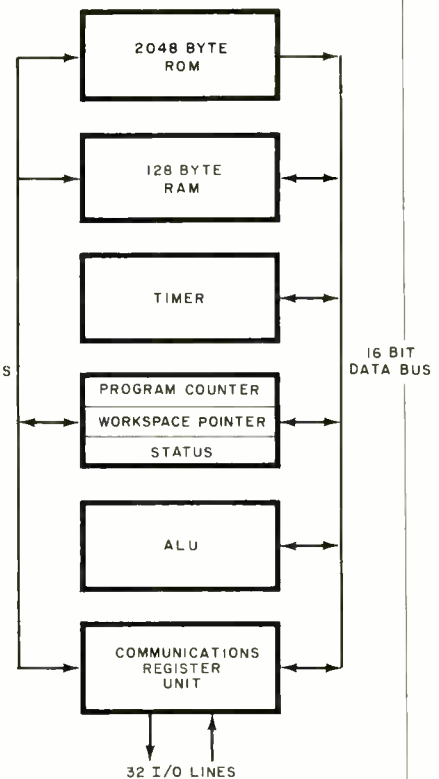

Fig. 3. Texas Instrument's TMS 9940 16-bit chip.

power supply that consumes less than two watts when powered by 12 to 35 V dc. The camera and power supply are housed in a sturdy case that measures only 3" × 3" × 2.5" and weighs less than one pound.

Two versions of the new camera are available. The TN2505 has a resolution of 244 by 388 pixels. The TN2506 has a resolution of 290 by 416 pixels. Both cameras incorporate an LSI scan generator and an LSI preamplifier. The signal-to-noise ratio of the system is an impressive 50 dB.

Though this new camera is intended primarily for security and surveillance, it may have applications in robotics as well. Another intriguing use is for pattern recognition. Until recently, the cost of the extensive memory required to implement these applications with the help of a personal computer has restricted this field to a very few affluent hobbyists and experimenters. Perhaps the cost of GE's new camera, which was not provided in its announcement, will be low enough to permit the average experimenter to explore some of these fascinating applications. ♦



The C&E  
Staff Answers  
Your Questions  
About Computers

**SERIAL VS. PARALLEL**

**Q.** What is the difference between se-

rial and parallel computer output? Is one better than the other?—Joseph Miller, Easton, PA.

**A.** Inside the CPU, data moves on a parallel data bus that is either 8, 16, or 32 bits wide. To transfer this data to an outside peripheral, we can extend the bus by means of a cable and

send one complete ASCII or byte character at a time over the cable. We call this method of data transmission "bit parallel, character serial" because data bits are sent along separate parallel wires and one byte is transmitted at a time. The reason it is used is that it makes possible high-speed data transmission.

Parallel data transmission requires a cable with a wire for each data bit plus additional wires for ground and parity checking and other handshaking signals. Such a cable must be kept as short as possible to avoid electromagnetic interference problems. In most cases, parallel printer cable must be no more than 10 ft long. Another problem with parallel data transmission is that there is no standard for cables, connectors, or anything else.

The other popular method of data transmission is called serial data transmission because it sends data over the wire one bit at a time. This is very popular because it can be transmitted over longer distances and the cables require fewer wires. In addition, it can be coupled into the telephone system through peripherals called modems.

Since data is transmitted in a parallel mode inside the computer, it must be converted to an external serial transmission mode. At the destination the serial data is then converted back into parallel form for use by a printer or other device. Extra bits are added to mark the start of a data word and to provide handshaking signals to make sure that the data sent is the same as the data received. A standard for serial data transmission called RS-235 was agreed upon, and we are now using the "C" version. It specifies the type of connectors to be used, the rates of speed, timing, and identity of each wire in the cable. Without handshaking signals, a minimum of three wires must exist; additional wires up to 25 can be added for parity checking and other handshaking functions.

Neither parallel nor serial data transmission is "better" than the other. They have different uses and applications. ◇

## AUDIO CRITICS RAVE ABOUT THE V15 TYPE V:



"Our tests show that the Shure V15 Type V not only lives up to the claims made for it, but in virtually every respect OUTPERFORMS the best cartridges we have previously tested....It is hard to imagine how the V15 Type V could be improved significantly. It offers the MOST PERFORMANCE in the most areas, plus the most convenience and safety in installation and operation."—Julian Hirsch, *Stereo Review*, June, 1982

"... (The V15 Type V) is definitely the FINEST pickup Shure has ever made, which makes it one of the finest ever made, period."—High Fidelity, July, 1982

"... In a world of audiophile discs with demanding tracking requirements, the Shure V15 Type V KEEPS AHEAD of the times."—

Rich Warren, Chicago *Sun-Times*, June 4, 1982

"(The V15 Type V) REDEFINES its maker as a pioneer in cartridge

design not only from the beginnings of micro-groove technology but well into the future of the LP disc."—FM Guide (Canada), June, 1982

"... It may be safe to say that this cartridge's excellent tracking ability is NUMBER ONE in the world. Provides exquisite and elaborate sound."—Swing Journal (Japan), May, 1982

Find out why the critics are so excited: Send for free fact-filled brochure AL694A.

\$50\* U.S. Savings Bond Bonus with the purchase of a V15 Type V Phono Cartridge until December 31, 1982.

\*Value at Maturity



Call for the Name of the Dealer Nearest You, 24 Hours a Day, 7 Days a Week. 800-323-6556 Ask for Dept. R15 In Illinois: 800-942-6345 Ask for Dept. R15

Shure Brothers Inc., 222 Hartrey Avenue, Evanston, IL 60204

# SHURE®

CIRCLE NO. 45 ON FREE INFORMATION CARD

# COMPUTERS & ELECTRONICS

# WIN AN ATARI®

# SWEEPSTAKE

Save up to 33% on Computers & Electronics, too!

**T**he Computers & Electronics Sweepstakes is open to all our readers. No purchase is necessary—and you'll receive a fantastic Atari home computer system worth over \$1600 if you're the lucky winner!

### How the Sweepstakes works

Just mail the attached card or the coupon below after filling in your name and address. Be sure to indicate whether you're also subscribing to *Computers & Electronics* at the special rates shown—you can save as much as 33%.

Then, if you win, you'll get a superb Atari personal computer system: the Atari 800 with 16K RAM and 10K ROM... an 810 Disk Drive... a 16K RAM Memory Module for extra memory... a pair of Joystick Controllers for game interaction. Use the Atari to handle small business and professional applications as well as sophisticated home processing functions—and, of course, for entertainment. Analyze your investments, learn



languages, do business accounting, play video games. Programmable in Basic or Assembly, the 800 can use all Atari peripherals and can control up to four disk drives and a 60 lpm printer. In all, the 800 and its accessories form a package worth a full \$1620 at retail!

### You're sure to win with Computers & Electronics!

Whether you win our Sweepstakes or not, the hours you spend on a personal computer—or with home electronics projects—are certain to be winners when you subscribe to *Computers & Electronics* (formerly *Popular Electronics*). It's the Number One magazine in its field—concentrating on computers, but packed with news of audio equipment, communications and electronics.

Why not enjoy a year or more of *Computers & Electronics* at our low introductory prices? You'll save up to 33% if you subscribe at the same time you enter our Sweepstakes!

*Atari is a registered trademark of Atari, Inc.*

### OFFICIAL RULES

#### No Purchase Necessary

1. On an official entry form or a 3" x 5" piece of paper, hand print your name, address and zip code. Enter as often as you wish, but mail each entry separately to Computers & Electronics Sweepstakes, P.O. Box 2785, Boulder, Colorado 80322. Entries must be received no later than March 31, 1983, and the drawing will be held by April 21, 1983. All entries become the property of Computers & Electronics, which reserves the right to reprint the name and address of the winner.
2. The winner will be selected in a random drawing from among all entries received, under the supervision of the publishers of Computers & Electronics, whose decision will be final. Only one prize will be awarded in this Sweepstakes. Winner will be notified by mail and may be required to execute affidavit of eligibility and release. Odds of winning will depend on the number of entries received. Ziff-Davis will arrange delivery of prize. Taxes are the responsibility of the winner. Any manufacturer's warranties will apply, but Ziff-Davis makes no warranties with regard to any prizes. Prize is not transferable. No substitutions for prizes.
3. Sweepstakes open to all residents of the U.S., its territories and possessions except employees (and their families) of Ziff-Davis Publishing Company, its affiliates, and its advertising and promotion agencies. Void wherever prohibited or restricted by law.
4. For the winner's name, send a stamped, self-addressed envelope to Computers & Electronics Sweepstakes, Circulation Department, Ziff-Davis Publishing Company, One Park Avenue, New York, N.Y. 10016.

### OFFICIAL ENTRY FORM

Mail to: **Computers & Electronics Sweepstakes**  
P.O. Box 2785, Boulder, Colorado 80322

**YES!** Enter my name in the Computers & Electronics Sweepstakes, and start my subscription to *Computers & Electronics* for the term checked:

- One year (12 issues) only \$12.97—19% off!
- Two years only \$22.97—28% off!
- Three years only \$31.97—33% off!

Savings based on full one-year subscription price of \$15.97.

**NO** I don't wish to subscribe now, but tell me if I've won the Computers & Electronics Sweepstakes.



#### CHECK ONE:

- Payment enclosed.
- Bill me later.

4N062

Mr./Mrs./Ms. \_\_\_\_\_ (please print full name)

Address \_\_\_\_\_ Apt. \_\_\_\_\_

City \_\_\_\_\_ State \_\_\_\_\_ Zip \_\_\_\_\_

Offer valid only in the U.S., its territories and possessions. Please allow 30 to 60 days for delivery of first issue if you subscribe.





## *A Trio of Desktop*

# BUSINESS COMPUTERS:

## APPLE III, NORTHSTAR ADVANTAGE, VICTOR 9000

*By Stan Veit*

**T**ODAY a business person looking for a small computer often wants more than just a word processor or an accounting machine. He might be looking for the capability of doing accounting, word processing, forecasting, scheduling, inventory, materials control, and communications. These are the main applications that comprise small-business computing and these are the criteria that are applied when making a system selection.

All three of the systems examined in this article can accomplish these tasks. In addition, they can do other things—such as graphics. However, they are quite different in features, price, and level of support. The problem of evaluating these systems and deciding which is most suitable for any particular small business merely illustrates the larger prob-

lem of selection among all the computer systems on the market. We have thoroughly tested each of the machines discussed with regard to characteristics that affect their operation, software availability, maintenance support, user documentation, cost, and other factors that are not necessarily obvious to the reader.

The Victor 9000, NorthStar Advantage, and Apple III are all designed to be used on a desk like an ordinary typewriter.

### Victor 9000

The Victor 9000 consists of three units. The System Unit is a rectangular chassis 16" W × 13" D × 7" H containing two 1.2M-byte minifloppy disk drives.

Design of the disk system is inge-

nious. The drives run at variable speeds so they can pack the diskettes with almost twice the amount of data that can be stored on the same size diskettes running at constant speed. Victor is now offering double-sided disk drives as an option. This increases the storage to 2.4M bytes. We used many types of ordinary diskettes with the Victor over the two months we had the computer. The disk system had no failures or loss of data, even with diskettes not rated for double density! This is a tribute to the design.

There are no switches on the front panel; the only indicators are the two disk-operation indicator lights on the drives. The rear panel has the power switch, reset switch, and cable connectors. There are no other controls except on the keyboard.

The system has a parallel printer connector and two RS232C serial connectors. This is very handy because it allows the user to have a serial printer and a modem connected at the same time. The serial interface can be set to operate in asynchronous mode at baud rates up to 19.2K baud. It will also operate in bisynchronous mode up to 56K baud. Furthermore, it also operates in SDLC (synchronous data link) to communicate with large main frames. The mode and baud rate are set under software control.

The other connectors on the rear panel are for the detached keyboard and the video display. The video monitor is a 12" diagonal green-screen CRT. CRT intensity and contrast are controlled by keys on the keyboard. This unique feature allows the operator to adjust the display during operation to meet changing light conditions without stopping the work being done. The video display is mounted on an adjustable mounting which permits the viewer to rotate the CRT in a horizontal direction about 45 degrees in either direction. The mount also tilts to raise or lower the viewing angle. This is another part of the ergonomic design by Victor Business Systems under the direction of Chuck Peddle, an outstanding computer designer and Victor's president.

Another unusual feature of the Victor 9000 is the system keyboard, which may be one of several types. In the United States, there is a U.S. Word-Processing keyboard, Victor "Standard" Keyboard, and a Victor Programming Keyboard. All of the keyboards have the same major groups such as typewriter keys, numeric entry and calculation keys, cursor control keys, and special-function keys. There are five keys on the left side for such functions as clear, home, scroll, reverse video, vertical tab, underline, and re-

peat. Across the top is a group of user-programmable function keys that provide application-specific functions. They are defined by the program being run.

To the right of the typewriter keys on the Word-Processing and Programming Keyboards is a second set of function keys that control intensity and contrast of the video display and loudness of sound generated by a built-in loudspeaker. In addition, these keys control cursor movement and such functions as insert, delete, and help when used with the appropriate software. Further to the right is a complete numerical calculator keypad with its own ENTER key.

Access to the interior is obtained by unscrewing the rear panel and sliding and lifting the top cover to the rear. With the cover removed, the internal construction is observed to be neatly laid out. The main board holds most of the circuitry, including the 8088 CPU, the memory, video and I/O circuits; a second board contains the disk-drive controller circuits.

The Victor comes with 128K of RAM memory, which can be expanded to 896K. Since the 8088 CPU can directly access all this memory without memory management schemes, the Victor has plenty of room to grow.

There are also five slots for plugging in boards for future growth and additional applications. Even after maximum memory is installed there are two slots left. One of them can be used for a controller for hard disks of 5 and 10M. These should be available by the time this appears.

Like many other computers, the Victor 9000 has an audio amplifier with a good speaker. However, it also includes a Coder/Decoder (CODEC) circuit that digitizes and reconstructs a human voice. Your Victor can speak to you!

This, then, is the physical design of the Victor 9000 and its CRT. It has many features that recommend it for use in an office, home, classroom, or laboratory.

---

## Apple III Computer

---

The pros and cons of Apple III Computer have been discussed long and often in its brief history. Apple has spent a lot of time and money upgrading and advancing the capabilities of this top-of-the-line desktop computer.

The problems that plagued the Apple III in its introductory phase seemed to be the result of having too small a memory for the new operating system it used. People were used to simple things from Apple. Applesoft and Apple DOS are easy to learn and to use. The wonderful things it did were a function of the intelligent design of the Apple II. Then the Apple III came along with an operating system so sophisticated that Apple named it Sophisticated Operating System (SOS). To accompany this new system, the company introduced Business Basic and expanded graphics and color capabilities.

It was all very nice, except that it was not expected from Apple. Perhaps it was a case of too much too soon. When we closely examined the Apple III and its supporting soft-

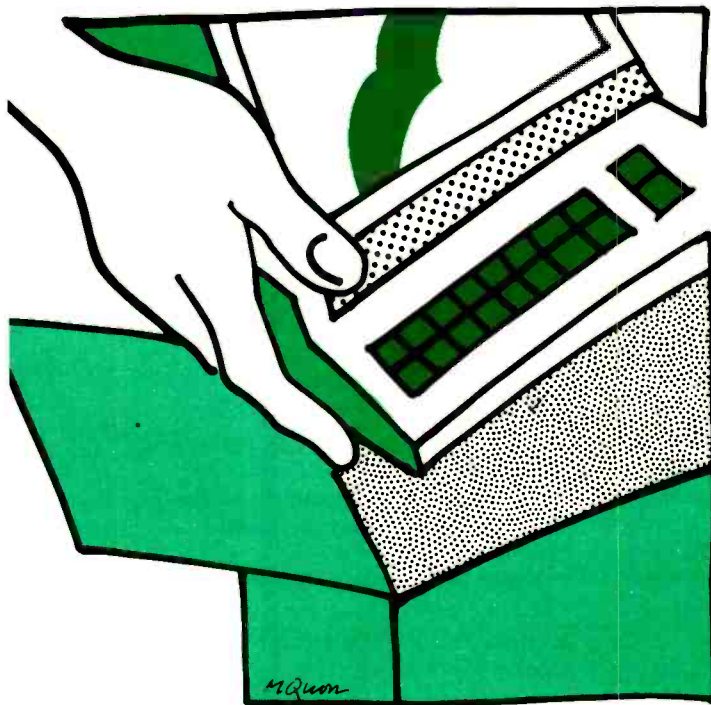



## ...BUSINESS COMPUTERS

ware, we became convinced that this is an underrated machine.

The physical aspect of the Apple III is pleasing. Moreover, it is designed for easy use. It is a one-piece unit, although the keyboard looks like it is detached. Unlike the Apple II, which is housed in a plastic case, the Apple III is built into a sturdy metal chassis. A single Apple III disk drive is mounted in the front of the cabinet and there are a few connectors on the rear panel. First, there is a connector for a disk drive which enables the connection of up to three additional disk drives in a daisy chain. (The first additional drive plugs into the connector and then the second additional drive plugs into the first, etc.)

Next to the drive connector are two ports for the connection of various input/output devices such as joysticks and graphics digitizers. Each port has circuitry for X and Y directional inputs and for a switch. One of these two ports can be used for the connection of the Apple Silentype Printer. This is an electrothermal printer that is very good for graphics and program listings.

There are two video ports. One is designed for connection of a color monitor and it will support either NTSC composite video (such as you have on your TV set) or red, green, blue (RGB) color video. Signals available at this port enable the user to connect any color or black-and-white monitor, a studio RGB video monitor, a video tape recorder, or any other video device.

The B/W video port carries only the black-and-white video signals, and is to be connected to a monochrome monitor.

There is an audio port that enables any sound generated by the Apple III to be sent to an external speaker or any other audio device. When a plug is inserted into this jack, it turns off the internal speaker.

Lastly there is an RS232C serial port that can be used by a serial printer, a modem, or any other serial device.

There are no parallel ports for printer connection on the rear pan-

el. If one wishes to use a parallel printer such as an Epson MX80, for example, a special interface card must be added to the Apple III by plugging it into one of the peripheral slots in the computer. The connector for this card projects through a slot in the rear of the chassis. Before any peripheral can be used with the Apple III, it must be integrated into the software operating system. The cassette port, a fixture on the Apple II, has been eliminated on the Apple III.

The keyboard on this computer is one of its nicest features. It is designed like an electric typewriter keyboard with a few additions for computer operation. It is a sculptured design, with keys set at a comfortable angle for the operator.

the Sanyo and Electrohome, and the color video appears to my eyes to be as good or better than anything else in the personal computer field.

There is a Winchester-type hard disk called the Profile designed to work with the Apple III. It fits on top of the Apple III, under the video monitor.

The Profile has a capacity of 5 megabytes and is a very useful peripheral because the Apple's floppy-disk storage capacity is not too generous. The single floppy in the front panel holds only 140K bytes and the system can support up to 3 additional drives, also 140K each. By today's standards, this is not much disk storage.



Almost any high-grade video monitor can be used with the Apple III. However, Apple Computer has introduced a monochrome video monitor that is styled to complement the Apple III and which bears the Apple logo. This was an unfortunate choice because it seems to be an inferior monitor. The Sanyo monitor that Apple previously sold with the Apple III was a much better monitor (as are most of the medium-priced units on the market, I believe).

Apple does not have an "official" color monitor. However, we have used the Apple III with both NTSC color monitors and with high-resolution RGB color monitors such as

*On this page is the NorthStar Advantage. Opposite above is the Victor 9000; and below that, the Apple III.*



Access to the inside of the Apple III is achieved by removing the heavy metal cover held by captive screws on the bottom. Inside are slots for four plug-in boards. Card guides are built into the chassis and openings in the rear panel allow access for cables going to the connectors mounted on the plug-in cards. When no card is installed in a slot, the opening in the rear panel is covered by a "dummy card" plugged into the slot.

There has been some criticism leveled at the design for only providing four slots, though direct connections are provided on the rear panel for the disk drives, serial ports, video ports, and miscellaneous peripherals. While valid, this is the price one pays to get compact desktop design.

The power supply is contained in a sealed cabinet beside the card slot area. There is no fan in the Apple III, a practice carried over from the Apple II. The massive metal cabinet and the air spaces are designed to cool by transmission and convection. This does not always work when using the computer is a closed warm area. A fan would have been appreciated.

Memory expansion is also done by adding chips to the main board through a plug-in board. The standard Apple III comes with 128K bytes, with 256K bytes optional. It turned out that one of the slots was usually filled by a parallel interface board to operate a printer like an Epson, IDS, C. Itoh, Star Micronics, or Centronics. Another slot may be used for a Micro Modem (physically modified to fit) and that only leaves two slots for expansion. One of them is used if you add the Profile hard disk, leaving you with one slot!

Again, all of the desktop designs share this slot shortcoming.

### North Star Advantage

One of the first things you notice about the NorthStar Advantage is its compact design. It is a self-contained, desktop, general-purpose computer designed to be used in an office environment and to appear as a nonthreatening office machine to those who will use it. It succeeds in



this very well. It is not much bigger than an office electric typewriter, although it packs a lot of computing power into a small space.

The Advantage keyboard has a Selectric typewriter arrangement with a 14-key numeric keypad and an ENTER key. Across the top of the keyboard there are 14 special function keys. These are labeled F1 through F15. In addition, there are character delete (X), Cursor Lock, ESC (escape), CONTROL, and CMD (command) keys. All of the functions are defined by program control. On the rear panel there are the ON/OFF switch, RESET pushbutton, and a brightness control for the CRT.

The 12" diagonal, P31-phosphor, nonglare video display, is protected by a safety shield. It produces a 1920-character display (24 lines by 80 characters).

The characters are 5 × 7 dots in an 8 × 10 matrix, a very readable configuration. In the graphics mode, the screen is set up as 240 pixels high by 640 pixels wide, permitting high-resolution graphics.

There are two 5¼" floppy disk drives mounted in the front of the cabinet. They are double-sided, double-density units with 360K bytes capacity each. The diskettes used are hard-sectored (10-hole), formatted with 512 bytes/sector, 10 sectors/track, 35 tracks per side, 2 sides/per diskette.

An alternate configuration has one floppy disk and a Winchester hard disk with either 5M or 15M bytes capacity. Prior to 1983, it was not possible to upgrade to the hard-disk configuration once a floppy-disk version had been purchased. Since the introduction of the 15M byte drive, a retrofit kit has been made available.

Another recent enhancement is the Ad-

vantage 8/16 CPU board, which upgrades the computer to run 16-bit or 8-bit software. It adds the MSDOS software to the already impressive list of operating systems.

The top cover of the Advantage is taken off by removing the screws on the bottom of the cabinet and carefully lifting the cover. Inside the cabinet, there is the main board assembly, the disk-drive assembly holding the drives, the power-supply transformer, and the keyboard. The CRT and the fan remain in the top-coverd assembly. There are six slots to plug in I/O and other boards. Normally the computer comes with a serial board installed. To add a parallel printer, a parallel interface board (PIO) must be installed and the operating system must be modified and patched. The hard-disk controller also plugs into one of the slots.

The Advantage has a Z80A CPU to run the computer and a separate 8035 auxiliary microprocessor to operate the keyboard and disk.

The main RAM memory is 64K bytes and there is an additional 20K bytes for the video display. There is also a 2K boot PROM. It is not possible to add additional memory to the Z80 configuration. However, the Advantage 8/16 Board, which adds the 16-bit 8088, comes with 64K of additional RAM. Up to

256K of RAM can be added with piggy-back boards that plug into the expansion board.

## Operating Systems and Systems Software

The Victor 9000 has been supplied with a choice of the major 16-bit operating systems being used. Most of the application software offered for this computer runs under the Digital Research Inc., CP/M-86 operating system, although Microsoft's MSDOS is also provided. This gives the Victor the widest selection of languages and application software of any of the machines tested. Although the Victor 9000 uses a unique disk format, it is possible to read diskettes from the IBM-PC by downloading, using a communications program called Move-It from Woolf Software (23842 Archwood St., Canoga Park, CA 91307).

In addition to the 16-bit software, the Victor 9000 can use CP/M-80 software when a Victor 80 board is installed. This CP/M-80 board for the Victor 9000 is manufactured by Small Systems Inc. (1056 Elwell Ct., Palo Alto, CA 94303 Tel. 415-964-8201).

The board comes in two versions. The Victor 80A has a 4-MHz Z80 and costs \$595, while the Victor 80B uses a 6-MHz Z80 and costs \$650. There is a bonus when you buy these boards since they have their own 64K of RAM on board. They also directly interface to the Corvus hard-disk drives.

The Apple III operating system, SOS, (pronounced "sauce") is the underlying structure for all programs running on the Apple III. Only advanced programmers who work in machine language will directly use the system, Apple III users must be aware of it. SOS must be includ-



ed on every boot diskette used to start up the Apple III, for example. The system is resident on diskette so that newer versions can be added by updating the system on the boot diskettes. The system communicates with the outside world through "devices" that may be part of the Apple III, or a piece of peripheral equipment that transfers information into or out of the Apple III. Typical devices include the keyboard, screen, disk drives and printers.

Special programs called "device drivers" operate the foregoing devices. In order for the Apple III to recognize that a device exists, it must be configured into the operating system. If this is not done, SOS does not recognize its use even though it may be physically connected to the system. Every time a device is changed, a revised version of SOS must be placed on every boot diskette used with the computer.

SOS works on files and there is a hierarchy of files and directories (tree structure) that permit the user to access information at various levels of the tree by specifying pathways and directories. This is a very powerful feature for locating data and building programs into software systems.

The main language of the Apple III is Business BASIC, a very powerful version of the language that has many more features than Applesoft BASIC. An updated version of Pascal can also be run on the Apple III. When using it, a completely different operating system is in effect. This is an update of the UCSD Pascal used in the Apple II.

One of the features incorporated in the Apple III to make up for the initial lag in the development of application software for a new computer was the Apple II Emulation mode. This enables users to run Apple II software on the Apple III. It does not extend the power of this software so that it can use the Apple III features, such as eighty columns with Apple II word processors. However, except for one Apple II feature, you are able to use the huge collection of software written for the Apple II.

The one exception is software that uses both Applesoft and Inte-

ger Basic and moves back and forth between them. In the Emulation mode you have to select either Applesoft or Integer BASIC. Unfortunately, many graphic programs use this technique.

The Apple II Emulation is a useful feature; but as more software is developed for Apple III, it has become much less important.

SOS is indeed a sophisticated operating system, but it is not easy to learn or easy for a beginner to use. For that reason the Apple III has not become the same kind of a popular software development tool that



the Apple II is. Most of the users of Apple III turn out to be business organizations that have programmers who develop their software or who use packaged software.

Programmers who use SOS like it and find that, used with Business Basic, it is effective for business and graphics programming. But it is not the same kind of a "user friendly" operating system that Apple II DOS is.

In all of the Apple III operating systems and languages there are provisions to include color. These color commands add the ability to use color display screens to illustrate programs. This capability is not available in the other desktop computers tested.

There is now a Z80 CPU card called Apple Softcard III for \$450. It includes a SOS/Utilities disk, the CP/M master disk including Microsoft BASIC, and extensive documentation and manuals. This enables the Apple III user to run CP/M. The user memory area for CP/M applications is 51K. The Ap-

ple III with Softcard III will run CP/M application software that will operate within these memory limitations and that has been configured for the Apple Softcard III. This will open up a large library of software for the Apple III, but first a lot of work has to be done to reconfigure CP/M software for the Apple III.

**The NorthStar Advantage** comes equipped with a broad range of operating software for graphics, language support, and application software support.

The Graphics Disk Operating System, (GDOS) was designed specially for the Advantage to allow the user to run a number of utilities and to create, run and debug programs written in Graphics BASIC or other compatible languages. It also supports application programs designed for use with GDOS. This system can be used either with floppy or hard disks.

NorthStar has also provided a special version of the CP/M system called Graphics CP/M. This system supports languages and application programs that are written to run under CP/M. It is designed to use all of the graphics features of the Advantage.

Graphics CP/M (R) will operate with either the floppy or the hard-disk models of the Advantage. NorthStar has developed an extensive package of business applications specially for the Advantage. To support them on the hard-disk version, a separate operating system called HDOS-ADV is supplied.

---

## Language and Applications Support

---

**Victor 9000.** No new microcomputer has ever had such initial support as the Victor 9000. Victor Business Products is a division of Kiddie Inc., a huge diversified industrial corporation. It is experienced in the business-machine industry and has spared no effort to launch the Victor with a solid base of computer languages and applications software. In addition, there is a network of Victor Business Machines offices staffed with maintenance people



who support both the dealers and the end users.

The Victor 9000 supports Microsoft's GW-BASIC, BASIC-86, CBASIC, MS-PASCAL, MS-FORTRAN, MS-COBOL, and CIS COBOL. Victor has provided three word processors including WordStar, Select and Victor Writer (which includes a mail merging program). In the electronic spreadsheet department, there is SuperCalc, VictorCalc, and Multiplan. At this time, dBase II is available as a data base, although Victor plans to offer users a choice in the category as well.

Since the Victor 9000 runs on both CP/M-86 and MSDOS, hundreds of programs running under these operating systems can be used. Lifeboat Associates and Westico Software will both support the Victor format and adapt their 16-bit software for it. With the addition of the Z80 Card, thousands of 8-bit CP/M-80 programs can be made available.

**Apple III.** Although the Apple III has been on the market longest of the three programs tested, it has less applications software than any of the three. Because it has a unique operating system and there were not too many computers of this type in the field, software developers have been slow to write software for the Apple III. The situation is now much better since Apple Computer has released many application programs.

VisiCalc III is the most important of these. Indeed many Apple III computers were sold just to run the improved version of VisiCalc that operates on it. There are several word processors running on the Apple III, but Apple Writer III from Apple seems to be the best of these. When using Pascal, the Script III programs format text written using the Pascal Editor. Mail List Manager is another popular application package. In the data-base category, the PFS system is available under SOS.

The Peachtree Business software now runs on the Apple III, too, fill-

ing its promise as a real business computer. These programs include the Peachpak 8 Accounting Series, General Ledger, Accounts Receivable, Accounts Payable, Sales-Invoicing, Inventory Control, and Peachpak payroll. There is also the PeachText word processor, PeachCalc, electronic spreadsheet, and a Spelling Proofreader, Mailing List Manager and Telecommunications.

With the addition of the CP/M card the whole world of CP/M software will open to Apple III users. Many programs developed for the Apple II CP/M will run on the Apple III under CP/M with slight modification. The library of CP/M-80 programs will shortly be available for the Apple III.

Last but by no means least is the graphics support for the Apple III. Apple has released the Business Graphics software for Apple III, and many other software houses have graphic software for it. Apple III graphics, both in full color and monochrome, are unique among



desktop computers as far as their availability and support are concerned.

**NorthStar** has provided a broad range of applications software under its own operating system, including NorthWord, a word processor (\$399); and InfoManager, a data base program (\$199). There also is the ACCPAC group of business application programs, at \$499 each. These include General Ledger, Accounts Receivable, Accounts Payable, Inventory Control, Order Entry, and Invoicing. Professional Client Accounting & Billing (ProPac, \$1499) system has been designed for professional practices.

Since the Advantage also runs under CP/M, there is a large population of software available under that operating system. WordStar (\$500), SpellStar (\$250), MailMerge (\$150), MicroPlan (\$399), and dBase II (\$700) are only the best-known of the CP/M software for the Advantage.

The version of CP/M supplied for the Advantage is called Graphics CP/M owing to the built-in graphics capabilities. This is important because one of the features of this computer is the ability to compose and display graphic images.

## Conclusions

The three computers we tested here are typical of the offerings to business people with modest computing requirements. They all have excellent support with regard to software, and they come from manufacturers with good track records in the microcomputer industry.

The Victor 9000 is one of the new generation of 16-bit computers using the latest in operating software and technology. It performs like one and it is a pleasure to operate. I used the Victor video display all day and had no eye strain or tiredness. The NorthStar display is almost as good. In contrast, the Apple III monitor was terrible. After a short time my eyes exhibited strain from viewing it. However, I have used the Apple III with a high-quality monochrome video monitor such as the Sanyo, BMC, or Electrohome, as well as with a high resolution color monitor. Not having this complaint with these, I know it is not the fault of the computer.

The keyboards on all three computers were superior to those found on most personal computers. Of the three, the Apple III had the best feel, with the NorthStar a close second.

The Victor keyboard does not live up to the quality of the rest of the machine, unfortunately. Its design is excellent and very easy to use, but it is mechanically inferior to either the Apple III, or the NorthStar Advantage. The BACKSPACE key became stuck after a short time; the other keys seemed "loose" when typing with them. Most of all, I did

## ...BUSINESS COMPUTERS

not like the location of the ESCAPE key. It is a shift on the OFF/ON RVS key, which is seldom used. Why couldn't the ESCAPE have been the prime function?

Service and company support are very important to business users because a computer that is not working is more than a mere annoyance. It represents lost money. In this respect all three companies have maintenance provisions expected by business people. Victor has offices throughout the United States fully staffed with personnel for both software and hardware support. Their dealers are fully trained to provide the same level of service.

NorthStar has maintenance through Sorbus, the nationwide computer maintenance service; or the dealers provide service in conjunction with the factory. Apple III is serviced by its dealers, and every authorized Apple dealer includes a service facility with factory-trained people and back-up. A user can buy an extended warranty for the system.

The overriding criterion in buying a computer often is the price/value ratio. This gets to be a

harder and harder way to determine which is the best machine for your applications. Among the machines discussed in this article, Victor 9000, including 128K of RAM, two single-sided disk drives (612K each), keyboard, monitor, CP/M-86, and MSDOS, is priced at \$4495. The same system with double-sided drives is \$5950. Memory boards are \$800 for a 128K board, or \$2500 for a 384K board. The Winchester hard disk is \$4995.

The Apple III system is priced at a suggested \$3495 for a 128K system with one disk drive; extra drives are \$495 each. The Profile Winchester disk is \$2995. An extra \$945 expands the computer to 256K of RAM plus \$45 installation if this option is not ordered from the factory. The CP/M card is \$450 and includes CP/M software.

When you add the extras to bring the Apple III up to the capabilities of the Victor, it costs about the same price. You do get the color graphics with the Apple III; and if this is important to your application, Apple is the only way to go. The Victor offers 16-bit performance, which is slightly faster than the 8-bit machines, and has the potential to perform much faster in the near future if the 8087 chip is installed. You

have to weigh the various features of these two machines and cancel out the ones you want or don't need in order to come to a judicious decision.

The NorthStar Advantage is priced about \$3599, with CP/M software adding an extra \$150. Thus, it is the least expensive of the three systems examined here. It has the potential to become a powerful multi-user system with hard-disk support, and it now can be upgraded to 16-bit operation with the potential to run CP/M-86 and MSDOS. In its new 16-bit configuration it will retain all of the graphic capabilities. The Advantage then can be considered a worthy competitor to the more expensive Apple III and the Victor. For those who do not need all the computing power at once, at lowest money outlay, it deserves serious consideration.

We have never believed that speed benchmarks were a valid measure of the worth of a small business computer. This is a carry-over from the world of mainframe computers. However, we have run benchmark tests on the computers in this article and the results are shown in the box. The features chart may be more helpful than measurements of speed. ◇

## BENCHMARK TESTS

This benchmark program is based on the Sieve of Eratosthenes, modified by Jim Gilbreath of the Naval Ocean Systems Center, and adapted for the various operating systems and BASIC versions used by the computers tested. The benchmark program generates the prime numbers from 0 to 8190 and finds 1899 prime numbers. The times required for the three computers were:

Victor 9000 using MBASIC under MSDOS: 266 seconds.

Apple III using Business BASIC under SOS: 284 seconds.

NorthStar Advantage using NorthStar BASIC under GDOS: 235 seconds.

The results are interesting because the Victor 9000 uses the 8088 16/8-bit microprocessor, whereas the others use an 8-bit CPU. Apple III uses the 6502B microprocessor running at 2 MHz peak, 1.4 MHz average. The NorthStar Advantage uses the Z80A microprocessor running at 4 MHz, and an 8035 microprocessor is used as an auxiliary to operate the keyboard and disk. (There was no disk access during the test.) ◇

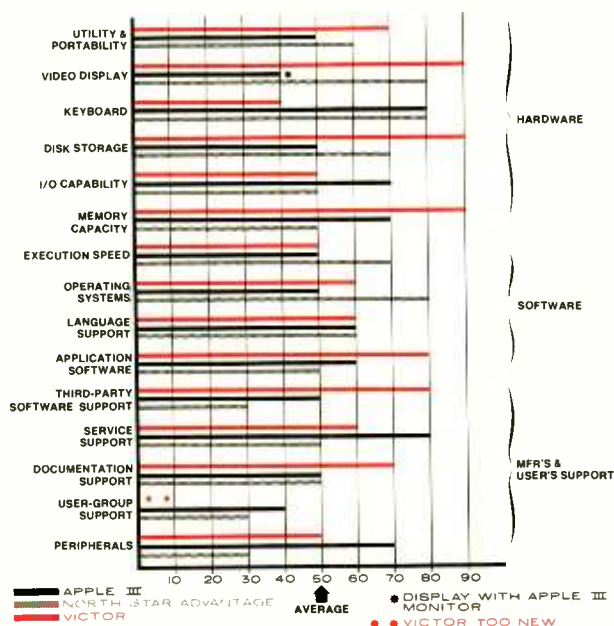

Comparative analysis of the three computers.



and pick up small objects. And it's pretty light on its wheels, too, turning in a one-foot radius, which makes it a perfect companion for those evenings at the roller disco. HERO knows how to conserve as well as expend energy by utilizing a "sleep" mode that's reported to have been developed by a group of Tibetan EE's.

We found HERO's sultry speech patterns reassuringly familiar in a delightfully robotic way. The phoneme-based speech synthesizer uses Votrax's familiar SC-01 chip, permitting generation of 64 phonemes to simulate human speech or sound effects. Reference pitch is hardware selectable and variable over four inflection levels with software control. Some prompts and canned phrases are inbred, such as "Ready" when it is switched on. HERO also tells you if logic or drive batteries are low.

When complimented on its speech facility, our RobotMate exhibited a flash of insecurity. "I know that anyone who meets me is impressed by my speech," HERO said, "but, frankly, I wish I had a National Semi instead of a Federal Screw vocal box. Why, it sounds so, uh...you know...robot-like!"

Hmm...seems that the circuits are always greener....

HERO's "head" is also remarkable. In a rather fetching display of modesty it initially declined to expose it during our early bare photography session. "A little mystery makes me more desirable," HERO coyly insisted. But after some gentle coaxing, it graciously revealed it later, as a picture here shows. A stepper motor rotates the head 350 degrees, enhancing the built-in senses, which include ultrasonic ranging and motion, light, and sound detection. Here's where a breadboard area is mounted, too, so that Robot Masters can develop and connect circuit cards. (Its amoebic parent, Heath Company, says that a bus system soon will be available for experimenters.) The intravenous-like system provides direct access to a user I/O port, a user-defined interrupt, the CPU control lines, and both +12- and +5-volt supplies.

When we voiced our admiration for its pulsed ultrasonic ranging system, which has a maximum range of 8 ft and a resolution of 0.42 in., with 30-degree horizontal and vertical beam width, HERO surprisingly dismissed this attribute. "My echo system, which operates at 35 kHz, is OK, I guess. But RB5X has a Polaroid option that goes out to 35 ft!" it replied petulantly. We gallantly observed that HERO was talking about a system that became available too late in its design cycle, but the inconsolable HERO kept mum-

bling about an electronic Right-to-Life designer who wouldn't abort.

HERO hears sound omnidirectionally over a frequency range of 200 to 5000 Hz, converting it into 8-bit digital words. Though it will never appreciate the value of a hi-fi speaker's tweeter, it does capture audio where most of the energy rests, with a resolution of 1 part in 256.

This robot uses two senses to see, so you can't escape its attention (not that any of our red-blooded readers would want to). In pitch-black darkness, a motion detector that uses continuous-wave ultrasonics will spot an adult walking toward it at a distance up to 15 ft, with omnidirectional sensing if looking toward a wall. A light detector responds to the presence (or absence) of ambient light levels over the visible spectrum, with a sensor-beam angle of about 30 degrees. HERO can be programmed to make decisions based on anything these senses detect, giving the security industry and the watchdog society cause to worry.

The most prominent feature of HERO's movable turret is its single, long robotic arm. Connected to a mounting point on its head, this arm can rotate horizontally with the turret. With a shoulder motor able to raise and lower the arm 150 degrees in a vertical plane, HERO is likely adept at frontal deltoid raises. (We hasten to add that this in no way detracts from its robotically electronic charm.) And what any prize fighter would give for its jabbing ability! Another motor extends and retracts its fist—a two-claw

HERO's top with the cover removed and the arm partially extended.



gripper—a full five inches upon command. Moreover, HERO's arm can manipulate objects and communicate with gestures, moving up and down, right and left, and in and out. Its wrist can rotate almost a full circle, twist 90 degrees, and move up or down 90 degrees above and below its arm axis. A linear actuator opens



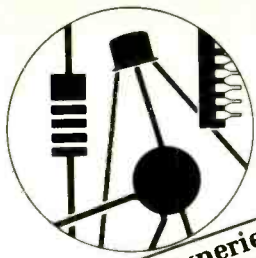

The **ELECTRONICS BOOK CLUB**  
 Exciting projects,  
 troubleshooting and repair  
 tips, and hands-on,  
 do-it-yourself info . . . plus  
 hundreds of time- and  
 money-saving ideas!

18 years experience

Select 5 fact-filled volumes  
 for only **\$2.95** (total value up to \$96.75)



1465  
List \$15.95



1396  
List \$13.95



1288  
List \$14.95



1435  
List \$15.95



1245  
List \$15.95 (paper)



1128  
List \$11.95

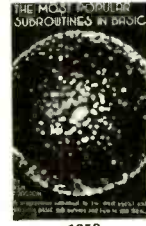

1050  
List \$12.95



1420  
List \$17.95



1409  
List \$15.95



1108  
List \$13.95



1306  
List \$15.95



973  
List \$6.95 (paper)



1218  
List \$16.95



1429  
List \$14.95



1436  
List \$16.95



1211  
List \$14.95



1467  
List \$16.95



1138  
List \$9.95



1199  
List \$17.95



1169  
List \$17.95



1390  
List \$14.95



1349  
List \$14.95



1296  
List \$18.95

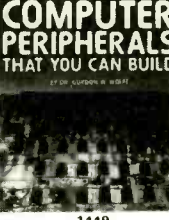

1449  
List \$19.95



335  
List \$14.95

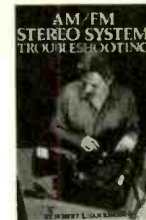

1383  
List \$18.95

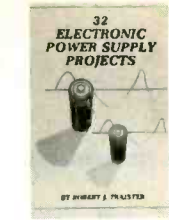

1486  
List \$17.95



1277  
List \$19.95



1113  
List \$10.95

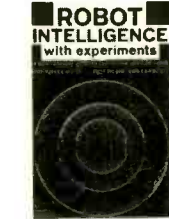

1191  
List \$16.95

## 7 very good reasons to try Electronics Book Club

Blue Ridge Summit, PA 17214

- **Reduced Member Prices.** Save 20% to 75% on books sure to increase your know-how
- **Satisfaction Guaranteed.** All books returnable within 10 days without obligation
- **Club News Bulletins.** All about current selections—mains, alternates, extras—plus bonus offers. Comes 13 times a year with dozens of up-to-the-minute titles you can pick from
- **"Automatic Order."** Do nothing, and the Main selection will be shipped automatically! But . . . if you want an Alternate selection—or no books at all—we'll follow the instructions you give on the reply form provided with every News Bulletin
- **Continuing Benefits.** Get a Dividend Certificate with every book purchased after fulfilling membership obligation, and qualify for discounts on many other volumes
- **Bonus Specials.** Take advantage of sales, events, and added-value promotions
- **Exceptional Quality.** All books are first-rate publisher's editions, filled with useful, up-to-the-minute information



## ELECTRONICS BOOK CLUB

Blue Ridge Summit, PA 17214

Please accept my membership in Electronics Book Club and send the 5 volumes circled below, billing me \$2.95 plus shipping and handling charges. If not satisfied, I may return the books within ten days without obligation and have my membership cancelled. I agree to purchase 4 or more books at reduced Club prices (plus shipping/handling) during the next 12 months, and may resign any time thereafter.

335 973 1050 1108 1113 1128 1138 1169  
 1191 1199 1211 1218 1245 1277 1288  
 1296 1306 1349 1383 1390 1396 1409 1420  
 1429 1435 1436 1449 1465 1467 1486

Name \_\_\_\_\_ Phone \_\_\_\_\_

Address \_\_\_\_\_

City \_\_\_\_\_

State \_\_\_\_\_ Zip \_\_\_\_\_

(Valid for new members only. Foreign and Canada add 20%. Orders outside Canada must be prepaid with international money orders in U.S. dollars.)  
 This order subject to acceptance by Electronics Book Club PE-183



and closes the gripper, which has protective cushioning.

Shaking hands with HERO is a strange but memorable experience. It pinched me uncomfortably, using the full closing force of 5 ounces at its fingertips. With its two fingers being able to touch and having a full opening capacity of 6 in., HERO is obviously dexterous, though delicate operations such as mixing and pouring a martini are best left to a humanoid companion.

Like its industrial counterpart, HERO can be programmed relatively quickly and easily by using the teaching pendant that is part of its uniform. Connected through a 6-ft line, the pendant runs through action routines with the arm and body, which the robot memorizes in system RAM and can repeat over and over again. Arm payload is only 16 oz when fully retracted and 8 oz fully extended, but it doesn't have much to worry about in its 39-lb weightlifting division.

The robot's head also contains a programming keyboard, LED display, and one of its four batteries. Its 17-key hexadecimal keypad with multi-function keys gives one access to its onboard processor in machine language so that HERO can make decisions from its sensing inputs, arm and drive-wheel position, voice, and so on. Dumping data to a cassette tape, HERO can exchange programs with friends.

You can read HERO's mind, too, by looking at data displayed on six 7-segment LEDs on top of its head. Also, a four-year calendar clock keeps track of date and time with an accuracy of  $\pm 120$  second/year, even with power shut off. So HERO will never miss performing a task at a given date and precise time for years ahead.

HERO's microprocessor has a host of operating modes. One is for utility functions such as arm homing; another is for repeating a stored program; and so on. Perhaps the most interesting one is the "sleep" mode mentioned earlier.

In this mode, HERO is shut down to conserve power and awakened only by the electronic kiss of a



The teaching pendant can be used to program HERO.

preset timer. When this happens, the robot wakes up and performs whatever programmed task it was assigned. For instance, HERO's motion detector can be programmed to turn on for 10 seconds, sleep for the next 10 seconds, and repeat this sequence over and over. When motion is detected, the robot could scream, "Halt, who goes there!" If silence follows, HERO could bellow, "Thief! Thief!" and wheel toward the closest person with its arm extended as a lance. (Imagine returning home to find a thief on the floor who died of fright.) Should there be an audio response, such as "Friend!" HERO would shut off to save power.

HERO has seven stepper motors directly driven by its internal computer through optical interfaces that are used to prevent back-EMF spikes produced by motor windings from damaging the semiconductor system. Seven input and nine output ports, all 8-bit parallel, interface the computer to motors, sensors, and control lines.

The energy-conscious robot uses a power-management scheme to conserve its electrons. Each output line is connected to a parallel switching circuit so that current is used only when that particular function is operating. As an example, when the "sleep" line goes high, a 10-second hardware timer starts, and power to all circuits except the timer and RAM is turned off. When the timer times out, normal power is restored to all systems and the next

program instruction is executed.

HERO's interpreter in the ROM is essentially a high-level language that minimizes the number of commands needed to achieve an end result. For example, with step-by-step programming, it may take about 30 bytes of code to move a stepper motor a certain distance. With the interpreter, however, it takes just three bytes. Clearly, this is an efficient robot.

When questioned about its hopes for the future, HERO replied that it would like to emulate "Midnight Flash," winner of the IEEE *Spectrum's* first "Amazing Micro-Mouse" maze-running contest, and be first among learning/personal robots, rather than miss out by 10 seconds like "Harvey Wallbanger" did in the robot-mice race. Shades of Claude Shannon!

Among its favorite activities is wheeling into a Robot Master's bedroom each morning to tell him to get up, announcing such important events as an anniversary or a business appointment, and even singing "Happy Birthday."

As the interview drew to a close, I reluctantly prepared to take my leave, but posed one final question to our January RobotMate.

"Do you think humans should get you in assembled or kit form?"

"A kit would be desirable."

I asked why and could swear I detected the glistening of moisture in HERO's "eyes" as it replied, "Dr. Frankenstein would have wanted it that way." ◇

## JVC HR-C3U Portable VHS Video Cassette Recorder



**I**N LAST year's January issue, I praised Technicolor's Model 212 portable VCR for its light weight—only 7 lb with battery. This model used ¼" tape in a package the size of an audio tape cassette and held up to 30 minutes of video information. It was not compatible with other video cassette formats, though. Here I am one year later reporting on another portable VCR, this time a 5.3-lb battery-equipped machine that uses conventional ½" tape in a compact VHS videocassette (TC-20), records for 20 minutes (SP speed), and is fully compatible with standard VHS machines using an adapter.

The JVC Model HR-C3U machine is smaller, too, measuring only 7½" W × 3" H × 8½" D. Only ½" is added to the depth when used with the snap-on battery pack. Unlike the Technicolor VCR, the HR-C3U can be powered from a standard ac outlet, too. Removing the battery pack reduces weight to only 4.4 lb. The unit comes with a regular (0.7 AH) battery pack, a

battery charger, wired remote control, carrying case, and shoulder strap. Options include a high-capacity (1.2 AH) battery pack and car-battery adapter. \$850.

**General Description.** JVC's compact VCR contains all of the essential features of a standard VCR. This means that the ½" tape-recording standards are identical, using the same rotary, slant azimuth, two-head helical-scan system. It also means that video bandwidth, luminance, and color performance are inherently the same as for a full-size VCR. In theory, the only difference between the performance of a full-size and a compact VCR should be the length of the recording.

All of the controls are located on the front panel. The key operating controls—PLAY, RECORD, STOP, PAUSE, REWIND, FAST FORWARD, and AUDIO DUB—are all of the feather-touch, pushbutton type, with LED indicators next to them. These controls are recessed and can be covered by a sliding panel for

carrying protection or when the remote control is used. LED indicators alert a user to excessive moisture (DEW) and low battery. An LCD tape counter display indicates how much tape is used and, pressing a miniature button, how much tape record time is left in minutes and seconds. There are two other miniature buttons controlling the counter's function. One is a memory set button to allow the user to stop at specific parts of a recording during rewind. The other resets the counter. The RECORD-LOCK button permits the tape to remain loaded when power is off and to start recording instantly when the record button is pressed after a pause.

Video and audio input as well as control signals are brought in through the standard camera cable connector, and there are three output connectors at the side of the case. Two are RCA-type phono jacks, for video and audio signals, respectively. The third is a standard coax antenna connector for the r-f signal on channel 3 or 4, depending



on the setting of a screwdriver-operated switch at the bottom of the case.

Miniature phone jacks are available on the front panel for a microphone input and for earphones. A third phone jack accepts the thin cable for the remote control unit, which contains the same seven key operating controls as the front panel.

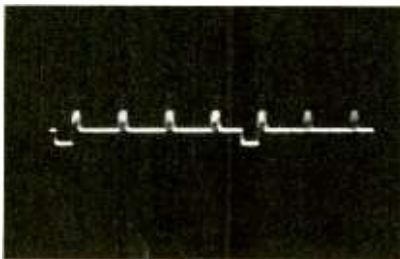
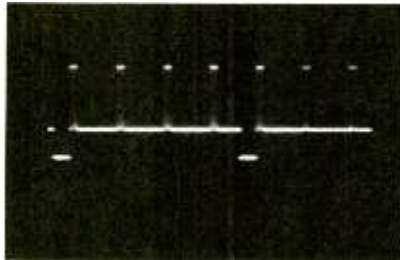

Fig. 1. Color-bar signal: input (top) and output (bottom).

el, plus the power switch. An EJECT lever is moved upward so that the cassette tray rises to accept a compact cassette.

The JVC HR-C3U can operate either from rechargeable batteries, from a car battery, or from the ac line through the charger, which also serves as power supply. The NiCd battery supplied with the unit is reported to be able to provide 40 minutes of continuous recording and be recharged in just 60 minutes. JVC also offers a special 60-minute battery, which, of course, requires a longer recharge time. Nominal power consumption is 5.2 watts, and to keep battery drain to a minimum, the VCR will shut itself off automatically when it is in the PAUSE or STOP mode for more than five minutes. With the use of the RECORD-LOCK switch, any delay of more than five minutes in camera adjustment, scene changes, etc., will automatically shut the recorder

power off; but when the camera RECORD control goes on, the VCR starts again automatically. The memory of the LCD tape counter remains on for at least one hour.

When recording is stopped, an automatic backspace feature rolls the tape back 30 frames so that the next segment is synchronized. To confirm recording of the previous scene, the automatic quick review feature presents the last second of the recording to a separate camera's viewfinder.

The REWIND and FAST-FORWARD controls can be used in JVC's "shuttle search" mode to watch the recorded picture at three times normal speed in either direction.

JVC offers a set of adapter cables that permit the HR-C3U to record from a TV monitor, tuner, another VCR, or any other source of video and audio.

**Laboratory Measurements.** Our tests included use of the VCR with a studio-quality camera and monitor, as well as the recording of standard test signals such as staircase, window, color bar, and high-frequency step. As expected, the overall performance was essentially that of any standard VCR in the VHS format. Color fidelity was excellent on the video monitor, but a slight degradation was discernable when we used the r-f output and viewed the recorded test picture on a good color TV receiver. The picture appeared to have lost some fine detail in passing through the r-f modulator. As indicated in the table of test results, the resolution from a wedge test pattern was about 220 lines on the monitor and about 210 on the color TV set. (We used another brand of VCR to verify that the TV receiver was capable of showing more than 220 lines on channel 3.)

Comparing the input of the color-

bar test signal and the output at the video terminal, as in Fig. 1, shows relatively good reproduction, which was further confirmed by viewing the color-bar pattern on a monitor. When viewed on a color TV set, there seemed to be again a slight degradation, especially at the vertical color-bar edges. The video bandwidth of 2.7 MHz was measured at the video output terminal and corresponds approximately to the observed resolution of 220 lines. These

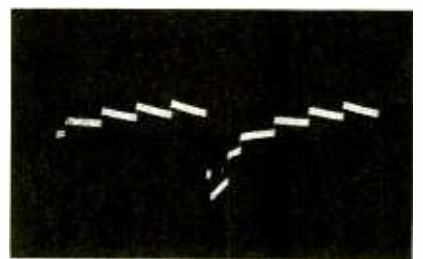
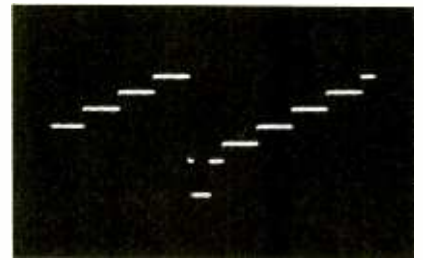

Fig. 2. Staircase signal: input (top) and output (bottom).

values are typical of moderate-priced full-size VCRs and result in very satisfactory images.

The grey-scale input and video-output signals are shown in Fig. 2. Though there is some differentiation at the output, no grey-scale distortion could be observed on the monitor. We carefully checked the recorded signal for noise, cross modulation, or interference; but on repeated playbacks, we observed none. Several observers viewed images of these test patterns, plus actual studio scenes, on both a monitor

### LABORATORY MEASUREMENTS JVC MODEL HR-C3U VCR

Parameter	Measurement
Video bandwidth:	2.7 MHz at -6 dB
Resolution:	220 lines at video 210 lines ar r-f (Ch. 3)
Video input:	2.0 V p-p at 75 ohms
Video output:	1.0 V p-p at 75 ohms
Video S/N:	45 dB (No discernable noise)

# The world of electronics gee-wizardry

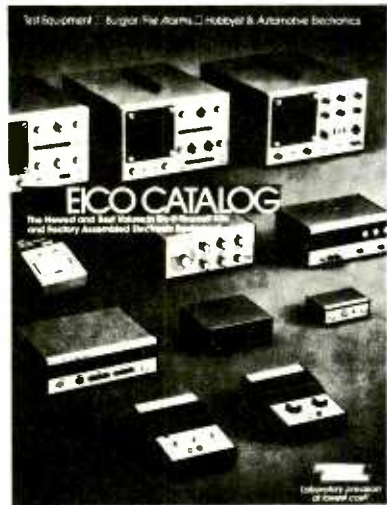

## -YOURS FREE.

32-pages of test instruments — from the latest digital multimeters to the famous EICO scopes. Security systems. Automotive and hobbyist products. Kits and assembled. EICO quality. EICO value. For FREE catalog, check reader service card or send 50¢ for first class mail.

**EICO** 108 New South Road  
Hicksville, N.Y. 11801

CIRCLE NO. 43 ON FREE INFORMATION CARD

## CALCULATOR SAVINGS



HP-10C Scientific	\$66.95	82161A Cassette Drive	\$419.95
HP-11C Programmable	79.95	82162A HP-IL Printer	379.95
HP-12C Financial	114.95	82163A Video Interface	249.95
Solution Bk Free with 11C/12C		82165A GP-10 Interface	259.95
HP-15C Programmable	104.95	82180A Extnd Functns	59.95
HP-16C Hexadecimal	117.95	82181A Extnd Memory	59.95
HP-41C Alpha Prog	149.95	82182A Time Module	59.95
HP-41CV Full Memory	207.95	82183A Extnd I/O	59.95
Port-X-Tender to 10 dis	169.95	82184A Plotter ROM	CALL
82104A Card Reader	154.95	HP-97 Desk Progrmble	599.95
82143A Printer	289.95		
82153A Wand	99.95		
Gordon Battery System	34.95		
HP-41 Pacs	26.95 to 64.95		
82160A HP-IL Module	94.95		

Call for Low Prices on all Accessories and Software

Texas Instruments 99/4A Computer	\$329.95	TI-35	\$19.95
Extended BASIC Module	74.95	TI-55-II	39.95
Peripheral Expansion Box	192.95	TI-58C	89.95
Call for low prices on all TI-99/4A products		TI-59	189.95
Get a \$20 rebate from TI with TI-59 purchase		PC-100C	169.95
\$100 rebate from TI on TI-99/4A purchase		LCD Progr.	59.95

Olivetti Praxis 35 Triple-pitch Electronic Typewriter	\$429.95
Sharp PC-1211 Computer, free cassette interface	499.95
CE-122 Cassette Interface/Printer	79.95
PC-1500 Advanced Handheld Computer	209.95
CE-150 Cassette Intrfc/4-color Printer-Plotter	179.95
CE-151 4K Memory Expansion for PC-1500	59.95
CE-155 8K Memory Expansion for PC-1500	99.95
CE-158 RS-232C & Parallel Interface for PC-1500	179.95
CE-159 8K Memory Expans with Battery Back-up	139.95

Casio FX-702P Handheld Computer, 1680 Steps	\$99.95
FA-2 Cassette Interface for FX-702P	42.95
FP-10 Printer for FX-702P	79.95
FX-602P Alphanumeric Programmable, 512 Steps	69.95
MT-40 Keyboard with Bass and Rhythms	159.95
MT-60 Home Entertainment Keyboard	249.95
MT-70 Advanced Memory Keyboard	299.95
CT-701 Advanced Electronic Organ with Memory	729.95
CT-1000P Polyphonic Synthesizer	549.95

Pearl-ri-corder S904 Two-speed, Two-hour Recorder	\$49.95
S901 Two-speed, Two-hour, Tape Counter	99.95
5501 Two-speed, Compact, Memory Rewind	149.95
X-ii Ultra-thin All Electronic	199.95
XR Advanced Tiny Recorder/AM/FM	299.95
Olympus Pearlcorder Microcassettes	10 for 29.95

We accept cashier's checks, money orders, VISA and M/C. Personal checks take 5 weeks to clear. Add shipping. 1% of your order (\$3.95 minimum). East of Missip Riv add \$1.50. CA res add 6%. Subject to availability. USA prices.

ORDER 800-421-5188  
TOLL-FREE Information line (213) 633-3282 CA AK HI

**tam's** INCORPORATED  
Tam's Inc, Dept. CE-12  
14932 Garfield Ave.  
Paramount, CA 90723  
(213) 633-3282

CIRCLE NO. 42 ON FREE INFORMATION CARD

...JVC VCR

and a color TV set. All agreed that the pictures showed good color fidelity and resolution, and appeared free from interference, noise, and instability. The signal-to-noise ratio was measured at 45 dB, a typical value for full-size VCRs and very satisfactory. The audio-frequency bandwidth ranged from about 150 Hz to 10 kHz, again a typical VCR test result.

**User Comment.** Housed in its carrying case, we found the JVC HR-C3U a very handy recorder when used with a handheld or shoulder-mounted video camera. It was impossible, however, to change cassettes or battery packs in this position. To change the battery pack, the entire bottom of the carrying case has to be zipped off, parts of the plastic case have to be pushed away, and the battery pack carefully lined up with an arrow and then snapped into place. When done at home, none of these tasks is a problem, but in the field, without a table or shelf handy, replacing a cassette or battery pack can be a struggle.

Another problem is that the camera cable connector is the only point of video input. It would have taken just one more RCA-type phone jack to be able to connect the output of a tuner, monitor, or a second VCR. With the present scheme, you need a special cable connector adapter.

Aside from these relatively minor complaints, we found the HR-C3U easy to use and versatile. Above all, it produces a good color picture. We were impressed with the smooth operation of the shuttle-search feature, and the fact that, unlike many other VCRs, this unit does not have a noisy solenoid action. While the ability to play the 20-minute compact cassette on a regular VCR through an adapter shell is appealing in and of itself, a further advantage is the possibility of re-recording a number of 20-minute cassettes onto a longer-playing tape. In this way, you can collect live-action scenes, edit and mix them, and then re-use the 20-minute cassette.

—Walter Buchsbaum

CIRCLE NO. 102 ON FREE INFORMATION CARD

# TS1000-ZX81

OWNERS



## WIN \$20,000 or more

KRAKIT™ is an adventure and a treasure hunt for the ZX81 and TS1000 computers. The bank account and prize money actually exist. Be the first to crack the puzzle and the prize is yours. Only one prize will be awarded.

### SOLVE 12 CLUES LIKE THIS!

*Where it all began. Where the torch was first lit. Where muscles and sinews strain. Where our heroes win acclaim. Where the symbols hold the key.*

KRAKIT™ consists of 12 clues on a ready-to-run ZX81 or TS1000 cassette tape (16k RAM). The answer to each clue is the name of a country, a city or town, and a number. If you are the first qualified entrant to solve all 12 clues and declared the winner, you receive two tickets to the city of the secret KRAKIT™ vault location. When you arrive at that location, a check for a minimum amount of \$20,000.00 (U.S.) will be presented to you. The amount of the prize money is augmented weekly.

## TS1000-ZX81

### RULES

1. The first qualified entrant to be confirmed by the judges to have completed all the clues correctly is the winner.
2. There will be one winner only.
3. No persons connected to International Publishing & Software Inc. or their families are eligible to enter KRAKIT™
4. This offer is not valid where prohibited by law.
5. Due to the confidential nature of KRAKIT™ we regret we are unable to enter into any individual correspondence. All the required information, including how to claim the prize, is on the computer tape.
6. The winner will be required to sign an affidavit of compliance with these rules.

**INTERNATIONAL PUBLISHING & SOFTWARE INC.**  
P.O. BOX 1654, BUFFALO, N.Y. 14216

Mail to:  
**INTERNATIONAL PUBLISHING & SOFTWARE INC.**  
P.O. BOX 1654, BUFFALO, N.Y. 14216

Please send \_\_\_\_\_ copies of KRAKIT™ at \$19.95 plus \$1.50 shipping.

Total \_\_\_\_\_ enclosed is  check  money order

Charge to  visa  Mastercard

Name \_\_\_\_\_

Expiry \_\_\_\_\_ Signature \_\_\_\_\_  
*Please Print*

Name \_\_\_\_\_

Address \_\_\_\_\_

City \_\_\_\_\_ State \_\_\_\_\_ Zip \_\_\_\_\_

*Allow 2 weeks for personal checks.*

*Dealer inquiries welcome.*

CIRCLE NO. 13 ON FREE INFORMATION CARD



# Scott Model 458A Integrated Stereo Amplifier

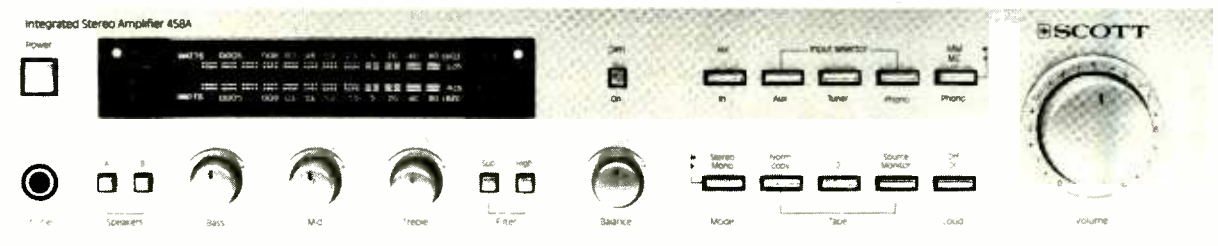

**T**HE 458A, currently heading Scott's line of integrated stereo amplifiers, is rated to deliver 65 watts per channel to 8-ohm loads, between 20 and 20,000 Hz, with no more than 0.03% total harmonic distortion. The 458A has phono preamplification for both moving magnet (MM) and moving coil (MC) cartridges, dual autoranging fluorescent power meters with peak-hold, and pushbutton mode and program selection.

The amplifier, whose metal panel and covers are finished in satin silver, with matching knobs, measures about 17" W × 12¾" D × 3½" H, and weighs 18¼ lb. Its suggested retail price is \$350.

**General Description.** The input program is selected by pressing one of a group of narrow buttons on the panel. They are mechanically interlocked, and operate with a soft, yet positive action. The available sources are AUX, TUNER, and PHONO (another button selects the input termination and preamplifier gain for either a MM or MC cartridge). On the same row of buttons is a stereo/mono selector.

Operating modes are chosen by a second row of controls parallel to the input selectors. These include the tape monitoring and dubbing facilities for 2 tape decks, an ACCESSO-

ry button that inserts the input from a signal processor, and a LOUDNESS button. The large VOLUME knob is to the right of the button groups.

To the left is a dark window behind which are a number of luminous displays that show the operating status of the amplifier. They include LEDs for the selected input source and the status of the amplifier's "Safety" system (whose relay disconnects the speaker outputs in the event of improper operation and during the stabilizing period after the amplifier is first turned on).

The most prominent part of the display consists of two horizontal rows of blue-white fluorescent lights that show the instantaneous output of each channel. The highest reading attained by each row is held for a couple of seconds after the level drops. When the amplifier is first turned on, the calibrated light segments cover the range from 0.0015 watts to 1 watt. If the output exceeds 1 watt, the display range automatically scales upward by a factor of 100, so that the readings cover 0.15 to 100 watts.

The POWER button is to the left of the display window, and below it is an array consisting of the phone jack, small buttons that independently connect the two sets of speaker outputs, the low- and high-cut filter buttons, and three tone

controls (for BASS, MID, and TREBLE ranges). The balance knob to the right of the array completes the front panel control lineup. The tone and balance controls have light center detents, but otherwise all the knobs operate smoothly and continuously.

On the rear apron of the 458A are input jacks for all program sources, plus outputs for the two tape decks and an input/output pair for the accessory connection. The two sets of speaker outputs have insulated spring connectors that accept the stripped end of an insulated lead, gripping it firmly when the connector is released. There are also two switched ac convenience outlets and one unswitched outlet.

We were not provided with a schematic or other specific circuit information for the unit. We can tell you, however, that its power amplifier is direct-coupled internally and to the speakers.

**Laboratory Measurements.** The standard FTC (Federal Trade Commission) preconditioning left the top of the amplifier quite hot, and it became even hotter during our subsequent high power testing. The internal protective system operated effectively to prevent damage to the amplifier, especially when we drove low-impedance loads. (The outputs

# Move up to Microsystems

**THE JOURNAL FOR SOPHISTICATED  
MICROCOMPUTER USERS.**

*Microsystems* is not, in any sense, for beginners. Unlike "personal computer" magazines, *Microsystems* is written *exclusively* for expert users and designers in the software and support hardware field.

If you need a reliable, high-level, up-to-date journal devoted to CP/M,<sup>®</sup> MP/M,<sup>®</sup> MS-DOS,<sup>™</sup> UNIX,<sup>®</sup> XENIX,<sup>™</sup> OASIS and other operating systems, then *Microsystems* is for you. We feature tutorials on the modification and special use of systems, offer short-cut routines, show you debugging procedures, techniques for interfacing, and much more. Our one purpose is to keep the advanced microcomputer professional at the leading edge of DOS development and use.

## **In a few recent issues of Microsystems you would have seen:**

- Reviews of four C compilers: BDS C, Small C, tiny c TWO<sup>™</sup> and Whitesmiths C.
- A programming style comparison: Digital Research PL/I-80<sup>™</sup> vs. Microsoft BASIC.
- Twenty-seven 16-Bit DOS compared.
- Virtual segment procedures under UCSD Pascal.
- An in-depth look at MP/M-80 II<sup>™</sup>.
- A simple 6-byte hexadecimal ASCII conversion routine.
- Using CP/M's undocumented "Autoload" feature.
- An explanation of double density disk controllers.

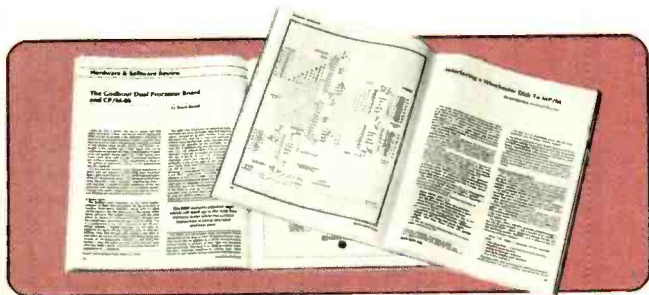

- A comparison of five popular S-100 disk controller cards.
- OS-1—a UNIX-like DOS with a CP/M adapter.

Every issue of *Microsystems* keeps you at the forefront of the industry in customizing software and adapting hardware to meet new requirements and standards. You'll also find industry news, book and new product reviews, plus our regular *Software Directory* listing newly available programs.

To get the high-level systems information you want, join the club of serious microcomputer professionals who subscribe to *Microsystems*. Use the coupon below to order, and save up to 33%!

### **PROFESSIONALS PLEASE NOTE:**

Your subscription to *Microsystems* may be tax deductible. Check with your accountant.

#### **Trademarks:**

XENIX: Microsoft; tiny c TWO: tiny c assoc.; PL/I-80, MS-DOS, MP/M-80 II: Digital Research.

#### **Registered Trademarks:**

CP/M, MP/M: Digital Research; UNIX: Bell Laboratories.



**Microsystems** CN 1987  
Morristown, New Jersey 07960

**YES**, enter my subscription to *Microsystems* for:

- 12 issues at \$19.97—I save 20%.
- 24 issues at \$36.97—I save 26%.
- 36 issues at \$49.97—I save 33%.

Savings based on full 12-issue subscription price of \$24.97.

Mr. \_\_\_\_\_ BH12  
Ms. \_\_\_\_\_

(please print full name)

Company \_\_\_\_\_

Address \_\_\_\_\_

City \_\_\_\_\_

State \_\_\_\_\_ Zip \_\_\_\_\_

**CHECK ONE:**  Payment enclosed.  Bill me later.  
Offer valid in U.S. and possessions only. Please allow 30 to 60 days for delivery of first issue. Satisfaction guaranteed or a prompt refund for unmailed issues.

**NEW SUBSCRIBERS ONLY**



...SCOTT

were disconnected by the relay before the output waveform was clipped by 2-ohm loads.) After a couple of hours of testing, an internal power supply fuse (8-A, slow-blow) opened up, although we believe this to be the result of a long period of abnormal operation at high power with low impedance, rather than to any output condition. Replacing the soldered-in fuse would normally take a serviceman.

The outputs clipped at 73 watts per channel into 8 ohms, and 80 watts into 4 ohms, corresponding to an 8-ohm clipping headroom of 0.52 dB. With 2-ohm loads (for which the amplifier is not rated) the outputs were disconnected by the protective relay at about 85 watts, with both channels driven, and at about 128 watts with only one channel driven. In neither case was any waveform clipping visible before the relay operated.

With the pulsed 20-millisecond signal of the dynamic headroom test, the output clipped at 156 watts into 8 ohms, corresponding to a very high dynamic headroom rating of 3.8 dB. With 4- and 2-ohm loads, the protective relay was triggered before waveform clipping was seen, at respective outputs of about 148 and 118 watts per channel.

With both channels driving 8-ohm loads at 1000 Hz, the distortion was unmeasurable below 10 watts (being masked by system

noise). It was between 0.002 and 0.005% from 10 to 70 watts, just below the clipping point. Driving 4-ohm loads, the distortion readings were only slightly higher, from 0.004% at 10 watts to 0.013% at 70 watts. As usually happens, the distortion was even higher with 2 ohms, rising from 0.011% at 1 watt to 0.11% at 40 watts and 0.22% at 90 watts.

With 8-ohm loads, the distortion at the rated 65 watts varied from 0.01% at 20 Hz, to less than 0.003% in the midrange, and a maximum of 0.021% at 20,000 Hz. It was very similar at lower power outputs. The IHF-IM distortion was measured with equal amplitudes of 18 and 19 kHz, whose peak value was equal to that of a 65-watt sine wave. The third-order distortion at 17 kHz was -72 dB (relative to 65 watts) and absolutely no second-order distortion (at 1000 Hz) could be detected down to our measurement floor of -100 dB.

At maximum gain, the 458A required an input of 18.5 millivolts (AUX) for a reference output of 1 watt. The A-weighted S/N was 76.4 dB. The PHONO sensitivity was 0.29 millivolts (MM) or 30 microvolts (MC), and the S/N for the MM input was a very good 77.7 dB. The S/N could not be measured for the MC, but in listening tests it was audibly poorer than for the MM input. The MM input overloaded at inputs between 136 and 160 millivolts, depending on frequency. The phono MM input impedance was 49

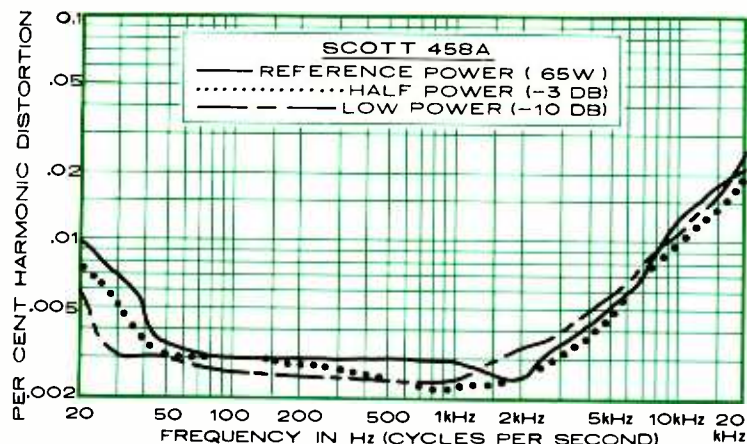

Total harmonic distortion with both channels driven into 8 ohms.

## CONTROLS AND INDICATORS

### FRONT PANEL

#### Pushbuttons:

STEREO/MONO MODE; INPUT SELECTORS (AUX, TUNER, PHONO); PHONO SELECTOR (MM/MC).

ACC (OUT/IN): Permits connection of signal processing accessory through rear jacks.

TAPE: SOURCE/MONITOR; recorder selector (1, 2); dubbing selector (NORM/COPY).

LOUD: Connects loudness compensation to volume control circuit.

POWER: Turns power to amplifier ON/OFF.

SPEAKERS: Two buttons, (A,B).

FILTER: Two buttons (SUB, HIGH).

#### Knobs:

Tone Controls (BASS, MID, TREBLE): Center detented.

BALANCE: Center detented.

VOLUME.

Jack: PHONES.

#### Indicators:

INPUT: Red LEDs for AUX, TUNER, PHONO, TAPE.

SAFETY: Red LED flashes while amplifier protective system is operating.

Power Output: Two parallel horizontal rows of fluorescent light segments. Readings from 0.0015 to 1.00 W and 0.15 to 100 W (autoranging). Peak hold for about 2 seconds.

### REAR APRON

Phono jacks: L and R pairs for PHONO, TUNER, AUX input, TAPE 1 REC and PLAY, TAPE 2 REC and PLAY, ACCESSORY IN and OUT.

Speakers: Insulated output connectors for two sets of speakers (A, B).

AC Outlets: Three (two switched).

kilohms in parallel with a relatively high capacitance of 270 pF. The MC phono input resistance was 370 ohms.

The amplifier was stable with a variety of reactive loads, simulating loudspeaker operation. Its Slew Factor was greater than our measurement limit of 25. The power output indications were all somewhat higher than the actual output (by about 40 to 50%).

The RIAA phono equalization of the preamplifier section was accurate within +1 dB from 20 to 20,000 Hz. With the tone controls centered, and the volume set to the reference gain (1 watt output for 0.5 volt input) the frequency response was within  $\pm 0.5$  dB from 20 to 13,000 Hz, falling to -1.5 dB at 20,000 Hz. The bass tone control turnover frequency varied from under 100 Hz to about 500 Hz as the

...SCOTT

control was varied, and the treble curves were hinged at about 2000 Hz. The midrange control affected much of the audio bandwidth, from about 300 to 10,000 Hz, with the maximum in the 1000 to 2000 Hz range. Its maximum boost of about 7 dB however, prevented it from having an excessive effect on the sound balance.

At maximum volume, the high frequencies rolled off above 5000 Hz, to -5 dB at 20,000 Hz. The SUB filter reduced the response by about 3 dB in the 70-to-100-Hz range, and the HIGH filter response was down 3 dB at 2500 Hz. Both had gradual slopes of 6 dB per octave beyond their cutoff frequencies. The loudness compensation boosted both low and high frequencies at low volume settings. (The high-frequency boost was much less than that for the low frequencies.)

**User Comment.** The measurements show, and our ears confirm, that the Scott 458A is a top-quality amplifier. Although its power rating is modest by contemporary standards, the rating itself is conservative. In fact, it has an exceptional short-term power capability (particularly when driving very low impedance loads) and a very high dynamic headroom with 8-ohm loads. In other words, it is a lot more amplifier than its ratings suggest!

Operation of the controls adds to a feeling of precision that one gets when using this amplifier. Everything works smoothly and silently, and we had the distinct impression that when an input selector was pressed, the change of program took place smoothly over a short time period (a fraction of a second) instead of in the usual abrupt manner.

The instruction booklet is generally adequate, but I felt that some of the amplifier's features were not explained sufficiently. For example, there is no elaboration of the possible role of the accessory signal connector. I wondered if it might be used in lieu of separate preamplifier outputs and power amplifier inputs (perhaps the only worthwhile feature Scott has omitted). According-

ly, it was necessary to experiment to discover what a simple block diagram would have told us—that this circuit follows the tape monitoring circuits, but it comes before the volume control, and therefore cannot be used to separate the preamp from the power amp.

All in all, we had strongly positive feelings about the Scott 458A. Even a blown fuse did not dampen our enthusiasm, since we doubt that

it could ever blow in a normal home music system. (Ordinarily, we take a dim view of internal fuses, especially soldered-in fuses, because of the hassle involved when a consumer tries to replace them.) In hours of normal operation, however, the top of the 458A became only slightly warm in contrast to the almost sizzling temperatures during some of our tough tests. —Julian Hirsch

CIRCLE NO. 101 ON FREE INFORMATION CARD

# VIC20

# PERSONAL COMPUTER

## TOP 10 ARCADE GAMES

VIC-20 TAPE PROGRAM SALE!!

Rank	Name	List	Sale
1.	Super Paratrooper (Fantastic)	\$24.95	\$19.95
2.	Exterminator-Plus (Better than Centipede)	\$24.95	\$19.95
3.	Cricket (Better than Frogger)	\$24.95	\$19.95
4.	3-D Hackman (3-Dimensional)	\$24.95	\$19.95
5.	Snackman (Better than Packman)	\$19.95	\$15.95
6.	Bug Blast (Creepy)	\$19.95	\$16.95
7.	Anti Matter Splatter (Nuclear Disaster)	\$24.95	\$19.95
8.	Bombs Away (Great)	\$18.95	\$15.95
9.	3-D Maze-Escape	\$16.95	\$14.95
10.	Krazy Kong	\$16.95	\$14.95

**BUY ANY FOUR — DEDUCT 10% MORE**

## VIC-20 ACCESSORY SALE!!

**1. TRACTION-FRICTION LINE PRINTER** This new COM-STAR deluxe printer, prints 8½" x 11" full size letter quality single, roll or fan fold paper, labels and etc. Impact dot matrix bi-directional 40, 66, 80, 132 columns. Includes interface cable that plugs direct into the VIC-20 computer, no other costly interface is needed. List \$599.00 — Sale \$399.00.

**2. UP TO 60K EXPANSION MODULE** Aero Space designed—6 slot—add up to 6 cartridges— switch select any program. Start and stop any program with reset button—not necessary to remove cartridges or turn off computer, saves time, television and computer (one year warranty) List \$149.00 — Sale \$89.00.

- 10 DAY FREE TRIAL
- WE HAVE THE LOWEST PRICES
- ONE DAY DELIVERY EXPRESS MAIL
- FREE CATALOGS
- WE LOVE OUR CUSTOMERS!

# PROTECTO

## ENTERPRIZES (FACTORY-DIRECT)

BOX 550, BARRINGTON, ILLINOIS 60010  
Phone 312/382-5244 to order

CIRCLE NO. 40 ON FREE INFORMATION CARD





camera. Since the combined current consumption of the receiver and decoder is only 13 mA and the camera's batteries are rated at 1200 maH, the additional load is not significant so long as the power is switched off between flights.

Together with four nylon suspension lines and some snap swivels, the package in Fig. 3 weighs 12 oz. The first system I assembled, which used an RC system salvaged from a toy car, required a 9-V battery and weighed a full pound.

Ace R/C's special applications receiver weighs less than the Aero Sport receiver and can trigger a disc camera *without* a decoder circuit. It requires a 3-V (or 2.4-V) supply, however, and cannot be directly powered by the camera's 6-V supply.

**Borrowing Power from the Camera.** There are two ways to connect leads to the 6-V lithium battery in the disc camera. One is to carefully solder wrapping wire to the exposed portions of the wires to which the two series connected lithium cells are terminated. Solder the leads to the bare wire in the small gap between the insulated portion and the terminal.

A better method, the one I've used, is to solder wrapping wire to the termination points of the battery leads on the back side of the circuit board. The points can be located visually and confirmed with a voltmeter.

**Caution:** Should you choose to power your system by borrowing current from the camera, it is *absolutely essential* that you follow *all* the procedures and safety precautions given in Part 1 of this series (November 1982). (If you've misplaced Part 1, you can find a copy of it at most libraries.) You must also abide by the precautions printed on the lithium batteries: "CAUTION! May explode, leak, and/or flame if crushed, cut, soldered, short circuited, connected backwards, recharged, heated, or disposed of in fire."

**Rigging the Airborne Package.** After experimenting with various rigging arrangements, I've settled upon the straightforward approach shown in Fig. 4.

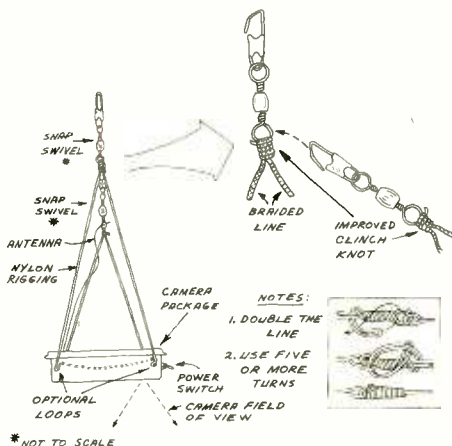

Fig. 4. Rigging the airborne camera package.

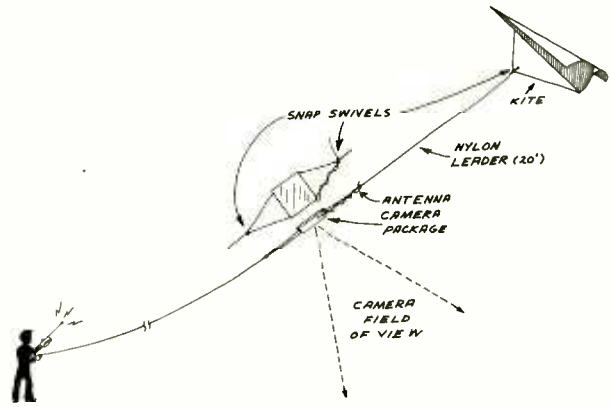

Fig. 5. Taking an oblique-away photo from kite.

Variations of this four-line rigging can be attached to a kite line to provide vertical and two kinds of oblique photos. It's also well suited for use with balloons.

Referring to Fig. 4, form each pair of rigging lines from a single high-strength, braided-nylon line several feet long. Tie two knots, each with an extension loop, about 5" apart and equidistant from the ends of each line. Pass the ends of the lines through the inside of adjacent holes in the box. The knots will secure the lines in place. Later, when the camera is flown from a kite, the loops can be pulled through the holes to provide tie down points for additional rigging that permits oblique photography toward the kite flier.

**Flying the Camera from a Kite.** The thrill of flying a camera from a kite hundreds of feet in the air or the total helplessness of watching it suddenly dive to within inches of hard rocks or deep water before zooming back to its former altitude is indescribable. Best of all is the ability, when the wind is right, to maneuver the camera directly over a sailboat mast, palm trees, tall signs, and even flying birds!

You'll need a sturdy, reliable kite to accomplish these aerial feats. Many different homemade kites can be fashioned from readily available materials, and you can find excellent books on their design and construction at a library. An early (1929) book reissued by Dover Publications is Leslie L. Hunt's "25 Kites That Fly." Mr. Hunt was formerly a kite maker for the U.S. Weather Bureau.

I have used with excellent results a 3' x 6' nylon Spinnaker™ delta kite manufactured by Spectra Star Kites. The kite is available in six color patterns and retails for \$22.00. When properly rigged, these kites will lift a full pound in a 15-mph wind.

There are several ways to attach the disc camera package to a kite line. Figure 5, for example, shows how the camera package is rigged to provide oblique photos in the direction *away* from the kite flier. This simple rigging arrangement resists camera swing and is easy to fly. The rigging holes must be near the top of the camera package to prevent the package from flipping over high in the air.

The attachment in Fig. 5 is ideal for aerial views of the horizon. Many of the photos I've made resemble those taken from the window of an aircraft. The major drawback is the guesswork required to "aim" the camera.



Figure 6 shows how the camera is rigged to provide oblique photos in the direction *toward* the kite flier. The camera package's four nylon lines are connected together and to the kite's leader. A halter made from four clear fishing leaders having a test strength of at least 20 lb. each is attached via snap swivels to the loops on the camera package rigging (Fig. 4). All four leaders are terminated at a single size-6 (or larger) snap swivel which is then connected to the main kite line.

To prevent the camera package from rotating or taking tilted photos, it may be necessary to use a counterweight. I slipped a  $\frac{1}{4}$ " x 36" wood dowel under the heavy-duty rubber band that secures the camera package's cover. A length of brightly colored plastic streamer was slipped through a small eyescrew in the end of the dowel to provide a convenient visual reference of the camera's orientation when it is high in the air.

I've used the rigging in Fig. 6 to photograph my family feeding seagulls from the vantage point of the gulls. I've also used it to photograph the stern of a tour boat from the stern of the same boat, and my car from an altitude of 545'. Surprisingly, the barely visible halter through which the photos are taken does not detract from their appearance.

Figure 7 shows how the camera is rigged for vertical photographs. The stabilizer boom prevents camera rotation. It does not, however, eliminate camera swing. To avoid blur, trigger the camera only when it is not swinging.

**Kite Flying Tips.** I've flown my RC cameras from kites as high as 550' over both land and water and have obtained hundreds of aerial photos. Here are some kite flying tips I've learned:

1. Flying a camera kite can be both tricky and busy at times. It helps to have someone to hold the RC transmitter and to stay with the equipment while you rescue a downed kite or walk one down.
2. Unless you design a kite to which the camera package is directly attached, insert a 20' leader between the camera and the kite. This will allow the kite to gain altitude and stability before it's required to lift any weight.
3. Always use quality nylon line. Braided line is best. I always use at least 50-lb test line with a Spectra Star delta.
4. Flying a payload from a kite requires a stiff breeze. I've found that the camera package will swing wildly and strike the ground if the wind is under 12-15 mph.
5. Avoid flying downwind from hills, buildings, bridges, signs, and other obstacles that cause turbulence.
6. If the wind is strong, be sure to protect your hands from the possibility of painful burns by wearing gloves.
7. Practice flying with a dummy payload before flying the real thing. Flying a working kite is a unique experience, and you'll learn valuable skills that may later save your camera package from a possible crash.
8. Observe appropriate safety precautions such as not flying your camera kite near airports, power lines,

Fig. 6. Oblique-in photo arrangement from kite.

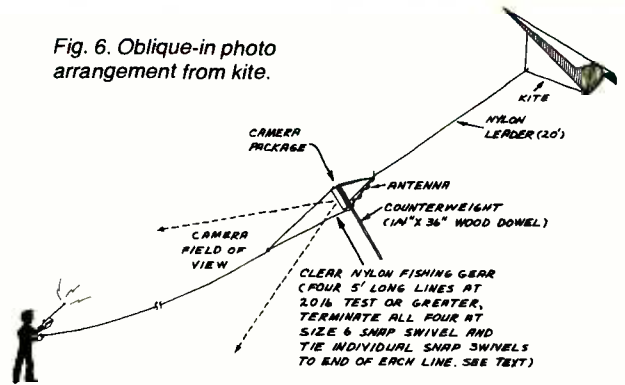

Fig. 7. Taking vertical photos from a kite.

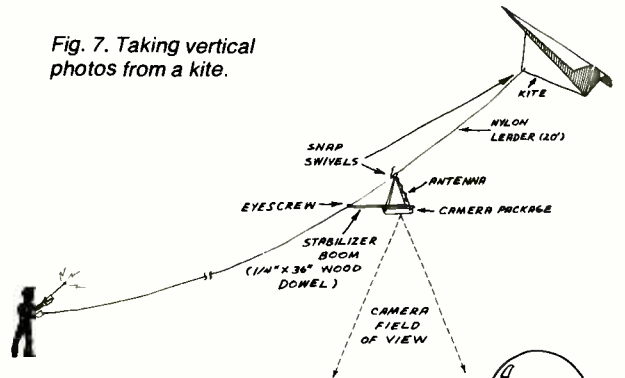
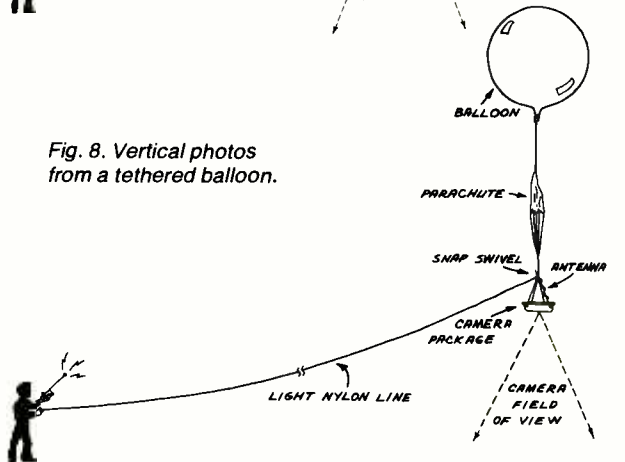

Fig. 8. Vertical photos from a tethered balloon.



buildings, highways, and other potentially hazardous locations.

9. Finally, never fly your camera kite when it is raining or with a wire tether or a two-conductor remote switch attachment. Researchers have measured potentials as high as 50,000-V on the lines of wire-tethered kites flown on perfectly clear days!

**Flying the Camera from a Balloon.** I've found a balloon to be the best lifting device for pinpoint aerial photography. Unlike a kite, a balloon can be easily guided directly over an area of interest without guesswork or the help of an assistant to tell you where the camera is pointing. Unfortunately, balloon flying is riskier and requires almost perfectly calm air. Furthermore, preparing for a flight entails considerably more expense and time than does a kite launch.

First, a source of helium must be found. Welding and party shops sell the gas and, depending upon the volume of the cylinder, you can expect to pay 23¢ or more

...EXPERIMENTER'S CORNER

per cu. ft. plus a deposit for the cylinder and regulator. Good balloons are more difficult to find than helium. I've spent \$18 each for heavy-duty 4' diameter rubber balloons.

To fly a camera balloon in a breeze requires an aerodynamically shaped balloon. The minimum cost for such balloons, which require a hundred or more cu. ft. of gas, is several hundreds of dollars.

Helium lifts about 1.1 oz. per cu. ft. Allowing a 15% excess lift margin and assuming a *total* airborne package weight of 16 oz. (camera system, balloon, parachute and tether), you'll need about 17 cu. ft. of gas. This implies a spherical balloon having a diameter of about 3.2'.

While this seems like an ideal arrangement for a 3' diameter balloon, I've learned the hard way *never* to fill a balloon to its rated capacity. You can avoid the unpleasant experience of having an expensive balloon full of equally expensive helium burst in your face by filling your balloons to only half to two-thirds their rated capacity. This implies using a 4' or 5' diameter balloon or two or more smaller balloons.

The advantage of using two or more balloons is that, should one burst, the camera package will descend to earth relatively slowly rather than crashing outright. I discovered this firsthand when one of two balloons popped a hundred feet over my house.

The advantage of a single, large balloon is simplicity. In case of catastrophe, however, you will need to include a lightweight parachute between the balloon and camera to protect the camera and any people below it (see Fig. 8).

**Balloon Flying Tips.** My balloon flying experiences have brought home some important lessons about flying a camera from a tethered balloon. Here are some key pointers:

1. Fly only when the air is *perfectly* calm. Otherwise, the balloon will drift with the breeze and begin to descend and vibrate when it reaches the end of its tether.
2. Check the atmospheric conditions with a small pilot balloon before inflating and launching the camera rig. Keep the small balloon tied nearby to a 20' tether. If the breeze blows it down, do not fly your camera rig.
3. Use only helium to inflate your balloons. Hydrogen and other lighter-than-air gases are highly flammable.
4. Tie the tether between the parachute and the camera package. Be sure to tie the free end of the tether to a heavy object. If you need to run toward the balloon, you can drop the tether without fear of losing the balloon.
5. Avoid jerking the tether when the balloon is flying low over trees. You may pull the tether and the balloon down into the branches.
6. If you use multiple balloons, rig them so the suspension lines do not rub against any balloon. Otherwise, the balloon may burst.
7. Never use a metallic tether or a two-conductor remote switch arrangement.
8. Avoid flying a balloon near airports, power lines, and high buildings. ♦

# Microline 83A



**\$694.88 UPS DELIVERED**

- 120 characters per second, bi-directional, logic-seeking print action
- Full 136 columns. 10, 16, 5 & 8 cpi, true U/I case (9-pin printhead)
- Both parallel & RS-232C interfacing standard
- Tractor & friction feed with rear & bottom paper paths
- Okigraph ROM for the Microline 83A. .... \$44.88

### ANADIX

Anadix DP-9500A .....	\$1459.88
Anadix DP-9501A .....	\$1459.88
Anadix DP-9629A .....	\$1549.88

### CENTRONICS

Centronics 129-1 .....	\$829.88
Centronics 129-3 .....	949.88
Centronics 352 .....	\$1649.88
Centronics 353 .....	\$2324.88

### C. ITOH

8510 Prowriter .....	\$499.88
w/RS-232C .....	\$614.88
1550 Prowriter 2 .....	\$734.88
w/RS-232C .....	\$794.88

C.Itoh F-10 Starwriter, 40 cps	
Parallel or RS-232C .....	\$1499.88
C.Itoh F-10 Printmaster, 55 cps	
Parallel or RS-232C .....	\$1799.88
F-10 Tractor .....	\$289.88

### DAISYWRITER

Daisywriter 2000 .....	\$1089.88
Daisywriter Tractor .....	\$149.88
Daisywriter Cable .....	\$49.88

### DATASOUTH

Datasouth DS-180 .....	\$1369.88
------------------------	-----------

### DIABLO

Diablo 62C .....	\$1349.88
Diablo 63C .....	\$2264.88
Diablo 63C KSR .....	\$2794.88
630 Tractor .....	\$314.88

### DMP

DMP-85 Printer .....	\$469.88
----------------------	----------

### IDS

IDS Microprism .....	\$684.88
IDS Prism 80 .....	\$1174.88
Prism 80 w/4-color .....	\$1539.88
IDS Prism 132 .....	\$1254.88
Prism 132 w/4-color .....	\$1699.88

### OKIDATA

Microline 8U .....	\$349.88
Microline 82A .....	\$439.88
80/82A Tractor .....	\$59.88
82A Roll Paper Holder .....	\$49.88
82A Okigraph ROM .....	\$44.88
Microline 84 w/graphics, tractor	
Parallel, 200 cps .....	\$1044.88
RS-232C, 200 cps .....	\$1164.88

### NEC

NEC PC-8023A-C .....	\$509.88
NEC 3500RD .....	\$1649.88
NEC 3510 .....	\$1929.88
NEC 3530 .....	\$1809.88
NEC 3550 .....	\$2199.88
3500 Tractor .....	\$239.88
NEC 7710 .....	\$2559.88
NEC 7730 .....	\$2559.88
7700 Tractor .....	\$359.88

### QUME

Qume Sprint 9/45 .....	\$2109.88
------------------------	-----------

### SMITH-CORONA

Smith Corona TP-1 .....	\$599.88
10 or 12 cpi, parallel or RS-232C	

**Information & Orders**  
**(603)-673-8857**

Orders Only: (800)-343-0726

**NO HIDDEN CHARGES**

FREE UPS shipping on all orders—No extra charge to use credit cards—All equipment shipped factory fresh with manufacturer's warranty—COD orders accepted (\$10 fee added)—No purchase orders accepted—No foreign or APO orders accepted—Minimum \$50 per order—Prices subject to change

HIGH TECHNOLOGY AT AFFORDABLE PRICES

# THE BOTTOM LINE

Milford NH 03055-0423

CIRCLE NO. 7 ON FREE INFORMATION CARD



# ENGLISH BROADCASTS

## Audible in

# No. A MERICA

By Glenn Hauser

### STATEMENT OF OWNERSHIP, MANAGEMENT AND CIRCULATION (Required by 39 U.S.C. 3685)

- Title of Publication: Computers & Electronics (formerly Popular Electronics)
  - Publication No. 00324485
- Date of filing: October 1, 1982
- Frequency of issue: Monthly
  - No. of issues published annually: 12
  - Annual subscription price: \$15.97

4. Location of known office of publication: One Park Avenue, New York, New York 10016.

5. Location of the headquarters or general business offices of the publishers: One Park Avenue, New York, New York 10016.

6. Names and complete addresses of the publisher, editor, and managing editor: Publisher: Joseph E. Mesics, One Park Avenue, New York, New York 10016; Editor: Arthur P. Salsberg, One Park Avenue, New York, New York 10016. Managing editor: John R. Riggs, One Park Avenue, New York, New York 10016.

7. Owner: Ziff-Davis Publishing Company, One Park Avenue, New York, New York 10016; Ziff Corporation, One Park Avenue, New York, New York 10016

8. Known bondholders, mortgagees, and other security holders owning or holding 1 percent or more of total amount of bonds, mortgages or other securities: None.

#### 10. Extent and Nature of Circulation:

	Average		Actual No. Copies of Single Issue Published Nearest to Filing Date
	No. Copies Each Issue During Preceding 12 Months	No. Copies of Single Issue Published Nearest to Filing Date	
A. Total no. copies printed (net press run)	573,177	539,763	
B. Paid circulation			
1. Sales through dealers and carriers, street vendors and counter sales	98,835	92,400	
2. Mail subscriptions	311,618	303,029	
C. Total Paid Circulation (sum of 10B1 and 10B2)	410,453	395,429	
D. Free distribution by mail, carrier or other means, samples, complimentary, and other free copies	81,227	55,705	
E. Total distribution (sum of C and D)	491,680	451,134	
F. Copies not distributed			
1. Office use, left over, unaccounted, spoiled after printing	2,163	1,529	
2. Returns from news agents	79,334	87,100	
G. Total (sum of E, F1, and 2 —should equal net press run shown in A)	573,177	539,763	

11. I certify that the statements made by me above are correct and complete.

WILLIAM L. PHILLIPS,  
Assistant Treasurer

TIME EST	TIME UTC/GMT	STATION	QUAL.	FREQUENCIES, kHz <sup>2</sup>
4:00-4:15 a.m.	0900-0915	BBC	A	15070, 11955, 11750, 9640, 9510, 6195
4:00-4:30 a.m.	0900-0930	R. Japan <sup>4</sup>	B	15195, 9505
4:00-5:30 p.m.	0900-1030	R. Australia	B	15115
4:00-5:00 a.m.	0900-1000	AFRTS, Los Angeles	A	9590, 9530, 6030
4:00-6:00 a.m.	0900-1100	FR3, New Caledonia	C	11710, 7170
4:15-6:00 a.m.	0915-1100	BBC	C	17790, 15070, (21660 Sat. & Sun. and daily from 1030), 11750, 9740
4:30-5:00 a.m.	0930-1000	AWR, Portugal	C	9670 (Sun. only)
4:30-5:20 a.m.	0930-1020	V. of Germany	C	17800, 17780, 15275
5:00-5:30 a.m.	1000-1030	V. of Vietnam	C	12036, 10080
5:00-6:00 a.m.	1000-1100	R. Japan	C	15235, 11875
5:00-6:00 a.m.	1000-1100	R. Korea	B	9570
5:00-6:00 a.m.	1000-1100	All India Radio	C	17875
5:00-6:00 a.m.	1000-1100	AFRTS, Los Angeles	A	11805, 9700, 9590, 9530, 6030
5:00-fade out	1000-	R. Australia	B	6045, 5995
5:00-8:00 a.m.	1000-1300	R. Moscow (via Cuba)	B	9600
5:00-11:02 a.m.	1000-1602	ABC, Perth	B	9610, 6140
5:10-12:00 a.m.	1010-1700	V. of Nigeria	C	15120
5:15-5:45 a.m.	1015-1045	UN Radio	B	15250, 13860-SSB, 9565 (Sat.)
5:30-6:30 a.m.	1030-1130	Sri Lanka Br. Corp.	C	17850, 15120, 11835 (not all Eng.)
6:00-6:30 a.m.	1100-1130	R. Japan	B	9505
6:00-6:30 a.m.	1100-1130	V. of Vietnam	C	12036, 10080
6:00-6:30 a.m.	1100-1130	R. Mogadishu	D	9585
6:00-6:56 a.m.	1100-1156	R. RSA	C	25790, 21535, 15220
6:00-7:00 a.m.	1100-1200	V. of Asia, Taiwan	C	5980 (Sun. 1030-1040)
6:00-7:00 a.m.	1100-1200	AFRTS, Los Angeles	A	6030
6:00-7:50 a.m.	1100-1250	R. Pyongyang	C	9977, 9740
6:00-8:00 a.m.	1100-1300	VOA	B	21840, 11715, 9760, 9565, 6110
6:00-8:00 a.m.	1100-1300	TWR-Bonair	A	11815 (Sat. & Sun. 1100-1330)
6:00-8:00 a.m.	1100-1300	R. Australia	A	9580
6:00-8:30 a.m.	1100-1330	BBC	A-B	25650, 21710, 21660, 21550, 21470, 11775, 11750, 9740, 9510, 6195
6:00-9:00 a.m.	1100-1400	4VEH, Haiti	C	11835, 9770
6:00-12:00 a.m.	1100-1700	AFRTS, Los Angeles	A	15430, 15330, 11805, 9700
6:15-6:30 a.m.	1115-1130	Vatican R.	C	21485, 17840 (not Sun.)
6:30-6:55 a.m.	1130-1155	R. Nacional, Angola	D	11955, 9535 (Mon.-Fri.) (irreg.)
6:30-7:10 a.m.	1130-1210	R. Polonia	D	17865, 11840, 9675, 9525
6:30-7:30 a.m.	1130-1230	R. Thailand	C	11905, 9655
6:45-7:15 a.m.	1145-1215	R. Malaysia Sabah	C	5980, 4970
6:58-9:00 a.m.	1158-1400	CBC Northern Service	B-C	9625, 6065 (not all Eng.)
7:00-7:15 a.m.	1208-1215	V. Of Kampuchean People	C	11938, 9694 (vary)
7:00-7:20 a.m.	1200-1220	Vatican R.	B	21485, 17840 (not Sun.)
7:00-7:25 a.m.	1200-1225	R. Finland	B	15400, 21475 (not Sun.)
7:00-7:30 a.m.	1200-1230	Kol Israel	C	25640, 21625, 21495, 17630, 15605, 15585
7:00-7:30 a.m.	1200-1230	R. Tashkent	C	11785, 9540, 6025, 5945
7:00-7:30 a.m.	1200-1230	HCJB, Ecuador	A	26020, 15115, 11740
7:30-7:55 a.m.	1200-1255	R. Peking	B	9820
7:00-9:00 a.m.	1200-1400	WRNO, New Orleans	A	9715 (Sun.) (not all Eng.)
7:00-9:00 a.m.	1200-1400	R. Moscow World Service	B	15150, 15135, 12030, 11720, 9750, 9580
7:00-9:00 a.m.	1200-1400	WYFR, Family R.	A	21545, 17785, 11830
7:00 a.m.-1:00 p.m.	1200-1800	R. Peking	C	11600
7:00-7:35 a.m.	1200-1235	R. Ulan Bator, Mongolia	C	12070, 6383 (not Sun.)
7:30-7:55 a.m.	1230-1255	R. Tirana	D	11960, 9515
7:30-7:57 a.m.	1230-1257	Austrian R.	B	21615
7:30-8:00 a.m.	1230-1300	R. Bangladesh	D	15282, 17743 (variable)
7:30-8:15 a.m.	1230-1315	V. of Germany	B	21600
7:30-9:30 a.m.	1230-1430	SLCB, Sri Lanka	C	15425, 9720
7:30-9:30 a.m.	1230-1430	HCJB, Ecuador	A	26020, 17885, 15115, 11740
7:35-7:45 a.m.	1235-1245	V. of Greece	C	17560, 15050, 11645 (Mon.-Sat.)
8:00-8:25 a.m.	1300-1325	R. Canada International	A	17860, 15440, 11955, 11855, 9575 (Mon.-Fri.)
8:00-8:25 a.m.	1300-1325	R. Finland	B	21475, 15400 (Mon.-Sat.)
8:00-8:30 a.m.	1300-1330	R. Bucharest	A	17850, 15250, 11940
8:00-8:45 a.m.	1300-1345	R. Japan	B	9505
8:00-9:00 a.m.	1300-1400	VOA	A	21840, 15205, 11715, 9760, 9565
8:00-9:00 a.m.	1300-1400	R. Australia	C	9770
8:00-10:57 a.m.	1300-1557	R. RSA	B	25790, 21535, 15220
8:15-8:45 a.m.	1315-1345	Swiss R. International	B	25780, 21570, 21520, 17830, 15305
8:30-9:15 a.m.	1330-1415	R. Berlin International	C	21465
8:30-9:20 a.m.	1330-1420	R. Nederland	C	17605, 11930
8:30-9:30 a.m.	1330-1430	R. Korea	C	9750
8:30-9:30 a.m.	1330-1430	V. of Turkey	C	15125
8:30-9:30 a.m.	1330-1430	V. of Vietnam	C	15010, 10040
8:30-10:00 a.m.	1330-1500	All India R.	C	15335, 11810

8:30-10:25 a.m.	1330-1525	R. Finland	B	21475, 15400 (Sun.)
8:30-11:00 a.m.	1330-1600	BBC	B-C	25650, 21710, 21660, 21550, 21470, 15400 (from 1430), 15070, 11750
8:30-11:00 a.m.	1330-1600	R. Malaysia Sabah	C	5980, 4970
8:30 a.m. -fade	1330-	R. Australia	B	6060
8:30 a.m.-5:00 p.m.	1330-2200	R. Moscow World Service (via Cuba)	B	11840
8:57-11:55 a.m.	1357-1655	V. of Philippines	D	9578 (Sun.-1556) (not all Eng.)
9:00-9:25 a.m.	1400-1425	R. Finland	C	25950, 15400 (Mon.-Sat.)
9:00-9:30 a.m.	1400-1430	KTWR, Guam	C	9505
9:00-9:30 a.m.	1400-1430	R. Norway	B	26030, 25730, 21730, 21700, 17830 (Sun.)
9:00-9:30 a.m.	1400-1430	R. Sweden	B	21615
9:00-9:30 a.m.	1400-1430	V. Rev. Party, N. Korea	D	4557, 4109
9:00-9:30 a.m.	1400-1430	R. Tashkent	C	11785, 9600, 9540, 6025, 5945
9:00-9:35 a.m.	1400-1435	R. Ulan Bator	C	12070, 9575 (not Sun.)
9:00-9:45 a.m.	1400-1445	BRT, Belgium	B	21810, 17915 (Mon.-Fri.)
9:00-10:00 a.m.	1400-1500	WYFR, Family Radio	A	15215, 17785, 21545
9:00-10:00 a.m.	1400-1500	R. Moscow World Service	A	30300, 15150, 15135, 12030, 11900, 11720, 9750, 9580
9:00-10:00 a.m.	1400-1500	R. Malaysia Sarawak	C	7160, 4950
9:00-10:00 a.m.	1400-1500	V. of Indonesia	C	15200 or 15150, 11789
9:00-10:00 a.m.	1400-1500	VOA	A	26040, 21840, 15205, 11715, 9760, 9565, 6110
9:00-11:00 a.m.	1400-1600	WRNO, New Orleans	A	11940 (Sun.) (not all Eng.)
9:00-12:00 a.m.	1400-1700	CBC Southern Service	A	17820, 11955 (Sun.)
9:00-12:30 a.m.	1400-1730	R. Australia	C	17795, 9770, 9710
9:00 a.m.-6:30 p.m.	1400-2330	CBC Northern Service	C	11720, 9625 (not all Eng.)
9:30-10:25 a.m.	1430-1525	N. Nederland	B	21480, 17605, 11740
9:30-10:30 a.m.	1430-1530	HCJB, Ecuador	A	26020, 17885, 15115 (Sat. & Sun. 1430-1600)
9:30-11:00 a.m.	1430-1600	Burma Br. Ser.	D	5985, 5040
9:30 a.m.-5:00 p.m.	1430-2200	UN Radio	A	21670, 21625, 15410, 15120 (when in session)
9:35-10:20 a.m.	1435-1520	R. Nepal	D	3425, 7105 or 9589
9:45-10:20 a.m.	1445-1520	R. Ulan Bator	C	12070, 9575 (not Sun.)
10:00-10:30 a.m.	1500-1530	V. of Asia, Taiwan	D	5980 (not Sun.)
10:00-10:50 a.m.	1500-1550	V. of Germany	C	21600
10:00-11:00 a.m.	1500-1600	VOA	A	26040, 21840, 15205, 9760, 9565, 6110
10:00-11:00 a.m.	1500-1600	V. of Rev. Ethiopia	D	9560
10:00-11:00 a.m.	1500-1600	FEBA, Seychelles	C	11895, 15320†
10:00-11:00 a.m.	1500-1600	V. of Nigeria	C	11770 (varies)
10:00-11:00 a.m.	1500-1600	KTWR, Guam	C	9505
10:00-11:00 a.m.	1500-1600	BBC	B	17830, 15260 (Sat., Sun.)
10:00-11:00 a.m.	1500-1600	R. Moscow World Service	C	30300, 15150, 12050, 12010, 11900, 11720, 9580
10:00-11:00 a.m.	1500-1600	WYFR, Family Radio	A	15365, 15215, 17785, 21545
10:00-12:30 a.m.	1500-1730	BSHKJ, Jordan	D	9560
10:30-11:00 a.m.	1530-1600	R. Yugoslavia	C	15415
10:30-11:00 a.m.	1530-1600	Swiss R. International	B	21570, 17830
10:30-11:30 a.m.	1530-1630	V. of Vietnam	C	17560, 15010
10:35-10:45 a.m.	1535-1545	V. of Greece	C	17555, 15050, 11645 (Mon.-Sat.)
10:37-10:45 a.m.	1537-1545	R. Canada International	A	21695, (17820 Mon.-Sat.), 15325
11:00-11:15 a.m.	1600-1615	Vatican R.	C	17730
11:00-11:15 a.m.	1600-1615	R. Pakistan	C	21486, 17660, 17640, 15565, 15530
11:00-11:30 a.m.	1600-1630	R. Portugal	C	21685 (not Sun.)
11:00-11:30 a.m.	1600-1630	R. Norway	B	25730, 25615, 21725, 17875 (Sun.)
11:00-12:00 a.m.	1600-1700	VOA	A	26040, 21840, 15430, 15205, 9760, 6110
11:00-12:00 a.m.	1600-1700	R. Korea	C	11830, 9720
11:00-12:00 a.m.	1600-1700	WYFR	A	15365, 15215
11:00-12:00 a.m.	1600-1700	R. Moscow World Service	B	24020, 15240, 15150, 12050, 12030, 11900, 11720
11:00-12:00 a.m.	1600-1700	R. France Int'l	B	21620, 21580, 21525, 17850, 17795, 17620, 15315, 15300
11:00 a.m.-12:30 p.m.	1600-1730	VOA to Africa	A	26040, 26000, 21485, 19480-LSB, 17870, 15600, 15410
11:00 a.m.-12:45 p.m.	1600-1745	BBC	B	21710, 17830, 15260
11:00 a.m.-1:00 p.m.	1600-1800	WRNO New Orleans	A	15140 (Sun.) (not all Eng.)
-11:30 a.m. -1630		R. Singapore	C	11940, 5052, 5010 (fade-in-time varies)
11:15-12:00 a.m.	1615-1700	UAE Radio, Dubai	B	21655, 17775, 15320
11:45-12:00 a.m.	1645-1700	R. Canada International	A	21695, (17820 Mon.-Sat.) 15325
11:45-12:45 p.m.	1645-1745	R. Pakistan	C	15545, 11672
12:00-12:30 p.m.	1700-1730	R. Japan	C	9505
12:00-12:45 p.m.	1700-1745	BBC	C	17695, 21470
12:00-1:00 p.m.	1700-1800	R. Moscow World Service	A	15455, 15425, 15240, 15150, 12050, 12030, 11960, 11900
12:00-1:00 p.m.	1700-1800	WYFR, Family Radio	A	21615, 15440, 15365, 15215
12:00-1:30 p.m.	1700-1830	AFRTS, Los Angeles	A	15430, 15345, 15330, 11805, 9700
12:00-3:00 p.m.	1700-2000	4VEH, Haiti	C	11835, 9770 (Sun.)
12:00-4:00 p.m.	1700-2100	BSK Saudi Arabia	C	11850 (varies)
12:00-2:00 p.m.	1700-1900	VOA	B	21840, 17785, 15580, 15430, 15205, 11760
12:30-1:00 p.m.	1730-1800	HCJB, Ecuador	B	26020, 21477.5, 17825†
12:30-1:00 p.m.	1730-1800	VOA to Africa	A	26040, 26000, 21485, 19840-LSB, 17870, 15877.5-LSB, 15600, 15410
12:45-3:00 p.m.	1745-2000	BBC	C	15400, 15070, 12095
12:45-5:30 p.m.	1745-2230	All India R.	C	11620
1:00-3:00 p.m.	1800-1830	R. Canada International	A	17820, 15260 (Sat. & Sun. 1800-1900)
1:00-1:30 p.m.	1800-1830	V. of Vietnam	C	15010, 10040
1:00-2:00 p.m.	1800-1900	R. Moscow World Service	A	17700, 15455, 15425, 15240, 15150, 12050, 11960, 11900, 11700
1:00-2:00 p.m.	1800-1900	WYFR, Family Radio	A	21615, 15440, 15365
1:00-2:00 p.m.	1800-1900	V. of Nigeria	C	15120, 17800
1:00-3:00 p.m.	1800-2000	WRNO, New Orleans	A	17895 (not all Eng.)
1:00-4:00 p.m.	1800-2100	R. Kuwait	B	11675
1:00-4:00 p.m.	1800-2100	AFRTS, Los Angeles	A	17765, 15430, 15345, 15330, 11805
1:00-5:00 p.m.	1800-2200	VOA to Africa	A	26040, 26000, 21660, 21485, 19840-LSB, 17870, 15877.5-LSB, 15600, 15410
1:15-2:15 p.m.	1815-1915	R. Bangladesh	D	15285, 11765 (both vary)†
1:30-1:40 p.m.	1830-1840	UN Radio	A	21710, 20060-SSB, 18782.5-SSB, 15360, 15120 (Fri.)
1:30-1:57 p.m.	1830-1857	Austrian Radio	C	15560, 11860 (Sun. from 1805)
1:30-2:00 p.m.	1830-1900	V. of Revolution, Guinea	C	15309 (varies) 9650 (Mon., Wed. and Fri.) (irregular)
2:00-2:30 p.m.	1900-1930	V. of Vietnam	C	15010, 10040
2:00-2:30 p.m.	1900-1930	R. Canada International	A	17875, 15325, 11905 (Sat. & Sun. 1900-2000)

OF THE EIGHT MAJOR  
CAPACITANCE INSTRUMENTS  
MADE; ONLY THE CM-100...

**DETECTS  
LEAKAGE**  
(and at half the price!)

**\$89<sup>95</sup>**



**Usefulness** — Measure capacitors 10pF — 500µF; leakage 1 nA or .005 C.V., whichever is greater. **Accuracy** — To 2% depending on range. **Dependability** — Ruggedized construction; 1 yr. warranty. **Versatility** — In circuit measurement of capacitance and leakage. Output signal proportionate to measurement. **Portability** — 350 Hr. Battery Life.  
\* To 25,000µF with external voltmeter

Send check, address (NO P.O. BOX) plus \$3.50 Handling. CT res. add 7½ % tax.

Phone orders: (203) 423-7940

**ANDERS PRECISION INSTRUMENT CO., INC.**  
4 Bridge St. Plaza, P. O. Box 75 Willimantic, CT 06226

CIRCLE NO. 6 ON FREE INFORMATION CARD

**SEE YOUR DEALER TODAY**



FROM

**'Firestik'**  
ANTENNAS  
ACCESSORIES

HERE'S A TIP  
THAT'S PERFECT!

AM/FM AUTO RADIO  
AND CB

**'Firestik' II**  
GOLDEN SERIES

**BARE-HANDS TUNABLE  
"NO TOOLS NEEDED"  
HIGH PERFORMANCE ANTENNAS**

ALSO ANTENNAS FOR  
CORDLESS TELEPHONES  
MONITOR SCANNERS

Dealer & Distributor Inquiries Invited  
SEND FOR FREE CATALOG

'Firestik' Antenna Company  
2614 East Adams/Phoenix, AZ 85034

Name \_\_\_\_\_

Street \_\_\_\_\_

City \_\_\_\_\_

State \_\_\_\_\_ Zip \_\_\_\_\_

Serving the CB and  
Communications Market Since 1962.

**5-YEAR REPLACEMENT WARRANTY**

CIRCLE NO. 26 ON FREE INFORMATION CARD



# CABLE TV

## CONVERTERS DESCRAMBLERS

Largest Selection  
of Equipment Available  
\$ Buy Warehouse Direct & Save \$



36 channel  
converter  
**\$4595**

36 channel  
wired remote  
converter  
only  
**\$8895**



Send \$2 for complete catalog  
of converters and unscramblers

Quantity Discounts • Visa • Master Charge  
Add 5% shipping — Mich. residents add 4% sales tax

**C&D Electronics, Inc.**  
P.O. Box 21, Jenison, MI 49428  
(616) 669-2440

# FOCUS

FOR ORDERS ONLY! TOLL - FREE (800)221-0628

**Electronic/Computer**

**GAMES**  
NEW VECTRIX  
Arcade w/Screen  
**\$1899**  
Atari \$1189

Sold w/Combat Cartridge \$11.90  
Pacman Cartridge \$25.90

**Intellivision**  
By Mattel **\$1895**

Sold w/Blackjack Cartridge \$8.90  
Buy 10 Cart. for Mattel or Atari  
& get 1 free

Pacman Game \$42.90  
Donkey Kong Game \$24.95

**FIDELITY: CHESS**

Sensory Voice Chess \$119.90  
Mini Sensory \$39.95  
Sensory 6 \$89.95  
Chess Challenger 7 \$66.90  
Champion Sensory \$264.95  
Chess Sensory 9 \$119.90

**Computers**

Atari 400 w/16K 299.95  
Atari 800 w/Basic Cart 589.95  
Commodore Vic 20 expands to 32K 169.95  
Sharp PC 1211 w/Printer 118.90  
GL 122 81.95  
Sharp PC 1500 w/CI 107 printer 296.95  
Times Sinclair Computer 81.95  
TI 99/4A Comp 294.90  
1100 Mhz. rebate  
Franklin ACE 1000 Apple Comp 949.90  
Amdek 12' Green Monitor 139.90

**Original Oasey  
Dish Microwave  
Receiver**  
Reg. 21.24  
**\$12990**  
w/ 100 W. & 50 W. or 200 W.  
36 Channel Cable Converter 79.00  
with AC Power & 72 300 Chm Conv.

For information and all N.Y. State orders, please dial (212)871 7600. All items subject to availability and price change. Mail and phone orders C.O.D. Master Charge Visa O.K. Shipping extra. Everything Factory Fresh 10 day Money Back Guarantee (less shipping) FOCUS ELECTRONICS 45-23 13th Ave. Brooklyn NY 11218

**VIDEO** LARGEST AUTHORIZED  
SONY DEALER IN BROOKLYN

For Lowest Retail Prices Available

SONY SL-5000 Front Load 409.90  
RCA VCI 200 394.90  
PAN PV 1275 New w/Search 399.95  
JVC VR-7300 549.95

**SONY TRINITON**  
Color Television

For Lowest Retail Prices Available

Call KX-2501 Call  
KV-1901 w./A.M. & F.W./T 349.95  
Monitor \$59.95

**CALCULATORS**

SHARP EL1182A 59.95  
10 Digit Print Display  
VK-2185 deluxe 12-Digit 172.95  
Et-7001 Memowriter 84.95

**TEXAS INSTRUMENTS**

TI-59 after mh. rebate \$147.95  
TI-PC-100C \$148.95  
TI-58 \$78.95  
TI-130 Print & Display \$89.95  
TI-84 II \$35.95  
TI-54 \$32.95  
TI-55 II \$37.95  
TI Student BA-35 \$27.95

**CASIO**

HR-9 Card Print & Display \$25.95  
FX702P Scientific 108.95  
LC 950 Metric Converter \$19.95

**HEWLETT PACKARD**

HP 41 VC \$218.95  
HP 41C \$163.95  
HP 38C \$78.95  
HP 11C Scientific \$74.95  
HP 12C Financial \$110.95  
HP 15C Scientific \$103.95  
HP 16C Programmer \$114.95

FREE GIFT WITH THIS AD

2:00-2:30 p.m.	1900-1930	R. Afghanistan	C	15077 (varies), 9665, 11960
2:00-2:45 p.m.	1900-1945	R. Japan	B	17755
2:00-3:00 p.m.	1900-2000	H.C.B. Ecuador	C	26020, 2177.5, 17825†
2:00-3:00 p.m.	1900-2000	WYFR, Family Radio	A	15440, 15365, 15215, 11925
2:00-3:00 p.m.	1900-2000	R. Moscow World Service	A	17700, 15455, 15150, 12050, 11960
2:00-5:00 p.m.	1900-2200	VOA	A	21840, 17785, 15580, 15430† 15205, 11760
2:15-3:00 p.m.	1915-2000	BRT Belgium	B	15590, 7335
2:20-3:30 p.m.	1920-1930	V. of Greece	B	15050, 9865, 9420
2:30-3:00 p.m.	1930-2000	UN Radio	A	21710, 20060-SSB, 18782.5-SSB, 15360, 15120 (Fri.) 9022, 9765
2:30-3:30 p.m.	1930-2030	V. of Iran	C	15104 (time varies and irregular)
2:45-4:15 p.m.	1945-2115	R. Free Grenada	C	Some of 25700, 21725, 21635, 17745, 15370, 15307, 15215, 15160, 11810, 9760, 9610, 9510 (may be one hour later)
3:00-3:30 p.m.	2000-2030	R. Norway	C	17875, 15225, 15175, 11850 (Sun.)
3:00-3:30 p.m.	2000-2030	R. Canada International	A	17875, 17820, 15325, 11905 (Mon.-Fri.)
3:00-3:30 p.m.	2000-2030	Kol Israel	C	13745, 11637, 9815, 9420
3:00-4:00 p.m.	2000-2100	R. Moscow World Service	A	17700, 15425, 15150, 15100, 12050, 11960, 7390
3:00-4:00 p.m.	2000-2100	Spanish Foreign Radio	C	15375
3:00-4:15 p.m.	2000-2115	BBC	B	15260, 15070, 11750, 12095, 9410
3:00-5:00 p.m.	2000-2200	WRNO, New Orleans	A	15365 (not all Eng.)
3:00-5:00 p.m.	2000-2200	WYFR, Family R.	A	17845, 15440, 15365, 15215, 11925
3:10-4:40 p.m.	2010-2140	R. Habana Cuba	A	15365†
3:15 p.m.-2:15 a.m.	2015-0715	R. New Zealand	C	15485†, 17705
3:30-3:45 p.m.	2030-2045	Vatican R.	C	9645, 7250, 6190
3:30-4:20 p.m.	2030-2120	R. Nederland	B	21685, 17695, 17605, 15220, 9715
3:30-4:30 p.m.	2030-2100	V. of Vietnam	C	15010, 10040
3:30-4:30 p.m.	2030-2130	V. Turkey	C	9625
3:45-4:00 p.m.	2045-2100	Vatican R.	C	15120, 11700, 9625
3:50-4:40 p.m.	2050-2140	R. Habana Cuba	C	17750, 11725
4:00-4:15 p.m.	2100-2115	R. TV Benin	C	4870
4:00-4:30 p.m.	2100-2130	R. Japan	B	17755
4:00-4:30 p.m.	2100-2130	UN Radio	A	17730, 15120
4:00-4:50 p.m.	2100-2150	R. RSA	B	17745, 15155, 11900
4:00-5:00 p.m.	2100-2200	V. of Nigeria	C	15120, 17800
4:00-5:00 p.m.	2100-2200	AFRTS, Los Angeles	A	21570, 15430, 15345, 15330
4:00-5:00 p.m.	2100-2200	R. Moscow World Service	C	17700, 15425, 15240, 15100, 12050, 11960, 11750, 11700, 9700
4:15-4:30 p.m.	2115-2130	Vatican R.	C	15120, 11700, 9645
4:15-5:00 p.m.	2115-2200	BBC	A	15260, 15070, 11750, 6175
4:15-5:00 p.m.	2115-2200	BBC to Falklands	B	15390, 12040, 11820, 9915 (Tue., Thur., Sun.)
4:15-7:30 p.m.	2115-2430	R. Free Grenada	B	15045 (time varies)(irregular)
4:30-5:00 p.m.	2130-2200	R. Canada International	A	17820, 15150, 11945, 17875, 15325
4:30-5:00 p.m.	2130-2200	H.C.B. Ecuador	C	26020, 21477.5, 17825†, 15340†
4:30-5:00 p.m.	2130-2200	R. Sofia	B	7115
4:30-5:25 p.m.	2130-2225	R. Baghdad	C	9745
4:31-5:00 p.m.	2131-2200	KGEL, San Francisco	C	15280
4:40-5:40 p.m.	2140-2240	V. of Free China	C	17890, 15270 or 15210, 11825
4:45-5:00 p.m.	2145-2200	RTVC, Congo	C	15190 (irregular)
4:45-5:15 p.m.	2145-2215	Swiss R. International	C	21520, 17830, 17850, 15305
5:00-5:45 p.m.	2200-2245	BRT, Belgium	B	11975, 7335 (Mon.-Sat.)
5:00-6:00 p.m.	2200-2300	WYFR, Family Radio	A	17845, 15440, 15380, 15365, 11935
5:00-6:00 p.m.	2200-2300	R. Moscow World Service	A	21565, 17760, 17700, 15425, 12050, 11850, 11770, 11750, 11720, 11700, 9760, 9720, 9685, 9720, 9685, 9665, 9610
5:00-6:00 p.m.	2200-2300	CBC Radio	A	15325, 11925, 9760 (Mon.-Fri.)
5:00-6:00 p.m.	2200-2300	VOA to Africa	A	26040, 26000, 21660, 21485, 19480-LSB, 17870, 15600, 15415
5:00-6:00 p.m.	2200-2300	V. of Turkey	B	17760, 11900, 7215
5:00-6:00 p.m.	2200-2300	BBC	A	15260, 15070, 11750, 9915, 9410, 6175, 5975
5:00-7:00 p.m.	2200-2400	WRNO, New Orleans	A	11890† (not all Eng.)
5:00-7:00 p.m.	2200-2400	AFRTS, Los Angeles	A	21570, 17765, 15430, 15330
5:00-7:00 p.m.	2200-2400	VOA	A	26000, 21460, 17820
5:15-5:30 p.m.	2215-2230	R. Yugoslavia	C	9620
5:15-5:30 p.m.	2215-2230	R. Japan	C	17755, 15195 (via Portugal 9630†)
5:30-6:00 p.m.	2230-2300	Kol Israel	A	13745, 15585, 17630, 11655, 9815
5:30-6:00 p.m.	2230-2300	RAE, Argentina	D	11710 (Mon.-Sat.)
5:30-6:00 p.m.	2230-2300	R. Nacional, Angola	D	11955, 9535 (Mon.-Fri., irregular)
5:30-6:00 p.m.	2230-2300	R. Polonia	C	7125
5:30-6:30 p.m.	2230-2330	R. Sofia	B	15110, 9700
5:30-7:00 p.m.	2230-2400	R. Jamahiriya, Libya	B	11815
6:00-6:30 p.m.	2300-2330	R. Vilnius	B	17870, 15100, 12060, 11735, 9665
6:00-6:30 p.m.	2300-2330	R. Japan	C	17755
6:00-6:30 p.m.	2300-2330	R. Sweden	C	11705, 9695
6:00-7:00 p.m.	2300-2400	4VEH, Haiti	B	11835, 9770
6:00-7:30 p.m.	2300-2430	BBC	A	15260, 15070, 9915, 9590, 9410, 7325, 6175, 6120, 5975
6:00-7:50 p.m.	2300-2450	R. Pyongyang	C	15231, 9745
6:00-8:00 p.m.	2300-0100	CBC Southern Service	A	11850, 5960, (Sat. 2300-2330, Sun. 2300-2400)
6:00-8:00 p.m.	2300-0100	R. Moscow	A	21530, 9800, 9685, 9610, 7195, 7115
6:00-8:00 p.m.	2300-0100	WYFR Family R.	A	17845, 15365
6:00-7:00 p.m.	2330-2400	V. of Vietnam	B-C	12036, 10080
6:00 p.m.-1:07 a.m.	2330-0607	CBC Northern Service	C	9625, 6195 (not all English)
6:15-7:45 p.m.	2335-2345	V. of Greece	C	12045, 9865
6:15-7:45 p.m.	2345-2445	R. Japan	C	17825, 15300
7:00-7:25 p.m.	0000-0025	R. Tirana	B	9750, 7065
7:00-7:30 p.m.	0000-0030	Kol Israel	A	11655, 9815, 7410
7:00-7:30 p.m.	0000-0030	R. Norway	C	15175, 11870, 11860, 11850, 11760 9610, 6015 (Mon.)
7:00-7:55 p.m.	0000-0055	R. Peking	B	15520, 15120, 11650
7:00-8:00 p.m.	0000-0100	VOA	A	21460, 17820, 6873-USB
7:00-8:00 p.m.	0000-0100	R. Sofia	B	15110, 9700
7:00-8:00 p.m.	0000-0100	FEBC, Philippines	C	17810
7:00-8:00 p.m.	0000-0100	AFRTS, Los Angeles	A	21570, 15430, 15330, 11790, 6030
7:00-9:00 p.m.	0000-0200	VOA to Latin America	A	17730, 17640, (15650-LSB to 0100) 15205, 11740, 9650, 6130, 5995, 1580
7:00-9:00 p.m.	0000-0200	WRNO, New Orleans	A	11965†
7:00-9:00 p.m.	0000-0200	R. Luxembourg	C	6090 (Time varies)
7:00-12:00 p.m.	0000-0500	R. Moscow (via Cuba)	A	9600
7:00 p.m.-4:00 a.m.	0000-0900	UN Radio	A	6055 (when in session)
7:05-8:55 p.m.	0005-0155	Spanish Foreign R.	B	11880, 9630
7:15-8:00 a.m.	0015-0100	R. Berlin International	C	11975, 9730
7:30-8:00 p.m.	0030-0100	R. Prague	C	6055

CIRCLE NO. 18 ON FREE INFORMATION CARD

Computers & Electronics

7:30-8:00 p.m.	0030-0100	R. Kiev	B	17900, 11870, 9530
7:30-8:00 p.m.	0030-0100	La Cruz del Sur, Bolivia	D	4875 (Mon. only)
7:30-8:15 p.m.	0030-0115	BRT Belgium	C	11695, 9870
7:30-8:30 p.m.	0030-0130	HCJB, Ecuador	A	15175†
7:30-9:00 p.m.	0030-0200	R. Mexico	C	17765, 15430, 11770, 9705, 5985 (Sat.)
			A	15425
7:30-9:30 p.m.	0030-0230	SLBC, Sri Lanka	C	15260, 11750, 9915, 9515, 9410, 7325, 6175, 6120, 5975
7:30-9:30 p.m.	0030-0230	BBC	A	17885†, 15155, 9745
			B	11845, 9605, 6015
7:35-9:35 p.m.	0035-0230	HCJB, Ecuador	B	11800, 9575
8:00-8:15 p.m.	0100-0115	Vatican R.	A	11655, 9815, 7410
8:00-8:20 p.m.	0100-0120	RAI, Italy	B	11710 (not Mon.)
8:00-8:25 p.m.	0100-0125	Kol Israel	C	17755
8:00-8:30 p.m.	0100-0130	R. Argentina	C	4910
8:00-8:30 p.m.	0100-0130	R. Japan	A	11850, 5960
8:00-8:30 p.m.	0100-0130	La Voz De la Mosquitia, Honduras	C	11975, 9730
8:00-8:30 p.m.	0100-0130	R. Canada International	A	11865, 11785, 9565, 9640, 6145
8:00-8:45 p.m.	0100-0145	R. Berlin International	C	6085, 6040
8:00-8:50 p.m.	0100-0150	V. of Germany	A	11990, 11970, 9740, 9630, 7345, 5930
			B	15520, 15120, 11650
8:00-8:55 p.m.	0100-0155	R. Prague	C	17890, 15345, 11825
			A	6120 (variable Tue.-Sat.) (time varies)
8:00-8:55 p.m.	0100-0155	R. Peking	A	21460, 17735, 7205, 6873-USB
8:00-9:00 p.m.	0100-0200	V. of Free China	A	21570, 15430, 15330, 11790, 6030
8:00-9:00 p.m.	0100-0200	R. Zinica, Nicaragua	B	21740
			A	21530, 17720, 9800, 9685, 7195, 7115
8:00-9:00 p.m.	0100-0200	VOA	A	9715, 6065
8:00-9:00 p.m.	0100-0200	AFRTS, Los Angeles	B	11930, 11725
8:00-11:00 p.m.	0100-0400	R. Australia	C	3285, 834
8:00-11:00 p.m.	0100-0400	R. Moscow	B	15050, 12045, 9865 (not Sunday)
			B	9770, 5945
8:00-11:00 p.m.	0100-0400	WYFR Family R.	B	9750, 7120
8:00-11:50 p.m.	0100-0450	R. Habana Cuba	B	17710, 15220, 11910, 9835, 9585, 6025 (Wed. and Sat.)
8:20 p.m.-12:10 a.m.	0120-0510	R. Belize	C	21640, 21610, 17825, 15195
8:30-8:40 p.m.	0130-0140	V. of Greece	A	15305, 11715, 9725, 6135
8:30-8:57 p.m.	0130-0157	Austrian Radio	A	11655, 9815, 7410
8:30-8:55 p.m.	0130-0155	R. Tirana	A	11845, 5960 (Sat. & Sun. also 11940, 9755, 9535)
8:30-9:00 p.m.	0130-0200	R. Budapest	B	17710, 15220, 11910, 9835, 9585, 6025 (not Mon.)
			C	15120, 11815, 9525, 7270, 7145, 6135, 6095 (length varies)
8:30-9:30 p.m.	0130-0230	R. Japan	B	15325, 11730, 9560, 5980
8:45-9:15 p.m.	0145-0215	Swiss R. International	C	15380, 11940, 11830, 9570, 6155
9:00-9:25 p.m.	0200-0225	Kol Israel	B	15120, 11650
9:00-9:30 p.m.	0200-0230	R. Canada International	A	21460, 17735, 7205, 6873-USB
			A	17830, 15290
			B	11740
9:00-9:30 p.m.	0200-0230	R. Budapest	B	12000, 9475
			A	17640, 15205, 9650, 6130, 5995, 1580
9:00-9:40 p.m.	0200-0240	R. Polonia	A	11790, 6030
			A	6155
9:00-9:50 p.m.	0200-0250	R. RSA	B	17795 (not all English)
9:00-9:55 p.m.	0200-0255	R. Bucharest	A	15435, 6035, 15752-SSB, 10869-SSB (Sat.)
9:00-9:55 p.m.	0200-0255	R. Peking	C	21725, 21595, 17840
9:00-10:00 p.m.	0200-0300	VOA	B	9750, 7120
9:00-10:00 p.m.	0200-0300	R. Nacional, Brazil	C	11710, 9690 (not Mon.)
9:00-10:00 p.m.	0200-0300	V. of Free China (via WYFR)	B	11705, 9695, 17840-SSB
9:00-10:30 p.m.	0200-0330	R. Cairo	C	11975, 9730
9:00-11:00 p.m.	0200-0400	VOA to Latin America	A	9590, 6165 (Mon. 0230-0320)
			C	15575, 11810
			A	11750, 9915, 9515, 9410, 7325, 6175, 6120, 5975
			A	15155, 9745
			C	15120, 11815, 9525, 7270, 7145, 6135, 6095 (length varies)
9:00-11:30 p.m.	0200-0430	AFRTS, Los Angeles	C	17765, 15430, 11770, 9705, 5980 (Sun.)
9:00 p.m.-1:00 a.m.	0200-0500	WRNO, New Orleans	B	17710, 15220, 11910, 9835, 9585, 6025
9:00-12:00 p.m.	0200-0500	R. Australia	C	17755
9:15-9:30 p.m.	0215-0230	UN Radio	B	17900†, 17870
			A	11940, 11845, 9755, 9535, 5960
9:30-9:45 p.m.	0230-0245	R. Pakistan	B	11925, 9520
9:30-9:55 p.m.	0230-0255	R. Tirana	C	17750 (Fri.)
9:30-10:00 p.m.	0230-0300	RAE, Argentina	C	15345, 11825, 17800
9:30-10:00 p.m.	0230-0300	R. Sweden	B	11990, 11970, 9630, 9540, 7345, 5930
9:30-10:15 p.m.	0230-0315	R. Berlin International	B	15520, 15120, 11650
9:30-10:25 p.m.	0230-0325	R. Nederland	A	21460, 17740, 9670, 7200, 6040
9:30-10:30 p.m.	0230-0330	R. Korea	C	5055, (Mon. 0235-0435)
9:30-10:30 p.m.	0230-0330	BBC	A	5985, 17800
			D	21585, 15400, 11935
9:30-12:00 p.m.	0230-0500	HCJB Ecuador	B	4820 (Mon.)
10:00-10:25 p.m.	0300-0325	R. Polonia	B	15325 (irregular)
			C	11900†
10:00-10:25 p.m.	0300-0325	R. Mexico	B	9585, 7270, 5980, 4990, 3230
			B	15752-USB, 15240, 15185, 15175, 10880-USB, 10869-USB, 7280, 6035
10:00-10:30 p.m.	0300-0330	R. Budapest	C	12180, 6090, 5980
			C	3396 (exc. Sun.)
10:00-10:30 p.m.	0300-0330	R. Japan	B	7300, 6200
10:00-10:30 p.m.	0300-0330	R. Kiev	C	9770, 5945
10:00-10:30 p.m.	0300-0330	R. Canada International	B	17775, 15300, (length varies)
10:00-10:30 p.m.	0300-0330	R. Portugal	B	11975, 11890, 11840, 9560
10:00-10:30 p.m.	0300-0330	R. Australia to Antarctica	B	3300 (Mon. 0030-)
10:00-10:50 p.m.	0300-0350	V. of Free China	C	9410, 6175, 6120, 5975
10:00-10:55 p.m.	0300-0355	R. Prague	C	11760, 11725
			A	15050, 12045, 9865 (not Sun.)
10:00-10:55 p.m.	0300-0355	R. Peking	B	17795, 15330, 11905
10:00-11:00 p.m.	0300-0400	VOA	C	17900, 17870, 15100
10:00-11:00 p.m.	0300-0400	TIFC Costa Rica	B	17710, 15220, 11910, 9835, 9585, 6025 (Wed. & Sat.) (0400-0430 Mon.)
10:00-11:00 p.m.	0300-0400	V. of Free China (via WYFR)	A	
10:00-11:00 p.m.	0300-0400	R. Baghdad	D	
10:00-11:00 p.m.	0300-0400	HRVC, Honduras	B	
10:00-11:00 p.m.	0300-0400	R. Uganda	B	
10:00-11:00 p.m.	0300-0400	V. of Turkey	C	
10:00-11:26 p.m.	0300-0426	R. RSA	B	
10:00-11:30 p.m.	0300-0430	VOA to Africa	A	
			C	
10:00-12:00 p.m.	0300-0500	AWR Guatemala	C	
10:25 p.m.-fade	0325-	R. One, Zimbabwe	C	
10:30-10:55 p.m.	0330-0355	R. Tirana	B	
10:30-10:57 p.m.	0330-0357	Austrian Radio	C	
10:30-11:00 p.m.	0330-0400	U.A.E. Radio, Dubai	B	
10:30-11:15 p.m.	0330-0415	R. Berlin International	B	
10:30-11:30 p.m.	0330-0430	R. Cultural, Guatemala	C	
10:30-11:30 p.m.	0330-0430	BBC	C	
10:30 p.m.-1:00 a.m.	0330-0600	R. Habana Cuba	A	
10:40-10:47 p.m.	0340-0347	V. of Greece	B	
10:50-11:10 p.m.	0350-0410	RAI, Italy	B	
10:51-10:58 p.m.	0351-0358	V. of Yerevan	C	
11:00-11:12 p.m.	0400-0412	R. Budapest	B	

# NEW INDOOR ACTIVE ANTENNA

Covers 300 KHz - 30 MHz. For SWL, BCL, VLF DXers.

Rivals long wires  
**\$79.95** (+ \$4.00 shipping)



**MFJ-1020 NEW INDOOR ACTIVE ANTENNA** sits on your desk ready to listen to the world. Rivals can often exceed, reception of outside long wire. Unique **Tuned Active Antenna** minimizes intermod, provides RF selectivity, reduces noise outside tuned band. Also use as preselector for external antenna. Covers 300 KHz to 30 MHz in 5 bands. Adjustable telescoping antenna. Controls: Tune, Band Selector, Gain, On-Off/Bypass. LED. FET, bipolar circuitry. Phono jack for external ant. 6x2x6 in. 9-12 VDC or 9 V battery for portable use. 110 VAC with optional AC adapter, MFJ-1312, \$9.95.

Order from MFJ and try it. If not delighted, return it within 30 days for refund (less shipping). **One year unconditional guarantee.** Order today. Call TOLL FREE 800-647-1800. Charge VISA, MC. Or mail check, money order. Write for free catalog.

**CALL TOLL FREE ... 800-647-1800**  
 601-323-5869 in MS, outside continental USA.  
**MFJ ENTERPRISES, INCORPORATED**  
 921 Louisville Road, Starkville, MS 39759  
 CIRCLE NO. 32 ON FREE INFORMATION CARD

## Put Professional Knowledge and a COLLEGE DEGREE in your Electronics Career through

# HOME STUDY



## Earn Your DEGREE

No commuting to class. Study at your own pace, while continuing your present job. Learn from easy-to-understand lessons, with help from your home-study instructors whenever you need it.

In the Grantham electronics program, you first earn your A.S.E.T. degree, and then your B.S.E.T. These degrees are *accredited* by the Accrediting Commission of the National Home Study Council.

Our *free* bulletin gives full details of the home-study program, the degrees awarded, and the requirements for each degree. Write for *Bulletin ET-83*.

**Grantham College of Engineering**  
 2500 So. LaCienega Blvd.  
 Los Angeles, California 90034





# AMAZING DEVICES

PHASORS

**PHASOR PAIN FIELD** — Patented and recently developed in our labs is being tested by Gov't for riot control. Soon to come under weapons restrictions as an internal machine. Easily hand-held. Hazardous IF NOT USED WITH DISCRETION. **\$15.00**

**INVISIBLE PAIN FIELD GENERATOR** — Produces a directional field of moderately intense pain to back of head up to 50'. Cigarette pack size enclosure is easily hidden. **\$7.00**

**IPG-3 PLANS \$7.00** **IPG-3K KIT & PLANS \$44.50**

**IPG-30 (assembled for animal control) \$59.50**

**PHASOR STUN/BURNING WAND** — Produces sufficient electrical energy capable of burning flesh. Intended as a personal defense device. **\$8.00**

**PSW-3 PLANS \$8.00** **PSW-3K KIT & PLANS \$59.50**

LASERS

**RUBY LASER RAY PISTOL** — Intense visible red, burns hazardous, with parts sources (includes all part sources) **\$15.00**

**RUBY PLANS (includes all part sources)**

**CARBON DIOXIDE LASER** — Generates 20-40 watts of continuous power capable of burning, cutting, hazardous (with all part sources) **\$15.00**

**LASER RIFLE** — Produces 200-3000 pulses of 30 watt optical energy. Portable and easily hand-held. **\$10.00**

**LRG-3 PLANS**

**LRG-3K KIT PLANS (minus diode) \$129.50**

**POCKET LASER** — For the beginner, visible red optical version non-hazardous **\$5.00**

**LHC-2 \$5.00** **LHC-2K KIT & PLANS \$24.50**

**HIGH POWERED PORTABLE ENERGY SOURCE FOR LASERS AND MAGNETIC WEAPONS** — Exploding wires, shockwave, etc. Miniature size **\$8.00**

**HPS-1 PLANS \$8.00** **HPS-1K KIT & PLANS \$49.50**

**PARTICLE BEAM WEAPON — PLANS \$15.00**

SECURITY

**INFINITY XMTR** — Uses telephone lines for selective home or office listening while away on business or vacation. **\$15.00**

**INF-1 PLANS**

**SEE IN DARK** — Long range, total darkness. **\$10.00**

**SD-4 PLANS**

**LONG RANGE WIRELESS MIKE** — Crystal clear quality — miniature. **\$7.00**

**FBT-7 PLANS \$7.00** **FBT-7K PLANS & KIT \$34.50**

**WIRELESS TELEPHONE TRANSMITTER** — Long range, automatic. **\$10.00**

**VWPM-5 PLANS \$10.00** **VWPM-5K PLANS & KIT \$34.50**

Send for FREE catalog description of above plus hundreds more plans, kits and completed items. We accept MC or Visa or when ordering, send check or money order. We pay shipping charges on orders over \$50.00, otherwise include 10% with remittance.

SEND TO: **SCIENTIFIC SYSTEMS**  
DEPT. Q1 BOX 716 AMHERST, NH 03031

## Be an FCC LICENSED ELECTRONIC TECHNICIAN!

**NO NEED TO QUIT YOUR JOB OR GO TO SCHOOL**

You learn how to pass the FCC license exam at home at your own pace with this easy-to-understand, proven course. Within a few short weeks you could be on your way to being one of the highest paid workers in the electronics field. It's that easy! U.S. Federal law requires you to have an FCC license if you want to operate and maintain virtually all communications system — you don't need a College degree to qualify, but you DO need an FCC license. With this Home-Study course, you'll be ready to pass the FCC Government licensing exam in a remarkably short time. Send for FREE facts now. No obligation. No salesman will call. **MAIL COUPON TODAY!**

No costly School. No commuting to class. The Original Home-Study course that prepares you for the FCC Radio-telephone license exam in your spare time! Passing the exam is your "ticket" to thousands of exciting opportunities in Communications, Broadcasting, Mobile two-way systems, Microwave stations, Radar installations, Aerospace and more.

**NO NEED TO QUIT YOUR JOB OR GO TO SCHOOL**

You learn how to pass the FCC license exam at home at your own pace with this easy-to-understand, proven course. Within a few short weeks you could be on your way to being one of the highest paid workers in the electronics field. It's that easy! U.S. Federal law requires you to have an FCC license if you want to operate and maintain virtually all communications system — you don't need a College degree to qualify, but you DO need an FCC license. With this Home-Study course, you'll be ready to pass the FCC Government licensing exam in a remarkably short time. Send for FREE facts now. No obligation. No salesman will call. **MAIL COUPON TODAY!**

**COMMAND PRODUCTIONS**  
FCC LICENSE TRAINING, Dept. P  
P.O. Box 2223, San Francisco, CA 94126

Rush FREE facts on how I can prepare for my FCC license at home in my spare time.

NAME \_\_\_\_\_  
ADDRESS \_\_\_\_\_  
CITY \_\_\_\_\_ STATE \_\_\_\_\_ ZIP \_\_\_\_\_

CIRCLE NO. 16 ON FREE INFORMATION CARD

11:00-11:30 p.m.	0400-0430	R. Bucharest	C	11940, 11830, 9570, 6155, 5990
11:00-11:30 p.m.	0400-0430	R. Canada International	A	9755, 9535, 5960
11:00-11:30 p.m.	0400-0430	R. Norway	C	9865, 9675, 9610, 9590, 6185, 6030, 6015
11:00-11:55 p.m.	0400-0455	R. Peking	B	15120, 11650
11:00-12:00 p.m.	0400-0500	R. Sofia	C	7115
11:00-12:00 p.m.	0400-0500	R. Australia	B	21680, 21650, 17870, 17795, 17755, 17725, (15320 from 0430)
11:00-12:00 p.m.	0400-0500	FEBA, Seychelles	C	15240, 15160
11:00-12:00 p.m.	0400-0500	R. Moscow World Service	A	11810, 15200 (Sat.&Sun.)
11:00 p.m.-1:00 a.m.	0400-0600	WYFR, Family Radio	A	9665, 9610
11:00 p.m.-1:00 a.m.	0400-0600	VOA	A	6065
11:00 p.m.-2:30 a.m.	0400-0730	TWR, Bonaire	A	15205, 9670, 7200, 6040, 5995
11:00 p.m.-3:00 a.m.	0400-0800	R. Moscow	A	9755, 800
11:30-11:57 p.m.	0430-0457	Austrian R.	B	12050, 9580
11:30-12:00 p.m.	0430-0500	VOA to Africa	A	5945
11:30-12:00 p.m.	0430-0500	Swiss R. International	B	15752-USB, 15240, 15185, 15175, 10869-USB, 7280, 6035
11:30-12:00 p.m.	0430-0500	RAE Argentina	C	11715, 9725
11:30 p.m.-12:45 a.m.	0430-0545	BBC	C	11710, 9690
11:30 p.m.-1:00 a.m.	0430-0600	AFRTS, Los Angeles	A	15070, 9510, 9410, 6175, 5975
11:30 p.m.-1:30 a.m.	0430-0630	TWR, Swaziland	A	11790, 9755, 6030
11:55 p.m.-3:00 a.m.	0455-0800	V. of Nigeria	C	5055
12:00-12:15 a.m.	0500-0515	Kol Israel	B	15185 or 15120
12:00-12:30 a.m.	0500-0530	R. Japan	B	11655, 11637, 9815, 9420
12:00-12:50 a.m.	0500-0550	V. of Germany	C	15325
12:00-1:00 a.m.	0500-0600	R. Australia	C	11905, 9690, 9545, 5960
12:00-1:00 a.m.	0500-0600	R. Moscow World Service	C	21680, 17870, 17725, 15240, 15160
12:00-1:00 a.m.	0500-0600	VOA	C	17880, 12010, 11735, 9530
12:00-2:00 a.m.	0500-0700	HCJB Ecuador	A	15752-USB, 15345, 15185, 10869-USB, 7280, 6035
12:00-3:00 a.m.	0500-0800	R. Kuwait	B	11910, 9745, 6095
12:00-3:00 a.m.	0500-0800	R. Nigeria, Kaduna	B	15345
12:00-3:00 a.m.	0500-0800	WRNO, New Orleans	B	4770 (not all Eng.)
12:30-12:40 p.m.	0530-0540	R. Garoua, Cameroon	A	6155 (Sun) (not all Eng.)
12:30-1:00 a.m.	0530-0600	R. Portugal	C	5010
12:30-fade	0530-	R. Ghana	A	9520, 6075
12:30-1:25 a.m.	0530-0625	R. Nederland	C	3366, 4915
12:30-1:30 a.m.	0530-0630	Spanish Foreign R.	A	9715, 6155 (Mon. 0530-0620)
12:35-1:30 a.m.	0530-0630	R. Korea	B	11880, 9630
12:45-1:00 a.m.	0545-0600	Vatican Radio	C	15575, 11810
12:45-1:00 a.m.	0545-0600	UN Radio	C	9645, 6210 or 6190
12:45-2:30 a.m.	0545-0730	BBC	B	15105, 11740 (Sat.)
12:55-3:25 a.m.	0555-0825	V. of Malaysia	B	15070, 11955, 9640, 9510, 9410, 7150, 6175, 5975
1:00-1:30 a.m.	0600-0630	V. of Germany	C	15295, 12350, 9750
1:00-1:30 a.m.	0600-0630	R. Australia	C	17875, 15275, 11905, 11765, 9700
1:00-2:00 a.m.	0600-0700	AFRTS, Los Angeles	C	21680, 17870, 17795, 17755, 17725, 15395, 15240, 15160
1:00-2:00 a.m.	0600-0700	VOA	B	11790, 9755, 6030
1:00-2:30 a.m.	0600-0730	R. Kiribati	A	15205, 9670, 7325, 7200, 6060, 6040, 5995
1:00-2:30 a.m.	0600-0730	VOA to Africa	C	16433-SSB (not all English)
1:00-4:00 a.m.	0600-0900	R. Cook Islands	A	15752-USB, 15345, 15330, 11915, 10869-USB, 9530, 7280, 6125, 6080, 6035
1:10-2:10 a.m.	0610-0710	V. of Free China	D	11760, or 9695 or 5045
1:15-1:30 a.m.	0615-0630	R. Canada International	A	5985, via WYFR
1:30-1:45 a.m.	0630-0645	RTVC, Congo	B	(not all English)
1:30-2:00 a.m.	0630-0700	R. Australia	B	11960, 11825, 11775, 9760, 6140, 6045 (Mon-Fri)
1:30-2:00 a.m.	0630-0700	Radio Polonia	C	9715 (Mon-Fri)
1:30-2:30 a.m.	0630-0730	R. RSA	B	21680, 17870, 17725, 15240, 15160, 15115
1:30-2:00 a.m.	0630-0800	R. Habana Cuba	B	9675, 7270
1:45-2:00 a.m.	0645-0700	R. Canada International	C	17780, 15220, 11900
1:57-4:55 a.m.	0657-0955	V. of Philippines	A	9525
2:00-2:15 a.m.	0700-0715	R. Japan	B	11960, 11825, 11775, 9760, 6140, 6045 (Mon-Fri)
2:00-2:20 a.m.	0700-0720	R. Nederland	C	9578 (not all English)
2:00-2:30 a.m.	0700-0730	Swiss Radio International	C	15325, (15190 or 15270† via Portugal)
2:00-3:00 a.m.	0700-0800	ELWA, Liberia	C	21480, 15560, 11720, 9895
2:00-3:00 a.m.	0700-0800	V. of Vietnam	C	15305, 9625, 9560, 9535, 6165, 3985
2:00-3:30 a.m.	0700-0830	HCJB, Ecuador	C	11830
2:00-4:00 a.m.	0700-0900	R. Australia	C	9840
2:00-6:00 a.m.	0700-1100	HCJB, Ecuador	C	11810, 9760
2:10-2:15 a.m.	0710-0715	UN Radio	B	21680, 17725, 15115, 12290-SSB, 9570
2:25-4:40 a.m.	0725-0940	TWR, Monte Carlo	C	11925, 6130, (9745, 0700-1030)
2:30-3:25 a.m.	0730-0825	R. Nederland	A	17815, 15195, 15120, 11740 (Sat.)
2:30-4:00 a.m.	0730-0900	BBC	B	9495 (Sun. to 1100)
2:30-6:15 a.m.	0730-1115	R. New Zealand	B	9770, 9715
2:30-6:30 a.m.	0730-1130	Solomon Isl. Broadcasting	B	15070, 11955, 9640, 9510, 7150, 9410
2:30-9:00 a.m.	0730-1402	ABC Melbourne	C	11960, 15485
2:30 a.m.-fade	0730-	Action Radio, Guyana	C	9545 or 5020 (not all Eng.)
2:45-4:30 a.m.	0745-0930	KTWR, Guam	C	9680
3:00-3:15 a.m.	0800-0815	UN Radio	C	5950
3:00-7:00 a.m.	0800-1200	WRNO, New Orleans	B	11840
3:15-3:30 a.m.	0815-0830	R. Vanuatu	A	17860, 15235, 15120, 11740 (Sat.)
3:30-4:25 a.m.	0830-0925	R. Nederland	A	6145 (not all Eng.)
3:30-5:00 a.m.	0830-1000	FEBC, Philippines	D	7260, 3945
24 Hours	24 Hours	CFRX, Toronto	B	9715
			C	11890
			C	6070

**Explanatory Notes.**

1. Times in first column are EST. For AST add 1 hour, CST subtract 1 hour; MST subtract 2 hours; PST, subtract 3 hours. Days of week are in GMT.

2. Quality. A—Strong signal and very reliable reception. B—regular reception. C—occasional reception under favorable conditions. D—rarely audible. These ratings are for locations in the central USA. European and African stations are in general, more reliably received in eastern North America. Asian and Pacific stations are more reliably received in western North America. North American stations are received well except in areas too close to the transmitter.

3. The information in the listing is correct to press time. However, frequencies and schedules are constantly changing. Listen to "SWL Digest" on R. Canada International for late changes, Saturday at 2135; Sunday at 1930; GMT Mondays at 0106 and 0406.

4. R.—Radio; V.—Voice

† = frequent changes

## A Multifunction VMOS Oscillator

By Forrest M. Mims

**I**N THIS era of increasingly complex integrated circuits, it's easy to overlook the versatility offered by some very simple transistor circuits. Figure 1, for example, shows a multivibrator made with a pair of VMOS MOSFETs. This circuit has many useful applications.

To understand how the multivibrator operates, assume that initially  $C1$  is discharged and  $C2$  is charging to  $V_{DD}$ . Therefore,  $Q2$  is off and  $Q1$  is on. Components  $C2$  and  $R3$  form a differentiator that delivers to the gate of  $Q1$  a voltage that decreases in time. Eventually, the voltage falls to a point at which  $Q1$  is switched off. Then  $C1$  in the differentiator formed by  $C1$  and  $R4$  immediately begins charging and turns on  $Q2$ . The charge-discharge cycle then repeats, and the two transistors are alternately switched on and off.

The basic circuit has an oscillation frequency of approximately the reciprocal of 3.6 multiplied by  $R$  times  $C$  where  $R = R3 = R4$  and  $C = C1 = C2$ . Under these conditions, the on and off times for  $Q1$  and  $Q2$  are equal. It's easy to produce nonsymmetrical operation where one transistor is on or off longer than the other simply by altering the RC

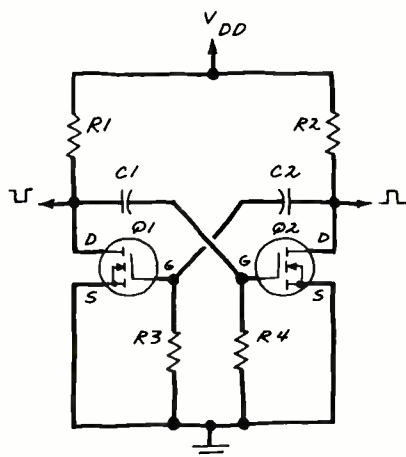

Fig. 1. Multivibrator made with a pair of VMOS MOSFETs.

time constant of one or both halves of the circuit.

**Practical Applications.** The circuit in Fig. 1 has two important advantages over similar types that use bipolar transistors. First, the VMOS power MOSFET transistors are capable of driving directly such current-demanding loads as incandescent lamps. Second, the almost infinite gate resistance of VMOS MOSFETs makes it possible to have cycle times much longer than those obtained when bipolar transistors are used.

Figure 2 shows the most obvious application for a VMOS multivibrator, a dual LED flasher. Here  $R1$  and  $R2$  limit current through the LEDs to a safe level. Note the inclusion of  $Q3$  to provide an enable input that can be controlled by a TTL or CMOS signal. When  $Q3$ 's gate is high, the oscillator operates. Otherwise the oscillator is disabled. If an enable input is not needed,  $Q3$  can be omitted or replaced by an spst on-off switch.

Another interesting addition to the circuit is potentiometer  $R5$ . Reducing its resistance *increases* the circuit's flash rate. If the resistance of  $R5$  is reduced below about 1 kilohm, the circuit will cease oscillation. Therefore you may wish to insert a 1.5-kilohm fixed resistor in series with  $R5$ . Should the circuit cease to oscillate and then fail to restart when power is interrupted, it can be restarted by momentarily shorting one or both timing capacitors.

The circuit in Fig. 2 can be easily modified for different flash rates and nonsymmetrical operation by changing the values of the RC components. A particularly interesting application is to replace  $R3$  and  $R4$  with thermistors or cadmium-sulfide photocells. The circuit can then be used to visually monitor temperature or light level differences in two locations.

For example, say you wish to match the temperatures of two solutions of darkroom chemicals but you have misplaced your thermometer. First immerse the thermistors in each of the two solutions. If the temperatures are identical, the LEDs will flash on and off at equal time intervals. If, however, the temperatures are different, the flash rate will be uneven. Simply add ice to the warmer solution until the flash rate is even.

For this application to be successful, you should use glass-bead thermistors. They are fragile, but they can be immersed. You will also have to devise some flexible leads to connect the thermistors to the circuit. Be sure to completely insulate the connection between the thermistors and the leads as moisture may cause erroneous results.

The circuit in Fig. 2 can also be used as a tone generator. Piezoelectric speakers can be connected directly across the LEDs, or standard 8-ohm miniature speakers can be substituted for the LEDs. You will need to reduce the resistances of  $R1$  and  $R2$  to about 100 ohms. One or two speakers can be used, depending upon your application.

If the device(s) you wish to drive adversely affects the operation of the circuit, you can always use additional VMOS transistors as buffers. Simply connect their gate leads to the drain connection of  $Q1$  or both  $Q1$  and  $Q2$ .

Finally, to provide one cycle of operation, insert a capacitor between  $R4$  and ground. Add a normally open pushbutton switch and 1.5-kilohm resistor in series across the capacitor. When the switch is closed, the circuit will operate. Release the switch, and it will cease operation after one cycle. Use any capacitance from 0.01 to 0.1  $\mu$ F for the capacitor.  $\diamond$

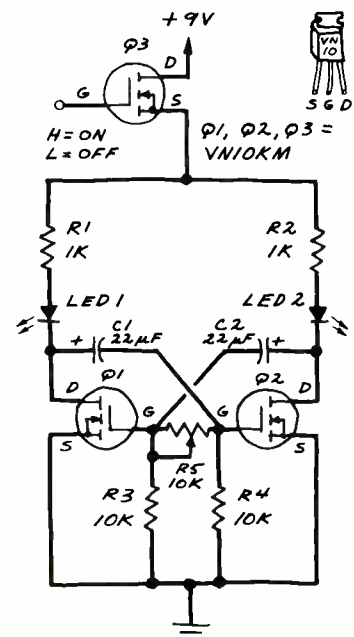

Fig. 2. Adjustable rate dual LED flasher with enable input.











# QUALITY parts at DISCOUNT PRICES

## MINI BSR



\$17.50 each

## AUTOMATIC RECORD CHANGER

B.S.R. MODEL C136P/C13  
PLAYS 33/45/78 RECORDS  
MINI SIZE: 8 1/4" X 12"  
INCLUDES DUST COVER AND PLASTIC CASE (NOT PICTURED) WITH FRONT CUT OUT TO FIT STEREO UNIT (NOT INCLUDED).

## COMPUTER GRADE CAPACITOR

1700 mfd. 150VDC \$2.00  
2 1/2" DIA X 4 3/4" HIGH  
3,600 mfd. 40VDC \$1.00  
1 1/2" DIA X 3 1/2" HIGH  
6,400 mfd. 60VDC \$2.50  
1 3/8" DIA X 4 1/2" HIGH  
12,000 mfd. 40VDC \$3.00  
2" DIA X 4 1/2" HIGH  
18,000 mfd. 75VDC \$4.00  
2 1/2" DIA X 4 1/2" HIGH  
22,000 mfd. 15VDC \$2.00  
2" DIA X 2 1/2" HIGH  
22,000 mfd. 40VDC \$3.00  
2" DIA. X 6" HIGH  
24,000 mfd. 30VDC \$3.50  
1 3/4" DIA X 4" HI  
31,000 mfd. 15VDC \$2.50  
1 3/4" DIA X 4" HI  
72,000 mfd. 15VDC \$3.50  
2" DIA. X 4" HIGH

## TRANSFORMERS

120 volt primaries

5.6 VOLTS at 750 MA \$3.00  
6 VOLTS at 150 MA \$1.25  
16.5 V. at 3 AMPS \$8.50  
18 VOLTS at 350 MA \$2.00  
18 VOLTS at 1 AMP \$4.50  
18 VCT. at 2 AMP \$5.50  
24 VOLTS at 250 MA \$2.50  
28 VCT. at 3.6 AMP \$6.50  
35 VCT. at 1 AMP \$1.50  
42 VCT. at 1.2 AMP \$4.50  
65 VCT. at 2 AMP \$5.50

## JOYSTICK

PRECISION DEVICE... CONTAINS 4 50K CENTER TAPPED ALPS POTS. \$4.75 ea

## BLACK PLASTIC CASE

PAC-TEC SERIES C  
BLACK PLASTIC ENCLOSURE ADJUSTABLE HEIGHT FROM 1.63" TO 2.93"; WIDTH 6.85"; DEPTH 8". BUILT-IN STAND OPFS FOR P.C. BOARDS... FRONT AND BACK PANELS NOT INCLUDED... \$5.25 PER CASE

## VARACTOR DIODE

MV2205 3 FOR \$1.00  
100 FOR \$70.00

## MITSUMI MODEL UES-A55F VARACTOR UHF TUNER

FREQ RANGE 470 - 889 MHZ  
ANTENNA INPUT 300 OHMS  
\$25.00 each  
10 FOR \$220.00

## PHOTO-FLASH

35 MFD 330 VOLT 1" X 5/8" DIA.  
45¢ EACH... 10 FOR \$4.00  
170 MFD 330 VOLT 1 1/8" X 7/8"  
2 FOR \$1.50/10 FOR \$7.00  
600 MFD 360 VOLT 3 1/2" HIGH X 1" DIA.  
\$1.00 EA. 10 FOR \$9.00  
750 MFD 330 VOLT 2" HIGH X 1 1/4" DIA.  
\$1.25 EACH 10 FOR \$11.00

## COMPUTER GRADE CAPACITOR SPECIAL

180,000 mfd. at 6V 7/8" DIA X 4 1/2" HIGH \$1.50  
CLAMPS TO FIT CAPACITORS 50K & 22K

## L.E.D.'s

STANDARD JUMBO DIFFUSED  
RED 10 FOR \$1.50  
GREEN 10 FOR \$2.00  
YELLOW 10 FOR \$2.00  
FLASHER LED 5 VOLT OPERATION  
RED JUMBO SIZE \$1.00 EACH  
BI POLAR LED 2 FOR \$1.70  
SUB MINI LED RED .079" X .098" 10 FOR \$1.00  
20 MA at 1.75V 200 FOR \$18.00

## 0-15 VDC METER

THIS 2 1/4" SQUARE METER MEASURES 0-15 VDC.  
\$4.50 EACH

## DC WALL TRANSFORMER

ALL ARE 115VAC PLUG IN

4 VDC at 70 MA \$2.50  
5.8 VDC at 125 MA \$2.50  
9 VDC at 100 MA \$2.00  
9 VDC at 225 MA \$3.00  
22 VDC at 60 MA \$2.50

## LED HOLDERS

TWO PIECE HOLDER FOR JUMBO LED  
10 FOR 65¢ 200 FOR \$10.00

## 8' LINE CORD

5/8" M/F 18 - 3  
ROUND GRAY \$2.00 EACH 10 FOR \$18.50

FREE! SEND FOR OUR NEW 1983 40 PAGE CATALOG FREE!

## KEYBOARD w/ case

16 KEY KEYBOARD MATRIX ENCODED  
TERMINATES TO FLEXIBLE CABLE WITH CONTACTS ON .100 CENTERS. EDGE CONNECTOR INCLUDED...  
\$4.50 PER KEYBOARD, CASE, AND CONNECTOR...

## 4PDT RELAY

14 pin style  
3 amp contacts  
24 volt c.c. or 120 volt a.c. coil  
Used but fully tested  
\$1.70 EACH  
Specify coil voltage  
LARGE QUANTITIES AVAILABLE  
SOCKETS FOR RELAY 50¢ EACH

## 4 WATT STEREO AMP

ASSEMBLY INCLUDES VOLUME, BALANCE AND TONE CONTROLS. CERAMIC PHONE INPUT, LINE INPUT AND 8 OHM OUTPUT FOR SPEAKER OR HEADPHONE.  
OPERATES ON 12 VAC @ 500MA.  
OR ABOVE 12 VOLT TRANSFORMER  
IDEAL FOR THIS APPLICATION  
\$4.50 EACH

## MINI-PUSH BUTTON

S.P.S.T. MOMENTARY NORMALLY OPEN  
1/4" BUSHING  
35¢ EACH 10 FOR \$3.25  
SPECIFY COLOR: RED, BLACK, WHITE, GREEN, YELLOW.

## EDGE CONNECTOR

ALL ARE .156" SPACING

15/30 GOLD SOLDER EYELET \$2.00 EACH  
18/36 GOLD SOLDER EYELET \$2.00 EACH  
22/44 GOLD SOLDERTAIL (P.C. STYLE) \$2.50 EA 10 FOR \$27.50  
22/44 TIN SOLDERTAIL (P.C. STYLE) \$1.35 EA 10 FOR \$12.50  
22/44 GOLD SOLDER EYELET \$2.50 EACH

## 6 VDC RELAY

MINIATURE D.P.D.T.  
3 AMP CONTACTS  
FUJITSU # FBR3210005  
\$1.75 EA 10 / 16.00

## 13 VDC RELAY

CONTACT: S.P.N.C.  
10 AMP @ 120 VAC  
ENERGIZE WITH TO OPEN CONTACT...  
COIL: 13 VDC 650 OHMS  
SPECIAL PRICE \$1.00 EACH

## KEY SWITCH

S.P.S.T. 5 AMPS @ 125 VAC  
KEY REMOVES BOTH POSITIONS \$3.50 EA

## 2 CHANNEL LIGHT ORGAN

EASILY HOOKS INTO STEREO SPEAKERS AND ALLOWS 110 VAC LIGHTS TO DANCE WITH MUSIC. TWO SEPARATE 110 VAC OUTPUTS FOR HIGH AND LOW FREQUENCY AUDIO SIGNALS. USE TWO ORGANS FOR STEREO... \$6.50 PER UNIT  
COLOR LIGHT STRING AVAILABLE \$1.75 FA

## LIGHTED PUSH BUTTON

RED LIGHTED 120 VAC 10 AMP. S.P.S.T. "POWER" PRINTED ON FACE. MOUNTS IN 7/8" SQUARE HOLE... \$1.50 EA 10 / \$13.50

## FOOT CONTROL WITH SIDE SWITCH

MEASURES 4 3/4" X 9 3/4" WITH 100 K LINEAR POT AND MOMENTARY S.P.D.T. SWITCH. \$6.50 EACH

## 6 volt 9amp/hr RECHARGEABLE

ELPOWER # EP690 SOLID GEL CELL  
5 1/2" X 4 1/4" X 2 3/4"  
\$15.00 EACH

## CANNON XLRA-3-13 CONNECTOR

3 PINS CHASSIS MOUNT CONNECTOR  
\$2.00 EACH 10 for \$19.00

## SLIDE POTS

500K linear taper 2 7/8" LG... 1 3/4" TRAVEL 75¢ EACH  
DUAL 100 K AUDIO TAPER SLIDE POT 3 1/2" LONG 2 1/2" TRAVEL... \$1.50 EACH

## MINIATURE 6VDC RELAY

SUPER SMALL SPDT RELAY; GOLD FINGER CONTACTS. RATED 1 AMP AT 30 VDC. HIGHLY SENSITIVE. TTL DIRECT DRIVE POSSIBLE. OPERATES FROM 4.3 TO 6 V. COIL RES. 220 OHM. 1 3/16" X 13/32" X 7/16" ARMOAT # RSD-6V \$1.50 EACH 10 FOR \$13.50

## BLACK LIGHT (ULTRAVIOLET)

G.E. # F675BL \$2.50 each

## CRYSTALS

CASE STYLE HC33/U  
2 MHZ: \$3.50 EACH  
3579.545 KC \$1.00 EACH

## METAL OXIDE VARISTOR

G.E. # 9827A12 50 VOLTS, NOMINAL D.C. VOLTAGE. 5/8" DIAMETER. 2 FOR \$1.50

## EQUIPMENT SLIDES

CHASSIS-TRAK MODEL C3005  
3 SECTION. LENGTH 22" CLOSED. HOLDS TO 85 LBS., EXTENDS 23" \$5.00 PER PAIR SOME HARDWARE INCLUDED

- Quantities Limited
- Min Order \$10.00
- Add \$2.50 Shipping USA
- Call Res Add \$1.25
- Prompt Shipping NO C.O.D.

# ALL ELECTRONICS CORP.

TOLL FREE ORDERS ONLY  
1-800-826-5432 (ORDER ONLY)  
ALASKA, HAWAII, CALIF OR INFORMATION (213) 380-8000

905 S VERMONT AVE P.O. BOX 20405 LOS ANGELES, CA 90006

CIRCLE NO. 3 ON FREE INFORMATION CARD

# OPERATION ASSIST

If you need information on outdated or rare equipment—a schematic, parts list, etc.—another reader might be able to assist. Simply send a postcard to Operation Assist, Computers & Electronics, 1 Park Ave., New York, NY 10016. For those who can help readers, please respond directly to them. They'll appreciate it. (Only those items regarding equipment not available from normal sources are published.)

RCA Model WT115A color picture tube tester. Need manual and schematic. Gordon S. Johnson, 1570 Diana Blvd., Merritt Island, FL 32952

Electronic Designs Inc., Model 100 voltmeter. Need schematic, parts list and operating manual. H. A. Russo, 604 Painter Ave., Ford Clif, PA 16228.

Jackson Model 64R tube tester. Need manual, top portion of case and original tube chart. R. Chadwell, 132 Wilberforce Ave., Oak Ridge, TN 37830.

General Electric Model P1905 radio. Need schematic and parts list. J. Pachuta, 167 Santiago Road, Imperial, PA 15126.

Optics Technology Inc., Model 210 laser. Need schematic and any information available. Winston Ellis, Box 55, West Tremont, ME 04690.

Halicrafters Model HT-32 ham transmitter. Need manual, service guide and service bulletins. Jim Muehlberg, 6030 Wentworth, Minneapolis, MN 55419.

Sylvania Model 220 tube tester. Need most current roller chart. Bill Thompson, 852 9th St., Beloit, WI 53511.

Halicrafters Model S-72R receiver. Need schematic and operating manual. Brad Tombaugh, 2324 Westmoor Dr., Findlay, OH 45840.

Hickok Model 665 oscilloscope and Model 288X signal generator. Need schematics and operating manuals. Gary Cook, Box 5, Serrerville, MO 63633.

A.B. Dumont AN/USM-32 oscilloscope. Need probes. Sean Powell, 8509 Rawlis Ave., Pensacola, FL 32504.

Precision Model ES-500A oscillograph. Need schematic and service manual. Jon Andreasen, 70 West End Ave., #5-6B, Newton, NJ 07860.

Dura Model 1041 word processor. Need schematic and service manual. B.A. Rogers, 9 St. Paul Ct., Hampton, VA 23666.

Jackson Model CRO-2 oscilloscope. Need operator's manual, wiring diagrams or schematics. Paul Fleming, Box A, Fort Washington, PA 19034.

Heathkit Model 1PW-27 power supply. Need manual and schematic. R.F. Aftanas, 1119 Troy Hill Rd., Pittsburgh, PA 15212.

Tektronix Type 31 scope. Need service manual. Robert Sorenson, 2411 Middlefield #15, Redwood City, CA 94063.

American Bosch Magneto Corp., Model 28 receiver. Need schematic. Henry M. Cantor, 21 Friendly Court, Babylon, NY 11702.

Triplet Serial #40122 RX microtabulometer. Need schematic diagram. Bill Gilbert, WD234VW, 26 Terrill Lane, Kings Park, NY 11754.

Gonset Model 3442 GA38A communicator. Need manuals and schematic or any technical data. Jack D. Brainard, 514 Mark Dr., Westminster, MD 21157.

EMC Model 801 capacitor/resistor tester and Sotar Model CB-1 60 capacitor analyzer. Need schematics, manuals and parts lists. J. R. Hetherington, 2820 So. Main St., Soquel, CA 95073.

Nikoltronix Model GN1375B CB analyzer. Need operating instructions and schematics. T. G. Stikeleather, 39 Hibiscus Ave., PPO, San Francisco, CA 96630.

Collins R-388/URR receiver. Need manual and schematic. Larry Gotts, Box 44, Pleasant Mount, PA 18453.



# ANNOUNCING TWO NEW TERMINALS

Smart • Fast • Graphics • Matching Modem and \$295 Printer

Netronics announces a state of the art breakthrough in terminals, now at prices you can afford, you can go online with data-bank and computer, phone-line services. It's all yours. "electronic newspapers," educational services, Dow-Jones stock reports, games, recipes, personal computing with any level language, program exchanges, electronic bulletin boards... and more every day!!!



Netronics offers two new terminals, both featuring a full 56 key/128 character typewriter-style keyboard, baud rates to 19.2 kilobaud, a rugged steel cabinet and power supply. The simplest one, FASTERM-64, is a 16 line by 64 or 32 character per line unit, with a serial printer port for making hard copy of all incoming data, and optional provisions for block and special character graphics. The "smart" version, SMARTERM-80, features either 24 line by 80 characters per line or 16 by 40 characters per line. It offers on-screen editing with page-at-a-time printing, 12,000 pixel graphics, line graphics, absolute cursor addressing, underlining, reverse video, one-half intensity and much more... simply plug them into your computer or cur phone modem and be on-line instantly. Use your TV set (RF modulator required) or our deluxe green-phosphor monitor pictured above. For hard copy just add our matched printer.

Price breakthrough!!! Own the FASTERM-64, a complete terminal kit, ready to plug in for just \$199.95 or order the SMARTERM-80 kit for just \$299.95. (both available wired and tested) Be on-line with the million-dollar computers and data services today... we even supply the necessary subscription forms

More good news... All the components in our terminals are available separately (see coupon), so you buy only what you need!!!

**FASTERM-64** DISPLAY FORMAT: 64 or 32 characters/line by 16 lines... 96 displayable ASCII characters (upper & lower case) 8 baud rates 150, 300, 600, 1200, 2400, 4800, 9600, 19,200, (switch sel.) LINE OUTPUT: RS232C or 20 ma current loop VIDEO OUTPUT 1V PIP (EIA RS-170) CURSOR MODES: home & clear screen, erase to end of line, erase cursor line, cursor up & down, auto carriage return/line feed at end of line & auto scrolling

**SMARTERM-80** DISPLAY FORMAT: 80 characters by 24 lines or 40 characters by 16 lines 128 displayable ASCII characters (upper & lower case) 8 baud rates 110, 300, 600, 1200, 2400, 4800, 9600, 19,200... LINE OUTPUT: RS232C or 20 ma current loop VIDEO OUTPUT 1V PIP (EIA RS-170) EDITING FEATURES: insert/delete line, insert/delete character, forward/back tab LINE OR PAGE TRANSMIT PAGE PRINT FUNCTION CURSOR POSITIONING: up, down, right, left, plus absolute cursor positioning with read back VISUAL ATTRIBUTES: underline, blink, reverse video, half intensity, & blank GRAPHICS 12,000 pixel resolution block plus line graphics ON-SCREEN PARITY INDICATOR PARITY off, even or odd STOP BITS 110 baud 2, all others 1 CHAR OUTPUT 7 by 11 character in a 9 by 12 block PRINTER OUTPUT 60 OR 50 Hz VERTICAL REFRESH BLINKING BLOCK CURSOR CRYSTAL CONTROLLED 2K ON BOARD RAM ASCII ENCODED KEYBOARD: 56 key/128 character 4K ON BOARD ROM COMPLETE WITH POWER SUPPLY

**TELEPHONE MODEM 103 O/A** FULL DUPLEX, FCC APPROVED DATA RATE 300 baud INTERFACE: RS232C and TTY CONTROLS: talk/data switch (no need to connect and disconnect phone), originate/answer switch on rear panel NO POWER SUPPLY REQUIRED

**ASCII KEYBOARD ASCII-3** 56 KEY/128 CHARACTER ASCII ENCODED UPPER & LOWER CASE FULLY DEBOUNCED 2 KEY ROLL-OVER POS OR NEG LOGIC WITH POS STROBE REQUIRE: +5 12V DC (SUPPLIED FROM VIDEO BOARDS)

**PRINTER COMET I** SERIAL I/O TO 9600 BAUD 80 CHARACTER COLUMN (132 COMPRESSED) 10" TRACTOR FEED UPPER/LOWER CASE INDUSTRY STANDARD RIBBONS 4 CHARACTER SIZES 9 BY 7 DOT MATRIX BI-DIRECTIONAL PRINTING



Continental U.S.A. Credit Card Buyers Outside Connecticut

**CALL TOLL FREE 800-243-7428**

To Order From Connecticut Or For Tech. Assist. Call (203) 354-9375

**NETRONICS R&D LTD.** Dept. CE

333 Litchfield Road, New Milford, CT 06776

Please send the items checked below:

- COMPLETE FASTERM-64 TERMINAL (includes FASTVID-64 video board ASCII-3 keyboard, steel cabinet and power supply) ... kit \$199.95 plus \$3 P&I ... wired & tested \$249.95 plus \$3 P&I ... graphics option: add \$19.95 to each of above
- COMPLETE SMARTERM-80 TERMINAL (includes SMARTVID-80 video board, ASCII-3 keyboard, steel cabinet and power supply) ... kit \$299.95 plus \$3 P&I ... wired & tested \$369.95 plus \$3 P&I
- FASTVID-64 VIDEO BOARD (requires +5 & -12V DC) ... kit \$99.95 plus \$3 P&I ... graphics option add \$19.95
- SMARTVID-80 VIDEO BOARD (requires +5 & -12V DC) ... kit \$199.95 plus \$3 P&I ... wired & tested \$249.95 plus \$3 P&I
- DELUXE STEEL TERMINAL CABINET ... \$19.95 plus \$3 P&I
- ASCII-3 KEYBOARD (requires +5 & -12VDC) ... kit \$69.95 plus \$3 P&I ... wired & tested \$89.95 plus \$3 P&I
- POWER SUPPLY (powers ASCII-3 keyboard & video boards) ... kit only \$19.95 plus \$2 P&I
- ZENITH VIDEO MONITOR (high resolution green phosphor) ... wired & tested \$149.95 plus \$6 P&I
- TELEPHONE MODEM MODEL 103 O/A ... wired & tested \$189.95 plus \$3 P&I
- DOT MATRIX PRINTER Comet I ... wired & tested \$299.95 plus \$10 P&I
- RF MODULATOR MOD RF-1 ... kit only \$8.95 plus \$1 P&I
- 3FT-25 LEAD MODEM/TERMINAL OR PRINTER/TERMINAL CONNECTOR CABLE ... \$14.95 ea plus \$2 P&I

For Canadian orders, double the postage Conn. res. add sales tax.

Total Enclosed \$

Personal Check  Cashier's Check/Money Order  
 VISA  MasterCard (Bank No. \_\_\_\_\_)  
Acct. No. \_\_\_\_\_ Exp. Date \_\_\_\_\_

Signature \_\_\_\_\_  
Print Name \_\_\_\_\_  
Address \_\_\_\_\_  
City \_\_\_\_\_ State \_\_\_\_\_ Zip \_\_\_\_\_

# FOR ONLY \$129.95 Learn Computing From The Ground Up

Build a Computer kit that grows with you, and can expand to 64k RAM, Microsoft BASIC, Text Editor/Assembler, Word Processor, Floppy Disks and more.

## EXPLORER/85

Here's the low cost way to learn the fundamentals of computing with the all-important basics you'll need more and more as you advance in computer skills. For just \$129.95 you get the advanced-design Explorer/85 motherboard, with all the features you need to learn how to write and use programs. And it can grow into a system that is a match for any personal computer on the market. Look at these features: 8085 Central Processing Unit, the microprocessor "heart" of the Explorer/85 (Join the millions who will buy and use the 8080/8085 this year alone) Four 8-bit plus one-bit input/output ports from which you can input and output your programs, as well as control external switches, relays, lights, etc. a cassette interface that lets you store and reload programs you've learned to write. A deluxe 2,000 byte operating system/monitor makes it easy to learn computing in several important ways. It allows simpler, faster writing and entering of programs. It permits access by you to all parts of the system so you can check on the status of any point in the program. It allows tracing each program step by step, with provision for displaying all the contents of the CPU (registers, flags, etc.) and it does much more!

You get all this in the starting level (Level A) of the Explorer/85 for only \$129.95. Incredible! To use, just plug your AVDC power supply and terminal or keyboard/display — if you don't have them see our special offers below

- Level A computer kit (Terminal Version) \$129.95 plus \$3 P&I
- Level A kit (Hex Keypad/Display Version) \$129.95 plus \$3 P&I

**LEVEL B** — This "building block" converts the motherboard into a two-slot \$100 bus (industry standard) computer. Now you can plug in any of the hundreds of \$100 cards available:

- Level B kit \$49.95 plus \$2 P&I
- \$100 bus connectors (two required) \$4.85 each, postpaid

**LEVEL C** — Add still more computing power: this "building block" mounts directly on the motherboard and expands the \$100 bus to six slots:

- Level C kit \$39.95 plus \$2 P&I
- \$100 bus connectors (five required) \$4.85 each, postpaid

**LEVEL D** — When you reach the point in learning that requires more memory, we offer two choices: either add 4k of a memory directly on the motherboard or add 16k of 4k of memory by means of a single \$100 card, our famous [JAWS] — see above

**Level D kit (CHECK ONE)**  4k on board \$49.95 plus \$2 P&I  16k \$100 [JAWS] \$149.95 plus \$2 P&I  32k \$100 [JAWS] \$199.95 plus \$2 P&I  48k \$100 [JAWS] \$249.95 plus \$2 P&I  64k \$100 [JAWS] \$299.95 plus \$2 P&I

**LEVEL E** — An important building block it activates the 8k ROM/EPROM space on the motherboard. Now just plug in our 8K MICROSOFT BASIC or your own custom programs

- Level E kit \$5.85 plus \$1c P&I

**MICROSOFT BASIC** — It's the language that allows you to talk English to your computer! It is available three ways:  8k cassette version of Microsoft BASIC (requires Level B and 12k of RAM minimum, we suggest a 16k \$100 [JAWS] — see above) \$64.95 plus \$2 P&I  8k ROM version of Microsoft BASIC (requires Level B & Level E and 4K RAM, just plug into your Level E sockets. We suggest either the 4k Level D RAM expansion or a 16k \$100 [JAWS] — see above) \$69.95 plus \$2 P&I  Disk version of Microsoft BASIC (requires Level B 12k of RAM, floppy disk controller, 8" floppy disk drive) \$325 postpaid

**TEXT EDITOR/ASSEMBLER** — The editor/assembler (a software tool (a program) designed to simplify the task of writing programs. As your programs become longer and more complex, the assembler can save you many hours of programming time. This software includes an editor program that enters the programs you write, makes changes and saves the programs on cassettes. The assembler performs the tedious task of translating symbolic code into the computer readable object code. The editor/assembler program is available either in cassette or a ROM version

- Editor/Assembler (Cassette version) requires Level B and 8k minimum RAM — we suggest 16k [JAWS] — see above) \$59.95 plus \$2 P&I
- Editor/Assembler (ROM version) supplied on a \$100 card, requires Level B and 4k RAM min. — we suggest 8" floppy D or 16k [JAWS] — see above) \$99.95 plus \$2 P&I

**8" FLOPPY DISK** — A remarkable building block. Add our 8" floppy disk when you need faster program more convenient program storage, perhaps a business application, and access to the literally thousands of programs and program languages available today. You simply plug them into your Explorer/85 disk system — it accepts all IBM formatted CP/M programs

- 8" Floppy Disk Drive \$499.95 plus \$12 P&I
- Floppy Controller Card \$199.95 plus \$2 P&I
- Disk Drive Cabinet & Power Supply \$69.95 plus \$3 P&I
- Drive Cables (set up for two drives) \$25.00 plus \$1.50 P&I

CP/M 2.2 Disk Operating system includes Text Editor/Assembler, dynamic debugger, and other features that give your Explorer/85 access to the thousands of existing CP/M-based programs. \$150.00 postpaid

**NEED A POWER SUPPLY?** Consider our AP-1. It can supply all the power you need for a fully expanded Explorer/85 (note: disk drives have their own power supply). Plus the AP-1 fits neatly into the attractive Explorer steel cabinet (see below)

- AP-1 Power Supply kit (8V @ 5 amps) in deluxe steel cabinet: \$39.95 plus \$2 P&I

**NEED A TERMINAL?** We offer you choices: the least expensive one is our Hex Keypad/Display kit that displays the information on a calculator-type screen. The other choice is our ASCII Keyboard/Computer Terminal kit that can be used with either

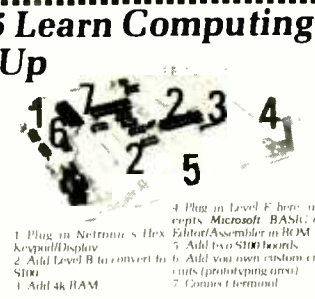

- 1 Plug in Netronics Hex Keypad/Display Kit
- 2 Add Level B to convert to \$100 bus
- 3 Add your own custom cards (prototype cards)
- 4 Plug in Level E hardware (except Microsoft BASIC or Editor/Assembler in ROM)
- 5 Add two \$100 boards
- 6 Add your own custom cards (prototype cards)
- 7 Connect terminal

a CRT monitor or a TV set (if you have an RF modulator)

- Hex Keypad/Display kit \$69.95 plus \$2 P&I
- FASTERM-64 TERMINAL KIT Featuring a 56 key ASCII Keyboard, 128 character set upper and lower case 75 mm output, 8 baud rates, 150 to 19,200 (switch select) RS232-C or 20 MA output, 32 or 64 character by 16 line format, complete with Deluxe Steel Cabinet and Power Supply \$199.95 plus \$3 P&I

- RF Modulator kit (allows you to use your TV set as a monitor) \$8.95 postpaid
- 12 Video Monitor (10MHz bandwidth) \$139.95 plus \$5 P&I
- Deluxe Steel Cabinet for the Explorer/85 \$49.95 plus \$3 P&I
- Fan for cabinet \$15.00 plus \$1.50 P&I

**ORDER A SPECIAL-PRICE EXPLORER/85 PAK — THERE'S ONE FOR EVERY NEED.**

**Beginner Pak** (Save \$26.00) — You get Level A (Terminal Version) with Monitor Source Listing (\$25 value) AP-1 5-amp power supply Intel 8085 Users Manual (Reg. \$149.95) SPECIAL \$189.95 plus \$2 P&I

**Experimenter Pak** (Save \$53.40) — You get Level A (Hex Keypad/Display Version) with Hex Keypad/Display Intel 8085 User Manual Level A Hex Monitor Source Listing and AP-1 5-amp power supply (Reg. \$279.95) SPECIAL \$219.95 plus \$6 P&I

**Special Microsoft BASIC Pak** (Save \$103.00) — You get Levels A (Terminal Version) B (14K RAM) E (8K Microsoft in ROM) Intel 8085 User Manual, Level A Monitor Source Listing, and AP-1 5-amp power supply (Reg. \$439.95) SPECIAL \$339.95 plus \$7 P&I

**Add ROM-Version Text Editor/Assembler** (Requires Levels B and D or \$100 Memory) \$99.95 plus \$2 P&I

**Starter 8" Disk System** — Includes Level A, B floppy disk controller one CDC 8" disk-drive two-drive cable two \$100 connectors just add your own power supply cabinets and hardware \$99.95 plus \$13 P&I

**32k Starter System** \$1045.95 plus \$13 P&I  **48k Starter System** \$1095.95 plus \$13 P&I  **64k Starter System** \$1145.95 plus \$13 P&I

Add to any of above Explorer steel cabinet, AP-1 5-amp power supply, Level C with two \$100 connectors, disk drive cabinet and power supply, two 5-ohm D connectors for connecting your printer and terminal (Reg. \$225.95) SPECIAL \$199.95 plus \$13 P&I

**Complete 64K System** (Wired & Tested) \$1650.00 plus \$26 P&I

**Special Complete Business Software Pak** (Save \$625.00) — Includes CP/M 2.2 Microsoft BASIC, General Ledger, Accounts Receivable, Accounts Payable, Payroll Package (Reg. \$1325) SPECIAL \$699.95 postpaid

\*P&I stands for postage & insurance. For Canadian or other, double this amount

Continental Credit Card Buyers Outside Connecticut:

**TO ORDER**  
Call Toll Free:  
**800-243-7428**

To Order From Connecticut, or For Technical Assistance, Call (203) 354-9375

CP/M is a reg. trademark of Digital Research

★ (Clip and mail entire ad) ★ CE

SEND ME THE ITEMS CHECKED ABOVE  
Total Enclosed (Conn. Residents add sales tax) \$ \_\_\_\_\_  
Paid by

Personal Check  Cashier's Check/Money Order  
 VISA  MASTER CARD (Bank No. \_\_\_\_\_)

Acct. No. \_\_\_\_\_ Exp. Date \_\_\_\_\_

Signature \_\_\_\_\_  
Print Name \_\_\_\_\_

Address \_\_\_\_\_  
City \_\_\_\_\_ State \_\_\_\_\_ Zip \_\_\_\_\_

**NETRONICS Research & Development Ltd.**  
333 Litchfield Road, New Milford, CT 06776



# 4164 64K DYNAMIC \$625

200 NS

# TMM2016 2KX8 STATIC \$415

200 NS

ALL MERCHANDISE 100% GUARANTEED!

CALL US FOR VOLUME QUOTES

## STATIC RAMS

2101	256 x 4 (450ns)	1.95
5101	256 x 4 (450ns) (cmos)	3.95
2102-1	1024 x 1 (450ns)	.89
2102L-4	1024 x 1 (450ns) (LP)	1.29
2102L-2	1024 x 1 (250ns) (LP)	1.69
2111	256 x 4 (450ns)	2.99
2112	256 x 4 (450ns)	2.99
2114	1024 x 4 (450ns)	8/14.95
2114L-4	1024 x 4 (450ns) (LP)	8/15.25
2114L-3	1024 x 4 (300ns) (LP)	8/15.45
2114L-2	1024 x 4 (200ns) (LP)	8/15.95
2147	4096 x 1 (55ns)	4.95
TMS4044-4	4096 x 1 (450ns)	3.49
TMS4044-3	4096 x 1 (300ns)	3.99
TMS4044-2	4096 x 1 (200ns)	4.49
MK4118	1024 x 8 (250ns)	9.95
TMM2016-200	2048 x 8 (200ns)	4.15
TMM2016-150	2048 x 8 (150ns)	4.95
TMM2016-100	2048 x 8 (100ns)	6.15
HM6116-4	2048 x 8 (200ns) (cmos)	4.95
HM6116-3	2048 x 8 (150ns) (cmos)	5.95
HM6116-2	2048 x 8 (120ns) (cmos)	8.95
HM6116LP-4	2048 x 8 (200ns) (cmos)(LP)	6.95
HM6116LP-3	2048 x 8 (150ns) (cmos)(LP)	8.95
HM6116LP-2	2048 x 8 (120ns) (cmos)(LP)	10.95
Z-6132	4096 x 8 (300ns) (Qstat)	34.95

LP - Low Power Qstat - Quasi-Static

## DYNAMIC RAMS

TMS4027	4096 x 1 (250ns)	1.99
MK4108	8192 x 1 (200ns)	1.95
MM5298	8192 x 1 (250ns)	1.85
4116-300	16384 x 1 (300ns)	8/11.75
4116-250	16384 x 1 (250ns)	8/11.95
4116-200	16384 x 1 (200ns)	8/13.95
4116-150	16384 x 1 (150ns)	8/15.95
4116-120	16384 x 1 (120ns)	8/29.95
2118	16384 x 1 (150ns) (5v)	4.95
MK4816	2048 x 8 (300ns) (5v)	24.95
4164-200	65536 x 1 (200ns) (5v)	6.25
4164-150	65536 x 1 (150ns) (5v)	7.25

5V - single 5 volt supply

## EPROMS

1702	256 x 8 (1us)	4.50
2708	1024 x 8 (450ns)	3.95
2758	1024 x 8 (450ns) (5v)	5.95
2716	2048 x 8 (450ns) (5v)	3.95
2716-1	2048 x 8 (350ns) (5v)	6.25
TMS2716	2048 x 8 (450ns)	7.95
TMS2532	4096 x 8 (450ns) (5v)	7.95
2732	4096 x 8 (450ns) (5v)	4.95
2732-250	4096 x 8 (250ns) (5v)	12.95
2732-200	4096 x 8 (200ns) (5v)	16.95
2764	8192 x 8 (450ns) (5v)	16.95
2764-250	8192 x 8 (250ns) (5v)	18.95
2764-200	8192 x 8 (200ns) (5v)	19.95
TMS2564	8192 x 8 (450ns) (5v)	24.95
MC68764	8192 x 8 (450ns) (5v)(24 pin)	call

5v = Single 5 Volt Supply

## EPROM ERASERS

	Timer	Capacity Chip	Intensity (uW/Cm <sup>2</sup> )	
PE-14		6	5,200	83.00
PE-14T	X	6	5,200	119.00
PE-24T	X	9	6,700	175.00
PL-265T	X	20	6,700	255.00
PR-125T	X	16	15,000	349.00
PR-320	X	32	15,000	595.00

## DISC CONTROLLERS

1771	16.95
1791	29.95
1793	38.95
1795	54.95
1797	54.95
6843	34.95
8272	39.95
UPD765	39.95
1691	18.95
2143	18.95

## INTERFACE

8T26	1.69
8T28	2.49
8T95	.99
8T96	.99
8T97	.99
8T98	.99
DM8131	2.95
DP8304	2.29
DS8835	1.99
DS8836	.99

## MISC.

3242	7.95
3341	4.95
MC3470	4.95
MC3480	9.00
11C90	13.95
95H90	7.95
2513-001 UP	9.95
2513-002 LOW	9.95

## SOUND CHIPS

76477	3.95
76489	8.95
AY3-8910	12.95
MC3340	1.49

## CRT

6845	14.95
68B45	35.95
HD46505SP	15.95
6847	12.25
68047	24.95
8275	29.95
7220	99.95
CRT5027	39.95
CRT5037	49.95
DP8350	49.95

## BIT-RATE GENERATORS

MC14411	11.95
BR1941	11.95
4702	12.95
COM5016	16.95
COM8116	10.95
MM5307	10.95

## UARTS

AY3-1014	6.95
AY5-1013	3.95
PT1472	9.95
TR1602	3.95
2350	9.95
2651	8.95
TMS6011	5.95
IM6402	7.95
IM6403	8.95
INS8250	14.95

## KEYBOARD CHIPS

AY5-2376	11.95
AY5-3600	11.95
74C922	See 74C00
74C923	Series Prices

## CLOCK CIRCUITS

MM5314	4.95
MM5369	3.95
MM5375	4.95
MM58167	8.95
MM58174	11.95
MSM5832	6.95

## Z-80 2.5 Mhz

Z80-CPU	3.95
Z80-CTC	5.95
Z80-DART	15.25
Z80-DMA	17.50
Z80-PIO	5.75
Z80-SIO/0	18.50
Z80-SIO/1	18.50
Z80-SIO/2	18.50
Z80-SIO/9	16.95

## 4.0 Mhz

Z80A-CPU	6.00
Z80A-CTC	8.65
Z80A-DART	18.75
Z80A-DMA	27.50
Z80A-PIO	6.00
Z80A-SIO/0	22.50
Z80A-SIO/1	22.50
Z80A-SIO/2	22.50
Z80A-SIO/9	19.95

## 6.0 Mhz

Z80B-CPU	17.95
Z80B-CTC	15.50
Z80B-PIO	15.50

## ZILOG

Z6132	34.95
Z8671	39.95

## CRYSTALS

32.768 khz	1.95
1.0 mhz	4.95
1.8432	4.95
2.0	3.95
2.097152	3.95
2.4576	3.95
3.2768	3.95
3.579535	3.95
4.0	3.95
5.0	3.95
5.0688	3.95
5.185	3.95
5.7143	3.95
6.0	3.95
6.144	3.95
6.5536	3.95
8.0	3.95
10.7836	3.95
14.31818	3.95
15.0	3.95
16.0	3.95
18.0	3.95
18.432	3.95
20.0	3.95
22.1184	3.95
32.0	3.95

## DATA ACQUISITION

ADC0800	15.55
ADC0804	3.49
ADC0809	4.49
ADC0817	9.95
DAC0800	4.95
DAC0806	1.95
DAC0808	2.95
DAC1020	8.25
DAC1022	5.95
MC1408L6	1.95
MC1408L8	2.95

## 8000

8035	5.95
8039	6.95
INS-8060	17.95
INS-8073	24.95
8080	3.95
8085	5.95
8085A-2	11.95
8086	29.95
8087	CALL
8088	39.95
8089	89.95
8155	7.95
8156	8.95
8185	29.95
8185-2	39.95
8741	39.95
8748	29.95
8755	32.00

## 8200

8202	29.95
8203	39.95
8205	3.50
8212	1.80
8214	3.85
8216	1.75
8224	2.25
8226	1.80
8228	3.49
8237	19.95
8238	4.49
8243	4.45
8250	10.95
8251	4.49
8253	6.95
8253-5	7.95
8255	4.95
8255-5	5.25
8257	7.95
8257-5	8.95
8259	6.90
8259-5	7.50
8272	39.95
8275	9.95
8279	8.95
8279-5	10.00
8282	6.50
8283	6.50
8284	5.50
8286	6.50
8287	6.50
8288	25.00
8289	49.95

## FUNCTION GENERATORS

MC4024	3.95
LM566	1.49
XR2206	3.75
8038	3.95

## INTERSIL

ICL7103	9.50
ICL7106	9.95
ICL7107	12.95
ICL8038	3.95
ICM7107A	5.59
ICM7208	15.95

## 6800

68000	99.95
6800	4.95
6802	7.95
6808	13.90
6809E	19.95
6809	12.95
6810	2.95
6820	4.95
6821	3.25
6828	14.95
6840	12.95
6843	34.95
6844	25.95
6845	14.95
6847	12.25
6850	3.45
6852	5.75
6860	9.95
6862	11.95
6875	6.95
6880	2.25
6883	24.95
68047	24.95
68488	19.95
6800 = 1MHZ	
68B00	10.95
68B02	22.25
68B09E	29.95
68B09	29.95
68B10	7.95
68B21	12.95
68B45	35.95
68B50	12.95
68B00 = 2 MHZ	

## 6500 1 MHZ

6502	5.95
6504	6.95
6505	8.95
6507	9.95
6520	4.35
6522	8.75
6532	11.25
6545	22.50
6551	11.85

## 2 MHZ

6502A	9.95
6522A	11.70
6532A	12.40
6545A	28.50
6551A	12.95

## 3 MHZ

6502B	14.95
-------	-------

## EXAR

XR 2206	3.75
XR 2207	3.85
XR 2208	3.90
XR 2211	5.25
XR 2240	3.25

## 9000 SERIES

9316	1.00
9334	2.50
9368	3.95
9401	9.95
9601	.75
9602	1.50
96S02	1.95

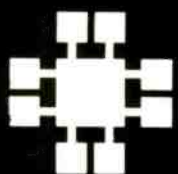

# JDR MICRODEVICES, INC.

1224 S. Bascom Avenue  
San Jose, CA 95128

800-538-5000 • 800-662-6279 (CA)  
(408) 995-5430 • Telex 171-110

©1982 JDR MICRODEVICES, INC.

VISIT OUR  
RETAIL STORE

— NEW HOURS —  
M-W-F, 9-5  
T-Th., 9-9 Sat. 11-3

PLEASE USE YOUR CUSTOMER NUMBER WHEN ORDERING

TERMS: For shipping include \$2 for UPS Ground or \$3 for UPS Blue Label Air. Items over 5 pounds require additional shipping charges. Foreign orders include sufficient amount for shipping. There is a \$10 minimum order. Bay Area and Los Angeles Counties add 6 1/2% Sales Tax. Other California residents add 6% Sales Tax. We reserve the right to substitute manufacturer. Not responsible for typographical errors. Prices are subject to change without notice. We will match or beat any competitor's price provided it is not below our cost.

## 74LS00

74LS00	.24	74LS86	.39	74LS169	1.75	74LS323	2.75
74LS01	.25	74LS90	.55	74LS170	1.49	74LS324	1.75
74LS02	.25	74LS91	.89	74LS173	.69	74LS352	1.29
74LS03	.25	74LS92	.55	74LS174	.55	74LS353	1.29
74LS04	.24	74LS93	.55	74LS175	.55	74LS364	1.35
74LS05	.25	74LS95	.75	74LS181	2.15	74LS364	1.95
74LS08	.28	74LS96	.89	74LS189	8.95	74LS365	.49
74LS09	.29	74LS107	.39	74LS190	.89	74LS366	.49
74LS10	.25	74LS109	.39	74LS191	.89	74LS367	.49
74LS11	.35	74LS112	.39	74LS192	.79	74LS368	.45
74LS12	.35	74LS113	.39	74LS193	.79	74LS373	.99
74LS13	.45	74LS114	.39	74LS194	.69	74LS374	.99
74LS14	.59	74LS122	.45	74LS195	.69	74LS377	1.39
74LS15	.35	74LS123	.79	74LS196	.79	74LS378	1.18
74LS20	.25	74LS124	2.90	74LS197	.79	74LS379	1.35
74LS21	.29	74LS125	.49	74LS221	.89	74LS385	1.90
74LS22	.25	74LS126	.49	74LS240	.95	74LS386	.45
74LS26	.29	74LS132	.59	74LS241	.99	74LS390	1.19
74LS27	.29	74LS133	.59	74LS242	.99	74LS393	1.19
74LS28	.35	74LS136	.99	74LS243	.99	74LS395	1.19
74LS30	.25	74LS137	.99	74LS244	.99	74LS399	1.49
74LS32	.29	74LS138	.55	74LS245	1.49	74LS424	2.95
74LS33	.55	74LS139	.55	74LS247	.75	74LS447	.37
74LS37	.35	74LS145	1.20	74LS248	.99	74LS490	1.95
74LS38	.35	74LS147	2.49	74LS249	.99	74LS624	3.99
74LS40	.25	74LS148	1.35	74LS251	.59	74LS668	1.69
74LS42	.49	74LS151	.55	74LS252	.59	74LS669	1.89
74LS47	.75	74LS153	.55	74LS257	.59	74LS670	1.49
74LS48	.75	74LS154	1.90	74LS258	.59	74LS674	9.65
74LS49	.75	74LS155	.69	74LS259	2.75	74LS682	3.20
74LS51	.25	74LS156	.69	74LS260	.59	74LS683	3.20
74LS54	.29	74LS157	.69	74LS266	.55	74LS684	3.20
74LS55	.29	74LS158	.59	74LS273	1.49	74LS685	3.20
74LS63	1.25	74LS160	.65	74LS275	3.35	74LS688	2.40
74LS73	.39	74LS161	.65	74LS279	.49	74LS689	3.20
74LS74	.35	74LS162	.69	74LS280	1.98	74LS783	24.95
74LS75	.39	74LS163	.65	74LS283	.69	81LS95	1.49
74LS76	.39	74LS164	.69	74LS283	.89	81LS96	1.49
74LS78	.49	74LS165	.95	74LS283	.89	81LS97	1.49
74LS83	.60	74LS166	1.95	74LS285	.99	81LS98	1.49
74LS85	.69	74LS168	1.75	74LS298	.89	25LS2521	2.80
						25LS2569	4.25

## IC SOCKETS

8 pin ST	1.99	100
14 pin ST	.13	11
16 pin ST	.15	12
16 pin ST	.17	13
18 pin ST	.20	18
20 pin ST	.29	27
22 pin ST	.30	27
24 pin ST	.30	27
28 pin ST	.40	32
40 pin ST	.49	39
ST = SOLDER TAIL		
8 pin WW	.59	49
14 pin WW	.69	52
16 pin WW	.69	58
18 pin WW	.99	90
20 pin WW	1.09	90
22 pin WW	1.39	128
24 pin WW	1.49	135
28 pin WW	1.69	149
40 pin WW	1.99	180
WW = WIREWRAP		
16 pin ZIF	6.75	call
24 pin ZIF	9.95	call
ZIF = TEXT TOOL (Zero Insertion Force)		

## 7400

7400	.19	74132	.45
7401	.19	74136	.50
7402	.19	74141	.65
7403	.19	74142	2.95
7404	.19	74143	2.95
7405	.25	74145	.60
7406	.29	74147	1.75
7407	.29	74148	1.20
7408	.24	74150	1.35
7409	.19	74151	.55
7410	.19	74152	.65
7411	.25	74153	.55
7412	.30	74154	1.25
7413	.35	74155	.75
7414	.49	74156	.65
7416	.25	74157	.55
7417	.25	74159	1.65
7420	.19	74160	.85
7421	.35	74161	.69
7422	.35	74162	.85
7423	.29	74163	.69
7425	.29	74164	.85
7426	.29	74165	.85
7427	.29	74166	1.00
7428	.45	74167	2.95
7430	.19	74170	1.65
7432	.29	74172	5.95
7433	.45	74173	.75
7437	.29	74174	.89
7438	.29	74175	.89
7440	.19	74176	.89
7442	.49	74177	.75
7443	.65	74178	1.15
7444	.69	74179	1.75
7445	.69	74180	.75
7446	.69	74181	2.25
7447	.69	74182	.75
7448	.69	74184	2.00
7450	.19	74185	2.00
7451	.23	74186	18.50
7453	.23	74190	1.15
7454	.23	74191	1.15
7460	.23	74192	.79
7470	.35	74193	.79
7472	.29	74194	.85
7473	.34	74195	.85
7474	.33	74196	.79
7475	.45	74197	.75
7476	.35	74198	1.35
7480	.59	74199	1.35
7481	1.10	74221	1.35
7482	.95	74246	1.35
7483	.50	74247	1.25
7485	.59	74248	1.85
7486	.35	74249	1.95
7489	2.15	74251	.75
7490	.35	74259	2.25
7491	.40	74265	1.35
7492	.50	74273	1.95
7493	.35	74276	1.25
7494	.65	74279	.75
7495	.55	74283	2.00
7496	.70	74284	3.75
7497	2.75	74285	3.75
74100	1.75	74290	.95
74107	.30	74293	.75
74109	.45	74298	.85
74110	.45	74351	2.25
74111	.55	74365	.65
74116	1.55	74366	.65
74120	1.20	74367	.65
74121	.29	74368	.65
74122	.45	74376	2.20
74123	.49	74390	1.75
74125	.45	74393	1.35
74126	.45	74425	3.15
74128	.55	74426	.85
		74490	2.55

## CMOS

4000	.29	4528	1.19
4001	.25	4531	.95
4002	.25	4532	1.95
4006	.89	4538	1.95
4007	.29	4539	1.95
4008	.95	4543	1.19
4009	.39	4555	.95
4010	.45	4556	.95
4011	.25	4581	1.95
4012	.25	4582	1.95
4013	.38	4584	.75
4014	.79	4585	.75
4015	.39	4702	12.95
4016	.39	74C00	.35
4017	.69	74C02	.35
4018	.79	74C04	.35
4019	.39	74C08	.35
4020	.75	74C10	.35
4021	.75	74C14	.59
4022	.79	74C20	.35
4023	.29	74C30	.35
4024	.65	74C32	.39
4025	.29	74C42	1.29
4026	1.65	74C48	1.99
4027	.45	74C73	.65
4028	.69	74C74	.65
4029	.79	74C76	.80
4030	.39	74C83	1.95
4034	1.95	74C85	1.95
4035	.85	74C86	.39
4040	.75	74C89	4.50
4041	.75	74C90	1.19
4042	.69	74C93	1.75
4043	.85	74C95	.99
4044	.79	74C107	.89
4046	.85	74C150	5.75
4047	.95	74C151	2.25
4049	.35	74C154	3.25
4050	.35	74C157	1.75
4051	.79	74C160	1.19
4053	.79	74C161	1.19
4060	.89	74C162	1.19
4066	.39	74C163	1.19
4068	.39	74C164	1.39
4069	.29	74C165	2.00
4070	.35	74C173	.79
4071	.29	74C174	1.19
4072	.29	74C175	1.19
4073	.29	74C192	1.49
4075	.29	74C193	1.49
4076	.79	74C195	1.39
4078	.29	74C200	5.75
4081	.29	74C221	1.75
4082	.29	74C373	2.45
4085	.95	74C374	2.45
4086	.95	74C901	.39
4093	.49	74C902	.85
4098	2.49	74C903	.85
4099	1.95	74C905	10.95
14409	12.95	74C906	.95
14410	12.95	74C907	1.00
14411	11.95	74C908	2.00
14412	12.95	74C909	2.75
14419	7.95	74C910	9.95
4502	.95	74C911	8.95
4503	.65	74C912	8.95
4508	1.95	74C914	1.95
4510	.85	74C915	1.19
4511	.85	74C918	2.75
4512	.85	74C920	17.95
4514	1.25	74C921	15.95
4515	1.79	74C922	4.49
4516	1.55	74C923	4.95
4518	.89	74C925	5.95
4519	.39	74C926	7.95
4520	.79	74C927	7.95
4522	1.25	74C928	7.95
4526	1.25	74C929	19.95
4527	1.95	74C930	19.95

## CONNECTORS

RS232 MALE	2.95
RS232 FEMALE	3.50
RS232 FEMALE	
RIGHT ANGLE	5.25
RS232 HOOD	1.25
S-100 ST	3.95
S-100 WW	4.95

## DIP SWITCHES

4 POSITION	.85
5 POSITION	.90
6 POSITION	.90
7 POSITION	.95
8 POSITION	.95

## Prices Slashed! 74S00

74S00	.32	74S163	1.95
74S02	.35	74S168	3.95
74S03	.35	74S169	3.95
74S04	.35	74S174	.95
74S05	.35	74S175	.95
74S08	.35	74S181	3.95
74S09	.40	74S182	2.95
74S10	.35	74S188	1.95
74S11	.35	74S189	6.95
74S15	.35	74S194	1.49
74S20	.35	74S195	1.49
74S22	.35	74S196	1.49
74S30	.35	74S197	1.49
74S32	.40	74S201	6.95
74S37	.88	74S225	7.95
74S38	.85	74S240	2.20
74S40	.35	74S241	2.20
74S51	.35	74S244	2.20
74S64	.40	74S251	.95
74S65	.40	74S253	.95
74S74	.50	74S257	.95
74S85	1.99	74S258	.79
74S86	.50	74S260	.79
74S112	.50	74S274	19.95
74S113	.50	74S275	19.95
74S114	.55	74S280	1.95
74S124	2.75	74S287	1.90
74S132	1.24	74S288	1.90
74S133	.45	74S289	6.89
74S134	.50	74S301	6.95
74S135	.89	74S373	2.45
74S138	.85	74S374	2.45
74S139	.8		



# MAKE RADIO SHACK YOUR PARTS PLACE™

No Minimum Order! No Waiting! Huge Selection!

## Project Enclosure Sale!



Up to  
**25% Off**

**A** Deluxe. Classy 2-tone styling, easy-to-work plastic end panels. 2 1/4 x 5 x 5 1/4". Reg. 7.95. 270-218 . . . Sale 5.95  
**B** "Silver-Look". Vented steel tops, easy-to-work aluminum chassis, rubber feet.

Size	Cat. No.	Reg.	SALE
3 1/4 x 7 1/2 x 5 7/8"	270-229	9.95	7.99
2 1/2 x 5 1/16 x 4 9/16"	270-228	6.95	5.49

## Computer Communicators



14-Pin DIPs With Data

**179** Each

**1488. RS232 Quad Line Driver.** Interfaces terminal equipment with communications devices or connects different logic families. Current limited output. Split supply, 15VDC max. 276-2520 . . . . . 1.79

**1489. RS232 Quad Line Receiver.** Use with above. Will perform logic level translation. Sections can be paralleled to obtain multiple outputs from one input. Input threshold hysteresis. Single supply, 10VDC maximum. 276-2521 . . . . . 1.79

**SN75446 Dual Peripheral Driver.** Drives relays and other devices up to 350 mA, 50VDC from logic level input. Diode-clamped inputs. Single 5.5VDC supply. 276-2530 . . . . . 2.79



8-Pin DIP With Data

**279**

**40-Pin DIP With Data**  
**AY-3-1015. Single-Supply UART.** Full-duplex universal transceiver accepts asynchronous serial binary characters and converts to a parallel format, and vice versa. Selectable baud rate, number of data bits, stop bits, parity mode. Fully buffered outputs. Low power design. 4.75 to 5.25VDC. 276-1794 . . . . . 5.95

## EMI/RFI Filter

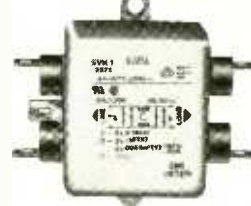

**1195**

Keeps radio frequency interference from being conducted into sensitive equipment from power line or into line from equipment. 5A at 120VAC, 4A at 250VAC. 273-100 . . . . . 11.95

## MOV Spike Protector

**V130LA10A Metal Oxide Transient Voltage Absorber.** Guards 120VAC equipment against malfunctions caused by voltage spikes. Fast response. Ideal for use with EMI/RFI filter. 276-570 . . 1.59

**159**

Easy to install



## PC Board Holder

Reg. 6.95



**488 Cut 30%**

Frees hands for easier soldering and repair. Mounts on bench or in a vice. Holds board securely at any angle. 276-1568 . . . . . Sale 4.88

## Dual IC Board

**149**



Accepts two 6 to 20-pin DIP ICs. Four contact points for each IC pin. 276-159 . . . . . 1.49

## Miniature SPDT Relays

For limited-space projects that require switching up to 3 amps at 125VAC. Excellent for computer control and other digital circuits. 72-ohm, 5VDC coil. 275-246 . . . . . 3.49  
**12VDC Coil.** 400 ohms, 30 milliamps. For mobile communications and automotive switching. 275-247 . . . . . 3.49

9/16 x 25/32 x 5/8"



**349** Each

## Low-Voltage Sensor



**359**

TO-72 Case

**ICM7201.** Lights LED (not incl.) when voltage falls below preset 2.9V level. Add voltage divider for low-battery warning—ideal for nickel-cadmium packs! 276-2333 . . . . . 3.59



\*Has Center Tap  
**Shielded Power Xformers**

■ 120VAC Primaries  
■ Miniature Size ■ U.L. Listed

Secondary VAC	Cat. No.	Each
6.3 at 450 mA	273-1364	2.99
12.0* at 450 mA	273-1365	3.59
24.0* at 450 mA	273-1366	3.99

## Semiconductor Guide

**349**

Over 280 Fact-Filled Pages!



Exclusive substitution section lists over 80,000 types and their low-cost Radio Shack equivalents! Also has pin-outs and detailed data on Radio Shack ICs, SCRs, LEDs, diodes and opto devices, replacement tips. 276-4006 . . . . . 3.49

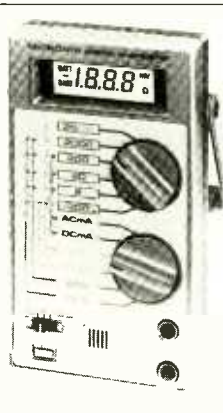

## LCD Multimeter

**7995** • Easy-to-Read Display  
• Beep Indicates Range Change & Continuity

Time-saving audible continuity function sounds at less than 300 ohms resistance. Tests forward conduction of diodes and transistors. Measures up to 1000 volts DC in four ranges; up to 500VAC in four ranges (accurate from 45 Hz to 10 kHz); AC and DC current up to 200 mA in six ranges; resistance to 20 megohms in six ranges. All ranges overload protected. Requires two "AA" batteries. With spare fuse and test leads. 22-191 . . . . . 79.95

## Check These Video/RF Bargains!

**A UES-A56F.** Sensitive and stable—great for custom video projects and replacement. No moving parts—tuned by 0 to 28VDC control voltage. 75-ohm in/out. 12VDC. With data. 277-220 . . . . . 24.95

**B Trimmer Capacitors.** 5-60 pF, PC mount. Ideal for IF and low-level RF peaking. 50VDC max. 272-1340 . . . . . Pkg. of 2/1.59

**C MC1330 Video Detector.** 3rd IF, detector, video and AFT buffers. 10-24VDC. 276-1757 . . . . . 2.49

**C MC1350 Universal IF Amp With AGC.** For radio and TV use, DC to 60 MHz + . 12VDC. 276-1758 . . . . . 2.19

**D MC1358/CA3065 FM Detector.** IF amp, limiter, FM detector, electronic volume attenuator and audio driver. Perfect for homebrew receivers with 100 kHz to 5.5 MHz IFs. 10-24VDC. 276-1759 . . . . . 1.79

**2495**  
**Varactor UHF-TV Tuner**

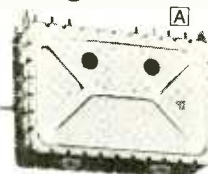

8-Pin DIP With Data



14-Pin DIP With Data

## Great Low Prices on Snap-In Panel Lamps



Pkg. of 2  
**199**

**A**



Pkg. of 2  
**189**

**B**

**A Neons.** One red, one green. Built-in resistors for 120VAC use. Mount instantly in 7/16" holes. 272-709 . . . . . Pkg. of 2/1.99  
**B 12V Snap-Ins.** One amber, one blue for for 1/2" holes. Long 4" leads. 272-335 . . . . . Pkg. of 2/1.89

## Electret Mike



**119**

**Omnidirectional.** PC mount. 20 Hz to 15 kHz response. Requires 2-10VDC, just 1 mA max. current drain. 9.4 mm dia. 6.6 mm high. 270-090 . . . . . 1.19

## Micro 5V Relay

Actual Size! **249**



Just 1 1/32 x 3/8 x 1/4"! SPDT contacts: 1 amp at 125VAC, 55-ohm, 90 mA coil. .100" centers. 275-240 . . . 2.49

# Radio Shack®

A DIVISION OF TANDY CORPORATION • OVER 8500 LOCATIONS WORLDWIDE

Retail prices may vary at individual stores and dealers







# 1983 SAVINGS at 1982 PRICES

Mention this  
magazine  
and get a  
free gift

## REGULATED TRIPLE POWER SUPPLY, LOW PRICED! DM-6



A fully assembled and tested triple benchtop power supply. Includes fixed 5V @ 1 Amp, 5V to 15V @ 0.5 Amp and -5V to -15V @ 0.5 Amp—all supplies regulated, short proof. Each supply has a power on indicator LED. Complete and ready for use in a durable (8" x 6" x 3 1/2") metal case.

**\$99<sup>95</sup>**

## LOW OHM METER MODULE, DM-10

Measure resistance from 10 milliOhms to 20 Ohms. Now you can measure resistance down to 10 milliOhms with this low cost, easy to use DVM module. Check coil resistance, transformers, relays, chokes, printed circuit board copper paths and ground cables. Special zero balance control nulls out input cable resistance to insure accurate readings. Your DVM has to be set to 2V range during operation.



- Resistance range 10 milliOhms to 20 Ohms
- Zero Calibration control
- Battery powered (push to read battery saver circuit). Requires 9 Volt Battery (not included)
- Size 6.25" x 3.75" x 2"
- Incl. Model 336 Test Clips

**\$55<sup>95</sup>**

## 8 CHANNEL SCOPE MULTIPLEXER, DM-12

Convert your single channel scope into a 4 or 8 channel instrument; just connect the DM-12, 8 channel scope multiplexer to your scope, clip the 8 input probes to the signals you want to view. Simple, easy, fast—can handle logic level TTL signals from DC to 3MHz. Features separate spacing and trace amplitude controls and selectable sampling rate—all to insure easy clear scope display.

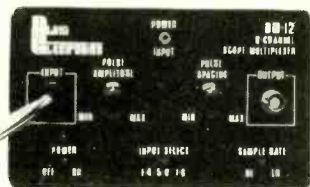

COMPLETELY  
ASSEMBLED  
AND TESTED!  
READY TO USE!

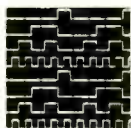

VIEW 8  
CHANNELS  
AT ONCE!

**\$74<sup>95</sup>**

- 8 TTL compatible input channels (1 TTL load per channel) can drive 50 Ohm scope cable
- Maximum full screen amplitude 1.6 Volts adjustable.
- Trace amplitude and spacing controls.
- 4 or 8 channel selector switch.
- 8 color coded input cable, 24" long with insulated alligator clips.
- External 9 VDC power supply included (Model MMAC-2).
- Size 6.25" x 3.75" x 2"
- BNC Output Cable Accessory (Model PSA-2 add \$14.95).

## LOW COST CAPACITANCE METER MODULE, DM-8



Connect this high quality low cost Capacitance Meter Module, DM-8 to your digital Volt Meter and turn it into a Digital Capacitance Meter—the Low Cost Way!

- 2V Output
- Accuracy better than 5%
- Push to read range (button) from 1 pF to 20,000 μF
- Zero Calibration control
- In one easy to use, self-contained package
- Battery powered, with "push to read" battery saver circuit (9V batteries not included)
- Size 6.25" x 3.75" x 2"
- Includes Model 336 Test Clips

COMPLETELY  
ASSEMBLED  
AND TESTED!  
READY TO USE!

**\$79<sup>95</sup>**

## PORTABLE SELF-CONTAINED CIRCUIT DESIGNER, DM-5

Contains 8 LEDs and 8 logic switches.

- Control switches and buffered LED logic indicators
- Plug your ICs into solderless breadboards, tie in power and ground, connect your logic switches and LED indicators

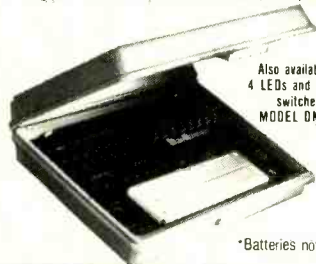

Also available in  
4 LEDs and 4 logic  
switches.  
MODEL DM-5A

- All interconnections between LEDs, switches and circuits via 22-26 solid wire
- Self-powered. In compact, durable carrying case
- Battery (4 1 1/2 Volt C cells) or AC powered providing economical bench use or convenient portable use. Available in two models.

**\$69<sup>95</sup>**

\*Batteries not included

## LOW COST HIGH FREQUENCY COUNTER



MODEL NO. DM-7

The Albia Model DM-7, 8 Digit High Frequency Counter is easy to use, switch selectable time base input by a single BNC, nothing to build!

- 5 Hz to 550 MHz
- 8 big easy-to-read 43" high intensity LED display
- Crystal (±3 ppm @ 25 C) controlled 0.1 or 1.0 sec gate times
- Convenient benchtop size (7" x 10" x 3") durable attractive case

COMPLETELY  
ASSEMBLED  
PRE-CALIBRATED  
PRE-TESTED

**\$149<sup>95</sup>**

PRICES & SPECIFICATIONS SUBJECT TO CHANGE • SPECIAL ENDS FEB. 30th



FOR FASTER  
SERVICE  
USE YOUR  
CREDIT CARD.

# Albia Electronics

44 KENDALL STREET  
NEW HAVEN, CT. 06512



MOST ORDERS SHIPPED NEXT DAY.

BACKED BY ALBIA'S FAMOUS WARRANTY.

**CALL TOLL FREE 1-800-243-6953**

9 AM  
5 PM  
EST

# Computers & Electronics

## ADVERTISERS INDEX

RS no.	ADVERTISER	PAGE no.
2	Albia Electronics	124
3	All Electronics Corp.	116
6	Anders Precision Instruments	109
4	Apple Computer	50,51
7	Bottom Line, The	107
	C & D Electronics	110
	Classified Advertising	126-134
	Cleveland Institute of Electronics, Inc.	42-45
16	Command Productions	112
29	Commodore Computer	Cover 4
19	CompuServe	49
8	Computers & Electronics Supply Co.	71
10	Computer Exchange	14,15
11	Computer Mail Order	21
	Connecticut MicroComputer	55
14	Digi-Key Corp.	114,115
43	EICO	99
25	Epson America	8A-8H
26	Firestik	109
18	Focus	110
19	Gladstone Electronics	67
	Grantham College of Engineering	111
44	Hays Microcomputer Products, Inc.	1
24,28	Heath Co.	4,5,29-32

41	IBM Corporation	34,35
13	International Publishing & Software, Inc.	99
21	Jameco Electronics	123, Cover 3
22	JDR Microdevices	120,121
23	J & R Music World	125
20	Leading Edge	Cover 2
31	McIntosh Laboratory, Inc.	81
32	MFJ Enterprises	111
37	Magtek Media Data Supplies Ltd.	81
30	Maxell Corp. of America	19
	Menotech	13
33	Microhouse	6,7
	Netronics, R & D Ltd.	119,125
17,27	New Horizons	57,73
	NRI Schools	24-27
40	Protecto Enterprises	103
34	Quest Electronics	126
15	Quick Brown Fox	17
	Radio Shack	122
	Scientific Systems	112
45	Shure Brothers, Inc.	84
36	Sintec Co.	22
38	Star Micronics	23
39	Tab Books	95
42	TAMS, Inc.	99
48	3-M Data Recording	52
	Tektronix	36
	Timex Computer	2

# WE TAKE YOU BY THE HAND!

You'll learn all about computers: how to build, program, service, even play TV games—without knowing the first thing about it!

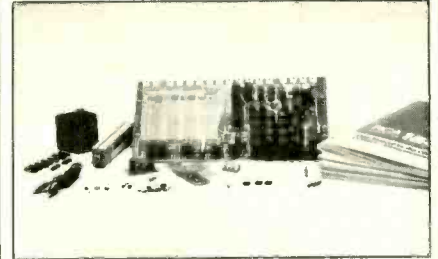

## The New ELF II "Beginners" Package

Your own expandable micro-computer kit, 5 diagnostic analyzers plus circuit, programming, diagnostic manuals, even games you can play on TV. All only \$139.95.

Even if you don't know bits from bytes, now it's easy and inexpensive to build your own micro-computer. Learn how it works, program it, service it—even play games with it on your TV! It's here in the New ELF II "Beginners" Package, only from Netronics. Only \$139.95. Here's the package: 1. your own micro-computer, the famous ELF II (featuring the RCA 1802 CMOS microprocessor) in kit form with step-by-step instructions on how to build it. Diagnostic Analyzers including 2. your own Logic Probe. 3. Pulse Catcher. 4. 8 bit Test Register. 5. Logic Analyzer. 6. Gate Arrays. 7. Non-Tech Manuals on how to use analyzers, how to get into the guts of the computer, what makes it tick, how to service it. 8. Sample Programs that teach you machine language programming plus how to correct or "debug" any programming mistakes. 9. TV games you can play. If your TV set has no video input, an optional converter (RF Modulator), is available. Then, once you've got this "Beginners" Package under your belt, keep on expanding your ELF II with additions like the Typewriter Key Board, added RAM, Full Basic Interpreter, Electric Mouth Talking Board, Color/Music, A/D-D/A Boards for Mouth Controls and much, much more. We'll take you by the hand with the New ELF II "Beginners" Package. Only \$139.95. Mail or phone in your order today and begin.

Specifications ELF II "Beginners" Package:  
The computer features an RCA CMOS 1802 8 bit microprocessor, addressable to 14K bytes with DMA, interrupt, 18 Registers, ALU, 236 byte RAM, expandable to 14K bytes. Professional Hex keyboard, fully decoded so there's no need to waste memory with keyboard scanning circuits. Built in power regulator. 5 slot plus expansion BUS (less connectors), stable crystal clock for timing purposes and a double sided, plated through PC Board plus RCA 1861 video I/O to display any segment of memory on a video monitor or TV screen along with the logic and support circuitry you need to learn every one of the RCA 1802's capabilities. The diagnostic analyzers aid in understanding and trouble shooting your ELF II, as well as other computer and microprocessor products.

Continental U.S.A. Credit Card Buyers Outside Connecticut  
**CALL TOLL FREE 800-243-7428**

To Order From Connecticut or For Technical Assistance, Etc.,

Call (203) 354-9375  
**NETRONICS R&D LTD.** (Dept. 474)  
333 Litchfield Road, New Milford, CT 06776

Please send the items checked below:  
 ELF II "Beginners" Kit ..... \$139.95  
 RF Modulator ..... \$ 8.95

Plus \$3.00 for postage, handling and insurance (\$6.00 Canada)

Connecticut Residents add sales tax

Total Enclosed \$ \_\_\_\_\_

Personal Check  Cashier's Check/Money Order

Visa  Master Charge (Bank No. \_\_\_\_\_)

Signature \_\_\_\_\_ Exp. Date \_\_\_\_\_

Print Name \_\_\_\_\_

Address \_\_\_\_\_

City \_\_\_\_\_

State \_\_\_\_\_ Zip \_\_\_\_\_

## WHILE OTHERS PROMISE.... WE DELIVER!

ORDER TOLL FREE (800) 221-8180  
IN NEW YORK (212) 732-8600

<p><b>COMMODORE VIC-20</b> <b>\$179.95</b></p> <p>COMMODORE HARDWARE VIC 1530 Data Cassette \$59.95 VIC 1540 Single Disk Drive \$79.95 VIC 1525 Graphic Printer \$99.95 VIC 1600 Telephone Interface \$59.95 VIC 1111 16K Memory Expander \$49.95 VIC 1110 8K Memory Expander \$48.95 VIC 1210 32K Memory Expander \$55.95 CARDBOARD 6 40K Expander \$84.95</p> <p>COMMODORE SOFTWARE VIC 1907 Adventures \$23.95 VIC 1904 Superkid \$23.95 VIC 1911 The Sky is Falling! \$23.95 VIC 1914 Adventure Land \$28.95 VIC 1915 Pirate Cove \$28.95 VIC 1916 Mission Impossible \$28.95 VIC 1919 Sargon II Chess \$28.95 VIC 1920 Dental Spectacular \$28.95 VIC 1922 Cosmic Cruncher \$23.95 VIC 1923 Golf \$28.95 VIC 1924 Omega Race \$28.95</p> <p>UMI SOFTWARE FOR COMMODORE AMOK Cartidge \$36.95 ALIEN BLITZ Cartidge \$28.95 CLOUD BURST Cartidge \$28.95 KOSMIC KONGKASE (80K 3K Expander) \$18.95 OUTWORLD Cartidge \$46.95 RENAISSANCE Cartidge \$33.95 SATELLITE &amp; METEORITES \$36.95 VIC-CHECK Checkbook Balancer \$18.95 NUTKOP SOFTWARE FOR COMMODORE ALLEN PANIC Cassette \$59.95 BOMBER Cassette \$59.95 DEFENDER ON TRI (80K 3K Expander) \$11.95 ESCAPE Cassette \$59.95 INVASION Cassette \$59.95 JOURNEY Cassette \$59.95 KRAZY YONG Cassette \$59.95 QUIRK Cassette \$59.95 RACEWAY Cassette \$59.95 RESCUE FROM NARROW Cassette \$59.95 SEARCH Cassette \$59.95 SIX GUNNER Cassette \$59.95 TANK Cassette \$59.95 VIC MAN Cassette \$59.95</p> <p>YES SOFTWARE FOR COMMODORE AGGRESSOR \$28.95 CONCENTRATION \$28.95 DAM BOMBER \$14.99 FUEL PIRATES \$13.99 SYN THE SOUND \$17.95 TANK TRAP \$17.95 TANK WARS \$17.95 TURTLE GRAPHICS \$64.95 VIC FORTH \$59.95</p> <p>TAYLOR MADE SOFTWARE FOR COMMODORE LEMONADE \$14.49 TOUCH TYPING TUTOR \$14.49</p>	<p><b>TI 99/4A</b> <b>\$299.95</b></p> <p>TI HARDWARE PHD 1500 (800K Synthesizer) \$114.95 PHD 1600 (800K Memory) \$168.95 PHD 1700 (85 252 Interface) \$168.95 PHD 1800 (80K Drive Controller) \$218.95 PHD 1850 (80K Memory Drive) \$559.95 PHD 2300 (Memory Expander) \$368.95</p> <p><b>TIMEX SINCLAIR COMPUTER</b> TIMEX SINCLAIR HARDWARE \$47.95 TIMEX SINCLAIR SOFTWARE \$85 TIMEX SINCLAIR EXPANDER \$47.95</p> <p>MEMOPAK MEMOTECH 116K Exp. for Timex \$54.95 MEMOTECH 32K Exp. for Timex \$49.95 MEMOTECH 60K Exp. for Timex \$164.95 Memotech peripherals designed to fit together in "daisy daisy" fashion. CHECKBOOK MANAGER \$49.95 STOCK OPTIONS \$15.95 VU-CAL BUSINESS \$17.95</p> <p><b>SHARP COMPUTERS</b> SHARP PC-1500 \$209.95 PC 1211 Pocket Computer \$227.95 CE 121 (Cassette Interface) \$32.95 CE 150 (Printer for PC 1500) \$174.95 CE 151 (8K RAM Expansion) \$47.95 CE 155 (8K RAM Expansion) \$87.95</p> <p>MAXELL MD-1 (Box of 10) \$34.90 MAXELL MD-20 (Box of 10) \$44.90 BASE FD-10 (Box of 10) \$32.90</p> <p>PC-8001A Microcomputer With 32K RAM \$739 PC-8012A (2 Unit) with 32K RAM \$739 PC-8031A Dual minidisk drive unit \$739</p> <p>TOP 1000 (16K Computer) \$339.95 TOP 1010 (Same as above) \$419.95 TOP 1100 (Color Printer) \$229.95 TOP 1100 (Color Printer) with 128K \$289.95 TOP Finance \$39.95 TOP Polaris \$29.95</p>	<p><b>FRANKLIN ACE 1000</b> Apple Compatible Professional Personal Computer • 64K of RAM memory <b>\$849</b></p> <p>APPLE HARDWARE APPLE II (4K) \$1149 DISC II DRIVE \$549</p> <p>AUTOMATED SIMULATIONS SOFTWARE FOR APPLE INVASION (80K 48K) \$19.95 HELPER WARRIOR (48K) \$17.95 KEY OF ACHERON (48K) \$17.95 MADLY TOWER (48K) \$19.95 DRAGON'S EYE (48K) \$19.95 STAR WARRIOR (48K) \$19.95 RICHOCHEY (48K) \$17.95 JABBERJAW (48K) \$24.95</p> <p>ROBBERBUND SOFTWARE FOR APPLE RED ALERT \$24.95 SPACE QUARKS \$24.95 SPACE WARRIOR \$19.95 TRACK ATTACK \$26.95 CHOPLETTER \$26.95 GALAXY WARS \$19.95</p> <p>GERBELL SOFTWARE FOR APPLE RUSSKI DUTK \$26.95 RIBBID \$24.95 HORIZON 5 \$26.95 LASER SLIP \$26.95</p> <p>ON LINE SYSTEMS SOFTWARE FOR APPLE JAWBREAKER (48K) \$25.95 SABOTAGE (48K) \$19.95 THRESHOLD (48K) \$25.95 TIME ZONE (48K) \$64.95 PROGGER (48K) \$25.95 MYSTERY HOUSE (48K) \$19.95 MISSION ASTEROID (48K) \$17.95</p> <p>PRINTERS EPSON MX80 III \$439 EPSON MX80 II (Inkjet Feed) \$489 EPSON MX100 III \$689 EPSON MX100 II (Inkjet Feed) \$629 OXIDATA 82 \$889 NEC PC-8023A \$465</p>	<p><b>ATARI 800</b> <b>\$589</b></p> <p>ATARI HARDWARE ATARI 410 Program Expander \$79.95 ATARI 810 Disk Drive \$429 ATARI 825 (80 Column Printer) \$59.95 ATARI 830 Acoustic Modem \$149.95 ATARI 850 Interface Module \$169.95 BLUE CHIP 16K RAM Board \$68.95 ALIEN GROUP Public pkg. \$104.95</p> <p>ATARI SOFTWARE ATARI CX4002 (2K) \$30.95 ATARI CX4115 (Montage &amp; Loan) \$17.95 ATARI CX4006 (Super Breakout) \$35.95 ATARI CX4002 (Basic Cartidge) \$43.95 ATARI CX4015 (Adventure) \$31.95 ATARI CX401 (Word Processor) \$109.95 ATARI CX4011 (Star Raiders) \$35.95 ATARI CX4017 (Block Analysis) \$19.95 ATARI CX4008 (Isare Invaders) \$33.95</p> <p>AVALLON HILL SOFTWARE FOR ATARI B-1 NUCLEAR BOMBER \$14.95 CONFLICT 2500 (32K) \$14.95 DRIEYER RIVER LINE (48K) \$24.95 KNOCKOUT 15K \$17.95 MOON PATROL (16K) \$19.95 MIDWAY CAMPAIGN (32K) \$18.95 VOYAGER (32K) \$19.95</p> <p>DATA SORT SOFTWARE FOR ATARI ARCADE SHOOTOUT \$24.95 CANYON CLIMBER (24K) \$24.95 CANYON CLIMBER (Cassette) \$24.95 CLOWNS AND BALLOONS \$24.95 PACIFIC COAST HIWAY \$19.95 MICRO PAINTER (48K) \$24.95</p>
---	--	---	---

**J&R MUSIC WORLD**

23 PARK RD., DEPT. CE1, NYC NY 10038

HOW TO ORDER BY MAIL: FOR PROMPT AND COURTEOUS SHIPMENT, SEND MONEY ORDER OR CHECK. CASHIER'S CHECK, MASTERCARD, VISA, UNICARD, CARD NUMBER, INTERBANK NO., EXPIRATION DATE AND SIGNATURE! DO NOT SEND CASH, PERSONAL AND BUSINESS CHECKS MUST CLEAR BANK BEFORE PROCESSING. \$25 MINIMUM ORDER. Shipping, handling & insurance charge is 5% of Total Order with a \$3.95 minimum. WE SHIP TO CONTINENTAL U.S., ALASKA, HAWAII, PUERTO RICO, AND CANADA ONLY. (Canada Orders Add 10% Shipping with a \$7.95 minimum charge). For shipments by air, please double check charges, sorry, NO C.O.D.'S. NEW YORK STATE RESIDENTS PLEASE ADD SALES TAX. ALL MERCHANDISE SHIPPED BRAND NEW, FACTORY FRESH AND 100% GUARANTEED.

SEND FOR FREE 240 PAGE AUDIO/VIDEO CATALOG

CIRCLE NO. 23 ON FREE INFORMATION CARD







# Computer Mart

RATE: Ads are 2" by 3". 1 insertion: \$625.00. 6 insertions: \$600.00 ea. 12 insertions, \$575.00 ea. Closing date: 1st of the 2nd mo. preceding cover date. Send order and remittance to Computer Mart, Computers & Electronics, 1 Park Ave., N.Y., N.Y. 10016. Direct inquiries to (212) 725-4216.

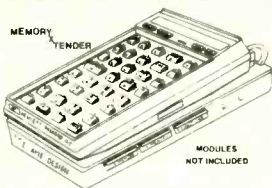

## NEW! PLUG-IN MEMORY-X-TENDER

Expand your HP-41C/CV to 10.6k (1600 registers) with the AME DESIGN Memory-X-Tender. Requires no modification to the calculator. Card Reader remains in place. One switch selects Bank A or B. Each bank can hold one X-FUNCTION and two X-MEMORY Modules. Additional slot for HP-IL Module. Built-in Lithium battery to maintain memory.

SPECIAL INTRODUCTORY PRICE!!

\$99.00

### AME DESIGN

Box 373  
13450 Maxella, G185  
Marina del Rey, CA 90291  
(213) 306-1249

Please add \$2.00 for shipping, include 6% sales tax in California.

© 1982 AME DESIGN

CIRCLE NO. 101 ON FREE INFORMATION CARD

## A ZX-81 breakthrough!



### The CAI/ESF mass storage device

• Load or store 27K bytes in less than 30 seconds.

- Your existing cassette-stored programs transfer easily.
- Menu-driven, access by keyboard command.
- Second drive easily added for greater flexibility.
- For T/S 1000, ZX-81 and ZX-80.

**\$119.95\***

\*Requires CAI/O Board for interface \$69.95

Order by phone or mail. Check, money order, VISA or MasterCard (include number and exp. date). Post. in U.S. \$5

### CAI Instruments

PO Box 2032, Midland, MI 48640

© Copyright 1982 CAI Instruments, Inc.

**517-687-7343**

CIRCLE NO. 104 ON FREE INFORMATION CARD

## 5 Meg Hard Disk \$600.00

High reliability Shugart 8" SA1002 hard disk drives.



(803) 877-7471

105 S. Main St. Greer, S.C. 29651

Add-on disk systems for IBM PC, OSBORNE, TRS-8011, XEROX, HEATH, S-100 and STD BUS from \$1500.00

CIRCLE NO. 107 ON FREE INFORMATION CARD

Television Signal Processing Manual ... \$15.95

Microwave Television Education Manual ... \$16.25

Both TV Manuals *only* ... \$26.95

### Your Fortune in the Microcomputer Business

Vol I: Getting Started ... \$75.90

Vol II: Growth, Survival and Success ... \$75.95

Both Microcomputer Books ... \$26.85

Catalog on Video Products and exciting kits only \$2.00. Include 5% shipping. California residents add tax.

### Abex

P.O. Box 26601-CE  
San Francisco, CA 94126



CIRCLE NO. 102 ON FREE INFORMATION CARD

**SINGLE BOARD CONTROL COMPUTERS.**

BOTH FEATURING  
8085 CPU  
CRYSTAL TIME BASE  
ON-BOARD REGULATOR

TIMER COUNTER  
256 BYTES OF RAM

SR85-1  
★ Has 2K/4K ROM/EPROM (ROM's are not supplied).  
★ 16 I/O Lines (Parallel/Series/Handshake) and  
★ 5 levels of interrupt Price: \$129 (A&T)

SR85-2  
★ Has 2 K ROM/EPROM (ROM's are not supplied).  
★ 22 I/O Lines - Parallel/Series/Handshake) and  
★ 2 levels of interrupt Price: \$99

**CER-TEK**  
6020 Dorisphan 3B El Paso, TX 79932 (915) 581-6697  
ELECTRONICS MANUFACTURING SINCE 1975

CIRCLE NO. 105 ON FREE INFORMATION CARD

## YOU CAN PAY MORE BUT YOU CAN'T GET MORE!



Model III 16K

**\$799**

Model III 48K

2 disk & RS232 c

**\$1899**

BUY DIRECT. These are just a few of our great offers which include Printers, Modems, Computers, Peripherals, Disc Drives, Software and more. call TOLL FREE 1-800-343-8124

We have the lowest possible fully warranted prices and a full complement of Radio Shack Software.



Color Computer 16K

**\$249**

w/16K Ext. Basic

**\$335**

w/32K Ext. Basic

**\$449**

Write for your free catalog.

**computer plus**  
480 King Street  
Littleton, MA 01460  
617-486-3193

CIRCLE NO. 108 ON FREE INFORMATION CARD

MODULES FOR:

## TIMEX-Sinclair

64K MEMORY \$119.95 KIT

\$129.95 W&T WHY PAY MORE?

MODEM \$119.95 KIT \$149.95 W&T

(RS-232 Port & Software Included)

RS-232 PRINTERINTERFACE

Only \$59.95 KIT \$69.95 W&T

CONTROL MODULE \$59.95 KIT

8 Relays, 8 Inputs, 8 LED's \$69.95 W&T

Expand your 16K to 32K with our M-16  
\$59.95 KIT \$69.95 W&T

90-Day Warranty On All Modules.  
10-Day Return Privilege

ORDER PHONE 803-532-5812  
Add \$4.95 shipping & handling to all orders.

BYTE-BACK CO.  
Rt. 3 Box 147 Brodie Rd.  
Leesville, S.C. 29070

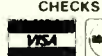

THOUSANDS IN USE WITH PROVEN RELIABILITY.  
ALL MODULES IN STOCK.

CIRCLE NO. 103 ON FREE INFORMATION CARD

Why pay more for  
**TRS-80** EPSON  
Color Computer Model II Model III Model 16  
Printers  
We have cables to interface with Commodore, IBM, and Osborne computers.

We'll meet or beat any price from an authorized dealer!

FRANKLIN  
OKIDATA  
APPLE  
ATARI

Our prices are so low we aren't allowed to print them!

Most items in stock for immediate shipment.  
Call or write for Free 40 page catalog.

**Computer Discount of America**  
15 Marshall Hill Road  
West Milford, NJ  
West Milford, NJ 07480-2198  
In New Jersey call 201-728-8080

**CALL TOLL FREE: 800-526-5313**

CIRCLE NO. 106 ON FREE INFORMATION CARD

## SINCLAIR ZX81 FORM FITTING DUST COVER ONLY \$11.95\*



Protect your ZX81 from dust, grime and spills with a quality dust cover from The Computer Trader. The form fitted cover provides protection during storage or transport. Available colors: black, tan, royal blue, brown, navy blue and burgundy.

DEALER & DISTRIBUTOR INQUIRIES WELCOME

\*California residents add 6% sales tax. Please include \$1 postage and handling. Allow 1-3 weeks for delivery. Specify color and amount.

The Computer Trader  
P.O. Box 20976  
San Diego, CA 92120

(619) 283-9273

CIRCLE NO. 109 ON FREE INFORMATION CARD



# SAVE 90%

YES you can save up to 90% on a computer system of your own.

\$150.00 buys a 4MHz Z80A with 64KB & a real Front Panel

\$200.00 buys a Full Function 24x80 CRT with Keyboard

You can have your own computer and be running Fortran, Basic, Pascal, etc. If you get our

FREE BROCHURE TODAY

DIGATEK CORPORATION  
Suite 7  
2723 West Butler Drive  
Phoenix AZ 85021

ROLL-YOUR-OWN TECHNOLOGY AND SAVE A BUNDLE

CIRCLE NO. 110 ON FREE INFORMATION CARD

# TRS-80 COLOR COMPUTER

Quality Software on:

- DISK
- CARTRIDGE
- CASSETTE

Send for our free catalog

----- clip and mail -----

Eigen  
Systems

Box 10234  
Austin, TX 78766  
(512) 837-4665

Name \_\_\_\_\_

Address \_\_\_\_\_

Zip \_\_\_\_\_

CIRCLE NO. 111 ON FREE INFORMATION CARD

IBM — XEROX — TRS-80 — CBM  
HEWLETT-PACKARD — NORTHSTAR  
DEC — HEATH — ZENITH — PMC  
OSBORNE — OSI — INTERTEC . . .

WE HAVE

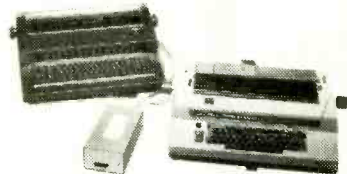

## THE CONNECTION

Connect your IBM Selectric\*, IBM Electronic, or Olivetti typewriter to any Microcomputer.

UNDER \$600

### ESCON Products, Inc.

12919 Alcosta Blvd.

San Ramon, Ca. 94583

(415) 820-1256

(800)

227-2148

CIRCLE NO. 112 ON FREE INFORMATION CARD



EWING ELECTRONICS  
200 E. SPRING VALLEY  
RICHARDSON, TX 75081  
(214) 231-6725

QUALITY PARTS AT DISCOUNT PRICES

RAMs		
4116	200 N.S.	\$1.30
4116	250 N.S.	1.20
4164	150 N.S.	5.50
EPROMs		
2708	450 N.S.	3.25
2716	450 N.S.	3.50
2732	450 N.S.	6.50
2732	350 N.S.	7.50
2532	450 N.S.	7.50
MICROPROCESSORS		
Z80-CPU		3.25
Z80-S10/1		12.95
Z80A-CPU		4.95
Z80A-S10/0		14.95

CALL US WITH ALL OF YOUR COMPONENT NEEDS. WE STOCK TTL, 74LS, 74F, 74S, CMOS, LINEAR, CRYSTALS, MEMORY, CAPS, TRANSISTORS, DIODES, RESISTORS, ETC. CALL OR WRITE FOR OUR NEW CATALOG.

TERMS: COD, VISA, MASTERCARD, CHECK, OR MONEY ORDER. PLEASE ALLOW 10 DAYS FOR PERSONAL CHECKS TO CLEAR.

SHIPPING: ADD \$3.00 FOR UPS (+ 1.50 IF COD) ADD \$4.50 FOR UPS BLUE (+ 1.50 IF COD)

CIRCLE NO. 113 ON FREE INFORMATION CARD

## FUTRA COMPANY

### PRINTERS



MX

100 FT

NEC 8023

NEC 8023 ..... \$489.00

Epson MX-80FT ..... \$529.00

Epson MX-100FT ..... \$695.00

Mail Order: (213) 328-8951  
FUTRA COMPANY (800) 421-5006  
P.O. Box 4380-PE TWX 910 349-6211  
Torrance, CA 90510 AGENFTRA TRNC

Retail: 20695 S. Western Ave. #124  
OMC Torrance, CA 90501  
(213) 328-1760

Terms: Add 3% for product shipped within continental USA via UPS surface (min. \$3.00). If order is prepaid with U.S. funds in the form of check or money order, a total charge of \$3.00 is all you pay within the continental USA via UPS surface. CA residents add 6% sales tax (LA County 6.5%). All offers subject to change or withdrawal without notice.

CIRCLE NO. 114 ON FREE INFORMATION CARD

## Sinclair ZX81

Software on cassette.



MULTIFILE Data Storage System: A versatile multi-purpose filing system for 16K ZX81. Menu-driven. The number, size and heading of files are user-definable. Files may be created, modified, replaced and searched, and are protected by a security lock. Output to ZX printer is provided. MULTIFILE is supplied on cassette with three blank cassettes for data storage, and packed in an attractive permanent storage case. Supplied with extensive documentation describing applications for both business and personal use. \$29.95

ZX81 Machine Code Assembler (16K)	\$9.95
ZX81 Machine Code Disassembler/Debugger (16K)	\$9.95
ZX CHESS! Your choice of 7 levels of play, white or black, set up any position to be analyzed, change levels of play during a game, swap sides, and more! (16K)	\$24.95
INVADERS! Ten levels of play! (16K)	\$9.95
STARTREK Trek across the galaxy. (16K)	\$9.95
ADVENTURE: Damsel and the Beast! (16K)	\$14.95
1K PROGRAM PACK, 8 compact, entertaining programs	\$9.95
16K PROGRAM PACK, Four entertaining programs	\$14.95
10 EXCITING ZX81 PROGRAMS	\$14.95

Books  
30 Programs for the ZX81 (1K) \$14.95  
Understanding Your ZX81 (16K) \$19.95  
ZX81 ROM Disassembly Part A \$14.95  
Full replacement warranty all tapes.  
Write for our FREE SOFTWARE CATALOGUE for ZX81

## Gladstone

Gladstone Electronics 991 Fuhmann Blvd. Buffalo, NY 14203  
Telephone Orders (716) 849-0735 VISA/MC NO C.O.D.s please  
Mail Orders: Send check, money order, Visa or MC number \$1.50 per order handling

CIRCLE NO. 115 ON FREE INFORMATION CARD

# STOP

Wasting Money! We Have the World's Most Cost Effective Development System.



- Includes Hexkit 1.0, a powerful 100% machine code editor / debugger utility program that makes coding for 8-bit micros a snap.
- Program from Commodore VIC-20 keyboard into built-in 4K ROM emulator
- Jumper to target ROM socket
- Test programs in circuit
- Built-in EPROM programmer and power supply
- Burns & runs EPROMs for the Commodore VIC-20, too
- Comprehensive manuals
- Fits EXPANSION PORT

Send for Free Brochure

PROMQUEEN CARTRIDGE ONLY \$199



Gloucester  
Computer Bus Co.

6 Brooks Rd.  
Gloucester, MA 01930  
617-283-7719

VISA AND MASTERCARD ACCEPTED

CIRCLE NO. 116 ON FREE INFORMATION CARD

# RAM

For ATARI  
48K RAM BOARD FOR THE 400  
with Lifetime Warranty

- Highest quality available
- Reduces power consumption
- Reduces heat

48K Board (400) \$175

32K Board (400/800) \$ 90

16K Board (800) \$ 60

FREE SHIPPING ANYWHERE IN U.S.A.

INTEC

PERIPHERALS  
CORP

906 E. Highland Ave.  
San Bernardino, CA 92404  
(714) 881-1533



ATARI, 400, 800 are Trademarks of ATARI, Inc.

CIRCLE NO. 117 ON FREE INFORMATION CARD

## SINCLAIR ZX80/1

TIME X 1000  
I/O Board with our Real Time Clock/Calendar  
Time Month Date Year Day of wk  
23:59:59 12 31 99 7

- 8 Outputs capable of driving relays
- 8 TTL Compatible inputs
- Battery back-up for clock
- All software included
- Feed through Sinclair Bus connector to allow normal expansion
- Output lines expandable through Multiplexing
- 5 volt regulator
- 90 day warranty

Future products used with I/O board:

- Touch Tone™ encoder/decoder
- Speech and Sound synthesizer

Model	Description	price
310	I/O port with real time clock	\$49.95
315	PC board and manual of #310	\$24.95
320	A to D and D to A converter	\$39.95
325	PC board and manual of #320	\$19.95
330	Wireless control system (BSR™)	\$54.95
340	Solidstate 25amp sw. modules	\$19.95
350	8 SPDT 5 amp relay board	\$69.95
317	Clock IC and crystal (tested)	\$12.95
	Shipping and handling	\$3.95

Built and tested Calif. residents add 6% tax  
Mail order check/money orders Foreign orders in US money Visa/Mastercard

## JK AUDIO

P.O. Box 3295, Escondido, CA 92025 - 0580  
Info: (714) 741-5132  
24 hour order line only **NATL 800-227-1617**  
Calif. Res. 800-772-3545 Ext. 367

CIRCLE NO. 118 ON FREE INFORMATION CARD

## POWER LINE PROBLEMS?

### SPIKE-SPIKERS™... The Solution!

Minimize equipment damaging spikes and conducted RF noise to or from sensitive equipment. Transient surge protection plus low pass RFI hash filtering. All units 120V 15A.

**MINI II \$44.95**  
Wall Mount  
3-stage filter  
2 sockets

**DELUXE \$79.95**  
Dual 5-stage filtered  
ckts. 8 switch sockets  
main switch, fuse, light

**QUAD II \$59.95**  
Wall mount. Dual 3-stage filter,  
4 sockets & light

**Order Factory Direct**  
**215-865-0006**

Out of Store  
**800-523-9685**

DEALERS INVITED  
PA Res. Add 6% • COD add \$3.00 + Shipping

Kalglo Electronics Co., Inc.  
65 B4 Ruch Rd., Dept. C E  
Bethlehem, PA 18017

## SINCLAIR/TIMEX ZX81/TIMEX 1000

### TouchaMatic™ Overlay

\$9.95 plus \$1.50  
Postage/Handling  
Call or send for FREE Catalog.

### SIGNALMAN MODEM

- Direct Connect
- 300 Baud
- Easy to use
- Accurate

**\$99.95 Plus \$3.00 Postage/Handling.**

**KOPAK Creations, Inc.**  
Dept. CE  
448 W. 55th. St.  
New York, N.Y. 10019  
(212) 757-8698  
24 Hours MasterCard/Visa

## LEO ELECTRONICS, INC.

8921 S. Sepulveda #208  
Los Angeles, CA 90045  
(213) 641-3101 (800) 421-2418

### WHY PAY MORE? SAVE MONEY! LOWEST PRICES ON PARTS!

EPROMS	
2708	2.60
2716	4.00
2715-1(350ns)	6.50
TMS 2716	6.00
2732	6.00
2532	12.00
2764	17.50

REGULATORS	
7805	7.5
7812	7.5
7815	7.5
7905	8.5
7912	8.5
7915	8.5

RAMS	
4116(200ns)	8/10.75
4116(150ns)	8/13.00
2114(200ns)	8/18.00

MICROPROCESSORS	
2-80A-CPU	5.50
8080A	2.25
8085A	7.00
6116P-3	5.75

**TERMS:** Check Visa, MasterCard. Call for C.O.D.  
U.S. Funds only. California Residents add 6% Sales Tax.  
**SHIPPING:** Add \$2.00 for Ground \$5.00 for Air.  
**ALL MAJOR MANUFACTURERS  
ALL PARTS 100% GUARANTEED**

## UV EPROM ERASER

• Erases over 15 EPROMS - 15 minutes erase time  
• Erases in 7200 hours  
• Memory 1200, 1400, 1611  
• Erases all UV EPROMS (2716, 2732, 2516, 2532, etc.)

**\$49.95**  
HOBBY MODEL

**INDUSTRIAL MODEL**  
QUV/TB/2N  
**\$68.95**

**WITH TIMER & SAFETY SWITCH**  
QUV/TB/2T  
**\$97.50**

**ABOVE 220VAC**  
50HZ  
QUV/TB/2TE  
**\$109.50**

**STAND ALONE RS-232 INTELLIGENT PROGRAMMER \$489.00**

PROGRAMS: 2506, 2516, 2532, 2716, 2732, 2732A, 2758, 8748, 8749  
OPTIONAL MODULES: 2564, 2764, 8755A, 8741  
• STAND ALONE CRT OR COMPUTER CONTROL  
• UP/DOWN/LOAD IN MOTOROLA OR INTEL HEX FORMAT  
• MICROPROCESSOR BASED • 4 K INTERNAL RAM  
• 90 DAY PARTS & LABOR WARRANTY ON ALL PRODUCTS  
• PHONE ORDERS (305) 776-5870  
• TWX: 516-955-9480 • WE ACCEPT VISA, MC, CHECKS, C.O.D., MONEY ORDER

**LOGICAL DEVICES, INC.**  
781 W. OAKLAND PARK BLVD. • FT. LAUDERDALE, FL 33311  
A001-84-00 SHIPPING \$2.00 C.O.D. CHARGES

## COMPUTER DISKETTES COMPUTER CASSETTES, CASSETTE DUPLICATING SERVICE

APPLE-IBM(P.C.)-ATARI-HEATH-OSBORN  
COMMODORE-TRS-80-SINCLAIR-NORTH STAR

Disquettes 100% Certified	Unit Price	10 Pack
5-1/4" SSDD Soft Sector		
W/Hub Ring	\$2.75	\$25.00
5 1/4" SSDD 10 Hard Sector	2.75	25.00
5 1/4" DSDD Soft Sector	3.75	35.00
8" SSDD IBM Compatible	3.50	32.50

Computer Cassettes with MAXELL Computer  
Cassette Tape 100% Certified - Instant Play/  
Record - Sliding Lock Out Doors

C-5 (25 Feet)	2.00	17.50
C-10 (50 Feet)	2.25	20.00
C-20 (100 Feet)	2.65	22.00
C-30 (150 Feet)	2.75	24.00
C-60 (300 Feet)	2.90	26.00
C-90 (450 Feet)	3.10	30.00

Cassette Duplicating - Add \$2.00 per unit.  
 Check  Master Charge  Visa  
Card # \_\_\_\_\_ Expiration Date \_\_\_\_\_

Send to: Magnetic Information Systems  
P.O. Box 806, 415 Howe Ave., Shelton, CT 06484  
(203) 735-6477 • Dealers Inquiry Welcomed  
**Minimum Credit Card Order \$10.00**

## Find your EPROM bug

### BUG CATCHER™

**FEATURES:**  
Locate Eprom bugs in minutes  
Accepts all common Eproms  
Convenient size (4 1/2" x 3" x 1")  
Ideal for field service or laboratory  
Very economical  
**\$149.95 plus Postage & Handling**

MARTEC SYSTEMS INC.  
Box 2069  
Newburgh, NY 12550  
(914) 265-4044

## COMPUTERS Buy By Direct Mail

**1-800-841-0860**

### Call For Your Discount Prices

TR-80 ATARI  
SMITH-CORONA EPSON  
TEXAS INSTRUMENTS FRANKLIN  
OKIDATA Commodore

## MICRO MANAGEMENT SYSTEMS, INC.

PARCEL DIVISION DEPT. NO. 12  
2803 Thomasville Rd. East  
Cairo, Georgia 31728  
**912-377-7120**

## Votrax SC-01A SPEECH SYNTHESIZER

**Votrax** \$50. Each  
40 in 100's

### Order in Ones or Thousands

The SC-01A Speech Synthesizer is a completely self-contained solid state device. This single chip phonetically synthesizes continuous speech of unlimited vocabulary.

The SC-01A contains 64 different phonemes which are accessed by a 6-bit code. Computer interfaces and text-to-speech algorithms also available for product development. Largest U.S. Distributor Of  
**Votrax Chips**  
Votrax is a trademark of Federal Screw Works  
Call 1-800-645-3479, in N.Y. 1-516-374-6793

MICROMINT INC.  
917 Midway  
Woodmere, N.Y. 11598

Call for quantity pricing.

I WILL BEAT ANY COMPETITOR'S PRICE PROVIDED IT IS NOT BELOW MY COST. TRY TO BEAT THESE IC PRICES:

DYNAMIC RAM		
64K	200 ns	\$5.75
64K	150 ns	6.25
16K	150 ns	1.25

EPROM		
2764	250 ns	\$10.00
2732	450 ns	4.15
2716	450 ns	3.43
2532	450 ns	4.94

STATIC RAM		
6116P-3	150 ns	\$4.75
6116LP-3	150 ns	5.50
2114	200 ns	1.60

Z80A FAMILY		
CPU, CTC, or PIO		\$ 3.50
DART		7.50
DMA or SIO		13.50

MasterCard VISA or UPS CASH COD  
All Prime Parts  
**MICROPROCESSORS UNLIMITED**  
24,000 South Peoria Ave.  
BEGGS, OK 74427  
(918) 267-4796

Prices subject to change. Call for volume prices. Subject to available quantities. Shipping & Insurance extra.



# VIC-20

## VIC-20 INTERFACING BLUE BOOK

Did you know that your VIC can be used to control a 99c toy motor so effectively that it runs like a precision machine? Or that you can build an accurate digital thermometer using the VIC and four parts costing less than \$5?

These and other 18 interfacing projects selected for usefulness, ease of construction and low cost are detailed in the VIC-20 Interfacing Blue Book, a veritable gold mine of practical information on how to build a variety of interfaces for your computer.

Projects include: Connecting VIC to your stereo; Pickproof digital lock; Capacitance meter; Liquid level sensor; Telephone dialer; Voice output; 8K/16K RAM/ROM expansion; 128K RAM expansion; 8-bit precision D/A; 8-bit A/D converter; MX-80 interface and more.

Written by a college professor in a friendly and informative style, the Blue Book gives you theory of operation, schematics, program listings, parts list, construction hints and sources of materials for each one of the 20 projects.

If you want to get the most out of your VIC this book is a must. Cost is \$14.95 (less than 75c per project!). Price includes postage.

**microsignal** Dept. B1  
P.O. Box 22  
MILLWOOD, NY 10548

VIC-20

CIRCLE NO. 128 ON FREE INFORMATION CARD

# ANNOUNCING...

## An affordable, commercial-quality Signature Analyzer.

*Signature analysis is an exacting microprocessor troubleshooting tool. The  $\mu$ T1000 provides industry-compatible signatures at a third of the price.*

The N.W.S. Inc.  $\mu$ T1000 will perform Signature Analysis on most microprocessor-based systems and projects. Stable signatures at up to 8 MHz. more than sufficient for all 8 and most 16 bit microprocessors.

Also available, *Implementing Signature Analysis*, a technical manual providing all the details necessary to implement Signature Analysis on any microprocessor-based design.

Manual provided with each  $\mu$ T1000, or available separately.

$\mu$ T1000 ..... \$279.00  
Implementing S.A. .... \$10.00

**N.W.S. Inc.**  
P.O. Box 62  
Westminster, MD 21157  
(301) 875-4054  
(301) 848-4828  
Dealer inquiries invited.

CIRCLE NO. 129 ON FREE INFORMATION CARD

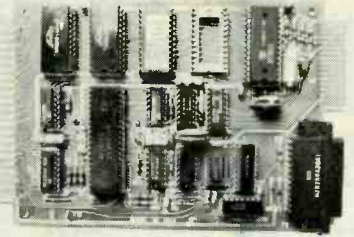

## CONTROL THE WORLD!

A/D conversion, high current outputs, switch closure and logic inputs, BASIC language, RS-232 and cassette interfaces, and EPROM programmer are only some of the features of this family of single board computers. The lowest cost unit can control more than 2000 external devices. Programmed learning text, software, and other support available. Industrial, educational, and home uses. Prices start below \$150.

Octagon Systems Corporation  
5150 West 80th Avenue Suite B  
Westminster, CO 80020  
(303) 426-9780

CIRCLE NO. 130 ON FREE INFORMATION CARD

# TIMEX SINCLAIR 1000 SOFTWARE

ALSO COMPATABLE WITH ZX81

## FREE CATALOGUE

Fill out reader service card or write:

**ORBYTE**  
SOFTWARE  
THE CREATIVE FORCE LTD M

P.O. Box 948, Waterbury, CT 06720  
203-753-8308

CIRCLE NO. 131 ON FREE INFORMATION CARD

## ARBITRARY WAVEFORM GENERATOR ONLY \$345!

Generate any custom waveform with the Apple Computer.

- analog and digital outputs
- up to 20 volts p-p output
- 7 thru 10 MHz
- 125 ns/pt. - 1 sec/pt
- 64 words
- up to 2048 points
- 18 channels
- 8 bit resolution
- Interval timer
- Delayed triggering
- Sequential triggers
- State and timing display

Use the Apple Computer to capture and display digital data

## LOGIC ANALYZER • ONLY \$995.00!

PACIFIC MICROSYSTEMS INC.  
160 GATE 5 ROAD • SAUSALITO,  
CA 94965 (415) 331-2525

CIRCLE NO. 132 ON FREE INFORMATION CARD

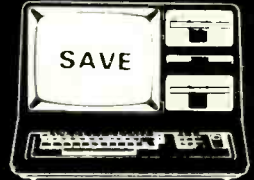

## RADIO SHACK TRS-80's™

We offer Special Discounts, Free Shipping and a Toll Free Order Number

1-800-531-7466 TOLL FREE

## Pan American Electronics

Dept. P.E. - 1117 Conway Avenue  
Mission, Texas 78572  
(512) 581-2766 Telex 767339

CIRCLE NO. 133 ON FREE INFORMATION CARD

## SYMBIOTE 'SETTE

The Subscription Magazine for the  
**Sinclair ZX-81/TS-1000**

Microcomputers

Games, Educational, Business, Graphics  
Tutorial, 1K, 2K, 16K, Etc.

12 Mo. Issues — 6 Bi-Month  
CASSETTES  
AT LEAST 6 PROGRAMS EACH



\$39.50



Ill. Residents add \$2.07 tax  
outside USA add \$10.00

Ask for operator # 383  
24 Hr. Hot Line 800-543-1300

THE S & S COMPANY  
388 W. Lake Street, Dept. CE  
Addison, IL 60101  
(312) 628-8955

CIRCLE NO. 134 ON FREE INFORMATION CARD

# TIMEX TS 1000 SINCLAIR ZX81 SOFTWARE

## WRITE FOR FREE CATALOG AND FREE PROGRAM LISTING

**SOFTSYNC, INC.**

P.O. Box 480, Murray Hill Station,  
New York, N.Y. 10156  
(212) 685-2080

CIRCLE NO. 135 ON FREE INFORMATION CARD

## SPARTAN Electronics Inc.

CALL MAIL

(516) 499-9500  
6094 Jericho Tpke.  
Commack, N.Y. 11725

## Remote T.V. Converter



139.95 Ea.  
4 & up 125.00  
60 Channel  
Wireless Control

## FREE SOFTWARE 6 PAK



When you  
purchase a  
VIC 20 8K Exp  
55.00 16K  
Exp 110.00

## 40 Channel VHF to UHF



**Block Converter**  
28.95 Ea.  
24.95 4 & up

## Volume Discounts

• Visa, MC, BAC, Amex, Check  
COD, Money Order  
• Add For Shipping

Min Order \$10.00	to 75.00	\$2.50
Shipping Overseas	76.00 to 250.00	\$4.50
20% Add'l	251.00 to 500.00	\$6.00
Prices subject to change	501.00 to 750.00	\$8.50
without notice	751.00 to 1000.00	\$12.00
COD 2.00 Extra	Over 1000.00	\$12.50

Visit our Retail Store  
Mon-Th 9-8 Tu-W-F 9-6 Sa 9:30-5

CIRCLE NO. 136 ON FREE INFORMATION CARD

## SUPER SALE

EPROM'S	1-7	8 up	50 up
2716 (5V, 450nS)	\$3.95	\$3.55	CALL
2732 (5V, 450nS)	7.49	6.55	CALL
2532 (5V, 450nS)	8.49	7.55	CALL
2764 (5V, 300nS)	19.95	CALL	CALL

### STATIC RAM

6116P-3 (150nS)	6.50	6.30	CALL
2114L-2 (200nS)	2.10	1.70	CALL

### DYNAMIC RAM

4164-2 (200nS)	7.90	7.49	CALL
(150nS also available)	CALL		

### MISC

CPU Z80A	\$5.29 ea.
CDP-1854ACE (UART)	\$4.80 ea.
16K RAM Expansion Kit	
for TRS-80 Mod III	\$12.95/8



**SUNTRONICS CO., INC.**  
12621 CRENSHAW BOULEVARD  
HAWTHORNE, CALIFORNIA 90250

STORE HOURS: Mon-Fri, 9:00am to 6:30pm — Sat 10am to 5pm  
IN CALIFORNIA OUTSIDE CALIFORNIA TOLL FREE

(213) 644-1149 1-800-421-5775

Min Order: \$10. P/H: \$2. Accept VISA, Mastercard, Check or M.O.

## TRS-80 COMPUTERS

Model II 64k	\$3288
Model III 16k	\$825
Model III 48k 2 Drives RS232	\$2069
Color Computer 4k Level I	\$308
Color Computer 16k Extended Basic	\$459

### EPSON Printers SCALL

All printers and accessories in stock.

### Discount Prices

on full line of Radio Shack & TCS Custom Computers and Accessories. Call for catalog

### Texas Computer Systems

P.O. Box 1327 Arlington, Texas 76004-1327

TOLL FREE 800-433-5184

Texas Residents 817-274-5625

PAYMENT: Money order, cashier's check or certified check. Prices reflect 3% cash discount. Call for VISA and Mastercard prices

CIRCLE NO. 137 ON FREE INFORMATION CARD

## ★MICROCOMPUTER★ BUSINESS SOFTWARE

MEDICAL MGMT...  
DENTAL MGMT...  
INSURANCE AGENT  
LEGAL BILLING....  
PROPERTY MGMT..  
AND MUCH MORE !

### UNIVAIR INTERNATIONAL

9024 St. Charles Rock Road  
ST. LOUIS, MISSOURI U.S.A. 63114

(314) 426-1099

CIRCLE NO. 138 ON FREE INFORMATION CARD

### EDGE CARD CONNECTORS

S-100		APPLE BUS	
PC MOUNT	QTY WIREWRAP	PC MOUNT	QTY WIREWRAP
\$5.25	1 to 9 Pieces	\$6.25	\$3.20 1 to 9 Pieces
4.97	10 to 49 Pieces	5.82	3.05 10 to 49 Pieces
4.66	50 to 99 Pieces	5.45	2.56 50 to 99 Pieces
4.24	100 to 249 Pieces	4.95	2.40 100 to 249 Pieces

WESTLAND ELECTRONICS has a complete line of Texas Instruments Edge Card Connectors

### MEMORY

4116	300 ns	8/\$12.95 each
4116	250 ns	8/\$13.95
4116	200 ns	8/\$15.95
4116	150 ns	8/\$17.95
6116	P32K X 8 CMOS RAM	\$ 7.25
2716	2K X 8 EPROM	\$ 4.49
2732	4K X 8 EPROM	\$ 6.95
2764	HK X 8	\$18.00

SC-01 VOICE SYNTHESIZER CHIP \$55.00

WESTLAND ELECTRONICS now stocks all standard values of 1% metal film resistors from 10 OHMS to 1 MEG OHMS.

SEND FOR A COMPLETE CATALOG

CALL OR WRITE:

WESTLAND ELECTRONICS

37387 FORD ROAD

WESTLAND, MI. 48185

313-728-0650 In Michigan

1-800-521-0664 outside Michigan

CIRCLE NO. 139 ON FREE INFORMATION CARD

## COMPUTER CASSETTES



### BASF -DPS

THE WORLD'S FINEST

Data media for all microcomputers. Used nationwide by software manufacturers, hobbyists, schools and businesses. Premium 5-screw shell with leader fits all standard recorders.

SATISFACTION GUARANTEED OR MONEY BACK.

ITEM	1 DOZ.	2 DOZ.
C-05	<input type="checkbox"/> 7.50	<input type="checkbox"/> 13.50
C-10	<input type="checkbox"/> 8.00	<input type="checkbox"/> 14.40
C-20	<input type="checkbox"/> 10.00	<input type="checkbox"/> 18.00
Hard Box	<input type="checkbox"/> 2.50	<input type="checkbox"/> 4.00

Send for free brochure. Ask for quantity discounts. Calif. residents add sales tax. SHIPPING/HANDLING (UPS) 1 doz. \$2; 2 doz. \$3.50; 3 doz. \$4.50; ea. additional doz. \$.50. For parcel post instead of UPS add \$1. Outside Continental USA, add \$2.

FOR IMMEDIATE SHIPMENT USE YOUR VISA OR MASTERCARD CALL 213/710-1430

**YORK IO™ Computerware**

24573 Kilridge St., P1 Canoga Park, CA 91307

CIRCLE NO. 140 ON FREE INFORMATION CARD

## FREE CATALOG!

Just let us know and we'll mail you a FREE *Creative Computing* Catalog—16 pages filled with books, buyer's guides, magazines, and more!

To get your FREE catalog, write to: *Creative Computing* Catalog, Dept. NA1N, 39 East Hanover Ave., Morris Plains, NJ 07950.

# Computers & Electronics Marketplace

**CLASSIFIED RATES:** Per Word, 15 Word Minimum. **COMMERCIAL:** \$4.00. **PERSONAL:** \$2.30. **EXPAND-AD\*:** \$6.00. Ads set in all bold type @ 20% premium. Ads set with background screen @ 25% premium. **DISPLAY:** 1" x 2 1/4", \$485.00. 2" x 2 1/4", \$970.00 3" x 2 1/4", \$1,455.00. **GENERAL INFORMATION:** Frequency rates and prepayment discounts available. Payment must accompany order except credit card—Am. Ex., Diners, MC, VISA (include exp. date)—or accredited ad agency insertions. Copy subject to publisher's approval; must be typewritten or printed. First word set in caps. Advertisers using P.O. Boxes MUST supply permanent address and telephone number. Orders not acknowledged. They will appear in next available issue after receipt. Closing date: 1st of the 2nd month preceding cover date (e.g., Mar. issue closes Jan. 1). Send order & remittance to: Classified Advertising, **Computers & Electronics Magazine**, 1 Park Avenue, New York, NY 10016. Direct inquiries to Rose Lynch, (212) 725-7686.

### FOR SALE

GOVERNMENT and industrial surplus receivers, transmitters, snooper scopes, electronic parts, Picture Catalog 25 cents. Meshna, Nahant, Mass. 01908.

ELECTRONIC PARTS, semiconductors, kits. FREE FLYER. Large catalog \$1.00 deposit. BIGELOW ELECTRONICS, Bluffton, Ohio 45817.

SAVE UP TO 50% on name brand test equipment. Free catalog and price list. Salen Electronics, Box 82, Skokie, IL 60077.

RECONDITIONED TEST EQUIPMENT \$1.00 for catalog. WALTER'S TEST EQUIPMENT, 2697 Nickel, San Pablo, CA 94806, (415) 724-0587.

BUILD AND SAVE. TV EARTH STATION. DETECTIVE ELECTRONICS. Video Recorders, Color Cameras, advanced Telephone Projects. BROADCAST Electronics. 50 page color catalog of unusual electronic projects AIR MAILED \$3.00; with 3 hour audio cassette dramatization of our catalog \$5.00. Don Britton Enterprises, PO Drawer G, Waikiki, Hawaii 96815.

POLICE/FIRE SCANNERS, crystals, antennas, CBs, Radar Detectors. HPR, Box 19224, Denver, CO 80219.

ELECTRONIC PARTS. Stamp for flyer, \$1.00 deposit for catalog. DAYTAPRO ELECTRONICS, 3029 N. Wilshire, Arlington Hts., IL 60004.

PRINTED CIRCUIT BOARDS, your artwork. Quick delivery. Reasonable. Atlas Circuits, Box 892, Lincolnton, NC 28092. (704) 735-3943.

ELECTRONIC CATALOG. Over 4,500 items. Parts, & components. Everything needed by the hobbyist or technician. \$2.00 postage & handling (United States Only), refundable with first \$15.00 order. T & M Electronics, 472 East Main St., Patcoque, NY 11772. (516) 289-2520.



### SATELLITE TV FANTASTIC 80 TV CHANNELS

New antenna construction plans plus big 8 x 11 book loaded with aiming info. kits. LNAs and receivers at wholesale prices: Far better than cable TV! Enjoy crystal clear reception. Send \$9.95 today. Add \$2.00 for 1st class (air mail) or call our 24 hr. COD order line (305) 862-5068 Now.

Global TV Electronics, P.O. Box 219-E, Matland, FL 32751



## Telephone Listening Device

Record telephone conversations in your office or home. Connects between any cassette or tape recorder and your telephone or telephone LINE. Starts automatically when phone is answered. Records both sides of phone conversation. Stops recorder when phone is hung up. This device is not an answering service.



Each  
**\$19.95**  
Qty. Disc. Avail.

## Super Powerful Wireless Mic

10 times more powerful than other mics. Transmits up to 1/4 mile to any FM radio. Easy to assemble kit. 15V battery (not incl). Call (305) 725-1000 or send \$19.95 + \$1.00 shipping per item to USI Corp., P.O. Box PM-2052, Melbourne, FL 32901. COD's accept. For catalog of transmitters, voice scramblers and other specialty items, enclose \$2.00 to USI Corp.



Size 2" x 3" x 1/4"

SATELLITE TELEVISION... HOWARD/COLEMAN boards to build your own receiver. For more information write... ROBERT COLEMAN, Rt. 3, Box 58-APE, Travelers Rest, S.C. 29690.

**SAVE UP TO 85%**

**GOVT SURPLUS and NEW EQUIP'T**



**Blower/Fan**  
100-CFM  
115-VAC  
LIST OVER \$12.00  
**\$8.79**  
F.O.B. Lincoln



**Powerful Battery Motor**  
13 lbs  
**\$34.95**  
Normal Retail Over \$100.00 F.O.B. Lincoln

\* (ITEM #16-940) -- Use for intake, exhaust, cool electronic gear. 4" diam. blade, mounts in 6-1/2" diam. opening. 4-1/4" deep. (2-1/2 lbs.)

\* (ITEM #1066) -- High torque, 1/2-HP. 12 to 36-VDC, 1200 to 3600-RPM. Motorize bikes, make small electric cars, drive pumps, compressors. Shaft 3/4" diam. Overall lgh 9"

100-Page Catalog  
Send 60-CENTS  
COIN or STAMPS  
100's of BARGAINS

**SURPLUS CENTER PE-013** Lincoln, Ne. 68501  
(402) 474-4366

SATELLITE TELEVISION INFORMATION \$4. Build or buy your Earth Station. Satellite Television, RD 3, Oxford, NY 13830.

SOUND SYNTHESIZER KITS—Surf \$19.95, Wind \$19.95, Wind Chimes \$24.95, Musical Accessories, many more. Catalog free. PAIA Electronics, Box J14359, Oklahoma City, OK 73114.

CABLE TV CONVERTERS & EQUIPMENT. Plans and parts. Build or buy. For more information send \$2.00: C & D ELECTRONICS INC., P.O. Box 21, Jenison, MI 49428.

MICROWAVE TV DOWNCONVERTERS, Downconverter board, power supply board, Antenna Cookbook, with detailed plans, \$20.00 Downconverter parts \$15.00, power supply parts \$15.00. Micro Engineering, P.O. Box 17231, Minneapolis, MN 55417.

FREE FLYER! IC's, resistors, capacitors, jacks, etc., plus SSM music synthesizer/audio IC's, power amp modules, analog delay IC's, computer books, and more. Also plans for analog delay/chorus unit! PGS Electronics, P.O. Box 749-A, Terre Haute, IN 47808.

ACOUSTIC TEST SET for adjusting equalizers, speakers; \$449.00. Free Brochure. HALL ENGINEERING, Dept. 22, P.O. Box 506, Martinsville, N.J. 08836.

**Satellite Earth Station**

**Complete systems from \$1,899.00**

Call or write for our latest brochure.

**TENNESSEE ELECTRONICS**

P.O. Box 181108  
Memphis, TN 38118  
(901) 795-4504

TELETYPE EQUIPMENT: Copy Military, Press, Weather, Amateur, Commercial Transmissions. Catalog \$1.00. WEATHER-MAP RECORDERS: Copy Satellite Photographs, National-Local Weather Maps. Learn How! \$1.00. Atlantic Sales, 3730 Nautilus Ave., Brooklyn, NY 11224. Phone: (212) 372-0349.

**SATELLITE TV**

• SYSTEMS • COMPONENTS • LNA's •  
• ANTENNAS • RECEIVERS •

WE CAN HELP YOU!

**HIGH FRONTIER**

2230 E. Indian School Rd., Phoenix, AZ 85016  
(602) 954-6008

**ANTI GRAVITY**



**ELECTRONIC LEVITATION**

No moving parts, magnets, gases or exotic fuels. BUILD FLYING MODELS. Plans, schematics, diagrams, performance charts & more in PRIMER VOL. 105 pgs 8 x 10 mimeo \$20 ppd. GUARANTEED! VISA/MC add \$5. FOREIGN ADD \$10. SAUCER TECHNOLOGY, Box 132-M, Eureka Springs, Ark. 72632

MICRO TOPOLOGY EXPOSED! Discover the incredible detail of a microprocessor chip enlarged over 20,000 times into a large full color poster. See how an LSI circuit, the 6502 CPU, is built. Poster only \$4.50 with free 6502 fact sheet. OMICRON DIGITAL SYSTEMS LTD., Box 3055-PE, Falls Church, VA 22043.

**ELECTRONICS WALL CHART**  
A VISUAL TOOL

- Design your own projects
- Analyze & Repair Circuits
- AC/DC Theory • Power Supplies • More
- 3 Colors • Easy to read • 23 x 35

Shipped in sturdy tube \$9.95 + \$1.00 postage

**ELECTRONICS REFERENCE INC.,**  
P.O. BOX 312, BKLYN, N.Y. 11214

SAVE!! (KITS) 2.5 GHZ Downconverter \$29.95, P/S less Transformer \$15.00. Plans \$7.50. Hoptronix, Box 402183, Garland, TX 75040.

**SHORTWAVE AND SCANNER LISTENERS**

Tune in spies, smugglers, secret satellites, undercover agents, pirate stations, foreign broadcasts. Choose the proper equipment to hear more, hear farther... Discover listening excitement beyond your dreams by reading MONITORING TIMES, respected authority on monitoring. For your FREE SAMPLE call toll-free TODAY! 1-800-438-8155 or 1-704-837-2216, or write

**GROVE ENTERPRISES**  
Dept. A, 140 Dog Branch Road  
Brasstown, NC 29802

TELEPHONES AND ACCESSORIES. FCC registered. Send 20¢ stamp for catalog. UNIQUE COMMUNICATIONS, 6335 S.R. 97 Galion, Ohio 44833.

DEALERS: MATV/CATV/VCR Equipment, audio cables, telephone accessories, antennas, needles batteries. (212) 897-0509. D&WP, 66-19 Booth, Rego Park, NY 11374.

OPEN REEL TAPE—Mostly AMPEX 641/671 used once, unspliced, unboxed, 7" 1800' or 2400, 50 reels; \$65.00. Sample \$2.00. Ten 3600', 10 1/2" reels; \$27.50. Sample \$2.50. New premium cassettes and 8 track cartridges available. Sample: \$1.00 each. AUDIO TAPES, Box 9584-E, Alexandria, VA 22304. (703) 892-8722, VISA/MC.

FREE SPEAKER CATALOG—Thousands of speakers and accessories at the lowest prices. Free cabinet plans, plastic woofers, ribbon tweeters. Send \$1.00 postage to: SRC Audio, Dept. P.E., 3238 Towerwood Dr., Dallas, TX 75234. (214) 243-4145.

SATELLITE RECEIVER IF SWEEP GENERATOR. 70 Mhz IF. Sweeps 40-100 Mhz \$79. Head End Systems, P.O. Box 8758, Portland, Oregon 97207.

R-174/GRR-5 Military Communications Receiver, 1.5-18 MHz AM-CW-SSB, amateur, shortwave, military frequencies, mint; \$47.50; good: \$27.50. ARC-27 Aircraft Guard Receiver Assembly, 238 MHz AM, mint: \$12.50. Technical data included. Add \$5 shipping. Baytronics, Dept. CE, Box 591, Sandusky, OH 44870.

MICROWAVE TELEVISION "DOWNCONVERTERS." Exclusive new five stage design. Easily assembled. Catalogue: \$2.00 (refundable). NDS, Box 12652-E, Dallas, 75225.

GEARMOTORS: 12VDC, 125 inch lbs., 40-100 RPM. 2-15 AMPS., Reversible, reconditioned, guaranteed. 6lb. \$30.00, 4/100.00. Sepac, 625 NW 41st St., Seattle, WA 98107.

LOUDSPEAKERS! Electro-Voice raw components ready to ship with competitive prices. FREE catalog. SONIX CO., Box 58-CE, Indian Head, MD 20640. (301) 753-6432.

## CABLE TV CONVERTERS DESCRAMBLERS

BUY DIRECT & SAVE



36 CHANNEL REMOTE CONTROL CABLE CONVERTER  
\$88.00

### AMATEUR MICROWAVE ANTENNA

• 26 DB Gain  
• Advanced Down Converter  
• Complete-Ready to Install  
\$119.00



### LINDSEY JET II WIRELESS THE ULTIMATE T.V. CONVERTER

56 CHANNEL INFRARED REMOTE CONTROL COMPLETELY PROGRAMMABLE  
\$169.00

Send \$1 for Complete Catalog VISA • MASTERCARD • COD

**DIRECT VIDEO SALES**

P.O. BOX 1329  
JEFFERSONVILLE, INDIANA 47130

CALL TOLL FREE  
1-800-826-1533

OVER 200 PROJECTS AND KITS. Send stamp for list, MATCO ELECTRONICS, Box 316P, Cadillac, MI 49601.

POLICE CODE UNSCRAMBLERS, lets you hear the coded messages of Police, Fire and Medical channels; magnetic mobile scanner antennas and other scanner accessories, satisfaction guaranteed. DNE Inc., Rt. 7, Box 257-A, Hot Springs, AR 71901. (501) 623-6027.

**REPAIR ATARI GAMES AT HOME**

Complete repair course on 3 hour video tape (Beta or VHS) plus schematics and technical literature enables you to start earning money right away. All popular repair parts in stock for immediate shipment. \$1.00 for parts/price list and additional information refundable with order. Exclusive National Distributor

**ELECTRONICS WAREHOUSE CORP.**  
1910 Coney Island Avenue  
Brooklyn, N.Y. 11230 (212) 375-2700

HOME MICROWAVE RECEIVER—2.0-2.6 GHz with 20" solid Parabolic dish and 40DB gain power supply in wood cabinet, complete system with cables — \$149.00. Send Money order only to: D.F.E., 414 North State College Blvd., Suite C-173, Anaheim, CA 92806. 6 month warranty. DEALER INQUIRIES WELCOME!!!

FREE FLYER 99 cent kits. Parts, Bargains Galore! ALLKIT, 434 West 4th St., West Islip, New York 11795.

TRANSISTORS, IC's, RF Power, LED's and Sanyo rechargeable batteries. For best buys plus service call TOLL FREE 800-458-6053. PA call 800-672-7100. MC/VISA honored. Savings. Service. Quality. At B&D we do it better. B&D ENTERPRISES, Box 305, Kane, PA 16735.

TUBES. Large selection. Unused, in original cartons. SASE brings list. Fala Electronics, Box 04134-9, Milwaukee, WI 53204.

AC WALL RECEPTACLE TESTER: Tests for Neutral/Ground reversal of wires (not just with respect to the hot wire but among themselves). Sent postpaid, guaranteed, airmail, for \$40., patented, VISA, CASH, COD from SADCO, 11621 Hughes NE, Albuquerque, NM 87112. Tester could save your life, improve HiFi/TV.

SHORTWAVE LISTENERS! Free catalog. High quality SWL equipment! RADIO WEST, 3417 Purer Rd., Escondido, CA 92025. (714) 741-2891. The Only all SWL store in the Known World.

RESISTORS, 1/4W-1/2W-5% C.F., 3ea., 1% Metalfilms. NO MINIMUMS. Quantity Discounts. Write: JR INDUSTRIES, 5834-A Swancreek, Toledo, OH 43614.

PLASTIC BAGS. All Sizes. Buy small quantities. Free catalog. SAKET, 6151-CE, Colbath, Van Nuys, California 91401.

DISCOUNT AUTO STEREO PRODUCTS. Details send S.A.S.E. or \$1.00 to: STEREO Discount, Box M, Santa Rosa, California 95402.

SATELLITE ANTENNA—Build or buy from \$160 approved leading Electronics Magazine. Prototype Engineers, Box 1812, Deming, NM 88030.

CABLE TV BOXES & ACCESSORIES. Complete units. Money-back guarantee. For catalog send \$1.00: Veejer Electronics, 2951 Industrial Rd., Dept. 199 NE, Las Vegas, NV 89109.



**Call or Send for Free SINTEC ELECTRONIC PARTS CATALOG**

Thousands of Quality Components No Mail Order "Seconds"

Call Toll Free **800-526-5960**

NJ Residents call 201-996-4093 Sintec, Drawer Q, Milford, NJ 08848

**FAST, DEPENDABLE MAIL-ORDER!** Prime semiconductors, parts, accessories. Free 54 page catalog. The Parts Store, Dept. 180, 999 44th St., Marion, IA 52302

**Tiger TECH ELECTRONIC COMPONENTS**

SEND 25 CENTS U.S. FOR FLYER REFUNDABLE WITH ORDER BOX 576, BROOMFIELD, COLO 80020

RESISTORS, 1/4W5% C.F. 1-9/type \$0.03, 10/type \$0.25, 100/type \$0.015, 500/type \$0.013, 1000/type \$0.011. Special discount available. Presto Enterprise, 3575 Greenlee Dr., #131, S.J., CA 95117.

SINGLE BOARD CONTROLLER Z8671. A/D input. Triac port. Write: H.H.S. Microcontrollers, 5876 Old State Road, Edinboro, PA 16412.

**MICROWAVE ANTENNAS**

Highest gain systems available anywhere! Guaranteed to out-perform all dish styles! All units complete. Factory direct sales, 1 yr. warranty by: **J&A Electronics**, 7515 Greenback Ln., Citrus Heights, CA 95610. Tel. 916/723-3025. Send check, MO, COD. Mastercard or Visa. Add 5% for shipping.

HOW TO BUILD A SATELLITE TV LNA OR DOWNCONVERTER! Save Hundreds! Free information! XANDI, Box 25647, Dept. 22F, Tempe, AZ 85282.

**RELIABLE MICROWAVE TV ANTENNAS**

2.1 to 2.6 GHz Frequency Range

34db System Gain (or Greater)  
Complete System (pictured) \$149.95  
Down Converter Probe Style (Assembled & Tested) \$ 84.95  
Power Supply (12V to 16V DC) (Assembled & Tested) \$ 59.95

**PETERSON ELECTRONICS**

4558 Auburn Blvd  
Sacramento, CA 95841  
(916) 486-9071

SPECIAL QUANTITY PRICING  
Dealers Wanted - COD'S

1 YEAR WARRANTY PARTS & LABOR



**WIDE BAND HAM MICROWAVE RECEIVERS**

2.0 to 2.5 GHz Antennas



**Daisy-Tenna Dish \$ 85.00**  
32 db Gain  
Complete/ready to install

3 - 30 units \$ 59.90  
36 & Up units \$ 54.90



**Daisy-Tenna Rod \$ 95.00**  
40 db Gain  
Complete/ready to install

2 - 23 units \$ 69.90  
24 & Up units \$ 64.90



**Daisy-Tenna Grid \$110.00**  
50 db Gain  
Complete/ready to install

6 - 30 units \$ 74.90  
30 & Up units \$ 69.90

All units are complete/ready to install with "HIGH QUALITY" Power Supply.

**GUARANTEED SUPERIOR TO ANY OTHER UNITS ON THE MARKET!**

Quantity Pricing  
Dealers Wanted

6 Month Warranty  
Parts & Labor

Yes! You Can Charge It!



DAISY-TENNA  
P.O. Box 42010  
Phoenix, AZ 85050  
(602) 863-2208

MICROWAVE ANTENNA SYSTEMS—2 Ghz. Complete system: Downconverter, Dish antenna, power supply and warranty \$59.95. Assembled & tested, ready to install. NOT A KIT. Dealers wanted! NEVADA SATELLITE CORPORATION, (702) 367-0333.

**COMPUTER EQUIPMENT/PARTS**

SAVE 90% Build Your own Minicomputer. Free Details. Digatek, 2723 West Butler Dr., Suite 20C, Phoenix, AZ 85021.

PLUGS-INS AND ADD-ONS FOR THE IBM PERSONAL COMPUTER. Available in kit form as well as assembled. Build it yourself and save. Free information. Compatible Computer Corp., Dept CE 8, Box 51102, Seattle, WA 98115.

**LOW PRICED COMPUTER PRODUCTS, Printers, CRT's, Mainframes. Angel Computer Products, 1719 South Carmelina, Los Angeles, 90025, (213) 820-4231.**

ZENITH ZVM/121, 12" diagonal green screen \$105. MICRO-COMPUTER RESOURCES, 33576 Orange Lawn, Livonia, Michigan 48150. (313) 522-6151.

8" FLOPPY DRIVES \$150. Diablo Daisy Wheel Printer \$400. Qume Diablo RS232 interface \$95. CDI, 105 S. Main, Greer, SC 29651.

APPLE BUILDERS—Send stamp for our flyer of Apple parts. IC sets, ROM sets, connectors, Shugart drive to Apple modification kits etc. Electrovalue Industrial Inc., Box 157-P, Morris Plains, NJ 07950.

MICROPROCESSOR CRYSTALS, wide range of frequencies. Example: 4mhz \$2.00 each. Write: Sigmotek, 327 Clarkin Court, Walnut Creek, CA 94598.

**COMPUTER SOFTWARE**

SINCLAIR ZX81/TS-1000/TRS-80 COLOR COMPUTER PROGRAMS. Wide selection/High quality. Catalog \$1.00. Zeta Software, Box 3522, Greenville, SC 29608.

CROSS ASSEMBLERS, SIMULATORS. Written in FORTRAN for most microprocessors. IDI, Box 163P, Dillon, CO 80435. (303) 468-0112.

DISCOUNT SOFTWARE—Available for Apple, TRS-80 and TI 99/4 Personal Computers. Professional applications for the doctor, dentist, attorney, school administrator, teacher, contractor and general office personnel. Catalog, \$1.00. Creative Discount Software, 256 S. Robertson Blvd., Suite 2156, Beverly Hills, CA 90211.

...ZX81...TIMEX/SINCLAIR 1000 SOFTWARE. Introductory 5 game tape ONLY \$3.95! FREE catalog send SASE to: Software Development Assoc., Dept C2, 2240 W. McRae Way, Phoenix, AZ 85027. AZ. res. add tax.

10 PRINT "ZX81 DATA-SHARE" receive up to 100 ZX81 programs approximately 10 cents each. Send one ZX81 program with documentation and \$10.00 "DATA-SHARE," P.O. Box 2024, Modesto, California 95351.

THE CRITICAL CONNECTION! Now you can buy an inexpensive ATARI-400, and have it use the disk drives, printer and keyboard on your CP/M computer. Complete package \$147.00. DEALER INQUIRIES WELCOME. USS ENTERPRISES, 6708 Landerwood Lane, San Jose, CA 95120, (408) 997-0264.

VIC SOFTWARE FOR SMALL BUSINESS/HOME. Send \$1.00 for catalog and put your computer to work. WMS Software, 4715 Bedford, Mesquite, TX 75150.

ZX81/TS1000. High Quality, reasonably priced machine language software. Free Catalog. SPYDER ELECTRONICS, Box 4172, Morgantown, WV 26505.

SOFTWARE AT WHOLESALE PRICES for all popular systems. Write for free catalogue. New York Software Exchange, P.O. Box 722, Newtown, PA 18940.

**COMPUTER PUBLICATIONS**

FREE CATALOG of special function ic's and quality components. Goldsmith Scientific, Box 318M, Commack, NY 11725.

COLOR COMPUTER USERS—Send for free Hardware and Software catalogue. Spectrum Projects, 93-15 86 Drive, Woodhaven, NY 11421.

**TIMEX/SINCLAIR**

16K (ZX81), Dominos plus new games. Free brochure. \$9.95 cassette, check/M.O.: JPR SOFTWARE, Box 4155, Winter Park, Florida 32793.

**AMATEUR RADIO**

RADIO AMATEUR CALLBOOKS: 1983 Directories of Radio Amateurs around the world. U.S. Callbook \$23.00; Foreign Callbook \$22.00, shipping included. See your Dealer or write for FREE catalog. RADIO AMATEUR CALLBOOK, Dept CE, 925 Sherwood Dr., Lake Bluff, IL 60044.

CALL AND ORDER NOW SPECIALS: Yaesu FT-102, \$999.; Kenwood TS-530S, \$600. DISCOUNTS! DISCOUNTS on many more! Fast shipping. MADISON ELECTRONICS, Houston, TX call: (713) 658-0268.

VIDEOSCAN 1000 Slow Scan TV—HIGH RESOLUTION (amateur, phone line, monitoring, teleconferencing). CODE\*STAR—DECODE Morse, RTTY, ASCII. LARGE LEDs or connect computer/printer. MORSE-A-KEYER—CW Keyboard. TRI-VOLTAGE POWER SUPPLY. Kits/Assembled. FREE brochures. MICROCRAFT CORPORATION, Box 513-PE, Thiensville, WI 53092. (414) 241-8144.

**C.B. EQUIPMENT**

IMPROVE CB PERFORMANCE! Modification hardware, books plans, Catalog \$2. CBC INTERNATIONAL, Box 31500PE, Phoenix, AZ 85046.

**CABLE TV**

**FREE THE GREAT ELECTRONIC THINGS & IDEAS BOOK!**

HUNDREDS OF UNUSUAL PARTS, GADGETS & IDEA ITEMS. UNAVAILABLE IN STORES OR CATALOGS ANYWHERE! Bargain prices on everything! New items in every issue! Rush Postcard for your copy!

**ETCO ELECTRONICS**  
Dept. 310  
Plattsburgh, N.Y. 12901

**PLANS AND KITS**

PRINTED CIRCUIT Boards from sketch or artwork. Kit projects. Free details. DANOCINTHS Inc., Dept. PE, Box 261, Westland, MI 48185.

GIANT SCREEN TV projection system converts any television into 7-foot picture. Lens & instructions \$14.95. (Dealers welcome). Bell Video, 4616 Belair Rd., Baltimore, MD 21206.

FREE CATALOG OF LOW - cost electronic kits. Sirens, Strobes, Color-Organs, Combination Locks, etc. PPG ELECTRONICS, 791 Redrock Road, St. George, Utah 84770. Call 1-800-453-1708.

TELEVISION TO OSCILLOSCOPE CONVERSION KIT, \$19.00. As featured in September, 1982 POPULAR ELECTRONICS. Microgrid, Box 613B, Ithaca, NY 14850.

AT LAST an end to noisy intermittent test probes especially involved with digital instrument. Enjoy instant display setting. Only \$5.95 per pair shipped postpaid. Send now check or M.O. to: Echo Electronics, Box 703, Glen Echo, MD 20812.

AMPLIFIER HEADPHONES—for use with electric guitars. Simple construction, made with standard headphones. Send \$2.00 for plans, SHINKO, E-1, P.O. Box 252, Eatontown, NJ 07724.

FREE PHONE CALLS made by users of this electronic device. Complete report and plans sold for information, education only \$7.50: DISTRIBUTORS MART, Box 333, Modena, NY 12548.

PROJECTION TV... Convert your TV to project 7 Foot picture... Results equal to \$2,500 projector... Total cost less than \$20.00. PLANS & LENS \$17.50. Illustrated information FREE. Macrocom, Washington Crossing, Pennsylvania 18977. Creditcard orders 24 hours. 215-736-3979.

**ALARMS**

**Burglar-Fire Protection**

Protect Your Life, Home, Business, Auto, etc.

Our catalog shows how. Install your own alarm systems and devices and save \$\$\$\$! We offer FREE write-in engineering service.

**FREE CATALOG** Lowest Prices on Reliable, High-Quality Alarm Systems and Devices

Burdex Security Co. Box 82802-PE Lincoln, Ne. 68501

BURGLAR, FIRE, CAR! Finest equipment! Save! Free Catalog. AAS, 414A Lorna Square, B'ham, AL 35209.

**HIGH FIDELITY**

TOP QUALITY SPEAKERS AND KITS. Send \$3.00. Speaker Warehouse, 801 North Route 441, Hollywood, FL 33021.

DIAMOND NEEDLES and STEREO CARTRIDGES at DISCOUNT PRICES for SHURE, PICKERING, STANTON, EMPIRE, GRADO, AUDIO TECHNICA, ORTOFON, ADC, SONUS and DYNAVECTOR. Send S.A.S.E. free catalog. LYLE CARTRIDGES. Dept. P, Box 69, Brooklyn, NY 11218. For fast COD service Toll Free 800-221-0906. N.Y. State (212) 871-3303. 9AM-8PM except Sunday.



## WANTED

GOLD, Silver, Platinum, Mercury, Tantalum wanted. Highest prices paid by refinery. Ores assayed. Free circular. Mercury Terminal, Box 191 Norwood, MA 02062.

## TUBES

TUBES—"Oldies", Latest. Supplies, components, schematics. Catalog Free (stamp appreciated). Steinmetz, 7519-PE Maplewood, Hammond, Ind. 46324.

TUBES-RECEIVING, Industrial and Semiconductors Factory Boxed. Free price sheet including TV, Radio and audio parts list. Translateronic, Inc., 1365 39th St., Brooklyn, New York 11218. Telephone: (212) 633-2800. Toll free: 800-221-5802.

HUGE INVENTORY! Thousands of types. Wholesale prices. FREE CATALOG! ETCO Electronics, DEPT. 290, Plattsburgh, NY 12901.

## GOVERNMENT SURPLUS

FREE GOVT SURPLUS. Send \$1.00, S.A.S.E. to: "Surplus", P.O. Box 49126, Atlanta, GA 30359.

## PERSONALS

MAKE FRIENDS WORLDWIDE through international correspondence, illustrated brochure free. Hermes-Verlag, Box 110660/Z, D-1000 Berlin 11, W. Germany.

CORRESPONDENCE FOR FRIENDSHIP IN PHILIPPINES, MALAYSIA. Free information. AAWS-(PE), Box 2777, Orcutt, California 93455-0777.

PENFRIENDS—ENGLAND—USA, through correspondence. Send age, interests. Free reply. Harmony, Box 89PE, Brooklyn, New York, 11235.

UNIVERSITY DEGREES BY MAIL! Bachelors, Masters, Ph.D.'s... Free revealing details, Counseling, Box 317-EP01, Tustin, California 92680.

UNIVERSITY DEGREES BY SPECIAL EVALUATION of existing credits and Job experience. Fast, inexpensive. Call (614) 863-1791. Or write: EVALUATION, Box 13151-X1, Columbus, Ohio 43213.

SCANDINAVIAN LADIES, sincere, seek correspondence for friendship. Details—Send stamp: Scannclub, Box 4-(CE), Pittsford, NY 14534.

VITAMINS DIRECT FROM MANUFACTURER. 14 years quality service, unbelievable savings. Catalog \$1.00. LIFE CYCLE VITAMINS, 6354 Van Nuys Blvd., Dept 136CE, Van Nuys, CA 91401.

WORLD'S LARGEST PARTNER-PHOTO-CATALOG for Friendship/Marriage. Information free. Personalized introductions. INTERMATE, Box 12, Toronto, Canada M4A 2M8. U.S. Inquiries.

ORIENTAL SINGLES seeking cultural exchange, friendship, sharing, marriage. Write: CHERRY BLOSSOMS, Box 1021P, Honokaa, Hawaii 96727.

BEAUTIFUL PHILIPPINE ladies seek nice friendship, correspondence! Photos, information, free! Transcor-B Box 2321, Manila, Philippines 2801.

## INSTRUCTION

UNIVERSITY DEGREES BY MAIL! Bachelors, Masters, Ph.D.'s. Free revealing details. Counseling, Box 317-PE01, Tustin, California 92680.

LEARN WHILE ASLEEP! HYPNOTIZE! Astonishing details, strange catalog free! Autosuggestion, Box 24-ZD, Olympia, Washington 98507.

### Be an FCC LICENSED Electronic Technician

Earn up to \$600 a Week & More!  
No costly school — The Original FCC Test Answer's exam manual that prepares you at home for FCC General Radiotelephone License. Newly revised multiple-choice exams cover all areas tested on the actual FCC Govt exam! No previous experience required. \$12.95 post paid. Moneyback Guarantee.  
Dept. P P.O. Box 26348, San Francisco, CA 94126



**COTLAND & PRODUCTIONS**

MEDICAL ELECTRONICS TECHNOLOGY, home study. Troubleshoot medical instruments. WTI, P.O. Box 3124, Fresno, CA 93650-3124.

UNIVERSITY DEGREES BY SPECIAL EVALUATION of existing credits and Job Experience. Fast, inexpensive. Call (614) 863-1791. Or write: EVALUATION, Box 13151-A1, Columbus, Ohio 43213.

## Be an ELECTRICIAN

• MAINTENANCE • CONTRACTOR • CONSTRUCTION

Make more money! Check out Electrician's wages against the kind of money you make now!

TRAIN AT HOME IN SPARE TIME

Make extra money in spare time while you train for a full-time job. Do odd jobs for friends and neighbors. Save money doing your own electrical work. Learn everything from repairs and maintenance to complete electrical installations. No previous experience needed. Everything explained in easy-to-understand language with plenty of drawings, diagrams and photos. Tools, materials, test equipment included with course. Approved for Veterans and G.I.'s. Be ready to take almost any electrician licensing examination offered by state, city or county. No cost, no obligation, no salesman will call!

MAIL COUPON TODAY!

**ICCS** SINCE 1961  
Electrician School, Dept. PD0C2  
ICCS Center, Scranton, PA 18515

Rush free facts that tell how I can train at home in spare time to be an electrician

APPROVED FOR VETERANS

NAME \_\_\_\_\_  
ADDRESS \_\_\_\_\_  
CITY/STATE/ZIP \_\_\_\_\_

## ATTENTION ELECTRONIC TECHNICIANS

Highly Effective Home Study BSEE Degree Program for Experienced Electronic Technicians. Our New Advanced Placement Program grants Credit for previous Schooling & Professional Experience. Advance Rapidly! Our 36th Year!

FREE DESCRIPTIVE LITERATURE!

Cook's Institute of Electronics Engineering  
DESK 15 P.O. BOX 20345, JACKSON, MS 39209

COMPUTER REPAIR, PROGRAMMING, WORD PROCESSING Courses. Exciting "Hands On" training in 4 months, lifetime placement assistance. Systems Technology Institute, 6442 Edgewater Drive, Orlando, FL 32810. (305) 299-6535.

HANDLE YOUR OWN LEGAL AFFAIRS—Be a Paralegal. Accredited Attorney Instruction. Home Study. FREE CATALOG. Southern Career Institute, Drawer 13E-2158 Boca Raton, FL 33427. (305) 368-2522.

TECHNICIAN'S NOTES: Learn Electronics Easily: formulas, shortcuts, references. \$3. TRK Industries, Box 2976, Kalamazoo, MI 49003-2976.

REPAIR ELECTRONIC ORGANS—Revised home study course covers all current makes and models. Free booklet. Niles Bryant School, P.O. Box 20153, Sacramento, CA 95820.

TEXAS INSTRUMENTS COMPUTER ADVANTAGE CLUB (TICAC) announces computer awareness classes for adults and children. Offerings for children include general micro-computer operation, TI LOGO and TI BASIC. Offerings for adults include general microcomputer operation and TI BASIC. Classes available in cities across the USA. For schedules and locations nearest you call toll free: 1-800-692-1318 (inside Texas 1-800-858-4069). Special rates for large groups.

## FOR INVENTORS

### INVENTORS! IDEAS HAVE VALUE!

Ever think of an idea, forget it and see it later on the market? Many people don't forget, act quickly and are rewarded by American Industry. Write down your idea! We offer free disclosure registration and initial consultation regarding your idea's potential value. Call or write without delay for your free information package.

AMERICAN INVENTORS CORPORATION  
59 Interstate Drive, Dept. PE  
West Springfield, MA 01089  
(413) 737-5376

A fee Based Marketing Company  
Offices Coast to Coast

IDEAS, inventions, new products wanted! Call toll free 1-800-528-6050. In Arizona, 1-800-352-0458. Extension 831.

PATENT AND DEVELOP your invention. FREE PATENT INFORMATION. Richard L. Miller, P.E., 3612-E, Woolworth Building, New York, NY 10007, (212) 267-5252.

## BUSINESS OPPORTUNITIES

FREE CATALOGS. Repair air conditioning, refrigeration. Tools, supplies, full instructions. Doolin, 2016 Canton, Dallas, Texas 75201.

MAILORDER OPPORTUNITY! Start profitable home business without experience or capital. Information free. Mail Order Associates, Dept 586, Montvale, NJ 07645.

MECHANICALLY INCLINED individuals desiring ownership of Small Electronics Manufacturing Business—without investment. Write: BUSINESSSES, #2-K1 Brighton 11th, Brooklyn, New York 11235.

ERASE DEBTS with little-known law—create wealth! Details FREE—Moneywise, No. EE1, LaGrange, NY 12540.

ONE MAN CRT FACTORY. T.V.'s, Business machines. Monitors, Scopes, VDT's. \$3.00 rebuilding nets \$100-\$500 each tube. Higher profits overseas. New/used. FACTORY. 1909 Louise, Crystal Lake, IL 60014. (815) 459-0666.

MAKE MONEY SELLING ELECTRONICS. Wholesale dealer catalog \$5. (redeemable). ETCO, Dept. 532, Box 840, Champlain, N.Y. 12919.

BORROW \$25,000 "OVERNIGHT." Any purpose. Keep indefinitely! Free Report! Success Research, Box 19739-GA, Indianapolis, IN 46219.

FREE BOOK "2042 Unique Proven Enterprises." Fabulous "unknowns," second inflation income. Haylings-M, Carlsbad, CA 92008.

LIFETIME INCOME, \$3,000 WEEKLY POSSIBLE! Unique system beats envelope stuffing anyway! Elliott, Box 7206-PE1, Columbia, MO 65205.

END YOUR MONEY WORRIES! Amazing system requires no investment. Guaranteed legal. Free Details. O. LOPEZ FINANCIAL SERVICES, INC., Box 650220, Miami, Florida 33165.

HIGH PROFITS—Low Investments with our C.R.T. REBUILDING MACHINE. Complete training. ATOLL TELEVISION, 6425 Irving Park, Chicago, Illinois 60634, (312) 545-6667.

COMPUTER CASH. 101 Exciting, new spare-time home business. \$3.50. RESEARCH, Box 22485P, Houston, TX 77227.

ATARI REPAIR BUSINESS. Start your own. Send \$5 for more information to: IRATA REPAIRS, 2562 E. Glade, Mesa, Arizona 85204.

BECOME AN INSTANT MILLIONAIRE. \$Millions won weekly in Canadian Government lotteries. Enter NOW! Free details. Winfall Enterprises, Dept. PE, Box 554, Town of Mount Royal, Montreal, Quebec, Canada H3P 3C7. U.S. Inquiries.

BE A TI99 COMPUTER DEALER. INEXPENSIVE. Start part time. Send \$4.95 for details. JOE, Box 321, Aurora, CO 80040.

EARN MONEY AND BUILD A CAREER in Audio and Video Sales. You may qualify as a Regional Sales Representative. Knowledge of High Fidelity Components Important. Distributors of quality high fidelity components will help train you and send you sales leads for your area. Call TOLL-FREE 1-800-638-8806, or 1-301-488-9600 between 9 AM & 9 PM Daily or Saturday before 5 PM. Ask for Campus Rep Program—International HI-FI Distributors. Moravia Center Industrial Park, Baltimore, MD 21206.

MAKE FUDGE AT HOME FOR \$500.00 A WEEK. When my husband lost his job, I did it to make ends meet. Both he and I were amazed at the money I earned. No selling of any kind either. Send a dollar for postage and handling and I'll tell you about it. REVELATIONS, Div J-710, 1116A 8th Street, Suite 184, Manhattan Beach, CA 90266.

THE DEMAND FOR MAID SERVICES is incredible with more women working every day. My wife started with \$12 worth of supplies and brought in \$45,000 last year. We'll show you how to do it. For more details write: SAB Inc., Div. J-711, 21203 A Hawthorne Blvd., Suite 5437, Torrance, CA 90509 and enclose \$1.00 to cover our postage and handling.

BE THE PRESIDENT of your own corporation for \$45.00. Big tax advantages. Complete incorporation kit for any state and easy to follow instructions. For more details, send a dollar to cover mailing costs to: AEA Corporation Supply, Div. J-712, 211 Pontius Avenue, Los Angeles, CA 90064.

PROFESSIONAL VIDEO GAME MACHINES free if you want to start your own Arcade. Companies ready to place them & do all the service if you provide the location. For more information write to: AE RESEARCH, Div. J-713, 13450 Maxella, Suite G185-384, Marina Del Rey, CA 90291.

WHERE TO FIND BARGAIN items that will be hot sellers at flea markets and swap meets. 483 sources and how to negotiate the best deal. Also ideal products for mail order. For more information, send \$1.00 postage and handling to: PINNACLE RESEARCH, 11727 Mississippi Avenue, Suite J-714, Los Angeles, CA 90025.

I'VE BEEN IN Import/Export for many years. I see amateurs getting ripped off with courses, books, phony products, and unrealistic dreams. Let me tell you how it really is and how you can make money. Just send a dollar for my time. BARONBROOK PUBLISHING, Div. J-715, 90954 Worldway Center, Los Angeles, CA 90009.

211 MOST PROFITABLE small businesses you can start with little cash and make lots of money. 64 page catalog gives details on each and how you can get started. Send \$1.00 for a copy. American Entrepreneurs Association, 2311 Pontius Avenue, Suite J-716, Los Angeles, CA 90064.

Classified Adv. cont'd. on pg. 126







# WHEN WE ANNOUNCED THE COMMODORE 64 FOR \$595, OUR COMPETITORS SAID WE COULDN'T DO IT.

## THAT'S BECAUSE THEY COULDN'T DO IT.

The reason is that, unlike our competitors, we make our own IC chips. *Plus* all the parts of the computer they go into.

So Commodore can get more advanced computers to market sooner than anybody else. And we can get them there for a lot less money.

### WHAT PRICE POWER?

For your \$595,\* the Commodore 64™ gives you a built-in user memory of 64K. This is hundreds of dollars less than computers of comparable power.

Lest you think that the Commodore 64 is some stripped-down loss leader, a look at its available peripherals and interfaces will quickly convince you otherwise.

### SOFTWARE THAT WORKS HARD.

The supply of software for the Commodore 64 will be extensive. And with the optional plug-in Z80 microprocessor, the Commodore 64 can accommodate the enormous amount of software available in CP/M.®

Add in the number of programs available in BASIC and you'll find that there are virtually no applications, from word processing to spreadsheets, that the Commodore 64 can't handle with the greatest of ease.

### PERIPHERALS WITH VISION.

The Commodore 64 interfaces with all the peripherals you could want for total personal computing: disk drives, printers and a telephone modem that's about \$100, including a free hour's access to some of the more popular computer information services. Including Commodore's own Information Network for users.

### RUN YOUR BUSINESS BY DAY.

### SAVE THE EARTH BY NIGHT.

At the end of a business day, the Commodore 64 can go into your briefcase and ride home with you for an evening's fun and games.

Because of its superior video quality (320x200 pixel resolution, 16 available colors and 3D Sprite graphics), the Commodore 64 surpasses the best of the video game machines on the market. Yet, because it's such a powerful computer, it allows you to invent game programs that a game machine will never be able to play; as well as enjoy Commodore's own video game cartridges.

### ATTACK, DECAY, SUSTAIN, RELEASE.

If you're a musicologist, you already know what an ADSR (attack, decay, sustain, release) envelope is. If you're not, you can learn this and much more about music with the Commodore 64's music synthesizing features.

It's a full-scale compositional tool. Besides a programmable ADSR envelope generator, it has 3 voices (each with a 9-octave range) and 4 waveforms for truly sophisticated composition and playback—through your home audio system, if you

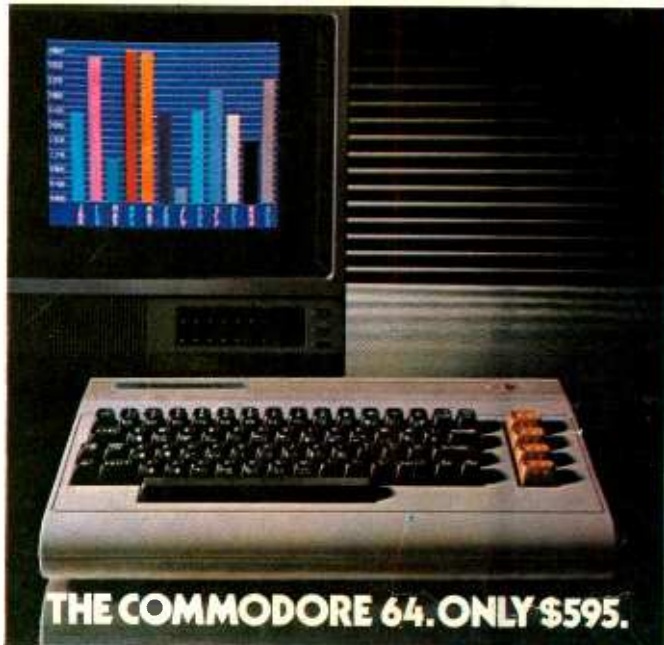

wish. It has sound quality you'll find only on separate, music-only synthesizers. And graphics and storage ability you won't find on any separate synthesizer.

### DON'T WAIT.

The predictable effect of advanced technology is that it produces less expensive, more capable products the longer you wait.

If you've been waiting for this to happen to personal computers, your wait is over.

See the Commodore 64 soon at your local Commodore Computer dealer and compare it with the best the competition has to offer.

You can bet that's what the competition will be doing.

Commodore Business Machines  
Personal Systems Division  
P.O. Box 500, Conshohocken, Pennsylvania 19428

Please send me more information on the Commodore 64™

Name \_\_\_\_\_ Title \_\_\_\_\_

Company \_\_\_\_\_

Address \_\_\_\_\_

City \_\_\_\_\_ State \_\_\_\_\_

Zip \_\_\_\_\_ Phone \_\_\_\_\_

 **commodore**  
COMPUTER

CE-1

\*Manufacturer's Suggested Retail Price\* July 1, 1982. Disk drives and printers are not included in prices. The 64's price may change without notice. CP/M® is a registered trademark of Digital Research, Inc.

CIRCLE NO. 29 ON FREE INFORMATION CARD