

Popular Electronics®

WORLD'S LARGEST SELLING ELECTRONICS MAGAZINE OCTOBER 1982/\$1.25

Video Accessories for VCRs & TV

Evaluating the Low-Cost VIC-20 Computer

How to Extend Test Meter Ranges

Communication Networks for Computers



Tests in this issue:

Toshiba TFL Video Camera
Denon DR-F7 Stereo Cassette Deck
BBC-Metrawatt Digital Multimeter



**Right away,
you can see a difference.**



Stop in a store near you. Take a look.
You'll be instantly taken with some of the features that make the IBM Personal Computer so different.

Like the non-glare screen — easy on the eyes during those number-crunching tasks like payroll and general ledger.

80 characters a line — with upper and lower case letters for a quick and easy read.

And the flexibility of a system that lets *you* move the components around at will.

(To get really comfortable, try the keyboard on your lap and put your feet up.)

Go ahead, compare.

As you progress from casual observer to comparison shopper, you'll want the inside story of the IBM Personal Computer.

Like user memory expandable up to 512KB. And 40KB of permanent memory. (Which not only includes the BASIC language, but diagnostic instructions that automatically check the system every time you turn it on.)

A 16-bit microprocessor that can improve speed and productivity.

A mix of crisp text and high-resolution color graphics on your own TV set — clearly helpful for creating charts to target forecasts and trends.

Or the 10 programmable function keys that let you bid goodbye to the tedium of repetitious tasks.

And the list goes on. Which is why we've included a box (at right) that tells all.

There's more than meets the eye.

Some of the best things about the IBM Personal Computer aren't part of the computer.

Like the instruction manuals that help you set up your system and teach you to use it with the greatest of ease.

IBM PERSONAL COMPUTER SPECIFICATIONS

User Memory 16K-512K bytes*	Display Screen High-resolution* 80 characters x 25 lines Upper and lower case Green phosphor screen*	Permanent Memory (ROM) 40K bytes*
Microprocessor 16-bit, 8088*		Color/Graphics Text mode: 16 colors*
Auxiliary Memory 2 optional internal diskette drives, 5¼", 160K bytes or 320K bytes per diskette	Operating Systems DOS, UCSD p-System, CP/M-86†	256 characters and symbols in ROM* Graphics mode: 4-color resolution: 320h x 200v*
Keyboard 83 keys, 6 ft. cord attaches to system unit*	Languages BASIC, Pascal, FORTRAN, MACRO Assembler, COBOL	Black & white resolution: 640h x 200v*
10 function keys* 10-key numeric pad Tactile feedback*	Printer Bidirectional* 80 characters/second 12 character styles, up to 132 characters/line* 9 x 9 character matrix*	Simultaneous graphics & text capability* Communications RS-232-C interface Asynchronous (start/stop) protocol Up to 9600 bits per second
Diagnostics Power-on self testing Parity checking*		

*ADVANCED FEATURES FOR PERSONAL COMPUTERS

And an expanding library of software programs that meet IBM's demanding specifications.

Programs for business. Education. The lab and the home. Programs that make the IBM Personal Computer *your* tool for modern times.

See for yourself.

The quality, power and performance of the IBM Personal Computer are what you'd expect from IBM. The price isn't.

So stop in and take a look.

Visit an authorized IBM Personal Computer dealer. For a store near you, (or for information from IBM about quantity purchases) call (800) 447-4700.

In Illinois, (800) 322-4400. In Alaska or Hawaii, (800) 447-0890.

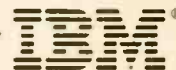

The IBM Personal Computer A tool for modern times

Popular Electronics

WORLD'S LARGEST-SELLING ELECTRONICS MAGAZINE

The Electronic World

COMMUNICATIONS NETWORKS FOR COMPUTERS/*Stan Veit* 51
How telephone lines and other systems transmit digital information.

Feature Articles

VIDEO ACCESSORIES/*Ivan Berger and Lancelot Braithwaite* 63
What's available, what they do and how to use them.

CIRCUIT ANALYSIS WITH YOUR TRS-80 COMPUTER/*Roy Babylon* 76
Five programs to simplify electronic design work.

Construction Articles

THIS IS YOUR COMPUTER SPEAKING, PART 2/*Randy Carlstrom* 43
Build a speech synthesizer for an S-100 bus computer.

INCREASE YOUR ANALOG METER'S RANGE/*John Bailey* 72
Adding the right shunt to your circuit will extend your measuring range.

PLUG-IN ACCESSORY UPGRADES POCKET SCANNERS/*Pat Johnstone* 75

Equipment Reviews

DENON MODEL DR-F7 CASSETTE DECK 20

TOSHIBA MODEL TK-1900 TTL VIDEO CAMERA 32

COMMODORE MODEL VIC-20 LOW-COST COMPUTER SYSTEM 37

BBC-METRAWATT/GOERZ MODEL MA 3D DIGITAL MULTIMETER 82

Columns

COMPUTER SOURCES/*L. Solomon & S. Veit* 40

COMPUTER BITS/*Stan Veit* 84
News from the Computer Shows.

PROGRAMMER'S NOTEBOOK/*Jim Keogh* 88
Keeping Score.

SOLID-STATE DEVELOPMENTS/*Forrest M. Mims* 90
The Microprocessor Enters Its Second Decade.

EXPERIMENTER'S CORNER/*Forrest M. Mims* 92
Experimenting With a Servomechanism.

PROJECT OF THE MONTH/*Forrest M. Mims* 98
Controller for Small DC Motors.

Departments

EDITORIAL/*Art Salsberg* 6
Meet Computers & Electronics.

LETTERS 9

NEW PRODUCTS 10

ELECTRONICS LIBRARY 97

NEW LITERATURE 106

OPERATION ASSIST 115

ADVERTISER'S INDEX 115

PERSONAL ELECTRONIC NEWS 116

COVER PHOTO BY JAY BRENNER

COPYRIGHT © 1982 BY ZIFF-DAVIS PUBLISHING COMPANY. All rights reserved. Popular Electronics (ISSN 0032-4485) October 1982, Volume 20, Number 10. Published monthly by Ziff-Davis Publishing Co., at One Park Ave., New York, NY 10016. Richard P. Frieze, President; Selwyn Taubman, Treasurer; Bertram A. Abrams, Secretary. One year subscription rate for U.S. and Possessions, \$15.97; Canada, \$20.97; all other countries, \$23.97 (cash orders only, payable in U.S. currency). Second Class Postage Paid at New York, N.Y. 10016 and at additional mailing offices. Authorized as second class mail by the Post Office Dept., Ottawa, Canada, and for payment of postage in cash. POPULAR ELECTRONICS including ELECTRONICS WORLD. Trade Mark Registered. Indexed in the Reader's Guide to Periodical Literature. Ziff-Davis also publishes Boating, Car and Driver, Cycle, Flying, Popular Photography, Skiing, Stereo Review, Electronic Experimenter's Handbook, and Tape Recording & Buying Guide. POSTMASTER: Send address changes to POPULAR ELECTRONICS, Circulation Dept. P.O. Box 2774, Boulder, CO 80302. Please allow at least eight weeks for change of address, enclosing, if possible, an address label from a recent issue. Permissions. Material in this publication may not be reproduced in any form without permission. Requests for permission should be directed to John Babcock, Rights and Permissions, Ziff-Davis Publishing Co., One Park Ave., New York, NY 10016.

Popular Electronics

JOE MESICS
Publisher

ARTHUR P. SALSBERG
Editorial Director

LESLIE SOLOMON
Technical Director

JOHN R. RIGGS
Managing Editor

EDWARD I. BUXBAUM
Art Director

JOSEPH DESPOSITO
Technical Editor

STANLEY VEIT
Computer Editor

DAVID M. WEBER
Features Editor

ANDRE DUZANT
Technical Illustrator

CARMEN ROBLES
Production Editor

JEFF NEWMAN
Editorial Assistant

Contributing Editors:

Walter Buchsbaum, Len Feldman,
 Glenn Hauser, Julian Hirsch
 Jim Keogh, Forrest Mims, Carl Warren

MARIE MAESTRI
Executive Assistant

Editorial and Executive Offices
 One Park Avenue
 New York, New York 10016
 212 725-3500

New York Office
 Advertising Director:
 Richard Govatski 212 725-7460

Sales:
 Tom Ballou 212 725-3578
 Ken Lipka 212 725-3580

Midwestern Office
 Suite 1400, 180 N. Michigan Ave.,
 Chicago, IL 60601 312 346-2600
 Robert Vanek

Western Office
 3460 Wilshire Blvd.
 Los Angeles, CA 90010 213 387-2100
 Sales: Ted Welch

Representation in Japan
 J.S. Yagi
 Iwai Trading Co., Ltd.
 603 Ginza Sky Heights Bldg.
 18-13, Ginza 7-Chome
 Tokyo, Japan 104

Ziff-Davis Publishing Company

Richard P. Frieze	President
Albert S. Traina	President, Consumer Magazine Division
Furman Hebb	Executive Vice President
Phillip T. Heffernan	Senior Vice Presidents
Sidney Holtz	
Edward D. Muhlfield	
Philip Sine	
Robert Bavier	Vice Presidents
Paul Chook	
Baird Davis	
George Morrissey	
Selwyn Taubman	Treasurer
Bertram A. Abrams	Secretary

Editorial correspondence: POPULAR ELECTRONICS, 1 Park Ave., New York, NY 10016. Editorial contributions must be accompanied by return postage and will be handled with reasonable care; however, publisher assumes no responsibility for return or safety of manuscripts, art work, or models submitted.

The publisher has no knowledge of any proprietary rights which will be violated by the making or using of any items disclosed in this issue.

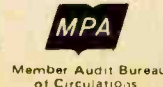

MAKE ONE SOUND INVESTMENT

The V15 Type V Phono Cartridge

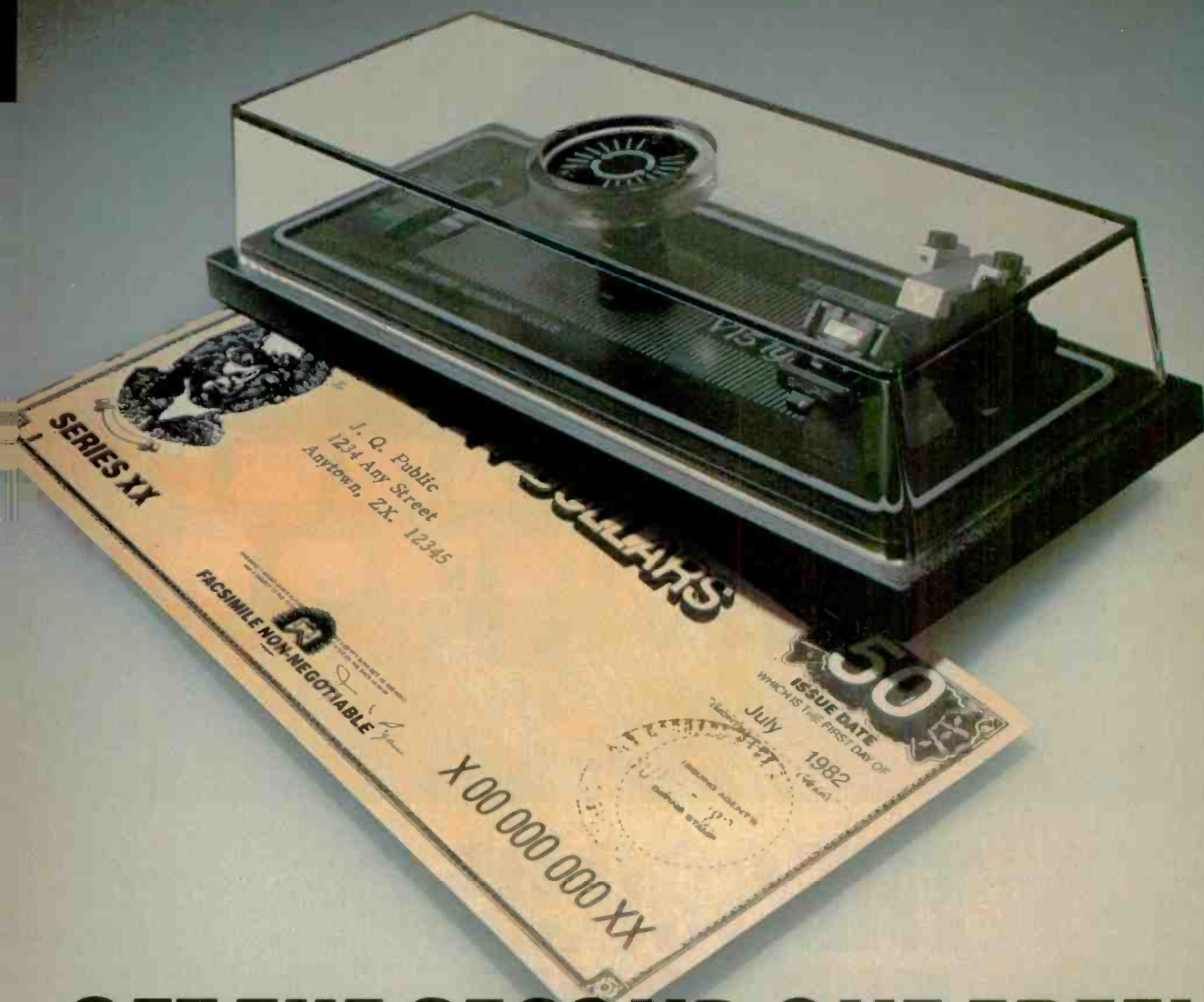

GET THE SECOND ONE FREE!

LIMITED TIME \$50* BOND BONUS

As A Special "Buy Now" Bonus, From September 15th Until December 31, 1982, You'll Receive A \$50* U.S. Savings Bond From Shure With Your Purchase Of A V15 Type V Phono Cartridge.

U.S. Technology triumphs again. Throughout the world, leading audio critics have lavished unequivocal praise on the Shure V15 Type V, saying "It may be safe to say that this cartridge's excellent tracking ability is *Number One* in the world" (*Swing Journal*, May 1982, Japan). "Without any doubt, *THE* top range absolutely universal cartridge." (*Hi-Fi Stereo*, June 1982, France). "...not only lives up to the claims made for it, but in virtually every respect outperforms the best cartridges we have previously tested." (*Stereo Review*, June 1982, U.S.A.)

The Type V is the world's most innovative, most precision-engineered, and complete phono cartridge system. It offers

unequaled trackability and ultra-flat frequency response, a result of the exclusive MICROWALL/Be™ Beryllium stylus shank's incredibly high stiffness-to-mass ratio. Among its many exclusive features, the Type V has the patented Dynamic Stabilizer/Destaticizer to overcome the major problems of record playback that cause pops, clicks, and mistracking.

Your investment in a V15 Type V will bring you a sophisticated array of important new construction features, performance capabilities, and high technology instrumentation.

It all adds up to a truly sound investment that will upgrade the performance of your entire playback system. Shure proves again that the world's finest phono cartridge technology continues to come from this U.S.A. plant in Evanston, IL. See your participating dealer for details.



For the name of the dealer nearest you, call:
800-323-6556. Ask for Dept. R15.
In Illinois: 800-942-6345. Ask for Dept. R15.

*Value at Maturity

SHURE®

Shure Brothers Inc., 222 Hartrey Ave. Evanston, IL 60204

CIRCLE NO. 54 ON FREE INFORMATION CARD

ZX81



Introducing the Sinclair ZX81.

If you're ever going to buy a personal computer, now is the time to do it.

The Sinclair ZX81 is the most powerful, yet easy-to-use computer ever offered for anywhere near the price:

only \$99.95* completely assembled.

Don't let the price fool you. The ZX81 has just about everything you could ask for in a personal computer.

A breakthrough in personal computers.

The ZX81 is a major advance over the original Sinclair ZX80 – the first personal computer to break the price barrier at \$200.

In fact, the ZX81's 8K extended BASIC offers features found only on computers costing two or three times as much.

Just look at what you get:

- Continuous display, including moving graphics

THE \$99.95 PERSONAL COMPUTER.

- Multi-dimensional string and numerical arrays
- Mathematical and scientific functions accurate to 8 decimal places
- Unique one-touch entry of key words like PRINT, RUN and LIST
- Automatic syntax error detection and easy editing
- Randomize function

useful for both games and serious applications

- 1K of memory expandable to 16K
- A comprehensive programming guide and operating manual

The ZX81 is also very convenient to use. It hooks up to any television set to produce a clear 32-column by 24-line display. It comes with a comprehensive programming guide and operating manual designed for both beginners and experienced computer users. And you can use a regular cassette recorder to store and recall programs by name.

Order at no risk.**

We'll give you 10 days to try out the ZX81. If you're not completely satisfied, just return it to Sinclair Research and we'll give you a full refund.

And if you have a problem with your ZX81, send it to Sinclair Research within 90 days and we'll repair or replace it at no charge.

Introducing the ZX81 kit.

If you really want to save money, and you enjoy building electronic kits, you can order the ZX81 in kit form for the incredible price of just \$79.95.* It's the same, full-featured computer, only you put it together yourself. We'll send complete, easy-to-follow instructions on how you can assemble your ZX81 in just a few hours. All you have to supply is the soldering iron.

A leader in microelectronics.

The ZX81 represents the latest technology in microelectronics. More than 10,000 are sold every week. In fact, the ZX81 is the fastest selling personal computer in the world.

We urge you to place your order for the ZX81 today.

To order.

To order, simply call toll free. Or use the coupon below. Remember, you can try it for 10 days at no risk.** The sooner you order, the sooner you can start enjoying your own computer.

Call toll free 800-543-3000.

Ask for operator #509. In Ohio call: 800-582-1364; in Canada call: 513-729-4300. Ask for operator #509. Phones open 24 hours a day, 7 days a week. Have your MasterCard or VISA ready.

These numbers are for orders only. If you just want information, please write: Sinclair Research Ltd., 2 Sinclair Plaza, Nashua, NH 03061.

*Plus shipping and handling. Price includes connectors for TV and cassette, AC adaptor, and FREE manual.
**Does not apply to ZX81 kits.

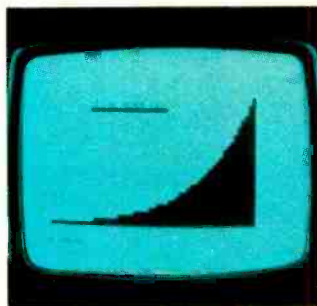

NEW SOFTWARE: Sinclair has published pre-recorded programs on cassettes for your ZX81. We're constantly coming out with new programs, so we'll send you our latest software catalog with your computer.



16K MEMORY MODULE: Like any powerful, full fledged computer, the ZX81 is expandable. Sinclair's 16K memory module plugs right onto the back of your ZX81. Cost is \$49.95, plus shipping and handling.

sinclair

To order call toll free: 800-543-3000

Ad Code	AOPEOS	Price*	Qty.	Amount
ZX81		\$99.95		
ZX81 Kit		79.95		
16K Memory Module		49.95		
Shipping and Handling		4.95		\$4.95
TOTAL				

MAIL TO: Sinclair Research Ltd.,
One Sinclair Plaza, Nashua, NH 03061.

Name _____

Address _____

City _____ State _____ Zip _____

*U.S. dollars





EDITORIAL

Meet Computers & Electronics

In the first issue of POPULAR ELECTRONICS, October 1954, editor-in-chief Oliver Reed introduced you to a new magazine concept, observing that it was devoted to the science of electronics at the "How it works," "How to do it," and "How to use it" level. Remarkably, this charter has not swerved over the years. What has changed, however, is the continually evolving editorial content that greets you each month with the newest twists and turns occurring in electronics... new devices, new circuit applications, new equipment.

As the lineal editorial descendent of Olly, I have an equally important announcement to make as we enter our 29th year: **THIS IS THE LAST ISSUE OF POPULAR ELECTRONICS!**

Yes, it's true! Next month you will see us with a new name—**COMPUTERS & ELECTRONICS**. This title more appropriately describes who we are in an age when computers are certain to command more and more of your active interests. I'll be celebrating this change with you in November and succeeding issues by preparing a large number of *extra* editorial pages devoted to the fast-paced computer field. Thus, you'll be getting more for your money while still enjoying all the other areas of electronics that give you so much learning and working pleasure: construction projects, audio, video, communications, test instruments, and the latest in applied electronics technology.

Here's an example of the exciting computer editorial lineup awaiting you next month—features we could not have ordinarily included without extra pages!

- A modestly priced computer board kit that generates eye-boggling shades of color and black-and-white video.
- Pitting computer clones against the original.
- Examining point-graphics software packages.
- Comparing competing disk drives.
- A hard look at Motorola's popular MC68000 16-bit microprocessor.

Add to the foregoing a host of informative columns: "Les Solomon on Hard-

ware"; "Stan Veit on Software"; a Q & A section to respond to readers' hardware and software problems; "Computer Bits"; and more. I know you'll like these columns because we're not only turning your favorite writers on to computers, we're also turning them loose. You'll be reading about new computer hardware and software, written with a refreshing candor you'll appreciate... by writers who have deep experience in the small-computer field and who sharpen their computer knowledge daily.

Our technical director, Les Solomon, for example, is considered by many to be the granddaddy of personal computers, while Stan Veit, a long-time technical writer and computer instructor, was one of the pioneer computer store owners in the country. Forrest Mims, a major author of computer and electronics books, will lead the way in the computer devices area in "Solid State" (as well as continuing to write "Experimenter's Corner" and "Project of the Month"). And Carl Warren will continue to share his special insights to computer equipment as he travels across the country visiting manufacturers.

Of course, you'll still get Julian Hirsch's reliable audio product reviews, only there'll be more than before, served up with a welcome forthrightness. The same applies to test reports by Dr. Walter Buchsbaum (Sc.D.) in the video area.

Some of you among our 400,000+ readers might bemoan the name change for sentimental reasons. You'll soon recognize, though, that this is a natural evolution that complements what's happening in electronics today.

When I joined POPULAR ELECTRONICS some ten years ago, I was determined to carve out a new-development path for the magazine. Even at that time, I recognized that success in this direction would make the magazine's name an anachronism because our contents would be more sophisticated than before and attract a more knowledgeable and deeply inquisitive reader who wants to be at the leading edge of practical electronics. Not

"popular" at all in terms of mass appeal.

This evolution started in our August 1973 issue with plans on how to make a low-cost sweep function generator. After a series of exciting "breakthrough" articles, I featured a two-IC \$39.50 professional ASCII keyboard and encoder on the April 1974 cover. Here was the springboard for a brand new field for our readers, I determined—computers! A poor man's version of Data General's "Nova," I thought at the time.

Initiating a search for a powerful, modestly priced computer kit that would match commercially available models selling at rather high prices (with my technical editor, Les Solomon, as point man) led to another important change. To accommodate the larger schematics we'd be required to print, our 6" by 9" page size was expanded to an 8½" by 11" format in the August 1974 issue.

Just in time, too, because our cover story for January 1975 featured the \$397 Altair computer kit, the shot that reverberated 'round the world, acknowledged to have spearheaded the beginning of a new industry—personal computers. This publishing triumph was followed by a series of remarkable articles: the first low-cost modem; the first small-computer color graphics system; the first integrated computer system; the first widely used tiny computer (the "ELF"); and so on.

For more of the foregoing electronics excitement and challenge, follow **COMPUTERS & ELECTRONICS** as it travels a new bend in the road, supported by more pages and a larger editorial staff. I'm confident you'll enjoy reading it as much as my staff and I enjoy putting it together.

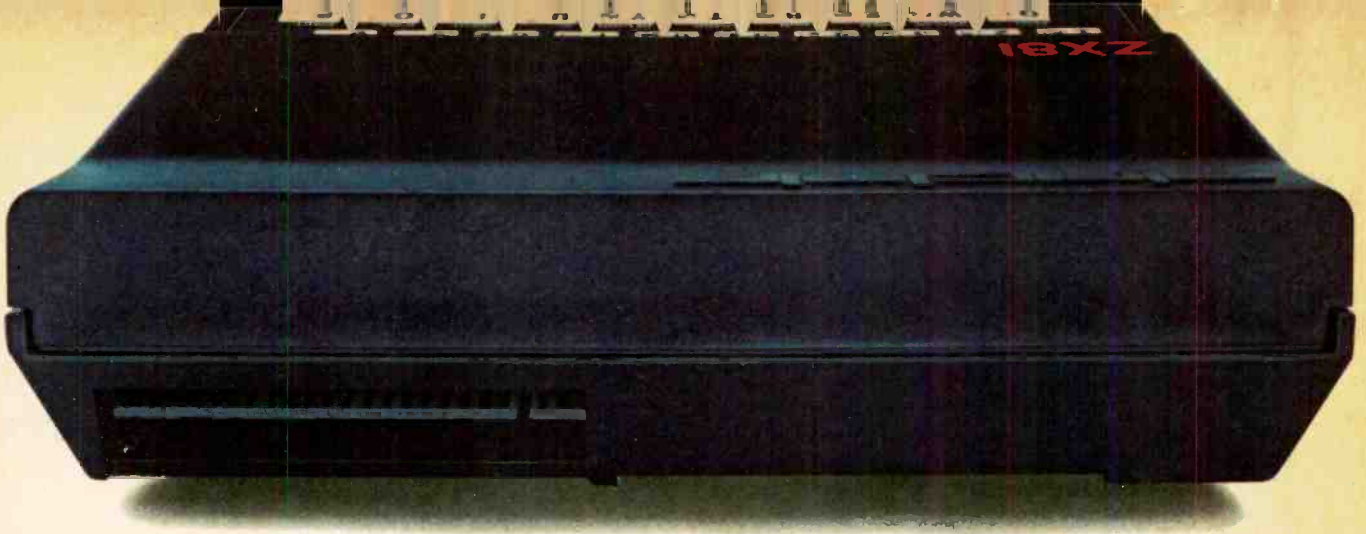

BEHIND EVERY GOOD SINCLAIR IS A MEMOPAK

If you own a Timex-Sinclair 1000 or ZX81 computer, you should have a Memopak behind it. From increased memory to high resolution graphics, Memotech has a Memopak to boost your system's capabilities. Every Memopak peripheral comes in a black anodised aluminum case and is designed to fit together in "piggy back" fashion to enable you to continue to add on and still keep an integrated system look.

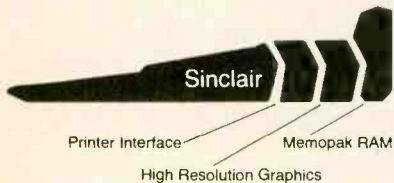

Order at no risk

All Memotech products carry our 10-day money back guarantee. If you're not completely satisfied, return it in ten days and we will give you a full refund. And every Memotech product comes with a six month warranty. Should anything be defective with your Memopak, return it to us and we will repair or replace it free of charge. Dealer inquiries welcome. To order any Memotech product call our toll-free number **800/662-0949** or use the order coupon.

MEMOTECH
CORPORATION

7550 West Yale Avenue
Denver, Colorado 80227
(303) 986-1516
TWX 910-320-2917



Memopak 64K RAM The 64K RAM extends the memory of your Sinclair by 56K to a full 64K. It is directly addressable, user transparent, is neither switched nor paged and accepts such basic command as 10 DIM A (9000). The Memopak 64K turns your Sinclair into a powerful computer suitable for business, recreational and educational use. No additional power supply is required.

Memopak 32K RAM The 32K RAM Memopak offers your Sinclair a full 32K of directly addressable RAM. Like the 64K Memopak, it is neither switched nor paged and enables you to execute sophisticated programs and store large data bases. It is also fully compatible with Sinclair's or Memotech's 16K RAM to give you a full 48K of RAM.

Memopak 16K RAM The Memopak 16K RAM provides an economical way to increase the capabilities of your Sinclair. And at the same time, it enables you to continue to add on other features with its "piggy back" connectors. It is compatible with the Sinclair 16K or a second Memopak 16K or Memopak 32K to give 32K or 48K of RAM respectively.

Memopak High Resolution Graphics The Memopak HRG contains a 2K EPROM monitor and is fully programmable for high resolution graphics. The HRG provides for up to 192 by 248 pixel resolution.

Memopak Printer Interface The memotech centronics parallel or RS232 printer interface packs enable your Sinclair to use a wide range of compatible printers (major manufacturers' printers available through Memotech at significant savings). The resident software in the units gives the ASCII set of characters. Both Memopak printer interfaces provide lower case character capabilities. The RS232 Interface is also compatible with modems.

New products coming soon Memotech will soon be introducing four new Sinclair compatible products: a high quality, direct connection keyboard, a digitizing tablet, a 16K EPROM and a disk drive. Watch for our future advertisements.

Mail to: Memotech Corporation, 7550 West Yale Ave., Denver, CO 80227			
Code: PE-10	*Price	Qty	Total
64K RAM	\$179.95		
32K RAM	109.95		
16K RAM	59.95		
Centronics Parallel Printer Interface	104.95		
RS232 Printer Interface	139.95		
High Resolution Graphics	144.95		
Shipping and handling	4.95		\$4.95
* All prices quoted in U.S. dollars		Tax**	
** Colorado residents please add sales tax		Total	
<input type="checkbox"/> Check <input type="checkbox"/> MasterCard <input type="checkbox"/> Visa			
Account No.			Exp.
Name			
Address			
City	State	Zip	

EXPERIENCED MILITARY HELP WANTED.

**Part-time only.
Great fringe benefits.**

If you've served in the military, there's a tremendous opportunity waiting for you in the Air National Guard.

The skilled positions we're looking to fill are part-time jobs. Just two days a month plus two weeks a year. And, today when extra income really comes in handy, you'll be glad to know that we'll pay you well for your time. In fact, you'll probably start at your old rank.

You'll also regain many of the military benefits you previously enjoyed in the military. Low-cost life insurance, base exchange privileges, a retirement plan and more.

Reach new heights in the Air Guard.

In the Air Guard, you'll make new friends and take on new responsibilities while you put your prior military skills back to work. Back to work for you, your country, your state and your home town. You'll be doing something really important. You'll be guarding America's skies.

If you think it's time you put your military experience back to work for you, call the Air National Guard, toll-free, today. **800/638-0936**.* And find out how you can reach new heights in the Air National Guard.

*(In Maryland call 301/981-6716. Outside the continental U.S. consult your local phone directory.)

**We Guard
America's Skies.**



CIRCLE NO. 64 ON FREE INFORMATION CARD

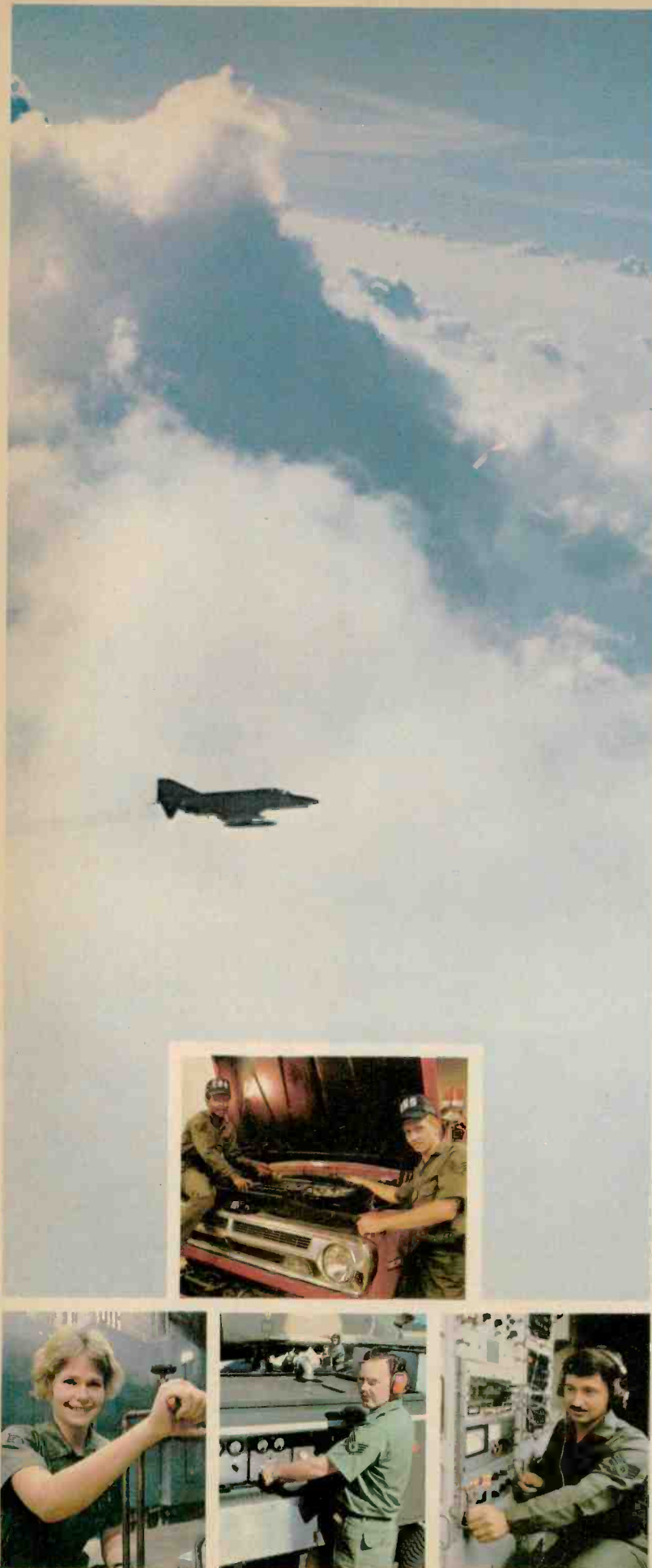

LETTERS

forward-bias base current from base to emitter but rather a reverse current of 2 μ A from emitter to base. Thus the transistor is cut off. Collector voltage should be 12 V, not 6 V as was given; and emitter voltage should be 0 V instead of 1.6 V.—Bruce Reed, Springfield, MO.

Your analysis of the circuit is incorrect. Note that the circuit can be redrawn as shown in Fig. A. It can now be simplified by taking the Thevenin equivalent of the circuit to the left of the transistor (Fig. B).

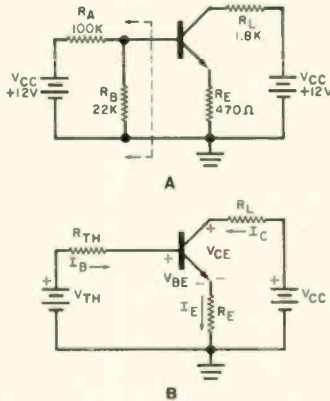

The Thevenin voltage is $V_{CC}(R_2/R_1 + R_2)$, while the Thevenin resistance is $R_1 R_2 / (R_1 + R_2)$. You are now left with a circuit that has two loops. By using Kirchhoff's voltage law, you can now solve for I_B —Ed.

Analyzing Transistor Circuit

I was trying to analyze the transistor troubleshooting quiz (April, 1982) when I suddenly realized it was impossible. Resistor RB drops 2.2 V and draws 100 μ A. Resistor RA drops 9.8 V and draws 98 μ A (see diagram). This means there is no

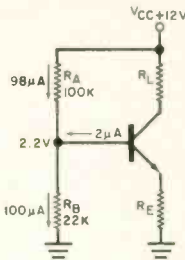

Watch Out for Side Effects

The application of energy saving devices in the home requires an analysis of possible side effects as well as savings in first costs and fuel. For instance, in "New Vacation Thermostat, Set to Just Above Freezing, Saves Heating Costs" (August 1982), the author describes temperature settings that might drop the temperature to 35° or 40°F—in a home that was formerly never below 65°. A few examples of side effects that might occur are: killing of house plants; cracking of walls and ceilings; aquarium heaters not able to keep the water warm enough; and possible dropping of temperatures even further due to temporary power failures. The possible savings of utilizing such a device could easily be offset by any one of these effects.—Earl C. Haag, York, PA.

Out of Tune

In "A new, Effective Anti-Burglary System" (June 1982), C5 and C6 should be 0.0022 μ F; C23 should be 0.05 μ F; a 22- μ F, 50-V capacitor (C25) should be added between pin 13 of IC2 and ground; IC2 and IC3 should be listed as 556; Q7 should be listed as a type 2N6121; R27 should not be listed under 1 kilohm; R37 should be shown on the pc layout between the base of Q5 and ground; D13 should be shown between D9 and ground; and the capacitor labelled Q1 in Fig. 4 should be C21.

We accept VISA, MC, C.O.D., CHECK or M.O.

FIRST QUALITY COMPONENTS - NOT MAIL ORDER "SECONDS"

Min order \$10.00 - add 5% Shpg and \$1.00 Ins

ARIES ZERO INSERTION FORCE SOCKETS

cam actuated, true zero insertion - tin plated solder tail pins - capable of being plugged into dip sockets, including wire wrap

Stock No	No Pins	1-24	25-50
11055	24	\$ 4.35	\$ 3.90
11056	28	4.50	4.05
11057	40	5.95	5.35
11058	64	10.50	9.45

RESISTOR ASSORTMENT

82508 - 700 pcs. 1/ each below assort: **\$22.50**

Stock No. 82501 10 ea. of 10-12-15-18-22-27-33-39-47-56 OHM \$3.95 each for any assortment

Stock No. 83502 10 ea. of 68-82-100-120-150-180-220-270-330-390 OHM

Stock No. 82503 10 ea. of 470-560-680-820-1K-1.2K-1.5K-1.8K-2.2K-2.7 OHM

Stock No. 82504 10 ea. of 3.3K-3.9K-4.7K-5.6K-6.8K-8.2K-10K-12K-15K-18K OHM

Stock No. 82505 10 ea. of 22K-27K-33K-39K-47K-56K-68K-82K-100K-120K OHM

Stock No. 82506 10 ea. of 150K-180K-220K-270K-330K-390K-470K-560K-680K-820K OHM

Stock No. 82507 10 ea. of 1M-1.2M-1.5M-1.8M-2.2M-2.7M-3.3M-3.9M-4.7M-5.6M OHM

WILD ROVER

Touch switch capsule. Operating motion is .005" without the use of a levered arm. Extremely fast on and off with low noise. Normally operated 115 VAC, 1.5 amp-30 million resistance - 615 radius by 160 thick.

Stock No	1	10	25
12098	\$1.28	\$1.12	\$.95

60/40 ROSIN CORE SOLDER

Stock No	Dia	Length (feet)	Weight (oz.)	Price
50075	.062	9	1.5	\$3.28
50076	.062	25	4	4.36
50077	.062	50	8	6.02
50078	.032	33	1.5	4.08
50079	.032	88.5	4	5.16
50080	.032	175	8	6.82

TI WIRE WRAP SOCKETS

Tin plated phosphor bronze contact - 3 wrap

Stock No.	No Pins	1-24	25-100
11301	8	\$ 4.59	.40 \$.36
11302	14	.68	.59
11303	18	.72	.64
11304	18	.82	.73
11305	20	1.11	.99
11306	22	1.26	1.12
11307	24	1.41	1.25
11308	28	1.71	1.52
11309	40	2.31	2.05

TI LOW PROFILE SOCKETS

Tin plated phosphor bronze contact pins with gas tight seal

Stock No.	No Pins	1-24	25-100
11201	8	\$1.5	\$1.3
11202	14	.16	.15
11203	18	.21	.18
11204	18	.24	.21
11205	20	.27	.24
11206	22	.30	.26
11207	24	.33	.30
11208	28	.38	.34
11209	40	.53	.45

ELPAC POWER SUPPLIES - DC/DC CONVERTERS

SINTEC Stock No.	ELPAC Part No.	Input Voltage (VDC)	Output Voltage (VDC)	Output Current (mA)	Dimensions (HxWxD) in inches	Price
13825	CB3801	3.0-7.0	12.0-6	0.25	.48x.51x.30	\$ 7.95
13826	CB3811	3.0-7.0	12.0-6	0.75	.48x.51x.30	7.95
13827	CB3802	3.0-7.0	15.0-7	0.20	.48x.51x.30	7.95
13828	CB3812	3.0-7.0	15.0-7	0.20	.48x.51x.30	7.95
13829	CB3804	3.0-7.0	28.0-7	0.10	.48x.51x.30	7.95
13830	CB3814	3.0-7.0	28.0-7	0.10	.48x.51x.30	7.95

1.5 W TYPE

Stock No.	CL3801 <th>4.0-7.0</th> <th>12.0-6</th> <th>125</th> <th>.85x1.1x2.17</th> <th>58.95</th>	4.0-7.0	12.0-6	125	.85x1.1x2.17	58.95
13832	CL3811	4.0-7.0	12.0-6 <td>125 <th>.85x1.1x2.17</th> <th>58.95</th> </td>	125 <th>.85x1.1x2.17</th> <th>58.95</th>	.85x1.1x2.17	58.95
13833	CL3802	4.0-7.0 <td>15.0-7 <td>100 <th>.85x1.1x2.17</th> <th>58.95</th> </td></td>	15.0-7 <td>100 <th>.85x1.1x2.17</th> <th>58.95</th> </td>	100 <th>.85x1.1x2.17</th> <th>58.95</th>	.85x1.1x2.17	58.95
13834	CL3812	4.0-7.0 <td>15.0-7 <td>100 <th>.85x1.1x2.17</th> <th>58.95</th> </td></td>	15.0-7 <td>100 <th>.85x1.1x2.17</th> <th>58.95</th> </td>	100 <th>.85x1.1x2.17</th> <th>58.95</th>	.85x1.1x2.17	58.95
13835	CL3804	4.0-7.0 <td>28.0-7 <td>50 <th>.85x1.1x2.17</th> <th>58.95</th> </td></td>	28.0-7 <td>50 <th>.85x1.1x2.17</th> <th>58.95</th> </td>	50 <th>.85x1.1x2.17</th> <th>58.95</th>	.85x1.1x2.17	58.95
13838	CL3814	4.0-7.0 <td>28.0-7 <td>50 <th>.85x1.1x2.17</th> <th>58.95</th> </td></td>	28.0-7 <td>50 <th>.85x1.1x2.17</th> <th>58.95</th> </td>	50 <th>.85x1.1x2.17</th> <th>58.95</th>	.85x1.1x2.17	58.95

13825-1 DATA SHEET FOR DC/DC CONVERTERS \$ 25

TEACHERS! STUDENTS!

Send for free flyer on Electronic Teaching Aid Kits.

Prices start at **\$4.95** each

kits come complete with all components. P.C. board and learn-as-you-go instruction manual.

MODUTEC

Miniclamp AC Volt-Ammeter allows singling one conductor out of many without disarrangement.

Stock No. AC Amperes Price

13730	0-25A	\$39.50
13731	0-50A	39.50
13732	0-100A	39.50

Accessory Line Splitter allows last readings of AC power consumption of plug in equipment without separation of leads.

Stock No. 13727 **\$9.95**

ELPAC POWER SUPPLIES - SOLV SERIES FULLY REGULATED

SINTEC Stock No.	ELPAC Part No.	Output Voltage	Output Current Rating	Dimensions (HxWxD) in inches	OVP	Price
13802	SOLV15-5	5	3.0A	4.7/18x8.2	Fixed included	\$39.95
13803	SOLV18-12	12	1.5A	4.7/18x8.2	Fixed included	39.95
13804	SOLV18-15	15	1.2A	4.7/18x8.2	Fixed included	39.95
13808	SOLV18-24	24	0.75A	4.7/18x8.2	Fixed included	39.95
13809	SOLV30-5	5	6.0A	5.5/8x7.8x3.316	OVP-A	59.95
13809	SOLV30-12	12	4.0A	5.5/8x7.8x3.316	OVP-A	59.95
13810	SOLV30-18	15	3.3A	5.5/8x7.8x3.316	OVP-A	58.95
13812	SOLV30-24	24	2.0A	5.5/8x7.8x3.316	OVP-A	59.95

13802-1 Data Sheet for SOLV Series \$ 25

PIN FORMING TOOL

puts IC's on their true row to row spacing. One side is for .300 centers, Flip tool over for devices on .600 centers. Puff device in tool and squeeze.

ONE TOOL DOES 8 THRU 40 PINS!

Stock No. 11059 **\$12.95**

POCKET SIZED BATTERY TESTER

for all types of small batteries from 1.35v to 4.5v

Stock No. 13733 **\$13.95**

VOLT-ICATOR

automotive diagnostic meter plugs into lighter socket and indicates battery condition and charging rates.

Stock No. 13736 **\$12.95**

AC VOLTAGE TESTER

plugs into any 110v service receptacle to check time voltage over 50-150 VAC

Stock No. 13735 **\$9.95**

VOM-MULTITESTER

versatile Volt-Ohm-Milliammeter in small package

Stock No. 13729 **\$13.95**

HUNTER TOOLS

8 Blades, sizes .050, 1/16", 5/16", 3/32", 7/64", 1/8", 9/64", 5/32"

Stock No. 51002 **\$3.45**

Nutdriver Kit

7 most popular sizes - 3/16", 7/32", 1/4", 9/32", 5/16", 11/32", 3/8"

Stock No. 51001 **\$21.95**

THE PIKE

5 in 1 Tool

CRIMPS #10 - #24 wire STRIPS solid #12-22 and stranded #14-24

SCREW CUTTER for 6 most common screw sizes

CUTTER and PLIERS

Stock No. 51005 **\$12.95**

SINTEC CO.

Drawer Q Milford NJ 08848-9990



TOLL 800-526-5960 FREE in NJ (201) 996-4093

Send for Free Catalog over 1100 parts

NEW PRODUCTS

Additional information on new products covered in this section is available from the manufacturers. Either circle the item's code number on the Free Information Card or write to the manufacturer at the address given.

High-Resolution Color Monitor



Designed with an RGB video input and a commercial grade CRT, the new portable 13" Color III monitor from Amdek is reported to provide high-resolution graphics (260 H x 300 V; 80 x 24 characters) for Apple II and Apple III personal computers. The interface between the computer and monitor is effected by what Amdek calls a Digital Video Multiplexor (DVM) with four discrete channels: one for existing Apple text, two for graphics (low and high resolution, respectively), and another for a supplemental 80-character/line video text board. The DVM is also color programmable, allowing the red, blue, and green signals to be selectively turned on or off by the Apple's software. Display colors include yellow, cyan, magenta, and white (in addition to red, green, and blue). User controls on the monitor are ON/OFF, VOLUME UP/DOWN, BRIGHTNESS, CONTRAST, and VERTICAL HOLD. Dimensions are 17" W x 14½" H x 15" D. \$569.

CIRCLE NO. 91 ON FREE INFORMATION CARD

Programmable Turntable

The new CP-1028R direct-drive automatic single-play turntable from Onkyo permits up to eight selections to be programmed in any order. An optoelectronic sensor detects record size and counts the spaces between the bands to select a particular musical piece. A repeat function permits the playing of any one piece indefinitely. The turntable has front panel, soft-touch controls, and a digital display for the automatic programming mode. It uses an electronic servo-con-



trolled brushless dc motor to drive the 12¼" aluminum die-cast platter. Speed is adjustable ±3% (aided by a LED that shows red for slow or fast, green for correct speed). Wow and flutter are rated at 0.028%. Wrms and S/N is given as 72 dB. The tonearm is made of static-balanced black anodized aluminum. The cartridge is a V-magnet type (Model OCH55V) with optical sensing. Frequency response is 18 to 25,000 Hz; output voltage is 4 mV; and tracking force is specified at 2g with a 0.6 mil round diamond stylus. Size is 16½" W x 5¾" H x 14¾" D. \$260.

CIRCLE NO. 92 ON FREE INFORMATION CARD

Power Supply for Digital Circuits

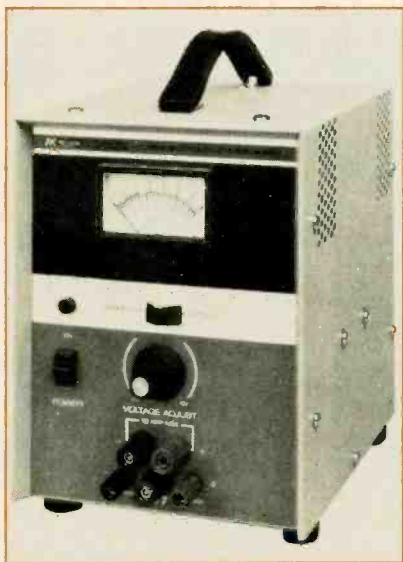

The B&K Precision Model 1654 power supply, designed to work with digital circuits, provides a continuously variable 2-to-6-volt output, adjusted by a vernier control. The unit is reported to be able to sense the voltage through a load and compensate accordingly if the potential drops below a given threshold (the 1654 has a reserve power rated at 10 A max.). A convection cooling system is said to permit operation at ambient temperatures up to 40°C. Output connections are flexible—either terminal can be referenced to an external voltage or connected to a chassis or earth ground. For very high current requirements, two supplies can be paralleled. \$395.

CIRCLE NO. 93 ON FREE INFORMATION CARD

Portable Data Terminal

Radio Shack has entered the portable terminal market with its new PT-210. Designed for applications where hard copy from a computer or videotex service is needed, the terminal incorporates a ASCII typewriter keyboard, thermal printer, and a 110/300 baud (Bell 103A compatible) acoustic telephone coupler. The keyboard generates a total of 99 codes, including 67 printable characters, 32 terminal control characters, and offers a switch-selectable digital keypad. It operates in half- and full-duplex modes, and at odd, even, or no parity. The non-impact thermal printer uses a 35-element (5 x 7) matrix and has variable contrast control. Seventy-one characters are printable, with lower-case letters automatically printed as their upper-case equivalents. Each 8" line



can include up to 80 characters, and carriage return is automatic at the 81 column of any line. Printing speed is 50 cps, with six lines per vertical inch. Indicators include a ¼-s tone bell, a power-on lamp, a carrier-detect lamp, and a character error-detect lamp. An optional plug-in RS232C Interface Module is said to facilitate the use of the terminal as a "front end" (to a computer or peripheral) dumb terminal and/or printer. Dimensions of the PT-210 are 15½" x 14½" x 5"; weight is 15 lb with a 100' roll of 8½"-wide thermal paper installed. Cost is \$995; the Interface Module (76-1002) is \$70.

CIRCLE NO. 94 ON FREE INFORMATION CARD

Quartz-Synthesizer Receiver



The amplifier section of Sansui's Z-5000 Quartz Synthesizer Compu-Receiver is rated at 70 W/ch into 8 ohms, with a frequency response from 20 to 20,000 Hz at 0.007% THD. S/N is given as 100 dB. The tuner section uses PLL quartz digital synthesizer tuning, giving a rated S/N of 74 dB with a THD of 0.2%. Sensitivity is 10.8 dBf. There are 16 station presets (8 AM/8 FM) with station scanning, a choice of auto or manual tuning, a digital fluorescent frequency display, and a LED peak power meter. The Z-5000 provides front panel selection for two speaker pairs, two tape monitor circuits with dub-

Introducing the first no crystal hand-held scanner. The Bearcat® 100.

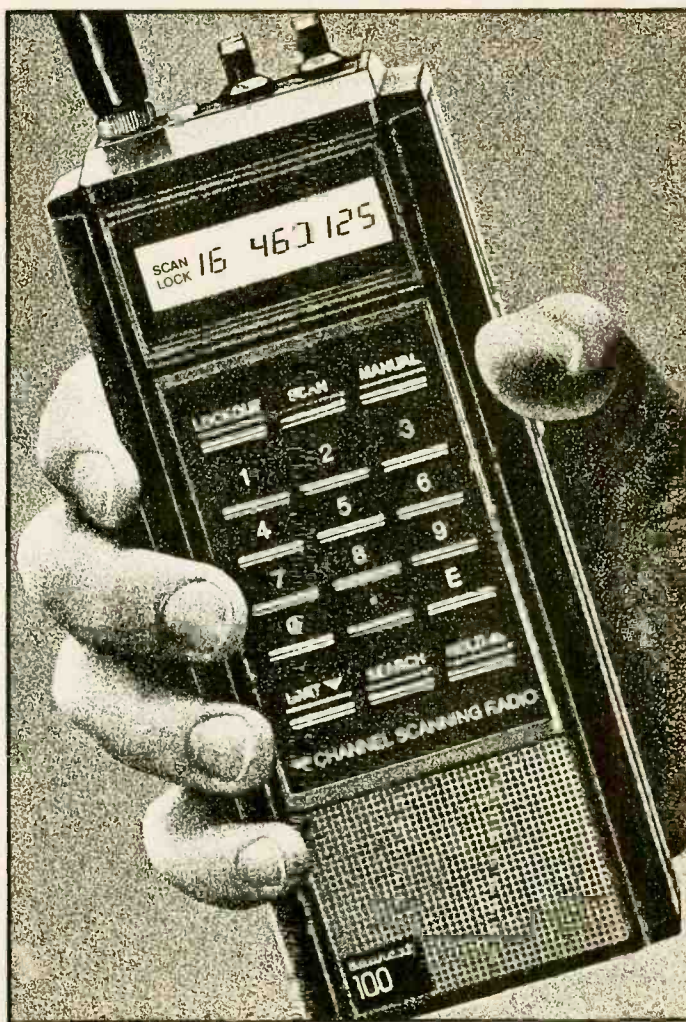

Now you can have the one scanner you've always wanted—a no crystal, fully synthesized hand-held scanner. The incredible, new, Bearcat 100.

Push button programming.

The new Bearcat 100 works just like the full size, no crystal Bearcat Scanners. Push button controls tune in all police calls, fire calls, weather warnings, and emergency information broadcasts, the split second they happen. Automatically.

All the features you want.

16 channels for storing

frequencies. 8 band coverage—including high, low, UHF and "T" public service bands; both the 70 cm and 2 meter amateur bands; plus, for the first time ever, both the military and federal government land mobile bands. Both automatic and manual search, lockout, scan delay, direct

channel access. Even a liquid crystal display. Flexible antenna, earphone, AC adapter/battery charger and carry case are included.

Your Bearcat Dealer wants to hand you an earful.

See your Bearcat Dealer now for a demonstration of the amazing, new Bearcat 100. Get complete information about the world's one and only hand-held, no crystal scanner.

BEARCAT® SCANNERS

Electra Electra Company
Division of Masco Corp. of Indiana
300 East County Line Road
Cumberland, Indiana 46229
International Business Office
Suite 102, 1828 Swift
North Kansas City, Missouri 64116

Protect Sight and Sound

Discwasher® Video Head Cleaners are designed to provide routine head cleaning maintenance for both VHS and BETA format video cassette machines. Unlike many cleaners, the Discwasher Video Head Cleaner cares for audio and sync heads as well as the video heads of all machines.

PROVEN EFFECTIVE

Scientific laboratory tests show Discwasher's special nonabrasive fabric

grid is successful in removing contamination from the video heads as well as the audio heads, resulting in both improved picture resolution and clearer sound.

PROVEN SAFE

After repeated use, Discwasher Video Head Cleaners have proven to be nonabrasive and totally safe to delicate video heads. Use it with total confidence.



discwasher®

1407 North Providence Road
P.O. Box 6021
Columbia, Missouri 65205 USA

A DIVISION OF JENSEN
an ESMARK Company

CIRCLE NO. 10 ON FREE INFORMATION CARD

new products

bing capability, and microphone mixing. The frequency display converts to a quartz clock (when the appropriate button is pushed) with a built-in 3-memory program timer. \$500.

CIRCLE NO. 95 ON FREE INFORMATION CARD

Hand-Held Solder Dispenser

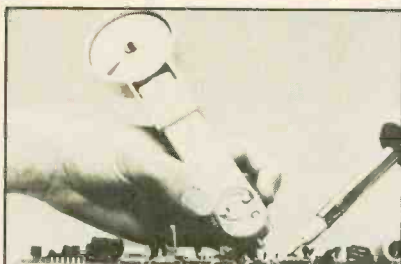

A solder dispenser said to increase soldering productivity by as much as 30% has been introduced by the Granite Corporation. Named "Speedy Feeder" (Model SD-1), it feeds out wire solder when the control wheel is turned. According to Granite, the solder can be dispensed faster and more continuously than with the fingers. An optional solder magazine that clips on the end of the dispenser is also available. It holds 60 feet of 22 SWG solder, and can accommodate solder widths up to 14 SWG. \$7.50; solder magazine (Model SM-1) is \$2.50. Address: Granite Corp., 24200 Burbank Blvd., Woodland Hills, CA 91367.

Koss Floor-Standing Loudspeaker



The Model 110 is a three-way, four-driver speaker system with dual tweeters. It has a rated frequency response of 20 to 30,000 Hz; an impedance of 8 ohms; a minimum power requirement of 10 W/ch; and a maximum power-handling capability of 100 W. The 110's vented driver system features a 10" woofer, 1 3/4" midtweeter, and two 1 1/4" tweeters. Dimensions of the walnut-grain vinyl cabinet are 23" H x 14" W x 10 1/4" D. Weight is 18.5 lb. \$150 each.

CIRCLE NO. 96 ON FREE INFORMATION CARD

8/16-Bit Microcomputer

Vector Graphic has introduced a new small-business and professional microcomputer that uses both Z80 8-bit and 8088 16-bit microprocessors. Called the Vector 4, it of-



fers a choice of operating systems, including CP/M, MS-DOS, and Oasis. The Vector 4's main memory (128K using 64K RAM chips, expandable to 256K) is time-shared between the CPU and the video display controller, allowing the screen memory to be moved anywhere in the main memory. (Access to the entire memory is reported to be possible in increments as small as 2K.) High-resolution graphics are provided by a 640H x 312V pixel display. Alphanumeric characters are displayed using a high-density matrix of 16H x 13V dots per character cell. Display of charts, graphs, and drawings is claimed to be enhanced by four levels of gray scale with 320 x 132 pixels of resolution (or by 16 levels with 160 x 312 pixels). The Vector 4 also generates standard RGB signals to drive a color monitor, while its own CRT uses a high-contrast green phosphor screen. Parallel interfaces for Centronics, Qume, and NEC printers are provided along with RS232 serial printer and modem interfaces. Features include a programmable tone generator with speaker and a detached keyboard that has a dedicated microprocessor, 15 programmable function keys, cursor control keys, and a 10-key numeric pad. The Vector 4 uses a single-board microprocessor, but also has three S-100 card slots for adding peripherals. The unit is available in two models: the Model 4/20 with dual floppy-disk drive and a 630K-byte capacity on each 5 1/4" disk, and the 4/30 with a single 630K-byte floppy disk drive, and a Winchester hard disk with 5M-byte capacity. In addition to CP/M, standard Vector 4 software includes Microsoft Basic 80, SCOPE program editor, RAID program debugger, and ZSM assembler. The 4/20 is \$4495; the 4/30 is \$5995.

CIRCLE NO. 97 ON FREE INFORMATION CARD

A/D Hybrid Tuner



JVC's T-K20(L) quartz-locked digital synthesizer AM/FM tuner features an analog dial, but employs digital circuitry to tune in stations. An up/down button raises or lowers the tuned frequency in predetermined steps for manual tuning or, in the automatic mode, tunes to the next station up or down

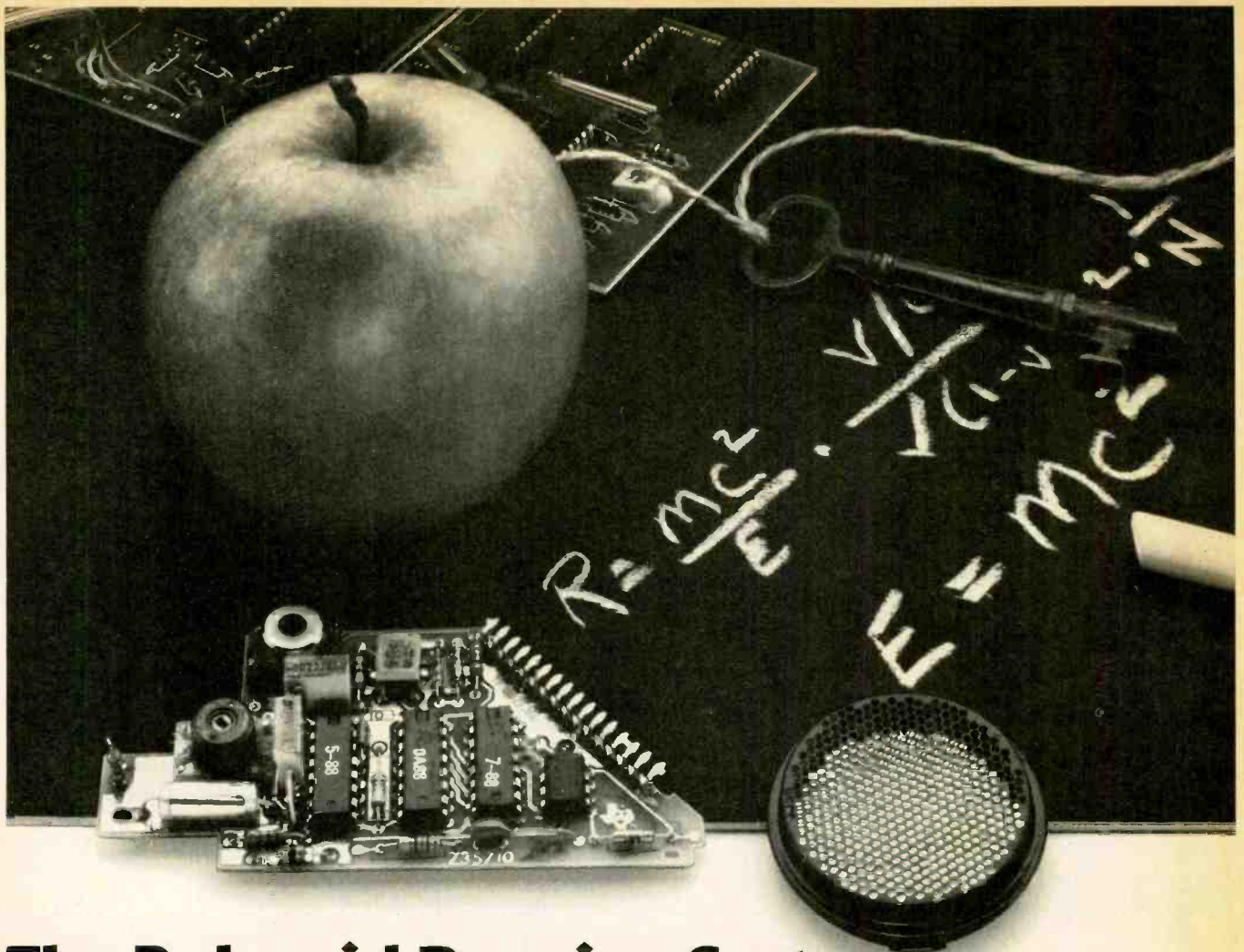

The Polaroid Ranging System. It will bring out the Newton, Franklin and Einstein in you.

There's one definition of invention Isaac, Ben and Albert would agree on. Namely, that invention "is the power to conceive new ideas and relationships." And this is precisely the power that Polaroid's Ultrasonic Ranging System Designer's Kit puts at your fingertips.

Ultrasonic and Ultrasensitive

The Polaroid Ranging System is the same ultrasonic system that automatically focuses our SX-70 Sonar cameras. It's so sensitive it can detect the presence of a flower stem and measure distances from 0.9 to 35 feet away. But, what's really amazing about the Designer's Kit is its possibilities. They are as unlimited as your imagination.

From Conservation to Computers

For example, you might invent your own energy conservation system. Your Designer's Kit can be made to accurately regulate things like your heating, air-conditioning and lights. Or hook-up your kit to your home computer, you'll find your computer may be a lot smarter for it. Or set up your own very private home security system. Or measure any room in your house with electronic ease.

Like we said, the possibilities are virtually unlimited.

Order Your Kit Today

Each Polaroid Designer's Kit comes ready to use with pre-assembled circuit boards with LED display, electro-

static transducers, Polaroid POLAPULSE batteries, instructions—everything you need to bring out the Newton, Franklin and Einstein in you. To order, simply send in the coupon below and your check or money order for \$150, plus applicable taxes.

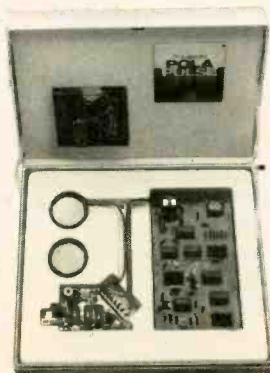

Polaroid Corporation, Battery Division
Mail Stop 4P, 784 Memorial Drive
Cambridge, MA 02139

I can't wait to get my hands on the Polaroid Ranging System.

- Please send me _____ at \$150 each (plus applicable tax).
- Please send me additional information.

Name _____

Address _____

City _____ State _____ Zip _____

Phone (Area Code) _____

POLAROID®

©1982 Polaroid Corporation "Polaroid" and "SX-70"™

QUALITY parts at DISCOUNT PRICES

4 CHANNEL 8 TRACK HOME UNIT

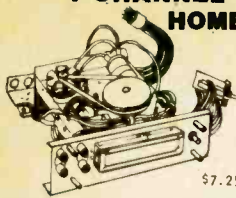

BRAND NEW UNITS... ASSEMBLY INCLUDES; TAPE HEAD, MOTOR BELT, 110VAC MOTOR, PRE-AMP, LIGHTS, SWITCHES, SOLENOID AND OTHER USEFUL PARTS... AN EXCEPTIONAL BUY! \$7.25 PER ASSEMBLY

MINI BSR



\$17.50 each

AUTOMATIC RECORD CHANGER

• B.S.R. MODEL C136R/C/3
• PLAYS 33/45/78 RECORDS
• MINI SIZE: 8 1/4" X 12"
INCLUDES DUST COVER AND PLASTIC CASE (NOT PICTURED) WITH FRONT CUT OUT TO FIT STEREO UNIT (NOT INCLUDED).

JOYSTICK



PRECISION DEVICE... CONTAINS 4 50K CENTER TAPPED ALPS POTS. \$4.75 ea

BLACK PLASTIC CASE



PAC-TEC SERIES C BLACK PLASTIC ENCLOSURE ADJUSTABLE HEIGHT FROM 1.63" TO 2.93"; WIDTH 6.85"; DEPTH 8". BUILT-IN STAND OFFS FOR P.C. BOARDS... FRONT AND BACK PANELS NOT INCLUDED... \$5.25 PER CASE

COMPUTER GRADE CAPACITOR

1700 mfd. 150VDC \$2.00
2 1/2" DIA X 4 3/4" HIGH
3,600 mfd.
40VDC \$1.00
1 3/8" DIA. X 3" HI
6,400 mfd.
60VDC \$2.50
1 3/8" DIA X 4 1/4"
12,000 mfd. 40 VDC \$3.00
2" DIA X 4 1/4" HIGH
18,000 mfd. 75 VDC \$4.00
2 1/2" DIA X 4 1/2" HIGH
22,000 mfd. 15VDC
2" DIA X 2 1/2" HIGH \$2.00
22,000 mfd. 40VDC
2" DIA. X 6" HIGH \$3.00
25,000 mfd. 75 VDC \$4.50
3" DIA X 4 3/8" HIGH
45,000 mfd. 25 VDC
2" DIA. X 4" HIGH \$3.50
72,000 mfd. 15 VDC
2" DIA. X 4" HIGH \$3.50
COMPUTER GRADE CAPACITOR SPECIAL
180,000 mfd. at 6V
2 1/2" DIA X 4 1/4" HIGH \$1.50
CLAMPS TO FIT CAPACITORS 50c ea.

TRANSFORMERS

120 volt primaries
5.6 VOLTS at 750 MA \$3.00
6 VOLTS at 150 mA \$1.25
12 V.C.T. at 500 mA \$2.50
16.5 V. at 3 AMPS \$6.50
18 VOLTS at 350 MA \$2.00
18 VOLTS at 1 AMP \$4.50
18 V.C.T. at 2 AMP \$5.50
25.2 V.C.T. at 2.8 AMP \$5.50
35 V.C.T. at 1 AMP \$3.50
42 V.C.T. at 1.2 AMP \$4.50
65 V.C.T. at 2 AMP \$5.50

VARACTOR DIODES

BB-103 3 FOR \$1.00
100 FOR \$30.00
MV2205 3 FOR \$1.00
100 FOR \$30.00

PHOTO FLASH CAPACITORS

170 MFD 330 VOLT
1 1/2" X 7/8" 2 FOR \$1.50
2" 10 FOR \$7.00
600 MFD 360 VOLT
3 3/4" HIGH X 1" DIA.
\$1.00 EA. 10 FOR \$9.00

DC WALL TRANSFORMER

ALL ARE 115 VAC PLUG IN
4 VDC at 70 MA \$2.50
5.8 VDC at 125 MA \$2.50
9 VDC at 100 MA \$2.00
9 VDC at 225 MA \$3.00

L.E.D.'s STANDARD JUMBO DIFFUSED

RED 10 FOR \$1.50
GREEN 10 FOR \$2.00
YELLOW 10 FOR \$2.00
FLASHER LED 5 VOLT OPERATION RED JUMBO SIZE 2 FOR \$1.70
BI POLAR LED 2 FOR \$1.70
SUB MINI LED .079" X .098" RED 20 mA at 1.75v 10 FOR \$1.00 200 FOR \$18.00 QUANTITY PRICES AVAILABLE
BLACK LIGHT (ULTRAVIOLET) G.E. # F6T5BL \$2.50 each

MITSUBI MODEL UES-A55 VARACTOR UHF TUNER

FREQ RANGE 470 - 889 MHz
ANTENNA INPUT 300 OHMS
\$25.00 each
10 for \$220.00

SLIDE POTS

500K linear taper
2 7/8" LG. 75c EACH
1 3/4" TRAVEL

new products

the dial. Six FM and six AM stations can be preset for one-touch recall and a 16-LED "digilog" shows the frequency against a graduated tuning scale. Other features of the T-K20(L) include station identification tags and a detachable low-impedance AM loop antenna. Manufacturer's specs (for the FM section) include an alternate channel selectivity of 60 dB; THD (stereo) of 0.3%; S/N (stereo, IHF-A) at 70 dB; and a frequency range from 20 to 12,500 Hz. \$180.

Portable Dual-Trace Scope

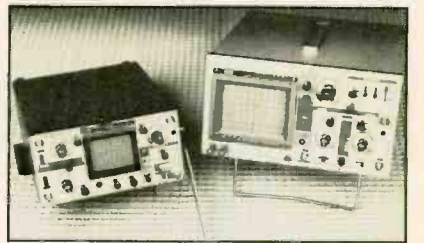

The Model 315P from A. W. Sperry Instruments is a portable ac/dc, 15-MHz, dual-trace oscilloscope with a built-in battery pack. It has three glass-epoxy circuit boards (said to permit easy servicing) and comes with two test probes (1X and 10X). Features include: automatic battery recharge, high sensitivity (2 mV/div), a high-intensity CRT with internal graticule, front-panel trace rotation adjustment, video/sync separator, and XY display modes. Added or subtracted signals can be observed by using the "invert" knob; and a 5X magnification expands sweep to 0.1 μs/div. Rated rise time is 24 ns; maximum input voltage is 600 V p-p or 300 V dc + ac peak; input impedance is said to be better than 60 dB at 1 kHz. Operating temperature is 0° to 40°C at up to 90% humidity. Weight is 12.1 lb. \$950.

Shortwave Antenna

MFJ introduces its Active Outdoor Receiving Antenna with whip. It is reported to give improved reception of signals in the 50-kHz to 30-MHz range. At lower frequencies it is said to be equivalent to an outside wire antenna hundreds of meters long, and at high frequencies to have a high-gain amplifying action. A high dynamic range r-f amplifier is mounted at the antenna for maximum signal-to-noise ratio. A 20-dB attenuator switch on the control unit is designed to prevent receiver overload, and a separate switch permits use of an auxiliary antenna when the main unit is off. Another switch allows a user to select between two receivers; and there is a gain control and power on/off LED indicator. The control unit measures 6" X 2 1/2" X 5" and the remote unit is 3" X 2" X 4". The telescoping whip is 4.5' long when extended. It operates on 12 V dc or 117 V ac with optional adapter (MFJ-1312). \$130

FREE! SEND FOR OUR NEW 40 PAGE CATALOG FREE!

KEYBOARD w/ case

16 KEY KEYBOARD MATRIX ENCODED
TERMINATES TO FLEXIBLE CABLE WITH CONTACTS ON .100 CENTERS. EDGE CONNECTOR INCLUDED... \$4.50 PER KEYBOARD, CASE, AND CONNECTOR...

4PDT RELAY

14 pin style
3 amp contacts
24 volt d.c. or 120 volt a.c. coil
Used but fully tested
\$1.70 EACH
Specially coil voltage
LARGE QUANTITIES AVAILABLE
SOCKETS FOR RELAY 50c each

KEY SWITCH S.P.S.T.

4 AMPS @ 125 VAC
KEY REMOVES BOTH POSITIONS \$3.50 EA

MULTI-SWITCH 8 STATION

INTERLOCKING ASSEMBLY
4-D.P.D.T./4-4.P.D.T.
6 1/2" MOUNTING CENTERS
\$3.00 PER ASSEMBLY

EDGE CONNECTOR

ALL ARE .156" SPACING
15/30 GOLD
SOLDER EYELET \$2.00 EACH
18/36 GOLD
SOLDER EYELET \$2.00 EACH
22/44 GOLD
SOLDERTAIL (P.C. STYLE)
\$2.50 EA 10 FOR \$22.50
22/44 TIN
SOLDERTAIL (P.C. STYLE)
\$1.35 EA 10 FOR \$12.50
42/84 GOLD
SOLDER EYELET \$4.00 EACH

6 VDC RELAY

MINIATURE
D.P.D.T.
3 AMP CONTACTS
FUJITSU # FBR321D006
\$1.75 EA 10 / 16.00

13 VDC RELAY

CONTACT: S.P.N.C.
10 AMP @ 120 VAC
ENERGIZE COIL TO OPEN CONTACT...
COIL: 13 VDC
650 OHMS.....
SPECIAL PRICE \$1.00 EACH
10 FOR \$9.00

5 STATION

INTERLOCKING ASSEMBLY
3-4.P.D.T./2-D.P.D.T.
4 1/8" MOUNTING CENTERS
\$2.50 PER ASSEMBLY

3 STATION

NON-INTERLOCKING
2-D.P.O.T./1-4.P.O.T.
PUSH ON/PUSH OFF STYLE
2 1/2" MOUNTING CENTERS
\$1.50 PER ASSEMBLY

2 CHANNEL LIGHT ORGAN

EASILY HOOKS INTO STEREO SPEAKERS AND ALLOWS 110 VAC LIGHTS TO DANCE WITH MUSIC. TWO SEPARATE 110 VAC OUTPUTS FOR HIGH AND LOW FREQUENCY AUDIO SIGNALS. USE TWO ORGANS FOR STEREO... \$6.50 PER UNIT
COLOR LIGHT STRING AVAILABLE \$1.75 EA

L-PAD

STANDARD 8 OHM
50 DB L-PAD...
\$1.50 EACH

8' LINE CORD

SUT M/E
18 - 3
ROUND GRAY
\$2.00 EACH 10 FOR \$18.50

LIGHTED PUSH BUTTON

RED LIGHTED 120 VAC
2 10 AMP. S.P.S.T.
"POWER" PRINTED ON FACE. MOUNTS IN 7/8" SQUARE HOLE...
\$1.50 EA 10/ \$13.50

MICROWAVE TRANSISTORS

12 FOOT
R.C.A. PLUGS BOTH ENDS. USED FOR VIDEO GAMES, ETC \$1.25 EA

0-10 MINUTE TIMER

ADJ. TIMING MOTOR FROM 0 - 10 MIN. RATED 10 AMPS. 125 VAC MOUNTS ON 1" CENTERS... \$4.75 EACH

6volt 9amp/hr RECHARGEABLE

ELPOWER # EP690
SOLID GEL CELL
5 1/2" X 4 1/4" X 2 3/4".....
\$15.00 EACH

CANNON XLRA-3-13 CHASSIS MOUNT CONNECTOR

3 PRONG CHASSIS MOUNT CONNECTOR
\$2.00 EACH
10 for \$19.00

EQUIPMENT SLIDES

CHASSIS-TRAK MODEL C3005
3 SECTION. LENGTH 22" CLOSED.
HOLDS TO 85 LBS., EXTENDS 23"
\$5.00 PER PAIR SOME HARDWARE INCLUDED

2" ALLIGATOR CLIPS

7 clips for \$1.00
100 clips for \$12.00
500 clips for \$50.00

2 Mhz CRYSTAL

CASE STYLE HC337U \$3.50 EACH

ALL ELECTRONICS CORP

905 S. Vermont Ave.
P.O. BOX 20406
Los Angeles, Calif. 90006

• Quantities Limited
• Min Order \$10.00
• Add \$2.50 Shipping USA
• Calif Res. Add 6%
• Prompt Shipping
• NO C.O.D.

TOLL FREE ORDER NUMBER
800-826-5432
AK HI CA (213)380-8000

CIRCLE NO. 27 ON FREE INFORMATION CARD

CIRCLE NO. 100 ON FREE INFORMATION CARD

Introducing incredible tuning accuracy at an incredibly affordable price: The Command Series RF-3100 31-band AM/FM/SW receiver.* No other shortwave receiver brings in PLL quartz synthesized tuning and all-band digital readout for as low a price.† The tuner tracks and "locks" onto your signal, and the 5-digit display shows exactly what frequency you're on.

There are other ways the RF-3100 commands the airways: It can travel the full length of the shortwave band (that's 1.6 to 30 MHz). It eliminates interference when stations overlap by narrowing the broadcast band. It improves reception in strong signal areas with RF Gain Control. And the RF-3100 catches Morse



RF-6300 8-band AM/FM/SW

communications accurately with BFO Pitch Control.

Want to bring in your favorite programs without lifting a finger? Then consider the Panasonic RF-6300 8-band AM/FM/SW receiver (1.6 to 30 MHz) has microcomputerized preset pushbutton tuning, for programming 12 different broadcasts, or the same broadcast 12 days in a row. Automatically. It even has a quartz alarm clock that turns the radio on and off to play your favorite broadcasts.

The Command Series RF-3100 and RF-6300. Two more ways to roam the globe at the speed of sound. Only from Panasonic.

*Shortwave reception will vary with antenna, weather conditions, operator's geographic location and other factors. An outside antenna may be required for maximum shortwave reception.

†Based on a comparison of suggested retail prices.

This Panasonic Command Series™ shortwave receiver brings the state of the art closer to the state of your pocketbook.



With PLL Quartz Synthesized Tuning and Digital Frequency Readout.

Panasonic
just slightly ahead of our time.

Now NRI takes you inside the new TRS-80 Model III microcomputer to train you at home as the new breed of computer specialist!

NRI teams up with Radio Shack advanced technology to teach you how to use, program, and service state-of-the-art microcomputers.



It's no longer enough to be just a programmer or a technician. With microcomputers moving into the fabric of our lives (over 250,000 of the TRS-80™ alone have been sold), interdisciplinary skills are demanded. And NRI can prepare you with the first course of its kind, covering the complete world of the microcomputer.

Learn at Home in Your Spare Time

With NRI training, the programmer gains practical knowledge of hardware, enabling him to design simpler, more effective programs. And, with advanced programming skills, the technician can test and debug systems quickly and easily.

Only NRI gives you both kinds of training with the convenience of home study. No classroom pressures, no night school, no gasoline wasted. You learn at your convenience, at your own pace. Yet you're always backed by the NRI staff and your instructor, answering questions, giving you guidance, and available for special help if you need it.

You Explore the New TRS-80 Model III Inside and Out

NRI training is hands-on training, with practical experiments and demonstrations as the very foundation of your knowledge. You don't just program your computer, you go inside it... watch how circuits interact... interface with other

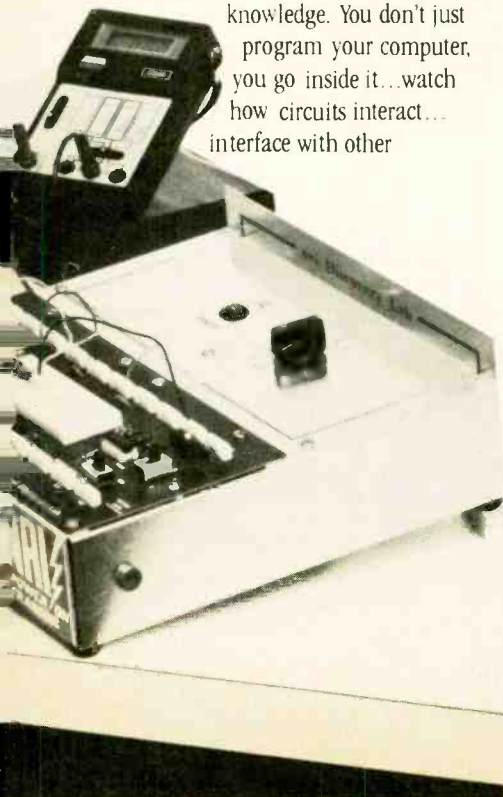

systems... gain a real insight into its nature.

You also work with a professional 4-function multimeter, featuring full portability and a 3½-digit liquid crystal display. Using it along with the exclusive NRI



Training includes the TRS-80 Model III microcomputer, professional LCD multimeter, the NRI Discovery Lab, Computer Assisted Instruction programs and hundreds of demonstrations and experiments.

Discovery Lab® and your TRS-80, you perform over 60 separate experiments. You learn how to troubleshoot and gain greater understanding of the information your testing procedures give you.

Advanced Technology Microcomputer Is Yours to Keep

As part of your training, NRI sends you the new, state-of-the-art TRS-80 Model III microcomputer. This functional unit is complete with 65-key keyboard and 12" display in one desk-top unit. It features high-speed cassette loading, built-in interface for parallel printer, and provisions for optional disk drive. Its 4K RAM is internally expandable to 16K or 48K and its BASIC language is compatible with most Model I software.

Along with your multimeter and the NRI Discovery Lab, this latest concept in

advanced microcomputers is yours to learn with, yours to keep and use for your own personal programs, business use, and other applications.

Computer Assisted Instruction

Your TRS-80 even helps train you. You receive 8 special lesson tapes in BASIC computer language. Using them in your microcomputer, you "talk" to it as you progress. Errors are explained, graphics and animation drive home key points. Within a matter of minutes, you'll be able to write simple programs yourself.

Send for Free Catalog... No Salesman Will Call

Get all the details on this exciting course in NRI's free, 100-page catalog.

It shows all equipment, lesson outlines, and facts on other electronics courses such as Electronic Design, Industrial Electronics, TV/Audio/Video Servicing... 11 different career opportunities in all.

Send today, no salesman will ever bother you. Keep up with the latest technology as you learn on the world's most popular computer. If postcard has been used, write to NRI Schools, 3939 Wisconsin Ave., Washington, D.C. 20016.

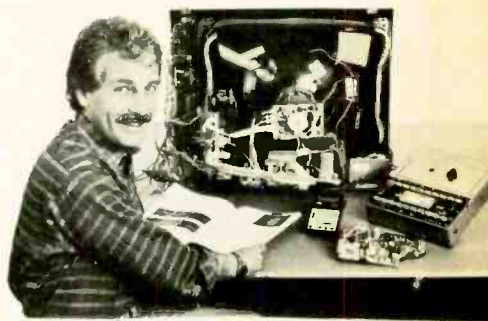

NRI Schools
McGraw-Hill Continuing
Education Center
3939 Wisconsin Ave.
Washington, D.C. 20016
We'll give you tomorrow.

(TRS-80 is a trademark of the Radio Shack division of Tandy Corp.)

Audio Product of the Month

CHOSEN BY THE EDITORS OF POPULAR ELECTRONICS



Denon Model DR-F7 Cassette Deck

THE Denon DR-F7 is a versatile, three-head, two-motor cassette deck, featuring metal tape compatibility, Dolby B and Dolby C noise reduction, and an automatic microprocessor-controlled tape optimization system. The DR-F7 presents a clean, uncluttered appearance, free from the arrays of lights and LEDs found on many of today's audio components. Program levels are displayed on two large illuminated meters, and light-touch buttons are pressed to operate the tape transport functions through solenoid action.

The Denon DR-F7 is about 17" W × 12½" D × 4⅝" H, and weighs 16½ pounds. Suggested retail price is \$500.

General Description. The permalloy recording and playback heads of the Denon DR-F7, which are magnetically and electrically separate, are mounted in a common housing that fits into the normal head opening on the edge of the cassette. Since the two head gaps are made parallel during manufacture, a single azimuth adjustment sets both of them cor-

rectly. The separate heads provide a recording gap width of 4 micrometers, and a very narrow playback gap of only 0.5 micrometers for extended high frequency response.

The electronic portions of the machine, including its Dolby noise reduction circuits, are duplicated for the recording and playback functions. This makes it possible to monitor the playback from a tape a fraction of a second after it is recorded.

The capstan is driven by a "Flat Twin" direct-drive servo-controlled motor, whose high operating frequency of 906 Hz minimizes mechanical vibration. The tape hubs are driven by a single dc motor through an idler system that does not use slip clutches, and tape tension is continually monitored and adjusted by a servo system.

The FTS (Flat Tuning System) microprocessor is activated by pressing a front panel button before making a recording. This records a series of test tones on the tape with a range of bias levels, using the playback level to establish the optimum bias. The recording level is similarly ad-

justed, matching the sensitivity of the tape to the level requirements of the Dolby circuits. The bias and sensitivity settings are automatically stored in the computer memory, and the tape rewinds to the point where the process began. A small green LED next to the FTS button blinks while the calibration is in progress, and remains lit when the operation is completed.

The entire process takes less than 6 seconds. A PRESET button provides typical fixed recording adjustments for the basic tape types, as selected by the TAPE SELECT switch. Alternate operations of this button toggle between the preset values and the optimized values so that either can be used.

The amplifiers of the Denon DR-F7 are direct-coupled throughout, and are operated from a split ±12-volt power supply. According to Denon, this results in an amplifier with very low distortion and wide dynamic range. The level meters, calibrated from -20 to +6 dB, are augmented by three LEDs which read the higher of the two channel levels. They flash at levels of 0 dB, +5 dB, and

Heathkit®



Make something special

Share the value and satisfaction that come from building it yourself.

CIRCLE NO. 34 ON FREE INFORMATION CARD

www.americanradiohistory.com

Who makes the best products for your home? You do. Thousands of people just like you have built Heathkit products. And we've been helping them build pride for 56 years.



Share pride of accomplishment.

Nobody builds products like you and your family. And the things you build together become extra-special. You build more than a kit. You build pride.

It's not a kid's game. But they love to be part of the hands-on fun and learning.

And the enjoyment you get out of building your kit is matched only by the care we put in it to make sure you succeed.

It's also the affordable route to ownership of the finest products for your home.

Choose from hundreds of home electronics and other products in every area of interest, every range of capability.

Simple starter kits develop confidence fast. More advanced projects challenge your skills, both in construction and application.

No experience is necessary. Every step of the way, you have our promise: "We won't let you fail."

Help is always as close as your phone or the nearest Heathkit Electronic Center. But you probably won't need assistance because 56 years of experience have shown us how to write and illustrate step-by-step manuals that lead you to success.

In as little as 15 hours you can build one of the most advanced color TV sets available today.

It features Peak Resolution picture circuitry for



And enjoy pride of ownership.

maximum clarity, quartz electronic tuning, and digital circuits that scan and lock in the signal. Gives you remote control convenience, too.

You couldn't create a more beautiful heirloom than the stately 76½" Grandfather Clock from the Heathkit furniture line.

The solid red oak cabinet is accented with rare Carpathian elm burl overlays. The movement is precision solid brass. Melodious chimes sound Westminster, St. Michael or Whittington strains.

State-of-the-art electronics characterize Heathkit audio products.

Pro-Series components deliver studio-quality sound unheard of in systems priced for the home.

It's a system with exceptional audio technology and space-saving visual appeal.

There's no better way to learn about home computer systems — and save money — than by building one yourself.

The Heathkit All-In-One Computer has big system power, with two microprocessors, up to 64K RAM and CP/M operating capability. And it's part of a complete, integrated system of hardware, peripherals, and software designed to grow with you.

Money saving professional instruments make all your electronic projects easier. Heathkit digital multimeters test key functions, are easy to build.

It's easy to get started. Just turn the page...

Heathkit[®]
Heath
Company



GRS-2501-2.
25" Color Television Kit
with Remote Control
and Classic Cabinet.
\$749.90



F-2530.
Grandfather Clock Kit.
\$895.



Pro-Series Components
AJ-1600
Digital AM/FM
Tuner Kit
\$449.95

AP-1800
Stereo Preamp/Kit
\$399.95

AD-1703
Ten Band Equalizer Kit
\$269.95

AD-1702
Variable Electronic
Crossover Kit
\$199.95

AA-1600
Stereo Amplifier Kit
\$359.95

AE-1705
Pro-Series Rack
\$279.95



H-25.
Dot Matrix Lite Printer Kit.
\$995.

HS-89-3.
All-In-One
Computer Kit.
\$1595.



M-2264.
Digital Multimeter Kit.
\$249.95

ID-4001.
Computerized Weather
Station Kit.
\$339.95

It's easy to get started.

Call 800-253-0570 toll-free. (In Alaska, Hawaii and Michigan call 616-982-3411.) We'll tell you the location of your nearest Heathkit Electronic Center, or take your order for any Heathkit product. You can charge it to your VISA or MasterCard.

Choose a Heathkit product for your home. You'll be proud you did.

Free Catalogs!

Heathkit® Heath Company,
Dept. C10-944
Benton Harbor, MI 49022

"Yes, please send my FREE Heathkit
 Electronics Furniture Catalogs."

More than 60 Heathkit Electronic Centers to serve you

- | | | |
|--|--|--|
| ARIZONA
Phoenix
Tucson | INDIANA
Indianapolis | Rochester
White Plains |
| CALIFORNIA
Anahelm
El Cerrito
Los Angeles
Pomona
Redwood City
Sacramento
San Diego
San Jose
Woodland Hills | KANSAS
Kansas City | OHIO
Cincinnati
Cleveland
Columbus
Toledo |
| COLORADO
Denver | KENTUCKY
Louisville | OKLAHOMA
Oklahoma City |
| CONNECTICUT
Hartford | LOUISIANA
New Orleans | PENNSYLVANIA
Philadelphia
Pittsburgh |
| FLORIDA
Jacksonville
Miami
Ft. Lauderdale
(Plantation)
Tampa | MARYLAND
Baltimore
Rockville | RHODE ISLAND
Providence |
| GEORGIA
Atlanta | MASSACHUSETTS
Boston (Peabody)
Boston (Wellesley) | TEXAS
Dallas
Fort Worth
Houston
San Antonio |
| HAWAII
Honolulu
(Pearl City) | MICHIGAN
Detroit
East Detroit
St. Joseph | UTAH
Salt Lake City |
| ILLINOIS
Chicago
Downers Grove | MINNESOTA
Minneapolis
(Hopkins)
St. Paul | VIRGINIA
Alexandria
Norfolk |
| | MISSOURI
St. Louis | WASHINGTON
Seattle
Tukwila
Vancouver
(Portland, OR) |
| | NEBRASKA
Omaha | WISCONSIN
Milwaukee |
| | NEW JERSEY
Fair Lawn
Ocean (Asbury Park) | |
| | NEW YORK
Buffalo
Jericho | |

Name _____
Address _____
City _____ State _____ Zip _____ CO-101A

Heathkit Electronic Centers are units of Veritechnology Electronics Corp.
Prices Subject to change.

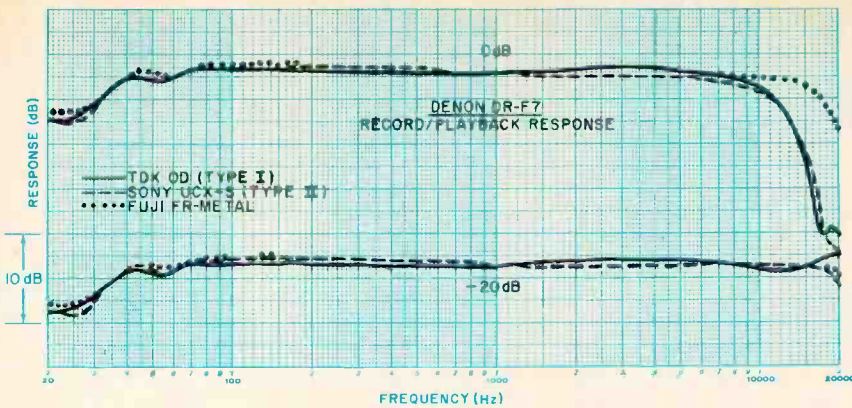

Record/playback responses at 0 and -20 dB of three tape types.

+8 dB, and provide instant warning of excessive peak levels as well as assurance that the average level is correct (shown by frequent flashing of the 0-dB light).

The six transport control buttons operate somewhat differently from those on most cassette decks. Pressing RECORD activates the meter display for setting recording levels, but tape motion does not start until the "play" button (identified by a single arrow pointing in the direction of tape travel) is also pressed.

The combined PAUSE/MUTE button stops the tape when touched during playback, and pressing "play" restores normal operation. During recording, pressing the PAUSE/MUTE button removes the recording signal from the heads, but continues the tape motion to record a silent portion on the tape for as long as the button is held in. Only when it is released does the tape stop. To resume recording, only the "play" button need be pressed.

A "flying start" recording from the playback mode is made by holding in the "play" button while pressing RECORD.

The control buttons can be pressed in any sequence without first pressing STOP. Colored lights on the RECORD, play, and PAUSE/MUTE buttons show their current status. The DR-F7 can be operated unattended (in playback or recording modes) by using an external clock timer and setting the recorder's TIMER switch. A small pushbutton activates the MPX filter for recording FM stereo broadcasts from a tuner with inadequate filtering of the 19-kHz pilot carrier signal. Another button connects either the input program or the playback signal to the line outputs.

Laboratory Measurements. The playback equalization of the Denon DR-F7 was measured with BASF standard test tapes. The response, identical for the 70- and 120-microsecond time constants, was ± 1 dB from 31.5 to 18,000 Hz.

To check the effectiveness of the FTS system, we measured the record/playback response with a number of different tapes. The differences between competitive tapes were negligible. We selected

the following for the full series of tests: Type I (ferric) TDK OD; Type II (high bias or chrome) Sony UCX-S; Type IV (metal) Fuji FR-Metal. No tests were made with a Type III (ferrichrome) tape, although the recorder is designed to use them with the "normal" ferric tape settings.

At the usual -20-dB recording level, the frequency response curves were virtually identical for all the tapes. It was within ± 2 dB from about 32 to 20,000 Hz. At a 0-dB recording level, the two ferric tapes produced identical curves, quite flat to 10,000 Hz and rolling off to -10 dB between 14,000 and 15,000 Hz. As expected, the metal tape was outstanding at 0 dB. Its response was ± 2 dB from 38 to 13,000 Hz, and down only 7 dB at 20,000 Hz. This was a better response (at 0 dB) than we have measured from many cassette recorders (using ferric tape) at -20 dB. The response of the MPX filter was perfectly flat up to 15,000 Hz, and down about 25 dB at 19,000 Hz.

We checked the "tracking" of the Dolby B and C systems by measuring the frequency response of the machine at input levels of -10, -20, -30, and -40 dB, with and without the noise reduction activated. Ideally, there should be no change in response from using the noise reduction, but because of level mismatches and imperfect flatness in the basic recorder frequency response, variations up to ± 2 dB over the frequency range are not uncommon, and are considered acceptable.

With Dolby B, the response was changed by less than ± 0.5 dB up to 20,000 Hz at the three higher levels. Even at -40 dB, the change was no more than 1 dB up to 15,000 Hz, and 1.5 dB up to 20,000 Hz. Using Dolby C, the changes were greater, with the largest errors occurring at the higher signal levels. The worst case was at -20 dB, where the error was 2 to 3 dB over much of the audio range. At -40 dB, however, the tracking was within 0.5 dB overall up to 20,000 Hz.

For a 0-dB indicated recording level, the required input at 1000 Hz was 72 millivolts (line) or 0.225 millivolts (microphone). The maximum playback output was between 0.57 and 0.62 volts, depending on the tape. The microphone input overloaded at a safe 77 millivolts.

The third harmonic playback distortion from a 1000-Hz 0-dB recording was -47 dB with Type I tape, and -54 to -55 dB with the others. With each of the tapes, it was necessary to record at +10 dB to measure 3% (-32 dB) playback distortion. The unweighted playback signal-to-noise ratio, referred to that signal level, was 54 dB with Type I tape and 56 dB with the others. A CCIR/ARM

CONTROLS AND INDICATORS

Transport Controls

- RECORD
- PAUSE/MUTE
- > Play
- Stop
- >> Fast Forward
- << Rewind

Pushbuttons

- EJECT: Swings open cassette door for loading or removing cassette.
- POWER: Switches power to recorder.
- RESET: Resets mechanical index counter to 000.
- START-FTS: Initiates automatic tape optimization cycle.
- PRESET: Selects internal bias and level settings; on alternate operations selects FTS values.
- MONITOR: Selects TAPE or SOURCE for line output program.
- MPX FILTER: Switches in 19-kHz MPX filter.

Knobs

- TAPE SELECT: Sets equalization and approximate bias range for type of tape.
- DOLBY NR: Selects B or C Dolby, or off.
- OUTPUT LEVEL: Adjusts line output level for both channels.
- INPUT LEVEL: Concentric recording level adjustments for both channels.

Other Features:

- TIMER: Slide switch with positions for "play," "off," and "rec."
- REMOTE: Socket for optional remote control unit.
- Tape index counter.
- MIC: Two 1/4" jacks for microphones. Plugging in microphone replaces rear line input with mic signal.
- PHONES: Stereo headphone jack.
- Level meters: Two meters, reading both record and play levels.
- PEAK LEVEL: Three LEDs, flashing at 0, +5, +8 dB.

“If you’re going to learn electronics, you might as well learn it right!”

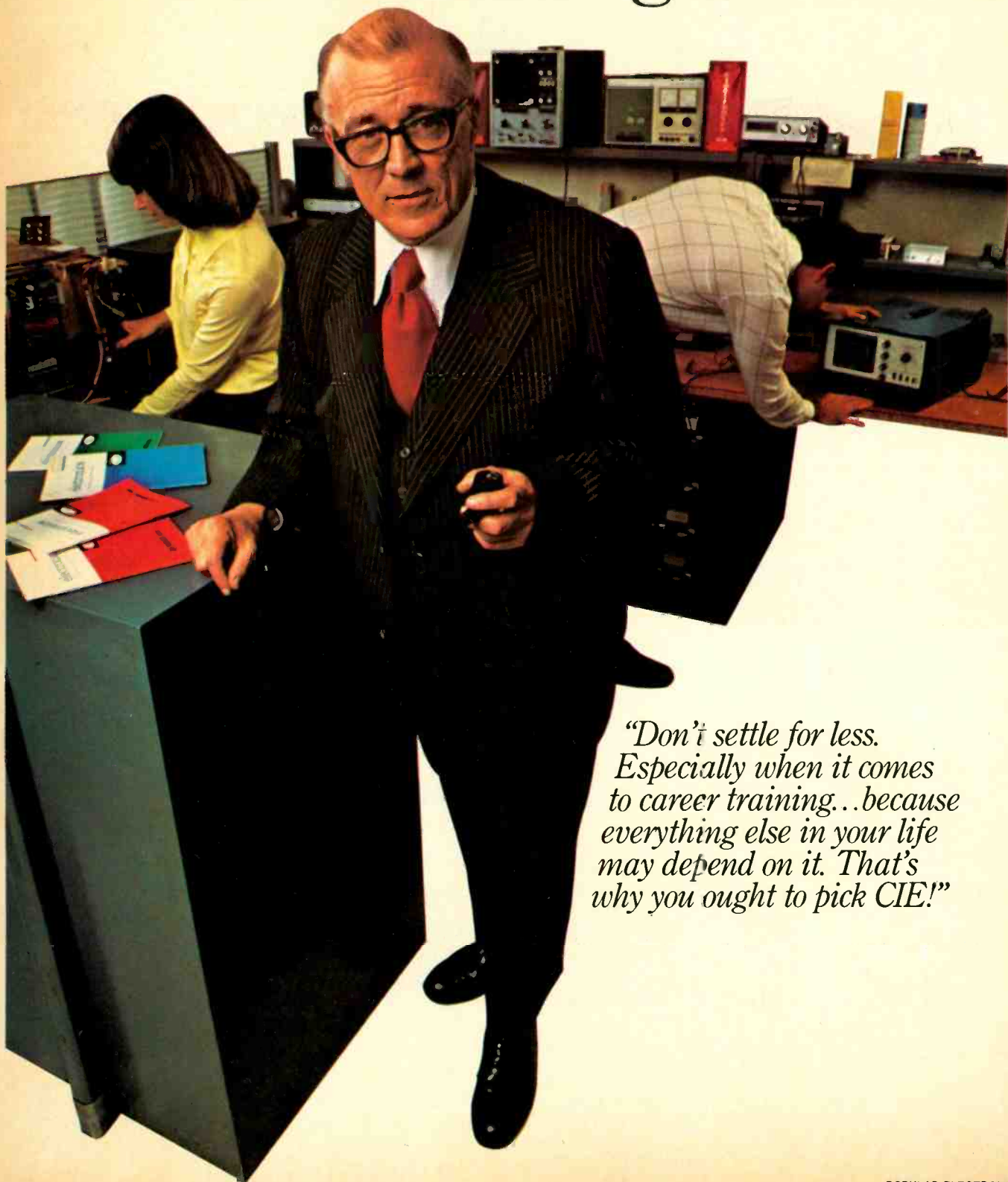

“Don’t settle for less. Especially when it comes to career training...because everything else in your life may depend on it. That’s why you ought to pick CIE!”

You've probably seen advertisements from other electronics schools. Maybe you think they're all the same. They're not!

CIE is the largest independent home study school in the world that specializes exclusively in electronics.

Meet the Electronics Specialists.

When you pick an electronics school, you're getting ready to invest some time and money. And your whole future depends on the education you get in return.

That's why it makes so much sense to go with number one... with the specialists... with CIE!

There's no such thing as bargain education.

If you talked with some of our graduates, chances are you'd find a lot of them shopped around for their training. Not for the lowest priced but for the best. They pretty much knew what was available when they picked CIE as number one.

We don't promise you the moon. We do promise you a proven way to build valuable career skills. The CIE faculty and staff are dedicated to that. When you graduate, your diploma shows employers you know what you're about. Today, it's pretty hard to put a price on that.

Because we're specialists, we have to stay ahead.

At CIE, we've got a position of leadership to maintain. Here are some of the ways we hang onto it...

Our step-by-step learning includes "hands-on" training.

At CIE, we believe theory is important. And our famous Auto-Programmed® Lessons teach you the principles in logical steps.

But professionals need more than theory. That's why some of our courses train you to use tools of the trade like a 5 MHz triggered-sweep, solid-state oscilloscope you build yourself—and use to practice troubleshooting. Or a Digital Learning Laboratory to apply the digital theory essential to keep pace with electronics in the eighties.

Our specialists offer you personal attention.

Sometimes, you may even have a question about a specific lesson. Fine. Write it down and mail it in. Our experts will answer you promptly in writing. You may even get the specialized knowledge of all the CIE specialists. And the answer you get becomes a part of your permanent reference file. You may find this even better than having a classroom teacher.

Pick the pace that's right for you.

CIE understands people need to learn at their own pace. There's no pressure to keep up... no slow learners hold you back. If you're a beginner, you start with the basics. If you already know some electronics, you move ahead to your own level.

Enjoy the promptness of CIE's "same day" grading cycle.

When we receive your lesson before noon Monday through Saturday, we grade it and mail it back—the same day. You find out quickly how well you're doing!

CIE can prepare you for your FCC License.

For some electronics jobs, you must have your FCC License. For others, employers often consider it a mark in your favor. Either way, it's government-certified proof of your specific knowledge and skills!

More than half of CIE's courses prepare you to pass the government-administered exam. In continuing surveys, nearly 4 out of 5 CIE graduates who take the exam get their Licenses!

Associate Degree

Now, CIE offers an Associate in Applied Science Degree in Electronics Engineering Technology. In fact, all or most of every CIE Career Course is directly creditable towards the Associate Degree.

Send for more details and a FREE school catalog.

Mail the card today. If it's gone, cut out and mail the coupon. You'll get a FREE school catalog plus complete information on independent home study. For your convenience, we'll try to have a CIE representative contact you to answer any questions you may have.

Mail the card or the coupon or write CIE (mentioning name and date of this magazine) at: 1776 East 17th Street, Cleveland, Ohio 44114.



CIE Cleveland Institute of Electronics, Inc.
1776 East 17th Street, Cleveland, Ohio 44114

PE-73

YES... I want the best of everything! Send me my FREE CIE school catalog — including details about the Associate Degree program — plus my FREE package of home study information.

Print Name _____

Address _____ Apt. _____

City _____

State _____ Zip _____

Age _____ Phone (area code) _____

Check box for G. I. Bill information: Veteran Active Duty

MAIL TODAY!

The ADC Sound Shapers.[®] Improvements on perfection.

When you make a line of equalizers that audiophiles consider to be the best, it's difficult to make them better.

But we did. And our exciting new Sound Shaper[®] line reinforces our reputation as the leader in the equalizer world.

You'll find the same superb electronics and high performance technology that you've come to expect from ADC. With LED-lit slide controls that let you custom-tailor your sound to compensate for room and system deficiencies. And now, you'll find our Sound Shapers updated with new refinements and sleek styling that makes them look as good as they function.

Our top-of-the-line SS-30 is a perfect example. A ten-band equalizer with LED meters and two-way tape dubbing, it has its own integrated spectrum analyzer built in, so you can clearly see the altered frequency response. And unlike many other equalizers with integrated spectrum analyzers that require outside pink noise sources, our SS-30 has its own pink noise generator built right in. So now, you can accomplish corrective equalization of your room without

an additional component.

The rest of the line is equally impressive. From our 12-band SS-20 to our ten-band SS-10 to our five-band SS-5, all ADC Sound Shapers offer you fingertip control of your frequency response, with features geared to your equalization needs.

If you're serious about equalization and want to maximize the potential of your present system, an ADC Sound Shaper is your answer. The new ADC Sound Shapers. Perfect examples of sound thinking. Improved.



Sound Shaper
Frequency Equalizers



Sound thinking has moved us even further ahead.

ADC, Route 303, Blauvelt, N.Y. 10913

® Sound Shaper is a registered trademark of Audio Dynamics Corporation.



CIRCLE NO. 49 ON FREE INFORMATION CARD

Sound Shaper Thirty

www.americanradiohistory.com

audio

weighted measurement, using Dolby B, was 66.3 dB for Type I, and about 69 dB with the other two tapes. Finally, using Dolby C, the weighted S/N reading was 76 dB with Type I, 78.5 dB with Type II, and 77.5 dB with Type IV. The noise through the microphone inputs was 7 dB greater at maximum gain, but was insignificant at settings even slightly below maximum.

The meter calibrations place the standard Dolby level of 200 nWb/m at +3 dB, and a Dolby calibration tape gave exactly that reading on both channels. The 0-dB peak light came on at exactly 0 dB indicated meter input, and the +5-dB light was equally accurate. The +8-dB light came on at an indicated +9-dB input. The meter ballistics matched VU standards, reading 100% of steady-state values with 0.3-second bursts of 1000 Hz once per second.

The tape speed error was less than 0.2%. The flutter (JIS, or weighted rms) was 0.065%, and the weighted peak flutter (CCIR) was $\pm 0.1\%$. The fast speeds rewind a C60 cassette in 66 seconds, in either direction. Crosstalk between the two pairs of tape tracks was -60 dB at 1000 Hz.

User Comment. Tests show that the Denon DR-F7 is an outstanding cassette recorder. In fact, few other recorders in its price range can match its combination of wide frequency response, low distortion, high S/N, and operating flexibility. Taping FM broadcasts and most LP records resulted in subjectively perfect copies.

We also put the DR-F7 through a very severe test, dubbing dbx encoded records (originally from digital tape masters) through a dbx decoder and using the Dolby C noise reduction of the Denon recorder. The sonic differences between the input and output programs were very small. Dolby C does not give quite as much noise reduction as dbx, and we had a little difficulty (even with metal tape) in avoiding compression of the very high frequencies at maximum amplitude. Nevertheless, the Denon machine gave a very good account of itself in this rather extreme test; nor was there undue compression when the 85-to-90-dB dynamic range of the input program was fed into the 80-dB range of the cassette deck.

The FTS is easy to use and works so effectively, that there is no reason not to use it before every recording. Under ordinary conditions, the "preset" mode is actually redundant.

By any standards, the Denon DR-F7 is an excellent recorder, and it is an especially fine value at its moderate price.

—Julian Hirsch

CIRCLE NO. 101 ON FREE INFORMATION CARD

POPULAR ELECTRONICS

THE POWER IS WITHIN YOUR REACH.

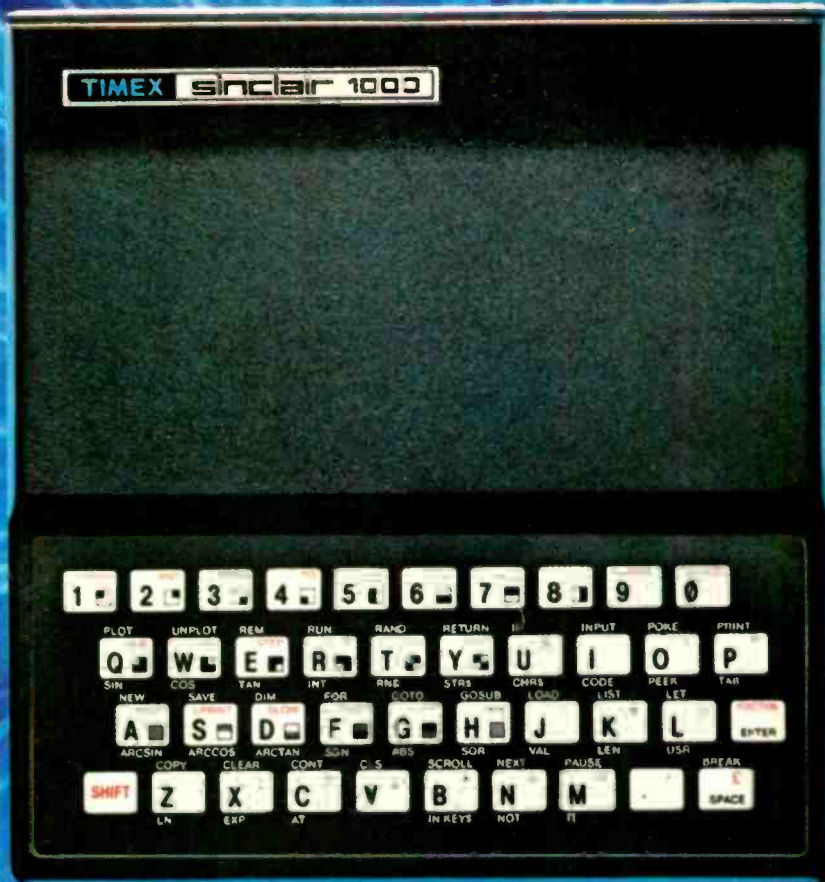

TIMEX INTRODUCES THE POWER OF THE COMPUTER FOR JUST \$99⁹⁵*

TIMEX Sinclair 1000

This new computer from Timex represents a major breakthrough: a real computer at an almost unreal price. What makes it possible are our advances in microchip technology and computer circuitry. And, as technology increases, price decreases. It happened to the calculator. It happened to the digital watch. Now Timex has made it happen to the computer.

The Timex Sinclair 1000™ allows you to use your own TV as a display monitor, and your audio cassette

recorder for storing programs. For \$99.95* you get everything else you need, including our step-by-step learning guide that'll have you running programs within hours. And writing them within weeks.

Pre-programmed cassettes for the Timex Sinclair 1000 are available on such subjects as education, finance and entertainment. And for \$49.95* you can add an additional 16K RAM memory bank that will let you do further advanced programs.

The power of the computer is within your reach today. Visit your local retailer or call our toll-free

number 1-800-248-4639 for the Timex computer dealer nearest you.



TIMEX COMPUTERS

THE POWER IS WITHIN YOUR REACH

Suggested retail price

© Timex Computer Corporation 1987

Popular Electronics Tests

Toshiba IK-1900 TTL Video Camera



STANDARD home movie cameras are slowly being displaced by video cameras and accompanying video cassette recorders. Toshiba's IK-1900 video camera makes such a transition particularly comfortable owing to some imaginative engineering. It incorporates "through-the-lens" full-color viewing much as home movie cameras (and single-lens-reflex cameras) do, as compared to the traditional black-and-white electronic viewfinder incorporated in other high-quality video cameras. A byproduct of this is light weight (4.4 lb), less bulk, and lower-than-usual cost (suggested retail price, \$899). An ac adapter is available for \$70.

General Description. The optics consist of an F1.6 Nikon lens (Nikkor 12.5 mm to 100 mm), including a motorized 8X zoom function plus a wide-range "macro" adjustment for really tight close-ups.

The display in the viewfinder is framed to show the exact color picture area that will be picked up by the camera. Four separate indicators are located in a concentric area surrounding the frame. The letter "U" lights up in red whenever the picture is underexposed, and the letter "V" is illuminated to indicate that the VCR is "on" and recording. To warn the

user that the battery voltage is low, the letter "B" is lit. The fourth indication, the letter "W," is used for white balance (as will be explained later).

Power to the camera is supplied either by the VCR (ac or battery) or by a separate ac adapter that also provides audio and video signal line amplifiers. In addition, the camera contains a built-in lens filter that can be switched in or out to adjust for sunlight (outdoors) or incandescent light (indoors). A three-position EXPOSURE switch can be set for NORMAL, bright background (B.L.C.), and CLOSED. In the closed position, the camera tube is protected from excessively bright light. There is also a small lever that opens and closes a shutter to protect the viewfinder. Zooming can be either manual, by rotating a lever on the lens assembly, or motorized, by depressing either the "W" (wide angle) or "T" (telephoto) button at the top of the camera.

Among the well-thought-out features

of the Toshiba IK-1900 are a folding handgrip with a convenient locking and releasing lever and a VCR control trigger that is duplicated at the bottom of the handgrip for use when the camera is tripod mounted. A rolling knob above the eyepiece allows adjustment for fine focus of the eyepiece, and the rubber eyecap can be turned up to fit the person wearing eye glasses. A rubber lens hood is incorporated to avoid intense reflections.

The only adjustment that caused us some confusion was the white balance. The term refers to the mixture of colored light that appears as white to the human eye. A coarse correction for the difference in white under outdoor and indoor conditions is provided by the FILTER switch. Next to it, however, is the WHITE BALANCE switch that can be set to MANUAL or AUTO.

In the AUTO mode, the WHITE BALANCE switch must be depressed and held there for at least one or two seconds while the camera is focused on a white object. Once this is done, the correct setting is "memorized," as indicated by the illumination of the letter "W" in the viewfinder frame. When shooting conditions or lighting levels change, this procedure must be repeated to ensure optimum color.

In the MANUAL mode, which can be

MORE GAIN THAN A VARACTOR UHF TUNER

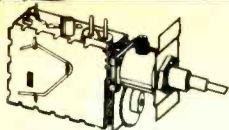

SATISFACTION GUARANTEED

\$15.00

Freq. Range UHF470-
889MHz Channels 14-83
Output Channel 3.

Available on request: Ch 2 or 4.

Part No. B20
Modified High Gain Tuner. **\$15.00**

1. The first thing we do is change the standard diode found in every tuner to a Hot Carrier Diode.
2. The tuners output is then measured and compared to our computer derived chart from which we determine the correct value coil to add across the IF output for maximum Pre-Peaked gain.
3. The tuner is fed a standard 10db antenna input, and while monitoring the output on our Spectrum Analyzer, the tuner is tuned to the desired channel and its oscillator is offset for the desired output frequency as follows:

Ch. 2: 58Mhz Ch. 3: 63Mhz Ch. 4: 68Mhz

We call this step peaking because the tuners output looks like a peak on our spectrum analyzer and the highest point of that peak is actually adjusted for the desired output.

4. Finally, we measure the tuners output one more time which is again compared to our computer derived performance chart to ascertain the correct value of the second coil which is added to the tuners internal connections.

This procedure was developed by GILCO and its our computer derived performance charts that make our tuner better. That's because almost every tuner gets a different value coil before it's peaked and then a different value coil after it's peaked. The combinations are endless and the way we determine the values is our secret.

PRINTED CIRCUIT BOARDS

Part No. B21 Printed Circuit Board. **\$17.00**

1. This Printed Circuit Board uses only one jumper, others use 9.
2. The component layout is screen printed on the Component side of the pre-drilled P/C Board.
3. The solder side of the P/C Board is covered with High Temperature Solder Resist for ease of assembly.
4. This P/C board was designed to take advantage of the Gilco High Gain Tuner which means its circuitry is simpler and more efficient than those circuits that require inferior Varactor Tuners.

ELECTRONIC PARTS KITS

Part No. B22 Complete Parts Kit. **\$80.00**

All resistors (30), Potentiometers (1-5K, 3-10K), Panel Mount Potentiometer (10K), Electrolytic Capacitors (6), Ceramic and Mylar Disc Capacitors (35), Variable Capacitors (4), All Integrated Circuits (7), Voltage Regulator, Heat Sink, Diodes (4), IC Sockets (4-8 pin, 3-14 pin), Power Transformer (24V/1A), Coil Kit with No. 26 wire (4), Speaker (4" 3 Oz.), Standoffs, Coaxial cable, All misc Hardware, etc. All parts are individually packaged and labeled.

All components including the wire, Hardware, Coaxial Cable and heat sinks are included in the parts kit. This means your assembly time from start to finish is only 4 hours.

Order all 3, B20, B21, B22. **110.00**

Order 5 each, B20, B21, B22. **95.00/set**

ACCESSORIES: AMPLIFIERS

Part No.

A02	New 2 Stage Low Noise 28db gain RF Amplifier Specially designed for kit builders	Kit \$18.00
A03	New 1 Stage Low Noise 14db gain Amplifier	Kit \$10.50
A04	75-300 OHM matching Transformer	\$1.00
F59	Coaxial Connectors	.30

Mail order only. Send check or money order to:

GILCO INTERNATIONAL, INC.
P. O. Box 8817, Coral Gables, FL 33124

Tel. (305) 823-5891 For COD orders add 10% shipping and handling or for orders over \$50 add 5%.

FL residents add 5% sales tax. Please write for more information

video

used when one forgets how to set the white balance, the user adjusts the white balance control potentiometer for best picture on a color TV screen—not in the viewfinder. No effect can be seen in the viewfinder because the adjustment affects the video output signal rather than the optical image.

The IK-1900 is also supplied with an extendable, high-impedance directional boom microphone mounted on an acces-

two screens were about equally excellent. When lighting levels were reduced, the picture from the Toshiba IK-1900 deteriorated earlier than the more costly camera, even though we switched the Toshiba's filter and readjusted the white balance.

Next we tried the zoom, both manual and motorized, and found it to work as specified. The "macro" feature on the IK-1900 was tested on a printed label

PERFORMANCE TEST RESULTS TOSHIBA IK-1900 VIDEO CAMERA

Sensitivity: (A) 50 lux for 1 V p-p (underexposed)
(B) 80 lux for 1 V p-p (normal)

Video S/N: 46 dB

Horizontal Resolution: 240 lines

Horizontal Linearity: Excellent

Vertical Linearity: Excellent

Color Fidelity: Excellent (indoors, proper white balance)

Power Required: 6 W at 12 V dc

sory shoe at the top of the camera. A separate input jack is available for an external microphone. The camera comes with a 2.5-meter cable, and an optional extension cable increases this distance potential from a VCR to 10 meters (33 ft).

Performance Tests. Two characteristics are generally considered key in measuring video camera performance. One is sensitivity and the other is the signal-to-noise ratio. Sensitivity refers to the illumination on a white target with 60% reflectance vs. the camera signal output. The S/N in dB is defined as 20 times the log of the ratio of the peak-to-peak video signal to the rms noise signal. (See Table.)

We used as reference the video output signal at the 1-V peak-to-peak level specified by the manufacturer. This output was obtained with an illumination as low as about 40 lumens per square meter (lux), though the letter "U" in the viewing frame indicated underexposure. Using 80 lumens resulted in satisfactory pictures and exposure indication. According to our test, the signal-to-noise ratio of this camera was about 46 dB. The lens opening was F1.6 for both tests. These results correspond closely to the manufacturer's specifications and indicate that the camera provides satisfactory sensitivity and good S/N.

Horizontal resolution was established by focusing on a wedge test pattern. We measured about 240 lines, somewhat less than the specified 260 lines but still an excellent figure. Using a dolly-mounted, professional video camera side-by-side with the IK-1900, we aimed both cameras at our color test pattern and observers agreed that color reproduction, linearity, and overall picture quality of the

with the camera held as close as two inches away. We were able to focus perfectly.

We recorded the test pictures as well as indoor and outdoor scenes on a Sony Betamax VCR, using ordinary speech for audio test signals. On playback, both video and sound proved fine, with the directional qualities of the boom microphone clearly apparent.

Comments. The Toshiba IK-1900's through-the-lens viewing format makes it a distinctive home video camera that's especially easy to use. What you see is essentially what you get since the user views a scene in full color rather than black and white. The camera's light weight is most welcome, too.

Overall construction appeared to be good, though the lavish use of plastic leaves us to believe it is not too rugged. (One would not want to drop any camera, of course, even if made like a battleship.) The boom mike, in particular gives the impression of some fragility owing to its material.

Performance, both in picture quality and operation, is average or better. Nikon optics lend a sense of prestige for those who appreciate such things.

The rather low price for a good-performing camera such as this should appeal to many who will trade off a tiny monitor screen (for field playback of a video recording in black and white), features such as fade in and fade out, titling, etc., for the savings. If one does not use a color TV monitor with its inherently high resolution, this video camera has sufficient good attributes to make it attractive to amateur video recordists.

—Walter Buchsbaum

CIRCLE NO. 103 ON FREE INFORMATION CARD

Build your own computer for \$79.95



The Sinclair ZX81 personal computer kit

Imagine building your own computer for only \$79.95!

That's exactly what you can do with the ZX81 kit. It comes with all the parts you need and complete diagrams and instructions for putting it together. All you have to supply is soldering iron, solder, and a screwdriver. Plus, of course, a little bit of work.

But you get a lot more than several hours of kit-building fun. You also get a surprisingly powerful personal computer. The ZX81 hooks up to any TV for a 32-character by 24-line display (we provide the connecting cables). You can also use a standard cassette recorder to store your programs (again, we provide the cables).

Most important, you get a BASIC programming language that's powerful enough to challenge and interest the most experienced programmers. The ZX81 can handle multidimensional string and numerical arrays. It has full mathematical functions accurate to eight decimal places. Single-key entry for every command. Syntax error detection, debugging codes, and easy editing. Plus features that are ideal for creating games, such as 20 graphic symbols, continuous

display, and random number generator.

The ZX81 can be expanded too. You can increase the memory from 1K to 16K with our Memory Module for \$49.95. And you get a comprehensive manual that completely documents the capabilities of the ZX81, and teaches programming from the ground up.

In short, you get all the features that have made the Sinclair ZX81 the fastest selling personal computer in the world. And you get the satisfaction and fun of building it yourself.

A few years ago, this kind of computer power was simply unavailable to the individual. Even today, most personal computers are too expensive to buy for personal use.

But the ZX81 kit can be yours for only \$79.95. Take advantage of this unique offer today. To order, send the coupon along with a check or money order. Or for faster delivery, call our toll-free number and use your MasterCard or VISA.

To order call toll free: 800-543-3000.
 Ask for operator #509. In Ohio call: 800-582-1364; in Canada call: 513-729-4300.
 Ask for operator #509. Phones open 24 hours a day, 7 days a week. Have your

MasterCard or VISA ready.

These numbers are for orders only. If you just want information, please write: Sinclair Research Ltd., 2 Sinclair Plaza, Nashua, NH 03061.

AD CODE A01E0K	MAIL TO: Sinclair Research Ltd., One Sinclair Plaza, Nashua, NH 03061.		
	PRICE*	QTY.	AMOUNT
ZX81 Kit	\$79.95		
16K Memory Module	\$49.95		
Shipping and Handling	\$4.95		\$4.95
*U.S. dollars	TOTAL		
Name _____			
Address _____			
City _____		State _____	Zip _____

Sinclair technology is also available in Times/Sinclair computers under a license from Sinclair Research Ltd.

sinclair

Now! A 60 MHz Tektronix scope built for your bench.

Wide-range vertical sensitivity: Scale factors from 100 V/div (10X probe) to 2 mV/div (1X probe). Accurate to $\pm 3\%$. Ac or dc coupling.

Two high-sensitivity channels: dc to 60 MHz bandwidth from 10 V/div to 20 mV/div; extended sensitivity of 2 mV/div at > 50 MHz.

Sweep speeds: from 0.5 s to 50 ns. To 5 ns/div with X10 magnification.

Delayed sweep measurements: Accurate to $\pm 3\%$ with single time-base 2213; to $\pm 1.5\%$ with dual time-base 2215.

Complete trigger system. Includes TV field, normal, vertical mode, and automatic; internal, external and line sources; variable holdoff.

Probes included. High-performance, positive attachment 10-14 pF and 60 MHz at the probe tip.

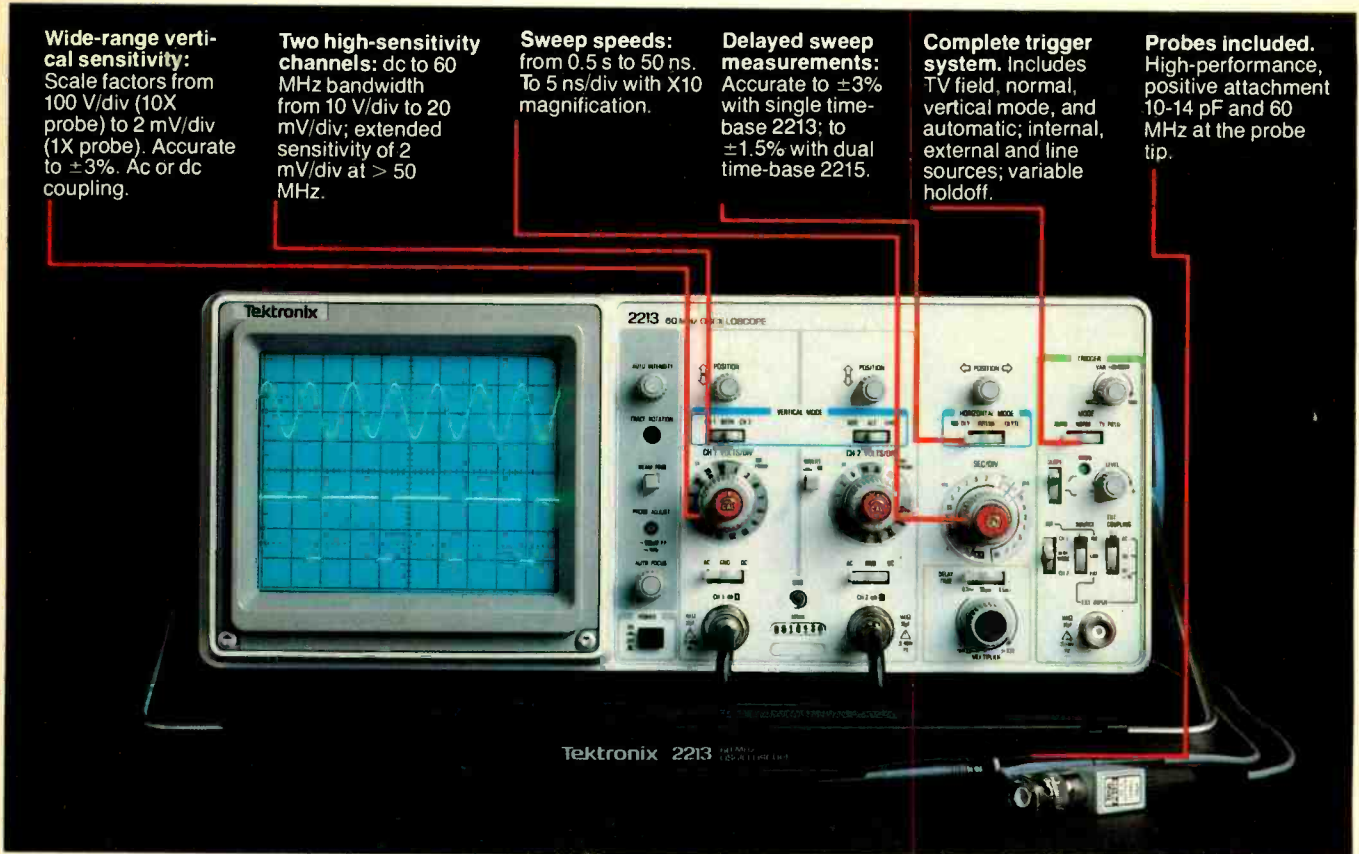

In 30 years of Tektronix oscilloscope leadership, no other scopes have recorded the immediate popular appeal of the Tek 2200 Series. The Tek 2213 and 2215 are unapproached for the performance and reliability they offer at a surprisingly affordable price.

There's no compromise with Tektronix quality: The low cost is the result of a new design concept that cut mechanical parts by 65%. Cut cabling by 90%. Virtually eliminated board electrical connectors. And obviated the usual cooling fan.

Yet performance is written all over the front panels. There's the bandwidth for digital and analog circuits. The sensitivity for low signal measurements. The sweep speeds for fast logic families. And delayed sweep for fast, accurate timing measurements.

**The cost: \$1100 for the 2213*.
\$1400 for the dual time base 2215.**

You can order, or obtain more information, through the Tektronix National Marketing Center, where technical personnel can answer your questions and expedite delivery. Your direct order includes

probes, operating manuals, 15-day return policy and full Tektronix warranty.

For a demonstration stop by your local Tektronix Sales Office.

**ORDER TOLL FREE
1-800-426-2200**

Ask for Department J0238

In the state of Washington,

Call (206) 253-5353 collect.

*Price F.O.B. Beaverton, OR

Popular Electronics Tests

Commodore VIC-20 Low-Cost Computer System



THE Commodore VIC-20 is that company's entry into the Home Computer Sweepstakes. This puts Commodore in competition with Texas Instruments, Atari, and Radio Shack for the growing market for low-cost home computers. The VIC-20 and Atari 400 are running neck-and-neck, with Radio Shack's TRS-80 Color Computer coming up fast. Texas Instruments' TI 99/4 is fourth, but running hard with the stamina for a long race.

All of these machines are now in the price range from \$200 to \$400 for the basic computer unit. The VIC-20 has a manufacturer's suggested price of \$300 for the computer unit, power supply, and r-f modulator, although the selling price in many stores is much less. The VIC-20 was introduced at the 1981 computer shows and has developed a large following of users for a variety of reasons: high-resolution graphics (176 by 184 pixels), color capability (8 border colors and 16

screen colors), sound and music generation, a large supply of software and firmware (cartridges), many peripherals, and relatively low cost for a "real" computer. In addition, it is inexpensive to expand because costs of peripherals have been kept in proportion to the original cost of the computer.

Commodore has provided a range of peripherals for the VIC-20 that enables the owner to configure several different types of personal system. The owner who wishes to contact one of the Public Information Services, such as CompuServe or The Source, only has to plug in the VICMODEM cartridge, connect a telephone handset cord into the modem, and dial the network access number to be connected to the service. Commodore offers a free one-year subscription to CompuServe and one hour's free time on the network.

In addition, Commodore supplies the VICTERM-1 software, which programs

the VIC-20 to act as a "smart terminal." Information on the network can be stored on the Commodore Datasette recorder. If a VIC disk is part of the system, information can be transferred from the network to the VIC disk, or from the VIC disk to the network disk system. To encourage VIC users to use the telecomputing capabilities, Commodore has sponsored the Commodore Information Network, a special-interest group on CompuServe. This provides a "hotline," a public information bulletin board, and an area where computer hobbyists can get programming tips and technical assistance.

The VIC-20 owner who wants to use his computer for home computing, or even simple business applications, can expand the machine's limited memory by plugging in a Memory Expansion Cartridge sold by Commodore in 3K, 8K or 16K sizes. Larger memory expansions are made by several other companies in

sizes up to 24K. A 24K memory expansion is the maximum expansion possible since that brings the total RAM to 32K, which is the largest RAM memory this computer can support.

In addition, there are external expansion units that add additional slots to the memory expansion port and permit the simultaneous use of either additional circuit boards or cartridges. Also there are expansion units for the RS-232 interface, and an IEEE Adapter interface that permits the VIC-20 to be connected to standard Commodore CBM computers and to share peripherals with the larger machine. The VIC-20 system also includes a low-cost, 30-cps printer (about \$400) which has tractor feed and the ability to print VIC graphics as well as text. For those who want a disk drive, the VIC single-disk drive (170K per drive) is one the lowest-cost units on the market (about \$500 for both controller and disk drive). However, for those who require more disk storage, the VIC can be adapted to use standard Commodore CBM dual-disk drives.

When it comes to software, VIC-20 is one of the better-supplied computers on the market. Hundreds of programs of every type are available for the VIC-20 on cassette, disk, and firmware cartridge.

POPULAR ELECTRONICS has tested the basic VIC-20 and some of the software. (We have seen the disk system and modem in operation though we did not test them.)

The VIC-20 Computer is packed in a

styrofoam box that contains the power supply, keyboard computer unit, and r-f modulator. Removing the beige-color keyboard unit, you'll find that it's similar to a typewriter with four extra keys down the right side. At the top of the cabinet is a power indicator light. On the right side of the cabinet is a recessed area containing the power cord socket, an on/off switch, and a "D" socket for plugging in a joystick or other game-control device.

At the rear of the unit, are several types of connections. First, there are three card-edge connectors. The largest (on the left) is to plug in VIC Program cartridges or peripheral connectors. Then there are two round DIN connector ports. The 5-pin one is for connecting the video r-f modulator cable. The second one is for connecting special serial devices such as the line printer and the disk drive. Next is a card-edge connector for the cassette recorder. The last card-edge connector is for special accessories that will be developed from time-to-time.

Setting up the VIC-20 is easy enough. To use it with a TV receiver, the r-f modulator has to be set for either channel 3 or 4. (One of these channels is clear in every area of the United States.) On our unit, however, the switch was not marked with the channel position so some experimenting to find the correct channel was necessary. To use a color or black-and-white monitor, the modulator is not used, of course, and the video cable is run directly to the monitor.

Once the VIC-20 is running, the screen

displays the number of bytes of memory that are free for programming. If a cartridge program is to be used, the computer should be switched off at this point and the cartridge plugged in, per directions supplied with the program cartridges. The manual supplied with the computer does not mention this at all.

The VIC-20's keyboard follows the usual Commodore arrangement of using multi-shifts for graphic characters and upper/lower case characters. Looking at the keys, the user finds there are two graphics characters on the front of most of them. When you turn on the VIC-20, the computer is automatically in graphics mode. You can type upper case and the 60 graphics characters shown on the front of the keys. To print the right-hand graphics characters, you hold down the shift key and depress the key with the left-hand graphic character, you hold down the key with the COMMODORE logo on it. Graphics pictures are created by placing the graphics characters together to create the pattern you want.

To use the VIC-20 in text mode, you press the SHIFT and COMMODORE keys at the same time. You will now be able to type upper- and lower-case letters and the graphics characters on the left side of the keys. These characters are useful for charts and graphs. This multi-shift system permits the VIC-20 to reproduce many more characters than would otherwise be possible. It is not a familiar operation for someone who is not used to Commodore keyboards; but after a while, we became proficient in producing interesting graphics designs as well as text on the screen.

The top row of keys has color designations inscribed on their fronts. The colors are red, cyan (light blue), white, black, purple, green, blue, and yellow. With these keys you can change the color of the characters inside or outside a program. Once the color is "set," the display remains in that color until it is changed. The "9" and "0" keys have the letters RVS ON and RVS OFF on the front. They turn on the reverse-color capability so that you can reverse color of the characters and the background. The Commodore color system is very different from that used by other computers with color capabilities, but we found that it was very easy to use and very effective.

The keyboard also contains four function keys on the right side of the console. These are not defined when the VIC-20 is turned on. They are assigned functions or tasks when used with the plug-in cartridges, or they can be assigned functions within a program loaded from a disk or tape, or entered from the keyboard. The existence of user programmable function keys in a low-cost computer is unusual

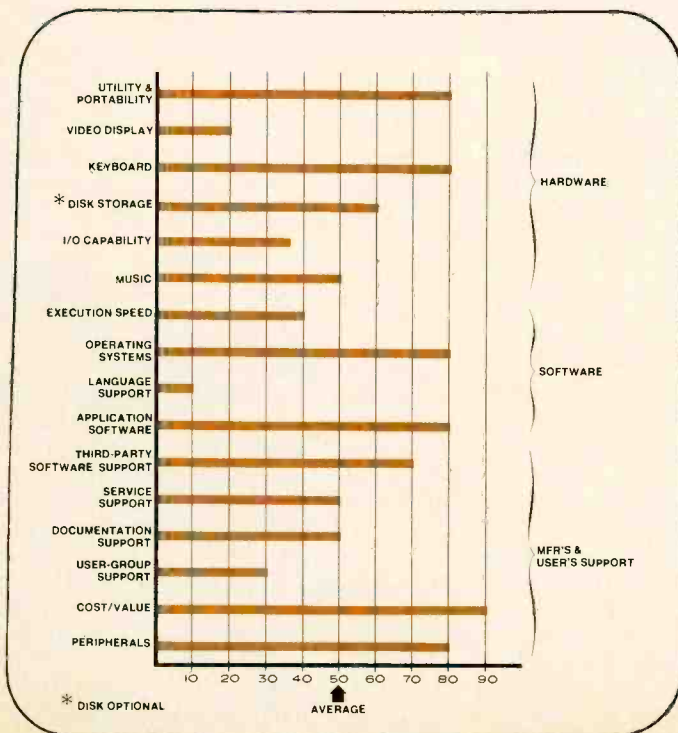

Comparative analysis of Commodore VIC-20 System.

and indicative of excellent design in the VIC-20.

The VIC-20 has another useful characteristic: the ability to make sounds and music without adding devices. The VIC has four voices enabling it to "sing" simultaneously in four different notes. Using this capability, you can create interesting audio effects and fairly complex music.

One serious drawback of the VIC-20 is its 22-character display. This may not be more than an annoyance to a person who is learning programming on the VIC, but to an experienced person who is used to a display at least twice as great, the 22 characters can be a limiting factor. It is sufficient for the games and simple programs given as examples in the owner's manual; but even for use on the CompuServe network, 22 characters are hardly enough. It should be noted that there is a Video Combo Cartridge from Quantum Data that extends the screen width to 40 or 80 characters at a cost of \$199; the same cartridge can be obtained with 16K of RAM and a PROM socket for \$299.

There are several other expansion units made by independent manufacturers, including RAM and ROM Expansors, RS-232 Interfaces, and expansion motherboards. At this year's NCC, a new expansion motherboard unit from Great Britain was previewed that includes six expansion slots for boards or cartridges, and it has its own power supply.

One of the plug-ins for the VIC-20 is the PROM QUEEN cartridge, which

PHYSICAL CHARACTERISTICS

Housing: Metal with separate power supply and r-f modulator.

Keyboard: Full ASCII (64 characters) with numerals and calculation symbols. Four programmable function keys. Full PET-type graphics character set generated directly from keyboard. Auto-repeat on control keys.

I/O: Centronics-type printer and disk-drive parallel port. Joystick, paddle, and lightpen port. Digital-cassette, composite-video, modem, and bus-expansion ports for plug-in programs and expansion of memory. RS-232C interface capability.

Video Display: 22 characters wide by 23 lines deep.

Program Line Length: 88 characters.

Graphics: High-resolution capability. 176 by 184 pixel (32,384) max. resolution.

Color: Eight border colors, 16 screen colors. Eight screen colors generated directly from keyboard.

Music and Sound: Four tone generators covering five octaves. White-noise generator for special effects.

OPERATIONAL CHARACTERISTICS

Language: BASIC

Assembly Language: Optional

Memory Capacity: 5K expandable to 32K

Disk Storage: 170K

Telecommunications Operation: 300 baud

turns the VIC-20 into a software development system. This cartridge programs 2732 and 2716 EPROMs or acts as a 4K-byte EPROM emulator. It takes its input from the keyboard, the modem, or another EPROM, thus permitting direct duplication.

When the unit supplied by Commodore was tested, we found considerable r-f interference displayed on the screen. This could not be cleared up with the fine-tuning control on the TV set, but we discovered that, as we moved the keyboard to different positions in the room, we could reduce the pattern on the screen. When we mentioned this to our contact at Commodore, we were told that we had been supplied an early model and that this interference did not exist in present production units. However, examining units on display at several stores, we found that the interference occurred on at least half of them.

The game cartridges tested with the VIC-20 included VIC Avenger, Jupiter Landing, Midnight Drive, and Blackjack. The Arcade-type games were as good as we have seen on much more expensive computers. There are several special features in the VIC cartridge system, one of which enables the user to adjust the image on the screen by pressing the CSR control key. This allows for differences in various TV sets.

The games are set up to permit use of either a joystick or the keyboard as a controller. However we learned that the Aliens had a big advantage over us when we tried to use only the keyboard. We also wrecked more race cars than usual. Conclusion: you really need a joystick control to play the arcade games. The high score indicates the highest total reached, so you have something to shoot for. We did not test the new Bally/Midway series of games that Commodore has just come out with as they had not been released in time for our tests.

User Comments. The Commodore VIC-20 is more computer for the money than we had expected to see. It offers an excellent low-cost way for a person to start computing, yet there is enough programming capability to maintain interest and to learn programming, graphics, and the fundamentals of music. Users can always take a break by plugging in a cartridge to play a wide variety of games. With video and memory expansion units installed, the VIC can also be used as a word processor. Further, it can provide low-cost access to the world of information networks.

The VIC-20 has real computer capability, as well as being a commendable games player and educational tool.

—Stan Veit

CIRCLE NO. 102 ON FREE INFORMATION CARD



Some of the peripherals that are available to use with the VIC-20.

COMPUTER SOURCES

By Leslie Solomon, Technical Director, and Stan Veit, Computer Editor

Hardware

IBM Expansion Options. Designed for the IBM Personal Computer, the PC-MATE Winchester/10 is a 10-megabyte hard disk that contains its own power supply and has six additional expansion slots. The PC-MATE CMOS Memory with battery backup is a 32K CMOS memory card. The PC-MATE Speed Disk is a floppy disk simulator using dynamic RAM and is compatible with normal system operation. It provides a speed increase between 5 and 50 depending on the operation being performed. The PC-MATE Base Board parallel digital in-digital out option has a basic set of 96 lines and can be further configured via

additional modules. Each Base Board will support up to four "daughter" boards for further expansion. **Address:** Tecmar Inc., Personal Computer Products, 23600 Mercantile Rd., Cleveland, OH 44122 (Tel: 216-464-7410).

Apple III Printing. The PKASO Interface adds text and graphics printing capabilities to the Apple II and III computers. Characteristics include full "snapshot" dump of a screen image, 16 level gray scale printing, user created or software defined characters, and both HIRES and LORES graphics. It supports the Epson, Okidata, Centronics, IDS, NEC, and C. Itoh printers. When used with the Apple III, the interface provides full printing and graphics capability in either the native mode or the Ap-

ple II emulation mode. \$165. **Address:** Interactive Structures, Inc., 112 Bala Ave., Box 404, Bala Cynwyd, PA 19004 (Tel: 215-667-1713).

Printer Adapter. The ADAX70 allows Commodore/CBM computers to output to the Epson MX-70 parallel printer. It supports upper and lower case, and the Epson MX-70 graphics. Its two-foot cable plugs into the PET IEEE port while another IEEE card edge is provided. A switch selects either upper/lower case, u/l reversed, upper case only and graphics. It works with WordPro, VisiCalc and other software. Power is from the printer or an external supply may be used. BASIC 4.0 is required. \$129. **Address:** Connecticut Microcomputers, 36 Del Mar Drive, Brookfield, CT 06804 (Tel: 203-775-4595).

Data Switch. Data-Path Director and Data-Path Protector (key activated) is a high-quality, gold-flashed contacts switch that allows the user to select from any of four terminals tied into its RS232 ports. It is compatible with all 25-line RS232 ports. Models come with 2, 3, and 4 connections. Prices start at \$195. **Address:** EMS, 1861 Reynolds Ave., Irvine, CA 92714 (Tel: 714-556-6111).

SS50 CP/M. The Z809 Softboard System enables 6809 SS50 bus computers to

Remove Vocals

Remove the lead vocal and substitute your own voice with most stereo recordings using our new, low cost VOCAL ZAPPER™. Great for practice, professional demos or just for fun.

WITH THE
VOCAL ZAPPER™



CHARGE TO VISA OR MC TOLL-FREE
1-800-654-8657 9AM to 5PM CST MON-FRI

DIRECT INQUIRIES TO:

PAIA Electronics, Inc.

1020 W. Wilshire, Oklahoma City, OK 73116 (405)843-9626

- Rush my Vocal Zapper Kit, \$24.95 plus \$3 postage & handling enclosed.
 Send assembled Vocal Zapper, \$39.95 plus \$3 postage enclosed Send Free Catalog

name _____
address _____
city _____ state _____ zip _____

PAIA Electronics, dept 10P, 1020 W. Wilshire, Okla City, OK 73116

CIRCLE NO. 45 ON FREE INFORMATION CARD

SEE YOUR DEALER TODAY

FROM



HERE'S A TIP
THAT'S PERFECT!

AM/FM AUTO RADIO
AND CB

'Firestik' II

GOLDEN SERIES

BARE-HANDS TUNABLE
"NO TOOLS NEEDED"
HIGH PERFORMANCE ANTENNAS

ALSO ANTENNAS FOR
CORDLESS TELEPHONES
MONITOR SCANNERS

Dealer & Distributor Inquiries Invited
SEND FOR FREE CATALOG

'Firestik' Antenna Company
2614 East Adams/Phoenix, AZ 85034

Name _____
Street _____
City _____
State _____ Zip _____

Serving the CB and
Communications Market Since 1962.

5-YEAR REPLACEMENT WARRANTY

CIRCLE NO. 42 ON FREE INFORMATION CARD

AMAZING DEVICES

PHASORS
PHASOR PAIN FIELD — Patented and recently developed in our labs is being tested by Gov't for riot control. Soon to come under weapons restrictions as an infernal machine. Easily hand-held. Hazardous IF NOT USED WITH DISCRETION.
PPF-1 PLANS (sold for animal control) \$15.00
INVISIBLE PAIN FIELD GENERATOR — Produces a directional field of moderately intense pain to back of head up to 50'. Cigarette pack size enclosure is easily hidden.
IPG-3 PLANS \$7.00 IPG-3K KIT & PLANS \$44.50
IPG-30 (assembled for animal control) \$59.50
PHASOR STUN/BURNING WAND — Produces sufficient electrical energy capable of burning flesh. Intended as a personal defense device.
PSW-3 PLANS \$8.00 PSW-3K KIT & PLANS \$59.50

LASERS
RUBY LASER RAY PISTOL — Intense visible red. burns. hazardous, with parts sources
RUBY PLANS (includes all part sources) \$15.00
CARBON DIOXIDE LASER — Generates 20-40 watts of continuous power capable of burning, cutting, hazardous (with all part sources). \$15.00
LASER RIFLE — Produces 200-3000 pulses of 30 watt optical energy. Portable and easily hand-held.
LRG-3 PLANS \$10.00
LRG-3K KIT PLANS (minus diode) \$129.50
POCKET LASER — For the beginner, visible red "optical version", non-hazardous.
LHC-2 \$5.00 LHC-2K KIT & PLANS \$24.50
HIGH POWERED PORTABLE ENERGY SOURCE FOR LASERS AND MAGNETIC WEAPONS — Exploding wires, shockwave, etc. Miniature size.
HPS-1 PLANS \$8.00 HPS-1K KIT & PLANS \$49.50
PARTICLE BEAM WEAPON — PLANS \$15.00

SECURITY
INFINITY XMTR — Uses telephone lines for selective home or office listening while away on business or vacation.
INF-1 PLANS \$15.00
SEE IN DARK — Long range, total darkness.
SD-4 PLANS \$10.00
LONG RANGE WIRELESS MIKE — Crystal clear quality miniature.
FBT-7 PLANS \$7.00 FBT-7K PLANS & KIT \$34.50
WIRELESS TELEPHONE TRANSMITTER — Long range, automatic.
VWPM-5 PLANS \$10.00 VWPM-5K PLANS & KIT \$34.50

Send for **FREE** catalog description of above plus hundreds more plans, kits and completed items. We accept MC or Visa or when ordering, send check or money order. We pay shipping charges on orders over \$50.00, otherwise include 10% with remittance.

SEND TO: **SCIENTIFIC SYSTEMS**

DEPT. Q1 BOX 716 AMHERST, NH 03031

run CP/M software. The System will be fully supported with optional copy utility programs that permit the user to transfer any type of file between CP/M and FLEX, CP/M and OS9 and OS9 and FLEX. Address: Meta Lab, 2888 Bluff St., Suite 106, Box 1559, Boulder, CO 80306 (Tel: 303-499-4236).

Printer Graphics. GRAFTRAX-Plus is an advanced graphics capability for Epson MX Series printers, and is also available as a retrofittable ROM. It offers 66 different type fonts including italics, subscript, superscript, and international symbols for most Western languages. It can also underscore with one pass of the printhead. Other features include programmable form length, horizontal tab and right margin, software printer reset, and true backspace. It can also produce ultra high resolution bit image patterns with up to 120 DPI horizontally and 216 vertically. Address: Epson America, 3415 Kashiwa St., Torrance, CA 90505 (Tel: 213-539-9140).

IBM PC Wire-Wrap. The PC-Proto1000 is a wire-wrap/prototype board for the IBM Personal Computer. It takes advantage of the maximum space available within the PC. Address: Legend Industries Ltd., POB 112, Pontiac, MI 48056.

Software

Inventory Control. Written for the TRS-80 Model II, INV-X is an inventory control system that features built-in sort/merge, a new hashing algorithm enabling 1.5 I/O's even on a 28,000 standard reports, and a capacity of 6,600 records on the Model II, or 28,000 for unlimited disk storage. It requires a dual-disk system with 64K of RAM and TRSDOS. \$299. CP/M and IBM PC versions soon to be available. Address: Micro Architect Inc., 96 Dothan St., Arlington, MA, 02174 (Tel: 617-643-4713).

Apple Programs. Apple Alarm monitors on/off alarm switches and can sound an alarm, or keep time when triggered. A 12-page application manual is provided. Requires 32K, disk, DOS 3.2/3.3, and Applesoft. \$20. Hypnosis is an aid to suggestive relaxation, behavior modification, and trance induction. It uses photo-optic and acoustic sensory stimulation and is designed for professionals and students of the medical, psychological, and social sciences. Requires disk and integer BASIC. \$20. Address: Andent, 1000

North Ave., Waukegan, IL 60085 (Tel: 312-244-0292).

VIC-20 Utility. Budget II maintains a full calendar years budget data on tape. It requires each month's net income, and 16 budget categories. Data is saved and reloaded at any time. Each month's data is displayed in dollar amounts, percentages, and color bargraphs. In addition to the 12 months, it can display the total year amounts and monthly averages. Requires VIC-1530 Datasette and 8K. \$9.95. Address: RAK Electronics, POB 1585, Orange Park, FL 32073.

Apple Forth. Forth-79 Version 2 is now available for the Apple. Floating point and HIRES graphics are also available. It meets all the provisions of Forth-79 Standard. The base system includes a screen editor, macro-assembler, string package, 32-bit integer arithmetic, and a 200-page tutorial and reference manual. \$99.95. With enhancements \$139.95. Address: MicroMotion, 12077 Wilshire Blvd., #506, Los Angeles, CA 90025 (Tel: 213-821-4340).

Apple Quick File III. A simple data file system for the Apple III, Quick File III allows for simple arrangement of data into alphabetic, numeric, date, or time

POWER-LINE FILTERS

These filters protect any sensitive electronic equipment from power line transient damage and radio frequency interference. Both models offer surge suppression for power line "spikes". RF interference is suppressed using both inductive and capacitive components. Ideal for computers, test equipment, or TV.

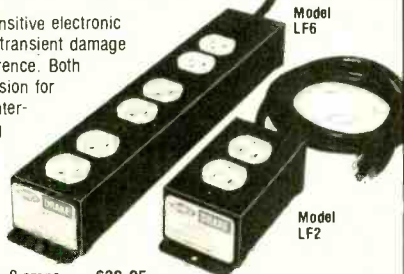

LF2—A duplex outlet, 120V, 8 amps ... \$39.95
 LF6—Three separately filtered duplex outlets, 120V, total fused capacity 15 amps, power switch and indicator lamp ... \$69.95

Add \$2.50 shipping and handling per order. Send check with order and provide street address for UPS shipment. Ohio residents add Sales Tax. Charge card buyers may call toll-free:



1-800-543-5612

In Ohio, or for information, call: 1-513-866-2421



R. L. DRAKE COMPANY

540 Richard Street, Miamisburg, Ohio 45342

INSTITUTIONAL AND DEALER INQUIRIES INVITED

More BLOCKBUSTER BARGAINS!!

Parallel, TTL Input I/O "Selectric"® TYPEWRITER / PRINTER

The manufacturer put 'em into storage to depreciate 'em. Now they're FINALLY AVAILABLE!! Removed from working systems, these fantastic machines have built-in driver and decoder circuitry and take TTL level, 6-bit character, plus 4-bit function input signals. Easily driven by most any micro. Use as a typewriter (with add'l "repeat" circuitry) or as a KSR I/O printer or both. Requires 115, 60Hz for type-writer motor. 5 VDC for TTL and 24 VDC for solenoids. "Table Top" style case. Each "Selectric"™ I/O machine is complete and in operational condition! Includes schematics, data, case, platen and ribbon. (Type element not included.)



TESTED & OPERATIONAL!

New Type Element \$21.00ea. I/O Selectric \$399.00ea.
 Add \$20 for Packaging and Handling - Pay Shipping on Delivery

SAVE!!! Untested version of the above, otherwise whole & complete. May require some service. \$279.00ea.

GE "Terminet 340" BAND LINE PRINTERS

Featuring:

- Over 80% Off Mfr.'s List Prices
- Microcomputer Compatible
- 230 to 340 Lines per Minute!
- 132 Columns, 64 Characters
- Fully Formed Characters
- Nationwide Service from GE!
- Parallel Input!
- Mfr.'s Price Over \$4K



Like New!

"CENTRONICS" I/O OPTION AVAILABLE FROM G.E.!!

These ultra-reliable, continuous-band Printers offer speeds of over 230 lines per minute, are fully operational and ready to use. Built and serviced nationwide by General Electric. Print band, schematics and data included.

115 VAC, 60HZ \$795.00ea.

Please Add \$20.00 for Packaging Shipped via Truck. Freight-Collect

We Offer New & Used FLOPPY DRIVES, DISK DRIVES, PRINTERS, & MORE at BARGAIN PRICES! Write or Call for Our Latest Flyer NOW!!!

™ Selectric is a registered trademark of IBM Corporation

Computer Products & Peripherals Unlimited

WAREHOUSE: 18 Granite St. Haverhill, Mass. 01830

MAIL ORDERS: Box 204, Newton, New Hampshire 03858

TELEPHONE ORDERS: 617/372-8637

Sorry, No Collect Calls. MasterCard & VISA Accepted



Poly Paks BRAND NEW!
FIRST TIME ANYWHERE!

SEE IN THE DARK!
With IR SCIENTIFIC'S
INFRARED VIEWER

In easy to assemble kit form

- Build it yourself & SAVE!
- Everything you need incl. comprehensive instruction manual
- Lightweight binocular type case
- Factory preselected & pretested components
- For night surveillance, IR communications & control, document authentication, thermal viewing & more



Cat. No. 7289 Reg. \$189.95

SAVE \$10.00 Now only **\$179.95**
Mass. Res. Add 5% Sales Tax
Shipping & Handling Add \$3 per kit

SPECIFICATIONS:

Image Converter	—Type 6032
Spectral Response	—500 to 1200 nanometers (800 max)
Resolution	—50 lines/mm
Magnification	—3x
Focus Range	—3 ft. to infinity
Lens	—150mm, 13.0 10" field infrared telephoto and 10 X Ramsden eyepiece
Infrared Source	—900 nanometer, 4500 max. candlepower
Case Size	—7 1/2" x 6 1/2" x 2 1/4"
Power Requirement	—6V DC 14 "D" cells or equiv. not incl.

Send For FREE POLY PAKS CATALOG
Order by Mail or Call TOLL FREE
800-343-3086
Mass. Res. Call 617-245-3828
ORDER SHIPPED IN 24 HRS.

Poly Paks Inc.
16-18 Del Carmine St., PE-10
Wakefield, MA 01880



CIRCLE NO. 3 ON FREE INFORMATION CARD

THE SINCLAIR ZX81

Programming for Real Applications
Randle Hurley



Here are 11 fully documented programs which will cast aside any beliefs that the ZX81 is too small for any real programming work.

These programs not only work—they are true work horses, doing real jobs in a variety of environments. Designed to run with the 16K memory module, the programs include a bulk storage program, word processor, financial applications, banking uses, plus educational programs.

Software available on cassette and can be ordered from back of book. Programs will also run on the Timex Sinclair.
166 pages **\$9.95**

YES, Please send me THE SINCLAIR ZX81 by Randle Hurley. I understand I may return it for a full refund if I am not satisfied.

I enclose \$9.95 plus \$1 to cover the shipping and handling.

Or call our toll free number 800-547-1842 to charge your order on VISA OR M/C.

Please send me your free catalog.

Name _____
Address _____
City, State, Zip _____

MAIL TO: dlithium Press, P.O. Box 606, Beaverton, OR 97075.

CIRCLE NO. 56 ON FREE INFORMATION CARD

computers

order and produces reports in either of two formats—tables (rows and columns); or index card format. Quick File III can calculate totals and subtotals of numeric information, it can also allow for the choice of which rows and columns are to be printed and in what order. This program requires an Apple III system with at least 128K bytes of RAM. \$100. Scheduled to be available in August 1982.

Apple LOGO. Requiring an Apple II with a 16K RAM extension, this MIT LOGO package includes the LOGO language system, a unique instant LOGO tutorial program, an introduction to LOGO, a very fascinating teaching program called Alice in Logoland, and a LOGO back-up disk. It also works in color. Materials describing the Young Peoples LOGO Association are also available. \$179.95. Address: Krell Software, 21 Millbrook Drive, Stony Brook, NY 11790 (Tel: 516-751-5139).

Genealogy Program. Your Family Tree, is a genealogical program that sets up a data base to hold pertinent information about each ancestor including name, date, place of birth, marriage, and death information, plus a comment line. Access is virtually unlimited, with full search capability on any key field using full or partial information. For TRS-80 Model I and III. Cassette or diskette. \$29.95. Address: Acorn Software Products Inc., 634 North Carolina Ave., S.E. Washington, DC 20003 (Tel: 202-544-4259).

6809 FORTRAN. Running under FLEX and UniFLEX, this compiler complies with ANSI FORTRAN-77 (ANSI X3.9-1978) subset of FORTRAN, with the following exceptions; INTRINSIC and SAVE statements are ignored, EQUIVALENCE is not currently implemented, BACKSPACE is allowed on direct access files, ENDFILE performs no useful function, statement functions are not supported, variable names may be of any length with 7 characters significant, all keywords are reserved names, and direct access files are not available under FLEX. It includes modules for 16.8 digit floating point arithmetic, standard scientific functions, complete file manipulations, runtime traceback features, and a post-mortem dump. Available on 5- or 8-inch diskette. UniFLEX version is \$450, FLEX is \$375. Address: Technical Systems Consultants, Inc., Box 2570, West Lafayette, IN 47906 (Tel: 317-463-2502).

Apple Utility. The Manager contains programs to set up a turnkey memory management system for the Apple making use of either one or two 16K boards. HIDOS loads the DOS onto one 16K card, thus freeing the normally occupied 10.5K space. It will also alter a copy of the System Master so that its utilities make full use of the extra memory. HIDOS then looks for a second 16K card and if found, loads an alternate language.

SOLIDOS makes a 16K card into a small (45 sector) disk emulator. \$34.95. Address: Omega MicroWare, 222 S. Riverside Plaza, Chicago, IL 60606 (Tel: 312-648-4844).

IBM SuperCalc. This spreadsheet takes advantage of the color capability of the IBM Personal Computer. The additional memory allows users to fill in all 16,000 cells with 5-digit numbers, and will allow 10 year projections month by month. Negative values and diagnostic messages are displayed in red, with protected formulas displayed in yellow. Address: Sorcim, 405 Aldo Avenue, Santa Clara, CA 95050. (Tel: 408-246-2181).

HP85 Utility. The Professional Organizer is a personal data base management program for the HP-85 that does not have a disk. Data may be manipulated using ADD, DELETE, LIST, CHANGE, INSERT, and TALLY commands. Data files may be saved on and restored from tape cartridges. A linking program enables qualified BASIC programmers to interface with the program. It is supplied on a tape cartridge. \$149. Address: SCELBI Inc., 35 Old State Road, Oxford, CT 06483. (Tel: 203-888-1946).

VisiCalc Utility. The Consolidator links VisiCalc files and allows manipulation of totals without requiring the user to re-enter information. It will also print out VisiCalc commands, formulas, and locations where they apply. It will handle any matrix size, column widths, rows and columns that can be accommodated on the Apple. \$49.95. Address: Omega MicroWare Inc., 222 S. Riverside Plaza, Chicago, IL 60606 (Tel: 312-648-4844).

ZX80/ZX81 Stock Programs. These programs help make intelligent decisions on stock market and call option strategies. One program keeps an up-to-date portfolio of up to ten different stocks and calculates accrued dividends, gains, yields, and length of time each stock held. The second program analyzes call option strategy when purchasing a stock and selling a call option against the same stock. Both programs account for broker commission, and have COPY commands for the ZX printer. Both programs require 16K of RAM and are supplied on cassette. \$29.95. Address: M.H. Marks Ent., 315 Throneberry Court, Pittsburgh, PA 15237 (Tel: 412-486-1694).

Check Accounting. MAXI CRAS is a personal accounting program that can print checks, balance the account, and reconcile it with bank statements. It can handle an almost unlimited number of checks and deposits each month. As many as 223 income and expense accounts are supported. It also interfaces with VisiCalc. Requires a 48K TRS-80 Model I or III with two disk drives and printer, \$99.95. Address: Adventure International, Dept. G., Box 3435, Longwood, FL 32750 (Tel: 800-327-7172).

*A speech synthesizer
you can build for use
with an S-100
bus computer*

THIS IS YOUR COMPUTER SPEAKING

PART 2

BY RANDY CARLSTROM

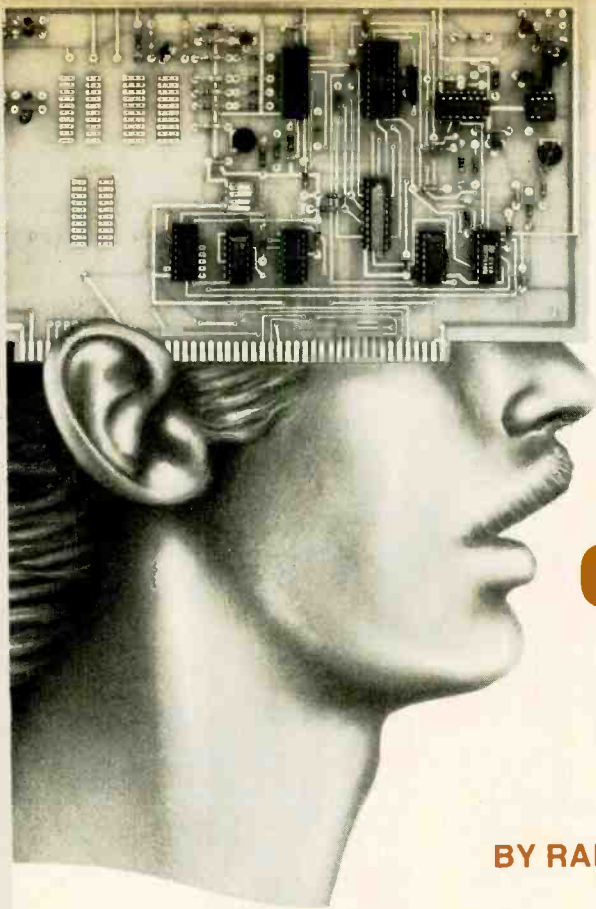

LAST month, in Part 1 of this article, we discussed some of the principles of speech production and synthesis and developed a circuit for your computer to accomplish such synthesis. Here is a description of the software required and several practical applications for the project.

Software. The 64 phonemes produced by the SC-01 synthesizer chip are given in Table I. Accompanying each hex phoneme code is its symbol, average duration in milliseconds for a 720-kHz clock, and an example word. The italic segments of the example words demonstrate the use of the particular phoneme.

The assembly listing of a vocabulary development program, written in 8080 machine language, and too long to be reproduced here, is available at mailing cost as shown in the Parts List. The operation of the program can be understood from the comments in the source listing.

Five commands are available via the program. The first (XAn; n=0-3) sets the amplitude (audio output power) of the system from zero through two discrete volume settings to full audio output; the second (XFn; n=1-16) adjusts the synthesizer clock frequency in 16 discrete steps to make possible many different intonation variations; the third (XIn; n=1-4) sets the inflection

(pitch) of the audio output; the fourth (XE) sets the synthesizer in the sound-effects mode to create all types of human and nonhuman sounds; while the fifth (XS) sets the synthesizer to the normal (speech) mode.

Any of these commands may be used an unlimited number of times in phoneme sequences for dynamic parameter control of the synthesized signal such as intonation and stress pattern variations during the production of words.

There are also two control functions available to the user. Striking the ESC key will cause the current phoneme sequence to be repeated while control-C exits the program and returns to a user-defined memory location (see line 0415 of the program source listing).

Words are programmed into the synthesizer via the system keyboard by entering the appropriate sequences of phoneme symbols from Table I. All phoneme symbols, including any commands used, must be separated by commas. Typing a carriage return (RET) will terminate the current phoneme input sequence and initiate its execution. Commands appearing in a sequence do not go into effect until the next phoneme in the sequence is encountered. Parameter values altered by the various commands remain current until changed otherwise.

As an example of phonetic programming, try entering the following famil-

iar words: "PA1,P,AH1,UH3,P,Y1,IU,L,ER,PA0,EH3,L,EH1,K,T,R,AH1,UH3,N,I2,K,S,PA1 RET;" or this sequence, which uses one of the parameter control commands for a special effect: "PA1,XA3,EH,K,O,XA2,EH,K,O,XA1,EH,K,O,PA1 RET."

Note the PA1 (pause) phoneme appearing at the beginning and ending of both phoneme sequences. This is necessary for proper operation of the SC-01's dynamic articulation controller, to maintain articulation of the first and last sounds in the sequences. The program automatically inserts a PA1 phoneme at the beginning and ending of phoneme sequences, but it is good practice to also explicitly include the PA1 phonemes, should the sequences be later transferred to a ROM (or other type of storage media) for use without the program.

A PA0 (short pause) phoneme may be used between words for rhythm, as was done in the first example. This phoneme is also sometimes used to separate fricative stop sounds (T,DT,K, and P) when they occur consecutively in a phoneme sequence. An example of this usage is in the word *affect* (UH1,F,EH,K,PA0,T).

Developing vocabulary words for the synthesizer is basically a trial-and-error method. Slowly pronounce the words to be synthesized out loud several times, noting the different sounds com-

Fig. 8. At (A) is an extract of a typical vocabulary table (numerical values are hexadecimal). (B) A modification of an application program to include vocal output. (C) A speech driver interrupt-servicing routine.

3F	STOP	"JUNE"
3E	PAI	
IE	D	
IA	J	
36	IU	
2B	U	
0D	N	
3E	PAI	"JULY"
3F	STOP	
3E	PAI	
IE	D	
IA	J	
32	UHI	
IB	L	
15	AH1	
00	EH3	
29	Y	
3E	PAI	
3F	STOP	
3E	PAI	

A

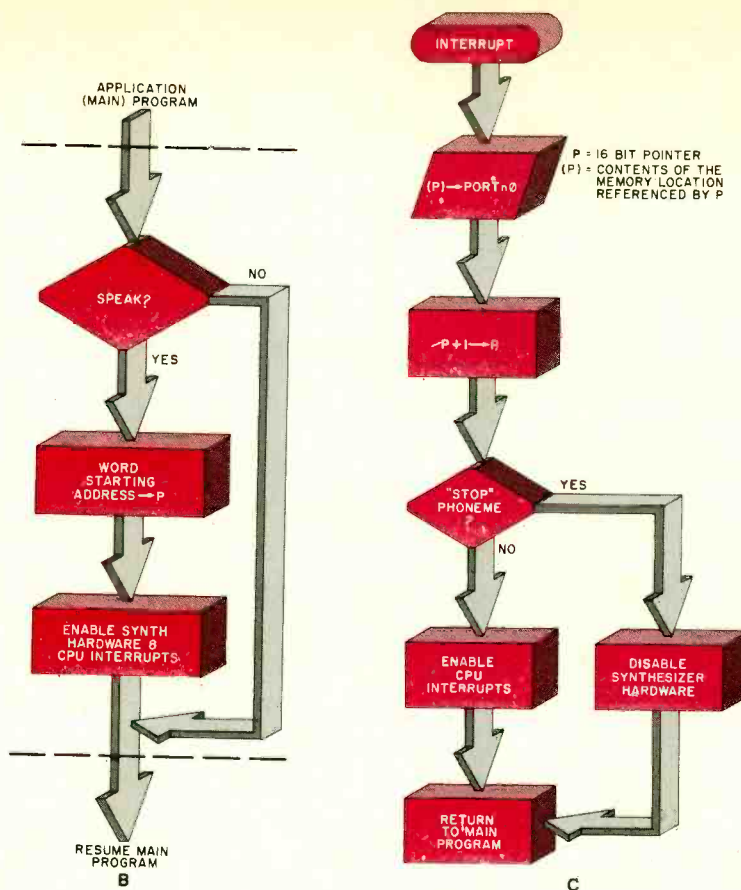

prising each word. Using Table I, select the phoneme symbols corresponding to each word sound, and enter them into the computer in the order of their occurrences in the words. Carefully listen to the synthesizer's output, paying particular attention to the proper durations of syllables and the rhythm of each word. Adjust the phoneme sequence as many times as necessary to achieve the desired pronunciation. Here are two examples:

Word: intruder

Initial sequence: I,N,T,R,U,D,ER

Refined sequence;

I1,I3,N,T,R,IU,U1,U1,D,ER,R

Word: amplifiers

Initial sequence:

AE,M,P,L,I,F,Y,ER,S

Refined sequence:

AE1,EH3,M,P,L,I3,F,AH1,EH3,AY,ER,Z

Once vocabulary words have been developed, the binary phoneme codes can be transferred to a ROM or look-up table in the computer's RAM for use with other programs. Fig. 8B illustrates a method of using the synthesizer with user-defined application programs, and a vocabulary look-up table (Fig. 8A). When a word is to be synthesized, the main program initializes an index pointer *P* to the beginning address (the first phoneme) of the desired word in the look-up table.

The computer's interrupt system and synthesizer hardware are enabled, and the main program resumes execution. The synthesizer servicing routine of

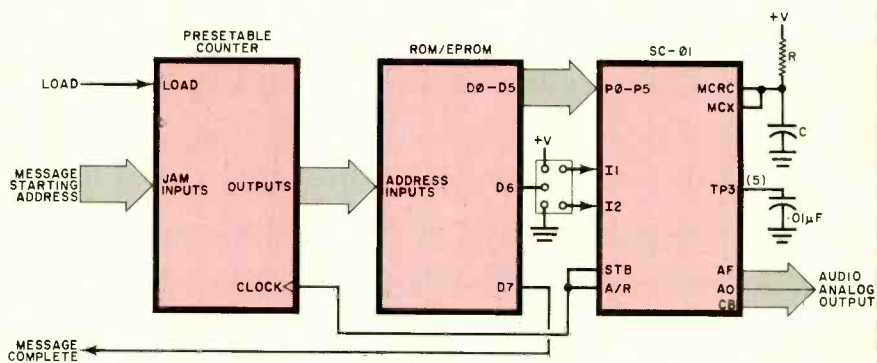

Fig. 9 Block diagram of a stand-alone, multiple-message speech synthesizer.

Fig. 8C is called each time the synthesizer hardware interrupts the CPU, i.e., whenever the synthesizer is ready to accept a new phoneme. Each time the routine is entered, the contents of the memory location referenced by the index pointer is sent to the phoneme data port of the synthesizer. The pointer is then incremented to the next location in the table, in anticipation of sending the next phoneme. A STOP phoneme (3FH) signals the end of the phoneme sequence for the particular word, and the CPU's interrupt system is re-enabled or left disabled depending on

whether the end of the word has been reached. Note that the two inflection bits (XIn) are included in bits 6 and 7 of the phoneme data byte (bits 0 through 5 are reserved for the actual phoneme code). The parameter control bits can also be updated in a similar manner.

Applications. Now that we have a means of developing vocabulary words for the synthesizer, let's explore some ways in which the synthesizer can be used. The most obvious is a talking computer terminal. With it, you can finally give your infallible electronic



The Computer Book Club

The ONLY Book Club dedicated exclusively to the special interests of microcomputer hobbyists and experimenters

... the latest books and software at the lowest prices!

Select 5 fact-filled books for only \$2.95 (total value up to \$94.75)



1416 List \$19.95 1414 List \$15.95 335 List \$14.95



1062 List \$12.95 1241 List \$12.95 1398 List \$14.95



7 very good reasons to try The Computer Book Club

Blue Ridge Summit, PA 17214

- **Reduced Member Prices.** Save up to 75% on books sure to increase your know-how
- **Satisfaction Guaranteed.** All books returnable within 10 days without obligation
- **Club News Bulletins.** All about current selections—mains, alternates, extras—plus bonus offers. Comes 13 times a year with dozens of up-to-the-minute titles you can pick from
- **"Automatic Order."** Do nothing, and the Main selection will be shipped automatically! But ... if you want an Alternate—or no books at all—we'll follow the instructions you give on the reply form provided with every News Bulletin
- **Continuing Benefits.** Get a Dividend Certificate with every book purchased after fulfilling membership obligation, and qualify for discounts on many other volumes
- **Extra Bonuses.** Take advantage of added-value promotions, plus special discounts on software, games, and more
- **Exceptional Quality.** All books are first-rate publisher's editions, filled with useful, up-to-the-minute information



The Computer Book Club

Blue Ridge Summit, PA 17214

Please accept my membership in The Computer Book Club and send the 5 volumes circled below, billing me \$2.95 plus shipping and handling charges. If not satisfied, I may return the books within ten days without obligation and have my membership cancelled. I agree to purchase 4 or more books at reduced Club prices (plus shipping/handling) during the next 12 months, and may resign any time thereafter.

- 335 336 337 338 806 1055 1062
 1088 1111 1160 1169 1205 1209 1241 1251
 1271 1275 1276 1295 1299 1330 1333
 1345 1391 1394 1396 1398 1414 1416 1466

Name _____ Phone _____

Address _____

City _____

State _____ Zip _____

(Valid for new members only. Foreign and Canada add 20%. Orders outside U.S. or Canada must be prepaid with international money orders in U.S. dollars.)
 This order subject to acceptance by The Computer Book Club PECC-1082

TABLE I.—PHONEME CHART

Phoneme Code	Phoneme Symbol	Duration (ms)	Example Word	Phoneme Code	Phoneme Symbol	Duration (ms)	Example Word
00	EH3	59	jacket	20	A	185	day
01	EH2	71	enlist	21	AY	65	day
02	EH1	121	heavy	22	Y1	80	yard
03	PA0	47	no sound	23	UH3	47	mission
04	DT	47	butter	24	AH	250	mop
05	A2	71	made	25	P	103	past
06	A1	103	made	26	O	185	cold
07	ZH	90	azure	27	I	185	pin
08	AH2	71	honest	28	U	185	move
09	I3	55	inhibit	29	Y	103	any
0A	I2	80	inhibit	2A	T	71	tap
0B	I1	121	inhibit	2B	R	90	red
0C	M	103	mat	2C	E	185	meet
0D	N	80	sun	2D	W	80	win
0E	B	71	bag	2E	AE	185	dad
0F	V	71	van	2F	AE1	103	after
10	CH*	71	chip	30	AW2	90	salty
11	SH	121	shop	31	UH2	71	about
12	Z	71	zoo	32	UH1	103	uncle
13	AW1	146	lawful	33	UH	185	cup
14	NG	121	thing	34	O2	80	for
15	AH1	146	father	35	O3	121	aboard
16	OO1	103	looking	36	IU	59	you
17	OO	185	book	37	U1	90	you
18	L	103	land	38	THV	80	the
19	K	80	trick	39	TH	71	thin
1A	J*	47	judge	3A	ER	146	bird
1B	H	71	hello	3B	EH	185	get
1C	G	71	get	3C	E1	121	be
1D	F	103	fast	3D	AW	250	call
1E	D	55	paid	3E	PA1	185	no sound
1F	S	90	pass	3F	STOP	47	no sound

/T/ must precede /CH/ to produce CH sound.
 /D/ must precede /J/ to produce J sound.

chess companion a personality with a voice. You can warp around an uncharted region of space as captain of the USS Enterprise as you receive verbal status reports from your crew. Realistic, simulated sounds of phaser fire, explosions, red alerts, etc. are also possible with the sound effect abilities of the synthesizer.

There are also many practical applications of the speech synthesizer. How about using its multilingual ability in a translation application, or giving a verbally impaired person a voice? There are many areas of education where a speech synthesizer might also be employed.

The SC-01 chip can be used in a stand-alone voice system by supplying it with phoneme-select code sequences from an address counter/ROM circuit, as shown in Fig. 9. Typical applications of such a system would be a talking clock or in robotics, where fixed vocabularies are acceptable.

As a final application example, let's see how a speech synthesizer can be used in the home.

Using an 8080-based CPU module (See "Designing with the 8080 Microprocessor, Part 2," POPULAR ELECTRONICS, October 1981, p.80) an "electronic helpmate" can be constructed. The operating program, speech recognition word templates, and speech synthesizer vocabulary (look-up) tables are stored in the CPU module's EPROM memory. Lights and appliances can be controlled from a remote control system (such as Radio Shack's *Plug'n Power* control center), which is interfaced to an output port of the CPU module. A 12-V battery back-up circuit powers the critical security portion of the system in the event of a power failure as shown in Fig. 10.

In this approach, the primary inputs to the system are verbal commands via

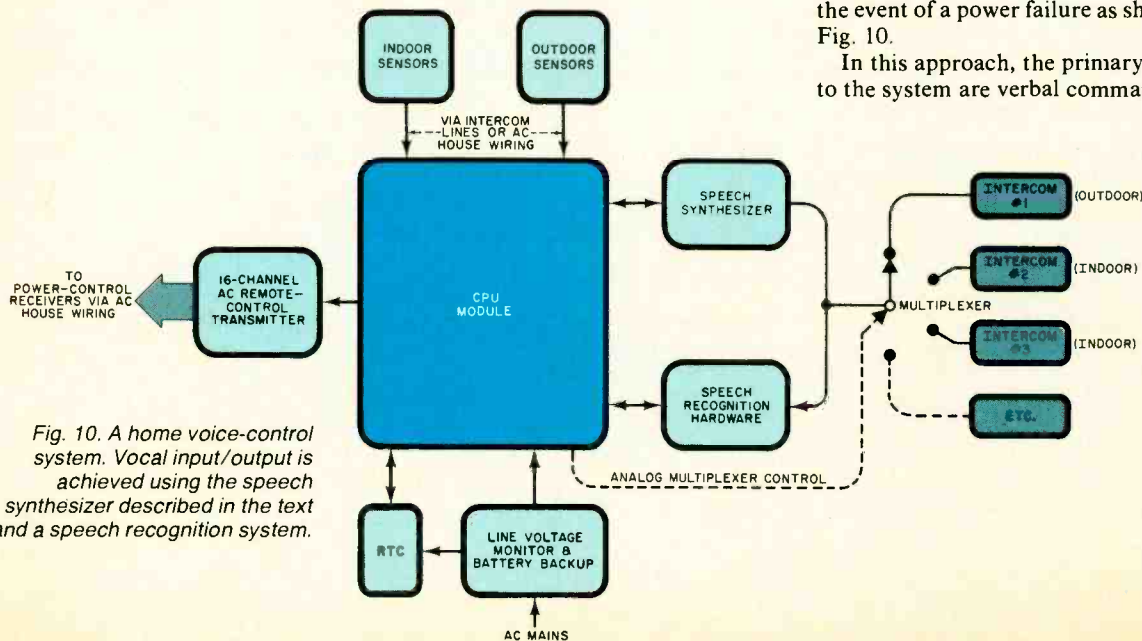
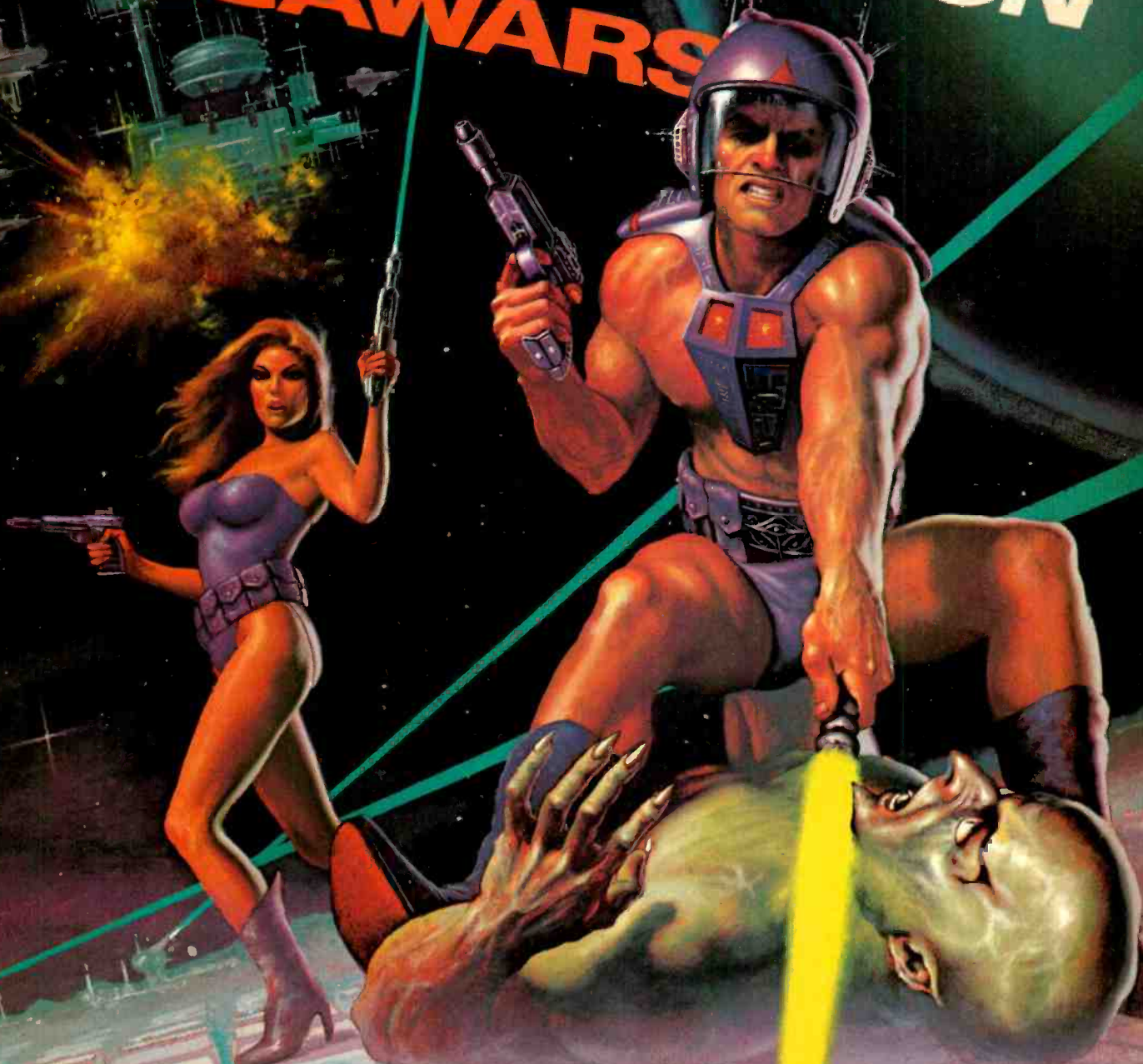

Fig. 10. A home voice-control system. Vocal input/output is achieved using the speech synthesizer described in the text and a speech recognition system.

CRUSH THE KRYON EMPIRE IN ENLIST MEGAWARS



MegaWars, a real-time space battle

between the forces of the Colonists and the Kryon Empire. Join an intergalactic shootout with up to eight starship commanders transmitting orders from the keyboard cockpits of their craft anywhere in the U.S.A.

THE ULTIMATE COMPUTER CONFLICT

Attacking, evading, scanning, communicating. That's MegaWars. Easy to learn but difficult to master. That's why CompuServe will give one free hour to every MegaWars player entering a game before December 31, 1982.

Call toll free
800-848-8990.

You'll receive the illustrated guide to CompuServe, America's most comprehensive Videotex service, plus the MegaWars Commanders Briefing.

CompuServe

5000 Arlington Centre Blvd.
Columbus, Ohio 43220
800-848-8990

CIRCLE NO. 17 ON FREE INFORMATION CARD

"It's all in that box, hunh?"

Introducing the all-in-one dbx Model 228 Dynamic Range Expander/Disc Decoder, Noise Reduction System/Disc/Tape. It gives you 50% more dynamic range from any source and better than twice the noise reduction of a Dolby C*-type noise reduction system. It also decodes dbx Discs—considered the best audiophile discs in the world.

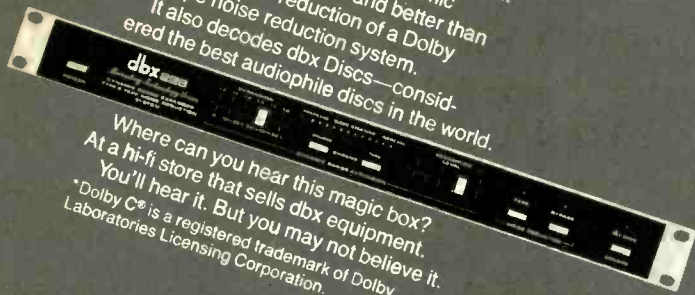

Where can you hear this magic box?
At a hi-fi store that sells dbx equipment.
You'll hear it. But you may not believe it.
Dolby C is a registered trademark of Dolby Laboratories Licensing Corporation.

dbx. Music can't live without us.

dbx, inc., 71 Chapel St., Box 100C, Newton, Mass. 02195 U.S.A. Tel. (617) 964-3210, In Canada: BSR (Canada) Ltd
CIRCLE NO. 55 ON FREE INFORMATION CARD

28K Commodore VIC Personal Computer **\$259** (60% more powerful than VIC-20)

FOR THE SPECIAL SALE PRICE OF **\$259.00**, you get the Commodore VIC-20 computer, plus we add 60% more programming power. This powerful full sized extra featured computer includes the 6502 microprocessor (LIKE APPLE), 20,000 bytes ROM with a 16K extended microsoft LEVEL 11 BASIC, 8000 bytes user RAM, plug in expandable to 32K RAM, 66 key typewriter professional keyboard with graphic symbols on keys, 16 colors with command keys, sound and music, real time, upper/lower case, full screen editing cursor, floating point decimal and trig functions, has high resolution graphics, 512 displayable characters, test display is 23 lines, 22 characters, will accept TAPE-DISK-PLUG IN CARTRIDGES. We have great games and many other programs. It has low cost, direct plug in peripherals, does not require an expensive interface board for modems, printers or floppy disks, connects to any TV, includes AC adapter, RF modulator, switch box, self teaching instruction book, 90 day immediate replacement warranty, comes in a beautiful console case for only \$259. (You can get a 41K COMMODORE VIC for \$339) We stock more VIC-20 programs than anyone!—Write for free catalog!

15 DAY FREE TRIAL. Return within 15 days complete and undamaged for refund of purchase price.

DON'T MISS THIS FANTASTIC SALE!! Phone 312-382-5244 to order and get delivery in 2 to 7 days, or send a certified check, money order or personal check to: **PROTECTO ENTERPRIZES, BOX 550 BARRINGTON, ILL. 60010. WE HONOR VISA AND MASTER CHARGE**, ship COD. Add 10.00 for shipping, handling, insurance. Illinois residents add 6% tax.

speech synthesizer

intercoms located in strategic locations of the house. The CPU module "decodes" the verbal commands using an integrated speech-recognition system and processes them accordingly. The speech synthesizer's output is also piped throughout the house using the intercom system. If but even one *wireless* intercom is used, adding a "terminal" at any location is as easy as plugging the intercom into the nearest outlet. This technique may be carried a step further to even include two-way radio links to the CPU module. Thus, there are many applications possible with this type of I/O.

A real-time clock (RTC) can be employed to facilitate time and date-related functions of the system. These functions may include remembering an appointment, pseudo-randomly turning house lights on and off as a security measure, turning an electric blanket or coffee pot on or off, or announcing the time. These functions can be invoked by verbal commands from any intercom location in the house.

Various sensors installed around the house and premises communicate with the CPU module via the intercom system or via simple remote transmitters installed in the vicinity of each group of sensors. Each sensor generates a unique frequency (in the ultrasonic range) when triggered, thereby enabling the CPU module to identify the triggered sensor(s) and take appropriate action.

To eliminate much of the unsightly wiring, each sensor may utilize an infrared emitter, which is driven at the sensor's unique assigned frequency. An infrared detector in each remote transmitter (or intercom) receives this infrared energy, and relays the sensor's frequency ("device code") to the CPU module via the house wiring (or intercom system) for detection. The detection circuitry basically consists of a frequency-to-voltage converter connected to the input of a dot/bar display driver IC operating in the "dot" mode. The outputs of the display driver are connected to an input port of the CPU module for sampling. LEDs connected to these outputs also provide a visual indication of the sensors' status.

Besides the types of sensors depicted in Fig. 10, the sensors may also include dual infrared beams across doorways, allowing the CPU module to keep track of the number of people in each room of the house. The CPU module may use this data to turn lights off automatically when the last person has left the room, or to "talk" a burglar out of the house (such as after a pre-specified time of night or whenever the house is supposed to be unoccupied). ♦

**“Our reputation rests on
digits, decimal points, and details.
We wouldn't trust them to anything less
than Scotch® Brand Data Cartridges.”**

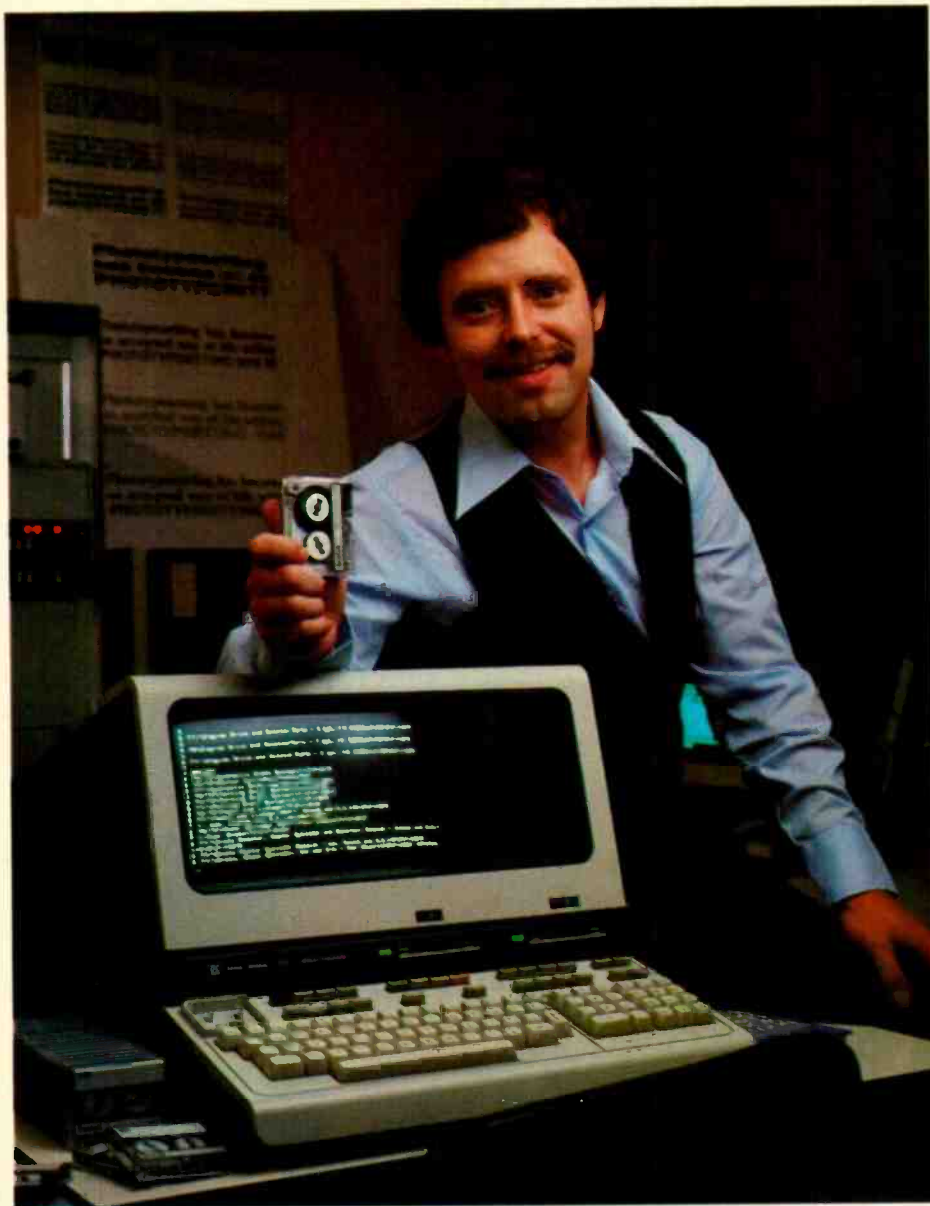

**Bill Birkett, Vice President,
Trade Graphics, Inc.,
Livonia, Michigan**

The unique design of a data cartridge provides great reliability, high storage capacity and long tape life. And where could you possibly get better data cartridges than Scotch Brand, made by 3M, the people who invented the data cartridge system itself?

3M controls every step in manufacturing. Top quality magnetic tape and precision components are part of every Scotch Data Cartridge. Over twenty-five years of service to the computer industry assure you of the utmost reliability.

Scotch Data Cartridges are available in miniature DC 100A, the standard-size DC 300A and now, an extra-length DC 300XL with 50% more storage capacity. They are compatible with most cartridge systems including Hewlett-Packard, IBM, NCR, Tektronix and TI.

To find out where you can find Scotch Data Cartridges or virtually any other data recording medium, call toll-free: 800-328-1300. (In Minnesota, call collect: 612-736-9625.) Ask for the Data Recording Products Division.

**If it's worth remembering,
it's worth Scotch
Data Recording Products.**

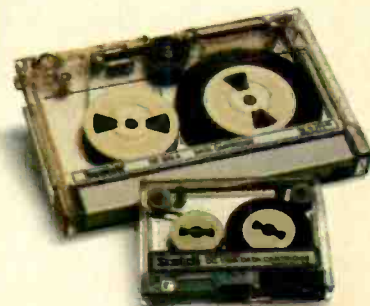

3M



Try this with an ordinary computer.

Epson.

The new Epson HX-20 is no ordinary computer. Not by a long shot. It's the world's only Notebook Computer with the power of a desktop and the portability of a handheld.

So you can do serious computing, data processing, even word processing. Anytime. Anywhere.

To start with the HX-20 has 16K RAM (optionally expandable to 32K), 32K ROM (optionally expandable to 64K), RS-232C and serial interfaces, a full-size ASCII keyboard, a built-in micro-printer with dot addressable graphics, a scrollable LCD screen, five programmable function keys, and . . . well, that's just the beginning.

The HX-20 is small enough to tuck inside a briefcase or under your arm. It runs on internal power for 50-plus hours and recharges in eight. It lets you interface with peripherals like MX Series printers, the CX-20 battery-powered acoustic coupler, a barcode reader, and audio cassette. And you can even get it with options like a micro-

cassette drive, ROM cartridge, floppy disk and display controller.

Now, prepare to have your mind boggled by one more feature: the price. The Epson HX-20 Portable Notebook Computer retails for less than \$800. That's right — less. Which means it's just right for students, businesspeople, kids — anybody who's looking for an affordable way into serious computing.

Powerful. Portable. Affordable. The HX-20 is just what you'd expect from Epson.

The extraordinary.



EPSON
EPSON AMERICA, INC.
COMPUTER PRODUCTS DIVISION

3415 Kashiwa Street • Torrance, California 90505 • (213) 539-9140
CIRCLE NO. 59 ON FREE INFORMATION CARD

www.americanradiohistory.com

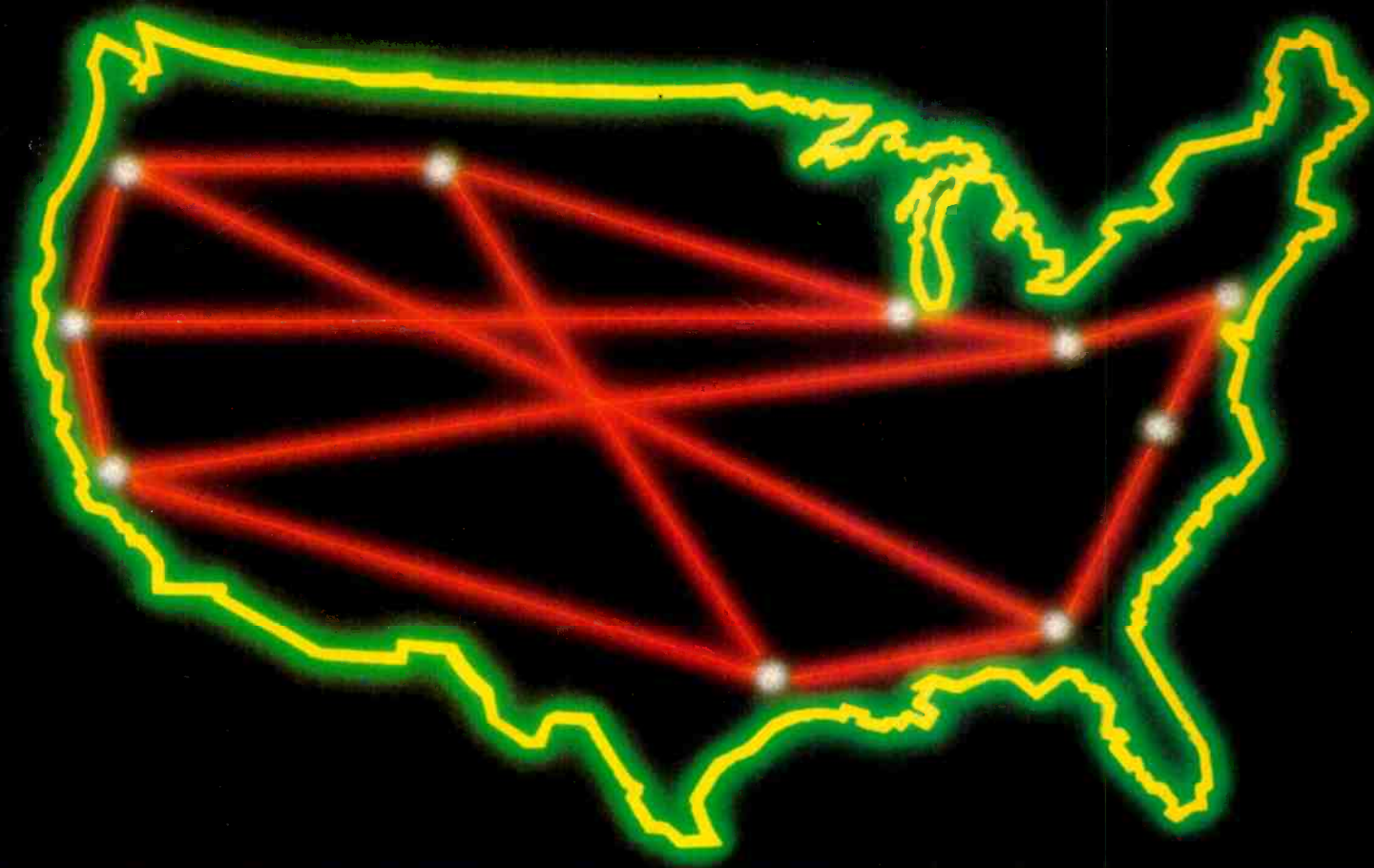

Communications Networks for Computers

BY STAN VEIT

THE American telephone system spans the nation and reaches into almost every home, store, factory and office. It's also connected by cable and satellite into an international network that enables us to talk with people all over the world just by dialing a number. This familiar communications network was originally designed for voice transmission, but nowadays it's also used to transmit digital data.

In this article we'll explore the communication networks that use telephone lines to transmit digital information. We'll take a look at the companies that provide the information, learn how to use their services, find out what they cost, and how to access them. Finally, we'll investigate other avenues of communications like television cable and local computer networks.

Data-Communication Networks. There are many data-communication networks that transmit digital data across the country. They receive the data from local sources and compress it into "packets" that are sent in a continuous stream from point to point. At the destination, the data is routed over local lines to receiving terminals. As a result of this efficient utilization of transmission time, the data networks can charge much less than if an individual leased a line from AT&T for computer-to-computer communication.

The principal companies in this business are Tymnet, which is part of a computer time-sharing company called Tymshare, and G.T.E. Telenet. It's expected that American Bell, the new data-communications subsidiary of AT&T,

*Communications and information transfer
expand the ability of small computers*

NEC's crisp, clear, high-performance JC1202 RGB color monitor, an industry standard. Also available, the JC1201 composite video version.

NEC's classic JB1201 green monitor, one of microcomputing's performance legends. Easy on the eye, and the checkbook.

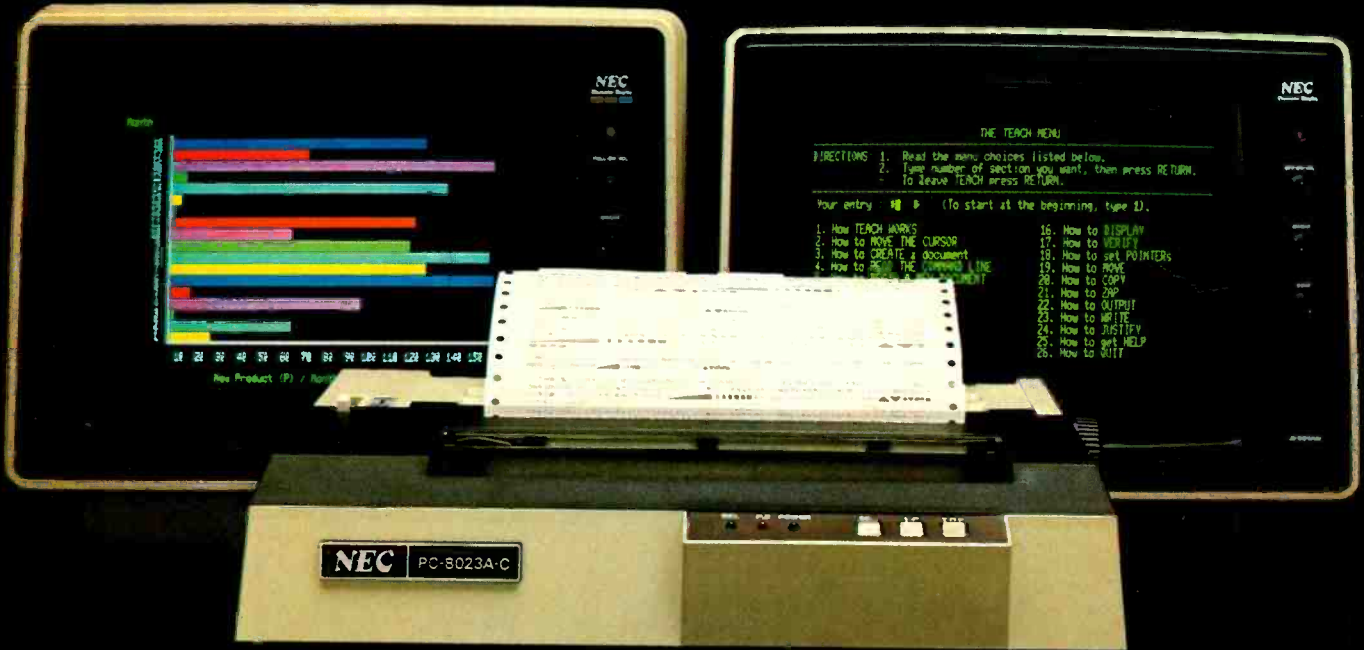

Our impressive new NEC dot matrix printer. Parallel interface, 100 cps, 2k buffer, pin or friction feed. Stunning performance and compatibility in the hottest new peripheral of the year.

Give your IBM system some NEC, and watch its performance soar.

You don't need an all-NEC system to benefit from NEC peripherals.

Our sparkling new JC1203 color monitor is plug and pin compatible with the 16-color IBM® PC, and delivers the bright, sharp, clear, and stable screen image for which the entire NEC line has long been famous. Similar compatibility is available to owners of Apple II®, Radio

Shack®, and Atari® computers, not to mention our own outstanding NEC PC-8000 series. Also available is a brand new, extremely low cost, NEC green monochrome monitor, the JB1260, perfect companion for an Osborne®, for instance.

Ask your dealer for a demonstration. Or write us at 1401 Estes Avenue, Elk Grove Village, IL 60007.

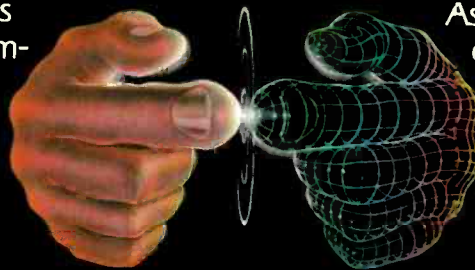

**Productivity
at your fingertips™**

NEC

**NEC Home Electronics (U.S.A.), Inc.
Personal Computer Division**

Nippon Electric Co., Ltd., Tokyo, Japan

THE ELECTRONIC WORLD

and IBM will become very active in this field. Telenet and Tymnet are providing most of the data-communication services for the computer information networks.

Computer Networks. In general, computer networks are groups of computers connected by wires, sharing large resources such as printers and data storage devices. However, the term "networks" has become one of the buzzwords of the decade and has been used to describe several very different operations. For example, computer networks are quite different from time-sharing systems. A time-sharing system has one or more large computers at a central location. Clients use remote terminals to access the computers and then use them as if they were in the same office. The computer network also has one or more large computers accessed by remote terminals. However, the large computers provide predetermined information services and some computing services. Typical of the information services they provide are newspapers and magazines, electronic mail, banking and purchasing, reservations and travel, games and personal communications.

Two of the largest networks were started several years ago by time-sharing services as a method of using their large computer and communications resources during the hours when businesses were closed. The Source (1616 An-

derson Road, McLean, VA 22102) and CompuServe (5000 Arlington Centre Blvd., Columbus, OH 43220) were the first of the public computer information networks and are still the most prominent.

On a smaller scale, Dow Jones Electronic News Service, once a local service for Wall Street users, is now a national information network providing a variety of financial services.

Lockheed Information Services, Palo Alto, CA, started a "data base of data bases" and it has grown to be the largest source of research information in the world. Called Dialog, it provides index information on the contents of thousands of data bases.

There are many other specialized networks, some of which are described later in this article. Furthermore, new companies are entering the field every month. American Bell says it will provide services that are extensions of the business of moving data. It is thought that they may offer information services.

Another new company has been started by Kemmons Wilson, the founder of Holiday Inn. He will franchise local outlets for a new computer information utility called INC Telecommunications, which will use the satellite facilities of National Public Radio. Steven G. Wozniak, one of the founders of Apple Computer, has been engaged to write the software needed for the new system.

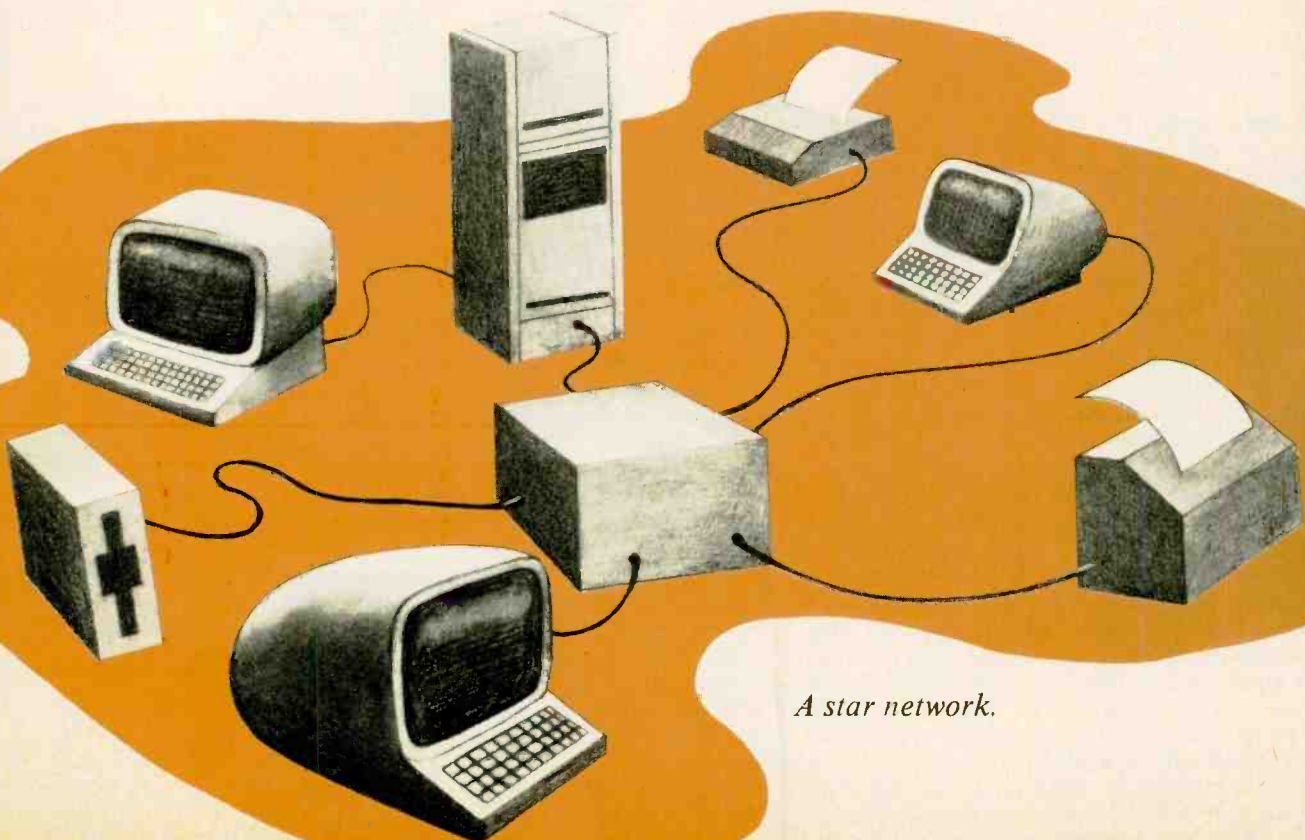

A star network.

Network Costs. Naturally, these computer services all cost money. The subscriber pays an initial fee when he joins the network. An ID number is assigned and the subscriber chooses a secret password for his account. The charges for use of the network are calculated by the length of time that the subscriber is connected and for any extra services he orders. There are higher charges for service during "prime time" business hours.

In addition, when special commercial and financial services are accessed, extra charges are common. For example, Dow Jones may be accessed from CompuServe at an extra charge. Other special services are extra, too. For instance, most of the computer language manuals are charged to the subscriber's account, as are special printing services and diskette copies of software. Payment for the network service is charged to the subscriber's credit card. Moreover, the initial registration fee covers only a minimum amount of disk storage, with extra storage available at additional cost. Also remember that, in addition to the network's fees, the user must pay for telephone service.

Network Operation

THE Source and CompuServe operate similarly, but there are differences that make the use of each a separate experience. To illustrate this, we will discuss the operation of each system.

CompuServe. This is a network service operating out of Columbus, Ohio. It is a subsidiary of the H&R Block company. A CompuServe subscriber joins the system after paying a modest fee of about \$20, which includes an hour of use. Usage time is \$5 per hour except for "prime time" hours when it is higher. The new subscriber is given a questionnaire, an I.D. number, and a password.

The user dials a local-access number and waits for a high-pitched tone. Then he places the telephone handset into the rubber cups of an acoustic-coupler (or similar type) modem. If a direct-connect modem is used, the procedure is slightly different. You call the local number using the phone or the computer keyboard (depending on the modem) and the connection is made automatically. At this point, the system begins communication with the caller. The system prompts the caller to identify himself as a subscriber, and the caller responds by entering an identification number and password. This is called the system sign-on (or log-on). It not only identifies the caller, but adjusts the system output to the precise equipment he is using. The subscriber is now confronted with the top level of the system menus. He then makes a selection from one of the following broad subject ar-

reas: Business And Financial Services, Personal Computing Services, or Home Services.

The business services include stock and commodity data bases and quotation services. Electronic mail service is also provided. The home services provide computerized banking, buying and selling of merchandise, local and national news, and schedules for airlines, trains, buses and theaters. You can make reservations and purchase tickets through this service. A subscriber can also contact other subscribers all over the country in a simulation of CB radio. He can use the free noncommercial classified ads on the system. In addition, there are bulletin boards maintained by publications or by the various computer manufacturers. They use this service to inform owners of the latest fixes and modifications to their equipment, and sometimes provide software support.

This magazine, as a pioneer in electronic publishing, maintains an edition of POPULAR ELECTRONICS on CompuServe. To access it, enter GO PEM-1. Besides columns by the staff editors and

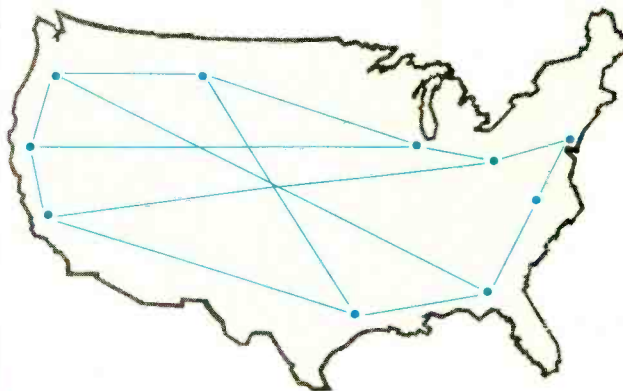

writers, it also has a SIG (Special Interest Group) where people can request information or help from the magazine's staff. The advantages of this "quick reaction" service over normal mail are obvious.

Electronic communications, news, and data bases are not the only attractions of CompuServe. There are computer games available, too, including nationwide contests that test your computer gaming skills.

Personal computing services involve the interactive use of the large computing facilities by subscribers. To a user connected to the network computer, it seems as if he were using his own machine. Many different computer languages are offered and the user can store his work and data on the system disks. Computer printout services are also available at network headquarters, with the results delivered to customers by mail or UPS.

The public access area is another personal computing service that can be utilized by subscribers. It features a user-donated software exchange where programs in the public domain can be downloaded from the CompuServe data storage to the subscriber's own disk system. However, not all of the software is free. There are companies that sell programs over the net-

Autosound Sale!

Save \$60



Display Dimmer

Locking Rewind

Stereo/Mono

Auto Eject

Locking Fast Forward

Manual Eject And Clock Display

33% Off Our AM/FM Stereo Cassette With Digital Frequency Display/Clock



Easy Do-It-Yourself Installation—Includes Both a Trim Plate for In-Dash Mounting and a Nosepiece for Under-Dash Use. Shafts Adjust From 5¹/₈ to 6⁵/₁₆" (130 to 160mm).

Enjoy great listening with this sensational auto-sound value! Now you can get our Realistic® AM/FM stereo cassette with LED digital station frequency and time display at one-third off our regular low price of 179.95. Designed for mounting in dash of most domestic mid or full-size cars, mounts conveniently under dash in others. Built-in quartz clock displays the time when playing cassette or when radio is off, shows exact station frequency when listening to the radio. Delivers great sound with 14 watts total output. Locking fast forward and rewind help you find tape selections quickly. Cassette ejects automatically at end of tape in all modes or when ignition is turned off. Also has electronic manual eject. Size: 7 x 1³/₄ x 5¹/₈" (178 x 44 x 130mm). Nosepiece: 4¹/₈ x 1³/₄ x 1³/₈" (105 x 44 x 35mm). Hurry in and save! #12-1889. Now only 129.95. Sale ends Oct. 31, 1982.

Radio Shack®

A DIVISION OF TANDY CORPORATION

Retail price may vary at individual stores and dealers

THE ELECTRONIC WORLD

work. The advantage to buying software this way is that you can try a demo program before you buy, and you can get delivery at once.

There is a feeling of excitement that you get when using CompuServe because there's so much to try and to learn. Some of this enthusiasm is generated by personal messages from the "sysops" (system operators). These are volunteers who run the various bulletin boards. They act as moderators, instructing newcomers and helping them become part of the group. Sysops develop a following who may "tune-in" to listen and talk with them just as people follow talk shows on radio and TV. In any event, the sysops are an attraction on CompuServe because they humanize an otherwise regimented process of menu selection from one level to another.

To heighten subscriber's interest, CompuServe publishes a monthly magazine, *Today*, that all members receive at no additional cost along with a newsletter called *Update*. These publications generate interest in using the network and the many services that are available.

The Source. This is a public information utility operated by The Source Telecomputing Corporation, a subsidiary of The Readers Digest Association. It operates from a bank of large Prime computers in McLean, VA, and it is accessed over the facilities of Telenet and Tymnet in much the same way as CompuServe. The initial fee to join the Source is \$100. The evening, weekend, and holiday hourly rate is \$7.75 while after midnight the rate drops to \$5.75. Prime time hourly rates are significantly higher.

The sign-on procedures for The Source are

almost identical to those on CompuServe, except that the subscriber always uses either Telenet or Tymnet to access the system. The only direct access is in the area around Washington, D.C. and Northern Virginia, where the main computer is located.

The Source offers the same type of services as CompuServe but there is less variety. For example, the only local newspaper on The Source is the N.Y. Times. The Source is a network of data bases that are accessible in two ways. You can call a database after obtaining its address from The Source index; or you can find information through a command level from which other levels are connected through a hierarchy of menus.

The Source features communications, information, and computer services. In the communications area they offer electronic mail, "Chat," and "Post." The electronic mail service allows you to send messages to any other subscriber, while Chat allows you to have an interactive dialog with another subscriber who is on line the same time you are. Post is a free classified ad bulletin board. Information abounds on The Source. It features 36 categories of news and commentary on business and financial markets, plus abstracts from leading financial publications. Prices on stocks, bonds, commodities, metals, money-market certificates, federal notes, and bills are given from all the major markets and from the over-the-counter market. Compu-U-Star is a discount shopping service that is accessed on The Source and offers savings to members on high-ticket items such as



THE ELECTRONIC WORLD

cars, appliances, furniture, and electronic equipment.

Through the The Source you can get airline schedules, travel tips, and reservations for airlines, hotels, and tours. They also have restaurant reviews that can be a big help to a business person who wants to know where to eat and entertain while traveling. The Source also offers subscribers games, bulletin boards, and personal computing services. An unusual service is called the User Publishing section. In this area, users are encouraged to publish anything they want, provided they do not exceed the standards of decency or violate the rights of others.

If you access The Source through the index, it's like being all by yourself in a big library where you can use the card catalog to find out where the book you need is located. You can then go to the correct stack where you locate the right shelf and find the book you want.

The Source doesn't seem to be as interactive as CompuServe. True, The Source has the Chat area where you can talk to others, but I have never found anyone home to talk to! When you want specific information such as airline schedules, The Source may be quicker to use, and it has been said that the data bases available on The Source are more complete and thorough. But CompuServe seems to be a bit more friendly, a place where you not only can find information but also interact with others.

Dow Jones News/Retrieval. This service offers subscribers prices, news, and analysis of

all major security and commodity markets. It provides in-depth information on all factors that affect the financial community and enables subscribers to evaluate the performance of their own portfolio against that of the leading money managers. Many subscribers prefer the expertise that Dow Jones is known for. The Dow Jones service not only provides the market activity of a company, but gives all the news about that company. Stock prices are maintained on a current basis, and past performance information is available, too. The Dow Jones service is available through Apple dealers, Commodore dealers, and Radio Shack stores.

Lockheed's Dialog. Many of the largest information networks are devoted to the retrieval of scientific, medical, and legal information. The largest and oldest of these is Lockheed's Dialog (3460 Hillview Ave., Palo Alto, CA 94304). It is the key to hundreds of data bases on every subject from agriculture to zoology. These data bases contain information concerning business/economics, government and foundation grants, current research, research papers, humanities, arts, law, medicine, science, technology, engineering, and just about every other subject known to mankind.

A researcher skilled in the use of Dialog can find bibliographical references and abstracts on any subject. Actually, these references to database information are all that the system contains, but normally that's all that is needed. The actual documents can be ordered once the researcher knows where they are. A minute with Dialog is worth hours, or days, of research in libraries.

Dialog does not require complicated equipment to access it. Simple personal computers



Topology of a loop network.

THE ELECTRONIC WORLD

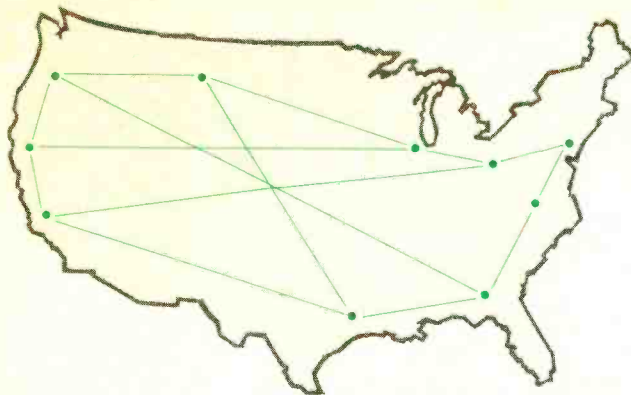

or dumb terminals can be used. However, the researcher must know how to use the system, and that is not simple. In fact, there are people who research Dialog for others for a fee. There is a database of databases, called Dialindex, used in Dialog to find the proper data base to conduct a search for a subject. In addition there is a related service called Dialorder used to order the documents you find with Dialog.

Other Networks. Mead's Lexus is a law database which requires a special terminal to access it. A database in a much different subject area is Aero Net of Titusville, FL, which connects aircraft dealers all over the United States in a trading and multi-listing network. The development of business information and sales networks like these may become the most important marketing concept of the 1980's.

The *New York Times* owns The Information Bank which provides on-line information derived from the newspapers. This information bank is now available on The Source.

Graphnet (329 Alfred Ave., Teaneck, NJ 07666), although not an information bank, is a service that provides electronic teletype interface to subscribers. A personal computer can be used to access the major teletype systems and to send and receive messages.

EIES (Electronic Information Exchange System) is a nationwide independent computerized network originally funded by the National Science Foundation. It is now operated on a membership basis. Users sign in through Telenet.

The Plato network was originally developed at the University of Illinois. Now owned and operated by The Control Data Corp. (P.O. Box O, Minneapolis, MN 55440), it is an interactive learning system that has courses on many subjects. Plato produces its lessons on "pages" with which the student interacts by means of a keyboard. Each page asks questions and produces new pages as the result of the student's answers. Because of the high cost of a Plato terminal (around \$5000), it is used at Control Data Learning Centers throughout the United States.

The networks mentioned here are just a sampling of those that are available; and new ones are added every month. Since some are devoted to one industry, one profession, or one scien-

tific discipline, they rarely come to our attention. However, we will become more aware of them in the future as colleges and public libraries make their services available to the general public.

Computer Bulletin Boards. Some computer hobbyists are also radio amateurs who have a tradition of regular interactive communication. Because of an FCC ban on the transmission of ASCII code by ham radio, these hobbyists established computer bulletin boards. The development of the TRS-80, Apple II, and PET personal computers provided the other necessary element for the spread of computer bulletin boards. Here for the first time were large groups of identical computers. This meant that standard bulletin board programs could be used and anyone with the proper equipment could call in and use the service.

The software to operate these bulletin boards was developed by a number of individuals. Ward Christensen and Randy Seuss were the original developers of the Computerized Bulletin Board™ software. Their concepts were extended in the formation of ABBS (Apple Bulletin Board System) for Apple, Forum-80 for Radio Shack TRS-80 computers, PAN for PET computers, and RBBS (Remote Bulletin Board System) for CP/M-based computers. The services provided by these computer bulletin boards, in addition to message transmission, include the distribution of public-domain software collected by Apple, TRS-80, and CP/M user groups.

Most of the computer bulletin boards are sponsored by computer clubs and user groups. The management of the computerized bulletin board is done by a system operator who often owns the equipment. The system consists of communications software, the computer, disk drives, and a modem.

The bulletin board program starts the computer when a call is received. The caller can then "sign-on" and receive the information on the bulletin board. In some cases, the caller can leave a message of his own. When the caller disconnects, the software system detects the disconnect, "hangs up the phone," and awaits the next call. Some of these bulletin boards have enough capacity to transmit a complete club newsletter.

Telephone numbers and time of operation for many club bulletin boards are listed in magazines covering club activities. AMRAD (Amateur Radio Research Corp., 1524 Springdale Ave., McLean, VA 22101) has a list they will send for \$1.00. The Source and CompuServe also list locations and information regarding the CBBS as part of their services to clubs.

Accessing Networks

A NETWORK subscriber need not own a computer to use the services of the networks.

THE ELECTRONIC WORLD

All that's necessary is a "dumb" terminal and a communication interface. Several advertisers in this magazine offer low-cost terminals capable of connecting to the various services.

In addition, low-cost computers such as the Radio Shack Color Computer, the Commodore VIC-20, and TI-99/4A can be used with communications peripherals. Timex/Sinclair plans to offer a modem for its Model 1000/ZX81 \$99.95 computer. The Panasonic/Quasar hand-held computer has a communication interface and other pocket models like those from Casio, Epson, Radio Shack/Sharp, and others are expected to follow suit. A pocket terminal was recently introduced by IXO. A network subscriber can now carry the terminal, or computer, in an attache case and communicate with the network from a telephone booth anywhere in the country.

The small computer owner can use his equipment without a disk drive, using the mass storage of the network, or he can obtain software that will permit loading of data from the network onto his own disk. This is called downloading. Data stored on the local computer disk can also be transmitted to the network. This is called uploading. Both techniques extend the capabilities of the subscriber's computer. A typical application might consist of transmitting programs or data from a subscriber in New York to one in

Los Angeles. The NY subscriber would upload the data to the network and give permission for the LA user to access it. The LA user can then download the information or program. It is that simple.

Modems. Modems are the connecting link for all of the services we have discussed in this article. A modem is the translating element between the computer and the telephone system. It would be very convenient to be able to directly transmit or receive information on our computers (or terminals) via the telephone. The trouble is that the output from computers or terminals is a series of digital pulses. Our telephone system was only designed to transmit human speech.

This problem is solved by converting the digital output into a series of audio tones that can be transmitted over the telephone line. The same thing is done to record computer data on an audio cassette. Converting the data from digital pulses into audio tones is called modulation. Going from audio tones back to digital pulses is called demodulation. The device that does this is called a "modulator/demodulator" or modem for short. This is the device we need to communicate digital data over the standard telephone lines.

In most systems, we use tones of one frequency to signify a logic "one" and tones of a

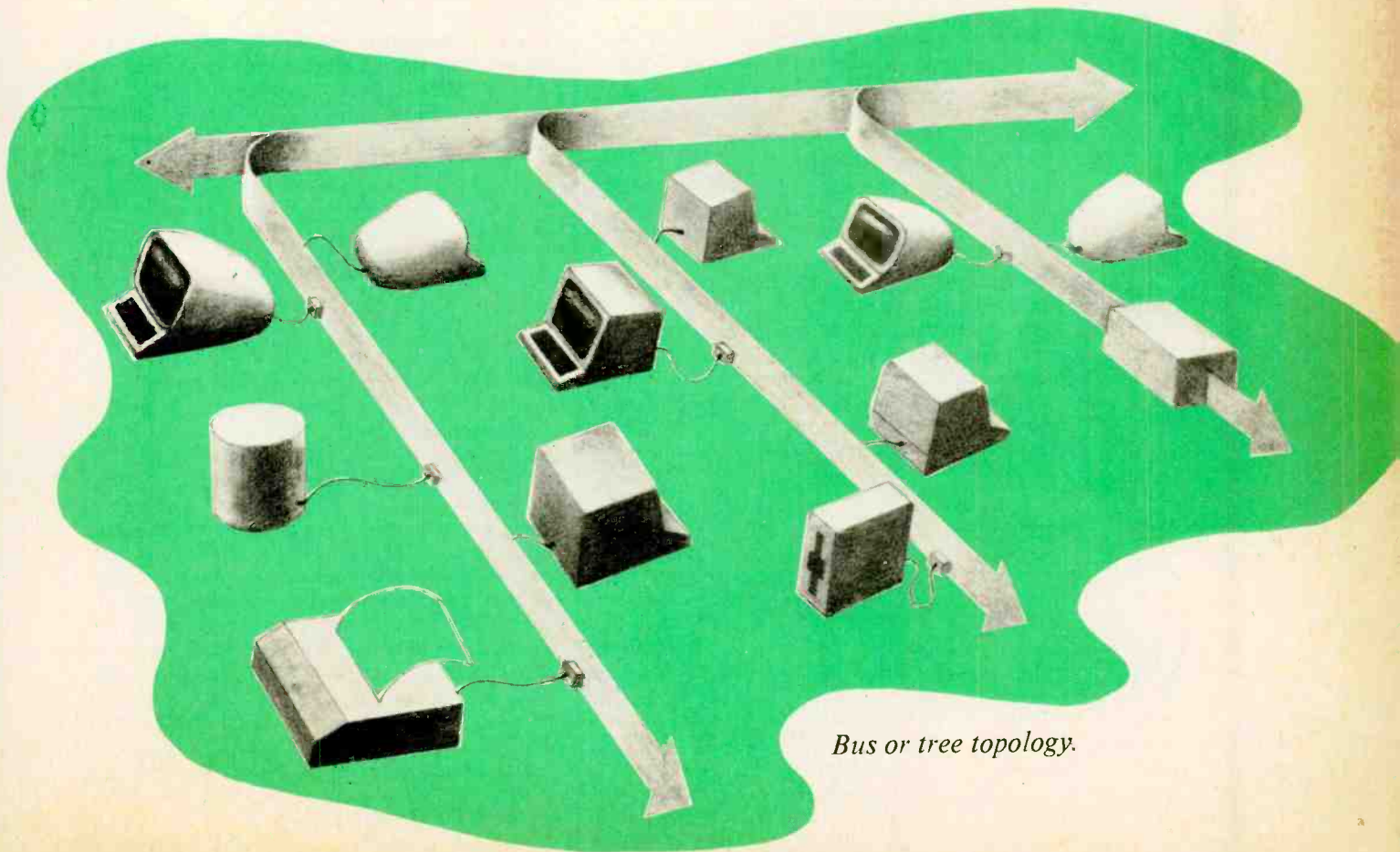

Bus or tree topology.

different frequency to signify a logic "zero." When we change or shift the tones to correspond to the ones and zeros in the data stream, it is called frequency-shift-keyed modulation (FSK).

With an audio-cassette system, data travels in only one direction at a time and, therefore, only one set of tones is required. However, in a bi-directional telephone transmission there would be a problem with only one set of tones. Data can be sent both ways over the same set of wires (called full-duplex) but it wouldn't work if the same set of tones were used to transmit data in both directions. Therefore a modem uses two sets of tones. One set of tones (1070 Hz for zero and 1270 Hz for one) is used for originating data. Another set of tones (2025 Hz and 2225 Hz) is used for receiving data. If your computer were connected to The Source, for example, you would be the originating system and your data would be sent with tones of 1070 Hz for zeros and 1270 Hz for ones. The Source computer would answer you with tones of 2025 Hz for zeros and 2225 Hz for ones.

If you use your modem to call up network systems you need an "Originate Only Modem" which has a 1070/1270-Hz modulator, and a 2025/2225-Hz demodulator. If you also receive calls, you might need an answer modem with a modulator using 2025/2225 Hz and a demodulator using 1070/1270 Hz. It really doesn't matter which set of frequencies is used as long as there is agreement between both ends.

When the data is transmitted over the telephone system, noise on the line is likely to interfere with the communication if the data is transmitted too fast. Therefore, most data transmissions are done at 300 bits per second maximum. This rate is also called 300 baud, and it results in a transfer speed of about 30 characters per second. But there are special modems that can transmit at 1200 baud. For really high-speed data communications, data is transmitted over specially conditioned low-noise lines at a rate up to 9600 baud.

To simplify the connection between the computer and the telephone system, there are modems that use the transmitter and receiver of an ordinary telephone handset to make the connection. The telephone instrument is placed into rubber cups to minimize the noise. This type

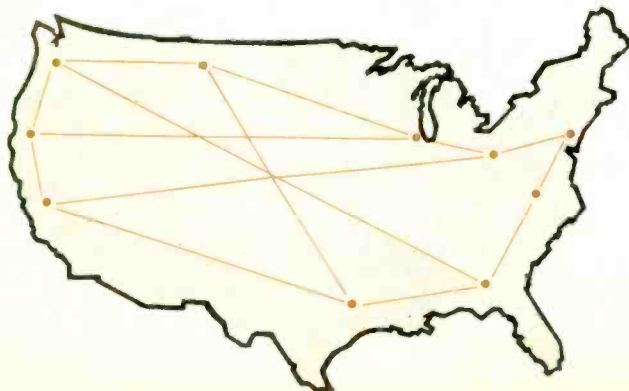

is called an acoustic-coupler modem. The other type of modem connects directly into the telephone line and is called a direct-connect modem. The acoustic couplers are cheaper but are more likely to pick up noise interference.

Cable Networks

TODAY, many homes have a second set of communication wires coming into the house—the TV cable. Cable services provide many more channels than vhf and uhf stations make available. Since at least one-half of a terminal exists in the TV set, it isn't difficult to provide the keyboard and additional parts to make one or more cable channels interactive computer networks. This has already been tried on an experimental basis and it is just a matter of time before television and home computers will merge. Cable companies charge a flat rate for a month's service, which is an incentive to use the TV cable instead of the telephone system.

The Warner Communications Corp. and American Express have been experimenting with a prototype two-way, interactive cable TV network in Columbus, OH. The QUBE system uses simple pushbutton terminals to provide yes/no/multiple choices to televised questions and offers to sell products. This service has proven to be very popular. Other attempts to offer an interactive game-playing service via two-way cable TV will soon be underway in major cities in the United States. If these are successful, it is predicted that fully interactive personal-computing and information-utility services will move to the TV cable within five years.

Local Networks

SEVERAL computers, or computers and terminals, can be connected within a local area to share common peripherals and/or software. Such a local network can be as simple as several small computers in a classroom, connected to share a disk and printer. It can also be as complex as all the computers, terminals, and other business machines in a large office connected together to provide the interactive services needed by a large business organization.

The Xerox Corp. and other major manufacturers such as Digital Equipment Corp. and Intel have proposed a system called Ethernet that uses coaxial cable to connect computers, word processors, copiers, fax, and other machines into an automated office. This system uses a transmission scheme which is called a *baseband system* because it operates at low voltage and frequency.

In local networks each station (called a

THE ELECTRONIC WORLD

“node”) can communicate with every other node without requiring a special management node (or processor). The signals are broadcast along the wire in the same way that a radio broadcasts—every other station can listen—but a reply is expected only from the node addressed. Each node can detect when another node is “talking” so that it refrains from sending and thus avoids collisions that would lose data. There are various methods of designing the network, as shown in the accompanying diagrams.

The most common design (or topology) is the *star*, where the branches radiate from a central node. This is the design of the telephone switchboard and, since many offices have PBXs, they can be used for wiring. The trouble with the star design is that if the central node goes down, the net is no longer connected.

Another design is the *ring* or *loop*. Here the nodes are connected to each other through repeaters. When a signal is received, it is amplified and passed to the next node. If a node fails, it opens the loop and the net fails.

The third topology is the *bus*, which is simply a long piece of cable that runs past the node locations. When a device is to be added, it is merely tapped in through a plug-in socket. If a node fails, it does not bring down the entire net, and additional nodes can be added without reconfiguring the system. This is why Xerox advertises Ethernet with a picture of a wall socket ready for you to plug-in your electronic staple machine.

The expression *baseband* has to do with the frequency of the data transmission. If the center conductor is referenced to zero volts, and then raised to some non-zero value, another node can detect the change in voltage condition and decode the information. These changes occur at relatively low frequencies used by microcomputers.

Another type of local network called a *broadband system* also uses a coaxial cable but transmits at very high frequencies. A typical example is the television cable, which uses frequencies of 50 MHz to 100 MHz. At these frequencies, signal losses due to the cable almost disappear and the signal can be sent for miles rather than a few thousand feet. Wang and other companies have developed broadband network systems for connecting computers. However, the argument between baseband and broadband systems continues and there is no sign of agreement. Since the outcome is uncertain, it has limited the growth of local network systems. IBM and AT&T have yet to be heard from and the method they choose will greatly influence the outcome. The use of the telephone system and its requirement for simple, low-cost wiring seems to favor the baseband systems. However, if the primary connecting medium becomes TV cable and/or satellites, then local broadband systems seem to make more sense.

Personal Computer Networks. At the low end of the computer business there is no such confusion. Several systems have been suc-

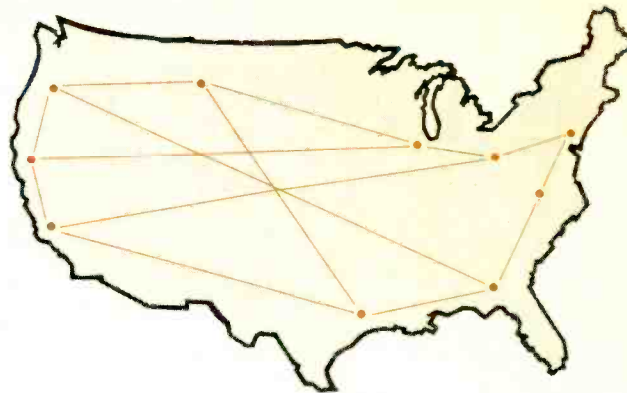

cessfully sold. These are all slow-speed baseband networks. Some of them use twisted-pair wires rather than coaxial cable.

The Cluster One system from Nestar ties groups of Apple computers together to provide complex financial-information networks. The Omnet from Corvus also works with Apple. Commodore and Radio Shack each have a network system and there are several for CP/M-based computers. North Star Computer has announced a new network system which is the first to permit different types of computers to operate on the same network.

Schools, as well as automated offices, seem to be the targets of microcomputer networking. Here the network offers the use of many computers sharing expensive peripherals such as hard disks, printers, plotters, and analog-data-collecting equipment. The network offers system control while providing the flexibility to add equipment as the system grows.

We have just begun to see the growth of local networks. As long as small 8-bit computers were limited to 64K of memory and small, low-cost floppy disks, it didn't make much sense to connect them. In fact, the very concept of the personal computer called for a cheap stand-alone unit operated by one user. We are now entering into the period of 16- and 32-bit microprocessors with megabytes of memory and large hard-disk data storage.

We are also developing single-chip video and communications circuits. These can be used to build very cheap terminals. All the elements are in place for local networks of powerful microcomputers, sharing large disk drives and peripherals such as printers, plotters, and data-collection equipment. Perhaps we will see a computer network in each classroom, or in each department of a school. In this case, each student would have an individual terminal and could access the computer for information, or submit work for review by the instructor (or the instructor's program!).

The ultimate will be the interface of the local network with the world-wide public information networks beaming their data from satellites. Of course, it won't stop there. Next, the satellites will be collecting additional information from our space probes throughout the solar system and beyond. ◇

SWD-1 VIDEO CONVERTER

FOR CABLE TV



The SWD-1 Video Converter is utilized on cable TV systems to remove the KHz's signal from a distorted video (channel 3 in/out) and also pass thru the normal undistorted/detected audio signal. Rocker switch selects operating mode to remove KHz's distortion from the video or pass all other channels normally. Simple to assemble—less than 30 minutes. Pre-tuned. Input/output Channel 3. Impedance 75 ohms. 117VAC.

SWD-1 Video Converter Kit \$69.95

VTR ACCESSORIES

SIMPLE SIMON VIDEO STABILIZER



Simple Simon Video Stabilizer, Model VS-125, eliminates the vertical roll and jitter from "copy guard" video tapes when playing through large screen projectors or on another VTR. Simple to use, just adjust the lock control for a stable picture. Once the control is set, the tape will play all the way through without further adjustments. Includes 12V power supply.

VS-125 Video Stabilizer, wired \$54.95

SIMPLE SIMON VIDEO SWITCHING BOX



The Affordable Video Control Center

Excellent in isolation and no loss routing system. Simple Simons VSB-300 Video Switching Box enables you to bring a variety of video components together for easy viewing/dubbing. Also you gain the ability to record one channel while viewing another. Unit includes two F-type quick connector ended cables.

VSB-300 Video Switching Box, wired \$19.95

UHF ANTENNAS and ACCESSORIES

MDS-AMATEUR-ETV 32 ELEMENT YAGI ANTENNA

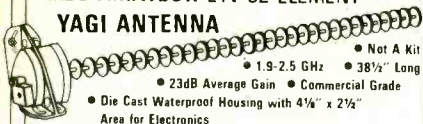

● Not A Kit
● 1.9-2.5 GHz
● 23dB Average Gain
● Commercial Grade
● Die Cast Waterproof Housing with 4 1/4" x 2 1/4" Area for Electronics

● Includes P.C. Probe, F-61 Connector and Mounting Hardware

MAE-2 32 Element YAGI Antenna \$23.95

Kato Sons' Down Converter Kit ★1.9 - 2.5GHz★

Designed for Simple Simon by former Japanese CQ Amateur Magazine's UHF Editor/Engineer. Unit utilizes new ingenious Printed Circuit Probe for maximum gain. Circuit board fits inside MAE-2 antenna housing. Requires 1 hour assembly. IC and capacitors pre-soldered.

Model KSDC-KIT 1.9 - 2.5GHz Down Converter Kit \$34.95

Kato Sons' Regulated Variable DC Power Supply

For use with KSDC-KIT 1.9 - 2.5GHz Down Converter. Completely assembled with Attractive Cabinet, TV/Converter Mode Switch, Frequency Control and LED Indicator.

Model KSPS-1A Assembled Power Supply \$23.95

SPECIAL INTRODUCTORY SAVINGS

ORDER ALL THREE ITEMS

MAE-2, KSDC-KIT and KSPS-1A for Only **\$74.95**

Regular price if ordered separately \$82.85

—CO-AX CABLES ARE NOT INCLUDED—

ZYZZX VHF-UHF Wideband Antenna Amplifier



Revolutionary New HYBRID IC Broadband Amplifiers

50 MHz - 900 MHz Model ALL-1 12dB Gain
Model ALL-2 35dB Gain

These units are not available anywhere else in the world. Each unit will serve many purposes and is available in Kit or Assembled form ideal for outdoor or indoor use. I/O impedance is 75 ohms. Amplifiers include separate co-ax feed power supply. Easily assembled in 25 minutes. No coils, capacitors to tune or adjust.

ALL-1 Complete kit w/power supply \$24.95 ALL-1 Wired/Tested w/pwr supply \$34.95

ALL-2 Complete kit w/ovwr supply \$4.95 ALL-2 Wired/Tested w/pwr supply \$4.95

Our New STVA 14.5dB GAIN, 14 ELEMENT CORNER REFLECTOR YAGI ANTENNA



STVA-3 Yagi Antenna, 14.5dB Gain, Selectable 75 or 300 ohm Channel 80-80 \$19.95

STVA-4 Yagi Antenna, 14.5dB Gain, Selectable 75 or 300 ohm Channel 44-52 \$19.95

RG-59/U 75 ohm Low Loss Coax Cable \$12w/ft F-59 Coax Connector \$39 ea.

MT-1 Special UHF 75-300 ohm Matching Transformer \$14.45 ea.

Switch to Bambi!

Electronically

Bambi Electronic Video Switch ... makes switching of your VCR/VTR, Pay TV Decoders, Cable TV, Video Discs, Video Games, Closed Circuit TV, Antennae and Microcomputer as easy as pushing buttons.

The Bambi Electronic Video Switch is an electronic switching network which can accept up to six different sources of video signals and provide the flexibility of directing the inputs to any or all of the three outputs.

Now you can eliminate ... the drudgery of disconnecting and reconnecting your video equipment each time you use it ... the tangled mess of cables which are impossible to trace out ... not being able to use more than one function at a time.

Bambi lets you enjoy using your video equipment the way it should be ... electronically and on line at the push of a button.

Model BEVS-1 Wired

\$129.95



Bambi's front panel was designed with the user in mind. Computer styled construction, with soft-touch keyboard (rated for over 10 million operations), arranged in matrix form allows easy input/output selection without referring to charts. Functions selected through the keyboard are immediately displayed on the 18 LED status indicators.



Check the quality of Bambi against that of much higher priced competition. All solid state electronic switching provides low attenuation (3dB), wide frequency response (40-890 MHz), and excellent isolation between signal sources (each I/O section individually shielded for 65dB min. isolation).



Bambi's Specifications:

- Input/Output Impedance 75 ohm
- Signal Loss 3dB ±1dB
- Noise 4dB ±1dB
- Input Return Loss 12dB min.
- Isolation 65dB min.
- Power Req. 117VAC 60 Hz, 2W
- Dimensions 10 1/4" W x 6 1/4" D x 3 1/4" H
- Weight 4 1/2 lbs

7+11 SWD PARTS KITS

MITSUMI VARACTOR UHF TUNER Model UES-A56F \$24.95

Freq. Range UHF470 - 889MHz
Antenna Input 75 ohms
Channels 14-83 Output Channel 3

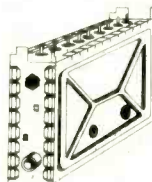

KIT NO.	PART NO.	DESCRIPTION	PRICE
1	VT1-SW	Varactor UHF Tuner, Model UES-A56F	\$24.95
2	CB1-SW	Printed Circuit Board, Pre-Drilled	18.95
3	TP7-SW	P.C.B. Potentiometers, 1-20K, 1-1K, and 5-10K ohms, 7-pieces	5.95
4	FR35-SW	Resistor Kit, 1/4 Watt, 5% Carbon Film, 32-pieces	4.95
5	PT1-SW	Power Transformer, PRI-117VAC, SEC-24VAC, 250ma	6.95
6	PP2-SW	Panel Mount Potentiometers and Knobs, 1-1KBT and 1-5KAT w/Switch	5.95
7	SS14-SW	IC's 7-pcs, Diodes 4-pcs, Regulators 2-pcs Heat Sink 1-piece	29.95
8	CE9-SW	Electrolytic Capacitor Kit, 9-pieces	5.95
9	CC33-SW	Ceramic Disk Capacitor Kit, 50 W.V., 33-pieces	7.95
10	CT-SW	Variable Ceramic Trimmer Capacitor Kit, 5-65pfd, 6-pieces	5.95
11	L4-SW	Coil Kit, 18mHs 3-pcs, 22µHs 1-piece (prewound inductors) and 1 T37-12 Ferrite Toroid Core with 3 ft of #26 wire	5.00
12	ICS-SW	I.C. Sockets, Tin inlay, 8-pin 5-pieces and 14-pin 2-pieces	1.95
13	SR-SW	Speaker 4x6" Dual and Prepunched Wood Enclosure	14.95
14	MISC-SW	Misc. Parts Kit Includes Hardware, (6/32, 8/32 Nuts & Bolts), Hookup Wire, Ant. Terms, DPDT Ant. Switch, Fuse, Fuseholder, etc.	9.95
When Ordering All Items, (1 thru 14), Total Price			139.95

7+11 PWD PARTS KITS

INTRODUCING OUR 7+11 PWD PARTS KITS



KIT NO.	PART NO.	DESCRIPTION	PRICE
1	1VT1-PWD	Varactor UHF Tuner, Model UES-A56F	\$24.95
2	2CB1-PWD	Printed Circuit Board, Pre-drilled	18.95
3	3TP7-PWD	PCB Potentiometers 4-20K, 1-5K, 2-10K, 2-5K, 1-1K, and 1-50k (11 pieces)	8.95
4	4FR-31-PWD	Resistor Kit, 1/4W, 5% 29-pcs, 1/2 W 2-pcs	4.95
5	5PT1-PWD	Power Transformer, PRI-117VAC, SEC-24VAC at 500ma	9.95
6	6PP2-PWD	Panel Mount Potentiometers and Knobs, 1-1KBT and 1-5KAT with switch	5.95
7	7SS17-PWD	IC's 7-pcs, Diodes 4-pcs, Regulators 2-pcs Transistors 2-pcs, Heat Sinks 2-pcs	29.95
8	8CE14-PWD	Electrolytic Capacitor Kit, 14-pieces	6.95
9	9CC20-PWD	Ceramic Disk Capacitor Kit, 50 WV, 20-pcs	7.95
10	10CT5-PWD	Variable Ceramic Trimmer Capacitor, 5-65pfd, 5-pieces	4.95
11	11L5-PWD	Coil Kit, 18mHs 3-pcs, 22µHs 1-piece (prewound inductors) and 2 T37-12 Ferrite Toroid cores with 6 ft #26 wire	6.00
12	12ICS-PWD	IC Sockets, Tin inlay, 8 pin 4-pcs, 14 pin 1-pc and 16 pin 2-pcs	2.95
13	13SR-PWD	Enclosure with PM Speaker and Pre-drilled Backpanel for mounting PCB and Ant. Terms	14.95
14	14MISC-PWD	Misc. Parts Kit, Includes Hardware, (6/32, 8/32 Nuts & Bolts), Hookup Wire, Solder, Ant. Terms DPDT Ant. Switch, Fuse, Fuseholder, etc.	9.95
15	15MCM16-PWD	Mylar Capacitors, 14-pcs and Silver Mica Capacitors 2-pieces	7.95
When Ordering All Items, (1-15), Total Price			159.95

SIMPLE SIMON ELECTRONIC KITS, Inc.

3871 S. Valley View, Suite 12, Dept. P, Las Vegas, NV 89103

NEEQ 6 OR MORE OF AN ITEM WRITE FOR QUANTITY DISCOUNTS

In Nevada Call: 702-871-2892

Outside Nevada Call: 1-800-782-3716

Available by Mail Order Only
Send Check* or Money Order. Minimum Order: \$16.95. Add 10% Shipping and Handling on orders under \$40.00. For orders over \$40.00, add 5% Minimum Shipping and Handling \$2.00. Cat. \$1.00
VISA and Mastercard Acceptable —
*Check orders will be held 30 days before shipping.

Video Accessories

*What's available,
what they do,
and when to use them*

BY IVAN BERGER AND LANCELOT BRAITHWAITE

A LONG with the current boom in home video has come a proliferation of video accessories: video stabilizers, image enhancers, distribution amplifiers, switchers, channel converters, commercial killers, and color processors. Many of these devices are familiar to broadcasters and other professionals; but they're new to home users, who wonder just what they do, how they do it, and how to know when it needs to be done.

Some of these accessories have been around for years but they are just now being used at home. This is because they have to do with video signals—such as those from TV cameras—rather than r-f signals such as those that go to TV antenna terminals. Until cameras, VCRs, video disc players, and TV sets with direct audio and video (monitor) inputs became common in the home, there was no way to use most video accessories.

Stabilizers. Video stabilizers restore vertical sync pulses that have been weakened, deleted, misshaped or otherwise modified to the point where the hold controls (especially automatic vertical-hold

circuits) on a receiver or monitor can't keep the picture from rolling. Some home stabilizers also clamp horizontal sync pulses to the proper level; but only professional stabilizers can fix errant or damaged horizontal sync.

The problem can occur with misaligned VCRs. But it occurs most often when a TV set with no manual vertical hold is used to view prerecorded video cassettes made with copy-guarding schemes that modify the vertical sync pulses. The object of such schemes is to misshape or weaken the pulses just enough so that any further change (as would occur when illicitly copying the tape) would alter the sync so that it no longer prevents rolling, though the original tape could play normally. Considering the wide variations between VCRs and TVs, the scheme provides a very fine line to tread, which is why some combinations can't make the grade without a little help from a stabilizer.

Figure 1 shows the block diagram of a fairly elaborate stabilizer. There are low-cost stabilizers that work without some of the stages shown here. The one shown

has a buffered input (sometimes not used) to prevent interactions between the stabilizer and the equipment feeding it and between the stabilizer's own two signal paths. The buffer may also, in some units, amplify the input signal a bit.

The lower signal path is fairly straightforward. The input signal is amplified and then clamped to ensure that it doesn't get too high. Refurbished sync is added to it by the sync inserter; and then the signal is fed to the output amplifier where it is buffered.

The upper signal path of Fig. 1 is where the actual processing is done and where that refurbished sync signal comes from. The video signal is first inverted, to cancel crosstalk and to make signal comparisons easier. (This is another circuit often omitted.)

The signal is then fed through a sync separator, which strips off the picture information, leaving only sync. (The process is actually quite simple, since sync pulses in a standard, 1.0-volt video signal are always between 0 and $\frac{1}{3}$ volt, while picture information is between $\frac{1}{3}$ and $\frac{2}{3}$ of a volt.)

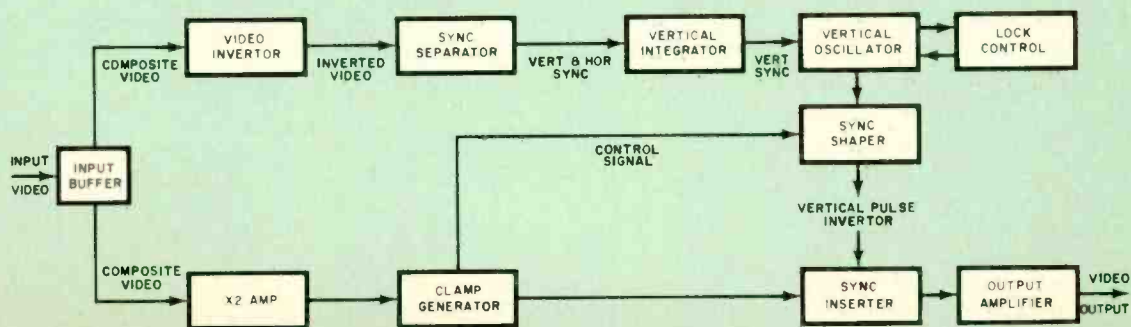

Fig. 1. In a video stabilizer, video and sync are separated and mishapen sync is restored.

Because both horizontal and vertical sync pulses fall into that voltage range, the vertical integrator must screen out the horizontal component. It works on a time, not a voltage, basis. Since horizontal pulses (which occur 262.5 times per field or once per line) are much briefer than vertical ones (which occur only between fields), the integrator assumes that any pulse too long to be a horizontal one is vertical.

The vertical sync output from the integrator is then used to trigger the vertical oscillator, because it's often better to regenerate sync pulses than to fix them. The vertical lock control trims the oscillator to match its output frequency to that of the TV set. This is the equivalent of a receiver's vertical hold control.

The sync pulses are then shaped, and a control signal from the clamp generator makes sure they have the correct amplitude (approximately 0.3 volt). The vertical pulse inverter is usually combined with the sync shaper, and is only needed when the signal from which the new sync was derived has already gone through an inverter stage.

At the sync inserter stage, the new sync is combined with the picture information of the original signal, which is then fed to the output amplifier/buffer stage.

While all home-video stabilizers have video inputs, there are a few whose outputs are r-f, for use in systems consisting of a single VCR and a TV set with no monitor inputs.

Image Enhancers. Image enhancers are used to make pictures look crisper, sharper, and more detailed. Details, in video, correspond to transients in audio. The scanning beam must make fast voltage transitions as it encounters each new detail, while it should make no transitions at all when traversing a perfectly smooth expanse of a single color. The higher the frequency response, the more crisply such transients come across. (That's why bandwidth and horizontal resolution can be equated when discussing video systems.)

The obvious way to sharpen picture details is to extend or boost video high-frequency response. Though the solution is obvious, however, the complexity of the video signal makes the solution difficult to accomplish as shown in Fig. 2.

One reason for the complexity is shown in Fig. 3. This shows the chrominance (color) and luminance (object shape and size) information in a video signal. The signals occur at discrete frequencies separated by 15,750 Hz, the horizontal scanning rate. By offsetting the chroma frequencies so that they fall between those used by the luminance signals, the two can be kept from interfering

with each other. (This is the main reason for a comb filter in a color TV set.)

But though their individual frequencies are interleaved, their frequency ranges overlap. Thus, though boosting the higher frequencies in the video signal enhances sharpness, it boosts chroma level, which oversaturates the colors.

The chroma trap is designed to deal with this problem, usually by the simple process of stripping off the 3.58-MHz colorburst signal and chroma information, giving the enhancement circuits only luminance to work on.

The next stage actually performs two functions. It amplifies the luminance signal to make sure its level will be high enough. Of its three outputs, the one feeding the phase shifter/delay buffer is "differentiated" to emphasize its higher frequencies. The delay in the next stage shifts the phase of this differentiated signal so that it and the undifferentiated signal can be compared more readily by the stage that follows.

This stage, the transient magnitude discriminator, derives a primitive correction signal based on the difference between the two versions of the luminance signal. The more detail there is in the picture, the more high frequencies there are in the luminance signal, and the greater the enhancement signal the discriminator puts out. The enhancement signal includes lower picture frequencies, too, since some picture details also show up there. But since the signal has been differentiated, the high frequencies, which are most in need of enhancement, will predominate.

The next stage is primarily a buffer, but with a filter circuit attached. Since noise rises with frequency in video just as it does in audio, the discriminator's high-frequency-enhanced output will contain more noise than the normal luminance signal does. A variable high-cut filter is therefore added to reduce that noise. Use of the noise filter invariably cuts back some of the gains in sharpness and detail. But if the filter and boost characteristics are properly chosen, this cutback can be minimized. The enhance control simply regulates how much of the enhancement signal is fed to the summing amplifier.

This amplifier has three inputs, one each for chroma (from which the luminance was stripped by the composite color processor stage), luminance (from the luminance amplifier) and the enhancement signal itself. The output amplifier stage is for buffering and gain adjustment.

Enhancers can be used in one of two ways: to enhance details in signals being viewed or to pre-enhance already-sharp signals before recording. The latter reduces the loss of detail usual in home taping. Either way, the enhancer can only

help to bring out details already present, not re-create details which have already been lost.

Distribution Amplifiers. Video distribution amplifiers need very little description. Basically, they are amplifiers whose input buffer circuits feed several independent outputs rather than a single one. This serves two purposes that a simple, resistive splitter would not: it buffers the outputs, preventing electrical interaction between them and it prevents unintentional reduction in video signal level.

A distribution amplifier, however, can be equipped to do more. Give it enough gain, and its output signal can be stronger than its input, reducing generation loss in taping and even brightening dark scenes in the signals fed through it. In such a case, it will often have both a level control and an output level meter to assure correct video output. The level control adjusts the brightness of the signal, and helps control the buzz that sometimes leaks into the audio from high-contrast program material. One model (the Showtime Video Ventures VV-70P) has an indicator which lights when the output is at the standard, 1-volt level. Some noise filtration may be built into distribution amplifiers, too.

Audio distribution amplifiers are even more likely to have level controls and noise filters. Some may also have tone controls and mixing inputs for microphones.

Switchers. Switchers come in three varieties: audio, video and r-f. They differ mainly in the types of jack used for input and output connections, the amount of capacitance that can be permitted in the circuits, and the amount and type of shielding used. (Stray capacitance is never desirable, but more can be tolerated in audio than in video switchers, which in turn can tolerate more than r-f switchers can.)

Most such switchers are matrix types, with multiple outputs as well as inputs. This allows devices to be interconnected at will, without plugging and unplugging cables, so that one could (for example) dub from a Beta to a VHS deck while feeding the output from a video disc player to the monitor screen, but switch the monitor occasionally to look in on the progress of the dub. Usually, each input circuit feeds a signal bus, and each output circuit has a switch that can be connected to any of these busses.

Some switchers are mechanical, while others are all-electronic. In electronic switchers, contact resistance is lower and capacitance and crosstalk are easier to control. Electronic switchers (especially video switchers) are also more likely to contain some amplification to compen-

Shown here (top to bottom) are:
 MFJ's Enhancer/Stabilizer;
 ColorMax VTS-157 Splitter;
 Cable Works Switcher;
 Showtime Video Ventures Color Processor;
 Vidicraft VCR Image Enhancer.



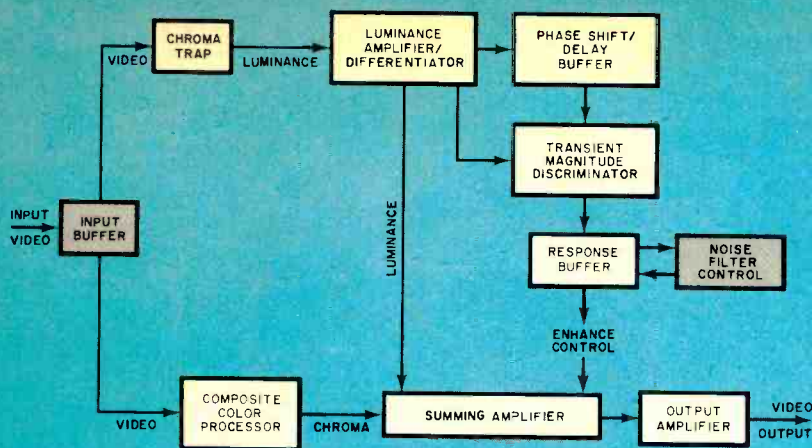

Fig. 2. Luminance information is enhanced without oversaturating colors.

sate for signal losses in the switching circuits, and to buffer the outputs.

Some switchers link audio and video, so that when dubbing from one device to another, the audio and video are dubbed together. Others switch the two independently, and may even be independent devices. R-f switchers, of course, switch video and audio together, as both are part of the r-f signal.

Patch bays are an alternative to switchers. They have two sets of jacks, one each in the front and rear. All devices in the system are connected to the rear jack, and any two devices can then be interconnected by plugging short patch cables between their corresponding jacks in the front. Some patch bays are "normalised." That is, the connections most commonly used are automatically made when no patch cables are plugged in but are broken when patches are made. This is more common in audio than in video or r-f patch bays, though.

Patch bays designed for stereo sound use may sometimes be used for audio and video, if the capacitance is carefully controlled. In such a setup, one of the original stereo channels would carry audio and the other video, and a patch cord would connect them together. At least one manufacturer of audio patch bays, Audio Visual Systems of Los Angeles, recommends its product for such use.

Channel Converters. Channel converters are among the few video accessories that operate on r-f rather than video and audio signals. There are two types.

One is the type most cable companies provide, which transposes any selected channel to a specific channel such as 3, 4 or 12, with channel selection done by a switch on the converter or a remote control attached to it. The main advantage to using them is to save the cost of renting one from the cable company or to get ca-

ble service without paying a fee—which is strictly illegal, of course.

The other type is the "up-converter," which raises midband and superband cable channels to uhf frequencies, where TV receivers and VCR tuners that are not "cable-ready" can tune them in without cable-company converter boxes. (Cable-ready sets, of course, can tune them in directly.) Transposed to standard broadcast frequencies, the cable channels can be tuned in with a TV receiver's remote channel selector, or programmed into a VCR's tuner/timer. There's also a saving offered by many cable companies to users who do not need to rent converter boxes.

Since the spacing between cable channels is the same as that between normal broadcast channels (6 MHz), conversion is easy. By beating all cable signals against an r-f oscillator, the converter can raise all signals to the uhf band. A 584-MHz shift (as on the Marshall VR-533 converter) would put channels 2 through 6 (54-88 MHz) onto uhf channels 42-46, channels A-I (120-174 MHz) onto uhf channels 52-60, vhf channels 7-13 (174-216 MHz) onto uhf channels 61-

67, and cable channels J-X (216-312 MHz) onto uhf channels 68-82.

Channel converters differ in the number of channels they can convert. A "35-channel" converter in addition to the uhf band, will handle the 12 vhf channels plus 23 cable ones (A-W), giving the same channel capacity as a "105-channel" cable-ready TV receiver. Since cable channel frequencies are not completely standardized, up-converted cable channels may not always fall within the tuning range of some receivers. The problem is probably uncommon, but one should ask for a guarantee when purchasing a converter, just in case.

Channel converters leave one problem unsolved: how to handle pay cable channels, which must be decoded before use by the cable system's converter. One solution is Energy Video's "Channelizer." (Other companies have similar products.) It has two inputs: one for the decoder's output, and another for the r-f signal from a cable or a vhf/uhf antenna. It also has an output to feed the TV's antenna input. The Channelizer converts the decoder's channel-3 signal onto any other vhf channel. It can also be used with outputs from other devices using channel 3, such as VCR's, video disc players, video games or home computers.

A simpler solution is to combine a splitter with a switch, as in Fig. 4A. In one switch position, the TV or VCR receives the cable signal; in the other, it receives the output from the cable company's converter. Figure 4B shows a more complex configuration, with extra switching to enable the VCR and the TV to receive either decoded or undecoded signals independently.

Commercial Killers. It's bad enough to have commercial interruptions when you're watching a show, but it's even worse to see the same commercials over and over when you re-play your off-the-air tapes. It costs more to tape commercials, too—a movie scheduled to run 2½ hours on television can often fit into two

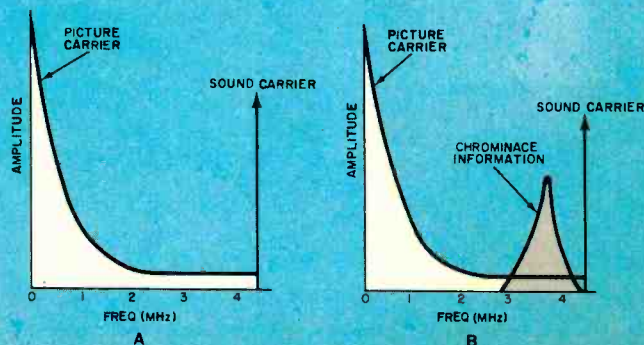

Fig. 3. Envelopes of (A) monochrome signal and (B) with chrominance added. Energy is actually bunched at intervals of horizontal scanning rate of 15,750 Hz to give an interleaving effect and avoid interference.

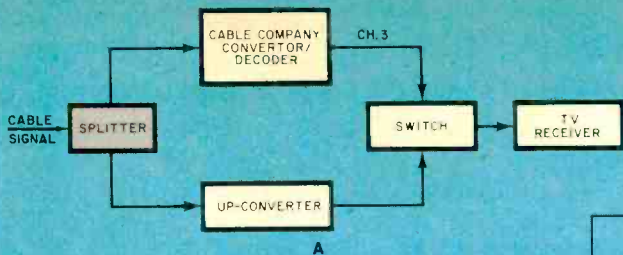
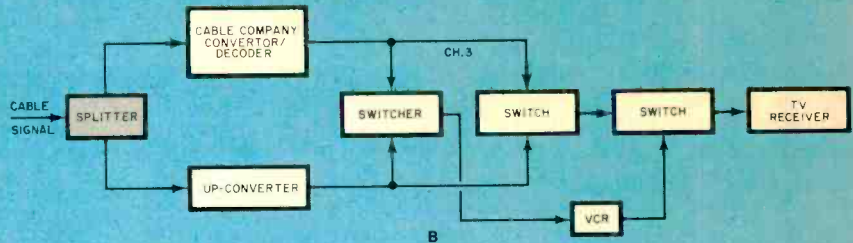

Fig. 4. An up-converter (A) allows you to tape mid- and superband (cable) channels via a VCR's uhf input. A channel splitter lets you watch one cable channel while taping another.



hours of tape if all its commercials and announcements are eliminated. What's needed is a way of catching commercials and editing them out. Several accessories are available to help with this.

The simplest is the tone alert, such as the Vidicraft Commercial Alert. It beeps when it detects the brief flash of black which, by FCC regulations, must precede and follow each commercial. When you hear the warning beep, you can either hit your VCR's pause control, or rewind the tape to the start of the commercial break, then put the deck into record-pause mode until the break is over.

The latter method eliminates all traces of commercials, though it may, on older VCR designs, cause some picture break-up at the transition between old and new recordings. It also takes more time, but have you ever seen a commercial break which didn't leave you enough time to go through all these manipulations and still dash out to the kitchen for a soda or beer? A good partner for Commercial Alert would be the Videomega Adzap, a wireless remote control which can mute the TV or make the VCR pause for a preset time.

The Killer, from Video Services, is more automated, but more specialized, too. Its specialty is eliminating commercials and announcements from black-and-white movies. Since all commercials and announcements are in color these days, it operates by sensing when the TV station turns its colorburst on, and triggering the VCR's pause control till the color goes away. The Killer will not work, however, if the station leaves its colorburst on while transmitting black and white material (when a station does this, you will sometimes notice color casts on black-and-white film).

Like the Commercial Alert, the Shelton Editor works by detecting the momentary shift to black which accompanies transitions into or out of commercial breaks, but also checks for the interruption in the sound which occurs between commercials and other blocks of material.

The new, 300-series Editor models do even more. Instead of pausing the recorder at the start of the first commercial, they wait till that commercial ends, then rewind the tape back to the point where they sensed the first break to black. They can then resume taping. They continue rewinding each time they sense a break to black within 2 minutes of the last one. Anything lasting longer than two minutes is presumed to be program, and not rewind. This system only works, of course, with VCR's offering remote-controlled rewinding, but it does eliminate all but a few seconds of program loss.

Color Processors. If you're critical about video color, then you're probably dissatisfied with much of the color you see on you TV screen. Variations in reception, camera adjustment, VCR response, and even picture-tube phosphors can all lead to unsatisfactory color: colors so hot they practically fluoresce or so pallid they turn the world into pastel.

You can correct these problems, to some extent, with the tint and color controls on your set, but that can mean re-correcting for each channel you receive and each tape you play. With a color processor, though, you can correct off-color signals before taping them, and never have to touch the set's controls—at least not while playing back your tapes.

Color processors vary in the degree and type of color correction they provide. Most have chroma gain and phase and video level controls. Chroma gain, like a receiver's color control, adjusts color saturation (intensity) over the range from mild black and white to hot, sizzling color. Chroma phase, like a receiver's tint or hue control, adjusts the picture hue from an overall green cast at one end of the scale to purple at the other. Since tint is a function of chroma phase (which can rotate 360 degrees at most), color shifts actually chase themselves around a circle. When the control is set to its maximum green position, the shift of reds toward green also causes greens to shift toward blue and blues toward red; set to maximum blue position,

colors shift the other way. Since color perception is also affected by screen brightness, there's usually a luminance control, too.

The Showtime Video Ventures VV-777P adds yet another control, burst amplitude, which changes the relative levels of the burst and chrominance signals. In practical terms, its major effect is to give some additional control of flesh tones with relatively little effect on other colors. Since burst amplitude and chroma gain both affect color saturation, it will usually be necessary to re-adjust one control after adjusting the other. Burst amp setting may also affect high-frequency video rolloff, which controls sharpness and detail. This should be watched for when setting the control.

Combinations. Since each of these devices does a different job, you may want to use several of them in combination. In that case, you should look into components that combine a number of functions. If such an accessory exists, has all the functions you need, costs no more (and preferably less) than the equivalent separate components, and performs at least as well as they do, then you would probably be well-advised to buy it. It will also save space and create less of a rats' nest of cables.

However, individual components let you pick and choose the functions you like, and shop for the best or most cost-effective component in each category. They also let you buy the most important functions first, then add the others as your budget permits.

The order in which these components are connected can make a difference in how they perform. Combination units automatically connect things in the proper sequence. If you do have individual units, we suggest connecting them as follows:

- VCR out
- Stabilizer
- Enhancer
- Color Processor
- Input to second VCR, monitor, or r-f converter. ◇

EQUIPMENT AND TRAINING NO OTHER SCHOOL CAN MATCH.

**NTS HOME TRAINING INVITES YOU TO EXPLORE MICROCOMPUTERS,
DIGITAL SYSTEMS AND MORE, WITH STATE-OF-THE-ART EQUIPMENT
YOU ASSEMBLE AND KEEP.**

Without question, microcomputers are the state of the art in electronics. And NTS is the only home study school that offers you training for this booming field with a choice of 3 production-model micro computers.

We'll explain the principles of troubleshooting and testing your microcomputer and, best of all, we'll show you how to program it to do what you want.

You'll use a digital multimeter, a digital logic probe and other sophisticated testing gear to learn how to localize problems and solve them.

Send for the full color catalog in the electronics area of your choice—discover *all* the advantages of home study with NTS!

NTS also offers courses in Auto Mechanics, Air Conditioning and Home Appliances. Check card for more information.



We believe that training on production-model equipment, rather than home-made learning devices, makes home study more exciting and relevant. That's why you'll find such gear in most of NTS's electronic programs.

For instance, to learn Color TV Servicing you'll build and keep the 25" (diagonal) NTS/HEATH digital color TV.

In Communications Electronics you'll be able to assemble and keep your own NTS/HEATH 2-meter FM transceiver, plus test equipment.

But no matter which program you choose, NTS's Project Method of instruction helps you quickly acquire practical know-how.



Simulated TV Reception

4.

3. The NTS/Heath HN-89A Microcomputer features floppy disk storage, "smart" video terminal, two Z80 microprocessors, with 32K RAM Memory, expandable to 64K on board. 4. The NTS/Heath GR 2001 Digital Color TV (25" diagonal) features specialized AGC-SYNC muting, filtered color and new solid-state high voltage tripler rectifier.

NTS NATIONAL TECHNICAL SCHOOLS

TECHNICAL-TRADE TRAINING SINCE 1905
 Resident and Home-Study Schools
 4000 SO. FIGUEROA ST., LOS ANGELES, CA. 90037



1. The NTS/Rockwell AIM 65 Dedicated Microcomputer A Single board unit featuring on board printer and display—4K RAM (expandable). Application Functions: Central processor—Controller/Monitor—Development System. 2. "The NTS/SYM-1 Microcomputer" 6502 Based CPU—4K bytes ROM (expandable)—1K RAM (expandable). 51 active I/O lines for versatile interfacing: disk drives, ASCII key boards, cassette tape, etc.

NATIONAL TECHNICAL SCHOOLS

4000 South Figueroa Street. Dept. 205-132
 Los Angeles, California 90037

Please rush FREE color catalog on course checked below

- | | |
|---|---|
| <input type="checkbox"/> MicroComputers/MicroProcessors | <input type="checkbox"/> Auto Mechanics |
| <input type="checkbox"/> Communications Electronics | <input type="checkbox"/> Air Conditioning |
| <input type="checkbox"/> Digital Electronics | <input type="checkbox"/> Home Appliances |
| <input type="checkbox"/> Industrial Technology | <input type="checkbox"/> Color TV Servicing |

Name _____ Age _____

Address _____

Apt. _____ City _____

State _____ Zip _____

- Check if interested in G.I. information.
 Check if interested ONLY in classroom training in Los Angeles.

INCREASE YOUR ANALOG METER'S RANGE

Adding the right shunt to your meter's circuit will extend its measuring range

BY JOHN BAILEY

IN AN analog meter, dc current flowing through a meter coil creates a magnetic field that works against the field of a fixed magnet. The resulting force causes the meter coil to rotate, moving the meter needle, which is attached to the coil, upscale. If too much current flows through the meter coil, the magnetic field may be so strong that the meter needle actually wraps itself around the upper limit stop. Thus, each meter has a built-in upper current limit (its range) to prevent such accidental damage. If you want to use a meter at a current value that is higher than its limit, you must use a meter shunt.

A meter shunt is actually a resistor that "shunts" excessive current around the meter movement. As the higher current flows through the shunt, the voltage drop across it ($E = IR$) is applied to the meter coil. The resistive shunt must be designed so that, at the maximum desired current flow, the voltage generated across the shunt will cause a current flow ($I = E/R$) within the meter coil to allow its pointer to just reach the top of its scale. Thus, by proper selection of the shunt resistance, a meter with almost any current rating can be used to measure almost any desired current. All that has to be changed is the meter scale.

The range of a milliammeter can be increased to almost any value by using a shunt whose resistance is calculated from $R_s = R_m / [(new\ range/meter\ range) - 1]$ where R_s is the shunt resistance and R_m is the meter resistance. For example, to

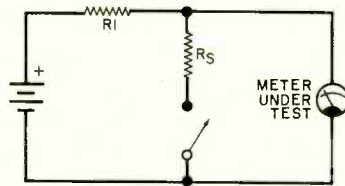

Fig. 1. Circuit for determining meter resistance using two precision resistors.

increase the range of a 1-mA, 50-ohm meter to measure 20 mA, $R_s = 50 / [(20/1) - 1] = 50/19 = 2.6316$ ohms.

Determining Meter Resistance. If the meter resistance is not known, you may be able to measure it using the resistance function of a DMM. However, the measuring voltage of most DMMs may be high enough to drive a sensitive analog meter off scale. *Do not* use a VOM because there is normally too much voltage

across their probe tips. Besides, the accuracy of a typical VOM is not good enough for this type of measurement.

The well-known procedure of shunting the meter being measured with a resistor of such value that a normal full-scale deflection is reduced to half-scale deflection (thus making the meter resistance equal to the shunting value) is basically sound; but it requires an adjustable constant-current source. Even if such a source were available, the value of the shunting resistor would have to be measured with a bridge.

Fortunately, there is a relatively simple and easy way to determine the resistance of a meter. All you need is a low-voltage battery and two precision resistors. The circuit required is shown in Fig. 1. Precision (1%) resistor R_1 is selected to produce a little less than full-scale deflection (battery voltage is not important). Note this deflection and call it "A." The meter is then shunted with another precision resistor R_s selected to produce a deflection of approximately half scale. This deflection is noted as "B." Solve for R' using $R' = R_s[(A-B)/B]$. Enter R' into $R_m = (R_1 \times R') / (R_1 - R')$ to determine meter resistance. For example, assume a 1-mA meter and a 1.5-V dry cell. Then R_1 was

ANNOUNCING TWO NEW TERMINALS

Smart • Fast • Graphics • Matching Modem and \$295 Printer

Netronics announces a state of the art breakthrough in terminals, now at prices you can afford, you can go on-line with data-bank and computer phone-line services. It's all yours: "electronic newspapers," educational services, Dow-Jones stock reports, games, recipes, personal computing with any level language, program exchanges, electronic bulletin boards... and more every day!!!

Netronics offers two new terminals, both feature a full 56 key/128 character typewriter style keyboard, baud rates to 19.2 kilobaud, a rugged steel cabinet and power supply. The simplest one, FASTERM-64, is a 16 line by 64 or 32 character per line unit, with a serial printer port for making hard copy of all incoming data, and optional provisions for block and special character graphics. The "smart" version, SMARTERM-80 features either 24 line by 80 characters per line or 16 by 40 characters per line, it offers on-screen editing with page-at-a-time printing, 12,000 pixel graphics, line graphics, absolute cursor addressing, underlining, reverse video, one-half intensity and much more... simply plug them into your computer or your phone modem and be on-line instantly. Use your TV set (RF modulator required) or our deluxe green-phosphor monitor pictured above. For hard copy just add our matched printer.

Price breakthrough!!! Own the FASTERM-64, a complete terminal kit, ready to plug in for just \$199.95 or order the SMARTERM-80 kit for just \$299.95, (both available wired and tested.) Be on-line with the million-dollar computers and data services today... we even supply the necessary subscription forms.

More good news. All the components in our terminals are available separately (see coupon), so you buy only what you need!!!

FASTERM-64 DISPLAY FORMAT: 64 or 32 characters/line by 16 lines. 96 displayable ASCII characters (upper & lower case). 8 baud rates: 150, 300, 600, 1200, 2400, 4800, 9600, 19,200 (switch sel.). LINE OUTPUT: RS232C or 20 ma current loop. VIDEO OUTPUT: 1V PIP (EIA RS-170). CURSOR MODES: home & clear screen, erase to end of line, erase cursor line, cursor up & down, auto carriage return/line feed at end of line & auto scrolling. REVERSE VIDEO. BLINKING CURSOR. PARITY: off, even or odd. STOP BITS: 1, 1.5, 2. DATA BITS PER CHARACTER: 5, 6, 7 or 8. CHARACTER OUTPUT: 5 by 7 dot matrix in a 7 by 12 cell. PRINTER OUTPUT: prints all incoming data. 1K ON BOARD RAM. 2K ON BOARD ROM. CRYSTAL CONTROLLED. COMPLETE WITH POWER SUPPLY. OPTIONAL GRAPHICS MODE: 24 Green & math characters plus 30 special graphics characters. ASCII ENCODED KEYBOARD. 56 key/128 characters.

SMARTERM-80 DISPLAY FORMAT: 80 characters by 24 lines or 40 characters by 16 lines. 128 displayable ASCII characters (upper & lower case) 8 baud rates: 110, 300, 600, 1200, 2400, 4800, 9600, 19,200. LINE OUTPUT: RS232C or 20 ma current loop. VIDEO OUTPUT: 1V PIP (EIA RS-170). EDITING FEATURES: insert/delete line, insert/delete character, forward/back tab. LINE OR PAGE TRANSMIT. PAGE PRINT FUNCTION. CURSOR POSITIONING: up, down, right, left plus absolute cursor positioning with read back. VISUAL ATTRIBUTES: underline, blink, reverse video, half intensity & blank. GRAPHICS: 12,000 pixel resolution block plus line graphics. ON-SCREEN PARITY INDICATOR. PARITY: off, even or odd. STOP BITS: 110 baud 2, all others 1. CHAR. OUTPUT: 7 by 11 character in a 9 by 12 block. PRINTER OUTPUT: 60 or 50 Hz VERTICAL REFRESH. BLINKING BLOCK CURSOR. CRYSTAL CONTROLLED. 2K ON BOARD RAM. ASCII ENCODED KEYBOARD. 56 key/128 character. 4K ON BOARD ROM. COMPLETE WITH POWER SUPPLY.

TELEPHONE MODEM 103 O/A. FULL DUPLEX. FCC APPROVED. DATA RATE: 300 baud. INTERFACE: RS232C and TTY. CONTROLS: talk/data switch (no need to connect and disconnect phone), originate/answer switch on rear panel. NO POWER SUPPLY REQUIRED.

ASCII KEYBOARD ASCII-3. 56 KEY/128 CHARACTER ASCII ENCODED. UPPER & LOWER CASE. FULLY DEBOUNCED. 2 KEY ROLL-OVER. POS OR NEG LOGIC WITH POS STROBE. REQUIRES +5 & -12V DC (SUPPLIED FROM VIDEO BOARDS).

PRINTER COMET I. SERIAL I/O TO 9600 BAUD. 80 CHARACTER COLUMN (132 COMPRESSED). 10" TRACTOR FEED. UPPER/LOWER CASE. INDUSTRY STANDARD RIBBONS. 4 CHARACTER SIZES. 9 BY 7 DOT MATRIX. BI-DIRECTIONAL PRINTING.



FOR ONLY \$129.95 Learn Computing From The Ground Up

Build a Computer kit that grows with you, and can expand to 64k RAM, Microsoft BASIC, Text Editor/Assembler, Word Processor, Floppy Disks and more.

EXPLORER/85

Here's the low cost way to learn the fundamentals of computing, the all-important basics you'll need more and more as you advance in computer skills. For just \$129.95 you get the advanced design Explorer/85 motherboard with all the features you need to learn how to write and use programs. And it can grow into a system that is a match for any personal computer on the market. Look at these features: 8085 Central Processing Unit; the "microprocessor heart" of the Explorer/85. (Join the millions who will buy and use the 8080/8085 this year alone!) Four 8-bit plus one 6-bit input/output ports from which you can input and output your programs, as well as control exterior switches, relays, lights, etc. as cassette interface that lets you store and reload programs you've learned to write. A deluxe 2,000 byte operating system/monitor makes it easy to learn computing in several important ways. • It allows simpler, faster writing and entering of programs. • It permits access by you to all parts of the system so you can check on the status of any point in the program. • It allows tracing each program step by step, with provision for displaying all the contents of the CPU (registers, flags, etc.) and it does much more!

You get all this in the starting level (Level A) of the Explorer/85 for only \$129.95. Incredible! To use, just plug in your 8VDC power supply and terminal or keyboard/display — if you don't have them, see our special offers below.

- Level A computer kit (Terminal Version) \$129.95 plus \$3 P&I*
- Level A kit (Hex Keypad/Display Version) \$129.95 plus \$3 P&I*

LEVEL B — This "building block" converts the motherboard into a two-slot \$100 bus (industry standard) computer. Now you can plug in any of the hundreds of \$100 cards available.

- Level B kit \$49.95 plus \$2 P&I*
- \$100 bus connectors (two required) \$4.85 each, postpaid.

LEVEL C — Add still more computing power; this "building block" expands on the motherboard and exceeds the \$100 bus to six slots.

- Level C kit \$39.95 plus \$2 P&I*
- \$100 bus connectors (five required) \$4.85 each, postpaid.

LEVEL D — When you reach the point in learning that requires more memory, we offer you choices: either add 4k of a memory directly on the motherboard or add 16k to 64k of memory by means of a single \$100 card, our famous "I/AWS".

- Level D kit (CHECK ONE)
 - 4k on board [AWS] \$49.95 plus \$2 P&I*
 - 16k \$100 [AWS] \$149.95 plus \$2 P&I*
 - 32k \$100 [AWS] \$199.95 plus \$2 P&I*
 - 48k \$100 [AWS] \$249.95 plus \$2 P&I*
 - 64k \$100 [AWS] \$299.95 plus \$2 P&I*

LEVEL E — An important "building block" it activates the 8k ROM/EPROM space on the motherboard. Now just plug in our 8k Microsoft BASIC or your own custom programs.

- Level E kit \$5.95 plus \$2 P&I*

Microsoft BASIC — It's the language that allows you to talk English to your computer! It is available three ways:

- 8k cassette version of Microsoft BASIC (requires Level B and 12k of RAM minimum, we suggest a 16k \$100 [AWS] — see above) \$64.95 plus \$2 P&I*
- 8k ROM version of Microsoft BASIC (requires Level B and Level E and 4k RAM, just plug into your Level E sockets. We suggest either the 4k Level D RAM expansion or a 16k \$100 [AWS] — \$99.95 plus \$2 P&I*
- Disk version of Microsoft BASIC (requires Level B and 12k of RAM, floppy disk controller, 8" floppy disk drive) \$325 postpaid.

TEXT EDITOR/ASSEMBLER — The editor/Assembler is a software tool (a program) designed to simplify the task of writing programs. As your programs become longer and more complex, the assembler can save you many hours of programming time. This software includes an editor program that enters the programs you write, makes changes and saves the programs on cassettes. The assembler performs the tedious task of translating symbolic code into the computer-readable object code. The editor/Assembler program is available either in cassette or a ROM version.

- Editor/Assembler (Cassette version, requires Level B and 8k (min.) of RAM — we suggest 16k [AWS] — see above) \$59.95 plus \$2 P&I*
- Editor/Assembler (ROM version, supplied on a \$100 card, requires Level B and 4k RAM (min.) — we suggest either Level D or 16k [AWS] — \$99.95 plus \$2 P&I*

FLOPPY DISK — A remarkable "building block" that adds 8" floppy disk when you need faster operation, more convenient program storage, perhaps a business application, and access to the thousands of programs and program languages available today. You simply plug them into your Explorer/85 disk system — it accepts all IBM-formatted CP/M programs.

- 8" Floppy Disk Drive \$499.95 plus \$12 P&I*
- Floppy Controller Card \$199.95 plus \$2 P&I*
- Disk Drive Cabinet & Power Supply \$69.95 plus \$3 P&I*
- Drive Cables (set up for two drives) \$25.00 plus \$3 P&I*
- CP/M 2.2 Disk Operating System, includes Text Editor/Assembler, dynamic debugger, and other features that give your Explorer/85 access to thousands of existing CP/M-based programs. \$150.00 postpaid.

NEED A POWER SUPPLY? Consider our AP-1. It can supply all the power you need for a fully expanded Explorer/85 (note: disk drives, other than power supply). Plus the AP-1 fits neatly into the attractive Explorer steel cabinet (see below).

- AP-1 Power Supply kit (HV @ 5 amps) in deluxe steel cabinet \$39.95 plus \$2 P&I*

NEED A TERMINAL? We offer you choices, the least expensive one is our Hex Keypad/Display kit that displays the information on a calculator-type screen. The other choice is our ASCII Keyboard/Computer Terminal kit, that can be used with either

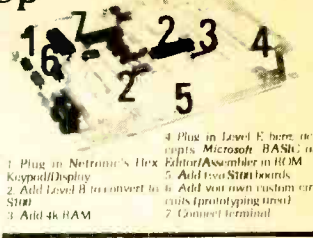

- 1. Plug in Netronics' Hex Keypad/Display
- 2. Add Level B to convert to a \$100 bus
- 3. Add 4k RAM
- 4. Plug in Level E board to microprocessor (BASIC, Text Editor/Assembler in ROM)
- 5. Add two \$100 boards
- 6. Add your own custom circuit (floppy disk drive)
- 7. Connect terminal.

ORDER A SPECIAL-PRICE EXPLORER/85 PAK — THERE'S ONE FOR EVERY NEED.

- Beginner Pak** (Save \$26.00) — You get Level A (Terminal Version) with Monitor, Source Listing (\$25 value) AP-1, 5-amp power supply, Intel 8085 Users Manual... (Reg. \$199.95) SPECIAL \$169.95 plus \$4 P&I*
- Experimenter Pak** (Save \$63.40) — You get Level A (Hex Keypad/Display Version) with Hex Keypad/Display, Intel 8085 User Manual, Level A Hex Monitor, Source Listing and AP-1, 5-amp power supply... (Reg. \$279.95) SPECIAL \$219.95 plus \$6 P&I*
- Special Microsoft BASIC Pak** (Save \$103.00) — You get Levels A (Terminal Version), B (4k RAM), E, 8k Microsoft in ROM, Intel 8085 User Manual, Level A Monitor, Source Listing and AP-1, 5-amp power supply... (Reg. \$439.70) SPECIAL \$329.95 plus \$7 P&I*
- 4k Add-on-Version Text Editor/Assembler** (Requires Levels B and D or \$100 Memory) \$99.95 plus \$2 P&I*
- Starter 8" Disk System** — Includes Level A, 8" floppy disk controller, one CDC 8" disk-drive two-drive cable, two \$100 connectors, just add your own power supply, cabinet and power supply. (Reg. \$1065.00) SPECIAL \$999.95 plus \$13 P&I*
- 4k Starter System** \$1045.95 plus \$13 P&I*
- 4k Starter System \$1095.95 plus \$13 P&I***
- 64k Starter System** \$1145.95 plus \$13 P&I*
- Add in any of above Explorer steel cabinet, AP-1, 5-amp power supply, Level C, with two \$100 connectors, just add your own power supply, two sub-D connectors for connecting your printer and terminal. (Reg. \$225.95) SPECIAL \$199.95 plus \$13 P&I*
- Complete 64k System** (Wired & Tested) \$1650.00 plus \$26 P&I*
- Special Complete Business Software Pak** (Save \$625.00) — Includes CP/M 2.2 Microsoft BASIC, General Ledger, Accounts Receivable, Accounts Payable, Payroll Package... (Reg. \$1325) SPECIAL \$699.95 postpaid.

*P&I stands for "postage & insurance." For quantities or orders, double this amount.

Continental U.S.A. Credit Card Buyers Outside Connecticut
CALL TOLL FREE 800-243-7428

To Order From Connecticut Or For Tech. Assist. Call (203) 354-9375
NETRONICS R&D LTD. Dept. PE
333 Litchfield Road, New Milford, CT 06776

- Please send the items checked below:
- COMPLETE FASTERM-64 TERMINAL (includes FASTVID-64 video board ASCII-3 keyboard, steel cabinet and power supply) ... kit \$199.95 plus \$3 P&I ... wired & tested \$249.95 plus \$3 P&I ... graphics option: add \$19.95 to each of above
 - COMPLETE SMARTERM-80 TERMINAL (includes SMARTVID-80 video board, ASCII-3 keyboard, steel cabinet and power supply) ... kit \$299.95 plus \$3 P&I ... wired and tested \$369.95 plus \$3 P&I
 - FASTVID-64 VIDEO BOARD (requires +5 & -12V DC) ... kit \$99.95 plus \$3 P&I ... graphics option add \$19.95 ... wired & tested \$129.95 plus \$3 P&I ... graphics option add \$19.95
 - SMARTVID-80 VIDEO BOARD (requires +5 & +/-12V DC) ... kit \$199.95 plus \$3 P&I ... wired & tested \$249.95 plus \$3 P&I
 - DELUXE STEEL TERMINAL CABINET ... \$19.95 plus \$3 P&I
 - ASCII-3 KEYBOARD (requires +5 & -12VDC) ... kit \$69.95 plus \$3 P&I ... wired & tested \$89.95 plus \$3 P&I
 - POWER SUPPLY (powers ASCII-3 keyboard & video boards) ... kit only \$19.95 plus \$2 P&I
 - ZENITH VIDEO MONITOR (high resolution green phosphor) ... wired & tested \$149.95 plus \$6 P&I
 - TELEPHONE MODEM MODEL 103 O/A ... wired & tested \$189.95 plus \$3 P&I
 - DOT MATRIX PRINTER Comet I ... wired & tested \$299.95 plus \$10 P&I
 - RF MODULATOR MOD RF-1 ... kit only \$8.95 plus \$1 P&I
 - 3FT-25 LEAD MODEM/TERMINAL OR PRINTER/TERMINAL CONNECTOR CABLE ... \$14.95 ea plus \$2 P&I

For Canadian orders, double the postage. Conn. res. add sales tax.

Total Enclosed \$ _____

Personal Check Cashier's Check/Money Order

VISA MasterCard (Bank No. _____)

Acct. No. _____ Exp. Date _____

Signature _____

Print Name _____

Address _____

City _____ State _____ Zip _____

Continental Credit Card Buyers Outside Connecticut.
TO ORDER
Call Toll Free:
800-243-7428
To Order From Connecticut,
or For Technical Assistance,
Call (203) 354-9375

CP/M is a reg. trademark of Digital Research

★ (Clip and mail entire ad) ★

SEND ME THE ITEMS CHECKED ABOVE

Total Enclosed (Conn. Residents add sales tax) \$ _____ Paid by: _____

Personal Check Cashier's Check/Money Order

VISA MASTER CARD (Bank No. _____)

Acct. No. _____ Exp. Date _____

Signature: _____

Print Name: _____

Address: _____

City: _____

State: _____ Zip: _____

NETRONICS Research & Development Ltd.
333 Litchfield Road, New Milford, CT 06776



Audio Modules



MOSFET Power Amplifiers

*BUILT-IN HEATSINKS *ONLY 5 CONNECTIONS REQUIRED * 5 YEAR WARRANTY

Choose ILP MOSFET power amps when you need the utmost in performance without spending big money. They provide the fastest possible slew rate, low distortion at high frequencies, + better thermal stability. MOSFET power amps work with complex loads without difficulty and without crossover distortion. Three models are available, with integral heatsink to mount on your own chassis (optional rack mount cabinet available). Connection is simple - via 5 pins. MOSFETs can be combined with other ILP modules to create almost any audio system, whatever your age or experience. Ultra-fi specifications: Slew rate 20V/us. Rise time 3 us. S/N ratio 100 db. Frequency response (3 db) 15 Hz - 100 kHz. THD (Typical at 1kHz) < 0.005%. IMD (50Hz/7kHz 4:1) < 0.006%.

MOS120 60W/4.8Ω (requires ± 45V) \$79.95
MOS200 120W/4.8Ω (requires ± 55V) \$129.95
MOS400 240W/4Ω (requires ± 55V) \$199.95

WRITE FOR FREE CATALOGUE LISTING:
*BIPOLAR POWER AMPLIFIERS *HIFI PREAMPS
*MIXERS *POWER SUPPLY UNITS *CABINETS
*GUITAR PREAMP and more

GLADSTONE

Electronics 901 Fuhrmann Blvd., Buffalo, NY, 14203

CALL (716) 849-0735 to order. Have your VISA or MasterCard ready. For information call (416) 787-1448 or circle reader number. Dealer/OEM enquiries (416) 787-1488. In Canada: Gladstone Electronics, Toronto.

CIRCLE NO. 12 ON FREE INFORMATION CARD

SAVE!

MONEY • TIME • FREIGHT

QUALITY STEREO EQUIPMENT AT LOWEST PRICES.

YOUR REQUEST FOR QUOTATION RETURNED SAME DAY.

FACTORY SEALED CARTONS - GUARANTEED AND INSURED.

SAVE ON NAME BRANDS LIKE:

PIONEER	JVC
KENWOOD	TEAC
MARANTZ	SANSUI
TECHNICS	SONY

AND MORE THAN 50 OTHERS BUY THE MODERN WAY BY MAIL - FROM

illinois audio

BANK CARDS ACCEPTED

12 East Delaware

Chicago, Illinois 60611

312-664-0020

800-621-8042

CIRCLE NO. 43 ON FREE INFORMATION CARD

meter range

selected as 1580 ohms and it produced a deflection of 0.92 mA ("A"). Similarly, R_s was selected as 51.1 ohms and it produced a deflection of 0.47 mA ("B").

Thus, $R' = [51.1(0.92-0.47)]/0.47 = 48.93$ ohms. The meter resistance is determined by calculating $R_m = (1580 \times 48.93)/(1580 - 48.93) = 50.49$ ohms.

Making a Shunt. For noncritical applications, a shunt is formed by scramble winding a length of enameled copper wire on a high-value resistor body which serves as a form with axial leads. The wire gauge and length are found from a Wire Table that covers gauge and resistance/foot.

It has been customary to wind on slightly more wire than was needed according to calculations and then to remove turns until the exact value was reached. However, there is a slight problem in this approach.

When the shunt wire is soldered to the resistor leads, the temperature of the wire, and the associated resistor body/leads may increase the total resistance due to the positive temperature coefficient of the wire. In conjunction with this, usually insufficient time was allowed for the wire and resistor to cool down to room temperature before removing any turns. This resulted in the shunt appearing to have too much resis-

Adjust the current calibration potentiometer until the desired current flows through the series circuit as indicated on the calibration meter. The meter to be shunted should display a slightly lower indication due to the slightly smaller shunt.

Grip one end of the heavy-gauge shunt lead in a bench vise, and the other soldered end in a pliers. Make sure that there are no kinks in the shunt wire as it may break in the next step.

While observing the meter-to-be-shunted indications, gently pull the wire using the pliers. The wire will stretch with a soft "give" feeling and its resistance will increase. Keep stretching the shunt wire until the meter to be shunted produces the desired indication (via the calibration meter). It may be necessary to readjust the calibration meter depending on how much disparity there was between the two meter deflections when the process was started.

To illustrate stretching versus resistance, a 5-foot length of #34 gauge wire was stretched 18" as its resistance increased 40% approximately linearly. This amount of stretch should not be used, but it does show what happens during a wire stretch.

Shunt Example. Assume a 1-mA meter is to be shunted so that its new full-scale value will be 20 mA. The meter resis-

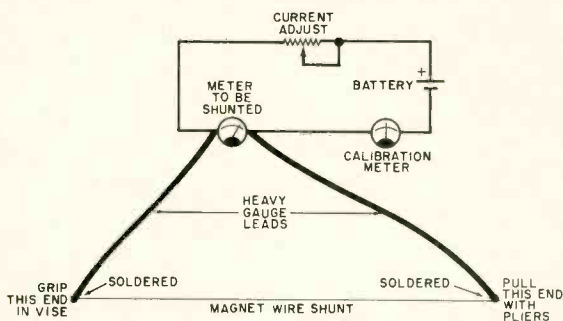

Fig. 2. Heavy-gauge leads are used to reduce any resistance between the meter and the shunt to be stretched. Do not stretch the magnet wire shunt to the breaking point.

tance, so more turns than necessary were removed. Then, when the shunt had cooled, it was found to have too low a value.

However, there is a way to "tweak" the shunt resistance to the correct value while it is connected to the meter with which it will be used.

Start by using the wire table to determine the gauge and length of wire whose resistance is slightly less than that required for the shunt. This is found using the first equation in this article. Do not wind this wire on the resistor body at this time. Instead, use the setup shown in Fig. 2. Solder a heavy-gauge wire (large enough so that its resistance will be negligible) to each end of the length of magnet wire, and connect the other ends across the meter to be shunted.

tance (using the equations in this article) was found to be 50.49 ohms. The value of the shunt was found to be 2.657 ohms. A wire table showed that #36-gauge wire has 423 ohms per 1000 feet (0.423 ohms/foot). Therefore, 6.31 feet produces 2.67 ohms. Six feet was selected to produce 2.538 ohms, slightly less than the calculated value.

Using the circuit of Fig. 2, the wire was stretched until the shunted meter indicated exactly full scale when the calibration meter indicated 20 mA.

The wire was then scramble wound on a 1000-ohm (any high value will do), half-watt resistor body with the ends of the shunt wire soldered to the resistor body axial leads. The completed shunt was then installed on the meter, and the meter scale re-calibrated. ♦

PLUG-IN ACCESSORY UPGRADES POCKET SCANNERS

A simple circuit provides power-supply protection, backup power, trickle charging, and other features without modifying your portable

BY PAT JOHNSTONE

THE pocket scanner is a popular item among reporters, radio enthusiasts, volunteer workers, and others who want to monitor public-service broadcasts. However, its small size usually means a sacrifice in features. For example, most pocket scanners have a poorly protected power supply, short battery life, and little flexibility. The circuit described provides pocket scanners with features found on bulkier base units.

Before we discuss the circuit, let's examine the pocket scanner in more detail. Pocket scanners usually have a jack for external power. When the scanner is powered from this jack, an internal switch disconnects the scanner's batteries from the circuit, isolating them from the external power. In this mode the batteries are not charged by the external source. To recharge the nickel-cadmium batteries, a second jack is provided to isolate the scanner circuit from the battery eliminator/charger. This provides recharging power to the NiCad batteries but makes the scanner inoperative. Thus, the user must choose between operating the radio or charging its batteries. The only way to get around this is to purchase separate charger/eliminators for each function. However, if you did use a separate charger and eliminator, you would still have the problem of an

unprotected power source. The scanner is committed to the ac power as long as the battery eliminator is in use; and if it should fail, the scanner goes dead. An unnoticed blown fuse can mean lost communication.

An inexpensive solution to these problems and more can be found in the simple circuit shown in Figure 1. The entire assembly can be point-to-point wired to work on any scanner that has separate "charge" and "power" jacks.

Circuit Operation. The parts specified in the list are for Bearcat Thin-Scan® models. The same circuit can be used for Realistic or similar scanners by substituting coaxial power plugs for the ones specified here.

A 1/8" mini plug, *P1*, for external power and a 3/32" submini plug, *P2*, for charge are soldered to a stiff piece of copper wire to hold them at the proper spacing so they will fit their respective jacks without bending. Join only the ground (negative) bases of these. External power from a car battery or eliminator/charger is applied to the circuit via *J1* (a submini jack here, but it can be coaxial if needed). Reverse-polarity protection, another feature not found on many small units, is provided by diode *D1*. At this point a bridge rectifier could be substituted for *D1* if you are unsure of the

polarity of the external supply. In either case, a negative-ground supply should be present after rectification.

Electrolytic capacitor *C1* acts to remove the ripple (buzz) from the ac-powered battery eliminator. Both eliminators and scanners provide some filtering, but their small size only allows for small filter capacitors so hum or buzz is often a problem. Furthermore, a polarized capacitor across power supply leads is good practice even if the ac adaptor is not used.

After filtering, power enters the scanner via *P1*, acting as a battery eliminator. Simultaneously, power is applied across the poles of the NiCad batteries via *P2*, acting as a charger. The charge rate is limited by resistor *R1*, which can be altered to suit the users needs and the charge-current demand of the NiCads. In the event of a power failure or removal of the external supply, power from the batteries is allowed to pass back through diode *D2* and operate the scanner (and any accessory plugged into *P3*, mentioned later) without interruption of service. Diode *D1* also prevents back drainage through the external supply.

As an option, subminiature plug *P3* can be added across the leads of *C1* (observing polarity) to power other outboard accessories, such as tone-activated relays or the plug-in descrambler module made by Paralin, 2511 E. 25th St., Tulsa, OK 74114. (This module is made especially for pocket scanners.) Since accessories connected through *P3* use the scanner's batteries, descramblers or other devices may be used with the same portability as the pocket scanner. For neatness and physical protection, the completed and tested assembly can be cast in a mold of epoxy or polyester resin, available at most hobby shops. The resin can be molded and dyed black to match the color and contour of the scanner. ♦

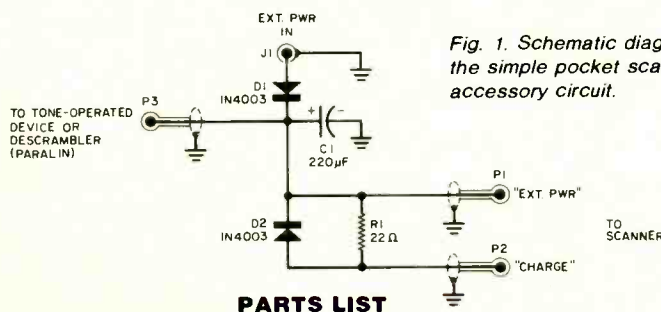

Fig. 1. Schematic diagram of the simple pocket scanner accessory circuit.

PARTS LIST

C1—220- μ F electrolytic
D1,D2—Diode (1N4003)
J1—Submini jack (see text)

P1—Mini plug (see text)
P2,P3—Submini plug (see text)
R1—22- Ω , 1/2-W resistor

Circuit Analysis with your TRS-80 Computer

Here are five programs to simplify electronic design work.

BY ROY BABYLON

AC Formulas

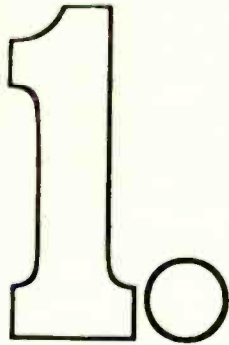

THE first program in this group deals with six areas of general interest in ac circuit design. The first three have to do with the relationship among peak voltage, instantaneous voltage, and the angle of the sine wave. The next two involve the relationship between frequency and wavelength. Anyone working with tuned circuits or antennas will find these sections useful. A unique feature of the program is that it gives answers in both feet and meters. This part is also helpful in converting scope readings. Normally measured in time (period), these readings are converted into the more familiar and useful frequency equivalents. The final

part of the program handles conversion between the various relationships of rms, peak, peak-to-peak, and average amplitude values.

The program was converted from a Level I to a Level II format (which explains its layout), and it is directly compatible with either one. The main difference between the two formats is that Level II has subroutines such as square root, angle functions, etc., built in. This is why all the subroutines were placed at the end of the program. For a Level I machine, enter the program as written. It must be modified accordingly for a Level II machine. ◇

```

3 CLS
20 PRINTTAB(15):"VARIOUS A.C. FORMULAS":PRINT
35 PRINT "ENTER NUMBER NEXT TO UNKNOWN:"PRINT
40 PRINT "PEAK VOLTS=1", "PERIOD-FREQUENCY=4"
41 PRINT "INSTANTANEOUS VOLTAGE=2", "WAVELENGTH (METERS OR FEET)=5"
43 PRINT "ANGLE POINT ON WAVE=3", "RMS-PEAK-AVERAGE CONVERSIONS=6":PRINT
50 INPUT"REQUESTED FORMULA IS ";U
60 IF U=1 GOTO90
65 IF U=2 GOTO140
70 IF U=3 GOTO410
75 IF U=4 GOTO460
80 IF U=5 GOTO560
85 IF U=6 GOTO190
90 INPUT"ENTER INSTANTANEOUS VOLTAGE";I
100 INPUT"ENTER ANGLE IN DEGREES";X
110 GOSUB 30376
120 PRINT"PEAK VOLTAGE EQUALS ";I/V;"VOLTS"
130 END
140 INPUT"ENTER PEAK VOLTAGE IN VOLTS";E
150 INPUT"ENTER ANGLE IN DEGREES";X
160 GOSUB30376
170 PRINT"THE INSTANTANEOUS VOLTAGE IS";E*v;"VOLTS"
180 END
190 PRINT"ENTER THE NUMBER NEXT TO THE KNOWN VOLTAGE"
200 PRINT"RMS (EFFECTIVE) VOLTAGE 1"
210 PRINT"PEAK VOLTAGE 2"
220 PRINT"AVERAGE VOLTAGE 3"
230 INPUT"THE KNOWN VOLTAGE IS";U

```

```

240 IF U=1 GOTO270
250 IF U=2 GOTO310
260 IF U=3 GOTO360
270 INPUT"ENTER THE RMS VOLTAGE";X
280 PRINT"THE PEAK TO PEAK VOLTAGE IS";2.828*X;"VOLTS"
290 PRINT"THE PEAK VOLTAGE IS";1.414*X;"VOLTS"
300 PRINT"THE AVERAGE VOLTAGE IS";.9*X;"VOLTS"
305 END
310 INPUT"ENTER PEAK VOLTS";P
320 PRINT"THE PEAK TO PEAK VOLTAGE IS";2*P;"VOLTS"
330 PRINT"THE RMS VOLTAGE IS";.707*P;"VOLTS"
340 PRINT"THE AVERAGE VALUE IS";.636*P;"VOLTS"
345 END
360 INPUT"ENTER AVERAGE VOLTAGE";A
370 PRINT"THE PEAK VOLTAGE IS";1.57*A;"VOLTS"
380 PRINT"THE PEAK TO PEAK VOLTAGE IS";3.14*A;"VOLTS"
390 PRINT"THE RMS VOLTAGE IS";1.11*A;"VOLTS"
400 END
410 INPUT"ENTER PEAK VOLTAGE";P
420 INPUT"ENTER INSTANTANEOUS VOLTAGE";I
430 S=I/P
435 GOSUB 30550
440 PRINT"THE ANGLE ON THE SINE WAVE IS";V;"DEGREES"
442 END
444 INPUT"ENTER PEAK VOLTAGE";P
445 INPUT"ENTER PHASE ANGLE IN DEGREES";X
446 GOSUB 30376
448 PRINT"THE INSTANTANEOUS VOLTAGE IS";P*v;"VOLTS"

```



```

450 END
460 PRINT "PERIOD=1, FREQUENCY=2"
470 INPUT "FORMULA DESIRED 15";X
480 IF X=1 GOTO 500
490 IF X=2 GOTO 530
500 INPUT "ENTER FREQUENCY IN HERTZ";F
510 PRINT "THE PERIOD OF";F;"HERTZ IS";1/F;"SECONDS"
520 END
530 INPUT "ENTER PERIOD IN SECONDS";T
540 PRINT "THE FREQUENCY IS";1/T;"HERTZ"
550 END
560 PRINT "WAVELENGTH=1, FREQUENCY=2"
570 INPUT "DESIRED FUNCTION ?";X
580 IF X=1 GOTO 600
590 IF X=2 GOTO 650
600 INPUT "ENTER F IN HERTZ";F
610 V=3E8/F
620 X=984E8/F
630 PRINT "THE WAVELENGTH(LAMBDA)IS EQUAL TO";V;"METERS OR";X;"FEET"
640 END
650 INPUT "ENTER WAVELENGTH";W
660 INPUT "METERS=1, FEET=2";C
670 IF C=1 GOTO 690
680 IF C=2 GOTO 700
690 PRINT "FREQUENCY=";3E8/W;"HERTZ"
695 END

```

```

700 PRINT "THE FREQUENCY OF";W;"FEET IS";984E8/W;"HERTZ"
710 END
30376 Z=ABS(X)/X:X=Z*X
30380 IF X>360 THEN X=X/360 : X*(X-INT(X))*360
30390 IF X<0 THEN X=X/90 : Y=INT(X) : X=(X-Y)*90-0N1GOTO30410,30420,30430
30400 X=X/57.29578 : IF ABS(X)<2.48616E-4 Y=0:RETURN
30405 GOTO30440
30410 X=90-X : GOTO 30400
30420 X=-X : GOTO 30400
30430 X=X-90 : GOTO 30400
30440 Y=X-XXX*X/6+XXXXXXX*X/120-XXXXXXX*X/5040
30455 RETURN
30500 REM *ARCCOS* INPUT S, OUTPUT V,W
30510 REM V IS IN DEGREES, W IS IN RADIANS
30520 GOSUB 30550 : Y=90-Y : W= 1.570796-W : RETURN
30550 X=S : IF ABS(S)<= .707107 THEN 30610
30560 X=1-S*5 : IF X<0 THEN PRINT S; "IS OUT OF RANGE" : STOP
30570 W=X/2 : Z=0
30580 V=(X/W-W)/2 : IF (Y=0)+(Y=Z) THEN X=W : GOTO 30610
30600 W=W+V : Z=Y : GOTO30580
30610 Y=X+XXX*X/6+XXXXXXX*X* .075+XXXXXXX*X*4.464286E-2
30620 W=Y+XXXXXXXXXXXXXXXXX*3.038194E-2
30625 IF ABS(S)>.707107 THEN W=1.570796E-2
30630 Y=W*57.29578 : RETURN

```

Impedance Matching

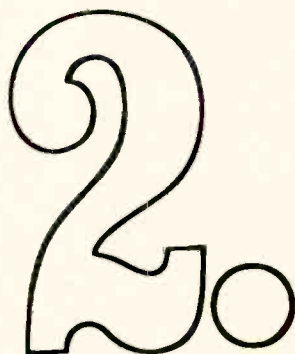

THIS short program for the TRS-80 Level II was designed to furnish the proper values of resistors for an L-type impedance-matching network and also draws the circuit diagram and figures out the system loss in decibels.

The program is self-prompting and uses no subroutines. Lines 20 and 30 ask the designer for the two impedances to be matched. Lines 40 through 70 are the "working" lines and operate on the data supplied in lines 20 and 30. The working lines are self-explanatory. Lines 90

through 130 print component identification and values for the circuit drawn by lines 140 and 150. Line 140 draws all the horizontal lines, and line 150 takes care of the vertical. Line 160 is a simple clock, which keeps the drawing on the screen for a predetermined amount of time. With the value used, the drawing remains for about 35 seconds. (To increase this time, increase the value of "N.") After the clock in line 160 times out, the computer goes to line 170 which returns it to line 10 to await the next problem. ♦

```

10 CLS
15 PRINT@8(15)"L TYPE IMPEDANCE MATCHING NETWORK"
20 INPUT "ENTER INPUT IMPEDANCE";Z1
30 INPUT "ENTER OUTPUT IMPEDANCE";Z2
40 R1=Z1*50R(1-(Z2/Z1))
50 R2=Z2/50R(1-(Z2/Z1))
60 M=50R(Z1/Z2)+50R((Z1/Z2)-1)
70 L=20*(LOG(M)/LOG(10))
80 CLS
90 PRINT@520,"Z IN >>>"
100 PRINT@205,"R1=";R1,"OHMS"
110 PRINT@560,"Z OUT <<<"
120 PRINT@920,"LOSS IN DBS IS";L
130 PRINT@595,"R2=";R2,"OHMS"
140 V=15 :FORX=10T030:SET(X,Y):NEXTX:Y=12:FORX=30T058:SET(X,Y):NEXTX:Y=18:FORX=30T058:SET(X,Y):NEXTX:Y=15:FORX=58T0100:SET(X,Y):NEXTX:Y=21:FORX=74T087:SET(X,Y):NEXTX:Y=32:FORX=74T087:SET(X,Y):NEXTX:Y=36:FORX=10T0100:SET(X,Y):NEXTX:Y=150:FORX=12T018:SET(X,Y):NEXTX:Y=58:FORX=12T018:SET(X,Y):NEXTX:Y=80:FORX=15T021:SET(X,Y):NEXTX:Y=74:FORX=21T032:SET(X,Y):NEXTX:Y=87:FORX=21T032:SET(X,Y):NEXTX:Y=80:FORX=32T036:SET(X,Y):NEXTX:Y=150:FORN=1T010000:NEXTN
170 GOTO 10

```

Capacitance Networks

3.

HERE is a Level II program covering eight different areas in the design of capacitance networks. The first three areas are of primary interest to students taking a course in electronics and will probably be of little use to experimenters. The other five areas, however, will be useful for both groups.

The program is self-explanatory and self-prompting when run. One unique feature of the program (section 8) allows you to change the total capacitance of a network by a specific amount. This section of the program not only tells you what value to add, but also tells whether to put the added capacitance in series or parallel. \diamond

```

10 CLS
20 PRINTAB(15)*"VARIOUS CAPACITIVE FORMULAE"
30 PRINT*CHARGE ON A CAPACITOR          #1*
40 PRINT*VALUE OF A CAPACITOR (PHYSICAL FACTORS) #2*
50 PRINT*ENERGY IN AN ELECTROSTATIC FIELD #3*
60 PRINT*RESISTOR & CAPACITOR TIME CONSTANTS #4*
70 PRINT*SERIES & PARALLEL REACTANCES #5*
80 PRINT*CAPACITIVE REACTANCE #6*
90 PRINT*IMPEDANCE #7*
100 PRINT*SERIES/PARALLEL CAPACITORS #8*
120 INPUT U
130 ON U GOTO 125,290,325,375,515,565,605,645
135 CLS
140 INPUT*ENTER UNKNOWN Q=1 , C=2 , E=3*:X
150 ON X GOTO 160,210,250
160 INPUT*ENTER CAPACITOR VALUE IN U-FARADS*:C
170 INPUT*ENTER VOLTAGE*:V
180 PRINT*THE CHARGE IS*(C*V)/(1E6). "COULOMBS OF ELECTRONS "
190 END
210 INPUT*ENTER VOLTAGE*:V
220 INPUT*ENTER CHARGE IN COULOMBS*:Q
230 PRINT*THE CAPACITANCE IS*(Q/V)*(1E6). "MICROFARADS"
240 END
250 INPUT*ENTER CAPACITANCE IN U-FARADS*:C
260 INPUT*ENTER CHARGE (Q) IN COULOMBS*:Q
270 PRINT*THE VOLTAGE IS*(Q/C)*1E6. "VOLTS"
280 END
290 INPUT*ENTER AREA OF PLATES IN SQ. METERS*:A
300 INPUT*ENTER DISTANCE BETWEEN PLATES IN METERS*:D
310 INPUT*ENTER DIELECTRIC CONSTANT (FROM TABLE)*:K
320 PRINT*THE CAPACITOR VALUE IS*(K*(A/D))*8.85. "U-FARADS"
330 END
335 CLS
340 INPUT*ENTER THE VOLTAGE VALUE*:V
350 INPUT*ENTER CAPACITOR VALUE IN U-FARADS*:C
360 PRINT*THE ENERGY IN THE ELECTROSTATIC FIELD IS*.1/(2*C)*(V**2)*(1E6). "JOULES"
370 END
375 CLS
380 INPUT*ENTER UNKNOWN , TIME=1 , RESISTOR=2 , CAPACITOR=3*:X
390 ON X GOTO 400,440,480
400 INPUT*ENTER RESISTOR VALUE IN OHMS*:R
410 INPUT*ENTER CAPACITOR VALUE IN U-FARADS*:C
420 PRINT*THE TIME CONSTANT IS*.R*C*1E-6. "SECONDS"
430 END
435 CLS
440 INPUT*ENTER TIME IN SECONDS*:T
450 INPUT*ENTER CAPACITOR IN U-FARADS*:C
460 PRINT*THE RESISTOR VALUE IS*.T/C*1E6. "OHMS"
470 END
475 CLS
480 INPUT*ENTER TIME IN SECONDS*:T
490 INPUT*ENTER RESISTANCE IN OHMS*:R
500 PRINT*THE CAPACITOR VALUE IS*.T*R*1E6. "U-FARADS"
510 END
515 CLS
520 INPUT*ENTER CAPACITIVE REACTANCE (XC1)*:A
530 INPUT*ENTER (XC2)*:B
540 PRINT*THE SERIES REACTANCE IS*(A*B). "OHMS CAPACITIVE"
550 PRINT*THE PARALLEL REACTANCE IS*(A*B)/(A+B). "OHMS"
560 END
565 CLS
570 INPUT*ENTER CAPACITOR VALUE IN U-FARADS*:C
580 INPUT*ENTER FREQUENCY IN HERTZ*:F
590 PRINT*THE REACTANCE IS*(1/(6.28*F*C*1E-6)). "OHMS OF XC"
600 END
605 CLS
610 INPUT*ENTER REACTANCE (XC) IN OHMS*:B
620 INPUT*ENTER RESISTANCE IN OHMS*:R
630 PRINT*IMPEDANCE (Z) EQUALS*.50*(B**2)+(R**2). "OHMS"
640 END
645 CLS
650 INPUT*ENTER 1 FOR TOTAL VALUE , 2 FOR CHANGING TOTAL VALUE*:D
660 ON D GOTO 670,840
665 CLS
670 INPUT*ENTER NUMBER OF CAPACITORS USED , 2 , 3 , OR 4*:X
680 ON X GOTO 685,725,775
685 CLS
690 INPUT*ENTER VALUE OF C1*:A
700 INPUT*ENTER VALUE OF C2*:B
710 PRINT*THE SERIES VALUE IS*(A*B)/(A+B). "AND THE PARALLEL VALUE IS".A*B. "U-FARADS"
720 END
725 CLS
730 INPUT*ENTER VALUE OF C1*:A
740 INPUT*ENTER VALUE OF C2*:B
750 INPUT*ENTER VALUE OF C3*:C
760 PRINT*THE SERIES VALUE IS*.1/(1/R*1/B*1/C*1E6). "AND THE PARALLEL VALUE IS".A*B+C. "U-FARADS"
770 END
775 CLS
780 INPUT*ENTER VALUE OF C1*:A
790 INPUT*ENTER VALUE OF C2*:B
800 INPUT*ENTER VALUE OF C3*:C
810 INPUT*ENTER VALUE OF C4*:D
820 PRINT*THE SERIES VALUE IS*.1/(1/R*1/B*1/C*1/D). "AND THE PARALLEL VALUE IS".A*B+C*D. "U-FARADS"
830 END
835 CLS
840 INPUT*ENTER PRESENT TOTAL VALUE OF CAPACITANCE*:T
850 INPUT*ENTER DESIRED VALUE*:D
860 IF T-D GOTO 870 ELSE 880
870 PRINT*TO OBTAIN*:D. "AS A FINAL VALUE , ADD*(T-D)*. "IN SERIES WITH YOUR PRESENT CIRCUIT"
875 END
880 PRINT*TO OBTAIN*:D. "AS A FINAL VALUE ADD*-D-T. "IN PARALLEL WITH YOUR PRESENT CIRCUIT. "
890 END

```

Common-Emitter Amp Design

4.

IF YOU are designing a common-emitter amplifier such as that shown in the diagram and have only minimum information about the transistor, this is a useful program to have. The only data needed is the maximum collector current, maximum collector voltage, beta, and type of transistor (silicon or germanium). The layout of the program is straightforward and it is self-prompting when run.

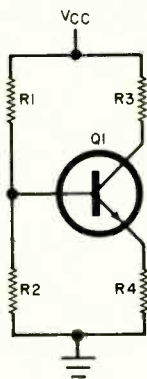

Lines 30 through 70 ask for information needed for the calculations in lines 80 through 140. Lines 150 through 190 print out the results of the calculations and label what they are. These values are the "ideal" and it is up to the designer to pick the closest standard values available.

The remainder of the program draws a schematic of the circuit and labels all parts values. Line 200 begins by asking if a schematic is necessary. If not, the program jumps to line 220 which ends it. If a schematic is desired, the program jumps to line 230, which begins the graphics by clearing the screen and then printing the parts values and labels. Lines 250 through 310 draw the rest of the schematic.

Line 320 is a simple clock. With the value of "N" used, the graphics remain on the screen for about 20 seconds. To increase this time, make "N" a larger number. After the clock times out, the screen is cleared and the program is sent back to line 20 to await the next problem. ◊

```

20 PRINT"COMMON EMITTER AMPLIFIER"
30 INPUT"ENTER MAX. COLLECTOR CURRENT";A
40 INPUT"ENTER BETA";B
50 INPUT"ENTER VCC VOLTAGE";C
60 INPUT"ENTER TYPE: SILICON=1 , GERMANIUM=2";D
70 INPUT"ENTER LOWEST FREQUENCY TO BE AMPLIFIED";K
80 E=.5*A*I C
90 F=.45*C/V C
100 G=1*C/V E
110 I=E/B*I B
120 IF D=1 H=G+.6 ELSE H=G+.3/V B
130 J=(C-F)/I /R1
140 L=1*(G/E);M=(1/(.6.28*K*L))*1E6
150 PRINT"R1=";J;"OHMS"
160 PRINT"R2=";(G/C)*J;"OHMS"
170 PRINT"R3=";(C-F)/E;"OHMS"
180 PRINT"R4=";G/E;"OHMS"
190 PRINT"C1=";M;"MICRO FARADS"
200 INPUT"IS A SCHEMATIC DESIRED ? YES=1 , NO=2";R
210 IF R=1 GOTO230ELSE 220
220 END
230 CLS
240 PRINT@204;"R1":PRINT@218;"R3":PRINT@19;"VCC":PRINT@349;"C":PRINT@469;"B":PRINT@540;"E":PRINT@716;"R2":PRINT@730;"R4":PRINT@743;"
C1 "=":PRINT@914;"GROUND":PRINT@192;J;:PRINT@210;:(C-F)/E;:PRINT@705;:25*J;:PRINT@723;:G/E;:PRINT@747;:M;" MICRO FARADS"
250 X=40:FOR Y=17T026:SET(X,Y):NEXT Y:
260 X=40:Y=20:SET(X,Y):X=40:Y=20:FOR N=1T010:SET(X,Y):X=X+1.5:Y=Y-.5:NEXT N:X=53:FOR Y=14T016:SET(X,Y):NEXT Y:X=53:FOR Y=28T030:SET(X,Y):
NEXT Y:X=40:Y=24:SET(X,Y):X=40:Y=24:FOR N=1T010:SET(X,Y):X=X+1.5:Y=Y+.5:NEXT N:
270 Y=4:FOR X=26T053:SET(X,Y):NEXT X:Y=6:FOR X=22T030:SET(X,Y):NEXT X:Y=6:FOR X=49T057:SET(X,Y):NEXT X:Y=14:FOR X=22T030:SET(X,Y):NEXT X:Y=1
4:FOR X=49T057:SET(X,Y):NEXT X:Y=22:FOR X=26T040:SET(X,Y):NEXT X:Y=30:FOR X=22T030:SET(X,Y):NEXT X:
280 Y=30:FOR X=49T057:SET(X,Y):NEXT X:Y=28:FOR X=53T069:SET(X,Y):NEXT X:Y=33:FOR X=64T074:SET(X,Y):NEXT X:Y=35:FOR X=64T074:SET(X,Y):NEXT X:
Y=30:FOR X=49T057:SET(X,Y):NEXT X:Y=38:FOR X=22T030:SET(X,Y):NEXT X:Y=38:FOR X=49T057:SET(X,Y):NEXT X:
290 Y=40:FOR X=26T069:SET(X,Y):NEXT X:Y=6:FOR X=22T030:SET(X,Y):NEXT X:Y=6:FOR X=49T057:SET(X,Y):NEXT X:X=39:FOR Y=3T04:SET(X,Y):NEXT Y:X=22
:FOR Y=6T014:SET(X,Y):NEXT Y:X=26:FOR Y=4T06:SET(X,Y):NEXT Y:X=26:FOR Y=14T030:SET(X,Y):NEXT Y:
300 X=26:FOR Y=38T040:SET(X,Y):NEXT Y:X=49:FOR Y=6T014:SET(X,Y):NEXT Y:X=49:FOR Y=38T038:SET(X,Y):NEXT Y:X=53:FOR Y=4T06:SET(X,Y):NEXT Y:X=5
3:FOR Y=38T040:SET(X,Y):NEXT Y:X=57:FOR Y=6T014:SET(X,Y):NEXT Y:X=57:FOR Y=38T038:SET(X,Y):NEXT Y:
310 X=69:FOR Y=28T033:SET(X,Y):NEXT Y:X=69:FOR Y=35T040:SET(X,Y):NEXT Y:X=40:FOR Y=40T042:SET(X,Y):NEXT Y:X=30:FOR Y=6T014:SET(X,Y):NEXT Y:X
=22:FOR Y=30T038:SET(X,Y):NEXT Y:X=30:FOR Y=30T038:SET(X,Y):NEXT Y:
320 FOR N=1T010000:NEXT N:CLS
330 GOTO20
    
```

Voltage-Regulator Design

5.

THIS final program can be used in the design of three different types of zener-diode voltage-regulator circuits. It was designed and tested with TRS-80 Level II, but is directly compatible with TRS-80 Level I.

The program is applicable to all three of the circuits shown in the diagram. Lines 30 through 70 ask for information common to all three. Lines 100 through 110 are used only in the first circuit. (We really don't care about the diode's impedance in the other circuits since it isn't seen by the load.)

Line 120 asks which circuit is of interest and lines 130 to 150 branch to the respective graphic "subroutines," which draw the circuits. Lines 860, 1060, and 1250 are simple timing clocks to hold the schematic of the regulator on the screen for a specified amount of time. With the value shown, the display remains for about 20 seconds.

After the clock times out, the comput-

er goes to the next line which directs the computer to the proper line number for the start of that particular part of the program. The first few lines of each individual circuit program query the designer for any additional data that is needed. Following these query lines are a number of data-operation or formula lines.

Following these calculations, the computer prints the results. Unfortunately these results are "ideal" values, and it is up to the designer to pick the nearest standard value. Another set of values is calculated with a 50% safety factor.

One change you may want to make in the program is in lines 60 and 70. Instead of entering power in these two lines, you may want to enter the maximum and minimum current. By doing this, you can eliminate lines 80 and 90. (However, use "J" as the variable in line 60 and "K" in line 70 so that you don't have to rewrite these factors in the remainder of the program. \diamond)

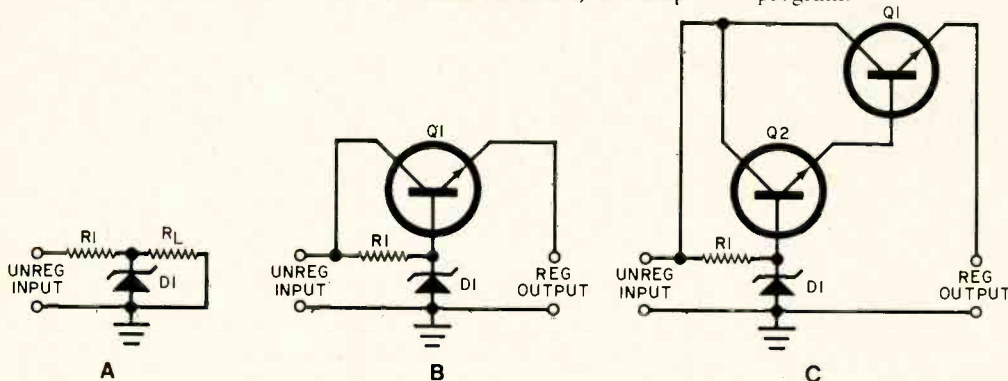

The program here is applicable to any one of these circuits.

```

10 CLS
20 PRINT@16,"VOLTAGE REGULATOR CIRCUITS"
30 INPUT"ENTER REGULATED OUTPUT VOLTAGE DESIRED";A
40 INPUT"ENTER MINIMUM VOLTAGE FROM POWER SUPPLY FILTER";B
50 INPUT"ENTER MAXIMUM VOLTAGE FROM POWER SUPPLY FILTER";C
60 INPUT"ENTER MAXIMUM POWER OF LOAD";D
70 INPUT"ENTER MINIMUM POWER OF LOAD";E
80 J=D/A
90 K=E/A
100 L=A/.1*J
110 F=A/.1*K
120 INPUT"ENTER CIRCUIT DESIRED 1 = 2 OR 3";M
130 IF M=1 THEN 720
140 IF M=2 THEN 880
150 IF M=3 THEN 1080
160 CLS
170 PRINT"THE CIRCUIT YOU HAVE PICKED WILL REQUIRE ONE ZENER DIODE AND ONE SERIES RESISTOR. REFER TO CIRCUIT #1."
180 G=(C-A)/(1.1*J)
190 I=(C-A)*(1.1*J)
200 H=A*(J-K)
210 PRINT"CALCULATED VALUE OF R1 IS";G;"OHMS (PICK NEXT STANDARD LOWER VALUE)"
220 PRINT"CALC. WATTAGE OF R1 IS";I;"WATTS"
230 PRINT"CALC. VALUE OF D1 IS";A;"VOLTS @";H;"WATTS"
240 PRINT"MAX. LOAD CURRENT IS";J;"AMPS."
250 PRINT"MIN. LOAD CURRENT IS";K;"AMPS."
260 PRINT"MIN. DIODE IMPEDANCE IS";F;"OHMS"
270 PRINT"MAX. DIODE IMPEDANCE IS";P;"OHMS"
275 PRINT" < < < < "
280 PRINT"FOR A SAFETY FACTOR OF 50%:"
290 PRINT"R1 SHOULD EQUAL ";G;"OHMS AT";1.5*I;"WATTS"
300 PRINT"ZENER DIODE D1 SHOULD EQUAL";A;"VOLTS AT";1.5*H;"WATTS"
310 END
320 PRINT"THE CIRCUIT YOU HAVE CHOSEN WILL REQUIRE 1 ZENER DIODE, 1 SERIES RESISTOR , AND 1 TRANSISTOR. REFER TO CIRCUIT #2."
330 INPUT"ENTER BETA OF Q1";N
340 INPUT"ENTER IF Q1 IS SILICON=1, GERMANIUM=2";L
350 I=J/N
360 IF L=1 THEN H=A+.6 ELSE H=A+.3
    
```

Popular Electronics Tests

BBC-Metrawatt/Goerz Model MA 3D Digital Multimeter



THE BBC-Metrawatt/Goerz Model MA 3D Digital Multimeter is a general-purpose 3½-digit LCD multimeter of unique physical design—it folds down on itself to protect its display and switches. When closed, it looks like a transistor radio in a black plastic case, with very little indication that it is a DMM.

When the case is open, the “cover” exposes a 3½-digit, 0.72” high, seven-segment, high-contrast LCD readout, with only a function rotary switch and a power on-off switch on the other half. The LCD display cover can be positioned at any of 8 selectable (detent) angles from closed to flat open. Thus, there is no need for a tilt stand since the display can be

positioned as desired. The color-coded test leads are plugged into submerged safety connectors on one side as is the external power connector.

The protective safety leads and connectors comply with the safety rules set down by VDE 0411/DIN 57 411, assuring safety for the instrument and the user.

The power switch is automatically placed in the off position when the case is closed, while a carrying strap enables the meter to be slung from the neck, leaving the hands free to use the test leads.

The 25 ranges include five each for ac and dc voltages from 200 mV to 650 volts full scale, five each for ac and dc current from 2 mA to 10 A full scale, and five for resistance measurement from 2 kilohms to 20 megohms full scale. Accuracy is ±0.25% on the dc ranges. (Complete specifications are shown in the accompanying Table).

The shock-resistant case is 5¾” wide, 4¾” deep, 2” thick (case closed), and it weighs slightly under one pound. Suggested retail price is \$199.



TECHNICAL SPECIFICATIONS BBC-METRAWATT/GOERZ DMM

AC/DC Voltage Ranges:

Accuracy: DC $\pm 0.25\%$ of rdg + 1 dig
 AC $\pm 0.75\%$ of rdg + 2 dig
 Input Resistance: 10 megohms, 40 pF
 Resolution: 0.1 mV on 200 mV
 1 mV on 2 V
 10 mV on 20 V
 100 mV on 200 V
 1 V on 650 V
 Overload Protection: 250 V on 200 mV
 780 V on 2 to 650 V

AC/DC Current Ranges:

Accuracy: DC $\pm 1\%$ of rdg + 1 dig
 AC $\pm 1.5\%$ of rdg + 2 dig
 Resolution: 1 μ A on 2 mA
 10 μ A on 20 mA
 100 μ A on 200 mA
 1 mA on 2 A
 Voltage Drop: 200 mV on 2 and 20 mA
 240 mV on 200 mA
 650 mV on 2 A
 Overload Protection: 250 V

Resistance Ranges:

Accuracy: $\pm 0.5\%$ of rdg + 1 dig on
 2, 20, 200 $\pm 2\%$ of rdg + 1 dig
 on 2, 20 megohms
 Resolution: 1 ohm on 2 kilohms
 10 ohms on 20 kilohms
 100 ohms on 200 kilohms
 1 kilohm on 2 megohms
 10 kilohm on 20 megohms
 Full-Range Voltage: 0.5 V on 2 kilohms
 0.78 V on 20 kilohms
 0.83 V on others
 Open-Circuit Voltage: 1.23 V
 Overload Protection: 250 V

Frequency Range:

AC Voltage:
 200 mV to 200 V:
 30-400 Hz, $\pm 1\%$ of rdg + 4 dig
 15 Hz-4 kHz, $\pm 3\%$ of rdg + 8 dig
 650 V:
 30-200 Hz, $\pm 1\%$ of rdg + 4 dig
 15-600 Hz, $\pm 3\%$ of rdg + 8 dig
 AC Current:
 30-400 Hz, $\pm 2\%$ of rdg + 4 dig
 15 Hz-4 kHz, $\pm 3\%$ of rdg + 8 dig

Display: 7-segment LCD, 18 mm 3 1/2 dig

Full-Scale Value: 1999
 Overrange: Left digit remains on
 Polarity: No sign is positive.
 Minus sign is negative.
 Decimal Point: Automatic.

Power Supply: 9-V battery

Life: 100 hr with manganese-dioxide
 200 hr with alkaline-manganese
 Arrow appears if below limit.
 Power Line: NA 2-9/20 adapter (7-13 V dc)

Case:

Class: II, VDE 0411/DIN 57 411
 Type: IP50-DIN 40 050, IP20 at
 connectors
 Dimensions: 146 x 118 x 44 mm
 Weight: 0.45 kg less battery

General Description. The model MA 3D has only one operational control—an indented function/range switch used to select the desired function and any of its five ranges. Each function and its associated five ranges are clearly identified so that there is no possibility of error. The base section top cover carries the identification of the three input connectors (+, common, 10A) and the fuse data. The 9-volt transistor radio battery is concealed within the large "hinge" section with access via a snap on/off panel.

The meter is entirely black plastic with sharp white engraved identifications. The only touch of color is the bright red power on/off switch in the lower right corner. When the cover is swung to the closed position, this switch is mechanically coupled to a detent in the cover that automatically turns the power off.

User Comments. The Model MA 3D was checked by the Lockheed Instrumentation Measurement Laboratory (Plainfield, NJ) against standards traceable to the Nation Bureau of Standards, and the instrument was found to meet or exceed its claimed specifications in all respects.

We put the Model MA 3D to work on our bench, where it made a big hit due to its rather large (3 1/4") high-contrast LCD readout and the tiltable cover that contains the display. Four small rubber "feet" make the instrument skid-proof on the benchtop.

By connecting the slender three-foot braided strap to its support pins on the case, and tilting the meter "face" at 90° to the instrument base, the instrument can be carried while keeping the display clearly visible. This leaves both hands free to manipulate the test leads. This is ideal for those who must make measurements when standing up or in cramped quarters.

We found the function/range switch easy to use, the legends clear and easy to read, and the LCD readout one of the best we have seen. We appreciate the thought given to the safety test leads, with their large protective rim to keep fingers from contacting the metal probe tips where dangerous voltages might exist. At the other end of the test leads, the covered ends fit into submerged connectors, removing these from any finger contact.

Besides being an excellent bench instrument, when closed the Model MA 3D easily fits within a pocket. (Its rounded edges avoid tearing of pocket linings.) We can highly recommend this uniquely packaged, modestly priced digital multimeter.

—Leslie Solomon

CIRCLE NO. 104 ON FREE INFORMATION CARD

Make up to \$1250 an hour
Start your own money making business!
Be Your Own Boss!

Hundreds of Foley-Belsaw trained men have succeeded in this fascinating and highly profitable field...
YOU Can Do It Too!

BE A LOCKSMITH

Never before have money-making opportunities been so great for qualified locksmiths. Now lucrative regular lock and key business has multiplied a thousandfold as millions seek more protection against zooming crime. Yet there's only one Locksmith for every 17,000 people!

Train FAST at Home—Collect CASH PROFITS Right Away.

You're in business, ready to earn up to \$1250 an hour a few days after you begin Foley-Belsaw's shortcut training. Take advantage of today's unprecedented opportunities in locksmithing for your own EXTRA INCOME in spare time—or full time in a high-profit business of your own. Hundreds who've trained have done it. So can YOU! All tools plus Professional Key Machine given you with course. These plus practice materials and equipment plus simple, illustrated lessons plus expert supervision plus business building guidance will enable you to KEEP THE MONEY COMING IN! Ideal for retirement—good jobs too.

FREE BOOKLET!



SEND FOR EXCITING FACTS—No Obligation!
ALL SPECIAL TOOLS AND EQUIPMENT INCLUDED!

PRO KEY MACHINE YOURS TO KEEP!

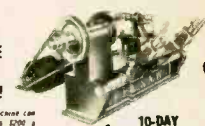

FREE RUSH COUPON!

10-DAY NO RISK TRIAL!

RUSH Send for your coupon! copy today!



FOLEY-BELSAW INSTITUTE
 10051 Field Bldg.
 Kansas City, MO. 64111

There is NO OBLIGATION and NO SALESMAN Will Call—even!

FREE! **FOLEY-BELSAW INSTITUTE**
 10051 Field Bldg., Kansas City, Mo. 64111
 Please rush FREE Book "Keys to your Future."

NAME _____
 ADDRESS _____
 CITY-STATE-ZIP _____

CIRCLE NO. 2 ON FREE INFORMATION CARD

CABLE TV

CONVERTERS DESCRAMBLERS

Largest Selection of Equipment Available
\$ Buy Warehouse Direct & Save \$

36 channel converter \$4595

36 channel wired remote converter only \$8895

Send \$2 for complete catalog of converters and unscramblers

Quantity Discounts • Visa • Master Charge
 Add 5% shipping—Mich. residents add 4% sales tax

C&D Electronics, Inc.
P.O. Box 21, Jenison, MI 49428
(616) 669-2440

By Stan Veit
Computer Editor

News from the Computer Shows

SOME major computer shows are over, everybody has gone home, and it is time to evaluate the wonders exhibited there. Houston, Texas hosted the National Computer Conference (NCC) and it was a "Texas-size" event indeed with over 90,000 people attending. Atlantic City, NJ, the former home of the eastern computer shows returned as an exhibit site for COMDEX and attracted Independent Sales Organizations from all over the world. Both shows were a success as showcases for a new generation of small desktop and portable computers.

At the NCC, it seemed every manufacturer had a new personal computer. Similarly, companies that had previously produced only mainframe computers or large minis introduced microcomputers and those that had been in the personal-computer business were showing portable machines. Many of the new offerings were built around 8/16-bit processors or 16/32-bit processors. However, some of the large mainframe manufacturers showing personal computers gave the impression that they just had a toe in the water and they might not really produce the machines they were showing.

The 8086/8088 family from Intel and the M68000 family from Motorola have won the competition to become the dominant microprocessor chips of the eighties. This fact was obvious from the number of computers using one or the other of these sixteen-bit microprocessor chips. In spite of this, the Z80 has won a new lease on life because many of the new computers support the older processor as a "slave" or secondary processor. The TRS-80 Mod 16 is a typical example. It uses the 68000 as the main processor, but also has a Z80 to run the existing Mod II software. Even the IBM PC, which uses the 8088, operates with a plug-in Z80.

The "Battle of the Operating Systems" was not much in evidence at either NCC or COMDEX. CP/M was the main operating system for 8-bit systems, while MDOS (PC DOS) was the main system shown for 8088/8086 computers. The competing system from Digital Research, CP/M-86, did not seem to be used as the primary operating system for many of the new offerings although it is offered as an alternate on almost all of

the 8088/8086-based systems. UNIX™ was much talked about as a future 16/32-bit operating system, but few new computers are using it at this time. Fortune Computer's 16:32 Computer, with the M68000, was one of the new computers now using Unix. The Charles River Data System's Universe 68 series of 68000 computers and the 16-bit Onyx Computers are others.

As more 68000 systems come into use, UNIX will likely become a stronger competitor. A lot will depend upon Radio Shack's choice of a M68000 Operating System for the Mod 16. If Radio Shack adopts UNIX, it will be the most used 16-bit microcomputer operating system. If Radio Shack decides on a system unique to TRS-80 Mod 16, UNIX will still be a strong contender and the Mod 16 might suffer from lack of software. The UCSD P-System (UCSD Pascal) grew in strength as it was adopted as a secondary operating system for more computers. It stands today as the only transportable microcomputer operating system. It is already so well established that it is number two among software operating systems. However it is number two on almost all the computers where something else is number one! Not a bad position to be in for any product, though.

Portables were the main hardware innovation at both NCC and COMDEX. They come in three sizes. The first is the suitcase size represented by the Osborne 1 and similar machines. The next size is the briefcase size such as the Epson HX-20, the Compass, the Sony Typecorder, and the Teleram, all of which fit in a briefcase or attache case. The smallest size is the hand-held computers.

The Osborne 1 has a new front panel that makes the unit physically more attractive. There is also a double-density version and a modification kit that retrofits this needed improvement to all previous units. The addition of double density permits the release of a large body of CP/M software in Osborne format. This makes the Osborne 1 a much more useful computer. As a bonus, the Osborne Computer Co. is giving users the UCSD runtime package for its machines. While this alone does not permit the running of Pascal on the Osborne, it does allow many

application programs written in UCSD Pascal to be run on the machine.

The success of the Osborne 1 has apparently impressed others as some computer companies have rushed their versions of a portable computer into prototype production. The Kaycomp II from Non-Linear Systems, for example, offers most of the Osborne 1 features at the same price, but it includes a 9" CRT instead of the 5" CRT used in the Osborne. Since this is one of the shortcomings of the Osborne 1, the Kaycomp II could be a strong competitor.

The Fox from Digital Microsystems is another portable from one of the established manufacturers. It offers the advantage of being compatible with a broad library of CP/M software that can run on larger machines.

Morrow Design's Micro Decision is another portable offering all of the features of the Osborne 1, including either one 200K drive or two drives that store 400K. The Morrow computers only cost \$1195 for the single-drive model or \$1545 for the double-drive computer. Neither model comes with a video monitor, but for the difference in price, the user can select any size or quality monochrome monitor desired.

A new company, Janos Ltd., of Anaheim, CA, offers some innovative portable computer designs. The Courier Portable features a 9" CRT, a Z80A CPU with 64K of memory, and a serial interface. The computer uses the Standard Bus and provides five card slots for system expansion. The disk drive is the new Sony 3¹/₂" system that stores 322K bytes per disk. The Janos Courier is priced at \$3995, twice the cost of the Osborne 1, but it offers many additional features. Janos has another model with two removable 5-megabyte hard-disk cartridges in place of the floppy disks. This is the ultimate in portable computer data storage: 10 megabytes of data storage in a package you carry like a suitcase!

From Canada comes the Hyperion Portable Computer made by Dynalogic Infotech of Ottawa. This was easily the most attractive design at both of the shows. It is a portable compatible with the IBM PC computer, running the Microsoft MS DOS Operating System with advanced disk BASIC. It has both serial and parallel I/O ports and is compatible with the IBM PC printer, or other Epson or Centronics-type printers. It includes a built-in 300-baud modem for data communications and a time and date clock with battery back-up.

The Hyperion weighs 20 lb and measures only 18" W by 10" D by 8¹/₂" H. The keyboard stores in the case and the entire assembly fits into a vinyl carrying case. The Hyperion costs \$4999 but its IBM compatibility and design features will make it attractive to many users.

Another portable that attracted a lot of attention at both the NCC and the COMDEX shows was the Otrona which was the subject of an article in the June issue of this magazine.

The briefcase class of computers and terminals also aroused much interest. The Compass computer by Grid Systems features a fold-down, flat electroluminescent screen with a 24-line by 53-character display with horizontal scrolling. All of the other briefcase-size units either show a single line or, in the case of the Epson HX-80 and the Teleram T-3000, a four-line display. The Compass is still in the early production stage. It is priced at over \$8000, but it represents the logical future of portable computers.

The Epson HX-20 is a more affordable briefcase system, packing a powerful computer into an 11" x 8½" x 1¾" package. It contains two CMOS 6301 CPUs, 16K of RAM memory (expandable to 32K) and 32K of ROM memory (expandable to 64K), a 24-character by 4-line display with horizontal scrolling to 255 characters. A dot-matrix printer is included as well as an RS-232C port. Parallel interfaces are provided for connection to a standard Epson printer, a bar-code reader, the cassette, and an extension of the system bus. An optional

microcassette is available too. This is mounted in the front panel and makes the HX-20 a complete self-contained computer system.

The Teleram-3000 features bubble memory data storage and the ability to run the popular CP/M operating system. This is made possible by a low-power version of the Z80 CPU, 64K of RAM, and 4K of ROM. The bubble memory simulates the Drive A required by CP/M and the display is 80 characters by 4 lines. Provision is made to add an expansion unit for office use. This permits the installation of up to four external disk drives, a video monitor, and other peripherals. At the less than \$3000 price quoted, the Teleram will find many users who want more portability than is offered by the suitcase-size machines.

Handheld computers were represented by the Sharp 1500 which also is sold under the Radio Shack label and the Matsushita brand which is sold by Panasonic, Quasar, and Olympic, as well by the designers, Friends Amis. The Sharp 1500 features increased memory over its previous version and an interface to a four color printer/plotter. This is one of the most ingenious peripherals ever developed for a small computer. It produces printing in several sizes and

colors and can plot histograms, line graphs, and even pie charts.

The Panasonic (Quasar, et al) unit has an interconnecting bus unit with peripherals that plug-in producing an attachable computer system composed of the computer, a small printer, a modem with communications software in ROM, and a video unit with both a color graphics display and a black and white display. There is also a bus extension and an RS-232C interface. Memory expansion units can be plugged in to expand the memory up to 56K. In addition, there is a plastic connector unit that permits any two units to be connected without the main interconnecting unit. The computer uses both Microsoft BASIC and a Forth-like language called Snap. The CPU is a 6502 and the Apple II+ can be used as a development system to develop Snap programs. All of the versions of the system are identical, except that Friends Amis have developed their own expansion capability using a holding device called the "Datashuttle." This holds the basic HHC and adds up to 40K of nonvolatile RAM. It has interfaces for a modem, a tape cassette, an RS-232C interface, an ac adapter, and battery charger. It retains the standard parallel connector for peripherals and the bus expander. →



NEW LARGE DISPLAY FOLDING MULTIMETERS FROM METRAWATT

available from your Metrawatt Distributor

2 year warranty



AK-Juneau Electronics, Juneau	907-586-2260	MD-Brimberg Distributors, Wheaton	301-946-2670
AL-Brownell Electro, Inc., Mobile	205-479-8581	NC-Brownell Electro, Inc., Charlotte	704-597-1270
AR-Tri-State Instr. Lab Inc., Morrilton	501-354-1849	NC-Brownell Electro, Inc., Raleigh	919-876-6524
AZ-Metermaster, Phoenix	602-243-4111	NC-Meter Metrics, Raleigh	800-446-7230
AZ-Jensen Tool and Alloys, Tempe	602-968-6241	NJ-Brownell Electro, Inc., S. Plainfield	201-753-4600
CA-Metermaster, Los Angeles	213-685-4340	NJ-Hosica Laboratories, No. Caldwell	201-256-7724
CA-Metermaster, Palo Alto	415-968-0313	NJ-Route Electronics 22, Springfield	201-379-7710
CA-Metermaster, San Diego	714-560-4841	NJ-William Electronics Sup., Edison	201-985-3700
CA-Rexanne Products, Los Angeles	213-663-3261	NY-Advance Electronics, New York	800-223-0474
CO-Air-Row Instruments, Inc., Arvada	303-421-4204	NY-Brownell Electro, Inc., New York	212-691-1171
CO-R&R Instrumentation, Inc., Aurora	303-340-8728	OK-Tri-State Instr. Lab., Inc., Tulsa	918-836-0286
CT-Brownell Electro, Inc., Hartford	203-278-9004	OR-Radar Electric Co., Inc., Portland	503-232-3404
FL-Brownell Electro, Inc., Miami	305-591-3215	TN-Brownell Electro, Inc., Knoxville	615-966-3441
FL-Brownell Electro, Inc., Orlando	305-843-6770	TN-Brownell Electro, Inc., Memphis	901-795-8487
FL-Electronic Equipment Co., Inc., Miami	305-871-3500	TN-Brownell Electro, Inc., Nashville	615-889-8230
FL-Electronic Equip. Co., Winter Park	305-644-4833	TX-Metermaster, Garland	214-271-5671
GA-Brownell Electro, Inc., Atlanta	404-762-5181	TX-Metermaster, Houston	713-733-9814
IA-Farnsworth Electronics, Waterloo	319-234-6681	TX-Acudata, Inc., Houston	713-488-2750
IL-Commodore-I, Inc., Rolling Meadows	312-394-5441	VA-Meter Metrics, Richmond	800-552-7952
IL-Metermaster, Elk Grove Village	312-593-8650	WA-Radar Electric Co., Inc., Seattle	206-282-2511
MA-Brownell Electro, Inc., Woburn	617-935-7820	WA-Radar Electric Co., Inc., Spokane	509-747-3053
MA-Metermaster, Boston	617-523-2580	WI-Metermaster, Milwaukee	414-643-0554

The Finest Craftmanship Second to None

BBC - METRAWATT/GOERZ 165 Fieldcrest Avenue, Edison, New Jersey 08837 • (201) 225-4414
Division of Kent Process Control, Inc.



Make your music a moving experience with TDK AD.

Whether you're skating or biking with your portable cassette player or enjoying rock, jazz or classical on your car stereo, you deserve the best sound reproduction you can get. TDK AD cassettes make your music come alive with clear, crisp sound. Its Laboratory Standard Mechanism and high quality tape are so reliable, TDK backs it with a Full Lifetime Warranty.



TDK
Music lives on TDK®

CIRCLE NO. 23 ON FREE INFORMATION CARD

FREE

McIntosh STEREO CATALOG and FM DIRECTORY

Get all the newest and latest information on the new McIntosh stereo equipment in the McIntosh catalog. In addition you will receive an FM station directory that covers all of North America.

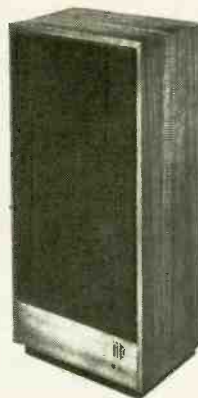
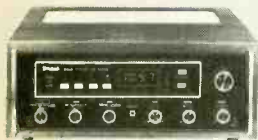

**SEND
TODAY!**

McIntosh Laboratory Inc.
East Side Station P.O. Box 96
Binghamton, N.Y. 13904-0096

PE

NAME _____

ADDRESS _____

CITY _____ STATE _____ ZIP _____

If you are in a hurry for your catalog please send the coupon to McIntosh.
For non rush service send the Reader Service Card to the magazine.

computers

In spite of the emphasis on portable computers, many companies introduced standard desktop and rack-mounted machines. Digital Equipment Corporation entered the personal computer field with four new computers. The first of these, the Rainbow, marked the first time that DEC has ever used an outside CPU and operating system. The Rainbow features a Z80 processor and uses the CP/M operating system and software. The other new DEC computers use a new LSI version of the PDP-11/23 and the standard DEC operating systems. One new machine is an updated word processor based on the PDP8 series.

Zenith has also departed from its usual bus and operating system by introducing the Z100 series of desktop computers. The Z100 represents Zenith's 8088/8086 16-bit generation. The series consists of two types of computers. The Series 110 is a low-profile color computer with no monitor. The Z120 is a one-piece cabinet with a built-in monitor. Both have 128 bytes of dynamic RAM, expandable to 196K on the main board. Both also have dual 5 1/4" drives with 48 tracks and use double-density, double-sided media. Optional 8" drives are available and a Winchester technology hard-disk drive will be available soon. I/O consists of both serial RS-232C ports and a Centronics-compatible parallel port. In one of its most important departures from the past, Zenith has adopted the S-100 bus for memory expansion and peripheral interface. The memory can be expanded up to 768K bytes using S-100 memory boards. The color unit offers eight colors with color memory standard in the Z120 and optional in the Z110. The display format is 24 lines of 80 characters, with 225 lines of 640 dots available for graphics. Video output for the Z120 is RGB and either monochrome or RGB for the Z110. Zenith also introduced its new terminal for use with Videotext services.

By far the most innovative thing at the NCC was not at the Astrodome. We were taken to a distant hotel and shown a new approach to computing. However, we were requested to sign a nondisclosure agreement before we were shown this wonder. We can say this much, however. It is a computer system and it operates in the same manner as a human mind. It can stop one operation and do another, then go back to the first, without missing anything. It is super "user friendly" and will work for the new user as well as the most experienced computer operator. This is no "blue sky" operation. It is the joint effort of some of America's most talented designers and Japan's precision manufacturers. It will be on the market in the last quarter of 1982. We predict that it will change the way people think about "personal computers." ♦

7

Good reasons why you should subscribe to *Creative Computing*.



It's the Number One magazine of computer applications and software!

There's one place you can always be sure of learning more about microcomputer software and applications: *Creative Computing*.

Every month *Creative Computing* provides you with a continuing education on everything related to microcomputers and computer equipment. Useful articles, "how to" tutorials, exciting new applications, games and "no holds barred" reviews of the latest software and equipment make up a major part of *Creative Computing's* editorial content.

We give you probing features on programming breakthroughs and important news. Plus in-depth articles on elementary, intermediate and advanced software and applications topics—to help you develop your knowledge and skills, save hundreds (perhaps thousands) of dollars in unneeded software, discover uses for your personal computer that you might never have considered. Articles that increase your overall "computer consciousness." Here's how:

1

Creative Computing gives you things to actually do with a computer.

Just owning a computer isn't enough. You've got to know what to do with it. That's why applications are our primary focus. Text editing, animation, graphics, business simulations, data base and file systems, music synthesis, control of household devices, communications, games—some of the applications and software you'll learn about in *Creative Computing*.

2

Creative Computing discusses business applications in simple, nontechnical language.

If you're a business person who needs to know about the latest developments in word processing and office applications, turn to *Creative Computing*. We clarify such business applications as investment analysis, futures evaluations, data base management, mailing list programs, text editing, word processing and simulations. And all the software available for business people.

3

Creative Computing helps you decide which computer equipment is best for you.

Our tough, no-nonsense equipment profiles arm you with the facts before you walk into a computer store. You'll know the right questions to ask and how to cut through the jargon and sales hype. We give you authoritative guidance in deciding what you need, what you don't need—and what's right for you and your pocketbook.

4

Creative Computing covers computer education in depth.

We started out as a computer education publication, and we're still committed to the educational community. We regularly carry articles on designing educational software, evaluating educational software, teaching concepts and terminology in computer education, text editing applications for literature and computer simulations in the classroom—plus a great deal more.

5

Creative Computing brings you hours of mind-expanding game entertainment.

We've got a soft spot for the computer game addict—and computer game software. We know you want to understand more about the new computer games flooding the market: which ones are easiest to learn? Require the most skill? Offer the most surprises? Give you the best graphics? Provide the most challenge? Contain a new twist? *Creative Computing* brings you the answers.

6

Creative Computing features the state of the art.

Columns on the most popular personal computers, a "software legal forum," letters to the editor. Reviews of books, games, organizations, dealers and events. Fascinating interviews with leading innovators, equipment designers, program developers and game inventors—men and women who'll give you a real glimpse of the future!

7

Our price is right.

By subscribing to *Creative Computing* now, you can save as much as 33% off the full subscription price. To learn elsewhere what you'll learn from *Creative Computing*, you might spend hundreds of dollars in course fees and books. Then you'd have to winnow out what you could use from all that you'd learned. But *Creative Computing* does that for you, so you'll have time to enjoy your own computing interests. And that saving of time makes this offer very inexpensive indeed.

SAVE UP TO 33%!

Creative Computing · P.O. Box 5214 · Boulder, Colorado 80322

YES! Send me *Creative Computing* for:

- One year (12 issues) for \$19.97—I save 20%!
- Two years (24 issues) for \$36.97—I save 26%!
- Three years (36 issues) for \$49.97—I save 33%!

Savings based on full one-year subscription price of \$24.97.

Check one: Payment enclosed. Bill me later.

Mr./Mrs./Ms. _____ (please print full name) 8H138

Address _____ Apt. _____

City _____

State _____ Zip _____

Offer valid in U.S. and possessions only. Please allow 30 to 60 days for delivery of first issue.

**Join over 150,000
Creative Computing readers
by subscribing today!
Just use the coupon
at right.**



PROGRAMMER'S NOTEBOOK

By Jim Keogh

Keeping Score

THERE are many times when you want your computer to keep track of one or more events. The most common occasion is probably when you want to keep score during a computer game. In this month's column, we will discuss how you can use your micro-computer to keep score during a game or count events.

For a computer to keep score, the programmer must include, in the program, one or more registers. These are

similar in function to the cash registers used in retail stores. In the store, every transaction is recorded. For instance, the clerk reads the price tag on the merchandise and records the amount on the cash register.

The register then adds the amount of the transaction to the previous transactions. Many times there are two or more registers (counters) within the equipment. These include registers for taxes and departments. At the end of

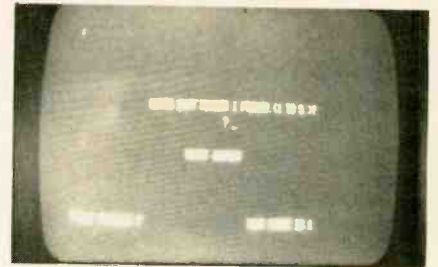

How a score appears on screen.

PROGRAMS FOR KEEPING SCORE OR COUNTING EVENTS

TRS-80

```

5 REM CLEAR SCREEN
10 CLS
15 REM SET REGISTERS TO ZERO
20 C = 0
30 X = 0
35 REM RANDOM NUMBER
  GENERATOR
40 A = RND (5)
45 REM REGISTER STATEMENT
50 X = X + 1
55 REM GAME INSTRUCTIONS
60 PRINT @ 400, "GUESS WHAT
  NUMBER I PICKED (1 TO 5)?"
70 REM INPUT STATEMENT
80 INPUT "          " ; F
85 REM DISPLAY OF REGISTER
  COUNTER
90 PRINT @ 832, "TIMES
  GUESSED";X
95 REM COMPUTER DECIDES IF AN-
  SWER IS CORRECT
100 IF F = A THEN GOTO 160 ELSE
  110
105 REM COMPUTER TELLS IF AN-
  SWER IS WRONG
110 PRINT @ 600, "WRONG ANSWER"
115 REM TIMING LOOP
120 FOR EE = 1 TO 75
130 DD = EE + 1
140 NEXT EE
145 REM LOOP TO BEGINNING OF AN-
  OTHER CHANCE
150 GOTO 40
155 REM COMPUTER TELLS IF AN-
  SWER IS RIGHT

```

```

160 PRINT @ 600, "RIGHT"
165 REM REGISTER STATEMENT
170 C = C + 1
175 REM COMPUTER TELLS
  OPERATOR HIS OR HER SCORE
180 PRINT @ 870, "YOUR SCORE IS";C
185 REM TIMING LOOP
190 FOR EE = 1 TO 75
200 SS = EE + 1
210 NEXT EE
215 REM LOOP TO BEGINNING OF AN-
  OTHER CHANCE
220 GOTO 40

```

APPLE II

```

5 REM CLEAR SCREEN
10 CALL - 936
15 REM SET REGISTERS TO ZERO
20 C = 0
30 X = 0
35 REM RANDOM NUMBER
  GENERATOR
40 A = RND (5)
45 REM REGISTER STATEMENT
50 X = X + 1
55 REM GAME INSTRUCTIONS
60 HTAB (15)
61 VTAB (20)
63 PRINT "GUESS WHAT NUMBER I
  PICKED (1 TO 5)?"
70 REM INPUT STATEMENT
80 INPUT "          " ; F
85 REM DISPLAY OF REGISTER
  COUNTER
90 HTAB (5)

```

```

91 VTAB (35)
92 PRINT "TIMES GUESSED";X
95 REM COMPUTER DECIDES IF AN-
  SWER IS CORRECT
100 IF F = A THEN GOTO 160 ELSE
  110
105 REM COMPUTER TELLS IF AN-
  SWER IS WRONG
110 HTAB (15)
111 VTAB (25)
112 PRINT "WRONG ANSWER"
115 REM TIMING LOOP
120 FOR EE = 1 TO 150
130 DD = EE + 1
140 NEXT EE
145 REM LOOP TO BEGINNING OF AN-
  OTHER CHANCE
150 GOTO 40
155 REM COMPUTER TELLS IF AN-
  SWER IS RIGHT
160 HTAB (15)
161 VTAB (25)
162 PRINT "RIGHT"
165 REM REGISTER STATEMENT
170 C = C + 1
175 REM COMPUTER TELLS
  OPERATOR HIS OR HER SCORE
180 HTAB (20)
181 VTAB (35)
182 PRINT "YOUR SCORE IS";C
185 REM TIMING LOOP
190 FOR EE = 1 TO 150
200 SS = EE + 1
210 NEXT EE
215 REM LOOP TO BEGINNING OF AN-
  OTHER CHANCE
220 GOTO 40

```

computers

the day, the totals for each register are printed out on the register tape. The equipment is then reset to zero and is ready to record the next day's transactions.

The register in our computer program operates in a similar manner. First, the registers are set to zero. This must be done at the beginning of the program. For example, we will call the register A. At the start of the program, we use the statement "A = 0." The program will then be executed. Before the program is concluded or looped to its beginning again, the register (counter) statement must be inserted into the program. This is "A = A + 1." (Read as "A equals A, incremented by one.")

The program can then continue and be looped to the line that immediately follows the statement "A = 0." When the program once again reaches the line with the statement "A = A + 1," the computer will add 1 to the value of A. Since this is the second time the program was executed, the value of A is now 1. The new value of "A = A + 1" is 2. This statement has just recorded that the program was executed twice.

To find the final tally, we must insert the statement "PRINT A." This is usually the last statement in the program loop. Briefly, the computer executes the program and adds the number of times the program is executed to the previous total in the register. At the end of the program, the computer prints the final tally of each register.

The following set of commands illustrates a program register:

- 10 A = 0
- 20 REM BODY OF PROGRAM IS EXECUTED
- 30 A = A + 1
- 40 PRINT A
- 50 GOTO 20

To illustrate the application of this subroutine, the following guessing game was developed. It is rather simple, using two registers. The first register counts the number of right guesses while the second counts the total number of guesses, whether right or wrong.

The program also includes a random number generator. The computer will generate a random number from one to five without displaying the number. It is up to the operator to guess which number the computer picked. If the guess is correct, the computer will print the word "RIGHT" and score the answer as being correct. Both registers will increase by one. If the guess is wrong, the computer will print "WRONG ANSWER" and increase the second register count by one.

By reviewing the details of the program, you should be able to develop a thorough understanding of how computer registers within a program operate. You can have as many registers as you require by just using a few command statements and let the computer do all the counting for you.

WHILE OTHERS PROMISE... WE DELIVER!

ORDER TOLL FREE (800) 221-8180
IN NEW YORK (212) 732-8600

<h3 style="text-align: center; margin: 0;">BLANK TAPES</h3> <h4 style="text-align: center; margin: 0;">VIDEO</h4> <table border="0" style="width: 100%; font-size: small;"> <tr><td>ANY BRAND T-120 (Except HGI)</td><td>\$11.95</td></tr> <tr><td>ANY BRAND L-500 (Except HGI)</td><td>19.95</td></tr> <tr><td>ANY BRAND L-750 (Except HGI)</td><td>11.95</td></tr> <tr><td>ANY BRAND L-850 (Except HGI)</td><td>11.95</td></tr> <tr><td>ANY BRAND T-180 (Except HGI)</td><td>18.95</td></tr> <tr><td>ANY BRAND HGT-120</td><td>14.95</td></tr> <tr><td>ANY BRAND HGT-500</td><td>12.95</td></tr> <tr><td>ANY BRAND HGT-750</td><td>14.95</td></tr> </table> <h4 style="text-align: center; margin: 0;">SPECIALS</h4> <table border="0" style="width: 100%; font-size: small;"> <tr><td>SCOTCH T-120</td><td>\$11.49</td></tr> <tr><td>AMPEX T-120</td><td>10.95</td></tr> <tr><td>AMPEX L-500</td><td>18.95</td></tr> <tr><td>SCOTCH L-500</td><td>18.49</td></tr> <tr><td>BASF L-500</td><td>19.49</td></tr> <tr><td>MINIKOREX T-120</td><td>11.49</td></tr> </table> <p style="font-size: x-small; margin: 5px 0;">WE CARRY TAPES BY: MAXELL, TDK, SONY, SCOTCH, FUJI, MEMorex, BASF, AMPEX, JVC, PANASONIC, ZENITH</p> <h4 style="text-align: center; margin: 0;">AUDIO</h4> <p style="font-size: x-small; margin: 0;">MINIMUM ORDER 12 TAPES</p> <table border="0" style="width: 100%; font-size: small;"> <tr><td>MAXELL UD9U or UD 9LH C-90</td><td>\$2.95</td></tr> <tr><td>MAXELL ULS or ULS C-90</td><td>3.99</td></tr> <tr><td>MAXELL UD-90</td><td>2.49</td></tr> <tr><td>TDK DC-90</td><td>11.49</td></tr> <tr><td>SONY UCS-90</td><td>13.79</td></tr> </table>	ANY BRAND T-120 (Except HGI)	\$11.95	ANY BRAND L-500 (Except HGI)	19.95	ANY BRAND L-750 (Except HGI)	11.95	ANY BRAND L-850 (Except HGI)	11.95	ANY BRAND T-180 (Except HGI)	18.95	ANY BRAND HGT-120	14.95	ANY BRAND HGT-500	12.95	ANY BRAND HGT-750	14.95	SCOTCH T-120	\$11.49	AMPEX T-120	10.95	AMPEX L-500	18.95	SCOTCH L-500	18.49	BASF L-500	19.49	MINIKOREX T-120	11.49	MAXELL UD9U or UD 9LH C-90	\$2.95	MAXELL ULS or ULS C-90	3.99	MAXELL UD-90	2.49	TDK DC-90	11.49	SONY UCS-90	13.79	<div style="text-align: center;"> <p>JVC HR-7300U *Programmable \$579</p> </div> <div style="text-align: center;"> <p>TDK SA-90 Audio Tape \$229</p> </div> <div style="text-align: center;"> <p>Commodore VIC-20 Home Computer \$219</p> </div> <h3 style="text-align: center; margin: 10px 0;">VIDEO & TV'S</h3> <div style="display: flex; justify-content: space-between;"> <div style="width: 48%;"> <h4 style="text-align: center; margin: 0;">HOME VIDEO RECORDERS</h4> <table border="0" style="width: 100%; font-size: x-small;"> <tr><td>JVC HR-7650 (VHS)</td><td>1949</td></tr> <tr><td>PANASONIC PV-1275 (VHS)</td><td>1479</td></tr> <tr><td>PANASONIC PV-1170 (VHS)</td><td>1899</td></tr> <tr><td>QUASAR VH-5610 (VHS)</td><td>7999</td></tr> <tr><td>RCA VFT-250 (VHS)</td><td>1639</td></tr> <tr><td>RCA VFT-450 (VHS)</td><td>1699</td></tr> <tr><td>RCA VFT-650 (VHS)</td><td>1729</td></tr> <tr><td>RCA VCT-200 (VHS)</td><td>1489</td></tr> <tr><td>SONY SL-2000 (Beta)</td><td>1999</td></tr> <tr><td>SONY SL-5000 (Beta Recorder)</td><td>1519</td></tr> <tr><td>SONY SL-6000 (Beta Recorder)</td><td>1799</td></tr> <tr><td>ZENITH VR-8500 (Beta)</td><td>1499</td></tr> <tr><td>ZENITH VR-8900 (Beta)</td><td>1549</td></tr> <tr><td>ZENITH VR-9775 (New Beta)</td><td>1949</td></tr> <tr><td>SANYO VC-4000 (Beta)</td><td>1429</td></tr> </table> </div> <div style="width: 48%;"> <h4 style="text-align: center; margin: 0;">PORTABLE VIDEO RECORDERS</h4> <table border="0" style="width: 100%; font-size: x-small;"> <tr><td>JVC NR-2650 (VHS w/ Tuner)</td><td>1949</td></tr> <tr><td>PANASONIC PV-5110 (VHS w/ Tuner)</td><td>1659</td></tr> <tr><td>PANASONIC PV-5200 (New Port VHS)</td><td>1745</td></tr> <tr><td>PANASONIC PV-5500 (Port VHS)</td><td>1849</td></tr> <tr><td>ZENITH VR-9800 (Beta w/ Tuner)</td><td>1939</td></tr> <tr><td>SONY SL-2000 (Beta Recorder / Tuner/Timer)</td><td>1995</td></tr> <tr><td>AKAI VPS-7350 (VHS w/ Tuner)</td><td>1899</td></tr> <tr><td>HITACHI VR-680 (VHS w/ Tuner)</td><td>1989</td></tr> <tr><td>QUASAR VP-5420 (Port. VHS)</td><td>1499</td></tr> <tr><td>QUASAR VA-520 (Prog. Tuner/Timer)</td><td>1249</td></tr> <tr><td>RCA VCR-170 (New Port. VHS)</td><td>1945</td></tr> <tr><td>TOSHIBA V-9035 (Beta w/ Tuner)</td><td>1889</td></tr> </table> </div> </div>	JVC HR-7650 (VHS)	1949	PANASONIC PV-1275 (VHS)	1479	PANASONIC PV-1170 (VHS)	1899	QUASAR VH-5610 (VHS)	7999	RCA VFT-250 (VHS)	1639	RCA VFT-450 (VHS)	1699	RCA VFT-650 (VHS)	1729	RCA VCT-200 (VHS)	1489	SONY SL-2000 (Beta)	1999	SONY SL-5000 (Beta Recorder)	1519	SONY SL-6000 (Beta Recorder)	1799	ZENITH VR-8500 (Beta)	1499	ZENITH VR-8900 (Beta)	1549	ZENITH VR-9775 (New Beta)	1949	SANYO VC-4000 (Beta)	1429	JVC NR-2650 (VHS w/ Tuner)	1949	PANASONIC PV-5110 (VHS w/ Tuner)	1659	PANASONIC PV-5200 (New Port VHS)	1745	PANASONIC PV-5500 (Port VHS)	1849	ZENITH VR-9800 (Beta w/ Tuner)	1939	SONY SL-2000 (Beta Recorder / Tuner/Timer)	1995	AKAI VPS-7350 (VHS w/ Tuner)	1899	HITACHI VR-680 (VHS w/ Tuner)	1989	QUASAR VP-5420 (Port. VHS)	1499	QUASAR VA-520 (Prog. Tuner/Timer)	1249	RCA VCR-170 (New Port. VHS)	1945	TOSHIBA V-9035 (Beta w/ Tuner)	1889	<h3 style="text-align: center; margin: 0;">COMPUTERS</h3> <h4 style="text-align: center; margin: 0;">HARDWARE</h4> <table border="0" style="width: 100%; font-size: x-small;"> <tr><td>ATARI 400 (Computer/16K)</td><td>1249</td></tr> <tr><td>ATARI 800 (Computer/32K)</td><td>1549</td></tr> <tr><td>ATARI 800 (Computer/16K)</td><td>1099</td></tr> <tr><td>ATARI 800 (Computer/32K)</td><td>1645</td></tr> <tr><td>ATARI 800 (Computer/16K)</td><td>1709</td></tr> <tr><td>ATARI 410 (Program Recorder)</td><td>174.95</td></tr> <tr><td>ATARI 810 (Disk Drive)</td><td>1429</td></tr> <tr><td>ATARI 820 (Printer)</td><td>1449</td></tr> </table> <h4 style="text-align: center; margin: 0;">COMMODORE HARDWARE</h4> <table border="0" style="width: 100%; font-size: x-small;"> <tr><td>VC-1210 (K) expand.</td><td>\$9.90</td></tr> <tr><td>VC-1550 (Cassette Drive)</td><td>64.95</td></tr> <tr><td>VC-1540 (Disk Drive)</td><td>1449</td></tr> <tr><td>TI 99/4 (Computer w/RR)</td><td>1309</td></tr> <tr><td>TI PH-1100 (15" Color Monitor)</td><td>1524</td></tr> <tr><td>SHARP PC-150 (Hand Held)</td><td>1729</td></tr> <tr><td>SHARP PC-150 (Printer for PC-1500)</td><td>1719</td></tr> <tr><td>OKIDATA B3A (Printer)</td><td>1429</td></tr> </table> <h4 style="text-align: center; margin: 0;">VIDEO GAMES</h4> <table border="0" style="width: 100%; font-size: x-small;"> <tr><td>ATARI Video Game (IC-2000)</td><td>134.95</td></tr> <tr><td>MATTEL Intellivision</td><td>1219.95</td></tr> <tr><td>COLECO PAC-MAN (Hand Held)</td><td>154.95</td></tr> <tr><td>COLECO SPACE MAN (Hand Held)</td><td>154.95</td></tr> <tr><td>ASTROCADE (Video Game)</td><td>129.95</td></tr> </table> <h4 style="text-align: center; margin: 0;">GAME CARTRIDGES</h4> <table border="0" style="width: 100%; font-size: x-small;"> <tr><td>ATARI Berserker</td><td>124.95</td></tr> <tr><td>ATARI Yars Revenge</td><td>124.95</td></tr> <tr><td>ATARI Defenders</td><td>127.95</td></tr> <tr><td>ATARI Super Breakout</td><td>124.95</td></tr> <tr><td>ATARI Circus</td><td>121.95</td></tr> <tr><td>ATARI Space Invaders</td><td>124.95</td></tr> <tr><td>ATARI Missile Command</td><td>124.95</td></tr> <tr><td>ATARI Pac-Man</td><td>127.95</td></tr> <tr><td>ATARI Asteroids</td><td>124.95</td></tr> <tr><td>MATTEL Auto Battle</td><td>124.95</td></tr> <tr><td>MATTEL PCA Golf</td><td>124.95</td></tr> <tr><td>MATTEL Sea Battle</td><td>124.95</td></tr> <tr><td>MATTEL Boxing</td><td>124.95</td></tr> <tr><td>MATTEL Football</td><td>124.95</td></tr> <tr><td>MATTEL Space Battle</td><td>124.95</td></tr> <tr><td>MATTEL Baseball</td><td>124.95</td></tr> <tr><td>MATTEL Soccer</td><td>124.95</td></tr> <tr><td>MATTEL Bowling</td><td>124.95</td></tr> <tr><td>MATTEL Astro Smash</td><td>124.95</td></tr> <tr><td>MATTEL Space Hawks</td><td>115.95</td></tr> <tr><td>MATTEL Star Stripes</td><td>115.95</td></tr> </table> <h4 style="text-align: center; margin: 0;">MAGIC GAMES FOR ATARI</h4> <table border="0" style="width: 100%; font-size: x-small;"> <tr><td>IMAGIC Cosmic Ark</td><td>124.95</td></tr> <tr><td>IMAGIC Atlantis</td><td>124.95</td></tr> <tr><td>IMAGIC Demon Attack</td><td>124.95</td></tr> <tr><td>IMAGIC Star Voyager</td><td>124.95</td></tr> </table> <h4 style="text-align: center; margin: 0;">SUPERCHARGER NEEDED FOR ALL GAMES!</h4> <table border="0" style="width: 100%; font-size: x-small;"> <tr><td>Supercharger w/Praser Printer</td><td>\$9.90</td></tr> <tr><td>Control Meters from 50 spaces</td><td>13.90</td></tr> <tr><td>Suicide Mission</td><td>13.90</td></tr> <tr><td>Fireball</td><td>13.90</td></tr> </table> <h4 style="text-align: center; margin: 0;">ACTIVISION GAMES FOR ATARI</h4> <table border="0" style="width: 100%; font-size: x-small;"> <tr><td>ACTIVISION Tennis</td><td>18.90</td></tr> <tr><td>ACTIVISION Kar-Bout</td><td>18.90</td></tr> <tr><td>ACTIVISION Grand Prix</td><td>13.90</td></tr> <tr><td>ACTIVISION Topper Command</td><td>13.90</td></tr> <tr><td>ACTIVISION Starmaster</td><td>13.90</td></tr> </table>	ATARI 400 (Computer/16K)	1249	ATARI 800 (Computer/32K)	1549	ATARI 800 (Computer/16K)	1099	ATARI 800 (Computer/32K)	1645	ATARI 800 (Computer/16K)	1709	ATARI 410 (Program Recorder)	174.95	ATARI 810 (Disk Drive)	1429	ATARI 820 (Printer)	1449	VC-1210 (K) expand.	\$9.90	VC-1550 (Cassette Drive)	64.95	VC-1540 (Disk Drive)	1449	TI 99/4 (Computer w/RR)	1309	TI PH-1100 (15" Color Monitor)	1524	SHARP PC-150 (Hand Held)	1729	SHARP PC-150 (Printer for PC-1500)	1719	OKIDATA B3A (Printer)	1429	ATARI Video Game (IC-2000)	134.95	MATTEL Intellivision	1219.95	COLECO PAC-MAN (Hand Held)	154.95	COLECO SPACE MAN (Hand Held)	154.95	ASTROCADE (Video Game)	129.95	ATARI Berserker	124.95	ATARI Yars Revenge	124.95	ATARI Defenders	127.95	ATARI Super Breakout	124.95	ATARI Circus	121.95	ATARI Space Invaders	124.95	ATARI Missile Command	124.95	ATARI Pac-Man	127.95	ATARI Asteroids	124.95	MATTEL Auto Battle	124.95	MATTEL PCA Golf	124.95	MATTEL Sea Battle	124.95	MATTEL Boxing	124.95	MATTEL Football	124.95	MATTEL Space Battle	124.95	MATTEL Baseball	124.95	MATTEL Soccer	124.95	MATTEL Bowling	124.95	MATTEL Astro Smash	124.95	MATTEL Space Hawks	115.95	MATTEL Star Stripes	115.95	IMAGIC Cosmic Ark	124.95	IMAGIC Atlantis	124.95	IMAGIC Demon Attack	124.95	IMAGIC Star Voyager	124.95	Supercharger w/Praser Printer	\$9.90	Control Meters from 50 spaces	13.90	Suicide Mission	13.90	Fireball	13.90	ACTIVISION Tennis	18.90	ACTIVISION Kar-Bout	18.90	ACTIVISION Grand Prix	13.90	ACTIVISION Topper Command	13.90	ACTIVISION Starmaster	13.90
ANY BRAND T-120 (Except HGI)	\$11.95																																																																																																																																																																																																											
ANY BRAND L-500 (Except HGI)	19.95																																																																																																																																																																																																											
ANY BRAND L-750 (Except HGI)	11.95																																																																																																																																																																																																											
ANY BRAND L-850 (Except HGI)	11.95																																																																																																																																																																																																											
ANY BRAND T-180 (Except HGI)	18.95																																																																																																																																																																																																											
ANY BRAND HGT-120	14.95																																																																																																																																																																																																											
ANY BRAND HGT-500	12.95																																																																																																																																																																																																											
ANY BRAND HGT-750	14.95																																																																																																																																																																																																											
SCOTCH T-120	\$11.49																																																																																																																																																																																																											
AMPEX T-120	10.95																																																																																																																																																																																																											
AMPEX L-500	18.95																																																																																																																																																																																																											
SCOTCH L-500	18.49																																																																																																																																																																																																											
BASF L-500	19.49																																																																																																																																																																																																											
MINIKOREX T-120	11.49																																																																																																																																																																																																											
MAXELL UD9U or UD 9LH C-90	\$2.95																																																																																																																																																																																																											
MAXELL ULS or ULS C-90	3.99																																																																																																																																																																																																											
MAXELL UD-90	2.49																																																																																																																																																																																																											
TDK DC-90	11.49																																																																																																																																																																																																											
SONY UCS-90	13.79																																																																																																																																																																																																											
JVC HR-7650 (VHS)	1949																																																																																																																																																																																																											
PANASONIC PV-1275 (VHS)	1479																																																																																																																																																																																																											
PANASONIC PV-1170 (VHS)	1899																																																																																																																																																																																																											
QUASAR VH-5610 (VHS)	7999																																																																																																																																																																																																											
RCA VFT-250 (VHS)	1639																																																																																																																																																																																																											
RCA VFT-450 (VHS)	1699																																																																																																																																																																																																											
RCA VFT-650 (VHS)	1729																																																																																																																																																																																																											
RCA VCT-200 (VHS)	1489																																																																																																																																																																																																											
SONY SL-2000 (Beta)	1999																																																																																																																																																																																																											
SONY SL-5000 (Beta Recorder)	1519																																																																																																																																																																																																											
SONY SL-6000 (Beta Recorder)	1799																																																																																																																																																																																																											
ZENITH VR-8500 (Beta)	1499																																																																																																																																																																																																											
ZENITH VR-8900 (Beta)	1549																																																																																																																																																																																																											
ZENITH VR-9775 (New Beta)	1949																																																																																																																																																																																																											
SANYO VC-4000 (Beta)	1429																																																																																																																																																																																																											
JVC NR-2650 (VHS w/ Tuner)	1949																																																																																																																																																																																																											
PANASONIC PV-5110 (VHS w/ Tuner)	1659																																																																																																																																																																																																											
PANASONIC PV-5200 (New Port VHS)	1745																																																																																																																																																																																																											
PANASONIC PV-5500 (Port VHS)	1849																																																																																																																																																																																																											
ZENITH VR-9800 (Beta w/ Tuner)	1939																																																																																																																																																																																																											
SONY SL-2000 (Beta Recorder / Tuner/Timer)	1995																																																																																																																																																																																																											
AKAI VPS-7350 (VHS w/ Tuner)	1899																																																																																																																																																																																																											
HITACHI VR-680 (VHS w/ Tuner)	1989																																																																																																																																																																																																											
QUASAR VP-5420 (Port. VHS)	1499																																																																																																																																																																																																											
QUASAR VA-520 (Prog. Tuner/Timer)	1249																																																																																																																																																																																																											
RCA VCR-170 (New Port. VHS)	1945																																																																																																																																																																																																											
TOSHIBA V-9035 (Beta w/ Tuner)	1889																																																																																																																																																																																																											
ATARI 400 (Computer/16K)	1249																																																																																																																																																																																																											
ATARI 800 (Computer/32K)	1549																																																																																																																																																																																																											
ATARI 800 (Computer/16K)	1099																																																																																																																																																																																																											
ATARI 800 (Computer/32K)	1645																																																																																																																																																																																																											
ATARI 800 (Computer/16K)	1709																																																																																																																																																																																																											
ATARI 410 (Program Recorder)	174.95																																																																																																																																																																																																											
ATARI 810 (Disk Drive)	1429																																																																																																																																																																																																											
ATARI 820 (Printer)	1449																																																																																																																																																																																																											
VC-1210 (K) expand.	\$9.90																																																																																																																																																																																																											
VC-1550 (Cassette Drive)	64.95																																																																																																																																																																																																											
VC-1540 (Disk Drive)	1449																																																																																																																																																																																																											
TI 99/4 (Computer w/RR)	1309																																																																																																																																																																																																											
TI PH-1100 (15" Color Monitor)	1524																																																																																																																																																																																																											
SHARP PC-150 (Hand Held)	1729																																																																																																																																																																																																											
SHARP PC-150 (Printer for PC-1500)	1719																																																																																																																																																																																																											
OKIDATA B3A (Printer)	1429																																																																																																																																																																																																											
ATARI Video Game (IC-2000)	134.95																																																																																																																																																																																																											
MATTEL Intellivision	1219.95																																																																																																																																																																																																											
COLECO PAC-MAN (Hand Held)	154.95																																																																																																																																																																																																											
COLECO SPACE MAN (Hand Held)	154.95																																																																																																																																																																																																											
ASTROCADE (Video Game)	129.95																																																																																																																																																																																																											
ATARI Berserker	124.95																																																																																																																																																																																																											
ATARI Yars Revenge	124.95																																																																																																																																																																																																											
ATARI Defenders	127.95																																																																																																																																																																																																											
ATARI Super Breakout	124.95																																																																																																																																																																																																											
ATARI Circus	121.95																																																																																																																																																																																																											
ATARI Space Invaders	124.95																																																																																																																																																																																																											
ATARI Missile Command	124.95																																																																																																																																																																																																											
ATARI Pac-Man	127.95																																																																																																																																																																																																											
ATARI Asteroids	124.95																																																																																																																																																																																																											
MATTEL Auto Battle	124.95																																																																																																																																																																																																											
MATTEL PCA Golf	124.95																																																																																																																																																																																																											
MATTEL Sea Battle	124.95																																																																																																																																																																																																											
MATTEL Boxing	124.95																																																																																																																																																																																																											
MATTEL Football	124.95																																																																																																																																																																																																											
MATTEL Space Battle	124.95																																																																																																																																																																																																											
MATTEL Baseball	124.95																																																																																																																																																																																																											
MATTEL Soccer	124.95																																																																																																																																																																																																											
MATTEL Bowling	124.95																																																																																																																																																																																																											
MATTEL Astro Smash	124.95																																																																																																																																																																																																											
MATTEL Space Hawks	115.95																																																																																																																																																																																																											
MATTEL Star Stripes	115.95																																																																																																																																																																																																											
IMAGIC Cosmic Ark	124.95																																																																																																																																																																																																											
IMAGIC Atlantis	124.95																																																																																																																																																																																																											
IMAGIC Demon Attack	124.95																																																																																																																																																																																																											
IMAGIC Star Voyager	124.95																																																																																																																																																																																																											
Supercharger w/Praser Printer	\$9.90																																																																																																																																																																																																											
Control Meters from 50 spaces	13.90																																																																																																																																																																																																											
Suicide Mission	13.90																																																																																																																																																																																																											
Fireball	13.90																																																																																																																																																																																																											
ACTIVISION Tennis	18.90																																																																																																																																																																																																											
ACTIVISION Kar-Bout	18.90																																																																																																																																																																																																											
ACTIVISION Grand Prix	13.90																																																																																																																																																																																																											
ACTIVISION Topper Command	13.90																																																																																																																																																																																																											
ACTIVISION Starmaster	13.90																																																																																																																																																																																																											

MUSIC & RECORDS WORLD

23 PARK ROY. DEPT. PE10, NYC NY 10038

HOW TO ORDER BY MAIL FOR PROMPT AND COURTEOUS SHIPMENT - SEND MONEY ORDER, CERTIFIED CHECK, CASHIER'S CHECK, MASTERCARD, VISA (INCLUDE CARD NUMBER). (No. of copies, expiration date and signature) DO NOT SEND CASH, PERSONAL AND BUSINESS CHECKS MUST CLEAR OUR BANK BEFORE PROCESSING. \$25 MINIMUM ORDER. Shipping, handling & insurance charges is 5% of total order with a \$1.95 minimum charge for NY. SHIP TO CONTINENTAL U.S., ALASKA, HAWAII, PUERTO RICO, AND CANADA ONLY. (Canadian orders add 10% shipping, with a \$1.95 minimum charge) For shipments by air, please double these charges. MONEY ORDER C.O.D.'S, NEW YORK STATE RESIDENTS PLEASE ADD SALES TAX. ALL MERCHANDISE SHIPPED BRAND NEW, FACTORY FRESH AND 100% GUARANTEED.

SEND FOR FREE 240 PAGE AUDIO/VIDEO CATALOG

Shelf Conscious?

Now you can organize your copies of

Popular Electronics

Now your magazines can be a handsome addition to your decor, well organized, and easy to find, thanks to these durable library-quality cases or binders. They're made of luxury-look leatherette over high-quality binders board. And both styles are custom-designed for this or any magazine you save, with size, color, and imprint selected by the publisher. FREE transfer foil included for marking dates and volumes.

Magazine binders hold a year's issues on individual snap-in rods, combining them into one volume. \$7.95 each; 3 for \$22.50; 6 for \$42.95. Mixed titles OK for quantity prices.

Open-back cases store your issues for individual reference. \$6.95 each; 3 for \$19.75; 6 for \$37.50. Mixed titles OK for quantity prices.

Popular Electronics, P.O. Box 5120 Philadelphia, PA 19141

Please send: Cases Binders

Popular Electronics: (Other titles):

ENCLOSED IS \$ _____ *Add \$1.00 per order for post. & handling. Outside USA add \$2.50 per unit ordered. Send U.S. funds only. CHARGE ORDERS accepted for American Express, VISA, or MC. PHONE 24 HRS. TOLL FREE 800-345-8112, PA only 800-662-2444. BY MAIL include credit card name, #, and exp. date. MINIMUM CHARGE ORDER \$10.

Print Name _____

Address _____

City/State/Zip _____

*Residents of CA, CO, DC, FL, IL, MA, MI, MO, NJ, NY, State, OH, SC, TN and VT add applicable sales tax.

CALCULATOR SAVINGS

(hp) HEWLETT PACKARD

HP-11C Scientific	479.95	82161A Cassette Drive	419.95
HP-12C Financial	114.95	82162A HP-IL Printer	379.95
Solution 8K Free with 11C/12C		82163A Video Interface	239.95
HP-15C Programmable	104.95	82104A Card Reader	164.95
HP-16C Hexadecimal	117.95	82143A Printer	289.95
HP-41C Alpha Prog.	189.95	82180A Extnd Functions	59.95
HP-41CV Full Memory	236.95	82181A Extnd Memory	59.95
Port-X-Tender to 10 pts	169.95	82170A Quid Memory	76.95
82104A Card Reader	164.95	82182A Time Module	59.95
82143A Printer	289.95	Gordon Battery System	34.95
82180A Extnd Functions	59.95	HP-41 Paccs	26.95 to 64.95
82181A Extnd Memory	59.95	82160A HP-IL Module	94.95
82170A Quid Memory	76.95		
82182A Time Module	59.95		
Gordon Battery System	34.95		
HP-41 Paccs	26.95 to 64.95		
82160A HP-IL Module	94.95		

Call for Low Prices on all Accessories and Software

Texas Instruments 99/4A Computer	\$29.95	TI-35	119.95
Extended BASIC Module	74.95	TI-55-II	39.95
Mini Memory (4K)	79.95	TI-58C	85.95
Tunnels of Doom	49.95	TI-59	189.95
Peripheral Expansion Box	192.95	PC-100C	169.95
Get a 20 rebate from TI with TI-59 purchase		TI-88	279.95
\$100 rebate from TI with TI-99/4A purchase		PC-800	149.95
		CA-800	49.95

Olivetti Praxiss 35 Triple-pitch Electronic Typewriter 449.95 |

Sharp PC-1211 Computer, free cassette interface 199.95 || CE-122 Cassette Interface/Printer | 79.95 | | |
PC-1500 Advanced Handheld Computer	229.95		
CE-150 Cassette Intrfc/4-color Printer-Plotter	189.95		
CE-151 4K Memory Expansion for PC-1500	64.95		
CE-155 8K Memory Expansion for PC-1500	129.95		

Casio FX-702P Handheld Computer, 1680 Steps 139.95 || FA-2 Cassette Interface for FX-702P | 42.95 | | |
FP-1 Printer for FX-702P	79.95		
MT-31 Compact Musical Keyboard	119.95		
MT-40 Keyboard with Bass and Rhythms	159.95		
MT-60 Home Entertainment Keyboard	249.95		
MT-70 Advanced Memory Keyboard	299.95		
CT-701 Advanced Electronic Organ with Memory	799.95		
CT-1000P Polyphonic Synthesizer	579.95		

Pearl S202 Microcassette Recorder, One Hour 79.95 || S801 Two-speed, Two Hour Recorder | 99.95 | | |
S801 Two-speed, Compact, Memory Rewind	149.95		
X-01 Ultra-thin All Electronic	199.95		
XR Advanced Tiny Recorder/AM/FM	299.95		
Olympus Pearlcor Microcassettes	10 to 29.95		

We accept cashier's checks, money orders, VISA, and M/C. Personal checks take 5 weeks to clear. Add shipping: 1% of your order (\$3.95 minimum). East of Missip Rivr add \$1.50. CA res add 6%. Subject to availability. USA Prices.

ORDER TOLL-FREE **800-421-5188** Outside CA, AK, HI

Information line (213) 833-3262

tam's

INCORPORATED

Tam's Inc, Dept PE-10
14932 Garfield Ave.
Palo Alto, CA 90723
(213) 833-3262

SOLID-STATE DEVELOPMENTS

By Forrest M. Mims

The Microprocessor Enters its Second Decade

IMAGINE a 4-bit microprocessor that can process 45 instructions, add two numbers in 850 microseconds, and directly drive up to 4K by 8 bits of ROM. As a bonus, this microprocessor, which is supplied in a 16-pin DIP, can be operated as a microcomputer with the addition of a single ROM.

Impressive? It certainly is, particularly when you consider that these are the specifications for history's *first* microprocessor, Intel's 4004.

The microprocessor is now nearly a full year into its second decade. With sales of around 150 million chips per year, it has become far more successful than anyone could have imagined when first announced back in November of 1971.

This pioneering 2300-transistor chip was the brainchild of Marcian E. "Ted" Hoff, an Intel employee. Hoff had been assigned the development of a complex set of new integrated circuits for a Japanese company that planned to use them in a new programmable calculator. He found that the proposed design was much too complex for implementation with conventional random logic. Instead, falling back on his knowledge of minicomputers, he proposed integrating on a small number of chips a sequential processor designed like the central-processing unit of a digital computer. The operation of the processor would be controlled by a program in one or more ROMs.

Meanwhile, Gary Boone at Texas Instruments was also involved in pioneering microprocessor-related work. In 1971, Texas Instruments filed patent applications for a single-chip microprocessor and a single-chip microcomputer. By 1974, the TMS-100 family of 4-bit microcomputers had evolved from this early work.

The microprocessor is one of the most important integrated circuits yet developed. They are used in industrial controllers, traffic lights, scientific instrumentation, and such consumer products as calculators, appliances, and toys. But their most important application is as the processing unit for personal computers.

The Birth of the Personal Computer.

One of the first engineers to anticipate the eventual role of microprocessors in small computers was H. Edward Roberts. In 1969, Ed, Robert Zaller and I were young officers at the Air Force Weapons Laboratory in Albuquerque, NM. Stan Cagle was an engineer for a private consulting firm. Under Ed's leadership, the four of us formed a small company to manufacture telemetry gear for model rockets. Later, we made a lightwave-communicator kit that was featured as a construction project in *POPULAR ELECTRONICS* ("The Opticom," November 1970).

By late 1970, our company, M.I.T.S. was not faring well, and Bob and Stan had developed other interests. I had decided to become a full-time freelance writer, and the three of us sold our shares to Ed. Staying with the nearly bankrupt company, Ed managed to get the backing required to bring out a line of kit calculators, some of which were featured as construction projects in *POPULAR ELECTRONICS*. The calculator market, however, soon dried up in the face of massive competition from major companies.

Again facing bankruptcy, Ed sought new electronic products to market. About that time, Intel introduced its 8080 microprocessor, a \$360 chip that could handle 78 basic instructions and directly access 64 kilobytes of memory. Having had previous experience with minicomputers, Ed immediately realized that the 8080 could be used as the processor in a small-computer system. I well remember the excitement in his voice as he told me this new product would "revolutionize" computers. At the time, I could not understand how a computer in a metal box that was programmed in machine language by a laborious process of manually actuating a row of toggle switches could revolutionize anything. Nevertheless, I agreed to write the operator's manual in exchange for an early production model of one of the computers.

The story of how the Altair 8800 was featured on the cover of the January 1975 issue of *POPULAR ELECTRONICS* is now

legend in the annals of personal computer history. Ed's company, by then known simply as MITS, sold thousands of Altair 8800's as a result of that article. Many of them are still in use today. With no keyboard or CRT, the Altair 8800 was far from a user-friendly system. Nevertheless, at \$397 for a complete kit, which included the \$360 8080 microprocessor, it ushered in the era of affordable, personal computing.

Though the concept of sequential program operation remains unchanged, microprocessors have come a long way since the development of the 4004 and 8080. Now 16- and even 32-bit microprocessors are available. They permit faster program execution, and can address considerably more memory than the older 8-bit units. Let's examine one of these new microprocessors to see just how far their development has come.

A 16-Bit Microprocessor. Intel's latest microprocessor, the 80186, is light years ahead of the 4004. This chip, which is also known as the iAPX 186 CPU, contains the functional equivalent of a single-board, 16-bit, digital-computer, central-processing unit. In other words, the 80186 replaces the microprocessor and from 15 to 20 associated chips normally required to provide a 16-bit central-processing unit (CPU).

Intel claims the 80186 delivers double the performance of their older 8086 microprocessor. It includes such on-chip features as provisions for selecting memory and peripherals, counting and timing functions, interrupt control, direct memory access, local bus control, and system timing (clock). Most previous high-level microprocessor chips require additional support chips to implement most or even all these functions. These as well as many other features, plus its 8-MHz clock speed make the 80186 ideally suited for use as the processor in high-power, multi-language personal and business computers.

Thanks to on-chip hardware, the 80186 chip accomplishes multiplication and division five times faster than the 8086. Software compatible with both the 8086 and 8088, the 80186 includes ten new instructions that provide what Intel calls a "superset" of instructions. Among the new instructions are provisions for efficiently moving long strings of data from memory to an I/O (input/output) port at high speed. New "Enter" and "Leave" instructions facilitate the implementation of high-level languages like Pascal.

Two new multiplication instructions enhance the 80186's ability to perform advanced calculations. Furthermore, the 80186 can be used with the 8087 Numeric Processor Extension chip for high-performance, floating-point math.

solid-state developments

Intel's existing line of graphic, keyboard, cathode-ray-tube, floppy-disk, and parallel- and serial-interface controllers is fully compatible with the 80186. The actual chip, which measures 300 mils on a side, is installed in a 68-pin, hermetically sealed, chip carrier. It operates from a single 5-V supply and sells for \$50 each in quantities of 100. For more information, contact an Intel distributor or write Intel (2625 Walsh Avenue, Santa Clara, CA 95051).

A CRT Controller Chip Set. If you remember Don Lancaster's pioneering designs for do-it-yourself TV typewriters, you know something about the complexity of the circuits required to display information on a CRT screen. Fortunately, things have changed for the better with the introduction by Signetics of a new CRT-controller LSI chip set. It halves the number of ICs formerly required to implement a full-featured terminal for a microcomputer.

According to Steve Stewart, Marketing Manager for Signetics' MOS Microprocessor Division, a complete CRT terminal can be implemented with as few as 15 ICs. The resulting product, Stewart added, will "simplify production, increase reliability, and reduce field-maintenance costs."

A complete CRT controller board has been designed around four new chips. An SC2670 Display Character and Graphics Generator converts character and line address information into dot patterns for raster-scanned displays and stores 128 characters. It also provides up to 256 graphic characters, 15 of which are segments for producing line drawings on a CRT display.

The SC2671 Programmable Keyboard and Communications Controller provides keyboard encoding and an asynchronous transmitter/receiver. It also includes a baud-rate generator. The SC2672 Programmable Video Timing Controller generates the necessary sync and blanking signals. It also provides timing signals for such features and functions as a cursor, underlining, blinking, and a light pen. The SC2673 Video Attributes Controller takes care of a variety of housekeeping functions and adds such extras as control over intensity, blink, underline, reverse video, nondisplay, and graphics.

The new circuit controller board also includes an SC8049 microcomputer, some memory, and several TTL logic chips to complete the controller. All that's necessary to assemble a complete terminal is a nonencoded electromechanical or capacitive keyboard, a CRT monitor, and appropriate power supplies. The result is a terminal that provides such "nice-to-have" features as four-key rollover, autorepeating keyboard, underlining, both thin-line and block graphics, screen reversal, variable cursor type, and an audio-alarm signal.

In quantities of 100, the SC2670 and SC2671 sell for \$7.30 and \$13.65, respectively. The SC2672 and SC2673 are \$16.00 and \$20.40, respectively. If you work for a company, you can get a complete CRT Information Kit that fully describes the new chip set (and includes data sheets, article reprints, application notes, and other information) by sending a request *on your company letterhead* to Microprocessor Marketing, Signetics Corp., Main Stop 1276, P.O. Box 409, Sunnyvale, CA 94086.

Latchable CMOS Multiplexers. Interfacing a microprocessor to the analog world can become a rather complex problem. Siliconix (2201 Laurelwood Road, Santa Clara, CA 95054) has substantially simplified this chore with its recent introduction of two new microprocessor-compatible CMOS multiplexer/demultiplexer IC's.

The DG528 provides eight channels of single-ended multiplexing of ± 15 -V analog signals. Since it has an enable input, two or more DG528's can be cascaded to provide 16 or more multiplexed lines under program control.

The DG529 provides four channels of differential multiplexing of both common- and differential-mode signals. Like the DG528, the DG529 is installed in an 18-pin DIP.

In a typical application, any of up to eight-channels of analog data (e.g. temperature, wind speed, pressure, etc.) is applied under microprocessor control to an analog-to-digital converter. The digitized output is then applied to the microprocessor for processing or stored for later use in a RAM.

Some of the specific applications Siliconix has targeted for these new interface chips include microcomputer-based communications systems, environmental control, home security systems, avionics equipment employing scanning techniques, and automatic test equipment. The company points out that the latter application will be served well by the bidirectional capability of the new chips. In this role, for example, a single channel might be used to transmit signals in *both* directions between a microprocessor in the test equipment and the device or system undergoing testing. \diamond

Gnat's Eyebrow, Indeed!



Sonic accuracy depends on your stylus. At A-T, we precision-shape our best styli with square shanks to micron accuracy (one micron = 0.0000393"). A perfect mounting hole is drilled in the beryllium cantilever by laser. Another laser beam checks each stylus surface for absolute alignment far more accurately than any microscope. All to assure you uncommonly low distortion and dramatic stereo separation...impossible with ordinary round-shank styli. Hear the Audio-Technica difference today!

 **audio-technica**

EXPERIMENTER'S CORNER

By Forrest M. Mims

Experimenting With a Servomechanism

A SERVOMECHANISM is an automatic control system. The word servo comes from the Latin *servus*, which means *slave*. The terminology is accurate, for under the proper conditions a servo (to use the normal short form) is totally obedient to any control or input signals applied to it.

In operation, a servo develops an output signal that is continually compared to the input signal. Any difference or error between the two signals is fed back to the input, thus causing the output signal to move toward and eventually match the input signal.

The feedback loop is shown in Fig. 1. This simplified diagram illustrates the operation of servos that are entirely electronic, such as phase-locked loops, and those that incorporate electromechanical devices, such as motors or solenoids.

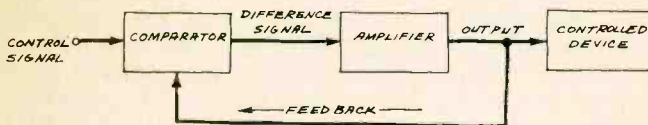

Fig. 1. A basic closed-loop servomechanism.

Previous installments of "Experimenter's Corner" have covered the operation and use of various kinds of phase-locked loops. See, for example, the installments of July and August of 1980. If you cannot find these issues of *POPULAR ELECTRONICS* at a library, both of the columns cited above are scheduled to be published by McGraw-Hill in *The Forrest Mims Circuit Scrapbook*. You may also want to refer to Howard Berlin's excellent book *Design of Phase-Locked Loop Circuits, With Experiments* (Howard W. Sams & Co., Inc., 1978).

The servos discussed in this column are electromechanical. Considering the increasing interest in robotics, radio control, and computer control, electronics experimenters should be fully aware of the operation and capabilities of such servomechanisms.

The Electromechanical Servo. Many kinds of electromechanical servomechanisms exist. Most incorporate a motor, a comparator, and a position-sensing transducer connected as shown in Fig. 2. In this figure, the input voltage is provided by

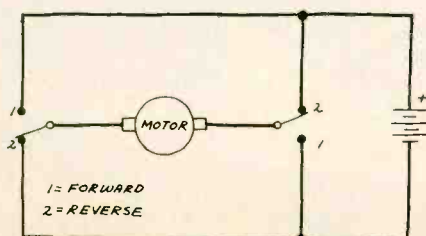

Fig. 2. Components of an electromechanical servo.

one potentiometer of a two-axis joystick. The position-sensing transducer is a potentiometer whose wiper arm is rotated by the motor's armature. Both potentiometers are connected as voltage dividers.

To understand the operation of this servo, assume the voltages applied to both inputs of the comparator are equal. The output of the comparator will then be low and the motor will be off. When the joystick is moved so that the voltage applied to the noninverting input of the comparator exceeds the voltage from the position-sensing potentiometer, the comparator output will be high and the motor will be activated. This will cause the position-sensing potentiometer to deliver a progressively higher voltage.

When the two voltages are again equal or when the voltage from the position-sensing potentiometer is slightly higher than that from the joystick, the comparator will switch off and the motor will cease rotation. The end result is that the motor has tracked the position of the joystick. In other words, the physical movement of the motor's armature is directly proportional to the movement of the joystick.

The simple servo shown in Fig. 2 is not suitable for most practical applications since no provision is made for reversing the motor. Motor reversal can be achieved under mechanical control by using the dpdt switch arrangement shown in Fig. 3.

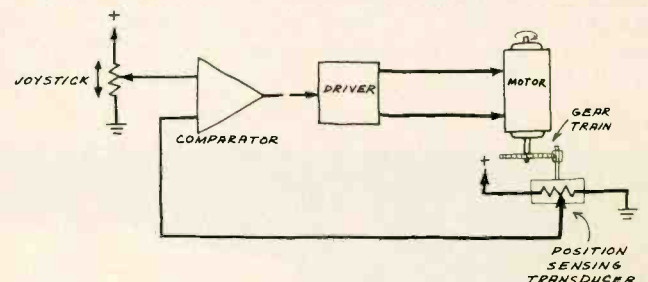

Fig. 3. Double-pole double-throw motor reverser.

Forward-reverse operation can also be achieved by substituting transistors for the switches, as in Fig. 4. The circuit in Fig. 4 is actually the motor-driver portion of Signetics' NE544 Servo Amplifier, a chip designed specifically for controlling a dc servo motor.

Integrated Servo Amplifiers. The input to an NE544 and similar servo-amplifier chips is a train of variable-duration pulses. The output signal causes a small dc motor to rotate in proportion to the average duration of the incoming pulses. Pulse-duration (or width) modulation is used because it makes it easy to transmit signals via radio or infrared for remote-control applications. Even though this method is not a true digital-control system, it's commonly referred to as digital proportional control.

Figure 5 is a block diagram and connection network for the

experimenter's corner

Signetics NE543 Servo Amplifier. In operation, pulse-duration-modulated pulses from a receiver are applied to the input. If the pulse duration *exceeds* that of an internally generated pulse, the difference is stretched and applied to the appropriate output stage. This causes the motor to rotate the wiper of feedback potentiometer *R3*. The resistance of *R3* governs the duration of the internally generated pulses. When *R3*'s value has been altered so that the duration of the internally generated

pulses matches that of the incoming pulses, the motor is deactivated.

If the duration of the incoming pulses is *less* than that of the internally generated pulses, then the difference is stretched and applied to the output stage that rotates the motor in the opposite direction. When the value of *R3* causes the duration of the

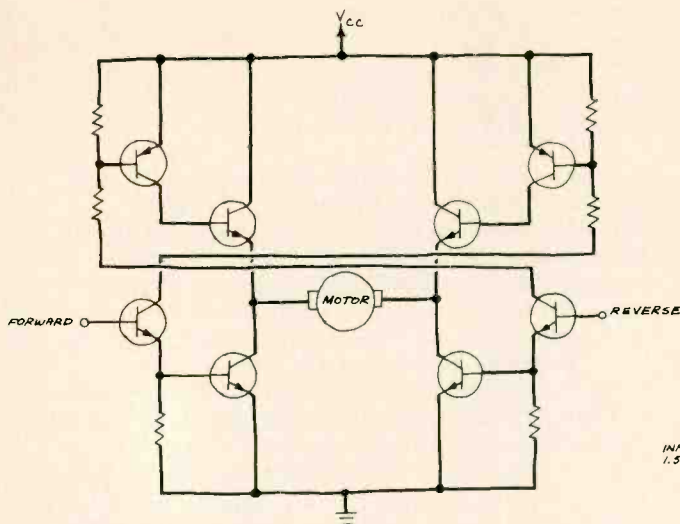

Fig. 4. Motor control circuit in Signetics NE544.

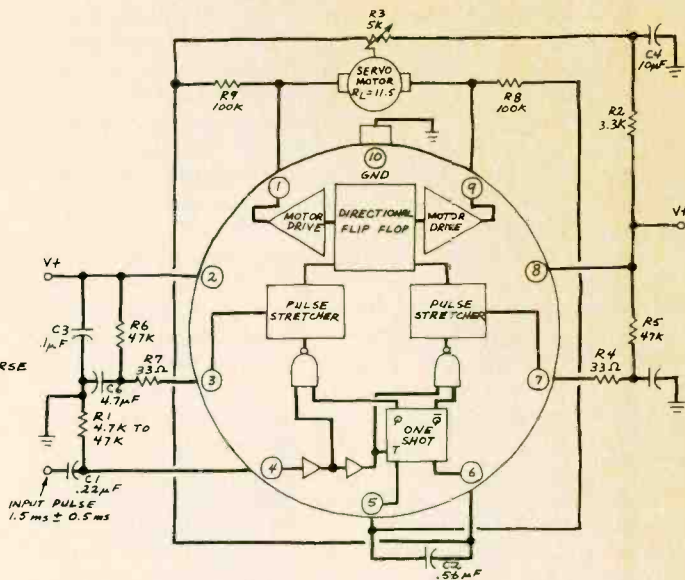

Fig. 5. Block diagram of NE543 servo amplifier.

Do your breadboarding by the numbers with A P PRODUCTS new Circuit-Strips.™

Now there's an easy way to build your electronic projects. No need for perf boards...no need for soldering...when you build electronic circuits with A P PRODUCTS new Circuit-Strips.™

With Circuit-Strips, all you do is simply plug in components and interconnect them with ordinary #22 AWG solid hook-up wire. Circuit-Strips' spring clip terminals not only accommodate a wide range of leads, but also provide excellent electrical connection to every one. Economically priced,

solderless Circuit-Strips are compatible with DIP's of all sizes and a wide variety of discrete components which can be used over and over again. Circuit-Strips have a

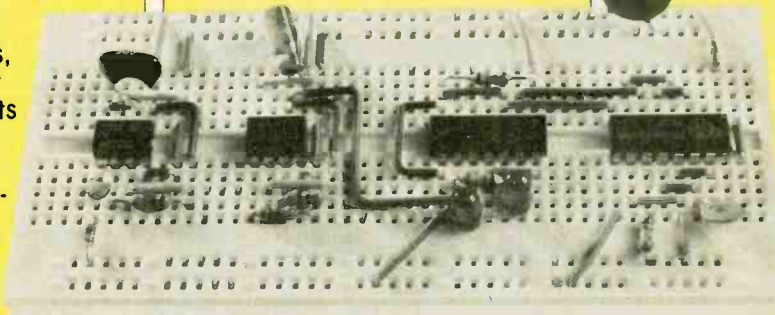

molded-in alpha-numeric grid for faster and easier identification of every tie-point in your circuit. They

feature 610 plug-in tie-points, and have a capacity of up to 6 14-pin DIP's. Model #923253 is available with alloy 770 terminals at only \$14. Model #923749 is available with gold plated alloy 770 terminals at only \$28.

Call TOLL FREE, 800-321-9668, for the name of the distributor nearest you. (In Ohio, call collect: (216) 354-2101.)

A P PRODUCTS INCORPORATED
9450 Pineneedle Drive
P.O. Box 603
Mentor, Ohio 44060
(216) 354-2101
TWX: 810-425-2250



In Europe, contact A P PRODUCTS GmbH
Baumlesweg 21 • C-7031 Weil 1 • W. Germany

internally generated pulses to match the incoming pulse duration, the motor is deactivated.

The net result of this feedback operation is that the motor armature position follows the duration of the input pulse. If the input pulses are received from a transmitter in which the duration of pulses is controlled by the position of a joystick, the armature position accurately tracks the joystick position, even though the two are separated by a considerable distance.

The successful operation of a servo amplifier such as the one in Fig. 5 involves some important subtleties. Assume, for example, that the motor has rotated the feedback potentiometer's wiper to the point where the duration of the internal reference pulses matches that of the incoming pulses. Though the motor-drive transistor is switched off, the inertia of the motor's armature causes it to rotate *beyond* the null point. Now the duration of the reference and incoming pulses again differs, so the servo amplifier switches the motor into reverse in an effort to find the null point. The motor may again *overshoot* the null, thus requiring a series of command pulses before it assumes the desired position.

The forward-reverse oscillation of the motor around the null point is called *hunting* or *seeking*. In most cases, the damping effect of the motor's gears will cause progressively less hunting per cycle, thus allowing the motor to eventually stop at the desired position. In very sensitive systems, however, the motor may never settle down and will hunt continuously.

The hunting problem can be controlled by purposely designing a margin of error or, as it is sometimes called, *slop* into the system. In Fig. 5, this is accomplished by the inclusion of resistors *R4* and *R7*. They establish what is called a *deadband* of about 5 μ s. The motor will not be switched on until the input pulse duration differs from that of the internal reference pulses

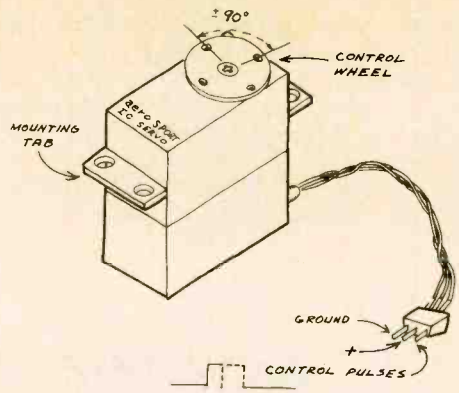

Fig. 6. A typical miniature servomechanism.

by *more* than the deadband. If hunting still occurs, the deadband can be widened by increasing *R4* and *R7*.

The NE544, whose motor-drive section is shown in Fig. 4, is a second-generation servo amplifier that features more precise operation than the NE543. You can find out more about both these chips by referring to their data sheets in the Signetics Analog Data Manual. The data sheets for the NE544 include two pc-board layouts suitable for use in miniature servos.

Servo amplifier chips are also made by Texas Instruments and Exar. TI's SN76602 and SN76604 both feature an adjustable deadband and bidirectional motor drive.

Exar's XR-2264 is a pulse-proportional servo amplifier designed to directly drive a motor. The XR-2265 is a similar chip designed to drive relays, optical couplers, and triacs. The XR-2266 is designed specifically to provide two control channels

Drake's New Digital Multimeter with Advanced Auto Ranging Features.



Simple and easy to operate. The Drake DM2350 Digital Multimeter automatically measures your selected functions in up to 5 ranges, at the touch of a button. Drake's Digital Multimeter will not overload circuits and DC accuracy is 0.8% of reading \pm 0.2% of full scale. A continuity test sounds a signal when circuit resistance is less than 20 ohms. The liquid crystal display and three step protection feature with auto-zeroing, polarity indication and over-range warning signal make it ideal for servicemen or hobbyists.

The Drake Digital Multimeter is sold complete with batteries (battery life is greater than 300 hrs.), probes, 20 amp current shunt, spare fuse, and soft carrying case for only \$95.95.

Add \$2.50 shipping and handling per order. Send check with order and provide street address for UPS shipping. Ohio residents add Sales Tax.



In Ohio, or for information call: 1-513-866-2421

Credit-Card buyers may call toll free 1-800-543-5612

R. L. DRAKE COMPANY
540 Richard Street, Miamisburg, Ohio 45342

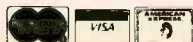

NEW INDOOR ACTIVE ANTENNA

Covers 300 KHz - 30 MHz.
For SWL, BCL, VLF DXers.

Rivals long wires

\$79.95 (+ \$4.00 shipping)



MFJ-1020 NEW INDOOR ACTIVE ANTENNA sits on your desk ready to listen to the world. Rivals, can often exceed, reception of outside long wire. Unique Tuned Active Antenna minimizes intermod, provides RF selectivity, reduces noise outside tuned band. Also use as preselector for external antenna. Covers 300 KHz to 30 MHz in 5 bands. Adjustable telescoping antenna. Controls: Tune, Band Selector, Gain, On-Off/Bypass. LED. FET, bipolar circuitry. Phono jack for external ant. 6x2x6 in. 9-12 VDC or 9 V battery for portable use. 110 VAC with optional AC adapter, MFJ-1312, \$9.95.

Order from MFJ and try it. If not delighted, return it within 30 days for refund (less shipping).

One year unconditional guarantee.

Order today. Call TOLL FREE 800-647-1800. Charge VISA, MC. Or mail check, money order.

Write for free catalog.

CALL TOLL FREE ... 800-647-1800

601-323-5869 in MS, outside continental USA.

MFJ ENTERPRISES, INCORPORATED

921 Louisville Road, Starkville, MS 39759

CIRCLE NO. 44 ON FREE INFORMATION CARD

For more information on advertised products, equipment tested, etc., circle appropriate number on postpaid Free Information Card.

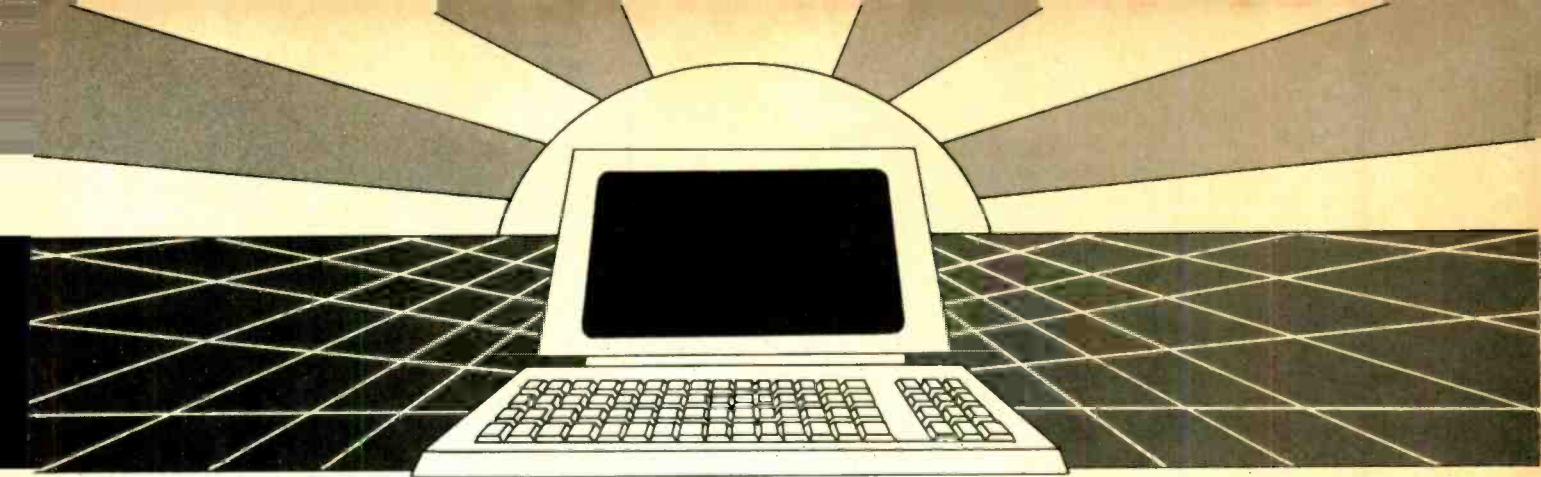

DISCOVER THE MAGAZINE THAT HELPED LAUNCH THE MICROCOMPUTER INDUSTRY

Popular Electronics

How Temperature Affects Components
Preview of the VHD Video Disc Player
Two Projects for Summer

Word-Processing Computer Systems



Radio Shack, Sinclair, Xerox), software (dBASE II), audio equipment (Bang & Olufsen, Crown, dbx, Hitachi, JBL, Mitsubishi, Optonica, Sansui, Yamaha), and video (GE, Hitachi, Pioneer, Panasonic, Quasar, RCA, Sharp, Sony, Technicolor, Toshiba, Zenith).

Innovative construction projects

If you're a do-it-yourselfer, you'll love the construction projects in *Popular Electronics*. Not only have we brought the

Popular Electronics

Incredible as it may seem, *Popular Electronics* helped launch the microcomputer industry. Back in 1975, we published plans for building the world's finest microcomputer based on the 8080 cpu. These plans generated incredible excitement—and started the world thinking about personal computing.

Popular Electronics always helps its readers experience the advances of the future—today. We do it with clearly written, in-depth articles explaining an innovation. Plans for building useful, low-cost projects incorporating the new technology. And reviews of mass-produced equipment when manufacturers finally catch on. Whether it's audio, video, computers, telephones, lasers or something that's just been invented, *Popular Electronics* will help you have fun with the newest, the most sophisticated, the most innovative electronics technology around.

Helpful buying guides

Popular Electronics compares and contrasts electronics gear in handy buyer's guide articles. We discuss features and options, what to look for, and how to get the best value on the market. Recent buyer's guide articles have covered computer printers, cordless home telephones, video cassette recorders, high-tech audio cassettes, video disc players, sophisticated telephones, projection televisions, pocket "beepers," video cameras and oscilloscopes.

World-famous test reports

In every *Popular Electronics* issue you'll find our famous in-depth test reports. We take a new electronics product, test it, and analyze the results. Recently we've tested computers (Apple, APF, Atari, Hewlett-Packard, IBM, Netronics, Ohio Scientific,

world the 8080 microcomputer, but also projects for building the first low-cost modem. The first computer keyboard integrated with the computer (SOL). The first low-cost voice synthesizer. The first low-cost logic analyzer. A low-cost 1802-based microcomputer (ELF). An 1802-based EPROM programmer. An automatic line voltage regulator....

As you can see, our construction projects, while not terribly difficult, will keep you at the forefront of technological development—without your spending much money. And in the future, we'll be bringing you construction projects to help you get more from your computer, including ways to interface your microcomputer with new advances in radio, telephones and video!

Get the leader in the field— at up to 33% off!

Popular Electronics is the world's most widely read electronics magazine. Now you can subscribe at big savings—up to 33% off! At our New Subscriber rates, a one-year subscription is only \$12.97. Take advantage of this offer—complete and return the coupon or postage-paid reply card today!

Popular Electronics

P.O. Box 2774, Boulder, Colorado 80322

- YES!** Send me one year (12 issues) of *Popular Electronics* for \$12.97—I save 19%
 I prefer two years for \$22.97—I save 28% Make that three years for \$31.97—I save 33%

Savings based on full one year subscription price of \$15.97

8H302

Mr./Mrs./Ms _____ (please print full name)

Address _____ Apt _____

City _____ State _____ Zip _____

CHECK ONE: Payment enclosed. Bill me later

Offer valid in U.S. and possessions only.

experimenter's corner

for radio-controlled cars. One channel controls the direction and speed of travel. The second controls the steering. The direction/speed control channel can also directly drive a pair of back-up lights to provide another degree of realism.

Experimenting With a Servo. Though it's possible to assemble a servomechanism from scratch, you can buy many different preassembled servos ranging in price from about \$12 to \$50 from suppliers of radio-controlled cars, boats, and planes. Nearly all these servos are installed in tough plastic cases no larger than two side-by-side 9-V batteries.

A typical inexpensive servo is shown in Fig. 6. For a device of such compact size and relatively low price (around \$20), it is quite sophisticated. Typically, it contains a high-quality miniature motor coupled to a train of three or four reduction gears. The feedback potentiometer is mechanically coupled to the gear train. The electronics are installed on a small circuit board

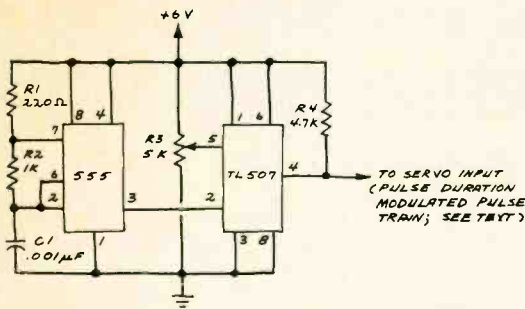

Fig. 7. Pulse-duration modulator for miniature servo.

adjacent to the motor and below the gear train. The axle of the output gear passes through a bushing or ball-bearing assembly in the top of the servo case. Various wheels and arms can be attached to the axle by means of a small screw.

A servo like the one in Fig. 6 weighs about 1.25 to 2 ounces and can deliver several pounds of thrust. It can travel through its rotational limit of 90 degrees in about half a second. Typical no-load current is around 80 mA, and stall current is approximately 450 mA.

Figure 7 is a simple variable-pulse-duration pulse generator I've used to drive an Aero Sport GS-ICR Servo. This servo, which is typical of those used in radio-controlled cars, boats and planes, responds to a pulse duration of from 1 to 2 ms. The servo is at its center (neutral) position when the incoming pulse has a duration of 1.5 ms. At 6V, it consumes around 25 mA at idle and around 80 mA when travelling. Its stall current is around 250 mA.

Resistor R3 in Fig. 7 can be a potentiometer in a joystick assembly or a standard potentiometer. It can even be a variable-resistance transducer to give a mechanical movement in response to some environmental change. For example, a fixed resistor in series with a pair of electrodes inserted into soil will provide a transducer that gives a voltage output dependent upon soil moisture content. The servo to which this transducer is connected could open and close a small water valve to keep the soil moisture at any desired level.

Applications for Servo. By now you've probably thought of several applications for servomechanisms in addition to those mentioned thus far. Servos are used in remote-controlled television cameras, self-focusing film cameras, toys, industrial robots, and military hardware. ◇

WARNING!
Electric Power Pollution, Spikes, Interference & Lightning HAZARDOUS to HIGH TECH EQUIPMENT!!

PAT. # 4,259,705

ISO-3

MicroComputers, VTR, Hi-Fi, Lasers, Spectrometers are often damaged or disrupted due to Power Pollution. High Tech components may interact!

Our patented ISOLATORS eliminate equipment interaction, curb damaging Power Line Spikes, Tame Lightning bursts & clean up interference.

Isolated 3-prong sockets; integral Spike/Lighting Suppressor. 125 V, 15 A, 1875 W Total, 1 KW per socket.

ISO-1 ISOLATOR. 3 Isolated Sockets; Quality Spike Suppression; Basic Protection \$69.95

ISO-3 SUPER-ISOLATOR. 3 DUAL Isolated Sockets; Suppressor; Commercial Protection \$104.95

ISO-17MAGNUM ISOLATOR. 4 QUAD Isolated Skts; Suppressor; Laboratory Grade Protection \$181.95

Master-Charge, Visa, American Express
TOLL FREE ORDER DESK 1-800-225-4876
(except AK, HI, MA, PR & Canada)
SATISFACTION GUARANTEED!

Electronic Specialists, Inc.
171 South Main Street, Natick, MA 01760
Technical & Non-800: 1-617-655-1532

CIRCLE NO. 11 ON FREE INFORMATION CARD

Put Professional Knowledge and a COLLEGE DEGREE in your Electronics Career through HOME STUDY

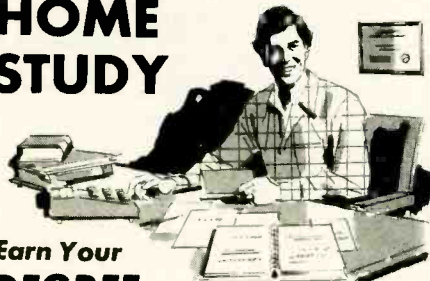

Earn Your DEGREE

No commuting to class. Study at your own pace, while continuing your present job. Learn from easy-to-understand lessons, with help from your home-study instructors whenever you need it.

In the Grantham electronics program, you first earn your A.S.E.T. degree, and then your B.S.E.T. These degrees are *accredited* by the Accrediting Commission of the National Home Study Council.

Our *free* bulletin gives full details of the home-study program, the degrees awarded, and the requirements for each degree. Write for *Bulletin ET-82*.

Grantham College of Engineering
2500 So. LaCienega Blvd.
Los Angeles, California 90034

www.americanradiohistory.com

FOCUS

FOR ORDERS ONLY! TOLL - FREE (800)221-0828

ATARI HEADQUARTERS VIDEO
LARGEST AUTHORIZED SONY DEALER IN BROOKLYN

Computers

Atari 400	264.95	NEW SONY SL-5100 Wireless 7-Day	659.95
Atari 800 w/Basic Cart	679.95	NEW SONY MFC 2400 Camera	853.95
Commodore Vic 20, expands to 32K	229.95	SONY SL-2000 Portable w/AC/20	849.95
Sharp PC-1211	99.95	SONY SL-2500 Compact/Wireless Remote	995.95
w/Ine Cassette interface		SONY SL-5000 Front Load	508.95
Sharp PC-1500	209.95	SONY MFC-2200 Camera w/FRE Cable	740.95
Times-Sinclair Computer	34.95	RCA VCR-500 Delay Sound -14 Day	1048.95

SONY Trinitron COLOR TELEVISION

KV-4100 w/AM & FM/Tape/Monitor	639.95	NEW RCA CC2015	979.95
KV-9400 9" Electronic Tuning	379.95	RCA CC011 - Neuvicon Tube	778.95
KV-1201 12"	324.95	J.V.C. New HR-7850 Cable Ready/ Stereo/Wireless	354.95
KV-1545RS 15" Remote Cable Ready	449.95	J.V.C. HR-7300	809.95
KV-1746R 17" Remote	495.95	PAN PV-1275 New w/Search Cable Ready/Wireless	1000.00
KV-1947R 19" Cable Ready/Remote	588.95	PAN PV-1900 Stereo Delay 14 day/ Cable Ready/Wireless	979.95
KV-2148R 21" Cable Ready/Remote	699.95	PAN PK-700 Color Camera	429.95
KV-2647R 26" Cable Ready/Remote	919.95	PAN PK-802 Auto Focus	719.95
KV-2648R Stereo 105 Ch. Black	985.00	PAN PK-956	854.95
		PAN PV-5000 Portable Wireless/ 14 day/Cable Ready	849.95
		PAN PV-5200 Portable w/T. 12 Func. Remote	759.95

CONSUMERS BEWARE!
All our Walkmans include the one and only ORIGINAL HEADPHONES supplied by the factory at no additional cost!

SONY WALKMAN-1 \$65.00

SANYO MG-30 AM & FM	62.95	VHS-8 ft.	5 pc/\$47.95	
WALKMAN 2 w/MOR-4115	82.95	T.D.K. T-120 8 in.	5 pc/\$54.80	
Headphones	82.95	MAXELL New MGR T-120	5 pc/\$70.70	
WALKMAN's Executive Black, Thin	89.95	Video Cassette II	5 pc/\$38.95	
TC5310 Stereo Record and Play	89.95	BETA L-750	5 pc/\$52.95	
FM WALKMAN SRP-30W Stereo	49.95	SONY L-830	5 pc/\$68.98	
NEW GE Stereo Escape II		VIDEO ACCESSORIES		
Smallest Walkman Stereo Made	96.95	Video Guard Stabilizer	49.95	
TOSSIBA KTR-1 Stereo, Record, FM	86.95	Video Guard Stabilizer w/RF	149.95	
		Video Cassette II	199.95	
		P.G.R. Dubmaster/Stabilizer/Enhancer/Fader/Rev/Improved Circuitry		
		REG. \$219.95	only 179.95	
		VIDEO LIGHT	VIDEO CADDY	VIDEO TRIPOD

LARGEST SELECTION OF FIRST RUN MOVIES IN STOCK AT DISCOUNT PRICES

For information and all N.Y. State orders, please dial (212)871-7600. All items subject to availability and price change. Mail and phone orders C.O.D. Master Charge, Visa O.K. Shipping extra. Everything Factory Fresh 10 day Money Back Guarantee! (less shipping) FOCUS ELECTRONICS 4523-13th Ave., Brooklyn, NY 11219

CIRCLE NO. 61 ON FREE INFORMATION CARD

ELECTRONICS LIBRARY

Practical Troubleshooting Techniques for Microprocessor Systems

by James W. Coffron

This text deals with troubleshooting techniques for 8-bit devices, covering circuits that utilize the 8080, 8085, Z80, and 6800 microprocessor systems. Chapter One begins with an overview of 3-bus system architecture and its role in 8-bit systems. Then the various microprocessors are compared in terms of circuit organization and operating parameters. The bulk of the book, however, details methods of hardware testing and the practical aspects of hardware debugging. The central premise is that most hardware faults can be located using simple and inexpensive static techniques.

Published by Prentice-Hall, Inc., Englewood Cliffs, NJ 07632. Hard Cover. 246 pages, \$19.95

The Radio Amateur's Handbook

This is the 1982 edition, and it contains some important new information not found in previous handbooks. The additional material includes a six-page spectrum chart, 10-MHz information added to several construction projects, an introduction to Packet Radio and Spread Spectrum Techniques, a new RFI chart showing the frequency relationship between amateur bands and other telecommunications services, 10-GHz Gunnplexer communications, new antennas for vhf FM, and an updated list of parts suppliers. Among the construction projects are: a code-practice oscillator, 250-W linear covering of the 30-meter WARC band, a two-tone generator, an SSB speech processor, a general-purpose RTTY demodulator, etc. In addition, there is the customary information concerning the electronic principles of radio transmission; calibration and use of test equipment; and standards and procedures for operating a ham station.

Published by the American Radio Relay League, Newington, CT 06111. Soft cover. 23 chapters. \$10.

The Multilingual Computer Dictionary

By Alan Isaacs, Editor

If you deal with computers on an international basis, you might need a working knowledge of foreign computer terminology. This dictionary is a useful reference that lists 1600 of the most common computer terms in six languages: English, French, German, Italian, Spanish, and Portuguese. Each term is listed so that you can look it up in any one of the six languages, and immediately see its equivalent in the other five. Separate entries are given for British and American English

where usage differs in the two countries. Published by Facts on File, Inc., 119 W. 57th St., New York, NY 10016. Hard Cover. 332 pages. \$19.95

Automotive Ignition Systems

by Frank C. Derato

Here is a guide for the do-it-yourselfer who wants to be able to tune-up his rig and troubleshoot ignition problems. In order to be able to perform the procedures given in the book you'll need a voltmeter, ohmmeter, tack, and dwellmeter, as well as a set of basic automotive tools. The book starts with a description of the principles of electricity, and an overview of how a standard ignition system works. If you are familiar with these things, the author suggests you go right to Chapter 11 (the book has 29 chapters), which provides an introduction to electronic ignition systems; or to Chapter 20, which begins the discussion of computer-controlled ignition. The book is clearly written in a step-by-step, how-to fashion, and the illustrations are good, but there is not quite enough information pertaining to foreign cars.

Published by McGraw-Hill, 1271 Ave. Americas, N.Y., NY 10020. Soft cover. 272 pages. \$13.50

Apple Pascal Games

by Douglas Hergert and Joseph T. Kalash

This book presents a collection of the most popular games written in Apple Pascal (Apple Pascal incorporates UCSD Pascal plus Apple extensions). For each game, the book covers game rules and includes a guide to understanding the programs. A structure chart is also offered to graphically show the organization and listing of the whole program. Thus, the reader learns not only how to play the game, but also to discover how the games are implemented on the computer. Some of the games are: Baccarat, Nim, Snake, Hangman, and Blackjack.

Published by Sybex, 2344 Sixth St., Berkeley, CA 94710. Soft cover. 371 pages. \$14.95

BASIC Betting

by James Jasper

Those of you with sporting blood should find this one interesting: it's about using your home microcomputer to make money through gambling. That is, the book contains BASIC programs that are written to allow you to predict more accurately the probabilities and point spreads for football, basketball, horse racing, and blackjack. The football program, for example, divides a team's record into discrete categories—such as, teams beaten, teams beaten by seven or more points, teams lost to, teams lost to by a given spread, etc. At the end of the book, there is a program for money management, in case you don't know what to do with your winnings.

Published by St. Martin's Press, 175 Fifth Ave., N.Y., NY 10010. Soft cover. 283 pages. \$9.95.

WE TAKE YOU BY THE HAND!

You'll learn all about computers: how to build, program, service, even play TV games—without knowing the first thing about it!

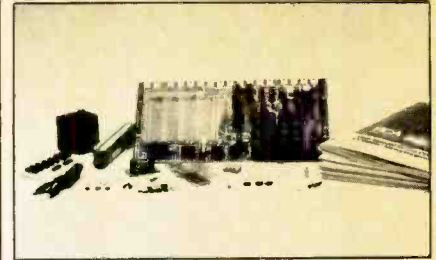

The New ELF II "Beginners" Package

Your own expandable micro-computer kit, 5 diagnostic analyzers plus circuit, programming, diagnostic manuals, even games you can play on TV. All only \$139.95.

Even if you don't know bits from bytes, now it's easy and inexpensive to build your own micro-computer. Learn how it works, program it, service it—even play games with it on your TV! It's here in the New ELF II "Beginners" Package, only from Netronics. Only \$139.95. Here's the package: 1. your own micro-computer, the famous ELF II (featuring the RCA 1802 CMOS microprocessor) in kit form with step-by-step instructions on how to build it. Diagnostic Analyzers including 2. your own Logic Probe. 3. Pulse Catcher. 4. 8 bit Test Register. 5. Logic Analyzer. 6. Gate Arrays. 7. Non-Technical Manuals on how to use analyzers, how to get into the guts of the computer, what makes it tick, how to service it. 8. Sample Programs that teach you machine language programming plus how to correct or "debug" any programming mistakes. 9. TV games you can play. If your TV set has no video input, an optional converter (RF Modulator), is available. Then, once you've got this "Beginners" Package under your belt, keep on expanding your ELF II with additions like the Typewriter Key Board, added RAM, Full Basic Interpreter, Electric Mouth Talking Board, Color/Music, A/D-D/A Boards for Robot Controls and much, much more. We'll take you by the hand with the New ELF II "Beginners" Package. Only \$139.95. Mail or phone in your order today and begin.

Specifications: ELF II "Beginners" Package. The computer features an RCA CMOS 1802 8-bit microprocessor addressable to 64K bytes with DMA, interrupt, 18 Registers, ALU, 256 byte RAM expandable to 64K bytes, Professional-Hex keyboard, fully decoded so there's no need to waste memory with keyboard scanning circuits, built-in power regulator, 5 slot plug-in expansion BUS (16 connectors), stable crystal clock for timing purposes and a double sided, plated through PCB Board plus RCA 1861 video IC to display any segment of memory on a video monitor or TV screen along with the logic and support circuitry you need to learn every one of the RCA 1802's capabilities. The diagnostic analyzers aid in understanding and trouble shooting your ELF II, as well as other computer and microprocessor products.

Continental U.S.A. Credit Card Buyers Outside Connecticut

CALL TOLL FREE 800-243-7428

To Order From Connecticut or For Technical Assistance, Etc.,

Call (203) 354-9375

NETRONICS R&D LTD. (Dept. 113) 333 Litchfield Road, New Milford, CT 06776

Please send the items checked below:

ELF II "Beginners" Kit \$139.95
 RF Modulator \$ 8.95

Plus \$3.00 for postage, handling and insurance (\$6.00 Canada)

Connecticut Residents add sales tax

Total Enclosed \$

Personal Check Cashier's Check/Money Order
 Visa Master Charge (Bank No. _____)

Acct. No. _____

Signature _____ Exp. Date _____

Print

Name _____

Address _____

City _____

State _____

Zip _____

PROJECT OF THE MONTH

By Forrest M. Mims

Controller for Small DC Motors

SMALL dc motors that operate in both forward and reverse directions are used in many kinds of devices such as tape recorders, toy cars, and card readers. The rotational direction of these motors is reversed by means of a dpdt switch connected as shown in Fig. 1. Also shown is a pictorial view of the switch contacts wired for forward-reverse directional control.

Many applications require that the rotational direction of a small motor be controlled by a low-level logic signal rather than a mechanical switch. This is readily accomplished by substituting transistors for the switches in Fig. 1. Bipolar transistors can be used, but VMOS power transistors are a better choice since they can be readily interfaced with TTL, LS and CMOS logic.

A Solid-State Motor Reverser. Figure 2 shows one way to substitute VMOS FETs in the circuit of Fig. 1. Two gates in a CMOS 4011 quad NAND gate provide the steering logic necessary to switch the appropriate VMOS FETs on and off.

In operation, when the input is low, $Q1$ and $Q2$ are switched on, and $Q3$ and $Q4$ are switched off. This applies a positive polarity to the A terminal of the motor, and the motor rotates in a corresponding direction. When the input is high, $Q3$ and $Q4$ are switched on, and $Q1$ and $Q2$ are switched off. This reverses the polarity of the voltage applied to the motor and causes it to reverse its direction of rotation.

An interesting feature of the circuit is that, in a low-noise environment, directional control can be implemented by making the input high or low momentarily and then allowing it to float. The motor will stop and reverse direction even *after* a momentary change in the input level has taken place. Of course the input should not be allowed to float in a noisy environment since the CMOS gate may switch in response to spurious signals.

Adding a Speed Control. Figure 3 shows how the circuit in Fig. 2 can be expanded to include adjustable rotational speed. A bonus feature of the expanded circuit is that the two unused gates in the 4011 are connected as a free-running oscillator—no additional chips are required.

The pulse-repetition rate of the oscillator is governed by $R2$ and $C1$. VMOS FET $Q5$ is connected as a solid-state

switch that applies power to the motor-reverser circuit under control of the oscillator.

The oscillator has a fixed duty cycle of about 50 percent. In other words, the duration of each output pulse is about equal to the time between pulses. When the oscillation frequency is high, the pulses are narrow and the motor turns slowly. When the oscillation frequency is low, the pulses are wide and the motor turns more rapidly.

When the pulses are too wide (a few hundred or more milliseconds), the motor pulsates and may even operate in a start-stop mode. When the pulses are too narrow (50 to 100 microseconds), the motor will cease operation and may emit a high-pitched tone. Different motors may behave in different ways as the pulse train is altered.

Operating Tips. The circuit in Fig. 3 is designed for use with low-voltage, low-power hobby motors such as those in model cars and robots.

Though I used VN67 VMOS FETs (available from Siliconix distributors and Radio Shack stores), most other types will work. But be sure the motor's current drain doesn't exceed the ratings for the VMOS FETs, and use heat sinks if necessary. You can parallel VMOS FETs to obtain a lower *on* resistance and more efficient operation.

Finally, remember that this circuit uses MOS semiconductors. Be sure to follow appropriate handling precautions to avoid causing damage to either the 4011 or any of the transistors. If your circuit fails to operate properly, one of the gates in the 4011 or one of the VMOS FETs may be defective. \diamond

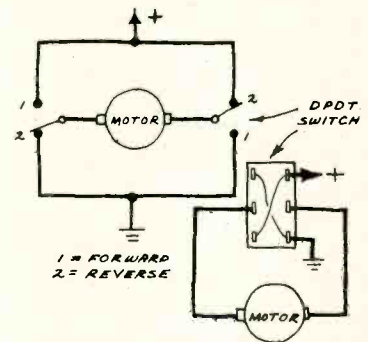

Fig. 1. (Above right.) A mechanical switch motor reverser.

Fig. 2. (Right) A solid-state motor reverser circuit.

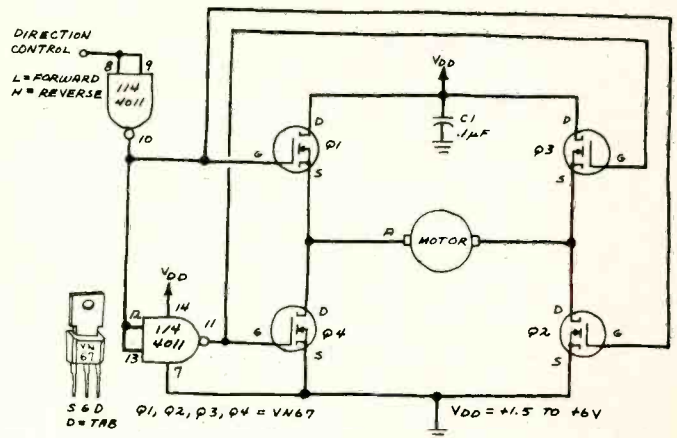
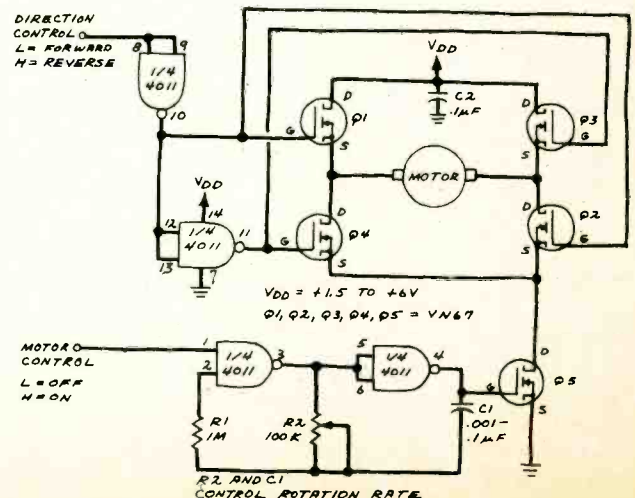

Fig. 3. Small motor direction and speed controller.



4116 16K DYNAMIC RAMS 250 NS

8/\$11.95 SET

LINEAR

.M301	.34	LM350K	5.60	NE570	4.75	LM1800	2.99
.M301H	.79	LM350T	4.60	NE571	3.95	LM1812	8.25
.M307	.45	LM358	.98	NE592	2.75	LM1815	5.20
.M308	.98	LM359	1.79	LM703	.89	LM1818	2.90
.M308H	1.15	LM376	3.75	LM709	.59	LM1820	3.50
.M309H	1.95	LM377	2.29	LM710	.75	LM1830	3.50
.M309K	1.49	LM378	2.50	LM711	.79	LM1871	5.49
.M310	1.75	LM379	4.50	LM723	.49	LM1872	5.49
.M311	.64	LM380	1.29	LM723H	.55	LM1877	3.25
.M311H	.89	LM380N-8	1.10	LM733	.98	LM1889	2.49
.M312H	1.75	LM381	1.60	LM741N-8	.35	LM1896	1.75
LM317K	3.95	LM382	1.60	LM741N-14	.35	LM2877	2.05
LM317T	1.95	LM383	1.95	LM741H	.40	LM2878	2.25
LM318	1.49	LM384	1.95	LM747	.79	LM2900	.85
LM318H	1.59	LM386	1.50	LM748	.59	LM2901	1.00
LM319H	1.25	LM387	1.40	LM1014	2.75	LM3900	.59
LM319	1.25	LM389	1.35	LM1303	1.95	LM3905	1.25
LM320 (see 7900)		LM390	1.95	LM1304	1.19	LM3909	.98
LM322	1.65	LM392	.69	LM1305	1.49	LM3911	2.25
LM323K	4.95	LM394H	4.60	LM1307	.85	LM3914	3.95
LM324	.59	LM399H	5.00	LM1310	2.90	LM3915	3.95
LM329	.69	NE531	3.75	MC1330	1.89	LM3916	3.95
LM331	3.95	NE536	6.00	MC1349	1.89	MC4024	3.95
LM334	1.30	NE555	.39	MC1350	1.29	MC4044	4.50
LM335	1.40	NE556	.69	MC1358	1.79	RC4136	1.25
LM336	1.75	NE558	1.50	LM1414	1.59	RC4151	3.95
LM337K	3.95	NE561	19.95	LM1458	.69	LM4250	1.75
LM337T	2.95	NE562	6.00	LM1488	.99	LM4500	3.25
LM338K	6.95	NE564	3.95	LM1489	.99	LM13080	1.29
LM339	.99	LM565	.99	LM1496	.85	LM13600	1.49
LM340 (see 7800)		LM566	1.49	LM1558H	3.10	LM13700	1.49
LM348	1.20	LM567	1.29				

H = TO-5 CAN

T = TO-220

K = TO-3

VOLTAGE REGULATORS

7805T	.89	7905T	.99
7806T	.89	7908T	.99
7812T	.89	7912T	.99
7815T	.89	7915T	.99
7824T	.89	7924T	.99
7805K	1.39	7905K	1.49
7812K	1.39	7912K	1.49
7815K	1.39	7915K	1.49
7824K	1.39	7924K	1.49
78L05	.69	79L05	.79
78L12	.69	79L12	.79
78L15	.69	79L15	.79
78H05K	9.95	LM323K	4.95
78H12K	9.95	UA73540	1.95

T = TO-220

K = TO-3

L = TO-92

WE NOW STOCK A COMPLETE STOCK OF DISC, ELECTROLYTIC, MONOLITHIC AND TANTALUM CAPACITORS

MICROCOMPUTER HARDWARE HANDBOOK

FROM ELCOMP — \$14.95

Over 800 pages of manufacturers data sheets on most commonly used IC's.

Includes:

- * TTL — 74/74LS and 74F
- * CMOS
- * Voltage Regulators
- * Memory — RAM, ROM, EPROM
- * CPU's — 6800, 6500, Z80, 8080, 8085, 8086/8
- * MPU support & interface — 6800, 6500, Z80, 8200, etc.

RESISTORS

1/4 WATT 5% CARBON FILM ALL-STANDARD VALUES FROM 1 OHM TO 10 MEG OHM

- 50 PCS. SAME VALUE .025
- 100 PCS. SAME VALUE .02
- 1000 PCS. SAME VALUE .015

5 1/4" DISK DRIVES TANDON

TM100-1 (FOR IBM PC) 229.00
SHUGART

SA 400L 199.95

CABINET FOR 5 1/4" DISK DRIVE

- * COLOR MATCHES APPLE
- * FITS SHUGART

SPECIAL — \$29.95

POWER SUPPLIES

MODEL 1 \$29.95

OPEN FRAME STYLE
MANUFACTURED
BY SIGMA

+5 VOLT 4 AMP

MODEL 2 \$39.95

MOUNTED ON PC BOARD
MANUFACTURED BY CONVER

+5 VOLT 4 AMP
±12 VOLT 1 AMP



FOR SHIPPING PLEASE INCLUDE \$4.00 FOR UPS GROUND; \$13.00 FOR UPS BLUE LABEL

"JDR SUPER SPECIALS"

MEMORY CLEARANCE

STATIC		DYNAMIC	
2k x 8	TMM2016-200NS	64k x 1	4164-200NS
1k x 1	2102L-450NS	4k x 1	4027-250NS
	\$5.95 EA.		\$7.25
	100/\$75		\$1.95

CPU SALE

8 BIT

Z-80 CPU 2MHZ	\$3.95 (10/ 3.75 EA)
6502 1 MHZ	\$5.95 (10/ 5.75 EA)
6809 INT. CLOCK	\$12.95 (10/11.25 EA)

16 BIT

8086	\$29.95
68000 8MHZ	\$99.95

BAUD-RATE GENERATORS

MC14411	7.95	#0/7.25
1.8432 CRYSTAL	4.95	
4702	8.95	10/7.95
2.4576 CRYSTAL	4.95	

TRANSISTORS

PN2222	1000/€9.00
2N3904	1000/€9.00
2N3906	1000/€9.00

IC SOCKETS LOW PROFILE SOLDERTAIL

HIGH RELIABILITY DUAL SIDE WIPE STYLE

8 pin	100 pcs	075
14 pin	09	085
16 pin	09	085
18 pin	12	110
24 pin	20	150
40 pin	22	190

SALE ENDS SEPTEMBER 30, 1982

IF YOU CAN FIND A PRICE LOWER ELSEWHERE. LET US KNOW AND WE'LL MEET OR BEAT THEIR PRICE! (SEE TERMS BELOW)

DISKETTES

5 1/4"

ATHANA SS SD SOFT	24.95
MEMOREX SS SD SOFT	26.95
VERBATIM SS SD SOFT	29.95
VERBATIM 10 SECTION HARD	29.95

8"

VERBATIM SS SD SOFT	44.95
---------------------	-------

VISIT OUR RETAIL STORE

HOURS: M-F, 9-5; Sat. 11-3

PLEASE USE YOUR CUSTOMER NUMBER WHEN ORDERING

TERMS: For shipping include \$2 for UPS Ground or \$3 for UPS Blue Label Air. Items over 5 pounds require additional shipping charges. Foreign orders include sufficient amount for shipping. There is a \$10 minimum order. Bay Area and Los Angeles Counties add 6 1/2% Sales Tax. Other California residents add 6% Sales Tax. We reserve the right to substitute manufacturer. Not responsible for typographical errors. Prices are subject to change without notice. We will match or beat any competitor's price provided it is not below our cost.

JDR MICRODEVICES, INC.

1224 S. Bascom Avenue
San Jose, CA 95128

800-538-5000 • 800-662-6279 (CA)
(408) 995-5430 • Telex 171-110

© 1982 JDR MICRODEVICES, INC.

4116 16K DYNAMIC 250NS **8/\$11⁹⁵** SET **2114** 1KX4 STATIC LOW POWER 200NS **8/\$15⁹⁵** SET

ALL MERCHANDISE 100% GUARANTEED!

CALL US FOR VOLUME QUOTES

STATIC RAMS

2101	256 x 4 (450ns)	1.95
5101	256 x 4 (450ns) (cmos)	3.95
2102-1	1024 x 1 (450ns)	.89
2102L-4	1024 x 1 (450ns) (LP)	1.29
2102L-2	1024 x 1 (250ns) (LP)	1.69
2111	256 x 4 (450ns)	2.99
2112	256 x 4 (450ns)	2.99
2114	1024 x 4 (450ns)	8/14.95
2114L-4	1024 x 4 (450ns) (LP)	8/15.25
2114L-3	1024 x 4 (300ns) (LP)	8/15.45
2114L-2	1024 x 4 (200ns) (LP)	8/15.95
2147	4096 x 1 (55ns)	9.95
TMS4044-4	4096 x 1 (450ns)	3.49
TMS4044-3	4096 x 1 (300ns)	3.99
TMS4044-2	4096 x 1 (200ns)	4.49
MK4118	1024 x 8 (250ns)	9.95
TMM2016-200	2048 x 8 (200ns)	5.95
TMM2016-150	2048 x 8 (150ns)	6.95
TMM2016-100	2048 x 8 (100ns)	7.95
HM6116-4	2048 x 8 (200ns) (cmos)	6.95
HM6116-3	2048 x 8 (150ns) (cmos)	7.10
HM6116-2	2048 x 8 (120ns) (cmos)	9.95
HM6116LP-4	2048 x 8 (200ns) (cmos)(LP)	8.75
HM6116LP-3	2048 x 8 (150ns) (cmos)(LP)	8.95
HM6116LP-2	2048 x 8 (120ns) (cmos)(LP)	12.95
Z-6132	4096 x 8 (300ns) (Qstat)	34.95

LP = Low Power Qstat = Quasi-Static

DYNAMIC RAMS

TMS4027	4096 x 1 (250ns)	2.50
MK4108	8192 x 1 (200ns)	1.95
MM5298	8192 x 1 (250ns)	1.85
4116-300	16384 x 1 (300ns)	8/11.75
4116-250	16384 x 1 (250ns)	8/11.95
4116-200	16384 x 1 (200ns)	8/13.95
4116-150	16384 x 1 (150ns)	8/15.95
4116-120	16384 x 1 (120ns)	8/29.95
2118	16384 x 1 (150ns) (5v)	4.95
MK4816	2048 x 8 (300ns) (5v)	24.95
4164-200	65536 x 1 (200ns) (5v)	7.25
4164-150	65536 x 1 (150ns) (5v)	8.25

5V = single 5 volt supply

EPROMS

1702	256 x 8 (1us)	4.50
2708	1024 x 8 (450ns)	3.95
2758	1024 x 8 (450ns) (5v)	9.95
2716	2048 x 8 (450ns) (5v)	3.95
2716-1	2048 x 8 (350ns) (5v)	7.95
TMS2716	2048 x 8 (450ns)	9.95
TMS2532	4096 x 8 (450ns) (5v)	7.95
2732	4096 x 8 (450ns) (5v)	6.95
2732-250	4096 x 8 (250ns) (5v)	12.95
2732-200	4096 x 8 (200ns) (5v)	16.95
2764	8192 x 8 (450ns) (5v)	16.95
2764-250	8192 x 8 (250ns) (5v)	18.95
2764-200	8192 x 8 (200ns) (5v)	19.95
TMS2564	8192 x 8 (450ns) (5v)	24.95
MC68764	8192 x 8 (450ns) (5v)(24 pin)	call

5v = Single 5 Volt Supply

EPROM ERASERS

	Timer	Capacity Chip	Intensity (uW/Cm ²)	
PE-14		6	5,200	83.00
PE-14T	X	6	5,200	119.00
PE-24T	X	9	6,700	175.00
PL-265T	X	20	6,700	255.00
PR-125T	X	16	15,000	349.00
PR-320	X	32	15,000	595.00

DISC CONTROLLERS

1771	20.95
1791	29.95
1793	38.95
1795	54.95
1797	54.95
6843	34.95
8272	39.95
UPD765	39.95
1691	18.95
2143	18.9F

INTERFACE

8T26	1.69
8T28	2.49
8T95	.99
8T96	.99
8T97	.99
8T98	.99
DM8131	2.95
DP8304	2.29
DS8835	1.99
DS8836	.99

MISC.

3242	7.95
3341	4.95
MC3470	4.95
MC3480	9.00
11C90	13.95
95H90	7.95
2513-001 UP	9.95
2513-002 LOW	9.95

SOUND CHIPS

76477	3.95
76489	8.95
AY3-8910	12.95
MC3340	1.49

CRT CONTROLLERS

6845	14.95
68B45	35.95
HD46505SP	15.95
6847	12.25
68047	24.95
8275	29.95
7220	99.95
CRT5027	39.95
CRT5037	49.95
TMS9918A	39.95

BIT-RATE GENERATORS

MC14411	11.95
BR1941	11.95
4702	12.95
COM5016	16.95
COM8116	10.95
MM5307	10.95

UARTS

AY3-1014	6.95
AY5-1013	3.95
PT1472	9.95
TR1602	3.95
2350	9.95
2651	18.95
TMS6011	5.95
IM6402	7.95
IM6403	8.95
INS8250	14.95

KEYBOARD CHIPS

AY5-2376	11.95
AY5-3600	11.95
74C922	5.25
74C923	5.50

CLOCK CIRCUITS

MM5314	4.95
MM5369	3.95
MM5375	4.95
MM58167	8.95
MM58174	11.95
MMS5832	6.95

Z-80 2.5 Mhz

Z80-CPU	3.95
Z80-CTC	5.95
Z80-DART	15.25
Z80-DMA	17.50
Z80-PIO	5.75
Z80-SIO/0	18.50
Z80-SIO/1	18.50
Z80-SIO/2	18.50
Z80-SIO/9	16.95

4.0 Mhz

Z80A-CPU	6.00
Z80A-CTC	8.65
Z80A-DART	18.75
Z80A-DMA	27.50
Z80A-PIO	6.00
Z80A-SIO/0	22.50
Z80A-SIO/1	22.50
Z80A-SIO/2	22.50
Z80A-SIO/9	19.95

6.0 Mhz

Z80B-CPU	17.95
Z80B-CTC	15.50
Z80B-PIO	15.50

ZILOG

Z6132	34.95
Z8671	39.95

CRYSTALS

32.768 khz	1.95
1.0 mhz	4.95
1.8432	4.95
2.0	3.95
2.097152	3.95
2.4576	3.95
3.2768	3.95
3.579535	3.95
4.0	3.95
5.0	3.95
5.0688	3.95
5.185	3.95
5.7143	3.95
6.0	3.95
6.144	3.95
6.5536	3.95
8.0	3.95
10.0	3.95
14.31818	3.95
15.0	3.95
16.0	3.95
18.0	3.95
18.432	3.95
20.0	3.95
22.1184	3.99
32.0	3.95

DATA ACQUISITION

ADC0800	15.55
ADC0804	4.95
ADC0809	5.25
ADC0817	10.95
DAC0800	4.95
DAC0806	2.25
DAC0808	4.95
DAC1020	8.25
DAC1022	8.25
MC1408L6	2.25
MC1408L8	4.95

8000

8035	7.25
8039	7.95
INS-8060	17.95
INS-8073	29.95
8080	3.95
8085	7.95
8085A-2	11.95
8086	29.95
8087	CALL
8088	39.95
8089	89.95
8155	7.95
8156	8.95
8185	29.95
8185-2	39.95
8741	39.95
8748	29.95
8755	32.00

8200

8202	29.95
8203	39.95
8205	3.50
8212	1.85
8214	3.85
8216	1.80
8224	2.50
8226	1.80
8228	4.90
8237	19.95
8238	4.95
8243	4.45
8250	14.95
8251	4.75
8253	9.25
8253-5	9.85
8255	4.75
8255-5	5.25
8257	8.50
8257-5	8.95
8259	6.90
8259-5	7.50
8271	39.95
8272	39.95
8275	29.95
8279	9.50
8279-5	10.00
8282	6.65
8283	6.65
8284	5.70
8286	6.65
8287	6.50
8288	25.00
8289	49.95

FUNCTION GENERATORS

MC4024	3.95
LM566	1.49
XR2206	3.75
8038	3.95

INTERSIL

ICL7103	9.50
ICL7106	9.95
ICL7107	12.95
ICL8038	3.95
ICM7107A	5.59
ICM7208	15.95

6800

68000	99.95
6800	4.95
6802	10.95
6808	13.90
6809E	19.95
6809	12.95
6810	2.95
6820	4.95
6821	4.95
6828	14.95
6840	12.95
6843	34.95
6844	25.95
6845	14.95
6847	12.25
6850	3.45
6852	5.75
6860	10.95
6862	11.95
6875	6.95
6880	2.95
6883	24.95
68047	24.95
68488	19.95

6800 = 1MHZ

68B00	10.95
68B02	22.25
68B09E	29.95
68B09	29.95
68B10	7.95
68B21	12.95
68B45	35.95
68B50	12.95

6500 1 MHZ

6502	5.95
6504	6.95
6505	8.95
6507	9.95
6520	4.35
6522	8.75
6532	11.25
6545	22.50
6551	11.85

2 MHZ

6502A	9.95
6522A	11.70
6532A	12.40
6545A	28.50
6551A	12.95

3 MHZ

6502B	14.95
-------	-------

EXAR

XR 2206	3.75
XR 2207	3.85
XR 2208	3.90
XR 2211	5.25
XR 2240	3.25

9000 SERIES

9316	1.00
9334	2.50
9368	3.95
9401	9.95
9601	.75
9602	1.50
96S02	1.95

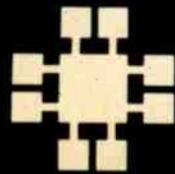

JDR MICRODEVICES, INC.

1224 S. Bascom Avenue
San Jose, CA 95128

800-538-5000 • 800-662-6279 (CA)
(408) 995-5430 • Telex 171-110

© 1982 JDR MICRODEVICES, INC.

VISIT OUR RETAIL STORE

HOURS
M-F, 9-5, Sat 11-3

PLEASE USE YOUR CUSTOMER NUMBER WHEN ORDERING

TERMS: For shipping include \$2 for UPS Ground or \$3 for UPS Blue Label Air. Items over 5 pounds require additional shipping charges. Foreign orders include sufficient amount for shipping. There is a \$10 minimum order. Bay Area and Los Angeles Counties add 6% Sales Tax. Other California residents add 6% Sales Tax. We reserve the right to substitute manufacturer. Not responsible for typographical errors. Prices are subject to change without notice. We will match or beat any competitor's price provided it is not below our cost.

THERE'S NO PLACE LIKE THE PARTS PLACE™

No Waiting! No Minimum Order! Low Prices!

Shielded Transformers

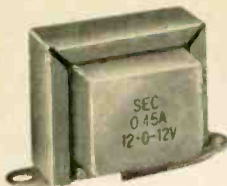

Low As
299 NEW!

Color-coded wire leads for easy hookup. U.L. listed. 120VAC primaries. CT = center tap.

Secondary	Mounting Centers	Cat. No.	Only
6.3VAC at 450 mA	2"	273-1364	2.99
12VAC at 450 mA (CT)	2"	273-1365	3.59
24VAC at 450 mA (CT)	2 7/16"	273-1366	3.99

Miniature SPDT Relays



NEW!
349
Each

Contacts Rated
3 Amps at 125VAC

9/16 x 25/32 x 5/8"

5VDC, 70-Ohm Coil. 275-246 3.49
12VDC, 400-Ohm Coil. 275-247 3.49

LCD 3 1/2-Digit Autoranging Multimeter



NEW!
8995

It's the DVM That "Thinks"!

- Built-In "Beep" Continuity Check
- Low-Battery And Over-Range Indicators
- With Test Leads, Spare Fuse and Instructions

You choose the function... it selects and displays the range automatically—even if probes are reversed! Convenient "beep" continuity and range-change indicator (switchable). Range-hold feature overrides auto-ranging when desired. Measures up to 1000 VDC, 500 VAC, 200 mA (DC and AC), 2 megohms with very accurate low-resistance readings. 6 3/8 x 3 1/2 x 1 3/8". Requires two "AA" batteries. 22-192 89.95

NFET IC Op Amps

NEW!

Low As
179

Frequency Compensated



Input: one trillion ohms, typical. Short-circuit protected. Senses input levels at or near ground potential. 3 to 36VDC, single or split supply.

Type	DIP	Cat. No.	Each
TL091 (Single)	8-pin	276-1745	1.79
TL092 (Dual)	8-pin	276-1746	2.29
TL094 (Quad)	14-pin	276-1747	4.49

Varactor UHF-TV Tuner

NEW!
2495

Brand New—NOT Surplus

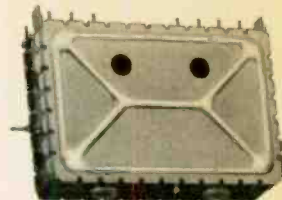

UES-A56F. Sensitive, stable—great for projects, replacement, conversion to 450 MHz ATV. 75-ohm in/out. V+ = 12VDC. 0 to 28VDC for tuning. With data. 277-220 24.95

Pigtail Fuses



NEW! Fast-Acting

Amps	Cat. No.	Pkg. of 2
1/4	270-1220	.99
1/2	270-1221	.99
3/4	270-1222	.99
1	270-1223	.99
1.5	270-1224	.99
2	270-1225	.99
2.5	270-1226	.99
3	270-1227	.99

IF, FM/Audio and Video Detector ICs

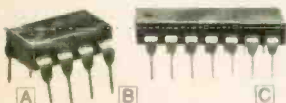

- A** MC1330. 3rd IF, video detector, video and AFC buffers. High linearity. Outputs: Wideband video, AFT, narrow-band reverse video. 8-pin w/specs. 276-1757 2.49
- B** MC1350 Universal IF Amp With AGC. For radio and TV circuits to 60 MHz. Typical gain at 45 MHz: 50 dB. 8-pin w/specs. 276-1758 2.19
- C** MC1358/CA3065. IF amp (100 kHz to 5.5 MHz), limiter, FM detector, electronic attenuator, audio driver. 14-pin w/specs. 276-1759 1.79

Push-In Neon Lamps



NEW!
Pkg. of 2 **199**

One red, one green. Built-in dropping resistors for 120VAC. Mount instantly in 7/16" holes. 272-709 Pkg. of 2/1.99

5VDC DIP Relay



299 NEW!

3/8 x 9/16 x 3/8"

Fits 14-pin DIP socket or mounts on PC board. SPDT contacts: 2 amps at 125VAC. 72 mA, 70-ohm coil. 275-243 2.99

PC-Mount Electret Mike



119 NEW!

Omnidirectional, with 20 to 15,000 Hz ± 4 dB response. 2-10VDC, 1 milliamp max. current drain. 9.4mm dia. x 6.6mm. 270-090 1.19

Boards & Connectors for Computer Projects



Low As **129**

NEW!

Radio Shack Exclusive!

For clean—not kluged—projects! Ideal for peripheral circuits and transforming one computer format to another. These top quality, dual-sided glass boards accept card edge connectors, sockets and headers. They are indexed to save time and reduce wiring errors.

Fig.	Connectors	Contact Points	Size	Cat. No.	Each
A	40 position	1520	4 1/4 x 5 1/4	276-163	4.95
A	50 position	1520	4 1/4 x 5 1/4	276-164	4.95
B	40 position	2898	5 1/4 x 8 1/4	276-165	9.95
B	50 position	2898	5 1/4 x 8 1/4	276-166	9.95

- C** 40-Pin Card Edge Socket. Solder eyelets. 276-1544 2.59
- D** 50-Position Card Edge Socket. Solder eyelets. 276-1545 2.99
- D** 40-Position Socket With 12" Cable. 276-1542 4.99
- E** 50-Position Socket With 12" Cable. 276-1543 5.49
- E** 40-Position Header. 276-1540 1.29 50-Pos. 276-1541 1.49

PC-Mount Piezo Buzzer

NEW! **249**



Great for security, use in clock radios, digital projects and more. 3.0-20VDC. 12 milliamps at 12VDC. 17.5 x 4.5mm diameter. 273-065 2.49

Micro-Mini 5VDC Relay

NEW! **249**



Just 1 1/2 x 3/8 x 1/4", and ideal for crowded boards with 100" centers. SPDT contacts: 1 amp at 125VAC. 55-ohm, 90 mA coil. 275-240 **Actual Size** 2.49

AC Outlet Analyzer

NEW!
595

Neon readout warns you instantly if a 3-wire (grounded) outlet or extension cord is faulty. Just plug it in before using tools, appliances or amplified musical instruments. 22-101 5.95



Radio Shack®

A DIVISION OF TANDY CORPORATION • OVER 8500 LOCATIONS IN 80 COUNTRIES
Retail prices may vary at individual stores and dealers

7400

*Number of Pins of each I.C. for easy sorting

MICROPROCESSOR COMPONENTS

*Evaluation Kits



Table with columns: Part No., Pins, Price. Lists various microprocessors like 80C01, 80C02, 80C03, etc.

Table with columns: Part No., Pins, Price. Lists static RAMs like 1101, 2102, 2102L, etc.

Table with columns: Part No., Pins, Price. Lists dynamic RAMs like 1103, 4027, 4118A, etc.

Table with columns: Part No., Pins, Function, Price. Lists various ICs like 7400, 7401, 7402, etc.

74LS

Table with columns: Part No., Pins, Price. Lists 74LS series components like 74LS00, 74LS01, 74LS02, etc.

EPROMS

Table with columns: Part No., Pins, Price. Lists EPROMs like 1702A, 2708, 2708-16, etc.

MICROPROCESSOR CHIPS

Table with columns: Part No., Pins, Price. Lists microprocessor chips like 80C01, 80C02, 80C03, etc.

MICROPROCESSOR MANUALS

Table with columns: Part No., Pins, Price. Lists manuals like M-280, M-CDP1802, M-2650.

8080/8080A SUPPORT DEVICES

Table with columns: Part No., Pins, Price. Lists support devices like MC6800, MC6801, MC6802, etc.

ROM'S

Table with columns: Part No., Pins, Price. Lists ROMs like 2513, 2513 (302), 2513 (302).

NMOS READ ONLY MEMORIES

Table with columns: Part No., Pins, Price. Lists NMOS ROMs like MC68712P, MC68712B, MC68712C.

DATA ACQUISITION

Table with columns: Part No., Pins, Price. Lists data acquisition components like MC6800, MC6801, etc.

74C-C/MOS

Table with columns: Part No., Pins, Price. Lists 74C-C/MOS components like 74C00, 74C01, 74C02, etc.

LINEAR

Table with columns: Part No., Pins, Price. Lists linear components like LM002CN, LM100LH, LM100LH, etc.

74S/PROMS*

Table with columns: Part No., Pins, Price. Lists 74S/PROMS components like 74S00, 74S01, 74S02, etc.

NATIONAL EPROM-RAM SALE

Table with columns: Part No., Pins, Price. Lists National EPROM-RAM components like 2708-5, 2710-8, 2716-8, etc.

CONNECTORS

Table with columns: Part No., Pins, Price. Lists connectors like 25 Pin - D Subminiature, 18 Pin - D Subminiature, etc.

CA-LINEAR

Table with columns: Part No., Pins, Price. Lists CA-LINEAR components like CA0100H, CA0103H, etc.

IC SOCKETS

Table with columns: Part No., Pins, Price. Lists IC sockets like 18 Pin L.P., 16 Pin L.P., etc.

CD-CMOS

Table with columns: Part No., Pins, Price. Lists CD-CMOS components like CD4001, CD4002, etc.

WIRE WRAP (GOLD) SOCKETS

Table with columns: Part No., Pins, Price. Lists wire wrap sockets like 8 Pin L.P., 16 Pin L.P., etc.

CAPACITOR CORNER

Table with columns: Value, Price. Lists capacitor values like 10 pF, 22 pF, 47 pF, etc.

100 VOL MYLAR FILM CAPACITORS

Table with columns: Value, Price. Lists 100V Mylar capacitors like .001µF, .002µF, etc.

*20% DIPPED TANTALUM (Solid) CAPACITORS

Table with columns: Value, Price. Lists 20% dipped tantalum capacitors like .1µF, .22µF, etc.

MINI ALUMINUM ELECTROLYTIC CAPACITORS

Table with columns: Axial, Radial, Price. Lists mini aluminum electrolytic capacitors like .1µF, .22µF, etc.

\$10.00 Minimum Order - U.S. Funds Only

California Residents Add 6 1/2% Sales Tax. Spec Sheets - 30c each. Send \$1.00 Postage for your FREE 1983 JAMECO CATALOG. Prices Subject to Change.



1355 SHOREWAY ROAD, BELMONT, CA 94002. PHONE ORDERS WELCOME - (415) 592-8097.

CIRCLE NO. 13 ON FREE INFORMATION CARD

NEW LITERATURE

Audio Microcomputer Brochure

A six-page brochure and 20-page 5½" × 8½" flip chart detailing the features of the BDP-2 Audio Microcomputer are now available from Crown International. The BDP-2 is an audio test instrument with a full-color CRT that is reported to provide a high level of computing and display capability. The brochure gives an overall description of the unit, and the flip chart provides step-by-step instructions for its setup and use. The brochure is free of charge; the chart is provided free with the BDP-2 or can be purchased separately from Crown for \$2. **Address:** Advertising Dept., Crown International, 1718 W. Mishawaka Rd., Elkhart, IN 46517.

Power FETs

Siemens SIMPOS Power FETs are the subject of a new, 42-page color brochure available through the company's Components Division. Technical data, perfor-

mance parameters, and inverse diode characteristics are discussed with reference to their applications in power electronics, e.g., power switches for motor control, printers, ultrasonic generators, etc. **Address:** Components Division, Siemens Corp., Box 1000, Iselin, NJ 08830.

Base and Mobile Antennas

Antenna Specialists has just released a full-line professional catalog of base and mobile antennas for the land mobile industry. More than 300 products are described, covering the entire spectrum from low band to 800 MHz. Major new products include the Dura-Flex elastomeric shock mount antenna line and the Avanti no-ground plane, on-glass antennas. **Address:** Marketing Dept. Antenna Specialists Co., 12435 Euclid Ave., Cleveland, OH 44106.

Surge Protection

Engineers, designers, and operators of private and interplant telephone systems will find information on protecting interconnect telephone systems from electrical surge in a new guide available from TII Industries. The literature focuses on the various protection devices needed for a particular application: including products for single-phone stations and exposed cable runs between buildings. Typical interconnect arrangements are shown. **Address:** TII Industries, Inc., 1375 Akron St., Copiague, NY 11728.

Audio History

Buff's of the history of hi-fi and audio products might be interested in this brief overview of Bogen's fifty years in the sound business. It was printed as part of Bogen's golden anniversary celebration this year. **Address:** Dept. GAC, Bogen Division of Lear Siegler, Inc., Box 500, Paramus, NJ 07652.

ZX81 Software

A software catalog for the Sinclair ZX81 Computer has been published by Gladstone Electronics. The cassette software includes games (Chess, Backgammon, Star Trek), the Multifile Data Storage System, Vu-Calc for financial projections, machine code assembler, flight simulation, and more. **Address:** Gladstone Electronics, 901 Fuhrmann Blvd., Buffalo, NY 14202.

Switching Products Catalog

A new 16-page catalog from C&K Components includes photos, dimensions, drawings, and model numbers for the company's complete selection of conventional slide, rotary slide, rocker and pushbutton switches. Featured is the small-diameter "F" Series Rotary Slide, the Power Rocker "C" Series Switches, the low-cost "K" Series Switches, and the low-cost "K" Series pushbutton. **Address:** C&K Components c/o John Benson, 15 Riverdale Ave., Newton, MA 02158-1082.



Quest ELECTRONICS

FULL LINE ALL PARTS & COMPUTER PRODUCTS

P. O. Box 4430C
Santa Clara, CA 95054
Will call: 2322 Walsh Ave.
(408) 988-1640

Same day shipment. First line parts only. Factory tested. Guaranteed
money back. Quality IC's and other components at factory prices.

INTRODUCING A BRAND NEW MICROCOMPUTER



Venture

VENTURE is a single board computer that is an adventure for the hobbyist. It is a learning training computer as well as just plain fun for anyone who wants to get into a state-of-the-art computer at reasonable cost.

VENTURE comes in kit form or fully assembled and tested. You can get it in its minimum configuration for as little as \$195.00 or take it all the way to floppy disks and voice. It can be expanded as a kit or fully assembled, at your own pace and choice.

VENTURE is a 16" by 20" main board with separate ASCII and HEX keyboards. It runs fast, almost 4 MHz and has the capability of putting almost 1 megabyte of RAM and ROM on the board along with a variety of inexpensive options.

On Board Options

16 channel A to D; 5 slot 60 pin bus, 2 serial ports, parallel ports; 3 video options, 48K RAM. Votrax voice synthesizer, sound generator, EPROM: Full Basic, disassembler, editor, assembler, metal cabinet, additional power supply. ASCII keyboard real time clock calendar.

Expansion Options

Floppy Disc, EPROM Programmer, light pen, universal user programmable music, sound board high resolution color/grayscale pixel mapped video board, General Purpose Instrument Bus.

Minimum VENTURE System \$195.00
Kit includes CPU and control with 4K of RAM, 1K of scratchpad, 2K monitor, 1861 video graphics, cassette interface and separate HEX keyboard with LED displays for address and output. Power supply is included along with 2 game cassettes. The main board is 16" x 20" and includes space for all of the previously discussed on-board options. Full on-board expansion can be completed for under \$1000.00. Call for further details, option prices etc.

INTEGRATED CIRCUITS			Phone orders only (800) 538-8196		
74LS00 TTL	MOS MEMORY RAM	6551	11 85	N82523	2 95
74LS00N	25 2101-1	1 95	6800	5 70	N825123
74LS02N	25 2102-1	1 95	6802	11 95	N825126
74LS04N	25 2102AM-4	1 75	6820	4 95	N825129
74LS05N	25 2102AM-2L	1 65	6850	3 50	N825131
74LS08N	35 2107A-4	4 95	8080A	3 95	N825137
74LS10N	25 2107B-4	4 75	8085A	8 50	DM85077
74LS13N	45 2111-1	2 99	7804	6 00	2716-1
74LS14N	99 2112-2	2 50	280A-510	21 95	AYS-1014A
74LS20N	25 2114	2 99	280 S10	18 50	AYS-1013
74LS22N	25 2144-300ns	2 37	8214	1 85	AYS-1014A
74LS259N	25 2144-450ns	2 37	8216	1 80	1612-95
74LS30N	25 4116-200ns	2 25	8216	3 75	3341
74LS33N	25 4116-200ns	2 25	8224	1 80	3341
74LS33N	35 84116-200ns	1 75	8224	2 50	8025
74LS359N	35	MM5300	3 00	8208	4 95
74LS74N	45	MM5321	9 95	8251	4 75
74LS75N	50	MM5330	5 94	8253	8 95
74LS80N	60	951011	6 95	9255	4 75
74LS93N	65	4200A	11 50	8257	8 75
74LS95N	85	9368	5 50	8259	6 90
74LS107N	40	4100	10 00	1802CE plus	12 95
74LS112N	45	416	2 50	1802C plus	17 95
74LS113N	45	TMM016	9 95	1861P	5 95
74LS132N	75	HM6116	10 95	8025	8 75
74LS135N	49	HM6116 LP3	11 95	8028	8 75
74LS151N	75	4164-200ns	8 95	280 P10	6 50
74LS155N	79	MK 4816	24 50	280 P10	5 95
74LS157N	75	MICROPROCESSOR	280A P10	5 95	8179
74LS162N	95	6502	6 95	280A CTC	5 95
74LS163N	95	6502A	6 95	280A CTC	6 65
74LS174N	50	6502B	14 95	PROM	4 50
74LS190N	1 00	6504	6 95	1702A	9 50
74LS221N	1 19	6522	8 75	2532	9 50
74LS259N	69	6530	9 50	2708	3 75
74LS287N	69	6532	14 95	27161	8 50

Linear CMOS and 7400 complete lines in stock. Send for catalog.

RESISTORS % watt 5%		IC SOCKETS	
2715 5 Volt	2732	Solder Tin	Low Profile
7499	2758	Pin 1UP	Pin 1UP
8741A	39 95	14 24	30
8748	29 95	14 24	30
8755	31 95	18 26	30

8-4116 200ns Dynamic RAM B/S13 75

Modem Kit \$60.00
State of the art, orig., answer. No tuning necessary. 103 compatible 300 baud. Inexpensive acoustic coupler plans included. Bd. Only \$17.00. Article in June Radio Electronics.

280 Microcomputer
16 bit I/O, 2 MHz clock. 2K RAM, ROM Bread-board space. Excellent for control. Bare Board \$28.50. Full Kit \$99.00. Monitor \$20.00. Power Supply Kit \$35.00. Tiny Basic \$30.00

Video Modulator Kit \$9.95
Convert TV set into a high quality monitor w/o affecting usage. Comp. kit w/full instr.

Multi-volt Computer Power Supply
8v 5 amp, ±18v .5 amp, 5v 1.5 amp, -5v 5 amp, 12v 5 amp, -12v option, ±5v, ±12v are regulated. Basic Kit \$35.95. Kit with chassis and all hardware \$51.95. Add \$4.00 shipping.

60 Hz Crystal Time Base Kit \$4.40

Rockwell AIM 65 Computer
6502 based single board with full ASCII keyboard and 20 column thermal printer. 20 char. alphanumeric display ROM monitor, fully expandable. \$439.00. 4K version \$454.00. 4K Assembler \$35.00. 8K Basic \$65.00. FORTH \$65.00

Elf II Adapter Kit \$24.95
PROM Eraser
assembled. 25 PROM capacity \$37.50 (with timer \$69.50) 6 PROM capacity OSHA UL version \$78.50 (with timer \$108.50)

TERMS: \$5.00 min. order U.S. Funds. Calif. residents add 6% tax. \$10.00 min. VISA and MasterCard accepted. \$1.00 insurance optional. Shipping: Add 5%; orders under \$25.00—10%.

Prices subject to change

FREE: Send for your copy of our NEW 1982 QUEST CATALOG. Include 88¢ stamp.

Computer Mart

RATE: Ads are 2" by 3". 1 insertion: \$550.00. 6 insertions: \$525.00 ea. 12 insertions, \$500.00 ea. Closing date: 1st of the 2nd mo. preceding cover date. Send order and remittance to Computer Mart, POPULAR ELECTRONICS, 1 Park Ave., N.Y., N.Y. 10016. Direct inquiries to (212) 725-4216.

Your Fortune in the Microcomputer Business

VOLUME I - GETTING STARTED \$15.90
 VOLUME II - GROWTH, SURVIVAL and SUCCESS \$15.95
 SAVE - BOTH VOL I & VOL II \$26.85

SUBSCRIPTION TELEVISION EDUCATION MANUAL \$14.95
 MICROWAVE TELEVISION EDUCATION MANUAL \$16.25
 Combination offer—both Education Manuals \$26.95

Catalog includes information on manuals kits and video products \$2.00
 Include 3% shipping. CA residents add sales tax.

Abex
 P.O. Box 26601-RC
 San Francisco CA 94126



CIRCLE NO. 116 ON FREE INFORMATION CARD

TRS-80 DISCOUNT COMPUTERS

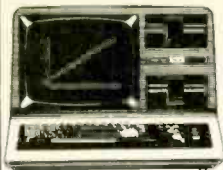

CALL US LAST for the LOWEST price!

918-825-4844

it will be worth the call!

AMERICAN Small Business COMPUTERS
 118 S. MILL ST. PRYOR, OK. 74761

CIRCLE NO. 117 ON FREE INFORMATION CARD

SINGLE BOARD CONTROL COMPUTERS

BOTH FEATURING 8085 CPU CRYSTAL TIME BASE ON-BOARD REGULATOR
 TIMER COUNTER
 256 BYTES OF RAM

★ Has 2K/1K ROM/EPROM (ROM's are not supplied)
 ★ 16 I/O Lines (Parallel/Serial/Handshake) and
 ★ 5 levels of interrupt Price: \$129 (A&T)
 ★ Has 2 K ROM/EPROM (ROM's are not supplied)
 ★ 22 I/O Lines-Parallel/Serial/Handshake) and
 ★ 2 levels of interrupt Price: \$99
 CER-TEK
 6020 Daniphan 3R Ft. Worth, TX 76132 (915) 581-6697
 ELECTRONICS MANUFACTURING SINCE 1975

CIRCLE NO. 118 ON FREE INFORMATION CARD

CHIPS & DALE

Z80A CPU \$4.50
 8251A \$4.00
 1791 Controller \$16.50
 1771 \$16.00
 —RAM—
 4116 300NS 8'S \$11.00
 4116 250NS 8'S \$12.00
 4116 200NS 8'S \$12.50
 4116 150NS 8'S \$14.50
 2114L 300NS 8'S \$15.00
 2114L 200NS 8'S \$16.50
 4164 200NS \$7.50
 6116 150NS \$7.75
 1661 200NS \$5.75

—EPROM—

2714(5V) 450NS 8'S \$3.75 ea. \$4.00 ea.
 2716 (15V) 350NS 8'S \$5.50 ea. \$6.25 ea.
 2732(5V) 450NS 8'S \$7.25 ea. \$9.00 ea.
 2532(5V) 450NS 8'S \$7.25 ea. \$9.00 ea.
 2764 300NS (28 Pin) \$20.00 ea.

Call for quantity pricing/catalog.

Please allow up to 3 wks. for personal checks to clear.

Mastercard/VISA

Add \$3.50 shipping & handling.

Wash. residents add 6.6% sales tax. Prices subject to change without notice.

CHIPS & DALE
 10655 M.E. 4th St., Suite 400.
 Bellevue, WA 98004
 1-(205)-451-9770

CIRCLE NO. 119 ON FREE INFORMATION CARD



Comp case



• AP103

- AP101 Apple II with Single Disk Drive \$109
- AP102 Apple II with Double Disk Drives 119
- AP103 Apple II, 9 inch Monitor & Double Drives 129
- AP104 Apple III, two additional Drives & Silentype 139
- AP105 12 inch monitor plus accessories 99
- RS201 TRS-80 Model I, Expansion Unit & Drives 109
- RS202 TRS-80 Monitor or TV set 84
- RS204 TRS-80 Model III 129
- RS205 Radio Shack Color Computer 89
- AT301 Atari Computer & Accessories 109
- P401 Paper Tiger 440 445 460 99
- P402 Centronics 730 737 Line Printer II IV 89
- P403 Epson MX70 or MX80 89
- P404 Epson MX100 99
- CC90 Matching Attache Case 75

computer case company

3150 NORTON BLVD. FT. COCKERHAM, TEXAS 75123 (915) 808-3467

CIRCLE NO. 120 ON FREE INFORMATION CARD

YOU CAN PAY MORE BUT YOU CAN'T GET MORE!



Model III 16K \$799
 Model III 48K \$1949
 2 disk & RS232 c



Color Computer 16K \$305
 w/16K Ext. Basic \$399
 w/32K Ext. Basic \$499

BUY DIRECT. These are just a few of our great offers which include Printers, Modems, Computers, Peripherals, Disc Drives, Software and more. call TOLL FREE 1-800-343-8124

We have the lowest possible fully warranted prices and a full complement of Radio Shack Software

computer plus

Write for your free catalog.
 245A Great Road
 Littleton, MA 01460
 617-486-3493

CIRCLE NO. 121 ON FREE INFORMATION CARD

TRS-80 by Radio Shack

Model 16 2 Drive 128K \$4777. Save over \$1000.



Also available new TRS-80 DMP-200, DMP-400, DWP-410 and DMP-500

Call For Prices

Price — We have the best price. Check the others, but call us.

Selection — ATARI • APPLE • TRS-80 • EPSON • OKI/OATA • C. ITOH. etc.

Service — Most items in stock for immediate shipment. Call or write for Free 40 page catalog of over 600 items.



15 Marshall Hill Road
 West Milford Mall
 West Milford, NJ
 07480-2198
 In New Jersey call
 201-728-8080

CALL TOLL FREE: 800-526-5313

CIRCLE NO. 122 ON FREE INFORMATION CARD

COMPUTERWARE products for COLOR COMPUTER

SOFTWARE

Color Invaders • Pac Attack • Monitor • Adventure Games • Text Editors • Assemblers • PASCAL • Finance • Color Data Organizer • Starship Chameleon • Berserk • Scribe Word Processor

Address Factory • Home Money Manager • Forth • "FLEX" software • Mazerace

HARDWARE

16 K / 32 K / 64 K Memory Expansions
 Lower Case Adapter • Cables • Interfaces • Printers

ACCESSORIES

Books • Cassettes • Supplies • Service Manuals

Dealer Inquiries Invited

*FLEX is a trademark of TSC.
 Call or Write



COMPUTERWARE
 Dept. C • Box 668
 Encinitas, CA 92024 • (714) 436-3512

6809 Specialists
 Computerware is a trademark of Computerware

CIRCLE NO. 123 ON FREE INFORMATION CARD

IBM — XEROX — TRS-80 — CBM
 HEWLETT-PACKARD — NORTHSTAR
 DEC — HEATH — ZENITH — PMC
 OSBORNE — OSI — INTERTEC . . .

WE HAVE



THE CONNECTION

Connect your IBM Selectric*, IBM Electronic, or Olivetti typewriter to any Microcomputer.

UNDER \$600

ESCON Products, Inc.

12919 Alcosta Blvd.
 San Ramon, Ca. 94583 (800) (415) 820-1256 227-2148

CIRCLE NO. 124 ON FREE INFORMATION CARD

Dear Electronic Enthusiast:
Here is the first really low-cost learning system designed for personal use. It will truly become your Personal Computer.

Sincerely,
Chris Johnson
Customer Service

ONLY \$149.95

Z-80 BASED Microprofessor
A superb learning tool for students, instructors, hobbyists. Complete experimenter's manual, easy instructions, 18 experiments. Fully expandable for Z80-CTC, Z80-PIO, EPROM, bread-boarding and prototyping. Buy 2 for only \$279.95. Money back guarantee. 2KB BASIC available. \$19.00

PLUS-FREE GIFT:
Z-80 Programming and Interfacing textbook FREE when you order within 7 days. \$12.95 value.

ETRONIX Dept. PE082
14803 NE 40th
Redmond, WA 98052

OR CALL **TOLL-FREE 1-800-426-1044**

CIRCLE NO. 125 ON FREE INFORMATION CARD

NEW COMMODORE 64



VIC 20

NEC PC-8001 Computer \$759.00
RCA VP-3501 Videotex Data Terminal SCALL
Scotch 744-ORH Box of 10 SS, SD, O-Sec \$27.00

ADD-ONS: Videx, Microsoft, TKC, Hayes, Epson, Zenith, Mt. Computer, UMI, NEC, Sony, Games

Mail Order: FUTRA COMPANY
P. O. Box 4380-CC, Torrance, CA 90510
(213) 328-8951 (800) 421-5006
TWX 910 349-6211 AGENFTRA TRNC

Retail: OMC
20695 S. Western Ave. # 124
Torrance, CA 90501
(213) 328-1760

CIRCLE NO. 126 ON FREE INFORMATION CARD

5 1/4" Floppy Disk Drives
(Direct IBM® Plug-in)

TANDON Model TM 100-1 .. \$199* ea.
TANDON Model TM 100-2 .. \$299* ea.
12" Green Phosphor Zenith Monitor \$109* ea.

Also available - TM 602S, 603S, and 603E Winchester Drives

For info or orders call — 316-683-9225 or 316-685-9445

MC / VISA or C.O.D. with certified check or money order. Kansas residents add 3% sales tax.

* Plus shipping



G-H Computer Systems, Inc.
923 Longfellow Street
Wichita, KS 67207

CIRCLE NO. 127 ON FREE INFORMATION CARD

Sinclair ZX81
Software on cassette.



MULTIFILE Data Storage System. A versatile multi-purpose filing system for 16K ZX81. Menu-driven. The number, size and heading of files are user-definable. Files may be created, modified, replaced, and searched, and are protected by a security lock. Output to ZK printer is provided. MULTIFILE is supplied on cassette with three blank cassettes for data storage, and packed in an attractive permanent storage case. Supplied with extensive documentation describing applications for both business and personal use. \$29.95

ZKAS Machine Code Assembler (16K) \$9.95
ZKDB Machine Code Disassembler/Debugger (16K) \$9.95
ZK CHESS! Your choice of 7 levels of play, white or black, set up any position to be analyzed, change levels of play during a game; Swap sides, and more (16K) \$24.95
INVADERS! Ten levels of play! (16K) \$9.95
STARTREK Trek across the galaxy (16K) \$14.95
ADVENTURE, Damsel and the Beast (16K) \$14.95
1K PROGRAM PACK 8 compact entertaining programs \$9.95
16K PROGRAM PACK Four entertaining programs \$9.95
10 EXCITING ZX81 PROGRAMS \$14.95

Books
30 Programs for the ZX81 (1K) \$14.95
Understanding Your ZX81 ROM \$19.95
ZX81 ROM Disassembly Part 1 \$14.95
Full replacement warranty all tapes.
Write for our **FREE SOFTWARE CATALOGUE** for ZX1

GLADSTONE
Gladstone Electronics 901 Fuhrmann Blvd., Buffalo, NY 14203
Telephone Orders (716) 849-0735 VISA/MC. NO C.O.D.s please
Mail Orders: Send check, money order, Visa or MC number \$1.50 per order handling.

CIRCLE NO. 128 ON FREE INFORMATION CARD

RAM
For ATARI

48K RAM BOARD FOR THE 400 with Lifetime Warranty

- Highest quality available
- Reduces power consumption
- Reduces heat

48K Board (400) \$240
32K Board (400/800) \$100

FREE SHIPPING ANYWHERE IN U.S.A.

INTEC PERIPHERALS CORP
906 E. Highland Ave.
San Bernardino, CA 92404
(714) 881-1533

ATARI 400/800 are Trademarks of ATARI, Inc.

CIRCLE NO. 129 ON FREE INFORMATION CARD

LEO ELECTRONICS, INC.
8921 S. Sepulveda #208
Los Angeles, CA 90045
(213) 641-3101 (800) 421-2418

**WHY PAY MORE? SAVE MONEY!
LOWEST PRICES ON PARTS!**

EPROMS		REGULATORS	
2708	3.00	7805	.75
2716	4.00	7812	.75
2716-1(350ns)	6.50	7815	.75
TMS 2716	6.00	7905	.85
2732	7.50	7912	.85
2532	8.00	7915	.85

RAMS		MICROPROCESSORS	
4116(200ns)	8/13.00	Z-80A-CPU	5.50
4116(150ns)	8/16.00	8080A	3.00
2114(200ns)	8/18.00	8085A	7.00
4164(200ns)	8/54.00		
4164(150ns)	8/56.00		

TERMS: Check, Visa, Mastercard. Call for C.O.D. U.S. Funds only. California Residents add 6.5% Tax.
SHIPPING: Add \$2.00 for Ground \$5.00 for Air
**ALL MAJOR MANUFACTURERS
ALL PARTS 100% GUARANTEED**

CIRCLE NO. 130 ON FREE INFORMATION CARD

UV EPROM ERASER
• Erases over 15 EPROMS in 30 minutes - base line
• Operates in 7700 hours
• Memory 176K, 512K, 1M, 2M
• Erases 30 UV EPROMS (2716, 2732, 2516, 2532, etc.)

\$49.95

INDUSTRIAL MODEL
OLV-TB/P2N \$68.95

WITH TIMER & SAFETY SWITCH
OLV-TB/P2E \$97.50

ABOVE 220VAC 50HZ
OLV-TB/P2E \$109.50

STAND ALONE RS-232 INTELLIGENT PROGRAMMER \$489.00
PROGRAMS: 2508, 2516, 2532, 2716, 2732, 2732A, 2758, 8748, 8749

PRICE INCLUDES ALL PERSONALITY MODULES

• STAND ALONE CRT OR COMPUTER CONTROL
• UP/DOWN/LOAD IN MOTOROLA OR INTEL HEX FORMAT
• MICROPROCESSOR BASED - 2.4 INTERNAL 8088
• 8028 PRINT & LAUNCH WARRANTY ON ALL PRODUCTS

• BASIC PROGRAMMER
• 16K 770A PERSONALITY
• 16K 770A PERSONALITY

PHONE ORDERS (305) 776-5870
TX 510 955-9496 • WE ACCEPT VISA, MC, CHECKS, C.O.D., MONEY ORDER

LOGICAL DEVICES INC.
781 W. OAKLAND PARK BLVD. • FT. LAUDERDALE, FL 33311
ADD \$4.00 SHIPPING & HANDLING

CIRCLE NO. 131 ON FREE INFORMATION CARD

Get more out of your Apple with the MICRO on the Apple Series

Vols. 1, 2, & 3 \$24.95
+ \$2.00 shipping each volume

Each book includes more than 30 programs — all on DISKETTE

Machine Language Aids
I/O Enhancements
Runtime Utilities
Graphics & Games
Hardware & Reference Information

To order toll free:
1-800-345-8112
In PA 1-800-662-2444

MICRO INK, Dept. PE
P.O. Box 6502
Chelmsford, MA 01824

CIRCLE NO. 132 ON FREE INFORMATION CARD

BUY DIRECT SAVE



TRS-80™ DISCOUNT DIRECT PRICES

Learn To WRITE FOR
"Do It Yourself" FREE
And Save Money CATALOG

1-800-841-0860 TOLL FREE

YOUR TRS-80
PERSONAL COMPUTER HEADQUARTERS
PURE RADIO SHACK EQUIPMENT
MICRO MANAGEMENT SYSTEMS, INC.
Parcel Division
DEPT. NO. 12
2803 Thomasville Rd. E. • Cairo, Georgia 31728
912-377-7120 Ga. Phone No.

CIRCLE NO. 133 ON FREE INFORMATION CARD

DISKETTES CASSETTES

Error-Free 5 1/4-inch Diskettes (MD-5) single-sided, soft sector, single or double density, reinforced hub.

Item	Qty 10	Qty 50
MD-5	\$25.00	\$110.00
C-10	\$ 7.50	\$ 32.50
C-20	9.00	39.00
C-60	11.50	50.00
C-90	15.00	70.00

UPS SHIPPING INCLUDED
in Continental USA
CA Customers add taxes

MICROSETTE

475 Ellis St., Mt. View,
CA 94043 (415) 968-1604

CIRCLE NO. 134 ON FREE INFORMATION CARD

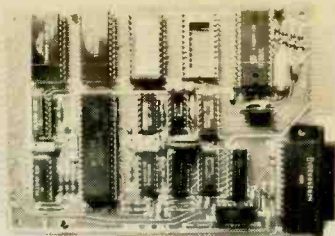

CONTROL THE WORLD!

A/D conversion, high current outputs, switch closure and logic inputs, BASIC language, RS-232 and cassette interfaces, and EPROM programmer are only some of the features of this family of single board computers. The lowest cost unit can control more than 2000 external devices. Programmed learning text, software, and other support available. Industrial, educational, and home uses. Prices start below \$150.

Octagon Systems Corporation
5150 West 80th Avenue Suite B
Westminster, CO 80020
(303) 426-9780

CIRCLE NO. 135 ON FREE INFORMATION CARD



RADIO
SHACK
TRS-80™

and

HEWLETT-PACKARD 85, 87 & 125 COMPUTERS

We offer Special Discounts, Free Shipping
and a Toll Free Order Number

1-800-531-7466 TOLL FREE

Pan American Electronics

Dept. P.E. - 117 Corway Avenue
Mission, Texas 78572

(512) 581-2766 Telex 767339

Branch

2912 North Main St.
Fort Worth, Texas 76106
(817) 625-6333 Telex 794836

CIRCLE NO. 136 ON FREE INFORMATION CARD

SCR SUPER-BUYS

1982 BUYERS GUIDE
NOT JUST ANOTHER
CATALOGUE BUT A
BUYERS GUIDE
"OF THE FUTURE"

FREE

1 UHF-VHF CONVERSION KIT
Complete with PC board, all required
components, jumper wire, cabinet with
speaker, and comprehensive brochure
incl. schematic, board layout, mount-
ing and hook-up diagrams, parts list,
and assembly and set-up instructions.
All parts are industrial prime quality.

\$119⁹⁵
ea

2 MITSUMI - MODEL UES-A55
VARACTOR UHF TUNER
FREQ. RANGE 470-889 MHZ
ANTENNA INPUT 300 OHMS

23.95 ea
10 for \$205.00

OUTSIDE CAL 800-854-8660
INSIDE CAL (714) 527-2554

SCR ELECTRONICS INC.

VISIT OUR NEW SUPER CENTER
5303 Lincoln Ave., Cypress, CA 90630
Pay by CHECK, M.O., VISA, M/C
\$10.00 MIN. ORDER HANDLING SHIPPING \$2.50
UPS ANYWHERE IN CONTINENTAL U.S.

CIRCLE NO. 137 ON FREE INFORMATION CARD

SYNCHRO SETTE

The Subscription Magazine for
the Sinclair ZX-81 TS-1000
Microcomputers

Games, Educational, Business, Graphics
Tutorial, Etc.

12 Mo. Issues — 6 Bi-Month
CASSETTES
AT LEAST 6 PROGRAMS EACH



\$39.50



Ill. Residents add \$2.07 tax
outside USA add \$10.00

Ask for operator # 383
24 Hr. Hot Line 800-543-1300

THE S & S COMPANY
388 W. Lake Street
Addison, IL 60101
(312) 628-8955

CIRCLE NO. 138 ON FREE INFORMATION CARD

SUPER SALE

EPROM's

	1-7	8 up	50 up
2716 (5V, 450nS)	\$3.95	\$3.55	CALL
2732 (5V, 450nS)	7.85	6.95	CALL
2532 (5V, 450nS)	8.25	7.95	CALL

STATIC RAM

6116P-3 (150nS)	7.50	7.20	CALL
2114L-2 (20nS)	2.10	1.70	CALL

DYNAMIC RAM

4164 (200nS)	7.90	7.49	CALL
--------------	------	------	------

MISC

CPU Z80A	\$5.29 ea.
CDP-1854ACE (UART)	\$5.29 ea.
16K RAM Expansion Kit for TRS-80 Mod III	\$12.95/8



SUNTRONICS CO., INC.

12621 CRENSHAW BOULEVARD
HAWTHORNE, CALIFORNIA 90250

STORE HOURS: Mon-Fri 9:00am-6:30pm Sat 10am-5pm
IN CALIFORNIA OUTSIDE CALIFORNIA TOLL FREE

(213) 644-1149 1-800-421-5775

Min Order \$10. P/H \$2. Accept VISA, Mastercard, Check or M.O.

TRS-80 COMPUTERS

Model II 64k	\$3288
Model III 16k	\$825
Model III 48k 2 Drives RS232	\$2069
Color Computer 4k Level I	\$308
Color Computer 16k Extended Basic	\$459

EPSON Printers SCALL

All printers and accessories in stock.

Discount Prices

on full line of Radio Shack & TCS Custom
Computers and Accessories. Call for catalog

Texas Computer Systems

P.O. Box 1327 Arlington, Texas 76004-1327

TOLL FREE 800-433-5184

Texas Residents 817-274-5625

PAYMENT Money order, cashier's check or
certified check. Prices reflect 3% cash discount.
Call for VISA and Mastercard prices

CIRCLE NO. 139 ON FREE INFORMATION CARD

YORK 10 BASFDPS WORLD STANDARD TAPE



MONEY BACK
GUARANTEE

COMPUTER GRADE BLANK CASSETTES

"We monitored the output to the computer
with a specially built meter and found abso-
lutely no dropouts throughout the tape."
Stace Papadopoulos
Beaverton, OR

ITEM	1 DOZ	2 DOZ
C-05	7.50	13.50
C-10	8.00	14.40
C-20	10.00	18.00
Hard Box	2.50	4.00
Soft Box	2.00	3.40

Call residents add 6% sales tax
Shipping 1 doz \$2 2 doz \$3.50
3 doz \$4.50 Each additional doz
\$5.50

Write or call for QUANTITY DISCOUNTS

IMMEDIATE
SHIPMENT ON
CREDIT CARD
ORDERS

Call: 213/710-1430

YORK 10 Computerware

24573 Kittridge St., P-2 Canoga Park, CA 91307

SHOP OWNERS! SELL POPULAR ELECTRONICS

in your shop and make big
profits on every copy. We pay
all shipping and give you a
FREE display rack. Minimum
order 8 copies/issue.

FOR DETAILS,
CALL COLLECT:
(212) 725-4299

Electronics Classified

CLASSIFIED RATES: Per Word, 15 Word Minimum. **COMMERCIAL:** \$4.00. **PERSONAL:** \$2.30. **EXPAND-AD®:** \$6.00. Ads set in all bold type @ 20% premium. Ads set with background screen @ 25% premium. **DISPLAY:** 1" x 2 1/4", \$485.00. 2" x 2 1/4", \$970.00. 3" x 2 1/4", \$1,450.00. **GENERAL INFORMATION:** Frequency rates and prepayment discounts available. Payment must accompany order except credit card—Am. Ex., Diners, MC, VISA (include exp. date)—or accredited ad agency insertions. Copy subject to publisher's approval; must be typewritten or printed. First word set in caps. Advertisers using P.O. Boxes MUST supply permanent address and telephone number. Orders not acknowledged. They will appear in next available issue after receipt. Closing date: 1st of the 2nd month preceding cover date (e.g., Mar. issue closes Jan. 1). Send order & remittance to: Classified Advertising, Popular Electronics Magazine, 1 Park Avenue, New York, NY 10016. Direct inquiries to Rose Lynch, (212) 725-7686.

FOR SALE

GOVERNMENT and industrial surplus receivers, transmitters, snoopsopes, electronic parts, Picture Catalog 25 cents. Meshna, Nahant, Mass. 01908.

ELECTRONIC PARTS, semiconductors, kits. FREE FLYER. Large catalog \$1.00 deposit. BIGELOW ELECTRONICS, Bluffton, Ohio 45817.

SAVE UP TO 50% on name brand test equipment. Free catalog and price list. Saien Electronics, Box 82, Skokie, IL 60077.

BUILD AND SAVE. TV EARTH STATION. DETECTIVE ELECTRONICS. Video Recorders, Color Cameras, advanced Telephone Projects. BROADCAST Electronics. 50 page color catalog of unusual electronic projects AIR MAILED \$3.00; with 3 hour audio cassette dramatization of our catalog \$5.00. Don Britton Enterprises, PO Drawer G, Waikiki, Hawaii 96815.

POLICE/FIRE SCANNERS, crystals, antennas, CBs, Radar Detectors. HPR, Box 19224, Denver, CO 80219.

PRINTED CIRCUIT supplies, chemicals, tools, artwork, plating solutions. Major credit cards. Catalog \$2.00, refundable. CIRCOLEX, Box 198, Marcy, NY 13403.

RECONDITIONED TEST EQUIPMENT \$1.00 for catalog. WALTER'S TEST EQUIPMENT, 2697 Nickel, San Pablo, CA 94806, (415) 758-1050.

NEW ELECTRONIC PARTS. Continuously stocked. Stamp brings catalog. Daytapro Electronics, 3029 N. Wilshire Ln., Arlington Hts., IL 60004.

ELECTRONIC CATALOG. Over 4,500 items. Parts, & components. Everything needed by the hobbyist or technician. \$2.00 postage & handling (United States Only), refundable with first \$15.00 order. T & M Electronics, 472 East Main St., Patchogue, NY 11772. (516) 289-2520.

PRINTED CIRCUIT BOARDS, your artwork. Quick delivery. Reasonable. Atlas Circuits, Box 892, Lincolnton, NC 28092. (704) 735-3943.

Telephone Listening Device

Record telephone conversations in your office or home. Connects between any cassette or tape recorder and your telephone or telephone LINE. Starts automatically when phone is answered. Records both sides of phone conversation. Stops recorder when phone is hung up. This device is not an answering service.



size 1cu
Each
\$19.95
Qty Disc Avail

Super Powerful Wireless Mic

10 times more powerful than other mics. Transmits up to 1/4 mile to any FM radio. Easy to assemble kit. 15V battery (not incl). Call (305) 725-1000 or send \$19.95 + \$1.00 shipping per item to USI Corp., P.O. Box PM-2052, Melbourne, FL 32901. COD's accept. For catalog of transmitters, voice scramblers and other specialty items, enclose \$2.00 to USI Corp.



size 2" x 3" x 1/2"
Each
\$19.95
Qty Disc Avail

SATELLITE TELEVISION... HOWARD/COLEMAN boards to build your own receiver. For more information write... ROBERT COLEMAN, Rt. 3, Box 58-APE, Travelers Rest, S.C. 29690.

Latest microstrip model of the "original"

MICROWAVE TV SYSTEM KIT

- LT-13 Down Converter with Preamp
- 16 dB Slotted Antenna
- Deluxe Power Supply Kit
- All Coaxial Cables Included
- 2000 - 2600 MHz Tuning Range

\$164.95
+ \$40 shipping



LAB-TRONICS, INC.
P. O. Box 171
Rogers, MN 55374
612-428-4226

SOUND SYNTHESIZER KITS—Surf \$19.95, Wind \$19.95, Wind Chimes \$24.95, Musical Accessories, many more. Catalog free. PAIA Electronics, Box J14359, Oklahoma City, OK 73114.

SAVE UP TO 85%

GOV'T SURPLUS and NEW EQUIP'T



Blower/Fan
100-CFM
115-VAC
LIST OVER \$24.00
\$8.79
F.O.B. Lincoln

• (ITEM #16-940) - Use for intake, exhaust, cool electronic gear. 4" diam. blade, mounts in 6-1/2" diam. opening. 4-1/4" deep. (2-1/2 lbs.)



Powerful Battery Motor
BRAND NEW
\$34.95
(13 lbs.)
Manual Speed Over \$100.00 F.O.B. Lincoln

• (ITEM #1066) - High torque, 1/2-HP. 12 to 36-VDC, 1200 to 3600-RPM. Motorize bikes, make small electric cars, drive pumps, compressors. Shaft 3/4" diam. Overall lgh. 9".

• Many other motors shown in our catalog. Write for it!

100-Page Catalog
Send 60-CENTS
COIN or STAMPS
100's of BARGAINS

SURPLUS CENTER PE-102

Lincoln, Ne. 68501
(402) 474-4366

SATELLITE TELEVISION INFORMATION \$4. Build or buy your Earth Station. Satellite Television, RD 3, Oxford, NY 13830.

RESISTORS, 1/4W, 1/2W5% C.F. 3¢ ea., 1% Metal films. NO MINIMUMS, Cabinet Assortments, Quantity Discounts. Details from: JR INDUSTRIES, 5834-E, Swancreek, Toledo, OH 43614.

SATELLITE TV

FANTASTIC 80 TV CHANNELS

New antenna construction plans plus big 8 x 11 book loaded with aiming info, kits, LNAs and receivers at wholesale prices. Far better than cable TV! Enjoy crystal clear reception. Send \$9.95 today. Add \$2.00 for 1st class (air mail) or call our 24 hr. COD order line (305) 862-5068 Now.

Global TV Electronics, P.O. Box 219-E, Maitland, FL 32751



MICROWAVE TV ANTENNA \$169.95
18" Dish Type Antenna. Probe Mounted Down Converter. 6 Month Warranty

MICROWAVE TV MANUAL \$16.25
Plans and Concepts

SUBSCRIPTION TV MANUAL \$14.95
Theory, Schematics, Etc.

KITS AVAILABLE

INFORMATION PACKAGE \$2.00
Send Check or M.O. Add 5% Shipping. CA Residents Add Tax.

ABEX, P.O. Box 26601-PE, San Francisco, CA 94126

DECODE Morse, RTTY, and ASCII signals from airwaves with new CODE★STAR. LED readout or connect your computer/printer. Keyboard, other items also available. Kits or assembled. MICROCRAFT, Box 513PE, Thiensville, WI 53092. (414) 241-8144.

UNSCRAMBLE CODED MESSAGES FROM police, fire and medical channels. Also telephone recording adaptor. Same day service. Satisfaction guaranteed. Don Nobles Electronics, Inc. Route 7, Box 257-A, Hot Springs, AR 71901. (501) 623-6027.

RF MODULATORS FOR SATELLITE TELEVISION. MICROCOMPUTERS CCTV. Also monitors, cameras, kits. FREE VIDEO CATALOG. Phone (402) 987-3771. Dealers Welcomed. ATV RESEARCH, 13-P Broadway, Dakota City, NE 68731.

BUYER BEWARE—Consumer guide to SATELLITE TELEVISION—\$3. Ghostfighters, Route 2, Box 136B, Stevensville, Montana 59870.

MICROWAVE TV DOWNCONVERTERS, Downconverter board, power supply board, Antenna Cookbook, with detailed plans, \$20.00 Downconverter parts \$15.00, power supply parts \$15.00. Micro Engineering, P.O. Box 17231, Minneapolis, MN 55417.

CABLE TV CONVERTERS & EQUIPMENT. Plans and parts. Build or buy. For more information send \$2.00: C & D ELECTRONICS INC., P.O. Box 21, Jenison, MI 49428.

MICROWAVE TV ANTENNAS 2Ghz. Best in the West! Complete with cable, accessories, warranty. \$125.00. Dealers Wanted! GALAXY ELECTRONICS, 6007 N. 61st Ave., Glendale, Arizona 85301. (602) 247-1151.

FREE FLYER! IC's, resistors, capacitors, jacks, etc., plus SSM music synthesizer/audio IC's, power amp modules, analog delay IC's, computer books, and more. Also plans for analog delay/chorus unit! PGS Electronics, P.O. Box 749-A, Terre Haute, IN 47808.

MICROWAVE TELEVISION "DOWNCONVERTERS." Introducing powerful new 5-page design. Easily Assembled. Catalogue: \$2.00 (refundable). NDS, Box 12652-E, Dallas, Texas 75225.

TRANSISTORS, IC's, DIODES, RF Power, LED's. Lowest prices plus service and quality. Call TOLL FREE 1-800-458-6053. In Pennsylvania (814) 837-6820. MC/VISA honored. B&D ENTERPRISES, Box 305, Kane, PA 16735.

QUALITY MICROWAVE TV SYSTEMS

1.9 to 2.5 GHz Antennas

Complete System (Rod Style as pictured) \$124.95

Complete System (Reflector Style as pictured) \$149.95

Down Converter.
Assembled & Tested \$64.95
Power Supply (12 to 18v) \$49.95
Also Dish Style Antennas In Stock.

Galaxy Electronics
6007 N. 61st Ave.
Glendale, Az. 85301
(602) 247-1151
COD's Quantity Pricing

MasterCard VISA



90 DAY WARRANTY PARTS & LAB DR

SHORTWAVE LISTENERS! Free catalog. High quality SWL equipment! RADIO WEST, 3417 Purer Rd., Escondido, CA 92025. (714) 741-2891. The Only all SWL store in the Known World.

PAY TV KITS

Gated Pulse Suppressed... \$39.00
Sinewave Suppressed... \$37.00
Informative Catalog... \$ 2.00

J & W ELECTRONICS
P O BOX 61-K
CUMBERLAND, RI. 02864

ACOUSTIC TEST SET for adjusting equalizers, speakers; \$449.00. Free Brochure. HALL ENGINEERING, Dept. Z2, P.O. Box 506, Martinsville, N.J. 08836.

DISCOVER THE BROOK... Hear the soothing, peaceful sound of this UNIQUE SYNTHESIZER. Complete plans are now available. Incredibly refreshing, thoroughly relaxing. MONEY-BACK GUARANTEE! Send \$4.95 to: Synthesystems, Box 11843, Albuquerque, NM 87192.

PLASTIC FASTENER KITS offering complete selection of standard sizes. Free information. Alex F. Walker Company, P.O. Box 928 PE, Royal Oak, MI 48068.

STOP! DON'T PAY EXTRA! Buy our high gain 2-2.5 GHz Microwave Television Down Converter kit with temperature stabilization and power supply (less transformer) for \$45. Down Converter board and parts, only \$29.95. GUARANTEED! Send payment to: HOPTRONIX, Box 401382, Garland, TX 75040.

CABLE TV SECRETS, the informative publication the cable companies are trying to ban. HBO, Movie Channel, Showtime converters, descramblers etc. Send \$7.95 to: CABLE FACTS, Box 711-PE, Pataskala, Ohio 43062.

UHF CONVERTERS DELUXE Sine Wave UHF Converter. Sound out of TV like normal with only antenna connection to TV or VCR. Kits \$175. Plans free. 312/267-3455. LSR ENGINEERING, Box 6075, Chicago, IL 60680.

Satellite Earth Station
Complete systems from \$1,899.00
 Call or write for our latest brochure.
TENNESSEE ELECTRONICS
 P.O. Box 181108
 Memphis, TN 38118
 (901) 795-4504

SATELLITE TV
 • SYSTEMS • COMPONENTS • LNA's •
 • ANTENNAS • RECEIVERS •
 WE CAN HELP YOU!
HIGH FRONTIER
 2230 E. Indian School Rd., Phoenix, AZ 85016
 (602) 954-6008

The First Low Distortion Car Speakers.

Good news travels fast and sounds great when it's from Speakerlab—now with new speaker systems handmade for your car and featuring polypropylene woofers, custom crossovers, and more... If you have quality car audio electronics DON'T WASTE MONEY on poor speakers. Write for our FREE Speaker Catalog.



speakerlab
 Dept. CPE28, 735 N. Northlake Way
 Seattle, Washington 98103

MILITARY COMMUNICATIONS RECEIVER: GRR-5/R-174, tunes 1.5-18 MHz SSB-CW-AM, shortwave, amateur, military frequencies: \$47.50 mint; \$27.50 good. Specifications, schematic included. 45 Day guarantee. Add \$7.50 shipping. Baytrons, Dept. PE, Box 591, Sandusky, OH 44870.

LOUDSPEAKERS! Electro-Voice raw components ready to ship with competitive prices. FREE catalog. SONIX CO., Box 58-PE, Indian Head, MD 20640. (301) 753-6432.

SATELLITE TELEVISION! KLM Sky Eye 4 \$695., Sat Tec R2BR \$550., AvanteK 120 LNA \$445. Others! Communications Consultants, (501) 452-3149.

CRYSTAL, tube Experimenters' Catalog—\$1.00. None free. Sets, kits, coils, supplies, obsolete tubes. Laboratories, 1477-L, Garden Grove, CA 92642.

SATELLITE TV LOW NOISE AMPLIFIER OR DOWN CONVERTER. Build yourself and save! New, fully illustrated step-by-step instruction manuals \$10.00 each! Satisfaction guaranteed. XANDI, Dept. 22C, Box 25647, Tempe, AZ 85282.

Call or Send for Free SINTEC ELECTRONIC PARTS CATALOG
 Thousands of Quality Components No Mail Order "Seconds!"
Call Toll Free 800-526-5960
 NJ Residents call 201-996-4093
 Sintec, Drawer Q, Milford, NJ 08848

ANTI GRAVITY ELECTRONIC LEVITATION
 No moving parts, magnets, gases or exotic fuels. BUILD FLYING MODELS. Plans, schematics, diagrams, performance charts & more in PRIMER VOL. 105 pgs 8 x 10 mimeo \$20 ppd. GUARANTEED! VISA/MC add \$5. FOREIGN ADD \$10. SAUCER TECHNOLOGY, Box 132-M, Eureka Springs, Ark. 72632



CIRCUIT BOARDS, make your own, professional resist process \$17.95 kit. JESKEN ENTERPRISES, 6400 Sycamore, Coloma, MI 49038.

GIANT KIT EXPERIMENTERS delight loaded with books, diagrams, over 1 lb primè electronic parts only \$12.95. ALLKIT, 434 W. 4th St., West Islip, NY 11795.

ELECTRONIX LTD. The best in midwest surplus electronic. 3214 S. Norton, Sioux Falls, SD 57105.

E.T.—EXTRA TESTED. Unique kits for the beginner and experienced electronics buff. Fun to build, practical uses, make novel gifts. Most priced under \$10.00. Free flyer. Hco., Box 455, 145 East 7302 South, Sandy, UT 84091.

RESISTORS, ¼W5% 1-9/type 0.03, 10/type 0.025, 100/type 0.015, 1000/type 0.012. Details from: Eugene Lu, Box 19011, Cincinnati, OH 45219.

GET ACTIVE PUBLIC SERVICE FREQUENCIES for your area covering police, fire, government, emergency, aircraft, amateur and more. Send \$2.00 along with your name and address, including zip code, to Betty Bearcat, c/o ELECTRA COMPANY, P.O. Box 29243, Cumberland, IN 46229.

SATELLITE TELEVISION: Everything from LNA's, receivers, to CATV converters, microwave equipment. Catalog \$4.95. Microwave Specialties, Box 3124E, Santa Clara, CA 95055.

CONVERT YOUR TV INTO A GIANT SCREEN PROJECTOR! Lens and instructions \$14.95. BIG TV, Box 2595-P3, La Habra, CA 90631.

USED PARABOLIC ANTENNAS 6' 8' and 10' in diameter. Suitable for satellite reception. Were in commercial use. Best offer takes them. Call Jim: 216-647-5827 or 419-746-2378.

MUST SELL LARGE STOCK OLD STYLE RADIO TUBES. New In factory boxes. Send SASE. SUPERIOR, P.O. B. M8001, Westchester, OH 45069.

MICRO TOPOLOGY EXPOSED! Discover the incredible detail of a microprocessor chip enlarged over 20,000 times into a large full color poster. See how an LSI circuit, the 6502 CPU, is built. Poster only \$4.50 with free 6502 fact sheet. OMICRON DIGITAL SYSTEMS LTD., Box 3055-PE, Falls Church, VA 22043.

TELETYPE EQUIPMENT: Copy Military, Press, Weather, Amateur, Commercial Transmissions. Catalog \$1.00. WEATHER-MAP RECORDERS: Copy Satellite Photographs, National-Local Weather Maps. Learn How! \$1.00. Atlantic Sales, 3730 Nautilus Ave., Brooklyn, NY 11224. Phone: (212) 372-0349.

REPAIR ATARI GAMES AT HOME
 Complete repair course on 3 hour video tape (Beta or VHS) plus schematics and technical literature enables you to start earning money right away. All popular repair parts in stock for immediate shipment. \$1.00 for parts/price list and additional information refundable with order. Exclusive National Distributor.
ELECTRONICS WAREHOUSE CORP.
 1910 Coney Island Avenue
 Brooklyn, N.Y. 11230 (212) 375-2700

COMPUTER EQUIPMENT
 SAVE 90% Build Your own Minicomputer. Free Details. Digatek, 2723 West Butler Dr., Suite 20C, Phoenix, AZ 85021.
 APPLE BUILDERS—Send stamp for our flyer of Apple parts. Keyboards, IC sets, ROM sets, connectors, Shugart SA-400 disk drives with Apple modification kits etc. Electrovalve Industrial Inc., Box 157-P, Morris Plains, NJ 07950.

POWER SUPPLIES FOR FLOPPY and hard discs, mini and Micro Computers and many others. Extreme isolation Transformer, for ridding your computer of troublesome line noise. Send for free catalog: XENTEX, O. Drawer 1209, San Marcos, California 92609. (714) 744-3346.

US \$600.00 build 48K Apple compatible including housings, details US \$1.00. Reliant, P.O. Box 33610, Sheungwan, Hong Kong.

TRS-80 1/3 SOFTWARE. Games/Education/Utility. Free flyer. Tas Inc., 704-PE, N. Pennsylvania, Lansing, MI 48906. (517) 482-8270.

PLUGS-INS AND AD-ONS FOR THE IBM PERSONAL COMPUTER. Available in kit form as well as assembled. Build it yourself and save. Other 8088-based products too. Free information. Compatible Computer Corp., Dept PE 5, Box 51102, Seattle, WA 98115.

POWER—LINE FILTER, Limits RFI and Surges for protection of costly equipment. \$49.95 ea. plus \$2.50 handling. PATH ELECTRONICS, INC., 1500 E. Algonquin Rd., Arlington Hts., ILL 60005.

ATARI—Superior Joystick conversion, grip trigger, paddle. GREAT! Easy! \$4.00. Taylors, 1290 Ridgewood, Allison Park, PA 15101.

COMPUTER CASSETTES with Maxell Computer Tape. Also Cassette Programs Duplicating Service. Enquire: M.J.S., P.O. Box 806, Shelton, CT 06484. (203) 735-6477.

LATEST arcade, adventure, etc. software. Free discount catalog, American Computer Works, 228 Palen Ave., Newport News, VA 23601.

USED COMPUTER TERMINALS. Printers, Modems, surplus electronic parts. Catalog \$1.00. SPECIAL: Daisy Wheel Printer \$400.00. RONDURE COMPANY, THE COMPUTER ROOM, 2522-PE, Butler St., Dallas, TX 75235. (214) 630-4621.

COMPUTER SOFTWARE
 \$6 VIC-20 SOFTWARE arcade games too. Send stamped envelope: Videosoft, 26 Hollis St., Providence, RI 02907.

MICRO-WINDOW uses Hi-RES graphics to provide a window into the 6502 microprocessor by displaying a binary programming model during execution of machine language programs. For the APPLE II PLUS with 48K and DOS 3.3 \$120. Write for details. WINDOW RESEARCH, 13452-A N.E. 175th Street, #218, Woodinville, Washington 98072.

AMATEUR RADIO
 CALL US FIRST. For low Ham prices. All major brands. DISCOUNTS, DISCOUNTS! Prompt Shipping. Madison Electronics, 1508 McKinney, Houston, TX 77010. Daytime: 1-713-658-0268.

RADIO AMATEUR CALLBOOKS: Directories of Radio Amateurs around the world. Write for FREE catalog. Radio Amateur Callbook, Dept. PE, 925 Sherwood Dr., Lake Bluff, IL 60044.

C.B. EQUIPMENT
 GET MORE CB CHANNELS AND RANGE! Frequency Expanding, speech processors, PLL tricks, FM converters, how-to-books, plans, modifications. Catalog \$2. CB CITY, Box 31500PE, Phoenix, AZ 85046.

SSB RECEPTION without modifying your AM CB. Simple Instructions. Send \$5.00: POBCO, P.O. Box 251, Azusa, CA 91702.

CABLE TV

39.95 ADD \$2.50 FOR POSTAGE

30 CHANNEL CABLE TV CONVERTER

FREE! UNUSUAL 96 PAGE ELECTRONIC PARTS & IDEAS CATALOG!

ORDER No. 198AE047

ETCO ROUTE 9N. PLATTSBURGH, N.Y. 12901 Tel.: (518) 561-8700.

PLANS AND KITS
 PRINTED CIRCUIT Boards from sketch or artwork. Kit projects. Free details. DANOCINTHS Inc., Dept. PE, Box 261, Westland, MI 48185.

GIANT SCREEN TV projection system converts any television into 7-foot picture. Lens & instructions \$14.95. (Dealers welcome). Bell Video, 4616 Belair Rd., Baltimore, MD 21206.

MINI FM MIC

Compact size only 2 x 1 x 1/2. Transmit to FM radio 88-108 MHz. Exceptional audio quality. Transmits stable signal up to 900 ft. Complete kit incl. case battery & instructions. Only \$13.95 Assembled \$18.95. Add \$1.55 S&H ea. Send 20c stamp for brochure.

S.E. Corp., Box 1132-PE, Yorba Linda, CA 92686

NON-COMMERCIAL TELEVISION PROJECTS: UHF SINEWAVE SYSTEMS; 2300 MHZ MICROWAVE DOWNCONVERTER. Best systems available; no internal connections to TV! Plans \$10.00 each; both \$15.00. PARTS, KITS AVAILABLE; MC/VISA accepted on parts purchases. Send SASE for parts pricing and more information on these and other unique plans. COLLINS ELECTRONICS, Box 6424, San Bernardino, CA 92412.

FREE CATALOG OF LOW - cost electronic kits. Sirens, Strobes, Color-Organs, Combination Locks, etc. PPG ELECTRONICS, 791 Redrock Road, St. George, Utah 84770. Call 1-800-453-1708.

"PROFESSIONAL" GIANT SCREEN PROJECTION TV—"Don't be fooled with cheap imitations!" "Build the best!" Use EXACT SAME TYPE LENSES and SCREENS utilized by Sony, Zenith, Pioneer, and Maganavox! Simple construction! Profitable! Illustrated information and complete parts catalog \$2.00. Money back guarantee! POLI-VISION, 168-F Dunmore St., Throop, PA 18512.

PROJECTION TV... Convert your TV to project 7 Foot picture... Results equal to \$2,500 projector... Total cost less than \$20.00. **PLANS & LENS \$16.00.** Illustrated information FREE. Macrocomb, Washington Crossing, Pennsylvania 18977. Creditcard orders 24 hours. 215-736-3979.

ADD DELAYED SWEEP to your oscilloscope. Easy project, plans \$6.95. Use your scope as a video monitor, plans \$2.95. Random Access, Box 41770P, Phoenix, AZ 85080.

LASERS—build your own CO2 laser, 25 watts plus, from commercially available components. Send \$20.00 for complete working plans and details: Falcon Machine, Inc., 7255 W. Stewart Ave., Wausau, WI 54401.

CAPACITANCE INSTRUMENT Kit. \$69.95; write or phone: Anders Precision Instrument Co., 4 Bridge St., Plaza, P.O. Box 75, Willimantic, CT 06226, (203) 423-7940.

SUBSCRIPTION TELEVISION EDUCATION MANUAL. Complete theory and circuits \$9.95. Parts and kits available. D & S Enterprises, P.O. Box 110901PE, Nashville, Tennessee 37211.

ALARMS

Burglar-Fire Protection



Protect Your Life, Home, Business, Auto, etc.

- * Our catalog shows how to install your own alarm systems and devices and save \$\$\$\$ We offer FREE write-in engineering service.

FREE CATALOG Lowest Prices on Reliable, High Quality Alarm Systems and Devices

Burdex Security Co. Box 82802-PE Lincoln, Ne. 68501

BURGLAR, FIRE, CAR! Finest equipment! Save! Free Catalog. AAS, 414A Lorna Square, B'ham, AL 35209.

FOR ANY CAR EXTREMELY effective antitheft device. Only \$7.95. Money back guaranteed. Beta Industries, Dept. 202, Box 2296, Elizabeth, NJ 07207.

HIGH FIDELITY

TOP QUALITY SPEAKERS AND KITS. Send \$3.00, Speaker Warehouse, 801 North Route 441, Hollywood, FL 33021.

DIAMOND NEEDLES and STEREO CARTRIDGES at DISCOUNT PRICES for SHURE, PICKERING, STANTON, EMPIRE, GRADO, AUDIO TECHNICA, ORTOFON, ACUTEX, ADC and SONUS. Send S.A.S.E. free catalog. LYLE CARTRIDGES, Dept. P, Box 69, Brooklyn, NY 11218. For fast COD service Toll Free 800-221-0906. N.Y. State (212) 871-3303. 9AM-8PM except Sunday.

WANTED

GOLD, Silver, Platinum, Mercury, Tantalum wanted. Highest prices paid by refinery. Ores assayed. Free circular. Mercury Terminal, Box 191, Norwood, MA 02062.

TUBES

TUBES: "Oldies". Latest. Supplies, components, schematics. Catalog Free (stamp appreciated). Steinmetz, 7519-PE Maplewood, Hammond, Ind. 46324.

TUBES-RECEIVING, Industrial and Semiconductors Factory Boxed. Free price sheet including TV, Radio and audio parts list. Translateronic, Inc., 1365 39th St., Brooklyn, New York 11218. Telephone: (212) 633-2800. Toll free: 800-221-5802.

HUGE INVENTORY! Thousands of types. Wholesale prices. FREE CATALOG! ETCO Electronics, DEPT. 290, Plattsburch, NY 12901.

GOVERNMENT SURPLUS

"GOVERNMENT SURPLUS" ELECTRONICS, JEEPS \$30.00! 800,000 Items! Complete Information Your Area. Largest OFFICIAL Directory, \$3.00 (Guaranteed). SURPLUS (A246), 4620 Wisconsin Northwest, Washington, DC 20016.

SURPLUS JEEPS, CARS AND TRUCKS AVAILABLE. Many sell for under \$200. Call: 312-742-1143, Ext. 4649, for information on how to purchase.

PERSONALS

MAKE FRIENDS WORLDWIDE through international correspondence, illustrated brochure free. Hermes-Verlag, Box 110660/Z, D-1000 Berlin 11, W. Germany.

CORRESPONDENCE FOR FRIENDSHIP IN PHILIPPINES, MALAYSIA. Free information. AAWS-(PE), Box 2777, Orcutt, California 93455-0777.

PENFRIENDS—ENGLAND—USA, through correspondence. Send age, interests. Free reply. Harmony, Box 89PE, Brooklyn, New York, 11235.

UNIVERSITY DEGREES BY SPECIAL EVALUATION of existing credits and Job experience. Fast, inexpensive. Call (614) 863-1791. Or write: EVALUATION, Box 13151-X10, Columbus, Ohio 43213.

CORRESPONDENCE for friendship! Mexico, Philippines, Europe, USA. Free information. International, Box 1716-EL, Chula Vista, CA 92012.

UNIVERSITY DEGREES BY MAIL! Bachelors, Masters, Ph.D.'s... Free revealing details, Counseling, Box 317-EP10, Tustin, California 92680.

CLASSICAL MUSIC LOVERS' EXCHANGE—The link between unattached music lovers. Write: CMLE, Box 31, Pelham, NY 10803.

SCANDINAVIAN LADIES, sincere, seek correspondence for friendship. Details: Scannaclub, Box 4-PE, Pittsford, NY 14534.

INSTRUCTION

UNIVERSITY DEGREES BY MAIL! Bachelors, Masters, Ph.D.'s. Free revealing details. Counseling, Box 317-PE10, Tustin, California 92680.

LEARN WHILE ASLEEP! HYPNOTIZE! Astonishing details, strange catalog free! Autosuggestion, Box 24-ZD, Olympia, Washington 98507.

LEARN ELECTRONIC ORGAN SERVICING at home. Completely revised course covers latest models including digital, LSI's, synthesizers, etc. NILES BRYANT SCHOOL, PO Box 20153, Sacramento, CA 95820.



Be an FCC LICENSED Electronic Technician

Earn up to \$600 a Week & More!

No costly school... The Original FCC Test Answers exam manual that prepares you at home for FCC General Radiotelephone License. Newly revised multiple-choice exams cover all areas tested on the actual FCC Govt exam! No previous experience required. \$12.95 post-paid. Moneyback Guarantee.

COMTAND PRODUCTIONS
Dept. P P.O. Box 26348, San Francisco, CA 94126

MEDICAL ELECTRONICS TECHNOLOGY, home study. Troubleshoot medical instruments. WT1, P.O. Box 3124, Fresno, CA 93650-3124.

YOUR OWN RADIO STATION! AM, FM, cable, licensed, unlicensed, low cost transmitters! Free information. Broadcasting, Box 130-A10, Paradise, CA 95969.

UNIVERSITY DEGREES BY SPECIAL EVALUATION of existing credits and Job Experience. Fast, inexpensive. Call (614) 863-1791. Or write: EVALUATION, box 13151-A10, Columbus, Ohio 43213.

POWERFUL NEW KEYBOARD PLAYING COURSE. Exciting Benefits. Free Details, Write: ProMusic, Box 86K, Brookfield, CT 06804-0086.



Be an ELECTRICIAN

- MAINTENANCE
- CONTRACTOR
- CONSTRUCTION

Make more money! Check out Electrician's wages against the kind of money you make now!

TRAIN AT HOME IN SPARE TIME

Make extra money in spare time while you train for a full-time job. Do odd jobs for friends and neighbors. Save money doing your own electrical work. Learn everything from repairs and maintenance to complete electrical installations. No previous experience needed. Everything explained in easy-to-understand language with plenty of drawings, diagrams and photos. Tools, materials, test equipment included with course. Approved for Veterans and G.I.'s. Be ready to take almost any electrician licensing examination offered by state, city or county.

No cost, no obligation, no salesman will call!

MAIL COUPON TODAY!

IGS Electrician School, Dept. PD082
ICSCenter, Scranton, PA 18515

Rush free facts that tell how I can train at home in spare time to be an electrician.

APPROVED FOR VETERANS

NAME _____
ADDRESS _____
CITY/STATE/ZIP _____

Get Your 2-Year COLLEGE DEGREE in ELECTRONICS TECHNOLOGY

No previous experience necessary... Train at home in spare time for exciting opportunities in fast-growing space-age industries... Automation, Aerospace, Cable-TV, Electronic Circuitry, Computers, and much more. No need to quit your job. Instructors are as close as your telephone... we pay the bill. Send for free facts, color brochure. No salesman will call. CDS Electronics Center, Dept. PD092Scranton, PA 18515.

COMPUTER REPAIR, PROGRAMMING, WORD PROCESSING Courses. Exciting "Hands On" training in 4 months, lifetime placement assistance. Systems Technology Institute, 6442 Edgewater Drive, Orlando, Florida 32810, (305) 299-6535.

FOR INVENTORS

IDEAS, inventions, new products wanted! Call toll free 1-800-528-6050. In Arizona, 1-800-352-0458. Extension 831.

PATENT AND DEVELOP your invention. FREE PATENT INFORMATION. Richard L. Miller, P.E., 3612-E, Woolworth Building, New York, NY 10007, (212) 267-5252.

INVENTIONS WANTED

FREE CONSULTATION NO IDEA TOO SMALL

Disclosure registration Potential cash or royalties from manufacturers seeking new ideas For free information on how to register your ideas call or write

AMERICAN INVENTORS CORP.

59 Interstate Dr Dept PE
West Springfield, MA 01089 (413) 737-5376
A Fee Based Marketing Company
Offices Coast to Coast

BUSINESS OPPORTUNITIES

FREE CATALOGS. Repair air conditioning, refrigeration. Tools, supplies, full instructions. Doolin, 2016 Canton, Dallas, Texas 75201.

MECHANICALLY INCLINED individuals desiring ownership of Small Electronics Manufacturing Business—without investment. Write: BUSINESSES, 92-K10 Brighton 11th, Brooklyn, New York 11235.

ERASE DEBTS with little-known law—create wealth!! Details FREE—Blueprints, No. EE10, LaGrangeville, NY 12540.

MAILORDER OPPORTUNITY! Start profitable home business without experience or capital. Information free. Mail Order Associates, Dept 70, Montvale, NJ 07645.

ONE MAN CRT FACTORY. T.V.'s, Business machines, Monitors, Scopes, VDT's. \$3.00 rebuilding nets \$100-\$500 each tube. Higher profits overseas. New/used. FACTORY, 1909 Louise, Crystal Lake, IL 60014. (815) 459-0666.

LCD WATCH \$2.50, Pen watch \$3.60. Catalogue \$1.00: RELIANT ENGINEERING COMPANY, Box 33610, Sheungwan Post Office, Hong Kong.

\$25,000—INTEREST FREE!!! Keep indefinitely! FREE report.

Write: American, 1601 Main Street, Plainfield, Indiana 46168.

MAKE MONEY SELLING ELECTRONICS. Wholesale dealer catalog \$5. (redeemable). ETCO, Dept. 532, Box 840, Champlain, N.Y. 12919.

BORROW \$30,000 without interest! All eligible. Repay anytime. Free details. Infohouse, Box 1004—PE10, New York, NY 10003.

BORROW \$25,000 "OVERNIGHT." Any purpose, Keep indefinitely! Free Report! Success Research, Box 19739-GJ, Indianapolis, IN 46219.

MAKE 2 TO 3 TIMES your cost on 2500 fast selling products. Guaranteed. \$2.00 brings catalog. Refundable on first order. Jimmy King Company, Dept 5E, P.O. Box 12854, Pensacola, FL 32576.

FREE BOOK "2042 Unique Proven Enterprises." Fabulous "unknowns," second inflation income. Haylings-M, Carlsbad, CA 92008.

PROJECTION TV... Make \$200.00 + per evening assembling Projectors... Easy... Results equal to \$2,500 projectors... Your total cost less than \$15.00—PLANS, LENS & Dealers Information \$14.00... Illustrated information FREE... Macrocomb, Washington Crossing, Pennsylvania 18977. Creditcard orders 24 hours 215-736-2880.

LIFETIME INCOME, \$3,000 WEEKLY POSSIBLE! Unique system beats envelope stuffing anyway! Elliott, Box 7206-PE10, Columbia, MO 65205.

END YOUR MONEY WORRIES! Amazing system requires no investment. Guaranteed legal. Free Details. O. LOPEZ FINANCIAL SERVICES, INC., Box 650220, Miami, Florida 33165.

HIGH PROFITS—Low Investments with our C.R.T. REBUILDING MACHINE. Complete training. ATOLL TELEVISION, 6425 Irving Park, Chicago, Illinois 60634, (312) 545-6667.

MAKE DURABLE BUILDING PLASTIC EASILY. Waterproof, Fireproof. Economical. Bays Laboratory, 2086-2075 Drive, Cedaredge, CO 81413.

SECOND INCOME SELLING famous name brand car and home stereos, calculators, and watches at huge discounts. Free wholesale catalog. BETTER FUTURE INC., Dept. P, Box 1336, Berkley, MI 48072.

LIFETIME INCOME, \$3,000 WEEKLY POSSIBLE! Unique system beats envelope stuffing anyway! Elliott, Box 7206-PE9, Columbia, MO 65205.

EMPLOYMENT OPPORTUNITIES

ELECTRONICS/AVIONICS EMPLOYMENT OPPORTUNITIES. Report on jobs now open. Details FREE. Aviation Employment Information Service, Box 240E, Northport, New York 11768.

JOBS OVERSEAS - Big money fast. \$20,000 to \$50,000 plus per year. Call 716-842-6000, ext. 326.

ELECTRONIC FIRM is looking for assemblers interested in working at home. Send \$3.00 application fee: I.R.D.C., Joppa Hill Place, Manchester, NH 03102.

HOBBIES

1983 CATALOG, 200 PAGES. Thousands of chemicals, glassware, science/hobby equipment. Send \$2.00. Merrell Scientific, 1665 Buffalo Road, Rochester, New York 14624.

RECORDS & TAPES

RECORDS—TAPES! Discounts to 73% All labels; no purchase obligations; newsletter; discount dividend certificates. 100% guarantees. Free details, Discount Music Club, 650 Main St., PO Box 2000, Dept. 5-1082, New Rochelle, NY 10801.

REAL ESTATE

NEW FREE FALL CATALOG! Top real estate values coast to coast! Please specify types, property and location desired. UNITED FARM AGENCY, 612-EP West 47th, Kansas City, MO 64112.

RUBBER STAMPS

RUBBER STAMPS, BUSINESS CARDS. Free catalog 1-800-851-4945, Jackson's, E-100, Brownsville Rd., Mt. Vernon, Ill. 62864.

MISCELLANEOUS

MPG INCREASED! Bypass Pollution Devices easily REVERSIBLY!! Free details—Posco GEE10, LaGrangeville, NY 12540.

FREE PROMOTIONAL ALBUMS, concert tickets, stereos, etc. Information: **BARRY PUBLICATIONS, 477 82nd Street, Brooklyn, NY 11209.**

NEED CREDIT? Get MasterCard, others, w/no credit check. Guaranteed! Simple, Legal. Plus other credit secrets. Free details! Inflation Reports, PE-B, Box 60148, Los Angeles, CA 90060.

MILLIONAIRES created instantly by Canadian lotteries (Tax free). Free information. P Enterprises, Suite 125, 810 W. Broadway, Vancouver, B.C. V5Z 1J8.

NEW from Popular Electronics: INVITATION TO ELECTRONICS

This all-new guide for beginners makes learning about electronics easy—and fun! INVITATION TO ELECTRONICS covers all kinds of equipment and procedures including:

- Television and video
- Audio gear
- Personal computers
- Radio
- Wiring and circuits
- Test gear and trouble-shooting
- Education and careers



—and much more! Start enjoying the fascinating world of electronics with the new guide that makes it easy—INVITATION TO ELECTRONICS!

**INVITATION TO ELECTRONICS
P.O. Box 640, Holmes, PA 10943**

Send me INVITATION TO ELECTRONICS. I enclose \$3.95 (\$2.95* plus \$1.00 postage and handling). \$5.00 outside U.S.A.

Mr. _____
Mrs. _____
Ms. _____
(please print full name)

Address _____ Apt. _____

City _____

State _____ Zip _____

*Residents of CA, CO, CT, DC, FL, IL, MA, MI, MO, NJ, NY State, OH, SC, TN and VT please add applicable sales tax.

OPERATION ASSIST

If you need information on outdated or rare equipment—a schematic, parts list, etc.—another reader might be able to assist. Simply send a postcard to Operation Assist, POPULAR ELECTRONICS, 1 Park Ave., New York, NY 10016. For those who can help readers, please respond directly to them. They'll appreciate it. (Only those items regarding equipment not available from normal sources are published.)

Gonset Model GC-105 communicator receiver. Need manual, schematic and troubleshooting information. Michael R. Watson, 701 Central Ave., Sonoma, CA 95476.

Hygain Model 421 power meter. Need service data and schematic. Mark Alan, Box 2923, Greenville, NC 27834.

Allied Model TD1095 stereo reel-to-reel tape deck. Need playback head and manual. J. Dorf, Rt. 4, Box 299, Buffalo, MN 55313.

Halicrafters Model SX-100 receiver. Need schematic and operating manual. L. Black, 4126 Hollow Creek Dr., Indianapolis, IN 46268.

Singer Model 70 phototypesetter. Need schematic. C. Biegelow, 182 E. Jefferson, Bluffton, OH 45817.

RCA Model # 195 voltomist. Need schematic and manual. Lorin S. McNutt, 5460 West 1200 South, Fairmount, IN 46928.

B&K Model 375 VTM. Need instruction manual. B. Murphy, 260 Niagara St., Apt. 501, Buffalo, NY 14201.

Friden Model S machine calculator. Need operation manual. E. Christofferson, 303 Taylor St., N.W., Washington, D.C. 20011.

Webcor Model 300, transistor Model EP-2404-1 tape recorder. Need schematic. Byron Chamberlain, RFD-2, Box 166, Leesburg, VA 22075.

RCA Model WF-14A geiger counter. Need schematic and parts list. Don Foster, 10504 S.E. 2nd St., Vancouver, WA 98664.

Dumont Model 401 oscilloscope. Need schematic and any information available. Wayne A. Kallunki, 1228 Belleview Blvd., Clearwater, FL 33516.

Mohawk Model 1925, type A-5 radio. Need any information available. Neil Walgenbach, 30W141 Wildwood Ct., Warrenville, IL 60555.

Sony Model TC-630 tape recorder. Need service manual and schematic. Rocky Starland, 1310 Wilson St., Bay City, MI 48706.

Heathkit Model T-3 signal tracer. Need operation and assembly manuals and schematic. Mark Alan, Box 2923, Greenville, NC 27834.

EMC Model 600 oscilloscope. Need schematic and operating manual. Robert N. Bishop, 18109 E. 27th St., Independence, MO 64057.

NRI Model 34 signal tracer. Need manual and schematic. Harvey L. Felber, 1508 Myerlee C.C. Blvd., Fort Myers, FL 33907.

Halicrafters Model SX99 receiver. Need manual and schematic. Charles Boyd, 1237-170 St., Hammond, IN 46324.

Hy-Gain Models 16 and 20 CB. Need schematic and service manual. E. Joines, Miami Springs Senior High School, 751 Dove Avenue, Miami Springs, FL 33157.

Tennelec Model MS2 memory scanner. Need schematic, service manual and technical information. Carl J. Gray, 361 Spencer Ave., Lancaster, PA 17603.

Motorola Model TS-C9 television. Need owner's manual or any information available. Brian Douglas, 37220 Blacow Rd., Fremont, CA 94536.

Popular Electronics

ADVERTISERS INDEX

RS no.	ADVERTISER	PAGE no.
27	All Electronics Corp.	14
28	AP Products	93
64	Army National Guard	8
	Audio-Technica U.S., Inc.	91
5	BBC - Metrawatt/Goerz	85
49	BSR (USA) Ltd	30
	C & D Electronics	83
	Classified Advertising	109,115
	Cleveland Institute of Electronics, Inc	26-29
17	CompuServe	47
41	Computers, Peripherals, Unlimited	41
55	DBX, Inc.	48
7	Digi-Key Corp.	102
56	Dilithium Press	42
10	Discwasher	12
	R.L. Drake	41,94
25	Electra Corp	11
11	Electronic Specialists, Inc	96
59	Epsom America	50
42	Firestik	40
61	Focus	96
2	Foley-Belsaw Co	83
	Gilco International, Inc	34
12	Gladstone Electronics	74
	Grantham College of Engineering	96
34	Heath Co.	21,22,23,24
53	IBM Corporation	Cover 2,1
43	Illinois Audio	74
13	Jameco Electronics	104,105
71	JDR Microdevices	99,100,101
66	J & R Music World	89
52	Leading Edge	Cover 4
6	McIntosh Laboratory, Inc.	86
44	MFJ Enterprises	94
	Menotech	7
39	Multitech Electronics	Cover 3
	National Technical Schools	68-71
	Netronics, R & D Ltd.	73, 97
72	Nippon Electric Co., Ltd	52
	NRI Schools	16-19
45	PAIA Electronics, Inc.	40
35	Panasonic	15
	Polaroid	13
3	Poly Paks	42
26	Protecto Enterprises	48
46	Quest Electronics	106
	Radio Shack	55,103
	Scientific Systems	40
54	Shure Brothers, Inc.	3
	Simple Simon Kits	62
	Sinclair Research	4, 5, 35
48	Sintec Co.	9
14	Tab Books	45
67	TAMS, Inc.	89
23	TDK	86

ELECTRONICS WORLD®

Personal Electronics News

dbx NOISE REDUCTION will soon be available in portable stereos, according to dbx president, David Blackmer. In a joint venture, dbx and Matsushita have developed an extremely small IC chip that is designed to operate on two AA batteries (7V), or as little as 1.8V. Owners of car and Walkman-type stereos are said to be the main beneficiaries of this development, since it will enable them to play their dbx-encoded cassettes with less tape-hiss and greater dynamic range than had been previously possible. In addition, dbx believes that the new chips will be used universally when digital playback equipment becomes available for the mass market—since dbx is said to be uniquely suited to copying digital discs onto analog tape.

A COMPUTER TRAINING COURSE, called Computer Programming and Operations (COP), is being offered by the Control Data Institute. The course provides students with hands-on, interactive instruction in programming, debugging, and code creation. Emphasis is on standard programming languages and business systems analysis. No formal lectures are given, but individualized instruction is said to be provided through Control Data's PLATO computer-based education system, and by videotaped lessons and manuals. Instructors are also available should a student desire a human interface. After completing the 653 hours of course curriculum (during a period of six to ten months), students are reported to be qualified for entry-level positions as programmers, operators, assistant applications analysts, and customer service representatives. Applicants for the course must have completed at least two years of college and pass a standard admissions test. Cost is \$4975 per student.

"VIDEO LETTER FROM JAPAN" is the name of a new series of video programs designed to give American children in grades 5 through 7 a candid look at various aspects of life in Japan. Funded by the TDK Electronics Co., and coordinated by the Asia Society of New York, each Video Letter contains two 25-minute segments ($\frac{1}{2}$ " format in both VHS and Beta) that depict such topics as Japanese family life, education, economic structure, hobbies and sports, etc. The production takes the form of an audio-video profile in which a Japanese child shows and tells about a part of his life, which is interpreted for American children by an English language narration and professionally-developed teaching guides. Initial distribution of the Video Letter has begun in New York, California, and Georgia, with nationwide distribution to begin at the start of 1983.

THE TACOMA NARROWS BRIDGE COLLAPSE is the video disc feature of the newly launched Wiley Educational Software program from John Wiley & Sons. You might remember this famous disaster film from Physics 111, during the lectures on wave motion. The Wiley disc shows the actual collapse and provides a series of interactive investigations on the effects of wind speed, cable tension, and standing wave frequency. The disc offers three separate levels of presentation, depending on the user's background. It can be played on a programmed MCA DiscoVision 7820 or on a Pioneer VP-1000 player.

SOFTWARE DEVELOPERS FOR HOME COMPUTERS can now visit a center where they will have access to technical reference materials and instruction from a staff of trained professionals, according to Bruce W. Irvine, Vice President of Software for Atari's Home Computer Division. The center, located in the Crimson Galleria in Cambridge, MA, is the second of its kind—the first having been established in Sunnyvale, CA near Atari's corporate headquarters. Users of the facility will be assisted in developing software for entertainment, education, and home management, which will then be marketed by Atari. The center will also offer assistance in converting programs written for other computers to an Atari-compatible format.

TECHNICAL INFORMATION is available to electronics dealers via computer terminal as a result of an agreement between the National Electronics Service Dealers Association (NESDA) and Compu-Tips (formerly Compu-tel). The Compu-Tips National Network consists of a data base of technical tips imputed by the group of service dealers who formed the company last year. Servicing information for TV, VCR, video discs, TV games, and audio products is said to be added to the system at a rate of 500 tips per week. Other data will eventually include parts pricing and service contract management. At this writing, the system has over ten-thousand tips accessible in over 600 U.S. cities via a local phone call. For more information, contact J.W. Williams, NESDA, 2708 W. Berry, Ft. Worth, TX 76109.



LEARN HOW MICROPROCESSORS WORK FOR \$149.95. INTRODUCING THE MICRO-PROFESSOR.

The Micro-Professor MPF-1 is a serious, hands-on teaching device used by colleges and universities, technical schools, corporate training programs, and individuals, worldwide.

The heart of the MPF-1 is a Z-80 microprocessor. It is specifically designed to aid you in learning the architecture of the most popular 8-bit central processing unit on the market. In addition, with the MPF-1 you can do breadboarding and prototyping for both hardware and software applications.

- The Micro-Professor MPF-1 features
- 2k bytes of RAM (expandable to 4k)
 - 2k bytes of ROM (expandable to 8k)
 - 36 key calculator-type keyboard
 - Tiny BASIC interpreter for help in learning assembly language
 - Built-in speaker
 - Cassette recorder interface for program storage
 - 24 input/output lines
 - 3.5 x 1.36 inch breadboard area
 - Two 40-pin busses for the standard CPU and optional CTC/PIO allows for full expansion to Z-80 architecture capabilities
 - AC power supply included
 - Three instruction manuals include source monitor listing plus 18 experiments in hardware and software and the Micro-Professor comes in an attractive book-style carrying case for a micro price of only \$149.95 with a 90-day unconditional written warranty.

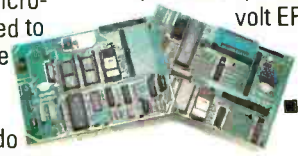

- User options include
- Thermal Printer (PRT-MPF) \$99.95
20 column, alphanumeric, printer, in BASIC, with disassembler.
 - EPROM Programming Board (EPB-MPF) \$169.95 For all 5 volt EPROMs (1KB, 2KB, 4KB).
Read, copy, list and verify capabilities.
 - Speech Synthesizer Board (SSB-MPF) \$139.95 A vocabulary of 1200+ words plus more in the future.

If you're serious about learning (or teaching) how microprocessors work, now is the time to order the Micro-Professor. Individuals using the Micro-Professor MPF-1 outside of structured classroom situations should have at least a

rudimentary knowledge of microcomputer technology. We will provide a list of appropriate literature to those who request it.

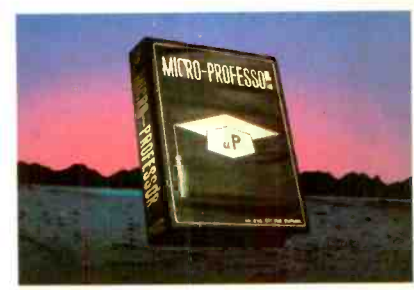

To order call toll free : 800-538-1542
In California call 408-773-8400
CIRCLE NO. 39 ON FREE INFORMATION CARD



Multitech Electronics Inc.

For further information or order:
In U.S. and Canada mail to:
Multitech Electronics Inc.
195 West El Camino Real
Sunnyvale, CA 94086
Tel: 408-773-8400
Tex: 176004

Outside of North America mail to:
Multitech Industrial Corporation
977 Min Shen E Road, 105
Taipei, Taiwan, ROC
Tel. 02-769-1225
TWX 19162 MULTIC,
23756 MULTIC

Name (Please Print) _____	MPF-1 Micro-Professor	\$149.95	Qty. _____	Amt. _____
Address _____	PRT-MPF Thermal Printer	\$99.95	_____	_____
City _____	EPB-MPF EPROM Programming Board	\$169.95	_____	_____
State _____ Zip _____	SSB-MPF Speech Synthesizer Board	\$139.95	_____	_____
Signature _____	Shipping and Handling	\$4.95	_____	4.95
Check or money order enclosed <input type="checkbox"/>	California residents add sales tax	_____	_____	_____
Visa <input type="checkbox"/> Mastercharge <input type="checkbox"/>	TOTAL	_____	_____	_____
Card No. _____ Expires _____				

Z-80 is a registered trademark of Zilog Inc.

THE PROWRITER COMETH

(And It Cometh On Like Gangbusters)



Evolution.

It's inevitable. An eternal verity.

Just when you think you've got it knocked, and you're resting on your laurels, somebody comes along and makes a dinosaur out of you.

Witness what happened to the Centronics printer when the Epson MX-80 came along in 1981.

And now, witness what's happening to the MX-80 as the ProWriter cometh to be the foremost printer of the decade.

SPEED

MX-80: 80 cps, for 46 full lines per minute throughput.

PROWRITER: 120 cps, for 63 full lines per minute throughput.

GRAPHICS

MX-80: Block graphics standard, fine for things like bar graphs.

PROWRITER: High-resolution graphics features, fine for bar graphs, smooth curves, thin lines, intricate details, etc.

PRINTING

MX-80: Dot matrix business quality.

PROWRITER: Dot matrix correspondence quality, with incremental printing capability standard.

FEED

MX-80: Tractor feed standard; optional friction-feed kit for about \$75 extra.

PROWRITER: Both tractor and friction feed standard.

INTERFACE

MX-80: Parallel interface standard; optional serial interface for about \$75 extra.

PROWRITER: Parallel and serial interface standard.

WARRANTY

MX-80: 90 days, from Epson.

PROWRITER: One full year, from Leading Edge.

PRICE

Heh, heh.

Distributed Exclusively by Leading Edge Products, Inc., 225 Turnpike Street, Canton, Massachusetts 02021. Call: toll-free 1-800-343-6833; or in Massachusetts call collect (617) 828-8150. Telex 951-624.

LEADING EDGE.

For a free poster of "Ace" [Prowriter's pilot] doing his thing, please write us.

CIRCLE NO. 52 ON FREE INFORMATION CARD