

Popular Electronics®

WORLD'S LARGEST SELLING ELECTRONICS MAGAZINE

MAY 1982/\$1

THE ELECTRONIC WORLD

Microcomputers: Which One Is Right for You?

Experimenting with Fiber Optics

Audio-Actuated Camera Flash

Easy Car Tuneup with a Digital Meter



Tested in this Issue:



84109 UT KE CY

05

PRT 28972092 741D NOV83

Radio Shack TRS-80 Model III Computer
Acoustic Research AR48s Speaker
a 13" Color TV Receiver

Make waves with an Apple.

If you'd like to spend more of your research budget on research and less on computer costs, consider the discoveries of Dr. John Lilly and the Human/Dolphin Foundation.

Dolphins vocalize at 2,000-40,000 Hz (compared with 300-3,000 Hz for humans) and "converse" 10-15 times faster than their bipedal brethren.

In 1968, Dr. Lilly's interspecies communication experiments stalled for lack of affordable computer power to bridge this gap. But today, with the help of Apple Personal Computers and a DEC[®] PDP/11, things are going swimmingly.

A new program called JANUS (Joint Analog Numeric Understanding System) uses a 48K Apple II Plus to generate dolphin-comprehensible wave forms matched to dolphin-

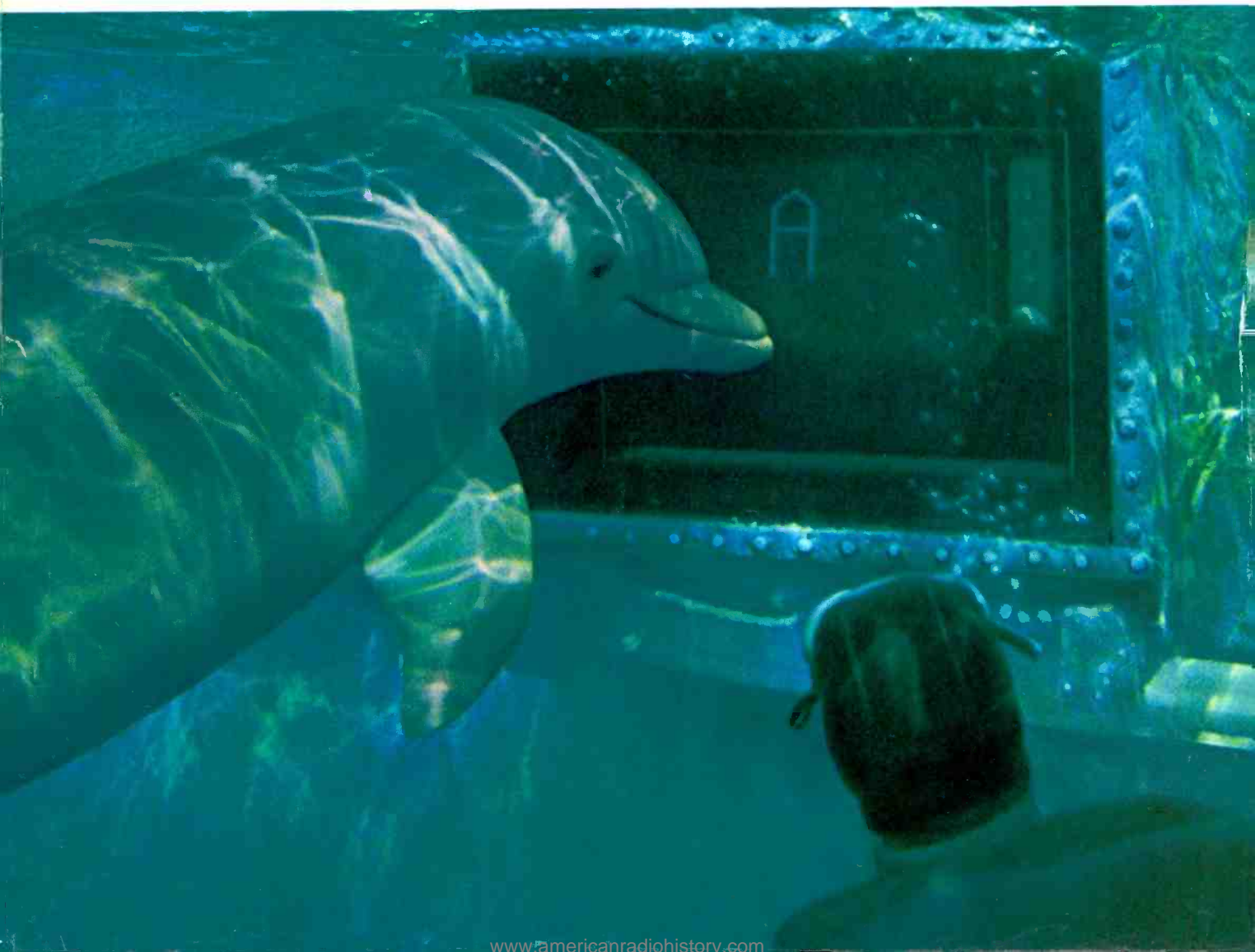

viewable symbols on an underwater screen. Dolphin responses are analyzed through a PDP/11. A second Apple monitors and analyzes data from all phases of the experiment.

The objective is to create an artificial language that is mutually intelligible to both species, with a beginning vocabulary of 48 sound/symbol morphemes associated with objects, locations and actions.

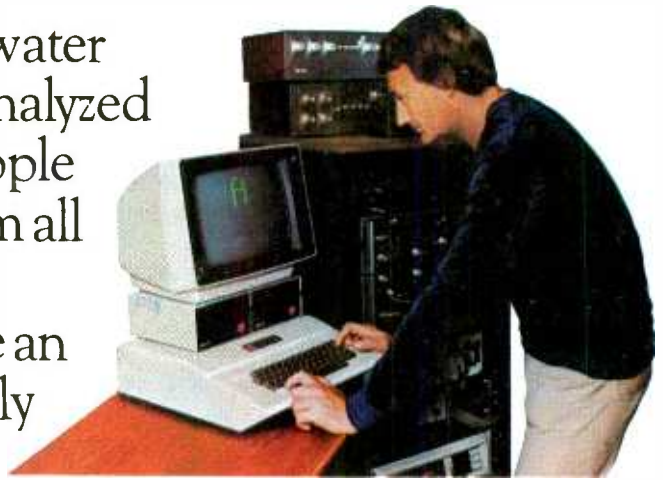

But, with all the micros available, why pick Apples?

Because they're inexpensive enough to allow the use of a stand-alone computing system for dedicated functions.

Because they're portable and rugged enough for field use in a wide range of environments.

And because they can be configured for many scientific

applications with no special I/O devices. (Apple's IEEE-488 interface card will program and operate virtually any test, measurement or control instrument.)

There's more software available for Apples than for any other microcomputer on

the market. And more full service dealers worldwide.

Communicate with one and find out how an Apple can make waves for you, whatever your, ah... porpoise.

The personal computer.  **apple**

The Human/Dolphin Foundation is a non-profit research organization. For more information, write Dr. John Lilly, P.O. Box 4172, Malibu, CA 90265. For the authorized Apple dealer nearest you, call (800) 538-9696. In California, call (800) 662-9238. Or write: Apple Computer Inc., 10260 Bandlely Dr., Cupertino, CA 95014.

CIRCLE NO. 6 ON FREE INFORMATION CARD

Popular Electronics®

WORLD'S LARGEST-SELLING ELECTRONICS MAGAZINE

Can you be a Recording Engineer?



Learn via

Audio Fundamentals Labs
Control Room & Console Labs
Studio Synthesizer Lab
Digital Logic Lab
Disc Cutting Lab

Obtain your **Diploma in Multi-track Recording Technology** in one year, or **B.S. Degree in Music Technology** in four years via the Institute of Audio Research—New York University joint program.

Summer '82 Quarter starts

Tuesday, July 6th.

Fall '82 Quarter starts

Thursday, September 30th.

Call or write for 24-pg. illustrated brochure

212/677-7580 or
1-800/847-4187

(Toll-free outside of N. Y. State)



Institute of Audio Research

64 University Place
Greenwich Village
New York, N.Y. 10003
(212) 677-7580

Established
1969

Licensed by N.Y. State Dept. of Education
Approved for Veterans Training

The Electronic World

COMPUTERS—WHICH ONE IS FOR YOU? / Joe Desposito 45
A guide to making a wise computer buying decision.

Feature Articles

CURRENT-LIMITING TECHNIQUES / Mark Pittelkau 62

LEARNING QUIZ FOR ELECTRONICS / Fredrick W. Hughes 86

Construction Articles

DIGITAL AUTOMOTIVE TUNE-UP METER / C.R. Ball 37
Measures dwell angle, engine rpm and voltage.

EXPERIMENTING WITH FIBER OPTICS / TJ Byers 63

SOUND-ACTIVATED PHOTO FLASH / Niel Ulevich 69
Simple circuit freezes the action in milliseconds.

HOW TO SWEETEN THE SOUND OF YOUR PHONO CARTRIDGE / Martin Nagel 70
Provides switching capability, precision performance and extremely low noise.

TEACH YOUR DIGITAL CLOCK TO CONTROL APPLIANCES / Robert Colwell 73
Turn a standard clock module into a versatile control center.

Equipment Reviews

ACOUSTIC RESEARCH AR48s THREE-WAY SPEAKER SYSTEM 20

SYLVANIA 13" COLOR TV RECEIVER 23

RADIO SHACK TRS-80 MODEL III DESKTOP COMPUTER 31

KROHN-HITE MODEL 4400 ULTRA-LOW DISTORTION OSCILLATOR 81

Columns

ENTERTAINMENT ELECTRONICS / Len Feldman 16
Listening Locations Equalized Digitally.

COMPUTER BITS / Carl Warren 34
Latest Micros Offer Power and Graphics.

COMPUTER SOURCES / Leslie Solomon 83

HOBBY SCENE / Joe Desposito 88

SOLID-STATE DEVELOPMENTS / Forrest M. Mims 89
The Rainbow LED.

DX LISTENING / Glenn Hauser 92
Taiwan Gets American Relay Station.

EXPERIMENTER'S CORNER / Forrest M. Mims 98
Experimenting with Low-Power Integrated Circuits.

PROJECT OF THE MONTH / Forrest M. Mims 108
Dual-Polarity Five-Volt Power Supply.

Departments

EDITORIAL / Art Salsberg 6
The Two-Way Editorial Street.

LETTERS 8

NEW PRODUCTS 10

OPERATION ASSIST 101

NEW LITERATURE 103

ADVERTISER'S INDEX 104

ELECTRONICS LIBRARY 107

PERSONAL ELECTRONICS NEWS 122

COVER PHOTO BY AARON KILEY
GRAPHICS BY JACK WARD COLOR SERVICES, INC.

COPYRIGHT © 1982 BY ZIFF-DAVIS PUBLISHING COMPANY. All rights reserved. Popular Electronics (ISSN 0032-4485) May 1982, Volume 20, Number 5. Published monthly by Ziff-Davis Publishing Co., at One Park Ave., New York, NY 10016. Richard P. Frieze, President; Selwyn Taubman, Treasurer; Bertram A. Abrams, Secretary. One year subscription rate for U.S. and Possessions, \$15.00; Canada, \$20.00; all other countries, \$23.00 (cash orders only, payable in U.S. currency). Second Class Postage Paid at New York, N.Y. 10016 and at additional mailing offices. Authorized as second class mail by the Post Office Dept., Ottawa, Canada, and for payment of postage in cash. POPULAR ELECTRONICS including ELECTRONICS WORLD, Trade Mark Registered. Indexed in the Reader's Guide to Periodical Literature. Ziff-Davis also publishes Boating, Car and Driver, Cycle, Flying, Popular Photography, Skiing, Stereo Review, Electronic Experimenter's Handbook, and Tape Recording & Buying Guide. Forms 3579 and all Subscription Correspondence: POPULAR ELECTRONICS, Circulation Dept., P.O. Box 2774, Boulder, CO 80302. Please allow at least eight weeks for change of address, enclosing, if possible, an address label from a recent issue. Permissions: Material in this publication may not be reproduced in any form without permission. Requests for permission should be directed to John Babcock, Rights and Permissions, Ziff-Davis Publishing Co., One Park Ave., New York, NY 10016.

POPULAR ELECTRONICS

897 N.W. Grant Ave. • Corvallis, Oregon 97330 • 503/758-0521

THE DAWN OF A NEW ERA FOR APPLE II®: THE ENHANCER II

Introducing the Enhancer II: a new Standard which is improving the relationship between Humans and Apples. The Enhancer II can help your Apple II's keyboard become more sociable by remembering words or phrases which can be entered into the Apple by the mere touch of a key. Life can become even easier because the Enhancer II can remember what you typed while your Apple was busy talking to your disc (or doing other things). Naturally, it knows the difference between upper and lower case letters and what shift keys are supposed to do. It even knows to auto repeat any key held down. The Enhancer II replaces the encoder board making installation simple.

Suggested retail price: \$149.00.

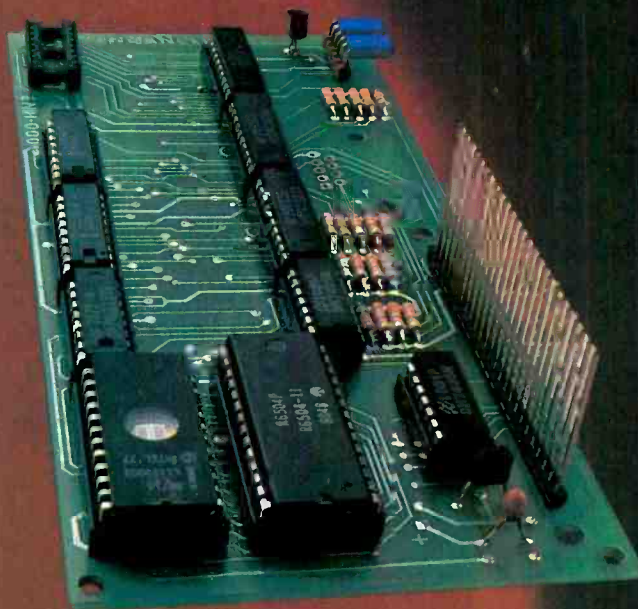

VIDEOTERM



The time tested Videoterm 80 column card:

- 80 characters x 24 lines
 - True decoders
 - 7 x 9 character resolution
 - Low power consumption
 - Compatible with most word processors
 - Softcard and CP/M compatible
 - Modem compatible
 - Most popular character set of any 80 column card
 - Alternate character fonts available
- Suggested retail price \$345.00

SOFT VIDEO SWITCH

The Soft Video Switch is an automatic version of the popular Switchplate. It knows whether it should display 40 or 80 columns or Apple graphics. It does the tedious work of switching video-out signals so you don't have to. The Soft Video Switch can be controlled by software. Any Videoterm with Firmware 2.0 or greater may be used with the Soft Video Switch. The single wire shift mod is also supported. Package price is \$35.00.



KEYBOARD AND DISPLAY ENHANCER



The original Keyboard and Display Enhancer is still available for Revision 0-6 Apples (on which the new Enhancer II will not fit). These Apples have memory select sockets at chip locations D1, E1 & F1. The Keyboard and Display Enhancer allows entry and display of upper & lower case letters with full functional shift keys. It does NOT have user definable keys nor a type ahead buffer. The price is \$129.00.

ACCESSORIES:

Videoterm Utilities Disc \$37.00 (includes)

- Fort Editor
- Pascal Mid-Res Graphics
- Applesoft Read Screen Utility
- Top & Bottom Scrolling
- Pascal Vidpatch
- Graphics Template

Character Set EPROMs \$29.00 ea

- Half Intensity
- Inverse
- German
- Katakana (Japanese)
- Line Drawing Graphics (Expanded)
- Spanish
- French
- Math & Greek Symbols
- Super & Subscript

Dvorak EPROM (Enhancer) \$29.00
Lower Case Chip \$29.00

The \$149⁹⁵ personal computer.

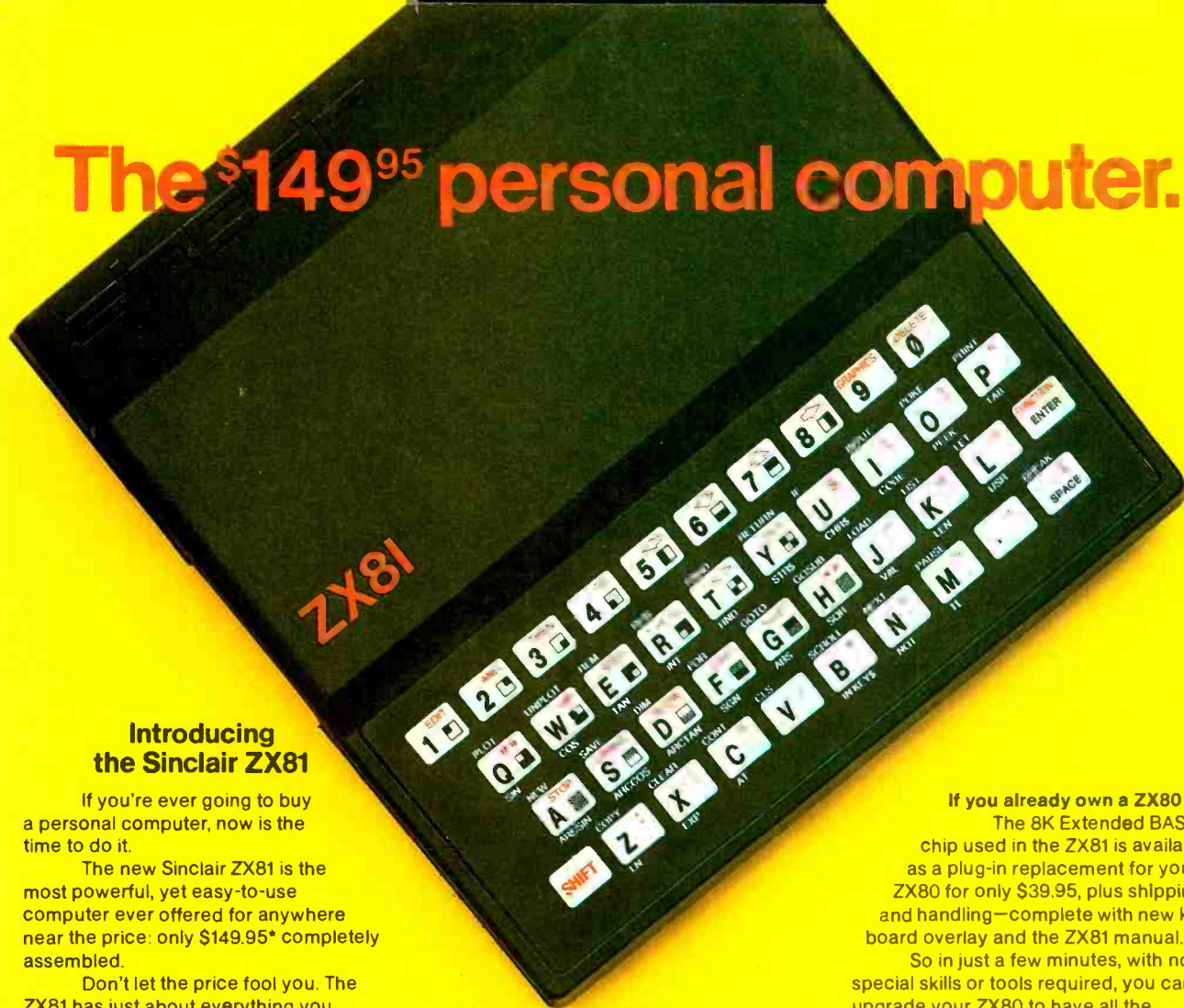

Introducing the Sinclair ZX81

If you're ever going to buy a personal computer, now is the time to do it.

The new Sinclair ZX81 is the most powerful, yet easy-to-use computer ever offered for anywhere near the price: only \$149.95* completely assembled.

Don't let the price fool you. The ZX81 has just about everything you could ask for in a personal computer.

A breakthrough in personal computers

The ZX81 is a major advance over the original Sinclair ZX80—the world's largest selling personal computer and the first for under \$200.

In fact, the ZX81's new 8K Extended BASIC offers features found only on computers costing two or three times as much.

Just look at what you get:

- Continuous display, including moving graphics
- Multi-dimensional string and numerical arrays

*Plus shipping and handling. Price includes connectors for TV and cassette, AC adaptor, and FREE manual.

- Mathematical and scientific functions accurate to 8 decimal places
- Unique one-touch entry of key words like PRINT, RUN and LIST
- Automatic syntax error detection and easy editing
- Randomize function useful for both games and serious applications
- Built-in interface for ZX Printer
- 1K of memory expandable to 16K

The ZX81 is also very convenient to use. It hooks up to any television set to produce a clear 32-column by 24-line display. And you can use a regular cassette recorder to store and recall programs by name.

If you already own a ZX80 The 8K Extended BASIC chip used in the ZX81 is available as a plug-in replacement for your ZX80 for only \$39.95, plus shipping and handling—complete with new keyboard overlay and the ZX81 manual.

So in just a few minutes, with no special skills or tools required, you can upgrade your ZX80 to have all the powerful features of the ZX81. (You'll have everything except continuous display, but you can still use the PAUSE and SCROLL commands to get moving graphics.)

With the 8K BASIC chip, your ZX80 will also be equipped to use the ZX Printer and Sinclair software.

Warranty and Service Program**

The Sinclair ZX81 is covered by a 10-day money-back guarantee and a limited 90-day warranty that includes free parts and labor through our national service-by-mail facilities.

**Does not apply to ZX81 kits

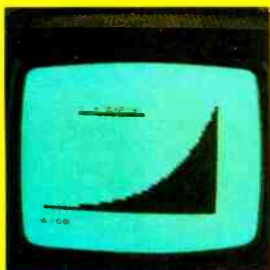

NEW SOFTWARE: Sinclair has published pre-recorded programs on cassettes for your ZX81, or ZX80 with 8K BASIC. We're constantly coming out with new programs, so we'll send you our latest software catalog with your computer.



ZX PRINTER: The Sinclair ZX Printer will work with your ZX81, or ZX80 with 8K BASIC. It will be available in the near future and will cost less than \$100.



16K MEMORY MODULE: Like any powerful, full fledged computer, the ZX81 is expandable. Sinclair's 16K memory module plugs right onto the back of your ZX81 (or ZX80, with or without 8K BASIC). Cost is \$99.95, plus shipping and handling.



ZX81 MANUAL: The ZX81 comes with a comprehensive 164-page programming guide and operating manual designed for both beginners and experienced computer users. A \$10.95 value, it's yours free with the ZX81.

The \$99.95 personal computer.



Introducing the ZX81 kit

If you really want to save money, and you enjoy building electronic kits, you can order the ZX81 in kit form for the incredible price of just \$99.95*. It's the same, full-featured computer, only you put it together yourself. We'll send complete, easy-to-follow instructions on how you can assemble your ZX81 in just a few hours. All you have to supply is the soldering iron.

How to order

Sinclair Research is the world's largest manufacturer of personal computers.

The ZX81 represents the latest technology in microelectronics, and it picks up right where the ZX80 left off. Thousands are selling every week.

We urge you to place your order for the new ZX81 today. The sooner you order, the sooner you can start enjoying your own computer.

To order, simply call our toll free number, and use your MasterCard or VISA.

To order by mail, please use the coupon. And send your check or money order. We regret that we cannot accept purchase orders or C.O.D.'s.

CALL 800-543-3000. Ask for operator #509. In Ohio call 800-582-1364. In Canada call 513-729-4300. Ask for operator #509. Phones open 24 hours a day, 7 days a week. Have your MasterCard or VISA ready.

These numbers are for orders only. For information, you must write to Sinclair Research Ltd., One Sinclair Plaza, Nashua, NH 03061.

sinclair

AD CODE	PRICE†	QTY.	AMOUNT
05PE	ZX81	\$149.95	
	ZX81 Kit	99.95	
	8K BASIC chip (for ZX80)	39.95	
	16K Memory Module (for ZX81 or ZX80)	99.95	
	Shipping and Handling	4.95	\$4.95
	To ship outside USA add \$10.00		
	TOTAL		

MAIL TO: Sinclair Research Ltd., One Sinclair Plaza, Nashua, NH 03061.

NAME _____

ADDRESS _____

CITY/STATE/ZIP _____

† U.S. Dollars



EDITORIAL

The Two-Way Editorial Street

Editing is a two-way street. We try our best to respond to your needs as cited by you in letters, phone calls, and reader studies. There are ways you can help us to assist you faster and better, though, as follows.

• If you wish to get an old issue of PE, please order it through Consumer Services Division, P.O. Box 278, Pratt Station, Brooklyn, NY 11205. Cost is \$3.00 (\$4.50 foreign) per copy, which includes postage and handling. Copies are available of issues dated from August 1978 to the present.

• Should you have a subscription problem—not receiving an issue, receiving two in the same month, etc.—don't call an editor. Instead, dial 212-725-3628 or 4197. You'll reach someone who talks to the demon computer that makes it happen.

• Photocopies of articles are no longer available from us. Government regulations made it prohibitive since our modest 25¢ charge requires maintaining sales tax information for each and every one. So check your library or order a back issue for this purpose. Sorry.

• Owing to the great volume of mail we receive from our more than 500,000 readers, we cannot help you modify a published design or provide circuit details for an idea you have.

• In most cases, we can't answer questions by phone and meet copy deadlines at the

same time. It's best to send a letter with a self-addressed envelope for reply. No SASE, and it's likely to be round-filed.

• You should assume that information published constitutes everything we have in our files. To research beyond what appeared will jeopardize our magazine deadlines, which is tantamount to attacking motherhood or apple pie.

• If you wish to contact a columnist or other author, address the mailing envelope to the author, c/o POPULAR ELECTRONICS, and enclose your letter in a SASE. We'll forward it. But don't expect him to act as your personal design consulting service, to perform prodigious research tasks, or to give you a short correspondence course on the subject he wrote about.

• If you're looking for a specific article from a past issue, before writing with your inquiry, refer to the annual index we publish in our December issues.

If you're a writer, here are ways to increase your chances of having an article accepted as well as speeding up evaluation response time.

• TYPE your manuscript and DOUBLE-SPACE lines. Handwritten manuscripts are not accepted! We love wide margins, too, and give extra points for them.

• Be sure that you use a fresh typewriter ribbon. Reading faded print is like reading

in the dark. Should a word-processing system be used with a dot-matrix printer for hard copy, it's doubly important that a fresh ribbon be used. If you have an overstrike capability, this should be employed. Moreover, if your printer has a coarse matrix pattern, it might be best not to use it at all for lengthy manuscripts, fresh ribbon or no.

• No upper-case-only letters, please. Upper- and lower-case, hopefully with descenders for the latter, are required.

• If your article involves wiring diagrams or other types of drawings, please make them neat. However, don't waste time trying to make the drawings reproducible since we redraw almost everything to our standards.

• If you want to include a photograph, fine; but if we are to reproduce it, it must be a good, well-lighted, in-focus glossy print. For a project, it's better to send us the working model to photograph and examine.

• Whatever you do, don't submit your article to two publishers at the same time.

Paying attention to the foregoing reasonable practices will enable the editors here to handle your requests with greater efficiency. Thanks for your cooperation.

Popular Electronics

JOE MESICS
Publisher

ARTHUR P. SALSBERG
Editorial Director

DONALD MENNIE
Executive Editor

LESLIE SOLOMON
Technical Director

JOHN R. RIGGS
Managing Editor

EDWARD I. BUXBAUM
Art Director

JOSEPH DESPOSITO
Technical Editor

DAVID M. WEBER
Features Editor

ANDRE DUZANT
Technical Illustrator

CARMEN ROBLES
Production Editor

JEFF NEWMAN
Editorial Assistant

Contributing Editors:
Walter Buchsbaum,

Len Feldman, Glenn Hausor, Julian Hirsch,
Forrest Mims, Stan Prentiss, Carl Warren

MARIE MAESTRI
Executive Assistant

Editorial and Executive Offices
One Park Avenue
New York, New York 10016
212 725-3500

Publisher
Joe E. Mesics
212 725-3568

New York Office
Advertising Manager:
Richard Govatski (725-7460)
Sales:
Tom Ballou (725-3578)
Ken Lipka (725-3580)

Midwestern Office
Suite 1400, 180 N. Michigan Ave.,
Chicago, IL 60601 (312 346-2600)
Sales: Ted Welch

Western Representative
Norman S. Schindler & Associates, Inc.
7050 Owensmouth Ave., #209
Canoga Park, CA 91303 (213 999-1414)
Sales: Norm Schindler, Jo Ann O'Hara

Representation In Japan
J. S. Yagi
Iwai Trading Co., Ltd.
603 Ginza Sky Heights Bldg.
18-13, Ginza 7-Chome
Tokyo, Japan 104

Ziff-Davis Publishing Company

Richard P. Friesen President
Albert S. Traina President, Consumer Magazine Division

Furman Hebb Executive Vice President
Phillip T. Heffernan Senior Vice Presidents

Sidney Holtz
Edward D. Muhlfeld
Philip Sine Vice Presidents

Robert Bavier
Baird Davis
George Morrissey

Selwyn Taubman Treasurer
Bertram A. Abrams Secretary

Editorial correspondence: POPULAR ELECTRONICS, 1 Park Ave., New York, NY 10016. Editorial contributions must be accompanied by return postage and will be handled with reasonable care; however, publisher assumes no responsibility for return or safety of manuscripts, art work, or models submitted.

The publisher has no knowledge of any proprietary rights which will be violated by the making or using of any items disclosed in this issue.



Member Audit Bureau of Circulations

POPULAR ELECTRONICS

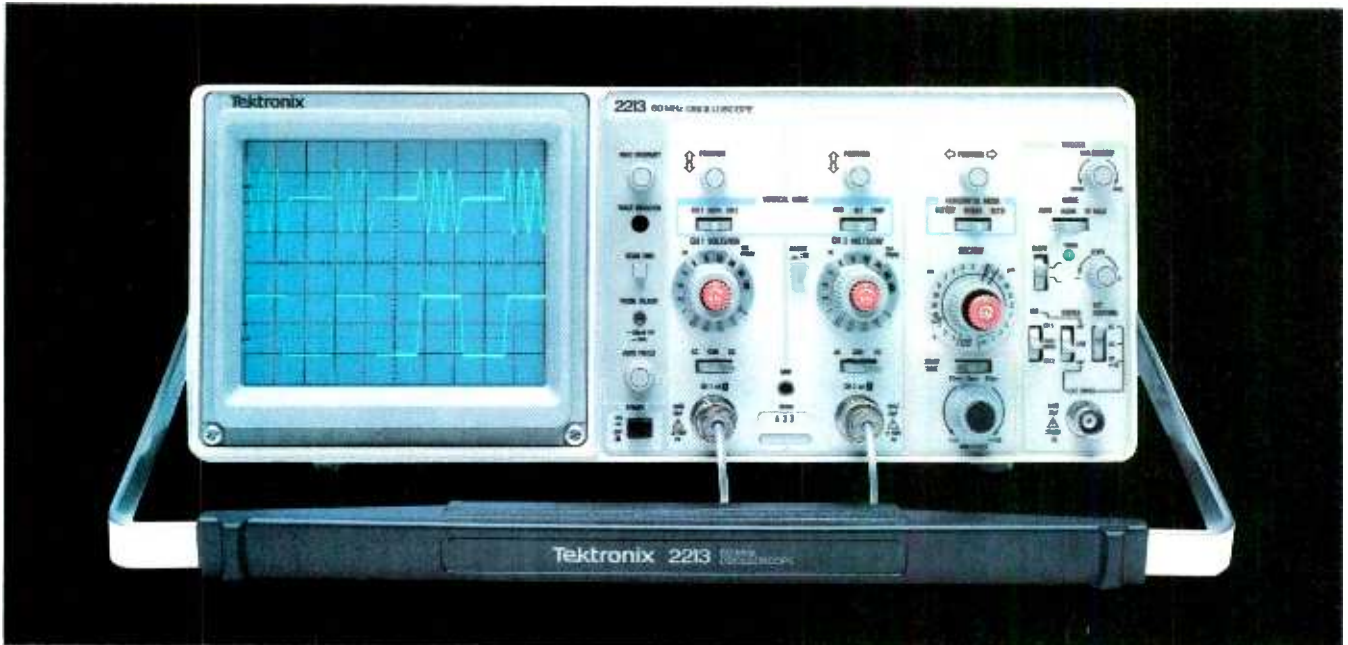

Introducing a direct line to a 60 MHz Tektronix scope built for your bench!

From the world's most respected name in oscilloscopes: a new scope, plus a new direct order number, that finally makes it practical to put Tektronix quality on your bench...at work or home.

Among professional engineers and technicians there is no substitute for the performance and reliability of Tektronix oscilloscopes.

Now, for the first time, Tektronix is offering an advanced scope at an unprecedented low price—and has a direct order line that lets you get your order processed today!

The scope: the 2213. Its radical new design brings you Tektronix quality for well below what you would pay for

lesser-name scopes.

The 2213's practical design includes 65% fewer mechanical parts, fewer circuit boards, electrical connectors and cabling. Result: a lower price for you plus far greater reliability.

Yet performance is pure Tektronix: there's 60 MHz bandwidth for digital and high-speed analog circuits. The sensitivity for low signal measurements. The sweep speeds for fast logic families. A complete trigger system for digital, analog or video waveforms. And new high-performance Tektronix probes are included!

2213 PERFORMANCE DATA

Bandwidth: Two channels, dc—60 MHz from 10 V/div to 20 mV/div. (50 MHz from

2 mV/div to 10 mV/div).

Sweep speeds: Sweeps from 0.5 s to 50 ns (to 5 ns/div with X10 mag).

Sensitivity: Scale factors from 100 V/div (10X probe) to 2 mV/div (1X probe). Accurate to $\pm 3\%$. Ac or dc coupling.

Delayed sweep measurements: Standard sweep, intensified after delay, and delayed.

(Need dual time-base performance and timing accuracy to $\pm 1.5\%$? Ask about our 2215 priced at \$1400.)

Complete trigger system: Modes include TV field, normal, vertical mode, and automatic; internal, external, and line sources; variable holdoff.

Probes: High perform-

ance, positive attachment, 10-14 pF and 60 MHz at the probe tip.

The price: Just \$1100 complete*. Order direct from Tektronix National Marketing Center. Phones are staffed by technical people to answer your questions about the 2213. Your direct order includes a 15-day return policy and full Tektronix warranty.

Now it's easier than ever to get your hands on a Tek scope!

ORDER TOLL-FREE

800-547-1845

Ask for Department A02

(In Oregon, Alaska and Hawaii: 1-503-627-5402 collect.) Lines are open from 8 am EST to 5 pm PST.

*Price FO B., Beaverton, OR.

WHY K40 BECAME THE LARGEST SELLING CB ANTENNA IN JUST ONE YEAR!

Because

K40

OFFERS A MONEY BACK

DOUBLE GUARANTEE

- TRANSMITS FARTHER
- RECEIVES CLEARER

...THAN ANY ANTENNA
IT REPLACES!



AN AMERICAN MADE PRODUCT
FROM AN AMERICAN COMPANY.

Call your local CB Dealer



For a FREE demo!

AMERICAN ANTENNA
© Copyright 1979 American Antenna Elgin, Illinois

LETTERS

Wrong Wow and Flutter

In the review of the Realistic SCT-32 cassette deck, the figure given for wow and flutter should have been 0.06% not 0.6%.—*M. Winston, Radio Shack, Ft. Worth, TX.*

Bass Boost and Distortion

Re "Electronic Bass Boost for Woofers" (November 1981), distortion is proportional to how far the diaphragm moves. Including greater motion by "equalizing" or whatever other means must inevitably create an increase in modulation distortion.

Harmonic distortion in loudspeakers, even up to several percent, may be ignored because the frequencies generated are harmonically related to the input frequencies. But modulation distortion, even in amounts of a fraction of a percent, causes objectionable effects.

Certain reviews deny the audibility and even the existence of modulation distortion, although both frequency-modulation distortion and amplitude-modulation distortion have been measured and demonstrated to be audibly perceived. For those who are deaf to distortion, bass boost is the way to go.—*Paul W. Klipsch, Klipsch and Associates, Hope, AK.*

Author's reply: Distortion is only indirectly related to diaphragm excursion. A driver's range of linear (undistorted) motion may be limited by its suspension, by voice coil overhang, and by the non-linearity of air under compression in the speaker enclosure. Larger drivers do not automatically guarantee lower distortion. Small drivers will often exhibit less transient, harmonic, and intermodulation distortion than larger drivers that have less cone motion due to imperfect piston motion of larger diaphragms. Intermodulation is normally present in music, but can be aggravated by cone breakup in larger diaphragms.

Equalization does not necessarily increase cone motion at a given cutoff frequency (for drivers of the same size) where one driver is equalized and the other is not. It can be demonstrated that equalization masks some forms of distortion. Any modulation distortion produced by bass boost is present only during the presence of deep bass in program material. My listening tests have shown this condition to be preferable to a lack of bass reproduction. For example, the lowest note on a piano is 27.5 Hz. If your speakers can't reproduce that note, pianos just won't sound real. (Even

when bass keys aren't struck, their strings resonate, adding to richness of sound.)

This is not to imply that my speakers now equal a pair three times as large with twice as many drivers, costing ten times as much. But distortion becomes noticeable only at sound levels far louder than what I would care to listen to.

Speaker design is very much a series of compromises, of trade-offs between different parameters. Bass equalization is certainly worthy of consideration for high-fidelity applications where healthy bass response is desired from reasonable-size speakers—even though the price is a greater power requirement. It is not necessary to accept high levels of distortion as a trade-off.—*Richard Kaufman, New York, NY.*

CP/M Users Address

In the January 1982 issue (p 30) the address for the CP/M Users Group, from which Computer Languages for CP/M use are available, should be 1651 Third Ave., New York, NY 10028.—*Stan Veit, New York, NY.*

Tax Tips

Your editorial "The IRS Cometh" (December 1981) is well-taken. I hope your readers will see it and heed its advice because it can save them some money.—*W. R. Ham, Jr., Milton, WV.*

Making PC Boards

In building projects from your magazine, I have developed a process for making pc boards that, I think, is simple and does not require any special photographic equipment. First, make a copy of the foil pattern on a photo-copying machine. Use a machine that produces clean white areas and a solid black trace. Second, make a negative on high-contrast film by direct-contact printing. The exposure is made with the photocopy face down against the emulsion on the film. Experiment with exposure times to get the best contrast. Finally, make the pc board from the negative, using negative photo-sensitive resist. To improve this process even more, it would be helpful if you printed the patterns with nothing on the reverse side so the photocopy step could be omitted and the negative made by direct-copy printing through the page.—*Kenrick Chin, Hamilton, Ontario, Canada.*

Introducing incredible tuning accuracy at an incredibly affordable price. The Command Series RF-3100 31-band AM/FM/SW receiver.* No other shortwave receiver brings in PLL quartz synthesized tuning and all-band digital readout for as low a price.† The tuner tracks and "locks" onto your signal and the 5-digit display shows exactly what frequency you're on.

There are other ways the RF-3100 commands the airways: It can travel the full length of the shortwave band (that's 1.6 to 30 MHz). It eliminates interference when stations overlap by narrowing the broadcast band. It improves reception in strong signal areas with RF Gain Control. And the RF-3100 catches Morse

communications accurately with BFO Pitch Control.

Want to bring in your favorite programs without lifting a finger? Then consider the Panasonic RF-6300 8-band AM/FM/SW receiver (1.6 to 30 MHz) has microcomputerized preset pushbutton tuning, for programming 12 different broadcasts, or the same broadcast 12 days in a row. Automatically. It even has a quartz alarm clock that turns the radio on and off to play your favorite broadcasts.

The Command Series RF-3100 and RF-6300. Two more ways to roam the globe at the speed of sound. Only from Panasonic.

*Shortwave reception will vary with antenna, weather conditions, operator's geographic location and other factors. An outside antenna may be required for maximum shortwave reception.

†Based on a comparison of suggested retail prices.



This Panasonic Command Series™ shortwave receiver brings the state of the art closer to the state of your pocketbook.



With PLL Quartz Synthesized Tuning and Digital Frequency Readout.

Panasonic
just slightly ahead of our time.

CIRCLE NO. 35 ON FREE INFORMATION CARD

NEW PRODUCTS

Additional information on new products covered in this section is available from the manufacturers. Either circle the item's code number on the Free Information Card or write to the manufacturer at the address given.

MOSFET-Output AM/FM Receiver

Cybernet's Kyocera Model R-451 is a 45-W/ch receiver rated at a frequency response from 20-20,000 Hz with a THD of 0.015%. Weighted S/N is 80 dB for



phono and 95 dB for other amplifier functions. The amplifier section uses a MOSFET output that is said to extend the power bandwidth to the higher frequencies. The FM tuner features linear i-f filters and a quartz PLL to give an S/N of 80 dB in mono and 74 dB in stereo. A fluoroscan digital read-out displays station frequencies; automatic or manual tuning allows one to program up to seven AM and seven FM stations (14 in all). Bass and treble tone controls provide sound shaping at ± 10 dB (100 Hz for bass and 10 KHz for treble). Also included is a subsonic filter of 12 dB/octave, and a high-frequency filter of 6 dB/octave. The system has two tape inputs with dubbing facilities. Function controls are soft-touch. \$570.

CIRCLE NO. 87 ON FREE INFORMATION CARD

Inductive-coupled Modem

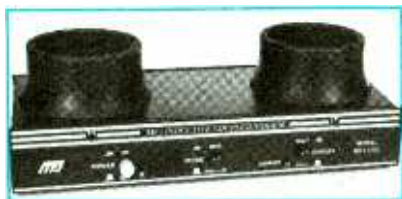

The MFJ-1230 Originate/Answer Modem resembles an acoustic modem, and functions the same way; but it uses an inductive-coupling technique for receiving. This technique is reported to give a more reliable data transfer by eliminating room noise and vibration errors. Bell 103-

Flat 2-inch TV Receiver



Sony's FD-200 (FD for Flat Display) is an ultra-thin, 2-in. screen, black-and-white TV that can be operated in the palm of one's hand. According to Sony, the small size is made possible by positioning the electron gun parallel to instead of behind the phosphor screen. Also by using a miniturized flyback transformer, a very thin deflection yoke, and extensive use of ICs in the power supply circuit. The unit features electronic tuning, and a sound-only switch—permitting the picture to be turned off while only the TV sound is heard. An ear-receiver (MDR-E3) is supplied for private listening; and the unit will also accommodate Walkman-type headphones. Power consumption is 1.8 W when video operates. There are four possible power sources: four AA batteries, an optional rechargeable BP-82 battery, household power (a power adapter is supplied), and a car battery (an external antenna jack accommodates a car antenna). Dimensions : $3\frac{1}{2}$ "W x $3\frac{3}{4}$ "H x $1\frac{1}{4}$ "D; weight is 1.2 lb. \$240.

CIRCLE NO. 89 ON FREE INFORMATION CARD

NR/Dynamic Range System

dbx, Inc. has integrated its noise reduction system with dynamic range expansion circuitry. According to dbx, the new Model 228 Tape Noise Reduction/Dynamic Range Expansion System is suitable for use with two-head recorders, and can provide full monitoring capability with three-head recorders. The unit is reported to offer noise reduction of 30 dB for tapes recorded on dbx equipment; 20 dB for FM broadcasts, pre-recorded tapes, and conventional LPs. Dynamic range is stated as

110 dB; and a dynamic range increase of 50% for commercially recorded music and FM broadcasts. Frequency response is given as 20-20,000 Hz ± 1.0 dB for the expander section; 40-20,000 Hz ± 0.5 dB for the noise reduction section. Expander section THD: 0.1% at 1.0 expansion; noise reduction THD: 0.1% from 100 to 20,000 Hz. IM distortion is 0.2%. Standard 19" rack mounts are supplied; wood sides available at additional cost. \$500.

CIRCLE NO. 91 ON FREE INFORMATION CARD



Portable Mike Mixer

The Shure Brothers compact M267 microphone mixer has four inputs that are



switchable to provide simplex power for condenser microphones. Featuring balanced, transformer-coupled line- and microphone-level outputs, specifications for the M267 are: frequency response 30 to 20,000 Hz ± 2 dB; total harmonic distortion, less than 0.35%; intermodulation distortion less than 0.5%; and maximum out-

compatible, the MFJ-1230 can operate at up to 300 baud, in half- and full-duplex modes, and has a six-pole active-bandpass filter to handle weak signals. It provides TTL and CMOS inputs and outputs, as well as RS-232 compatibility—covering the interfaces of almost all computers. Also, input/output ports for a cassette recorder let you save data for reloading or retransmission. A carrier-detect LED indicates when a signal has adequate strength for data recognition; there is no audio tone during a no-connect condition. The unit uses 110 V ac, or two internal 9-V batteries. \$130.

CIRCLE NO. 88 ON FREE INFORMATION CARD

Why use their flexible discs:

Athana, BASF, Control Data, Dysan, IBM, Maxell, Nashua, Scotch, Shugart, Syncom, 3M, Verbatim or Wabash

when you could be using

MEMOREX

high quality error free discs?

Product Description	Part #	CE quant. 100 price per disc (\$)
8" SSSD IBM Compatible (128 B/S, 26 Sectors)	3062	2.09
8" SSSD Shugart Compatible, 32 Hard Sector	3015	2.09
8" SSDD IBM Compatible (128 B/S, 26 Sectors)	3090	2.74
8" DSDD Soft Sector (Unformatted)	3102	3.34
8" DSDD Soft Sector (128 B/S, 26 Sectors)	3115	3.34
8" DSDD Soft Sector (256 B/S, 26 Sectors)	3103	3.34
8" DSDD Soft Sector (512 B/S, 15 Sectors)	3114	3.34
8" DSDD Soft Sector (1024 B/S, 8 Sectors)	3104	3.34
8" DSDD Burroughs B-80 Comp., 32 Hard Sector	3092	3.34
8" DSDD Shugart Compatible, 32 Hard Sector	3181	3.34
5 1/4" SSSD Soft Sector (Unformatted)	3401	1.94
5 1/4" SSDD Soft Sector w/Hub Ring	3481	2.34
5 1/4" SSDD 10 Hard Sector w/Hub Ring	3483	2.34
5 1/4" SSDD 16 Hard Sector w/Hub Ring	3485	2.34
5 1/4" DSDD Soft Sector w/Hub Ring	3491	3.09
5 1/4" DSDD 10 Hard Sector w/Hub Ring	3493	3.09
5 1/4" DSDD 16 Hard Sector w/Hub Ring	3495	3.09

SSSD = Single Sided Single Density; SSDD = Single Sided Double Density
DSDD = Double Sided Double Density

Memorex Flexible Discs...The Ultimate in Memory Excellence

Quality

Memorex means quality products that you can depend on. Quality control at Memorex means starting with the best materials available. Continual surveillance throughout the entire manufacturing process. The benefit of Memorex's years of experience in magnetic media production, resulting, for instance, in proprietary coating formulations. The most sophisticated testing procedures you'll find anywhere in the business.

100 Percent Error Free

Each and every Memorex Flexible Disc is certified to be 100 percent error free. Each track of each flexible disc is tested, individually, to Memorex's stringent standards of excellence. They test signal amplitude, resolution, low-pass modulation, overwrite, missing pulse error and extra pulse error. They are torque-tested, and competitively tested on drives available from almost every major drive manufacturer in the industry including drives that Memorex manufactures. Rigid quality audits are built into every step of the manufacturing process and stringent testing result in a standard of excellence that assures you, our customer, of a quality product designed for increased data reliability and consistent top performance.

Customer-Oriented Packaging

Memorex's commitment to excellent does not stop with a quality product. They are proud of their flexible discs and they package them with pride. Both their packaging and their labeling have been designed with your ease of identification and use in mind. The desktop box containing ten discs is convenient for filing and storage. Both box labels and jacket labels provide full information on compatibility, density, sectoring, and record length. Envelopes with multi-language care and handling instructions and color-coded removable labels are included. A write-protect feature is available to provide data security.

Full One Year Warranty—Your Assurance of Quality

Memorex Flexible Discs will be replaced free of charge by Memorex if they are found to be defective in materials or workmanship within one year of the date of purchase. Other than replacement, Memorex will not be responsible for any damages or losses (including consequential damages) caused by the use of Memorex Flexible Discs.

Quantity Discounts Available

Memorex Flexible Discs are packed 10 discs to a carton and 10 cartons to a case. Please order only in increments of 100 units for quantity 100 pricing. We are also willing to accommodate your smaller orders. Quantities less than 100 units are available in increments of 10 units at a 10% surcharge. **Quantity discounts** are also available. Order 500 or more discs at the same time and deduct 1%; 1,000 or more saves you 2%; 2,000 or more saves you 3%; 5,000 or more saves you 4%; 10,000 or more saves you 5%; 25,000 or more saves you 6%; 50,000 or more saves you 7% and 100,000 or more discs earns you an 8% discount off our super low quantity 100 price. Almost all Memorex Flexible Discs are immediately available from CE. Our warehouse facilities are equipped to help us get you the quality product you need, when you need it. If you need further assistance to find the flexible disc that's right for you, call the Memorex compatibility hotline. Dial toll-free 800-538-8080 and ask for the flexible disc hotline extension 0997. In California dial 800-672-3525 extension 0997. Outside the U.S.A. dial 408-987-0997.

Buy with Confidence

To get the fastest delivery from CE of your Memorex Flexible Discs, send or phone your order directly to our Computer Products Division. Be sure to calculate your price using the CE prices in this ad. Michigan residents please add 4% sales tax. Written purchase orders are accepted from approved government agencies and most well rated firms at a 30% surcharge for net 30 billing. All sales are final. Prices, terms and specifications are subject to change without notice. Out of stock items will be placed on backorder automatically unless CE is instructed differently. Minimum prepaid order \$50.00. Minimum purchase order \$200.00. International orders are invited with a \$20.00 surcharge for special handling in addition to shipping charges. All shipments are F.O.B. Ann Arbor, Michigan. No COD's please. Non-certified and foreign checks require bank clearance.

Mail orders to: Communications Electronics, Box 1002, Ann Arbor, Michigan 48106 U.S.A. Add \$8.00 per case or partial-case of 100 8-inch discs or \$6.00 per case or partial case of 100 5 1/4-inch mini-discs for U.P.S. ground shipping and handling in the continental U.S.A. If you have a Master Card or Visa card, you may call anytime and place a credit card order. Order toll-free in the U.S. Dial 800-521-4414. If you are outside the U.S. or in Michigan, dial 313-994-4444. Order your high quality, error free Memorex discs today.

Copyright © 1982 Communications Electronics™ Ad # 30882

High Quality Error Free



Order Toll-Free!

(800) 521-4414

In Michigan (313) 994-4444

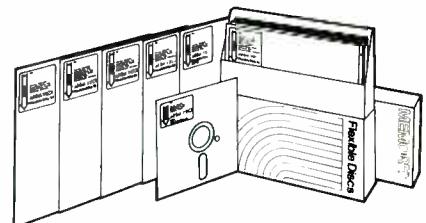

For Data Reliability—Memorex Flexible Discs

COMMUNICATIONS ELECTRONICS™

Computer Products Division

854 Phoenix □ Box 1002 □ Ann Arbor, Michigan 48106 U.S.A.
Call TOLL-FREE (800) 521-4414 or outside U.S.A. (313) 994-4444

put hum/noise, -53 dBV (master control up, input controls down). Each of the M267's four balanced microphone inputs has its own volume control, low-cut filter switch, and line/mic switch. The master volume control sets the overall program output level (+18 dBm maximum). A switchable, fast-attack limiter cuts output overload distortion during loud program segments without affecting normal program levels. In addition to its illuminated VU meter, the mixer has an LED peak indicator that indicates limiter operation. An automatic muting circuit eliminates audible "clicks" and "thumps" during turn-on and turn-off, and the headphone jack doubles as a separate unbalanced line feed. A built-in 1000-Hz tone oscillator (front-panel switchable) permits line test and level checks. The unit is powered by 120-V ac, an integral battery pack, or any external 30-V dc source. \$395

CIRCLE NO. 92 ON FREE INFORMATION CARD

Logic Trainer

The Broder Logic Trainer Model 100 is said to reduce the time required for a student to learn how gates and flip-flops function in circuits. The Trainer covers the following subjects: switch circuits, Venn diagrams, binary and BCD counting, relay logic, diodes, bipolar transistors, and nonlinear FETs. The student solves digital circuit problems by manipulating any of eight external switches; no wire or component manipulation is necessary. The Model 100 uses PMOS LSI circuitry, with an LCD. A 9-V battery is included. \$169.

CIRCLE NO. 93 ON FREE INFORMATION CARD

Cassette Deck with Super-D Noise Reduction

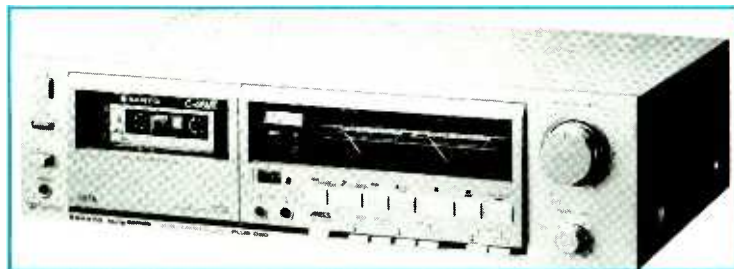

Sanyo's Plus 90 cassette deck is said to be capable of providing a dynamic range of 110 dB, with a signal-to-noise ratio of 100 dB with metal tape. In addition to Super-D noise reduction (which is used in conjunction with Dolby B/C NR), the Plus 90 offers the following: soft-touch, IC-controlled transport; 15-program Automatic Music-Select System (AMSS) which scans the tape at high speed (forward and reverse) and automatically plays the next recorded selection; a mute

Dot Matrix Printer



Developed by Star Micronics, Inc., the Model DP-8480 is an 80-column dot ma-

trix impact printer that features: bi-directional printing with a logic-seeking carriage control; 96-character ASCII, alpha/numeric, and non-Roman alphabet fonts; block graphics capacity; standard parallel interface with optional EIA RS-232C, IEEE-488, and 20 mA interfaces; software-selectable character pitches—10, 12, or 16.7 CPI, with a maximum yield of 132 characters per line; replaceable printing head with a life expectancy given as 100 million characters; and a built-in self-test mode. Dimensions are: 15.3"W x 12.2"D x 4.9"H. Paper width is 8" to 10" for sprocket-fed paper with the optional tractor-feed assembly. \$575; \$590 with tractor-feed.

CIRCLE NO. 95 ON FREE INFORMATION CARD

Microcomputer Board

Commodore Semiconductor has introduced the MMS 6508/1 Micromodule for

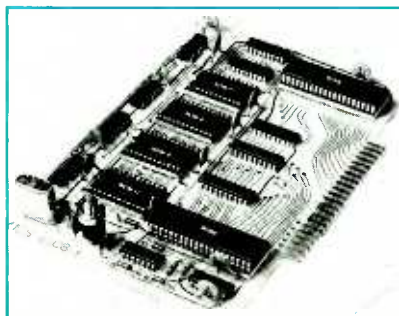

control applications that require only a moderate amount of program storage and read/write memory. Employing a 6508 microprocessor and the new 6525 Tri-port Interface chip, the board is compatible with the 6525 processor, and four 8-bit I/O ports. Sockets are provided for up to 16 K bytes of ROM or EPROM; and there are 1280 bytes of RAM. The edge connector is optimized for direct control rather than system expansion—consisting of the I/O ports, four pins for +5-V dc input power, four ground pins, a RESET line, and two clock phases (O1 and O2) for use in peripheral synchronization. The I/O ports may be configured as either 32 I/O lines, or as 24 I/O lines with two handshake lines and five priority interrupts. \$99.

CIRCLE NO. 96 ON FREE INFORMATION CARD

Low Voltage Soldering Irons

The "Soldr-Mite" from Wall Lenk is a miniature soldering tool that is claimed to



heat quickly (25 to 50s) from a potential of 6 V. Available in six models, from 4.5

CIRCLE NO. 94 ON FREE INFORMATION CARD

Pocket Concert Plus

NOW WITH FM STEREO

JUST \$69⁵⁰

DAK was in trouble. Our Pocket Concert cassette players were selling like crazy. Orders were coming from everywhere. We were able to get 24,000 players, but it wasn't enough. We stopped advertising but the orders still kept coming.

We were in a jam. We had angry customers everywhere. We couldn't find a new player good enough to satisfy our customers, or for that matter ourselves. After all, we had promised a player that could equal the sound of the Sony Walkman.

Well, money talks. Not only did we find a great replacement, but we've even got one with an FM module. It's smaller, lighter and the sound is fabulous. Because of DAK's massive buying ability, (an opening order of 10,000 players), we were able to bargain such a low price that we can offer the new Pocket Concert—Plus FM to you for just 50 cents more than our original cassette-only player.

Don't be confused— This is no cheap \$69 retail player. For example, Pacific Stereo, the gigantic California chain, sold this fine unit in their 'Super Sale' ad of December 20, 1981 for more than 140% of our low discount price. This is a state of the art, musical component you'll enjoy for years.

EXTRA HOME BONUS—Here's a cable system that lets you plug the Pocket Concert Plus into any 'aux' inputs in your home stereo, so you can copy cassettes by playing them on the Pocket Concert Plus and recording them on your main deck, or just listen through your main system. The sound is great. Just add \$4 (\$1 P&H) for the cable. Ord. No. 9200.

It's uncanny. You can sit, walk, ski or mow the lawn. And think of it, you can do it all in an environment controlled totally by YOU.

You can be doing the most mundane task, but your mind may be soaring thousands of miles away. It's no fluke that Sony has sold hundreds of thousands of their Walkman Cassette Players.

The power of music has been used for centuries to rouse the troops and relax the kings. But, only now with the new 1½ oz. Samarium Cobalt headphones are you able to get such a kaleidoscope of sound that the outside world seems to literally disappear.

And, the effect is so total that there are even laws to stop you from wearing these remarkable players while you ride a bike or drive a car.

WHAT SOUND

The sound is easily equal to a several thousand dollar home stereo system. Yet, the new Pocket Concert Plus with both cassette and FM stereo weighs only 12½ oz. and is so small you'll hardly know that you're wearing it.

The Pocket Concert Plus goes where you go with a protective leatherette case that easily hangs on your belt or rides comfortably in your pocket. It also has an adjustable shoulder strap.

So, whether you're into long walks, sitting in airplanes or washing your car, you'll enjoy the unbelievably rich stereo sound of the Pocket Concert Plus.

ENGINEERED FOR STRESS

Most fine stereo equipment is designed to be lovingly placed on a shelf and then never moved. Obviously, this isn't a practical way to listen when you're walking your dog or jogging.

The Pocket Concert Plus is specifically designed for rough treatment. Many other machines are really redesigned dictation recorders. The Pocket Concert Plus is designed to provide superb stable stereo music while you're on the move.



SPEAKER BONUS

\$5



Wow. Now personal stereo for one can be stereo music for all. The same mylar diaphragm technology that makes possible the fabulous feather-weight headphones now makes possible these great monitor speakers.

These speakers are less than 4" tall, and come complete with a connecting cable. They are so efficient that they require no additional amplification and plug in just like the headphones.

For serious listening you will still use your headphones, but for casual listening of portable radio quality, you'll be amazed at the volume level and sound quality of these new feather-weight speakers. With your order for the Pocket Concert Plus only, just add \$5 plus (\$1 Post. & Handling) for your pair of bonus speakers. Order Number 9334.

MUSIC AT YOUR COMMAND

You won't be 'roughing it' when you leave home. You can play all your cassettes since there is an equalization switch for Metal/Chrome or standard.

The sound is crisp and clean with a wide frequency response. It's operated by 3AA batteries, not included. There are convenient lock-in fast forward and rewind buttons, plus cue and review.

CIRCLE NO. 61 ON FREE INFORMATION CARD

You can listen to the outside world by pushing the Mute—FM/Tape switch without taking off the feather-light stereophones. Dual volume controls auto-stop and a LED operation indicator round out the convenience features.

PLUS FM STEREO

Just pop in the FM stereo module instead of a cassette and you'll be tuning in your favorite FM stereo stations.

The FM module automatically direct-couples with the cassette deck so it works off the deck's power. It feeds the FM signal directly to the amplifier, not through the head for great fidelity.

The headphone cable is used as the antenna for FM reception that is equal to the 'FM only' units on the market.

The Pocket Concert Plus utilizes superb electronics and an all new state of the art tape transport for stability. It is manufactured by Unipacific and backed by a standard limited factory warranty.

TRY THE POCKET CONCERT PLUS RISK FREE

Take your Pocket Concert Plus as you commute or on walks. Enjoy breathtaking stereo music wherever you are.

If for any reason you aren't 100% satisfied, simply return it in its original box within 30 days for a courteous refund.

To order your Pocket Concert Plus including the FM module, risk free with your credit card, call our toll free hotline, or send your check for just \$69.50. Plus \$2.50 postage and handling. Order Number 9303. If you wish the optional home cable and/or speaker bonuses, see above for their price and order numbers. Calif. residents please add 6% sales tax.

You'll be in control of your own environment and enjoying your favorite cassette and FM stereo music with the great sound of the Pocket Concert Plus.



Call TOLL-FREE (800) 423-2636
In California Call (213) 984-1559
10845 Vanowen St., North Hollywood, CA 91605

Memory

4116-250nS	8/14.95
4116-200nS	8/17.95
2114L	8/17.95
6116 2K x 8 CMOS RAM 200nS	12.95
2708 EPROM	3.49
2716 EPROM	5.49
2732 EPROM	12.99
2764 EPROM	34.95
Z6132 4K x 8 Quasi-Static RAM	24.95

Microprocessor & Interface

1771	24 50 6845	18 49 OAC-0800	3 99
1791	34.95 6850	4 49 INS8250	14 90
21102	1 49 8085A	8 95 MM58167	8 75
2112	2 39 8212	2 75 TMS9900	29 95
2516	5 49 8214	3 95 TR1602B	2 49
2532	12 99 8216	2 75 SC-01	55 00
2651	12 95 8224	3 29 Z80A-CPU	7 95
4044L-2	2 49 8226	2 79 Z80ACT	7 49
6502	8 99 8228	4 49 Z80A0art	19 95
6800	6 99 8251	6 95 Z80API0	7 49
6802	11 95 8255	6 49 Z80ASIO	17 95
6809	19 95 AY5-1013A	4 95 Z8603	74 95
6821	4 95 AY5-2376	14 95 Z8671	29 95

1 Amp TO-220 Voltage Regulators

PART #	1-24	25-99	100-499
7805 (LM340T-5)	.85	.75	.65
7812 (LM340T-12)	.85	.75	.65
7815 (LM340T-15)	.85	.75	.65
7818 (LM340T-18)	.85	.75	.65

Linear Integrated Circuits

8038	3 95 LM393	97 MC3302	90
LF351	75 LM733	99 MC1458	59
LF353	1 29 LM741-8	35 MC1514	1 39
LF357	1 39 LM741-14	35 NE555	45
LM301	45 LM747	77 NE556	.98
LM307	49 LM748	49 NE565	1 25
LM311	95 LM1310	2 49 NE5534	2 35
LM318	1 75 LM1458	69 NE5538	2 25
LM324	90 LM1800	2 49 SSM2010	7 50
LM339	79 LM1818	3 49 SSM2020	7 50
LM358	90 LM1889	2 99 SSM2030	7 50
LM377	2 49 LM2900	.69 SSM2040	7 50
LM380N-14	1 25 LM3900	89 SSM2044	5 75
LM381	1 89 LM3905	1 49 SSM2055	6 50
LM383	3 29 LM3914	3 79 XR2206	5 19
LM384	1 95 LM3915	3 79 XR4136	99
LM386	99 LM3916	3 79 XR4741	1 95
LM387	1 49 LM4500	3 29 XR558	1 99

5% Carbon Film Resistors

We stock all 5% standard values between 1 Ohm and 1 Meg Ohm.

¼ Watt

Package of 5	20
Package of 100 (one value)	1.65
Package of 1000 (one value)	12.00

½ Watt

Package of 5	25
Package of 100 (one value)	1.75
Package of 1000 (one value)	15.00

Sampler box consisting of 5 each of all 145 standard 5% values between 1 Ohm and 1 Meg Ohm.

¼ Watt Sampler Box	22.00
½ Watt Sampler Box	27.00

Minimum Order \$10.00

Shipping

10-24.99	3.00	Above 50.00	FREE
25-49.99	1.50	C.O.D.	Add 1.65

WESTLAND ELECTRONICS

37387 Ford Rd. • Westland, Mi 48185
Order Line - 1-800-521-0664
In Michigan - 313-728-0650

CIRCLE NO. 50 ON FREE INFORMATION CARD

new products

to 18.0W, with rated tip temperatures from 630°F to 960°F, each iron weighs less than ¼ oz. The thin shaft is said to afford improved visibility of the work area. Options include a variety of tips, a transformer with lighted ON-OFF switch, and a separate tool holder with sponge. Address: Wall Lenk Corp., Box 3349, Kinston, NC 28502-3349

Talking Pocket Calculator

Incorporating voice-synthesis technology, Sharp Electronics has introduced the Model EL-620 pocket-size calculator. It is said to deliver a clear "voice" announcement of whatever numeral has been depressed on the keyboard, as well as indicating which arithmetic operation has been selected. The answer, expressed in the proper units (hundred, thousand, million) is also announced. Other keyed entries are announced by a musical beep tone for verification. The EL-620 operates from three mercury batteries or an optional ac adapter. The 8-digit LCD model accommodates the four arithmetic functions, percent, square root, and a 4-key memory. Dimensions are: 3"W x 5½"H x ½"D. The calculator comes with a carrying wallet.

CIRCLE NO. 97 ON FREE INFORMATION CARD

Video Display Terminal



Altos Computer Systems has introduced its first video terminal, the Altos 1. It has a detached keyboard with a tiltable, rotating, green-phosphor display. The typewriter-style board (105 keys) is connected to the display via a 6-ft. cable. It can format 24 lines with 80 characters per row, with two additional lines for messages and function key identification. Eight program keys plus a function key provide up to 96 codes; 14 keys include the

numbers 0-9, period, comma, minus, and enter/tab. Functional command, editing, and cursor keys allow editing options as well as "send" and "print." The display is also capable of line drawing and horizontal/vertical split screen with independent scrolling. The Altos 1 uses 15 transmission baud rates from 50 to 9600 cps via a standard RS-232C interface. The printer port allows data transfers at the same rates. \$995.

CIRCLE NO. 98 ON FREE INFORMATION CARD

Beckman DMM



The new Tech™ 320B portable digital multimeter from Beckman Instruments has both visual and audible indication of continuity. That is, the meter will alert the user with a single "beep" tone when continuity is detected. Continuity is indicated visually by the appearance of an ohms omega in the corner of the LCD. The 320B has 29 ranges, with overload protection: voltage is protected to 1,500 V dc/1,000 V ac; resistance is protected to 500 V; current ranges are protected with a 2-A/250-V fuse, and are rated up to 20 A for 30 s. Resistance measurements are said to be sensitive enough to operate in-circuit (without turning on the diodes or semiconductors of the circuit being tested). A separate semiconductor test function provides a 0-2-V, 2-mA constant test current. Basic accuracy is given as 0.1%. \$189.

CIRCLE NO. 99 ON FREE INFORMATION CARD

Lighted CB Antenna

The Laser Rod is a tunable-tip CB antenna with 500 W of power. It can light up with a parallel array of replaceable bulbs (red, blue, green, amber, or clear), adding, it is claimed, to the visibility and bodaciousness of your rig. Available in 2' and 3' lengths, it transmits or receives with the lights on or off. Options include a switch and bracket, extra conductor wire, and cigarette lighter plug. \$28 for the two-footer; \$30 for the three.

CIRCLE NO. 100 ON FREE INFORMATION CARD

PEOPLE WHO OWN A FOX SCANNER...



LOVE ITS SIZE

The Fox BMP 10/60 is the smallest, lightest base station on the market today.



USE IT ANYWHERE

The Fox BMP 10/60 is the most versatile scanner in the world. With our optional Porta-Pac, it can be easily carried over your shoulder. * With our optional Mobile Mounting Bracket, it's a snap to attach it to your car.

TURN ON TO ADVENTURE

The FOX BMP 10/60 is packed with professional features—Skip, Action and Pause capabilities, two full watts of audio, complete 10 channel programmability and lots more. Scanning has never been easier, or more fun.



GET A FREE \$15 SPEAKER

Buy the BMP 10/60 now, and we'll send you a 4 watt Mini-Speaker free. Offer expires June 30, 1982. Ask your dealer for full details.

Call 800-543-7892 for the dealer nearest you, or ask about ordering directly from our factory.



Fox Marketing, Inc.

4518 Taylorsville Road • Dayton, Ohio 45424

*Some states may prohibit use of scanners in mobile or portable applications. Check your local laws.

CIRCLE NO. 17 ON FREE INFORMATION CARD

By Len Feldman

Listening Locations Equalized Digitally

WHILE everyone is busy predicting the "marriage" of audio and video, there has been little mention of a more obvious combining of technologies: audio and computers. To date, the incorporation of computer technology into audio gear has been almost crude, in terms of the microcomputer's true potential. Various memorizing functions (pre-setting of favorite stations on a frequency-synthesizing tuner), and timing functions (pre-programming of a video cassette recorder) have constituted the chief uses of microprocessors in audio/video applications.

If Acoustic Research, the well-known speaker system manufacturer, has its way, all of that is about to change. In last month's column I touched briefly upon AR's Adaptive Digital Signal Processor (ADSP), a "smart digital audio component" that can recognize and automatically correct frequency response errors in a sound reproduction system. According to AR's director of research,

Bob Berkovitz, the ADSP is especially effective in correcting loudspeaker shortcomings and errors related to non-ideal room acoustics.

The ADSP derives its "intelligence" from a novel computer program developed at AR. The program employs mathematical techniques which have, until now, been used primarily for speech synthesis and economic modeling. The millions of calculations required to execute the program are performed by a new 16-bit NMOS microcomputer chip produced by Texas Instruments, who worked on the project with the AR research team.

While first impressions of the ADSP suggest a glorified graphic or parametric equalizer, it is actually quite different from any analog equalizer. For example, it has no fixed-frequency characteristics, such as a definite number of bands, center frequencies, or filter bandwidths. The ADSP operates in a *time* domain, dividing the program into thou-

sands of fragments per second, through digital sampling. It then adds error correction to each fragment and finally reassembles them back into recognizable analog music signals. But for all the complexity of its computer program, the ADSP is as easy to use as some of the self-analyzing analog equalizer systems now available.

To activate the ADSP while listening to music, you simply press a button on a small hand-held module which also houses a tiny microphone. The music is then temporarily interrupted and the computer in the ADSP converts a series of numbers in its memory into a test signal which sounds a bit like white noise. This test signal is heard briefly from each of the two loudspeakers and is picked up by the hand-held microphone. The signal is then converted into a series of several thousand numbers which are stored in memory. These numbers are analyzed by the ADSP's computer for a mathematical order that indicates regular patterns. Patterns discovered in this way are then used by the computer to design a correction filter.

During this complex process (some of which AR left intentionally vague since full patent protection is still being obtained), numbers in another part of the ADSP's memory converge to a code that is a mirror image of the sonic errors produced by the loudspeaker/room-acoustics combination. The ADSP adds these "opposite errors" to the music signal. Now when music is played through the sound system and into the room, the two sets of errors cancel. The sound reaching the listener (at the position where the microphone module was originally held) is thus a more faithful reproduction of the original music. Because ADSP has no preset filter bands or adjustments, it can synthesize as many digital filters as are needed—normally a far greater number than the usual eight or ten bands associated with analog graphic equalizers. Typically, the ADSP will be called upon to provide extremely narrow filters, with more than fifty peaks and dips in a 1000-Hz bandwidth.

However, ADSP works only in the frequency region below 1 kHz. This represents about five out of ten octaves of the audio spectrum. But AR's research people maintain that errors in system response *above* 1 kHz in a typical listening room are affected more by a turn of the listener's head than by room acoustics. Flat response above that midpoint, they claim, is largely a matter of the manufacturer's choosing the correct combination of midrange and tweeter drivers when designing the speakers. Failing this, correction above 1 kHz is most easily accomplished using ordinary tone controls, since sharp peaks and valleys caused by room resonances are not commonly found in these upper frequency ranges.

The ADSP is not available yet, but AR hopes to have a first version of the device at retail outlets by mid-1982. The projected price should be under \$2000. ♦

HOW THE ADSP HANDLES ROOM REFLECTIONS

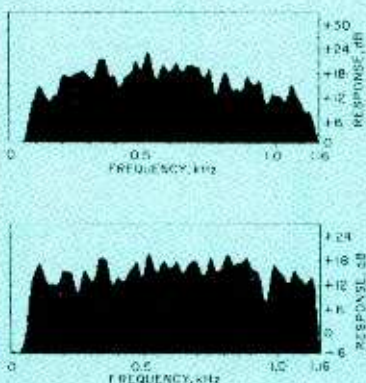

Effect before and after (top and bottom) of ADSP on a typical speaker.

The ADSP hardware, as presently configured, consists of Texas Instruments' TMS-9995 NMOS microprocessor and more than 100 integrated circuits driven by AR's proprietary software program. Unlike analog devices that may use microprocessors (and are often referred to as computer-operated components), the ADSP is entirely software-dependent.

To give an idea of how the system actually works, consider a good audiophile speaker in a typical listening room. The speaker, if measured in an anechoic chamber, would have yielded a uniform response to below 50 Hz. Yet, when measured in the listening room, the response is far from smooth (shown at top). After the application of the ADSP filter, however, a much flatter curve was obtained (shown at bottom). The important point to observe here is that the *degree* of detail provided by the ADSP correction is far greater than that provided by any analog equalizer available for home or professional use.

NEW! Here's a professional, portable DC-20 MHz Oscilloscope with build-it-yourself Heathkit savings



Compact enough to fit under an airplane seat, the Heathkit IO-3220 represents outstanding value in its class. Weighing only 16 pounds, the IO-3220 is designed for field service troubleshooters who need a light, portable battery-operated scope for use where AC power is not available.

Dual-trace versatility: The IO-3220 allows you to compare two different signals simultaneously – to make input/output comparisons, check phase relationships and accomplish other complex measurements. Algebraic functions add versatility.

Special invert display function: Enables you to compare two waveforms that are nearly 180 degrees out of phase – by inverting one of the waveforms.

FREE CATALOG

Complete details on Heathkit oscilloscopes – and nearly 400 other electronic kits for your home, work or pleasure – are in the new Heathkit catalog. Send the coupon at right for yours today, or pick one up at any of the 65 convenient Heathkit Electronic Centers** located throughout the U.S. and Canada.

If coupon is missing, write Heath Co., Dept. 010-896, Benton Harbor, MI 49022. In Canada write Heath Co., 148C Dundas St. E., Mississauga, Ont. L4X 2R7.



Heathkit®

*Mail Order, F.O.B. Benton Harbor, MI. Also available assembled, mail order priced at \$995.00. F.O.B. Prices, specifications and product availability subject to change without notice. ** See the white pages of your telephone book for the Heathkit Electronic Center nearest you. Heathkit Electronic Centers in the U.S. are operated by Veritechnology Electronics Corporation, a wholly-owned subsidiary of Zenith Radio Corporation. GX-387

CIRCLE NO. 28 ON FREE INFORMATION CARD



X-Y inputs for Lissajous measurements: Feed two separate input signals to the IO-3220.

Wide DC-20 MHz bandwidth: The IO-3220 can measure a very wide range of input signals.

Outstanding sensitivity: Vertical signals as low as 2 millivolts can be accurately measured by the very sensitive IO-3220. Accuracy is as high as 3 percent (from 20-30 deg. C), on both vertical and horizontal measurements.

Save more than 30% when you build it yourself: The IO-3220 Portable 20 MHz Oscilloscope Kit is value-priced at just \$689.95*.

Easy to build: Thorough Heathkit assembly manuals take you step-by-step, from unpacking to final plug-in. Anyone can do it. And experienced service techs are just a phone call away, to help you during building or servicing.

MAIL TO: Heath Company, Dept. 010-896
Benton Harbor, MI 49022

YES, Please send me your free Heathkit Catalog.
I'm not currently receiving your catalog.

Name _____

Address _____

City _____ State _____

GX-387 _____ Zip _____

**A STEP BEYOND
EXTRAORDINARY**

SHURE®



INTRODUCING THE V15 TYPE V

**MĀSAR™ POLISHED
HYPERELLIPTICAL
STYLUS TIP**

**BERYLLIUM
MICROWALL/BE
STYLUS SHANK**

**DYNAMIC STABILIZER/
DESTATICIZER**

**SIDE-GUARD
PROTECTION
SYSTEM**

FEATURING MICROWALL/Be TECHNOLOGY™

This revolutionary new phono cartridge is not just an advance in design... it's a quantum leap forward resulting in superior sound reproduction. The V15 Type V not only re-creates the music... it brings back the emotion of the performance! It solves such ever-present, record playback problems as "Superdisc" hot signals, record warp, static electricity, record wear, cartridge misalignment, and stylus breakage.

The Type V is totally optimized for flawless performance at 1.0 gram tracking force. Its trackability in the critical 5 kHz-plus region is double that of the nearest competitor; and its high frequency mechanical resonance is well beyond the audible range. All of this is due to the incredible Beryllium MicrOwall Technology Shure developed specifically for this cartridge.

A MASAR™-polished stylus tip contributes far less to record wear than any other high performance cartridge. This impressive array of features combines to give performance that goes far beyond what was —until now— considered the best. The performance is so improved that an entirely new, landmark system of measurement was developed: the Total Trackability Index (TTI).

PLUS! With the V15 Type V you'll receive a certificate good for Shure's newly developed TTR117 Trackability Test Record. Valued at \$15.00, this new standard-setting test record is yours **FREE!**
Send for our fact-filled brochure on this remarkable new cartridge. Ask for AL694.

No other cartridge, at any price, offers all these benefits:

- Incredibly accurate high frequency trackability due to the revolutionary new high stiffness, low mass Beryllium MICROWALL/Be™ stylus shank.
- Exclusive DYNAMIC STABILIZER that functions like a miniature shock absorber to eliminate warp-related problems such as groove skipping, cartridge bottoming, and signal wow. Simultaneously discharges surface static electricity.
- Accurate, distortion-free tracking—a result of the HYPERELLIPTICAL stylus tip.
- Reduced record-wall friction, stylus and record wear with the first MASAR™-polished stylus tip on a consumer cartridge.
- Unique SIDE-GUARD stylus protection system prevents accidental stylus damage.
- Highest performance with lowest record wear due to optimizing for 1.0 GRAM TRACKING FORCE.
- Designed with an ULTRA-FLAT FREQUENCY RESPONSE resulting in natural, uncolored sound.
- LEVELING ALIGNMENT STYLUS included to minimize crosstalk and maximize channel separation.
- DUO-POINT ALIGNMENT GAUGE included to minimize lateral tracking error distortion.
- A serialized, individual COMPUTER PRINT-OUT that verifies your cartridge's performance.



SHURE®

YOU'LL HEAR MORE FROM US

Shure Brothers Inc., 222 Hartrey Ave., Evanston, IL 60204

CIRCLE NO. 44 ON FREE INFORMATION CARD

Audio Product of the Month

CHOSEN BY THE EDITORS OF POPULAR ELECTRONICS

Acoustic Research AR48s Three-Way Speaker System

THE AR48s is one of the largest "bookshelf" speaker systems currently available from Acoustic Research. It is a three-way system, employing a 10-in. acoustic suspension woofer in a 1.32-liter sealed enclosure, a newly designed four-in. midrange cone driver in a sealed enclosure, and a one-in. dome high-frequency radiator. The crossover frequencies are 400 and 2500 Hz, and rated 3-dB bandwidth is 45 to 24,000 Hz.

Nominally a 6-ohm system, the AR48s has a rated minimum impedance of 4.8 ohms. The cabinet, covered with walnut-grain vinyl veneer, measures 25" x 14" x 10 $\frac{3}{4}$ " and has a dark brown cloth grille retained by plastic snaps. The speaker system weighs 38 lb. Suggested retail price is \$210.

General Description. Although the AR48s is not too different from its predecessors, it is novel in at least two areas: the new 4-in. midrange driver and the computer-designed crossover network described below.

The midrange (roughly 300 to 3000 Hz) is the most critical part of the audio spectrum for natural reproduction of the human voice. AR designed its 4-in. driver to cover this entire band, avoiding aberrations that could otherwise result from a crossover between drivers.

To obtain a smooth, uncolored output from a driver, it is necessary to suppress any resonant modes in its cone. These modes can introduce dips and peaks toward the higher end of the speaker's operating range that the crossover network cannot remove without sacrificing

the driver's high-frequency response.

AR cones, in general, are designed to be mechanically "lossy," and thus absorb internal reflections that could roughen their response. This is one reason for their continuing use of the paper cone (instead of plastic and metallic cone materials). They treat the paper cone with proprietary damping liquids that, once absorbed, deaden acoustic transmission.

A different method is used in the new AR 4-in. driver. Its cone is made of a fibrous material that is inherently lossy throughout its entire thickness and requires no additional treatment to achieve the desired low "Q." According to AR, this gives the small cone more consistent performance than would be possible with treated paper. To the touch, the AR midrange driver cone has a felt-like texture and consistency.

The AR48s crossover network has an unusual design. Its 12-dB-per-octave rolloff would normally call for four inductors and four capacitors, but by using a series configuration for the two lower frequency speakers and a parallel network for the tweeter, the two 3.8-mH coils needed for the 400-Hz crossover are replaced by a single 2.3-mH inductor. And since air-core windings are used, the savings in copper for the smaller inductor are appreciable.

The AR48s has been designed to give its flattest overall response with either of two room placements: against a wall at approximately ear height, and on the floor next to the wall. However, placing the speaker on a stand (or a foot or two from the wall) will permit cancellations from floor or wall reflections to degrade bass performance.

For an acoustic suspension speaker system, the AR48s is moderately efficient. Its rated voltage sensitivity is 88 dB Sound Pressure Level (SPL) at 1 meter on axis with 2.83 V applied. The recommended range of amplifier power is 15 to 100 W per channel. Acoustic Research defines very specific high-



power limitations: the AR48s can handle 100 W of continuous power, with the amplifier being driven into clipping no more than 10% of the time on normal speech and music in noncommercial applications (no public address or disco service). Since the AR48s's frequency response has been optimized by careful design of the drivers and crossover network, no user-accessible balance controls are provided. The input connectors are insulated spring clips with holes that accept stripped wires.

Laboratory Measurements. The room response of two AR48s's was measured with the speakers against a wall (about 28 inches above the floor), and the microphone on the axis of one and about 30 degrees off the axis of the other. The averaged response was almost perfectly flat, with small fluctuations that are characteristic of a "live room" measurement. The left and right speaker curves did not diverge appreciably until the test frequency exceeded 10,000 Hz, indicating very good tweeter dispersion characteristics.

The bass response was measured with close microphone spacing to eliminate room interactions and give a true anechoic response. Speaker output was maximum at 80 Hz, falling off gradually at higher frequencies and at 12 dB per octave at lower frequencies. Combining the bass and room response to create a composite frequency characteristic resulted in an impressively uniform curve that varied only ± 2.5 dB from 45 to 20,000 Hz. Using our analysis program with an Apple II computer, we were able to measure the anechoic frequency response of the AR48s from 180 to 17,000 Hz (these frequency limits are set by the measurement system, not the speaker). There were fairly narrow response dips at 3500 and 6500 Hz, and a peak of about 3 dB at 16,000 Hz, but the overall response (on axis) was within ± 3 dB from 180 to 17,000 Hz.

The bass distortion, also measured with close microphone spacing, was very low. At a 2.83-V (nominal 2-W) drive level the distortion was less than 0.5% everywhere down to 60 Hz, 1% at 50 Hz, and 3.6% at 40 Hz. A 10-dB level increase (nominal 10 W) made little difference. Distortion was about 1% everywhere down to 60 Hz, 2.5% at 50 Hz, and 5.6% at 40 Hz.

The AR48s's impedance was slightly lower than rated, reaching a minimum of 3.5 ohms from 700 to 900 Hz. Over the remaining audio range it was typically 4.5 to 9 ohms, with a maximum of 15 ohms at 56 Hz. Voltage sensitivity was exactly as rated, 88 dB SPL at 1 meter when driven by 2.83 V of random noise in the octave centered at 1 kHz.

User Comment. The AR48s shares a basic quality of all AR speakers: deep, clean, effortless bass. In fact, bass was essentially equivalent to AR's former top-of-the-line AR3a. The smoothness and range of the higher frequencies are

more in line with what we have come to expect from good-quality speakers, and the overall sound quality was consistent with the measured performance. In other words, the sound of the AR48s was excellent in every respect.

We also listened to several other speakers, both bookshelf and floor-standing types, priced well above and below the AR48s. And with respect to cleanness and natural sound balance, the AR48s certainly held its own. It has a slight tendency toward warmth, depending on the program material (the AR48's bass response is somewhat better than that of most speakers in its price

range), but above all the sound is smooth and not at all tiring.

The current AR product line includes both floor-standing and bookshelf speakers. A purchasing decision should probably be made on the basis of individual installation requirements. Although the AR48s is one of the larger "bookshelf" speakers, it is not too big or heavy for wall mounting (don't use a standard bookshelf, however, since it won't be deep enough). The AR tradition of honest value and accurate specifications is certainly evident in this fine, up-to-date product.—*Julian D. Hirsch*

CIRCLE NO. 101 ON FREE INFORMATION CARD

YOU'LL NEVER OUTGROW THE **HOBBY-BLOX**TM MODULAR CIRCUIT BUILDING SYSTEM

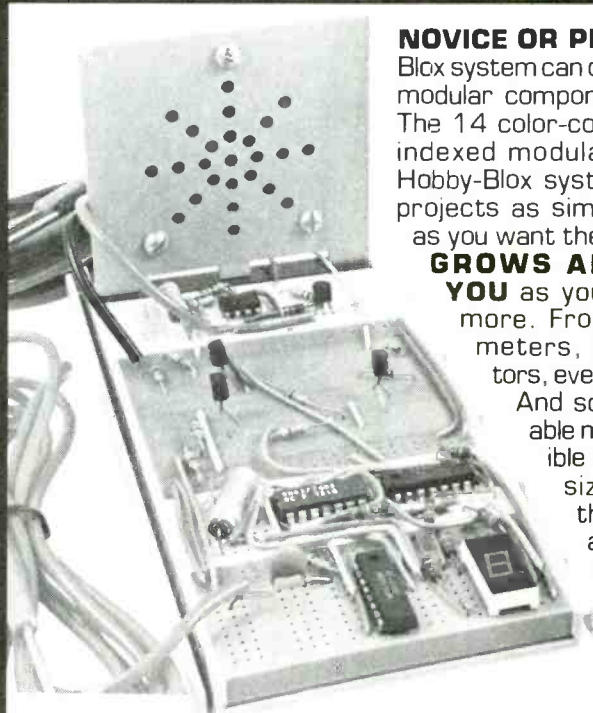

NOVICE OR PRO, the Hobby-Blox system can offer you exciting modular component challenges. The 14 color-coded and cross-indexed modular units in the Hobby-Blox system can create projects as simple or complex as you want them to be.

GROWS ALONG WITH YOU as you learn and do more. From Digital Voltmeters, Pulse Generators, even Slot Machines. And solderless, reusable modules compatible with DIP's of all sizes make even the most elaborate systems a snap.

Patents Pending.
© A P PRODUCTS
INCORPORATED 1980.

FREE CATALOG and the name of your nearest Hobby-Blox dealer — call toll-free (800) 321-9668. In Ohio, call collect (216) 354-2101.



A P PRODUCTS INCORPORATED
9450 Pineneedle Drive
P.O. Box 603
Mentor, Ohio 44060
(216) 354-2101
TWX: 810-425-2250

In Europe, contact A P PRODUCTS GmbH
Bäumlesweg 21 • D-7031 Weil 1 • W. Germany



What makes this radar detector so desirable that people used to willingly wait months for it?

Anyone who has used a conventional passive radar detector knows that they don't work over hills, around corners, or from behind. The ESCORT® radar warning receiver does. Its uncanny sensitivity enables it to pick up radar traps 3 to 5 times farther than common detectors. It detects the thinly scattered residue of a radar beam like the glow of headlights on a dark, foggy road. You don't need to be in the direct beam. Conventional detectors do. Plus, ESCORT's extraordinary range doesn't come at the expense of more false alarms. In fact, ESCORT has fewer types and sources of false alarms than do the lower technology units. Here's how we do it.

The unfair advantage

ESCORT's secret weapon is its superheterodyne receiving circuitry. The technique was discovered by Signal Corps Capt. Edwin H. Armstrong in the military's quest for more sensitive receiving equipment. ESCORT's Varactor-Tuned Gunn Oscillator singles out X and K band (10.525 and 24.150Hz) radar frequencies for close, careful, and timely examination. Only ESCORT uses this costly, exacting component. But now the dilemma.

The Lady or The Tiger

At the instant of contact, how can you tell a faint glimmer from an intense radar beam? Is it a far away glint or a trigger type radar dead ahead? With ESCORT it's easy: smooth, accurate signal strength information. A soothing, variable speed beep reacts to radar like a Geiger counter, while an illuminated meter registers fine gradations. You'll know whether the radar is miles away or right next to you. In addition, the sound you'll hear is different for each radar band. K band doesn't travel as far, so its sound is more urgent. ESCORT keeps you totally informed.

The right stuff

ESCORT looks and feels right. Its inconspicuous size (1.5Hx5.25Wx5D), cigarettier power connector and hook and loop or visor clip mounting make installation easy, flexible, and attractive. The aural alarm is volume adjustable and the alert lamp is photoelectrically dimmed after dark to preserve your night vision. And, a unique city/highway switch adjusts X band sensitivity for fewer distractions from radar burglar alarms that share the police frequency while leaving K band at full strength.

Made in Cincinnati

Another nice thing about owning an ESCORT is that you deal directly with the factory. You get the advantage

of speaking with the most knowledgeable experts available and saving us both money at the same time. Further, in the unlikely event that your ESCORT ever needs repair, our service professionals are at your personal disposal. Everything you need is only a phone call or parcel delivery away.



Carrying case and visor clip included

Corroborating evidence

CAR and DRIVER . . . "Ranked according to performance, the ESCORT is first choice . . . it looks like precision equipment, has a convenient visor mount, and has the most informative warning system of any unit on the market . . . the ESCORT boasts the most careful and clever planning, the most pleasing packaging, and the most solid construction of the lot."
BMWCCA ROUNDEL . . . "The volume control has a 'silky' feel to it; in fact, the entire unit does. If you want the best, this is it. There is nothing else like it."
PLAYBOY . . . "ESCORT radar detectors . . . (are) generally acknowledged to be the finest, most sensitive, most uncompromising effort at high technology in the field."
PENTHOUSE . . . "ESCORT's performance stood out like an F-15 in a covey of Sabrajets."
AUTOWEEK . . . "The ESCORT detector by Cincinnati Microwave . . . is still the most sensitive, versatile detector of the lot."

The acid test

There's only one way to really find out what ESCORT is all about. We'll give you 30 days to test it for yourself. If you're not absolutely satisfied, we'll refund

your purchase as well as pay for your postage costs to return it. In fact, try an ESCORT and any other detector of your choice. Test them both for 30 days and return the one you don't like. We're not worried because we know which one you'll keep. As further insurance for your investment, ESCORT comes with a full one year limited warranty on both parts and labor. This doesn't worry us either because ESCORT has a reputation for reliability. We know that once you try an ESCORT, radar will never be the same again. So go ahead and do it. Order today.

You don't have to wait

- Just send the following to the address below:
- Your name and complete street address.
 - How many ESCORTs you want.
 - Any special shipping instructions.
 - Your daytime telephone number.
 - A check or money order.



Visa and MasterCard buyers may substitute their credit card number and expiration date for the check. Or call us toll free and save the trip to the mail box.

CALL TOLL FREE . . . 800-543-1608
IN OHIO CALL 800-582-2696

ESCORT (Includes everything) . . . \$245.00
 Ohio residents add \$13.48 sales tax.

Extra speedy delivery

If you order with a bank check, money order, Visa, or MasterCard, your order is processed for shipping immediately. Personal or company checks require an additional 18 days.

ESCORT®

RADAR WARNING RECEIVER

CINCINNATI MICROWAVE
 Department 531
 255 Northland Boulevard
 Cincinnati, Ohio 45246

Popular Electronics Tests

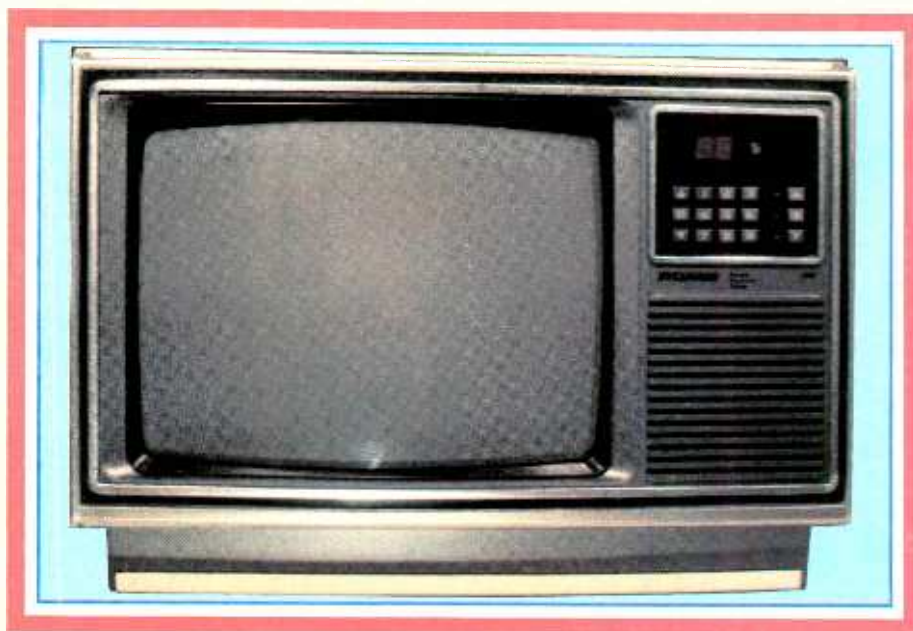

Sylvania 13" Color TV Receiver

THE Model CAA118WR is Sylvania's recent contribution to the expanding market for 13-in. receivers, which often serve as second color-TV sets. It features a new chassis (Model E31-02) with automatically regulated black-and-white and color levels, automatic fine tuning (aft), automatic gain control (agc), ambient light compensation, and a new horizontal/vertical countdown IC that eliminates manual picture-hold controls. Its infrared remote control has both direct-address and channel-scan, while the 105-channel tuner accepts uhf, vhf, and CATV inputs. Rear-panel controls allow the user to adjust sharpness, picture, color, and tint. The Chroma-Line picture tube is of the dark-faceplate variety. Dimensions are 13½" H × 19½" W × 15"D; weight is 27 lb. Suggested retail: \$480.

General Description. The main chassis consists of a single board for the signal-processing and deflection circuits. It is colored blue with easy-to-read white lettering for component and test-point identification. The chassis may be unplugged from the deflection yoke, cathode-ray tube (CRT), and tuner—permitting easy service of its well-laid-out components. (Most ICs are in sockets.) The dc voltages are plainly marked, and component positions are legibly shown on the pc board's bottom.

The set's power supply input has both line and choke transient protection and a 4-A ac fuse. A bridge-type rectifier and large filter capacitors supply full-wave dc rectification and filtering to a three-transistor, single silicon-controlled rectifier (SCR) circuit that regulates the main 112-V dc power bus. A phase detector and zener-clamped error amplifier sense any voltage changes and furnish the necessary correction to the SCR driver—controlling SCR conduction time. Anode potential for this SCR is derived from the flyback transformer at the horizontal scanning frequency.

There is also automatic shutdown (in the event of excess high voltage) in the horizontal oscillator startup circuit. This circuit consists of two zener diodes and an SCR. When the flyback transformer's 220-V output varies enough to cause gate turn-on, the SCR shuts down the horizontal oscillator, taking out both raster and sound.

The receiver's preamplifier has a surface acoustic-wave filter input to reject adjacent-channel and CB interference. Also, the fullwave video detector permits a maximum bandpass output. Unfortunately, there is no comb filter, so even with a highly effective auto/manual sharpness control, just 3 MHz of video is delivered to the CRT.

Integrated Circuits. All six of the TV

chassis's ICs are interesting, but two are of particular significance. (Sylvania's project engineering manager, George Kent, was kind enough to help. . . .)

The IC700 chip (Fig. 1) eliminates the need for vertical and horizontal hold controls. It receives separate horizontal and vertical sync via ac coupling to the horizontal automatic phase detector and vertical timing counter, respectively. A 503.5-kHz voltage-controlled oscillator (vco) and ceramic resonator determine the clock rate for this proprietary IC. The 503.5 kHz is first divided by 16 and then by 2 to establish the horizontal sweep rate of 15,734.375 Hz.

The vco frequency accuracy is derived from a standard automatic phase control (apc) that compares horizontal timing from the receiver with broadcast horizontal timing pulses from the sync separator. If there is no phase-match, the apc generates a dc voltage. This dc, delivered to the horizontal driver, corrects the receiver's horizontal timing output. The horizontal apc also controls the first chroma amplifier and color killer with a gated pulse burst to the IC600's internal keyer.

The IC900 chip (Fig. 2), the automatic video-chroma processor, corrects black-and-white level variations, has an automatic color-level detector, automatic peak-detector, and an automatic black-level control. (Cont'd on p. 28)

At CIE, you get electronics career training from specialists.

If you're interested in learning how to fix air conditioning, service cars or install heating systems – talk to some other school. But if you're serious about electronics...even earning an Associate Degree... come to CIE –The Electronics Specialists.

John E. Cunningham

**Special Projects Director
Cleveland Institute of Electronics**



POPULAR ELECTRONICS

My father always told me that there were certain advantages to putting all your eggs in one basket. "John," he said, "learn to do one important thing better than anyone else, and you'll always be in demand."

I believe he was right. Today is the age of specialization. And I think that's a very good thing.

Consider doctors. You wouldn't expect your family doctor to perform open heart surgery or your dentist to set a broken bone, either. Would you?

For these things, you'd want a specialist. And you'd trust him. Because you'd know if he weren't any good, he'd be out of business.

Why trust your education and career future to anything less than a specialist?

You shouldn't. And you certainly don't have to.

FACT: CIE is the largest independent home study school in the world that specializes exclusively in electronics.

We have to be good at it because we put all our eggs in one basket: electronics. If we hadn't done a good job, we'd have closed our doors long ago.

Specialists aren't for everyone.

I'll tell it to you straight. If you think electronics would make a nice hobby, check with other schools.

But if you think you have the cool — and want the training it takes — to make sure that a sound blackout during a prime time TV show will be corrected in seconds — then answer this ad. You'll probably find CIE has a course that's just right for you!

At CIE, we combine theory and practice. You learn the best of both.

Learning electronics is a lot more than memorizing a laundry list of facts about circuits and transistors. Electronics is interesting because it's based on some fairly recent scientific discoveries. It's built on ideas. So, look for a program that starts with ideas — and builds on them.

That's what happens with CIE's Auto-Programmed® Lessons. Each lesson uses world-famous "programmed learning" methods to teach you important principles. You explore them, master them completely . . . before you start to apply them!

But beyond theory, some of our courses come fully equipped with the electronics gear to actually let you perform hundreds of checking, testing and analyzing projects.

In fact, depending on the course you take, you'll do most of the basic things professionals do every day — even use a Digital Learning Laboratory to apply the digital theory essential today to keep pace with electronics in the eighties.

Plus there's a professional quality oscilloscope you build and use to "see" and "read" the characteristic waveform patterns of electronic equipment.

You work with experienced specialists.

When you send us a completed lesson, you can be sure it will be reviewed and graded by a trained electronics instructor, backed by a team of technical specialists. If you need specialized help, you get it fast . . . in writing from the faculty specialists best qualified to handle your question.

People who have known us a long time, think of us as the "FCC License School."

We don't mind. We have a fine record of preparing people to take . . . and pass . . . the government-administered FCC License exams. In fact, in continuing surveys nearly 4 out of 5 of our graduates who take

the exams get their Licenses. You may already know that an FCC License is needed for some careers in electronics — and it can be a valuable credential anytime.

Associate Degree

Now, CIE offers an Associate in Applied Science Degree in Electronics Engineering Technology. In fact, all or most of every CIE Career Course is directly creditable towards the Associate Degree.

Find out more! Mail this card for your FREE CATALOG today!

If the card is gone, cut out and mail the coupon.

I'll send you a copy of CIE's FREE school catalog, along with a complete package of independent home study information.

For your convenience, I'll try to arrange for a CIE representative to contact you to answer any questions you may have.

Remember, if you are serious about learning electronics . . . or building upon your present skills, your best bet is to go with the electronics specialists — CIE. Mail the card or coupon today or write CIE (and mention the name and date of this magazine), 1776 East 17th Street, Cleveland, Ohio 44114.

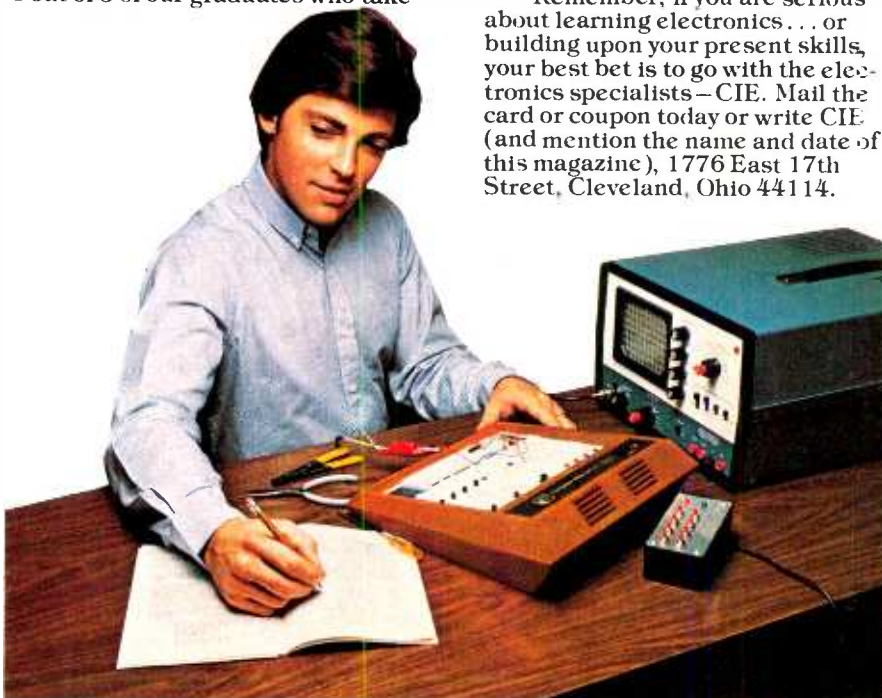

Pattern shown on oscilloscope screen is simulated.

CIE Cleveland Institute of Electronics, Inc.
1776 East 17th Street, Cleveland, Ohio 44114

YES . . . John, I want to learn from the specialists in electronics — CIE. Send me my FREE CIE school catalog — including details about the Associate Degree program — plus my FREE package of home study information.

Print Name _____

Address _____ Apt. _____

City _____

State _____ Zip _____

Age _____ Phone (area code) _____

Check box for G.I. Bill information: Veteran Active Duty

Mail today!

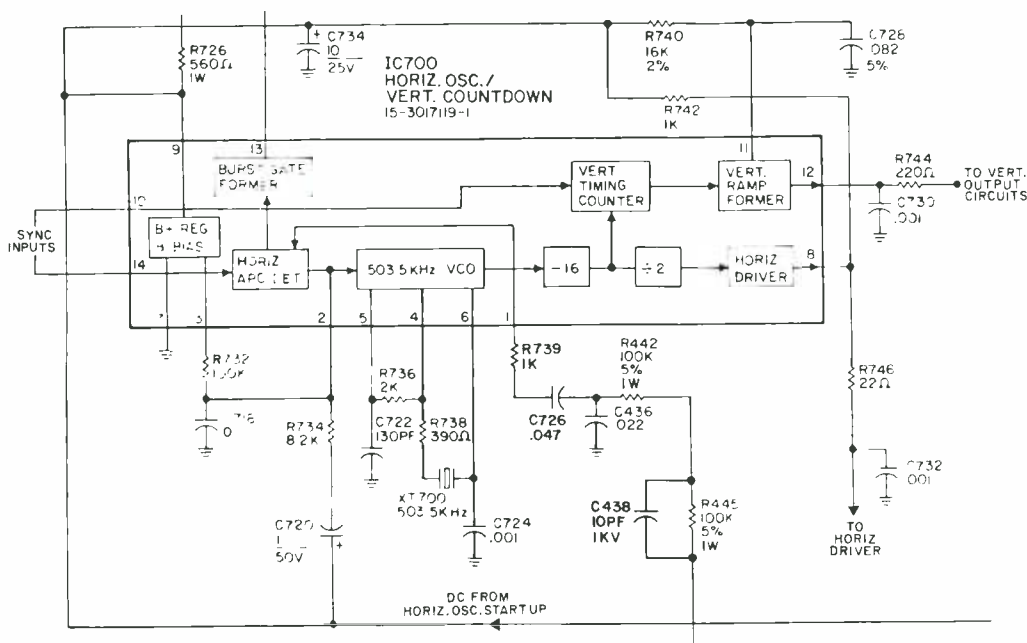

Fig. 1. Digital sync eliminates manual controls for vertical and horizontal holds.

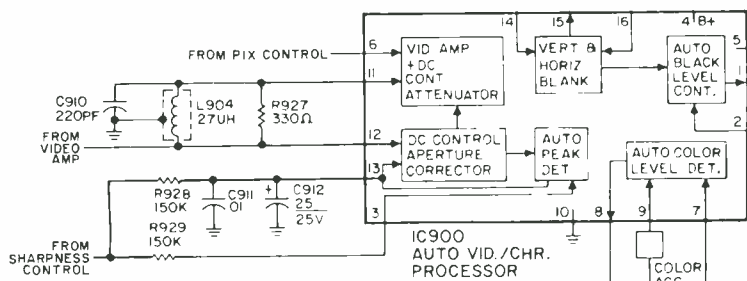

Fig. 2. Both color and luminance are controlled by this processor.

(Continued from page 23)

The IC900 also contains a dc aperture corrector that receives composite video from the second video amplifier (not shown) and is, in turn, controlled by the automatic peak detector and the manual sharpness control.

Common components C910, L904, and R927 form a short, unterminated delay line. Delayed and non-delayed video are matrixed to produce aperture correction, equalizing preshoot and overshoot characteristics to give faster rise and fall times for video transitions.

The automatic level detector is actually a feedback arrangement from the color amplifier. Having a color-level threshold control and an agc circuit to monitor chroma gain, it holds chroma level constant in response to the manual adjustment of the "color" control.

Both the horizontal and vertical blanking pulses are joined in the IC900, forming a pedestal for the video output and black level. In this way, blanking pedestal heights are controlled to maintain a black-level clamp for overall picture stability. The Vertical Interval Test and Reference Signals transmitted during vertical blanking intervals remain unblanked, and can be seen in the video output. During active line periods, video is sampled outside the IC900 and reintroduced into the picture as a black reference signal.

Remote Control. The receiver's remote-control section contains an infrared detector and amplifiers and a data set/reset NAND-gate flip-flop that is controlled by a microprocessor. This microprocessor carries out commands from either the remote keyboard or the keyboard on the receiver's front panel. When a command is received, it

selects the channel via an IC frequency synthesizer and a shift register and then generates the channel number on an LED display. The same register also provides 64-step up/down volume adjustment through a control buffer. A synthesizer compares tuner frequencies with the output of a crystal-controlled oscillator. A dc difference voltage is then routed to aft, which makes the necessary fine-tuning correction.

The remote keyboard has column and row identification, a clock generator, program controller with parallel-to-serial conversion, and pulse amplifiers for three infrared diodes and their driver. In practical terms, this means that the keyboard can handle channel-select (direct-address and scan), on/off, and volume up/down. You can also program access to a second channel (other than the one you're watching) onto the receiver, and the remote keyboard will call it up anytime you want a quick look.



Practical Advice From Isaac Asimov:

**“A TRS-80 Color Computer
Combines Out-of-This-World Fun
With Down-to-Earth Practicality!”**

— Isaac Asimov
Renowned Science and
Science Fiction Author



“Indulge Your Imagination With Radio Shack’s \$399 Color Computer!”

“It’s like having the cosmos at your fingertips!” That’s what Isaac Asimov says about the incredible Radio Shack TRS-80® Color Computer. “I just plug in an instant-loading Program Pak™ for a rousing game of Space Assault,” Asimov explains. “Then it’s up to me to repel invading aliens.”

“It’s also a very serious hard-working computer.” Radio Shack offers Program Paks for everything from personal finance to word processing. “And the electronic filing program lets me keep an insurance inventory of my personal possessions — in the event of invading earthlings!” Or program the Color Computer yourself in Color BASIC. “Color makes it fun to learn programming. And the excellent 308-page manual makes it easy.”

Radio Shack®
The biggest name in little computers™
A DIVISION OF TANDY CORPORATION

“We have entered into the Computer Age.” And Radio Shack makes the transition a smooth one. The Color Computer attaches to any TV set. And the Program Paks are remarkably inexpensive. When you are ready to expand into tomorrow, add up to four disk drives for greater storage.

See the remarkable TRS-80 Color Computer at your nearest Radio Shack store, dealer or Computer Center today.



I want a hard worker — that’s a lot of fun! Send me your free TRS-80 Computer Catalog!

Mail To: Radio Shack, Dept. 82-A-495
1300 One Tandy Center, Fort Worth, Texas 76102

NAME _____
ADDRESS _____
CITY _____ STATE _____ ZIP _____

Petail prices may vary at individual stores and dealers.

GUARDING YOUR ★ MILITARY EXPERIENCE

EXTRA INCOME

If you have experience in any branch of the Armed Forces, you have the chance to earn good extra income while you hold one of the most important jobs in America. In an Army National Guard unit close to home.

Take income. In the Army National Guard, the work you've put into military service can really go to work for you. For instance, if you left as an E-4 with three years experience, you can earn over \$1500 a year. As an E-5 with 6 years experience, over \$1700. And, if you have a critical skill you may also qualify for a cash bonus. To see exactly how far your rank and experience can take you, check out the chart below.

	PER YEAR (Including Annual Training)
E-3 with 2+ years	\$1375.68
3+ years	1427.34
E-4 with 3+ years	1519.92
4+ years	1630.17
E-5 with 4+ years	1687.11
6+ years	1789.80

Plus, a part-time job in the Army National Guard fits in well with your current lifestyle. Because all it takes is two days a month of your time, along with 15 days annual training. And, in the Guard, you're serving close to home, helping the people in your community and state when natural disasters or emergencies occur.

Extra income that's important to you, in a job that's important to your community. It's just one reason to Guard your military experience in the Army National Guard.

To learn about other reasons— from benefits to new skills—contact your local Guard recruiter, or call toll-free 800-638-7600.

^oIn Hawaii: 737-5255; Puerto Rico: 723-4450; Virgin Islands (St. Croix): 773-6438; Maryland: 728-3388; in Alaska, consult local phone directory.

The Guard is
America at its best.



CIRCLE NO. 33 ON FREE INFORMATION CARD

Laboratory Measurements. As previously stated, only 3 MHz of video information is delivered to the CRT. The intensity of luminance is 7000°K, producing a sharp, bold picture. (Note that degrees Kelvin in this instance is not a temperature, but a scale of brightness—7000°K being at the high end of the scale for a CRT.) The regulation of high and low voltages is good—ranging between 96 and 100% in all instances. Video signal-to-noise ratio is 42 dB, and dc restoration is a quite adequate 88%. Convergence ranks with the finest: 99%. Tuner sensitivity is satisfactory, and there is very good protection from CB interference.

Comments. This is a well-built chassis that uses the latest of Sylvania's advanced integrated circuits. These chips are augmented with a surface acoustic-wave input filter, overload protection, and a sharpness circuit that senses weak signal conditions and compensates by rolling off high frequencies and masking the noise. We also like the Perma-Tint feature for automatically "holding" fleshtones. And should you need to adjust this manually, the rear-panel controls are easy to reach.

The versatile remote-control keyboard, however, is large and a bit unwieldy, with a left-handed scan button position and a "zero" key in the middle. Its quick-view position to glimpse a second programmed channel is a plus. It would be nice if Sylvania would add a 4-MHz comb filter to the set. Overall, though, the receiver offers good video color and a steady picture that's remarkably crisp for 3 MHz of luminance bandwidth. In practical terms, therefore, the smallness of the screen reduces the need for a 4-MHz comb filter for standard picture viewing, with savings passed on to the consumer.

—Stan Prentiss

CIRCLE NO. 103 ON FREE INFORMATION CARD

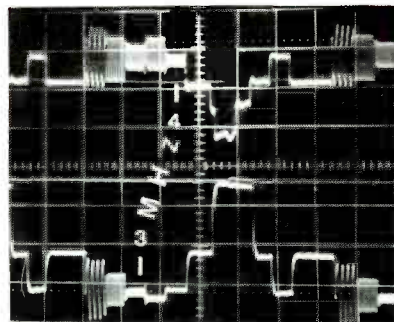

Multiburst test shows 4 MHz at video detector, 3 MHz at CRT.

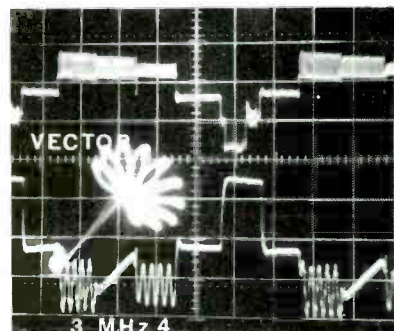

Swept chroma measurements show good vector and little rolloff at 4.08 MHz.

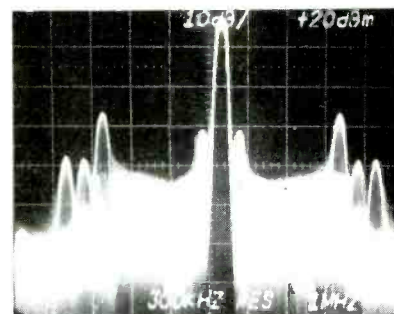

A 42-dB video signal-to-noise ratio rates with the best.

SYLVANIA MODEL CAA118WR 13" COLOR TV RECEIVER LABORATORY DATA

Parameter	Measurement
Tuner/receiver sensitivity (before snow):	vhf (Ch. 6): -5.5 dBmV uhf (Ch. 30): -3 dBmV
Voltage regulation w/signal input:	Low voltage: 24-V supply—100% 112-V supply—98.8% High voltage: 26-kV supply—96%
Video S/N at CRT:	42 dB
Luminance bandpass at CRT:	3 MHz
Luminance bandpass at video detector:	4 MHz
Dc restoration:	88%
Agc swing from saturation to cutoff:	62.5 dB (min.)
CRT color temperature:	7000°K
Horizontal overscan:	12%
Convergence:	99%
Power requirements (signal applied):	95 W (avg.)

Note: Instruments used in these measurements are: Tektronix 7L5, 7L12 spectrum analyzers; Telequipment D66, D67A oscilloscopes; Sadelco FS-30 VU 1/s meter; Winegard DX-300 amplifier; Data Precision 245, 258, 1750 multimeters; B&K-Precision 1250 and 3020 NTSC and sweep/function generators; Sencore VA48 (modified), CG169 video & color bar generators and PR56 variable power supply; Tektronix C-5A, Minolta XD-11 cameras; and Gossen Luna-Pro light meter.

Popular Electronics Tests



Radio Shack TRS-80 Model III Desktop Computer

THE Radio Shack TRS-80 Model III offers more capability than the older Model I, yet Model III users can enjoy all the older machine's programming options since the units are software-compatible. Also, the Model III's self-contained packaging eliminates the unsightly external cabling required for the Model I.

The basic Model III features a high-resolution 12-in. black-and-white video monitor that can display 64 characters per line (the full display height is 16 lines) from a selection of 96 text characters, 64 graphics characters, and 160 "special" characters. Also, there is a 65-key board which includes a 12-key numeric pad, a cassette port (cassette recorder optional) capable of handling 250 baud with Level I BASIC, a parallel printer interface, a buffered bus for external expansion, and provisions for adding two internal and two external double-density 5 $\frac{1}{4}$ " disk drives and an RS-232 port. A Z80 CPU operating at 2.03 MHz, 4K bytes of RAM internally expandable to 48K bytes, and 4K bytes of ROM expandable to 14K bytes are the principal electronic features.

Level I BASIC, stored in the 4K-byte ROM, features most standard BASIC commands, a screen display of 16 lines of 64 upper-case characters, 48 x 128

video graphics, a 250-baud cassette I/O rate, floating-point arithmetic, six-digit numeric accuracy, single-dimension arrays, limited string variables, command abbreviations, and simplified error codes. It also includes such printer commands as LLIST and LPRINT.

The optional Model III BASIC is stored in 14K bytes of ROM and requires 16K bytes of RAM to store variables. Execution time is about 30% faster than Level I and more features are available—repeating keys, a screen format of 16 lines of either 32 or 64 upper/lower-case characters, auto-scrolling, and a screen print command. The cassette baud rate is user-selectable (500 or 1500 baud), and you get multi-dimensional arrays, definable cursor, comprehensive string variable handling, automatic line numbering, extensive editing commands, TRACE/PEEK/POKE for machine-language routines, initialization of the optional RS-232 port, 23 error codes, and a special graphics set. Accuracy is 16 digits, and there is compressed storage for video display text. Program lines and string variables may contain up to 255 characters.

The Model III can control four double-density disk drives, each having 40 tracks of eighteen 256-byte sectors. The first drive (installed within the system)

contains TRSDOS and Disk BASIC and allows 131K bytes of user space. Each of the other three drives provide 175K bytes. (Certain system information must be stored on every diskette.) Two disk drives can be installed within the Model III's cabinet, while two more can be externally mounted.

The unadorned Model III with 4K-byte Level I BASIC is priced at \$699, the 16K-byte Model III BASIC system is tagged at \$999 (more RAM can be added in 16K-byte increments at \$99 each), and the RS-232 Serial Interface costs \$99. The first internally mounted disk drive—including TRSDOS and Disk BASIC—is \$849, and a second internally mounted drive is \$399. Each external disk drive costs \$499.

Several Model III configurations are also available—from a "starter" system to a full-blown business package—along with a considerable variety of software.

Expansion. It is very easy to expand or add peripherals to the Model III. If you want to add extra RAM or disks, the necessary items are available at your local Radio Shack store. However, be aware that the warranty is broken once you open the case.

For peripherals like printers, external disk drives, or a modem, the Model III

By Carl Warren

Latest Micros Offer Power and Graphics

THE microcomputer race is running at even a faster pace than it was just a few months ago. Already, a number of manufacturers are responding to IBM by offering 16-bit power, while others are enhancing 8-bit designs with graphics functionality or lowering of costs. The most notable entry in the last few months is the Model 16 from Tandy/Radio Shack.

Introduced this past January, the Model 16 is a "downward-compatible" machine to the Model II. Employing both the 16/32-bit Motorola 68000 and a Zilog 8-bit Z80A microprocessor, the system supports up to 512K bytes of user memory and is software compatible to the Model II. Besides serving as the "engine" in the 8-bit mode, the Z80 assumes the additional task of handling I/O duties, screen refresh, and general system housekeeping.

The Model 16 has a starter price of \$4999 for 128K bytes of memory, a single 1.25M-byte Tandon 8-in. drive, and one parallel and two serial RS-232C ports, one of which is capable of bisynchronous operation with IBM and other mainframes. A hard-disk port can be added to permit up to four 8.4-mega-byte drives. Provisions have been made to use the ARCNET local network, which can support any combination of

255 Model II and Model 16 computers. Adding memory is done in 128K increments with the first add-on costing \$499 for the 128K RAM chip set. Adding the final 256K costs an additional \$1200, \$699 for the board with 128K and \$499 for the final 128K RAM set. An additional drive is priced at \$799 for a full system price of \$7495. Adding the 8.4M-byte hard-disk system brings the price to \$9993.

For those applications that require graphics display, Radio Shack has the high-resolution graphics board for \$499. The board which is designed to fit on the backplane of either the Model 16 or Model II contains 153,600 bits of refresh memory to maintain the display. Cables are connected to the video board so the graphics screen is synchronized with the character video screen.

Working in tandem with the video board is an enhanced BASIC either for the Z80A or 68000 that provides such graphics attributes as: LINE, CIRCLE, PAINT, and GET and PUT.

Since the operating system for the Model 16 supports both multiuser and multitasking operations, you can attach either two additional TRS-80s or the TRS-80 Model DT-1 Video Data Terminal for \$699 each.

This 8-bit microprocessor-controlled

terminal emulates a Televideo 910, Adds 25, Lear Siegler ADM-5, or Hazeltine 1410. Terminal characteristics are saved during setup in EPROMs, thus eliminating the necessity of having DIP switches.

Should you already have a Model II and want the additional power offered by the 68000 microprocessor you can purchase the \$1499 Model 16 enhancement option. This two-board option fits into the backplane of a Model II, and contains a Z80A and 68000, plus necessary serial I/O. The memory board comes with 128K of memory expandable to 256K, which is the maximum permissible on the Model II due to power supply considerations.

To take advantage of all the attributes available in the system, Radio Shack has developed a multiuser/multitasking operating system. Even though they present the machine as being able to use all current Model II software, they have or are developing a number of application packages to take advantage of the 68000. You should, for example, be able to purchase now a 16-bit version of the popular ScripSit wordprocessing package, Profile database handler, and powerful communication software, that gives you IBM bisync compatibility.

Even more is available, from the Texas giant to enhance your data-processing capability. Introduced at the same time as the Model 16, the TRS-80 Pocket Computer Model PC-2 is priced at \$279.95. The PC-2 comes with a 16K ROM BASIC that is equivalent to that available on the Model III and uses a proprietary 8-bit CMOS microprocessor operating at 1.25 MHz. Four AA alkaline batteries supply power.

In addition, the powerful hand-held has programmable function keys. The LCD display has 26 character positions with upper/lower case, and the 7 x 156 dot matrix is completely controllable by BASIC for the generation of special characters including Greek math symbols. Furthermore, the display has an 80-character buffer with automatic scrolling for lines over 26 characters.

The basic unit comes with 2K of user memory, expandable to over 18K with a unique cartridge system that plugs into the back of the unit. Currently, you can purchase a 4K RAM module for \$69.95 with larger modules as well as special ROM modules available soon.

To further increase the functionality and expandability of the PC-2, there is a 60-pin I/O bus containing address, data, and control signals that enable connection to a wide range of peripheral modules. One of the first add-ons, is a printer that has 9 different character sizes with up to 36 characters per line in four colors on standard—cash register—2.25-in. paper. Any one of the four colors (red, blue, green, or black) can be selected under software control for creating graphics plots with resolution as fine as 200 x 500 points. When you add this \$239.95 option to the PC-2, you also get an additional 25 commands to enhance BASIC with special graphics.



Radio Shack TRS-80 Model 16 Microcomputer

In addition to the above, Radio Shack is offering a low-cost networking scheme called Network III, priced at \$599. This clever device is a software-controlled RS-232 serial multiplexer that allows as many as 16 users to share resources at data rates up to 19.2K baud.

Interestingly, the Network III, doesn't necessarily require a TRS-80. Therefore, it may make an ideal solution for networking a number of different systems. Be aware, however, that software is required to handle the polling function, and currently it's only available for Radio Shack equipment.

More for the home than the office, is Commodore Business Machines Inc.'s Ultimax and Commodore-64.

The Ultimax, which has a planned selling price of \$149.95, is a programmable color computer, which will compete with sophisticated video game machines like those offered by Atari and Intellivision. The Ultimax connects to any TV set, features a flat membrane keyboard, is programmed in BASIC and uses both ROM cartridges and tape cassettes for games, programming and music synthesis. In addition, you can add joysticks, paddles and light pens to enhance the "entertainability" of the machine.

To match the low end of the small business world, there is the Commodore-64 that has a price of \$595. This system is to compete with the Apple II+ and similar machines. It has a CP/M option and comes with 64K of memory and a 66-key keyboard with upper and lower case capability.

Color appears to be the rising attraction as a user-oriented feature. And Astrovision with the Astroarcade is prepared to cash in on the capability it offers.

The Astroarcade is a Z80 based add-on system starting at \$299 for the basic game unit with a \$599 keyboard unit that houses a disk controller. It also has serial ports, cassette tape controller and voice synthesizer, and is totally oriented toward color.

The system, designed by Jeff Frederiksen, developer of the coin-operated circuitry used in Bally arcade games, says it's the only personal computer that approaches the realism and animation capability found on coin-operated arcade machines. This wizardry is achieved by employing three microprocessors, 4K of RAM, 8K of ROM (expandable to 32K), and an optional Astro BASIC in ROM cartridge.

The custom-designed video processor chip, operating at 7 MHz, handles all color manipulation and NTSC broadcast quality video. The result is a color display that rivals even expensive commercial graphics processors.

In operation, you can select from a palette of 256 colors (four at a time in video games or two at a time with Astro BASIC). The screen is continually mapped in 4K RAM allowing for com-

Turn your TV into a time-sharing videotex display for \$399.*

Now you can connect your family to the informative and entertaining world of CompuServe, The Source, Dow Jones News/Retrieval and other time-sharing and data-base networks.

All you need is the RCA VP-3501 Videotex Data Terminal (with built-in modem and RF modulator), your telephone and your TV set. You can get instant access to regional newspapers and newsletters...weather reports and sports results...computer games and more. You can use the VP-3501 to make airline reservations...find restaurant recommendations in cities around the world. Plus stock market and corporate data. Or access your school or business computer. You can even send electronic mail and buy products.

In addition to information retrieval, the VP-3501 provides full interactive communications with a host computer. What you have working for you is a versatile, feature-packed interactive data terminal which can be worth far more to you than its low price. Its unique color-locking circuitry gives you sharp color graphics and rainbow-free characters. You get 20- and 40-character formats in one of eight foreground colors and separate color backgrounds.

With reverse video, you can emphasize certain letters, words, or sentences. A built-in tone generator...plus a white noise generator...let you create everything from the sound of explosions to the sound of music. The spill-proof, easy-to-clean keyboard is highly suitable for hostile environments. And its membrane key switches give you a natural feel.

The VP-3501 is truly a fine Videotex Data Terminal. And don't forget, it's made by RCA. The first name in television...now the foremost name in videotex terminals.

See a demonstration at your computer or electronics dealer, or contact RCA. Order now and you'll get a free password and a free hour's time-sharing on both CompuServe and Dow Jones News/Retrieval! (Limited time offer.)

For more information or to order, call toll-free 800-233-0094. (In Pennsylvania, call 717-393-0446.) Visa or MasterCard orders accepted by phone. Or send a check including \$3.00 delivery charge plus your local sales tax to RCA MicroComputer Products, New Holland Avenue, Lancaster, PA 17604.

*Suggested User Price.



plex imagery that approaches that found on expensive CAD graphics systems.

The second processor, also a custom I/O chip, handles the interfacing to hand-held controls, and is responsible for producing music equal to that available on expensive music synthesizers.

Attaching the Arcade to the ZGrass-32 (keyboard element) computer gives you Z80 power and the use of other peripherals including disks, printers, and modems. (See the color photo in "The Electronic World," made by Real Time Design, Inc., with this system.)

For business applications, there is the Toshiba Model T100. This powerful system built around a 4-MHz Z80A, sells for about \$800 with keyboard, 64K RAM, 32K ROM, and audio cassette interface. For \$1450 you can add disk storage and \$900 attaches the C. Itoh Model 8510 dot-matrix printer.

The display system can either be your home TV or a \$900 color monitor. The display is an 80-character x 24-line display and 25th status line, as well as the choice of 8 colors and graphics with resolutions as high as 640 x 200 dots.

By employing the yet unpriced expansion unit, you can add communication interfaces, and special controller cards such as an IEEE-488 board.

To ensure compatibility to a wide range of user software, Toshiba has elected to employ Digital Research's CP/M operating system, with a special BIOS to enhance the user interface via menu selection.

Although the T-100 was shown at the January CES, it isn't planned for full scale availability until sometime after NCC this June.

Even the Chinese are joining the race with a system from Tatung Company of America Inc. Their Model MCS-32xx series, built in Taipei Republic of China, is based on a Z80A 4-MHz single-board computer that supports up to 208K bytes of user memory, 6 serial ports, 1 parallel port and a hard-disk interface. A typical configuration is the Mode MCS-3240-4 with two quad-density, 8-in floppies for 2M bytes storage, 64K RAM, and a parallel port. It can support two users under Digital Research's MP/M II O/S, for under \$10,000 including the Model VT-8210

FOR MORE INFORMATION

To get more information on items mentioned in this column, contact the following manufacturers directly.

- Astrovision Inc.**
6460 Busch Blvd., Suite 215
Columbus, OH 43229
800-848-6989
- Commodore Business Machines Inc.**
681 Moore Rd.
King of Prussia, PA 19406
215-337-7100
- General Consumer Electronics Corp.**
233 Wilshire Blvd.
Santa Monica, CA 90401
213-394-9667
- Panasonic**
1 Panasonic Way
Secaucus, NJ 07094
201-348-7000
- Tandy Corp./Radio Shack**
1800 One Tandy Center
Fort Worth, TX 76102
817-390-3300
- Tatung Co. of America Inc.**
2131 Gladwick St.
Compton, CA 90220
213-637-2105
- Toshiba America Inc.**
Information Processing Systems
2441 Michelle Dr.
Tustine, CA 92680
714-730-5000

8085 microprocessor based intelligent terminal, which has a price of under \$1000 for a version with 8K RAM (expandable to 32K).

Using a memory management scheme, for the 4116, 16K, 200-ns RAM, the unit is able to effectively handle the necessary switching of memory banks to accommodate the needs of MP/M II.

Should small size and small price be what you're looking for, then take a look at Panasonic's JR-100 priced at \$199. Employing a Motorola 6802 microprocessor, it has 16K RAM (expandable to 32K) an 8K ROM operating system with integer BASIC, and attaches to your home TV. All the system components are housed in a small typewriter style keyboard. An expansion chassis is

used to provide voice synthesis and recognition, and joystick I/O and serial I/O ports for hanging on printers and modems. Power to the system is supplied via an ac adaptor with a more hefty power supply apparently required for the optional high-speed cassette.

Although Panasonic officials were reluctant to discuss the attributes of the machine, they did say that formal introduction is planned for about July with production models being available shortly thereafter. Apparent hang-ups center around the lack of FCC registration and paucity of software. One package that you might expect though is a \$10 word-processing system.

Getting even smaller, there is a microcomputer that fits on your wrist. So if you want to wipe out a few hundred alien invaders while sitting on an airplane, or pit your athletic prowess against the onslaught of nerveless electronic sportsmen, then you're a candidate for a wristwatch microcomputer.

These marvels of electronics couple a quartz watch with a 12x24 cell LCD display and are available from General Consumer Electronics Corp. (GEC) in a game-playing series of watches aptly called: Game-Time, Arcade-Time, and Sports-Time.

Each of these unique watches is priced at under \$40 and plays multiple challenging games in the electronic field. The Arcade-Time watch, for example, comes with Hyperblast, Planet Raiders, Galaxy Gunner, and Cosmic Clash.

While playing the games, you can use the built-in micro-joystick and firing button to maneuver your missiles and guns to just the right position to wipe out the opposing side. And as you tire of one game, a touch of another button sends you off on a new adventure.

If you're more addicted to the excitement of sport and want to pit your abilities against electronic Abdul Jabars, then select Sports-Time. With this watch you can play football, basketball, or soccer. Using the joystick, you can move in for that all important goal, hat trick, or out-fox the computer.

The game characters are depicted in multiple cell graphics symbols on the LCD display and interact with your moves. To increase excitement, sound is added as you unleash your weaponry against the unyielding foe.

To keep you in touch with reality, the watch even tells the time and date.

Of course you may have more important things to do in between playing games, like adding up the total of your expense account. GEC has the answer for this also with their under \$40 Chase-N-Counter calculators.

As with the watches, you can tell the time, have a quick game of Star-Sweep (a Star Trek type of game), or add up your wins using the calculator keypad.

A game-playing microcomputer on your wrist may seem frivolous now; but so was the Altair microcomputer introduced in POPULAR ELECTRONICS just six years ago. ◇



Radio Shack's Model PC-2 provides pocket-size high-level data processing.

DIGITAL AUTOMOTIVE TUNE-UP METER

Use it to measure and adjust dwell, rpm, voltage on your car, boat, cycle, or lawn mower

BY C. R. BALL

IT's costly to have a mechanic tune up your automobile regularly so that it can run smoothly and use gasoline efficiently. You can do it yourself, however, with no great investment in tools or training. All that's generally needed is a single combination instrument that will measure dwell angle, engine rpm, and voltage.

Such an instrument is the DATUM (Digital Automotive Tune-Up Meter) described here. Featuring a digital read-out, it's easier to use and is capable of

better accuracy than analog-type meters since there are no scales to be interpolated and there's freedom from parallax error. Cost to build is only about \$70.

The DATUM uses a 3-digit, 7-segment LED display, and can measure 0 to 9999 rpm, dwell angles from 0 to 99.9°, and dc levels from -9.9 to 99.9 volts. The instrument is compatible with most factory and add-on electronic ignition systems, as well as conventional Kettering (points/breaker) ignition. Any engine (4-, 6-, or 8-cylinder, 2- or

4-stroke) can be tuned up using this instrument. Therefore it is useful for motorcycles, boats and lawn mowers, as well as cars.

Circuit Operation. The basic voltage-measuring circuit (Fig. 1) is designed around *IC1*, a dual-slope, A/D converter, and *IC2*, a BCD-to-seven-segment decoder/driver. The latter drives the parallel-connected segments of *DIS1* through *DIS3*, while *Q1* through *Q3* provide the digit enable. This chipset,



originally developed for an RCA digital voltmeter, provides a full-scale sensitivity of 999 mV and is used for all DATUM measurements: VOLTS, DWELL, and TACH (rpm). In the VOLTS mode, the input signal applied between *J4* and *J3* is scaled by a 100:1 precision divider (*R14* and *R15*) to yield a full-scale reading of 99.9 V. In this mode, *S1C* provides the decimal point via *R3*.

The TACH and DWELL modes share a common conditioning stage (*C8*, *R10*, *D2*, *R8*, and *Q4*) in which the input signal from the distributor is standardized in height and shape. In the DWELL mode, the low-impedance output from the collector of *Q4* (across *R11*) is routed via DWELL CAL potentiometer *R12* and series resistor *R13* through switch *S1A* to the network consisting of *R16* through *R20* and *C9* which averages the value of the distributor duty cycle. Scaling is achieved by *R19* and *R20* in conjunction with the precision divider network *R16*, *R17*, and *R18*. The proper scale factor is selected by *S2B* for 4-, 6-, or 8-cylinder engines. The signal selected by *S1* is then applied to the input of *IC1*.

In the TACH mode, the signal from *Q4* triggers one-shot multivibrator *IC3* with each point closure. Extraneous triggering from the ignition system ringing is avoided by using a second one-shot within *IC3* to disable the first when the points open. A CMOS one-shot is used because a MOSFET device output does not have the inherent V_{ce} (SAT) offset of bipolar devices. The CMOS thus allows proper zero. The tachometer signal is also routed via *R9* and *S1* to *C9* for averaging, and application to the dc voltmeter chipset.

Five-volt operating power is provided by regulator *IC4*, which is driven from battery *B1* or an external 12-V input applied via *J1*. Diode *D1* protects the circuit from accidental reverse voltage application at *J1*.

Construction. Although the circuit can be hardwired, the use of a double-sided glass-epoxy pc board (as shown in Figs. 2 and 3) is suggested. Two separate pc boards can be fabricated (one for the top and the other for the bottom foil pattern) and used "back-to-back" with interconnections between the boards made via the component leads and IC socket pins (the three ICs should be mounted in sockets). In either case, drill all required holes.

Mount the components on the two sides of the pc board as shown in Figs. 4 and 5. Observe correct component polarity, soldering on both sides of the pc board where required. Make sure that there are no solder bridges between adjacent copper traces. Since *IC1*, pin 11, has a very high input resistance (ap-

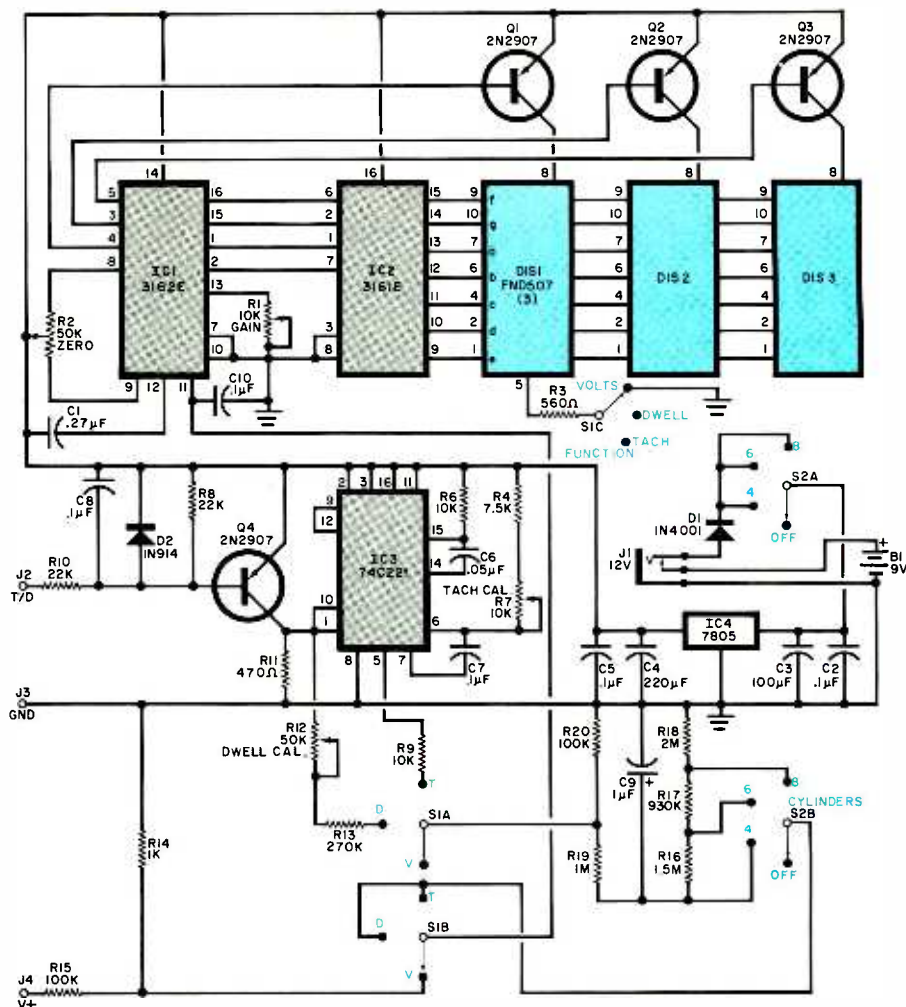

Fig. 1. Schematic diagram of the digital tune-up meter.

PARTS LIST

- B1—Six AA cells, alkaline or NiCd
 - C1—0.27- μ F, 100-V Mylar capacitor
 - C2, C5, C8, C10—0.1- μ F, 25-V ceramic capacitor
 - C3—100- μ F, 16-V aluminum electrolytic
 - C4—220- μ F, 10-V aluminum electrolytic
 - C6—0.05- μ F, 100-V Mylar capacitor
 - C7—0.1- μ F, 100-V Mylar capacitor
 - C9—1.0- μ F, 100-V Mylar capacitor
 - D1—1N4001 rectifier diode
 - D2—1N914 signal diode
 - DIS1 through DIS3—Common-anode seven-segment LED display, (Fairchild FND 507 or similar)
 - IC1—CA3162E, A/D converter
 - IC2—CA3161E, seven-segment decoder/driver
 - IC3—74C221, dual monostable
 - IC4—7805, 5-V regulator
 - J1—miniature regulated circuit jack
 - J2, J3, J4—Banana jack (H. H. Smith 1509 or similar)
 - Q1 through Q4—2N2907A transistor
The following are 5%, 1/4-W resistors unless noted otherwise.
 - R1, R7—10-k Ω , cermet trimpot (Sangamo-Weston 593-840P-10K)
 - R2, R12—50-k Ω , cermet trimpot (Sangamo-Weston 593-840P50K)
 - R3—560 Ω
 - R4—7.5 k Ω
 - R5—not used
 - R6, R9—10 k Ω
 - R8, R10—22 k Ω
 - R11—470 Ω
 - R13—270 k Ω
 - R14—1 k Ω , 1% metal film
 - R15, R20—100 k Ω , 1% metal film
 - R16—1.5 M Ω , 1% metal film (calculated 1.44 M Ω)
 - R17—930 k Ω , 1% metal film (calculated 910 k Ω)
 - R18—2 M Ω , 1% metal film (calculated 2.06 M Ω)
 - R19—1 M Ω , 1% metal film
 - S1—3-pole, 4-position pc-mount rotary switch (C&K 304-15-N-C-Q)
 - S2—2-pole, 6-position pc-mount rotary switch (C&K 206-15-N-C-Q)
 - Misc.—Enclosure (H.H. Smith 2257), heat sink for IC4, knobs (2), battery holder.
- Note:** The following are available from Ballaba-Atlanta, P.O.B. 776, Duluth, GA 30136: Complete kit of parts including enclosure for \$69.95 plus \$3 postage/handling. Also available separately: pc board (B10403) for \$9.95 plus \$1 postage/handling; two rotary switches (DSS) for \$5 plus \$1 postage/handling; IC1, IC2, and IC3 (DIC) for \$12.50 plus \$1 postage/handling. Georgia residents add 3% tax.

proximately 100 megohms), be certain all solder flux is removed from between this IC socket pin and adjacent foil traces. Other than the ICs that will be plugged in later, the remaining semiconductors—including the three displays—

can be soldered in place. Check that the displays are properly oriented.

Before installing the rotary switches suggested for *S1* and *S2*, note that they have adjustable stops. These are set for the proper number of positions by re-

moving the nut and washer and repositioning the stop tab. The circuit board has been designed so that the switches called for in the Parts List cannot be improperly installed. Drill the three 25/64" holes shown in Fig. 4 for easy wiring

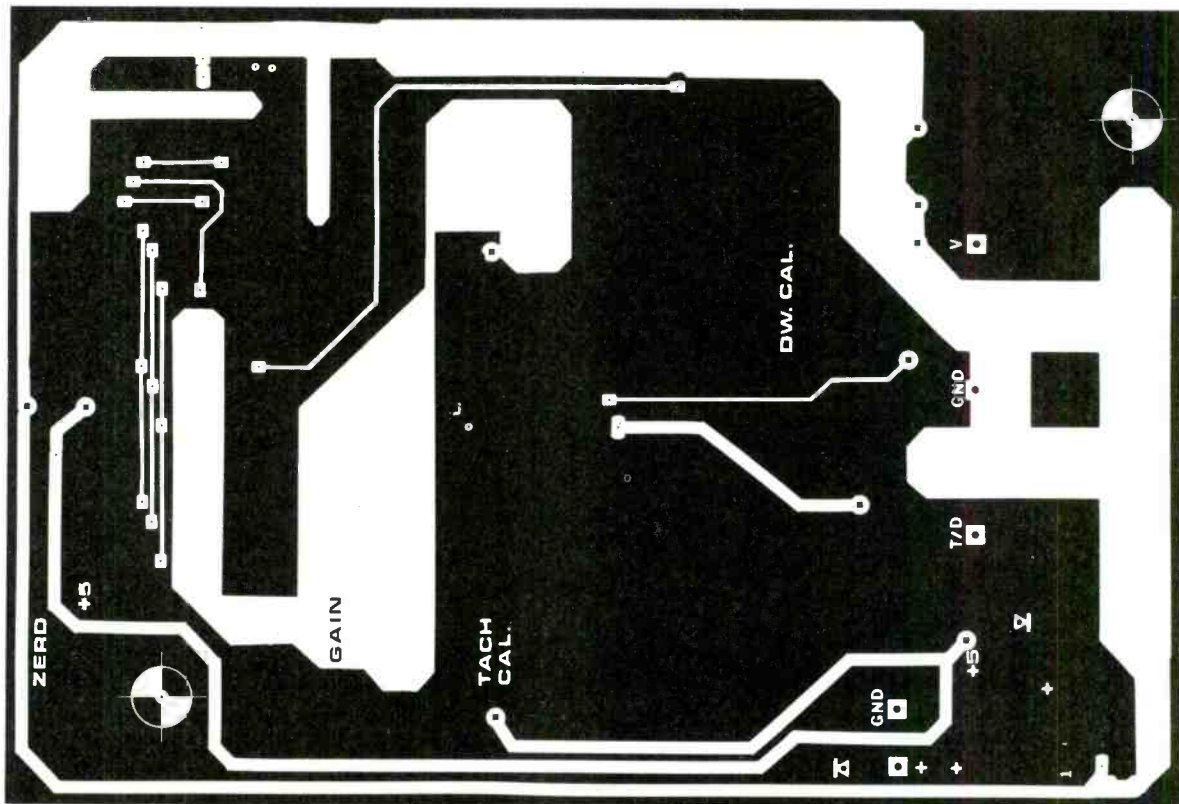
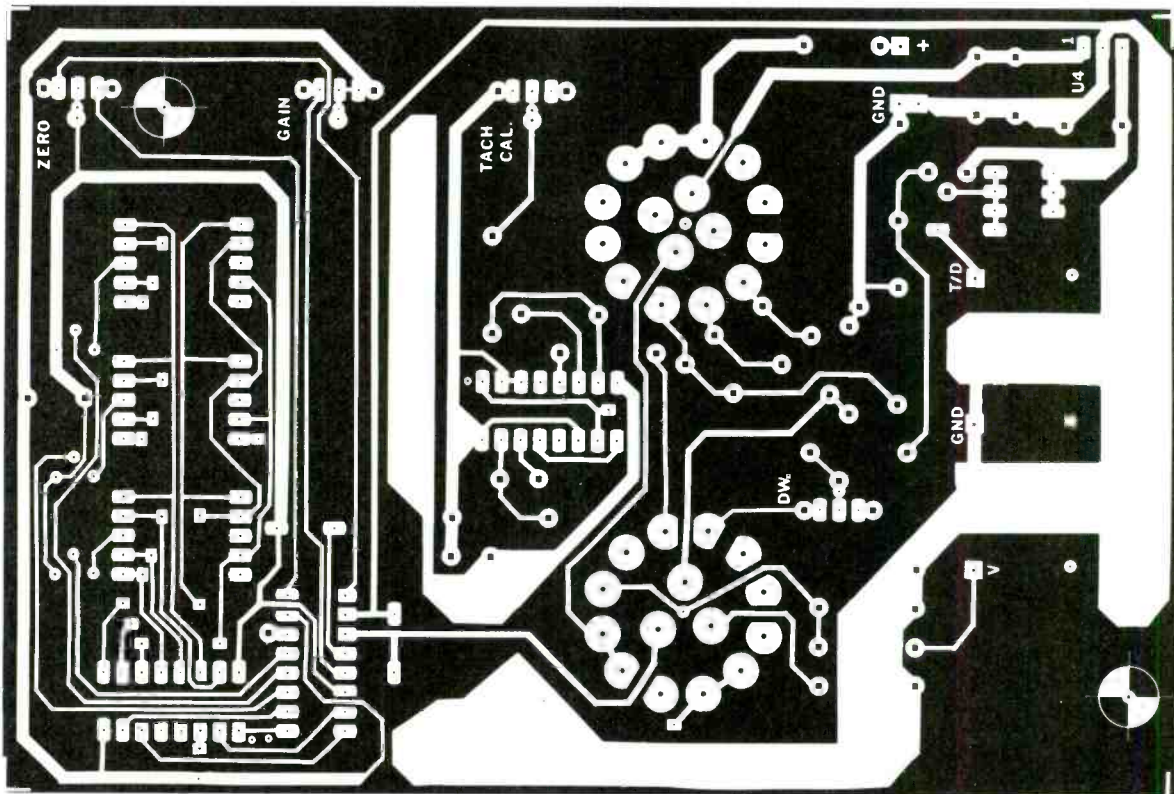

Figs. 2 and 3. Foil patterns for the two sides of the printed circuit board.

to the three front-panel input connectors: T/D, GND, and V+.

The finished pc board can be tested, before final installation, by connecting a 12-volt dc source across the proper J1 inputs (Fig. 5).

Look for 5 volts at the output of voltage regulator IC4. If this voltage is present, temporarily short pins 10 and 11 of IC1. The display may show a three-digit number (see Fig. 6F), positive overrange, or a minus sign and two digits (or Fig. 6E), negative overrange. In either case, adjust ZERO potentiometer R2 until the display shows 000. If any digits or segments are missing, check all connections to IC1, IC2, the digit driver transistors, and the displays.

Once the pc board is working, then the front panel can be drilled. (Note that the board is slightly smaller than the front panel of the suggested enclosure). Using the finished board as a guide, drill holes for J1, J2, J3, and J4, the two switches, and a rectangular cutout for the three displays. The display opening is covered with a piece of polarizing filter that's epoxied on the rear of the front panel.

After cutting the two switch shafts to length, knobs are installed, and each

stop position is identified. The six AA cells are installed in a battery holder secured to the bottom of the enclosure housing. Suitable lengths of color-coded lead connect the battery to the pc board. Diode D1 prevents damage in the case of inadvertant reverse-polarity installation. Before securing the board to the enclosure, test and calibration procedure should be done, as follows.

Test and Calibration. With the DATUM powered from either the internal battery, or from a 9-to-15-V external dc source at J1, note that the three displays illuminate. If 000 is not lit, readjust ZERO potentiometer R2 for this display.

Apply a known dc voltage (less than 99.9 V) to GND (J3) and V+ (J4). Adjust GAIN potentiometer R1 until the display indicates the known input voltage (do not readjust ZERO control R2). Error displays indicating an overvoltage condition and/or lead reversal are as shown in Fig. 6E and Fig. 6F.

Place CYLINDER switch S2 in the 4 position, and set FUNCTION switch S1 to DWELL. Allow a few seconds for the system to stabilize, then short the T/D and GND jacks together. Adjust DWELL CAL

potentiometer R12 until the display shows 90.0 ± 1 count. Rotate CYLINDER switch S2 to 6, and with the T/D and GND still shorted, note a display of 60.0 ± 1 count. Then, with S2 at 8, the display should indicate 45.0 ± 1 count.

If any variation is greater than one count in the 6 or 8 CYLINDERS position, check the divider network of R16, R17, and R18. To verify the conditioning and averaging circuit, use the test signal source of Fig. 7 connected between the T/D and GND connectors. The display should show one-half the previously mentioned indications.

The circuit of Fig. 7 can also be used to check the tachometer portion of the DATUM. The TACH X10 display (rpm) is derived from $(600 \times \text{frequency of test generator}) / (\text{sparks/second at 600 rpm})$. Since the output frequency of the test circuit is 60 Hz, and there are 40 sparks per second at 600 rpm for an 8-cylinder 4-stroke engine, the formula yields 900 rpm. The Table gives some pertinent engine ignition information.

With the test generator connected to the T/D and GND front-panel connectors, place the CYLINDER switch at 8 and the FUNCTION switch at TACH X10. Adjust TACH CAL potentiometer R7, for a dis-

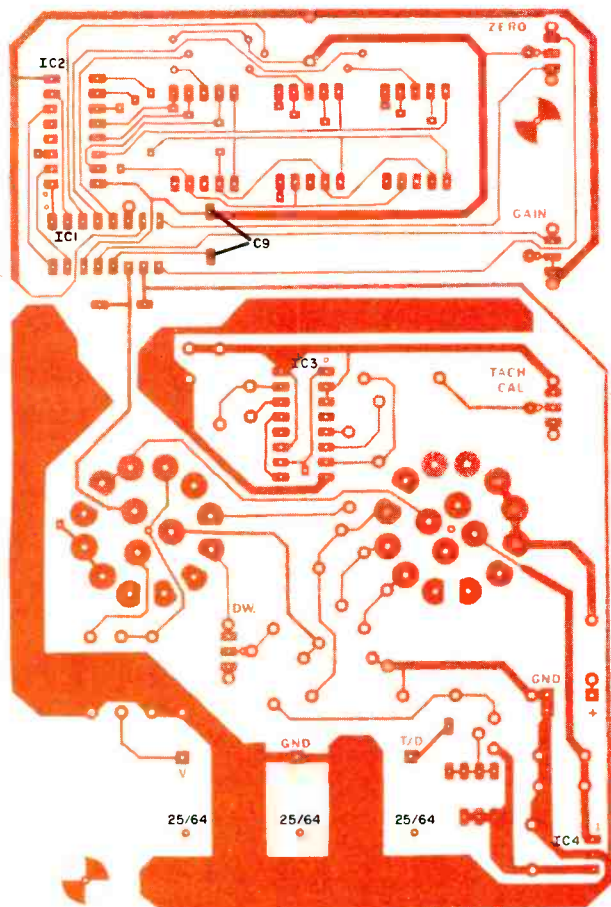

Fig. 4. This side of board goes against front panel.

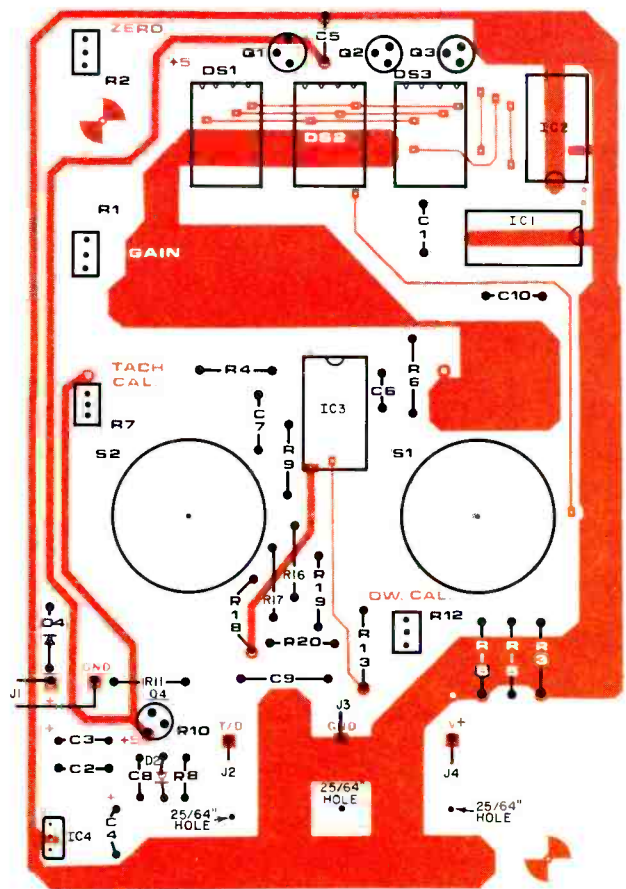

Fig. 5. Component layout for back of pc board.

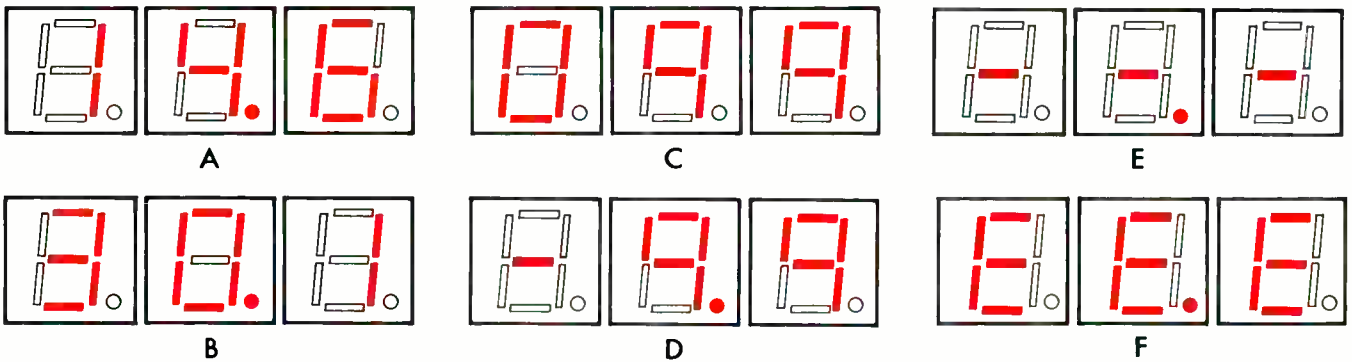

Fig. 6. Typical DATUM displays for different modes of operation.
(Note: Setting of CYLINDERS switch is not important for voltage measurement.)

(A). Battery voltage of a 12-V system with engine running (VOLTS function).
(B). Dwell of 4-stroke, 8-cylinder engine (DWELL function, 8 cylinders)
Note: the ".1" is insignificant since meter accuracy is specified ± 1 digit.

(C). Reading of rpm of a 4-stroke engine (8 cylinders, TACH $\times 10$ function).
Note: Must be multiplied by 10, yielding 990 rpm.
(D). Negative voltage measurement or accidental lead reversal (VOLTS function).

(E). Negative overrange display. Indicates reversed leads and voltage outside meter's range (VOLTS function).
(F.) Positive overrange display indicates voltage outside meter's range but proper lead orientation (VOLTS function).

play of 090. Note that the least-significant digit is not displayed, and all rpm values must be multiplied by 10 in this mode. With the CYLINDER switch set to 6, the display should show 120; when set to 4, the display should read 180.

Once calibration has been performed, place a small drop of adhesive or nail polish on each rotating shaft of the calibration potentiometers to eliminate the possibility of motion with vibration.

Tune-Up Tips. The DATUM is used in much the same way as any conventional analog tune-up meter. Space does not permit detailed information on all ignition systems, so only three basic systems will be referred to as examples (Fig. 8). Here are the basic tune-up procedures as related to the DATUM:

- Always refer to your owner's manual, shop manual, or engine nameplate for the specifications applicable to your vehicle, bike, or boat. Obtain manufacturer's literature for add-on capacitive discharge ignition (CDI) systems.
- For continuity checks, use only the Datum's batteries and disconnect the negative lead of the vehicle battery.
- Our discussion assumes a negative-ground system. For positive-ground systems, all lead connections mentioned here should be reversed.
- Some 24-V systems may have different specifications. Refer to the owner's manual.
- Dwell, rpm, and timing are interac-

tive. Dwell should be adjusted *before* timing since the dwell angle will affect the timing measurement. The best procedure is to repeat all measurements in sequence, trimming the adjustments until all readings are correct.

Continuity Checks. Although the DATUM does not have an ohmmeter function, it can still make continuity checks on wiring, bulbs, fuses, and diodes. Position the CYLINDERS switch to 8, and with the leads plugged into the T/D and GND jacks and shorted together, the DATUM should display 45.0

To check for continuity, connect the leads across the bulb, fuse, or diode of interest. A "good" fuse, bulb, etc., will display 45.0, while a defective or open unit will display 00.0 A "good" diode

will indicate 45.0 in one direction and 00.0 with the leads reversed. All bulbs, fuses, and diodes should be checked out-of-circuit to obtain valid readings.

Voltage Checks. The DATUM can measure voltages from -9.9 to 99.9 V dc with the test leads connected to the V+ and GND jacks. Negative overrange is indicated by three minus signs and a decimal point (Fig. 6E), while positive overrange is shown by three Es and a decimal point (Fig. 6F).

With the engine off and no load, the normal battery voltage in a 12-V (6-V) system should be between 12.2 (6.1) V and 12.8 (6.4) V. Readings below these values indicate a need for battery or charging-system maintenance.

Battery voltage drops significantly

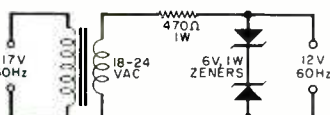
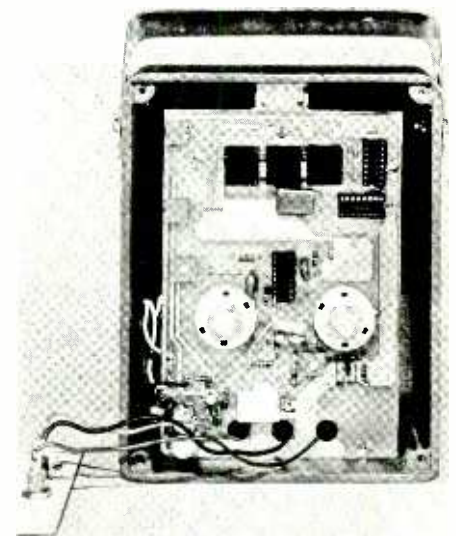

Fig. 7. Use this circuit to obtain a 60-Hz square-wave test signal for the meter.



Front and rear (with back removed) views of the assembled meter.

during cranking due to the high current drawn by the starter motor. In cold weather, this current is even higher because of bearing shrinkage and increased oil viscosity. An adequate 12-V (6-V) battery will measure about 9.5 V (4.75 V) during normal engine cranking at 25°C. Lower voltage measurements may indicate a defective battery, corroded battery posts (or cable), a worn starter, or improper ignition timing.

With the engine running and all accessories off, a fully-charged 12-V (6-V) battery should measure between 13.2 V (6.6) and 15.2 V (7.6 V) depending upon ambient temperature. Voltage readings less than 13.2 V (6.6 V) indicate a fault in the electrical system, battery, regulator, alternator/generator, or fan belt. Measurements in excess of 15.2 V (7.6 V) indicate a defective or improperly adjusted regulator, a defective battery, or wiring problems.

Dwell Measurements. Dwell refers to the amount of time the distributor points (or an equivalent electronic switching circuit) remains closed, supplying current to the ignition coil's primary winding. When the points open, the magnetic field created by the primary coil winding collapses, inducing a high voltage in the secondary winding that provides the spark. In capacitive-discharge ignitions (CDI) the energy stored in a capacitor is fed to the coil primary when the points open. Again, the coil is used as a pulse-type step-up transformer to generate the required spark voltage.

If the dwell time is not long enough, the magnetic field created by the primary winding will not contain the correct amount of energy and a weak, intermittent, or nonexistent spark will result. At higher rpms, improper dwell can cause misfiring and poor gas economy. In cold weather, starting difficulty may occur.

To adjust dwell, connect the DATUM GND jack to the vehicle ground and the T/D jack to the points side of the distributor (Fig. 8). Place the CYLINDERS switch to the appropriate position and the function switch to DWELL. Engines with conventional ignitions must have their breaker-point gap set to establish the correct dwell time. Some have "windows" that allow this dwell adjustment while the engine is running. Others require that the engine be turned off and the distributor cap and rotor button removed so that the gap (dwell) can be manually set. (Now this engine may be cranked and the dwell set without the engine starting.) Some breakerless electronic systems have adjustments for dwell. Dwell-extender CDI's must be removed from the circuit when the unit is used to adjust dwell.

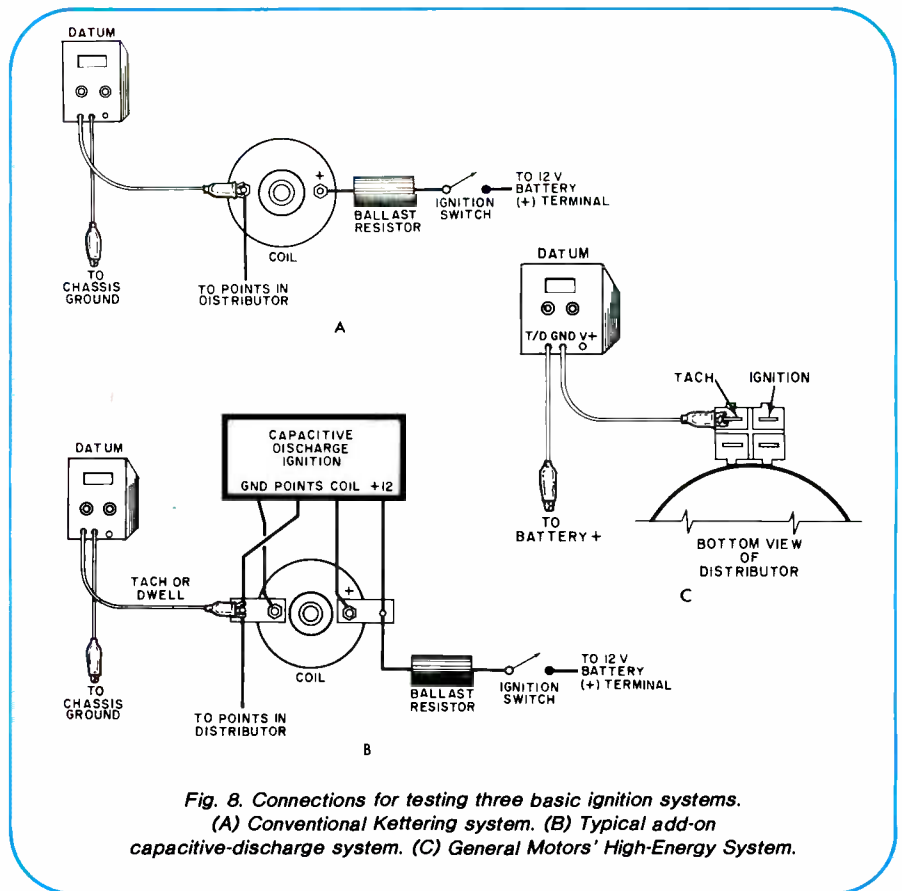

Fig. 8. Connections for testing three basic ignition systems. (A) Conventional Kettering system. (B) Typical add-on capacitive-discharge system. (C) General Motors' High-Energy System.

Although dwell angle is independent of engine rpm, the display will normally fluctuate slightly. Large, rapid readout fluctuations suggest that the points are bouncing. Increasing the tension on the point spring should alleviate this problem. Large gradual fluctuations in the display may indicate a worn and wobbling distributor shaft.

RPM Measurements. Rpm is the number of revolutions-per-minute an engine crank shaft makes. Most electrical (and some mechanical) adjustments are specified at a given rpm. For example, alternator/generator output must be checked at the rpm indicated by the manufacturer. Idle speed adjustments are particularly critical. The fast (cold weather) idle adjustment must allow the

engine to run while the automatic choke releases with increasing engine temperature. Normal idle allows the engine to run at the most economical rpm and not stall with accessory loading. Most carburetors have one or two idle-mixture adjustments.

To adjust rpm, connect the DATUM as you would for dwell. Then position the CYLINDERS switch to the appropriate number and the FUNCTION switch to TACH X10. All rpm measurements are made with the engine running and at normal operating temperature *except* fast idle, which should be adjusted when the engine has just started and is still cold. *Caution:* Although the DATUM will measure rpm as high as 9999, do not operate any engine above 3000 rpm under no-load conditions. ◇

AUTOMOTIVE IGNITION INFORMATION

Parameter	Two-cycle			Four-cycle			
	2	4	6	2	4	6	8
Cylinders	2	4	6	2	4	6	8
Sparks/revolution	2	4	6	1	2	3	4
Sparks/second at 600 rpm	20	40	60	10	20	30	40
Sparks/second at 6000 rpm	200	400	600	100	200	300	400
Cam degrees/spark	180	90	60	180	90	60	45
Crank degrees/spark	180	90	60	360	180	120	90

For 2-stroke engines, rpm displayed must be multiplied by 2

When it comes to microcomputers, we wrote the book.



If you're looking for understandable information on business or personal computers, remember the name SYBEX. We have the most comprehensive library of computer books you can find... from introductory and business books to hardware, programming and assembly language titles; all written by computer professionals. Since 1976 SYBEX books have received consistently high ratings from computer specialists and non-technical people alike. Why? Because our thorough, readable approach is unsurpassed. Hundreds of colleges and universities have adopted Sybex books as required reading.

Order today and find out why SYBEX is the name you should think of when you look for computer literature.



FROM THE ZAKS INTRODUCTORY SERIES

The CP/M Handbook, R. Zaks, \$14.95, Ref. C300. Complete reference guide to CP/M—the standard microcomputer operating system. Says *80 MicroComputing*, "If your future in computing goes beyond playing games, you'd better have a copy of this book on your shelf."

International Microcomputer Dictionary, \$3.95, Ref. X2. Just released! A handy pocket guide. Has definitions of all important terms used in "micro" jargon. Contains a 10-language vocabulary of essential computer words.

From Chips to Systems: An Introduction to Microprocessors, R. Zaks, \$14.95, Ref. C201A. This book takes you on a fast-paced, beautifully illustrated journey through the world of microprocessors. You'll discover how a computer system actually works and how the first microprocessor was (accidentally) developed. "...one of the best introductory texts to the hardware end of things" says *Elementary Electronics*. "For beginners in the field, a cover-to-cover reading would be well worthwhile," claims *Interface Age*.

Your First Computer, R. Zaks, \$8.95, Ref. C200A. The *Los Angeles Times* claimed that this book is "...an indispensable guide to buying, using and understanding the new generation of small computers..." Said *I/O News*, it "...belongs not just in every public library, but in the library of every business that needs, or will need computers."

DON'T! (or How to care for your computer), R. Zaks \$11.95, Ref. C400. Did you know that most computer

failures are caused by ignorance or negligence? *Don't* explains how to eliminate all common computer problems. All the do's and don'ts of caring for a small system.

"...Zaks has written another winner," says the *American Library Association Booklist*.

To order SYBEX books or get a free catalog, fill out the coupon, or call **TOLL-FREE 800-227-2346** (Within California 415-848-8233).

Send me: free catalog Microcomputer Dictionary \$3.95
 From Chips to Systems \$14.95 CP/M Handbook \$14.95
 Your First Computer \$8.95 Don't! \$11.95

Add: \$1.50/Book UPS 75¢/Book 4th Class
 \$8.00/Book Overseas Mail

Charge my VISA MasterCard American Express

Card # _____ Exp. date _____

Total Amount Enclosed \$ _____

Signature _____

NAME _____

ADDRESS _____

CITY _____ STATE _____ ZIP _____

 **MAIL TO SYBEX INC.**
 2344 Sixth St., Dept. F.
 Berkeley CA 94710

"My computer helped me write The Final Encyclopedia. I wouldn't trust anything less than Scotch® Brand Diskettes to make a long story short."

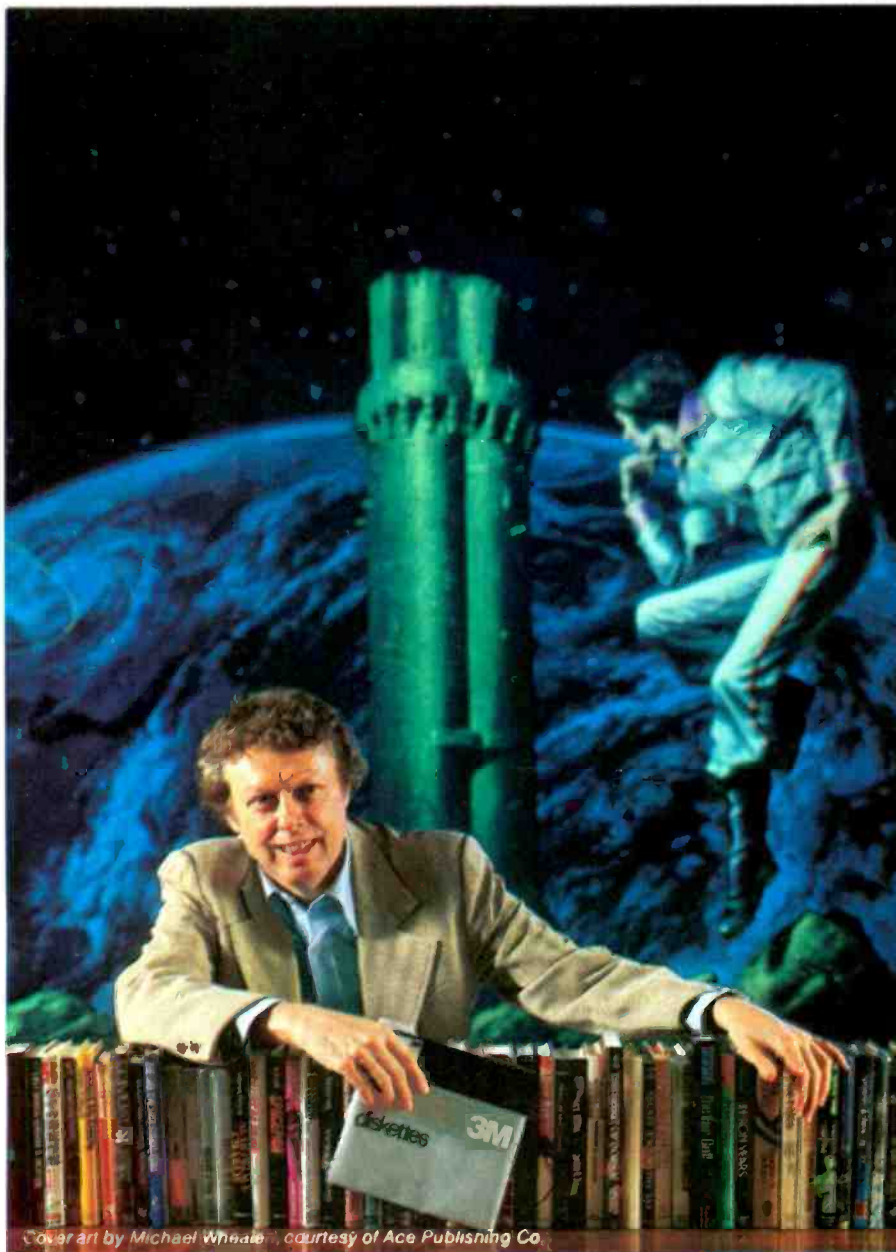

**Gordon R. Dickson,
Science Fiction Author,
Minneapolis, Minnesota**

Gordon Dickson: a small businessman whose product is his own imagination. He's written more than 40 novels and 150 short stories; his newest work is *The Final Encyclopedia*. He uses his personal computer and word processing software to maximize his production. All his words—his product—are stored on diskettes. He calls up sentences and paragraphs on demand, and gets more rewrite out of the time available. So he depends on Scotch diskettes to save himself production time.

Dependable Scotch media can work just as hard for you. Each Scotch diskette is tested before it leaves our factory, and certified error-free. So you can expect it to perform exactly right.

Scotch 8" and 5¼" diskettes are compatible with computer/diskette systems like TRS-80, Apple, PET, Wang and many others. Get them from your local 3M distributor. For the one nearest you, call toll-free: 800/328-1300. (In Minnesota, call collect: 612/736-9625.) Ask for the Data Recording Products Division. In Canada, contact 3M Canada, Inc., Ontario.

**If it's worth remembering,
it's worth Scotch
Data Recording Products.**



3M Hears You...

THE ELECTRONIC WORLD

COMPUTERS

**PERSONAL
PROFESSIONAL
EDUCATIONAL
SMALL BUSINESS**

WHICH ONE
IS FOR YOU?

BY JOE DESPOSITO

Technical Editor



The electronic digital computer has been affecting our lives ever since the room-sized ENIAC fired up its tubes and spewed out answers to complex technical problems more than 30 years ago. In recent years, electronic miniaturization has shrunk the size and cost of the basic unit to the point where virtually anyone can own and use a computer. The problem now is not buying a computer, but buying one that best meets an individual's needs.

A computer purchase follows the same laws as purchases of many other products—to get value, you have to weigh factors like price, performance, and desired functions. However, unlike most electrical and electronic products which are "dedicated" systems (for example,

a washing machine can only wash clothes), a computer is capable of performing a variety of tasks from entertainment to record-keeping, to teaching, to communications, etc.

Personal computers come in all sizes and prices so making a decision about which model to buy can be very confusing at times. The uppermost consideration is determining your individual needs, both present and near-future. This will help you narrow your field of choices, and you can make it even smaller by focusing your attention on one of the following areas: personal, professional, education, and small business. You could consider building a kit, too, in the interests of saving money and to provide ease of servicing (should it be required) and hardware education.



Created by Jan Hendricks
Courtesy Real Time Design Inc.

PERSONAL

We will define a personal computer user as someone who plans to use a microcomputer primarily in the home. We'll divide personal users further into two groups: those who want to make a minimal investment in hardware (\$100-500) and those who want to make a more sizable investment (more than \$1000).

People in the first group can get quite a bit of computing power for their dollar if they know what they want. Let's take a look at the general features available at this level to see how "what you want" can help you determine "what you get."

Computers that sell for less than \$500 can accomplish a variety of things. For example, they can help you become computer literate; they can perform calculations, they can entertain and teach you; and they can give you access to data networks by phone. However, not all of the machines in their basic configurations can do all of these things.

Let's consider computer literacy. Many people want to learn about computers and/or want to introduce their children to computer programming, BASIC, RAM, ROM,

bits, bytes, input, and output. Low-cost computers can do a thorough job of making a person computer literate. The Sinclair ZX81, for example, sells for less than \$150 (assembled), but goes a long way toward educating you in the benefits of having a computer in the home. The unit includes an r-f modulator that's used to connect the computer to your TV set. With the addition of an ordinary cassette tape recorder, you have the essentials of a computing system: a central processing unit, a display for input and output, and a storage medium for any programs that you want to save. How far can you go with this little system? You can learn BASIC and begin writing programs, and you can use pre-packaged software available for this computer (several companies provide such software). If, after a while, you begin to outgrow the basic system, you can add a 16K memory module and a small printer. Even with these add-ons, the system costs less than \$350.

However, if you want to play computer games like "Super Bustout" and "Blue Meanies from Outer Space" on your color TV, you'll have to look further than the ZX81. Examples of low-cost computers that offer color graphics are the Commodore VIC-20 for \$299.95 and Radio Shack's Color Computer for \$399. Both systems offer education and personal finance programs as well as the BASIC language that you can use to develop your

own programs. The VIC-20 needs an optional cassette recorder to store programs, while the Radio Shack model, which also has an optional cassette machine available, has provisions for using plug-in ROMs called "Program Paks." This is a factor to consider when looking at base prices. Among other considerations would be the quality and function of the keyboards, and video alpha-numeric resolution.

If you're on a low budget now but would like to expand your horizons later, you might consider starting out with either the TI 99/4A from Texas Instruments or the Superboard II from Ohio Scientific. The TI 99/4A, which "lists" at about \$600, but is heavily discounted, can get you started in computing. Like the Radio Shack Color Computer, it uses ROMs that plug into the console so you don't have to buy a cassette recorder immediately. These plug-in ROMs are great for children who might find it difficult to use a tape unit. The basic unit includes 16K of RAM memory, which is considerably more than the other computers mentioned thus far offer with their basic units, though they're all expandable. Probably the most important feature of this machine, for those with expansion in mind, is that it can run LOGO, an innovative language used for educational purposes.

If you're interested in computer music but want to avoid the expense of add-on music synthesizers, the VIC-20, the Color Computer, and TI 99/4A have tone generators that can be programmed to play songs or make other sounds such as whistles or explosions.

The Superboard II is a "bare bones" computer for \$329, which comes without case or power supply. If you enjoy looking at the innards of the machine while working, this is the one for you. The addition of a power supply and r-f modulator (another \$80) will get you rolling. This machine starts you off with the basics, yet offers a great deal of expandability when needed. (The Superboard II is essentially the "guts" of the Ohio Scientific Challenger 1P).

One note of caution. Of the five computers mentioned (and this does not cover every low-cost model available), all have expansion capabilities such as adding a printer. However, expansion means money! If you think you will eventually spend \$1000 or more on a system, you owe it to yourself to check into some of the higher-priced systems *before you buy*. In general, the latter offer more variety of software and peripherals which, in turn, gives a computer more flexibility and power.

Before we discuss higher-priced computer systems, let's examine another type of low-cost item. If you're not interested in programming but would like to hook into one of the giant data networks like CompuServe and The Source, you might consider either the RCA VP3501 Video Data Terminal or Radio Shack's TRS-80 Videotex terminal (each at \$399). These are not versatile computers, but they are capable of "plugging into" the big computer telephone networks. Both of these terminals have built-in modems and r-f modulators. This means that you just plug a phone cord into the terminal, connect the terminal to your TV set, and you're ready for action. The data networks offer an incredible amount of information and services. For example, they provide news, weather and sports from many major newspapers and international news services such as Associated Press and UPI. They offer financial information (with updates) and historical information on stocks, bonds, and mutual funds. In the entertainment field they provide theater, book, movie, and restaurant reviews. Electronic mail service is available so you can send and receive messages from other network users. In addition, they have challenging games, programming languages, word processing, and business and education programs. You can even get parts of computer-related editorial matter from PE.

One of the differences between the two terminals is the keyboard. The RCA model has a flat, touch-sensitive

board that's impervious to liquid spills, while the Radio Shack model has a standard typewriter-style keyboard. If you're a touch typist, a difference like this would be important to you. Both terminals are portable, so you can take them wherever you go as long as a telephone and TV are available when you get there.

Clearly, there's quite a bit you can do with a low-cost computer or terminal. But, if you want to spend more money, you can buy a personal computer that is more sophisticated than those mentioned thus far.

To get the most out of a computer, however, you will need to add some peripherals and develop a software base. In general, a substantial system should include a printer, one or more disk drives, a modem (for communications), and maybe a few other accessories such as joysticks, a voice synthesizer, a music synthesizer, a light pen, or a graphics tablet. Of course, adding all these peripherals to your system will skyrocket its cost into the thousands of dollars—and we haven't even considered software yet.

You could write your own programs, but it's more like-



ly that you'll buy most of the software you need. Some of the top software packages are Word Star and Scripsit for word processing, VisiCalc for financial applications, and CP/M for the computer's basic operating system. Besides these, there are thousands of other software packages to enable your computer to work harder for you. As we observed before, though, your own needs must be considered before you purchase anything.

Sometimes a particular software package will run on one machine but not on another (although most major computers have comparable software packages). Keep this in mind because it might influence you to buy one computer rather than another. (Since usefulness or utility is probably more important than price at this level, we will not make price comparisons among the different computer systems in the following section.)

If you plan on spending more than \$1000 on a computer system, some of the models available include the Apple II Plus, the Heath/Zenith Z89, the Atari 800, the TRS-80 Model III from Radio Shack, the IBM Personal Computer, and the NEC PC8001A. To make an intelligent buying decision, you have to look at some of the unique features of the machines that might be highly appealing to you.

If your main interest is color graphics, here are some features to consider. Color is available on all models except the TRS-80 Model III and the Z89, both of which come equipped with their own built-in monochrome monitors. High-resolution graphics are available on all models except the TRS-80 Model III. The difference between

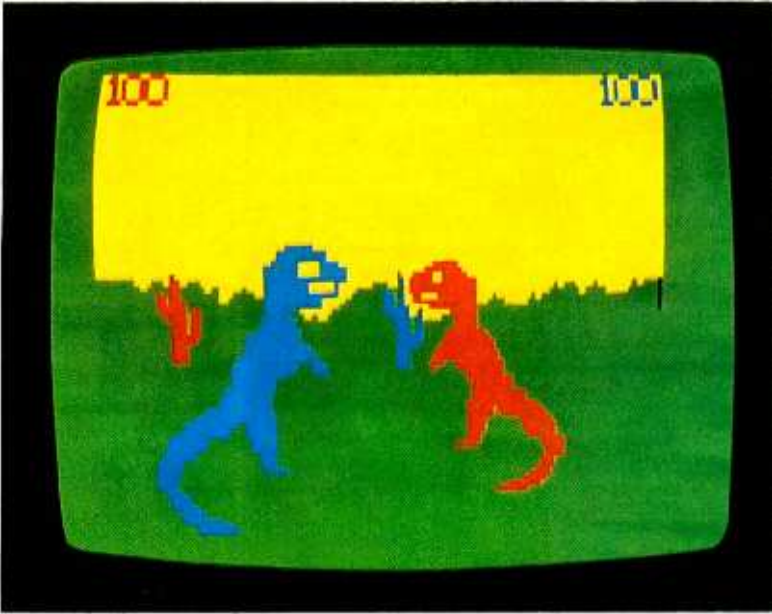

Courtesy Radio Shack

high- and low-resolution graphics is the number of points or pixels on the screen that can be addressed by the computer (turned on or off). The screen is divided into a certain number of pixels. A typical low-resolution number might be 128 x 48 (6144 pixels), while a high-resolution number might be 280 x 192 (53,760 pixels). The higher the number of pixels, the smaller the individual area that is being addressed. The high-resolution feature allows you to produce sophisticated graphics for animation or detailed figures.

Computers have different ways of displaying text. For example, the Z89, PC-8001A, and IBM Personal Computer have displays that are 80 characters across and 25 lines down. However, the TRS-80 Model III has a display that is 64 characters by 16 lines, while the Apple and Atari use 40 characters by 24 lines. In general, you need a video monitor if you want to work with a line that has more than 40 characters. A television set can't handle lines with more than 40 characters too well because of bandwidth limitations, so the letters are not sharply defined. If you want to use your computer with a high-quality color monitor, the Atari 800, NEC PC-8001A, and IBM Personal Computer provide an RGB (not the usual NTSC or composite signal) video output as a standard feature.

When examining the general quality of a text display, you should consider characteristics such as space between lines, sharpness of characters, and whether lower-case letters like g, j, p, q, y have true descenders; that is, the "tails" of the letters fall below the line as they should.

If you want an "intelligent" terminal, the Z89 is the only model of this group that offers this feature. This terminal has its own microprocessor and can perform operations separately from the computer. The most obvious advantage of this is increased speed since the computer doesn't have to share its processing power with the terminal. In addition, through relative or direct cursor addressing, you can insert and delete characters or lines anywhere on the screen, or erase a line or a page. The terminal also provides automatic scrolling and reverse video among other functions.

If you want a computer with expansion slots that are easily accessible, then the Apple or IBM models hold an advantage. The Apple II Plus has eight expansion slots attached to the motherboard while the IBM has five. If

you want to expand your system with the other computers in this group, you may need an I/O interface, which usually entails an investment of a few hundred dollars. The Z89 is the only one of these computers that includes an RS-232C port as a standard feature (it has three); the others offer it as an option. The RS-232 is the EIA standard serial interface.

The keyboards differ significantly on these computers. For example, a built-in calculator keypad is available only with the IBM, Radio Shack, NEC, and Heath/Zenith models. Some of the computers include user-definable function keys on the keyboard: the IBM has ten, the Z89 has eight, and the NEC has five. All models, except the Apple, include lower case letters as a standard feature. The IBM has many keys which have four selectable functions. This particular feature, it should be noted, is also available on two low-end computers, the VIC-20 and the ZX81.

The TRS-80 Model III and Z89 offer a compact design that includes a standard keyboard, a calculator keypad, a video monitor and space for a disk drive in one unit. (The TRS-80 has space for two drives.) Should you want a computer that runs a diagnostic test on itself before commencing operation, the IBM is the only one of this group that can.

If game and music playing are high on the list of things you want to do with a computer, the Apple II Plus and Atari 800 are your best choices at this time. Paddles or joysticks can be connected to these units to enhance your game-playing pleasure. Atari is the only one of this group that accepts plug-in modules for game playing (however, modules from their popular video game are *not* compatible with the computer). The Apple II Plus includes a speaker and tone generator for music and sound generation, while the Atari has a speaker and a four-voice sound generator with four octaves per voice. The TRS-80 Model III, because its software is compatible with the pioneer Model I, has many games available for it although you must use the keyboard for input and control of the games, which are in black and white. The IBM computer will be good for games and music, eventually. This computer has excellent graphics capabilities, and a sound generator with one voice and 32 tones. However, because it is a relatively new entry to the market, it lacks the software support of the others.

If home business and professional use are your main concerns, any of these computers can handle word-processing, financial, and data-base management tasks. However, machines like the Z89, NEC, and IBM have an advantage because they have an 80-column format, which is ideal for running programs like Word Star, Visi-Calc and DB Master. Also, these computers are CP/M compatible, which opens up a world of software for the machines. To use CP/M on the Apple, you have to purchase a plug-in module.

The TRS-80 Model III and Apple II Plus have the most software support at the present time, although the Heath/Zenith, Atari, and NEC models have a generous amount. It's anticipated that IBM will, too, in a year or two. Again, when attempting to make your choice, you should consider the features that you want both in terms of hardware *and* software before you make a purchasing decision.

PROFESSIONAL

In the last few years, the personal computer has blossomed into a serious tool for professional use. It's being used not only by engineers, scientists, and businessmen, but also by writers, artists, musicians, doctors,

dentists and many others. Usually, no computer knowledge is required because the software is "menu" driven. In other words, a list of options is presented and you need only select the option you want to operate the desired program.

Although the needs of an engineer differ from those of a musician, both can use the microcomputer as an aid to their work. In fact, many professionals are "writing off" the cost of a computer as work-related expense, which indeed it is. Since their needs are different, we'll discuss each area individually.



Courtesy Apple Computer, Inc.

Scientists were probably the first group of professionals to use electronic computing power in their work, though they used monster-size computers. Nowadays, engineers as well as scientists use micros for complex calculations, design analysis, graphs, control of experiments, etc. There are tons of programs available, both prepackaged and in books, to accomplish almost any kind of mathematical calculations. The personal computer is a whiz at analyzing the relationships between variables and, in fact, many companies offer software that performs complex chores like linear programming, multiple regression analysis, and circuit analysis. Another great attribute of a micro is that, after all the calculations are made, you can display your results in the form of a graph for visual analysis of the result and communicate with various "mainframes" or with other people.

In addition to the software, there are many electronic instruments available that feed information directly into the computer so that it can be used as a lab instrument for data-recording and device-control applications. These instruments measure temperature and pressure, and sense electrical currents and voltages among other things. The computer acts as a controller that reacts to these inputs by switching circuits on and off to regulate temperature, pressure, etc. The computer can also record, store, analyze, and display the data it receives.

Usually, these instruments are connected to a computer via the IEEE-488 bus. Also known as the General Purpose Interface Bus (GPIB), it is an 8-bit-parallel, byte-serial, standard digital interface that allows your computer to communicate with up to 15 programmable instruments. Using this interface, your computer can control instruments such as logic analyzers, frequency counters, digital multimeters, thermometers, and many others that are manufactured for compatibility with this bus.

When choosing a micro to use in scientific applications, you have to consider carefully what you want to do with it. Some computers, like the HP-85 from Hewlett-Packard, are geared to the technical professional. This

computer has a compact design that includes a 5" video display, a data cartridge tape drive, a keyboard with programmable keys and a calculator keypad, and a thermal printer. The HP-85 has excellent graphics capabilities so that you can easily print out complex graphs. It also has four levels of security protection for files on its data cartridges if you are security conscious. The company also provides an excellent assortment of technical software packages. There are good business packages, too.

The Apple II Plus, TRS-80 Model III, and Zenith Data Systems' assembled Z-89, because of their wide software bases, are likely to be used for technical applications. However, there are other computers available for this type of work so you should hold off buying anything until you've found the software and peripherals that will meet your needs.

Engineers and scientists are not the only professionals who can take advantage of a personal computer. Medical people like doctors and dentists are finding that computers can help clear up the logjam of paperwork which often overloads their staffs. Billings, for instance, are a source of an endless amount of work that's basically repetitive. Besides using software that is aimed at tackling this kind of work, the computer can be applied to tasks such as appointment scheduling, data management, and word processing. There are also several medical/dental computer bulletin boards that can be accessed by using a modem.

Other people such as writers, artists, and musicians can do wonderful things with a computer. Writers are obvious candidates for word-processing programs. Using a program like Word Star, they can type their manuscripts, edit them on the computer and print them out. Other programs like Spell Star can check a manuscript for spelling errors—it's almost like having a built-in proofreader.

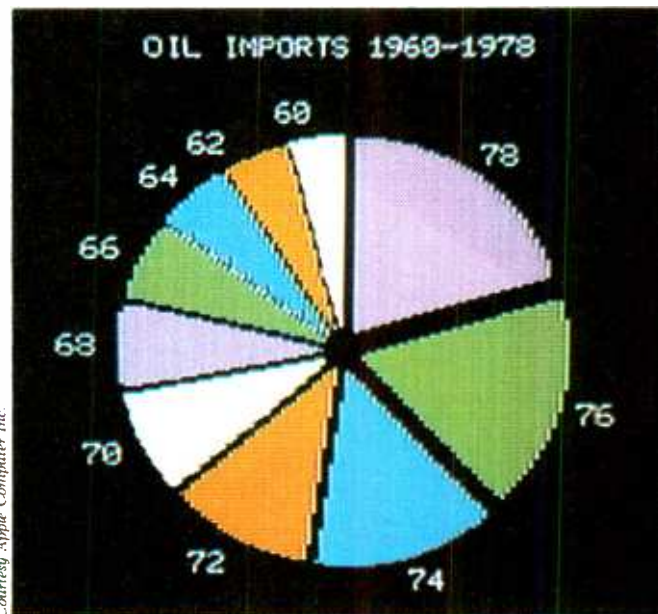

Courtesy Apple Computer, Inc.

Artists are finding that the computer is offering them a new mode of expression. Instead of a brush and paints, the artist is equipped with an electronic pen and tablet. Commercial artists can take advantage of the animation properties that a personal computer can provide. Software packages like Painter Power, Micro Painter, Electric Painter, Electric Crayon, and Micro Angelo are designed specifically to exploit a computer's graphic capabilities.

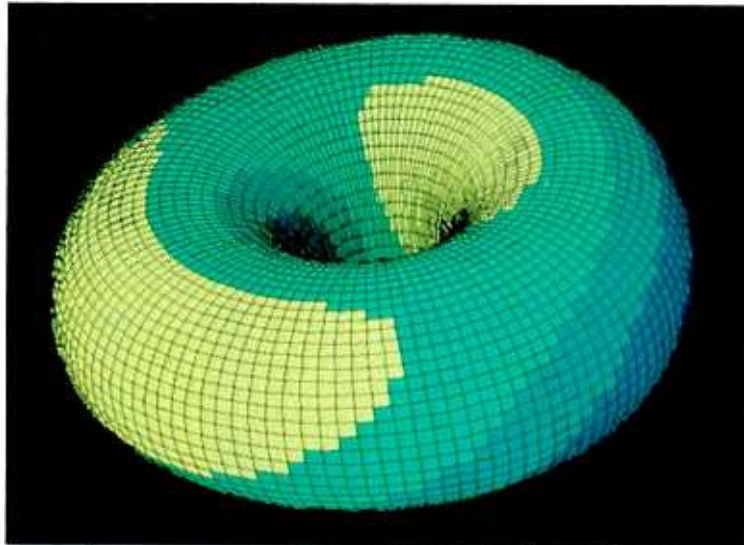

Courtesy Digital Equipment Corp.

Musicians can also use the microcomputer as a new mode of expression. There are synthesizers available which allow you to enter a musical score and listen to it or play along if you like. A musician can enter his own compositions into the computer and it will give him a concrete example of what's been playing in his head. Some of the popular music synthesizers are Music System from Mountain Hardware, the Music Composer cartridge from Atari, Casheab (for serious computer musicians) and the Alf Music Synthesizer.

If you want to buy a computer for word-processing applications, you can select any model which is compatible with the software and printer that you want. Art and music applications narrow your choices down to the Apple and Atari because most of the software is written for these machines.

One of the professional types we haven't discussed yet is the businessman. The person that we're talking about here is someone like an accountant, marketing manager, actuary, etc. This is to distinguish these people from the businessman who owns a small business (to be discussed later).

Businessmen, like other professionals, have certain needs in terms of software and peripherals. They might use a personal computer for scheduling, forward planning, investment analysis, income tax preparation, calculations, etc. Many standard programs are available in books and magazines. In addition, software manufacturers offer an enormous selection of pre-packaged programs. A businessman who travels frequently might do well to consider some of the portable computers that are on the market. The largest portable computer is the Osborne I. This is a full-fledged computer that is approximately the size of a piece of luggage. Not only can you travel with this system, but it includes two disk drives, a standard keyboard, a numeric keypad, and a monitor, plus a CP/M operating system, Word Star, and SuperCalc as standard features.

Although the Osborne I is portable and can run on batteries, you may want a computer that is small enough to be stowed in a briefcase. Computers that fit this description are pocket models like the TRS-80 Pocket Computer (Sharp also markets this model), the Panasonic HHC (also marketed by Quasar), the Hewlett-Packard HP-41, and the Casio FX-702P. If you require your hand-held to interface with a TV set or a modem, then you should investigate the HHC model. Otherwise, all these models offer a printer and cassette-tape storage as options.

EDUCATIONAL

It would seem that the role of the personal computer in education will be a monumental one, eventually. However, at the present time, educators are still struggling with the best ways to implement this powerful new tool in the everyday curriculum. Where do you fit into the educational picture? Even if you're not a teacher or admin-



Courtesy Atari Inc.

istrator, you may want to use the computer in an educational way. Suppose, for example, you are a parent who is being bombarded by words like LOGO, PILOT, tapes, disks, cartridges, and the like when the kids come home from school. You may want to take a more active part in their computer coursework and may even want to supplement it with a system at home that offers comparable material. If your main interest is in the educational uses of the computer there are some things you should know.

If you're hearing words like LOGO or PILOT being bandied about by your children, the school is using one of the innovative languages developed especially for education. LOGO is a language that helps children improve their problem solving abilities. It encourages a child to analyze a task, try different strategies, and modify a strategy until the task is completed. If you wanted to use LOGO with your child, you would need either a TI-99/4A or Apple II Plus because the language is available only for these computers at the present time. To run LOGO on the TI-99/4A, you would have to invest about \$300 in a TI LOGO command module. Other require-

HEATH/ZENITH & YOU, INC. ONE STRONG PARTNERSHIP

A computer purchase is the beginning of a long-term partnership between you and the people you buy from. Your ongoing need for software, peripherals and accessories requires a partner who will stand by you with a growing line of products to meet your needs. Heath/Zenith will be that strong partner for you. Look what we have to offer.

THE ALL-IN-ONE COMPUTER – The heart of the Heath/Zenith line is the stand-alone *89 Computer*. It's a complete system with built-in 5.25-inch floppy disk drive, professional keyboard and keypad, smart video terminal, two Z-80 micro-processors and three RS-232C Serial I/O Ports. It comes with 48K bytes of RAM, expandable to 64K.

PERIPHERALS AND ACCESSORIES – These include the popular *Heath/Zenith 19 Smart Video Terminal*, loaded with professional features. We also offer color and black and white monitors, modems, computer language courses, and high-speed typewriter-quality printers.

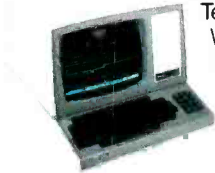

SOFTWARE – New software, includes the SuperCalc Spreadsheet and Condor Data Base Management System. *Word processing*, including three different programs. *Small Business Programs*, feature Peachtree's Series 5, Softstuff's General Ledger and Inventory Control. *HUG, Heath Users' Group*, offers members a library of over 500 low-cost programs for home, work or play.



PROGRAMMING LANGUAGES – For your own custom programs, Microsoft languages are available in BASIC (compiler and interpreter), FORTRAN and COBOL.

APPLICATIONS SOFTWARE – Expand the performance range of your computer with a broad selection of software, including the best of *Digital Research* and *Micropro* – as well as the complete line of *Softstuff™* products.

OPERATING SYSTEMS – Three versatile systems give you the capability to perform your specific tasks. *CP/M* by *Digital Research* makes your system compatible with thousands of popular CP/M programs. *UCSD P-System with Pascal* is a complete program development and execution environment. *HDOS, Heath Disk Operating System* gives you a sophisticated flexible environment for program construction, storage, and editing.

DISK SYSTEMS – The new *Heath/Zenith 67 Winchester Disk System*, for commercial use, adds nearly 11 megabytes of storage to your 89 computer. It includes an 8-inch

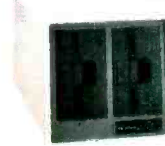

floppy disk drive for data portability. The new *5.25-inch 37 disk system*, available with 1 or 2 drives, adds up to 1.28 megabytes of storage. Both plug-in systems have write protection.

SERVICE AND SUPPORT – Prompt and professional service and assistance is available nationally through Heathkit Electronic Centers, Zenith Data Systems for commercial users or through Heath factory servicing and phone-in technical assistance.

Complete, integrated computer hardware and software, designed to serve and grow with you – that's what to look for in a strong partner. And with Heath/Zenith you get it all.

Heath/Zenith computer products are sold nationwide through Heathkit Electronic Centers* (check your white pages for locations). For a FREE catalog and mail order service, write: Heath Co., Dept. 010-894, Benton Harbor, MI 49022.



HEATH/ZENITH

Your strong partner

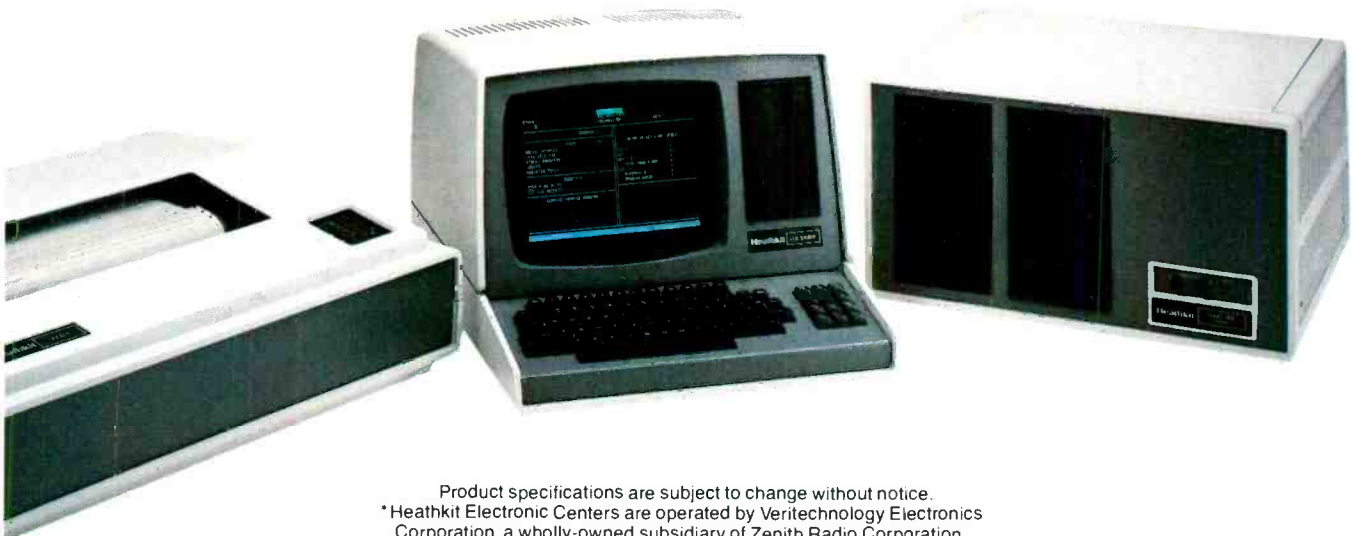

Product specifications are subject to change without notice.
*Heathkit Electronic Centers are operated by Veritechnology Electronics Corporation, a wholly-owned subsidiary of Zenith Radio Corporation.

CIRCLE NO. 57 ON FREE INFORMATION CARD

ments are a color monitor, disk drive, disk controller, and memory expansion unit. To run LOGO on the Apple, you would have to purchase a LOGO disk. In addition, you would need 48K bytes of memory, a color monitor, one disk drive, and an Apple language card.

PILOT is another language used for educational purposes. It is an interactive language that introduces students to the fundamentals of computer performance. It is available from Atari in cartridge format, from Apple in disk format, and from other sources.

If you're interested in buying other educational software, you should be forewarned that good software is hard to come by. There are many so-called educational programs that just reprint a textbook on the screen rather than taking full advantage of the capabilities of the computer.

If your child's school is not using computers right now, you may want to start a computer literacy program of your own. Traditional group activities like the Boy Scouts, Girl Scouts, Boys Club and 4-H Club offer a convenient vehicle for introducing children to computer fundamentals. If you're thinking of making a hardware purchase, you might consider trading off quality for quantity. Instead of having 20 people huddled around an Apple, you may be better off having five groups of four people working with Sinclair ZX81s.

Education, of course, is not just for children. You may have in mind furthering your own education or using a computer in an adult education program. Software is available for most subject areas, although as mentioned previously, much of it is not top-quality material. Because of the popularity of the Apple and Radio Shack computers, you'll find that most of the software available is written for these machines. Heath is coming up fast in this area, though.

In general, before purchasing any hardware, you should find the software that interests you. It will be written for a certain machine or machines, will require certain peripherals, and need a certain amount of memory. For example, if you're interested in programs from the Minnesota Educational Computer Consortium (MECC) software library, you'll need an Apple II Plus with a disk drive and a minimum of 48K memory. MECC software is not available for any other computers as of this writing. It's evident that knowing what you want in terms of software can be a big help in hardware decision making.

SMALL BUSINESS

For the person who owns a small business, runs a business from the home, or wants to computerize a small department of a large corporation, selecting hardware can sometimes be a treacherous undertaking. If things don't work out when you buy a computer for home use, you can always stash it in the closet. But, if you're making a major investment in hardware to help increase the productivity of your business, you can't just throw the computer away if it doesn't do what you want.

A broad strategy for computerizing a small business is to divide the problem in the following way: making the system work and keeping it that way. Making the system work entails the hardware and software aspects of the system, while keeping the system working concerns the service, training, expansion capabilities, and data-protection procedures of the system.

The first thing to consider is whether or not you can make the system work for you. You have to choose the software package that's right for you and you have to find the hardware to run it.

Some of the most popular business packages available are Word Star, Spell Star, and Scripsit for word processing; VisiCalc and SuperCalc for financial applications; and DB Master for data-base management. Other important software is the computer's operating system. The most popular operating system is CP/M, which is available for most computers. Other operating systems are available, too. Besides CP/M, the Apple III offers the SOS operating system, while Radio Shack offers TRSDOS (NEWDOS and LDOS are also available). Of course, if you can't find pre-packaged software that you're satisfied with, you may have to hire programmers to custom design a software package for you.

As far as hardware goes, you will have to think about peripherals as well as the main computing unit. If you buy a computer like the Northstar or Cromemco, which have an S-100 bus architecture, you will need a video terminal. A "smart" terminal offers features like relative and direct cursor addressing, dual intensity, and underlining among other things. This type of terminal can even change its parameters through software control. Disk storage is also an important factor to consider. Disk drives can be single-sided, single-density; single-sided, double-density; or double-sided, double-density. Also, they come in two sizes, 5 1/4 inches or 8 inches. Note that disk drives, software, and interfaces must all be compatible for a particular system.

Other peripherals that a small business might need that most people wouldn't are a hard-disk drive and a daisywheel printer. The hard-disk drive is usually a sealed unit that stores at least five megabytes of information. Hard disks are important for applications that deal with large amounts of data because they make the operation much more efficient. A daisywheel printer offers true letter-quality printing for use in business correspondence and other applications. Its quality is, of course, reflected in its price.

Keep in mind that the largest share of the microcomputer market is the small-business market. As a result, there is a much greater selection of computers geared for business use than for any other, and it follows that more disk software is available for business purposes than any other. Some popular very-small-business computers are the Apple III, the Xerox 820, the IBM Personal



Courtesy Atari Inc.

Wabash Breakthrough:

- Improved Coating Formulation
- Refined Burnishing Technique
- More Than 10,000,000 Test Passes Without Error
- Endorsement From The World's Most Prestigious Drive Manufacturers
- Compatible With All Office, Personal, Radiographic And Desk Top Computer Equipment
- More Reliable Than Ever
- Available Now In Our Innovative New Package



For new brochure call (800) 323-9868 or (312) 298-8585 or write Wabash DataTech Inc., 2700 Des Plaines Ave., Des Plaines, IL 60018

CIRCLE NO. 49 ON FREE INFORMATION CARD

Computer, the Northstar Horizon, the Commodore CBM, the NEC PC-8001A, the Radio Shack Model II, the Cromemco System One, and the Heath/Zenith Z89.

The main factors to consider after hardware and software are equipment service, personnel training, expansion capabilities of the system, and data and information protection procedures.

Once your system is in operation, your company will depend on it. When it goes down, you will need quick and efficient service to get it running again. You won't be able to wait two or three weeks for a part to arrive. Thus, when purchasing your computer you should pay close attention to the service-contract part of the deal. This is also true of any peripherals you purchase.

When your system first arrives, you'll have to train people to use both the hardware and software. If you want the transition period to be as painless as possible,

able to expand your system if you want to or need to? Are capabilities like networking available for the system that you buy? It was only this past year that Radio Shack announced that it had developed a networking system for its TRS-80 computer.

Once your system is operating efficiently, you want to keep it that way. Inadequate data-protection practices could not only slow you down, they could ruin your business. One of the things you have to think about is a file back-up system. When considering hardware and software needs, you have to think about the need for more than one set of files to protect you against disasters like fire and theft. This may affect your hardware considerations. If, for example, you plan on buying just two disk drives, you have to realize that time must be allowed so that the drives can be used just for making a duplicate copy of the files. When considering the cost of the system, all these things have to be taken into account.

The systems available for small-business applications are the most sophisticated microcomputers on the market so we're not going to try to direct you to one machine or another based on hypothetical needs. However, you *do* have specific needs and by analyzing them carefully and taking into account some of the factors presented above you can make an intelligent choice.

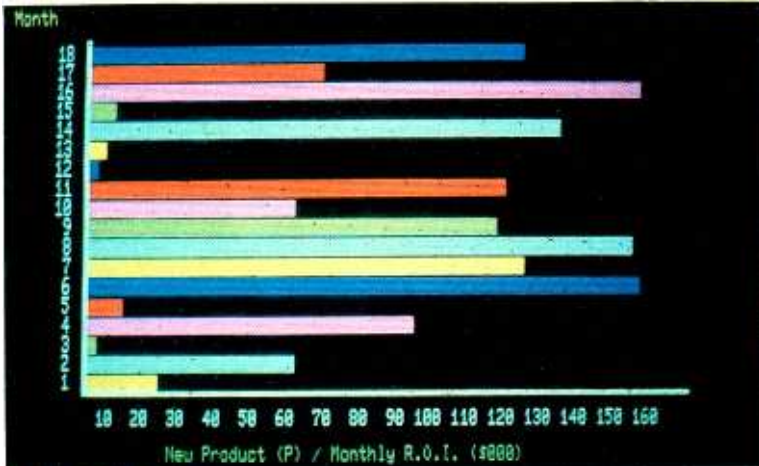

it's a good idea to have key personnel involved in the decision-making process from the start. After all, they are the people most familiar with the day-to-day details of the job and they are the ones who will use the system. It's a good idea to think about the "creature comforts" of the system. How does the keyboard feel? Is the system easy to use? Will you need a green monitor to reduce eye-strain? These and other questions should be considered before you buy.

Keep in mind also that documentation should be clear and easy to understand. If a new person is hired after the system is in operation, he or she may have no other recourse than to "read the book" to learn about specific procedures of the system.

When making your decision this year, don't forget about next year. A system that is operating smoothly and efficiently is a likely candidate for more work. Will you be

Building a computer from a kit will appeal to those who want a better understanding of computers. They're interested in the type of microprocessor used and its instruction set; they're perhaps interested in machine language and assembly coding; and they're interested in building a computer from scratch and want to save money in the process.

Kit builders are concerned with either low-cost training computers or full-fledged systems comparable to those discussed in the "personal" users section. There are a number of computers available in both classes. We'll discuss some of the more popular ones.

Some kit builders want to learn the basics of computer operation without making a major investment. They want a "training computer," which is generally a single-board unit that uses a hex-keypad for program and data entry. In the old days (about six or seven years ago), when micros were in their infancy, you had to program them with switches. In a sense, you had to feed the computer a bunch of ones and zeroes (switches that were either *on* or *off*) before you could get the computer to do anything for you. The hex-keypad that's popular today is

KIT BUILDERS

TRS-80™ DISCOUNT PERSONAL COMPUTERS

WE CARRY THE FULL LINE OF TRS-80's

MODEL II

26-4002 64K I Drive..... \$3279
Ask About Hard Drives

MODEL III

26-1062 16K..... \$819
26-1066 48K with
2 Drives, RS232..... \$2049

TM - TANDY CORPORATION
FREE COPY OF WARRANTY UPON REQUEST



BUY DIRECT

AT WHOLESALE PRICES

1-800-841-0860

COLOR COMPUTER

26-3001 4K..... \$309
26-3002 16K Ext. Basic..... \$455
26-3003 32K Ext. Basic..... \$569
26-3022 Color Drive # 1..... \$498

WRITE FOR FREE CATALOG

MICRO MANAGEMENT

SYSTEMS, INC.
DEPT. NO. 12

Downtown Plaza Shopping Center
115C Second Ave. S.W. • Cairo, Georgia 31728
912-377-7120 Ga. Phone No.

ANNOUNCING ANOTHER NEW IDEA FROM TELEVIDEO.[®] THE SMART 910 PLUS.



Our new ideas have a way of sweeping the market. In just a few years, TeleVideo has come from nowhere to become the No. 1 independent in CRT terminals. The reason: we offer exceptional quality, reliability and usability at a price no one can beat. (In fact, we use the same high quality modules, from keyboards to monitors, throughout the entire line.)

The smart 910 Plus Block Mode terminal is our latest innovation. For the money, you'll find nothing that outperforms it. For example, simply by touching a key you can activate its gated printer port.

Another point: since service is a

major concern, we have ours handled nationwide by one of the best: General Electric's Instrumentation and Communication Equipment Service Centers. Right now, we have the new 910 Plus ready for immediate delivery. To order or have questions answered call 800-538-8725 (toll-free outside California.) Since it's priced at just \$699 per unit, your decision should be very easy.

 **TeleVideo[®]**

TeleVideo Systems, Inc.
1170 Morse Avenue, Sunnyvale, CA 94086
800-538-8725 (toll-free outside California)

910 Plus Features

- Block mode
- Off-line editing
- 10 programmed function codes
- Changeable codes
- Protected fields
- 5 screen attributes (blink, blank, reverse, underline, half intensity)
- 15 baud rates (50b to 10.2Kb)
- Gated printer port
- Typewriter-style keyboard
- Typewriter tabs
- Erase to end line
- Erase to end of page
- Self-test
- Monitor mode
- 4 strappable languages

We Beat All Prices!



HEWLETT
PACKARD

HP-85

or

HP-125
CP/M based.

\$1989

Your Choice

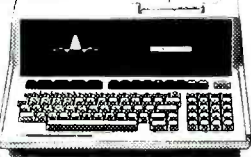

NEW HP-87... CALL

5 1/4" Dual Master Disk Drive **CALL**
8" Dual Master Disk Drive **CALL**

5meg WINCHESTER Hard Disk **\$3599**
5meg WIN. w/5 1/4" DSDD floppy **\$4399**

APPLE II PLUS, 48K **CALL**
APPLE III **CALL**
TI 99/4 **\$387**
COMMODORE VIC-20 **\$255**
NEC PC-8001-A, 32K **\$989**
XEROX 820 5 1/4" Disk Drives **\$2489**
XEROX 820 8" Disk Drives **\$3095**

TI CALCULATORS

TIP-55-II **\$38**
TIP-Business Analysis II **\$38**
TIP-58C **\$79**
TIP-59 **\$169**
TIP-P-100C **\$149**

HP-41CV with five times more memory **built in.**



List \$325
\$249

HP-41C
List \$250
\$189

HP-41CV Printer **\$289.00**
HP-41CV Quad Memory **\$83.95**
HP-41CV CardReader **\$167.95**
HP82160A HP-IL Module **\$99.00**
HP82161A Digital Cassette Drive **\$449.00**
HP11C **\$107.95**
HP12C **\$119.95**
HP33C **\$74.95**
HP34C **\$117.95**

ATARI® 800

\$689

*Limited time only

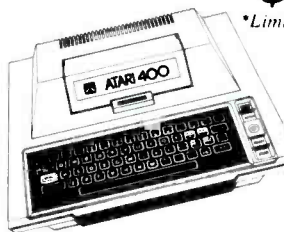

ATARI 400 **\$349**

Atari 830 Acoustic Modem **\$145**
Atari 825 80 Col. Impt. Ptr **\$565**
Atari 410 Prog. Recorder **\$69**
Atari 810 Disk Drive **\$419**

**Personal
PC computer
systems**
P.O. Box 1073
Syracuse, N.Y. 13201

(315) 475-6800

(800) 448-5259 For Placing Orders Only

Prices do not include shipping by UPS. All prices and offers are subject to change without notice

THE ELECTRONIC WORLD

one step removed from the switch arrangement. This keypad contains the numbers 0 through 9, as well as letters A through F. To program a training computer, one of the things you have to do is enter commands and data in hexadecimal codes like A1 or 11 or 4C (which stand for 10100001, 00010001, and 01001100, respectively).

(Continued on page 60)

SAMPLE CHECKLIST

After you've narrowed your choices to two or three computers, you'll want to take a closer look at each before making your final choice. The checklist shown below is a sample of what you might use to choose among a few high-level personal computers. In this case, the computer is to be used primarily in the home for a range of activities from word processing to game playing, with mailing-list maintenance in between. As you consider each item in the list, check it off. If a particular feature is not standard, but available as an option, note its cost. You may want to keep a notebook to record your observations as you go through the list.

Main Features

- Microprocessor(s)
- RAM (standard)
- RAM (maximum)
- Language (standard)
- Languages available
 - FORTRAN
 - COBOL
 - Pascal
 - LOGO
 - PILOT
 - Other
- Operating system (standard)
- Operating systems available

- Highlighting
- Inverse video
- General display quality

Audio

- Sound generator
- Number of voices
- Speaker
- Music synthesizer

Game Playing

- Cartridge slot
- Paddles
- Joysticks

Keyboard

- u/I case
- Graphics characters
- Function keys
- Calculator keypad
- Typing feel

Software availability

- Word processing
- Financial applications
- Data-base management
- Games
- Other

Input/Output

- TV output
- B/W video output
- NTSC output
- RGB output
- Hi-fi output
- Cassette port
- Disk-drive port
- Printer port
- Modem port
- RS-232 interface
- IEEE-488 interface

Peripherals

- 5 1/4-inch disk drive
- 8-inch disk drive
- Television
- Monitor
- Modem
- Printer
- Graphics tablet
- Music synthesizer
- Cassette recorder
- Speech synthesizer
- Speech recognition system

Graphics

- Display resolution
- Number of colors

General

- Computer clubs
- Software exchange
- Service availability
- Manufacturer's/dealer's reputation
- Warranty
- Documentation
- Cost

Text

- Number of characters/line
- Number of lines
- Lower-case descenders

28K

PERSONAL COMPUTER

Only

\$299⁰⁰

Special Sale Price



WHAT A SMART INVESTMENT!!!

- For Students and Schools
- Learn to program a computer
- Learn to operate a computer
- For Programmers & Teachers
- For Labs, Engineers, Etc.
- For Small Businesses
- For The Home Owner

PLUG IN EXPANSION

GREATEST BUY IN AMERICA

It has color, sound and music with a powerful 6502 microprocessor (Like Apple). 20,000 Bytes ROM with a 16K microsoft extended Level II Basic built in, 8,000 Bytes RAM plug in expandable to 32K RAM, Cursor, Real time, Full size easy to use 66 key professional typewriter keyboard, 62 keys with graphics symbols, 4 programmable function keys. High resolution graphics, 512 displayable characters, Text display is 23 lines 22 characters, 16 colors. Will accept Tape, Disk-Plug In Cartridges. Has low priced plug in peripherals, Connects to any TV or monitor, Includes AC adapter, RF modulator, Switch box, Cables and self teaching instruction book - all in a beautiful Creme Colored Console Case. This is a powerful-full sized-extra featured computer for only \$299.00

WHY SUCH A LOW PRICE

Selling on a direct to customer basis, we save you the profit margin normally made by computer stores and distributors. We are willing to take a small margin to develop volume to cut our cost of operation.

COMPETITIVE LIST PRICES

APPLE \$1125, T. I. \$525, ATARI \$399.95, RADIO SHACK TRS 80 color with only 12K memory sells for \$399.50.

LOW COST PLUG IN EXPANSION

Expansion accessories plug directly into this computer, extra RAM memory, Controllers, a Cassette, A Telephone Modem for only \$109.00, an 80 Column Printer for \$375.00, even the 170K Disk Drive plugs in direct. You do not have to buy an expensive expansion interface.

GET JOB OPPORTUNITIES NOW

Every newspaper has several pages of want ads for computer people. You can learn to operate and program a computer for these opportunities available to those who prepare for the computer revolution. This computer has extended Level II Basic with floating point decimal, Integer and String Arrays, Trig functions, Direct Statement Execution, Multi-statement Lines, Cursor, Full screen editing, Color Command Keys, Graphics, Scrolling, File Management, Upper-Lower Case, Direct Memory Access, Peek and Poke and much more! Assembly machine language is

available. We have easy to follow self teaching books and programs.

INVEST IN YOUR CHILDREN

Educate your children while they play. Every kid wants to play electronic games. (We have some of the best). The next natural step for their curiosity is to try simple programming. They can do this in 20 minutes with our simple self teaching instruction book. High schools are teaching computer math, science and programming - some start in grammar school. If you provide this computer as a Teacher and Tutor at home, before you know it your child will be writing computer programs. You can use your T.V. to EDUCATE not frustrate your family and eliminate T.V. boredom with programs that challenge, stimulate and entertain the whole family. We have a wide variety of games, recreational, home finance and educational programs to choose from. Why pay \$140.00 to \$295.00 for an electronic game when you can buy this powerful computer for only \$299.00.

COMMUNICATE WITH THE WORLD

Plug in your VIC telephone modem. Now you can get a world of information through your telephone, plus electronic mail. Just dial up the information you want. UPI wire service, stock market, historical information by topic from over 60 magazines, including New York times. Airline information, order tickets, get weather information anywhere in the world, restaurant and hotel information, thousands of categories are on line for you, business, finance, education, entertainment, games etc. YOU'LL BE THE TALK OF YOUR NEIGHBORHOOD. Our telephone modem price is by far the lowest available.

IMMEDIATE REPLACEMENT WARRANTY

If your computer fails because of warranty defect within 90 days from date of purchase, you simply send your computer to us via United Parcel Service prepaid. We will "immediately" send you a replacement computer at no charge via United Parcel Service prepaid. No one we know gives you this kind of warranty service. Most computer warranty service takes 30 to 90 days to handle - this fantastic "immediate replacement warranty" is backed by COMMODORE COMPUTER, a MAJOR national brand electronics manufacturer.

SPECIAL SALE PRICE \$299.00

For only \$299.00 you get the powerful 28K COMMODORE VIC with 20K ROM, 8K RAM and Extended Level II Basic, The professional 66 keyboard, color, sound, music, self teaching instruction book, AC adapter, RF modulator, TV switch box, owners manual, plus all of the other extra features listed, in a beautiful Creme Colored Console Case.

SPECIAL SALE PRICE \$379.00

For only \$379.00 you get the more powerful 41K COMMODORE VIC with 20K ROM, 21K RAM and Extended Level II BASIC, plus all of the extra features shown for the 28K COMMODORE VIC!

"15 DAY FREE TRIAL"

DON'T MISS THIS SALE - ORDER NOW

- Please send me the 28K Commodore VIC Computer for \$299.00
- Please send me the 41K Commodore VIC Computer for \$379.00
- Special Data Cassette \$69.00

We ship C.O.D. and honor Visa and Master Card.

Name _____

Address _____

City _____

State _____ Zip Code _____

VISA MASTER CARD C.O.D.

Credit Card No. _____

Expiration Date _____

Add \$10.00 for shipping, handling and insurance. Illinois residents please add 6% tax. Add \$20.00 for CANADA, PUERTO RICO, HAWAII orders. WE DO NO EXPORT TO OTHER COUNTRIES.

Enclose Cashiers Check, Money Order or Personal Check. Allow 14 days for delivery (21 days for Personal Check orders,) 2 to 7 days for phone orders. Canada orders must be in U.S. dollars.



we are
commodore VIC
experts!!

VIC 20 owners register with us for new product and program information.

PROTECTO ENTERPRIZES (FACTORY-DIRECT)

BOX 550, BARRINGTON, ILLINOIS 60010
Phone 312/382-5244 to order

CIRCLE NO. 39 ON FREE INFORMATION CARD

20M282

INDUCTIVE COUPLED MODEM

Eliminates noise, vibration problems. Originate/Answer. Bell 103. Cassette port saves data.



\$129⁹⁵ Money back if not delighted

MFJ-1230 INDUCTIVE COUPLED MODEM eliminates room noise, vibration caused by acoustic coupling. Gives more reliable data transfer. Used like acoustic modem. 0-300 Baud, Bell 103 compatible. Originate/answer. Half/full duplex. RS-232, TTL, CMOS compatible. Use any computer. Cassette tape ports save data. 110 VAC or 9 V batteries. Crystal controlled. Carrier detect, power LEDs. 9x1 1/2x4". MFJ-1231, \$39.95. Optional cable, software for Apple II, II Plus. Plugs into game port. No serial board needed.

MFJ-1108 AC POWER CENTER. Adds convenience, prevents data loss, head bounce, equipment damage. Relay latches power off during power

\$99⁹⁵



transients. Multi filters isolate equipment, eliminate interaction, noise, hash. Varistors suppress spikes. 3 isolated, switched socket pairs. One unswitched for clock, etc. Lighted power, reset switch. Pop-out fuse. 3 wire, 6 ft. cord. 15 A/125 V, 1875 watts. Aluminum case. Black. 18x2 3/4 x2 in. MFJ-1107, \$79.95. Like 1108 less relay, 8 sockets. 2 unswitched. Other models available.



It's like having an extra port **\$79⁹⁵**

MFJ-1240 RS-232 TRANSFER SWITCH. Switches computer between 2 peripherals (printer, terminal, modem, etc.). Like having extra port. Push button switches 10 lines (pins 2,3,4,5,6,8, 11,15,17,20). Change plug or cable to substitute other lines. Push button reverses transmit-receive lines. LEDs monitor pins 2,3,4,5,6,8,20. PC board eliminates wiring, crosstalk, line interference. 3 RS-232 25 pin connectors. 7x2x6 in.

Order from MFJ and try it. If not delighted, return within 30 days for refund (less shipping).

One year unconditional guarantee.

Order yours today. Call toll free 800-647-1800.

Charge VISA, MC. Or mail check, money order. Add \$4.00 each for shipping and handling.

CALL TOLL FREE ... 800-647-1800

Call 601 323 5869 for technical information, or der/repair status. Also call 601 323 5869 out side continental USA and in Mississippi.

MFJ ENTERPRISES, INCORPORATED

921 Louisville Road, Starkville, MS 39759

Then the hex numbers are translated into binary numbers, which are the computer's "machine language."

Originally, the program is coded in assembly language, which uses mnemonics as an aid to programming. The mnemonics represent the instruction set of a particular microprocessor and are unique to that microprocessor. Each mnemonic has a hexadecimal code associated with it which, as we said, gets translated into the binary code.

Two of the popular training computers are the Elf from Netronics and Quest, and the ET-3400 from Heath. When buying a training computer, some important items to look for are the type of microprocessor it uses and the documentation supplied by the manufacturer. You may want to learn more about a particular microprocessor because it's in one of the larger computers. For example, the Z80 microprocessor is used in the Radio Shack and Heath/Zenith models, while the 6502 microprocessor is used in the Apple, Commodore, and Atari computers. You might be interested in a microprocessor for other reasons, too. For example, the 6800 and 1802 microprocessors are great for use in control applications.

If you are an accomplished kit builder and want to construct something more substantial than a training computer, there are a few kits available that can satisfy your desire for computer expandability and power. Why would anybody want to build this type of computer from scratch? Two of the main reasons are the challenge and the cost savings. To give you an idea of the cost savings involved, the Heath/Zenith H-89 is \$1895 in kit form, while the assembled version (Z-89) is \$2895.

The two full-blown computers in kit form are the H-89, which we've just mentioned, and the Explorer-85 (8085 CPU) from Netronics. Both systems are computers for serious users. They can compete with other top models on the market, and often surpass them.

Another popular kit is the Sinclair ZX81. At \$99.95 for the basic computer, you will be hard pressed to find a better value. Though this computer is excellent at its own level, it's obviously not in the same class as the H-89 and Explorer-85.

For more power than either the H-89 or Explorer-85, in a kit-form computer, you might also consider the Heath copy of DEC's very popular PDP-11, the Heathkit H-11A. This is really a minicomputer, which at \$2995 represents a saving of about \$2300 over the assembled version of the computer.

CONCLUSION

What we've tried to illustrate in this article is that computers come in all shapes and sizes and can perform an amazing number of tasks. In order to choose wisely when buying a computer, there are a great number of factors to consider. The bottom line, however, is individual needs. You want a computer to do something for you. If you keep that first in your mind and consider everything else second, you are more likely to be a satisfied buyer.

The computers mentioned throughout this article are some of the more popular models available, but obviously are not the only ones on the market. Others not mentioned here may be more suitable for your particular purpose. Also, new computers are coming out all the time, not only from new companies, but from companies that are improving or expanding their existing line. It's wise to check the features of these new entrants before making a final decision. Also, prices cited are suggested retail selling prices only and you will find that they likely differ from one dealer to another. ♦

ANNOUNCING TWO NEW TERMINALS

Smart • Fast • Graphics • Matching Modem and \$295 Printer

Netronics announces a state of the art breakthrough in terminals, now at prices you can afford, you can go on-line with data bank and computer phone-line services. It's all yours — "electronic newspapers," educational services, Dow-Jones stock reports, games, recipes, personal computing with any level language, program exchanges, electronic bulletin boards — and more every day!!!



Netronics offers two new terminals, both feature a full 56 key/128 character typewriter-style keyboard, baud rates to 192 kilobaud, a rugged steel cabinet and power supply. The simplest one, FASTERM-64, is a 16 line by 64 or 32 character per line unit, with a serial printer port for making hard copy of all incoming data, and optional provisions for block and special character graphics. The "smart" version, SMARTERM-80, features either 24 line by 80 characters per line or 16 by 40 characters per line, it offers on-screen editing with page-at-a-time printing, 12,000 pixel graphics, line graphics, absolute cursor addressing, underlining, reverse video, one-half intensity and much more. Simply plug them into your computer or our phone modem and be on-line instantly. Use your TV set (RF modulator required) or our deluxe green-phosphor monitor pictured above. For hard copy just add our matched printer.

Price breakthrough!!! Own the FASTERM-64, a complete terminal kit, ready to plug in for just \$199.95 or order the SMARTERM 80 kit for just \$299.95 (both available wired and tested). Be on-line with the million-dollar computers and data services today — we even supply the necessary subscription forms.

More good news: All the components in our terminals are available separately (see coupon), so you buy only what you need!!!

FASTERM-64 DISPLAY FORMAT: 64 or 32 characters/line by 16 lines 96 displayable ASCII characters (upper & lower case) 8 baud rates 150, 300, 600, 1200, 2400 4800 9600, 19, 200 (switch set) LINE OUTPUT RS232C or 20 ma current loop VIDEO OUTPUT 1V PIP (EIA RS-170) CURSOR MODES home & clear screen erase to end of line, erase cursor line, cursor up & down, auto carriage return/line feed at end of line & auto scrolling. REVERSE VIDEO BLINKING CURSOR PARITY off, even or odd STOP BITS 1 1.5, 2 DATA BITS PER CHARACTER 5, 6, 7 or 8 CHARACTER OUTPUT 5 by 7 dot matrix in a 7 by 12 cell PRINTER OUTPUT prints all incoming data 1K ON BOARD RAM 2K ON BOARD ROM CRYSTAL CONTROLLED COMPLETE WITH POWER SUPPLY OPTIONAL GRAPHICS MODE includes 34 Greek & math characters plus 30 special graphics characters ASCII ENCODED KEYBOARD 56 key/128 characters

SMARTERM-80 DISPLAY FORMAT 80 characters by 24 lines or 40 characters by 16 lines 128 displayable ASCII characters (upper & lower case) 8 baud rates 110 300 600 1200 2400 4800 9600, 19, 200 LINE OUTPUT RS232C or 20 ma current loop VIDEO OUTPUT 1V PIP (EIA RS-170) EDITING FEATURES insert/delete line, insert/delete character, forward/back tab LINE OR PAGE TRANSMIT PAGE PRINT FUNCTION CURSOR POSITIONING up, down, right, left, plus absolute cursor positioning with read back VISUAL ATTRIBUTES underline, blink, reverse video, half intensity, & blank GRAPHICS 12,000 pixel resolution block plus line graphics ON-SCREEN PARITY INDICATOR PARITY off, even or odd STOP BITS 110 baud 2, all others 1 CHAR OUTPUT 7 by 11 character in a 9 by 12 block PRINTER OUTPUT 60 OR 50 Hz VERTICAL REFRESH BLINKING BLOCK CURSOR CRYSTAL CONTROLLED 2K ON BOARD RAM ASCII ENCODED KEYBOARD 56 key/128 character 4K ON BOARD ROM COMPLETE WITH POWER SUPPLY

TELEPHONE MODEM 103 O/A FULL DUPLEX, FCC APPROVED DATA RATE 300 baud INTERFACE RS232C and TTY CONTROLS talk/data switch (no need to connect and disconnect phone), originate/answer switch on rear panel NO POWER SUPPLY REQUIRED

ASCII KEYBOARD ASCII-3 56 key/128 CHARACTER ASCII ENCODED UPPER & LOWER CASE FULLY DEBOUNCED 2 KEY ROLL-OVER POS OR NEG LOGIC WITH POS STROBE REQUIRES +5 & -12V DC (SUPPLIED FROM VIDEO BOARDS) **PRINTER COMET I** SERIAL I/O TO 9600 BAUD 80 CHARACTER COLUMN (132 COMPRESSED) 10 TRACTOR FEED UPPER/LOWER CASE INDUSTRY STANDARD RIBBONS 4 CHARACTER SIZES 9 BY 7 DOT MATRIX BI-DIRECTIONAL PRINTING



Continental U.S.A. Credit Card Buyers Outside Connecticut
CALL TOLL FREE 800-243-7428

To Order From Connecticut Or For Tech. Assist. Call (203) 354-9375

NETRONICS R&D LTD. Dept. PE
333 Litchfield Road, New Milford, CT 06776

Please send the items checked below:

- COMPLETE FASTERM-64 TERMINAL (includes FASTVID-64 video board ASCII-3 keyboard, steel cabinet and power supply) ... kit \$199.95 plus \$3 P&I ... wired & tested \$249.95 plus \$3 P&I ... graphics option: add \$19.95 to each of above
- COMPLETE SMARTERM-80 TERMINAL (includes SMARTVID-80 video board, ASCII-3 keyboard, steel cabinet and power supply) ... kit \$299.95 plus \$3 P&I ... wired & tested \$369.95 plus \$3 P&I
- FASTVID-64 VIDEO BOARD (requires +5 & -12V DC) ... kit \$99.95 plus \$3 P&I ... graphics option add \$19.95 ... wired & tested \$129.95 plus \$3 P&I ... graphics option add \$19.95
- SMARTVID-80 VIDEO BOARD (requires +5 & +12V DC) ... kit \$199.95 plus \$3 P&I ... wired & tested \$249.95 plus \$3 P&I
- DELUXE STEEL TERMINAL CABINET ... \$19.95 plus \$3 P&I
- ASCII-3 KEYBOARD (requires +5 & -12VDC) ... kit \$69.95 plus \$3 P&I ... wired & tested \$89.95 plus \$3 P&I
- POWER SUPPLY (powers ASCII-3 keyboard & video boards) ... kit only \$19.95 plus \$2 P&I
- ZENITH VIDEO MONITOR (high resolution green phosphor) ... wired & tested \$149.95 plus \$6 P&I
- TELEPHONE MODEM MODEL 103 O/A ... wired & tested \$189.95 plus \$3 P&I
- DOT MATRIX PRINTER Comet I ... wired & tested \$299.95 plus \$10 P&I
- RF MODULATOR MOD RF-1 ... kit only \$8.95 plus \$1 P&I
- 3FT-25 LEAD MODEM/TERMINAL OR PRINTER/TERMINAL CONNECTOR CABLE ... \$14.95 ea plus \$2 P&I

For Canadian orders, double the postage. Conn. res. add sales tax.

Total Enclosed \$ _____
 Personal Check Cashier's Check/Money Order
 VISA MasterCard (Bank No. _____)
 Acct. No. _____ Exp. Date _____
 Signature _____
 Print Name _____
 Address _____
 City _____ State _____ Zip _____

FOR ONLY \$129.95 Learn Computing From The Ground Up

Build a Computer kit that grows with you, and can expand to 64k RAM, Microsoft BASIC, Text Editor/Assembler, Word Processor, Floppy Disks and more.

EXPLORER/85

Here's the low cost way to learn the fundamentals of computing — the all-important basics you'll need more and more as you advance in computer skills. For just \$129.95 you get the advanced design Explorer/85, motherboard with all the features you need to learn how to write and use programs. And it can grow into a system that is a match for any personal computer on the market. Look at these features: **8085 Central Processing Unit** — the microprocessor heart of the Explorer/85 (join the millions who will buy and use the 8080/8085 this year alone!) **Four 8 bit plus one 6 bit input/output ports** from which you can input and output your programs as well as control exterior switches, relays, lights, etc. a cassette interface that lets you store and reload programs you've written to write, delete or **2 8001 or 2 8008** in operation. **System/monitor** makes it easy to learn computing in several important ways: • It allows simpler, faster writing and entering of programs. • It permits access by you to all parts of the system so you can check on the status of any point in the program. • It allows tracing each program step by step with provision for displaying all the contents of the CPU (registers, flags, etc.) • and it does much more!

You get all this in the starting level (Level A) of the Explorer/85 for only \$129.95. In order to use just plug in your MVD power supply and terminal or keyboard/display — if you don't have them, see our special offers below.

- Level A computer kit (Terminal Version) \$129.95
- Level A kit (Hex Keypad/Display Version) \$129.95 plus \$3 P&I *
- Level B — This building block converts the motherboard into a two-slot \$100 bus (industry standard) computer. Now you can plug in any of the hundreds of \$100 cards available.
- Level B kit \$49.95 plus \$2 P&I *
- \$100 bus connectors (two required) \$4.85 each, postpaid.
- Level C — Add still more computing power, this "building block" mounts directly on the motherboard and expands the \$100 bus to six slots.
- Level C kit \$39.95 plus \$2 P&I *
- \$100 bus connectors (five required) \$4.85 each, postpaid.
- Level D — When you reach the point in learning that requires more memory, we offer you choices: either add 4k of memory directly on the motherboard, or add 16k to 64k of memory by means of a single \$100 card our famous **JAWS**.
- Level D kit (CHECK ONE) 4k on board \$49.95 plus \$2 P&I 16k \$100 **JAWS** \$149.95 plus \$2 P&I 32k \$100 **JAWS** \$199.95 plus \$2 P&I 48k \$100 **JAWS** \$249.95 plus \$2 P&I 64k \$100 **JAWS** \$299.95 plus \$2 P&I *
- Level E — An important building block, it activates the 8k ROM/EPROM space on the motherboard. Now just plug in our 8k Microsoft BASIC or your own custom programs.
- Level E kit \$9.95 plus \$0 P&I *
- Microsoft BASIC — Its language that allows you to talk English to your computer. It is available three ways: 8k cassette version of Microsoft BASIC, requires Level B and 12k of RAM minimum, we suggest a 16k \$100 **JAWS** — see above. \$64.95, postpaid.
- 8k ROM version of Microsoft BASIC, requires Level B and A level E and 4k RAM just plug into your Level E sockets. We suggest either the 4k Level D RAM expansion or a 16k \$100 **JAWS** — \$99.95 plus \$2 P&I *
- Disk version of Microsoft BASIC, requires Level B, 12k of RAM, floppy disk controller, 8" floppy disk drive. \$325, postpaid.
- TEXT EDITOR ASSEMBLER — The editor/assembler is a software tool (a program) designed to simplify the task of writing programs. As your programs become longer and more complex the assembler can save you many hours of programming time. This software includes an editor program that enters the programs you write, makes changes and saves the programs on cassettes. The assembler performs the clerical task of translating symbolic code into the computer readable object code. The editor/assembler program is available either in cassette or a ROM version.
- Editor/Assembler (Cassette version) requires Level B and 8k (min) of RAM — we suggest 16k **JAWS** — see above. \$69.95 plus \$2 P&I *
- Editor/Assembler (ROM version) supplied on an \$100 card, requires Level B and 4k RAM (min) — we suggest either Level D or 16k **JAWS** — \$99.95 plus \$2 P&I *
- 8" FLOPPY DISK — A remarkable building block. Add our 8" floppy disk when you need faster operation, more convenient program storage, perhaps a business application and access to the literally thousands of programs and program languages available today. You simply plug them into your Explorer/85 disk system — it accepts all IBM formatted CP/M programs.
- 8" Floppy Disk Drive \$499.95 plus \$12 P&I *
- Floppy Controller Card \$199.95 plus \$2 P&I *
- Disk Drive Cabinet & Power Supply \$69.95 plus \$3 P&I *
- Drive Cables (set up for two drives) \$25.00 plus \$1 \$0 P&I *
- CP/M 2.2 Disk Operating System — includes Text Editor/Assembler, dynamic debugger, and other features that give your Explorer/85 access to thousands of existing CP/M based programs. \$150.00, postpaid.
- NEED A POWER SUPPLY? Consider our AP 1. It can supply all the power you need for a fully expanded Explorer/85 (including drives, having their own power supply). Plus the AP 1 fits neatly into the attractive Explorer steel cabinet (see below).
- AP 1 Power Supply kit (6V @ 5 amps) in deluxe steel cabinet \$39.95 plus \$2 P&I *
- NEED A TERMINAL? Whether you choose the lowest cost, persistent one is our Hex Keypad/Display kit that displays the information on a calculator type screen. The other choice is our ASCII Keyboard/Computer Terminal kit that can be used with other

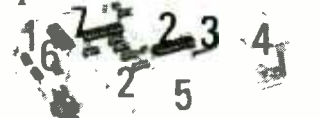

- 1 Plug in Netronics Hex Keypad/Display
- 2 Add Level B to convert to 6. Add your own custom programs (programming etc.)
- 3 Add 4k RAM
- 4 Plug in Level E, then 8k Microsoft BASIC or Editor/Assembler in ROM
- 5 Add 16k **JAWS**
- * Conn. & terminal

- CRT monitor or a TV set (if you have an RF modulator)
- Hex Keypad/Display kit \$69.95 plus \$2 P&I *
- FASTERM - 64 TERMINAL KIT — Featuring a 56 key ASCII Keyboard, 128 character set upper and lower case 75 mm pitch, 8 baud rates, 150 to 19,200 switch selectivity (RS232 C or 20 MA current), 32 or 64 character by 16 line formats, complete with Deluxe Steel Cabinet and Power Supply \$199.95 plus \$3 P&I *



ORDER A SPECIAL-PRICE EXPLORER/85 PAK — THERE'S ONE FOR EVERY NEED.

- Beginner Pak (Save \$26.00) — You get Level A (Terminal Version) with Monitor Source Listing (\$25 value) AP 1 5 amp power supply, Intel 8085 Users Manual (Reg. \$199.95) SPECIAL \$169.95 plus \$4 P&I *
- Experimenters Pak (Save \$51.00) — You get Level A (Hex Keypad/Display Version) with Hex Keypad/Display, Intel 8085 User Manual, Level A Hex Monitor Source Listing and AP 1.5 amp power supply (Reg. \$279.95) SPECIAL \$219.95 plus \$6 P&I *
- Add a Rom Version Text Editor/Assembler (Requires Levels B and D or \$100 Memory) \$100.00 — You get Level A (Terminal Version) B (16k RAM) E: 8k Microsoft in ROM, Intel 8085 User Manual, Level A Monitor Source Listing, and AP 1.5 amp power supply (Reg. \$499.70) SPECIAL \$329.95 plus \$7 P&I *
- Add a Rom Version Text Editor/Assembler (Requires Levels B and D or \$100 Memory) \$100.00 — You get Level A (Hex Keypad/Display Version) with Hex Keypad/Display, Intel 8085 User Manual, Level A Hex Monitor Source Listing and AP 1.5 amp power supply (Reg. \$499.70) SPECIAL \$329.95 plus \$7 P&I *
- Starter 8" Disk System — Includes Level A floppy disk controller, one CDC-R disk drive, two drive cable, two \$100 connectors, just add your own power supply, cabinet and hardware. \$1005.00 SPECIAL \$999.95 plus \$11 P&I 16k Starter System \$1045.95 plus \$11 P&I 48k Starter System \$1095.95 plus \$11 P&I 64k Starter System \$1145.95 plus \$11 P&I *
- Add to any of above Explorer steel cabinet, AP 1.5 amp power supply, Level C, with two \$100 connectors, disk drive cabinet and power supply, two soft D connectors for connecting your printer and terminal (Reg. \$225.95) SPECIAL \$199.95 plus \$11 P&I *
- Complete 64K System: Wired & Tested \$1650.00 plus \$26 P&I *
- Special Complete Business Software Pak (Save \$625.00) — Includes CP/M 2.2 Microsoft BASIC, General Ledger, Accounts Receivable, Accounts Payable, Payroll Package (Reg. \$1251) SPECIAL \$699.95, postpaid.

*P&I stands for postage & insurance. For cancellation or dues, double this amount.

Continental Credit Card Buyers Outside Connecticut

TO ORDER
Call Toll Free:
800-243-7428

To Order From Connecticut,
 or For Technical Assistance,
 Call (203) 354-9375

CP/M is a reg. trademark of Digital Research

★ (Clip and mail entire ad) ★

SEND ME THE ITEMS CHECKED ABOVE
 Total Enclosed (Conn. Residents add sales tax) \$ _____
 Paid by:
 Personal Check Cashier's Check/Money Order
 VISA MASTER CARD (Bank No. _____)
 Acct. No. _____ Exp. Date _____
 Signature _____
 Print Name _____
 Address _____
 City _____
 State _____ Zip _____

NETRONICS Research & Development Ltd.
 333 Litchfield Road, New Milford, CT 06776

CURRENT-LIMITING

Techniques

BY MARK PYTELKAU

How to protect power transistors from overload damage

POWER supplies, like audio power amplifiers, are designed to deliver a selected maximum current to a load. If for any reason the load should draw more current than the supply can safely deliver, severe damage can occur.

To prevent this from happening, fuses are usually used at the input to the power supply. However, thermal lag and overrating to accommodate turn-on surges often allow damage to occur before the fuse link pops. To overcome this deficiency, more and more designers are turning to fast-acting current-limiting circuits.

In this approach, a circuit is incorporated within the power supply to allow only a preset amount of current to flow to the load. If excessive loading occurs, the circuit will automatically limit the current to a safe value. When the excessive drain is removed, the supply resumes normal operation.

One commonly used technique, shown in Fig. 1 for both an audio amplifier (A) and a power supply (B), requires insertion of low-value resistance R_L in series with the load and power supply. In both cases, transistor $Q1$ (and its associated components) acts as a high-speed switch that controls base current to the power transistor.

Note that R_L is connected between

$Q1$'s emitter and base, with the $Q1$ collector connected to the base of the power transistor to be protected. When load current I_L flows through R_L the voltage generated across it is equal to $I_L R_L$. The load is selected so that when the desired maximum current flows, the developed voltage will turn $Q1$ on. When this occurs, $Q1$ will shunt the base drive to the power transistor and, in effect, hold it off for as long as load current demand is excessive. Current limiting occurs when the voltage drop across R_L is equal to about 0.6V, the barrier potential of a silicon junction. Therefore, $R_L = 0.6/I_L$. The value of R_L can be quite small and often will have an odd, difficult-to-locate value.

To prevent $Q1$ from switching so rapidly that the circuit becomes unstable, parasitic-suppression resistor R_B is included in the current-limiting circuit. (If R_B does not exist in your circuit, you can add one having a value between 100 and 1000 ohms.) The presence of R_B also allows voltage-divider resistor R_D to be added between the base and emitter of current-limiting transistor $Q1$. This in turn allows use of a higher resistance value for R_L . The simplified schematic of Fig. 1A shown in Fig. 2 is similar to that of Fig. 1B, except that I_L flows in the opposite direction and an *npn* trans-

sistor is used for $Q1$ instead of *pn*p type. This does not affect the following computations since only magnitudes are being considered.

The following example illustrates one method for calculating the correct value for R_D so that it will work with the value of the R_L you have. Assume that $I_L = 3.3$ amperes, R_L is 0.18 ohm, and we have only a 0.27-ohm resistor on hand. The 0.27-ohm resistor will decrease the current limit to 2.2 amperes, but the addition of R_D will increase the limit to any value within the capabilities of the pass transistor and the power source. At 3.3 amperes current flow (I_L), the voltage (V_{RL}) across the 0.27-ohm resistor can be calculated from $V_{RL} = I_L R_L$ (Eq. 1) which works out to 0.89 V.

Since control transistor $Q1$ is silicon, it will turn on when its base is biased at 0.6 volt (V_{BE}). This 0.6-volt must be dropped across R_B when 3.3 amperes flows through R_L . Resistor R_D must then drop V_{BE} or 0.6 volt at this current flow. See Eq. 3.

Using Fig. 1A as an example, $R_D = (91 \times 0.6)/(0.89 - 0.6)$, or 188 ohms. Using Fig. 1B as the example, R_D works out close to 970 ohms. In either case, one would use the closest standard value, or a slightly lower value with a series trimmer potentiometer for "fine tuning" if desired. A half-watt rating will be sufficient. To calculate the current flow through the R_B , R_D network, use Eq. 2.

To provide an optional variable current limit, a suitably valued potentiometer can be used for R_D . However, if this potentiometer is set to too low a resistance value, excessive current can flow. For safety, insert a low-value resistance in series with the R_D potentiometer. The value of this resistance should be selected so that slightly less than maximum current flows when the potentiometer is set to zero resistance. Be sure to use a resistor with sufficient dissipation capacity for R_L . Failure of this resistor may cause serious damage elsewhere in the circuit.

In Conclusion. The protective circuitry shown here may not work for a load that demands large, rapid changes in current, nor for wide-band width, high-powered audio amplifiers that may feed highly reactive loads.

Difficulties may also arise if the pass transistor ($Q2$) operates very close to its maximum ratings or is driven from a three-terminal regulator. In the latter case, the sum of the current rating of $Q1$ and the current drawn by the base of $Q2$ at maximum output current must exceed the maximum current delivered by the regulator. In general, the circuit will work satisfactorily for moderate variations in load current that do not occur extremely rapidly. \diamond

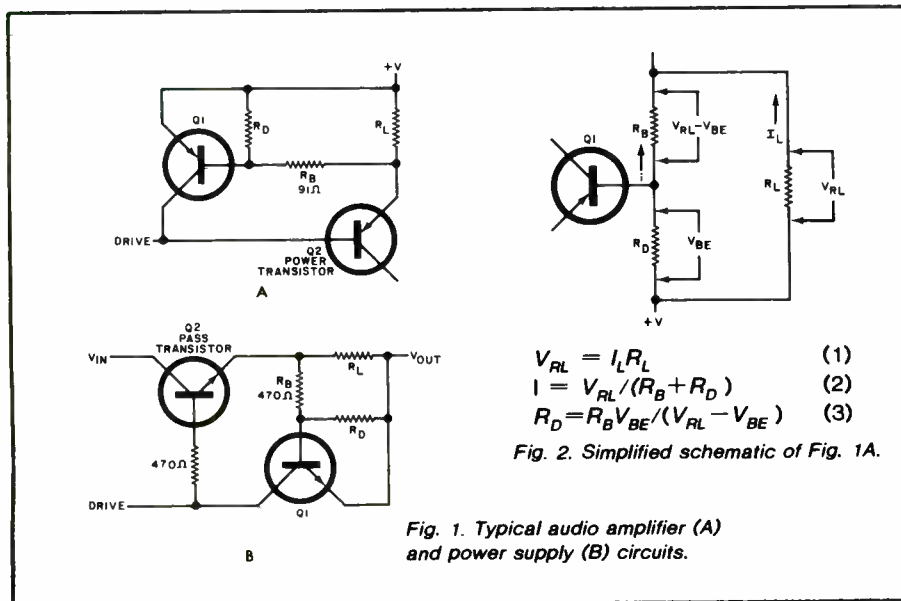

Fig. 1. Typical audio amplifier (A) and power supply (B) circuits.

EXPERIMENTING WITH FIBER OPTICS

Add audio capability to a digital fiber link and get hands-on experience with the latest communications technology

BY TJ BYERS

FIBER OPTICS is fast becoming a major component of computer communication systems that have traditionally relied on copper conductors. That's because a beam of light traversing a glass fiber no larger than a human hair can carry more information than a half-inch coaxial cable! And now the experimenter/hobbyist can easily get some hands-on experience with this new technology, thanks to the availability of moderately priced fiber-optic kits. Motorola Semiconductor, for example, offers such a kit, the Link II, for \$99.

Designed as a total communication system the Motorola link itself is transparent to the user. All he needs to know is where the signal goes in and where it comes out.

The Link II kit contains a TTL-compatible optical transmitter, a TTL-compatible optical receiver, and ten meters of already terminated optical glass fiber. All are assembled and ready to use.

Though intended to be an engineering evaluation kit, the Link II is far more than a bench curiosity. Several practical

applications are easily implemented once a basic understanding of the link's operation has been acquired.

How the Optical Link Works. In a typical fiber-optic communication link (Fig. 1), an electronic signal is processed to modulate a light-emitting source, usually operating in the infrared region. (The light source in the Link II happens to be an infrared LED, but lasers are often used. This is particularly true in telephone communications where bandwidths and distances are much greater.)

Next, the light is coupled to the optical fiber, which will carry the information. This interface is critical. Unless a virtually perfect optical coupling exists between emitter and fiber, much of the light energy will be lost due to dispersion. This problem had been minimized with fiber-aligned LEDs and close-tolerance ferrule connectors.

An identical ferrule connection is provided at the receiving end of the fiber cable to interface with a PIN diode.

This photodiode detects the incoming photons and converts them into a current. The output circuit changes the current into a voltage and the signal emerges from the receiver as electrical information.

Two methods are commonly employed to modulate the transmitted light: amplitude—or intensity—modulation, and digital encoding. The Link II uses the latter. A box inside the link modules shows how this electrical-to-light transformation takes place.

Since the Link II is intended to process digital data, assume (for this discussion) that all signals are TTL level, including input and output. Starting with the transmitter, the signal goes to a NAND Schmitt trigger (Fig. 2). The Schmitt gate has a large hysteresis swing, with trip-points typically set at $1/4V_{cc}$ and $3/4V_{cc}$, which conditions the incoming signal by removing unwanted noise. And, since one input is tied to V_{cc} , this gate also inverts the waveform.

At this point, the signal is split, with part of it going to another inverting



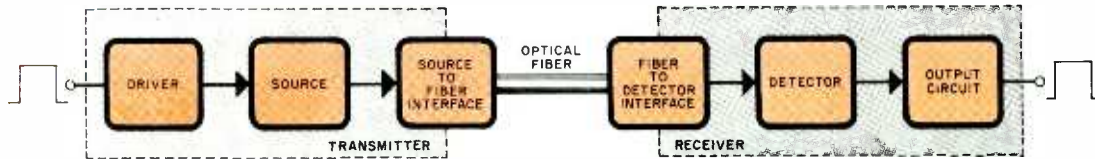

Fig. 1. The typical fiber-optic link with light modulator and demodulator and a length of optical fiber.

NAND gate. Now both the input signal and its complement are available. These complementary signals are then differentiated by a pair of 250-pF capacitors and fed to a bridge rectifier. This produces a positive pulse for every positive- or negative-going transition of the input signal.

These positive pulses are sent to a MC14528 monostable multivibrator (only one of the two available monostable circuits is used.) The one-shot multivibrator is programmed with an external resistor and capacitor (8.2 kilohms and 250 pF) to deliver one 2- μ s output pulse per event. These pulses drive the transmitter's infrared LED.

However, rather than drive the LED directly from the 2- μ s monostable pulses, the LED draws continuous idle current while its modulated output is determined by the transistor driver circuit. The NAND logic is such that one driver transistor is on while the other is off under no-signal conditions. This supplies about 50 mA to the LED through one of the two current-limiting resistors producing a continuous optical output.

When the input waveform goes positive, a 2- μ s pulse is generated by the monostable. This 2- μ s pulse is passed along to the NAND driver #2 and compared to the input signal. The resultant logic turns off the idle current transistor, thus shutting down the LED. So, for a period of 2 μ s no light is emitted.

During a negative transition of the input waveform, the 2- μ s monostable pulse is logically compared to the input in the Schmitt NAND gates. The result causes LED driver transistor #1 to turn on. Now twice the idle current (100 mA) passes through the LED, doubling its light output.

With this modulation technique, the receiver senses a constant optical input and reacts only to relative changes in light intensity. System sensitivity to variations in cable performance is thereby eliminated.

At the receiver, a PIN photodiode detects the incoming light and converts it to a current (Fig. 3). This current is changed to a voltage by op amp IC1A. It is programmed by a feedback resistor to produce 1 V output for every 4 μ A input. This voltage is amplified by IC1D which has a gain of 20.

Depending upon the length and optical properties of the fiber cable, there

will be a rather wide variation in the received light intensity—and therefore the output voltage level of IC1D. To overcome this problem, an integrator formed by IC1C clamps the reference output of IC1D (no signal) to $\frac{1}{2}V_{CC}$. The integrator allows the amplifier to respond to any rapid changes in light intensity, but smooths out all long-term variations, thereby setting a constant quiescent level over a wide range of idle-current light conditions (very similar to an automatic gain control).

Comparator IC2A is used to reconstruct the original signal. A hysteresis bandwidth is programmed into IC2A by the 470-kilohm feedback resistor, and the reference voltage is set to $\frac{1}{2}V_{CC}$ with buffer amplifier IC1B. Pulse polarity can now be sensed; a positive pulse, for instance, flips the comparator output to negative. However, if the pulse is removed, the comparator output remains negative (due to hysteresis) until a negative pulse comes along. This drives the comparator output positive, where it latches anew. Boosted to TTL levels, the

signal enters another comparator, IC2B, which improves rise time and inverts the waveform. Now the received signal is in phase with the transmitted signal.

Digital Applications. Since the Link II kit is built using CMOS chips, both the transmitter and receiver operate from a 5-V supply. This makes it very easy to add them to an existing TTL system. One word of caution: the transmitter and receiver modules *must* be operated from separate power supplies. Although you may be tempted to use only one supply, don't. During switching periods, the large transmitter currents generate glitches on the V_{CC} bus. This noise can easily create false signals inside the sensitive receiver if it shares the same bus. Fortunately, the receiver draws little power and will operate from a 9-V battery supply. (Fig. 4).

Get a feel for the kit by building a simple evaluation circuit such as that shown in Fig. 5. The CD4049 chip operates as a very low-frequency square-wave generator (about one pulse every

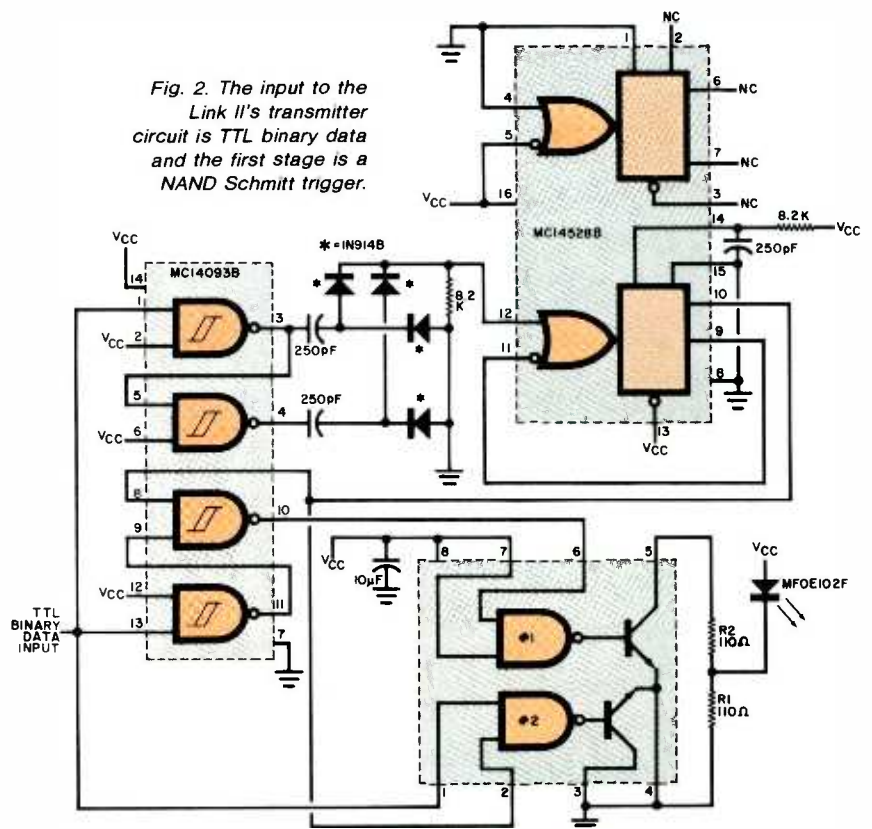

Fig. 2. The input to the Link II's transmitter circuit is TTL binary data and the first stage is a NAND Schmitt trigger.

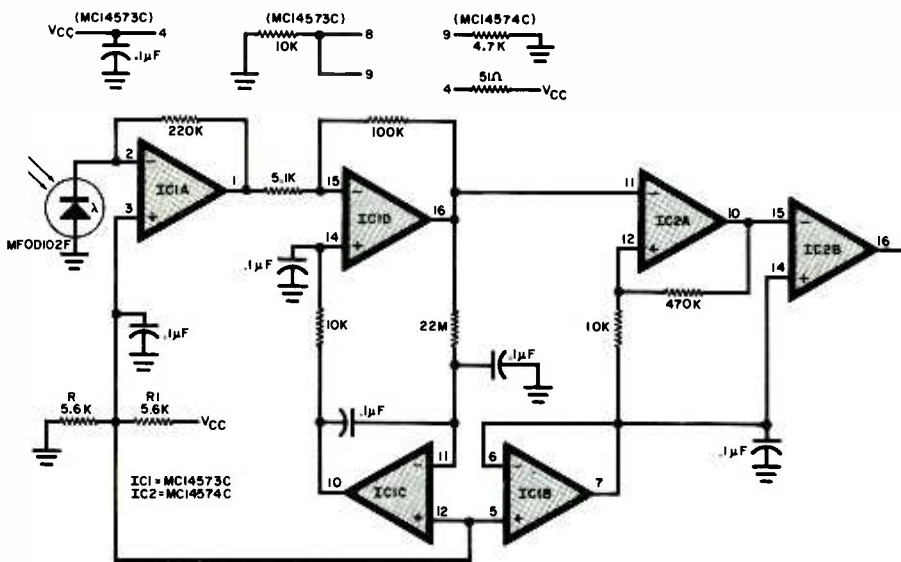

Fig. 3. The light is converted to a current by a PIN diode in the receiver.

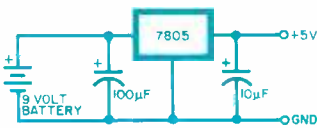

Fig. 4. Do not operate transmitter and receiver from the same power supply. Use a bench supply for transmitter and build this simple circuit for receiver.

three seconds) whose output state is monitored by an LED. This pulse generator connects directly to the Link II transmitter module. Both the generator circuit and transmitter module are powered by a single, regulated 5-V, 500-mA power supply. A single LED monitor is the only addition to the battery-powered Link II receiver module.

Now simply connect the optical cable between the mating connectors on the Link II modules. When the transmitter's input (pin 5) goes low, its LED monitor goes on, and the LED monitoring the receiver's output (pin 8) also lights. (The receiver output will drop as much as 10 mA.) This little setup quickly demonstrates link operation, and suggests how easily the Link II might interface with TTL logic.

An important factor in the development of fiber-optic technology is its immunity to external interference (and thereby error). It is quite easy for a standard coaxial cable to pick up stray signals (error bits), or have its data masked with nearby noise. However, glass fibers are immune to external radio-frequency or electromagnetic interference, so data transfer in noisy environments is error-free. For example the system in Fig. 6 transmits data from the computer to the terminal (reverse the modules and information will flow from the terminal to the computer).

Optical communication links do not

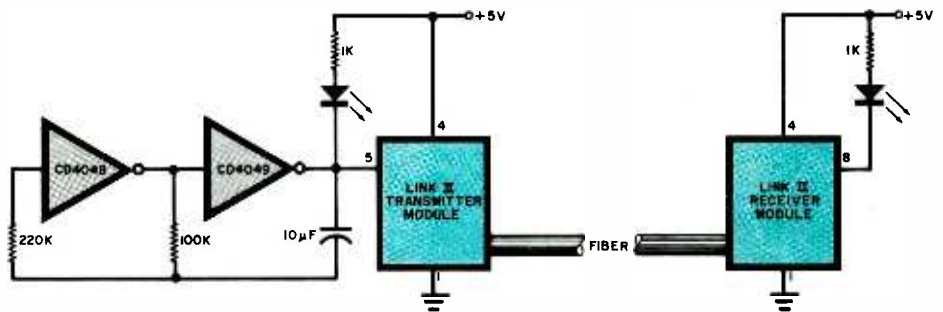

Fig. 5. Build this simple evaluation circuit to get to know the kit's features.

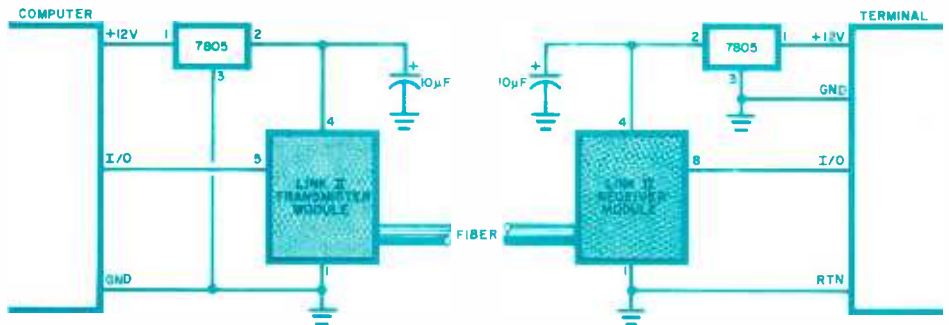

Fig. 6. Using a fiber-optic link between a computer and a terminal.

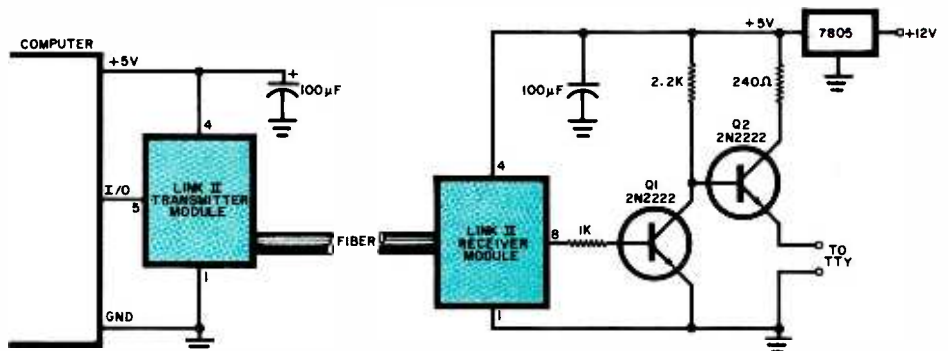

Fig. 7. A teletypewriter can be used at the receiver with suitable interfacing.

emit radiation either, a characteristic suggesting security applications. Eavesdropping is difficult at best, making it unlikely that sensitive information could be intercepted. A "secure" data transfer system using conventional electronics would be extremely costly—perhaps impossible.

Fiber-optic links also have no electrical isolation problems (input to output). With only a strand of glass connecting the active circuits, isolations of thousands of volts are possible. And optical coupling isn't limited to simple isolation; it is also capable of providing an interface for incompatible computer/peripheral formats.

For instance, a hardcopy printer often costs more than the processor and many hobbyists turn to substitutes. But these alternatives frequently present voltage-level and/or ground-loop problems.

A teletype typewriter (TTY), for in-

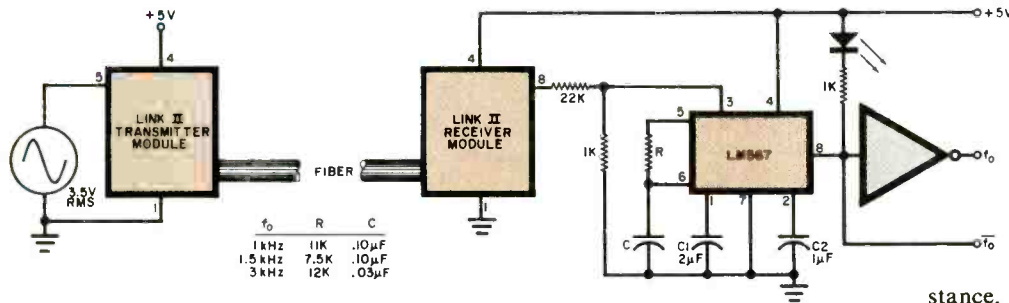

Fig. 8. An analog tone-signal link converts the input to a square wave for transmission. The tone decoder in the receiver circuit produces an output when the incoming frequency is within its bandwidth as determined by the components given in table.

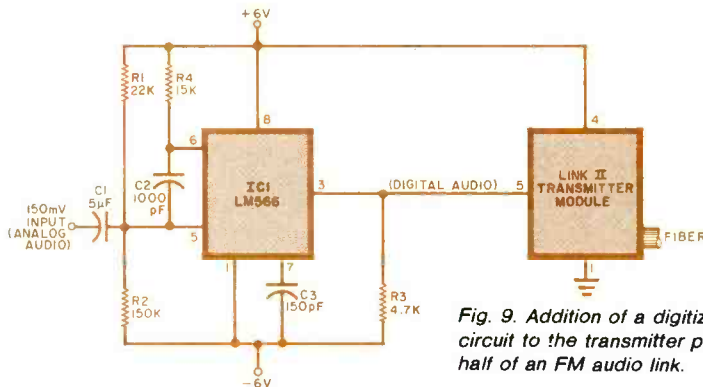

Fig. 9. Addition of a digitizer circuit to the transmitter provides half of an FM audio link.

PARTS LIST (Fig. 9)

- C1—5- μ F, 16-V capacitor
- C2—1000-pF capacitor
- C3—150-pF capacitor
- IC1—LM566 voltage-controlled oscillator
- R1—22-k Ω resistor
- R2—150-k Ω resistor
- R3—4.7-k Ω resistor
- R4—15-k Ω resistor

stance, requires a 20-mA loop for data input. Very few personal computers have provisions for a 20-mA loop. However, the circuit in Fig. 7 isolates the computer and TTY electrically and changes format. The transmitter module is driven directly from the computer I/O port. At the receiving end, transistor Q2 is biased ON with no signal present. This supplies a current of 20 mA to the TTY through the 240-ohm limiting resistor. When a pulse appears at the receiver output, Q1 conducts, shorting Q2's bias and interrupting the 20-mA flow momentarily. The TTY decodes these pulses and interprets them as characters and instructions.

Some Analog Uses. Although the Link II was designed with digital applications in mind, it will also handle analog signals. Of course the Schmitt trigger in the Link II transmitter will change any applied sine wave into a square wave, but in many instances this doesn't affect system performance. Here are two circuits that prove the point.

In the analog tone-signal link shown in Fig. 8, the input sine wave is boosted to 3.5 V rms and applied to the transmitter module, where it's converted to a square wave and relayed over the glass fiber. The receiver reconstructs the square wave which is sent to the LM567 tone decoder. The latter produces an output whenever the incoming signal's frequency falls within the detector's bandwidth.

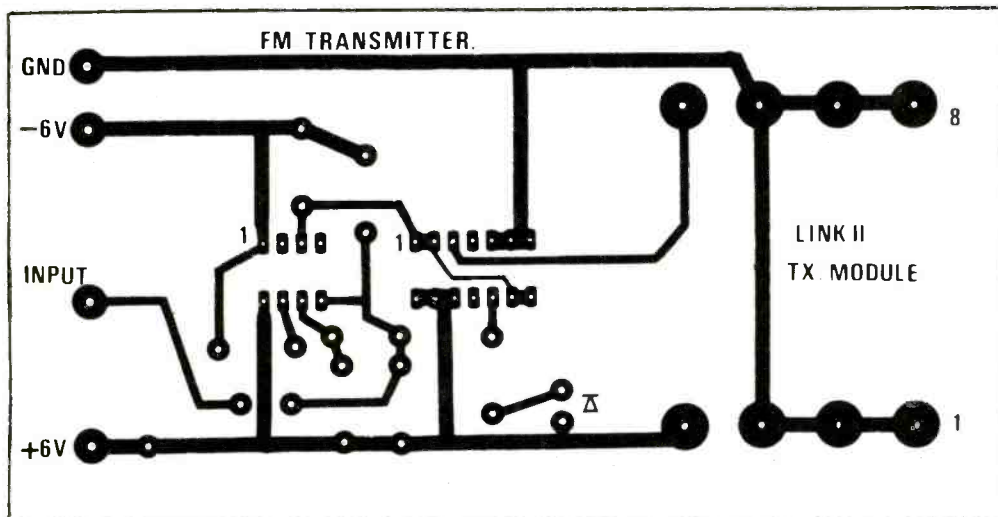
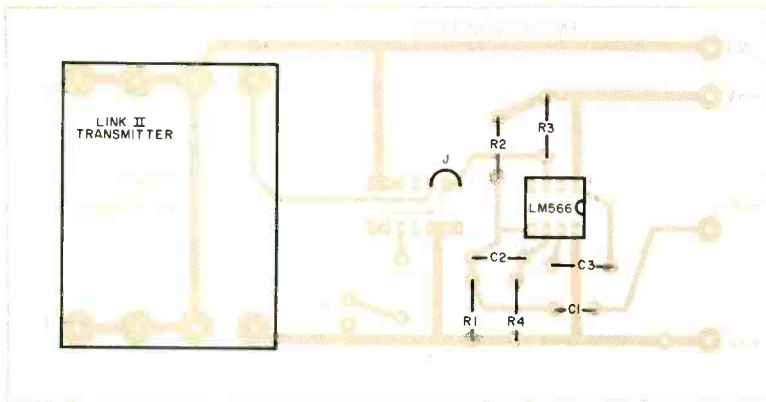

Fig. 10. Use the foil pattern at left and component layout above left to build the circuit shown in Fig. 9.

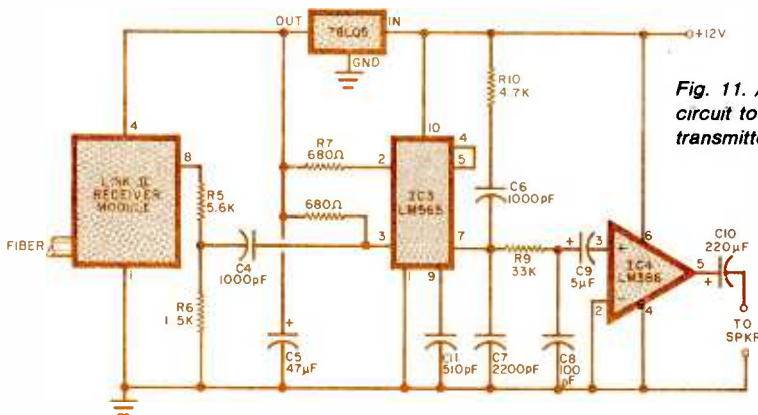

Fig. 11. An FM receiver circuit to go with the transmitter in Fig. 9.

PARTS LIST (Fig. 11)

- C4—1000-pF capacitor
- C5—47- μ F, 16-V capacitor
- C6—1000-pF capacitor
- C7—2200-pF capacitor
- C8—100-pF capacitor
- C9—5- μ F, 16-V capacitor
- C10—220- μ F, 16-V capacitor
- C11—510-pF capacitor
- IC2—78L05 voltage regulator
- IC3—LM565 phase-locked loop
- IC4—LM386 audio amplifier
- R5—5.6 k Ω
- R6—1.5 k Ω
- R7,R8—680 Ω
- R9—33 k Ω
- R10—4.7 k Ω

Note: The Link II kit (MFOL02) is available directly from Motorola for \$99.00. Write to: Motorola Semiconductor Products, Inc., P.O. Box 20912, Phoenix, AZ 85036. Also available for \$40 postpaid from Danacynth, Inc., P.O. Box 261, Westland, MI 48185 is a complete kit of parts for the FM voice link, including a pair of etched and drilled circuit boards. The PC boards are also available separately from the same source for \$16 postpaid (request part number RW-109). Michigan residents please add 4% sales tax.

FM voice/music link in Figs. 9 and 11 certainly is. It has a flat frequency response from 20 Hz to 20 kHz. The voice signal (about 150 mV) modulates an LM566 voltage-controlled oscillator. The oscillator frequency is determined by R4 and C3 but it isn't particularly critical (about 100 kHz). Two power supplies are used (± 6 V) rather than one 12-V source to circumvent interface problems. Ordinarily, when a 12-V source is used, the LM566 vco square-wave output swings between 6 and 11 V. But, by placing the Link II module ground at the power-supply common, the vco output can be connected directly to the transmitter. The transmitter input now fluctuates between ground and 5 V. A full-size etching and drilling guide and a components placement guide for this circuit appear in Fig. 10.

The FM receiver (Fig. 11) contains a companion chip, the LM565 phase-locked loop, which demodulates and amplifies the square-wave output from the receiver. First, a divider network (R5 and R6) reduces the square-wave signal to 1 V for input to the PLL through C4. The 78L05 voltage regulator supplies power for the module and establishes a bias current for the LM565.

The PLL center frequency is deter-

The frequency window of the LM567 is set by R and C using the formula $f_o = 1.1/RC$, where R ranges between 2 and 20 kilohms. When the decoder senses an input frequency within its specified bandwidth, its output goes low. Bandwidth is determined by the loop filter capacitor C2, and is adjustable from 0 to 14%. This is an inverse function; the larger the capacitor, the narrower the bandwidth.

Although it might be said that this is not a full-fledged analog application, the

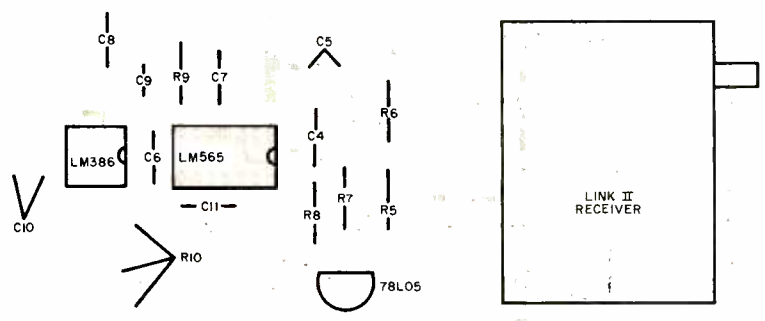
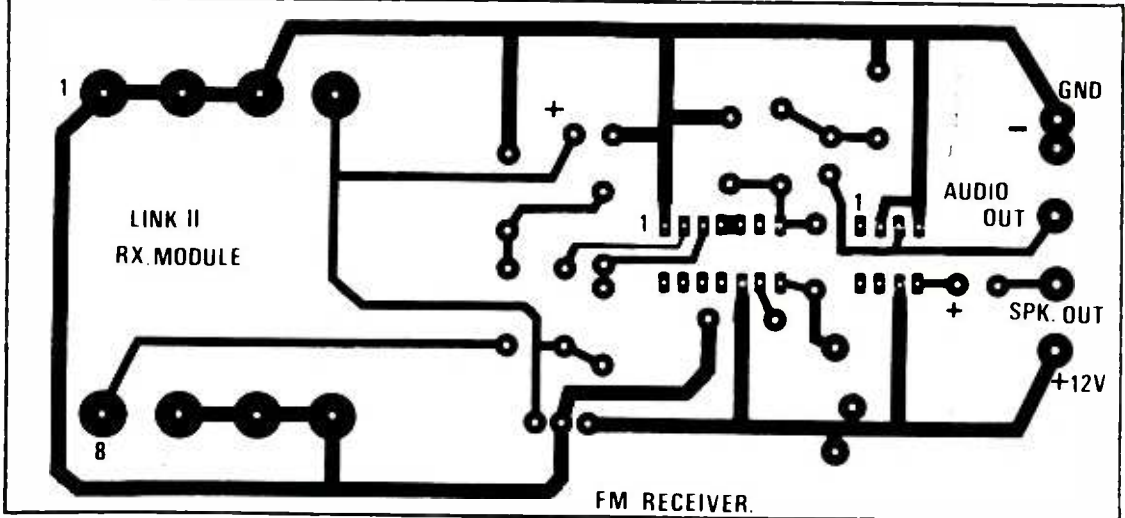

Fig. 12. Foil pattern (right) and component layout (above) for circuit in Fig. 11.



FIBER-OPTIC THEORY

mined by *R10* and *C11*; however, its capture range is ± 40 kHz. Some distortion and noise may result if the PLL has to search extensively before locking. Resistor *R10* can be replaced by a 10-kilohm trimpot if fine adjustment is desired.

The PLL's audio output is filtered and passed along to an LM386 audio amplifier, which can deliver 250 mW to an 8-ohm speaker. Audiophiles should note that, if the LM565 audio output is sampled before the power amplifier, a signal-to-noise ratio in excess of 100 dB is available. Refer to Fig. 12 for etching, drilling, and component placement.

Longer Links, Greater Bandwidth.

As it comes from the manufacturer, the Link II system is capable of a 200-kHz bandwidth over several hundred meters—almost a half-mile! But, there are improvements which you can make to increase both parameters.

First, and easiest, involves the optical output of the transmitter. Motorola makes an improved version of the transmitting LED, designated the MFOE106F, with increased optical power for greater distance. By substituting the brighter LED, operation is extended to several kilometers with no loss in bandwidth.

This distance can be extended even further by increasing the value of the *IC1A*'s feedback resistor and thus improving (by as much as three times) the sensitivity of the receiver. A maximum of 1 megohm is suggested. Unfortunately, this modification introduces instability and a 2-pF capacitor across the feedback resistor may be required.

Bandwidth can also be increased. Although 200 kHz is suitable for most applications, the limiting factor here is the transmission rate. This is controlled by the monostable multivibrator in the transmitter module. With a clock pulse width of 2 μ s, you can't get data through any faster than 200 kHz.

But, if you decrease the transmitter module's 250-pF capacitor (narrowing the trigger-pulse width), the data transmission rate increases. A 1- μ s pulse width will double it (400 kHz). This may be tricky, since all transmitter modules do not respond equally to increased data flow, and you'll have to experiment. Also, increasing bandwidth while extending fiber length isn't always possible. Due to modal dispersion in the glass fiber, and decreasing sensitivity at the receiver, a conflict between link length and data rate inevitably develops, and a compromise is necessary.

The foregoing gives you a chance to work with state-of-the-art devices that will undoubtedly shape the future of communications. \diamond

ANYONE who has ever seen a sunset across water has witnessed the operating principle that makes fiber optics possible. Basically, it involves the mechanics of refraction (the bending of light as it passes from one transparent material into another).

Light travels at a speed of 186,000 miles per second in a vacuum. However, when a ray of light (or photon) encounters anything other than a vacuum, it slows down, which creates refraction.

Take air and water as an example. The speed of light in air can be considered equivalent to that in a vacuum. However, light travels much slower in water.

The relationship between this decrease in light speed (relative to the speed in a vacuum) is the material's refractive index. When light passes between materials with different indexes (air to water), the change in speed shifts the original direction of travel. According to Snell's law, the amount of deviation is dependent upon the ratio between the refractive indexes involved and the angle at which the light strikes the boundary, or interface between materials. The light, therefore, enters at one angle and emerges at another.

However, at a certain angle of attack, light will not enter the second substance. Instead, all incident light bounces off the interface. This is called the critical angle, and all light approaching at an angle greater than this is reflected.

Now think of the sunset over water. While the sun is high (any angle less than the critical angle), sunlight enters the water, is refracted, and finally absorbed. However, as the sun drops toward the horizon the critical angle is reached and all the light reflects off the water instead of refracting into it—creating those breathtaking scenes.

This is exactly what happens in the typical optical fiber. The fiber core (the actual path traversed by the light) is usually made of silica glass (although plastic can be, and is, used). Upon that is bonded a cladding of silica glass with a different refractive index. It's the air-to-water interface all over again, only this time it involves two types of glass.

A ray of light entering the center core has three possible paths. It can (1) travel the entire length of the fiber unscathed (highly unlikely); (2) strike the glass/glass interface and be refracted (eventually to be absorbed by the protective outer jacket); or (3) bounce off the interface "wall" and continue on.

Some optical paths will contain more reflections than others, depending upon the initial encounter angle. Light beams that make just a few bounces go the shortest distance and require the least travel time. This effect is called modal dispersion, and it tends to stretch the information pulse (see diagram).

In order to reduce the modal dispersion associated with the simple step-index fiber, other types of fibers have been developed. By reducing the glass core diameter, it's possible to make the light "tunnel" so small that it will propagate only those rays with the fewest reflections. Since the sundry assortment of reflections has been reduced to very nearly one, dispersion is greatly improved in this "single-mode" fiber.

Single-mode fiber is extremely thin (2 μ m, the size of a human hair), and is difficult to handle. Nevertheless, it is the most efficient of available fibers and is used extensively in long-distance wide-band telephone communications.

Another way to reduce modal dispersion is to eliminate the reflections altogether, as is done in graded-index fibers. Even the name gives you a clue; the higher the refractive index, the slower the light travels. Consequently, the refractive index of this core isn't uniform, but is highest at the center, tapering in value radially. The farther light is from the fiber center, the faster it travels.

Due to the many refractive gradations, the light passing through this fiber isn't simply reflected, but gently bent, with the longest path also being the fastest. This causes all the incident light to reach the end of the fiber at about the same time. Graded-index fiber is difficult to manufacture, and therefore more expensive. However, its minimum dispersion and easy handling characteristics are making it very popular. \diamond

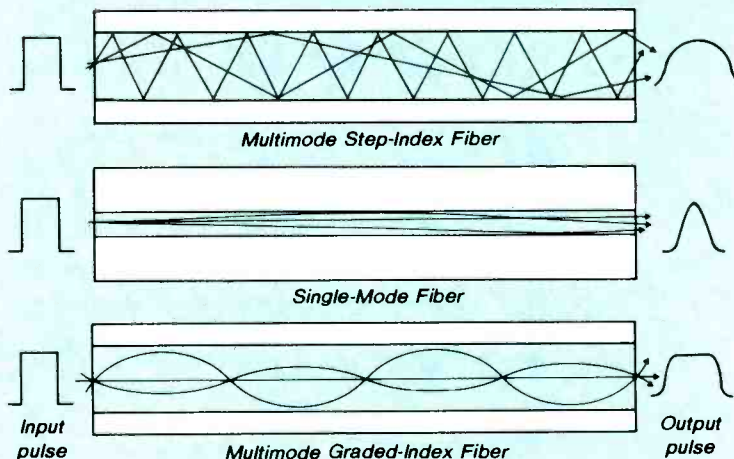

SOUND-ACTIVATED PHOTO FLASH

Simple circuit freezes split-second action

BY NEIL ULEVICH

SOUND triggers that activate stop-action flash units have been around for years. However, a couple of inexpensive integrated circuits make the circuit described here one that is easy to build and simple to operate. The circuit triggers a modern automatic electronic flash unit that delivers an ultra-short flash. This, in turn, freezes action of an event such as a bursting balloon or a breaking light bulb.

Circuit Operation. A crystal microphone senses the sound of the trigger event and feeds the signal to IC1, an LM386 low-voltage audio power amplifier. The amplifier, wired for maximum gain (about 200) triggers IC2, a 555 timer which serves as a monostable multivibrator or one-shot. The timer's output pulse turns on the SCR, which fires the flash unit and

also prevents repeat firing of the flash during the duration of the pulse. The LED gives visual indication that the circuit is operating. A single 9-volt battery powers the project.

Construction. Point-to-point wiring works well, or you can design and etch a simple printed-circuit board. Make sure you pay attention to the polarity of the SCR terminals when you connect the flash. Keep the microphone cord short.

Use. Sound is the slowpoke in triggering this solid-state circuit, so adjusting the distance between the crystal microphone and the trigger event (such as a balloon bursting) gives the photographer some control over timing. Just remember that sound takes about a millisecond to travel one foot.

After testing the circuit for operation by clapping, refocus the camera (a tripod or similar brace is mandato-

Photo showing internal view of the author's prototype.

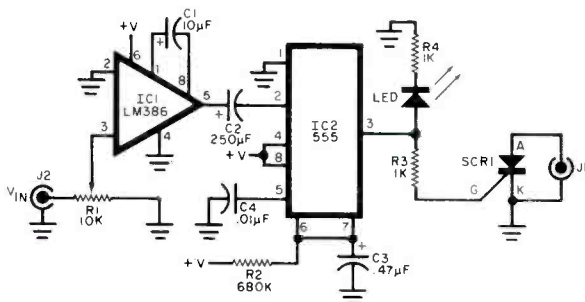
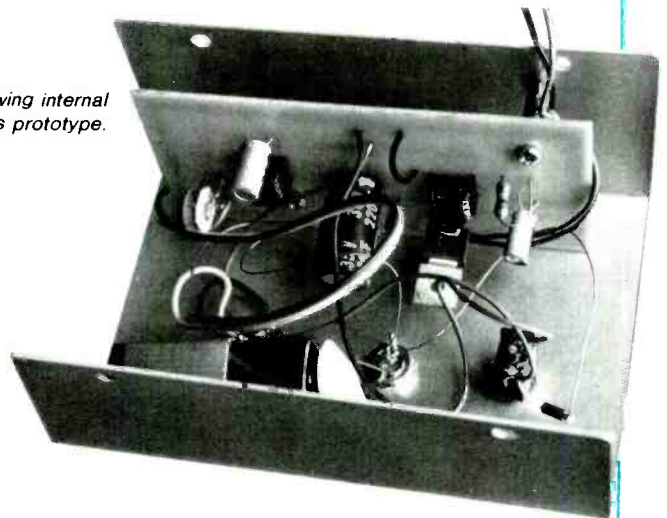

Signal from the sound source is amplified and applied to the one-shot 555.

PARTS LIST

B1—9-volt battery
C1—10- μ F electrolytic
C2—250- μ F electrolytic
C3—0.47- μ F electrolytic
C4—0.01- μ F ceramic capacitor
IC1—LM386 audio power amplifier
IC2—555 timer
J1, J2—Suitable jacks for microphone input and flash connections

LED1—Red light-emitting diode
R1—10-k Ω variable resistor
R2—680-k Ω , 1/4-W resistor
R3, R4—1-k Ω , 1/4-W resistor
SCR1—Silicon-controlled rectifier capable of handling the necessary voltage (200 V or more). Radio Shack 276-1067 or equivalent.

ry), turn out the lights, open the camera shutter and trigger the circuit with a loud sound. After the flash, close the shutter and restore the room light.

Modern automatic flash units, many of them moderate in cost, provide the incredibly short flash duration needed to stop most action. A flash used in the automatic mode at minimum distance from the subject can yield a flash as brief as 1/20,000 of a second.

Try it for yourself. Milliseconds never seemed so long! \diamond

HOW TO SWEETEN THE SOUND OF YOUR PHONO CARTRIDGE

A precision equalizer/preamp pinpoints the truly correct impedance match between a phono cartridge and receiver preamp for the best high-frequency response

BY MARTIN NAGEL

THE BEST LOAD for your cartridge may not be the nominal 47-kilohm phono input impedance available on most commercial preamps and receivers. This is important because incorrect cartridge loading can needlessly sacrifice high-frequency response. However, it is a relatively easy task to determine the optimum loading with a simple RC network. All that is required is an RIAA equalizer/preamp that can be switched between an equalized and a flat response, a flat-recorded test record, and an ac voltmeter or oscilloscope.

For about \$50, a compact state-of-the-art RIAA equalizer/preamp can be built that offers the required switching capability plus precision performance and extremely low noise (actually *less* than the thermal noise generated by a moving-magnet car-

tridge). The design also includes two 20-Hz rolloff switches (one for each stereo channel) that can selectively attenuate sub-audible record warp signals, and a stereo/mono switch to accommodate monophonic records or reduce noise when worn stereo records are played back in mono. Simple plug-in operation is accomplished via the auxiliary input jacks on your present preamp, receiver, etc. You will need to provide a ± 15 -V dc supply to power the unit, and a CBS STR 100 test record to use as a signal source.

Circuit Description. A dual low-noise operational amplifier, the Exar XR-5532AN, is especially suited to this equalizer/preamp design. The chip offers extremely low noise (input noise voltage specified as $5 \text{ nV}/\sqrt{\text{Hz}}$ at 1 kHz), high open-loop gain (typi-

cally 100 dB at low frequencies and 40 dB at 20 kHz), and high slew rate ($9 \text{ V}/\mu\text{s}$). The device's power bandwidth (140 kHz) and unity-gain bandwidth (10 MHz) preclude any type of transient or slew-induced distortion. And the chip's unusually good low-impedance drive capability (10 V peak into 600 ohms) means that long cables connected to the equalizer/preamp outputs will not attenuate high-frequency response.

In Fig. 1, R and C represent the load on the stereo cartridge. The printed-circuit layout of Fig. 2 was designed assuming that R and C are external to the equalizer. For example, R and C could be soldered inside a phono jack shell, with a phone plug on one end and a phono jack on the other. A load made in this manner would be fully shielded, and is especially convenient if you have two or more different cartridges each needing a different load for best high-frequency response. Furthermore when the cartridge loads are external, the equalizer can be used as a very low-noise microphone or oscilloscope preamp if the EQUALIZED/FLAT switches are set at the FLAT position and dc offset at the preamp output is not excessive. However, when just one cartridge is to be used, it is perfectly acceptable to solder R and C inside the equalizer.

With the equalizer/preamp's inputs connected to a stereo cartridge, the EQUALIZED/FLAT switches in the EQUALIZED position, and the 20-Hz rolloff switches in the upper (no rolloff) position, 1 or 2 volts of dc at the output can be expected. Therefore, it is recommended that the equalizer/preamp be connected to capacitor-

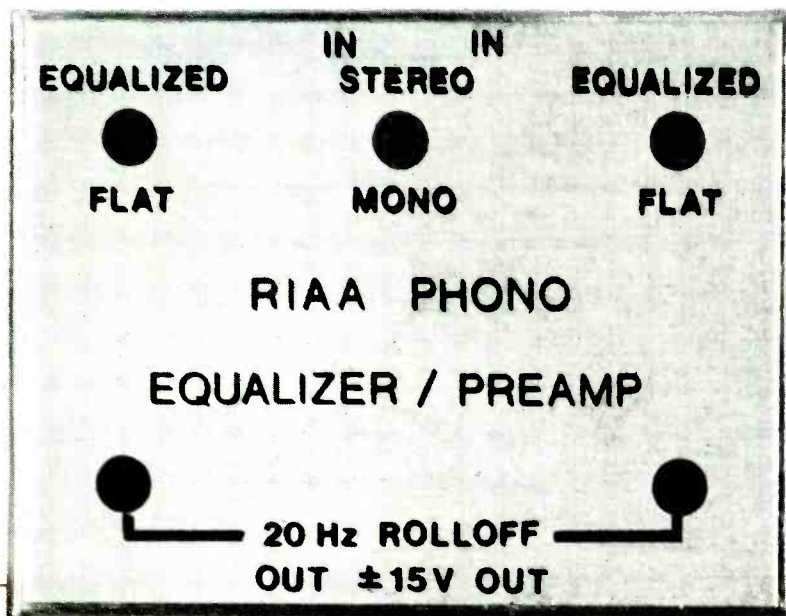

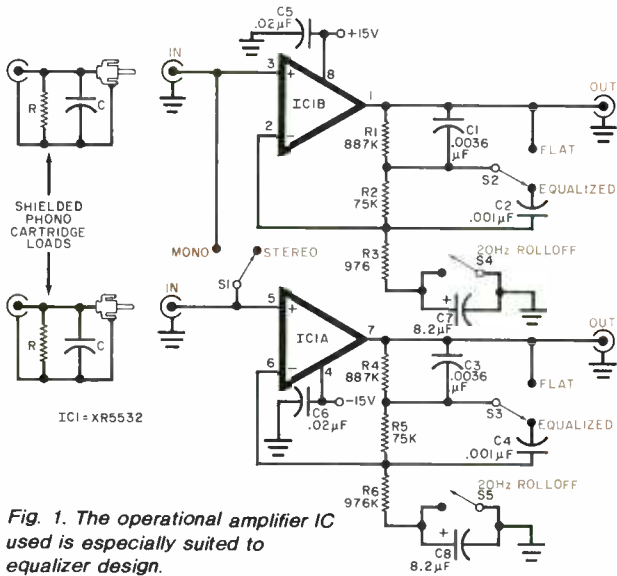

Fig. 1. The operational amplifier IC used is especially suited to equalizer design.

coupled inputs with a time constant of 65 ms (0.1 dB loss at 16 Hz) or greater, and an input impedance of 600 ohms or greater. Most preamplifier or receiver "auxiliary" or "line-level" inputs meet these conditions.

The equalizer/preamp's low-frequency ROLLOFF switches provide a response that is flat to dc in the "up" position or rolled off 3 dB at 20 Hz in the "down" position. This rolloff attenuates subsonic signals from warped records. Unchecked, these signals can cause intermodulation distortion due to excessive woofer-cone motion. The dc output offset voltage is also reduced when the rolloff position is selected. Since the International Electro Technical Commission (IEC) recommends a rolloff time constant of 7.95 ms (which produces a -3-dB frequency of 20 Hz), C7 and C8 of Fig. 1 are chosen so that $R3C7 = R6C8 \approx 7.95$ ms.

Construction. The foil pattern for the pc board is shown in Fig. 2. All

holes are 0.035" diameter (#65 drill).

Components are located as shown in Fig. 3. The colored band (outside foil) end of capacitors C1, C2, C3, and C4 should be nearest the center of the pc board. Do not mount IC1 backwards or it may burn out when the power is applied. Note the ground wire that is soldered to the case of all five switches. The purpose of this wire is to prevent hum pickup when the switches are touched (in the event the switch cases do not make good contact with the enclosure).

Mount the pc board in a suitable enclosure as shown in the photograph. Use fiberboard insulation between the board and the enclosure. Drill holes on the top for the switches and on the sides for the input and output jacks and power supply leads. Place a ground lug under the mounting nut of one of the output jacks.

Installation. The outputs of the equalizer/preamp should not be con-

PARTS LIST

- C1, C3—0.0036- μ F, 25-V, 1% polystyrene film capacitor
 - C2, C4—0.001- μ F, 25-V, 1% polystyrene film capacitor
 - C5, C6—0.02- μ F, 50-V, +80/-20% ceramic capacitor
 - C7, C8—8.2- μ F, 20-V, \pm 5% tantalum capacitor
 - IC1—Exar XR-5532AN or XR-5532AP or Signetics NE5532AN dual low-noise operational amplifier
 - R1, R4—887-k Ω , 1/8-W, 1% metal-film resistor
 - R2, R5—75-k Ω , 1/8-W, 1% metal-film resistor
 - R3, R6—976- Ω , 1/8-W, 1% metal-film resistor
 - S1 through S5—Spdt toggle switch (Alcoswitch TT11DG-PC-1 or C&K T101MH9CB)
- Misc.—Fiberboard insulation, pc board, 4 chassis-mount phono jacks, Bud CU-3000A aluminum minibox, decal, wire, \pm 15-V regulated power supply, etc.
- Note**—The following are available from Consumer Electronics Development Corp., 8136 Music Street, Chagrin Falls, OH 44022: Complete kit of parts (#RIAAEQ-1), including cut and drilled pc board and enclosure (less power supply), \$50; \pm 15-V wallmount regulated power supply, \$40; CBS STR 100 test record, \$15. Prices include UPS shipping in the U.S. when prepaid by check or money order. Ohio residents add 5% sales tax.

nected to the "phono" inputs of a standard preamplifier or receiver since these inputs are designed to receive signals directly from the stereo cartridge. Instead, connect the outputs of the equalizer/preamp to one of the high-level inputs ("aux," "tape," "line," etc.). Now when playing records, simply select the appropriate high-level input instead of "phono."

To avoid hum pickup, a separate \pm 15-V regulated dc power supply is required for the equalizer/preamp. Be sure to observe proper polarity when connecting the two-wire power supply cord from the equalizer/preamp to this supply. The COM terminal of the power supply should be connected to the chassis of your existing preamplifier or receiver, and the power supply should be plugged into a switched courtesy outlet. With this arrangement, the equalizer/preamp is connected to the power supply ground through the output cables that plug into the "auxiliary," "tape," or "line-

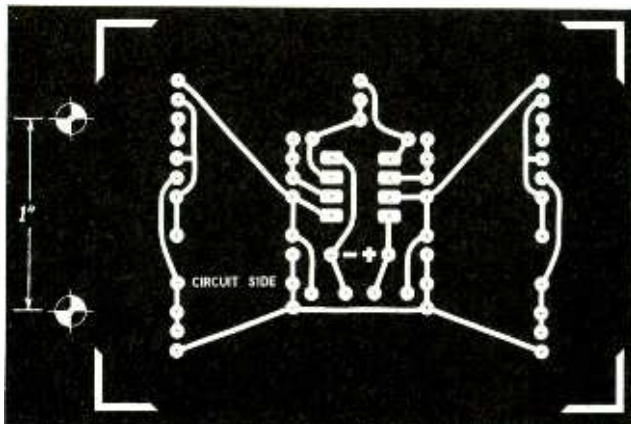

Fig. 2. Same-size foil pattern for pc board.

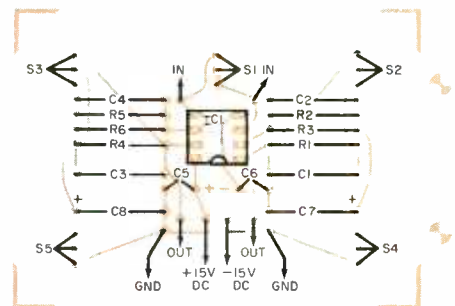

Fig. 3. Component layout for the pc board.

level" inputs of your existing preamplifier or receiver.

The equalizer/preamp will not overload when using high-output stereo cartridges and heavily recorded records. However, the output of the equalizer (which on very rare occasions can reach 5 V peak) may overload the inputs of certain preamplifiers or receivers. If this occurs, it can be corrected by adding resistive dividers at the equalizer/preamp's output.

Optimum Cartridge Loading. If you have an ac voltmeter or an oscilloscope with flat frequency response from 1 kHz to at least 20 kHz, you can now determine the load which produces the flattest high-frequency response from your stereo cartridge. Place a CBS STR 100 test record on your turntable. This record has frequency sweeps from 500 to 20,000 Hz recorded *without* equalization. Therefore, when playing these sweeps, a flat response should be observed with an ac voltmeter (or oscilloscope) connected to the outputs of the equalizer/preamp with the EQUALIZED/FLAT switches set to the FLAT position. This technique drastically reduces the low-frequency "jitter" that would be present if an RIAA-equalized test record were used. (This is because RIAA playback equalization involves considerable low-frequency boost).

Most stereo cartridge manufacturers recommend a load of 47 kilohms in parallel with a capacitance of 200 to 500 pF (which includes the capacitance of the cable from the cartridge to the load). However, it is sometimes possible to get much flatter high-frequency response by choosing the total cartridge load capacitance to resonate with the inductance of the cartridge at

**TYPICAL PHONO
EQUALIZER
PERFORMANCE**
(All switches in "up" position)

Equalization error: ± 0.1 dB (0 to 20,000 Hz)

Hum and noise: 87 dB (A-wtd) below 10 mV rms input
81 dB (A-wtd) per IHF-A-202

Total Harmonic distortion: 0.01% (0 to 20,000 Hz)

Gain (equalized): 100 (40 dB) at 1000 Hz

Gain (flat): 78 (38 dB) (0 to 140,000 Hz)

Input overload level: 100 mV peak at 1000 Hz

Output drive capability: 10 V peak into 600 ohms

Channel separation: 80 dB at 1000 Hz

Channel balance: ± 0.1 dB

Low-frequency response: Flat to dc or -3 dB rolloff at 20 Hz (switch selectable)

Recommended power supply: ± 15 V regulated

Current drain: 8 mA

10 to 12 kHz and then choosing the load resistance that provides the flattest high-frequency response. (A low-noise resistor is not required here because the resistor is in parallel with the much lower cartridge impedance, and no dc voltage appears across the resistor to generate current noise. However, because a polystyrene capacitor has a much lower dielectric absorption, it should be used—instead of a ceramic capacitor—for lowest distortion).

To optimize the cartridge load,

start with 47 kilohms in parallel with a capacitance of 330 pF. Run a sweep with the CBS STR 100 test record and note the high-frequency response. If there is a rolloff in the 15-20-kHz region (10 dB worst case) or a 5-8-dB peak somewhere around 10 to 12 kHz, adjusting the load can definitely improve the response flatness.

In the case where a rolloff exists at 15 to 20 kHz, the load has too much capacitance and/or too little resistance. Cut back the 330 pF by 20%, and repeat the sweep test. Next, increase the 47-kilohm resistor and again repeat the sweep. Experiment until you are satisfied that the high-frequency response is correct.

If a peak (resonance) at 10 to 12 kHz is evident, try decreasing the load capacitance and resistance alternately in 20% increments. This should move the peak higher in frequency as its amplitude is diminished. Too much capacitance and too little resistance will produce a high-frequency rolloff, so again a trial-and-error procedure is necessary. (If you wish to forego optimizing the cartridge load, then a 47-kilohm $\pm 10\%$, 1/4-W carbon resistor in parallel with a 330-pF, $\pm 10\%$ polystyrene capacitor soldered between each input and ground inside the equalizer/preamp is recommended and will provide reasonably flat high-frequency response with practically all moving-magnet stereo cartridges.)

Moving-Coil Needs More Gain.

Owing to the very low output of moving-coil cartridges, an additional gain stage is needed between the cartridge and the equalizer/preamp. Because of its extremely low noise, a second equalizer/preamp is perfect for this function. This second unit should be used with its EQUALIZED/FLAT switches in the FLAT position and its output modified from direct-coupled to capacitor-coupled. Solder an 8.2 μ F, $\pm 5\%$, 20-V tantalum capacitor in series with each output jack and a 47-kilohm $\pm 10\%$, 1/4-W carbon resistor from each output jack to ground. Both equalizer/preamps may be powered from the same ± 15 -V supply.

The gain of the second equalizer/preamp is given by $(R2 + R3)/R3$ and can be changed, if necessary, by changing the value of $R3$. This gain should be chosen so that the unit delivers about 5 mV rms when the moving-coil cartridge is playing sinusoidal record grooves recorded at 3.5-cm/second rms velocity. Again, the CBS STR 100 test record can be used for this check. \diamond

Photo of the interior of the author's prototype shows one way to lay out the project.

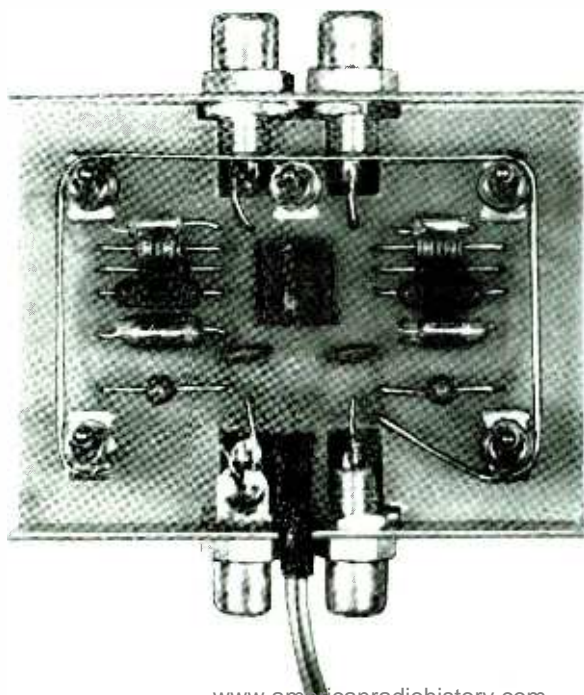

TEACH YOUR DIGITAL CLOCK TO CONTROL APPLIANCES

A few simple additions turn a standard clock module into a versatile control center

A DIGITAL alarm clock can control your electronic appliances if you add a simple circuit to the clock module. The circuit, which consists of just one IC and a few other components, transforms the clock into a flexible and useful timing-control device. But before we discuss the circuit, let's take a closer look at the clock module.

The digital alarm-clock module used for this project is National Semiconductor's MA1020. The MA1020 is a complete 12/24-hour digital clock with a full range of alarm functions and includes a 0.84-inch, red LED display.

To use the alarm function, an output device like a buzzer, radio or relay must be connected to the clock so that something happens at the "appointed time." The MA1020 can sound a buzzer or turn on a low-power radio if the buzzer (a small, eight-ohm speaker) or the radio and its power supply are connected to the module as shown in Fig. 1.

To control ac loads such as a stereo system, a lamp or television set, some type of interface circuitry must be provided so that the low MOS signal levels of the MA1020 can switch the 117-V ac power to the load. Besides low signal levels, one other difficulty arises with the

MA1020. Its radio output signal (the alarm indication) lasts a maximum of 59 minutes. Thus, if you relied on the MA1020 to turn your stereo off for the night, you would be disappointed because after 59 minutes the stereo would come back on.

To solve this problem, a flip-flop that "remembers" that the alarm has gone off (even after 59 minutes) must be added to the circuit (Fig. 2). The flip-flop outputs to a transistor-controlled relay to switch the ac load.

Circuit Operation. The main element of the circuit in Fig. 2 is the set/reset flip-flop (*IC1B* and *IC1C*). Any low inputs to *IC1B* cause the flip-flop to be set (*IC1B*'s output high), and low inputs to *IC1C* cause the flip-flop to be reset (*IC1B*'s output low). When the flip-flop is set, *IC1B*'s output is a logical one, transistor *Q1* turns on, and the relay is energized.

The MA1020 indicates that the alarm has gone off by supplying base current to a bipolar transistor within the MA1020 module. The emitter and collector leads of this transistor are brought out to pins 23 and 22, respectively. If we connect this transistor as in Fig. 2, with

the emitter tied to a positive voltage supply and the collector tied to ground through a resistor, we have converted the base current to a voltage that a CMOS gate will recognize as a logical one or zero. Thus, when the radio output is active, base current is supplied to this transistor, turning it on. When this transistor is on, it effectively "pulls up" *IC1A*'s inputs to a logical one. If the transistor is off (no base current) resistor *R1* "pulls down" *IC1A*'s inputs to a logical zero.

Of course, we'd like the radio output, when active, to set the flip-flop. Since the flip-flop sets when any *IC1B* inputs are logic zeroes, we must invert the radio output signal through *IC1A*. An active radio output signal therefore causes a logic zero at pin 5 of *IC1B*.

Meanwhile, *IC1C* has logical ones at pins 1 and 2 (assuming that both the ALARM-OFF switch and the SNOOZE switch are open), and its other input (pin 8) has just gone high as well due to *IC1B*'s switching as described above. So with all of its inputs at logic one, *IC1C*'s output is a logic zero.

This completes the flip-flop action because *IC1B* now has a zero at its pin 3 input (because of *IC1C*'s low output).

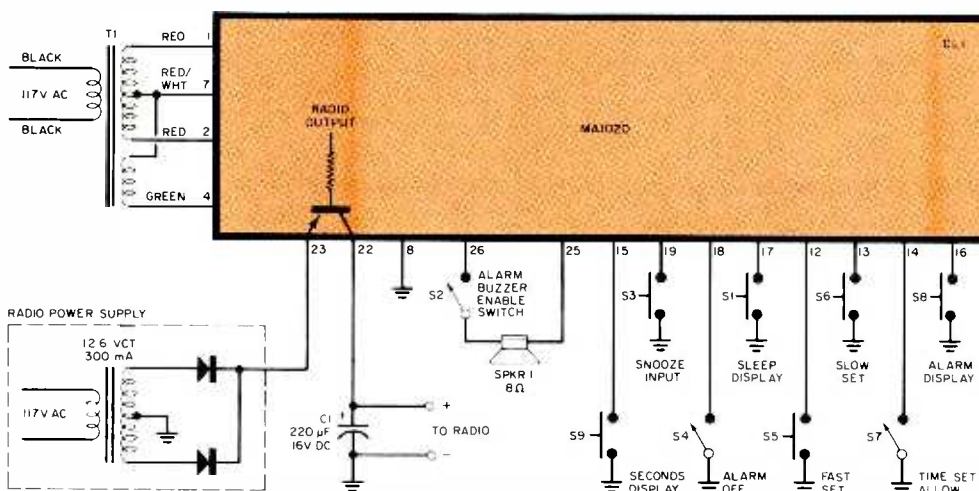

Fig. 1. These basic additions to the clock module will allow you to control a radio and a buzzer alarm.

So even after 59 minutes have elapsed and the MA1020 has removed its radio output, the flip-flop stays in its set state and the relay remains energized. (The stereo stays off as planned.)

Activating the snooze input or shutting off the alarm will reset the flip-flop. The flip-flop can also be manually overridden by inputting a logical zero directly into IC1B via switch S2. This switch can be very convenient if you want the appliance being controlled to be on or off regardless of the time (and you don't want to unplug the appliance from the clock).

Other Clock Features. Another feature of this clock module is a programmable 59-minute interval timer, which can be used to turn an appliance on or off for a period of up to 59 minutes, after which it will be returned to its original

state. This feature could save energy—(if you forget to turn off a lamp, the MA1020 will do it for you).

To use the interval timer, first close the ALARM-OFF switch, S4. Besides disabling the alarm inside the MA1020, this puts a logic zero on pin 2 of IC1C—a reset. Normally this is enough to keep the flip-flop in its reset state. However, momentarily closing the SLEEP-DISPLAY switch activates the interval timer inside the MA1020, and the radio output goes active. This supplies a set input to IC1B, pin 5, as described earlier.

The flip-flop now has both a set and a reset. What will it do? Both pin 6 and pin 9 will go high as long as the set and reset are still present. But the final state of the flip-flop depends on which of those two inputs lasts longest. In this case, the set input is removed after 59 minutes (or the interval you pro-

grammed) and the reset “wins” thereafter. The net effect is just what we wanted—the relay energizes only for the interval that the radio output is active.

The interval can be terminated prematurely by momentarily closing the snooze switch, S3.

The MA1020 also has battery backup capability. All you need add to the module to take advantage of this feature is a standard 9-volt battery and a 5-megohm potentiometer (Fig. 3).

Normally, the MA1020 bases its time-keeping on the 60-Hz ac line frequency, which permits it to maintain excellent long-term accuracy. However, if the ac power is lost, the MA1020 can switch automatically to a backup oscillator and the 9-volt battery so that it won't forget what time it is. Relatively high-power parts of the clock module such as the LED display and the relay

(Continued on page 80)

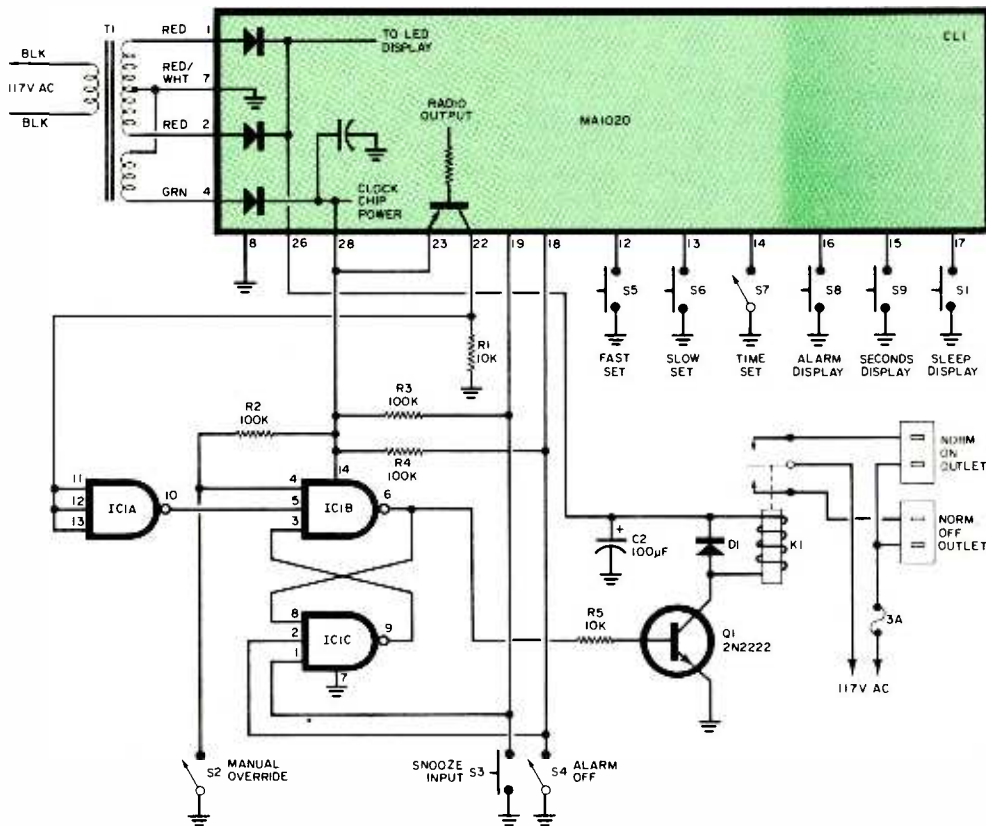

Fig. 2. To control ac appliances, an interface circuit must be added.

PARTS LIST

- B1—9-V transistor radio battery
- C1—220-µF, 16-V electrolytic
- C2—100-µF, 16-V electrolytic
- CL1—National Semiconductor's MA1020 clock module
- D1—1N4000 series, 1-A rectifier
- IC1—CD4012, CMOS triple, 3-input NAND gate

- K1—5-V, 440-Ω, spdt relay with 3-A, 117-V contacts
- R1, R5—10-kΩ, 1/4-W, 10% resistor
- R2, R3, R4—100-kΩ, 1/4-W resistor
- R6—5-MΩ, 1/4-W potentiometer
- S1, S3, S5, S6, S8, S9—Momentary-contact, normally open switch

- S2, S4, S7—spst switch
- SPKR 1—8-Ω, 2-inch audio speaker
- T1—Digi-Key MA 1020T transformer
- Misc.—Ac line cord, 3-A fuse and holder, 2 ac outlets, suitable enclosure, strain relief, pc or vector-board, 14-pin DIP IC socket, hookup wire, solder, etc.

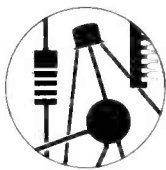

Find exciting projects, troubleshooting and repair tips, and hands-on, do-it-yourself info, plus hundreds of time- and money-saving ideas in the **ELECTRONICS BOOK CLUB**

Select 6 outstanding volumes for only **\$2⁹⁵** (total value up to \$140.60)

1367 List \$19.95

1070 List \$14.95

1249 List \$15.95

1338 List \$19.95

1277 List \$19.95

1306 List \$15.95

1288 List \$14.95

806 List \$15.95

1199 List \$16.95

1060 List \$9.95

1258 List \$10.95

1211 List \$14.95

1283 List \$18.95

1108 List \$12.95

1339 List \$13.95

1060 List \$9.95

1373 List \$11.95

1250 List \$16.95

1316 List \$16.95

1337 List \$9.95

1128 List \$11.95

1349 List \$18.95

1169 List \$15.95

7 very good reasons to try Electronics Book Club

Blue Ridge Summit, PA 17214

- **Reduced Member Prices.** Save up to 75% on books sure to increase your know-how.
- **Satisfaction Guaranteed.** All books returnable within 10 days without obligation
- **Club News Bulletins.** All about current selections—mains, alternates, extras—plus bonus offers. Comes 13 times a year with dozens of up-to-the-minute titles you can pick from
- **"Automatic Order."** Do nothing, and the Main selection will be shipped automatically! But... if you want an Alternate selection—or no books at all—we'll follow the instructions you give on the reply form provided with every News Bulletin
- **Continuing Benefits.** Get a Dividend Certificate with every book purchased after fulfilling membership obligation, and qualify for discounts on many other volumes
- **Bonus Specials.** Take advantage of sales, events, and added-value promotions
- **Exceptional Quality.** All books are first-rate publisher's editions, filled with useful, up-to-the-minute info



ELECTRONICS BOOK CLUB

Blue Ridge Summit, PA 17214

Please accept my membership in Electronics Book Club and send the 6 volumes circled below. I understand the cost of the books selected is \$2.95 (plus shipping/handling). If not satisfied, I may return the books within ten days without obligation and have my membership cancelled. I agree to purchase 4 or more books at reduced Club prices during the next 12 months, and may resign any time thereafter.

806 1060 1070 1108 1128 1169 1199 1211 1230
1245 1249 1250 1258 1277 1283 1288 1306 1316
1337 1338 1339 1349 1367 1373 1435 2084/2094 8434

Name _____ Phone _____

Address _____

City _____

State _____ Zip _____

(Valid for new members only. Foreign and Canada add 20%)

PE-582

Choose your training!

Only NRI gives you so many ways to get started on your TV/Video/Audio servicing career.

Only NRI gives you such a choice of practical experience projects with your training in servicing TV, video-cassette recorders and disc units, and audio systems. You can elect to build

NRI's 25" (diagonal) color TV with state-of-the-art fully-computerized programmable controls. Or, take your bench training on the latest model RCA programmable videocassette recorder

with exclusive videotaped lessons. Or concentrate on the world of audio as you work with a complete AM/FM stereo sound system. Any way you go, it's your choice... more choices than any other school.

Train with this programmable RCA video-cassette recorder



Each Course Complete

No matter which hands-on training program you select, your NRI course is complete. You get all 58 lessons covering every aspect of the field. TV, audio, and videocassette are just a start. You learn to install and service car radios and stereo systems... antenna systems including satellite TV... video disc players... cable TV... microprocessor controls and much more. NRI training is complete, thorough, and effective.

Learn at Home in Your Spare Time

NRI trains you at home, at your convenience. No need to quit your job or tie up your evenings with night



Train as you assemble this fully-computerized, programmable 25" diagonal color TV

Professional Instruments Included

You'll work with the famous NRI Discovery Lab®, where theory comes alive, exploring concepts and learning by doing. You'll use the Beckman LCD digital multimeter to read currents and resistances, keep it for professional troubleshooting. You'll build a CMOS digital frequency counter, another valuable servicing tool. And, depending on which experience project you choose, you'll also build your own 5" solid-state oscilloscope and function TV pattern generator. Use them for learning or use them for earning.

NRI Picked by the Pros

A national survey of successful TV repairmen shows that

more than half had home-study training, and among them, it's NRI 3 to 1 over any other school. That's why, more than 67 years and a million and a quarter students later, NRI is still the leader. You can't beat the up-to-the-minute training for effectiveness and value. See how NRI can do it for you.

Send for Free Catalog... No Salesman Will Call

Send today for our free 100-page catalog which shows... and equipment... lesson... payment... Or check out other fast-moving opportunity fields like Microcomputers & Microprocessors, Electronic Design Technology, Digital and Communications Electronics, and more. Mail the postage-paid card today and choose your training. If card has been removed, please write.



Learn by doing with NRI hands-on projects and professional instruments that you use and keep.

school pressures. NRI "fast-track" training makes learning easier... Action Audio Cassettes guide you step by step... NRI "hands-on" projects give you practical bench experience as you progress. You not only get theory, you actually build and test electronic circuits using professional equipment included with your course.

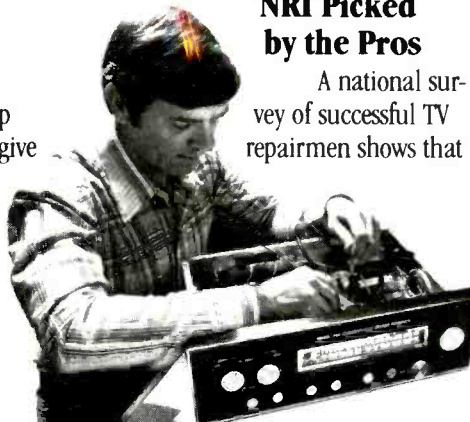

Train on this AM/FM stereo system complete with speakers



NRI Schools
McGraw-Hill Continuing
Education Center
3939 Wisconsin Ave.
Washington, D.C. 20016

We'll give you tomorrow.

**INTRODUCING
OUR
MDS - AMATEUR - ETV
32 ELEMENT YAGI ANTENNA**



- NOT A KIT
- 1.9-2.5 GHz
- 38½" LENGTH
- 23 dB AVERAGE GAIN
- DIE CAST WATERPROOF HOUSING FOR ELECTRONIC CIRCUITRY
- COMMERCIAL GRADE
- INCLUDES MOUNTING HARDWARE

MODEL NO. **MAE-1** ONLY **\$19.95**

VTR ACCESSORIES

SIMPLE SIMON VIDEO STABILIZER



Model **VS-125**

Simple Simon Video Stabilizer, Model VS-125, eliminates the vertical roll and jitter from "copy guard" video tapes when playing through large screen projectors or on another VTR. Simple to use, just adjust the lock control for a stable picture. Once the control is set, the tape will play all the way through without further adjustments. Includes 12V power supply.

VS-125 Video Stabilizer wired \$54.95

SIMPLE SIMON VIDEO SWITCHING BOX



Model **VS-300**

The Affordable Video Control Center!

Excellent in isolation and no loss routing system. Simple Simons VSB-300 Video Switching Box enables you to bring a variety of video components together for easy viewing/dubbing. Also you gain the ability to record one channel while viewing another. Unit includes two F-type quick connector ended cables.

VSB-300 Video Switching Box wired \$19.95

Available by Mail Order Only — Send Check or Money Order To:

SIMPLE SIMON ELECTRONIC KITS, Inc.

Calif. Orders:
3871 S. Valley View, Suite 12
Las Vegas, Nevada 89103
Tel: (702) 322-5273

All Other Orders:
11850 S. Hawthorne, Blvd.
Hawthorne, Calif. 90250
Tel: (213) 675-3347

Minimum Order: \$16.95. Add 10% Shipping and Handling on orders under \$40.00. For orders over \$40.00, add 5%. Minimum Shipping and Handling \$2.00. Catalog \$1.00. — VISA and Mastercard Acceptable —

SIMPLE SIMON ELECTRONIC KITS, Inc.

7 + 11 SWD PARTS KITS

MITSUMI VARACTOR UHF TUNER
Model UES-A56F
\$34.95

Freq. Range UHF470 - 889MHz
Antenna Input 75 ohms
Channels 14-83 Output Channel 3

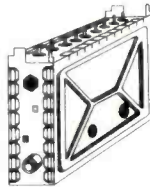

KIT NO.	PART NO.	DESCRIPTION	PRICE
1	VT1-SW	Varactor UHF Tuner, Model UES-A56F	\$34.95
2	CB1-SW	Printed Circuit Board, Pre-Drilled	18.95
3	TP7-SW	P.C.B. Potentiometers, 1-20K, 1-1K, and 5-10K ohms, 7-pieces	5.95
4	FR35-SW	Resistor Kit, ¼ Watt, 5% Carbon Film, 32-pieces	4.95
5	PT1-SW	Power Transformer, PRI-117VAC, SEC-24VAC, 250ma	6.95
6	PP2-SW	Panel Mount Potentiometers and Knobs, 1-1KBT and 1-5KAT w/Switch	5.95
7	SS14-SW	IC's 7-pcs, Diodes 4-pcs, Regulators 2-pcs, Heat Sink 1-piece	29.95
8	CE9-SW	Electrolytic Capacitor Kit, 9-pieces	5.95
9	CC33-SW	Ceramic Disk Capacitor Kit, 50 WV., 33-pieces	7.95
10	CT-SW	Variable Ceramic Trimmer Capacitor Kit, 5-65pfd, 6-pieces	5.95
11	L4-SW	Coil Kit, 18mhs 2-pieces, 22µhs 1-piece (prewound inductors) and 1 T37-12 Ferrite Toroid Core with 3 ft. of #26 wire	5.00
12	ICS-SW	I.C. Sockets, Tin Inlay, 8-pin 5-pieces and 14-pin 2-pieces	1.95
13	SR-SW	Speaker, 4x6" Oval and Prepunched Wood Enclosure	14.95
14	MISC-SW	Misc. Parts Kit Includes Hardware, (6/32, 8/32 Nuts, & Bolts), Hookup Wire, Ant. Terms, DPDT Ant. Switch, Fuse, Fuseholder, etc.	9.95
When Ordering All Items, (1 thru 14), Total Price			139.95

UHF ANTENNAS and ACCESSORIES

ZYZZX

VHF-UHF WIDEBAND ANTENNA AMPLIFIER

MODEL ALL-1
50 MHz — 900 MHz
12 dB GAIN ± 0.5dB

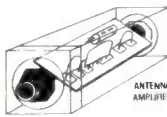

A Revolutionary New One Stage HYBRID IC Broadband Amplifier

This unit is not available anywhere else in the world. One unit serves many purposes and is available in Kit or Assembled form. Ideal for outdoor or indoor use. Input-output impedance is 75 ohms. Amplifier includes separate co-ax feed power supply. Easily assembled in 25 minutes. No coils, capacitors etc. to tune or adjust.

ALL-1 Complete Kit with power supply \$24.95
ALL-1 Wired and Tested with power supply \$34.95

Our New STVA 14.5 dB GAIN, 14 ELEMENT CORNER REFLECTOR YAGI ANTENNA

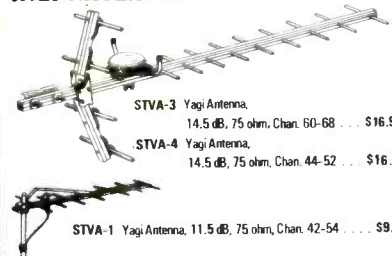

RG-59/U	75 ohm Low Loss Coax Cable \$.12 p/ft
F-59	Coaxial Connectors, ea.39
MT-1	Special UHF 75-300 ohm Matching Transformer, ea. 1.45
ALL-1	HYBRID IC Wideband VHF-UHF-FM Antenna Amplifier Kit 24.95
ALL-1	HYBRID IC Wideband VHF-UHF-FM Ant. Amp. Assembled 34.95

clock control

(Continued from page 74)

coil are turned off so that battery life is maximized.

The 5-megohm pot determines the frequency of the backup oscillator, which directly affects the timekeeping accuracy when the module is running on backup power. Adjust this pot so that a 20-Hz signal appears at pin 5 for optimal accuracy. (If you don't have a frequency counter handy, you can set this frequency by trial-and-error. Just set the clock to the correct time, adjust the pot, turn off the ac power to the

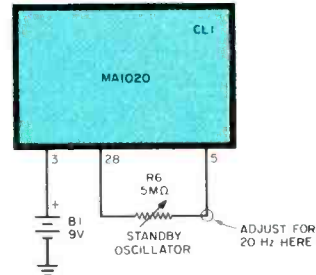

Fig. 3. A battery backup circuit can be added as shown here.

module, and wait a few minutes. When you turn on the ac power again, compare the time the module thinks it is to the correct time. Adjust the pot and try again, but leave the power off longer for each try.)

Use. One precaution that must be taken with this design: the ac load that is switched by the relay must not exceed the rating of the relay contacts. The relay specified in the parts list is rated for 3 A, 117 V, noninductive loads. This means that the relay will handle most lamps, radios, etc. But if you plug in your toaster, air conditioner, or washing machine you'll blow the fuse and may destroy the relay.

When you construct the physical housing for the timer, you may want to place the snooze switch in a place that is easy to reach. I mounted the switch under the top door of the housing so that pushing down on any part of the clock would activate the snooze feature.

Take the usual precautions that CMOS or NMOS deserve. For instance, the clock module is shipped wrapped in aluminum foil to prevent any possible damage from static electricity. It's prudent to keep this foil on the module until you're ready to wire it up. Also, avoid touching the pins of the CD4023 or the MA1020 as much as possible.

There are more modes and features built into the clock module than were described here. The documentation that accompanies the module covers them all and also describes tests to verify the health of the clock module. ◇

Popular Electronics Tests

Krohn-Hite Model 4400 Ultra-Low Distortion Oscillator

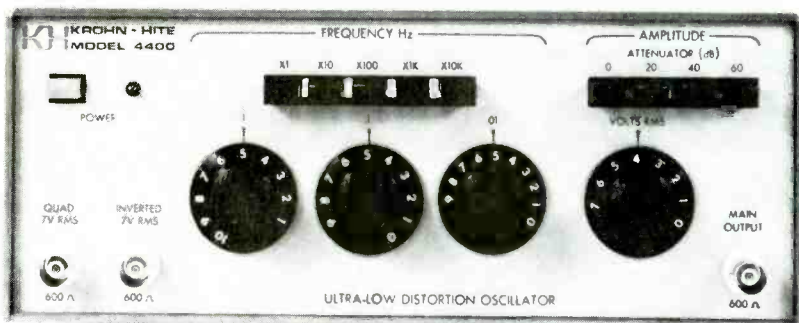

THE Krohn-Hite Model 4400 Ultra-Low Distortion Oscillator covers the range from 1 Hz to 110 kHz with less than 0.001% distortion and just ± 0.05 dB variation in frequency response. This makes the Model 4400 ideal for testing all types of audio equipment, including the latest state-of-the-art systems. It measures 3.5" H x 9" W x 8.5" D, and weighs 5 pounds. Suggested retail price is \$600.

General Description. All major con-

trols are on the front panel. These include the FREQUENCY HZ controls that allow two digits of frequency, calibrated in 1- and 0.1-Hz increments with a calibrated vernier between the 0.1-Hz steps, and a 5-decade pushbutton multiplier providing X1, X10, X100, X1K, and X10K steps. The output amplitude is a 7-V rms sine wave controlled by a 4-position pushbutton attenuator switch calibrated in 20-dB steps between 0 and 60 dB. There is a separate vernier providing an additional 30 dB of coverage, for a total

dynamic range of 90 dB. The output impedance is 600 ohms.

Simultaneous quadrature (90°) and inverted (180°) outputs are provided for multi-phase applications. Each of these outputs delivers a fixed 7 V rms from a 600-ohm source impedance. All outputs are via BNC connectors.

The rear apron contains a pair of screwdriver-adjust potentiometers for setting level, a slide switch for circuit ground selection, a 120/240-V line-selection switch, the fuse, and a three-

MANUFACTURER'S SPECIFICATIONS

Frequency range: 1 Hz to 110 kHz, 3-digit resolution
 Frequency control: 1- and 0.1-Hz steps plus vernier, 5-decade pushbutton multiplier
 Frequency accuracy: $\pm 1\%$ of frequency setting
 Frequency stability:
 Vs. time: 0.01% in 1 hr or less
 Vs. temperature: 0.05%/°C
 Vs. line: $<0.001\%$ for 10% voltage change
 Maximum output: 7 V rms open circuit, 3.5 V rms (+13 dBm) into 600-ohm load
 Amplitude control: Four-position pushbutton attenuator calibrated in 20-dB steps from 0 to 60 dB; accuracy is ± 0.25 dB per 20-dB steps; VOLTS RMS control greater than 30-dB coverage, accuracy $\pm 20\%$ of setting. Minimum output less than 0.2 mV
 Amplitude flatness:
 Main/inverted outputs: ± 0.05 dB, 1 to 110 kHz
 Quadrature output: ± 2 dB, 1 to 110 kHz
 Amplitude stability:
 Vs. time: 0.01% in 1 hr or less
 Vs. temperature: 0.05%/°C
 Vs. line: $<0.001\%$ for 10% voltage change
 Output distortion:
 Main/inverted outputs:

1 to 10 Hz: 0.0018% (-95 dB)
 10 Hz to 10 kHz: 0.001% (-100 dB)
 10 to 20 kHz: 0.0018% (-95 dB)
 20 to 50 kHz: 0.0056% (-85 dB)
 50 to 110 kHz: 0.01% (-80 dB)
 Quadrature output:
 1 to 10 Hz: 0.0056% (-85 dB)
 10 Hz to 10 kHz: 0.0031% (-90 dB)
 10 to 20 kHz: 0.0056% (-85 dB)
 20 to 50 kHz: 0.0174% (-75 dB)
 50 to 110 kHz: 0.031% (-70 dB)
 Output impedance: 600 ohms, $\pm 1\%$
 Phase accuracy:
 Inverted output:
 1 Hz to 10 kHz, $\pm 0.2^\circ$
 10 to 110 kHz, $\pm 1^\circ$
 Quadrature output:
 1 Hz to 1 kHz, $\pm 0.2^\circ$
 1 to 10 kHz, $\pm 1^\circ$
 10 to 110 kHz, $\pm 10^\circ$
 Hum and noise: Greater than 100 dB below signal (10 Hz to 20 kHz detector bandwidth)
 Ambient Temperature range: 0°C to 50°C
 Power requirements: 90 to 132 or 180 to 264 V, single phase, 50/60 Hz, 6 W.
 Floating ground: Switch-selectable float—from chassis ground to 100 V

pin power socket. Four large rubber feet and a tilt stand are located on the underside. Complete specifications are given in the Table.

Comments. The Model 4400 Ultra-Low Distortion Oscillator was checked by the Lockheed Electronics Instrumentation Measurements Laboratory (Plainfield, NJ) against a cesium-beam frequency standard (HP 5062C) traceable to the National Bureau of Standards. The Model 4400 met or exceeded its claimed specifications in all respects. And we found that the Model 4400 specifications are equal to or better than the specifications of much more costly instruments.

Since the Model 4400 is an excellent source of very low distortion sine waves, it was put to use in testing and adjusting some audio systems we had on the bench. Before we used it, however, we succumbed to the desire to compare the Model 4400 sine waves with the sine waves we were getting from our bench audio generator (about half the price of the Model 4400). We used a dual-trace scope, with both traces superimposed. Although we could not see any real difference between the two waveforms on the CRT display, our distortion analyzer told a different story. The audio generator produced a small but measurable distortion, while the 4400's output barely moved the analyzer's analog meter on-scale.

Although some might question the use of such a low-distortion audio generator for general-purpose bench work, we feel that test equipment is not "transparent" unless its specs are at least one order of magnitude better than the device being tested. Thus when problems are encountered, suspicion remains focused on the device under test, and is not easily diverted to the test equipment.

We used the Model 4400 to "tweak" a couple of high-quality audio systems. Although the results were not dramatic (our old audio generator was OK), there was enough change to hear.

Not only do we work with audio systems, we also handle ham slow-scan television, radio control, and other equipment using audio filters. Once such filters have been aligned using the Model 4400 low-distortion audio generator, we feel confident that an almost-ideal sine wave has been used to align the filter close to perfection—even though the real-world signal it typically works with is never this clean.

One major "problem" we encountered (as far as money is concerned) was that our audio distortion analyzer must now be replaced so we can take full advantage of the Model 4400 ultra-low distortion audio generator! We have encountered this phenomenon before. As we acquire state-of-the-art test equipment and put it to work, older companion equipment soon comes up short. This is the price to be paid for continuous technical improvement.—Les Solomon

CIRCLE NO. 104 ON FREE INFORMATION CARD

Our computerized equalizer makes music sound like you're right there... even if you're not here. Or over here, or down here.

The dbx 20/20 Computerized Equalizer/Analyzer can analyze and equalize up to 10 room locations perfectly. And automatically. It will also remember those 10 settings and call them up automatically. And perfectly. Among equalizers, the dbx Model 20/20 has no equal.

dbx. Music can't live without us.

dbx, Inc., 71 Chapel St., Box 100C, Newton, Mass. 02195 U.S.A. Tel. (617) 964-3210, In Canada: BSR (Canada) Ltd.

CIRCLE NO. 9 ON FREE INFORMATION CARD

WE'LL LURE YOU WITH OUR PRICES... AND WIN YOU WITH OUR SERVICE

VIDEO & AUDIO

STEREO-TO-GO

- SONY WALKMANN I (Cass. Stereo) 169
- SONY WALKMANN II (Deluxe Cass. Stereo) 1115
- YOSHIDA KFS-1 (Cass./FM Stereo) 169
- AIWA CS-1 (Cass./FM Stereo) 1435
- AIWA PK-1 (Cass./FM Stereo) 1115
- KOSS MUSIC BOX I (AM/FM Stereo) 164
- JVC QUINTEZ (Belt Stereo) 1349

HI-FI

- TECHNICS SA-404 Receiver 1385
- TEAC C-200 (Cass. Deck) 1422
- PIONEER PL-4 Turntable 1115
- SONY TC-FR60 (Cass. Deck) 2279
- PIONEER SL-7 Receiver 1341
- TECHNICS SB-LS0 (Speakers) 1125/Pair

COLOR T.V.

- SONY KV-1221R (12" Remote) 1460
- SONY KV-1511R (15" Screen) 1392
- SONY KV-1744R (17" Remote) 1658
- SONY KV-1914R (19" Screen) 1658
- SONY KV-1944R (19" Remote) 1669
- SONY KV-2141R (21" Remote) 1719

VIDEO CAMERAS

- PARASONIC PK-601 (6.1 Zoom) 1739
- RCA CC010 (Camera) 1629
- RCA VC1 (Auto Focus) 1649
- SONY VCC-220 (6.1 Zoom) 1940
- JVC CG-88 (Camera) 1639

VIDEO RECORDERS

- JVC HR-7650 (New VHS) 11099
- SONY SL-350R (New Beta) 11089
- SONY SL-300R (Beta) 1639
- JVC HR-7500 (VHS) 1689
- RCA VRT-650 (VHS) 1929
- RCA VR-170 (Beta VHS) 1699
- PARASONIC PV-1770 (VHS) 1849
- SONY SL-200R (SONY TT-2000 Beta Recorder/Tuner/Timer) 11445

HEADPHONES

- SONY MDR-3 (Mini) 124.90
- KOSS KSP (Micro) 124.90
- PIONEER SBL-3 123.90
- PIONEER SBL-5 131.90
- SONY MDR-507 (Micro) 144.90
- SONY MDR-607 (Micro) 159.90

VIDEO ACCESSORIES

- VIDEORAFT DETAILER I 1195
- VIDEORAFT DETAILER II 1195
- VIDEORAFT STAINLENER 139
- VIDEORAFT PROC AMP 1234

Rated No. 1 FOR SERVICE & RELIABILITY

\$105 ONLY

Sony Walkman II Player

\$335 ONLY

ATARI 400 HOME COMPUTER

ELECTRONICS

COMPUTERS

- COMMODORE VIC-20 (Computer) 1245
- ATARI 800 (Desktop Computer) 1635
- ATARI 810 (Disc Drive) 1445
- ATARI 825 (Printer) 1585
- EPSON MX-80 (Printer) 1459
- TI PKC-004 (Home Computer) 1379
- TI PKC-1500 (5.5 Printer) 1569
- TI PKC-1850 (Disk Drive) 1569

CALCULATORS

- CALCOW P7D (Balm Printer) 153.90
- CALCOW P-10 (Pocket Printer) 164
- CALCOW P-100 (Cass. Printer, disk) 164
- CASIO VL-1 (Music Machine) 159
- TI-5100 (Desk Calc.) 143.90
- SHARP EL-1182 (Printer) 169

CARTRIDGES

- PICKERING XSV-5000 197.90
- STANTON 8815 178.90
- AUDIO TECHNIKA AT155LC 1104.90
- SHURE V15 TYPE IV 199.90
- SHURE M97 HE 166.90
- SHURE M95 ED 129.90
- SHURE M91 ED 119.90

TELEPHONES

- GTE FURPHONE II 139
- PREEDOM PHONE 3500 (Mini Phone) 1225
- WEBCOR S55 (Wireless 500 Range) 1159
- WEBCOR 727 (Cordless) 135
- CORBA CP-200 (Wireless 600 Range) 1139

CAR STEREO

- FUZZBUSTER (Superbet) 1199
- FUZZBUSTER ELITE 1119
- FUZZBUSTER III 199

RADAR DETECTORS

- FOX FOX 1K 199
- FOX REMOTE 1169
- FOX SUPERFOX 1259

CAR STEREO

- IN-DASH Cassette w/AM/FM Radio CRACK T-600 (Auto Play 2022W) 1209
- SARVO FT-CB (Horn Mount) 1108
- JENSEN RE-818 (10W AutoPlay) 1219
- JENSEN R-406 (AutoPlay, 5 Drivers) 1198
- PAIKSONIC COS-761 (PB AIR) 1210
- MARKANTZ CAR-427 (Eq. AIR) 1260
- PIONEER KE-2100 1175
- PIONEER KEI-20 1215
- PIONEER KE-100 1210
- SLAUPUNKT CP-2010 1269

CAR SPEAKERS

- JENSEN J-2011 (6x9 Truck) 199.90/PAIR
- JENSEN J-1069 (6x9 Coax) 149.90/PAIR
- JENSEN J-1065 (6x9 Trax) 169.90/PAIR
- JENSEN J-2126 (4x Coax II) 153.90/PAIR
- JENSEN J-2041 (5 1/4 Coax II) 154.90/PAIR
- PIONEER TS-13 154.90/PAIR
- PIONEER TS-698 99.90/PAIR
- PIONEER TS-695 99.90/PAIR
- PIONEER TS-168 179.90/PAIR
- PIONEER TS-X9 1129.90/PAIR

ORDER TOLL FREE: (800) 221-8180 IN NEW YORK (212) 732-8600

BLANK CASSETTES

AUDIO MINIMUM ORDER 12 AUDIO TAPES

- AMPEX Metal C-60 13.99
- BASEF (Pure Chromium) C-90 12.99
- FUJI FX 101 C-90 12.99
- SCOTCH Highlander C-90 3-Pak 12.99
- SCOTCH Master C-90 13.25
- SCOTCH Master C-90 2-Pak 14.49
- AMIBOXEX Hi-Fi C-90 12.99
- SONY UX-C-90 11.99
- SONY Fec-C-90 12.89
- SONY HX-90 12.27
- SONY EHF-90 13.14
- TDK HD90 (Demagnetizer) 16.99
- TDK D-C60 11.25
- TDK D-C90 11.64
- TDK AD-C90 12.45
- TDK SA-C90 12.95
- TDK MA-C90 (MNH) 15.50
- TDK SA-C90 14.49
- MAXELL UD90 (UDXLI) C-90 12.49
- MAXELL UD-C90 12.49
- MAXELL UD-90 12.49
- MAXELL LN-90 2-Pak 13.89
- MAXELL LN-60 2-Pak 12.57

VIDEO

- WE CARRY VIDEO TAPES BY AMPEX, BASEF, FUJI, JVC, MAXELL, MEMOREX, PARASONIC, RCA, SCOTCH, SONY, TDK & ZENTH
- ALL BETA L-500 110.95
- ALL BETA L-750 122.95
- ALL VHS L-200 (Except HGI) 115.95
- BATTLES (Imitation Game) 234.95
- ALL MATTEL GAME CARTRIDGES 124.50
- ATARI Video Game C-2000 119.95
- ALL ATARI GAME CARTRIDGES (AVAILABLE!) 127.50
- ATARI SPACE INVADERS 74.50
- COLICO PAC MAN (Auto Head) 59.95

ADDITIONAL 5% DISCOUNT ON 100 OR MORE ASSORTED TAPES

23 PARK ROW, DEPT. PE 5, NYC 10038
SEND FOR FREE 240 PAGE AUDIO/VIDEO CATALOG



COMPUTER SOURCES

Hardware

IBM Computer Digitizer. The Graphics Analysis Package #1 includes a digitizer having 0.001" resolution (sizes of 11" x 11" to 42" x 60" active area also available), a stylus, power supply, communications interface cable, and manu-



al. The disk software includes material usage, cost; length, distance, and perimeter; area of irregular polygon; display XY coordinates to 0.001 inch; etc. A 22 function menu is provided, eleven predefined and eleven user defined. Requires an IBM Personal Computer, disk drive, and RS232 Interface. \$1419 with 11" x 11" digitizer; \$2606 with 11" x 17"; or \$3025 with a 20" x 20" translucent digitizer. **Address:** GTCO Corp., 1055 First St., Rockville, MD 20850 (Tel: 301-279-9550).

Apple I/O Board. The Programmable Serial I/O Board is fully compatible with current Apple software including Pascal 1.1, Applesoft, and Integer BASIC. It provides full EIA RS-232 DTE interface to most modems, printers, and terminals, as well as an opto-isolated current loop for full or half duplex, active or passive, 2- or 4-wire, and 20- or 60-mA. An on-board 1K ROM enables user-programmable printer width control, delay after carriage return, automatic line-feed generation, and video display. Serial character format is alterable. Baud rate is to 19.2K. Also featured is Automatic recognition of in-

coming data rate, and firmware routines to pulse-dial calls onto the international Telex-TWX network. \$199.95. **Address:** Intra Computer, 120-10 Audiey St., Kew Gardens, New York, NY 11415 (Tel: 212-947-5533).

Color Monitor. The ECM 1302-2 Color Video Monitor produces 580 x 235 pixels at a 10-MHz bandwidth. Input is RGB (TTL level) or NTSC via an optional module. Sync is either composite on NTSC or separate on RGB. High-voltage regulation is within 3%, geometric distortion is less than 3% of picture height, and linearity is maximum 10%, worst-case. The ECM 1302-2 is compatible with the Apple III, and with the NTSC option, with the Apple II. \$950. **Address:** Sigma Communications Associates, 59 Remington Blvd., Ronkonkoma, NY 11797 (Tel: 516-585-6800).

Solid-State Disk. The RAMDISK is a 320K memory system that functions like two 35-track floppy disk drives. The 200 ns RAM is compatible with Apple DOS 3.3 and Apple Pascal 1.1 while reserving 32K of RAM for advanced programming. It includes a slot-independent board that takes no power from the computer, memory refresh—even with the Apple turned off, and a built-in



battery system. Software includes diagnostics, fast load and copy routines, and business applications. **Address:** Axlon Inc., 170 N. Wolfe Rd., Sunnyvale, CA 94086 (Tel: 408-730-0216). The SEMI-DISK is an S-100 bus version having 512K bytes of storage. This requires an IEEE S-100, CP/M 2.x and 8080/8085/Z-80 system. Up to 32 can be linked for 16 megabytes. Operation

By Leslie Solomon
Technical Director

QUALITY parts at DISCOUNT PRICES!

4 CHANNEL 8 TRACK HOME UNIT

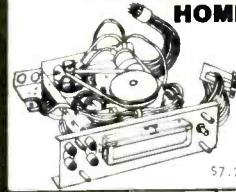

BRAND NEW UNITS...
ASSEMBLY INCLUDES:
TAPE HEAD, MOTOR BELT,
110VAC MOTOR, PRE-AMP,
LIGHTS, SWITCHES,
SOLENOID AND OTHER
USEFUL PARTS...
AN EXCEPTIONAL BUY!
\$7.25 PER ASSEMBLY

4PDT RELAY

• 14 pin style
• 3 amp contacts
• 24 volt d.c. or
• 120 volt a.c.
• Used but fully tested

\$1.70 EACH
Specify coil voltage
LARGE QUANTITIES AVAILABLE
CHECK FOR RELAY SIZE EACH



BLACK PLASTIC CASE

PAC-TEC SERIES C



BLACK PLASTIC ENCLOSURE
ADJUSTABLE HEIGHT FROM
1.63" TO 2.93"; WIDTH
6.85"; DEPTH 8". BUILT-
IN STAND OFFS FOR P.C.
BOARDS...FRONT AND BACK
PANELS NOT INCLUDED...
\$5.25 PER CASE

MINI SIZE BUZZERS

1 1/2 to 3 volts 75¢ ea
WITH WIRE LEADS

1 1/2 to 3 volts 75¢ ea
WITH PIN TERMINALS

3 to 7 volts
WITH PIN TERMINALS
75¢ each

MINI SIZE BUZZERS

1 1/2 to 3 volts 75¢ ea
WITH WIRE LEADS

1 1/2 to 3 volts 75¢ ea
WITH PIN TERMINALS

3 to 7 volts
WITH PIN TERMINALS
75¢ each

10 for \$220.00

MITSUMI MODEL UES-A55F VARACTOR UHF TUNER

FREQ RANGE
470 - 889 MHz

ANTENNA INPUT
500 OHMS

\$25.00 each
10 for \$220.00

FLAT LEVER MINI-TOGGLE SPDT (ON-ON)

5 AMP 120 VAC
5 K 7101

\$1.00 EACH
10 for \$8.50
100 for \$75.00

JOYSTICK

PRECISION DEVICE...
CONTAINS 4
50K CENTER
TAPPED ALPS
POTS...
\$4.75 each

SEND FOR NEW 1982 Free! 40 PAGE CATALOG Free!

COMPUTER GRADE CAPACITOR

1700 mfd. 150VDC \$2.00
2 1/2" DIA X 4 3/4" HIGH

3,600 mfd.
40VDC \$1.00
1 1/2" DIA X 3 1/4" HIGH

6,400 mfd.
60VDC \$2.50
1 3/8" DIA X 4 1/4" HIGH

12,000 mfd. 40VDC \$3.00
2" DIA X 4 1/4" HIGH

18,000 mfd. 75VDC \$4.00
2 1/2" DIA X 4 1/2" HIGH

20,000 mfd. 25VDC
2" DIA X 2 1/2" HIGH \$2.00

22,000 mfd. 15VDC
2" DIA X 2 1/2" HIGH \$2.00

22,000 mfd. 40VDC
2" DIA X 6" HIGH \$3.00

25,000 mfd. 75VDC \$4.50
2" DIA X 3 7/8" HIGH

45,000 mfd. 25VDC
2" DIA X 3 7/8" HIGH \$3.50

72,000 mfd. 15VDC
2" DIA X 3 7/8" HIGH \$3.50
CLAMPS TO FIT CAPACITORS \$0.25 ea

L.E.D.'s STANDARD JUMBO DIFFUSED

RED 10 FOR \$1.50

GREEN 10 FOR \$2.00

YELLOW 10 FOR \$2.00

FLASHER LED
5 VOLT OPERATION
JUMBO SIZE
2 FOR \$1.70

BI POLAR LED
2 FOR \$1.70

SUB MINI LED
.079" X .098"
20 mA at 1.75v
10 FOR \$1.00
200 FOR \$18.00

QUANTITY PRICES AVAILABLE

CANNON XLRA-3-13 CONNECTOR

5 PRONG
CRASH-SIS MOUNT
CONNECTOR
\$2.00 EACH
10 for \$19.00

BLACK LIGHT (ULTRAVIOLET)
G.E. # F6T5BL \$2.50 each

TRANSFORMERS

120 volt
primaries

6 VOLTS at 150 mA \$1.25

12 V.C.T. at 500 mA \$2.50

16.5 V at 3 AMPS \$6.50

18 VOLTS at 350 MA \$2.00

18 VOLTS at 1 AMP \$4.50

25.2 VCT at 2.8 AMP \$5.50

500K LINEAR SLIDE POT

2 7/8" LENGTH
1 3/4" TRAVEL
75¢ EACH

2" ALLIGATOR CLIPS

7 clips for \$1.00
100 clips for \$12.00
500 clips for \$50.00

SPECIAL MRF 901

MICROWAVE TRANSISTOR
\$2.50 EA.

ALL ELECTRONICS CORP.

905 S. Vermont Ave.
P.O. BOX 20406
Los Angeles, Calif. 90006
(213) 380-8000

Mon. - Fri. 9 AM - 5 PM Saturday 10 AM - 3 PM

TERMS
• Quantities Limited
• Min. Order \$10.00
• Add \$ 2.50
Shipping USA
• Calif. Res. Add 6%
• Prompt Shipping

speed of these systems is claimed to be 50 and 500 times faster than an 8" drive, between 100 and 2000 times faster than a minifloppy, and up to 30 times faster than a hard. **Address:** Semi-Disk Systems, P.O. Box GG, Beaverton, OR 97075.

IBM Hardware. A line of add-on and add-in hardware for the IBM Personal Computer has been announced as the TecMate series. There are more than 20 such items in the list covering a broad variety of applications. For example, there is an expansion chassis, BSR X10

controller, voice synthesizer, IEEE 488 interface, several A/D and D/A converters, music synthesizer, extender board, memory boards, and I/O interfaces. **Address:** Tecmar Inc., Personal Computer Products Div., 23600 Mercantile Rd., Cleveland, OH 44122 (Tel: 216-464-7410).

General Hardware. Building on its TRS-80 "work-a-like" computer (the AN-7000) that is compatible with Model I, Level II software, Design Solution Inc. is offering a number of hardware options. They include: AN-587 Inter-

face using a port address isolation technique that automatically masks reserved port address to prevent bus conflicts; AN-549 12-bit Analog Interface; AN-435 Printer/RTC Interface; AN-511 Digital Port Interface; AN-890 32K RAM Expansion Interface; AN-610 Audio Signal Processor; AN-538 8-bit Analog Interface; AN-213 Address-Data Buffer; AN-460 8-Channel MUX ADC Interface; AN-760 Disk Controller Interface; AN-920 Double Density

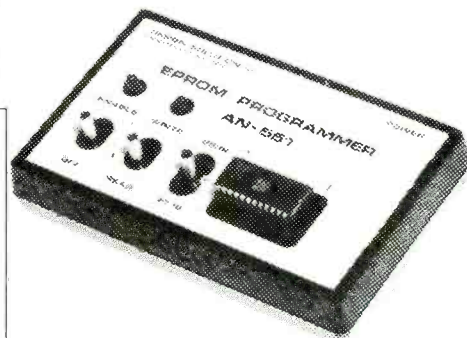

Converter; AN-522 8K Firmware Interface; AN-551 EPROM Programmer; AN-1000 DSI Megadrive; AN-464 RS-232 Interface; EE-1670 Multi-Range DVM Interface; and the EE-1470 Multi-Programmer. **Address:** Design Solution, Inc., Box 1225, Fayetteville, AR 72702 (Tel: 501-521-0281).

TRS-80 Hard Disk. The TRS-80 Model II Hard Disk System features an 8-inch Winchester that permits the storage of over 8.4 million characters on each drive. Up to three secondary hard disks can be added for a total storage of over 33 megabytes. TRSDOS is used, with two new utilities—Save and Restore. The Save utility saves data from the hard disk to one or more backup floppies, while Restore writes data from a floppy to the hard disk. \$4,495 with secondary disk units at \$3,495. **Address:** Radio Shack Computer Centers and dealers.

IBM Memory. The DSI-xx RAM Boards are a series of memory expansion plug-ins for the IBM Personal Computer. The DSI-64K is \$395, the DSI-192K board is \$845, with the DSI-256K board selling at \$1075. Each board is completely compatible with the IBM Personal Computer software and hardware, and can be placed in any free slot. **Address:** Davong Systems, Inc., 1061 Terra Bella Ave., Mountain View, CA 94043 (Tel: 415-965-7130).

VIC-20 Modem. The VICMODEM is a plug-in to the user port of the Commodore VIC-20 computer and is a direct connect, 300-baud modem having originate/answer and half/full duplex capability. \$109.95. **Address:** Commodore Business Machines, Inc., Computer Systems Div., 681 Moore Rd., King of Prussia, PA 19406 (Tel: 215-337-7100).

The professional breadboard.

(No matter what your profession.)



Our PB-203A Proto-Board® The solderless breadboard that set the industry standard for speed, versatility and convenience. With a capacity up to twenty-four 14-pin DIPs and three regulated power supplies (one fixed, two variable), the 203A features a large array of sockets and bus strips that emulates standard PC layouts. Permitting instant insertion and removal of virtually any component from the largest DIP to the smallest discret. Helping you design, assemble, test and modify circuits almost as fast as you can think. And built with professional durability, for all types of applications.

Our PB-203A. Only \$174* (kit \$149.95*) or PB-203 with single 5V supply, \$133.* One more reason so many people say "Proto-Board" for solderless breadboarding.

GLOBAL SPECIALTIES CORPORATION

70 Fulton Terr., New Haven, CT 06509 (203) 624-3103, TWX 710-465-1227
OTHER OFFICES: San Francisco (415) 648-0611, TWX 910-372-7992, Europe: Phone Salfron-Walden 0799-21682, TLX 817477
Canada: Len Finkler Ltd. Downsview, Ontario

Call toll-free for details **1-800-243-6077**
During business hours

*Suggested U.S. resale. Prices, specifications subject to change without notice.
© Copyright 1981 Global Specialties Corporation.

CIRCLE NO. 18 ON FREE INFORMATION CARD

Software

Sinclair Extensions. SUPER Z is a program for the Sinclair ZX-80 and MicroAce computers that adds TAB, SCROLL, MEM PAUSE, READ, RESTORE and DATA to the BASIC. The statements are contained in a machine-code module that is invisible to the user. \$9.95. **Address:** Lamo-Lem Laboratories, Box 2382, La Jolla, CA 92038 (Tel: 714-262-5681).

Spelling Proofreader. "Spell" is available for CP/M and HDOS systems. It detects misspelled words in documents such as WordStar and Magic Wand. Effective dictionary size is over 50,000 words with a user-expandable prefix/suffix table. Spell processes 4000 input words per minute and requires 48K of RAM. \$49.95 plus \$3 shipping. On 8" CP/M or 5" Heath/Zenith CP/M or HDOS. **Address:** The Software Toolworks, 14478 Glorietta Drive., Sherman Oaks, CA 91423 (Tel: 213-986-4885).

Learning Software. "Counting Bee" is designed for children ages 3 to 6 and introduces them to counting, addition, and subtraction. It features a learning management mode that allows parents and teachers to preset the system with emphasis and duration tailored to individual needs. Requires Applesoft, 48K, DOS 3.2 or 3.3. \$29.95. **Address:** EduWare Services, Inc., 22222 Sherman Way, Suite 203, Canoga Park, CA 91303 (Tel: 213-346-6783).

Communications Package. "Intercom" is a communications package for CP/M and is written in 8080 code. Designed for interactive communications as well as verified quantity file transfers (including object files) it uses several standard protocols. Features include four auto sign-on routines, four user-definable routines, batch mode for unattended operation, CP/M system level commands including directory with disk space utilization. \$75. **Address:** End of File, Inc., 3140 E. Shadowlawn Ave., Atlanta, GA 30305 (Tel: 404-233-9825).

Apple WP. "Word Three" is a full-screen editor designed for the Apple computer. Users can scroll forward or backward; modify or replace text; insert and delete characters, lines, paragraphs; insert or append text from other files; move blocks of text; set margins, tabs, page length; perform line centering, indenting, and justifying; and make automatic text search and replace. Multiple files can be printed, starting on any page. \$195. **Address:** Westico, Inc., 25 Van Zant St., Norwalk, CT 06855 (Tel: 203-853-6880).

Electronic Spread Sheet. CalcStar is an electronic spreadsheet based on CP/M and is useful for projects such as budget plans, sales forecasts, cash flow analysis, and evaluating the potential effect of financial decisions with speed and accuracy. Column widths may vary from 3 to 63 characters and as many as 600 figures can be entered in one spread sheet. Precision is to 12 digits. It also provides for AVERAGE, MINIMUM, MAXIMUM, TRIGONOMETRIC functions, and REGRESSION ANALYSIS. It can be used with WordStar. Requires CP/M, 48K memory, 80-column terminal. Soon to be available for Apple II and TRS-80, as well as UCSD Pascal. \$295. **Address:** MicroPro International Corp., 1299 Fourth St., San Rafael, CA 94901 (Tel: 415-499-0919).

Osborne 1 Utility. Micro-Link is a communications package for the Osborne 1 that supports communication with bulletin boards and information retrieval services, as well as send and receive files from other computers. It uses the RS-232 port with a standard modem. It supports originate and answer mode, full and half duplex, and operates at 300 baud. Files can be transmitted in character, line, or memory block protocols. \$89. **Address:** Osborne Computer Corp., 26500 Corporate Ave.,

Hayward, CA 94545 (Tel: 415-887-8080).

TRS-80 Business Package. CBP (cassette business package) runs on a TRS-80 Model III with 16K and consists of a data base manager, word processor, inventory control system, stock management program, check balancer, label printer, deposit calculator, a statistics program, a sort utility, and a key access utility. \$59. **Address:** Micro Architect Inc., 96 Dothan St., Arlington, MA 02174 (Tel: 617-643-4713).

Apple Atlas. What's Where in the Apple? is a comprehensive reference of Apple II firmware and hardware listing memory locations of PEEKS, POKES, and CALLS. A numerical atlas having 2,293 entries and an alphabetical Gazetteer with 1,419 entries provide names and locations of various monitor, DOS, Integer BASIC, and Applesoft routines and show what they are used for. Applesoft and Integer BASIC users will find information which will enable them to speed up programs. Assembly language users can simplify coding and interfacing. 128 pages. \$14.95. **Address:** Micro Ink, Inc., 34 Chelmsford St., P.O. Box 6502, Chelmsford, MA 01824 (Tel: 617-256-5515).

For more information on advertised products, equipment tested, etc., circle appropriate number on postpaid Free Information Card.

EXPAND YOUR ATARI 400* TO 32K!

FOR ONLY \$119.95

Now with the Mosaic Expander and your own Atari 16K RAM board you'll have 32K RAM. Plus all the famous Mosaic quality features: **Four year warranty, bus-compatibility, highest quality components, complete instructions. All for \$119.95.** Call toll free for your nearest Mosaic dealer.

FOR NOW AND INTO THE FUTURE.

MOSAIC
ELECTRONICS

1-800-547-2807
P.O. Box 748, Oregon City, Oregon 97045 503-655-9574
* Trade Mark of Atari Inc.

CIRCLE NO. 65 ON FREE INFORMATION CARD

LEARNING QUIZZES FOR ELECTRONICS

By FREDRICK W. HUGHES

Optoelectronics Quiz

Optoelectronics consists of two types of devices, sensors (photodiode, phototransistor, photoFet, LASCER, light activated resistor, solar cell) and emitters (incandescent lamp, LED). When light strikes a sensor, its resistance decreases (except for a solar cell which produces a small voltage). When voltage

is applied to an emitter it produces light. Which of the two choices shown below is the output voltage of the following circuits when light strikes the optoelectronic device? (Consider the device's internal resistance to be zero ohms when conducting and infinite when not conducting.)

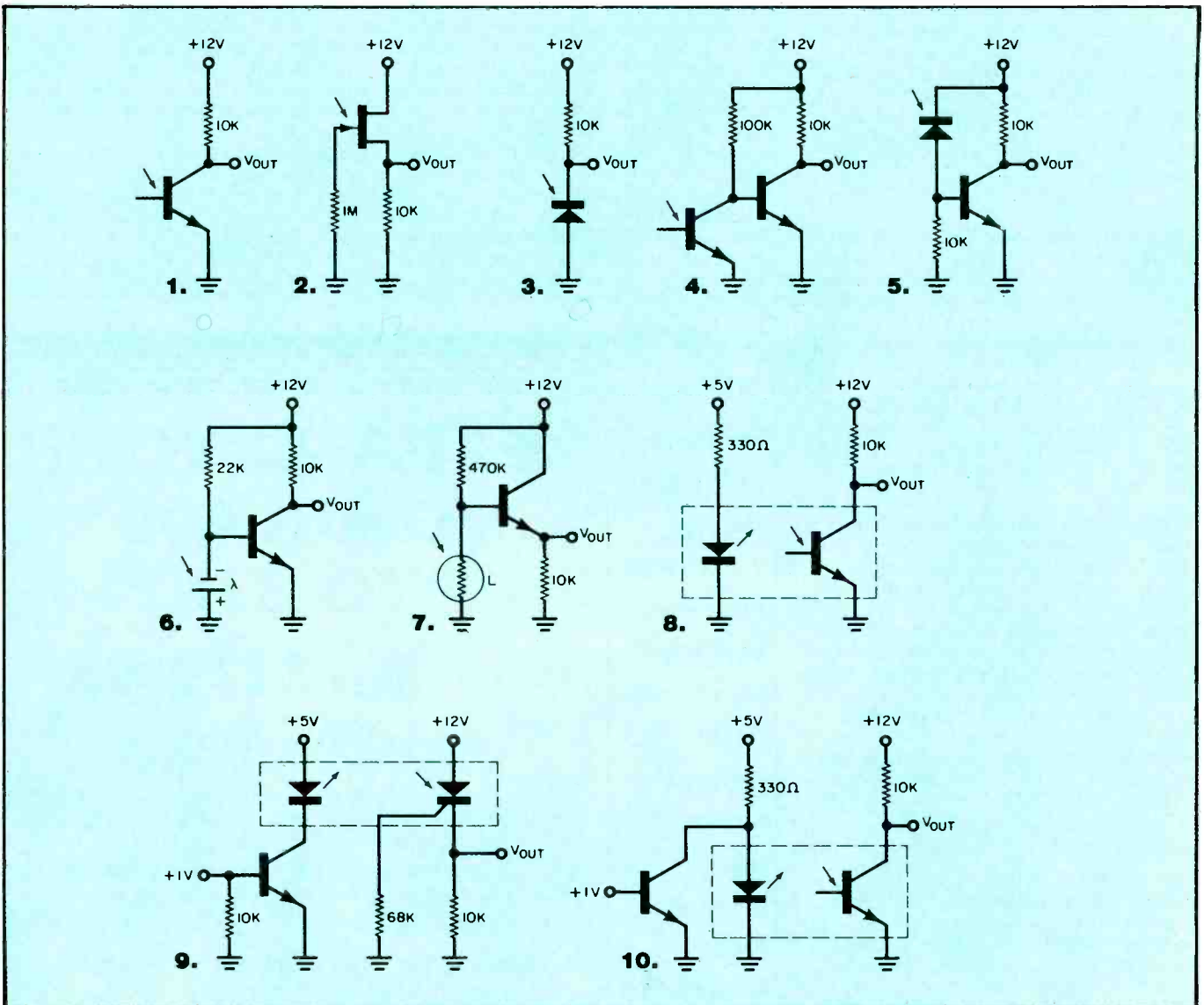

Choices: a. 0 V b. +12 V

ANSWERS: 1. a, 2. b, 3. a, 4. b, 5. a, 6. b, 7. a, 8. a, 9. b, 10. b.

Thyristors Quiz

Thyristors are solid-state switches. Match the following symbols, graphs, and statements with the correct device given in the choices.

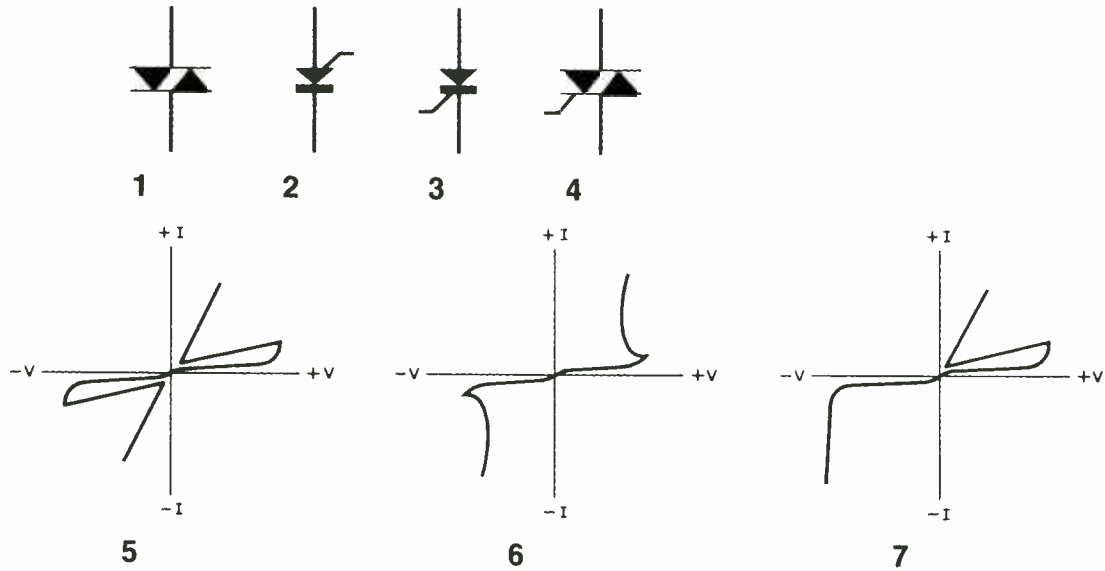

- 8. The device that conducts only in one direction and can be turned on with a negative pulse.
- 9. The device that conducts in both directions and can be turned on by a negative or positive pulse.
- 10. The device that conducts only when breakover voltage is reached.
- 11. The device that conducts only in one direction and can be turned on by a positive pulse.
- 12. The device that is most likely to be found as the active switch in a relaxation oscillator.

Choices: a. SCR b. PUT c. DIAC d. TRIAC

Answers: 1. c, 2. b, 3. a, 4. d, 5. d, 6. c, 7. a, 8. b, 9. a, 10. c, 11. a, 12. b.

Flip-Flop Quiz

Flip-flops can be turned on and off in various ways, depending on the type of flip-flop. A bubble at the input means a negative going pulse will cause the appropriate action. When a flip-flop is off, its Q output = 0 and its complementary Q̄ output = 1.

When a flip-flop is on, its outputs switch states so that Q = 1 and Q̄ = 0. With the input pulses shown, determine which choice represents the state of the outputs for each circuit. Consider all flip-flops initially off.

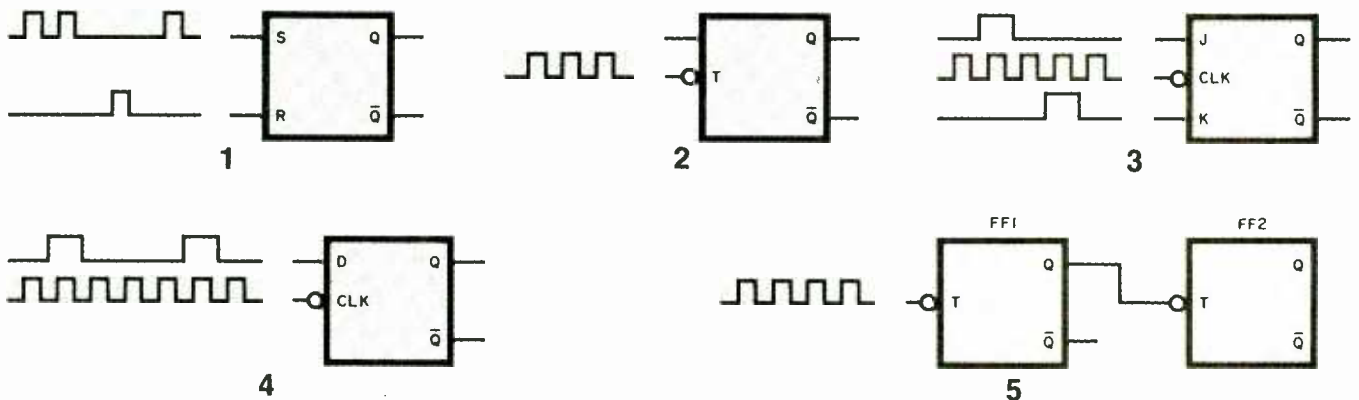

Choices: a. Q = 1, Q̄ = 0, b. Q = 0, Q̄ = 1

Answers: 1. a, 2. a, 3. b, 4. b, 5. b (Pulse 1 turns on FF₁, pulse 2 turns off FF₁, which turns on FF₂, pulse 3 turns on FF₁, pulse 4 turns off FF₁, which turns off FF₂)

AMAZING DEVICES

PHASORS/SHOCKWAVE

PPF-1 PHASOR PAIN FIELD — Is being tested by Gov 1 for riot control. Soon to come under weapons restrictions as an internal machine. Easily hand-held. Hazardous — Use with discretion. **SOLD ONLY FOR ANIMAL CONTROL.**

PPF-1 PLANS \$15.00

IPG-3 INVISIBLE PAIN FIELD GENERATOR — Produces directional field of moderately intense pain to lower back of head up to 50 ft. Cigarette pack sized enclosure is easily hidden.

IPG-3 PLANS \$7.00 IPG-3K KIT \$39.50

IPG-30 ASSEMBLED FOR ANIMAL CONTROL \$49.50

HUG-1 HIGH POWERED ULTRASONIC GUN — Produces directional 130 db's of sound pressure energy at 20-24 kHz. Hand-held, intended for lab use.

HUG-1 PLANS \$10.00

LASERS

PARTICLE BEAM WEAPON PLANS \$15.00

LHP-2 BEGINNER VISIBLE RED NON-HAZARDOUS OPTICAL DEVICE. Adjustable pulse.

LHP-2 PLANS \$7.00 LHP-2K KIT \$39.50

LP-3/LRG-3 LASER PISTOL AND RIFLE COMBINATION — 7-24 watts of infrared energy.

LP-3/LRG-3 PLANS \$10.00

LGU-1 VISIBLE RED LASER GUN for holography, special effects, cloud writing, etc.

LGU-1 PLANS \$10.00

LC-1 BURNING/CUTTING CO2 LASER — 10-40 watts continuous.

LC-1 PLANS \$15.00

RUB-1 WELDING/DRILLING RUBY/YAG LASER, intense red.

RUB-1 PLANS \$15.00

HPS-1 HIGH POWERED PORTABLE ENERGY SOURCE FOR LASERS & MAGNETIC WEAPONS exploding wires, shock waves, etc.

HPS-1 PLANS \$8.00 HPS-1K KIT \$49.50

SECURITY/PERSONAL PROTECTION

INF-1 INFINITY TRANSMITTER — Uses telephone lines for selective home or office listening while away on business or vacation.

INF-1 PLANS \$15.00

SD-4 SEE IN THE DARK — Device, long range.

SD-4 PLANS \$10.00

VWPM-5 WIRELESS TELEPHONE TRANSMITTER — Long range.

VWPM-5 PLANS \$10.00 VWPM-5K KIT \$34.50

FBT-7 WIRELESS MICROPHONE — Extended range.

FBT-7 PLANS \$7.00 FBT-7K KIT \$34.50

HOD-1/TT-6 ELECTRONIC TRACKING AND HOMING DEVICE —

HOD-1/TT-6 PLANS \$6.00 HOD-1K/TT-6K KIT \$39.50

TAT-2 TALK AND TELL — Device records telephone when in use.

TAT-2 PLANS \$5.00 TAT-2K KIT \$14.50

PSW-3 PHASOR STUN WAND — Produces energy capable of burning flesh intended as a last resort personal defense weapon.

PSW-3 PLANS \$8.00 PSW-3K KIT \$59.50

Send for free catalog descriptions of above items, kits and parts, plus hundreds more. We accept Master Charge and VISA or when ordering send check or money order to:

SCIENTIFIC SYSTEMS
DEPT. Q1, BDX 716, AMHERST N.H. 03031

HOBBY SCENE

By Joe Desposito
Technical Editor

Simple FS Meter

Q. My club does a lot of radio control flying/car racing. Although most of the guys keep their batteries charged, it often appears that some transmitters are not tuned for maximum output. Since commercial field strength meters are somewhat expensive, do you have a low-cost substitute?—Karl Elder, Mobile, AL

A. The simple circuit shown here is a voltage-doubling field strength meter

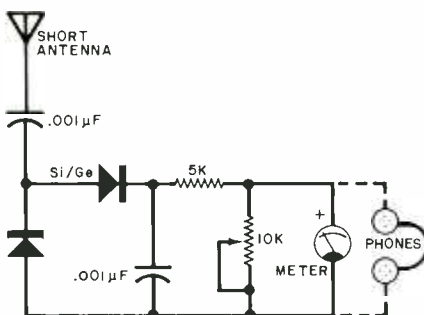

that requires no battery. The pot acts as a sensitivity control, and almost any low-current meter indicates relative field strength. You can use an earphone to listen to the modulation if desired. To use, place the FS meter a few feet from the transmitter, then touch up the output for maximum field strength.

Power-Supply Design

Q. I would like to build a regulated power supply. Specs: 0 to 50 V dc, 0 to 5 A. It should indicate voltage and current meters for output. I want to use it for transistor work.—S. Thompson, New York, NY.

A. I question your power supply specs. Do you really need the power you're asking for? If not, the "1982 Electronic Experimenter's Handbook" on the newsstands includes the complete design of a power supply that is adjustable from 1/4 to 33 volts and delivers up to 1 1/2 amperes with excellent regulation. I'm fairly sure that this supply will meet most of your needs if you are working with transistors.

Bomb-Burst Synthesizer

Q. I'm writing you in regard to the "Project of the Month" in the February 1982 issue. The project is a bomb-burst synthesizer, and the main component is a Texas Instruments sound generator chip,

SN76488. It says in your article to consult the Texas Instruments data sheet for more information. I am interested in making the project, but do not know where to get this component (or where to get the Texas Instruments data sheet).—Mark Scalise, Titusville, PA.

A. The chip is available from some of the companies that advertise in the back of this magazine. Data sheets can be purchased in book form (for example, Radio Shack sells the Archer "Semiconductor Replacement Guide") or ordered directly from the manufacturer. However, most electronics retailers will include the data sheet with the chip if you request it.

If you don't live near a good electronics parts store, it would be wise to stock up on catalogs from parts manufacturers. This way you will have a handy reference whenever you need parts.

Emergency Light System

Q. I would like to make my own emergency light system—the kind that turns on a battery-powered lamp when the commercial power goes down. Do you have a circuit?—Alexander Olson, Rochester, NY

A. Here is your circuit. All parts are readily available. The battery could be

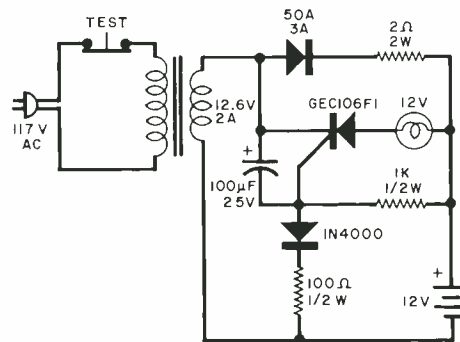

any lead-acid ranging from automotive, motorcycle, through garden tractor variety. The battery will be kept on charge as long as the commercial power is on. To test the system, depress the normally closed pushbutton switch. The lamp should light.

Have a problem or question in circuitry, components, parts availability, etc? Send it to the Hobby Scene Editor, POPULAR ELECTRONICS, One Park Ave., New York, N.Y. 10016. Though all letters can't be answered individually, those with wide interest will be published.



Digital Multimeter

The Drake DM2350 Digital Multimeter is a convenient, small handheld liquid crystal display meter ideal for the serviceman or hobbyist. This 3 1/2 digit meter is auto-ranging, auto-zeroing, has polarity indication, and an over-range warning signal. Battery life is greater than 300 hours with a "low battery" indicator. A continuity test sounds a signal when circuit resistance is less than 20 ohms. Dc accuracy is a basic 0.8%.

Batteries, probes, 20 amp current shunt, spare fuse and soft carrying case all included at \$95.95

Add \$2.50 shipping and handling per order

Send check with order and provide street address for UPS shipment. Ohio residents add Sales Tax. Charge card buyers may call toll free:

1-800-543-5612



DRAKE

In Ohio, or for information call 1-513-866-2421

R. L. DRAKE COMPANY

540 Richard Street, Miamisburg, Ohio 45342

INSTITUTIONAL AND DEALER INQUIRIES INVITED
CIRCLE NO. 13 ON FREE INFORMATION CARD

SOLID-STATE DEVELOPMENTS

By Forrest M. Mims

The Rainbow LED

A LIGHT-EMITTING diode capable of emitting each of the three primary colors (red, yellow and blue) in any combination would be an optical-display designer's dream. Such a LED would be far more than a tri-color emitter, for it could generate any color or hue. With all three colors activated, it would appear to be a white light.

So far, the rainbow LED remains an elusive goal. The major obstacle is the design of an effective blue emitter. Experimental gallium-nitride and silicon-carbide blue-emitting diodes have been demonstrated, but they are very difficult to make. A mass-produced blue LED has yet to appear.

I'm convinced that a practical rainbow LED will someday be developed. In the meantime, the next best substitute may be a gallium-phosphide (GaP) multicolor LED developed by Takao Yamaguchi and Tatsuhiko Niina of the Sanyo Electric Co., Ltd. (Hashiridani, Hirakata, Osaka, Japan). This new LED consists of a stacked pair of pn junctions arranged as shown in Fig. 1.

The new LED is constructed by first depositing n- and p-type layers of crystalline GaP on an n-type GaP substrate. The resulting pn junction emits red light when forward biased.

Next, a second pair of n- and p-type layers is deposited over the first two layers. This junction emits green light when forward biased. It also permits the passage of red light emitted by the underlying junction.

The green-emitting GaP layers block electrical access to the p-side of the red-emitting junction. Therefore, it is necessary to etch through the uppermost n-type layer to provide electrical access to the top side of the red junction. This explains the mesa structure in Fig. 1.

A non-mesa or planar diode may be formed by etching channels through the uppermost n-type layer. Contacts are more easily applied to a planar version of the diode.

You may be wondering why the first GaP pn junction emits red light while the second junction emits green. The key is the doping of the GaP crystalline layers, which are epitaxially deposited (grown) over the GaP substrate. When oxygen is added to p-type GaP, a red-emitting junction is formed. A green-emitting junction is formed when nitrogen is added to both p- and n-type GaP.

Either junction of this new LED may be biased independently of the other. This permits the diode to function as an emitter of either red or green light. When both junctions are simultaneously forward biased at various current levels, the eye perceives the resulting two-color combinations as red, orange, yellow or green. The perceived hue is determined by the relative brightness of the two junctions.

An identical effect can be obtained by switching each junction on and off at a rate greater than about 20 Hz. Even though only one junction is biased at any given instant, the human eye's persistence of vision causes the red and green to merge into intermediate hues. The color perceived is governed by the duty cycle and current level through each junction.

Applications for Sanyo's new LED include multi-color indicators and displays. The most interesting applications will incorporate arrays of the new diodes to form multi-color characters, digits, and even images.

Yamaguchi and Niina have published an interesting paper that describes in detail the construction and operation of this new LED. Entitled "A High Brightness GaP Multicolor LED," it appeared in the *IEEE Transactions on Electron Devices* (Vol. ED-28, No. 5, May 1981, pp. 588-592). You can find this journal at most technical libraries.

Conventional Multicolor LEDs. Until LEDs like the one in Fig. 1 become

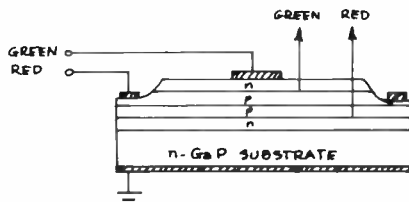

Fig. 1. Cross section of the new monolithic dual color LED.

FREE

The newest in home computers, fine stereo components, color TV, HAM radio, precision test equipment, innovative electronics for the home—all in easy-to-build, money-saving kits.

Send today for your **FREE Heathkit® Catalog**



If coupon is missing, write Heath Co., Dept. 010-892 Benton Harbor, MI 49022

Send to: Heath Co., Dept. 010-892 Benton Harbor, MI 49022.

Send my free Heathkit Catalog now I am not currently receiving your catalog

Name _____

Address _____

City _____ State _____

CL-724A Zip _____

CIRCLE NO. 19 ON FREE INFORMATION CARD

available commercially, you can experiment with two-chip versions that are available now. These devices are made by installing red- and green-emitting chips side-by-side on a single LED integrated circuit header.

Dual-chip LEDs made in this manner are called bi-color or tri-state LEDs. Tri-state refers to the possibility of obtaining a third color, yellow, by biasing both diodes simultaneously or in rapid sequence.

You can obtain bi-color LEDs from Radio Shack, Opcoa (330 Talmadge Rd., Edison, NJ 08817), AEG-Telefunken (Rt. 22, Orr Drive, Somerville, NJ 08876), and possibly other sources. The Radio Shack and Opcoa diodes are two-lead devices in which the two chips are internally connected in reverse-parallel. This means the direction of current flow must be reversed to switch colors. For the intermediate color of yellow, an ac bias must be provided.

Figure 2 shows a simple circuit to apply an ac bias to two-chip diodes like these. The two TTL gates form an astable multivibrator whose switching rate is controlled by potentiometer *R1*. At slow switching rates, the diode alternates between red and green. The effect is quite striking. At faster rates, the two colors merge into a washed-out orange or yellow hue.

For more information about this circuit and driving such dual-chip LEDs,

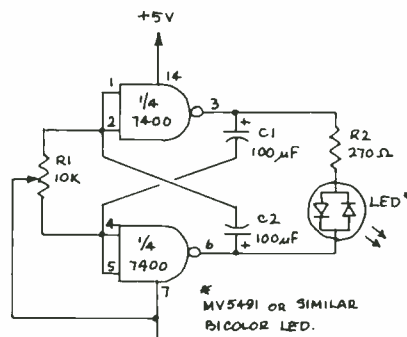

Fig. 2. Simple bicolor LED driver.

see "Tri-State LED Demonstrator," the "Project of the Month" in the September, 1979 issue of this magazine.

AEG-Telefunken's dual-chip LED, designated the V 518 P, incorporates separate anode connections to each of the two chips. The header to which the chips are soldered serves as a common cathode. Though I've not yet experimented with this new LED, I suspect it is better suited for the production of yellow than the two-lead, tri-state LEDs. A simple battery and potentiometer arrangement should be all that is necessary to produce red, yellow, green and intermediate hues.

A High-Quality Audio Amplifier. In an era of increasingly low-cost audio

amplifier integrated circuits, who would spend \$52 for a hybrid amplifier? Apparently, dedicated audiophiles and those requiring very-high-quality audio amplification.

Modular Audio Products, a unit of Modular Devices, Inc. (50 Orville Drive, Airport International Plaza, Bohemia, NY 11716), recently introduced the Model 5008 Hybrid Dual Balanced Transformerless Amplifier. The amplifier is housed in a nine-pin package measuring 1 inch by 0.8 inch by 0.25 inch.

The 5008 will operate from a bipolar supply of 12 to 20 V. The equivalent input noise is an exceptionally low -110 dB. Total harmonic distortion is 0.05% over a range of 20 to 20,000 Hz. The frequency response over this range varies within ± 0.25 dB. Crosstalk between the two channels is -80 dB at 20 kHz.

Modular Audio Products notes that the 5008 can be used in many different audio applications. For example, it can provide a pair of noninverting, high-impedance input amplifiers with up to 40 dB of gain, or it can be used to make a pair of inverting summing amplifiers. It can also be used in various differential input/single- and double-ended output applications. Write the company for more information.

Sensitive-Gate Triacs. Motorola (Box 20912, Phoenix, AZ 85036) has announced a new family of triacs designed to be triggered directly by microprocessors and microcontrollers. The new triacs, which will switch up to 8 A, can also be interfaced directly with 5-volt, low-level logic.

The MAC228-2 through MAC228-10 have a gate sensitivity of only 5 mA and can switch a maximum of 50 to 800 V, depending upon the device.

These new triacs range in price from 75¢ to \$2.55 in quantities of 100. They are well-suited for interfacing home computers with ac line-operated appliances and devices.

A High-Power Light-Activated SCR. Low-power light-activated SCRs (LASCRs) have been available for many years. They are often used to make remote photographic flash units (*slave* units), which fire when a master flash unit is activated some distance away.

An important application for LASCRs is in circuits susceptible to noise-induced false triggering. Ordinary SCRs are highly susceptible to false triggering.

Westinghouse Electric (Pittsburgh, PA 15222) has gone a step farther by making a high-power LASCR capable of switching up to 800 A at 3000 V. A standard SCR was used to make the new light-triggered version. The gate region of all SCRs is light sensitive. Westinghouse exploited this fact by placing one end of an optical fiber adjacent to the light-sensitive region of an existing SCR. The SCR is triggered by

SOMEDAY . . . In the comfort of your own home or office, you'll be able to shop and bank electronically, read instantly updated major newswires, analyze the performance of a stock that interests you, send electronic mail to business associates across the country, then play Bridge with your best friend in San Francisco and two strangers in Chicago and Dallas.

WELCOME TO SOMEDAY

Someday is today with the CompuServe Information Service. All this and more can be accessed with a local phone call in most major U.S. cities. For hardware you need a terminal or personal computer and a modem. The CompuServe Information Service costs only \$5.00 per hour, billed in minute increments to your charge card.

Ask for a demonstration at a Radio Shack® Computer Center. Videotex software is available for various brands of personal computers. CompuServe Information Service, 5000 Arlington Centre Blvd., Columbus, Ohio 43220. (614) 457-8650.

CompuServe

a pulse of infrared from a semiconductor laser.

Westinghouse plans to use the modified SCR in ac power-transmission systems. Though the light-triggered unit is more costly than the standard version, overall cost is lower since elaborate noise-reduction circuitry is no longer needed.

Light-activated SCRs are very useful for many hobbyist and experimenter applications. I last covered their use in the "Experimenter's Corner" published in this magazine in November, 1975 (pp. 109-110). If you cannot find this issue at a library, the column has been reprinted in *103 Projects for Electronics Experimenters* (Tab Books, Inc., 1981). If there is sufficient reader interest, I'll work up some new LASCR circuits and describe them in another column.

LED Numeric Display Price Breakthrough. Remember MITS, Inc., the company that introduced the first complete hobby computer kit? Before developing the Altair 8800, MITS developed several versions of a kit calculator. I will remember how Ed Roberts, then president of MITS, longed for the time when LED displays would be available for "only" \$1 per digit in large quantities.

Recently I received from Jameco Electronics (1355 Shoreway Road, Belmont, CA 94002) a flyer offering dozens of different kinds of LED displays at closeout prices as low as 5.5¢ per digit! For example, the National NSA198 9-digit multiplexed common-cathode display can be purchased at two for 99¢.

I assume these displays are being "dumped" as a direct result of the virtual demise of LED calculators and clocks. Liquid-crystal displays have almost taken over this market because they use much less current than LED versions. But at these ultra-low prices, I plan to stock up on some LED displays! They are very handy for circuits designed for operation at night or in dark-rooms. They're very small and can be operated at 5 to 10 mA in many cases. If that's too much current drain, it's possible to switch the display on for brief viewing periods every few seconds.

Jameco has a minimum order requirement of \$10. Their flyer reports only limited quantities available so act fast if you intend to order.

A New Timer. Panasonic (division of Matsushita Corp., 1 Panasonic Way, Box 1503, Secaucus, NJ 07094) has introduced a long-period timer in a 7-pin SIP (single in-line package). Designated the AN6780, the new timer can provide delays lasting one second to one week depending on the values of an external resistor and capacitor.

The timer consumes a maximum of 10 mA and can be operated from 4.5 to 12 V. It can directly drive a low-power relay. I haven't determined the single-unit cost of this new chip, but in 1000-unit quantities the AN6780 can be purchased for only \$1.05. For pricing and a data sheet, write Panasonic. ♦

CHANNEY

electronics inc.

- Minimum Order \$9.00
- Please include \$1.50 for shipping (UPS)
- We accept VISA and MASTERCARD
- EXTRA FAST SERVICE

P.O. BOX 27038, DENVER, COLO. 80227 PHONE ORDERS: 303-781-5750

TEACHERS AND HOBBYISTS

Chaney Electronics has been providing quality electronic kits for high schools, tech schools, universities and hobbyists for over 10 years and we hope you will join the thousands of satisfied Chaney Electronics builders. All of our kits contain quality electronic components and are easy to understand and assemble. You provide a battery for the battery operated kits and I'll deliver you may

SEND FOR OUR COMPLETE CATALOG OF KITS AND PARTS

<p>120VAC VARIABLE STROBE LIGHT KIT Complete variable rate strobe light kit produces brilliant flashes of light. Operates from standard 120VAC. Reliable design—thousands of these are in use throughout the world. Overall size of completed board: 3 1/2" x 2" W x 3" H C3071 \$7.50</p>	<p>ELECTRONIC WHEEL OF FORTUNE KIT Push the start button and a bright red ball (LEDS) appear to spin around ten numbers. When you release the button the electronic ball appears to slow down and finally comes to a stop on one number. As the ball spins a small speaker emits a ticking sound in synchronization. Unit operates from 9V battery. Size of board: 2 9/16" x 2 6/16" C3806 \$1 99</p>
<p>3VDC ELECTRONIC WARNING FLASHER KIT This portable battery operated device continuously emits bursts of intense light at a fixed repetition rate. Can be seen for great distances making it a great safety device. Features xenon flashtube. Operates on 3VDC (two 1.5V Batteries). Size of board: 2 1/2" L x 2" W C3207 \$7.95</p>	<p>AC FAILURE ALARM KIT Have you ever been late because the AC went off and your clock radio didn't work? Well, that need not happen again! Simply plug this unit into the wall outlet and if the AC goes off the unit emits a tone. Features green ready light and piezoelectric tone device. Operates on 9V battery. Size of board: 2 6/16" x 2 3/16" C4483 \$4.75</p>
<p>STROBOSCOPE KIT Reliable IC design kit for use in physics experiments or troubleshooting. Optically stops motion of fans, wheels, pulleys, flywheels, etc. The stroboscope operates from standard 120VAC and features bright xenon flash tube and IC design. Size of board: 3 5/8" x 4 7/8" C4070 \$29.95</p>	<p>10 WATT SIREN KIT Kit provides a loud alternating tone output. Uses two IC's and a power transistor to provide a reliable performance. Features variable sound control and 6 to 12VDC operation. Requires 8 ohm speaker. Size of board: 3 5/8" x 1 5/8" C4068 \$5.00</p>
<p>PHOTO SLAVE TRIGGER KIT Probably the most sensitive slave trigger kit on the market. Simply connect to the strobe that will be used as the slave. When the master strobe is fired the slave strobe will also flash. Size of board: 1 5/8" x 1 1/8" C4530 \$6.00</p>	<p>SOUND EFFECTS GENERATOR KIT Exciting sound effects kit uses the popular T176477 chip to develop phasor, locomotive, siren, tweeting bird organ, Model T, etc. sounds. Uses dip switch for simple programming of the generator. Operates from 9V battery. Size of board: 3 25/32" x 2 1/8" C4422 \$12.95</p>
<p>FASCINATION STAR KIT Produces an "exploding star" visual effect using 25 LEDs and IC circuitry. The center LED lights first then the next group of LEDs light and then another set of lights until the outer edge of the star lights up. The process then reverses itself. Operates from 9V battery. C4432 \$10.95</p>	<p>PHASOR GUN SOUND AND LIGHT KIT Here's a simple kit which makes an excellent first project. Uses special IC, darlington transistor and LED to produce outer space phasor gun sound and flashing red light. Operates from 9V battery. Size of board: 1" x 1 1/2" C4484 \$4.00</p>
<p>SEQUENTIAL LEO FLASHER KIT This kit combines IC circuitry and 10 jumbo red LEDs to produce a unique visual display. LEDs continuously light sequentially from right to left. Easy to build kit. Operates from 9V battery. Size of board: 5 25/32" x 1 5/8" C4431 \$6.75</p>	<p>3CHANNEL COLOR ORGAN Very popular 3 channel color organ causes lights of your choice to flash to beat of music. Features level control and 3 separate AC outlets to connect Christmas lights, lamps, etc. Operates from 120VAC. Size of board: 3" x 5" C4530 \$8.50</p>

CIRCLE NO. 7 ON FREE INFORMATION CARD

FREE

McIntosh

STEREO CATALOG and FM DIRECTORY

Get all the newest and latest information on the new McIntosh stereo equipment in the McIntosh catalog. In addition you will receive an FM station directory that covers all of North America.



SEND
TODAY!

PE

McIntosh Laboratory, Inc.
East Side Station P.O. Box 96
Binghamton, N.Y. 13904-0096

NAME _____

ADDRESS _____

CITY _____ STATE _____ ZIP _____

If you are in a hurry for your catalog please send the coupon to McIntosh. For non rush service send the Reader Service Card to the magazine.

CIRCLE NO. 30 ON FREE INFORMATION CARD

SEE YOUR DEALER TODAY

DEMAND THE ORIGINAL

'Firestik'
ANTENNAS
ACCESSORIES

**LET THE OTHERS
PLAY GAMES!**

WE MANUFACTURE
ONLY THE VERY BEST
ANTENNAS!

AM/FM AUTO RADIO
CITIZENS BAND
CORDLESS TELEPHONE

Dealer & Distributor Inquiries Invited
SEND FOR FREE CATALOG

'Firestik' Antenna Company
2614 East Adams/Phoenix, AZ 85034

Name _____
Street _____
City _____
State _____ Zip _____
Serving the CB and
Communications Market Since 1962.

5-YEAR REPLACEMENT WARRANTY

CIRCLE NO. 15 ON FREE INFORMATION CARD

SAVE!

MONEY • TIME • FREIGHT

- ♪ QUALITY STEREO EQUIPMENT AT LOWEST PRICES.
- ♪ YOUR REQUEST FOR QUOTATION RETURNED SAME DAY.
- ♪ FACTORY SEALED CARTONS—GUARANTEED AND INSURED.
- ♪ SAVE ON NAME BRANDS LIKE:

PIONEER	JVC
KENWOOD	TEAC
MARANTZ	SANSUI
TECHNICS	SONY

AND MORE THAN 50 OTHERS
BUY THE MODERN WAY
BY MAIL—FROM

illinois audio

BANK CARDS ACCEPTED
12 East Delaware
Chicago, Illinois 60611
312-664-0020
800-621-8042

CIRCLE NO. 22 ON FREE INFORMATION CARD

DX LISTENING

By Glenn Hauser

Taiwan Gets American Relay Station

THE *Voice of Free China*, Taipei, Taiwan, has broadcast to North America in English for many years. But because of relatively low power, unfavorable program scheduling, and poor propagation conditions, it has been particularly difficult to hear, especially along the eastern seaboard.

All this changed dramatically January 1, 1982, when *WYFR* (Family Radio) in Okeechobee, Florida, started relaying *VOFC* programs. There was no advance notice, and the move took everyone by surprise. This is the first time, to our knowledge—at least since World War II—that a private U.S. shortwave broadcaster has relayed programs for a foreign station.

WYFR believes in expanding its services. But just as the *VOFC* is tough to hear in eastern North America, *WYFR* has the same problems being heard in China and India. The only practical solution is to broadcast from a point closer to the target area, either by building a new relay station or by using an existing facility. *WYFR* had approached several other overseas stations about swapping program material (among them *Israel Radio*), but the first mutually satisfactory agreement involves the Nationalist Chinese.

The *VOFC*'s facilities carry *WYFR* broadcasts in Mandarin and English to China and India, for approximately the same number of hours that the *VOFC* is heard over *WYFR*. (*WYFR* says no money is changing hands.) However, this is not the first time the Broadcasting Corporation of China has carried a U.S. station's programs. Until a few years ago, several Taiwanese transmitters were at the disposal of *Radio Liberty*, so it could reach the Soviet Union from the east as well as the west.

The program trade did not begin until *WYFR* had an additional transmitter in use at Okeechobee, so there would be no net loss in its own broadcast time. The arrangement has raised some eyebrows in Washington, DC, since U.S. broadcasters, including shortwave, are supposed to operate in the "public interest, convenience and necessity," and not serve as foreign propaganda outlets. But lately, the FCC has attempted to limit its authority to technical matters, staying out of programming decisions. Three weeks after the *VOFC* broadcasts were first heard on *WYFR*, an FCC spokesman publicly stated that the Commis-

sion did "not officially know about" the arrangement.

The initial schedule for *VOFC*-via-*WYFR* (which by now may have made seasonal frequency changes, if the experiment has continued) included English at 0200-0300 GMT on 11,740 kHz, and 0300-0400 on 5985 kHz; three different Chinese dialects at 0000-0300 GMT on 5985 kHz; more Chinese at 2200-2300 GMT on 15,130 kHz; and Spanish at 2100-2200 GMT on 15,130 and 0400-0500 GMT on 11,740.

To keep programs timely and costs down, only the news portion of each broadcast is fed via satellite telephone; the remainder of the hour-long programs are on pre-shipped tapes. *WYFR* is well acquainted with this technique since all its regular programming is produced and recorded 3000 miles away in Oakland, California.

Starting a couple of weeks before the *WYFR* program swaps was another new shortwave English broadcast to North America. Muammar Qaddafi authorized his *Radio Jamahariyah* to insert an hour of English into its already extensive schedule of Arabic broadcasts, at 2300-2400 GMT on 11,815 kHz. At first the audio quality was incredibly bad. The programs include lots of material on U.S.-Libyan relations (mostly negative), readings from the Green Book, and news at 2330 GMT. Bending over backwards to attract an American audience, the station also plays Western music during this hour.

Americans who understand only English also benefit from the brief English segments broadcast by the Nicaraguan clandestine station, *Radio Quince de Septiembre*, 5565 kHz (variable). However, the accent is rather heavy, as the material is intended for the Caribbean minority along Nicaragua's east coast. These English segments are heard at various times (such as 1220 and 0355 GMT) within longer programs that are mainly in Spanish.

On the minus side, *Radio Free Europe* has dropped its weekly ten minutes in English because it wasn't getting much response from Czechoslovakia, the broadcast's target area. This program could be heard quite well even in the U.S. (except wintertime).

In December 1981, the Salvadorian government swept through a rebel stronghold in an effort to put clandestine station *Radio Venceremos* off the

air. Though the station disappeared for a couple of weeks, it came back with a stronger signal around 6907 kHz at 0000 and 1200 GMT and was soon joined by two more allied stations: *Radio Farabundo Martí*, first on 6914 and then on 6900 kHz at 1100-1200 and 0130-0230 GMT; and *Radio Unidad*, around 7000 kHz, which at first confined its broadcasts to weekends at about 2100 GMT.

Traveler's Information Service.

Besides the Caribbean Beacon, Anguilla, on 1610 kHz (which plans to add 1570 kHz from Grand Turk), there are an unknown number of very-low-power stations in the U.S. on this same frequency. They are Traveler's Information Service (TIS) stations, each with just a few watts of power for local reception. But under quiet nighttime conditions they can be heard hundreds of miles away. Programming is limited to a brief, repetitive tape loop.

We uncovered a few of these stations during a vacation trip last summer (some may be active only in the summer). There's one in Davenport, IA, advertising about highway construction much farther west on the Interstate. Devil's Tower National Monument sported signs about such a station, but it was not heard, and Mount Rainier is supposed to have a TIS station at its southwest and northwest entrances. Just southeast of the mountain, on U.S. 12 near Naches, another TIS transmitter advises about fire dangers in the national forest.

Yellowstone National Park has several such stations, one at each entrance and at major stops inside the park. (The transmitters at Old Faithful and Uncle Tom's Parking Lot were slightly off frequency—around 1609.8 kHz.) A new TIS station just went on the air this past July at Curecanti NRA, at the Elk Creek Visitor Center on U.S. 50 west of Gunnison, CO. The Elk Creek unit is mounted on a pole, including the solar cell power supply! Other TIS stations reportedly operate from the Sierra Nevada, Cape Canaveral National Seashore, and airports in Cincinnati, OH, and Tampa, FL.

At the bottom of the AM band (530 kHz) are more stations of this type, along with *Highway Advisory Radio (HAR)* outlets. There's an *HAR* station in Atlanta, GA, at the southern junction of I-75 and I-285, and another one recently appeared between Dallas and Fort Worth in Texas. Recently, Knoxville, TN, used a cluster of synchronized *HAR* transmitters while extensive construction to correct "Malfunction Junction" was underway. These have been heard as far away as Maryland and Florida. And at least one such outlet may continue to help expedite the 11-million visitors expected for the 1982 World's Fair opening in Knoxville for a six-month run starting May 1. Another low-power 530-kHz transmitter promotes the facilities at Gatlinburg. ♦

FOCUS

FOR ORDERS ONLY! TOLL-FREE (800)221-0828

BRING IN OR MAIL THIS ADV WITH ORDER AND GET FREE GIFT

SONY TRINITRON COLOR TELEVISION



PROTECT YOURSELF! Buy only from FACTORY AUTHORIZED DEALER for health assurance

<p>4400B 4" AC/DC 422.00</p> <p>4400B 4" AC/DC 440.00</p> <p>4400B 4" AC/DC 460.00</p> <p>4400B 4" AC/DC 480.00</p> <p>4400B 4" AC/DC 500.00</p> <p>4400B 4" AC/DC 520.00</p> <p>4400B 4" AC/DC 540.00</p> <p>4400B 4" AC/DC 560.00</p> <p>4400B 4" AC/DC 580.00</p> <p>4400B 4" AC/DC 600.00</p> <p>4400B 4" AC/DC 620.00</p> <p>4400B 4" AC/DC 640.00</p> <p>4400B 4" AC/DC 660.00</p> <p>4400B 4" AC/DC 680.00</p> <p>4400B 4" AC/DC 700.00</p> <p>4400B 4" AC/DC 720.00</p> <p>4400B 4" AC/DC 740.00</p> <p>4400B 4" AC/DC 760.00</p> <p>4400B 4" AC/DC 780.00</p> <p>4400B 4" AC/DC 800.00</p> <p>4400B 4" AC/DC 820.00</p> <p>4400B 4" AC/DC 840.00</p> <p>4400B 4" AC/DC 860.00</p> <p>4400B 4" AC/DC 880.00</p> <p>4400B 4" AC/DC 900.00</p> <p>4400B 4" AC/DC 920.00</p> <p>4400B 4" AC/DC 940.00</p> <p>4400B 4" AC/DC 960.00</p> <p>4400B 4" AC/DC 980.00</p> <p>4400B 4" AC/DC 1000.00</p>	<p>4400B 4" AC/DC 1020.00</p> <p>4400B 4" AC/DC 1040.00</p> <p>4400B 4" AC/DC 1060.00</p> <p>4400B 4" AC/DC 1080.00</p> <p>4400B 4" AC/DC 1100.00</p> <p>4400B 4" AC/DC 1120.00</p> <p>4400B 4" AC/DC 1140.00</p> <p>4400B 4" AC/DC 1160.00</p> <p>4400B 4" AC/DC 1180.00</p> <p>4400B 4" AC/DC 1200.00</p> <p>4400B 4" AC/DC 1220.00</p> <p>4400B 4" AC/DC 1240.00</p> <p>4400B 4" AC/DC 1260.00</p> <p>4400B 4" AC/DC 1280.00</p> <p>4400B 4" AC/DC 1300.00</p> <p>4400B 4" AC/DC 1320.00</p> <p>4400B 4" AC/DC 1340.00</p> <p>4400B 4" AC/DC 1360.00</p> <p>4400B 4" AC/DC 1380.00</p> <p>4400B 4" AC/DC 1400.00</p> <p>4400B 4" AC/DC 1420.00</p> <p>4400B 4" AC/DC 1440.00</p> <p>4400B 4" AC/DC 1460.00</p> <p>4400B 4" AC/DC 1480.00</p> <p>4400B 4" AC/DC 1500.00</p>	<p>4400B 4" AC/DC 1520.00</p> <p>4400B 4" AC/DC 1540.00</p> <p>4400B 4" AC/DC 1560.00</p> <p>4400B 4" AC/DC 1580.00</p> <p>4400B 4" AC/DC 1600.00</p> <p>4400B 4" AC/DC 1620.00</p> <p>4400B 4" AC/DC 1640.00</p> <p>4400B 4" AC/DC 1660.00</p> <p>4400B 4" AC/DC 1680.00</p> <p>4400B 4" AC/DC 1700.00</p> <p>4400B 4" AC/DC 1720.00</p> <p>4400B 4" AC/DC 1740.00</p> <p>4400B 4" AC/DC 1760.00</p> <p>4400B 4" AC/DC 1780.00</p> <p>4400B 4" AC/DC 1800.00</p> <p>4400B 4" AC/DC 1820.00</p> <p>4400B 4" AC/DC 1840.00</p> <p>4400B 4" AC/DC 1860.00</p> <p>4400B 4" AC/DC 1880.00</p> <p>4400B 4" AC/DC 1900.00</p> <p>4400B 4" AC/DC 1920.00</p> <p>4400B 4" AC/DC 1940.00</p> <p>4400B 4" AC/DC 1960.00</p> <p>4400B 4" AC/DC 1980.00</p> <p>4400B 4" AC/DC 2000.00</p>
--	---	---

CONSUMERS BEWARE! All our Walkman's include THE ONE AND ONLY ORIGINAL HEADPHONES 5.00 (not on the factory tag) (not included)

SONY WALKMAN 1 1.00

SONY WALKMAN 2 1.00

SONY WALKMAN 3 1.00

SONY WALKMAN 4 1.00

SONY WALKMAN 5 1.00

SONY WALKMAN 6 1.00

SONY WALKMAN 7 1.00

SONY WALKMAN 8 1.00

SONY WALKMAN 9 1.00

SONY WALKMAN 10 1.00

SONY WALKMAN 11 1.00

SONY WALKMAN 12 1.00

SONY WALKMAN 13 1.00

SONY WALKMAN 14 1.00

SONY WALKMAN 15 1.00

SONY WALKMAN 16 1.00

SONY WALKMAN 17 1.00

SONY WALKMAN 18 1.00

SONY WALKMAN 19 1.00

SONY WALKMAN 20 1.00

SONY WALKMAN 21 1.00

SONY WALKMAN 22 1.00

SONY WALKMAN 23 1.00

SONY WALKMAN 24 1.00

SONY WALKMAN 25 1.00

SONY WALKMAN 26 1.00

SONY WALKMAN 27 1.00

SONY WALKMAN 28 1.00

SONY WALKMAN 29 1.00

SONY WALKMAN 30 1.00

SONY WALKMAN 31 1.00

SONY WALKMAN 32 1.00

SONY WALKMAN 33 1.00

SONY WALKMAN 34 1.00

SONY WALKMAN 35 1.00

SONY WALKMAN 36 1.00

SONY WALKMAN 37 1.00

SONY WALKMAN 38 1.00

SONY WALKMAN 39 1.00

SONY WALKMAN 40 1.00

SONY WALKMAN 41 1.00

SONY WALKMAN 42 1.00

SONY WALKMAN 43 1.00

SONY WALKMAN 44 1.00

SONY WALKMAN 45 1.00

SONY WALKMAN 46 1.00

SONY WALKMAN 47 1.00

SONY WALKMAN 48 1.00

SONY WALKMAN 49 1.00

SONY WALKMAN 50 1.00

SONY WALKMAN 51 1.00

SONY WALKMAN 52 1.00

SONY WALKMAN 53 1.00

SONY WALKMAN 54 1.00

SONY WALKMAN 55 1.00

SONY WALKMAN 56 1.00

SONY WALKMAN 57 1.00

SONY WALKMAN 58 1.00

SONY WALKMAN 59 1.00

SONY WALKMAN 60 1.00

SONY WALKMAN 61 1.00

SONY WALKMAN 62 1.00

SONY WALKMAN 63 1.00

SONY WALKMAN 64 1.00

SONY WALKMAN 65 1.00

SONY WALKMAN 66 1.00

SONY WALKMAN 67 1.00

SONY WALKMAN 68 1.00

SONY WALKMAN 69 1.00

SONY WALKMAN 70 1.00

SONY WALKMAN 71 1.00

SONY WALKMAN 72 1.00

SONY WALKMAN 73 1.00

SONY WALKMAN 74 1.00

SONY WALKMAN 75 1.00

SONY WALKMAN 76 1.00

SONY WALKMAN 77 1.00

SONY WALKMAN 78 1.00

SONY WALKMAN 79 1.00

SONY WALKMAN 80 1.00

SONY WALKMAN 81 1.00

SONY WALKMAN 82 1.00

SONY WALKMAN 83 1.00

SONY WALKMAN 84 1.00

SONY WALKMAN 85 1.00

SONY WALKMAN 86 1.00

SONY WALKMAN 87 1.00

SONY WALKMAN 88 1.00

SONY WALKMAN 89 1.00

SONY WALKMAN 90 1.00

SONY WALKMAN 91 1.00

SONY WALKMAN 92 1.00

SONY WALKMAN 93 1.00

SONY WALKMAN 94 1.00

SONY WALKMAN 95 1.00

SONY WALKMAN 96 1.00

SONY WALKMAN 97 1.00

SONY WALKMAN 98 1.00

SONY WALKMAN 99 1.00

SONY WALKMAN 100 1.00

WIRELESS TELEPHONES ANSWERING MACHINES CODE A PHONE

1000 1.00

1500 1.00

2000 1.00

2500 1.00

3000 1.00

3500 1.00

4000 1.00

4500 1.00

5000 1.00

5500 1.00

6000 1.00

6500 1.00

7000 1.00

7500 1.00

8000 1.00

8500 1.00

9000 1.00

9500 1.00

10000 1.00

10500 1.00

11000 1.00

11500 1.00

12000 1.00

12500 1.00

13000 1.00

13500 1.00

14000 1.00

14500 1.00

15000 1.00

15500 1.00

16000 1.00

16500 1.00

17000 1.00

17500 1.00

18000 1.00

18500 1.00

19000 1.00

19500 1.00

20000 1.00

20500 1.00

21000 1.00

21500 1.00

22000 1.00

22500 1.00

23000 1.00

23500 1.00

24000 1.00

24500 1.00

25000 1.00

25500 1.00

26000 1.00

26500 1.00

27000 1.00

27500 1.00

28000 1.00

28500 1.00

29000 1.00

29500 1.00

30000 1.00

30500 1.00

31000 1.00

31500 1.00

32000 1.00

32500 1.00

33000 1.00

33500 1.00

34000 1.00

34500 1.00

35000 1.00

35500 1.00

36000 1.00

36500 1.00

37000 1.00

37500 1.00

38000 1.00

38500 1.00

39000 1.00

39500 1.00

40000 1.00

40500 1.00

41000 1.00

41500 1.00

42000 1.00

42500 1.00

43000 1.00

43500 1.00

44000 1.00

44500 1.00

45000 1.00

45500 1.00

46000 1.00

46500 1.00

47000 1.00

47500 1.00

48000 1.00

48500 1.00

49000 1.00

49500 1.00

50000 1.00

50500 1.00

51000 1.00

51500 1.00

52000 1.00

52500 1.00

53000 1.00

53500 1.00

54000 1.00

54500 1.00

55000 1.00

55500 1.00

56000 1.00

56500 1.00

57000 1.00

57500 1.00

58000 1.00

58500 1.00

59000 1.00

59500 1.00

60000 1.00

60500 1.00

61000 1.00

61500 1.00

62000 1.00

62500 1.00

63000 1.00

63500 1.00

64000 1.00

64500 1.00

65000 1.00

65500 1.00

66000 1.00

66500 1.00

67000 1.00

67500 1.00

68000 1.00

68500 1.00

69000 1.00

69500 1.00

70000 1.00

70500 1.00

71000 1.00

71500 1.00

72000 1.00

72500 1.00

73000 1.00

73500 1.00

74000 1.00

74500 1.00

75000 1.00

75500 1.00

76000 1.00

76500 1.00

77000 1.00

77500 1.00

78000 1.00

78500 1.00

79000 1.00

79500 1.00

80000 1.00

80500 1.00

81000 1.00

81500 1.00

82000 1.00

82500 1.00

83000 1.00

83500 1.00

84000 1.00

84500 1.00

85000 1.00

85500 1.00

86000 1.00

86500 1.00

87000 1.00

87500 1.00

88000 1.00

88500 1.00

89000 1.00

89500 1.00

90000 1.00

90500 1.00

91000 1.00

91500 1.00

92000 1.00

92500 1.00

93000 1.00

93500 1.00

94000 1.00

94500 1.00

95000 1.00

95500 1.00

96000 1.00

96500 1.00

97000 1.00

97500 1.00

98000 1.00

98500 1.00

99000 1.00

99500 1.00

100000 1.00

For information and all N.Y. State orders please dial 212 871 7600. All items subject to availability and price change. Mail and Phone Orders C.O.D. Master Charge Visa O.K. Shipping extra. Everything Factory fresh 20 day Money Back Guarantee (less shipping) FOCUS ELECTRONICS 4523 13th Ave. Blyn NJ 07003

CIRCLE NO. 55 ON FREE INFORMATION CARD

Computer Books With No Secrets

Computers for Everybody
Jerry Willis and Merl Miller

This fun-to-read book covers all the things you should know about computers. If you're anxious to buy one, use one or just want to find out about them, read this book first.
171 pages \$5.95

Small Computers for the Small Businessman

Nicholas Rosa and Sharon Rosa
If you've ever considered a computer for your business this is the book that will arm you with all the information you'll need to make an intelligent, cost-effective decision.
331 pages \$16.95

From dilithium Press

Yes, please send me the book(s) I have indicated. I understand that if I am not satisfied I may return for full refund.

- Computers for Everybody \$5.95
 - Small Computers for the Small Businessman \$16.95
- I enclose \$_____ plus \$1 to cover postage and handling.
- Please send me your free catalog.

NAME _____

ADDRESS _____

CITY, STATE, ZIP _____

Mail to:
dilithium Press, P.O. Box 606, Beaverton, OR 97075

CIRCLE NO. 11 ON FREE INFORMATION CARD

Four-Drive Double-Density Disk Controller for H/Z-89 Includes Parallel Printer Port

\$249.95

40- and 80-Track Add-On Drives for the H/Z-89 and H-8 from \$399

Now! Percom Disk Storage for Your Heath Computer.

At Percom we've been making mini-disk systems since 1977. Our proven disk controller design, featuring digital phase-lock loop data separation, gives rock-solid performance. Every Percom drive sold is double tested - to Percom specifications. And every drive receives a 48-hour operating burn-in, a qc check that virtually eliminates the possibility of shipping drives with latent defects.

Get all the details about Percom's new Z line of quality mini-disk systems for Heath computers. Fill out and mail us the coupon now.



PERCOM DATA COMPANY, INC.
11220 Pagemill Road - Dallas, Texas - 75243

Toll-Free Order Number: 1-800-527-1222

PRICES AND SPECIFICATIONS SUBJECT TO CHANGE WITHOUT NOTICE.
© 1981 PERCOM DATA COMPANY, INC.

Yes I'd like to know more about Percom Z drives and the Percom Z controller.
Rush me free literature.

Send to:
PERCOM DATA COMPANY, Inc., Dept 26P01
11220 Pagemill Road, Dallas TX 75243

name _____

street _____

city _____ state _____

zip _____ phone number _____

[] H Z 89 [] H 8

EQUIPMENT AND TRAINING NO OTHER SCHOOL CAN MATCH.

**NTS HOME TRAINING INVITES YOU TO EXPLORE MICROCOMPUTERS,
DIGITAL SYSTEMS AND MORE, WITH STATE-OF-THE-ART EQUIPMENT
YOU ASSEMBLE AND KEEP.**

Without question, microcomputers are the state of the art in electronics. And NTS is the only home study school that enables you to train for this booming field by working with your own production-model microcomputer.

We'll explain the principles of troubleshooting and testing your microcomputer and, best of all, we'll show you how to program it to do what you want.

You'll use a digital multimeter, a digital logic probe and other sophisticated testing gear to learn how to localize problems and solve them.

Send for the full color catalog in the electronics area of your choice—discover *all* the advantages of home study with NTS!

NTS also offers courses in Auto Mechanics, Air Conditioning and Home Appliances. Check card for more information.

1.



2.



We believe that training on production-model equipment, rather than home-made learning devices, makes home study more exciting and relevant. That's why you'll find such gear in most of NTS's electronics programs.

For instance, to learn Color TV Servicing you'll build and keep the 25-inch (diagonal) NTS/HEATH digital color TV.

In Communications Electronics you'll be able to assemble and keep your own NTS/HEATH 2-meter FM transceiver, plus test equipment.

But no matter which program you choose, NTS's Project Method of instruction helps you quickly to acquire practical know-how.



Simulated TV Reception

4.

3.

1. **The NTS/Rockwell AIM 65 Microcomputer** A single board unit with on-board 20 column alphanumeric printer and 20 character display. A 6502-based unit 4K RAM, expandable.
2. **The NTS/KIM-1 Microcomputer** A single board unit with 6 digit LED display and on-board 24 key hexadecimal calculator-type keyboard. A 6502 based microcomputer with 1K RAM, expandable.
3. **The NTS/HEATH H-89 Microcomputer** features floppy disk storage, "smart" video terminal, two Z80 micro-processors, 16K RAM memory, expandable to 48K.
4. **The NTS/HEATH GR-2001 Digital Color TV (25" diagonal)** features specialized AGC-SYNC muting, filtered color and new solid-state high voltage tripler rectifier.

NTS NATIONAL TECHNICAL SCHOOLS

TECHNICAL-TRADE TRAINING SINCE 1905
Resident and Home-Study Schools
4000 SO. FIGUEROA ST., LOS ANGELES, CA. 90037

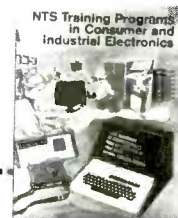

NATIONAL TECHNICAL SCHOOLS

4000 South Figueroa Street. Dept. 205-052
Los Angeles, California 90037

Please rush FREE color catalog on course checked below

- | | |
|---|---|
| <input type="checkbox"/> MicroComputers/MicroProcessors | <input type="checkbox"/> Auto Mechanics |
| <input type="checkbox"/> Communications Electronics | <input type="checkbox"/> Air Conditioning |
| <input type="checkbox"/> Digital Electronics | <input type="checkbox"/> Home Appliances |
| <input type="checkbox"/> Industrial Technology | <input type="checkbox"/> Color TV Servicing |

Name _____ Age _____

Address _____

Apt. _____ City _____

State _____ Zip _____

- Check if interested in G.I. information.
 Check if interested ONLY in classroom training in Los Angeles.

EXPERIMENTER'S CORNER

By Forrest M. Mims

Experimenting with Low-Power Integrated Circuits

INTEGRATED circuits did not replace discrete component circuits overnight. While it's true that some of the delay in switching to ICs was caused by resistance to new technology, early integrated circuits were often slower and more expensive, and usually required more power than their discrete transistor counterparts.

Today's ICs are far less costly than those sold a decade ago. They also operate at much faster speeds. Recently, considerable attention has been given the development of new ICs that consume much less power than their predecessors.

Though CMOS technology is the best known low-power IC technology, other kinds of micropower integrated circuits have been developed. Some combine conventional bipolar and MOS transistors. Others employ conventional bipolar fabrication in circuits optimized for low-power operation.

Though many one-of-a-kind low-power linear (analog) and digital chips have been available for some time, several semiconductor companies have concentrated on the development of low-power versions of existing conventional chips. The new chips can usually be substituted directly for their power-hungry predecessors.

Although low-power versions of existing chips often cost more, they pay their own way with the extension of battery life they provide. Keep this in mind as we examine several circuits before and after a low-power IC has been substituted for a functionally similar, or even identical, conventional IC.

555/7555 Bouncefree Switch. Figure 1 shows a straightforward bounceless pushbutton made by connecting a 555 timer or its low-power equivalent, the 7555, as a mono-

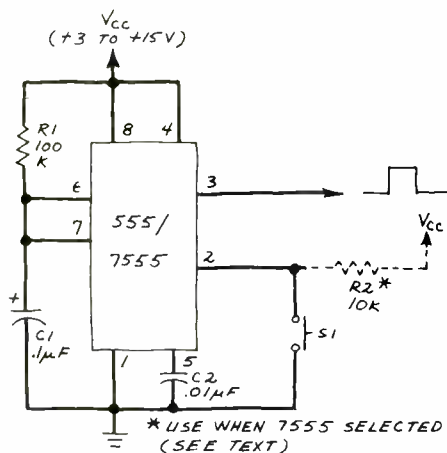

Fig. 1. Adjustable-output bouncefree switch.

stable multivibrator. Initially, $C1$ is short-circuited by a transistor in the timer. This forces the output (pin 3) to go low.

A negative pulse at the trigger input (pin 2) sets an internal flip-flop which turns off the transistor across $C1$. This causes the output to go high and allows $C1$ to charge through $R1$.

When the voltage on $C1$ reaches $\frac{2}{3} V_{cc}$, an internal compar-

ator resets the flip-flop, thereby turning on the transistor across $C1$. This discharges $C1$ and forces pin 3 low.

The time constant of the circuit is $0.69 \times R1/C1$. Therefore, when $R1$ is 100,000 ohms and $C1$ is 0.1 microfarad, the positive output pulse at pin 3 will be about 7 milliseconds.

Since the timing cycle does not begin until the trigger pulse is complete, momentary spikes such as those which accompany the closure of most mechanical switches will have no effect on the circuit's operation. They will merely reset the one-shot.

I have tried both 555 and 7555 versions of the circuit in Fig. 1. The 555 version worked perfectly the first time, but a problem developed when I exchanged the 555 for a 7555. The output remained high indefinitely. Sometimes it even switched from high to low for no apparent reason.

Since the low-power 7555 is supposed to be a direct replacement for the standard 555, I could not understand this problem. Besides, I have used the 7555 in various other circuits with no problems whatever.

Then I recalled the trigger input of the 7555 is a MOS transistor having a very high input (gate) impedance. When such an input is allowed to float, as when the input switch is open, the lead connecting pin 2 to the switch acts as an antenna which couples stray signals directly to the trigger input transistor. This explains the erratic operation of the circuit.

I solved the problem by inserting a 10-kilohm resistor between the trigger input and V_{cc} . This resistor forces the trigger input high when the switch is not depressed. It can be used with the 555 version also, but my 555 version did not trigger on stray signals.

As you can see, the 7555 is not necessarily a direct substitute for the 555 in all applications. Its use, however, does not always mean additional components are required. For example, in the free-running astable mode, the 7555 does not require a decoupling capacitor between the control-voltage input (pin 5) and ground. Furthermore, the 7555 has a wider supply voltage range (2 to 18 volts) and can operate at a speed of up to 500 kHz. It also requires much smaller trigger, threshold and reset currents, typically 20 picoamperes.

How do the supply currents differ? The standby current drain of the circuit in Fig. 1 is 6.7 milliamperes when a 555 is installed but only 0.16 milliamperes when a 7555 is used. When the output is triggered high the drain of the 555 version falls to 5.5 mA while that of the 7555 rises to 1.1 mA.

Obviously, the very low current consumption of the 7555 version makes the circuit in Fig. 1 well suited for battery powered operation. The 555 version consumes 42 times more current in the standby mode!

Though the 7555 typically costs twice the price of the 555, I've had very good success using it in a wide range of circuits, and I plan to use it in all battery powered circuits which require 555 timer chips.

The 7555 is made by Intersil (10710 N. Tantau Ave., Cupertino, CA 95014) and Exar (750 Palomar Ave., Sunnyvale, CA 94088). It's available from Jameco, Radio Shack, and other companies that advertise in this magazine.

567/XR-L567 Tone Decoder. Figure 2 shows a basic tone-decoder circuit that uses either a 567 or its low-power counterpart, the XR-L567, to detect a signal having a fre-

quency of about 10-kHz. The L567 achieves low-power operation by means of high-value resistors. Conventional on-chip resistors cannot have high values without taking up considerable space. However, the L567 employs ion implantation, a method of selectively disrupting the silicon surface with an ion beam, to produce small resistors with high resistances.

I've had mixed results using the L567. The circuit in Fig. 2

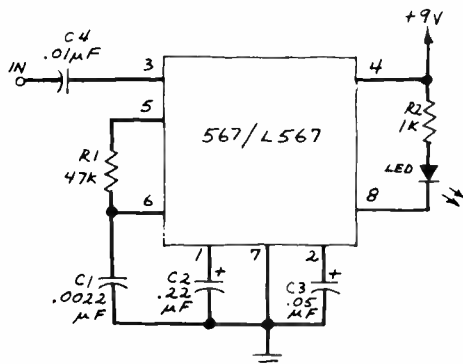

Fig. 2. A 10-kHz tone decoder.

works fine with either the 567 or L567. No component changes are necessary. The frequency responses of the two versions, however, are slightly different. The 567 version turns on the output LED when the input signal is about 10.3 kHz. The L567 actuates the LED when the input signal is about 9.1 kHz. This means exact substitutions may not be possible since trimming of some external components may be required before the L567 version will respond to the same frequency as the 567 version.

Current consumption of the L567 circuit in the standby mode is a very low 0.97 mA when V_{cc} is 7 volts. When a signal is detected and the LED is glowing, the current drain rises to 6.8 mA.

The standard 567 consumes much more current. During standby the drain is 10.4 mA. This rises to 22.5 mA when the LED is on.

Though the circuit in Fig. 2 works well, I've not been able to get the L567 version to respond to a 1-kHz signal. For this experiment, $R1$ was changed to 10 kilohms, $C1$ to 0.1 μ F, $C2$ to 2.2 μ F, and $C3$ to 1 μ F. Though the 567 version of the circuit responded well (at about 1.1 kHz), the L567 version failed to respond. I intend to continue working with the L567 in an effort to better understand this problem. Since many applications for this chip involve very low signal frequencies, it is imperative that the L567 work as well as its high-power counterpart.

The L567 is made by Exar (see the address given above). It costs about 50 percent more than the 567. In quantities of 100, the price is \$1.23. Contact an Exar distributor for current pricing and availability. Jameco stocks Exar chips and might have the L567 available. Their latest catalog, however, doesn't list this relatively new chip.

Low-Power Op-Amps. Many different low-power operational amplifiers are available. RCA's CA3440 BiMOS (bipolar/CMOS), for example, dissipates only 500 nanowatts. RCA also makes a low-power version of the 741. Designated the CA3420, the chip operates from as little as ± 1 volt and draws only 350 microamperes. National's LF441 is a low-power version of the LM148, which draws only 150 μ A.

One of my favorite low-power op-amps is the LM108/208/308. This family of op-amps will operate over a supply voltage range of ± 2 to ± 20 volts. The maximum supply current is 300 μ A.

(Continued overleaf)

For more information on advertised products, equipment tested, etc., circle appropriate number on postpaid Free Information Card.

STOP PAYING RENT TO THE PHONE COMPANY!!!

The phone company is charging you as much as \$7.77 a month for each telephone that you are renting. It makes good sense to return those outdated phones to "Ma Bell", and do away with rental fees forever.

Invest in the phones of the future from **US Tron™** Phonanza Model P.H. #1 will automatically redial the last number you have dialed and simplify the calling of busy numbers. The mute switch gives you privacy. All this at the remarkable price of **\$24.95**. Buy your first Phonanza at **\$24.95** and we will offer you a second one at only **\$19.95**. This will include two free wall holsters which value at **\$6.95** each.

Everyone's talking about U.S. Tron™ being the innovator in the telephone industry. Shouldn't you have your own U.S. Tron™ phone to talk on?

Other models available from U.S. Tron™ are:

DiaLog Model DJ: Last number redial, mute and on/off ringer switch **\$34.95**

DiaLog Model DJ-H: "Melody on Hold" **\$54.95**

DiaLog Model DJ-11: Built in 11 number automatic dialer **\$79.95**

DiaLog Model DJ-11H: Built in 11 number automatic dialer and "Melody on Hold" **\$89.95**

Wall holster **\$6.95**

If you are not fully satisfied, return to us within 30 days for a proper refund.

Order Toll Free (Credit card holders only) **800-554-3388**

Visa and Mastercard are welcome

Checks or Money orders to be sent to: **Consumer Wholesalers, Ltd.**
3572 High Green Drive
Marietta, GA 30067
Telephone: (404) 971-3464

* Please add \$2.50 for insured postage and handling for first product and \$1.00 for each additional product.



CIRCLE NO. 66 ON FREE INFORMATION CARD

 VIC-20 \$259 Cassette...\$69 Printer...\$339 Disk Drive...\$499	 400 \$329
 HEWLETT PACKARD HP 41CV CALCULATOR \$249 HP/IL PERIPHERALS IN STOCK!	 41C \$189 11C \$119 12C \$129 34C \$117 38C \$119 HP*41 Printer \$340
CALL FOR SOFTWARE INFORMATION	
MICRO COMPUTER DISTRIBUTING east USE YOUR MASTERCARD OR VISA west 800-233-8950 800-648-3351 In Pa. Call (717) 327-9575 In Nev. Call (702) 588-5654 477 E. Third St., Williamsport, PA 17701 P.O. Box 6689, State Line, NV 89449	

CIRCLE NO. 8 ON FREE INFORMATION CARD

The high input resistance of this op-amp family (70 megohms for the LM108/208 and 40 megohms for the LM308) allows its use in applications normally filled by FET amplifiers.

Figure 3 shows a high-performance, photodiode amplifier designed around an LM308. Though many different op amps can be used in this circuit, including the popular 741C, the LM308 provides superior gain (up to 300 V/mV), low-noise operation (about 300 μ V at 10 kHz), and reasonably good frequency response (a unity-gain frequency of nearly 1 MHz).

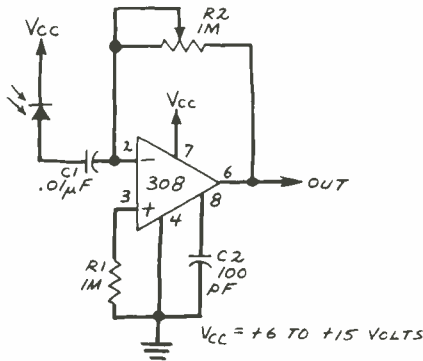

Fig. 3. An op amp photodiode amplifier.

The circuit in Fig. 3 consumes 230 μ A when the supply provides 6 V. When a 741C is substituted for the LM308, the current consumption rises to about 600 μ A. In addition, the noise level rises when a 741C is used, and both the frequency response and the gain fall. Obviously the LM308 is superior to

the more economical 741C in this and many other applications. The 741C, however, does not require an external frequency compensation capacitor (C2).

Incidentally, C2 can be connected to the LM308 in one of two ways. One enhances the chip's frequency response while the other reduces noise coupled from the power supply. See the LM108/208/308 data sheet for specific information.

The circuit in Fig. 3 is designed to receive pulsed lightwave signals. For dc applications, such as detecting starlight, remove C1 and connect the photodiode directly to the inverting input (pin 2) of the op amp. In either mode, the circuit functions as a current-to-voltage converter with gain. The output voltage is the product of the photodiode current and the feedback resistor (R1). When used with an LM308, this circuit provides the input stage for an exceptionally sensitive, high-performance, lightwave receiver.

TTL vs TTL LS. TTL is well liked for its fast switching speed (10 nanoseconds propagation delay per gate). However TTL is power hungry. The four gates in a 7400 Quad NAND gate package, for example, consume a total of 4 μ A when all four outputs are high. The drain rises to 12 μ A when all four outputs are low.

Low-power Schottky TTL preserves the very fast switching speed of conventional TTL but provides much lower current consumption. The 74LS00, for example, consumes a total of 0.8 μ A when all outputs are high and 2.4 mA when all outputs are low. This is only one-fifth the current required by the TTL 7400. Although TTL LS costs more than standard TTL, the low power consumption is worth the added price. Battery-powered operation becomes a real possibility for many TTL LS circuits.

CMOS. The advantages of CMOS have been proclaimed many times in this column. Consider, for example, the 74C00, which is the CMOS equivalent of the 7400/74LS00 described above. This gate package typically consumes a minuscule 0.01 μ A and a maximum of 15 μ A. What's more, CMOS ICs can operate over a supply voltage range of about 3 to 15 V. CMOS is also characterized by its high immunity.

Summing Up. Low-power chips represent one of the most important trends in today's integrated circuit technology. In coming years you can expect to see much more emphasis on CMOS and less on TTL or even TTL LS. You can also expect to see more low- and micropower versions of many kinds of linear ICs. \diamond

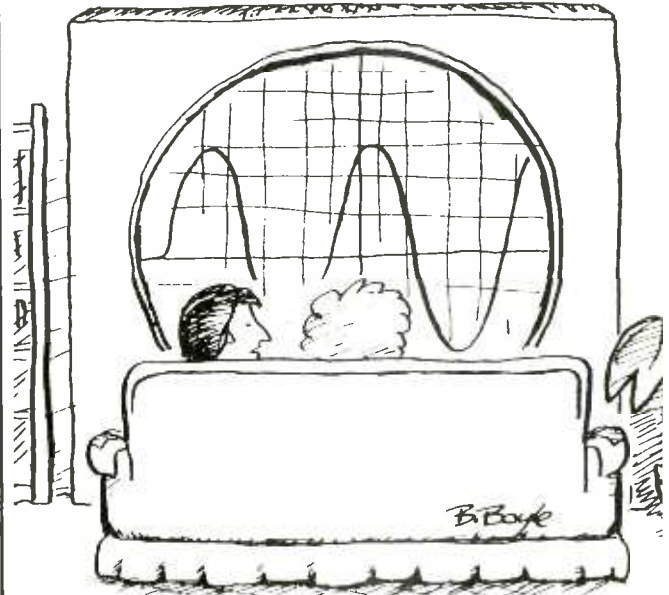

"Do you mind if I change the amplitude?"

BUY of the YEAR!!!
Parallel, TTL Input I/O "Selectric"®
TYPEWRITER / PRINTER

The manufacturer put 'em into storage to depreciate 'em... Now they're FINALLY AVAILABLE!! Removed from working systems, these fantastic machines have built-in driver and decoder circuitry and take TTL level, 6-bit character, plus 4-bit function input signals.. Easily driven by most any micro. Use as a typewriter (with add'l "repeat" circuitry) or as a KSR I/O printer or both. Requires 115, 60Hz for type writer motor. 5 VDC for TTL and 24 VDC for solenoids. "Table Top" style case. Each "Selectric"™ I/O machine is complete and in operational condition! Includes schematics, data, case, platen and ribbon. (Type element not included.)



I/O
SELECTRIC

New Type Element \$21.00ea I/O Selectric **\$399.00ea.**
 Add \$20 for Packaging and Handling - Pay Shipping on Delivery

WORD PROCESSOR CPU ASSEMBLY



Linked to and used with the above machine, this unit completes a system which originally sold for over \$4000.00 each! Features include: standard cassette deck, auto centering, auto repeat, auto underline, suppressed notations, record/playback, auto merge, editing, margin adjusting and much, much more. Parts include tape deck, cabinet, fans, power supply, mother board, connectors, cables, LEDs and more. Worth much more than our price for the parts alone. Includes schematics and data. Tested and functional plus one free cassette.

Only \$199.00 ea.
 Add \$20 for pkg. and handling - Pay shipping on delivery

Additional Cassette Deck
"Add-On" Assembly

Add-on package includes everything you need to add on the second deck. Easy to retrofit.

Only \$199.00 ea.

We Offer New and Used FLOPPY DRIVES, DISK DRIVES, PRINTERS,
 & MORE at BARGAIN PRICES!!!
 -Ask for Our Latest Flyer NOW!!!-

COMPUTERS,
PERIPHERALS,
UNLIMITED!

WAREHOUSE:
 18 Granite St., Haverhill, Mass. 01830

MAIL ORDER:
 Box 204, Newton, N.H. 03858

TELEPHONE ORDERS:
617/372-8637
 Sorry, No Collect Calls
 MasterCard & VISA Accepted

OPERATION ASSIST

If you need information on outdated or rare equipment—a schematic parts list, etc.—another reader might be able to assist. Simply send a postcard to Operation ASSIST, POPULAR ELECTRONICS, 1 Park Ave., New York, NY 10016. For those who can help readers, please respond directly to them. They'll appreciate it. (Only those items regarding equipment not available from normal sources are published.)

Hewlett-Packard Model 410C voltmeter. Need owner's manual, service manual, and schematics. J. Douglas Heath, 1602 Pat Dr., St. Joseph, MO 64506.

Sinclair Project 605, 606, & 608. Need manuals, schematics, or any technical information. Funk Ink Industries, P.O. Box 275, Downsview, Ontario, Canada M3M 2A6.

National Semiconductor Model SC/MP ISP-8A/5000 microprocessor IC and SC/MP kit. Need data sheet and technical description for IC, user's manual, and assembly language manual for kit. Michael F. Morra, 450 Villa Ave., Fairfield, CT 06432.

RCA Model MI-31023-A distortion and modulation test unit, **DuMont** Model 333 oscilloscope (dual trace), and **Anelab** Model 1100 oscilloscope with #600 plug-in. Need manuals and schematics. Glenn Gordon, 31722 W. Lk. Ketchum Rd., Stanwood, WA 98292.

Collins R388/URR communications receiver. Need operation manual, gear and front end alignment. Errol May, 74, Delhi, Ontario, Canada N482W4.

Marantz Model 250M power amp. Need service manual and output transistors marked F649 461-2010 and F718-462-2021. Winifried Kramer, Rua D. Pedro II, 798, Porto Alegre 90000, Rio Grande do Sul, Brasil.

RCA Model AR77 & GR10 receiver, and BC 733-D receiver. Also, **NARCO** Omnigator KM II transceiver and modulator. Need schematics and service manuals. A. J. Kammersgaard, RR3, Lanark, Ontario, Canada.

Sansui Model UE-930 AM/FM multiplex stereo. Need schematic. Roy H. Wilkinson, 10041 Penn Ave. S., Bloomington, MN 55431.

Sencore Model PS120 oscilloscope. Need 3RP1 CRT tube. R.W. Beck, 466 Sharon, San Antonio, TX 78216.

Vitro Electronics Type 1432 Nems Clarke phase-lock receiver. Need schematic. Wesley D. Lord, 2231 W. Page, Springfield, MO 65802.

EMC Model 215 tube and transistor checker. Need new set-up manual. Ed Tanrath, 3035 LaSalle Ave., Rockford, IL 61111.

Fisher Model 800T, receiver, **Marantz** Model No. FA-247 mobile equalizer, **RCA Victor** Model GL66L color TV, **Sylvania** Type 108 oscilloscope, and **Heathkit** Model EA-3 mono amp. Need schematics. Andy Gregory, 4 Nibang Ave., Old Gaybrook, CT 06473.

Inland Dynatronics Model 206 auto radio. Need parts. Thomas R. Loch, Box 818, Valier, MT 59486.

Concord VTR-700 video tape recorder and **Hughes** 105AR Memo-Scope. Need schematics and manuals. K.R. Johnson, Box 10063, Austin, TX 78766.

Monsanto Model 114A frequency counter. Need schematic and service manual. Robert Bollinger, 823 Belvedere St., Carlisle, PA 17013.

Yankee Model 1254 electronic siren. Need schematic and owner's manual. AIC Kenneth K. Jones, PSC Box 3756, APO San Francisco, CA 96328.

Sabtronics Model 1011C transceiver. Need schematic diagram. R. Craig Bracken, Rt. 2, Box 64A, Davenport, WA 99122.

Heathkit Model W5M amplifier and Model WAP2 preamplifier. Need schematics or assembly manuals. F.N. Lockwood WA6UCP, 910 Jack London Dr., Santa Rosa, CA 95405.

Tektronix Model 454 oscilloscope. Need manuals and schematics. John Gador, Box 1174, Gaylord, MI 49735.

Deimonico Nivico Model CT-151 Run #3 color TV. Need schematics and repair manual. Phillip Dumey, 412 S. Misouri, Cape Girardeau, MO 63701.

Sierra Electronics Model TS-1836 transistor tester. Need operations manual, schematic, and parts list. Also for **Precision Apparatus** Model CR-60 picture tube tester-rejuvenator. Joseph Chiaravolotti, 1212 Bullens La., Woodlyn, PA 19094.

Minshall-Estey Model "S" electronic organ. Need schematic and any other information. Richard Wood, 3636 W. 11th, Topeka, KS 66604.

Crosley Model 649-A radio, chassis #649. Need schematic

and pertinent data. S.J. Dennis, 164-B Bradford St., Provincetown, MA 02657.

Hoffman Model TS-323/AU frequency meter. Need manuals. Bill O'Meara, 807 E. Seminary Ave., Towson, MD 21204.

Hammarlund Model HQ-129X shortwave receiver. Need instruction book or Sams Photo Fact. James F. Quinney, 7 Carlson Rd., Hampton, NH 03842.

Analex Model 4-1000 high-speed printer. Need microprocessor controller plane and interface to RS-232 plane. Mario Pineire, 1237 Castre Barros 1224, Buenos Aires, Republica Argentina.

Macom Inc. Model 2001 and 3001 name caller automatic phone dialer. Need schematic and instructions. Bob Anderson, 1095 Dewey, Plymouth, MI 48170.

Rauland Corp. Model BC-1306 receiver and transmitter. Need operating instructions and any operating information. Bill Olson, 11765 Kelley-Rae Dr., Hayden Lake, ID 83835.

We're Number One In Quick Service- Top Quality Printed Circuit Boards!!!

We can ship most boards from your artwork in as little as 7 days, or our experienced designers can produce a finished artwork and manufacturing drawings from your schematic. The printed circuit board forms the basis for your product, so make your product a winner by going with a winner.

Timely Deliveries • Precision Work
Reasonable Prices

digltronic

P.O. BOX 2494 • TOLEDO, OH 43606 • (419) 473-0985

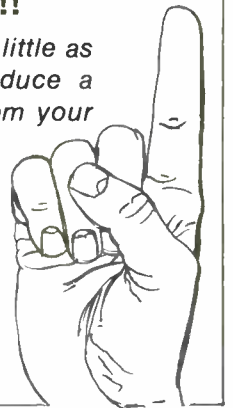

CIRCLE NO. 60 ON FREE INFORMATION CARD

Remove Vocals

Remove the lead vocal and substitute your own voice with most stereo recordings using our new, low cost VOCAL ZAPPER™. Great for practice, professional demos or just for fun.

WITH THE
**VOCAL
ZAPPER™**



CHARGE TO VISA OR MC TOLL-FREE
1-800-654-8657 9AM to 5PM CST MON-FRI

DIRECT INQUIRIES TO:

PAIA Electronics, Inc.

1020 W. Wilshire, Oklahoma City, OK 73116 (405) 843 9626

- Rush my Vocal Zapper Kit, \$24.95 plus \$3 postage & handling enclosed
 Send assembled Vocal Zapper, \$39.95 plus \$3 postage enclosed Send Free Catalog

name _____
address _____
city _____ state _____ zip _____

PAIA Electronics, dept. 5P, 1020 W. Wilshire, Okla. City, OK 73116

CIRCLE NO. 34 ON FREE INFORMATION CARD



FREE!
1982
DISCOUNT
ELECTRONICS
CATALOG

JOIN THE PAK!

Send for our Free catalog and become a member of our exclusive Pak. Our

members receive Poly Paks' exciting catalog several times a year. We offer:

Penny Sales, Free Premiums and Low, Low Prices on a wide variety of

Electronic Products such as Computer Peripherals, Integrated Circuits, Speakers, Audio Equipment, Rechargeable Batteries, Solar Products, Semiconductors, and much, much more! Take advantage of our 25 years as America's foremost Supplier of discount electronics.

RUSH ME YOUR FREEDISCOUNT CATALOG!

NAME: _____
ADDRESS: _____
CITY: _____
STATE: _____ ZIP: _____

CLIP AND MAIL COUPON TODAY TO:
POLY PAKS, INC.
P.O. BOX 942, PO-5
S. LYNNFIELD, MA. D194D (617) 245-3828

CIRCLE NO. 38 ON FREE INFORMATION CARD

Ling-Temco-Vought Model LTV G175-H 30-MHz to 260-MHz vhf receiver. Need schematic, manual, and service information. Duane Manchester, 2258 Warren, Muskegon, MI 49441.

Sabtronics Model 2000 DMM. Need source, schematic and parts list for PS-1 dc to dc converter. Michael Dombusch, 7249 Summerdale Dr., Dayton, OH 45424.

Paco Model Z-80 audio-f signal tracer. Need schematic. Clifford V. Rbwe, 1675 Berkeley AP26, Pomona, CA 91768.

Hazeltine Model 1200 video terminal-keyboard. 300/1200 baud-upper and lower case. Need schematic and service manual. Joe F. Sobieski, 2277 Menoher Blvd., Johnstown, PA 15905.

Heathkit Model O-11 oscilloscope. Need power transformer: 400-0-400 @ 80 MA, 650 @ 3 MA, 625 @ .6A, 6.3 UCT @ 3.5 amp and 6.3 U @ .6A, or plans for a power supply: +420 and -1300 vdc. John F. Jarrett, Box 1222, Showlow, AZ 85901.

Elco Model 470 oscilloscope. Need schematic. D.R. Christensen, 10134 Ladybird Dr., Auburn, CA 95063.

Lafayette Model 1TE-55 99-5011 tube tester. Need original tube chart. Also, **Lafayette Model KT-202 VTVM operating instructions.** Frank S. Bunting, 61 Ward Ave., Mt. Kisco, NY 10549.

Elco Model 753 ham transceiver. Require assembly manuals and vfo pc board, part #82520-1. Rick Gerson, The Ontario Cancer Institute, Physics Dept., 500 Sherbourne St., Toronto, Canada M4X1K9.

Heathkit Model V-7A VTVM. Need schematic and operating manual. Walter M. Signmund, 132 Spring St., Syracuse, NY 13208.

Hailcrafters Model S38B radio. Need schematic. John H. Taylor, Box 360 RD2, Glen Mills, PA 19342.

Concord Model 1207-inch reel. Need complete set of belts.

Walter H. Walkup, 1035 Arlington Ave., Apartment 402, St. Petersburg, FL 33705.

CMi Electronics Model SG-410 2-channel power amplifier. Need schematic and owner's manual. K. Phelan, 75 Davis St., Revere, MA 02151.

Miller Model 585 high fidelity-germanium-crystal tuner. Need schematic and parts layout. Robert M. Holberg, 805 Harris St., Lansing, MI 48906.

Computer Measurement Systems Model 204-A frequency counter. Need schematic and manual. Andy Sporer, RR3, Box 202, Walkerton, IN 46574.

Electro Instruments Model 8409 digital voltmeter. Need service manual and schematic. A. Reges, 16W761 White Pines, Bensenville, IL 60106.

Hellcrafters Model S-120A 4-band receiver. Need schematic. K. Berkeley, 57 Cedar St., Cambridge, MA 02140.

Federal Model 804-CS1 signal generator. Need instruction manual. John Phelps, 2025 Thousand Oaks Dr., Orange, TX 77630.

Conar Instruments Model 255 oscilloscope. Need schematic and service manual. James W. Lee, 6725 Spoonwood Ln., Fort Worth, TX 76137.

Flexowriter Model FL recorder-reproducer. Need maintenance and repair manual. Harry Mazur, 1450 Chestnut Pl., Boulder, CO 80302.

Detectron Model DS-222 geiger counter. Need schematic and manual. T. Lindquist, 1740 Beechwood Ave., St. Paul, MN 55116.

National Model NC-88 SW receiver. Need operation manual and schematic. Vito Paul Marrone, 497 S. Meadow Rd., N. Merrick, NY 11566.

Video Brain Model 1001 computer. Need schematic, accessories, cartridges, and any other information. Donald Camp-

bell, 1616 Reed St., Kalamazoo, MI 49001.

Lectrotech Model 7060 oscilloscope. Need circuit or schematic. Alberto Gomez C. Apolinario Figuero, 1390-1B, Buenos Aires, Argentina 1418.

Gregory Model 22A musical instrument amplifier. Need schematic. H. E. Pierce, RFD. 1, Box 232, Lamar, AR 72846.

Crown Model SX824 open reel tape deck. Need schematic or manual. Bill Stottlemeyer, Rt. 1, Box 125, Corinth, MA 38834.

Symphonic Model 112-235001 stereo with changer. Need schematic and power transformer. Leon Weston, PO Box 13, Winthrop, ME 04364.

Allied Model 333 stereo receiver. Need schematic and service information. John Beard, 1210 Willow, Pekin, IL 61554.

Precision Model E420 white dot and bar generator. Need schematic and any other manuals. Vemal Wood, 1002 E. Millbrook Way, Bountiful, UT 84010.

Hickock Model 750 Dynamic Mutual Conductance tube tester. Need schematic, operating instruction, and tube-checker guide. Michael Crain, RD1, Box 472, Harveys Lake, PA 18618.

Bradfor Model 1405C30 AM/FM stereo. Need owner's manual, service manual, and schematic. Mike Little, 4440 NW 171 Terrace, Opa-Locka, FL 33055.

Pilot Model 4024 stereo receiver. Need schematic and service manual. Randy J. Chartier, 5913 Craig St., Springfield, VA 22150.

Tennelec Model MCP-1 programmable scanner. Need schematic, service manual, and technical information. Bud Wintcher, 4714 Oklahoma Ave., Tampa, FL 33616.

Extensys Model RM-650 memory board for S-100 bus. Need documentation and schematic. W.R. Crawford, 6973 Miami Bluff Dr., Cincinnati, OH 45227.

CALCULATOR SAVINGS



HP-11C Scientific	104.95	HP-85 Computer	1979.00
HP-12C Financial	114.95	16K Memory/85	149.95
Solution Bk Free with 11C/12C		HP-87 Computer	1799.00
HP-32E Scientific	42.95	32K Memory/87	229.95
HP-33C Programmable	68.95	64K Memory/87	349.95
HP-34C Programmable	114.95	128K Memory/87	619.95
HP-41C Alpha Prog	184.95	CP/M Module/87	389.95
HP-41CV Full Memory	237.95	Series 80 Modem	319.95
Port-X-Tender to 10 pins	169.95	HP-125 Computer	1999.00
82104A Card Reader	164.95	82901M Dual Disc Dr	1749.00
82143A Printer	284.95	82905A Dot Matrix Pr	629.95
82153A Wand	92.95	7470A 2-spen Plotter	1199.00
82160A HP-IL Module	94.95	4 6MB Winchester Dr	3295.00
82161A Cassette Drive	419.95	9135A Winch/Floppy	4295.00
82162A HP-IL Printer	369.95	2601A Daisywheel Pr	2999.00
Quad Memory/41C	74.95		
Extended Functions	62.95		
Extended Memory	62.95		
Time Module	62.95		
HP-41 System Case	39.95		

Call for Low Prices on all Accessories and Software

TI-55-II	442.95	TI-99/4A (incl TV Adaptor)	5329.95
TI-58C	84.95	Extended BASIC Module	76.95
TI-59	174.95	32K Memory Expansion	289.95
PC-100C	159.95	P-Code Peripheral for Pascal	299.95
LCD Prog	59.95	Free modules from TI with 58C/59 purchase	

Sharp	PC-1211 Handheld Computer, 1424 Steps	1149.95
	CE-122 Cassette Interface/Printer	109.95
	PC-1500 Advanced Handheld Computer	249.95
	CE-150 Cassette Intrfc/ 4-color Printer-Plotter	199.95
	CE-151 4K Memory Expansion for PC-1500	64.95
	CE-155 8K Memory Expansion for PC-1500	129.95

Casio	FX-602P Slim Programmable, 512 Steps	99.95
	FX-702P Handheld Computer, 1680 Steps	159.95
	FA-2 Cassette Interface for 602/702	42.95
	FP-10 Printer for 602/702	79.95
	MT-31 Compact Musical Keyboard	134.95
	MT-40 Keyboard with Bass and Rhythms	159.95
	CT-403 Home Entertainment Keyboard	449.95
	CT-701 Advanced Electronic Organ with Memory	799.95
	CA-85 Calculator Alarm Chronograph Watch	34.95

Pearl-corder	S202 Microcassette Recorder, One Hour	79.95
	S802 Two-speed, Two Hour Recorder	99.95
	S901 Two-speed, Compact, Memory Rewind	139.95
	X-01 Ultra-thin All Electronic	199.95

Olivetti	Praxis 35 Electronic Portable Typewriter	499.95
----------	--	--------

For faster delivery use cashiers check or money order. Add shipping 1% of your order (\$3.75 minimum). East of Missis Riv. add \$1.50. CA res. add 6%. Subject to availability. VISA and MC accepted. USA Prices.

ORDER 800-421-5188 Outside
TOLL-FREE Information line (213) 633-3262 CA AK HI

tam's

INCORPORATED

Tam's Inc., Dept. PE-5
14932 Garfield Ave.
Paramount, CA 90723
(213) 633-3262

CABLE-TV

CONVERTERS DESCRAMBLERS

Largest Selection
of Equipment Available
\$ Buy Warehouse Direct & Save \$



complete
40 channel
converter
CLOSE OUT
SPECIAL
\$38.95

36 channel
wired remote
converter
ONLY
\$94.95

Send \$2 for complete catalog
of converters and unscramblers

Quantity Discounts • Visa • Master Charge
Add 5% shipping Mich residents add 4% sales tax

C&D Electronics, Inc.

P.O. Box 21, Jenison, MI 49428
(616) 669-2440

FIVE FOREIGN BANK NOTES-10¢



Money! Money! Money! It makes the world go around-and here's a collection of real foreign money that will bring you around to the exciting world of Foreign Bank Note collecting. You'll travel back in time to World War II with a Japanese occupation note of Malaya. You'll get a strange little note from Hong Kong. You'll also receive three other notes from Indonesia, China and Bulgaria-all for only 10¢. Also Fine Bank Notes from our approval service. Buy only what you like. Return balance promptly. Thank you. Order now!

Jamestown Stamp Co., B52PE,
Jamestown, NY 14701

MEMBER ASDA • APS • SPA

NEW LITERATURE

Peripherals

Personal computer disk systems, add-on drives, LSI 11-compatible disk systems, backup system products, network multiplexers and interface cards, cables, demo kits, software, and manuals are among the products described in a new free product catalog from Corvus Systems. **Address:** Corvus Systems, 2029 O'Toole Ave., San Jose, CA 95131.

Analog and Digital Multitesters

A 16-page catalog from the Soltec corporation features the new Sanwa line of multitesters, insulation and ground testers, clamp meters, and accessories. Included in the catalog is information concerning sensitivity, operating parameters, physical dimensions, and power requirements. **Address:** Soltec Corporation, 11684 Pendleton St., Sun Valley, CA 91352.

Power Line Noise

Having trouble with power line noise? Topaz Electronics has a new ac Line Noise Suppression Reference Manual, a basic text on the protection of sensitive electronic equipment from line transients and spikes; it covers protection from lightning strikes, too. **Address:** Topaz Electronics Division, 9192 Topaz Way, San Diego, CA 92123.

Test Equipment Brochure

Global Specialties Corporation announces the availability of its new, four-page brochure detailing the company's line of portable logic-oriented test equipment. Included are descriptions and specs on a full line of logic probes, pulsers, monitors, and logic analysis kits; along with information on the new LM-4 Logic Monitor and LP-4 ECL Logic Probe. **Address:** Global Specialties Corporation, 70 Fulton Terrace, P.O. Box 1942, New Haven, CT 06509.

Fluke DMMs

A twelve-page brochure from Fluke describes the company's entire line of seven handheld and bench/portable DMMs. Included is the new 8020B-Series—said to be improved versions of

Fluke's standard handheld DMMs. The instruments feature high-speed (50 μ s) response time, continuity beepers, and a two-year warranty. Also described are four new DMM probes designed to be used as voltmeter accessories.

Address: John Fluke Mfg. Co., Inc., P.O. Box C9090, Everett, WA 98206.

Solution to Static

A four-page brochure from 3M's Static Control System's Department offers what it claims is a solution to static-caused problems with commercial electronic equipment. Namely, mats for stand-up and sit-down applications in several colors and sizes. 3M points out that the mats are conductive and not merely anti-static.

Address: 3M, P.O. Box 33600, St. Paul, MN 55133.

Federal Frequency Directory

Covering the EMR spectrum from 2-420 MHz, this recently declassified directory contains 100,000 frequencies, together with the locations of the U.S. agencies associated with them. The listings are compiled exclusively from official Government files, and include as-

BYTE'S Best Cellar List

Ciarcia's Circuit Cellar,

Volumes I, II, & III

by Steve Ciarcia

Collections of Steve Ciarcia's perennially popular columns from BYTE Magazine, these three volumes are sure to please home computer users and electronic hobbyists. **Volume I** include power conversions, programming EPROMs, remote terminal interfacing, touch-input video display, and more. **Volume II**, focusing on projects which interface the personal computer with the home, features useful applications such as computer-controlled home security system, computerizing appliances, input-output expansion for the TRS-80, and even a computer-controlled wood stove. **Volume III** offers low-cost construction projects such as an ultrasonic rangefinder, handheld remote computer control, two speech synthesizers, and a remote-control motorized platform, to name just a few.

Build Your Own Z80 Computer

by Steve Ciarcia

This complete guide to building a working computer offers engineers, students, and hobbyists an exciting alternative to buying a computer. With clear instructions, Steve Ciarcia fully explains how to build a basic single-board microcomputer based on the Zilog Z80 microprocessor. The finished product features a 1 K-byte operating system, serial and parallel ports, hexadecimal display, audio cassette mass storage, and easy expansion to include a video terminal.



Please send

Ciarcia's Circuit Cellar, Vol. I \$8.00

Ciarcia's Circuit Cellar, Vol. III \$12.95

Ciarcia's Circuit Cellar, Vol. II \$12.95

Build Your Own Z80 Computer

Call Toll-Free 800/258-5420

Name _____	Check Enclosed _____
Address _____	Bill Visa/ MasterCard # _____
City _____ State _____ Zip _____	Expiration Date _____
BYTE Books 70 Main Street Peterborough, N.H. 03458	Please add 1.00 per book to cover shipping cost.

CIRCLE NO. 4 ON FREE INFORMATION CARD

ADVERTISERS INDEX

2	All Electronics Corp.	83	22	Illinois Audio	92
3	American Antenna	8	23	Institute of Audio Research	2
5	AP Products	21	24	Jameco Electronics	112, 113
6	Apple Computer	Cover 2, 1	25	Jamestown Stamp Co.	102
			26	JDR Microdevices	110, 111
			27	J&R Music World	82
4	Byte	103	28	Magnavox	Cover 3
			31	MFJ Enterprises	60
			8	Micro Computing Distributing	99
			30	McIntosh Laboratory, Inc.	91
			32	Micro Management Systems	56
			65	Mosaic	85
			33	National Guard, Army	30
				Natl. Technical Schools	94-97
			42	NEC America	Cover 4
				Netronics, R & D Ltd	33, 61
				NRI Schools	76-79
			34	PAIA	101
			35	Panasonic	9
				Percom	93
				Personal Computer Systems	58
			36	Poly Paks	101
			38	Protecto Enterprises	59
			39		
			41	Quest Electronics	114
				Radio Shack	29, 109
			40	RCA	35
			43		
			44	Shure Bros.	18, 19
				Sinclair Research	4, 5
				Simple Simon Kits	80
				Sybox	43
			45		
				Tab Books	75
				Tams	102
				Tektronics	7
				TeleVideo	57
				3-M	44
				Videx	3
			46		
			47		
				Wabash Tape	55
			48	Westland Electronics	14
			58		
			64		
			49		
			50		
61	DAK	13			
9	DBX	82			
10	Digi-Key Corp.	115			
60	Digitronics	101			
11	Dilithium Press	93			
12, 13	R.L. Drake	88, 107			
	Edmund Scientific	107			
15	Firestik	92			
	Fireworks Unlimited	107			
55	Focus	93			
17	Fox Marketing	15			
18	Global Specialties	84			
	Grantham College of Engineering	107			
19, 28,	Heath Co.	17, 51-53, 89			

new literature

signments for the Armed Forces, Coast Guard, Treasury, Postal Service, NASA, and others. It costs \$14.95.

Address: Grove Enterprises, Inc., Route 1, Brasstown, NC 28902.

Computer Supplies Relays

A new catalog from Universal Relay Co. is now available. It includes information on relays such as: solid-state, printed circuit, hermetically sealed, high speed, power, etc. There are also stepping switches. Universal points out that fluctuation in the prices of precious metals has invalidated some of the prices quoted in the catalog; and the reader should call for an update. **Address:** Universal Relay Corp., 42 White St., N.Y., NY 10013.

Energy Management

Hy-Cal Engineering has released a six-page bulletin describing a family of sensors and signal conditioning devices designed for installers of energy management and control systems, i.e., the products are for measuring and monitoring temperature, humidity, and solar energy. Information is also included on the calibration facilities for in-house testing at Hy-Cal, as well as calibration systems for the users' test laboratories. **Address:** Hy-Cal Engineering, 12105 Los Nietos Road, Santa Fe Springs, CA 90670.

Is Your Microwave Oven As Safe As It Should Be?

THE SEEKER® Microwave Oven Radiation Tester lets you guard against harmful radiation leaks... and save on costly service calls!

- A simple, safety-conscious operation that takes just seconds
- The Seeker® fits in the palm of your hand — no batteries needed
- Judged by a St. Louis independent testing lab to be the equal of the \$450 NARDA unit appliance service companies use
- Conforms to FDA standards for radiation testing

The microwave oven is one of the greatest labor and time-saving devices of the 20th century... but it has to be

used with caution. Over time, the oven seals, hinges and latches may dry out or wear, causing leaks which could allow harmful radiation to threaten your family's health.

Until now, the only way to check your microwave for leaks was to call a serviceman — often at a cost of \$35 or more. But now with the \$24.95 **Seeker® Microwave Oven Tester**, you can check your own oven for leaks any time you wish — simply, and safely.

You owe it to yourself and your family to test for microwave radiation leaks regularly. So save time and money and order **The Seeker®**. It will bring you real peace of mind... every time you use your microwave.

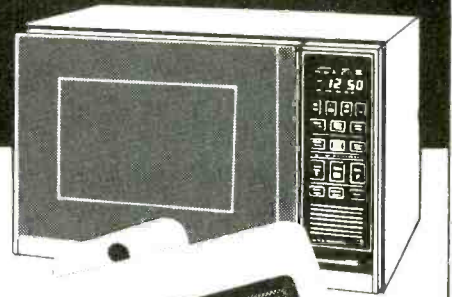

ORDER TODAY • PROMPT SHIPMENTS • NO C.O.D.'S PLEASE

PROTECTION CONSULTANTS, INC.
5483 Northwest Highway, Dept. PE42, Chicago, IL 60630

Please send me _____ SEEKERS at \$24.95 (shipping included) IL residents add \$1.50 each, 6% sales tax.

Check or money order enclosed. Total Amount \$ _____
 Charge to my MasterCard Visa

Card # _____ Exp. _____

Ship to attached list of names and addresses.

Name _____

Address _____

City/State/Zip _____

CALL TOLL FREE
Or Mail Coupon Now!
Illinois Residents
800-572-0444
All Others 800-621-0660

Your Guarantee of Satisfaction
5 Years' Service

Protection Consultants, Inc. guarantees **The Seeker®** for five years of regular use. If **The Seeker®** should stop performing within that period, simply return it for a prompt refund or replacement to PROTECTION CONSULTANTS, INC., 5483 Northwest Highway, Chicago, IL 60630.

THE SEEKER®
MICROWAVE OVEN
RADIATION TESTER

Power Line Filters

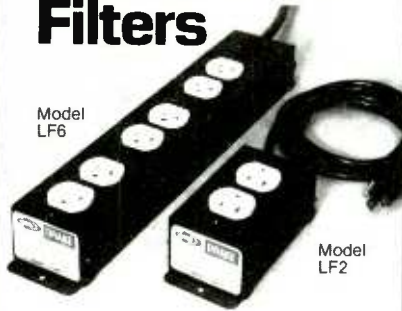

These filters protect any sensitive electronic equipment from power line transient damage and radio frequency interference. Both models offer common mode and differential mode surge suppression for power line "spikes". Rf interference is suppressed using both inductive and capacitive components ideal for computers, test equipment or TV.

LF2 a duplex outlet, 120V, 8 amps max. **\$39.95**
 LF6 three separately filtered duplex outlets 120 V, total fused capacity 15 amps power switch and indicator lamp **\$59.95**
 Add **\$2.50** shipping and handling per order

Send check with order and provide street address for UPS shipment. Ohio residents add Sales Tax. Charge card buyers may call toll free.

1-800-543-5612



In Ohio or for information call: 1-513-866-2421

R. L. DRAKE COMPANY

540 Richard Street, Miamisburg, Ohio 45342

INSTITUTIONAL AND DEALER INQUIRIES INVITED

CIRCLE NO. 12 ON FREE INFORMATION CARD

Put Professional Knowledge and a COLLEGE DEGREE in your Electronics Career through

HOME STUDY

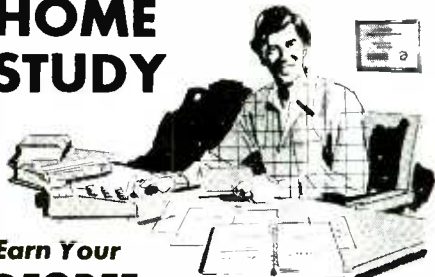

Earn Your DEGREE

No commuting to class. Study at your own pace, while continuing your present job. Learn from easy-to-understand lessons, with help from your home-study instructors whenever you need it.

In the Grantham electronics program, you first earn your A.S.E.T. degree, and then your B.S.E.T. These degrees are accredited by the Accrediting Commission of the National Home Study Council.

Our free bulletin gives full details of the home-study program, the degrees awarded, and the requirements for each degree. Write for *Bulletin ET-82*.

Grantham College of Engineering
 2500 So. LaCienega Blvd.
 Los Angeles, California 90034

ELECTRONICS LIBRARY

The BASIC Handbook—2nd Edition

by David A. Lien

The BASIC Handbook (1st edition) was written in 1978. Since then, the BASIC language has undergone substantial change—hundreds of new computers were introduced over the last four years, and the BASIC vocabulary has expanded accordingly. Thus, the 2nd edition has been fully revised to document and explain the nearly 500 BASIC words (238 of them not included in the 1st edition) used by businessmen, programmers, and students who employ micro, mini, and mainframe computers. The focus of the book is on providing information to help users solve the problem of program incompatibility due to the existence of so many BASIC dialects. Each word, therefore, is defined in plain English, and cross-referenced against possible alternate spellings and variations in usage. Especially helpful is the test program, which allows a user to enter a brief program into his computer to see if the interpreter or compiler recognizes the word in question. Another section offers advice, i.e., a roughly equivalent word, if your computer does not have the word you looked up.

Published by: *CompuSoft Publishing*, 1050 E. Pioneer Way, El Cajon, CA 92020; Soft covers. 480 pages. \$19.95.

Interference Handbook

by William R. Nelson

RFI is everywhere. Everyone has heard static on a radio, or seen "snow" on a TV caused by radio frequency interference. This book explains the effects of virtually all the usual sources of RFI, and suggests remedies in plain, non-technical language. If you have only a minimal background in electronics, you'll find the sections explaining the physics of interference informative and easy-to-understand. If your electronics background is more extensive, the circuit and block diagrams for defeating RFI will be useful. Barry Goldwater, Chairman of the Senate Communications Subcommittee, calls the book "a tremendous help to me and my staff."

Published by: *Radio Publications, Inc.*, Box 149, Wilton, CT 06897. Soft cover. 247 pages. \$8.95.

Experiments in Telecommunications

by Morris Tischler

This book is part of the LINEAR INTEGRATED CIRCUITS APPLICATIONS SERIES that is aimed at presenting linear ICs in a variety of applications. Here, telecommunications is covered. Some back-

(Continued on page 114)

Free!

Edmund Scientific Catalog



4,000 Unique Items

Astronomy, Microscopy, Biofeedback, Weather, Alternate Energy, Binoculars, Optics, Magnets, Magnifiers, Tools, Unique Lighting, Lab Equipment, and much more. Over 4,000 unique and fascinating products. Send for our FREE, colorful 1982 Edmund Scientific Catalog. . . Today!

Rush me your free catalog!

Name

Address

City

State Zip

Clip And Mail Coupon Today To:
 Edmund Scientific Co., Dept. 8211AV10
 Edscorp Bldg., Barrington, N.J. 08007

No. 3455 *1982 Edmund Scientific Co.



WE SHIP TO ALL FIFTY STATES

FIREWORKS

Thousands of Items to choose from
 For best selection order early.
 NO MINORS

Full Color Catalog Kit—\$2.00
 REFUNDABLE WITH YOUR FIRST ORDER

Toll Free Nationwide
 1-800-321-6001

MAJOR CREDIT CARDS ACCEPTED

FIREWORKS UNLIMITED

8550 ROUTE 224 * DEERFIELD, OHIO 44411

ORDER EARLY

YOU'LL EXCITE EVERYONE WITH OUR BIG AND BRIGHT ASSORTMENTS

Name

Address

City

State Zip

PLEASE PRINT TO ASSURE PROMPT CATALOG DELIVERY!

CIRCLE NO. 16 ON FREE INFORMATION CARD

PROJECT OF THE MONTH

By Forrest M. Mims

A Dual-Polarity Five-Volt Power Supply

A positive 5-volt power supply is required for TTL and low-power Schottky TTL integrated circuits. Many op-amp and MOS chips can be powered by a dual polarity, 5-volt supply; and most CMOS circuits can be powered by 5 volts. All these power-supply needs can be met by a very simple circuit assembled from a handful of components. Figure 1, for example, is a straightforward dual-polarity, 5-volt supply designed around a pair of fixed output, integrated voltage regulators.

The supply's positive output is provided by a 7805 5-volt regulator. The output of this chip is from 4.8 to 5.2 volts at a current up to one ampere. It requires a minimum input voltage of 7.3 V, and it can withstand a maximum input of 35 V.

An external heat sink is required for maximum power output. If the area of the heat sink is insufficient to dissipate the heat generated within the IC, an automatic thermal shutdown circuit will turn off the 7805 and prevent it from being damaged.

The power supply's negative output is provided by a 7905 -5-volt regulator. This chip provides from -4.8 to -5.2 volts at a current up to 1.5 amperes. It requires a minimum input of about -7 V, and it can tolerate a maximum input of -35 V. Like the 7805, the 7905 includes on-chip thermal shutdown circuitry.

Operation of the circuit in Fig. 1 is straightforward. Transformer *T1* drops the line voltage to 12.6 V. It also provides isolation from the ac line. A full-wave rectifier bridge, *B1*, converts the low-voltage ac from *T1* into a series of dc pulsations.

Since the secondary of *T1* is center-tapped, it can be used to form a ground (0-volt). Both positive and negative dc pulsations can then be obtained by referencing the respective positive and negative outputs of *B1* to ground.

The positive and negative excursions from *B1* are applied to the inputs of, respectively, the 7805 and 7905 regulator chips. Capacitors *C1* and *C3* serve as filters to smooth out the voltage pulsations from *B1* into a reasonably steady dc.

Incidentally, if the connections between *C3* and the 7905 regulator chip exceed several inches in length, a capacitor having a value of at least 25 μF (aluminum electrolytic) or 2.2 μF (solid tantalum) must be connected from close to the chip's input to ground.

The 7805 can tolerate more distance between its input and the positive supply. If considerable separation is involved, connect a 0.22 μF capacitor from close to the chip's input to ground.

Though output capacitor *C2* improves the transient response of the 7805, this chip will operate *without* it. The 7905, however, requires output capacitor *C4* for operating stability.

Always exercise caution when building line-operated power supplies!

In particular, the connections between the power cord and the circuit should be secure and well-insulated to provide short circuit protection. Likewise, the connections between power switch (*S1*), fuse (*F1*), and transformer (*T1*) should be well insulated.

For best results, assemble the supply on a perforated or etched circuit board and install it in an enclosure. It is essential to use an insulated strain relief (Radio Shack 278-1636 or similar) when connecting a power cord to a circuit housed in a metal enclosure. Failure to follow these safety precautions can pose a dangerous or even fatal shock hazard!

Both the 7805 and 7905 are available in 12- and 15-volt versions (7812, 7815, 7912 and 7915). You can use these chips in the circuit in Fig. 1 to obtain higher output voltages as long as a transformer capable of supplying the required input voltage is used. Of course, the voltage ratings for *B1* and all the capacitors will have to be adjusted upward. \diamond

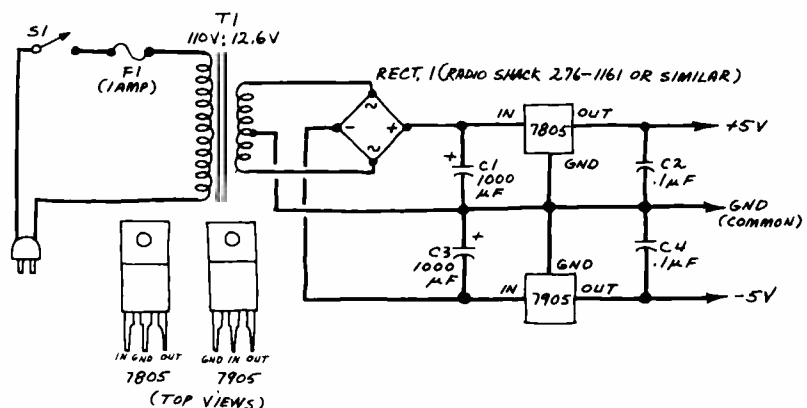

Fig. 1. Schematic of a standard dual-polarity 5-volt power supply.

Radio Shack Parts Bring Your Ideas to Life!

No Waiting! • No Minimum Order! • Low Prices!

Solar Power Demo Kit



NEW!
995

- Ready to Use
- Ideal for Models

A top-quality solar cell pre-wired to a precision DC motor—ready for your creative ideas! Great for building into model windmills, boats, radiometers and more. Includes miniature propeller, color wheels, illustrated booklet. 277-1201 9.95

Now That It's Working . . .



A 995 NEW! B 695

Dress up that special project! Both of these deluxe enclosures feature vented steel top, easy-to-work aluminum chassis, removable rubber feet and great-looking "TRS-80 gray" styling.

Fig.	Size	Cat. No.	Each
A	3 1/4 x 7 1/2 x 5 1/8"	270-229	9.95
B	2 1/2 x 5 1/8 x 4 3/16"	270-228	6.95

Here's a Fast, Easy Way To Design and Build!

Design and Debug Your Circuit On a Socket, Transfer It to the PC Board

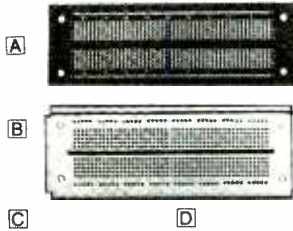

- A Pre-Drilled PC Board.** Holes match sockets (B and C) for easy transfer. 2 1/8 x 5 7/16 x 1/16", with 0.3" DIP center. 550 connection points. 276-170 . . . 3.29
- B Modular IC Breadboard Socket, DIP center.** These boards snap together for larger projects and accept 30 to 22-gauge solid wire. Two buses, 550 indexed connection points. 2 1/8 x 6". 276-174 . . . 10.95
- C Modular IC Breadboard Socket.** As above, but with 270 indexed connection points. 2 1/8 x 3 3/8". 276-175 . . . 6.49
- D Accessory Panel.** Snaps into interlock groove of B. Allows you to mount controls, switches and read-outs. 5 1/8 x 2 1/4". 276-171 . . . 1.99

Engineer's Notebook II

NEW!

Only

249

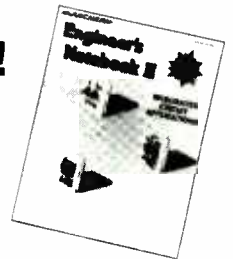

By Forrest Mims III

Gives you practical circuits for most analog and digital ICs. A wealth of information, presented in an easy-to-read format. 128 pages. Punched for three-ring binder. 276-5002 . . . 2.49

Computer Connectors

Solderless, Reusable Type



Fig.	Description	Cat. No.	Each
A	D-Sub Male for RS-232	276-1559	4.99
B	25-Pin D-Sub Female	276-1565	4.99
C	40-Position Card-Edge	276-1558	4.95
D	34-Position Card-Edge	276-1564	4.95

TV Horizontal Output Transistor



NEW!
795

25C1308. Top-quality NPN replaces ECG-238, GE-38, SK-3115 in many 19" color sets. With insulator, bushings. Why pay more? 276-2055 . . . 7.95

Joystick Pot



495

Includes Mounting Template

Great for video games, computers, radio control and more! Twin 100,000-ohm linear pots. 1"-long control. 271-1705 . . . 4.95

SPDT DIP Relay



299

Contacts Rated 1 Amp at 125VAC

5VDC, 56-Ohm Coil. Sensitive. Sub-mini size and ideal for PC board or DIP socket mounting. 3/8 x 1/2 x 7/16". 275-216 . . . 2.99

Photo Bargains!

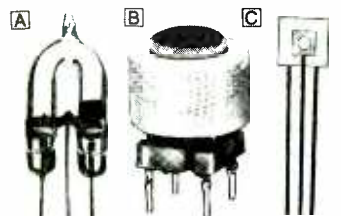

- A Xenon Strobe Flashtube.** Bright, long-life. Great for projects or replacement use. Trigger voltage: 4kV. Anode: 300V maximum. 200V min. With specs. 272-1145 . . . 2.99
- B 4kV Trigger Coil.** Use with flashtube (above). Requires 200-300VDC primary source. With wiring diagrams. 272-1146 . . . 1.49
- C LASCR Photo Detector.** Fast response makes it ideal for "slave" photoflash units. TO-92 case. 276-1095 . . . 1.99

Mercury Switch

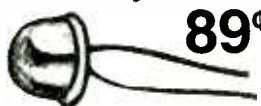

89¢

This submini gravity-actuated switch is ideal for tamper alarms, position detecting and more. Rated 100 milliamps at 24VDC. 275-025 . . . 89¢

Micro Test Clips



149

Pkg. of 2

Insulated

Spring-action—ideal for testing on hi-density PC boards. 1 1/2" long. Solder type. One red, one black. 270-370 . . . Pkg. of 2/1, 4.9

Micronta® Test Equipment Values



1995

3495

A Digital Logic Probe. Simplifies digital troubleshooting by indicating high, low or pulsed logic states with LEDs. Powered by circuit under test. 22-301 . . . 19.95

B 27-Range VOM. Measures AC/DC volts, ohms, DC milliamps, decibels. Big 4" mirrored scale. 30,000 ohms per volt DC sensitivity. With leads, manual. Requires "AA" and 9V batteries. 22-203 . . . 34.95



Binding Post Set

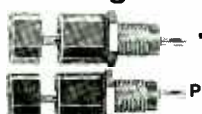

139

Pkg. of 2

Secure contact with push to release. Accept up to 14-gauge wire. Includes one red, one black. 274-660 . . . Pkg. of 2/1, 3.9

IC Protector Mat



NEW!

Only **89¢**

5 x 5" conductive foam mat protects sensitive ICs from static charges. Pays for itself with the first chip it saves! 276-2400 . . . 89¢

'Phone Adapters



A 1/4" Stereo Phone Jack to 1/8" Stereo Phone Plug. Use standard stereo headphones with the new mini portables. 274-366 . . . 2.59

B 1/8" Stereo Jack to 1/4" Stereo Plug. Use "mini" headphones with std. jacks. 274-367 . . . 2.39

5-Volt Reed Relay

Only

99¢



DPST contacts rated 0.5 amp at 125VAC 5-volt, 180-ohm coil. PC board mountable. 275-228 . . . 99¢

DC Microammeter



Cut 33%

Reg. 8.95

595

0 to 50 Microamps DC. Precision jeweled movement and easy-to-read face. 270-1751 . . . Sale 5.95

Radio Shack®

A DIVISION OF TANDY CORPORATION • OVER 8200 LOCATIONS IN 76 COUNTRIES

Retail prices may vary at individual stores and dealers

16K Memory

4116-200ns **8/15.95**

ALL MERCHANDISE 100% GUARANTEED!

CALL US FOR VOLUME QUOTES

EPROMS

	Each	8 pcs
1702 256 x 8 (1ns)	4.95	4.50
2708 1024 x 8 (450ns)	2.99	2.75
2758 1024 x 8 (5V) (450ns)	9.95	8.95
TMS2516 2048 x 8 (5V) (450ns)	6.95	5.95
2716 2048 x 8 (5V) (450ns)	5.50	4.95
2716-1 2048 x 8 (5V) (350ns)	9.00	8.50
TMS2716 2048 x 8 (450ns)	9.95	8.95
TMS2532 4096 x 8 (5V) (450ns)	12.95	11.95
2732 4096 x 8 (5V) (450ns) (200ns)	CALL	CALL
2764 8192 x 8 (5V) (450ns)	CALL	CALL

DYNAMIC RAMS

	100 pcs
4027 4096 x 1 (250ns)	2.50 2.00
4116-120 16,384 x 1 (120ns)	8/29.95 CALL
4116-150 16,384 x 1 (150ns)	8/18.95 1.95
4116-200 16,384 x 1 (200ns)	8/15.95 1.80
4116-300 16,384 x 1 (300ns)	8/14.95 1.75
4164 64,536 x 1 (200ns)	CALL

STATIC RAMS

	100 pcs
2101 256 x 4 (450ns)	1.95 1.85
2102-1 1024 x 1 (450ns)	.89 .85
21L02-4 1024 x 1 (LP) (450ns)	1.29 1.15
21L02-2 1024 x 1 (LP) (250ns)	1.69 1.55
2111 256 x 4 (450ns)	2.99 2.49
2112 256 x 4 (450ns)	2.99 2.79
2114 1024 x 4 (450ns)	8/16.95 1.95
2114L-2 1024 x 4 (LP) (200ns)	8/19.95 2.35
2114L-3 1024 x 4 (LP) (300ns)	8/18.95 2.25
2114L-4 1024 x 4 (LP) (450ns)	8/17.95 2.10
2147 4096 x 1 (55ns)	9.95 CALL
TMS4044-4 4096 x 1 (450ns)	3.49 3.25
TMS4044-3 4096 x 1 (300ns)	3.99 3.75
TMS40L44-2 4096 x 1 (LP) (200ns)	4.49 4.25
TMM2016 2048 x 8 (200ns) (150ns)	CALL
HM6116 2048 x 8 (200ns) (150ns) (120ns)	CALL

LP = LOW POWER

CRYSTALS

32.768 KHZ	3.95
1.0 MHZ	4.95
1.8432	4.95
2.0	3.95
2.097152	3.95
2.4576	3.95
3.2768	3.95
3.579545	3.95
4.0	3.95
5.0	3.95
5.0688	3.95
5.185	3.95
5.7143	3.95
6.5536	3.95
8.0	3.95
10.0	3.95
14.31818	3.95
18.0	3.95
18.432	3.95
20.0	3.95
22.1184	3.95
32.0	3.95

MISC.

AY5-2376	12.50
11C90	13.95
XR2206	4.95
3242	7.95
3480	9.00
MC4024	3.95
MC4044	4.50
7103	9.50
7106	9.95
7107	12.95
76477	3.95
8038	3.95
95H90	7.99
9602	1.50

DISC CONTROLLERS

1771	24.95
1791	36.95
1793	44.95
1797	54.95
UPD765	39.95

UARTS

AY3-1014	6.95
AY5-1013	3.95
TR1602	4.95
IM6402	7.95

INTERFACE

8T26	1.69
8T28	2.49
8T95	.99
8T96	.99
8T97	.99
8T98	.99
DM8131	2.95
DS8836	1.29

CLOCK CIRCUITS

MM5369	3.95
MM5375	3.95
MSM5832	7.45
7207	7.50
7208	15.95

CONVERTERS

MC1408 L8	4.95
DAC-0800	4.95
ADC-0804	4.95

MAY SPECIALS

16K APPLE* RAM CARD

* Upgrade your 48K Apple II to full 64K.

* Fully software and hardware compatible with Apple language card and microsoft 280 card.

* Eliminates the need for Applesoft or Integer Basic ROM card when used in conjunction with DOS 3.3.

* Allows you to run Apple Fortran or Pascal.

* Available as bare board, kit, or completed and tested board.

BARE BOARD \$ 40.00

KIT 89.95

ASSEMBLED & TESTED 109.95

6883 SAM 24.95

RS232 FEMALE 3.49

RS232 RIGHT ANGLE FEMALE 4.95

RS232 MALE 2.99

RS232 HOOD99

Specials end May 31, 1982. Please state "May Specials" when ordering.

6502

6502	6.95
6502-A	12.95
6504	6.95
6505	8.95
6507	9.95
6520	4.35
6522	9.95
6532	14.95
6551	11.85

Z80

Z80-CPU	8.95
Z80A-CPU	6.00
Z80-P10	6.50
Z80A-P10	6.00
Z80-CTC	5.95
Z80A-CTC	8.65
Z80-DART	15.25
Z80A-DART	18.75
Z80-DMA	17.50
Z80A-DMA	27.50
Z80-S100	23.95
Z80A-S10/0	28.95
Z80-S10/1	23.95
Z80A-S10/1	28.95
Z80-S10/2	23.95
Z80A-S10/2	28.95
Z80-S10/09	17.95
Z80A-S10/9	22.95
Z80B-CPU	18.95
Z80B-CTC	17.95
Z80B-P10	17.95
Z8671	39.95
Z6132	34.95

74LS00 SERIES

74LS00	25	74LS85	1.15	74LS166	2.40	74LS293	1.85
74LS01	25	74LS86	40	74LS168	1.75	74LS295	1.05
74LS02	25	74LS90	65	74LS169	1.75	74LS298	1.20
74LS03	25	74LS91	89	74LS170	1.75	74LS324	1.75
74LS04	25	74LS92	70	74LS173	.80	74LS352	1.55
74LS05	25	74LS93	65	74LS174	.95	74LS353	1.55
74LS08	35	74LS95	85	74LS175	.95	74LS363	1.35
74LS10	25	74LS96	95	74LS181	2.15	74LS364	1.95
74LS11	35	74LS97	95	74LS189	9.95	74LS365	95
74LS12	35	74LS98	40	74LS190	1.00	74LS366	95
74LS13	45	74LS99	40	74LS191	1.00	74LS367	70
74LS14	100	74LS100	40	74LS192	85	74LS368	70
74LS15	35	74LS101	45	74LS193	95	74LS373	99
74LS20	25	74LS102	50	74LS194	1.00	74LS374	1.75
74LS21	35	74LS103	45	74LS195	95	74LS377	1.45
74LS22	25	74LS104	95	74LS196	.85	74LS378	1.18
74LS26	35	74LS105	2.99	74LS197	.85	74LS379	1.35
74LS27	35	74LS125	95	74LS221	1.20	74LS385	1.90
74LS28	35	74LS126	85	74LS240	99	74LS386	65
74LS30	25	74LS132	75	74LS241	99	74LS390	1.90
74LS32	35	74LS136	55	74LS242	1.85	74LS393	1.90
74LS33	55	74LS137	99	74LS243	1.85	74LS395	1.65
74LS37	55	74LS138	75	74LS244	.99	74LS399	1.70
74LS38	35	74LS139	75	74LS245	1.90	74LS424	2.95
74LS40	35	74LS141	2.49	74LS247	.76	74LS447	.37
74LS42	55	74LS142	1.35	74LS248	1.25	74LS490	1.95
74LS47	75	74LS143	1.35	74LS249	.99	74LS668	1.69
74LS48	75	74LS145	1.75	74LS251	1.30	74LS669	1.89
74LS49	75	74LS147	2.35	74LS253	.85	74LS670	2.20
74LS51	25	74LS151	1.15	74LS257	.85	74LS674	9.65
74LS54	35	74LS156	95	74LS258	.85	74LS682	3.20
74LS55	35	74LS157	75	74LS259	2.85	74LS683	2.30
74LS63	1.25	74LS158	75	74LS260	.65	74LS684	2.40
74LS73	40	74LS159	75	74LS266	.65	74LS685	2.40
74LS74	45	74LS160	90	74LS273	1.65	74LS688	2.40
74LS75	50	74LS162	95	74LS275	3.35	74LS689	2.40
74LS76	40	74LS163	95	74LS279	.55	81LS95	1.69
74LS78	50	74LS164	95	74LS280	1.98	81LS96	1.69
74LS83	75	74LS165	95	74LS283	1.00	81LS97	1.69
				74LS290	1.25	81LS98	1.69

HOURS: Mon. - Fri., 9 to 5; Sat., 11 to 3

VISIT OUR RETAIL STORE!



JDR MICRODEVICES, INC.

1224 So. Bascom Ave.
San Jose, CA 95128
800-538-5000 • 800-662-6279 (CA)
(408) 995-5430 • Telex 171-110

TERMS: For shipping include \$2.00 for UPS ground, \$3.00 for UPS Blue Label air. \$10.00 minimum order. Bay Area residents add 6 1/2 % sales tax. California residents add 6 % sales tax. We reserve the right to limit quantities and substitute manufacturer. Prices subject to change without notice. Send SASE for complete list.

2716 EPROMS 450NS (5V)

8/4.95 ea.

ALL MERCHANDISE 100% GUARANTEED!

CALL US FOR VOLUME QUOTES

8000

8035	16.95
8039	19.95
8080A	3.95
8085	12.95
8085A-2	16.95
8086	99.95
8088	39.95
8155	11.95
8156	11.95
8185	29.95
8185-2	39.95
8741	39.95
8748	29.95
8755	44.95

8200

8202	45.00
8205	3.50
8212	1.85
8214	3.85
8216	1.80
8224	2.50
8226	1.80
8228	4.90
8237	19.95
8238	4.95
8239	4.85
8243	4.45
8250	14.95
8251	4.75
8253	9.25
8253-5	9.85
8255	4.75
8255-5	5.25
8257	8.75
8259	6.90
8272	39.95
8275	29.95
8279	9.50
8279-5	10.50
8282	6.65
8283	6.65
8284	5.70
8286	6.65
8287	6.50
8288	25.00
8289	49.95

TV CIRCUITS

MC1330	1.89
MC1350	1.29
MC1358	1.79
LM380	1.29
LM386	1.50
LM565	.99
LM741	.29
LM1310	2.90
LM1800	2.99
LM1889	2.49



APPLE* FAN \$69.00

- EXTRA PLUG-IN CARDS CAN CAUSE YOUR APPLE TO OVERHEAT
- ULTRA-QUIET APPLE FAN DRAWS COOL AIR THROUGH YOUR COMPUTER
- ELIMINATES DOWN TIME
- SAVES REPAIR CHARGES
- INCREASES RELIABILITY
- CLIPS ON — NO HOLES OR SCREWS
- COLOR MATCHES APPLE
- LONG LIFE, LOW NOISE MOTOR



*APPLE IS A TRADEMARK OF APPLE COMPUTER INC.

IC SOCKETS

	1-99	100
8 pin ST	13	.11
14 pin ST	15	.12
16 pin ST	17	.13
18 pin ST	20	.18
20 pin ST	29	.27
22 pin ST	30	.27
24 pin ST	30	.27
28 pin ST	40	.32
40 pin ST	49	.39
ST = SOLDDERTAIL		
8 pin WW	59	.49
14 pin WW	69	.52
16 pin WW	69	.58
18 pin WW	99	.90
20 pin WW	1.09	.98
22 pin WW	1.39	1.28
24 pin WW	1.49	1.35
28 pin WW	1.69	1.49
40 pin WW	1.99	1.80
WW = WIREWRAP		

CONNECTORS

RS232 MALE	3.25
RS232 FEMALE	3.75
RS232 HOOD	1.25
S-100 ST	3.95
S-100 WW	4.95

DIP SWITCHES

4 POSITION	85
5 POSITION	90
6 POSITION	90
7 POSITION	95
8 POSITION	95

6800

6800	5.70
6802	10.95
6808	9.95
6809	24.95
6809E	29.95
6810	4.60
6820	4.95
6821	4.95
6828	14.95
6834	16.95
6840	14.95
6843	42.95
6844	44.95
6845	16.95
6847	15.95
6850	4.75
6852	5.75
6860	10.95
6862	11.95
6875	6.95
6880	2.95
68B00	10.95
68B21	12.95
68B50	12.95

LEDS

Jumbo Red	10/1.00
Jumbo Green	6/1.00
Jumbo Yellow	6/1.00
5082-7760 43'CC	.79
MAN74 3'CC	.99
MAN72 3'CA	.99

EPROM ERASERS

PE-14	78.50
PE-14T (with timer)	108.50
PE-24T (with timer)	154.50

ALL ARE HIGH QUALITY UNITS ENCLOSED IN A BLACK ANODIZED ALUMINUM ENCLOSURE.

800-538-5000

800-662-6279

(CALIFORNIA RESIDENTS)

CALL JDR BEFORE YOU BUY!

WE WILL BEAT ANY COMPETITORS' PRICES

VOLTAGE REG'S

7805T	.79	7905T	.89
7808T	.99	7912T	.89
7812T	.79	7915T	1.19
7815T	.99	7924T	1.19
7824T	.99		
7805K	1.39	7905K	1.49
7812K	1.39	7912K	1.49
7815K	1.39	79L05	.79
78L05	.69	79L12	.79
78L12	.69	79L15	.79
78L15	.69		
LM309K	1.49	LM317K	3.95
LM317T	1.95	LM323K	4.95
		LM337K	3.95
T=TO-220 K=TO-3 L=TO-92			

LINEAR

LM301V	.34
LM308V	.98
LM309K	1.49
LM311	.64
LM317T	1.95
LM317K	3.95
LM318	1.49
LM323K	4.95
LM324	.59
LM337K	3.95
LM339	.99
LM377	2.29
LM380	1.29
LM386V	1.50
LM555V	.39
LM556	.69
LM565	.99
LM566V	1.49
LM567V	1.29
LM723	.49
LM733	.98
LM741V	.29
LM747	.79
LM748V	.59
LM1310	2.90
MC1330V	1.89
MC1350V	1.29
MC1358	1.79
LM1414	1.59
LM1458V	.69
LM1488	.99
LM1489	.99
LM1800	2.99
LM1889	2.49
LM3900	.59
LM3909V	.98
LM3914	3.95
LM3915	3.95
LM3916	3.95
75451V	.39
75452V	.39
75453V	.39

7400 SERIES

7400	.19	7451	.23	74136	.50	74186	18.50
7401	.19	7453	.23	74141	.65	74190	1.15
7402	.19	7454	.23	74142	2.95	74191	1.15
7403	.19	7460	.23	74143	2.95	74192	.79
7404	.19	7470	.35	74144	2.95	74193	.79
7405	.22	7472	.29	74145	.60	74194	.85
7406	.22	7473	.34	74147	1.75	74195	.85
7407	.22	7474	.35	74148	1.20	74196	.79
7408	.24	7475	.49	74150	1.35	74197	.75
7409	.19	7476	.35	74151	.65	74198	1.35
7410	.19	7480	.59	74152	.65	74199	1.35
7411	.25	7481	1.10	74153	.55	74221	1.35
7412	.30	7482	.95	74154	1.40	74246	1.35
7413	.35	7483	.50	74155	.75	74247	1.25
7414	.55	7485	.65	74156	.65	74248	1.85
7416	.25	7486	.35	74157	.55	74249	1.95
7417	.25	7489	4.95	74159	1.65	74251	.75
7420	.19	7490	.35	74160	.85	74259	2.25
7421	.35	7491	.40	74161	.70	74265	1.35
7422	.29	7492	.50	74162	.85	74273	1.95
7423	.29	7493	.49	74163	.85	74276	1.25
7425	.29	7494	.65	74164	.85	74279	.75
7426	.29	7495	.55	74165	.85	74283	2.00
7427	.29	7496	.70	74166	1.00	74284	3.75
7428	.45	7497	2.75	74167	2.95	74285	3.75
7430	.19	74100	1.00	74170	1.65	74290	.95
7432	.29	74107	.30	74172	5.95	74293	.75
7433	.45	74109	.45	74173	.75	74298	.85
7437	.29	74110	.45	74174	.89	74351	2.25
7438	.29	74111	.55	74175	.89	74365	.65
7440	.19	74116	1.55	74176	.89	74366	.65
7442	.49	74120	1.20	74177	.75	74367	.65
7443	.65	74121	.29	74178	1.15	74368	.65
7444	.69	74122	.45	74179	1.75	74376	2.20
7445	.69	74123	.55	74180	.75	74390	1.75
7446	.59	74125	.45	74181	2.25	74393	1.35
7447	.69	74126	.45	74182	.75	74425	3.15
7448	.69	74128	.55	74184	2.00	74426	.85
7450	.19	74132	.45	74185	2.00	74490	2.55

HOURS: Mon. - Fri., 9 to 5; Sat. 11 to 3

JDR MICRODEVICES, INC.
 1224 S. Bascom Ave.
 San Jose, CA 95128
 800-538-5000 • 800-662-6279 (CA)
 (408) 995-5430 • Telex 171-110



TERMS: For shipping include \$2.00 for UPS Ground, \$3.00 for UPS Blue Label Air. \$10.00 minimum order. Bay Area residents add 6 1/2% sales tax. California residents add 6% sales tax. We reserve the right to limit quantities and substitute manufacturer. Prices subject to change without notice. Send SASE for complete list.

Bulova Quartz Ladies Watches

ONE YEAR FACTORY WARRANTY



Your Choice — \$69.95 ea. any Model

CALL OR SEND ORDER IN REFERENCING TO THIS AD FOR SPECIAL PRICE
Because of Limited Supply, please provide a second and third choice

LITRONIX Stick Display Sale

MULTI-DIGIT REFLECTOR ARRAYS FOR CLOCK

SALE!

Part No.	Order Qty.	Price	Part No.	Order Qty.	Price
LS830 (3-Digit)	5 ea.	1.25	LS830 (3-Digit)	5 ea.	1.25
LS830 (3-Digit)	10 ea.	2.25	LS830 (3-Digit)	10 ea.	2.25

MULTI-DIGIT REFLECTOR ARRAYS

Order Qty.	Part No.	Price	Order Qty.	Part No.	Price
5 ea.	LS830 (3-Digit)	1.25	5 ea.	LS830 (3-Digit)	1.25
10 ea.	LS830 (3-Digit)	2.25	10 ea.	LS830 (3-Digit)	2.25

NATIONAL Stick Display Sale

LED NUMERIC ARRAYS

SALE!

Part No.	Order Qty.	Price	Part No.	Order Qty.	Price
NS430 (3-Digit)	5 ea.	1.25	NS430 (3-Digit)	5 ea.	1.25
NS430 (3-Digit)	10 ea.	2.25	NS430 (3-Digit)	10 ea.	2.25

COMPUTER GRADE CAPACITORS

MFD	VWDC	PRICE	MFD	VWDC	PRICE
10	50	0.02	10	100	0.03
10	200	0.04	10	200	0.04

LOW PROFILE (TIN) SOCKETS

Pin	1-24	25-49	50-100
8 pin LP	.17	.16	.15
14 pin LP	.20	.19	.18

SOLDERTAIL STANDARD (TIN)

Pin	1-24	25-49	50-100
8 pin WW	.59	.54	.49
10 pin WW	.69	.63	.58

WIRE WRAP SOCKETS (GOLD) LEVEL #3

Pin	1-24	25-49	50-100
8 pin WW	.59	.54	.49
10 pin WW	.69	.63	.58

1/4 WATT RESISTOR ASSORTMENTS - 5%

ASST. 1	5 ea.	10 Ohm	12 Ohm	15 Ohm	18 Ohm	22 Ohm	50 pcs.	\$1.95
ASST. 2	5 ea.	180 Ohm	220 Ohm	270 Ohm	330 Ohm	390 Ohm	50 pcs. <td>\$1.95</td>	\$1.95

Jameco ELECTRONICS

1355 SHOREWAY ROAD, BELMONT, CA 94002

PHONE ORDERS WELCOME — (415) 592-8017

INTERMIL

Part No.	Function	Price
7045PT	CMOS Precision Timer	14.95
7045EV/Kit*	Stowpatch Chip, XTL	24.95
7106CPL	3W Digt A/D (LCD Drive)	16.95
7106EV/Kit*	IC, Circuit Board, Display	34.95
7107CPL	3W Digt A/D (LED Drive)	15.95
7107EV/Kit*	IC, Circuit Board, Display	29.95

7400

SN7400N	.20	SN7402N	.25	SN74156N	.79
SN7401N	.20	SN7403N	.25	SN74157N	.79

7401

7401	.39	7402	.39	7403	.39
7404	.39	7405	.39	7406	.39

LINEAR

LM702H	.79	LM703C	.89	LM709N	.29
LM714CN	.29	LM7171N	.29	LM7233N	.69

7400

SN7400N	.20	SN7402N	.25	SN74156N	.79
SN7401N	.20	SN7403N	.25	SN74157N	.79

74LS

74LS00	.29	74LS02	.35	74LS156	1.15
74LS01	.29	74LS03	.35	74LS157	1.15

7401

7401	.39	7402	.39	7403	.39
7404	.39	7405	.39	7406	.39

74LS

74LS00	.45	74LS02	.55	74LS156	1.25
74LS01	.45	74LS03	.55	74LS157	1.25

CA-LINEAR

CA3010H	.99	CA3013H	2.15	CA3019H	1.25
CA3023H	3.25	CA3039H	2.40	CA3046N	1.30

CD-CMOS

CD4001	.39	CD4002	.39	CD4048	2.49
CD4003	.39	CD4004	.39	CD4050	.75

CAPACITOR CORNER

50 VOLT CERAMIC DISC CAPACITORS

Value	1-9	10-99	100+	Value	1-9	10-99	100+
10 pF	.08	.06	.05	100 pF	.08	.06	.05
22 pF	.08	.06	.05	220 pF	.08	.06	.05

100 VOLT MYLAR FILM CAPACITORS

100mf	.12	100	.07	0.22mf	.13	.11	.08
0.022mf	.12	10	.07	0.47mf	.21	.17	.13

MINI ALUMINUM ELECTROLYTIC CAPACITORS

Axial	1-99	100-499	500+	Radial	1-99	100-499	500+
4.7uF	.10	.10	.10	10uF	.15	.13	.12

(Continued from page 107)

ground in electronics is assumed even for the simpler experiments, although the experimental sequence is such that a student or hobbyist can practice the fundamentals of amplifier circuits before progressing to the electronics of r-f and touch-tone transmission. Specifically, the experiments cover such topics as AM and FM demodulation, SSB product detector demodulation, PLL detectors, touch-tone decoders, etc. Each experiment is presented with a parts list, and a list of the equipment required to test a circuit (usually a scope, function generator, DMM, and power supply). Self-test sections provide questions and answers. Device specification sheets are included.

Published by McGraw-Hill, 1271 Avenue of the Americas, N.Y., NY, 10020. Soft cover. 8 1/2" x 11" size; 186 pages; \$7.95.

Microprocessor Operating Systems

Edited by John Zarella

This book describes nine of the more important operating systems for microprocessors. It is intended for anyone involved in selecting, evaluating, or designing operating systems to support applications software. Included are National Semiconductor's BLMX-80, Intel's iRMX 80/88 and iRMX 86, Data General's MP/OS, Texas Instruments'

Rx, Bell Lab's UNIX, Motorola's VER-5Ados, and Zilog's RIO/CP and ZRTS. Each company's system is explained by an employee of that company—which seems to make for a complete, though somewhat biased description—but the listing of competing systems in a single book can facilitate a more objective comparison on the part of the reader. The technical focus is on multitasking, memory management, interfacing, and language support.

Published by: Microcomputer Applications, Suisun City, CA 94585. Soft cover. 208 pages. \$11.95.

The Complete Handbook of Magnetic Recording

by Finn Jorgensen

Here is a reference book that covers the entire field of magnetic recording in considerable detail. The first part is an overview of the history of recording. Then modern recording techniques and equipment are discussed, along with a comparison of their technical specifications. Attention is given to the theory of magnetism and acoustics, with ample diagrams and equations describing induction, coercivity, retentivity, etc. The language is clear; even a layman should be able to understand most of it. But if your only interest in magnetic recording is in deciding what tape deck or tape brand you should buy, you might find it tedious going through all the theory

before you get to the pertinent information. This is an excellent book, however, if you're interested in theory.

Published by TAB Book., Inc., Monterey Ave., Blue Ridge Summit, PA 17214. Soft cover. 448 pages. \$10.95

Computers and the Radio Amateur

by Phil Anderson

Written for the DXer with little background in computing, this book explores the possibilities that home computers can offer to the world of ham radio. The beginning chapters give an overview of the applications for computer equipment in the hamshack: a memory keyer for code paddles, a CW keyboard, 24-hour clock, RTTY or ASCII terminal, Morse reader, random code generator, message taker, QSL generator and filer, and station logger. The chapters explaining the principles of computer hardware and software are reasonably informative, but you're probably better off getting that kind of instruction from a source devoted exclusively to teaching a novice how to use a home micro. Once you have acquired some knowledge of computer fundamentals, you should know enough to go on to the chapter on interfacing the computer to your DX equipment.

Published by Prentice-Hall, Inc., Englewood Cliffs, NJ 07632. Hard cover. 208 pages. \$18.95.

QUEST ELECTRONICS

FULL LINE ALL PARTS & COMPUTER PRODUCTS

P.O. Box 44300
Santa Clara, CA 95054

Will call: 2322 Walsh Ave.
(408) 988-1640

Same day shipment. First line parts only. Factory tested. Guaranteed money back. Quality IC's and other components at factory prices.

Phone orders only (800) 538-8196

INTEGRATED CIRCUITS

74LS00 TTL	MOS MEMORY	PROM	MICROPROCESSOR	IC SOCKETS	DISPLAY LEADS
74LS00N 25 RAM 17024	25 2101-1 1.95 2532	4.50 8502	6.95	Solder Tin Low Profile	MAN7274 CA CA 300 75
74LS02N 25 2101-1 1.95 2532	17.50 8502A 9.50	17.50 8502A 9.50	6.95	PIN TUP PIN TUP	DL1704 CA CA 300 75
74LS04N 25 2102AL-4 1.25 27181	8.50 8552 8.75	14 14 24 30	14.95	DL1727/28 CA CC 500 190	DL1702 DL1707R CA CC 300 100
74LS08N 25 2102AM-2L 1.65 2718 5 Volt	5.50 8530 9.50	18 18 28 40	14.95	DL1747/750 CA CC 800 149	FN359 CA CC 257 70
74LS10N 25 2104B-4 4.95 82718 5 Volt	4.95 82718 5 Volt	39.00 8532 14.95	18 20 38 50	FN359 CA CC 257 70	
74LS13N 45 2107B-4 3.75 2732	17.50 8551 11.85	20 29 40 49	11.85	FN500 507 CA CA 500 99	
74LS14N 99 2111-1 2.99 2758	7.49 8600 5.79		5.79	FN500 S10 CA CC 25 90	
74LS20N 25 2112-2 2.99 8741A	39.95 8802 11.95		11.95	FN500 S10 CA CC 25 90	
74LS22N 25 2114 2.24 8748	39.95 8820 4.95	14 55 74 83	4.95	10 digit display CA CC 25 90	
74LS23N 35 2114L 300ns 2.50 8748-B	34.95 8850 3.50	16 57 28 1.95	16 57 28 1.95	7500 Glarex photocells CA CC 300 220	
74LS24N 25 2114L 450ns 2.37 8755A	49.95 8808A 3.95	19 67 40 1.59	19 67 40 1.59	TL1311 Hex CA CC 800 220	
74LS33N 55 2116 200ns 7.50 NR2523	2.95 280A 8.00	8.50 2.95	8.50	MAN4610 CA CA 40 99	
74LS37N 45 2116 200ns 7.50 NR2523	3.95 280A 8.00	8.50 2.95	8.50	MAN4610 CA CA 40 99	
74LS74N 45 MM5280 3.00 NR2526	5.75 8212 1.85		1.85	MAN4710 CA CC 40 95	
74LS75N 50 MM5291 9.95 NR2529	4.75 8214 3.75	2 MHz 3.95	3.95	MAN4740 CA CC 20 49	
74LS90N 60 MM5330 3.94 NR2531	4.95 8216 1.80	4 MHz 3.95	3.95	MAN5110 CA CC 95 99	
74LS93N 65 PS101L 8.95 NR2537	8.75 8224 2.50	4 MHz 3.95	3.95	MAN5710 CA CC 60 99	
74LS95N 85 4208A 11.94 NR2538	2.95 8228 4.95	5 MHz 3.95	3.95	MAN6740 CA CC 60 99	
74LS107N 40 9388 3.00 8223	3.50 8251 4.75	16 MHz 3.95	3.95		
74LS112N 45 410D 10.00	8253 8.95	18 MHz 3.95	3.95		
74LS113N 45 415 7.50	8255 4.75	20 MHz 3.90	3.90		
74LS132N 75 TM2016 12.95 8095	65 8257 8.75	32 MHz 4.00	4.00		
74LS138N 49 HM6116 12.95 8096	65 8259 6.90	32768 Hz 4.00	4.00		
74LS151N 75 2809 18.95 8098	65 1802CE plus 13.95	1.8525 MHz 4.50	4.50		
74LS155N 75 MICROPROCESSOR 8097	65 1802E plus 13.95	3.5785 MHz 4.50	4.50		
74LS157N 75 2809 18.95 8098	1.25 1861P 5.95	2.0100 MHz 1.95	1.95	56 key ASCII keyboard kit \$74.95	
74LS162N 95 280 P10 6.50 8109	1.25 1861P 5.95	2.097152 MHz 3.95	3.95	Fully assembled 84.50	
74LS163N 95 280A P10 5.95 8113	1.40	2.4576 MHz 3.95	3.95	Mini-Enclosure 19.95	
74LS174N 95 280 CTC 8.65 8120	1.75	2.7288 MHz 3.95	3.95	Enclosure 69.95	
74LS190N 100 280A CTC 8.65 8120	1.40	3.0090 MHz 3.95	3.95		
74LS221N 19 1UR ARTIFID	8.75	3.5180 MHz 3.95	3.95		
74LS259N 69 4145 3.95 8124	1.69	3.7443 MHz 3.95	3.95		
74LS367N 69 3341 6.95 8125	3.20	4.5536 MHz 3.95	3.95		

Linear CMOS and 7400 complete lines in stock. Send for catalog.

IC SOCKETS

WIRE WRAP LEVEL 3

CRYSTALS

KEYBOARDS

TYPE-N-TALK BY VOICEX

RESISTORS % watt 5%

8-4116 RAM 200ns \$815.40

Modem Kit \$60.00
State of the art, orig., answer. No tuning necessary. 103 compatible 300 baud. Inexpensive acoustic coupler plans included. Bd. Only \$17.00. Article in June Radio Electronics.

280 Microcomputer
16 bit I/O. 2 MHz clock. 2K RAM. ROM Breadboard space. Excellent for control. Bare Board \$28.50. Full Kit \$99.00. Monitor \$20.00. Power Supply Kit \$35.00. Tiny Basic \$30.00

Video Modulator Kit \$9.95
Convert TV set into a high quality monitor w/o affecting usage. Comp. kit w/full instr.

Multi-volt Computer Power Supply
8v 5 amp. ±18v 5 amp. 5v 1.5 amp. -5v 1.5 amp. 12v 5 amp. -12v option. ±5v. ±12v are regulated. Basic Kit \$35.95. Kit with chassis and all hardware \$51.95. Add \$4.00 shipping.

60 MHz Crystal Time Base Kit \$4.40

Rockwell AIM 65 Computer
6502 based single board with full ASCII keyboard and 20 column thermal printer. 20 char. alphanumeric display ROM monitor; fully expandable. \$419.00. 4K version \$449.00. 4K Assembler \$35.00. 8K Basic \$65.00 FORTH \$65.00

Free 14 Page Brochure
Send or call for a free brochure on all details and pricing of the Super Elf and its expansion. We will get it right out to you!

Free 14 Page Brochure
Send or call for a free brochure on all details and pricing of the Super Elf and its expansion. We will get it right out to you!

TERMS: \$5.00 min. order U.S. Funds. Calif. residents add 6% tax. \$10.00 min. VISA and MasterCard accepted. \$1.00 insurance optional. Shipping: Add 5%; orders under \$25.00—10%.

FREE: Send for your copy of our NEW 1982 QUEST CATALOG. Include 88¢ stamp.

CIRCLE NO. 41 ON FREE INFORMATION CARD

www.americanradiohistory.com

HIGHWAY 8-346-444 CORPORATION

In Mn., Ak., Ill. Call 218-681-6674

NATIONAL SEMICONDUCTOR • PANASONIC • QUALITY — Name brand products from nationally recognized manufacturers.
ARVID • CHEM-UK • BISHOP GRAPHICS • N. ARIES • PLESSEY • MOLEX • AVID • E. J. MACHINE • DIAMOND TOOL • UNGAR • GC CH. AS INSTRUMENTS • ITT • A.P. PRODUCTS • DIA. MOULD TOOL • UNGAR • GC CHEMICALS • ARIES • MOLEX • AVID • E. J.
NATIONAL SEMICONDUCTOR • PANASONIC • SAVINGS — Volume Discounts • OEM Quantity Pricing • Toll Free 800 Number

INTEGRATED CIRCUITS

4116	
Part No.	Price
4116A	1.50
4116B	1.50
4116C	1.50
4116D	1.50
4116E	1.50
4116F	1.50
4116G	1.50
4116H	1.50
4116I	1.50
4116J	1.50
4116K	1.50
4116L	1.50
4116M	1.50
4116N	1.50
4116O	1.50
4116P	1.50
4116Q	1.50
4116R	1.50
4116S	1.50
4116T	1.50
4116U	1.50
4116V	1.50
4116W	1.50
4116X	1.50
4116Y	1.50
4116Z	1.50

TEXAS INSTRUMENTS I.C. SOCKETS

Solder Tab Single Beam Dip Sockets
Body: 54 DVI polymer with Copoly-Alloy contacts.
Accommodates standard IC leads up to 0.18" thick and 0.025" wide. Contact is designed and plated to the optimum to give the lowest "hot" film of Cr-C adhesion for low insertion and high retention forces. Socket is designed to achieve maximum insertion strength.

Tin Plated Solder Tab Single Beam Prof. Dip Sockets
Microhm. 40° to +75°C

Gold Plated Solder Tab Single Beam Low Profile Sockets
Microhm. 45° to +125°C

WIRE WRAP DIP SOCKETS
Standard quality and universal mounting and wiring.

3 AMP SILICON RECTIFIER

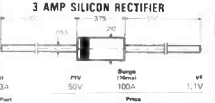

PANASONIC ELECTROLYTIC CAPACITORS

150 CAPACITORS
divided plastic case with built-in surge storage capacitor.
ASSORTMENT OF 15 POPULAR PANASONIC CAPACITORS
\$39.95

Panasonic LS Series Miniature Aluminum Electrolytic Capacitors

ITT SILICON ZENER DIODES

SILICON TRANSISTORS

NEW! KIT PANASONIC DISC CAPACITORS

NEW! KIT PANASONIC POLYESTER CAPACITORS

NEW! KIT PANASONIC METALLIZED POLYESTER CAPACITORS

NEW! KIT TANTALUM CAPACITORS

TANTALUM SUBSTITUTES

PANASONIC G-SERIES CAPACITORS

PANASONIC RL-SERIES CAPACITORS

PANASONIC RL-SERIES CAPACITORS

PANASONIC RL-SERIES CAPACITORS

7400 TTL 74500 TTL 74500 TTL

Part No.	Price	Part No.	Price	Part No.	Price
7400A	1.50	74500A	1.50	74500A	1.50
7400B	1.50	74500B	1.50	74500B	1.50
7400C	1.50	74500C	1.50	74500C	1.50
7400D	1.50	74500D	1.50	74500D	1.50
7400E	1.50	74500E	1.50	74500E	1.50
7400F	1.50	74500F	1.50	74500F	1.50
7400G	1.50	74500G	1.50	74500G	1.50
7400H	1.50	74500H	1.50	74500H	1.50
7400I	1.50	74500I	1.50	74500I	1.50
7400J	1.50	74500J	1.50	74500J	1.50
7400K	1.50	74500K	1.50	74500K	1.50
7400L	1.50	74500L	1.50	74500L	1.50
7400M	1.50	74500M	1.50	74500M	1.50
7400N	1.50	74500N	1.50	74500N	1.50
7400O	1.50	74500O	1.50	74500O	1.50
7400P	1.50	74500P	1.50	74500P	1.50
7400Q	1.50	74500Q	1.50	74500Q	1.50
7400R	1.50	74500R	1.50	74500R	1.50
7400S	1.50	74500S	1.50	74500S	1.50
7400T	1.50	74500T	1.50	74500T	1.50
7400U	1.50	74500U	1.50	74500U	1.50
7400V	1.50	74500V	1.50	74500V	1.50
7400W	1.50	74500W	1.50	74500W	1.50
7400X	1.50	74500X	1.50	74500X	1.50
7400Y	1.50	74500Y	1.50	74500Y	1.50
7400Z	1.50	74500Z	1.50	74500Z	1.50

MOLEX I.C. SOCKET PINS

TEXAS INSTRUMENTS GOLD EDGEBOARD CONNECTORS



SOLEUR TAB CONTACT PINS
Solder Tab Solder Tab Wire-wrap

M SERIES 100 & 200 EDGEBOARD CONNECTORS

M SERIES 125 & 230 EDGEBOARD CONNECTORS

M SERIES 156 & 200 EDGEBOARD CONNECTORS

1/2 WATT RESISTOR ASSORTMENTS

1/2 WATT RESISTOR ASSORTMENTS

1/2 WATT RESISTOR ASSORTMENTS

1/2 WATT RESISTOR ASSORTMENTS

NEW! MA1032 Clock Digital LCD Module

DIGI-KEY DIGI-CLOCK KIT

DIGI-CLOCK KIT

DIGI-CLOCK KIT

DIGI-CLOCK KIT

DIGI-CLOCK KIT

DIGI-CLOCK KIT

DIGI-CLOCK KIT

DIGI-CLOCK KIT

DIGI-CLOCK KIT

DIGI-CLOCK KIT

PANASONIC ISW Series Large Aluminum Electrolytic Capacitors

PANASONIC ISW Series Large Aluminum Electrolytic Capacitors

PANASONIC ISW Series Large Aluminum Electrolytic Capacitors

PANASONIC ISW Series Large Aluminum Electrolytic Capacitors

PANASONIC ISW Series Large Aluminum Electrolytic Capacitors

PANASONIC ISW Series Large Aluminum Electrolytic Capacitors

PANASONIC ISW Series Large Aluminum Electrolytic Capacitors

PANASONIC ISW Series Large Aluminum Electrolytic Capacitors

PANASONIC ISW Series Large Aluminum Electrolytic Capacitors

PANASONIC ISW Series Large Aluminum Electrolytic Capacitors

PANASONIC ISW Series Large Aluminum Electrolytic Capacitors

PANASONIC ISW Series Large Aluminum Electrolytic Capacitors

PANASONIC ISW Series Large Aluminum Electrolytic Capacitors

PANASONIC ISW Series Large Aluminum Electrolytic Capacitors

PANASONIC ISW Series Large Aluminum Electrolytic Capacitors

PANASONIC ISW Series Large Aluminum Electrolytic Capacitors

PANASONIC ISW Series Large Aluminum Electrolytic Capacitors

PANASONIC ISW Series Large Aluminum Electrolytic Capacitors

PANASONIC ISW Series Large Aluminum Electrolytic Capacitors

PANASONIC ISW Series Large Aluminum Electrolytic Capacitors

PANASONIC ISW Series Large Aluminum Electrolytic Capacitors

PANASONIC ISW Series Large Aluminum Electrolytic Capacitors

PANASONIC ISW Series Large Aluminum Electrolytic Capacitors

PANASONIC ISW Series Large Aluminum Electrolytic Capacitors

PANASONIC ISW Series Large Aluminum Electrolytic Capacitors

PANASONIC ISW Series Large Aluminum Electrolytic Capacitors

PANASONIC ISW Series Large Aluminum Electrolytic Capacitors

PANASONIC ISW Series Large Aluminum Electrolytic Capacitors

PANASONIC ISW Series Large Aluminum Electrolytic Capacitors

PANASONIC ISW Series Large Aluminum Electrolytic Capacitors

PANASONIC ISW Series Large Aluminum Electrolytic Capacitors

PANASONIC ISW Series Large Aluminum Electrolytic Capacitors

PANASONIC ISW Series Large Aluminum Electrolytic Capacitors

THE DIGI-KEY VOLUME DISCOUNT AND HANDLING CHARGES ARE SIMPLE TO APPLY. MOST ITEMS SOLD BY DIGI-KEY MAY BE COMBINED FOR A VOLUME DISCOUNT. ITEMS THAT ARE NOT DISCOUNTABLE ARE IDENTIFIED BY THE SUFFIX "ND" FOLLOWING THE PART NUMBER. AFTER WRITING YOUR ORDER, TOTAL ALL OF THE DISCOUNTABLE ITEMS AND APPLY THE APPROPRIATE DISCOUNT. TO THIS SUBTOTAL, ADD THE NON-DISCOUNTABLE ITEMS. THEN ADD THE HANDLING CHARGE. WE PAY ALL SHIPPING AND INSURANCE TO ADDRESSES IN THE U.S.A., CANADA AND MEXICO WHEN CHECK OR MONEY ORDER OCCASIONES ORDER.

WHEN ORDERING BY PHONE, CALL 1-800-346-5144 (Mn., Ak., Ill. call 218-681-6674) By mail send your order to: DIGI-KEY, Highway 22 South, Thiel River Falls, MN 56701

You may pay by check, money order, Master Charge, VISA or C.D. DIGI-KEY GUARANTEE: Any parts or products purchased from DigI-Key that prove to be defective will be replaced or refunded if returned within 90 days from receipt with a copy of your invoice. Prices subject to change without notice.

CIRCLE NO. 10 ON FREE INFORMATION CARD

www.americanradiohistory.com

ON-LINE DATABASE



The ON-LINE DATABASE is designed for high speed retrieval of large numbers of records. Using a machine language binary search and retrieve routing, it will locate any record within a maximum of 3 seconds, with 1000 records on file.

Using an assumed field option, redundant data for each record only has to be entered once.

A flexible report writer allows you to customize your printout. In addition, two built-in mailing label formats are provided.

Other features include:

- user defined sort & retrieval keys
- full screen cursor control during entry & editing of data
- print or display option at all times
- fully menu driven

The ON-LINE DATABASE is standard OOS 3.3, may be copied for backup purposes and is listable. No programming knowledge is required, and a tutorial with sample data is included.

Utilities available include:

- file merging
- arithmetic operations
- flexible mail label formats

Price: \$100.00



BLUE LAKES COMPUTING

3240 University Avenue
Madison, WI 53705
(608) 233-6502

CIRCLE NO. 125 ON FREE INFORMATION CARD

You can pay more — But you can't get more!



Model III 16K
\$839

Model III 48K
2 disc & RS232C
\$2100

Color Computer 4K
w/16K Ext. Basic
\$310
\$459

BUY DIRECT. These are just a few of our great offers which include Printers, Modems, Computers, Peripherals, Disc Drives, Software and more. **call TOLL FREE 1-800-343-8124**

We have the lowest possible fully warranted prices and a full complement of Radio Shack Software.



Write for your free catalog.
245A Great Road
Littleton, MA 01460
617 • 486 • 3193

CIRCLE NO. 128 ON FREE INFORMATION CARD

USE YOUR COMPUTER to transmit/receive data up to 300 Baud RTTY!



With the TU-300, a radio receiver and RTTY software for your computer, you can receive and transmit radio teletype. The TU-300 interfaces with RS-232 and TTL-type I/O's. 170 Hz standard, 425Hz/850Hz optional.

Fully assembled or easy-to-build kit.



Flesher Corporation
507 Jackson - P.O. Box 976
Topeka, Kansas 66601
913-234-0198 • telex 437125

Call or write

CIRCLE NO. 131 ON FREE INFORMATION CARD

UNIPROM

THE VERSATILE EPROM HANDLING SYSTEM

Reads/programs 2704, 2708, 2758, 2508, 2516, 2716 (1 supply), 2532 (T. I. pinout) and Intel/NEC 8755A with no personality modules required! All power is derived from the S-100 bus, all signals are S-100 compatible. Port mapping occupies NO memory space!

The UNIPROM software is 8080/280 compatible (2 or 4 mhz.) and includes a "menu" command, "intelligent" EPROM read/write and disk I/O commands, and functions usually found only in "monitors" and "debuggers."

Software is both on standard diskette formats or on a "bootstrappable" EPROM. Software is CDOS and CP/M compatible.

UNIPROM board (A & T) with documentation, including source listings — \$199.00.

UNIPROM disk-based software with source and listing (specify 5.25" or 8" CDOS or CP/M, or NORTHSTAR 5.25" CP/M) — \$38.00.

UNIPROM EPROM-based software with source and bootstrap listing — \$55.00.

CER-TEK, INC.
6020 Doniphan Dr. • El Paso, Texas 79932
(915) 581-6697

CDOS is a registered trademark of CROMECO INC.
CP/M is a registered trademark of DIGITAL RESEARCH, INC.
NORTHSTAR is a registered trademark of NORTHSTAR COMPUTER, INC.

CIRCLE NO. 126 ON FREE INFORMATION CARD

TAKE IT OFF

The Retail Price



IF TOTAL ORDER IS	DISCOUNT
Less than \$100.00	5%
\$100.01 to \$200.00	7 1/2%
\$200.01 to \$300.00	10%
\$300.01 to \$400.00	12 1/2%
\$400.01 to \$500.00	15%
\$500.01 to \$750.00	20%
OVER \$750.00	30%

EXAMPLE OF SAVINGS:

1. The Reprogrammable Data Base, for Apple II is capable of reprogramming 10,000 different types of data. Package also includes a 17 lesson program to teach BASIC, AppleSoft commands. Retail: \$150.00. Take off 7.5%.

2. Contractors "don't delay" The Apple II Construction Accounting program can compute your job costs, payroll and overhead expenses. Retail: \$550.00. Take off 25%.

Discounts are figured on the total merchandise before CA Sales Tax (6%) and Shipping Charges \$4.00. US FOREIGN orders add \$15.00 for Shipping and Handling. We accept Visa, Mastercard and checks.

To place orders or request free brochures, call TOLL FREE - Operator No 831 - 800-824-7868
Alaska/Hawaii 800-824-7919
California 800-852-7777

CREATIVE DISCOUNT SOFTWARE
256 So. Robertson Suite 2156
Beverly Hills, California 90211

TI 99/4
TRS 80
APPLE III

CIRCLE NO. 129 ON FREE INFORMATION CARD

NEC:



COMMODOR VIC. \$CALL

APPLE, ALTOS, HP & XEROX

RCA VP-3501 Videotex

Data Terminal \$345.00

Terminals
Addis. Hazeltine, Televideo
Calculators
H.P. & Sharp
Video Recorders
Mitsubishi (MGA), RCA & Sony
Scotch
Data Diskettes & VCR Tapes

Mail Order: FUTRA COMPANY
P.O. Box 4380-P, Torrance, CA 90510
(213) 328-8951 (800) 421-5006

Retail: OMC
20695 S. Western Ave #124,
Torrance, CA 90501
TWX 910 349-6211 AGENFTRA TRNC

CIRCLE NO. 132 ON FREE INFORMATION CARD

OVER 2,000 DIFFERENT SOFTWARE PROGRAMS IN STOCK

for ATARI • APPLE • PET
TRS-80 • HEWLETT PACKARD

for brochure write or call

COMPUTER CENTER

DigiByte Systems Corp.
31 East 31st Street, New York
480 Lexington Ave., New York
21 West Street, New York
In New York Call (212) 889-8130
Outside New York
Call Toll Free (800) 221-3144

CIRCLE NO. 127 ON FREE INFORMATION CARD

SAVE 90%

YES you can save up to 90% on a computer system of your own.

\$150.00 buys a 4MHz Z80A with 64KB & a real Front Panel

\$200.00 buys a Full Function 24x80 CRT with Keyboard

You can have your own computer and be running Fortran, Basic, Pascal, etc. If you get our

FREE BROCHURE TODAY

DIGATEK CORPORATION
Suite 7
2723 West Butler Drive
Phoenix AZ 85021

**ROLL-YOUR-OWN TECHNOLOGY
AND SAVE A BUNDLE**

CIRCLE NO. 130 ON FREE INFORMATION CARD

Sinclair ZX81

Software on cassette.



MULTIFILE Data Storage System. A versatile multi-purpose filing system for 16K ZX81. Menu-driven. The number, size and heading of files are user-definable. Files may be created, modified, replaced, and searched, and are protected by a security lock. Output to ZX printer is provided. MULTIFILE is supplied on cassette with three bank cassettes for data storage, and packaged in an attractive permanent storage case. Supplied with extensive documentation describing applications for both business and personal use. \$29.95.

ZXAS Machine Code Assembler (16K) \$9.95
ZXDB Machine Code Disassembler/Debugger (16K) \$9.95
ZX CHESS! Your choice of 7 levels of play, white or black, set up any position to be analyzed, change levels of play during a game, swap sides, and more (16K) \$24.95
INVADERS! Ten levels of play! (16K) \$9.95
STARTRAK Trek across the galaxy (16K) \$9.95
ADVENTURE: Damsel and the Beast! (16K) \$14.95
1K PROGRAM PACK, 8 compact, entertaining programs \$9.95
16K PROGRAM PACK, four entertaining programs \$9.95
10 EXCITING ZX81 PROGRAMS \$14.95

Books
30 Programs for the ZX81 (1K) \$14.95
Understanding Your ZX81 ROM \$19.95
ZX81 ROM Disassembly Part A \$14.95
Full replacement warranty all tapes
Write for our FREE SOFTWARE CATALOGUE for ZX81

GLADSTONE

Gladstone Electronics 901 Fuhrmann Blvd. Buffalo, NY 14203
Telephone Orders (716) 849-0735 (VISA/MC No C.O.D. please)

Mail Orders: Send check, money order, Visa or MC number.
\$1.50 per order handling.

CIRCLE NO. 133 ON FREE INFORMATION CARD

CROSS ASSEMBLERS WRITTEN IN FORTRAN IV

NOW AVAILABLE: two different cross-assemblers for each of the following microprocessors:
6800 6801 6805 6809 68000 8080/85 6502 1802

- Two-pass assembly, w/forward references
- Manufacturer's complete instruction set
- Long error messages, free-format input
- Written in 1966 ANSI standard FORTRAN IV
- "Industrial" Macroassemblers also feature macros, conditional assembly, relocatable object code

(Target Machine(s))	"INDUSTRIAL" MACRO-ASSEMBLERS	"HOBBYIST" ASSEMBLERS
6809 or 6502	\$400.00	\$200.00
Other 8-bit	350.00	150.00
16-bit	500.00	250.00

Prices include source code on tape and in printed form. User's Manual, shipping (USA) and program support. All programs shipped from stock.

*** SPECIAL ON PREPAID ORDERS Same-day EXPRESS MAIL shipping, for no extra charge. Call today—your program will arrive tomorrow!

IDM

INTELLIGENT DEVICES OF MINNESOTA
P.O. Box 492
Anoka, MN 55303
(612) 427-0787 8:00 - 12 Noon

CIRCLE NO. 134 ON FREE INFORMATION CARD

RAM

For ATARI

48K RAM BOARD FOR THE 400

- Highest quality available
- Reduces power consumption
- Reduces heat

48K Board (400) **\$299**
32K Board (400/800) **\$150**

INTEC
PERIPHERALS
CORP

3389 Del. Rosa Avenue
San Bernardino, CA 92404

(714) 864-5269

ATARI, 400, 800 are Trademarks of ATARI, Inc.

CIRCLE NO. 135 ON FREE INFORMATION CARD



LEO ELECTRONICS, INC.
8921 S. Sepulveda #208
Los Angeles, CA 90045
(213) 641-3101 (800) 421-2418

WHY PAY MORE? SAVE MONEY!
LOWEST PRICES ON PARTS!

EPROMS

2708	2.60
2716	4.60
2716-1(350ns)	6.50
TMS 2716	6.00
2732	12.00
2532	12.00

REGULATORS

7805	75
7812	75
7815	75
7905	85
7912	85
7915	85

RAMS

4116(200ns)	8/14.00
4116(150ns)	8/16.00
2114(200ns)	8/18.00

MICROPROCESSORS

Z-80A-CPU	5.50
8080A	2.25
8085A	7.00

TERMS: Check, Visa, Mastercard. Call for C.O.D. U.S. Funds only. California Residents add 6% Sales Tax. SHIPPING: Add \$2.00 for Ground, \$5.00 for Air. ALL MAJOR MANUFACTURERS. ALL PARTS 100% GUARANTEED.

CIRCLE NO. 136 ON FREE INFORMATION CARD



NEW! for
the '89 from

MAGNOLIA
MICROSYSTEMS

DOUBLE DENSITY DISK CONTROLLER

for both 5 1/4" & 8" drives

only **\$595** complete

including CP/M™ 2.2

MAGNOLIA MICROSYSTEMS, INC.
2264 - 15th Ave W. Seattle 98119
(206) 285-7266 (800) 426-2841

CP/M is a trademark of Digital Research.

CIRCLE NO. 137 ON FREE INFORMATION CARD

DISKETTES CASSETTES

Error-Free 5 1/4-inch Diskettes (MD-5) single-sided, soft sector, single or double density, reinforced hub.

Item	Qty 10	Qty 50
MD-5	\$25.00	\$110.00
C-10	\$ 7.50	\$ 32.50
C-20	9.00	39.00
C-60	11.50	50.00
C-90	15.00	70.00

UPS SHIPPING INCLUDED
in Continental USA
CA Customers add taxes

MICROSETTE

475 Ellis St., Mt. View,
CA 94043 (415) 968-1604

CIRCLE NO. 138 ON FREE INFORMATION CARD

WE ACCEPT TAX REFUNDS



SPEND YOUR TAX DOLLARS WITH US. WE SPECIALIZE IN QUALITY APPLE SOFTWARE FOR THE:

- | | |
|-------------------------|---------------------------|
| A. Doctor | G. Attorney |
| B. Dentist | H. Stock Broker |
| C. Student & Teacher | I. Accountant |
| D. School Administrator | J. For novice programmers |
| E. Secretary | try our teaching programs |
| F. Construction Worker | on BASIC. |

We also accept checks, Visa and Mastercard.
Call TOLL FREE for Complimentary Brochure
(800) 854-0561 In CA (800) 432-7257 Ext.802

For further information call (714) 365-6668

Monument
COMPUTER SERVICE

Village Data Center, P.O. Box 603, Joshua Tree, CA 92252

CIRCLE NO. 139 ON FREE INFORMATION CARD

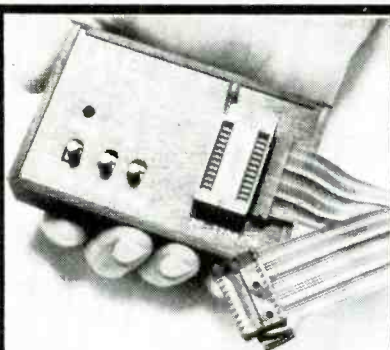

OAE's PP-Series EPROM Programmers plug directly into any vacant EPROM socket and allow you to transfer data directly from RAM to EPROMs. No additional power supplies are required. All timing & control sequences are handled by the programmer. Each unit includes internal DC to DC switching regulator, ZIF socket and 4 ft. ribbon cable terminated with a 24 pin plug. Programmers are available for all EPROMs from 2708 s thru 2532 s.

Oliver Advanced Engineering, Inc.
676 W. Wilson Ave., Glendale, CA 91203
(213) 240-0080 or Telex 194773
PP SERIES PROGRAMMERS

CIRCLE NO. 140 ON FREE INFORMATION CARD

REAL ESTATE SOFTWARE

for APPLE, TRS-80 • PET

PROPERTY MANAGEMENT SYSTEM: \$325

- | | |
|--------------------|----------------------|
| • Tenant History | • Ownership Files |
| • Late Rent Report | • Building Reports |
| • Vacancy Report | • Utilities Report |
| • Income Report | • Tax Expense Report |
| • Auto Late Charge | • Prints Checks |
| • Returned Checks | • Prints Receipts |

PROPERTY LISTINGS/COMPARABLES: \$325

- SCREEN BY —
- | | |
|----------------------|---------------------|
| • 22 Items/Listing | • Max/Min Price |
| • 1000 Listing/Disk | • Units/Zone/City |
| • Listing Memo Field | • Max Price/Income |
| | • Max Price/Sq Foot |
| | • Min Cashflow |

REAL ESTATE ANALYSIS MODULES: \$40/Module

- | | |
|----------------------------|-------------------------|
| • Home Purchase | • Tax Deferred Exchange |
| • Income Prop Analysis | • APR Loan Analysis |
| • Property Sales | • Loan Amortization |
| • Construction Cost/Profit | • Depreciation Analysis |

WORD PROCESSOR — MAGIC WAND: \$255

Realty
company

Computer Stores Everywhere
or Order C.O.D. Direct
Cal Residents add 6% Sales Tax
(213) 372-9419

Suite F, Dept P 116-8th St., Manhattan Beach, CA 90264

CIRCLE NO. 141 ON FREE INFORMATION CARD

ONE STOP FOR SINCLAIR ZX81 SOFTWARE

EDUCATIONAL PROGRAMS
GAMES AND BOOKS

Including
The Complete Basic Course
Machine Language
Programming
Super Invasion
Space Trek
and many more.

All Programs on Cassette

WRITE FOR FREE CATALOG
AND FREE PROGRAM
LISTING OF MASTERMIND

SOFTSYNC, INC.

P.O. Box 480, Murray Hill Station,
New York, N.Y. 10156 (212) 685-2080

CIRCLE NO. 142 ON FREE INFORMATION CARD

SUPER SALE

EPROM

	1-7	8 up	50 up
2716	4.15	3.90	CALL
2732	9.70	8.85	CALL

16K RAM EXPANSION KIT

For TRS-80 Model III
Set of 8 pieces UPD416-2 (200nS)
Data furnished with purchase on request. **\$13.95**

WRITE FOR FREE CATALOG



SUNTRONICS CO., INC.

12621 CRENSHAW BOULEVARD
HAWTHORNE, CALIFORNIA 90250

LOCATED NEXT TO ADIRUMBA INTERNATIONAL

STORE HOURS: Mon-Fri 10am-6:30pm, Sat 10am-5pm

IN CALIFORNIA OUTSIDE CALIFORNIA TOLL FREE

(213) 644-1149 1-800-421-5775

Mail Order—Minimum Order \$10. Send Money Order or Check to P.O. BOX 1957—Dept. P HAWTHORNE, CA 90250. Use your VISA or Mastercard (please include expiration date). Add \$2.00 postage and handling. California residents add 6% sales tax.

Circle No. 143 on Free Information Card

UNBELIEVABLE!

Sierra Data Sciences Single Board Computer

A complete Z-80
microcomputer
on one S-100 board

- 4 or 6 MHz
- 64K memory
- disc controller for up to 4 drives
- 2 serial ports
- 2 parallel ports and more ...

PRICE? UNDER \$900

Write for more information

SYNAPSE VIDEO

123 East 89th Street
New York, N.Y. 10028
(212) 860-5776

Circle No. 144 on Free Information Card

★MICROCOMPUTER★

BUSINESS SOFTWARE

MEDICAL MGMT...
DENTAL MGMT...
INSURANCE AGENT
LEGAL BILLING....
PROPERTY MGMT..
AND MUCH MORE !

UNIVAIR INTERNATIONAL

10327 Lambert International Airport
ST. LOUIS, MISSOURI U.S.A. 63145

(314) 426-1099

Circle No. 145 on Free Information Card

Electronics Classified

CLASSIFIED RATES: Per Word, 15 Word Minimum. **COMMERCIAL:** \$3.50. **EXPAND-AD:** \$5.25. **DISPLAY:** 1" x 2 1/4", \$425.00. 2" x 2 1/4", \$850.00. 3" x 2 1/4", \$1,275.00. Ads set in all bold type @ 20% premium. Ads set with background screen @ 25% premium. **GENERAL INFORMATION:** Frequency rates and prepayment discounts available. Payment must accompany order except credit card—Am. Ex., Diners, MC, VISA (include exp. date)—or accredited ad agency insertions. Copy subject to publisher's approval; must be typewritten or printed. First word set in caps. Advertisers using P.O. Boxes MUST supply permanent address and telephone number. Orders not acknowledged. They will appear in next available issue after receipt. Closing date: 1st of the 2nd month preceding cover date (e.g., Mar. issue closes Jan. 1). Send order & remittance to: Classified Advertising, Popular Electronics Magazine, 1 Park Avenue, New York, NY 10016. Direct inquiries to Rose Lynch. (212) 725-7686.

FOR SALE

FREE DISCOUNT ELECTRONICS CATALOG. Over 4 1/2 million satisfied customers. Low, low prices on I.C.'s LED readouts, computer peripherals, audio components, solar products and much, much more. Poly Paks, Box 942 PEC, Lynnfield, Mass. 01940.

GOVERNMENT and industrial surplus receivers, transmitters, snooper scopes, electronic parts. Picture Catalog 25 cents. Meshna, Nahant, Mass. 01908.

ELECTRONIC PARTS, semiconductors, kits. FREE FLYER. Large catalog \$1.00 deposit. BIGELOW ELECTRONICS, Bluffton, Ohio 45817.

SAVE UP TO 50% on name brand test equipment. Free catalog and price list. Salen Electronics, Box 82, Skokie, IL 60077.

TELETYPE EQUIPMENT: Copy Military, Press, Weather, Amateur, Commercial Transmissions. Catalog \$1.00. **WEATHER MAP RECORDERS:** Copy Satellite Photographs, National-Local Weather Maps. Learn How! \$1.00. Atlantic Sales, 3730 Nautilus Ave., Brooklyn, NY 11224. Phone: (212) 372-0349.

BUILD AND SAVE. TV EARTH STATION. DETECTIVE ELECTRONICS. Video Recorders, Color Cameras, advanced Telephone Projects. **BROADCAST Electronics.** 50 page color catalog of unusual electronic projects AIR MAILED \$3.00; with 3 hour audio cassette dramatization of our catalog \$5.00. Don Britton Enterprises, PO Drawer G, Waikiki, Hawaii 96815.

POLICE/FIRE SCANNERS, crystals, antennas, CBs, Radar Detectors. HPR, Box 19224, Denver, CO 80219.

PRINTED CIRCUIT supplies, chemicals, tools, artwork, plating solutions. Major credit cards. Catalog \$2.00, refundable. CIRCOLEX, Box 198, Marcy, NY 13403.

RECONDITIONED TEST EQUIPMENT \$1.00 for catalog. WALTER'S TEST EQUIPMENT, 2697 Nickel, San Pablo, CA 94806, (415) 758-1050.

NEW ELECTRONIC PARTS. Continuously stocked. Stamp brings catalog. Daytapro Electronics, 3029 N. Wilshire Ln., Arlington Hts., IL 60004.

PRINTED CIRCUIT BOARDS, your artwork. Quick delivery. Reasonable. Atlas Circuits, Box 892, Lincolnton, NC 28092. (704) 735-3943.

ELECTRONIC CATALOG. Over 4,500 items. Parts, & components. Everything needed by the hobbyist or technician. \$2.00 postage & handling (United States Only), refundable with first \$15.00 order. T & M Electronics, 472 East Main St., Patchogue, NY 11772. (516) 289-2520.

Telephone Listening Device

Record telephone conversations in your office or home. Connects between any cassette or tape recorder and your telephone or telephone LINE. Starts automatically when phone is answered. Records both sides of phone conversation. Stops recorder when phone is hung up. This device is not an answering service.



Each \$19.95 Qty Disc Avail

Super Powerful Wireless Mic

10 times more powerful than other mics. Transmits up to 1/2 mile to any FM radio. Easy to assemble kit. 15V battery (not incl). Call (305) 725-1000 or send \$19.95 + \$1.00 shipping per item to USI Corp., P.O. Box PE-2052, Melbourne, FL 32901. COD's except. For catalog of transmitters, voice scramblers and other specialty items, enclose \$2.00 to USI Corp.



CHEMICALS, Apparatus. Project Books. Wide Selection. Catalog send \$1.00 to Pioneer Corp., 14a Hughey Street, Nashua, NH 03060.

ROBOT KITS, PARTS, MATERIALS BOOKS. Send \$3 for subscription to catalog and newsletter. ROBOT MART, 19 West 34th St., New York, NY 10001.

SATELLITE TELEVISION . . . HOWARD/COLEMAN boards to build your own receiver. For more information write . . . ROBERT COLEMAN, Rt. 3, Box 58-APE, Travelers Rest, S.C. 29690.

UHF GATED PULSE SUPPRESSED KIT \$39.00. UHF SINEWAVE SUPPRESSED KIT, \$37.00. Both include parts, manual, and Etched Board. Manual only \$4.60. Catalog \$2.00. J&W Electronics, P.O. Box 61, Cumberland, RI 02864.

SATELLITE TELEVISION INFORMATION \$4. Build or buy your Earth Station. Satellite Television, RD 3, Oxford, NY 13830.

FREE CATALOG 99 cent kits. Parts. Bargains Galore! ALL-KIT, 434 West 4th St., West Islip, New York 11795.

Satellite TV

FOR THE HOME

Sick of Network TV?

Our receiver lets you get over 75 channels of television directly from earth-orbiting cable TV satellites: HBO Showtime, super stations, sports and movies worldwide.



From offshore oil rigs, data links to hotels and backyard installations, we wrote the book. Constantly updated, our 94 Page

We don't just sell information! We Manufacture Hardware!

technical information book and catalog gives you all the facts. Inexpensive dishes, feeds, telemetry software, kits and more. Recommended reading by NASA, The Office of Consumer Affairs and quality companies like Rockwell/Coltins. Send \$7.95 today!

CALL 24-hrs. C.O.D. Hotline (305) 339-7600

SPACECOAST

RESEARCH CORPORATION

P.O. Box 442-A, Altamonte Spgs, FL 32701



We're the leading manufacturer of GOES & METEO SAT WEFAX Satellite Antenna Systems. Our new illustrated WEATHER SAT Manual fully explains the technology, with a Geo-telemetry program in Basic. Complete information, \$9.95. Specify WEATHER SAT on above Hotline. SAVE - both manuals, \$15.

RF POWER TRANSISTOR - TUBE CATALOG FREE. MRF453/MRF455A/SK1451 - \$14.00; MRF454/SRF2072/MRF2769 - \$17.00; MRF245/MRF247 - \$27.00; 2N4048 - \$6.20; Exclusive Repair Center for PALOMAR PRIDE, etc. Westcom, 1320 Grand, San Marcos, CA 92069. (714) 744-0728.

Latest microstrip model of the original
MICROWAVE TV SYSTEM KIT

- LT-13 Down Converter with Preamp
- 16 dB Slotted Antenna
- Deluxe Power Supply Kit
- All Coaxial Cables Included
- 2000 - 2600 MHz Tuning Range

LAB-TRONICS, INC.
P.O. Box 171
Rogers, MN 55374
612 428-4226

\$164.95
+ \$4.00 shipping

MICROWAVE TV ANTENNA \$169.95
18 Dish Type Antenna Probe Mounted
Down Converter, 6 Month Warranty

MICROWAVE TV MANUAL \$16.25
Plans and Concepts

SUBSCRIPTION TV MANUAL \$14.95
Theory, Schematics Etc

KITS AVAILABLE

INFORMATION PACKAGE \$2.00
Send Check or MD Add 5% Shipping CA
Residents Add Tax

ABEX P.O. Box 26601-PE San Francisco, CA 94126

ANTI GRAVITY

ELECTRONIC LEVITATION

No moving parts, magnets, gases or exotic fuels BUILD FLYING MODELS Plans, schematics, diagrams, performance charts & more in PRIMER VOL. 105 pgs 8 x 10 mimeo \$20 ppd. GUARANTEED! VISA MC add \$5 FOREIGN ADD \$10 SAUCER TECHNOLOGY, Box 132-M, Eureka Springs, Ark. 72632

Buy Gov't Surplus SAVE To 85% SURPLUS CENTER

Send 60¢ For Big Bargain Catalog

1000's Of Bargains; Surplus; Excess Inventory; Brand Name New Equipment

COMPRESSORS • WINCHES • GEAR MOTORS
TELEPHONES • WELDERS • POWER PLANTS
SURVEYING INSTRUMENTS • ELECTRONICS
FIRE/BURGLAR ALARMS • PAINT GUNS
TAPES • BINOCULARS • TOOL BOXES
HYDRAULICS • AIR TOOLS • PUMPS

Box 82209-PE Lincoln, Nebraska
Zip Code 68501

Fresh on your Ears.



Speakerlab speakers feature recent technology like polypropylene woofers, samarium cobalt leaf tweeters, edgeless box construction, passive radiators and ports. They're styled in slim oak veneer or rosewood Clearseal® enclosures. Send for our FREE catalog and see our completely new line plus our huge offering of raw parts which now include musical instrument speakers and high-end car stereo speakers.

speakerlab
Dept. CPE25, 735 N. Northlake Way
Seattle, Washington 98103

FREE KIT CATALOG contains test equipment. Phone 415-447-3433. DAGE SCIENTIFIC INSTRUMENTS, Box 1054P, Livermore, CA 94550.

AMATEUR MICROWAVE T.V. ANTENNAS. Receive uninterfered movies, fully guaranteed. Also in kit form. For information and plans send \$8.00 to: MDS Specialist, P.O. Box 67, Southaven, MS 38671.

LOOKING FOR THE BEST BUYS in transistors, IC's, diodes. Call 800-458-6053, in PA (814) 837-6820. MC/VISA honored. Saving, service, quality, as only B&D can do. B & D Enterprises, P.O. Box 305, Kane, PA 16735.

SATELLITE T.V. Books, parts, low noise microwave transistors. Specs and catalog \$2.00. Elite Electronics, RR1 St. George, Ontario, Canada N0E1N0. U.S. Inquiries.

SOUND SYNTHESIZER KITS — Surf \$19.95, Wind \$19.95, Wind Chimes \$24.95, Musical Accessories, many more. Catalog free. PAIA Electronics, Box J14359, Oklahoma City, OK 73114.

RESISTORS, 1/4W, 1/2W 5% C.F. 3cea., 1% Metal films. NO MINIMUMS. Cabinet Assortments, Quantity Discounts. Details from: JR INDUSTRIES, 5834-E, Swancreek, Toledo, OH 43614.

SCANNER ACCESSORIES, both kits and factory assembled. Free catalog. Capri Electronics, Route 1P, Canon, GA 30520.

SUBSCRIPTION TELEVISION SYSTEMS. SINEWAVE SYSTEMS; 2300 MHZ MICROWAVE DOWNCONVERTER. Best systems available; no internal connections to TV! Plans \$10.00 each; both \$15.00. PARTS, KITS AVAILABLE; MC/VISA accepted on parts purchases. Send SASE for parts pricing and more information on these and other unique plans. COLLINS ELECTRONICS, Box 6424, San Bernardino, CA 92412.

INTERCOM!—Your pushbutton telephones can double as an intercom for under \$20.00 in parts! Plans and instructions. \$5.00. dB Enterprises, Box 453, Westwood, NJ 07675.

BOOTLEGGERS BIBLE FOR CB MODIFICATIONS, \$12.95. CB Radio Repair Manual, \$8.95. Linear Plan Book, \$11.95. Also Kits, complete units, and more. Catalog \$1.00 at: A.P. Systems, POB 263PE, Newport, RI 02840.

FREE CATALOG \$1.00 in 10-15 min. A.P. Systems 800-882-7864

SATELLITE TV FANTASTIC 80 TV CHANNELS

New antenna construction plans plus big 8 x 11 book loaded with aiming info, kits, LNAs and receivers at wholesale prices. Far better than cable TV! Enjoy crystal clear reception. Send \$9.95 today. Add \$2.00 for 1st class (air mail) or call our 24 hr COD order line (305) 862-5068 Now

Global TV Electronics P.O. Box 219-E Maitland FL 32751

VARIETY ELECTRONIC SURPLUS parts and pieces. Monthly picture flyer. Send \$2.00 for 6 issues. Star-Tronics, P.O. Box 683, McMinnville, OR 97128.

DECODE Morse, RTTY, and ASCII signals from airwaves with new CODE★STAR. LED readout or connect your computer/printer. Keyboard, other items also available. Kits or assembled. MICROCRAFT, Box 513R, Thiensville, WI 53092. (414) 241-8144.

UNSCRAMBLE CODED MESSAGES from police, fire and medical channels. Also telephone recording adaptor. Same day service. Satisfaction guaranteed. Don Nobles Electronics, Inc. Rt. 7, Box 610-A, Hot Springs, AR 71901. (501) 623-6027.

RF MODULATORS for SATELLITE TELEVISION, MICROCOUNTERS CCTV. Also monitors, cameras, kits. FREE CATALOG. Phone (402) 987-3771. Dealers Welcomed. ATV RESEARCH, 13-P Broadway, Dakota City, NE 68731.

WHOLESALE RADAR DETECTORS, POLICE/FIRE SCANNERS, CB accessories — Whistler Q1000 \$199.99; Q1000R Remote \$219.99; Fox Vixen \$209.99; SuperFox Remote \$224.99; Bearcat 100 \$295.99, Bearcat 300 \$336.99; plus \$3.00 shipping — VISA MC/COD — Free catalogue-Scanner World, 10-PE New Scotland, Albany, NY 12208 (518) 436-9606.

CORDLESS TELEPHONES. Low prices, all major brands. Inquires or Visa/Mastercard orders — (206) 743-3977. TRINETICS, Box 6005, Lynwood, WA 98036.

LASER POWER SUPPLIES - Ne/He 1 through 5 milliwatt — \$125 ea. New with 90-day guarantee. Specify laser manufacturer and model. M.T.I., 6929 North Ave., Lemon Grove, CA 92045.

MICROWAVE 2Ghz. BEST IN THE WEST! Downconverter kits \$39.00. Complete with antenna and control box \$99.00. Factory assembled - 90 day warranty. \$159.00. GALAXY ELECTRONICS, 6007N. 61st Ave., Glendale, AZ 85301. (602)247-1151.

MINIATURE PRINTED CIRCUIT CARD RACK

Small enough to carry in briefcase or hang in filing cabinet!

24.95 Add \$2.50 for postage

FREE CATALOG! TELEDATE

Box 173, Somerset, NJ 08873
Tel: 201-846-5182

ORDER NO. 7311-100-001

CARD RACK ACCESSORIES RACK STAND, PC CARDS, ETC.

BEARCAT SCANNERS - 10% ABOVE COST. . . Free details. 20/20 VIDEO, Dept. E5, Box 60132, Chicago, IL 60660.

OVER 200 PROJECTS and kits. send stamp for list. MATCO ELECTRONICS, Box 316P, Cadillac, MI 49601.

BUYER BEWARE - Consumer guide to SATELLITE TELEVISION - \$3. Ghostfinders, Route 2, Box 136B, Stevensville, Montana 59870.

SUBSCRIPTION TELEVISION Microwave Downconverters; UHF Sinewave Systems using Advanced Circuitry and Technology. External TV connections. Fifty other complete Kits available. Send \$10.00 for ALL PLANS AND PRICES to: BETA ELECTRONICS, 2081-G, 3rd Street, Riverside, CA 92507.

MAGNIFIERS/GIFTS — hobbies, shop, school. Full line magnifiers, talking watch, clock, calculators, unusual gift items. Packet includes page magnifier, descriptive literature, catalogue, vision aid pamphlet, \$2.00. SFB PRODUCTS, Box 144, Southeastern, PA 19399.

SEND 9 1/2" SASE for Free Electronic Surplus equipment; parts catalog. Williams, P.O. 7057, Norfolk, Virginia 23509.

INTEGRATED CIRCUITS compare our prices with anyone's. We have no minimum purchase. Buy only what you need. We also give quantity discounts so buy more for less. Send for free copy of our price listings. Chips Galore, P.O. Box 20362, Kansas City, MO 64195.

ELECTRICAL WALL PLUG, PATENTED to test for grounded neutral-wire in 110 volts AC receptacles. No other tester can do this. Tests for all other wiring faults in ground, neutral, hot terminals. Order Ppd., C.O.D., VISA/MC from: SADCO, (same co. that sells the fringe TV/FM slotted antenna array ppd. for \$25.00), 11621 Hughes Ave. N.E., Albuquerque, NM 87112. (505) 294-2935.

SATELLITE ANTENNA MANUAL — plans to build a 12 foot, screened, all-aluminum, parabolic antenna with polar mount. Only \$24.95. More information send \$1.00, refunded with order. SAE, Box 277, South Milwaukee, WI 53172.

LOW, LOW COMPONENT PRICES! Ask for free flyer. Write: EEP, 11 Revere Place, Tappan, NY 10983.

POWER SUPPLY PLANS AND I.C.'s \$15.00. Build a dual meter, 100 WATT, filtered DC, 0-100V, variable voltage and variable current limiting, 0-1 amp, versatile supply from common spare parts. MIDWEST SEMICONDUCTOR PRODUCTS, 3832 W. Lisbon, Milwaukee, WI 53208.

MICROWAVE MICROSTRIP TV DOWNCONVERTER PLANS. INCLUDES 3 SPECIAL TRANSISTORS, \$25.00. Variable 2.000 MHz - 2.400 mhz. Newest design and built with under 40 spare electronic parts. MIDWEST SEMICONDUCTOR PRODUCTS, 3832 West Lisbon, Milwaukee, WI 53208.

MODEL ROCKET ELECTRONIC novelty schematics 5 designs \$2.50. DL2, P.O. Box 3432, Quincy, Illinois 62305.

PRINTED CIRCUIT BOARDS solder plated & drilled from any artwork in this issue \$19.96. Other types per quote. Gemini Projects, P.O. Box #72100, Roselle, Illinois 60172.

Be an ELECTRICIAN

Skillful Electricians Average Over \$11 an Hour

Learn at home in spare time with no previous experience. We encourage you to check on the job market in your area and send for employment success figures of our graduates. Learn installation, maintenance, construction, lighting, heating, air conditioning applications. Send for FREE FACTS.

Electrician's School, Dept. PD042
ICS Center, Scranton, PA 18515

PAY TV ENCODING/DECODING. Latest systems covered, \$8.95. G.A.M. Engineering, 706 Akron Blvd, Kent, OH 44240.

SATELLITE TV LOW NOISE AMPLIFIER, Build for under \$100! Satisfaction guaranteed. Complete instruction manual \$7.00. XANDI, Box 25647, Dept 22, Tempe, AZ 85282.

CABLE TV CONVERTERS & EQUIPMENT. Plans and parts. Build or buy. For more information send \$2.00: C & D ELECTRONICS INC., P.O. Box 21, Jenison, MI 49428.

MICROWAVE TV DOWNCONVERTERS, Downconverter board, power supply board, Antenna Cookbook, with detailed plans. \$20.00. Downconverter parts \$15.00, power supply parts \$15.00. Micro Engineering, P.O. Box 17231, Minneapolis, MN 55417.

FOIL COPYGUARD kit. VHS/Beta compatible. Professional results. Easy assembly. Kit includes PC board, components and instruction manual. 14-day money-back guarantee \$52.95 ppd. CA add \$3.00 VIDEO TECHNICA, Box 2108, Downey, CA 90242.

PRINTED CIRCUIT BOARD GRAB-BAG \$3.50 plus 50¢ postage and handling. Ideal for the Home Experimenter! Bag contains nine P.C.B. - Size ranges from 2"x2" to 6"x6". Glasteel Laminates, 1727 Buena Vista St., Duarte, CA 91010.

GATED PULSE KIT. Watch uninterrupted Movies, Sports on T.V. Heavy Duty factory built units Available. Send \$2.00 for price catalog: MELI-TRON Div., Box 250, Trenton, NJ 48183.

EXPERIMENTAL FREQUENCY CONTROL MODULE. Finest available in either Sine Wave or Gated Pulse. Kits, plans or factory built. Information package \$2.00 refundable. LEE-TRONICS, P.O. Box 253, Taylor, MI 48180.

RADIO — T.V. Tubes — 49 cents each. Send for free catalog. Cornell, 4213 University, San Diego, Calif. 92105.

COMPUTER EQUIPMENT

SAVE 90% Build Your own Minicomputer. Free Details. Digatek, 2723 West Butler Dr., Suite 20C, Phoenix, AZ 85021.

SIMPLIFY digital testing with Octatrace. Converts any oscilloscope to display 8 channels of TTL signals. Board, case, manual-\$25.00. AB COMPUTER PRODUCTS, P.O. Box 571, Jackson, NJ 08527, (201) 370-9889.

COMPUTER EQUIPMENT. New/Used. For Sale through COMPUTER SHOPPER Magazine. It's like belonging to a buyers club, 6 months trial, only \$6. COMPUTER SHOPPER, Box F198, Titusville, FL 32780, 1-800-327-9920.

Ti-99/4A USERS, six super programs plus list \$5.95. Cash, check, MO; PROGRAMS, 1425 Burnley Sq. N., Columbus, Ohio 43229.

GAMES for TRS-80 color, free information, or send \$5.95 for cassette with 3 programs, Riemann, 4747 E. Lee, Tucson, Arizona 85712.

USED COMPUTER TERMINALS. Printers, Modems, Surplus Electronic Parts, Catalog \$1.00. SPECIAL: Daisy Wheel Printer \$400.00, Xerox 820 CPU Board \$150.00. RONDURE COMPANY, THE COMPUTER ROOM, 2522-PE, Butler St., Dallas, TX 75235, (214) 530-4821.

IBM PERSONAL COMPUTER and 8088 boards and plug-ins in kit form. Build it yourself and save. Free information. Compatible Computer Corp., Dept. PE1, Box 51102, Seattle, WA 98115.

AMATEUR RADIO

RADIO AMATEUR CALLBOOKS: 1982 Directories of Radio Amateurs around the world. U.S. Callbook \$22.00; Foreign Callbook \$21.00, shipping included. See your dealer or write for FREE catalog. Radio Amateur Callbook, Dept. PE, 925 Sherwood Dr., Lake Bluff, IL 60044.

PLAY YOUR TAPES, records, T.V. on any F.M. radio in your house - wireless - simple hook-up. Satisfaction guaranteed. \$24.95. Port-o-Sound Co., Box 279A, Howard Beach, NY 11414.

CALL US FIRST. For low Ham prices. All major brands. Call TOLL FREE 7PM-10PM. Central, Mon/Wed/Fri - 1-800-231-3057. Madison Electronics, 1508 McKinney, Houston, TX 77010. Daytime: 1-713-658-0268.

NO SALES TAX IN MONTANA. Spring Special: Kenwood R-1000; \$429, and with Kenwood coupon save additional \$30, through June 15th. Send \$1.00 for 1982 Catalog. CONLEY RADIO, 318-P N. 16th, Billings, MT 59101. (406) 259-9554.

C.B. EQUIPMENT

GET MORE CB CHANNELS AND RANGE! Frequency Expanders, speech processors, secret FM converters, how-to-books, plans, modifications. Catalog \$2. CB CITY, Box 31500PE, Phoenix, AZ 85046.

BOOTLEGGERS BIBLE FOR CB MODIFICATIONS. \$12.95, CB Radio Repair Manual, \$8.95. Linear Plan Book, \$11.95. Also Kits, complete units and more. Catalog \$1.00 at: A.P. Systems. POB 263PE, Newport, RI 02840.

CABLE TV

39.95
ADD \$2.50 FOR POSTAGE

30 CHANNEL CABLE TV CONVERTER

FREE!
UNUSUAL 96 PAGE ELECTRONIC PARTS & IDEAS CATALOG!

ORDER No. 198AE047
ETCO ROUTE 9N
PLATTSBURGH, N.Y. 12901
Tel.: (518) 561-8700

PLANS AND KITS

PRINTED CIRCUIT Boards from sketch or artwork. Kit projects. Free details. DANOCINTHS Inc., Dept. PE, Box 261, Westland, MI 48185.

LASERS HANDBOOK with burning, cutting, Ruby Reds. CO's complete plans, books, and parts. Send \$4.00 to: Famco, Dept. PE, Box 1902, Rochester, NH 03867.

PROFESSIONAL LIMITER-COMPRESSOR-EXPANDER KITS. Pro specs and features, balanced input, adjustable threshold, slope (1:1 to 100:1), attack and release. Models from \$79 and up. Rack mounting available. Free Info. STELLATRON, 4942, Whitsett-205, N. Hollywood, CA 91607.

GIANT SCREEN TV projection system converts any television into 7-foot picture. Lens & instructions \$14.95. (Dealers welcome). Bell Video, 4616 Belair Rd., Baltimore, MD 21206.

FM STEREO TRANSMITTER KIT. Range up to 1/2 mile, broadcast quality. 30 db separation, 300 mV audio input sensitivity. Tunes 88-108 Mhz, highly stable. 50 ohm out. Requires +-15V. Complete kit \$9.95. Commercial quality AM TRANSMITTERS also available. Free info. STELLATRON, 4942 Whitsett-205, N. Hollywood, CA 91607. 213/506-0415



MINI FM IC

Compact size only 2 x 1 x 1/2. Transmit to FM radio 88 108 MHz. Exceptional audio quality. Transmits stable signal up to 900 ft. Complete kit incl. case battery & instructions. Only \$13.95 Assembled \$18.95 Add \$1.55 S&H ea. Send 18c stamp for brochure.

S.E. Corp., Box 16969-P
Tempe Terrace, FL 33687

UNIQUE TV CIRCUIT plugs between UHF and VHF tuners on tube or solid state sets. Plans \$3.95. Drilled etched printed circuit boards \$23.00. HELICO ANTENNA receives multi polarized signals. Plans \$3.95. Antenna Kit \$19.95. Information \$2.00. HELICO, P.O. Box 304, Bridgewater, MA 02324.

TESLA COIL — 40' SPARKS! Plans \$7.50. Information 75 cents. Huntington Electronics, Box 2009-P, Huntington, Conn. 06484.

BUILD A MOVING coil cartridge amplifier under \$25.00. Plan \$5.00. OHTS, Box 83058, San Diego, CA 92138.

HOW TO BUILD DATA SPLITTER, WYE CABLE, Line Driver, ASCII character generator, and their power supplies. SCHEMATICS. ASCII Waveform chart. EIA specs. \$14.95. JOHN MUIR, Box 1274, Victorville, CA 92392.

PCB'S FIVE DAY SERVICE! Kit projects or artwork, no drilling charge, guaranteed quality, DITEK CORPORATION, 6244 Colby, Lincoln, NE 68505.

CUSTOM TV SCHEDULES for HBO or Showtime or The Movie Channel, \$15.00/yr, or send for free sample to: P.O. Box 947, Gresham, OR 97030-0192.

TELEVISION to oscilloscope conversion. No modifications to TV. Plans and PC board \$8.50. MICROGRID, Box 613B, Ithaca, NY 14850.

ROBOTS, eproms, PC Boards, games, tools, more. Catalog \$2. Cosmic Enterprises, Box 9045, Stockton, CA 95208.

PROJECTION TV... Convert your TV to project 7 Foot picture... Results equal to \$2,500 projector... Total cost less than \$20.00. PLANS & LENS \$16.00. Illustrated information FREE. Macrocomii, Washington Crossing, Pennsylvania 18977. Creditcard orders 24 hours. 215-736-3979.

AMAZING ELECTRONIC DICE GAME — LED display, complete kit \$12.95 — Kit \$39.95. D R DESIGN, P.O. Box 401382, Garland, Texas 75040.

DETECT BIRD CALLS from several hundred yards. Conversion from several hundred feet. Complete, easy to follow instructions. Money back guarantee. \$4.99. MAP, 2962 Yellowtail, Los Alamitos, CA.

MICROWAVE KIT

\$89.95 CONVERTS MICROWAVE TO VHF TELEVISION

COMPLETE INSTRUCTIONS, HARDWARE, POWER SUPPLY & YAGI ANTENNA.

CLEAR-VUE ELECTRONICS
P.O. Box 600, Rochester, MI 48063
313-375-9730

SUBSCRIPTION TELEVISION EDUCATION MANUAL. Complete theory and circuits \$9.95. Parts and kits available. D & S Enterprises, P.O. Box 110901PE, Nashville, Tennessee 37211.

LOGIC ANALYZER - SCOPE ATTACHMENT, 8-channel, ingenious design, very inexpensive to build. Plans \$2.50. TMZ, 184 Hillcrest Ave., Providence, RI 02909.

ALARMS

BURGLAR, FIRE, CAR! Finest equipment! Save! Free Catalog. AAS, 186A Oxmoor Road, Bham, AL 35209.

Burglar-Fire Protection

Protect Your Life, Home, Business, Auto, etc.

Our catalog shows how. Install your own alarm systems and devices and save \$\$\$\$ We offer FREE write-in engineering service.

FREE CATALOG Lowest Prices on Reliable, High Quality Alarm Systems and Devices

Burdex Security Co., Box 82802-PE Lincoln, Ne. 68501

UNIQUE ALARM. Connect your telephone with tape recorder through special connector to your burglar or smoke alarm. Your telephone will call automatically to any chosen number. Parts under \$15.00. Procedure and plans \$8.50. Monotron, Box 626, stn-H, Montreal, Canada H3G 2L5. U.S. Inquiries.

HIGH FIDELITY

TOP QUALITY SPEAKERS AND KITS. Send \$2.00. Speaker Warehouse, 801 North Route 441, Hollywood, FL 33021.

DIAMOND NEEDLES and STEREO CARTRIDGES at DISCOUNT PRICES for SHURE, PICKERING, STANTON, EMPIRE, GRADO, AUDIO TECHNICA, ORTOFON, ACUTEX and ADC. Write for free catalog. LYLE CARTRIDGES, Dept. S., Box 69, Brooklyn, NY 11218. For fast COD service Toll Free 800-221-0906. 9AM - 8PM except Sunday.

WANTED

GOLD, Silver, Platinum, Mercury, Tantalum wanted. Highest prices paid by refinery. Ores assayed. Free circular. Mercury Terminal, Box 191, Norwood, MA 02062.

TUBES

RADIO & T.V. Tubes — 49 cents each. Send for free Catalog. Cornell, 4213 University, San Diego, Calif. 92105.

TUBES: "Oldies", Latest. Supplies, components, schematics. Catalog Free (stamp appreciated). Steinmetz, 7519-PE Maplewood, Hammond, Ind. 46324.

TUBES-RECEIVING, Industrial and Semiconductors Factory Boxed. Free price sheet including TV, Radio and audio parts list. Transletronic, Inc., 1365 39th St., Brooklyn, New York 11218. Telephone: (212) 633-2800. Toll free: 800-221-5802.

HUGE INVENTORY! Thousands of types. Wholesale prices. FREE CATALOG! ETCO Electronics, DEPT. 290. Plattsburgh, NY 12901.

GOVERNMENT SURPLUS

GOVERNMENT SURPLUS! Millions of items (including Jeeps)... low as 1c on dollar! Most complete Directory available. \$2.00. DISPOSAL, Box 19107-HE, Washington, DC 20036.

GOVERNMENT SURPLUS ELECTRONICS! JEEPS! 900,000 items! Complete Information Your Area. LARGEST OFFICIAL DIRECTORY. \$2.00 (Guaranteed). GOVERNMENT REPRINTS, Department A-76, 4620 Wisconsin Northwest, Washington, DC 20016.

PERSONALS

MAKE FRIENDS WORLDWIDE through international correspondence, illustrated brochure free. Hermes-Verlag, Box 110660/Z, D-1000 Berlin 11, W. Germany.

CORRESPONDENCE FOR FRIENDSHIP IN PHILIPPINES, MALAYSIA. Free information. AACC-(PE), Box 1542, Canoga Park, Calif. 91304.

PENFRIENDS — ENGLAND — USA, through correspondence. Send age, interests. Free reply. Harmony, Box 89PE, Brooklyn, New York, 11235.

CORRESPONDENCE for friendship! Mexico, Philippines, Europe, USA. Free information. International, Box 1716-EL, Chula Vista, CA 92012.

UNATTACHED - Meet friendly interesting single people nationwide. Free details. THE ARTS WORLD, Box 833, Amityville, NY 11701.

UNIVERSITY DEGREES BY MAIL! Bachelors, Masters, Ph.D.'s... Free revealing details, Counseling, Box 317-EP5, Tustin, California 92680.

INSTRUCTION

LEARN ELECTRONIC ORGAN SERVICING at home. Completely revised course covers latest models including digital, LSI's, synthesizers, etc. NILES BRYANT SCHOOL, PO Box 20153, Sacramento, CA 95820.

LEARN WHILE ASLEEP! HYPNOTIZE! Astonishing details, strange catalog free! Autosuggestion, Box 24-ZD, Olympia, Washington 98507.

UNIVERSITY DEGREES BY MAIL! Bachelors, Masters, Ph.D.'s. Free revealing details. Counseling, Box 317-PE05, Tustin, California 92680.

Be an FCC LICENSED Electronic Technician

Earn up to \$600 a Week & More!

No costly school — The Original FCC Test-Answers exam manual that prepares you at home for FCC General Radiotelephone License. Newly revised multiple-choice exams cover all areas tested on the actual FCC Govt exam! No previous experience required. \$12.95 post paid. Moneyback Guarantee.

COMTAND PRODUCTIONS & DISTRIBUTORS
P.O. Box 26348, San Francisco, CA 94126



MEDICAL ELECTRONICS TECHNOLOGY, home study. Troubleshoot medical instruments. WTI, P.O. Box 124, Pine-dale, CA 93650.

COLLEGE DEGREES BY SPECIAL EVALUATION OF EXIST-ING Credentials & Job Experience. Fast, Inexpensive, (614) 863-1791. Guidance, Box 13151-A5, Columbus, Ohio 43213.

YOUR OWN RADIO STATION! AM, FM, cable, licensed, un-licensed, low cost transmitters! Free information. Broadcast-ing, Box 130-A5, Paradise, CA 95969.

UNIQUE OPPORTUNITY! Radio Broadcasting Engineering. Uncrowded field — Excellent Compensation. Information: So-mich, 3620 Barham #Y-308A, Hollywood, California 90068.

DOCTORAL OR MASTERS DEGREE Counseling Psychology—Education —Health Svcs Mgmt

For professionals with extensive exp. who are licensed in their field & who want to enhance their career position by earning a degree through our Guided Independent Study Program (GISP). No residency. One-on-one faculty counseling. For no-cost personal evaluation send resume or call (213) 278-1094. CENTURY UNIVERSITY, 9100 Wilshire Blvd., Dept. 70, Beverly Hills, CA 90212.

FOR INVENTORS

PATENT AND DEVELOP your invention. Registered Patent Agent and Licensed Professional Engineer. Send for FREE PATENT INFORMATION every inventor should have. Richard L. Miller, P.E., 3612-E Woolworth Building, New York, NY 10007. (212) 267-5252.

INVENTIONS WANTED

FREE CONSULTATION • NO IDEA TOO SMALL

Disclosure registration. Potential cash or royalties from manufacturers seeking new ideas. For free information on how to register your ideas. Call or write

AMERICAN INVENTORS CORP.

59 Interstate Dr. Dept PE
West Springfield, MA 01089 (413) 737-5376
A Fee Based Service Company

INVENTORS: INVENTIONS: Commercial feasibility evalua-tions. Evaluate before you invest. Confidential. For brochure write: Wisconsin Innovation Service Center, College of Busi-ness and Economics, University of Wisconsin-Whitewater, Whitewater, WI 53190-1790.

Ideas, inventions, new products wanted! Call toll free 1-800-528-6050. In Arizona, 1-800-352-0458. Extension 831.

BUSINESS OPPORTUNITIES

FREE CATALOGS. Repair air conditioning, refrigeration. Tools, supplies, full instructions. Doolin, 2016 Canton, Dallas, Texas 75201.

MECHANICALLY INCLINED individuals desiring ownership of Small Electronics Manufacturing Business — without in-vestment. Write: BUSINESSSES, 92-K5 Brighton 11th, Brook-lyn, New York 11235.

ERASE DEBTS with little-known law — create wealth!! Details FREE — Blueprints, No. EE5. LaGrangeville, NY 12540.

FREE BOOK "2042 Unique Proven Enterprises." Fabulous "unknowns." second inflation income. Haylings-M. Carlsbad, CA 92008.

MAILORDER OPPORTUNITY! Start profitable home busi-ness without experience or capital. Write for free book, case histories, plus complete details. No obligation. Mail Order As-sociates, Dept 708, Montvale, NJ 07645.

BORROW \$30,000 without interest! All eligible. Repay any-time. Free details. Infohouse, Box 1004-PE5, New York, NY 10003.

BORROW BY MAIL! \$500.00 - \$50,000.00. No collateral, bad credit no problem!!! Write: Gelco Financial Services, Box 34293-PE, Indpls., IN 46234.

BORROW \$25,000 "OVERNIGHT." Any purpose. Keep in-definitely! Free Report! Success Research, Box 29070-GE, Indianapolis, IN 46229.

BUMPER STICKER PRINTING DEVICE. Cheap, Simple, Portable. Free details. Bumper, POB 22791 (PE), Tampa, FL 33622.

MAKE MONEY, sell electronic energysaving devices. Sales guaranteed. Send \$5.95 to: RAL, Box 263, Duluth, MN 55801.

BUSINESS IN JAPAN - Hermanos Miwa Co. of Nagoya. Ja-pan invites inquiries either from manufacturers seeking out-lets in Japan for their products or from companies searching for specific products in Japan. Contact our representative Hi-sao Miwa, 5 Carey Ave., Watertown, MA 02172.

ONE MAN CRT FACTORY. T.V.'s, Business machines, Moni-tors, Scopes, VDT's. \$3.00 rebuilding nets \$100-\$500 each tube. Higher profits overseas. New/used. FACTORY, 1909 Louise, Crystal Lkns, IL 60014. (815) 459-0566.

PROJECTION TV... Make \$200.00 + per evening assem-bling Projectors... Easy... Results equal to \$2,500 projec-tors... Your total cost less than \$15.00 — PLANS, LENS & Dealers Information \$14.00... Illustrated information FREE... Macrocomlix. Washington Crossing, Pennsylvania 18977. Creditcard orders 24 hours 215-736-2880.

LOANS-BY-MAIL you may borrow up to \$10,000.00. No col-ateral required! Write for free details: F.C.A. Signature Loans, Box 6006, Lanc, PA 17603.

USED TV's - Tougher The Economy - More The Demand. Get Started in this lucrative part or full time business out of your own home. Complete details, how to buy, sell, price, service tips, much more. \$5.00. USED TV'S, P.O. Box 19754, Indian-apolis, IN 46219.

I HAVE MADE A FORTUNE in Mail Order, selling information. Let me show you how. Write: Kash, PE-701, Box 31051, In-dianapolis, IN 46241.

EMPLOYMENT OPPORTUNITIES

ELECTRONICS/AVIONICS EMPLOYMENT OPPORTUNI-TIES. Report on jobs now open. Details FREE. Aviation Em-ployment Information Service, Box 240E, Northport, New York 11768.

NATIONWIDE listings of major companies employing Engi-neers and Technicians. Free Details! AVI, Box 264-PE5, Buf-falo, NY 14215.

SAUDI ARABIA — OVERSEAS! Vital Employment Guide, 60 Companies. \$15: AJK-PEE, Box 32378, Washington, DC 20007.

DO-IT-YOURSELF

FREE UPIR DA,AGED TAPES? Cassette, 8 Track Tape Re-pair Kits. \$4.95 each. Guaranteed. Visa, Mastercard. KITS, Box 127, Sumner, WA 98390.

REAL ESTATE

NEW, FREE, SUMMER CATALOG! Top real estate values coast to coast! Please specify types, property and location de-sired. UNITED FARM AGENCY, 612-EP West 47th, Kansas City, MO 64112.

BOOKS AND MAGAZINES

SATELLITES complete programs listings, 12 monthly issues \$65.00, SATELLITE TV GUIDE, Box 53, Ayden, NC 28513-0053.

THE MASTERMIND - The art of trouble shooting in engineer-ing. 120 page manual. \$15 00. Free info. BOTTAI, 4020 Bran-dongate #10, Malton, Ontario L4T-3WB. U.S. Inquiries.

RUBBER STAMPS

RUBBER STAMPS, BUSINESS CARDS. Many new prod-ucts. Catalog, Jackson's, E-100, Brownsville Rd., Mt. Vernon, Ill. 62864.

REPAIRS & SERVICES

D&A EQUIPMENT REPAIRED: Virginia Sabala, D&A s head technician 15 years, is now operating a parts and repair ser-vice. Communications Unlimited, 1217 Ave C, Scottsblum, NE 69361. Phone: (308) 635-7365.

MUSICAL INSTRUMENTS

MUSICAL INSTRUMENTS' HOT LINE! Incredible prices. Amps, PA gear. All instruments. Huge selection. Sam Ash, established 1924. 800-645-3518. NYS: (212) 347-7757.

MOTION PICTURE/VIDEO

VIDEOTAPES - 8MM/16MM MOVIES. TWO 72 page cata-logs \$1.00. Both \$1.50. Reelimages, Box 137-PE, Monroe, Connecticut 06468.

MISCELLANEOUS

MPG INCREASED! Bypass Pollution Devices easily. RE-VERSIBLY!! Free details — Posco GEE5. LaGrangeville, NY 12540.

VACUUM CLEANERS "Discount Prices" New Rainbow \$349.95, Kirby, Filter Queen, Compact, Details: ABC Vacuum Warehouse, 7021 Burnet-PE, Austin, Texas 78757.

AUTOMOBILE RETUNING FOR MAXIMIZED ECONOMY. DETAILS FREE! Techneering, Box 1506DD, Princeton, NJ 08540.

KALSO* EARTH* SHOES, Boots, Sandals! Our Catalog: 25¢, Shoeworks, 3930E South Troost, Tulsa, OK 74105. (918) 252-5120.

SELL

POPULAR ELECTRONICS

IN YOUR STORE!

- Big profits on sales
- We pay shipping
- FREE display rack

Min. order 8 copies per issue.

FOR DETAILS CALL COLLECT: **(212) 725-7518**



ZD ZIFF-DAVIS PUBLISHING COMPANY

psychology today CASSETTES

PSYCHOLOGY TODAY offers a free catalog which includes a complete up to date listing of cassettes available. These tapes feature leading authorities who share their ideas and findings on a wide range of important topics in all areas of the behavioral and social sciences.

To obtain the Psychology Today Cassette catalog. FREE-OF-CHARGE, write to CASSETTE CATALOG, P.O. Box 278, Pratt Station, Brooklyn, N.Y. 11205.

HOW CAN YOU DRAW more attention to your Ex-pand-ad*? Put it in all BOLD type! Call 725-3927 for more information.

ELECTRONICS WORLD[®] *Personal Electronics News*

A COMPUTER REASONING PROGRAM has been developed at the Department of Energy's Argonne National Lab and Northern Illinois U. Called AURA, for "AUtomated Reasoning Assistant," it's being used as an intelligent colleague instead of being just a number cruncher. The new program is said to suggest paths of inquiry for a scientist to investigate, and has already been used to solve problems in formal logic and abstract math, as well as help design more efficient electronic circuits. It does this, say its developers, by inferences, as would a human, rather than by an exhaustive testing of all the possibilities, as, for example, in a chess program.

LOW-COST SCOPE SALES TO ZOOM, according to a recent Dataquest study. From \$26.1 million sales in 1974, projections are for \$171.5 million in 1984. With industry estimates that a sales call costs about \$130, the study observes that, for low-cost oscilloscopes, direct sales channels are advantageous. Test-instrument makers have been taking this route for some time, and have recently been joined in this distribution method by Tektronix, which has telephones (1-800-547-1845) manned by sales engineers to provide immediate technical consultation and applications assistance for its new low-cost line of scopes. (They'll take your order, too.)



ATARI'S \$25,000 STAR AWARD has been presented to Fernando Herrera, creator of My First Alphabet™, an educational computer program for children. Herrera, of Elmhurst, NY, submitted the program to the 1981 Atari Software Acquisition Contest, which offers cash and equipment prizes totaling \$100,000 annually to developers of programs for Atari 400 and Atari 800 home computers. Contest winners are selected from among those whose programs have been chosen for publication in the Atari Program Exchange Catalog. My First Alphabet was originally designed to help Herrera's visually-impaired son learn to read, but Atari believes that its innovative graphics and large, colorful letters and numerals make it a useful learning aid for all children between the ages of two and eight.

CUBAN INTERFERENCE TO AM STATIONS has been the subject of a strongly worded condemnation by the National Association of Broadcasters (NAB). Accordingly, the NAB has instructed the Task Force on Radio Allocations to confer with representatives of Congress, the State Department, the National Telecommunications and Information Administration, and the FCC on ways to deal with the problem. The Cuban delegation to the Region II Conference on Medium Frequency Broadcasting has already "walked out."

BOSE CORP. WINS JUDGEMENT against Consumers Union, the publisher of Consumer Reports magazine. The damages, in the amount of \$115,296, is the first libel suit Consumers Union has lost in its 45-year history. The court ruled that the Union "published a false statement of material fact with the knowledge that it was false or with reckless disregard of its truth or falsity." In May 1970 Consumer Reports stated that instruments heard through the Bose 901 speaker "tended to wander about the room." Chief Judge Gaffery noted that prior to publication of the article, the Bose 901 had received outstanding reviews from other sources.

MANUFACTURING ENGINEERING, which once took a back seat to less prosaic tasks such as sending men to the moon, has acquired a new status at engineering schools. The change, according to the New York Times, comes about largely in response to increased foreign competition in consumer electronics. Attention is being focused on robotics—especially the so-called third-generation robots that will be able to collect sensory information and act on it in a factory setting. Top academies are also incorporating computer-aided-design, materials science, and business management into their manufacturing engineering programs.

DON'T BUY A MAGNAVISION JUST BECAUSE IT PLAYS MOVIES.

Watch your favorite movie on Magnavision® and you'll hardly recognize it.

Because Magnavision gives you a sharp, astonishingly clear picture—better than any VCR can deliver. And most discs are recorded in brilliant stereo sound as well, so you can hear your movie sound track the way it was *meant* to be heard...a whole new dimension in video/audio entertainment systems.

But we didn't develop Magnavision just for movies.

Magnavision is a LaserVision player.

And you'll be able to do things with the LaserVision system that are impossible with other systems.

It all starts with a laser beam: the heart of Magnavision.

The laser beam picks up a picture from a special video disc (it's about the same size as a long-playing record, but it's made of tough aluminum plated acrylic).

Nothing touches the disc except a tightly focused beam of light which reads the 0.4 micrometer pit on the disc. *So there's nothing to wear out*, and you can expect to see the same sharp, clear picture time after time.

Variable speed slow motion, jitter-free freeze-frame on any of the standard disc's 54,000 individual frames, and a "Rapid Search" button let you find just the place you want, when you want it—in seconds.

This advanced technology also gives you *room-filling stereo sound* (you can play it

through your own stereo system—frequency response is 40 to 20,000 HZ ± 3db).

You can enjoy movies, shows and concerts (wait till you hear Olivia Newton-John's* new video *Physical disc* in stereo!).

And the list grows longer every day.

There are also more and more "interactive" laser discs available—that's where the fun begins.

These are *discs that let you participate*, using the Magnavision wireless Infrared Remote Control.

You can learn *How to Watch Pro Football*† (and be quizzed afterwards); or try all the games and puzzles on the Grammy nominated *The First National Kidisc*‡.

You can go on art gallery tours and attend classical, pop or rock concerts.

Don't know how to filet a flounder? Take the *Master Cooking Course*§ from Craig Claiborne and Pierre Franey. Just put your Magnavision into "Slow Motion" and they'll show you exactly how it's done.

You can see it all on Magnavision right now.

Just stop in at your nearest Magnavision Dealer, push the "PLAY" button, and step into the future. *To find your nearest dealer, call toll-free 800-447-4700.*

© 1982 N A P CONSUMER ELECTRONICS CORP
A NORTH AMERICAN PHILIPS COMPANY

*Olivia Newton-John © MCA †Optical Programming Associates ©

MAGNAVISION



LaserVision THIS LASERVISION MARK CERTIFIES COMMUNITY WITH OTHER LASER OPTICAL VIDEO PRODUCTS BEARING THE MARK

MAGNAVOX

The brightest ideas in the world are here today.

CIRCLE NO. 56 ON FREE INFORMATION CARD

www.americanradiohistory.com

Report Manager™ and the PC-8000 Personal Computer: An unprecedented three dimensions of management information.

All those legendary electronic spread sheets that have been making other kinds of personal computers so useful for managers are now literally flat by comparison to the remarkable combination of Report Manager™ and the NEC PC-8000 Personal Computer.

Here you get the power and versatility of an electronic book, not a mere electronic page. An axis of depth joins the horizontal and vertical—so you can, for instance, track a number of different profit centers over the same period of time... or follow actual performance against projections by both department and time frame.

The fact is that any sort of planning work you find useful in two dimensions, you will find that much more useful in three. The program allows you to see four separate "slices" of your 3-D "Data Cube™" on one screen, for fast, real time comparisons. There are, besides dozens of math and editing functions, built-in clock and calendar functions, too—an immensely useful convenience for scheduling, flow-charting, project management, and the like.

Watch Report Manager run—easy as A, B, C and powerful as X, Y, Z—on the PC-8000 at any NEC Home Electronics (USA) dealer.

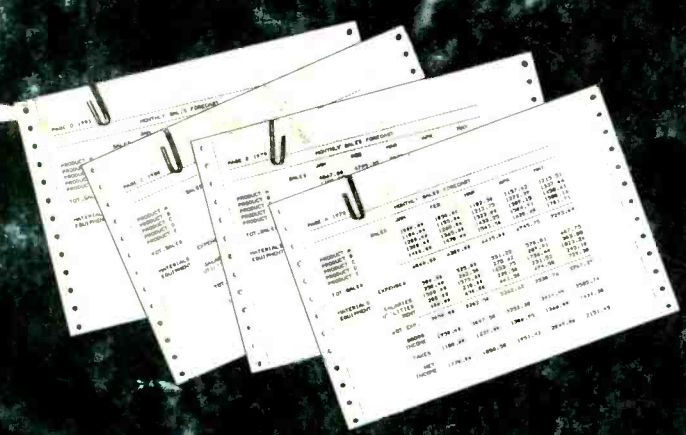
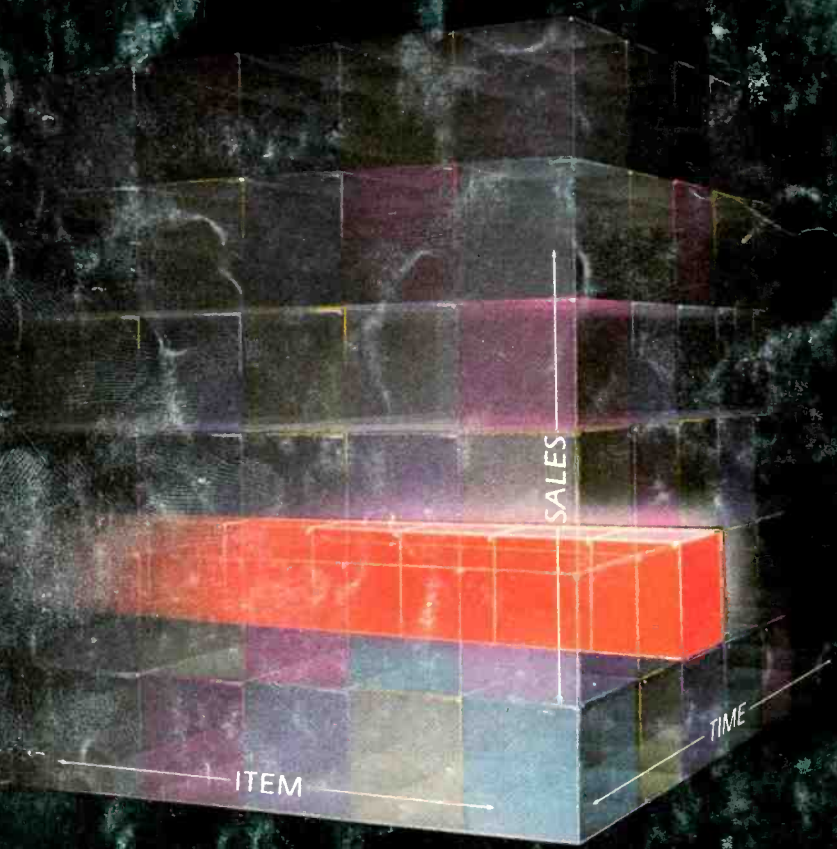

**Productivity
at your fingertips**

NEC
NEC Home Electronics (USA)
Personal Computer Division
1401 Estes Avenue
Elk Grove Village, IL 60007

Sample printout showing use of X, Y, and Z axes.
Report Manager and Data Cube are trademarks of The Image Producers, Inc.

CIRCLE NO. 42 ON FREE INFORMATION CARD

www.americanradiobistory.com