

Popular Electronics®

WORLD'S LARGEST-SELLING ELECTRONICS MAGAZINE

JANUARY 1981/95¢

Build a Car Battery Trickle Charger
Developing a Computerized Phone Dialer
How to "Type" Morse-Code Signals

PE Tests 8 Audio Power Amplifiers

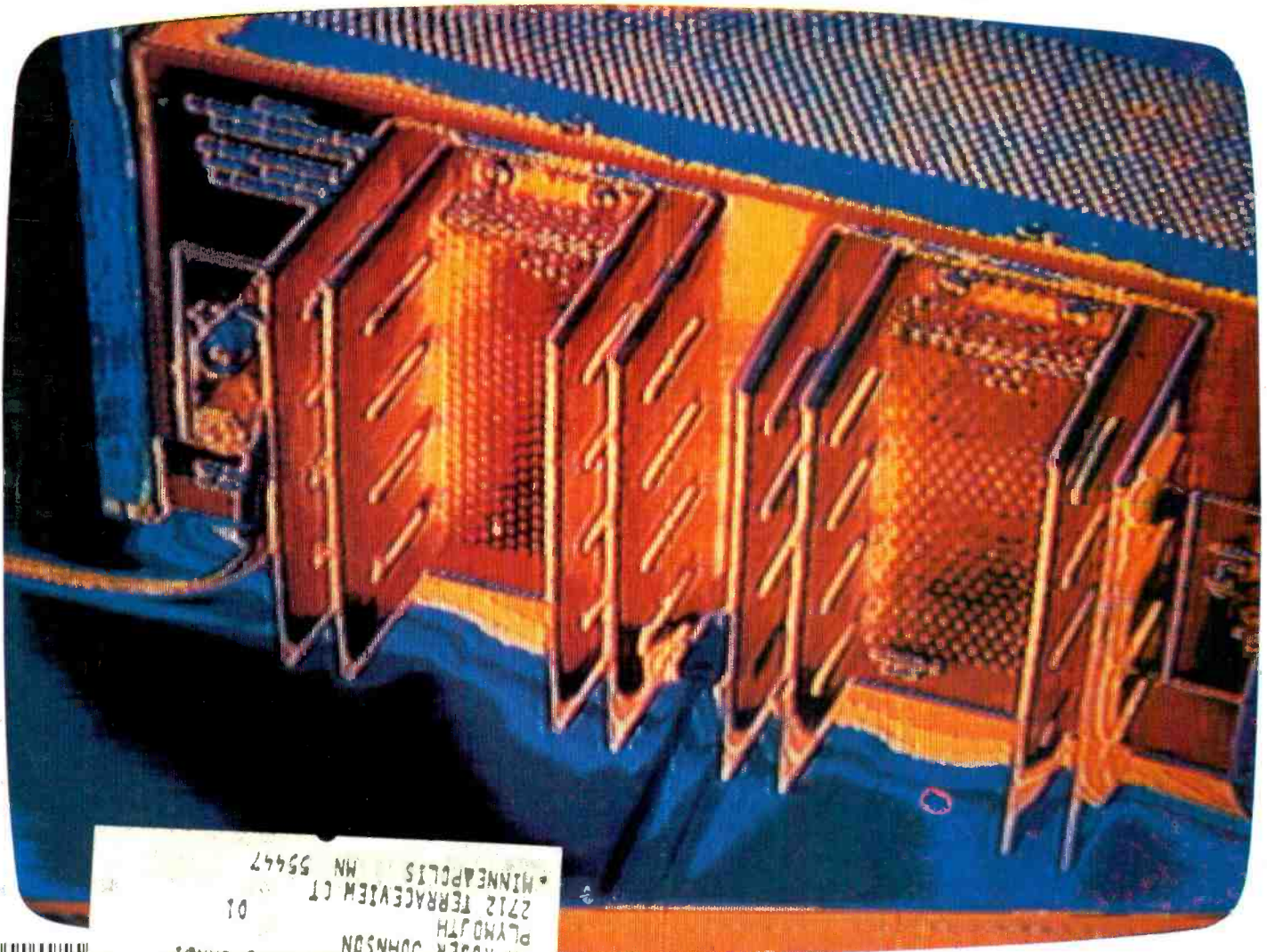

CARE WAREN EXAMINES:

Heath's H-89 "All-In-One" Computer





Edison had over 1,800 patents in his name, but you can be just as inventive with an Apple.

Apple is the company with the brightest ideas in hardware and software *and* the best support — so you can be as creative with a personal computer system as Edison was with the incandescent bulb.

How Apple grows with you.

With Apple's reliable product family, the possibilities of creating your own system are endless. Have expansion capabilities of 4 or 8 accessory slots with your choice of system.

Expand memory to 64K bytes or 128K bytes. Add an A to D conversion board. Plug into time sharing, news and electronic mail services. Use an IEEE 488 bus to monitor lab instruments. Add 4 or 6 disk drives — the 5¼", 143K bytes, high-speed, low-cost drive that's the most popular on the market.

Apple speaks many languages.

Since more than 100 companies create software for Apple, you'll have the most extensive library in the personal

computer world. Want to write your own programs? Apple is fluent in BASIC, Pascal, FORTRAN, PILOT and 6502 assembly language.

There's even a series of utility programs called the DOS Tool Kit that not only lets you design high-resolution graphic displays, but lets you work wonders with creative animation.

More illuminating experiences in store.

You won't want to miss all the Apple products being introduced at your computer store all the time. Don't let history pass you by. Visit your nearest



Apple dealer or call 800-538-9696.

In California, 800-662-9238. Or write:

Apple Computer, 10260 Bandy Drive,
Cupertino, CA 95014.

apple® computer inc.



CIRCLE NO. 3 ON FREE INFORMATION CARD



Beep Free

Doctors use them and so do many businessmen. The pocket beeper now takes a giant step forward with the introduction of the own-your-own system.

You're away from your desk in a meeting. Suddenly your pocket beeper starts beeping. You pull it out of your pocket, press a button and you hear your secretary's voice with a message.

"Big deal," you say. "What's so special about that. There are thousands of pagers like it in use." Yes, but this one is different.

TOTAL CONTROL

In the first place, you own the entire system. You own the transmitter and the beepers. Secondly, the system is inexpensive. It costs less than leasing one traditional beeper for a year. And finally, it solves the problems that other pagers can't solve—but more on that later.

The new Auto Page paging system consists of a transmitter that sits on your secretary's desk. When a call comes in, she presses a button which sends out a signal to your paging device. The antenna rests on your secretary's file cabinet and plugs easily into the transmitter so there's no installation.

MAKES NO SENSE

But like many breakthrough products the Auto Page System has limitations. The system was designed for office, factory, farm or home use. So its range is limited to one mile with voice and two miles with tone.

For doctors who are constantly on the road, the Auto Page does not make sense. For the business person, however, who moves frequently through an office or factory, the system is ideal.

Instead of using expensive paging or loud speaker systems, you can locate and communicate with your staff in privacy no matter where they are within your premises.

SERIOUS THOUGHTS

You can use up to six different pagers, each on different channels, and the entire system with two beepers costs only \$395.00.

Once you own the system there are no further costs. Conventional pagers rent for up to \$25.00 per month so in eight months the Auto Page System with two pagers would pay for itself and from then on your secretary can literally 'beep free.'

Each additional beeper costs \$75.00 or the equivalent of a three month lease on the typical beeper. But you can't compare a typical beeper with the Auto Page. The Auto Page has voice transmission. The typical beeper does not. The Auto Page is a totally personal system that can be used anywhere. The typical beeper must be used near a big city. And finally, the typical system is expensive—many times the cost of the Auto Page System.

HERE AND THERE

We suggest that before you decide to purchase, you experience the freedom and convenience of personal paging. Order a system from JS&A on our 30-day trial. Give a beeper to each member of your staff. See how easy it is to set up a system (just plug it in). And then actively use it for a month. If personal paging is not the most convenient and efficient way to communicate, return it anytime within 30 days for a prompt and courteous refund.

We've tested our system at construction sites, in large buildings, on farms, in the country, with motel operators and several small businesses. Based on our personal observations and sales success, we are convinced that the Auto Page System of personal paging is the future of paging.

JS&A is America's largest single source of space-age products—further assurance that your modest investment is well protected. Service should not be required for many years as the Auto Page is totally solid state, but if service is ever required, just pop your receiver or transmitter in its mailing carton and mail to the Auto Page service-by-mail center which will promptly repair and return your unit.

To order your system, send your check or money order for **\$395.00** for a system with two beepers and \$75.00 for each additional beeper up to six (Illinois residents add 6% sales tax) to the address below. Please add \$4 for postage and handling. Credit card buyers may use our toll-free number below.

We'll send you a transmitter, antenna, beepers, one-year limited warranty and complete instructions.

Personal paging and low-cost personal communications are nicely packaged in a system that will make your company more efficient from the very first day you test our system. Order one for your test at no obligation, today.



Dept. PE One JS&A Plaza
Northbrook, Ill. 60062 (312) 564-7000
Call TOLL-FREE 800 323-6400
In Illinois Call (312) 564-7000

© JS&A Group, Inc., 1980

Popular Electronics®

WORLD'S LARGEST-SELLING ELECTRONICS MAGAZINE

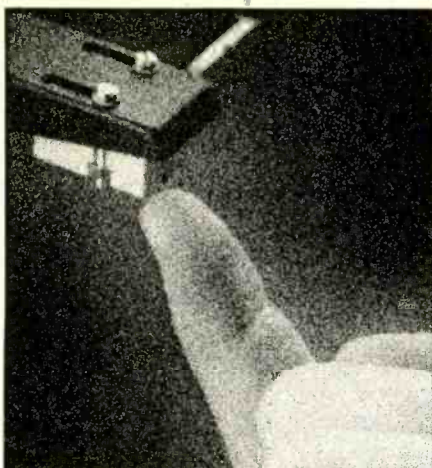

SC-2 gives your cartridge more than The Finger!

The famous SC-1 stylus brush (standard of the record and hifi industries) now has a synergistic fluid called SC-2.

SC-2 Fluid enhances and speeds cleaning and yet protects diamond adhesives, cartridge mounting polymers and fine-metal cantilevers against the corrosive effects of many other "cleaners."

The Discwasher SC-2 System. Stylus care you can finger as clearly superior.



discwasher®
PRODUCTS TO CARE FOR YOUR MUSIC

1407 N. Providence Rd.
Columbia, Missouri 65201

CIRCLE NO. 16 ON FREE INFORMATION CARD

Feature Articles

PE TESTS EIGHT AUDIO POWER AMPLIFIERS / <i>Julian D. Hirsch and Harold A. Rodgers</i>	52
ELECTRONIC GAMES: SPACE-AGE LEISURE ACTIVITY / <i>Jerry and Eric Eimbinder</i>	78
<i>Part 4: Video Cartridge Games.</i>	
THEY'RE WOONG YOU IN ELECTRONIC LAND! / <i>PE Editorial Staff</i>	82

Construction Articles

BUILD A MORSE-A-KEYER, Part 1 / <i>George Steber</i>	61
<i>Automatic Morse Code transmitting project.</i>	
TWO LOW-COST AUTOMOBILE PROJECTS	
1. Battery Booster / <i>Trickle Charger</i> / <i>Cass R. Lewart</i>	66
2. Automatic Alert to Shut Off Car Headlights / <i>C.R. Ball</i>	67
MICROPROCESSOR APPLICATIONS FOR THE 80's, PART III / <i>Ron Reese</i>	68
<i>A COMPUTERIZED AUTOMATIC TELEPHONE DIALER</i>	

Equipment Reviews

ACOUSTIC RESEARCH MODEL AR93 "HIGH TECH" SPEAKER SYSTEM	27
HEATH MODEL H89 MICROCOMPUTER	33
PANASONIC MODEL CT-9060 19" COLOR TV	43

Columns

ENTERTAINMENT ELECTRONICS / <i>Harold A. Rodgers</i>	22
<i>Miscellany.</i>	
COMPUTER BITS / <i>Carl Warren</i>	30
<i>Backup May Be on Your Mind.</i>	
COMPUTER SOURCES / <i>Les Solomon</i>	41
SOLID-STATE DEVELOPMENTS / <i>Forrest M. Mims</i>	84
<i>Wire-and-Glass Holdovers from the Pre-Solid-State Age.</i>	
EXPERIMENTER'S CORNER / <i>Forrest M. Mims</i>	86
<i>Experimenting With a Light Pen, Part II.</i>	
DX LISTENING / <i>Glenn Hauser</i>	94
<i>Trends in International Broadcasting.</i>	
PROJECT OF THE MONTH / <i>Forrest M. Mims</i>	99
<i>Ultra-Simple Power Flasher.</i>	

Departments

EDITORIAL / <i>Art Salsberg</i>	7
<i>Across My Desk.</i>	
LETTERS	12
NEW PRODUCTS	14
AUDIOPHILE RECORDINGS / <i>Harold A. Rodgers</i>	25
ADVERTISERS INDEX	102
OPERATION ASSIST	115
PERSONAL NEWS	116

COPYRIGHT © 1980 BY ZIFF-DAVIS PUBLISHING COMPANY. All rights reserved. Popular Electronics (ISSN 0032-4485) January 1981, Volume 19, Number 1. Published monthly by Ziff-Davis Publishing Co., at One Park Ave., New York, NY 10016. Philip B. Korsant, President; Selwyn Taubman, Treasurer; Bertram A. Abrams, Secretary. One year subscription rate for U.S. and Possessions, \$14.00; Canada, \$17.00; all other countries, \$19.00 (cash orders only, payable in U.S. currency). Controlled circulation Postage Paid at Salem, IL 62881. Authorized as second class mail by the Post Office Dept., Ottawa, Canada, and for payment of postage in cash. POPULAR ELECTRONICS including ELECTRONICS WORLD, Trade Mark Registered, Indexed in the Reader's Guide to Periodical Literature. Ziff-Davis also publishes Boating, Car and Driver, Cycle, Flying, Popular Photography, Skiing, Stereo Review, Electronic Experimenter's Handbook, and Tape Recording & Buying Guide, Forms 3579 and all Subscription Correspondence. POPULAR ELECTRONICS, Circulation Dept., P.O. Box 2774, Boulder, CO 80302. Please allow at least eight weeks for change of address, enclosing, if possible, an address label from a recent issue. Permissions: Material in this publication may not be reproduced in any form without permission. Requests for permission should be directed to John Babcock, Rights and Permissions, Ziff-Davis Publishing Co., One Park Ave., New York, NY 10016.

"Panasonic Color TV. So life-like, they play as brilliantly as I do."

Reggie Jackson

"When it comes to watching me, nothing makes me look better than a Panasonic color TV. Every Panasonic, from our 7" (meas diag) battery-operated portable to our big projection TVs, creates a picture that's so bright, so sharp, so colorful, it's really life-like. So life-like, you'll feel you're at the ballpark with me. And what's better than that?"

"I'll tell you: The two Panasonic CinemaVision projection TVs give you a picture that's not only life-like, but life-size. Our new rear projection CinemaVision (CT-4500 shown below) puts a 45" screen (meas diag) in a slim, trim body. Now you won't have to fill your room to get a roomful of picture. And you can control your CinemaVision from anywhere in the room. Because it has a

16-button synthesizer remote control. Synthesizer tuning, found in many Panasonic color TVs, uses computer technology. So you can go directly from the channel you're on to the channel you want, without having to go through all the channels in between.

"Panasonic CinemaVision and our other 3C color TVs make me look great. Whether it's a 7", 10", 12", 13", 19", 25", 45" or 5-foot Panasonic TV (all meas diag), you'll get a picture that's so life-like, you'll feel like you're part of the picture.

"That's why I say Panasonic color TVs play as brilliantly as I do."

TV picture simulated. Cabinetry is simulated woodgrain.

Panasonic.
just slightly ahead of our time.



CIRCLE NO. 60 ON FREE INFORMATION CARD

"Here's the best news yet about Fluke Digital Multimeters.

Now you can carry one home."

Right now, in selected electronics supply stores across the country, Fluke is introducing a new line of low-cost DMM's: the Fluke Series D. With their distinctive dark cases and full range of accessories, these five DMM's are designed to meet the test and measurement needs of the uncompromising service technician, home hobbyist, student or working engineer.

Fluke perfected the handheld DMM and set tough standards for accuracy and reliability that have made analog meters obsolete, and other digitals seem clumsy by comparison.

You've probably heard about their superior electrical performance, mechanical

ruggedness and environmental endurance. And now you can see for yourself at your favorite electronics dealer why Fluke DMM's have become the professional's choice the world over.

Series D Handheld Models.

D 800: Fluke's lowest-priced DMM, easy to operate, with six functions, 24 ranges and 0.5% dc voltage accuracy. Guaranteed a full year by Fluke. A sure-fire solution to basic measurement needs. \$125.*

D 802: Basic dc accuracy of 0.1% and conductance for high resistance measurements to 10,000 M Ω make this multimeter a solid price/performance value. \$179.*



If your dealer doesn't carry Series D Multimeters yet, call this number. We'll be happy to tell you who does. 1-800-426-9182

D 804: A powerful, versatile handheld DMM with nine functions, 26 ranges, 0.1% basic dc accuracy and more. Direct temperature readings in °C with K-type thermocouples; peak hold on voltage and current functions; even an audible indicator for instant continuity and logic level detection. Available January 1981. \$229.*

Series D Bench/Portables.

D 810: By means of a Fluke-built hybrid converter, this multi-purpose DMM delivers True RMS measurements of ac voltage and current with speed and precision. Also features conductance, 0.1% basic dc accuracy, an extra 10A range and diode test. \$259.*

D 811: Same performance features as the D 810 with the added convenience of battery power. Rechargeable "C" size Ni-Cad batteries deliver up to 40 hours continuous operation. \$299.*

Series D Accessories.

A wide range of accessories to extend the measurement capabilities of your Series D Multimeter is available, including temperature and current probes, carrying cases, deluxe test leads and thermocouples.

With Series D Multimeters so easy to find and economical to own, Fluke has made selecting the right DMM much simpler. This is your opportunity to own a Fluke.



From the world leader in DMM's. Now we've designed one for you.



CIRCLE NO. 20 ON FREE INFORMATION CARD

*suggested U.S. list price.
For technical data circle no.



NOW CLEANING YOUR OWN DISKETTE HEADS COULD SAVE YOU A \$40 SERVICE CALL. AND A LOT MORE.

The recording heads on your diskette drives may be dirty—and that can cause you a lot of grief. There's the serviceman you have to call when the machine doesn't perform. (You know how much service calls cost these days!) There's machine down-time. Idle data entry clerks. All the other delays a cranky machine can cause.

And that service call might not even be necessary.

3M solves the problem in seconds—and leaves your heads "Computer Room Clean".

The Scotch® head-cleaning diskette kit lets you clean the read-write heads on your 8" or 5¼" diskette drives. In just 30 seconds, without any disassembly mess or bother, the heads can be completely cleansed of dirt, dust, magnetic oxides—all the things that can get into your machines every day. And foul them up.

Just saturate the special white cleaning pad in its jacket with the cleaning solution. Then insert the jacket into the diskette drive and turn it on. Your machine does the rest. The



heads are microscopically cleaned without wear, without abrasion.

This 3M head-cleaning diskette kit has been evaluated and approved by major diskette drive manufacturers. It's the best possible way to clean your heads without service calls or machine teardowns.

At only \$1 per cleaning—it's the best insurance you can get.

This fast-cleaning new Scotch kit comes with everything you need (including special fluid, applicator tip, cleaning diskettes) to handle up to 30 cleanings. That's only about a dollar a cleaning.

With the Scotch head-cleaning diskette kit, you could save yourself a lot more than just a service call. So try this remarkable kit today. For the name of



A Scotch cleaning diskette shown before use, and after 15 cleanings of recording heads.



the dealer nearest you, call toll free: 800-328-1300.

(In Minnesota, call collect: 612-736-9625.) Ask for the Data Recording Products Division.

CIRCLE NO. 35 ON FREE INFORMATION CARD



3M



EDITORIAL

Across My Desk

We're continually inundated by mail, happily. Some of it contains interesting information that's filed for reference or stored in one's head for general-knowledge purposes on what's happening in the broad field of electronics. Here's a sampling of some of the latter.

• For the *Guinness Book of World Records*, Mitsubishi is now making available a color monitor that's capable of up to 1,800 lines of resolution, exceeding the old record of 1,200 lines.

• France has initiated an electronic telephone directory system that gives a visual displays of telephone numbers sought; entry is through an alphanumeric keyboard. Reports are that the French phone company expects to eliminate conventional telephone directories and phone "information" service by distributing more than 30-million free terminals over the next ten years.

• PE reported on cordless telephones in its December 1980 issue. These are short-range phones, typically with ranges up to 300 yards. However, there is a long-range portable telephone that provides nationwide outgoing-incoming phone service on the market. Called the "Travel Phone," from Travel Electronics, Costa Mesa, CA, it is available on a lease/purchase plan. \$3,895 and it can be yours!

• Video cassettes with three-dimensional capability have been released by MCA ("Creature from the Black Lagoon" and "It Came From Outer Space"). Special glasses must be worn, of course.

• The world's first "computerized" motorcycle was announced by Yamaha (Model SECA 750). Actually, it's a computer monitor mounted between handlebars that displays seven functions: sidestand, brake fluid level, engine oil level, battery level, headlight, taillight and stoplight conditions, and fuel condition. If trouble is detected, information is posted on an LCD display.

• A third video disc system is truly in the making, as General Electric, Matsushita, JVC, and Thorn EMI announced formation of jointly owned companies to launch the VHD (video high density) disc system in the U.S. in late 1981.

• A Japanese electronics company is reported to be constructing a factory in which electronic robots will be used to produce more robots. Robots are now priced from \$10,000 to \$150,000 or more. You can lease one for about \$1,000 per month. There are only about 10,000 robots in use throughout the world today, but it's projected that as many as 200,000 robots may be sold annually by 1990.

• The FCC finally made its "Computer

II" decision, one that will doubtlessly affect the computer business ever after. It gives total freedom to AT&T to enter the computer field in direct competition with other companies in the computer industry. Consequently, the phone company will now be able to enter the future, gigantic field that merges telephone lines with computer technology for data, advertising, and other information. This deregulatory decision has been castigated by computer industry spokesmen.

Obviously, there's a *potpourri* of mail that comes across my desk. This includes reader requests for circuit redesign for special purposes (sorry, we simply don't have the people power to provide such a consulting service), parts supplier names for specific devices (again, unless it's a very special part from one of our projects that was not offered in kit form, we cannot generally ferret out who stocks what in which area), and a host of others that cannot be considered reasonable requests. We do handle a lot of mail, but we caution you to include a stamped, self-addressed envelope if you wish to get a reply. Thanks for your understanding.

Art Salsberg

JOE MESICS
Publisher

ARTHUR P. SALSBERG
Editorial Director

HAROLD A. RODGERS
Executive Editor

LESLIE SOLOMON
Senior Technical Editor

JOHN R. RIGGS
Managing Editor

EDWARD I. BUXBAUM
Art Director

ALEXANDER W. BURAWA
Features Editor

JOHN J. McVEIGH
Technical Editor

ANDRE DUZANT
Technical Illustrator

CARMEN ROBLES
Production Editor

JEFF NEWMAN
Editorial Assistant

Contributing Editors

Carl Warren, Stan Prentiss
Glenn Hauser, Julian Hirsch, Forrest Mims

MARIE MAESTRI
Executive Assistant

OLIVIA WILSON
Promotion Coordinator

PEARL HARRINGTON
Assistant to the Publishing Director

SIDNEY HOLTZ
Publishing Director

Popular Electronics®

Editorial and Executive Offices
One Park Avenue
New York, New York 10016
212 725-3500

Publisher
Joe Mesics
212 725-3568

New York Office
Advertising Manager:
Richard Govatski (725-3939)

Eastern Advertising Manager
Bonnie B. Kaiser (725-3580)
Richard B. Eicher (725-3578)

Midwestern Office
Suite 1400, 180 N. Michigan Ave.,
Chicago, IL 60601 (312 346-2600)
Sales: Ted Welch

Western Representative
Norman S. Schindler & Associates, Inc.
7050 Owensmouth Ave., #209
Canoga Park, CA 91303 (213 999-1414)
Sales: Norm Schindler, Jon Marshall

Representation In Japan
James Yagi
Oji Palace Aoyama
6-25, Minami Aoyama, 6 Chome, Minato-Ku
Tokyo, Japan (407-1930/6821, 582-2851)

Ziff-Davis Publishing Company

Philip B. Korsant
Richard Friese
Phillip T. Heffernan
Sidney Holtz
Edward D. Muhlfield
Philip Sine
Albert S. Traina
Robert Bavier
Paul Chook (Research)
Baird Davis (Production)
Edgar W. Hopper (Marketing)
George Morrissey
Selwyn Taubman
Bertram A. Abrams

W. Bradford Briggs

Ziff Corporation

William Ziff
I. Martin Pompadur
Hershel B. Sarbin
Furman Hebb
Bruce Maggin
Lawrence Sporn

President
Senior Vice President
Senior Vice President
Senior Vice President
Senior Vice President
Senior Vice President
Senior Vice President
Vice President
Vice President
Vice President
Vice President
Treasurer
Secretary

Vice Chairman

Chairman
President
Executive Vice President
Vice President
Vice President
Vice President

Editorial correspondence: POPULAR ELECTRONICS, 1 Park Ave., New York, NY 10016. Editorial contributions must be accompanied by return postage and will be handled with reasonable care; however, publisher assumes no responsibility for return or safety of manuscripts, art work, or models submitted.

The publisher has no knowledge of any proprietary rights which will be violated by the making or using of any items disclosed in this issue.

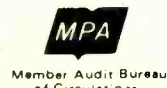

NRI will train you at home to be an electronics professional in the growing world of communications.

Learn to service, repair, and install everything from microwave antennas to two-way radios...from radar sets to TV transmitters.

TV Tape Recorders



TV Broadcasting



Antenna Systems



Marine Communications



Aviation Communications & Navigation Systems

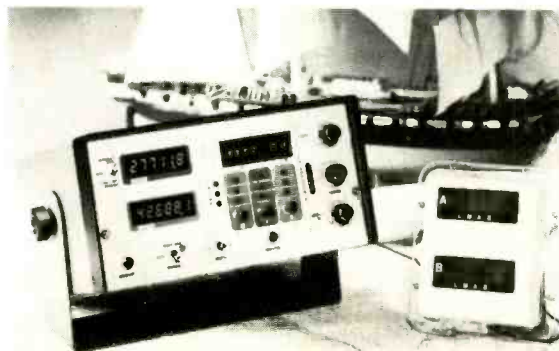

Direction Finders, Loran

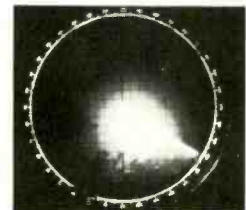

Radar

No other home-study course gives you such complete, professional training in so many fields of communication. No other gives you the actual bench training with kits and demonstration units specially designed for learning. Only NRI gives you the thorough preparation and training you need to achieve professional competence in the wide world of communications.

Learn at Home in Your Spare Time

Learn at your own pace, right in your own home. There's no need to quit your job or tie up your evenings

with night classes. No time or gas wasted traveling to school...NRI brings it all to you. You learn with NRI-pioneered "bite-size" lessons and proven, practical "power-on" training.

Build Your Own 2-Meter, Digitally Synthesized VHF Transceiver

NRI training is "hands-on" training. You get honest bench experience as you build and test this industrial-quality two-way radio and power supply. You reinforce theory lessons as you induce and correct faults, study individual circuits and learn how they interface with others. Or, at your option, you can train with a fully-assembled forty-channel mobile CB and base-station power supply converter.

You also build and keep for use in your work a transistorized volt-ohm

meter and digital CMOS frequency counter. NRI even gives you special lessons to get your Amateur License so



you can go on the air with your VHF transceiver.

FCC License or Full Refund

In all, you get 48 lessons, 9 special reference texts, and 10 training kits... the training you need to become a professional. And NRI includes training for the required FCC radiotelephone license examination. You pass or *your tuition will be refunded in full*. This money-back agreement is valid for six months after the completion of your course.

Free Catalog, No Salesman Will Call

NRI's free, 100-page full-color catalog shows all the equipment you get, describes each lesson and kit in detail, tells more about the many specialized fields we train you for. It includes all facts on other interesting areas like TV and audio servicing or digital computer electronics. Mail the postage-paid card and see how we can make you a pro.

If the card has been removed, write to:



NRI Schools
McGraw-Hill Continuing
Education Center
3939 Wisconsin Ave.
Washington, D.C. 20016



Mobile Radio



CB Radio



Aircraft Guidance & Landing Systems



AM & FM Broadcasting



Microwave Relay

WANT AUTO- RANGING?



AWS EZ 6100

AND...

- An unprecedented five-year warranty
- Pricing as low as \$105
- 3 1/2 digit display
- Autoranging on Volts and Ohms
- Continuity buzzer (Model EZ 6100)
- Range hold (Model EZ 6100)
- Autopolarity
- Automatic indication, unit and signs
- Feather touch button to select AC/DC - Lo Ω/Ω function
- Low battery warning sign
- Safety fused

EZ 6100	
DCV 0-1000	5-Autoranges
ACV 0-600	4-Autoranges
DCMA 0-200	2-Ranges
ACMA 0-200	2-Ranges
Ω 0-2000K Ω	5-Autoranges
Low Power Ω	0-2000K Ω
4-Autoranges Plus Continuity Buzzer	
EZ 6200	
DCV 0-1000	5-Autoranges
ACV 0-600	4-Autoranges
DCMA 0-200	1-Range
ACMA 0-200	1-Range
Ω 0-2000K Ω	5-Autoranges
Low Power Ω	0-2000K Ω
4-Autoranges	

- Order AWS EZ 6200... \$105
- Order AWS EZ 6100 with continuity buzzer and range hold \$142
- Order AWS C-30 Ever-Ready carrying case \$20
- For ordering information call toll-free: 800-645-5398

**A.W. SPERRY
INSTRUMENTS INC.**
The Measurable Advantage.

245 Marcus Blvd., Hauppauge, N.Y. 11787

LETTERS

Windshield Wiper Control

Thanks for the article on the design of an intermittent controller for a windshield wiper (August 1980). Readers will want to know that on some older cars, the cam-operated brake/park switch arm is internally connected to the wiper motor A+ on "park," not to the on-off switch. The return wire on these cars is in the "ground" or "park" contact.—P. L. Esmay, Tucson, AZ.

Capacitor Symbols

Why do your magazine's schematic diagrams show ceramic (and other non-polarized) capacitors with one curved plate, indicating a nonexistent polarization of some mysterious kind?—Clyde E. Wade, Jr., Little Rock, AR.

We make one side of all capacitors curved in accordance with the standards of the American National Standards Association and the Institute of Electrical and Electronics Engineers. Traditionally, this curved side is drawn on the side of the circuit that is closest to ground potential, whether the capacitor is polarized or not. If it is polarized, we add a plus sign to one side to indicate the polarity.—Ed.

Vocal Analyzer Connections

In "Build a Vocal 'Truth' Analyzer" (April 1980), the second paragraph on page 70 reads "Connect and solder the positive lead of B1's battery connector to the hole A-pad on the circuit board, the negative lead to the hole B-pad." Shouldn't the latter connection be to the pad next to the cathode of LED1? The A and B pads are connected together.—Daniel Narbone, Elmwood Park, NJ.

Correct. The component layout shows the proper connection.—Ed.

Hams and SWLs vs. OTHB

Regarding the "DX Listening" column of September 1980 on the USAF use of SWBC bands for OTHB radar, I am a SWL and an amateur operator and I don't understand how you think hams can move around to avoid such interference. The ham bands have very few useful kHz at any given time because of propagation. The broadcast bands have MHz after MHz that can be used to handle lots of signals.—R. Damato, Scituate, MA 02066.

Those "nonvoice" signals of CW, RTTY, and facsimile can suffer harmful interference just as easily as voice. Also, while it may be easy for two or three hams to change frequency, it is not easy for regular gatherings of 20 or more hams on a net to switch. What happens if OTHB pops up in the middle

of an emergency operation?—R. DeMattia, Milton, MA.

Glenn Hauser, our shortwave columnist, is obviously biased toward SWL, while ham operators favor amateur radio. Our columnists do not necessarily reflect the views of our editors, some of whom are hams and others SWLs.—Ed.

Video Paddle Game

"Electronic Games: Space-Age Leisure Activity" (October 1980) presented a fascinating history of electronic games, but I wonder if it was correct in attributing the invention of the video paddle game to Ralph Baer. Other articles have credited the design of the first practical paddle game to Nolan Bushnell of Atari.—W. Green, Albany, NY.

U. S. patent # 3,993,861, Nov. 23, 1976, on digital video modulation and demodulation, lists Ralph H. Baer as the inventor and includes 18 claims. He holds earlier patents relating to games, too. There's a license agreement for these patents between Sanders Associates and Magnavox and for rights to sublicense these patents, which other game makers do.—Ed.

A Two-Header

I'm a retailer who just got delivery of Panasonic's PV-1400 VCR, reviewed in your November issue. But it's a two-head machine, not a four-head one as you noted.—John Caig, New York, NY.

We're red-faced about this one. We requested a four-head machine, were told that there was only one prototype in the country, and it was finally received—the PV-1400—quite late in our schedule. Tests were made on the supposed four-head machine, which we discovered to be a two-header when publicity material was later received. Panasonic's four-head machine is its Model 1750.—Ed.

Cordless Telephones

In the Sampler Table in my article "PE Examines Cordless Telephones" (December 1980), the Radio Shack ET-310 should be listed as Simplex, and it does not have redial capability.—Jules Gilder.

Too Much Mistracking

There would appear to be something amiss with the mistracking diagram (Fig. 5) in the article "Phonograph Playback, It's Better than You Think" (November 1980) since the stylus paths are clear out of the grooves in some points.—R. Arata, Merrick, NY.

A printing error caused inaccurate registry of the colored lines. This threw the lines indicating the stylus paths out of place. The colored lines should have appeared approximately 1/8 in. to the left.—Ed.

New Price for High-Com II

In your excellent review of our High-Com II Noise Reduction System (October 1980), the retail price quoted for the unit should be \$480.—J. LeFevre, Nakamichi USA Corp.

Educator, Entertainer, Accountant.

Your Challenger Personal Computer.

Through the miracle of modern technology, a complete computer as powerful as the multimillion dollar room-sized computers of a few years ago can be put in a package the size of a typewriter and sells for as little as a color television set!

Through its years of microcomputer experience, Ohio Scientific has effectively channeled this tremendous computer power into a "friendly" computer with hundreds of personal uses, via a huge software library of programs for a broad range of personal, home, educational and business use.

This available software allows you to use and enjoy your computer without becoming an expert. The Challenger, however, is a powerful, general purpose computer which can be programmed in several languages by those who choose to.

Here are just a few of the popular uses of an Ohio Scientific Challenger Computer:

Education

The personal computer is the ultimate

educational aid because it can entertain while it educates. Software available ranges from enhancing your children's basic math, reading and spelling ability, through tutoring high school and college subjects, to teaching the fundamentals of computers and computer programming.

Entertainment

Many of the Challenger's games educate while they entertain, from cartoons for preschoolers to games which sharpen mathematical and logical abilities. But, entertainment doesn't stop here. The Challenger's graphics capabilities and fast operation allow it to display action games with much more detail than the best video games, providing spectacular action in games such as Invaders, Space Wars, Tiger Tank and more! All popular sports such as golf, baseball and bowling are available as simulated computer games as well as many conventional games such as chess where the computer plays the role of a formidable opponent.

Accounting

Your Challenger computer can keep track of your checkbook, savings account, loans, expenses, monitor your calorie intake and your biorythms.

If you are involved in a business, you can use it to do word processing; accounting, inventory control, order processing, customer lists, client records, mailing labels and planning.

And more:

This may seem like a lot of uses, but it's only the tip of the iceberg for a general purpose computer. For example, your Challenger can be expanded to control lights and appliances, manage your energy usage and monitor for fire and break-ins. Furthermore, it can communicate with you, with other computers and the new personal computer information services over the telephone.

In fact, the uses of general purpose, personalized computers are expanding daily as more and more people discover the tremendous capabilities of these new technological wonders.

Ohio Scientific offers you four personalized computer systems starting at just \$479.



CIRCLE NO. 40 ON FREE INFORMATION CARD

For a free catalog and the name of the dealer nearest you, call 1-800-321-6850 toll free.

OHIO SCIENTIFIC
1333 SOUTH CHILLICOTHE ROAD
AURORA, OH 44202 • (216) 831-5600

NEW PRODUCTS

Additional information on new products covered in this section is available from the manufacturers. Either circle the item's code number on the Free Information Card or write to the manufacturer at the address given.

Acutex Phono Cartridge



The Model 320 STR by Acutex is a new phono cartridge that employs a titanium cantilever and an induced-magnet transduction system. Its VITAL STR™ 0.3 × 1.6 × 0.5 mil stylus is said to have a symmetrical, elliptical contact area and effective tip mass of 0.5 mg. Rated frequency response is 20 to 20,000 Hz ± 0.75 dB; separation is 33 dB at 1 kHz and 29 dB at 10 kHz; IM distortion at +6 dB is 1.2%; channel balance is within 0.5 dB at 1 kHz; and output voltage is 3.5 mV at 5 cm/s and 1 kHz. The Saturn V headshell, into which the cartridge plug-mounts (no hardware or electrical connectors necessary) to maintain correct geometry, is optional. \$195; Saturn V headshell \$20.

CIRCLE NO. 86 ON FREE INFORMATION CARD

Communications Satellite Antenna

Vidiark Electronics Development Co. offers a 12-foot dish antenna, the Octasphere, for reception of signals from synchronous communications satellites. According to the manufacturer, the Octasphere has a shallow spherical curvature (7 1/4" deep at 6' from the center), an f/d ratio of 1.25, and focal length of approxi-

Sencore 60-MHz Scope



Sencore, Inc.'s model SC60 "WideBander" dual-trace scope is said to have 60-MHz bandwidth, and to be usable to 100 MHz. Using ECL logic and differential

amplifiers in the triggering circuit, it is claimed that sync is reliable with as little as 1 cm of true deflection throughout all settings of the timebase switch. No peaking coils are used in the vertical amplifiers. Rated sensitivity is 5 mV/cm on both channels; measurement capability is up to 1.6 kV peak-to-peak with full protection to 2 kV; and risetime is 6 ns. Delayed signals permit viewing leading edges on both traces. Both channels can be summed or subtracted, and the 5-MHz vector (X-Y) response is said to have 3° or less phase shift. Video sync separators allow use with video waveforms. \$1,695.

CIRCLE NO. 89 ON FREE INFORMATION CARD

mately 14.5'. It has a galvanized steel frame and a reflector surface of aluminum mesh. The recommended base (not supplied) consists of four concrete pads, each 12"D × 12"W × 24"H. The anten-



na can reportedly provide usable signals simultaneously from all satellites within a field of view of as much as 40°. A given satellite is selected by positioning a feed horn/LNA at the appropriate point in front of the reflector, which remains fixed. \$750. An optional sheet-metal feed horn designed to mate to a WR-229 waveguide is available for \$28.

CIRCLE NO. 88 ON FREE INFORMATION CARD

KEF Loudspeaker System

The KEF Model 303 Series II is a two-way loudspeaker employing a 7.9" bass

driver and a 1" soft-dome tweeter in a 0.6 ft³ sealed enclosure. Claimed on-axis frequency response is 70 to 20,000 Hz ± 3 dB at 6.6'; directional characteristics within ±2 dB of axial response to 10 kHz—±20° horizontal, ±5° vertical; and sensitivity 86 dB SPL on axis at 3.3' when driven by 1 watt of pink noise.



Rated maximum output is 103 dB SPL typical, power handling is 50 watts of program material, and rated maximum continuous sinusoidal input is 20 V rms from 20 Hz to 2 kHz and 10 V rms from 2.5 kHz to 20 kHz. Minimum recommended amplifier power is 10 watts/channel and nominal load impedance is 8 ohms. Rated system Q is 0.7 and resonance is 68 Hz. Enclosure dimensions are 20" × 10.4" × 9". Standard finish includes black or brown base, top, and grille. Optional, interchangeable grille sleeves are available in a choice of seven colors.

CIRCLE NO. 91 ON FREE INFORMATION CARD

Miniature Workbench Vise

The Mini Vise is a small (3" high) vise designed to hold items being assembled or repaired. The body of the Mini Vise is made of plastic, and the 1 1/2" long vise grips are metal. It attaches to a smooth

New S-100 Bus Computer

The Cromemco "System Zero" is an S-100 bus computer featuring a Z80A, 1K of RAM, and 3K Control BASIC in ROM. Three slots are available for expansion. A special version, System Zero/D, used with floppy disks, features a Z-80A, 64K of fast RAM, and a 16FDC disk controller that permits use of high-capacity drives storing 390K bytes on a 5 1/4" diskette. The controller has an on-board operating system (RDOS-2) that enables

reading or writing single-sided, double-sided, single-density, or double-density diskettes. Software features a system diagnosis for the memory, controller, and drives. Software support includes RPG II, FORTRAN, COBOL, 32K Structured BASIC, 16K BASIC, LISP, and a host of utilities. System Zero (Model CSO) is \$995; System Zero/D (Model CSO/D) is \$2995.

CIRCLE NO. 87 ON FREE INFORMATION CARD

Beckman brings a new dimension to hand held Digital Multimeters



True RMS capability at an affordable price





Now you can measure the exact power content of *any signal* — regardless of waveform. Beckman delivers the new TECH™ 330 multimeter with true RMS capability and many more fine performance features for just \$210.

Unlike most multimeters calibrated to read only the true power content of sine waves, the TECH 330 extends its true RMS capability to give you accurate readings of both sine and non-sine waveforms.

True RMS makes a significant difference in accuracy when measuring switching power supplies, flyback power circuits, SCR or TRIAC controlled power supplies or any other circuit generating a non-sine signal.

The TECH 330 also accurately measures the entire audio band up to 20 kHz. But that's not all you can expect from Beckman's top-of-the-line multimeter.

Measurement Comparison Chart

Waveforms (Peak = 1 Volt)	Average Responding Meter	Beckman TECH 330	Correct Reading
Sine Wave 	0.707V	0.707V	0.707V
Full Wave Rectified Sine Wave 	0.298V	0.707V	0.707V
Half Wave Rectified Sine Wave 	0.382V	0.500V	0.500V
Square Wave 	1.110V	1.000V	1.000V
Triangular Sawtooth Wave 	0.545V	0.577V	0.577V

You also get 0.1% basic dc accuracy, instant continuity checks, 10 amp current ranges, a separate diode test function, 22 megohm dc input impedance, and an easy-to-use rotary switch.

With so much capability in hand, you'll be able to depend on the TECH 330 for a long time. That's why Beckman designed it tough enough to go the distance.

Enclosed in a rugged water-resistant case, the TECH 330 can take a 6-foot fall onto concrete and still perform up to spec. And to further ensure reliable, trouble-free operation, the TECH 330 gives you 1500 Vdc overload protection, RF shielding, 2000-hour battery life, gold switch contacts, and fewer electronic components to worry about.

Add another dimension to your world of electronics. Visit your Beckman distributor today for more information on the TECH 330 and Beckman's complete line of digital multimeters, starting at \$120.

For your nearest distributor, or a free brochure:

CALL TOLL FREE

24 HOURS A DAY, 7 DAYS A WEEK

1-(800)-821-7700 (ext. 517)

in Missouri 1-(800)-892-7655 (ext. 517)

BECKMAN

CIRCLE NO. 9 ON FREE INFORMATION CARD

TEXAS INSTRUMENTS
electronic calculators

TI-30SP	17.95
TI-35SP NEW	24.95
Bus. Anal. I	21.95
BA II Exec. NEW	44.95
Bus. Card	39.95
Invest. Anal. NEW	49.95
TI-55	34.95
TI-57	54.95
TI-5100	39.95
TI-5015	64.95
TI-5040	89.95
TI-5135 NEW	79.95
TI-5142 NEW	124.95
TI-808 41 NEW	62.95
TI-58C	104.95



THE HP-85!

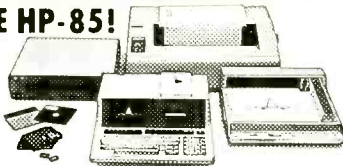

Complete Enhancements, Peripherals and Accessories

Your **hp** HEWLETT PACKARD Headquarters

HP-67	299.95	HP 31E	44.95
HP-92	399.95	HP 32E	54.95
HP-97	584.95	HP 33E	73.95
HP-33C NEW	89.95	HP 37E	59.95
HP-34C NEW	124.95	HP 38E	104.95
HP-38C NEW	124.95	HP 41C NEW	CALL
		HP 85 NEW	CALL

(714) 549-7373
INFORMATION LINE

(800) 432-7066
TOLL FREE (Within CA)

(800) 854-0523
TOLL FREE (Outside CA)

APF IMAGINATION MACHINE 495.00

apple computer II PLUS 16K 999.95

apple // APPLE III NEW CALL

6200 NEW EXECUTIVE 99.95

5813 NEW SCI PROGRAMMABLE 34.95

5100 NEW LCD ALPHANUMERIC 89.95

5102 NEW FIN. PROG 79.95

7000 NEW MEMO WRITER 124.95

CASIO M.L. 90 49.95

FX 68 27.95

CHESSE CHALLENGER "7" 99.95

800 (16K) STARTER SYSTEM 899.95

ATARI 1000 109.95

1750 NEW 269.95

CODE-A-PHONE

TIMER NEW 59.95

CONTROLLER COMMAND 33.95

ALSO: CANON, TOSHIBA, NSC, SEIKO, MATTEL, PEARLCORDER, ITT, GTE, AND MANY OTHERS. ALL AT GREAT PRICES!!

WE WILL MEET OR BEAT ANY COMPETITOR'S ADVERTISED PRICE ON MOST ITEMS IF HE HAS THE MDSE. ON HAND. VISA, MASTERCARD, MONEY ORDER, PERS. CK. (14 WRKG. DAYS TO CLR.), COD. ACCEPTED. MIN. \$4.95 SHIPPING U.S.A. AIR ON REQST. CAL. RES. ADD 6% SALES TX. ALL MDSE. SUBJ. TO AVAIL. PRICES SUBJ. TO CHANGE. SEND ORDERS TO POPELJ81



computique

WRITE OR CALL FOR FREE CATALOG

3211 SO. HARBOR BLVD.
SANTA ANA, CA 92704

NEWPORT ANAHEIM W. LOS ANGELES LAWDALE TARZANA PASADENA MID WILSHIRE BREA
(714) 549-7373 (714) 738-7775 (213) 820-0423 (213) 370-5795 (213) 705-7507 (213) 795-3007 (213) 385-7777 (714) 990-6600

PROFESSIONAL DISCOUNTS

CIRCLE NO. 14 ON FREE INFORMATION CARD

FREE McIntosh
STEREO CATALOG
and FM DIRECTORY

Get all the newest and latest information on the new McIntosh catalog. In addition you will receive an FM station directory that covers all of North America.

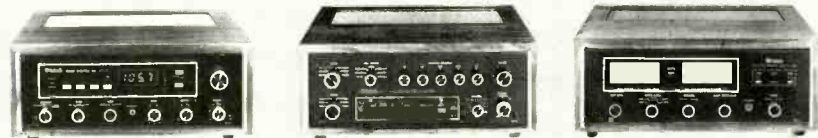

SEND TODAY!

McIntosh Laboratory, Inc.
East Side Station P.O. Box 96
Binghamton, N.Y. 13904

PE

NAME _____
ADDRESS _____
CITY _____ STATE _____ ZIP _____

If you are in a hurry for your catalog please send the coupon to McIntosh. For non rush service send the Reader Service Card to the magazine.

CIRCLE NO. 39 ON FREE INFORMATION CARD

new products

surface by means of a vacuum-grip base. \$2.95. Address: Heart's Desire, Box 4763, San Diego, CA 92104.

Front/Back Radar Detector



Leisure Time Development Associates announces availability of the Radar Intercept radar detector. Manufactured by JR Microwave Systems, the Radar Intercept is a dual-band (X and K) radar receiver that is said to respond to signal sources either in front of or behind the vehicle in which it is installed (or both). It can be mounted on the vehicle's sun visor and is activated when the unit is rotated to a vertical position. The dual conversion receiver has a rated sensitivity of -107 dBm/cm² on the X band and -90 dBm/cm² on the K band. Its antenna has a rated gain of 11 dBi, a horizontal beamwidth of 50°, and a vertical beamwidth of 25° on both X and K bands. Size is 5.7"W × 3.3"H and 1"D, and it draws 225 mA at +12 to +16 volts. \$279.95.

CIRCLE NO. 92 ON FREE INFORMATION CARD

Micro Seiki Belt-Drive Turntable



Micro Seiki's new Model MB18 is a semi-automatic, belt-drive turntable with a low-mass straight tonearm and a detachable carbon-fiber headshell. It incorporates a servo-controlled motor whose speed can be adjusted over a range of $\pm 5\%$. A strobe is included to facilitate accurate speed adjustment, and soft-touch push-buttons allow the user to select an operating speed of either 33 $\frac{1}{3}$ or 45 rpm. The turntable's base is ebony finished and has feedback-suppressing feet. Rated wow and flutter is less than 0.03% and S/N greater than 73 dB. \$275.

CIRCLE NO. 93 ON FREE INFORMATION CARD

(Continued on page 18)

IMMORTAL MUSIC SHOULDN'T BE KEPT ON MORTAL TAPE.



Good music never dies. Unfortunately, a lot of cassette tapes do. At Maxell, we've designed our cassettes to be as enduring as your music. Unlike ordinary cassettes, they're made with special anti-jamming ribs that help prevent tape from sticking, stretching and tearing.

And Maxell cassettes come with something else you won't find on most others. An unconditional lifetime warranty.

So if you'd like to preserve your old favorites for the years to come, keep them in a safe place. On one of our cassettes.



IT'S WORTH IT.

AMERICA'S BEST SELLING SCANNER JUST GOT EVEN BETTER.

Look what you get with the Bearcat 210XL. Exciting, new space-age styling. No-crystal, pushbutton tuning. New, 18 channel, 6-band coverage of over 6000 frequencies. And features like 2 scan speeds, Automatic Squelch, Search, and Lockout, Direct Channel Access, Selective Scan Delay. And much more. There's never been a Scanner like the Bearcat 210XL.

**"TAKE IT FROM A
SMART OPERATOR:"**

Tom Adams

**BEARCAT 210XL
SCANNER
\$209.**



THE LOWEST PRICED, FULL-FEATURE, BEARCAT NO-CRYSTAL SCANNER EVER.

Bring home all the real excitement of scanning and save! Bearcat 160 features a smooth, keyless keyboard for all controls including volume and squelch. Has 5-band, 16 channel coverage. Priority, Selective Scan Delay, Automatic Lockout, and Search. And much more. Bearcat is number one in scanning.

**"TAKE IT FROM A
SMART
OPERATOR:"**

Tom Adams

**BEARCAT
160 SCANNER
\$189.00**



Add \$6.00 per scanner for U.P.S. ground shipping in the continental U.S. or \$12.00 for U.P.S. air shipping. Send your cashier's check or money order to our address below or order by phone if you have a Visa or Master Charge card. Order today!

**C COMMUNICATIONS
ELECTRONICS™**

854 Phoenix □ Box 1002 □ Ann Arbor, Michigan 48106 U.S.A.
Call TOLL-FREE (800) 521-4414 or outside U.S.A. (313) 994-4444

18 CIRCLE NO. 1 ON FREE INFORMATION CARD

new products

Micro Bus Design System

Bishop Graphics has announced its new "E-Z Bus" design system, intended to aid in design of microprocessor interface circuits. It consists of bare, shaped, and drilled circuit boards, pressure-sensitive copper foils in a variety of shapes that adhere to the bare circuit boards, wrapped-wire sockets, and related components and hardware. The bare circuit boards or "E-Z Bus Cards" are available in configurations that are compatible with the Apple II, Commodore PET, Super KIM, TI 980, Altair 8800, IMSAI 8080, DEC, Heath, Motorola, Intel SBC80, National BLC80, and S-100 systems.

CIRCLE NO. 94 ON FREE INFORMATION CARD

Frequency Meter/Pulse Generator

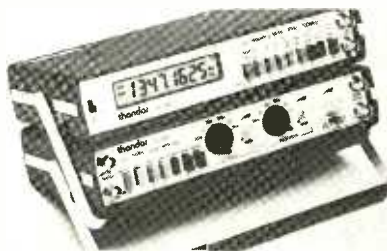

The Sinclair Thandar Model TF-200 frequency meter is battery-operated and has an 8-digit LCD display. Low-frequency input range is from 10 Hz to 20 MHz with a sensitivity of 10 mV; high-frequency input range is from 15 to 200 MHz with a sensitivity of 30 mV. The unit also has a totalizing mode to 20 MHz, five gate periods from 0.01 to 100 seconds, an external dc input jack, and a rear-panel jack for an external timebase. Internal crystal oscillator stability is better than ± 3 ppm from 18° to 28°C. \$394. The Thandar Model TG-105 Pulse Generator operates with pulse widths from 100 ns to 10 ms, and repetition rates from 200 ns to 20 ms. The output automatically goes to ground if the selected pulse width exceeds the period. Additional controls include external or manual trigger, free-run mode, and inverted output. Outputs include sync, TTL (fan-out of 20), and a 50-ohm output adjustable from 0.05 to 5.0 volts. \$219.

CIRCLE NO. 95 ON FREE INFORMATION CARD

Videocassette Eraser



Bib announces its new Model VE-3 Video Cassette Eraser, a handheld, line-powered device designed to quickly and thoroughly

erase previously recorded video cassettes. It is said to generate magnetic flux density of 2420 gauss at a distance of 1/8" and to have a built-in thermal cutout to ensure operating safety. A pushbutton switch activates the eraser circuit. \$47.50.

CIRCLE NO. 96 ON FREE INFORMATION CARD

Double Track/Density 5 1/4" Disk Drives

Shugart Associates has announced two new 5.25-inch disk drives having 96 tracks per inch. The SA410 (single-sided) and SA460 (double-sided) drives feature unformatted capacities of 500K bytes and 1M byte, respectively, using double-density recording. The drives incorporate helical cam V-groove leadscrew for head positioning to improve access time, a single-point ball follower to minimize hysteresis and friction, and a fast-starting dc spindle motor to allow the drive to be shut down when not in use. Track-to-track access time is 6 ms. An integral tachometer for speed control, "door open or disturbed" signal, and an active "in use" indicator are provided. Rated performance includes transfer rates of 250K bits/s for double-density, average access time of 160 ms, average latency of 100 ms, 1 soft-read error per 10^9 bits, 1 hard-read error per 10^{12} bits, and 1 seek error per 10^6 bits. \$325 for the SA410; \$400 for the SA460.

CIRCLE NO. 97 ON FREE INFORMATION CARD

Solar Controller Differential Thermostats



Wolfway Product Consultants Inc. announces availability of two differential thermostats for use in solar-heating and hot-water systems. The company offers Standard and Professional Models in assembled or kit form. Each model employs a 10-ampere triac that energizes a motor or some other load when two remote sensors detect existence of a given differential temperature between the medium in a solar collector and that in a storage tank. Assembled units have a preset triggering differential that can be readjusted. The Professional Model includes a 0° to 100° C dual-range analog thermometer, three additional sensors and input jacks so that additional points in the system can be monitored, plus an alarm circuit that can monitor any of the five sensors. Both models are housed in plastic cases with aluminum front panels. Professional Model

Watch technology may never be the same. Meticulous precision—thanks to the science of quartz—is now a remarkably common virtue. Alarms and stopwatches are turning up in more and more timekeepers. Even calculators have begun to find a place on people's wrists.

But the fact remains: all this available genius has never appeared in one under-\$200 timepiece—until now.

Introducing the new Megasonic calculator alarm chronograph. Only \$89, and only available through The Sharper Image.

A world exclusive: keys that talk back.

Megasonic engineers have come as close as anyone can to building an error free calculator.

First, they recessed all twenty keys. Meaning you can perform calculations with any pointed object—pencil, ball-point pen, even a felt tip pen—without slipping. And every key is metal reinforced, making it virtually impervious to wear.

Next, they went to the trouble of backing the entire keyboard with electronic sensors: every time a key is touched, a short beep tone confirms the entry. Audibly reassuring you that every number has been entered correctly. (No other wrist calculator, regardless of price, provides this feature.)

By the way, this electronic mathematician gives you the usual four functions—and a lot more. Like automatic discounts, mark ups, percentages, powers, reciprocals, and a full floating decimal. Plus a time display that's always visible, even during calculations.

The orchestra that never forgets.

Megasonic's wake up/appointment alarm is equally extraordinary.

Instead of annoying beeps, it attracts your attention with a musical masterpiece: Schubert's *The Trout*. And if you wish, this orchestral wonder will repeat the alarm every 24 hours—automatically.

You can also choose to have every hour punctuated with a two tone chime, on the hour.

And armed with a quartz crystal vibrating 32,768 times a second, this uncompromising chronograph delivers a host of other timing treats. Like 15 second-a-month accuracy. A day/date

calendar. A 1/100 second stopwatch, with lap times, reset, and a beep to confirm stops and starts.

There's even a choice between 12 or 24 hour time format—ideal for travelers.

Incidentally, you'll find all these features squeezed into a profile that's slimmer than a lot of conventional watches.

Great expectations.

You expect a lot from The Sharper Image. The watches we've introduced over the last few years are among the most talked about in America.

And we expect just as much from this Megasonic.

In addition to exceptional skills, it reveals the kind of dedicated detail found only in the most patiently engineered timepieces. The fully adjustable, solid stainless steel bracelet, for example. And the scratch-resistant, tempered mineral glass crystal.

In fact, we're so confident you'll share

our enthusiasm over this new calculator alarm that we're backing it up with an unusual triple guarantee.

First, the included factory warranty: limited one year parts and labor (in the rare event that repair is needed, you'll find this service-by-mail feature extremely convenient).

You'll also have the opportunity to decide if Megasonic is right for you. If not delighted, return it within two weeks (in new condition, please) for a prompt and courteous refund, including delivery charge. You must be satisfied.

Lastly, a third guarantee to introduce Megasonic to America—and give your investment even more protection. If this timepiece should fail for any reason (other than water damage, crushing, or deliberate abuse), return it to us within 90 days of receipt for a new replacement. Without charge. And without delay.

Megasonic comes with battery in place, full instructions and gift box. But initial quantities will be limited, so call now to ensure early delivery. And take advantage of all the genius the art of microelectronics has to offer.



Megasonic features the world's first sensor-touch wrist calculator, a musical alarm, a stopwatch and more. Dual display gives you constant time readout—even during calculations, stopwatch mode, alarm or date.

ORDER TOLL FREE

Ask for product #325. Credit card holders use our toll free number below. Or send check for \$89 plus \$2.50 delivery. Add \$5.34 sales tax in California. And please mention this magazine.

800 227-3436

In California 800 622-0733

THE SHARPER IMAGE™

260 California St.
San Francisco, CA 94111
(415) 788-8880

© 1980 The Sharper Image

**PUT AN ALARM, A STOPWATCH
AND A CALCULATOR ON YOUR WRIST.
FOR JUST \$89.**



\$144.95 assembled, \$99.95 in kit form; Standard Model \$74.95 assembled, \$49.95 in kit form. Wolfway Product Consultants, Inc., R.D. 1, Box 1135, Tamaqua, PA 18252.

Bidirectional Printer

The Qantex (Div. of North Atlantic Industries) Model 6000 is a serial dot-matrix impact printer having 136-column capacity and a printing speed of 150 characters per second. Using a 9 x 9 matrix,

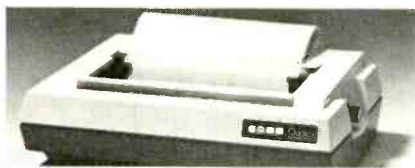

full lower-case descenders are provided. The printer also provides the capability of underlining. Other features include "look ahead" logic that decides whether a line goes from the left or right, a Centronics-compatible parallel and serial RS-232 1200-baud interface, and a 240-character

buffer. The printer can accommodate paper from 2" to 17 1/2" wide. It can print up to six multi-part forms and incorporates a vertical form control. There is also an impression control, 96-character ASCII set, and an out-of-paper sensor. It uses a cartridge ribbon. \$1,395.

CIRCLE NO. 98 ON FREE INFORMATION CARD

Pioneer AM/FM Stereo Receiver



Model SX-3500 by U.S. Pioneer is an AM/FM stereo receiver with rated output of 20 watts per channel continuous into 8 ohms from 20 to 20,000 Hz with no more than 0.05% THD. It has a 12-segment, two-channel fluorescent output-level indicator, an AM signal-strength/FM center-channel tuning meter, and an "AM Stereo" output jack that provides a buffered 450-kHz i-f signal tap. Rated IM distortion is no more than 0.05% at continuous rated output power. Other performance specifications include 11.2-dBf (2.0-μV) mono IHF usable sensitivity, 76-dB phono S/N (A weighted, input shorted), 78-dB tuner S/N (FM mono at 65 dBf), 35-dB FM stereo separation from 30 to 15,000 Hz, and 75-dB FM alternate-channel selectivity. Dimensions are 17 11/16" W x 12 1/16" D x 5 9/16" H, weight 16 3/4 lb. \$225.

CIRCLE NO. 99 ON FREE INFORMATION CARD

Pocket Digital Multimeter

The A.W. Sperry Inc. Model EZ-6100 digital multimeters feature autoranging on volts and ohms, 3 1/2-digit LCD display (10 mm high), auto indication of units and signs, autopolarity, overrange indica-

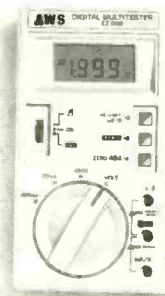

tor, low-battery warning, conventional and low-power resistance ranges, range hold, and compact dimensions as well. It is safety fused on ohms and current ranges. Power is from two 1.5-volt AA batteries. Ranges include: dc volts 0-0.2 2/20/200/1k; ac volts 0-2/20/200/600; ac/dc mA 0-20/200; ohms (normal test voltage) 200/2k/20k/200k/2M; ohms (low test voltage) 0-2k/20k/200k/2M. The Model 6100 also contains an audible continuity alarm. \$135.

CIRCLE NO. 100 ON FREE INFORMATION CARD

ΩMEGA DIRECT TO THE PUBLIC SALES WHOLESALE COMPUTER PRICES CO.

12 Meeting St., Cumberland, R.I. 02864

Christmas Specials

 Atari 800 '749	1-8K plug in RAM Module FREE (\$124.95 value)	1 Box (10 Pcs) 8" Diskettes FREE	 TRS-80 Model II - \$3449
 Apple II 16K - '999 (Regular or Plus)	1 Apple Tape Recorder FREE (\$40 value)	Microsoft Basic for only \$162.50	 INTERTEC SUPERBRAIN 32K RAM - \$2449.00 64K RAM - \$2649.00
 NEW! ATARI 825 PRINTER - \$949	Atari Interface Module FREE (\$219.95 value)	Statistics Pak or Carrying case FREE (\$95 value each)	 HP-85 - \$2899
APPLE II DISK with Controller - \$495 NEC Spinwriter 5530 or 5510 \$2449 OKIDATA MICROLINE 80 - \$529	FREE 1 Box (5 Pcs) Diskettes SOROC IQ 120 \$699	EPSON MX-80 80 Character, 9x9 Dot Matrix Roll & Pin Feed Printer for your Apple, TRS-80 or Commodore \$599 FREE Interface to Your Computer	

ΩMEGA OFFERS THE BEST DELIVERY AND PRICE ON:

APPLE • ATARI • TRS-80 MODEL II • INTERTEC • T.I. 810 • HEWLETT-PACKARD-85 • SOROC • COMMODORE • NEC • QUME • CENTRONICS

ΩMEGA sells only factory fresh, top quality merchandise to out customers.

ΩMEGA will try to match any current advertised price with similar purchase conditions.

Before you buy anywhere else — be sure to call ΩMEGA Sales Co.

TOLL FREE 1-800-556-7586

ΩMEGA ships via UPS, truck or air. COD's, VISA, Mastercharge accepted.

"A member in good standing of the Better Business Bureau."

TELEX: 952106



IN STOCK

DISCWASHER® AUDIO SCIENCE™ SERIES

Record Care, Part 1:

Aqueous Cleaning vs. Organic Solvents

Electron microscopy (Figure 1) shows the principal cause of record wear: small particles of microdust, deposited from the air by gravity, are ground along the record groove by the stylus. Surface noise goes up. Sound quality goes down.



Figure 1

In some record care products, organic solvents are used rather than water. Organic solvents such as ozone-gobbling chlorofluorocarbons, petroleum distillates (hexane, heptane) and alcohol concentrates are indeed speedy extractors and delivery solvents. They evaporate fast. Some organic solvents can dissolve vinyl stabilizers. Organic solvents may leave a "slick" looking record by treating the disc with other compounds carried in the solvent mix. In doing so, record contamination may also be dried back onto the disc in a nice even layer. Dust is often "held" to the record surface by "treatment."

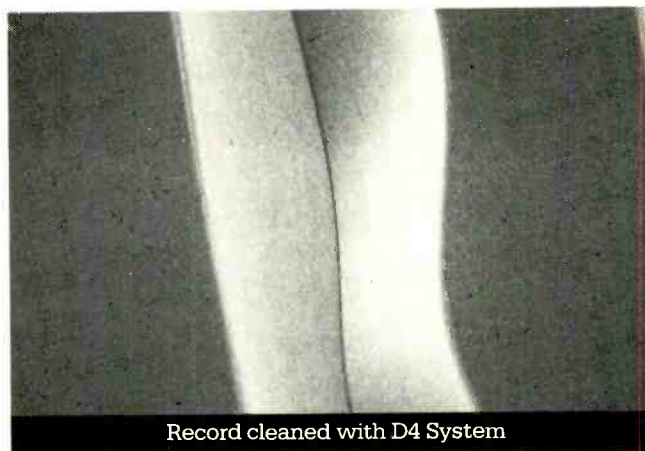

Figure 3

Electron micrograph (Figure 3) shows a record cleaned with the Discwasher D4 System. High technology record care leaves only a clean surface.

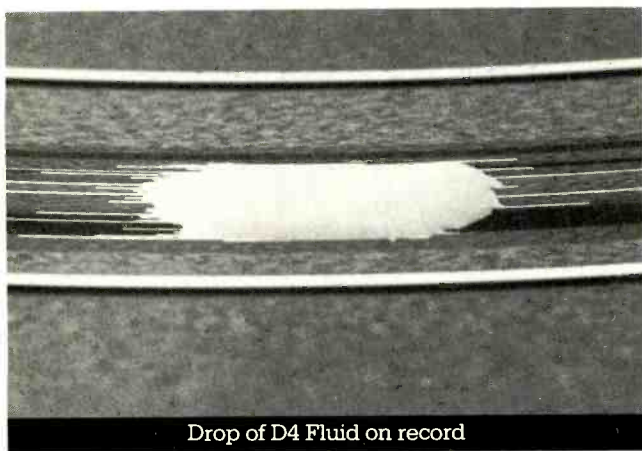

Figure 2

Figure 2 shows a drop of the aqueous Discwasher D4 Fluid, literally lifting dust and contamination out of record grooves. The extraordinarily complex D4 Fluid uses water pure enough for kidney dialysis, along with eleven chemically engineered additives that still results in lower dry-weight residue than most tap water. This formula is amazingly high in cleaning activity, uniquely safe for vinyl and vinyl additives, and preferentially "carries" contamination into the new Discwasher D4 pad.



discwasher®
PRODUCTS TO CARE FOR YOUR MUSIC

Discwasher, Inc., 1407 N. Providence Rd., Columbia, MO 65201

By Harold A. Rodgers
Executive Editor

Miscellany

Digital Recordings and Stress.

Opponents of digital recording have criticized it on grounds as naive as the undesirability of "chopping the sound up into pieces" and as sophisticated as phase shift caused by multipole anti-aliasing filters. But when J. Diamond asserted in a talk delivered to the Los Angeles AES convention last May that digital recordings produce symptoms of stress in human beings, he created quite a stir. Diamond supported his contention by demonstrating that the extended arms of volunteer subjects could be pushed down more easily when digitally recorded music was played.

A New Imaging System.

Since the introduction of the Carver Sonic Hologram, devices intended to enhance the imaging of stereo music systems seem to have caught the fancy of the public and designers alike. The latest entry to this relatively new marketplace is the Model IR2100 Image Restoration Control from Sound Concepts, available at a suggested price of \$250. Here is the manufacturer's description of the circuitry: "Previous units delay, rolloff, invert and cross-couple each channel into the other. The resultant comb filtering of the frequency response is maximized in the center where the (cancellation)

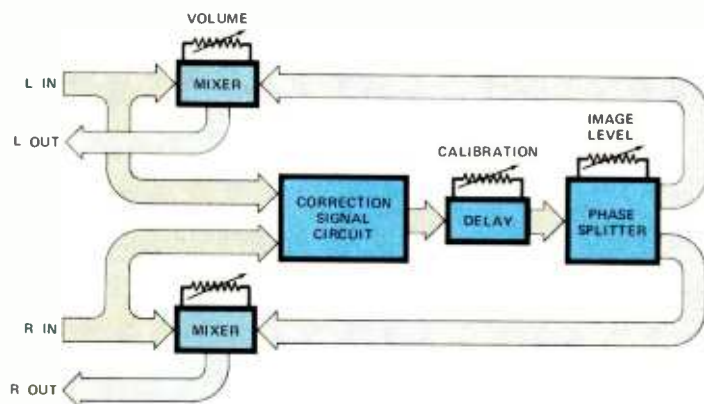

Fig. 1. Block diagram of the Sound Concepts Image Restoration Control.

Dissatisfied with the methodology used in the demonstration—notably, the lack of controls, the criterion for stress, and the fact that the test was not even single-blind—Nelson Morgan, now of National Semiconductor attempted to duplicate Diamond's results with a more carefully designed experiment. He reported his findings in a letter to the editor, published in the September *JAES*. Morgan used galvanic skin response and basal skin resistance as criteria indicative of stress, and had musical examples that were identical except for the way in which they were recorded. Analyzed statistically, Morgan's data show no correlation whatever between digitally recorded music and stress. That leaves digital sound in the small category of pleasures that are not bad for one's health.

process is least required and the uneven response most noticeable. By processing the directional information only (L-R signal), the IR2100 achieves the image expansion and focus with minimum side effects. Since the lower frequencies are predominantly monaural [sic], they are not processed or accentuated by the IR2100, and a highpass filter removes rumble which is a vertical or L-R signal. It is also possible to raise the image level and substantially amplify the correction signal to enhance the spaciousness of particular recordings, whereas doing that with conventional techniques would make them sound more monophonic. The complementary nature of the circuit also tends to keep the combined response of the two channels flat even at the extremes (of frequency)." A simplified block dia-

gram of the unit is shown in Fig. 1.

The device is housed in a box small enough to be hand-held that is connected to the TAPE or EXTERNAL PROCESSOR loop of the system control center and to its own ac-adaptor type power supply by a long "umbilical" cord. Protruding from the box are slide controls for VOLUME and IMAGE and a rotary control for CALIBRATION. A two-position switch bypasses the unit when the enhancement is not desired. Two LEDs are used: One is near the volume control, which is always active, and is on when power is supplied to the unit; the other shows when the image enhancement is in use.

Setting of the CALIBRATION depends on the distance between the speakers and the location of the listening position with respect to the plane of the speakers. Instructions for this adjustment are spelled out in the manual. Once the CALIBRATION is correctly set, the user can adjust VOLUME and IMAGE (the level of the correction signal) without ever leaving his chair. This is important, for the optimum corrected image occurs only at the listening position for which the unit is calibrated.

To examine the workings of the system in more detail, refer to Fig. 2. We see that the signal arriving at the left ear is that from the left speaker, L, plus a delayed signal from right channel R' that because of its greater path length is somewhat weaker. The relative attenuation of the right signal is α_2 . When the corrective signal is applied to the two channels in advance with the relative attenuation α_2 as shown in the diagram, the signal algebra given applies. Note that the prime (') operator represents a delay and distributes over a sum in parenthesis. That is, $(L - R)' = L' - R'$.

As we can see from the expression (1) for L_T , the signal reaching the ear

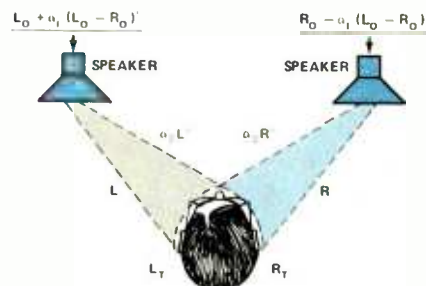

- (1) $L_T = L + \alpha_2 R'$
- (2) $= L_0 + \alpha_1 (L_0 - R_0)' + \alpha_2 (R_0 - \alpha_1 (L_0 - R_0))'$
- If $\alpha_1 = \alpha_2 = \alpha$
- (3) $L_T = L_0 + \alpha L_0' - \alpha_2 (L_0 - R_0)'$
- and by symmetry
- (4) $R_T = R_0 + \alpha R_0' + \alpha_1' (L_0 - R_0)'$

Fig. 2. Diagram and equations detailing the operation of the Image Restoration Control.

contains a large number of components. When the correction signal is set to precisely the level that best cancels interaural crosstalk, $\alpha_1 = \alpha_2$, expressions (3) and (4) apply, and the

World's First and Only Solar-Powered Watch*

Guaranteed to outperform any watch sold today... or costs you nothing!

The Sunwatch; acclaimed as the most accurate, most versatile, most rugged watch ever made.

These features make all other watches obsolete:

- Clearly visible by day or night
- Natural side-view window simplifies reading
- 100% solar-powered, you never replace batteries
- No resetting of calendar, not even in leap years

Space age accuracy

Now you'll never worry about accuracy again. Because the Sunwatch will keep you on time for the rest of your life. (Accurate to within 1 sec. per month.)

Solar age efficiency

Miniature solar cells automatically convert sunlight, daylight or ordinary bulb light into usable energy for storage. The solar cells last virtually forever. So you'll never replace a watch battery again.

Programmed for over a century

The built-in computer on a chip will always display the correct time date and month. Also, it automatically adjusts the watch calendar for long and short months, leap years and it's programmed until the year 2100!

Easy to read

The natural side-view display lets you tell the time, day and date without twisting your arm into an uncomfortable position.

Numbers always visible

Four varying light intensities are built into the viewing display, allowing the Sunwatch to adjust automatically to any light. This means you can always read it, even in the brightest sunlight.

10 Display functions

The Sunwatch is capable of displaying the following information: hours • minutes • seconds • months • date • day • leap year • speed calibration • AM/PM indicator • seconds count-off

Extreme accuracy

Unlike other electronic watches using tuned crystals to control timing accuracy the Sunwatch incorporates a unique, programmable, microcircuit synthesizer to make it the first watch in history that is accurate to less than 1 second per month. That's 5 times more accurate than the latest quartz Accutron.

The Power Source

Tiny silicon power cells, which are constantly being energized by natural sunlight, daylight or an ordinary light bulb keep the Sunwatch energy storage system charged. Should the watch not be exposed to light, it will continue to operate for months on stored power.

The most indestructible watch in the world

The workings of the watch: solar panels, energy cells, quartz crystal, computer on a chip, etc., are all permanently sealed in a Lexan module. This module is so unique it's protected by U.S. and foreign patents.

Completely waterproof

Leave the Sunwatch in salt water for months. Dive with it in depths up to 750 feet. There are no openings — magnetic slide bars activate all functions. With Sunwatch's exclusive, permanently sealed Lexan module, there are no 'O' rings or seals to leak.



Shock resistant to 25,000 G's

You can crash it into a rug-surfaced brick wall at 90 mph with no noticeable effect. Wear it while doing heavy work, exercise or any strenuous activity.

Temperature resistant

Put the Sunwatch in boiling water for 30 minutes, freeze it in a block of ice for a year. Extreme temperatures will not damage your Sunwatch.

Pressure resistant

There are no air spaces inside the Sunwatch. Therefore, it is not susceptible to high pressures such as might be encountered diving to great depths.

The perfect watch for a lifetime

Imagine split-second accuracy for the rest of your life. Sunwatch is a virtually indestructible, beautifully styled, space-age timepiece, and it's available in three exciting finishes: Brushed stainless steel, Gold tone stainless steel, or a Durable black finish on stainless steel. All Sunwatches come with a matching stainless steel band with removable links and adjustable clasp.

Made in the United States

The Sunwatch, designed by Roger Riehl, was being worn by its inventor nearly a year before the first electronic digital watch was even available to the general public. Since that time constant engineering evaluations and design improvements have been made on the Sunwatch to incorporate the latest in digital micro-circuit and solar power technology. Thus the Sunwatch today represents state-of-the-art electronics technology. It is built to the same rigid standards practiced by the manufacturer in creating sophisticated computer micro-circuits for the U.S. Government and other major users of these components.

* A word about other "Solar Watches"

Roger Riehl, designer of the Sunwatch, states that there is no other completely solar powered watch on the market today. Claims of solar power by other watch manufacturers are based on the use of a small solar cell. Due to their limited size, these cells can be proven, in technical terms, to be of virtually no significant value in extending the life of a watch battery. For this reason, all other so-called solar watches must have replaceable batteries. The Sunwatch's power storage system, however, need never be changed and is, in fact, permanently sealed to withstand abuse and the elements.

Unique and memorable gift

Available in a special gift box (see order form) the Sunwatch makes an ideal gift for special holidays, birthdays, graduation, Father's Day, etc. Perfect for business people, commuters, teachers, athletes and sportsmen, who require split second accuracy.

Free custom engraving

At your request, each Sunwatch will be hand-engraved with the name you specify.

Limited Warranty is your protection

The Sunwatch is covered by a 2 year limited warranty issued by Riehl Time Corporation (manufacturers of the prestigious Synchronor 2100) and included with your watch. A copy of the warranty may also be obtained free of charge by writing to Riehl Time Corp., 53 S. Jefferson Rd., Whippany, NJ 07981. This warranty gives you specific legal rights, and you may have other rights which vary from state to state.

15 Day no risk trial offer

Order your Sunwatch today and use it for 15 days. Then, if you are not completely satisfied return it for full money back.

CREDIT CARD ORDERS CALL

TOLL FREE 800-228-2626

Neb. Residents Call 800-642-8777

OR MAIL THIS NO RISK COUPON

RIEHL TIME CORP.

53 S. Jefferson Rd., Dept 44DWhippany, NJ 07981.

Please send me:

- _____ Brushed Stainless Steel Sunwatches at \$129.95 each
- _____ Black Finish on Stainless Steel Sunwatches at \$159.95 each
- _____ Gold Tone Stainless Steel Case Sunwatches at \$159.95 each
- _____ 24 Hour (Military Time) \$10.00 Additional
- _____ Gift Boxes at \$4.95 each

Please add \$3.95 per watch shipping and insurance. Enclosed is \$_____ Check or Money Order

*NJ Residents add appropriate sales tax

CHARGE IT: (Check One)

- Master Charge
- VISA (BankAmericard)

Credit Card# _____ Bank# _____

Issue Date _____ Exp. Date _____

Signature _____

Name to be engraved _____

Name _____

Address _____

City/State/Zip _____

Quick delivery direct from the manufacturer CIRCLE NO. 51 ON FREE INFORMATION CARD

www.americanradiohistory.com

DID YOU HEAR WHAT YOU'VE BEEN MISSING?



Listen with an 801 Omnisonic Imager™, a quantum leap forward in sound reproduction!

OMNISONIC IMAGERY™ IS HERE!

Our innovative state-of-the-art electronics restore the acoustical time-field characteristics and angular sonic positioning of the original recorded signal. The 801 analyzes the input signal and determines relative positions of instruments and vocals on the original source. They are then placed about the listening space creating the physiological sensation of three-dimensional sound – what we call omnisonic imagery™ – using only two speakers!* Sound appears to come from many sources within the listening space. A common reaction is to look about for other speakers. *And you don't have to sit rigidly fixed at a focal point between the speakers to enjoy the 801!*

*2 or more speakers!

LIFETIME WARRANTY!

You get a lifetime warranty on the active circuitry and one year on all other components (case and line cord excluded) provided your 801 is used as specified.

Now that you've read all about our 801 Omnisonic Imager™, don't you think it's time to hear one? If we have stimulated your interest in seeking the finest sound reproduction in the purest sense, please ask your dealer for a live demonstration. If you have any questions, or need to know the name of the dealer nearest you, call or write to:

OMNISONIX, LTD.

P.O. Box 430
Northford CT U.S.A. 06472

Call TOLL FREE
800-243-0688

In Conn. Call
(203) 239-6213

Omnisonic Imager™, Omnisonic Imagery™, Omnisonic Dimensional Sound™, and HBX™ are trademarks of Omnisonix, Ltd. All rights reserved.

© 1980 OMNISONIX, LTD.

NEW DIMENSIONS IN STEREO AND MONO!

Stereo with an 801 Omnisonic Imager™ creates a vivid feeling of "being there". Depending upon the source, the system, and the listener, sound appears to surround you, emanating from well beyond the speakers, above and below, near and far. The music is so alive it envelopes you. It is the sound of the future!

From mono, the 801 creates omnisonic dimensional sound.™ You can input an AM or TV source (from the earphone jack on your set) via the 801 and into your stereo system. The result is a "live" sound with depth and clarity, as well as separation. Television sound is vastly improved with the 801!

RETROFITS TO MOST STEREO SYSTEMS!

Any system with an internal tape loop can connect to the 801. Component systems can insert the 801 between pre-amp, other accessories, and the amplifier. There's a built-in tape monitor button on the 801, so you don't lose your existing tape monitor facility. The 801 works on any stereo or mono source – FM, tapes, records, AM, TV. You can record selections via the 801 and replay them on conventional home-use stereo equipment.



DON'T MISS:
Highway HiFi Imagery
With The
801-A Auto Unit
Coming Soon!

number of signal components is reduced. However, a delayed version of the original signal is introduced into each channel ($\alpha L_0'$ into L and $\alpha R_0'$ into R). L_0 and R_0 are the original signals recorded in the respective channels. The signals having the coefficients α^2 are relatively weak since α is less than 1.

Since the mixing of a signal with a delayed version of itself implies comb filtering, the frequency response for left-only and right-only signals is not flat. The location of the peaks and nulls depends on the setting of the delay control and the amplitude of the ripple on the setting of the image control. On the other hand, for centered signals, $L + R$, the correction signal is zero, meaning that there is no comb filtering of the center image.

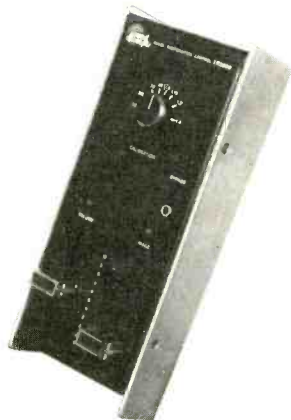

Sound Concepts
Image Restoration Control.

In practice, as the analysis predicts, the device works best when the delay and image controls are precisely set. An alternative method of adjustment, not mentioned in the instructions, may be somewhat more convenient. Disconnect one channel—say, the right—of the input signal fed into the Image Restoration Control. Then adjust the CALIBRATION so that the sound comes from as far to the left as possible. Do the same with the IMAGE control. These controls interact in their subjective effect, so the procedure should be repeated several times for optimum results. Finally, reconnect the right channel.

To experience the best performance the Image Restoration control can deliver, the listener must be located exactly at the point for which it is adjusted. Solitary listening, therefore, is the main application. The image produced under these conditions gives a good impression of depth and of location of sound sources. It extends slightly outside of the loudspeaker locations, though not as far as the image produced by some other devices of this general type. However, the residual comb filtering does impart a coloration to sounds, particularly those arising at the extreme left and right. Most often, if the recorded signal contains a reasonable amount of reverberation,

the effect is slight. And adding delayed signals via an outbound delay "box" and two auxiliary speakers to the sides or rear of the room tends to mask the coloration very nicely. ◇

CIRCLE NO. 104 ON FREE INFORMATION CARD

AUDIOPHILE RECORDINGS

By Harold A. Rodgers
Executive Editor

STRAVINSKY: *The Rite of Spring*. Lorin Maazel conducting the Cleveland Orchestra. Telarc DG-10054. This stunningly recorded disc is a welcome addition to Telarc's digital series. The sound is clean and detailed while retaining a good sense of ambience and perspective. During those passages in which the winds "play catch" with melodic fragments, the listener is made privy to the game—an unusual privilege, considering the complexity of the textures.

Part of this clarity is undoubtedly a result of the manner in which the work is performed. Tempos seem a little more relaxed than would generally be considered orthodox, which gives the ear time to digest this elaborate musical "meal." On the other hand, the slower pace robs the work of some of its compelling energy and drive. Nonetheless, the essential spirit of the work remains well intact. Whether this, or any other one interpretation of this modern classic, could be considered definitive seems highly questionable. Though Stravinsky himself may have been uncomfortable with the idea, the work provides ample room for differing opinions.

SPYRO GYRA: *Morning Dance*. Nautilus NR 9. The stature achieved by this album in its first release makes critical comment virtually superfluous. Selections from it have received so much air play that any jazz aficionado that does not know it well must have just returned from a vacation on Alpha Centauri. On the other hand, there is a degree of musical expressiveness and inventiveness that makes it all sound fresh.

An essential part of the good news about this album is the quality of its production. Half-speed cutting extracts details from the master tape that one would hardly believe were there. And if the surfaces are not the quietest I have encountered from a jazz disc, they must be awfully close. Nautilus, on the basis of history, can expect this disc to be a winner, and production as careful as this could hardly detract. ◇

...THEY HEARD WHAT THEY'VE BEEN MISSING!

"... In all of my more than 30 years as an Audio engineer... I can attest to the fact that the more than a half million dollars worth of professional and 'super' audio equipment that I designed and installed for the Conservatory of Music there, did not match the results obtained in using your '801' unit in connection with a new cassette recorder!"

H. White, Bradenton, Fla.
Audio Recording Engineer/
Consultant

"... A more lively and spacious sound which overcame the acoustical limitations of the room."

M. Conroy
B.C., Canada

"[Would you recommend an 801 to a friend?] Yes and no. Yes, because it is a really amazing thing that such a small piece of equipment can do to a system. The acoustics are a new dimension. No, because I get a little selfish about those people whose super-expensive systems now seem to be outdone by mine. Let'em eat their hearts out!!"

S., Conlon
Ames, Iowa

"... there isn't anything I've heard that improves the sound quality as much as the 801 does. Especially for such an economical cost."

J. Hagen, Milwaukee, WI

"On the basis of subjective experience, I can attest that the Omnisonic product works quite well. It seems to remove virtual sound sources from the plane of the loudspeakers and distribute them at various positions in the listening space, adding a sense of front-to-back dimension at the same time. At times, some sounds appear to come from in back of the listener, which is a startling effect, given that sound is being radiated only from the front. Another effect the device produces is a greatly increased sense of ambience or 'spaciousness.'"

Harold A. Rodgers
Executive Editor
POPULAR ELECTRONICS
July 1980

What better Holiday gift for yourself or your friend(s) than the 801 OMNISONIX IMAGER! Call or write today! (See opposite page.)

© 1980 OMNISONIX, LTD.

CIRCLE NO. 44 ON FREE INFORMATION CARD

Why the smallest digital scanner is also one of the smartest.

We started with very fast, sophisticated microprocessors. Then we made some highly complex circuitry very simple to operate. Just one touch tells the new M400 to monitor any active police, fire, weather and emergency frequency in your area. That's a lot of return for practically no effort. And it makes the M400 perfect for your home or car.

scan modes — whichever is best for you. We've also set aside a priority channel so you can monitor your favorite frequency every second. There's even a digital quartz clock and elapsed timer. And the control panel is backlit for the best possible visibility — day or night.



575 Channels, No crystals.

We've preprogrammed 545 channels with commonly used public service frequencies. Then we coded the touch sensitive keyboard with symbols for police, fire, marine, mobile telephone and weather. So all you have to do is touch the symbol for the type of activity and band you want to monitor. The M400 does the rest. If you want to search for unknown frequencies, the M400 lets you do that, too. And for those channels you want to store and hear again, you have 30 programmable channels to use. Plus you can use either manual or

**Take all the
action with you.**

With the new Regency Touch M400, you can have all the action, no matter where you are. It's the most complete scanner made primarily for mobile* use. And it works just great at home. So get the small scanner that's very smart. At your Authorized Regency Scanner Dealer.

Regency®

Regency Electronics, Inc.
7707 Records Street
Indianapolis, Indiana 46226

*Use of mobile scanners prohibited in certain locales.

CIRCLE NO. 49 ON FREE INFORMATION CARD

Audio Product of the Month

CHOSEN BY THE EDITORS OF POPULAR ELECTRONICS

Acoustic Research AR93 "High Tech" Speaker System

*A "no frills" speaker designed for
high performance at minimum cost*



MODEL AR93, part of Tele-dyne Acoustic Research's "High Tech" series of speaker systems, is a spin-off of the company's widely acclaimed top-of-the-line AR9, and incorporates many of its features. The 93 is designed to offer the consumer a maximum of performance at the lowest possible price. To this end, the cabinet is made of unfinished particle board, painted flat black and covered with a sleeve of acoustically transparent black grille cloth that slips over the cabinet like a giant stocking, and is drawn snug and stapled at the top. The top and bottom of the floor-standing cabinet are covered by black molded plastic plates, the bottom one including small supporting "feet." Input terminals are concealed under the cabinet.

Electrically, the system is a three-way design built with four drivers (two woofers are used). Designed to be driven to comfortable listening levels by power amplifiers in the 30-to-60-watt range, the AR93 can safely handle as much as 125 watts of continuous musical program material. Nominal system impedance is 6 ohms.

The AR93 measures 30 $\frac{5}{8}$ " H \times 14" W \times 10 $\frac{3}{4}$ " D and weighs 50 lb. Suggested retail price is \$249 each.

General Description. An obvious similarity between the AR93 and the AR9 lies in their use of twin side-firing woofers at the bottom of the cabinet. When the speaker is placed against a wall, this arrangement elim-

Brainchild

Yesterday — Remember the first Heathkit Analog Computer (1957)? Or the Heathkit Single-Sideband Transmitter (1958)? How about the Heathkit Multiplex Adapter for FM stereo reception (1960)?

Each was a ground-breaking innovation for its day. Each was a Heathkit brainchild.

Today — Today's brainchildren include the popular Heathkit All-In-One Computer, a complete computer system with disk storage, smart terminal, two Z80 microprocessors — all in one compact unit.

Also rising fast, the Heathkit Screen Star, a new projection TV that brings together the best in video technology to create the sharpest color picture ever on a six-foot diagonal screen.

Heath imagination applied to microprocessor electronics created the Heathkit Weather Computer. It monitors current weather, tracks changes, stores data — and puts it all at your fingertips.

Tomorrow — Tomorrow's brainchild, like today's and yesterday's, will combine the newest and the best in electronics to create a new state-of-the-art.

On the drawing boards right now are new designs for amateur radios, audio components, computers, color TV's, test instruments and new educational programs — all in easy-to-build, money-saving kits. They'll be appearing soon in Heathkit Catalogs and at Heathkit Electronic Centers. It's one catalog you don't want to be without.



Heathkit®

SEND FOR FREE CATALOG

Write to Heath Co., Dept. 010-734
Benton Harbor, MI 49022.

CIRCLE NO. 25 ON FREE INFORMATION CARD

VISIT YOUR HEATHKIT STORE

In the U.S. and Canada visit your nearby Heathkit Electronic Center where Heathkit products are displayed, sold and serviced. See the white pages of your phone book. In the U.S., Heathkit Electronic Centers are Units of Veritechnology Electronics Corp.



GX-379



inates the usual mid-bass cancellation and reinforcements due to the reflections from the rear wall. In the AR93, the woofers are 8"-diameter cone drivers in a fairly sizable enclosure (1.77 cubic feet, or 50 liters).

Also reminiscent of the AR9 is the vertical alignment of the midrange and high-frequency drivers on the center line of the front panel. The 8" midrange driver, which takes over from the woofers at 350 Hz, is housed in a separate sealed enclosure. At 2,000 Hz there is a crossover to the tweeter, which is a 1 1/4" cone unit. Its voice coil is cooled and damped by ferrofluid injected into its magnetic gap.

Although the recommended location for the speaker is with its back against a wall, alternate placements are acceptable as long as both woofers are at least 2 feet from any wall surface they may face. If the back of the speaker cannot be placed against a wall, it should be at least 2 ft away.

The crossover network, despite its apparent simplicity, aims at performance typical of more elaborate and expensive networks. Separation between the woofers and midrange driver is provided by a series network in which the impedance characteristic of each driver is used to help achieve a 12 dB-per-octave crossover for its neighbor with the minimum number of components. The high-frequency rolloff of the 8" midrange driver comes from its own mechanical parameters, without additional circuit elements; the matching 6 dB-per-octave slope for the tweeter crossover is obtained with a single capacitor.

An additional goal of the design of the crossover network and drivers was to provide a reasonably uniform and acceptably high-impedance characteristic for the system. The rated minimum impedance of the AR93 is 4.5 Ω , with a value of 6 Ω overall.

Another feature that has carried over from the AR9 (with some modifications) is the "acoustic blanket." In the AR9, this was a layer of acoustically absorbent material surrounding the middle- and high-frequency drivers to absorb high-frequency side radiation. This energy would otherwise undergo diffraction at the enclosure

edges and give rise to delayed reflections, blurring the stereo image and roughening frequency response. In the AR93, strips of absorbent material surrounding the tweeter at a distance of several inches perform a similar function.

Laboratory Measurements. Far-field measurements of the output from a pair of AR93s were made with the speakers about 3 feet from the rear wall of the room. Measurements made with the speakers against the wall yielded very similar results. Low-frequency response was measured in the near field of one of the woofers to eliminate possible room effects.

Smoothed far-field frequency response was quite flat up to about 7,000 Hz, rising slightly at higher frequencies (this is to some degree a characteristic of our test environment and instrumentation) and reaching +5 dB at 18,000 Hz. The close-miked woofer response was flat from about 80 to 250 Hz, sloping off at higher frequencies as the crossover network came into play. Low-frequency output peaked to about +4 or +5 dB at 70 Hz before falling off at lower frequencies at the expected 12-dB-per-octave rate.

The near- and far-field curves fit together unambiguously at about 350 Hz, resulting in a composite frequency response of ± 3.5 dB from 40 to 20,000 Hz. Considering that the principal deviations from flatness were at the frequency extremes, where they are most affected by measurement uncertainties and room acoustics, this is an exceptionally uniform response. Tweeter dispersion was especially good for a cone driver, as the response curves measured from the left and right speakers (on the axis of one and about 30 degrees off the axis of the other) diverged only moderately above 10,000 Hz. Tone-burst response was also very good, showing little sensitivity to frequency or microphone position changes.

Woofer distortion was measured at a constant 2.83-volt drive (nominally 1 watt into an 8-ohm load) and also at a level 10 dB higher (8.94 volts). At the lower level, the readings were ex-

tremely low in the midbass region and somewhat higher at lower frequencies. When the drive was increased to the higher level, distortion roughly doubled. Details are shown in Table I. Note that at 30 Hz with a 10-watt drive, the distortion spectrum is dominated by the relatively benign second harmonic.

System impedance reached a minimum of about 4.5 ohms at 20 Hz, and between 100 and 200 Hz. There was a resonant rise to 10 ohms at 50 Hz and a broad rise to about 12 ohms in the vicinity of 2,000 to 3,000 Hz. Average impedance over the audio range appeared to be about 6 ohms. System sensitivity, rated at 87-dB sound pressure level at 1 meter on axis from 1-watt input, was checked with a 2.83-V random-noise signal in an octave band centered at 1 kHz. Measured sensitivity was 88 dB SPL.

User Comment. In our listening room, the recommended placement (against the wall) tended to over-emphasize the lower frequencies. We preferred the sound with the speakers about three feet from the wall. As with any speaker, some experimentation is called for before deciding on a final position.

The AR93 is relatively uncolored in sound. Its very potent deep bass response does not cause heaviness and is not apparent until the program calls for it. When we made critical comparisons of the AR93 against some much more expensive, very flat speakers, we could hear a trace of added brightness in the AR93. This tended to confirm the slightly emphasized high-end response shown in our measurements, at least in our listening room. However, this rise in response was never noticeable when listening solely to the AR93, but only in close comparison with other speakers.

We noted with interest and approval that AR does not provide any user-adjustable tweeter or midrange level controls on the AR93. We have usually found such controls capable only of degrading overall response. In our experience, all necessary response alternations are possible via amplifier tone controls, whose function, in turn, cannot be performed by driver level controls. To our ears, the AR93 provides an exceptionally well-balanced, clean, musical sound, regardless of which of its suggested placements is used.

Although we were not able to compare the AR93 to other similarly priced speakers, our past experiences suggest that it would rank at or near the top of its price class in overall sound quality. Its appearance is somewhat stark and utilitarian, but if you are more concerned with good sound than a handsome furniture finish, a pair of AR93 speakers can go a long way toward providing true high-fidelity sound at moderate cost. \diamond

Julian D. Hirsch

CIRCLE NO. 101 ON FREE INFORMATION CARD

TABLE I—WOOFER DISTORTION

Frequency (Hz)	1 watt (2.83 V into 8 Ω)			10 watts (8.94 V into 8 Ω)		
	Harmonic content (dB)		THD (%)	Harmonic content (dB)		THD (%)
	Second	Third		Second	Third	
100	-55	-60	0.20	-46	-54	0.53
90	-52	-60	0.27	-42	-50	0.85
80	-48	-58	0.42	-42	-60	0.85
70	-56	-53	0.28	-39	-57	1.1
60	-36	-43	1.8	-33	-44	2.2
50	-34	-36	2.7	-31	-29	4.5
40	-30	-49	3.2	-23	-31	7.5
35	-23	-45	7.1	-17	-30	14.1
30	-17	-45	14.1	-13	-30	22.4

By Carl Warren

Backup May Be On Your Mind

AS A result of the growing number of Winchester disks being used for prime storage in microcomputer based systems, a need for backup has arisen. Numerous manufacturers are touting so-called streaming methods that employ magnetic tape. This backup philosophy, unfortunately, offers more disparities than it does possibilities. Among these are included:

- Inability of the streamer to accept data faster than 30 ips (30K bytes/s). This is primarily for 1/4-in. 3M cartridge drives. Drives that employ 1/2-in. reel-to-reel tape are able to handle fast data rates, but you pay the price.

- Although the 3M data cartridge works well in start-stop operations, it appears to be almost a detriment for streaming operations. The reason for this is that in a streaming environment, even at 30 ips, the tape is traveling at an unusually high rate for its design. As a consequence, the tape can lose its tension, causing a fluttering against the head; this produces both soft and hard errors.

There is an alternative to streaming tape drives, though, and it is available now. It is the Corvus Mirror®. The Mirror permits up to 100M bytes of removable back-up storage by using a Panasonic NV 8208 video cassette recorder and a Corvus controller. The Mirror is designed to back up the Corvus 10M byte Winchester drive and interface to a host of computer systems, including Apple, TRS-80, S-100, LSI-11 and Heath H89.

Essentially, 532 byte blocks of data are sent to the video recorder and, in the process, are transformed into video signal format as shown in the accompanying photo.

The advantage of the Mirror over other methods of backup, including floppies, is that individual blocks of data can be searched for on the tape, with specific portions either updated or written out to the disk. The only advantage streamers have over this device is speed. But speed is relative, especially when no real product exists and flexibility is at a minimum.

The Mirror is currently priced at \$790. This is the controller only and doesn't include the video recorder, which the company will sell to you but recommends that you buy elsewhere. A Corvus spokesman pointed out that

the Panasonic unit is back-ordered, and lead times aren't being given. Therefore, you might latch on to a less expensive device and forego the remote control operation. Manual operation takes only ten minutes of your time, at the longest, but can save you around \$1000.

Get Your System Ready. Those of you that have a Radio Shack TRS-80 will want to get your system ready to run nonmodified CP/M. This is important if you want to follow along with the various topics I'll be discussing in the next few months.

To update your system, you'll want



Corvus Mirror and VHS tape system provide tape backup for 8-in. drives.

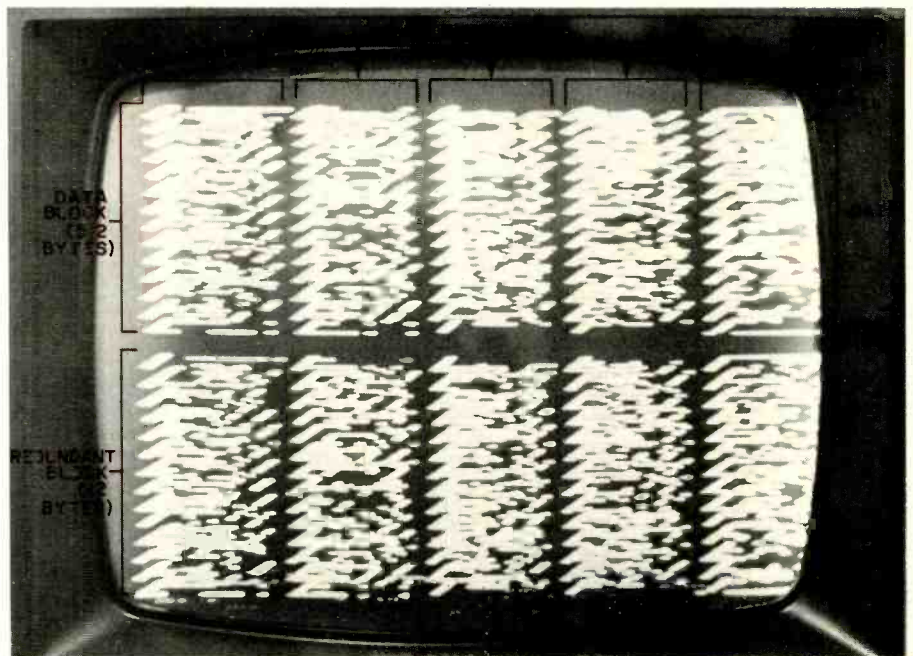

Digital data, transformed by the Corvus controller, looks like video data with specific attributes. (Copyright 1980, Corvus Systems)

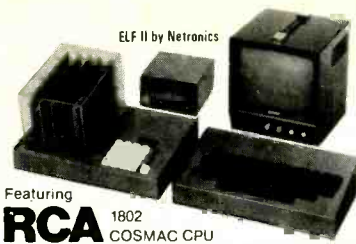

Write and run programs—the very first night—even if you've never used a computer before!

You're up and running with video graphics for just \$99.95—then use low cost add-ons to create your own personal system that rivals home computers sold for 5-times ELF II's low price!

Featuring
RCA 1802 COSMAC CPU

Own a powerful home computer system, starting for just \$99.95—a price that gets you up and running the very first night... with your own TV for a video display. \$99.95 ELF II includes RCA 1802 8 bit microprocessor addressable to 64k bytes with OMA, interrupt, 16 registers, ALU, 256 byte RAM, full hex keyboard, two digit hex output display, stable crystal clock for timing purposes, RCA 1801 video IC to display your programs on any video monitor or TV screen and 5 slot plug-in expansion bus (less connectors) to expand ELF II into a giant!

ELF II Explodes Into A Giant!

Master ELF II's \$99.95 capabilities, then expand with GIANT BOARD... KLUGE BOARD... 4k RAM BOARDS... TINY BASIC... ASCII KEYBOARD... LIGHT PEN... ELFBUG MONITOR... COLOR GRAPHICS & MUSIC SYSTEM... TEXT EDITOR... ASSEMBLER... DISASSEMBLER... VIDEO DISPLAY BOARD... and—

NEW!

16k Static Ram \$199.95 plus \$2 p&h
Full Basic ROM \$149.95 plus \$2 p&h
Cassette \$79.95 plus \$2 p&h
EPROM Burner \$39.95 plus \$2 p&h

Master This Computer In A Flash!

Regardless of how minimal your computer background is now, you can learn to program an ELF II in almost no time at all. Our *Short Course On Microprocessor & Computer Programming*—written in non-technical language—guides you through each of the RCA COSMAC 1802's capabilities, so you'll understand everything ELF II can do... and how to get ELF II to do it! Don't worry if you've been stumped by computer books before. The *Short Course* represents a major advance in literary clarity in the computer field. You don't have to be a computer engineer in order to understand it. Keyed to ELF II, it's loaded with "hands on" illustrations. When you're finished with the *Short Course*, neither ELF II nor the RCA 1802 will hold any mysteries for you.

In fact, not only will you now be able to use a personal computer creatively, you'll also be able to read magazines such as *BYTE*... *INTERFACE AGE*... *POPULAR ELECTRONICS* and *PERSONAL COMPUTING* and fully understand the articles. And, you'll understand how to expand ELF II to give you the exact capabilities you need!

If you work with large computers, ELF II and the *Short Course* will help you understand what they're doing.

Get Started For Just \$99.95, Complete!

\$99.95 ELF II includes all the hardware and software you need to start writing and running programs at home, displaying video graphics on your TV screen and designing circuits using a microprocessor—the very first night—even if you've never used a computer before.

ELF II connects directly to the video input of your TV set, without any additional hardware. Or, with an \$8.95 RF modulator (see coupon below), you can connect ELF II to your TV's antenna terminals instead.

ELF II has been designed to play all the video games you want, including a fascinating new target missile gun game that was developed specifically for ELF II. But games are only the icing on the cake. The real value of ELF II is that it gives you a chance to write machine language programs—and machine language is the fundamental language of all computers. Of course, machine language is only a starting point. You can also program ELF II with assembly language and tiny BASIC. But ELF II's machine language capability gives you a chance to develop a working knowledge of computers that you can't get from running only

ELF II Gives You The Power To Make Things Happen!

Expanded, ELF II can give you more power to make things happen in the real world than heavily advertised home computers that sell for a lot more money. Thanks to an ongoing commitment to develop the RCA 1802 for home computer use, the ELF II products—being introduced by Netronics—keep you right on the outer fringe of today's small computer technology. It's a perfect computer for engineering, business, industrial, scientific and personal applications.

Plug in the **GIANT BOARD** to record and play back programs, edit and debug programs, communicate with remote devices and make things happen in the outside world. Add **Kluge (prototyping) Board** and you can use ELF II to solve special problems such as operating a complex alarm system or controlling a printing press. Add **4k RAM Boards** to write longer programs, store more information and solve more sophisticated problems.

ELF II add-ons already include the **ELF II Light Pen** and the amazing **ELFBUG Monitor**—two extremely recent breakthroughs that have not yet been duplicated by any other manufacturer.

The **ELFBUG Monitor** lets you debug programs with lightning speed because the key to debugging is to know what's inside the registers of the microprocessor. And, with the **ELFBUG Monitor**, instead of single stepping through your programs, you can now display the entire contents of the registers on your TV screen. You find out immediately what's going on and can make any necessary changes.

The incredible **ELF II Light Pen** lets you write or draw anything you want on a TV screen with just a wave of the "magic wand." Netronics has also introduced the **ELF II Color Graphics & Music System**—more breakthroughs that ELF II owners were the first to enjoy!

ELF II Tiny BASIC

Ultimately, ELF II understands only machine language—the fundamental coding required by all computers. But, to simplify your relationship with ELF II, we've introduced an **ELF II Tiny BASIC** that makes communicating with ELF II a breeze.

Now Available! Text Editor, Assembler, Disassembler And A New Video Display Board!

The **Text Editor** gives you word processing ability and the ability to edit programs or text while it is displayed on your video monitor. Lines and characters may be quickly inserted, deleted or changed. Add a printer and ELF II can type letters for you—error free—print names and addresses from your mailing list!

ELF II'S Assembler translates assembly language programs into hexadecimal machine code for ELF II use. The Assembler features mnemonic abbreviations rather than numerics so that the instructions on your programs are easier to read—this is a big help in catching errors.

ELF II'S Disassembler takes machine code programs and produces assembly language source listings. This helps you understand the programs you are working with... and improve them when required.

The new **ELF II Video Display Board** lets you generate a sharp, professional 32 or 64 character by 16 line upper and lower case display on your TV screen or video monitor—dramatically improving your unexpanded \$99.95 ELF II. When you get into longer programs, the **Video Display Board** is a real blessing!

Now Available!

- A-D/D-A Board Kit** includes 1 channel (expandable to 4) D-A, A-D converters, \$39.95 plus \$2 postage & handling.
- PILOT Language**—A new text-oriented language that allows you to write educational programs on ELF II with speed and ease! Write programs for games... unscrambling sentences... spelling drills... fill in the missing word... tests, etc.! **PILOT** is a must for any ELF II owner with children. *PILOT Language on cassette tape, only \$19.95 postpaid!*
- Game Package** on cassette tape (requires 4k RAM), \$9.95 plus \$2 postage & handling.

By Netronics

ASCII/BAUDOT, STAND ALONE



Computer Terminal COMPLETE FOR ONLY \$149.95

The Netronics ASCII/BAUDOT Computer Terminal Kit is a microprocessor-controlled, stand alone keyboard/terminal requiring no computer memory or software. It allows the use of either a 64 or 32 character by 16 line professional display format with selectable baud rate, RS232-C or 20 ma. output, full cursor control and 75 ohm composite video output.

The keyboard follows the standard typewriter configuration and generates the entire 128 character ASCII upper/lower case set with 96 printable characters. Features include onboard regulators, selectable parity, shift lock key, alpha lock jumper, a drive capability of one TTY load, and the ability to mate directly with almost any computer, including the new Explorer/85 and ELF products by Netronics.

The **Computer Terminal** requires no I/O mapping and includes 1k of memory, character generator, 2 key rollover, processor controlled cursor control, parallel ASCII/BAUDOT to serial conversion and serial to video processing—fully crystal controlled for superb accuracy. PC boards are the highest quality glass epoxy for the ultimate in reliability and long life.

VIDEO DISPLAY SPECIFICATIONS

The heart of the Netronics Computer Terminal is the microprocessor-controlled Netronics Video Display Board (VID) which allows the terminal to utilize either a parallel ASCII or BAUDOT signal source. The VID converts the parallel data to serial data which is then formatted to either RS232-C or 20 ma. current loop output, which can be connected to the serial I/O on your computer or other interface, i.e., Modem.

When connected to a computer, the computer must echo the character received. This data is received by the VID which processes the information, converting to data to video suitable to be displayed on a TV set (using an RF modulator) or on a video monitor. The VID generates the cursor, horizontal and vertical sync pulses and performs the housekeeping relative to which character and where it is to be displayed on the screen.

Video Output: 1.5 P/P into 75 ohm (EIA RS-170) • Baud Rate: 110 and 300 ASCII • Outputs: RS232-C or 20 ma. current loop • ASCII Character Set: 128 printable characters—

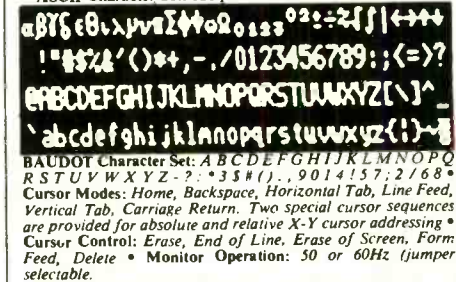

Continental U.S.A. Credit Card Buyers Outside Connecticut

CALL TOLL FREE 800-243-7428

To Order From Connecticut Or For Technical Assistance, Etc. Call (203) 354-9375

Netronics R&D Ltd., Dept. PE-1 333 Litchfield Road, New Milford, CT 06776

Please send the items checked below—

- Netronics Stand Alone ASCII Keyboard/Computer Terminal Kit, \$149.95 plus \$3.00 postage & handling.**
- Deluxe Steel Cabinet for Netronics Keyboard/Terminal In Blue/Black Finish, \$19.95 plus \$2.30 postage and handling.**
- Video Display Board Kit alone (less keyboard), \$89.95 plus \$3 postage & handling.**
- 12" Video Monitor (10 MHz bandwidth) fully assembled and tested, \$139.95 plus \$5 postage and handling.**
- RF Modulator Kit (to use your TV set for a monitor), \$8.95 postpaid.**
- 5 amp Power Supply Kit In Deluxe Steel Cabinet (±8VDC @ 5 amps, plus 6-8 VAC), \$39.95 plus \$2 postage & handling.**

Total Enclosed (Conn. res. add sales tax) \$ _____

By—
 Personal Check Cashiers Check/Money Order
 Visa Master Charge (Bank # _____)

Account # _____
Signature _____ Exp. Date _____

Print Name _____
Address _____
City _____

State _____ Zip _____

Send Me More Information

Netronics R&D Ltd., Dept PE-1 333 Litchfield Road, New Milford, CT 06776

Yes! I want my own computer! Please rush me—

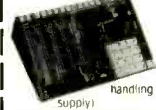

- Power Supply (required), \$4.95 postpaid.
- RCA 1802 User's Manual, \$5 postpaid.
- Tom Pittman's *Short Course On Microprocessor & Computer Programming* teaches you just about everything there is to know about ELF II or any RCA 1802 computer. Written in non-technical language, it's a learning breakthrough for engineers and laymen alike. \$5 postpaid.
- Deluxe Metal Cabinet with plexiglas dust cover for ELF II, \$29.95 plus \$2.50 p&h.
- I am also enclosing payment (including postage & handling) for the items checked below!
- I want my ELF II wired and tested with power supply, RCA 1802 User's Manual and Short Course—all for just \$149.95 plus \$3 p&h.

ALSO AVAILABLE FOR ELF II

- GIANT BOARD** kit with cassette I/O RS 232 C/11V I/O 8 bit P/I/O decoders for 14 separate I/O instructions and a system monitor/editor. \$39.95 plus \$2 p&h.
- Kluge (Prototype) Board** accepts up to 36 ICs. \$17.00 plus \$1 p&h.
- 4k Static RAM** kit. Addressable to any 4k page to 64k. \$89.95 plus \$3 p&h.
- Gold plated 86-pin connectors (one required for each plug-in board). \$5.70 ea. postpaid.
- Expansion Power Supply** (required when adding 4k RAM). \$34.95 plus \$2 p&h.
- Professional ASCII Keyboard** kit with 128 ASCII upper/lower case set, 96 printable characters, onboard regulator, parity logic section and choice of 4 hand-shaking signals to mate with almost any computer. \$64.95 plus \$2 p&h.
- Deluxe metal cabinet for ASCII Keyboard, \$19.95 plus \$2.30 p&h.**
- Video Display Board** kit lets you generate a sharp, professional 32 or 64 character by 16 line upper and lower case display on your TV screen or video monitor—dramatically improving your unexpanded \$99.95 ELF II. (Fits inside ASCII Keyboard cabinet). \$89.95 plus \$2 p&h.
- ELF II Tiny BASIC** on cassette tape. Commands include SAVE, LOAD, X, +, !

- 26 variables A-Z LET, IF/THEN, INPUT, PRINT, GO TO, GO SUB, RETURN, END, REM, CLEAR, LIST, RUN, PLOT, BREAK, POWER**. Comes fully documented and includes alphanumeric generator required to display alphanumeric characters directly on your TV screen without additional hardware. Also plays tick-tack-toe plus a drawing game that uses ELF II's hex keyboard as a joystick. 4k memory required. \$14.95 postpaid.
- Tom Pittman's Short Course on Tiny Basic** for ELF II. \$5 postpaid.
- ELFBUG™ Deluxe System Monitor** on cassette tape. Allows displaying the contents of all registers on your TV at any point in your program. Also displays 24 bytes of memory with full addresses, blinking cursor and auto scrolling. A must for the serious programmer! \$14.95 postpaid.
- Text Editor** on cassette tape gives you the ability to insert, delete or edit lines and words from your programs while they are displayed on your video monitor. (Add printer and you can use ELF II to type error-free letters plus insert names and addresses from your mailing list.) \$19.95 postpaid.
- Assembler** on cassette tape translates assembly language programs into hexadecimal machine code for ELF II use. Mnemonic abbreviations for instructions (rather than numerics) make programs easier to read and help prevent errors. \$19.95 postpaid.
- Disassembler** on cassette tape takes machine code

Continental U.S.A. Credit Card Buyers Outside Connecticut
CALL TOLL FREE: 800-243-7428
To Order From Connecticut Or For Technical Assistance, Call (203) 354-9375

Total Enclosed \$ _____
(Conn. res. add tax)

CHARGE IT! Exp. Date _____
 Visa Master Charge (Bank # _____)

Account # _____

programs and produces assembly language source listings to help you understand and improve your programs. \$19.95 on cassette tape.
SAVE \$9.90—Text Editor, Assembler & Disassembler purchased together, only \$49.95! (Require Video Dis play Board plus 4k memory.)
 ELF II Light Pen, assembled & tested, \$7.95 plus \$1 p&h.
 ELF II Color Graphics & Music System Board kit. \$49.95 plus \$2 p&h.
 ELF II connects directly to the video input of your TV set without additional hardware. To connect ELF II to your antenna terminals instead, order **RF Modulator \$8.95 postpaid.**
Coming Soon: A-D, D-A Converter, Controller Board and more!

Print Name _____
Address _____
City _____

State _____ Zip _____

DEALER INQUIRIES INVITED

DISCOUNT PRICES!

computers

Top Quality Money-Back Guarantee All Factory Prime

MICROPROCESSOR IC'S

Z-80	8.95	6800	6.75
Z-80A	10.95	6802	11.50
8080A	5.50	6502	9.50
8085A	11.95	6504	9.50
Z8001	189.00	6505	9.50
Z8002	139.00	2901	8.95

MICROPROCESSOR SUPPORT IC'S

8212	2.49	Z80-PIO	6.95
8214	3.90	Z80A-PIO	8.25
8216	2.49	Z80-CTC	6.95
8224	2.95	Z80A-CTC	8.25
8226	2.25	Z80-DMA	24.95
8228	4.75	Z80A-DMA	32.95
8238	4.90	Z80-SIO/9	33.95
3251	5.95	Z80A-SIO/1	37.95
8253	19.50	8726	1.49
8255	5.70	8728	1.49
8257	19.50	8797	1.19
8259	19.50	8798	1.19
6810	4.75	6860	8.95
6820	3.90	6520	6.75
6821	3.90	6522	9.75
6850	4.10	6532	19.95
6852	3.90	6551	13.75

MEMORY • RAMS • PROMS • EPROMS

2114L-450 ns	4.50	2101-450 ns	1.95
2114L-200 ns	5.95	21L02-250 ns	1.10
4044-450 ns	4.25	21L02-450 ns	.99
4116-200 ns	7.95	2111-450 ns	2.95
4116-150 ns	12.95	2112-450 ns	1.95
4096-5	4.50	2147-85 ns	19.95
MCM 6604 AC	4.50	2708-450 ns	8.95
AM 9060 CPC	2.95	2716-450 ns	9.95
4402	5.50	2732-450 ns	49.95

SOUND GENERATORS

SN76477	Complex Sound Generator	2.49
AY-3-8910	GI Sound Gen (Add \$3.00 for manual) 64 Pins	11.95

UARTS

AY-3-1013A	3.95	AY-3-1015A	5.10
AY-3-1014A	6.50	TRI602A	3.50

LINEAR

LM 301N-8	32	LM 340T Series	1.15
LM 301AH	32	LM 387N-8	.99
LM 307N-8	25	LM 393N-8	.99
LM 307H	25	LM 3900N-14	.58
LM 308H	75	LM 3909N-8	.99
LM 311N-8	59	LM 7390C-14	.99
LM 319H	90	LM 741CN-14	.19
LM 320K Series	1.35	LM 747CN-14	.59
LM 320T Series	1.15	RC 1556N8-8	1.25
LM 323K	4.95	LM 4250CH	.95
LM 339N-14	.98	CA 3130T	2.25
LM 340K Series	1.35	LM 4136N-14	.95
		LM 383T	1.25

VERBATIM DISKETTES

5 1/4" Soft, 10, 16	\$2.35
Ea. in boxes of 10	
8" Soft Hard	\$2.75
Ea. in boxes of 10	

DIP SWITCH

8 Pos	\$1.25 ea.
8 Pos	
Single Pole	
Double Throw	\$1.49 ea.

SPECIALS OF THE MONTH

While Supply Lasts	
ECL 10146L RAM (1024X) 29 ns	6.95
AM 3705 PMOS 8-Ch Multiplexer	8.95
95H90 Hi-Speed Div 10/11 Prescaler	10.95
MCT6 Dual Opt. Isolator 1500V	.99
ICL 7107 CPL 3 1/2-Digit A/D Conv. LED	11.50
AY-5-2376 Keyboard Encoder 88 Keys	10.50
AY-5-3600 Keyboard Encoder 90 Keys	9.95
1488 or 1489 Lmer. Driver/Receiver	.99
18-Pin Low Profile Socket End Stackable	.10
DAC 100 B & 10 Bit A to D Converter	13.95
LM337K Adjustable Neg. Volt. Reg. (-1.2 ~ -37)	5.95
18 Pin Low Profile Socket	.08
22 Pin Low Profile Socket	.08

HOW TO ORDER—Pay by check, credit card or C.O.D. Foreign pay in U.S. Funds. Order by phone or mail \$25.00 minimum. Prices valid thru last day of cover date. Shipping = \$2.00 for the first 2 lbs. For surface add 35c for ea. add'l lb. For air add 70c for each add'l lb. Foreign—Add 10% for shipping and handling. C.O.D. add \$1.85. Guaranteed satisfaction or your money back. We reserve the right to limit quantities some items subject to prior sale. We are not responsible for typos. SEND FOR OUR FREE FLYER! Contains complete list of 74LS00 IC's.

Components Express, Inc.

1380 E. Edinger, Unit PE
Santa Ana, CA 92705
(714) 558-3972

"Have you kissed your computer lately?"

Mapper I from Omikron. This \$199 piece of magic plugs into the TRS-80 MPU socket, and the processor is plugged into the mapper board. The board reorganizes TRS-80 memory to zero base, thus permitting the use of normal CP/M. Working in concert with Mapper I is Mapper II. This \$109 interface, including cable, permits the installation of 8-in. floppies.

Using these together you can switch between TRSDOS or CP/M and build up some reasonably large data bases for yourself.

Short Software Reviews. I mentioned a few months back that Microsoft's Consumer Products Div. was offering a number of unique packages for the TRS-80. For game lovers, there is Adventure (\$29.95). I can't say much about it, but my friend Ed Teja, who is a game nut, says this is a good one and makes for an enjoyable evening.

Typing Tutor (\$14.95) is an excellent tutorial program; it should be since it was written by Al Baker. You can learn to type from this, if you don't know how, or upgrade your skills.

Level III Basic (\$49.95) for the TRS-80. This software really represents unqualified slickness. Level III is designed for TRS-80's without disks, but gives you the same features adapted to tape.

The Editor/Assembler (\$29.95) is another nice piece of work, and also resides on tape. It's a good solid tool with few bells and whistles, but includes everything you need for most small-system designs.

Some Hints. In the December issue, I started telling you about the conversion of BASIC. I offered a challenge, more or less, for you to come up with possible methods to convert a simple program. Well, if you're working on it but not sure what to do, here are some hints:

• Use the IF... THEN... ELSE... statements to test data.

• String operators MID\$, LEFT\$, and RIGHT\$ are used to take words apart and put them back together again.

• Remember that two files exist: the source file (code to be converted) and the target file (converted code).

For all practical purposes, this is all you really need to know for developing the translation construction. I'd also suggest that you draw a flow-chart that shows where you want to get to.

Build a System. A few months ago, I suggested the possibility of assembling a single board computer (SBC). One such possibility, among others, is the Motorola 6809D4.

The D4 unit incorporates the MC-6809 microprocessor, a very powerful

monitor called D4BUG, and flexibility in adding memory both RAM and ROM. The system can be expanded with ease, using the optional card cage and accessories like memory boards and I/O boards.

Because the system is built around a 6809, it is easy to program and offers more power than you will find in similar systems that use co-processors to achieve 16-bit power in an 8-bit world.

A reasonable system can be built for well under \$1000, and systems languages, editor/assembler, BASIC and others are available from Motorola. Furthermore, a very tiny BASIC language, called VTL-09, which is designed after the 6800 implementation created by Frank McCoy and Gary Shannon for the Computer Store in 1977, is available. Instructions on using the language may be found in *The MC 6809 Cookbook*, published by Tab Books.

You might want VTL-09 since it is a fairly powerful BASIC-like language and is ROMable. For those of you who take advantage of the code, it's free, it can't be sold, and programs written for it must be given away. VTL-09 is not a commercial venture. The use of the code for the cookbook and free distribution of it for the 6809 were made possible by Dick Heiser of the Computer Store, Santa Monica, California. ♦

MORE INFORMATION

For additional information about products and services mentioned here, contact the companies directly.

Corvus Systems, Inc.

2029 O'Toole Ave.
San Jose, CA 95131
408-946-7700

Microsoft, Consumer Products Div.

10800 NE 8th St., Suite 507
Bellevue, WA 98004
206-454-1315

Omikron

1127 Hearst St.
Berkely, CA 94702
415-845-8013

Motorola, Inc.

3501 Ed Bluestein Blvd.
Austin, TX 78721
512-928-6000

Tab Books

Blue Ridge Summit, PA 71214
717-794-2191

Popular Electronics Tests



Heathkit H89 Microcomputer

THE Heathkit H89 microcomputer is an all-in-one system that is compact, expandable, and flexible, with software backup. Furthermore, it's available in kit or assembled versions. The H89 (also known as Z89 in the Zenith version) offers a number of features that make it highly versatile. Among these are:

- Dual Z80 microprocessors, separate for CRT terminal control and main system processing.

- A fully interlaced 12-in. raster-scan monochrome CRT that permits an 80 × 24-line display for a total of 1920 characters. (A nonscrolling 25th line, under software control, can be used for special function displays such as identifying the upper row of user-defined keys.)

The 80-key, typewriter-format keyboard generates upper- and lower-

case letters on a 5 × 7 dot matrix. Lower-case letters having descenders use a 5 × 9 dot matrix, while up to 33 graphic elements can be created using an 8 × 10 dot matrix. A 12-key dual-purpose numeric cluster is also provided. In the normal mode, these produce the numerals 0 through 9. In their other mode, they provide useful secondary functions such as cursor up, down, left, right and home, carriage return, back space, line feed, tab (standard 8-column), etc. Editing functions include inserting and deleting characters or lines, while erase includes page erase.

- Most operating parameters (underline/block cursor, reverse video, graphics, baud rate, etc.) are preset via internal switches. By taking the system off line (one keystroke), the user can make temporary changes via

the keyboard. When the system is turned off and re-powered, all functions automatically return to the Pre-set switch selections.

- Package size is 13" high, 17" wide, and 20" deep. The system operates from 120/240 volts ac, 50/100 Hz. The case is formed from structural foam plastic that combines lightness with strength. A fan provides a cooling air flow. A slide lock, one on each side, allows easy entry to the cabinet interior.

- A 5.25-in. single-density, hard-sector 40-track Seimens floppy-disk system is built-in with each diskette storing 100K bytes. A controller supports the two additional drives in the optional outboard H77 disk system.

- The H47 dual 8" disk drive (kit is \$2595, with \$3500 for the wired

(Continued on page 38)

Learning electronics is no picnic.

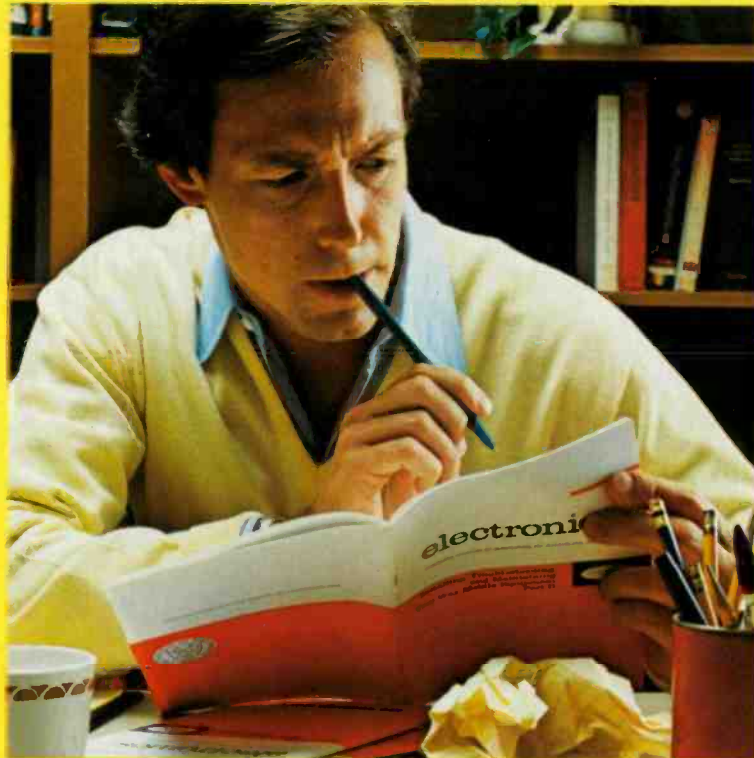

**At any level it
takes work and
a few sacrifices.
But with CIE,
it's worth it.**

Whoever said, "The best things in life are free," was writing a song, not living a life. Life is not just a bowl of cherries, and we all know it.

You fight for what you get. You get what you fight for. If you want a thorough, practical, working knowledge of electronics, come to CIE.

You can learn electronics at home by spending just 12 hard-working hours a week, two hours a day. Or, would you rather go bowling? Your success is up to you.

At CIE, you *earn* your diploma. It is not handed to you simply for putting in hours. But the hours you do put in will be on your schedule, not ours. You don't have to go to a classroom. The classroom comes to you.

Why electronics training?

Today the world depends on technology. And the "brain" of technology is electronics. Every year, companies the world over are finding new ways to apply the wonders of electronics to control and program manufacturing, processing...even to create new leisure-time products and services. And the more electronics applications there are, the greater the need will be for trained technicians to keep sophisticated equipment finely tuned and operating efficiently. That means career opportunities in the eighties and beyond.

Which CIE training fits you?

Beginner? Intermediate? Advanced? CIE home study courses are designed for ambitious people at all entry levels. People who may have:

1. No previous electronics knowledge, but do have an interest in it;
2. Some basic knowledge or experience in electronics;
3. In-depth working experience or prior training in electronics.

You can start where you fit and fit where you start, then go on from there to your Diploma, FCC License and career.

Many people can be taught electronics.

There is no mystery to learning electronics. At CIE you simply start with what you know and build on it to develop the knowledge and techniques that make you a specialist. Thousands of CIE graduates have learned to master the simple principles of electronics and operate or maintain even the most sophisticated electronics equipment.

CIE specializes exclusively in electronics.

Why CIE? CIE is the largest independent home study school that specializes exclusively in electronics. Nothing else. CIE has the electronics course that's right for you.

Learning electronics is a lot more than memorizing a laundry list of

facts about circuits and transistors. Electronics is interesting! It is based on recent developments in the industry. It's built on ideas. So, look for a program that starts with ideas and builds on them. Look to CIE.

Programmed learning.

That's exactly what happens with CIE's Auto-Programmed® Lessons. Each lesson uses famous "programmed learning" methods to teach you important principles. You explore them, master them completely, before you start to apply them. You thoroughly understand each step before you go on to the next. You learn at your own pace.

And, beyond theory, some courses come fully equipped with electronics gear (the things you see in technical magazines) to actually let you perform hundreds of checking, testing, and analyzing projects.

Experienced specialists work closely with you.

Even though you study at home, you are not alone! Each time you return a completed lesson, you can be sure it will be reviewed, graded and returned with appropriate instructional help. When you need additional individual help, you get it fast and in writing from the faculty technical specialist best qualified to

answer your question in terms you can understand.

CIE prepares you for your FCC License.

For some jobs in electronics, you must have a Federal Communications Commission (FCC) License. For others, some employers tend to consider your license a mark in your favor. Either way, your license is government-certified proof of your knowledge and skills. It sets you apart from the crowd.

More than half of CIE's courses prepare you to pass the government-administered exam. In continuing surveys, nearly 4 out of 5 graduates who take the exam get their licenses! You can be among the winners.

Associate Degree

Now, CIE offers an Associate in Applied Science Degree in Electronics Engineering Technology. In fact, all or most of every CIE Career Course is directly creditable towards the Associate Degree.

Today is the day. Send now.

Fill in and return the postage-free card attached. If some other ambitious person has removed it, cut out and mail the coupon. You'll get a FREE school catalog plus complete information on independent home study. For your convenience, we'll try to have a CIE representative contact you to answer any questions you may have.

Mail the card or the coupon or write CIE (mentioning name and date of this magazine) at: 1776 East 17th Street, Cleveland, Ohio 44114.



Pattern shown on oscilloscope screen is simulated.

CIE Cleveland Institute of Electronics, Inc.

1776 East 17th Street, Cleveland, Ohio 44114

Accredited Member National Home Study Council

YES... I want to learn from the specialists in electronics — CIE. Send me my FREE CIE school catalog...including details about the Associate Degree program...plus my FREE package of home study information. PE-10

Print Name _____

Address _____ Apt. _____

City _____

State _____ Zip _____

Age _____ Phone (area code) _____

Check box for G.I. Bill bulletin on Educational Benefits: Veteran Active Duty

MAIL TODAY!

version) features a pair of REMEX double-density, double-sided drives that support up to 1.2 megabytes/diskette.

□ Although it comes with 16K of RAM, the system has the ability to support up to 48K bytes of RAM simply by plugging the RAM chips into the sockets provided. (In conjunction with the 8-in. drive option, Heath will soon have a 16K-byte RAM add-on available to bring the system up to 64K, with a zero-base memory map.)

□ There is provision for serial op-

tion devices such as the Heath H14 line printer via an add-on RS-232C serial adaptor. (Use of this board also permits system-to-system communication using a modem.)

□ Software support is available from Heath and the Heath Users Group (HUG).

In addition, the H89 provides some functions that aren't readily evident. One of these allows it to be used as a terminal in a timesharing operation or as a front-end preprocessor. The basic system—with integral terminal, 16K

of RAM, H88-5 audio cassette interface, and a single 5¼" disk drive—costs \$1,695 in kit form; assembled, with 48K of RAM and a serial I/O port (but less an audio cassette interface), it is \$2,895. Options include a 16K RAM expansion kit (H88-2) for \$95; an assembled two-port serial I/O interface card (H88-3) for \$100; an assembled outboard floppy-disk drive (H77) for \$595 and a dual floppy-disk drive (WH87) for \$1,195; a modification kit (H88-6) for connecting the WH87 and other options to the H89 for \$50; an HDOS plus extended Benton Harbor BASIC, which requires 16K (32K recommended), a two-pass absolute 8080 assembler, text editor, debugger, and several utility programs (H89-17) on disk for \$150; and a Microsoft BASIC (H8-21) which requires 32K minimum RAM (48K recommended) for \$150.

Software. The HDOS is a very versatile library of utilities that looks like an excellent combination of a DEC operating system and CP/M. It requires 16K of RAM. Among the features are a 9-element debugger for machine-language programs, a text editor with a full range of commands, and an assembler for 8080 code that, when used with 16K of RAM, allows 350 user-defined symbols. HDOS (version 1.6) supports three disk drives.

Benton Harbor BASIC occupies about 13K of RAM and is full-featured. It includes 73 general-purpose commands and has 25 error messages. It will accommodate strings to 255 characters in length and accept variables consisting of a single letter or single letter with a digit (0-9). Both HDOS and BASIC must be on the same diskette to save a BASIC program. At least 16K of RAM is required for operation. This BASIC program will not accept a line having a syntax error.

Microsoft BASIC runs under HDOS and requires a minimum of 28K of RAM (32K is suggested). It features 116 statements, commands, and functions; has 23 general error messages and 16 error messages for disk operation. It also features 16 special-function characters. The BASIC contains provisions for single/double precision (16 digits), full editing, array erase, swap variables, trace/untrace, line width, a full complement of disk file operations, and all the capabilities associated with Microsoft BASIC. Other languages are available for the computer, including FORTRAN and COBOL.

Building the Kit. Construction of the H89 from a kit requires about 28 hours of assembly time. The process is straightforward and, as expected, provided no surprises. Before construction began, it was necessary to update the construction manual with some 15

HOBBY-BLOX™
The modular, circuit building system for electronic hobbyists.

Be careful. Your hobby is about to become an obsession.

The 14 modular units in the solderless, Hobby-Blox™ system are color-coded and cross-indexed. Projects go faster, easier.

For the beginner, there are two starter packs. One for integrated circuits, one for discrete components. Each has its own 10 project booklet.

Once you get into Hobby-Blox, look out. You're going to get hooked.

For a free catalog and the name of your nearest Hobby-Blox dealer, call Toll Free 800 321-9668. In Ohio call collect (216) 354-2101.

Patents Pending.
©AP PRODUCTS INCORPORATED 1980

 A P PRODUCTS INCORPORATED
9450 Pineneedle Drive
P.O. Box 603
Mentor, Ohio 44060
(216) 354-2101
TWX: 810-425-2250
In Europe, contact A P PRODUCTS GmbH
Baumlesweg 21 • D-7031 Weil 1 • W. Germany

Free Project-of-the-Month to Hobby-Blox purchasers!

pages of errata supplied by Heath to deal with typos and parts changes.

Assembly is greatly simplified since Heath supplies all logic assemblies completely wired and tested. This includes terminal-logic, main-CPU (with 16K bytes of RAM and system ROM), disk-controller, and cassette interface. Not only does this save assembly time, but it also relieves you of having to debug a system assembled from scratch. Assuming you wire the power supply, keyboard, and CRT circuit assemblies correctly and interconnect all cables properly, the preassembled logic boards should allow your H89 system to come up the first crack out of the barrel.

Most of the assembly you perform in putting together the H89 is mechanical mounting hardware, fastening and soldering connector pins to cable harnesses, and mounting and interconnecting subassemblies.

Even with extreme care taken during assembly, difficulties can arise, naturally. These can result from infant mortality of parts—only the preassembled boards (terminal controller, main processor board, and subcards like the disk controller) are already burnt-in. Specifically, I experienced a problem with insulating the video amplifiers on the heat sink. In this case, the mounting bolt of the IC caused a short to the heat sink, causing the circuit to blow. A call to Heath's service center produced a cure—new parts (free of charge), including insulating material for the mounting bolts.

CRT Electronics. The driving electronics for the CRT consist of the high-voltage section and fully interlaced vertical and horizontal circuits. The CRT is controlled by the terminal logic circuit board. This board provides seven functional blocks that include power supplies, keyboard encoder and configuration logic, terminal processor (Z80), master clock and system logic, communications, CRT and memory control, display memory, character generator, and video control logic.

The master clock, operating at a nominal 12.288 MHz, is crystal-controlled. In practice, the clock was found to operate at approximately 12.8 MHz with no adverse effect on the system.

The best resolution test for a CRT terminal is to first make sure that the brightness and focus are properly adjusted, then create a "test pattern" by filling the screen with *lower-case* "m"s. The bottom dots of the three small vertical lines that form the "m" create a light-dark-light pattern across each line on the crt. This is the maximum number of pixels developed by the circuit. To check resolution, note that each dot and "undot" are clear and distinct across the line from the top left corner of the display to the

lower right corner. Poor high-frequency response of the amplifier results in blurring images. By noting any size changes in the vertical and horizontal directions, the "m" pattern can also check vertical and horizontal linearity. Of course, there should be no dimensional changes over the screen. The CRT brightness control can be operated to check both screen brightness and dot "blooming" that tends to reduce resolution. The black-and-white Heath display passed these tests with flying colors.

One minor problem we noted is that the screen surface of the CRT is sufficiently reflective to make glare from room lights annoying. This can be easily avoided by using an anti-glare filter, such as Heath's new Pannelgraphix HCA-3 for \$8.95.

Z80 Keeps Terminal On Track. The Z80 processor in the terminal logic examines data and decides what to do with it. This CPU operates at 2 MHz and keeps track of terminal I/O, terminal personality (the H89 can be configured to emulate a DEC VT 52 terminal), and the location of the cursor. Operations of the terminal logic CPU are guided by an onboard ROM. This firmware program provides the ability to tell the terminal how to act under certain conditions, plus supporting the Z80 in performing general "housekeeping."

The terminal ROM, flexible as it is, does appear to have a bug in the transmit page function. Although the function appears to exist, adequate documentation doesn't. But according to a Heath system engineer, the problem is being solved in new updates of the ROM and by making the ROM software available in listed form.

Main CPU is a Z80. The terminal portion of the H89 communicates with the computer section via serial ports at selected (switches or software) rates up to 9600 baud. The main CPU logic board incorporates another Z80 microprocessor, system software ROMs for controlling the computer, system RAM (up to 48K bytes), and the system backplane that uses Molex pin connectors to allow

use of additional boards such as serial interface, disk controller, and cassette.

The main CPU board has a built-in interrupt structure in various levels to accommodate peripherals and program requirements. Interestingly, the flexibility of the main board makes it possible to change system ROMs to emulate almost any system. American Micro Systems, Inc. (AMI) uses the H89 as a development system (called the Phoenix 1), for example, operating totally through software.

Testing the System. Determining power of the software and hardware can be a difficult task. I decided that, although timing tests that establish the running speed of various BASICs served a purpose at one time, how fast BASIC executes makes no difference in processing of data. Consequently, I chose a different form of system test involving the use of CP/M, CBASIC, and Micro-AP's Selector III. (Note that, "as is," the H89 will not run standard CP/M without circuit changes that will be covered in an upcoming review of the H89/Magnolia system. The changes are related to system firmware in the memory field, not operating speed.)

Selector III was chosen because it is a good data manager and would exercise the RAM, disks and system software. Furthermore, Selector allows the user to create a large data base, manipulate it, print hardcopy reports, sort it, and make selective retrievals. CP/M and CBASIC were necessary for operation of Selector and allowed me to see how well the system worked with non-Heath software. The CP/M from Lifeboat Associates, patched to allow for the 4200₁₆ origin of memory, was used.

For the purposes of the test, a database of 200 records was created with each occupying 255 bytes. The test consisted of first asking Selector to find all records that had a particular code letter, then sort the list, print a selected list, print a label list, retrieve and update the first record, retrieve and update the last record, changing its code, then reselecting. During the course of operation, Selector does not re-order the entire list, but develops

The H89 computer with H77 dual-disk system and H14 line printer.



ILP AUDIO MODULES

A new concept in audio design

Compact high performance modules

Ideal for * Home music systems

- * Subwoofers and bi-amplification
- * Musical instrument amplification
- * Professional sound reinforcement

MODULAR SYSTEMS

APPROACH ALLOWS YOU TO BUY ONLY WHAT YOU NEED!

- * Stereo or Mono, you decide wattage
- * Basic power or with preamplification
- * Start simple, expand when you need to * Design your own custom cases

FULL FIVE YEAR WARRANTY

Power Amplifiers

- * Built-in heatsinks
- * Protected circuitry
- * No external parts required
- * 5 simple connections



HY50 30 watts RMS \$28.95

High performance amp with rugged aluminum heatsinks. Measures only 4" x 2" x 1" thick! Mounts with 2 screws. Gives 30 watts RMS at 0.02% distortion. Response 10 — 45 KHz. 4 to 16 ohms. ±25 V/2A. HY30. 15 watts RMS. Size/specs as HY50. 20 V/2A. 25.95

HY200 120 watts RMS \$79.95

High performance amplifier with large heatsink area for cool operation. Fully protected circuitry. Distortion only 0.01% at 120 watts RMS (1 KHz). Response 10 Hz — 45 KHz. S/N ratio 100 db. Only five connections. Amazingly compact — only 4 1/2" x 4" x 2" D. Mounts with 2 screws. Requires ±45 V/3A. HY120. 60 W RMS. Specs/size as HY200. 35 V/2A. 59.95

HY400 240 Watts (4 ohm). Double the power, double heatsink area! Same specs as HY120/200. May be used into 8 ohms at reduced output. \$99.95

HY400 bridging circuit for 480 watts available 1981.

PreAmplifiers

HY66 Stereo \$48.95
HY6 Mono \$25.95



Inputs for RIAA phono, tape with monitor, tuner, auxiliary and microphone; full tone control circuitry. Incredible performance: Response DC to 100 KHz, distortion 0.05%, S/N 90 db. Output to 4.5 V RMS. Supplied with edge connectors. Compact. Reliable. Internal voltage regulation — use from 15 to 50 V safely! May be used in multiples for PA, instrument mixers etc. Order optional pcb's to extend edge connectors: B6 (for HY6) \$3.75 and B66 (for HY66) \$4.75

Power Supplies

Circuit boards with all components plus TOROIDAL transformers (except PSU30 and 36). Toroidals are half the size and weight of conventional transformers; and are quieter and more efficient. Note: HY6 and HY66 can also be powered from any supply.

PSU50 for 1 or 2 HY50 \$33.60
PSU80 for 1 HY120 \$51.00
PSU70 for 1 or 2 HY120 \$64.00
PSU90 for 1 HY200 \$65.50
PSU180 for 1 HY400 or 2 HY200 \$89.50
PSU36 for 1 or 2 HY30 \$33.60
PSU30 for 12 HY6 or 6 HY66 \$22.95

Telephone Order (716) 849-0735

DEALER AND OEM ENQUIRIES INVITED

GLADSTONE Electronics

901 Fuhrmann Blvd., Buffalo N.Y. 14203

Name _____

Address _____

City _____ Zip _____

Please send _____

Amt. enclosed _____

Check () M/O () Visa () M/C ()

Number _____ Exp. _____

In Canada: Gladstone Electronics, 1736 Avenue Rd., Toronto (416) 787-1448

computers

an ordered index list for retrieval (the same for selecting by type). It then uses these index list pointers for printing reports, etc. Incidentally, the time it took to develop the data base is meaningless since it was done at various times and actually depends on the ability of the operator. The times for the operations as we measured them were as follows:

Function	Time (Min.)
Select 197 records	4.3
Sort	2.0
Print selected list	10.0 only company name, city, phone, and record #
Print label list	11.3 (six fields printed)
Retrieve-update and refile record #1	1.0
Retrieve-update and rerecord #200	1.4 (select code was changed)
Reselect	4.3

An operation similar to this, using an S-100 bus machine and a hard-disk subsystem decreased the times by orders of magnitude and gave a semblance of instant operation. But the Heath system scores are still respectable and indicate that the H89 is more than viable for a small business operation. Significantly, the H89 micro-computer performed the functions with accuracy each and every time they were performed.

Aftermarket Software. There are other types of software that are equally as exciting as the Selector system, and if you desire, these can be used to develop benchmarks for their operation. Among these is PIE 1.5 (Software Toolworks), a full-screen editor that permits using the Heath keyboard function keys to perform specific editing functions. The PIE editor is priced at \$29.95 and currently works with HDOS. However, it has been reported that as soon as Heath releases its new PROM, which permits the use of CP/M at a zero base address, the editor will be made available as a CP/M-oriented product.

Heath also offers editors, assemblers and other functional aids to support the system. Most importantly, the company has been instrumental in establishing the Heath Users Group (HUG). This organization operates as a separate entity from Heath and offers a large volume of software for the H89. One exciting package they have is the Modem control system (MCS), which has already been discussed in a past "Computer Bits" column. This system allows connecting the H89 into timesharing services such as

Compuserve's "Micronet."

Further increasing the utility of the H89, with a storage capacity in the range of 10M bytes, is Magnolia Micro system's interface that permits the H89 to operate the Corvus version of the IMI Winchester hard-disk system. The interface, card, drive with intelligent controller, and interconnecting cables are offered for \$5350. To make it all work, though, Magnolia's version of CP/M2.2 is required, as is the zero base memory map PROM, for a total of \$295 more.

Heath is just beginning to offer the complete CP/M system, including assemblers, editors, and CP/M compatible Microsoft products such as COBOL, Fortran, and BASIC. It is thus possible for users to run any CP/M-based software. Also, the new Zenith Electronic Typing disk—a word processing system that requires 48K of RAM, dual-drive floppy capability and a printer—is available for \$395. (Discounts are offered if you are also buying a computer or printer from Heath.)

The Bottom Line. The basic H89 is an excellent general-purpose computer. With the addition of an optional dual disk drive and the software now becoming available, the H89 is indeed a formidable small computer.

Exotic peripherals such as speech I/O, music, color graphics, remote control, etc., made for use with S-100 systems are not compatible but Heath engineers are currently evaluating the offering of such add-ons.

We have lived with the H89 for a while now and feel very comfortable with it. Even the disk system is quieter than most. The keyboard has a nice professional feel to it, with its IBM-style keys and slightly angled positioning. Furthermore, there's a "clicking sound" on-off switch should the user wish to be certain that keys indeed make contact when pressed. Good display contrast is in evidence with the P4-phosphor CRT. Do add an inexpensive anti-glare filter, though. Also, since the floppy drive motor is not "on" all the time, greater longevity than usual may be expected for this device.

In sum, the Heath H89 computer is certainly modestly priced in kit form for what it offers. Its all-in-one construction saves space and eliminates a rat's nest of interconnection cords compared to "separates." Furthermore, its professional-type features make it a pleasure to work with for long periods of time.

What Heath offers is indeed top-notch and should serve exceptionally well for any serious computerist who is not strongly motivated toward games and home-device controlling. Moreover, it is appropriate for very-small-business use where price is an object.—Carl Warren.

COMPUTER SOURCES

By Leslie Solomon
Senior Technical Editor

Hardware

Apple Tablet. The VersaWriter is a high-resolution color-graphics addition for an Apple II or Apple II Plus. The device consists of an 8½" by 11" Mylar plotting board having a clear plastic overlay. Attached to this board is a jointed drawing arm at the end of which is a magnifying lens with a crosshair. To use, the item to be copied is placed in the baseplate and "traced" using the crosshairs. As it is traced, the drawing appears in the CRT screen. Immediate software commands include color choice, width of drawing line, fill figure with color, draw a straight line between two points, use a different scale, edit, erase, smoothing factor (rounds off rough edges), store picture on disk, and more. Any picture can be stored as a shape table that can be manipulated as usual. Other programs include Textwriter enabling upper/lower case symbols, area/distance calculations, and calibration. \$252. Address: Peripherals Plus, 119 Maple Ave., Morristown NJ, 07960 (Tel: 201-538-3358).

TRS-80 Expansion. The Chatterbox peripheral for the TRS-80 features a COMM-80 Serial/Parallel Expansion Interface that includes an RS-232C interface, a parallel printer port, auxiliary expansion bus connector, power supply, and a modem. The device is completely hardware and software compatible with existing Radio Shack interfaces and application programs. It can also be used with the RS Expansion Interface to provide a serial port instead of adding the RS-232C board, or it can be used as a second port in systems already incorporating it. The serial/parallel port is address selectable and up to 16 COMM-80s can be attached to one TRS-80. The parallel port is 8 bits in and 8 bits out. COMM-80 (less modem) is \$179.95, the Chatterbox (COMM-80 plus modem) is \$259.95. Address: Hardside, 6 South St., Milford, NH 03055 (Tel: 603-673-5144).

Typewriter Interface. The Dynatyper is an electromechanical device that fits over the keyboard of almost any electric typewriter and is driven from an interface board. Other than mounting a pair of stick-on buttons,

there are no modifications made to the typewriter, and without the Dynatyper, machine can be used normally. Typing speed can reach the maximum at which the typewriter can operate. Each package contains an interface, power supply and software. The TRS-80, Apple, PET, Northstar, and Ohio Scientific versions are \$499, the GPIB system is \$489. Address: Rochester Data Inc., 3100 Monroe Ave., Rochester, NY 14618 (Tel: 716-385-4336).

68xx Systems. A new catalog, covering almost every peripheral for 6800/6809 systems is available. Items discussed include motherboards, power supplies, RAM and ROM boards, video and high-resolution boards, disk controllers, and a broad variety of I/O boards all for the SS50 and SS50C bus. Address: Gimix Inc., 1337 West 37th Pl., Chicago, IL 60609 (Tel: 312-927-5510).

S-100 Printer Interface. The I/O Master features two serial and two parallel ports as well as an 8-level interrupt control and dual interval timer. It supports OEM versions of NEC, Diablo, and Qume, as well as Centronics/Data Products printers. It allows driving a daisy-wheel printer at the full rated 55 cps. An asynchronous and synchronous RS-232 interface, crystal-controlled baud rates to 38,400, and external baud rates to 56k are featured. Complete software support including WordStar word processing system and CP/M*2.0 is available. \$400. Address: MicroPro International Corp., 1299 Fourth St., San Rafael, CA 94901 (Tel: 415-457-8990).

Software

Health and Education Programs. The Vista-Facts Series includes Growing Up, Talking about Sex, Drinking and Drugs, Birth Control, Your Blood Pressure, and Heart Attacks. They are available for Apple II, PET/CBM, and TRS-80 machines and are designed for use by families, schools, health education organizations, and the medical community. These programs have the approval of the Canadian College of Family Physicians. Each package comes with a 12- or 16-page manual containing illustrations and a glossary of medical terms. Each package is \$19.95. Address: Personal Software Inc., 1330 Bordeaux Drive, Sunnyvale, CA 94086 (Tel: 408-745-7841).

Statistics Package. NWASTATPAK is a multi-function statistics library for use with systems having CP/M and MBASIC. The package contains file utilities and computational programs. The file utilities allow the user to create, edit, and merge data files and select and scale data within files. The computational section contains programs for probability

calculations, single variable statistics, regression analysis, continuous and discrete distribution functions, means testing, nonparametric analysis and survey data, and contingency tables. Address: J.L. Cawley, Northwest Analytical, Inc., Box 14430, Portland, OR 97214 (Tel: 503-238-9760).

Data Manager. Information Master is a sophisticated, easy-to-use data manager for the Apple computer. The user can define, enter, edit, sort, and retrieve data and print report formats. The program includes screen formatting; error trapping; and ability to perform calculations, totals, subtotals, addition, multiplication, division and exponentiation. Files may be transferred or copied from one diskette to another even with one drive. Address: Tinka Bolding, High Technology Inc., Box 14665, Oklahoma City, OK 73113 (Tel: 405-840-9900).

TRS-80 Self Taught BASIC. This self-teaching guide is for learning how to program a Level II TRS-80 with no previous computer experience. Each chapter presents a single topic on BASIC, the TRS-80, or a program that is being developed. \$9.95 from all Radio Shack stores.

AIM-65 Graphics. The MTU K-1009-1C Text/Graphics Printout Program permits AIM-65 users to print text and high-resolution graphics with no modification to the computer or printer. Text print routine reproduces contents of the text buffer as 10 unbroken lines of up to 127 characters per line. Screen printout routine creates an exact image of a graphics display screen (in 8K memory) as a 300-wide by 200-high dot matrix. The Quick Print feature generates a 320 × 200 dot image on one paper strip. Quality Print generates the image as two 320 × 100 strips to be taped together. \$25. Micro Technology Unlimited, David B. Cox, 2806 Hillsborough St., Box 12106, Raleigh, NC 27605 (Tel: 919-833-1458).

Color Accounting. Using color as its key, Color Graphic Accounting uses a combination of color and graphics in the interpretation and display of accounting records generated through standard accounting functions of general ledger, accounts receivable, accounts payable, payroll, sales analysis, and inventory control. Use with Intecolor CP/M models. Address: The Rainbow Tree Corp., 1 West Court Square, Suite 30, Decatur, GA 30030 (Tel: 404-377-9921).

PET Library. The Jacksonville Area PET Society has a number of programs for the PET computer. They cover games, finance, ham radio, astronomy, music, graphics, and utility programs. Send a SASE to PET Library, 401 Monument Rd. #123, Jacksonville, FL 32211, for a three-page list. ♦

A Microcomputer for everyone at a Micro Price

The **MicroAce** - a new generation of miniature computers
A COMPLETE COMPUTER for \$149.00 for 1K Kit

Post and Packing FREE

(Add 6% Tax for Shipments inside California)

RAM (expandable to 2K on board) is roughly equivalent to 4K bytes in a conventional computer — typically storing 100 lines of BASIC. (Key words occupy only a single byte.)

The display shows 32 characters by 24 lines.

And Benchmark tests show that the MicroAce is faster than all other personal computers.

No other personal computer offers this unique combination of high capability and low price.

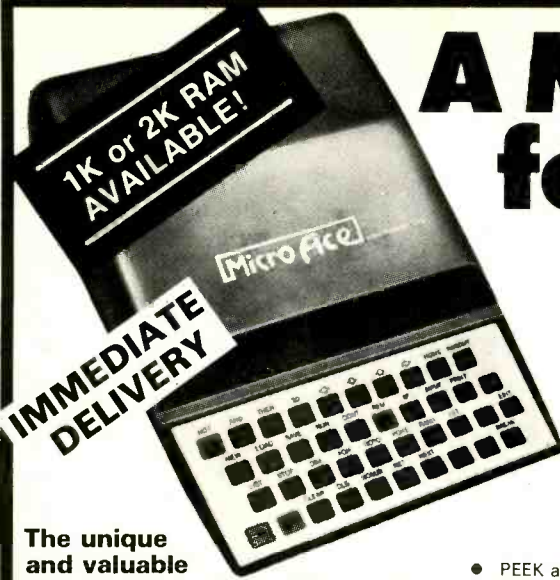

The unique and valuable components of the MicroAce

The MicroAce is not just another personal computer. Quite apart from its exceptionally low price, the MicroAce has two uniquely advanced components: the powerful BASIC interpreter, and the simple teach yourself BASIC manual.

The unique versatile BASIC interpreter offers remarkable programming advantages:

- Unique 'one-touch' key word entry: the MicroAce eliminates a great deal of tiresome typing. Key words (RUN, PRINT, LIST, etc.) have their own single-key entry.
- Unique syntax check. Only lines with correct syntax are accepted into programs. A cursor identifies errors immediately. This prevents entry of long and complicated programs with faults only discovered when you try to run them.
- Excellent string-handling capability — takes up to 26 string variables of any length. All strings can undergo all relational tests (e.g. comparison). The MicroAce also has string input — to request a line of text when necessary. Strings do not need to be dimensioned.
- Up to 26 single dimension arrays.
- FOR/NEXT loops nested up 26.
- Variable names of any length.
- BASIC language also handles full Boolean arithmetic, conditional expressions, etc.
- Exceptionally powerful edit facilities, allows modification of existing program lines.
- Randomise function, useful for games and secret codes, as well as more serious applications
- Timer under program control.

- PEEK and POKE enable entry of machine code instructions, USR causes jump to a user's machine language sub-routine.
- High-resolution graphics with 22 standard graphic symbols.
- All characters printable in reverse under program control.
- Lines of unlimited length.

'Excellent value' indeed!

For just \$149.00 (excluding handling charge) you get everything you need to build a personal computer at home... PCB, with IC sockets for all ICs; case; leads for direct connection to a cassette recorder and television (black and white or color); everything!

Yet the MicroAce really is a complete, powerful, full-facility computer, matching or surpassing other personal computers at several times the price.

The MicroAce is programmed in BASIC, and you can use it to do quite literally anything, from playing chess to managing a business.

The MicroAce is pleasantly straightforward to assemble, using a fine-tipped soldering iron. It immediately proves what a good job you've done: connect it to your TV ... link it to the mains adaptor ... and you're ready to go.

Fewer chips, compact design, volume production-more power per Dollar!

The MicroAce owes its remarkable low price to its remarkable design: the whole system is packed on to fewer, newer, more powerful and advanced LSI chips. A single SUPER ROM, for instance, contains the BASIC interpreter, the character set, operating system, and monitor. And the MicroAce 1K byte

The MicroAce teach-yourself BASIC manual.

If the features of the BASIC interpreter mean little to you—don't worry. They're all explained in the specially-written book *free* with every kit! The book makes learning easy, exciting and enjoyable, and represents a complete course in BASIC programming—from first principles to complex programs. (Available separately—purchase price refunded if you buy a MicroAce later.)

A hardware manual is also included with every kit.

The MicroAce Kit:
\$149.00 with 1K COMPLETE
\$169.00 with 2K

Demand for the MicroAce is very high: use the coupon to order today for the earliest possible delivery. All orders will be despatched in strict rotation. If you are unsuccessful in constructing your kit, we will repair it for a fee of \$20.00, post and packing FREE. Of course, you may return your MicroAce as received within 14 days for a full refund. We want you to be satisfied beyond all doubt — and we have no doubt that you will be.

Z80 A microprocessor chip, widely recognised as the best ever made.

Sockets for TV, cassette recorder, power supply.

Your MicroAce kit contains...

- Printed circuit board, with IC sockets for all ICs.
- Complete components set, including all ICs—all manufactured by selected world-leading suppliers.
- New rugged keyboard, touch-sensitive, wipe-clean.
- Ready-moulded case.
- Leads and plugs for connection to domestic TV and cassette recorder. (Programs can be SAVED and LOADED on to a portable cassette recorder.)
- Mains adaptor of 600 mA at 9VDC nominal unregulated.
- FREE course in BASIC programming and user manual.

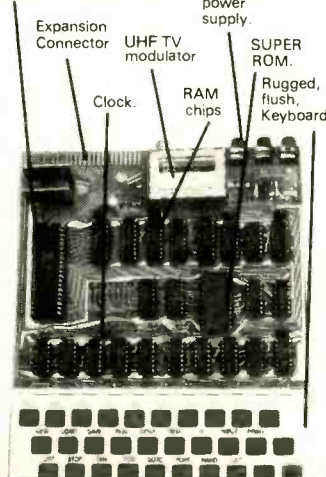

JOIN THE REVOLUTION - DON'T GET LEFT BEHIND - ORDER YOUR MICRO ACE NOW!!

Send Check, Money Order or quote your Credit Card No. to:
MicroAce 1348 East Edinger, Santa Ana, California, Zip Code 92705.
 or phone (714) 547 2526 quoting your Credit Card Number.

Quantity	Description	Unit Price	TOTAL
	MicroAce Kit 1K	\$149.00	
	MicroAce Kit 2K	\$169.00	
	Manual	\$10.00	
	1K Upgrade Kit	\$29.00	
		TOTAL	

- Amex.
- Diners
- Check
- Money Order
- Master Charge
- Visa

Card No. _____

Exp. Date _____

Shipments inside California add 6% TAX

Name _____

Address _____

City _____ State _____ Zip _____

Popular Electronics Tests

Panasonic Model CT-9060 19" Color TV

Super picture conversion, good reproduction of colors, and convenient servicing are hallmarks of this table model.

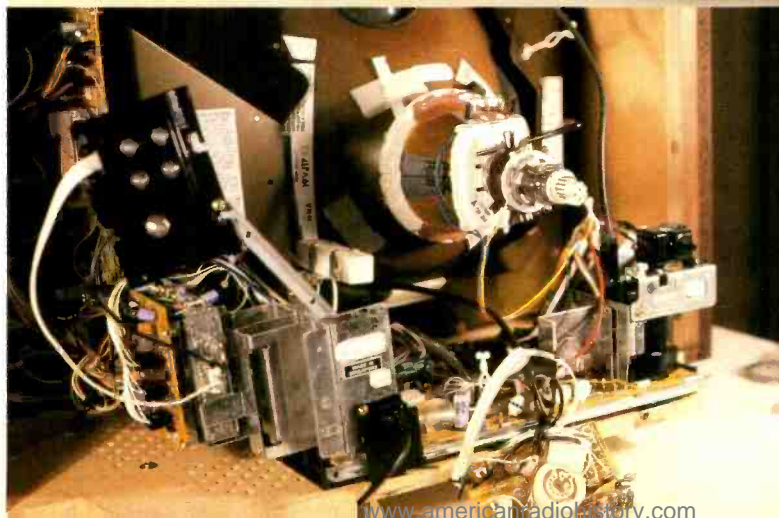

PANASONIC's Model CT-9060 is a full-featured 19-inch color-TV receiver. It offers "ColorPilot" (VIR), a sophisticated 16-button remote-control system with up/down scanning and random channel tuning, large LED channel display, and a light-sensor-controlled picture. Other features include a fast-warmup (6 seconds) picture tube, built-in whiteness enhancer (increases beam current to make whites appear whiter), CATV/MATV connector, a front-panel earphone jack, and an attractive simulated wood and brushed aluminum cabinet integrated atop a neat pedestal base.

Dimensions are 18 $\frac{1}{8}$ "H \times 19 $\frac{3}{8}$ "D \times 26 $\frac{3}{4}$ "W; weight is 60 lb. Suggested retail price is \$629.95. Other color receivers with the same NMX-L22 chassis used in the CT-9060 are the CT-9050 and CT-9040, both without remote-control facilities and the latter with no VIR.

General Information. This set is built around 16 transistors and seven integrated circuits. ICs are used for video i-fs and detection, sound detection, and output, VIR, automatic fine tuning (aft), sync countdown and phase detection, luminance processing (video jungle), and chroma processing and demodulation.

The CT-9060's modular chassis is very different from those in run-of-the-mill nondeluxe receivers. It features synthesizer, LED, remote-control, antenna, VIR, main, and CRT boards that are unpluggable and unscrewable. The only permanently

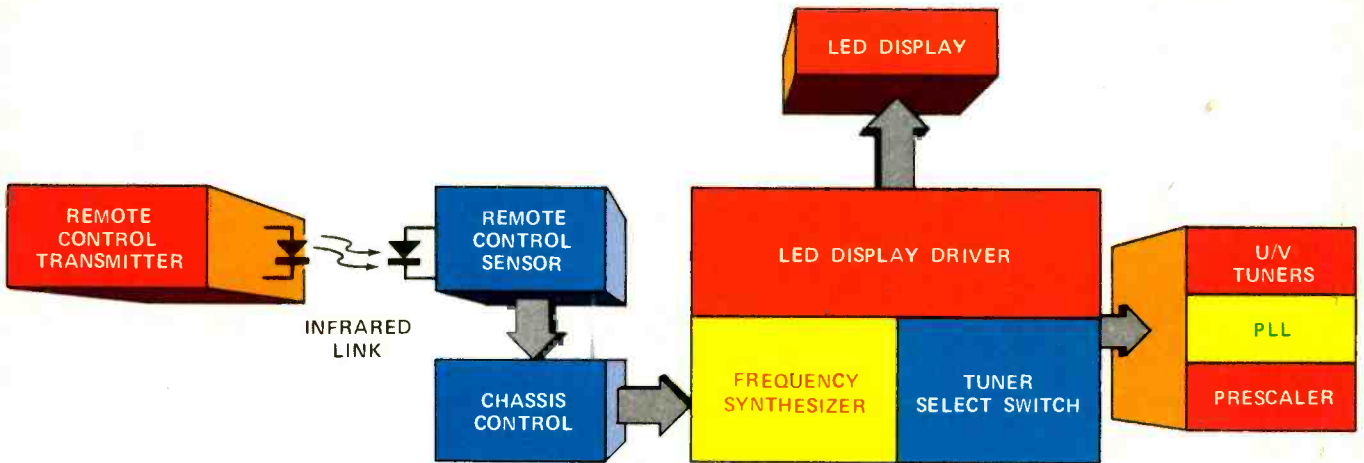
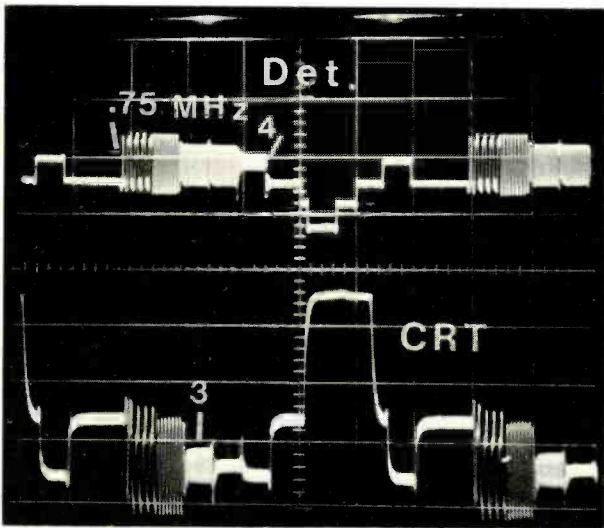
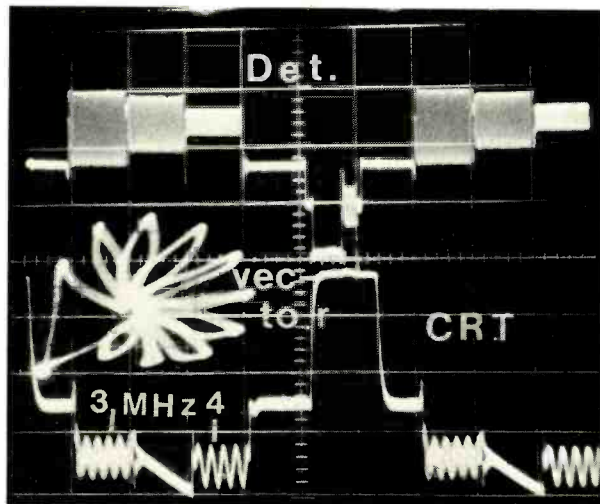

Fig. 1. Block diagram of the CT-9060 shows how the RemoCon system is linked to the receiver's up/down scan control.



Multiburst patterns at video detector and CRT showing luminance bandpass.



Swept chroma from 3.08 to 4.08 MHz at video detector output and CRT. Gated rainbow vector in center.

mounted items are the CRT and a portion of the power supply. The main chassis also slides out for convenient servicing.

A couple of "safety" features in this transformerless receiver deserve mention. First, the power supply uses a half-wave rectifier, which allows one side of the ac line to be grounded. (The usual bridge rectifier leaves both sides of the ac line floating.) Secondly, this is the one set we've recently tested that has transformer coupling to the speaker/headphone arrangement, permitting the latter to be isolated from the potentially "hot" chassis itself.

Technical Details. Specific information on the receiver's up/down transmitter and remote random address and front-panel up/down tuning system was not available at the time we tested the CT-9060. However, this is one of several similar schemes employed by TV receiver manufacturers. It was not difficult, therefore, to draw up a block diagram of Panasonic's system (Fig. 1). Such remotes have a local oscillator that generates the various command frequencies to modulate an ultrasonic or, as in the case of Panasonic's CT-9060, infrared carrier. In the Panasonic set, a remote receiver and additional electronics process all on/off, up/down, mute, and channel/volume changes through its RemoCon (remote-control) system that is also linked with the receiver's up/down scan control.

A frequency synthesizer recognizes all transmitted impulses from RemoCon and keys an LED channel display driver and uhf/vhf tuner switch. According to channel selection, the appropriate tuner is activated and a

(Continued on page 48)

All that's new and unique in quality electronic kits you can build

SEE THEM IN
THE LATEST
HEATHKIT®
CATALOG-

FREE!

The world's largest selection of easy-to-build, money-saving electronic kits for home, hobby or business



Budget-priced digital alarm clock



Low-cost professional-grade engine analyzer



DC-35 MHz dual-trace delayed-sweep oscilloscope

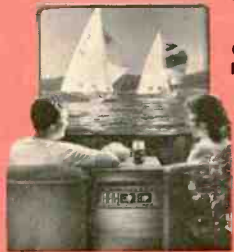

Giant screen Projection TV

Simulated TV picture



Precision Heathkit weather computer



An all-in-one computer system, complete with built-in floppy disk storage



Microprocessor self-instruction program - your key to computer knowledge

NEARLY
400
OF THE
FINEST
ELECTRONIC
KITS-
ALL FULLY
DESCRIBED &
ILLUSTRATED
IN THIS BIG,
COLORFUL 104-
PAGE CATALOG

FREE
SEND FOR YOURS
TODAY!

Plus...the latest line of electronic products in easy-to-build money-saving kit form: automotive • marine • home products • avionics • clocks • security • color TV • weather • tools • test instruments • books • amateur radio • stereo HiFi • computer systems • self-instruction programs.

Mail coupon or card NOW

Heathkit products are displayed, sold and serviced at Heathkit Electronic Centers coast to coast (Units of Ved-technology Electronics Corporation). See the white pages of your phone book.

If coupon is missing, write Heath Company, Dept. 010-732, Benton Harbor, Michigan 49022.

Heathkit

Heath Company
Dept. 010-732
Benton Harbor, MI 49022

Yes Please send me my FREE Heathkit Catalog. I am not currently receiving your catalog.

Name _____

Address _____

City _____ State _____

CL-749 _____ ZIP _____

TV Automatic Fine Tuning Circuit

CA3139E CA3139Q

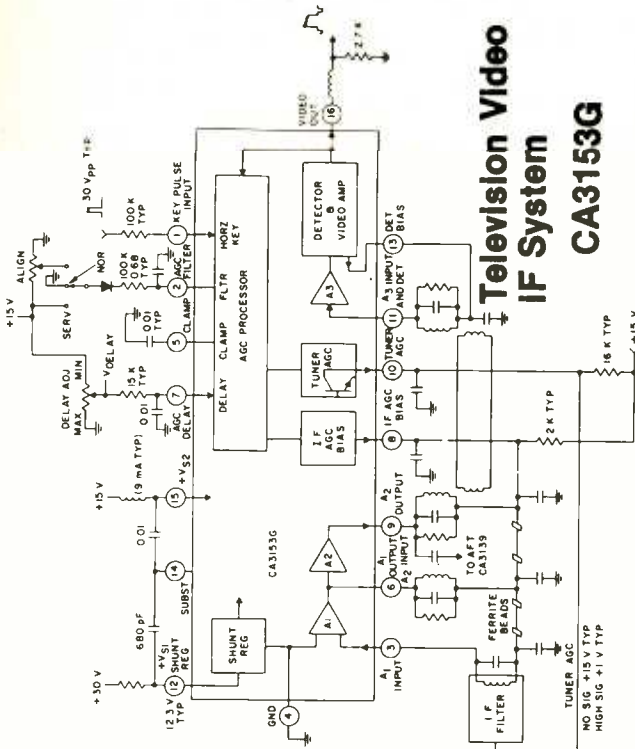

Block diagram and typical application of CA3139.

Television Video IF System CA3153G

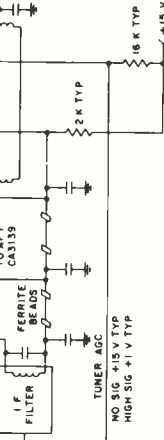

Functional block diagram of the IF amplifier-system of CA3153G with typical peripheral circuitry.

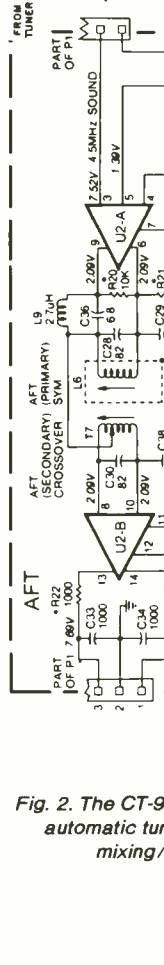
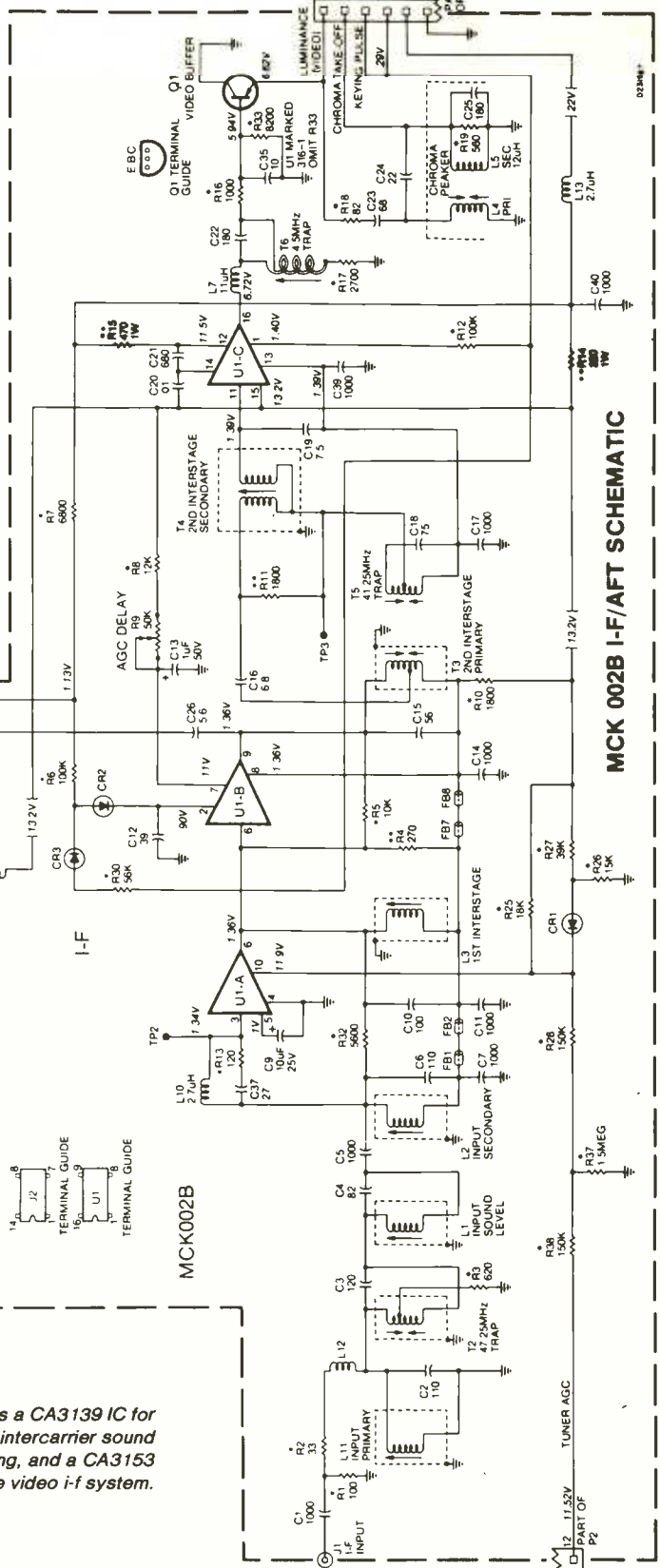

Fig. 2. The CT-9060 uses a CA3139 IC for automatic tuning and intercarrier sound mixing/amplifying, and a CA3153 for the video i-f system.



MCK 002B I-F/AFT SCHEMATIC

phase-locked loop (PLL) and prescaler (usually a divide-by-256 arrangement) track the selected frequencies between 54 and 890 MHz, locking on the particular channel via feedback voltage correction. In such an arrangement, aft may or may not be used, depending on the accuracy of regulated voltage, tuner capture range, and overall effectiveness of the PLL. In this instance, aft is always on, regardless of ColorPilot engagement, and has a channel frequency capture range of ± 1.5 MHz. The 40-pin synthesizer chip is undoubtedly an LSI (large scale integration) device.

The CT-9060 uses a U.S.-made CA3139GMI RCA IC for automatic fine tuning and 4.5-MHz intercarrier sound mixing/amplifying and an RCA CA3153GMI serves as an i-f amplifier, video detector, and agc processor. This latter IC receives tuner signals immediately after conventional adjacent-channel LC trapping between i-fs and tuner. Both ICs are very similar or identical to those listed on the MCK 002B i-f/aft schematic for RCA's CTC 96 chassis. Therefore, we'll use the well-defined RCA diagram in Fig.2 to describe operation of the two ICs.

The CA3139E/Q aft actually consists of five circuits listed by RCA as: cascode amplifier, bias, intercarrier mixer/amplifier, aft detector/dc amplifier, and voltage regulator. Incoming signals enter *U2-A* from *U1-B* through a frequency restrictive capacitor and are amplified by three transistors for the mixer and amplifier.

Video i-f and sound carriers at 45.75 and 41.25 MHz are beat together and down-converted to provide the 4.5-MHz intercarrier from which high-frequency "tweets" are removed with a low-pass filter. After further amplification, sound information passes to the audio IC for detection and final processing.

In the meantime, the original video carrier continues through an RLC network and detector transformer, where applied bias controls aft "bow tie" width and, thereby, overall amplifier gain. The transformer is an ordinary tunable center-tapped discriminator that furnishes out-of-phase voltages to a differential peak detecting dc amplifier. This stage supplies filtered push-pull outputs that vary directly with the position of the 45.75-MHz video carrier on the i-f response curve, keeping the u/v tuners within a few kilohertz of video channel center frequencies. The shunt regulator has a single transistor and two reference zeners.

The CA3153 video i-f system, of course, has many more functions than just voltage amplification and control. It also provides an improved, fast-acting automatic gain control (agc), keyed sample-and-hold circuits, linear video demodulation (without synchronous detection) high-gain i-f amplifiers, and an internal shunt regulator. All these functions are contained in a 16-pin dual in-line plastic package.

Inputs arrive via the various adjacent-channel sideband traps through a peaking network and go into *U1-A*,

**MODEL CT-9060 PANASONIC RECEIVER
LABORATORY DATA**

Parameter	Measurement
Tuner/receiver sensitivity (min. signal for snow-free picture):	vhf (Ch. 6): -12.5 dBmV (-61.3 dBm) uhf (Ch. 30): -8 dBmV (-56.8 dBm)
Voltage regulation (line varied from 105 to 130 V):	Low voltage: i12-V supply—99% 123-V supply—93%
Luminance bandpass at CRT:	High voltage: 25-kV supply—93%
Luminance bandpass at video detector:	3 MHz
S/N at CRT:	4MHz
Horizontal overscan:	36.1 dB
Barreling & pincushion effects:	16%
Convergence:	None
Audio bandpass (3 dB down):	99.8%
Agc effective range:	55 Hz to 900 Hz, 1 kHz to 5.5 kHz
Earphone outlet impedance:	> 40 dB
Chassis power requirements (signal applied):	11.8 ohms
	85 W

Note: Instruments used in these measurements are from Tektronix, Sadelco, Data Precision, B8K-Precision, and Sencore. They include: Telequipment D66, D67A oscilloscopes; FS-3D-VU f/s meter; models 245, 1350, 1750 multimeters; types 2148, 1250, CG169 and VA48 color bar and signal generators; and a variable PR57 power supply.

**TRS-80 MODEL III
48K \$1047**

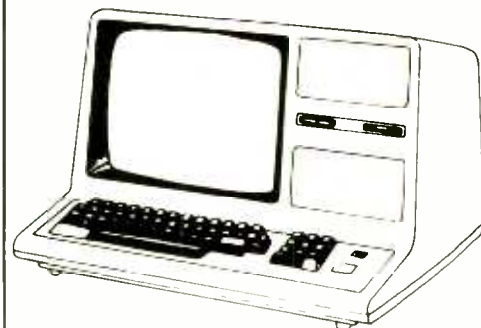

**APPLE - II +
48K \$1119**



**ATARI 800
48K \$1149**



PRINTERS

MICROLINE-80	\$639.00
MICROLINE-82	\$799.00
EPSON MX-80	\$599.00
CENTRONICS 737	\$869.00
VISTA V300	\$1799.00



6 SOUTH ST., MILFORD, NH 03055

**TOLL FREE ORDERS:
1-800-258-1790**
(in NH call 673-5144)



TERMS: Prices and specifications are subject to change. HARDSIDE accepts VISA & MASTERCARD. Certified checks and Money Orders; Personal checks accepted (takes 3 weeks to clear). HARDSIDE pays all shipping charges (within 48 states) on all PREPAID orders OVER \$100.00. On all orders over \$100 a \$2.50 handling charge must be added. COD orders accepted (orders over \$250 require 25% deposit) there is a \$5.00 handling charge. UPS, Blue Label, Air Freight available at extra cost.

CIRCLE NO. 24 ON FREE INFORMATION CARD

where there are two stages of i-f amplification and the first interstage transformer. The output from *U1-B* goes to the aft circuit discussed above and the second interstage transformer primary and 41.25-MHz soundtrap. From the latter, it goes to the succeeding stage's secondary and a diode-and-transistor detection system.

During horizontal blanking intervals, keying pulses reach *U1-C* coincidental with the horizontal sync pulse. These pulses charge an internal ca-

pacitor to a voltage proportional to the video signal magnitude and supply current to charge external agc filter capacitor *C12*. Keying pulses then effectively charge and discharge these capacitors.

There is also an internal noise gate, connected to the video output before the 4.5-MHz intercarrier sound trap, that reduces agc gain during noise spikes and turns on fully for large-amplitude noise interruptions. When this occurs, agc loop gain between *U1-*

A and *U1-B* is automatically reduced. An r-f agc delay for tuner applications is visible at the upper center of the diagram. The shunt regulator consists of several transistors in a feedback-loop configuration between ground and V_{cc} .

Comments. We found the CT-9060's performance to be on a par with most of the other similarly priced color receivers we tested, with 3-MHz bandpass at the CRT. Its overall picture brightness was about average. And the "whiteness enhancer" feature did, indeed, accentuate the whites and helped in providing good color rendition.

The remote-control (RemoCon) and VIR (ColorPilot) both worked properly and are worthy of more than passing mention. VIR operates only when the vertical interval reference signal is broadcast, which is about 90% of the time on larger stations.

Picture convergence was phenomenally good! The yoke/picture-tube match in our sample receiver couldn't have been better.

The receiver's up/down tuning system doesn't permit random channel selection. However, pressing and holding the up or down button allows fast scanning of the channels in the direction selected. A minor annoyance is that there's a slight lag in the audio when tuning from one channel to the next. Voltage regulation might have been better, too, but the less-than-ideal regulation isn't too much of a problem because the picture bloomed and shrank only slightly at 135 and 95 volts ac, respectively.

You'll note from our test-result chart that we've now adopted the dBmV figure for tuner sensitivity instead of the dBm figures we've used in the past. This is because we have switched over to more accurate instrumentation, and it reads out in dBmV. For those of you who wish to make sensitivity comparisons between this and receivers we've already tested, the conversion from dBmV to dBm is as follows: $\text{dBm (at } 75\Omega) = -48.85 \text{ dB} + \text{dBmV}$.

Test results, super conversion, and generally good operation lead us to conclude that the Panasonic CT-9060 is a high-quality color-TV receiver. We're particularly pleased with reproduction of the reds, the important magentas and cyans in the picture, and the high audio volume that can be obtained without speaker-cone break-up.—*Stan Prentiss*.

the best value in hi-fi

Three V15 Type IV
Technological Breakthroughs

Plus a Studio Cartridge
Innovation

Dynamic Stabilizer Suspended from two viscous-damped bearings, acts like a shock absorber to maintain constant cartridge-to-record distance and uniform tracking force; eliminates record groove skipping caused by warp; cushions the stylus from accidental damage.

Electrostatic Neutralizer 10,000 conductive graphite fibers discharge static electricity from the record during play. Eliminates attraction of dust and tracking force variations caused by static charges.

Telescoped Shank Greatly improves trackability at the critical middle and high frequencies. Lowest effective mass, with no sacrifice of necessary stiffness or strength.

SIDE-GUARD Stylus Deflector

A unique lateral deflection assembly developed by Shure for its professional studio cartridge—prevents the most common cause of stylus damage by withdrawing the *entire* stylus shank and tip safely into the stylus housing before it can be bent by sideways thrusts.

In 6 Models to Match Any Turntable, Any Budget

All these features are incorporated into six moderately-priced cartridges—with tracking forces ranging from $\frac{3}{4}$ to 3 grams, and three different stylus configurations—including the revolutionary distortion-reducing Hyperelliptical stylus. Headlining the M97 Series is the M97HE-AH, featuring a precision aligned cartridge-headshell and adjustable overhang.

For all the facts
circle 50 on
free information card



THE HEADLINER™
Model M97HE-AH
with adjustable integrated headshell

M97 SERIES phono cartridges



Shure Brothers Inc., 222 Hartrey Ave.
Evanston, IL 60204

In Canada: A. C. Simmonds & Sons Limited
Manufacturers of high fidelity components,
microphones, sound systems and related circuitry.



CIRCLE NO. 102 ON FREE INFORMATION CARD

POPULAR ELECTRONICS

The first personal computer for under \$200.

The Sinclair ZX80.
A complete computer—
only \$199.95 plus \$5.00 shipping.

Now, for just \$199.95, you can get a complete, powerful, full-function computer, matching or surpassing other personal computers costing several times more.

It's the Sinclair ZX80. The computer that "Personal Computer World" gave 5 stars for 'excellent value.'

The ZX80 cuts away computer jargon and mystique. It takes you straight into BASIC, the most common, easy-to-use computer language.

You simply take it out of the box, connect it to your TV, and turn it on. And if you want, you can use an ordinary cassette recorder to store programs. With the manual in your hand, you'll be running programs in an hour. Within a week, you'll be writing complex programs with confidence.

All for under \$200.

Sophisticated design makes the ZX80 easy to learn, easy to use.

We've packed the conventional computer onto fewer, more powerful LSI chips—including the Z80A microprocessor, the faster version of the famous Z80. This makes the ZX80 the world's first truly portable computer (6½" x 8½" x 1½" and a mere 12 oz.). The ZX80 also features a touch sensitive, wipe-clean keyboard and a 32-character by 24-line display.

Yet, with all this power, the ZX80 is easy to use, even for beginners.



Your course in computing.

The ZX80 comes complete with its own 128-page guide to computing. The manual is perfect for both novice and expert. For every chapter of theory, there's a chapter of practice. So you learn by doing—not just by reading. It makes learning easy, exciting and enjoyable.

You'll also receive a catalog packed with items that can make your ZX80 even more useful. Including 27 program cassettes, from games and home budgeting for just \$6.95, to Sinclair's unique Computer Learning Lab. And books, hardware options and other accessories.

ZX80's advanced design features.

Sinclair's 4K integer BASIC has performance features you'd expect only on much larger and more expensive computers.

- Unique 'one touch' entry. Key words (RUN, PRINT, LIST, etc.) have their own single-key entry to reduce typing and save memory space.



- Automatic error detection. A cursor identifies errors immediately to prevent entering programs with faults.
 - Powerful text editing facilities. Also programmable in machine code.
 - Excellent string handling capability—up to 26 string variables of any length.
 - Graphics, with 22 standard symbols.
 - Built-in random number generator for games and simulations.
- Sinclair's BASIC places no arbitrary restrictions on you—with many other flexible features, such as variable names of any length.

And the computer that can do so much for you now will do even more in the future. Options will include expansion of 1K user memory to 16K, a plug-in 8K floating-point BASIC chip, applications software, and other peripherals.

Order your ZX80 now!

The ZX80 is available only by mail from Sinclair, a leading manufacturer of consumer electronics worldwide.

To order by mail, use the coupon below. But for fastest delivery, order by phone and charge to your Master Charge or VISA. The ZX80 is backed by a 30-day money-back guarantee, a 90-day limited warranty with a national service-by-mail facility, and extended service contracts are available for a minimal charge.

Price includes TV and cassette connectors, AC adaptor, and 128-page manual.

All you need to use your ZX80 is a standard TV (color or black and white). The ZX80 comes complete with connectors that easily hook up to the antenna terminals of your TV. Also included is a connector for a portable cassette recorder, if you choose to store programs. (You use an ordinary blank cassette.)



The ZX80 is a family learning aid. Children 10 and above will quickly understand the principles of computing—and have fun learning.

Master Charge or VISA orders call:
 (203) 265-9171. We'll refund the cost of your call.
Information: General and technical—(617) 367-1988, 367-1909, 367-1898, 367-2555.
 Phones open Monday-Friday from 8 AM to 8 PM EST.

sinclair

Sinclair Research Ltd., 475 Main St.,
 P.O. Box 3027, Wallingford, CT 06492.

To: Sinclair Research Ltd., 475 Main St., P.O. Box 3027, Wallingford, CT 06492.

Please send me _____ ZX80 personal computer(s) at \$199.95* each (US dollars), plus \$5 shipping. (Your ZX80 may be tax deductible.)

I enclose a check/money order payable to Sinclair Research Ltd. for \$ _____.

Name _____

Address _____

City _____ State _____ Zip _____

Occupation: _____ Age: _____

Intended use of ZX80: _____

Have you ever used a computer? Yes No.

Do you own another personal computer? Yes No.

*For Conn. deliveries, add sales tax.

PE-1-1

PE TESTS EIGHT AUDIO POWER AMPLIFIERS

BY JULIAN D. HIRSCH

Hirsch-Houck Laboratories

AND HAROLD A. RODGERS

Executive Editor

and unbeknownst to its owner—drive its output devices beyond their safe operating margins or, more likely, trigger its protective circuitry. Behavior of the unit under stress can, therefore, legitimately be regarded as an index of performance. With this in mind, we have added to the usual tests others designed to simulate stress. Note also that we have chosen not to report insignificant differences in distortion, and have established a measurement “floor” at 0.01%. This represents a distortion level 80 dB below the signal of interest, which includes a generous safety margin. Even with pure sine waves, distortion of 0.1% or less is not noticed by listeners.

Often, in reading a test report, one could easily conclude that the most important question it will answer is: “Does this product meet its specifications?” This obviously is of interest, but is not sufficient documentation of performance. While it is possible to check manufacturers’ specs against our data, our measurements are in most cases more comprehensive.

How We Test. To rate an amplifier for harmonic distortion, we run a series of tests at full power, half power, and 1/10 power at various frequencies distributed across the audio band. If

ANYONE acquainted with the conclusion that we have reached over years of experience with power amplifiers—namely, that they are virtually indistinguishable in terms of sound when operated within their ratings of output power and load impedance—might wonder why we would bother to test them at all. The reason why we do is that in real-world applications, ensuring that ratings are not exceeded is not always an easy task.

Most of the ratings given power amps are based on their behavior when driving a purely resistive load, usually of 8 ohms. Even a cursory examination of the electrical characteristics of loudspeakers leads to the conclusion that such ratings are optimistic. Speakers as a rule do not maintain their nominal impedance ratings across the entire audio bandpass and

are most often reactive over at least part of the range. And while amplifiers are with few exceptions rated with 8-ohm loads, loudspeakers whose nominal impedances are as low as 4 ohms are common.

Taken together, these factors mean that a power amplifier can easily—



the worst-case figure is 0.01% or more, that datum is given along with the frequency and power level at which it occurred. Otherwise, we note that the figure is less than 0.01%.

Intermodulation distortion is assessed according to the IHF IM test. The amplifier is driven to full power by a signal consisting of 19- and 20-kHz tones of equal strength, and all detectable distortion products in the audio band are measured. Performance is considered acceptable when all products are at least -40 dB with respect to the desired signal.

Frequency response is measured via the common sweep-tone method at an output level of 1 watt. All of the amplifiers in the test were flat to within a small fraction of a decibel throughout the audio band and, in most cases well beyond. The differences found were not judged significant and will not be presented.

IHF slew factor is intended to check the response of an amplifier to out-of-band signals that may accompany an audio signal. It is measured by driving the amplifier with a 1-kHz

tone until rated power is reached, then increasing the frequency until the output waveform, as observed on an oscilloscope, departs from a sinusoid. The frequency at which this occurs is divided by 20 kHz to give the slew factor. Anything above 2 or so is probably satisfactory. Note that, if the amplifier incorporates a low-pass filter so that the waveform disappears before it becomes distorted, the slew factor is considered to approach infinity.

IHF dynamic headroom is a measure of amplifier behavior with signals that exceed its rated output for brief periods. It is measured with a repetitive test signal consisting of 20 cycles of a 1-kHz sine wave at one level followed by 480 cycles at a level 20 dB lower. The power level reached by the high-level burst just before clipping is referred to as the dynamic headroom of the amplifier and the ratio given in dB above rated power. Dynamic headroom of 3 dB is considered excellent.

The same test signal is used in checking recovery from overload. In this case, the drive signal is raised until the amplifier is subjected to 10 dB of overdrive by the high-level burst. Typically, when the drive level drops to $1/10$ rated power, there is a short delay before the waveform resumes a sinusoidal shape. This is the overload recovery time. All amplifiers chosen for this report have recovery times in the range of 30 μ s or less. This is

instantaneous as far as the ear is concerned; therefore these data have been omitted from the individual reports that follow.

Perhaps the most important use we have made of the dynamic headroom signal is in developing the voltage/current plots for each amplifier. These show the dynamic power available into 8-, 4-, and 2-ohm loads. One reason for using this signal is that in most cases it allows the tests to be made without triggering protective devices or blowing fuses. But equally important, this signal better approximates the waveforms the amplifier will handle in playing music. Steady-state power—which the FTC insists be used as the principal rating of amplifiers—has been verified in the harmonic distortion test.

As an additional test of ability to handle difficult loads, particularly those posed by electrostatic loudspeakers, we shunted the amplifiers' outputs with 3- μ F capacitors as they were driving low resistances and sometimes loudspeakers. In the lab, the test signal was a 10-kHz square wave. In the listening room, the signal, obviously, was music.

Additional factors we checked were input sensitivity and signal-to-noise ratio. The former is the measure of the driving signal needed at the amplifier input to deliver 1 watt to an 8-ohm resistive load. The latter is measured with respect to the voltage (2.83 V) developed under these conditions and is A-weighted.

Eight amplifiers, not all of the same power rating but representing a wide range of design philosophies, were chosen for testing. All of them did fairly well, usually having one or more outstanding features. But no one of them was a winner in all areas. Each unit is introduced with data excerpted from the manufacturer's specifications. Here they are:

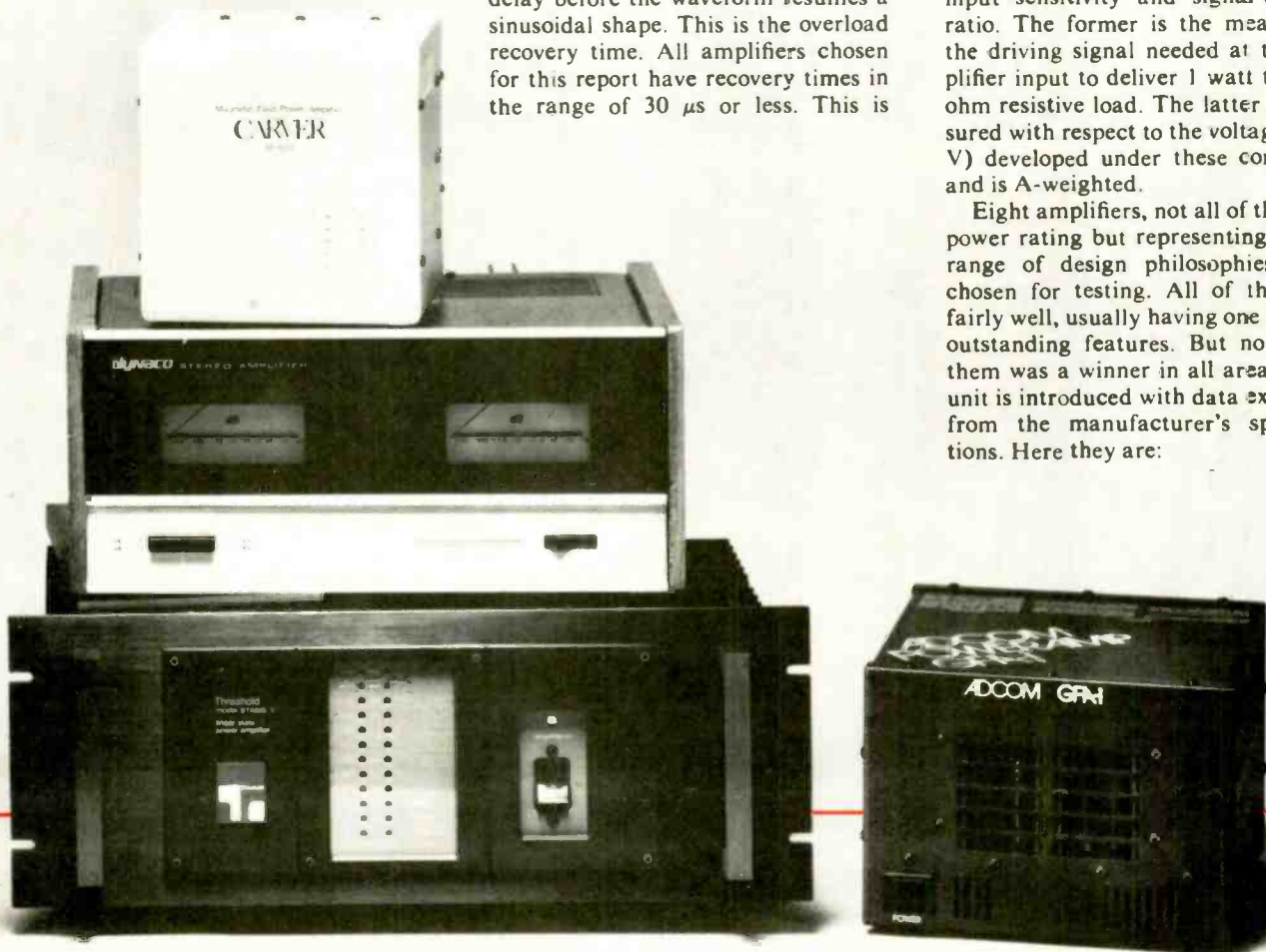

Apt 1



100 W/channel continuous into 4 or 8 ohms, 65 W/channel into 16 ohms, 20-20,000 Hz with no more than 0.03% THD, 150 W/channel into 2 ohms with no more than 0.05%, 200 W mono into 8 or 16 ohms; S/N (1 W) 80 dB; 3.12"H × 16.9"W × 10.19"D; suggested retail price \$641.

Apt has designed this amplifier to operate with a full reserve of headroom to all impedances from 2 to 16 ohms. A switch in the rear changes the power-supply voltage and current range to handle low-impedance loads without endangering the output transistors. The LED clipping indicators work very well; if they do no more than flicker from green to red occasionally, the amplifier is being used to its full capacity with no risk of any kind of distortion. This, plus the conservatively rated output section and the dual-voltage power supply, enables Apt to do away with conventional current-limiting circuits. Highly reactive loads do not bother this amplifier.

The Apt can drive 2-ohm loads with very high powers, and its high dynamic headroom rating (nearly 3 dB) applies under all load conditions. A warning red LED alerts the user that the impedance switch is set improperly (although no damage will come to the amplifier if it is set for "8-16 ohms" and one drives a 2-ohm load; under this condition it can pump well over 400 watts per channel into 2 ohms in 20-ms bursts).

Measured data: Harmonic distortion (8-ohm load, worst case) 0.028%, 20 kHz at full power; IHF IM distortion, second-order -94 dB, third-order -75 dB; IHF dynamic headroom 4.83 dB (see voltage/current plot); IHF slew factor 10; input sensitivity for 1-W output 92 mV; S/N (A-weighted) 89 dB.

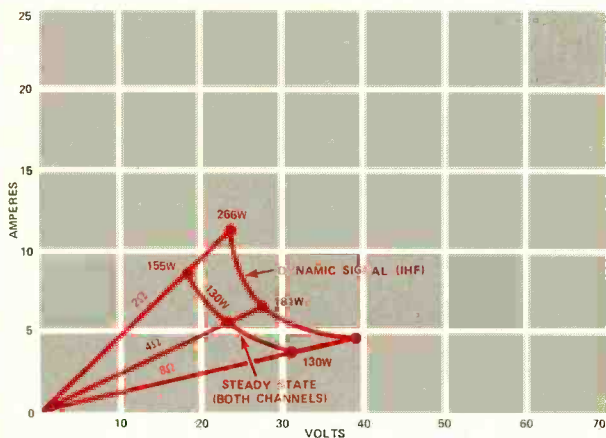

Heath AA-1800



250 W/channel continuous into 8 ohms, 20-20,000 Hz with no more than 0.025% THD; S/N (1 watt, unweighted) 85 dB; 7"H × 19"W × 16³/₄"D; suggested retail price \$600 in kit form.

This is the giant of the group, yet it gets *very* hot in preconditioning and high-power testing. It will drive low-impedance loads, but can readily blow internal fuses if pushed to clipping into 4 ohms or less. Its real forte is dynamic power capability, in which it far outdistances the other amplifiers. From 585 watts into 8 ohms to an incredible 1215 watts into 2 ohms, this amplifier should be able to cope with any demand of recorded program material—even when digital systems enter the home. Due to a built-in power limitation at ultrasonic frequencies, slew factor could not be measured. Judging from the manual and from examination of the test sample, this kit is no job for a tyro.

Measured data: Harmonic distortion (8-ohm load, worst case) 0.02%, full power at 15 kHz; IHF IM distortion, second order -93 dB, third order -76 dB; IHF dynamic headroom 3.7 dB; IHF slew factor not measurable; input sensitivity for 1-W output 100 mV; S/N (A-weighted) >90 dB.

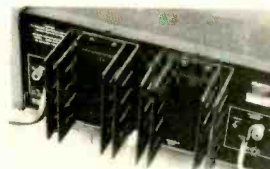
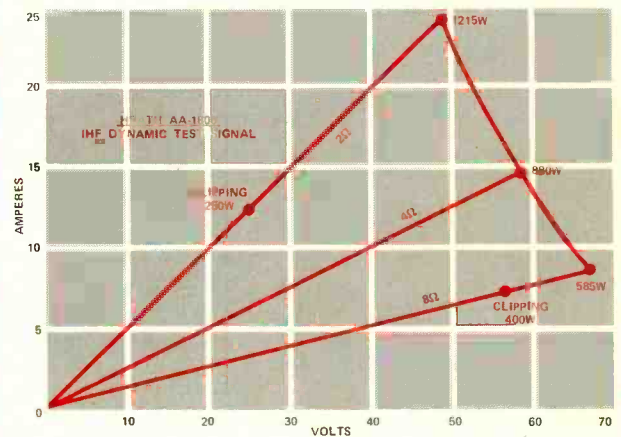

Cover Illustration

The original photo was an infrared image of a stereo amplifier delivering power to test loads. The image was color-enhanced by Wilson/Lund, Moline, IL 61265, using its Electronic Graphics Generator (EGG). The EGG employs a video camera, video monitor, and a control panel with 48 dials. With the EGG, an art technician can introduce varying degrees of 16 colors into images of black-and-white or color copy or illustrations, videotape frames, or even small three-dimensional objects. What appears on the cover is a color photograph of the image produced on the EGG's video monitor.

Carver M-400



200 W/channel into 8 ohms, 20-20,000 Hz with no more than 0.05% THD, 0.06% IM; S/N (A-weighted) 100 dB; 6¾"H, W, D; suggested retail price \$349.

This little giant of amplifiers is really a fairly conventional class-AB circuit, with a very "smart" power supply—essentially, a super-efficient switching type, somewhat resembling the high-voltage flyback supply of a TV set. It is controlled by the signal envelope and supplies no more dc to the amplifier than is required by the signal (three voltage levels are available). Protective and monitoring systems are connected to the power supply, so that the amplifier will shut down in time to protect itself and the speakers against damage. Operation is inverted in one channel to equalize loads on the positive and negative supplies.

The M-400 has no heat sinking other than the metal case. Because of the low average power output of music signals, and the high efficiency of the design, it runs cool under normal conditions. However, continuous power tests heat up its small thermal mass rapidly, and it can shut down in moments. Extraordinary power demands will blow its 15-ampere line fuse. (This large rating is used because much of the current drawn from the power line is reactive.)

In continuous distortion tests, the Carver M-400 operated on a duty cycle of about 34%—50 seconds on, 95 seconds off and shut down repeatedly. It blew numerous fuses and became extremely hot at times, yet was never damaged. It is capable of enormous power, even into low-impedance loads. In the mono connection (with built-in bridging) it can deliver more than 500 watts to 8 ohms, and almost a kilowatt on peaks.

Considerable change in the 10,000-Hz square-wave output with a 3- μ F capacitor added to the 8-ohm load resulted from the low-pass filters in the amplifier outputs. These remove ultrasonic switching components arising from the power-supply operation, and their cut-off properties can be affected somewhat by loading. This produces no audible effects.

Measured data: Harmonic distortion (8-ohm load, worst case) 0.18%, 20 kHz at 1/10 power; IHF IM distortion, second order -86 dB, third order -64 dB; IHF dynamic headroom 2.0 dB; IHF slew factor > 25; input sensitivity for 1-W output 92 mV; S/N (A-weighted) 85 dB.

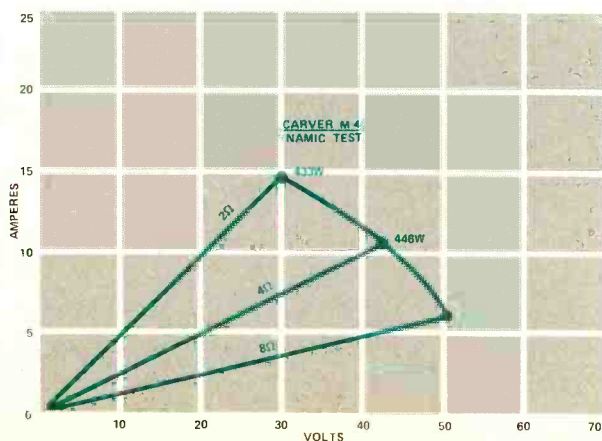

Adcom GFA-1



200 W/channel continuous into 8 ohms, 20-20,000 Hz with no more than 0.05% THD, 0.1% IM; 8½"H × 10½"W × 6½"D; suggested retail price \$400.

High power is packed into the GFA-1's case by using two strapped (bridged) amplifiers per channel. This approach requires *isolation of all grounds* or the output transistors will be destroyed. (This made it impossible for us to measure IM.) No protection against this sort of mishap is provided. The amplifier's fan, just about the quietest we have ever found in a home-entertainment product, keeps the unit cool when reproducing music. In preconditioning and testing, however, it ran very hot and was repeatedly shut down by its thermal protection. Its duty cycle was 33%—2 minutes on, 4 minutes off.

Loading the outputs with 3 μ F in parallel with 8 ohms produces strong ringing at about 20 kHz, but no outright instability. However, the load reflects back into the input, producing the same sort of ringing waveform at the inputs that appears at the outputs. What this means is not clear. In listening tests we could hear nothing wrong with the sound of the GFA-1, and no change occurred with 3- μ F capacitors across the speaker lines.

Measured data: Harmonic distortion (8-ohm load, worst case) 0.097%, full power at 20 kHz; IHF IM distortion not measurable; IHF dynamic headroom 2.90 dB; IHF slew factor 7; input sensitivity for 1-W output 72 mV; S/N (A-weighted) 80 dB.

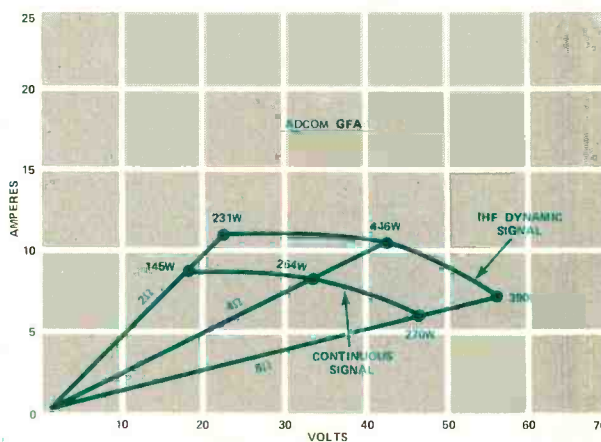

(more overleaf)

Kenwood L-07 MII



150 W (mono) into 8 ohms, 20-20,000 Hz with no more than 0.007% THD, 0.003% IM; S/N 120 dB; 6 ³/₃₂"H × 7 ⁷/₈"W × 15 ¹/₃₂"D; suggested retail price \$600.

As this is a mono amplifier, two are needed for stereo. Not especially powerful in view of its size, it belongs to the "vanishing distortion" school of design. The load is fed via a meter length of heavy speaker cable, and some of the benefits of the amplifier are said to be sacrificed if any other link is used. (One can hardly dispute the desirability of short, heavy speaker leads.)

We heard no magic quality to the sound from a pair of these amplifiers, but they are easily as good as any others one might name. The 0.14-microsecond rise time we measured places response well into the MHz range, and it must be noted that the IHF IM distortion was the lowest we have yet measured.

A 3- μ F capacitor on the output produces ringing, which also reflects to the inputs. Oddly, the *dynamic* power output of the Kenwood amplifier with 4- or 2-ohm loads is *less* than the continuous output. A Kenwood spokesman verifies that this is characteristic of the protection circuitry.

Measured data: Harmonic distortion (8-ohm load, worst case) <0.01%; IHF IM distortion, second order below -96 dB, third order -90 dB; IHF dynamic headroom 1.25 dB; IHF slew factor >25; input sensitivity for 1-W output 80 mV; S/N (A-weighted) >90 dB.

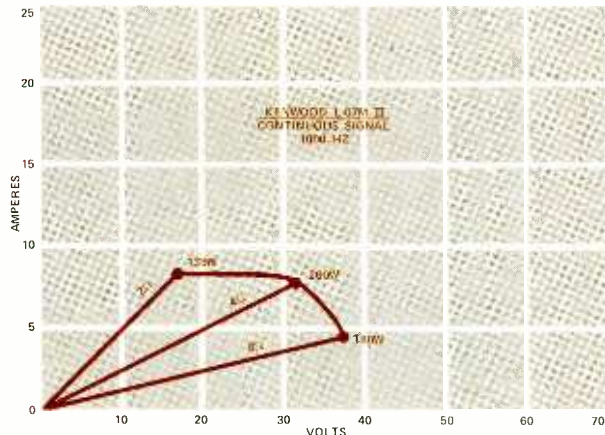

Phase Linear Model 400 Series II



210 W/channel continuous into 8 ohms, 20-20,000 Hz with 0.09% THD and IM distortion; S/N 110 dB (IHF "A"); approx. 7"H × 19"W × 10"D; suggested retail price \$700.

Designing an improved model based on the original Phase Linear 400 is a task sufficiently formidable that we are neither surprised nor disappointed that in this case the redesign is largely cosmetic. Rated power has been increased by 0.2 dB to 210 watts and the distortion rating decreased to 0.09%. Under the new skin, however, lies much the same amplifier as before, as evidenced by the fact that our sample met the old distortion spec handily, but could not quite make the new one. (Everything was fine until 20 kHz, where harmonic distortion rose to about 0.2%.) Needless to say, this does not impair sonic performance of the unit in any way, especially since IM products—which, unlike harmonics of 20 kHz, lie in the audible range—are extremely well suppressed.

The rating for continuous power into 8 ohms leaves a good safety margin, but fuses blew before clipping could be reached into lower impedances. Dynamic tests showed the unit's true capabilities—800 watts per channel are available into 2 ohms! Addition of the shunt capacitors caused no significant alteration of the square-wave signal. The amplifier gets very hot in preconditioning, but stays cool in normal use.

The only oddity we observed was minor and relates to the LED output indicators. These, like the meters on the earlier version, are calibrated with 0 dB at only 70 watts.

Measured data: Harmonic distortion (8-ohm load, worst case) 0.21% (¹/₁₀ power at 20 kHz); IHF IM distortion, second order -93 dB, third order -76 dB; IHF dynamic power 2.23 dB; IHF slew factor 3.2; input sensitivity for 1-W output 79 mV; S/N (A-weighted) 85.8 dB.

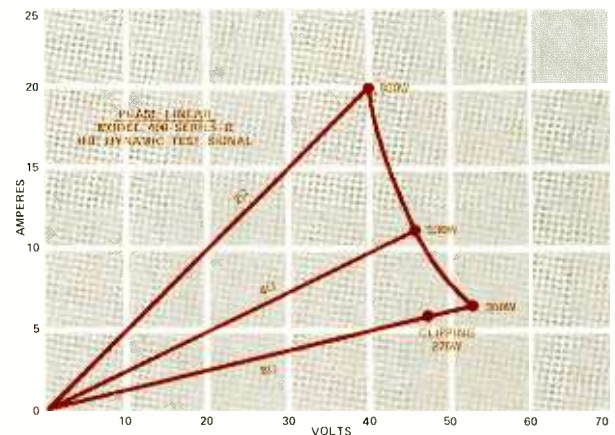

Van Alstine MOS-FET 150



60 W/channel into 8 ohms, 20-20,000 Hz with no more than 1% THD; S/N 88 dB; 7"H × 14½"W × 11"D; price \$600 by mail order (\$675 with meters, \$300 when a Dyna 150, working or not, is sent as a trade-in).

Built from a recycled Dyna 150, though retaining only the chassis and power transformer, this amplifier impressed us with the simplicity of its design approach. The goal was to optimize the transient response of the amplifier while eliminating all forms of transient and slew-induced distortion. In realizing this, Van Alstine showed little concern for conventional specifications, as evidenced by the seemingly outlandish distortion rating.

The unit is an all-FET amplifier having relatively low open-loop gain. There is considerable negative feedback at dc and low frequencies, diminishing with increasing frequency and disappearing altogether by 26 kHz.

The result shows in the IHF IM measurement. Odd-order IM products are more numerous of higher amplitude than on most amplifiers, and the 1,000-Hz difference tone is at only -73 dB. None of this is audible in any case, but we are not convinced that TIM/SID is audible either.

As one would suspect from a frequency response that is down 2.4 dB at 20,000 Hz, a 10,000-Hz square wave is quite rounded on its leading edge. Adding a 3-μF capacitor improves the shape considerably. Nothing at the output of the amplifier reflects in any way to its input. A major design goal was total stability under any conditions. Stages are all balanced so that there are *no* transients at turn-on or turn-off. Furthermore, it is nearly immune to line voltage shifts. When you drive it to about 1 watt and watch the output on a dc scope, reducing the line voltage from 120 to virtually zero has absolutely no effect on the output. When the drive is increased so that the waveform clips, a slight increase of line voltage restores proper operation. The meters are accurate and the readings match in both channels—quite a rarity.

This is a relatively low-power amplifier, and fairly expensive for its power rating. On the other hand, if you have a Dyna 150 to be converted, the cost is very reasonable.

Measured data: Harmonic distortion (8-ohm load, worst case) 0.86%, full power at 20 kHz; IHF IM distortion, second order -74 dB, third order -50 dB; IHF dynamic headroom 2.02 dB; IHF slew factor > 25; input sensitivity for 1-W output 30 mV; S/N (A-weighted) 85 dB.

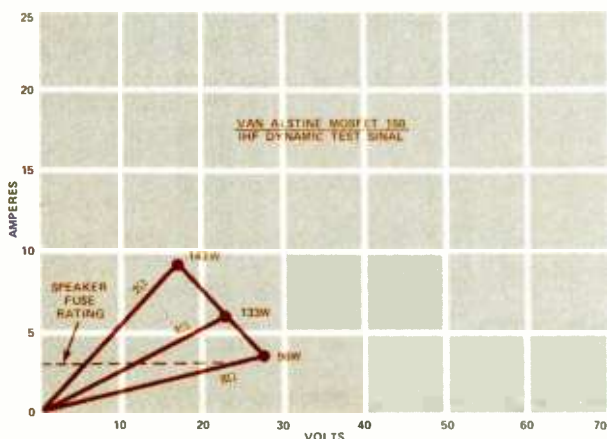

Threshold Stasis 3



100 W/channel continuous into 8 ohms, 20-20,000 Hz with harmonic and IHF IM distortion less than 0.1%; S/N 103 dB; approx. 7"H × 19"W × 18"D; suggested retail price \$1,675.

Here is one superbly constructed and over-engineered amplifier. Its principal features are its unique circuit configuration (which eliminates overall negative feedback and makes the unit, theoretically, free of TIM) and its use of 16 output devices per channel (which makes fuses the only protective devices necessary). However, on penalty of serious high-frequency oscillation, input and output grounds *must be kept isolated*.

During our lab evaluation, the amplifier blew fuses in the slew-factor test, which is normally not highly stressful. Apparently, at ultrasonic frequencies, the half of the output stage that is supposed to be nonconducting cannot turn off rapidly enough. This leaves the stage effectively a short circuit across the power supply. (In normal circumstances, this is extremely unlikely to happen.) Once the signal was removed and the fuses replaced, the amplifier seemed free of damage. (We had some difficulties in removing blown fuses from the holders, but Threshold advises that this is being corrected.)

For its power rating, the price of the Stasis 3 is high indeed. If there is any performance advantage to its special design, our lab and listening tests failed to detect it. On the other hand, no sonic flaws were turned up either. Finally, the dual LED ladders respond rapidly and accurately, giving a useful display of instantaneous power output.

Measured data: Harmonic distortion (8-ohm load, worst case) 0.075% (30 Hz, 10 W); IHF IM distortion, second order -94 dB, third order -76 dB; IHF dynamic headroom 2.30; IHF slew factor > 5; input sensitivity for 1-W output 125 mV; S/N (A-weighted) 89 dB.

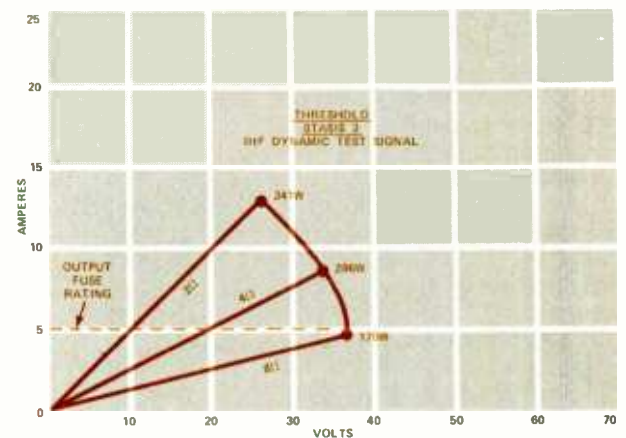

(more overleaf)

**Our secret
to tracking these
fantastic grooves
makes every
record you own
sound better!**

**New AT155LC
Vector-Aligned™
Stereo Cartridge**



Ⓐ There are perhaps a dozen reasons why the new AT155LC does so well tracking even the most explosive new digital records. An advanced new Line Contact stylus, our exclusive Vector-Aligned™ magnetic system, and new high-efficiency coil and core designs to mention just a few.

But it's our *sound*, not the construction that is important. And our capability to track even the tough records which benefits you every time you listen. Because even slight mis-tracking can quickly destroy any record, shortening both disc and stylus life dramatically.

Of course it's easy to claim "good tracking"... everybody says it. *Proving* it is something else. *Well, we guarantee that every new AT155LC will pass an objective test which easily exceeds the limits of most commercial pressings.* Specifically, at 1.2 grams the AT155LC cleanly tracks the 80-micron band of a standard

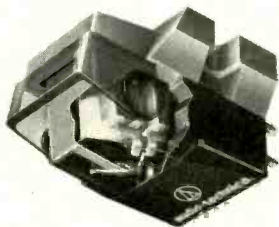

DIN 45 549 or AT6607 equivalent test record. And at 1.6 grams it even tracks the severe 90-micron band without visible distortion.

Of course tracking is not the only virtue of the new AT155LC. Response is uniform from 5 to 35,000 Hz, separation is great, and efficiency is uncommonly high*. All claims we back up with specific tests any lab can duplicate.

But the most important test is a visit to your Audio-Technica dealer. Ask to hear the new AT155LC with your favorite records and with the new digital blockbusters. We promise a remarkable sonic experience. And audible proof that the new AT155LC can unlock the full potential of every other hifi component you own.

*Performance specifications available on request.

audio-technica
AUDIO-TECHNICA U.S., INC.,
1221 Commerce Dr., Stow, OH 44224
Dept. 11P

General Comments. It is our view that, aside from intangible factors, the real advantages of one amplifier over another lie in reliability, freedom from "glitches," and ability to drive any load one might conceivably apply. Last but not least is the obvious matter of power output.

No one would go wrong with any of these amplifiers. In fact, the overall level of performance for the group is almost astonishingly high. On the basis of our auditions, it seems doubtful that anyone in a double-blind test could distinguish between them. When we drove them hard, it was easy to separate the 100-watt class from the 200-watt class, especially when there were large dynamic power demands. Still, that calls for listening at levels that would be extremely high for the home.

Choosing one of the group over the others would be very difficult, yet each has its particular strength. The Carver is unquestionably the most ingeniously designed amplifier, in addition to being the cheapest. The Threshold is the "best built" in respect to workmanship and component quality, but has a price to match. The Adcom gives the Carver close competition in the dollars-per-watt race, and has no deficiencies in a normal home situation.

The Apt is a gem, a small, highly sophisticated amplifier that is not fazed by anything one connects to it—but it is expensive for its power. Phase Linear is a good value for the money—and is very powerful into low impedances. The Heath unit is almost overwhelming in its massiveness and power, and clearly the champion in dynamic power. Kenwood's has extremely large bandwidth and is extraordinarily low in distortion, though the audible benefits of those qualities are not clear. And a pair of them is quite expensive for the power rating.

Finally, Van Alstine's wins a special place for its near-ultimate simplicity and freedom from idiosyncrasies. It is very expensive, however, for a 60-watt amplifier, although the conversion cost from a Dyna 150 falls in the bargain category.

Ultimately, the choice between units may depend partly on appearance, how well the unit fits the space available, or some intangible factor. If this series of tests does nothing else, it demonstrates that modern, high-quality power amplifiers have a good deal in reserve for stress situations. ♦

ITEM NO.
WK-7

CMOS SAFE

IC INSERTION/EXTRACTION KIT

KIT INCLUDES

- MOS-1416 14-16 CMOS SAFE INSERTER
- MOS-2428 24-28 CMOS SAFE INSERTER
- MOS-40 36-40 CMOS SAFE INSERTER
- EX-1 14-16 EXTRACTOR
- EX-2 24-40 CMOS SAFE EXTRACTOR



OK MACHINE & TOOL CORPORATION
3455 CONNER ST., BRONX, N.Y. 10475 U.S.A.
PHONE (212) 994-6600 TELEX MO 125091



PRINTED IN U.S.A.

PATENT PENDING

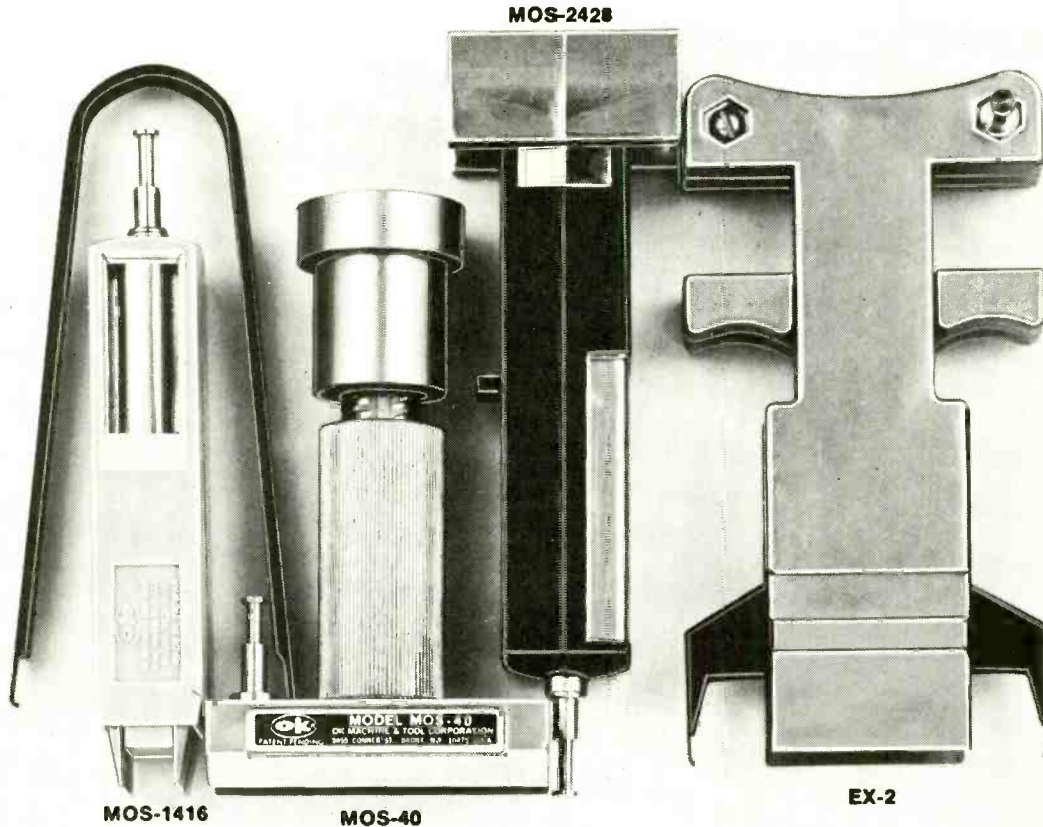

MOS-1416

MOS-40

EX-2

WK-7	COMPLETE IC INSERTER/EXTRACTOR KIT	\$29.95
------	------------------------------------	---------

INDIVIDUAL COMPONENTS

MOS-1416	14-16 PIN MOS CMOS SAFE INSERTER	\$ 7.95
MOS-2428	24-28 PIN MOS CMOS SAFE INSERTER	\$ 7.95
MOS-40	36-40 PIN MOS CMOS SAFE INSERTER	\$ 7.95
EX-1	14-16 PIN EXTRACTOR TOOL	\$ 1.49
EX-2	24-40 PIN CMOS SAFE EXTRACTOR TOOL	\$ 7.95

MINIMUM BILLING \$25.00. ADD SHIPPING CHARGE \$2.00. NEW YORK RESIDENTS ADD APPLICABLE TAX.

OK MACHINE & TOOL CORPORATION 3455 CONNER ST., BRONX, N.Y. 10475 (212) 994-6600/TELEX 125091

When it comes to performance, size doesn't count...anymore.

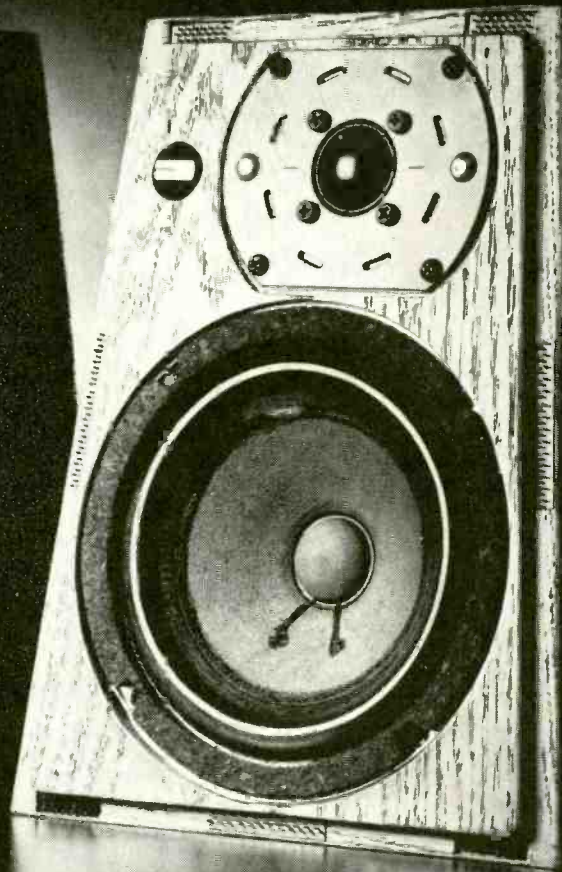

Up until now the sound quality of mini-speakers was exactly what you probably imagined... minimal. Minimal bass response. Minimal power handling capacity. Minimal definition.

That was until ADC perfected the incredible new MS-650 mini-speaker system. The only thing small about it, is its size.

Here's why. Unlike conventional mini-system drivers that can overheat and distort under high power, both the MS-650's 1" polyamide soft dome tweeter and 6 1/2" high compliance woofer are specially cooled with ferrofluic in the voice coil gap for better frequency response, lower distortion and greater power handling.

They're so effective the new MS-650 mini-speaker system can handle up to 150 watts of power! But what's even more amazing is that while it can handle all that power, it doesn't need it. A mere 20 watts input produces an awesome 102dB output. That's enough to wake the neighbors. And the whole neighborhood. But that's not all.

To further enhance sound quality

the MS-650's feature an effective combination of first and higher order crossover networks for a smooth, natural transition between high and low frequencies. That's a big difference between the crossover systems most mini-speakers use.

But the differences don't stop there. The MS-650's unique non-parallel cabinet sides were computed to allow a graceful termination of midrange frequencies at the cabinet edge. The sound you'll hear will be more natural...at all levels. Even the front face is sloped for improved phase coherency. To minimize the adverse effects of cabinet resonances, the MS-650 is constructed of Isopur T.F.M., a specially formulated non-resonant material.

The new ADC MS-650 mini-speaker system. The only thing small about it, is its size.

For your nearest ADC dealer or more information call (800) 243-9544 or write Audio Dynamics Corporation, Pickett District Road, New Milford, Connecticut 06776.

MS650
MINI-SPEAKER **ADC**
A BSR COMPANY

CIRCLE NO. 61 ON FREE INFORMATION CARD

WOULD you like to be able to send letter-perfect Morse at speeds ranging from 5 to 35 wpm without having to pound brass? You can, with the aid of the Morse-A-Keyer, which automatically converts ASCII data into perfectly formed Morse characters. When an ASCII keyboard is added, a complete CW keyboard keyer is obtained. A sidetone oscillator that lets the user hear the generated Morse is built-in, as is a reed relay that can be used to key a transmitter or transceiver. The Morse-A-Keyer offers the CW buff a means of conducting almost effortless Morse conversations. Used as a source of perfectly timed and spaced code characters, it is a valuable tool for Morse training sessions.

The Morse-A-Keyer employs low-power CMOS ICs and requires +5 volts dc at 120 mA. It accepts parallel data in seven-bit ASCII form from a microcomputer, an ASCII keyboard, or some other ASCII source and converts this data into Morse Code. The project can handle all standard alphabetical characters, as well as the Arabic numerals and common punctuation marks. In addition, the Morse-A-Keyer can generate special Morse characters such as SK, KN, AR

and AS that do not have direct ASCII equivalents. A 16-character elastic buffer permits the user to type ahead of the transmitted text, which is sent at a rate selectable over the range of 5 to 35 wpm. Project cost is approximately \$70.00.

About the Circuit. The Morse-A-Keyer is shown schematically in Fig. 1. Data in seven-bit, TTL-compatible

ASCII form is applied to EPROM IC12 via circuit points E through K. This data is encoded into a special set of parallel bits which appear at the output terminals of the EPROM (pins 4 through 11). The encoded bits are presented to an 8 × 16-bit shift register comprising IC8 and IC9 and are loaded into the register when a TTL-compatible strobe pulse is applied to circuit point L. A negative-

BUILD A **MORSE-A-KEYER**

*Automatic Morse Code
transmitting project*

BY GEORGE R. STEBER



going pulse can be used for this purpose if a jumper is connected between circuit points *J1* and *NS*. Similarly, a positive-going pulse can be used to strobe the input register if a jumper is connected between circuit points *J1* and *PS*.

If no data has previously been loaded into the shift register, which is of the FIFO (first-in, first-out) variety, any new data that is loaded into it immediately ripples through to the output pins of *IC8* and *IC9*. If data is already present in the registers, it is advanced when pins 1 and 15 of *IC8* and *IC9* are brought to ground potential. The data at the output lines of the FIFO register

(pins 10 through 13 of *IC8* and *IC9*) is presented to a second shift register comprising *IC1A* and *IC2A* through *IC4B*. These ICs function as an 8-bit register that accepts parallel data from the FIFO register.

Triple three-input NAND gate *IC5* is used to detect whether there is data corresponding to a character to be Morse encoded present at the outputs of register *IC1A* and *IC2A* through *IC4B*. If such data does appear, pin 1 of NAND gate *IC10A* is raised to logic 1. This actuates the basic Morse clock that consists of gates *IC10A* and *IC10B* and their associated passive (RC) timing

PARTS LIST

- C1,C3,C4,C7,C10,C15,C16,C19,C20—0.05- μ F, 50-V disc ceramic capacitor
- C2,C12,C13,C18—100- μ F, 6-V electrolytic
- C5,C14—22- μ F, 6-V electrolytic
- C6—0.47- μ F, 6-V tantalum capacitor
- C8—0.0047- μ F, 50-V Mylar capacitor
- C9,C11—0.01- μ F, 50-V Mylar capacitor
- C17—0.005- μ F, 200-V disc ceramic capacitor
- C21—12-pF disc ceramic capacitor
- D1,D2,D6—1N914 silicon diode
- D3,D4,D5—1N60 or 1N270 germanium diode
- D7—1N4001 silicon rectifier
- D8—1N5237 8.2-volt zener diode
- D9—1N5232 5.6-volt zener diode
- IC1,IC2,IC3,IC4—CD4013 dual D flip flop
- IC5—CD4023 triple 3-input NAND gate

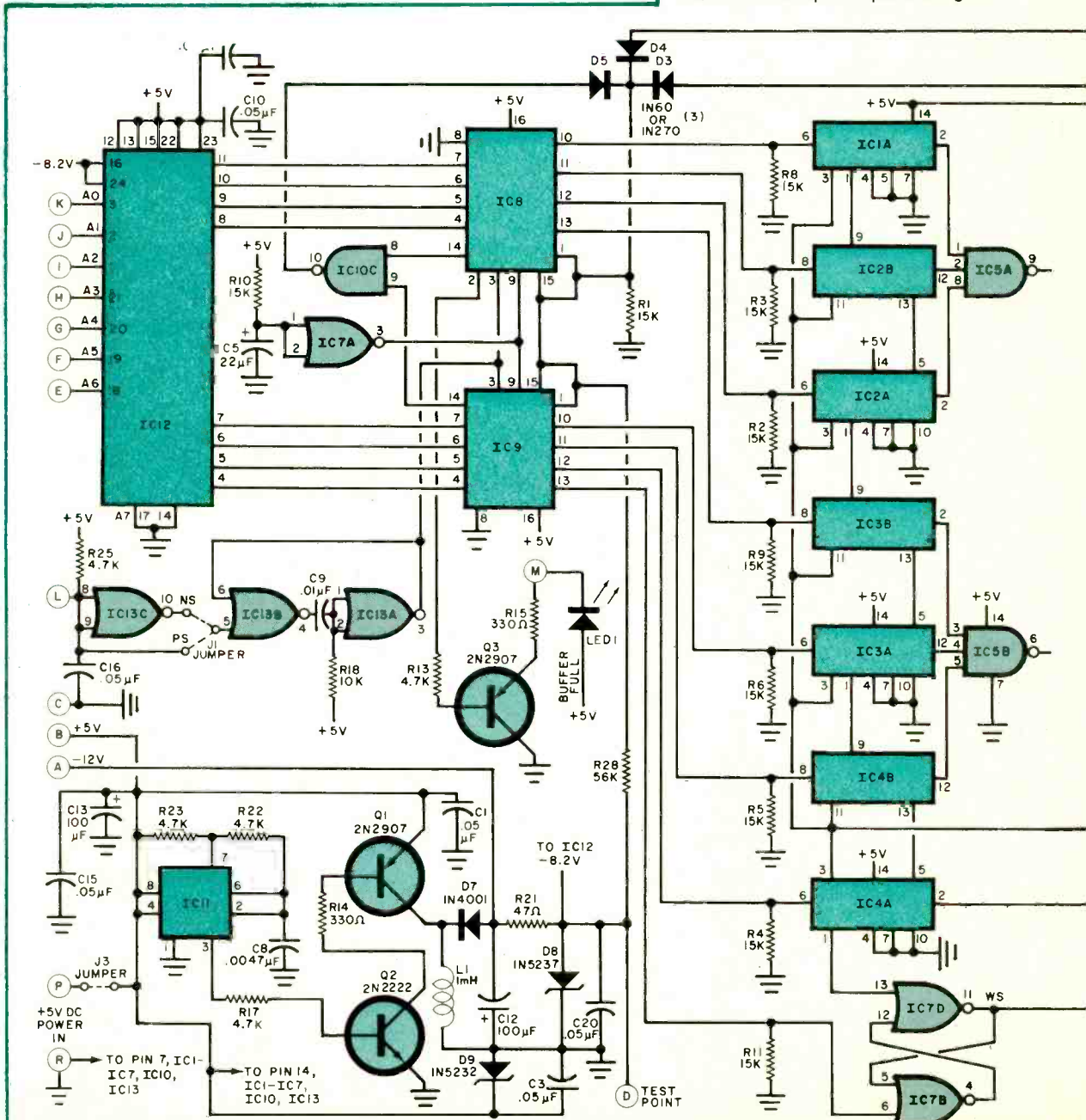

IC6,IC7,IC13—CD4001 quad 2-input NOR gate
 IC8,IC9—CD40105 FIFO shift register
 IC10—CD4011 quad 2-input NAND gate
 IC11,IC15—NE555 timer
 IC12—1702A PROM
 J1,J2,J3—Wire jumpers; see text.
 K1—5-volt DIP reed relay (Gordos 527-831A-1 or equivalent)
 L1—1-mH inductor
 LED1—Red light-emitting diode
 Q1,Q3—2N2907 pnp silicon transistor
 Q2,Q4—2N2222 npn silicon transistor
 The following, unless otherwise specified, are 1/4-watt, 5% carbon-composition fixed resistors.
 R1 through R11—15 k Ω
 R12, R26—82 k Ω
 R13, R16, R17, R19, R22, R23, R25, R29—4.7 k Ω

R14, R15—330 Ω
 R18—10 k Ω
 R20—27 k Ω
 R21, R24—47 Ω
 R27—10 Ω
 R28—56 k Ω
 R30—250-k Ω , linear-taper potentiometer
 R31—500- Ω , audio-taper potentiometer
 S1—Momentary contact, normally open pushbutton switch (optional; for transmitter tuning purposes)
 Misc.—Double-sided printed-circuit board, IC sockets or Molex Soldercons, appropriate input and output connectors, +5-volt power supply capable of furnishing approximately 120 mA, suitable enclosure, ASCII keyboard (optional), printed-circuit-board standoffs, 8-ohm dynamic speaker, hookup wire, solder, etc.

Note: The following is available from Microcraft Corp., Box 513, Thiensville, WI 53092 (414-241-8144): Complete kit of parts including etched and drilled printed-circuit board, all items in Parts List including ASCII keyboard, power supply, and prepunched and lettered enclosure (No. MAK-K) for \$159.95 plus \$5.00 postage and handling. Also available from the same source: Kit including etched and drilled pc board and all parts that mount on it (No. EPK-K) for \$69.95 plus \$3.00 postage and handling; etched and drilled pc board (No. PCB-K) for \$12.50 plus \$2.00 postage and handling; preprogrammed 1702A PROM (No. PROM-K) for \$10.00 plus \$1.50 postage and handling. Wisconsin residents, add 4% sales tax.

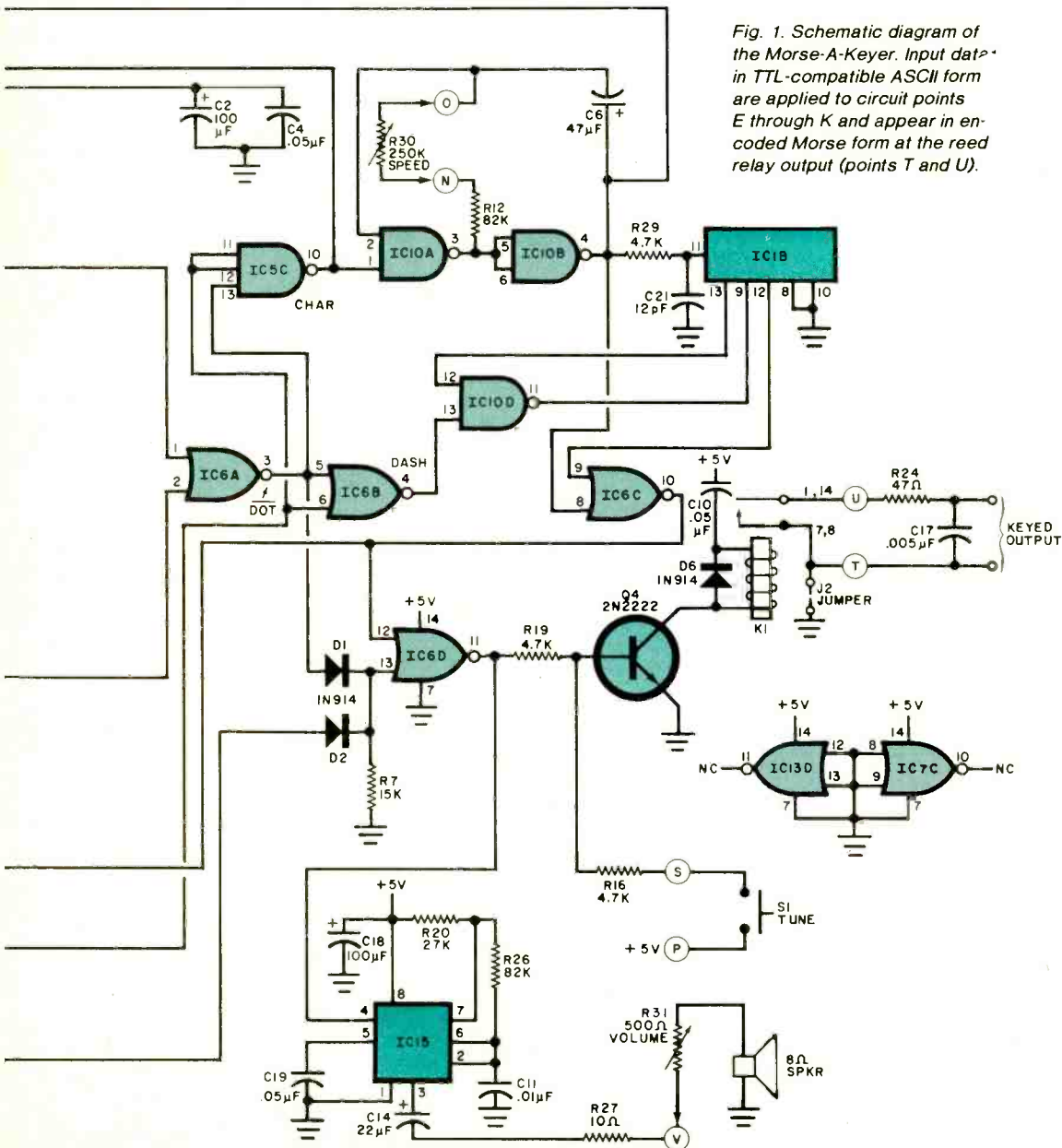

Fig. 1. Schematic diagram of the Morse-A-Keeyer. Input data in TTL-compatible ASCII form are applied to circuit points E through K and appear in encoded Morse form at the reed relay output (points T and U).

components. Portions of IC5, IC6, and IC7 function together to determine whether the data emerging from the register should be encoded as a dot, a dash, or an element space.

As each bit emerging from the register is processed, the remaining data in the register is shifted one position toward the output. This process continues until only one bit is left in the register (in IC4A). The Morse character is then rounded out with an element space and

applied to relay driver Q4 via NOR gate IC6C.

A DIP reed relay is specified for use in this project. Its contacts are rated at 200 volts and 250 mA. These ratings are compatible with the keying lines of most CW transmitters and transceivers of contemporary design, especially those that employ grid- or base- or gate-block keying. However, the project should not be used to key any transmitter unless it has been verified that neither the volt-

age appearing across the keying line nor the current flowing through it exceeds the ratings of the relay contacts. If your transmitter will overstress the contacts of the specified relay, use one whose contacts have higher ratings. Any substitute relay should have a rated coil current less than the rated maximum collector current of driver Q4.

No matter what relay is used, be sure to include diode D6 to suppress the high-voltage transients that appear across the relay coil when it is deprived of current. Otherwise, driver Q4 is at risk. As the schematic indicates, the relay contacts are connected to circuit points T and U. Both can be left floating, or the contact connected to point T can be grounded by means of jumper J2. Capacitor C17 and resistor R24 are connected across the relay contacts to suppress arcing as they open and close.

A sidetone oscillator that allows the user to monitor aurally the generated Morse is built around 555 timer IC15. The timer operates as an astable multivibrator whose frequency of oscillation is determined by the values of fixed components R20, R26 and C11. For the values specified, it is nominally 800 Hz. The output of the multivibrator is coupled via C14 and R27 to volume control R31 and thence to a small, 8-ohm dynamic speaker.

Because PROM IC12 requires both positive and negative supply voltages, the project incorporates a low-power dc/dc converter. This eliminates the need for an external, bipolar supply. A 555 timer (IC11) functioning as an astable multivibrator forms the heart of the converter. It drives transistor Q2 alternately into saturation and cutoff, and this transistor acts as a driver for Q1. Diode D7 rectifies the voltage generated across L1 into a negative dc level that is filtered by C12 and regulated by zener diode D8. The resulting -8.2-volt output of the dc/dc converter is adequate to power the 1702A PROM.

The power requirements of the project are relatively modest—+5 volts at approximately 120 mA. Any number of power supply configurations are acceptable so long as the maximum voltage does not exceed +5.5 volts. It is therefore suggested that the supply include a +5-volt discrete regulating network or regulator IC.

Next Month. Part 2 of this article next month will include the printed-circuit board etching and drilling guides, the component layout, and the instructions for constructing and operating the "Morse-A-Keyer" as well as a truth table for programming the 1702A PROM.

EXCITING MAIL ORDER DISCOUNTS



Apple II 16K computer

Disk II with Controller \$519... without \$425

Nearly Everything for Apple

\$899

APPLE II 32K \$999
APPLE II 48K \$1099

DOS 3.3 with upgrade kit \$48

<p>APPLE II ACCESSORIES</p> <p>Apple Joystick 47</p> <p>ALT Numeric Input Keyboard 114</p> <p>ALT Music Synthesizer 245</p> <p>Brighten Lightpen from Software 32</p> <p>Clear Copy for Apple Computer 26</p> <p>CCS Programmable Tuner Module 159</p> <p>Doc Parser Lower Case Kit 59</p> <p>Hayes Microcom T M 335</p> <p>Extender Board 27</p> <p>Graphics Input Tablet 449</p> <p>Introl X 10 Remote Control System 239</p> <p>Introl X 10 Controller Only 164</p> <p>M&R Sub 8 Term 80 Column Board 325</p> <p>Microsoft 2.80 Soft Card 299</p> <p>Novation Cal Modem 148</p> <p>Romwriter 215</p> <p>SpeechLink 2000 84 Word Vocabulary 239</p> <p>Sup R Mod RF TV Modulator 25</p> <p>SVA 8 Disc Controller Card 329</p> <p>Versa Writer Digital Drawing System 209</p>	<p>SOFTWARE</p> <p>Adventure by Microsoft 27</p> <p>Apple Bow 14</p> <p>Applebug Assembler/Disassembler 69</p> <p>Applebug Debugger 27</p> <p>Apple Green & Plot System 59</p> <p>Applesoft Meeting List System 44</p> <p>Applesoft Utility Programs by Hayden 27</p> <p>Apprentice Word Processor 59</p> <p>Bill Budges Space Game Album 39</p> <p>Bill Budges Trilogy of Games 29</p> <p>The Cashier Retail Management System 189</p> <p>CCS Date Management 84</p> <p>by Personal Software 84</p> <p>The Contributed Volumes 15</p> <p>emulsions 29</p> <p>Desktop Plan by Personal Software 29</p> <p>Down Jones Portfolio Evaluator 44</p> <p>Form II by Programma Software 159</p> <p>Fortran for use with Language System 395</p> <p>Parallel Language System 27</p> <p>Sargon II Chess Game disks 35</p> <p>Shel Gamma 27</p> <p>Space Invader Cassette 18</p> <p>Space Invader disk 29</p> <p>Sub Logic FS 1 Flight Simulator 27</p> <p>Cassette 27</p>	<p>Sub Logic FS 1 Flight Simulator disk 29</p> <p>Sybase Apple #8 8000 Simulator 17</p> <p>Viasoft by Personal Software 115</p> <p>Business Package 595</p>
<p>APPLE COMPUTER INTERFACE CARDS</p> <p>Asynchronous Serial Interface #7710A 645</p> <p>Applesoft II Firmware Card 149</p> <p>CCS Arithmetic Processor Card #7811B 329</p> <p>CCS Parallel Interface Card #7770A 156</p> <p>Centronics Printer Interface Card 179</p> <p>Apple Clock Calendar Card by Mountain Hardware 229</p> <p>Communications Card & DB25 Cable 179</p> <p>Integer Basic Firmware Card 148</p> <p>Parallel Printer Interface Card 139</p> <p>Phototyping Hobby Card 22</p> <p>Romplus Card with keyboard filter 188</p> <p>Romplus Card without keyboard filter 159</p> <p>SSM AIO Serial/Parallel I/O Assembler Kit Tested 169</p> <p>Serial Interface Card 139</p> <p>Synotec Light Pen Card 214</p>		
<p>PRINTERS, MONITORS, DISCS</p> <p>Daisy Wheel Printer 1795</p> <p>Analex DP8000 850</p> <p>Analex DP9000AP 950</p> <p>Centronics without cable 819</p> <p>Epson TX80-B W/Graphics 799</p> <p>MPF 801 650</p> <p>NEC Spinwriter #5510 2885</p> <p>Paper Tiger with Graphics 959</p> <p>Sanyo with Interface Card 495</p> <p>Lexlex Video 100-12 B&W 129</p> <p>Sanyo 9 B&W 155</p> <p>Oliva Monitor 11 349</p> <p>Orson disks 19kg 101 50</p> <p>Memorex 19kg 101 40</p> <p>Videxcom 19kg 101 30</p>		

WE SHIP FAST!



ATARI 800

PERSONAL COMPUTER SYSTEM

\$747

*High resolution COLOR Graphics
*I/O Basic in ROM
*RAM expandable to 48K

*57 key full stroke keyboard
If Atari makes it, we sell it!

"BEST PRINTER VALUE IN THE WORLD"
Check our prices on THE ULTIMATE IN QUALITY

Epson Printers

APPLE & MOST OTHER COMPUTERS

NEW! MX80, 40, 80, 132 columns
LIST **\$645**

TX 80 col. w/Graphics
LIST **\$799**

Apple Controller & Card & Cable.
LIST **\$110**

- Most reliable small printers ever sold!
- Uses standard printed paper.
- Dumps Apple screen graphics right on the paper — with graphics option.

<p>Atari 820 Printer \$489</p> <p>Atari 810 Disk Drive 569</p> <p>Atari 410 Program Recorder 69</p> <p>Atari 16K RAM Module 149</p> <p>Atari 8K RAM Module 99</p> <p>Atari Basic ROM 45</p> <p>Basketball 30</p> <p>Video Easel 30</p> <p>Super Breakout 30</p> <p>Music Composer 45</p> <p>Computer Chess 30</p> <p>Star Raiders 39</p> <p>3D Tic-Tac-Toe 30</p> <p>Joystick 19</p>	<p>TO ORDER: Phone orders invited using Visa, Mastercard, or bank wire transfers. Visa & MC credit card service charge of 2%. Max orders may send charge card number. Include expiration date, cashiers check, money order, or personal check (allow 10 business days for personal checks to clear). Please include phone number. Include 3% shipping, handling and insurance (65.00 minimum in USA. Shipments within Calif. add 6% sales tax. Foreign orders include 1% handling/shipping freight collect. Foreign orders over \$1000 allow 3 weeks extra and include \$25 license fee. All equipment is in factory cartons with the manufacturers warranty. Equipment is subject to price change and availability.</p>
--	---

MAIL TO: 1251 BROADWAY EL CAJON CA, 92021 (714) 579-0330

AUTHORIZED APPLE SALES & SERVICE

COMPUTER SPECIALTIES

DIVISION OF CMI



Start learning and computing for only **\$129.95** with a **Netronics 8085-based computer kit**. Then expand it in low-cost steps to a business/development system with **64k or more RAM, 8" floppy disk drives, hard disks and multi-terminal I/O.**

THE NEW EXPLORER/85 SYSTEM

Special! Full 8" floppy, 64k system for less than the price of a mini! Only **\$1499.95!**

(Also available wired & tested. \$1799.95)

Imagine — for only \$129.95 you can own the starting level of Explorer/85, a computer that's expandable into full business/development capabilities — a computer that can be your beginner system, an OEM controller, or an IBM-formatted 8" disk small business system. From the first day you own Explorer/85, you begin computing on a significant level, and applying principles discussed in leading computer magazines. Explorer/85 features the advanced Intel 8085 cpu, which is 100% compatible with the older 8080A. It offers on-board S-100 bus expansion. Microsoft BASIC in ROM, plus instant conversion to mass storage disk memory with standard IBM-formatted 8" disks. All for only \$129.95, plus the cost of power supply, keyboard/terminal and RF modulator if you don't have them (see our remarkable prices below for these and other accessories). With a Hex Keypad/display front panel, Level "A" can be programmed with no need for a terminal, ideal for a controller, OEM, or a real low-cost start.



Level "A" is a complete operating system, perfect for beginners, hobbyists, industrial controller use. \$129.95



Full 8" disk system for less than the price of a mini (shown with Netronics Explorer/85 computer and new terminal). System features floppy drive from Control Data Corp., world's largest maker of memory storage systems (not a hobby brand!)



Level "A" With Hex Keypad/Display.

LEVEL "A" SPECIFICATIONS

Explorer/85's Level "A" system features the advanced Intel 8085 cpu, an 8355 ROM with 2k deluxe monitor/operating system, and an advanced 8155 RAM I/O ... all on a single motherboard with room for RAM/ROM/PROM/EPROM and S-100 expansion, plus generous prototyping space.

PC Board: Glass epoxy, plated through holes with solder mask. • I/O: Provisions for 25-pin (DB25) connector for terminal serial I/O, which can also support a paper tape reader ... cassette tape recorder input and output ... cassette tape control output ... LED output indicator on SOD (serial output) line ... printer interface (less drivers) ... total of four 8-bit plus one 6-bit I/O ports. • Crystal Frequency: 6.144 MHz. • Control Switches: Reset and user (RST 7.5) interrupt ... additional provisions for RST 5.5, 6.5 and TRAP interrupts onboard. • Counter/Timer: Programmable, 14-bit binary. • System RAM: 256 bytes located at F800, ideal for smaller systems and for use as an isolated stack area in expanded systems ... RAM expandable to 64K via S-100 bus or 4k on motherboard.

System Monitor (Terminal Version): 2k bytes of deluxe system monitor ROM located at F000, leaving 0600 free for user RAM/ROM. Features include tape load with labeling ... examine/change contents of memory ... insert data ... warm start ... examine and change all registers ... single step with register display at each break point, a debugging/training feature ... go to execution address ... move blocks of memory from one location to another ... fill blocks of memory with a constant ... display blocks of memory ... automatic baud rate selection to 9600 baud ... variable display line length control (1-255 characters/line) ... channeled I/O monitor routine with 8-bit parallel output for high-speed printer ... serial console in and console out channel so that monitor can communicate with I/O ports.

System Monitor (Hex Keypad/Display Version): Tape load with labeling ... tape dump with labeling ... examine/change contents of memory ... insert data ... warm start ... examine and change all registers ...

single step with register display at each break point ... go to execution address. Level "A" in this version makes a perfect controller for industrial applications, and is programmed using the Netronics Hex Keypad/Display. It is low cost, perfect for beginners.

HEX KEYPAD/DISPLAY SPECIFICATIONS

Calculator type keypad with 24 system-defined and 16 user-defined keys. Six digit calculator-type display, that displays full address plus data as well as register and status information.

LEVEL "B" SPECIFICATIONS

Level "B" provides the S-100 signals plus buffers/drivers to support up to six S-100 bus boards, and includes: address decoding for onboard 4k RAM expansion selectable in 4k blocks ... address decoding for onboard 8k EPROM expansion selectable in 8k blocks ... address and data bus drivers for onboard expansion ... wait state generator (jumper selectable), to allow the use of slower memories ... two separate 5 volt regulators.

LEVEL "C" SPECIFICATIONS

Level "C" expands Explorer/85's motherboard with a card cage, allowing you to plug up to six S-100 cards directly into the motherboard. Both cage and card are neatly contained inside Explorer's deluxe steel cabinet. Level "C" includes a sheet metal superstructure, a 5-card, gold plated S-100 extension PC board that plugs into the motherboard, just add required number of S-100 connectors.



Explorer/85 With Level "C" Card Cage.

LEVEL "D" SPECIFICATIONS

Level "D" provides 4k of RAM, power supply regulation, filtering decoupling components and sockets to expand your Explorer/85 memory to 4k (plus the origi-

nal 256 bytes located in the 8155A). The static RAM can be located anywhere from 0000 to EFFF in 4k blocks.

LEVEL "E" SPECIFICATIONS

Level "E" adds sockets for 8k of EPROM to use the popular Intel 2716 or the TI 2516. It includes all sockets, power supply regulator, heat sink, filtering and decoupling components. Sockets may also be used for 2k x 8 RAM IC's (allowing for up to 12k of onboard RAM).

DISK DRIVE SPECIFICATIONS

- 8" CONTROL DATA CORP. professional drive.
- LSI controller.
- Write protect.
- Single or double density
- Data capacity: 401,016 bytes (SD), 802,032 bytes (DD), unformatted.
- Access time: 25ms (one track).

DISK CONTROLLER/ I/O BOARD SPECIFICATIONS

- Controls up to four 8" drives.
- 1771A LSI (SD) floppy disk controller.
- Onboard data separator (IBM compatible).
- 2 Serial I/O ports
- Autoboost to disk system when system reset.
- 2716 PROM socket included for use in custom applications.
- Onboard crystal controlled.
- Onboard I/O baud rate generators to 9600 baud.
- Double-sided PC board (glass epoxy).

DISK DRIVE CABINET/POWER SUPPLY

- Deluxe steel cabinet with individual power supply for maximum reliability and stability.

ORDER A COORDINATED EXPLORER/85 APPLICATIONS PAK!

Beginner's Pak (Save \$26.00!) — Buy Level "A" (Terminal Version) with Monitor Source Listing and AP-1 5-amp Power Supply: (regular price \$199.95), now at SPECIAL PRICE: \$169.95 plus post. & insur.

Experimenter's Pak II (Save \$53.40!) — Buy Level "A" (Hex Keypad/Display Version) with Hex Keypad/Display, Intel 8085 User Manual, Level "A" Hex Monitor Source Listing, and AP-1 5-amp Power Supply: (regular price \$279.35), all at SPECIAL PRICE: \$219.95 plus post. & insur.

Special Microsoft BASIC Pak (Save \$103.00!) — Includes Level "A" (Terminal Version), Level "B", Level "D" (4k RAM), Level "E", 8k Microsoft in ROM, Intel 8085 User Manual, Level "A" Monitor Source Listing, and AP-1 5-amp Power Supply: (regular price \$439.70), now yours at SPECIAL PRICE: \$329.95 plus post. & insur.

ADD A TERMINAL WITH CABINET.

GET A FREE RF MODULATOR: Save over \$114 at this SPECIAL PRICE: \$499.95 plus post. & insur.

Special 8" Disk Edition Explorer/85 (Save over \$104!) — Includes disk-version Level "A", Level "B", two S-100 connectors and brackets, disk controller, 64k RAM, AP-1 5-amp power supply, Explorer/85 deluxe steel cabinet, cabinet fan, 8" SD/DD disk drive from famous CONTROL DATA CORP. (not a hobby brand!), drive cabinet with power supply, and drive cable set-up for two drives. This package includes everything but terminal and printers (see coupon for them). Regular price \$1630.30, all yours in kit at SPECIAL PRICE: \$1499.95 plus post. & insur. Wired and tested, only \$1799.95.

Special! Complete Business Software Pak (Save \$625.00!) — Includes CP/M 2.0, Microsoft BASIC, General Ledger, Accounts Receivable, Accounts Payable, Payroll Package: (regular price \$1325), yours now at SPECIAL PRICE: \$699.95.

Please send the items checked below:

- Explorer/85 Level "A" kit (Terminal Version) ... \$129.95 plus \$3 post. & insur.
- Explorer/85 Level "A" kit (Hex Keypad/Display Version) ... \$129.95 plus \$3 post. & insur.
- 8k Microsoft BASIC on cassette tape. \$64.95 postpaid.
- 8k Microsoft BASIC in ROM kit (requires Levels "B", "D" and "E") ... \$99.95 plus \$2 post. & insur.
- Level "B" (S-100) kit ... \$49.95 plus \$2 post. & insur.
- Level "C" (S-100 6-card expander) kit ... \$39.95 plus \$2 post. & insur.
- Level "D" (4k RAM) kit ... \$69.95 plus \$2 post. & insur.
- Level "E" (EPROM/ROM) kit ... \$5.95 plus \$0 p/h.
- Deluxe Steel Cabinet for Explorer/85 ... \$49.95 plus \$3 post. & insur.
- Fan For Cabinet ... \$15.00 plus \$1.50 post. & insur.
- ASCII Keyboard/Computer Terminal kit: features a full 128 character set, u&l case, full cursor control; 75 ohm video output; convertible to baudot output, selectable baud rate, RS232-C or 20 ma. I/O, 32 or 64 character by 16 line formats, and can be used with either a CRT monitor or a TV set (if you have an RF modulator) ... \$149.95 plus \$3.00 post. & insur.
- Deluxe Steel Cabinet for ASCII keyboard/terminal ... \$19.95 plus \$2.50 post. & insur.
- New! Terminal/Monitor: (See photo) Same features as above except 12" monitor with keyboard and terminal is in deluxe single cabinet kit ... \$399.95 plus \$7 post. & insur.
- Hazeline terminals: Our prices too low to quote — CALL US
- Lear-Sigler terminals/printers: Our prices too low to quote — CALL US
- Hex Keypad/Display kit ... \$69.95 plus \$2 post. & insur.

- AP-1 Power Supply Kit ±8V @ 5 amps) in deluxe steel cabinet ... \$39.95 plus \$2 post. & insur.
- Gold Plated S-100 Bus Connectors ... \$4.85 each, postpaid.
- RF Modulator kit (allows you to use your TV set as a monitor) ... \$8.95 postpaid.
- 16k RAM kit (S-100 board expands to 64k) ... \$199.95 plus \$2 post. & insur.
- 32k RAM kit ... \$299.95 plus \$2 post. & insur.
- 48k RAM kit ... \$399.95 plus \$2 post. & insur.
- 64k RAM kit ... \$499.95 plus \$2 post. & insur.
- 16k RAM Expansion kit (to expand any of the above in 16k blocks up to 64k) ... \$99.95 plus \$2 post. & insur, each.
- Intel 8085 cpu Users' Manual ... \$7.50 postpaid.
- 12" Video Monitor (10MHz bandwidth) ... \$139.95 plus \$5 post. & insur.
- Beginner's Pak (see above) \$169.95 plus \$4 post. & insur.
- Experimenter's Pak (see above) ... \$219.95 plus \$6 post. & insur.
- Special Microsoft BASIC Pak Without Terminal (see above) ... \$329.95 plus \$7 post. & insur.
- Same as above, plus ASCII Keyboard Terminal With Cabinet, Get Free RF Modulator (see above) ... \$499.95 plus \$10 post. & insur.
- Special 8" Disk Edition Explorer/85 (see above) ... \$1499.95 plus \$26 post. & insur.
- Wired & Tested ... \$1799.95 plus \$26 post. & insur.
- Extra 8" CDC Floppy Drives ... \$499.95 plus \$12 post. & insur.
- Cabinet & Power Supply For Drive ... \$69.95 plus \$3 post. & insur.
- Drive Cable Set-up For Two Drives ... \$25 plus \$1.50 post. & insur.

- Disk Controller Board With I/O Ports ... \$199.95 plus \$2 post. & insur.
- Special! Complete Business Software Pak (see above) \$699.96 postpaid.

SOLD SEPARATELY

- CP/M 1.4 ... \$100 postpaid
- CP/M 2.0 ... \$150 postpaid.
- Microsoft BASIC ... \$325 postpaid
- Intel 8085 cpu User Manual ... \$7.50 postpaid.
- Level "A" Monitor Source Listing ... \$25 postpaid

Continental U.S.A. Credit Card Buyers Outside Connecticut

CALL TOLL FREE: 800-243-7428

To Order From Connecticut Or For Technical Assistance, call (203) 354-9375

Total Enclosed (Conn. res. add sales tax) \$ _____

Paid By:

Personal Check Cashier's Check/Money Order

VISA Master Charge (Bank No. _____)

Acct. No. _____ Exp. Date _____

Signature _____

Print _____

Name _____

Address _____

City _____

State _____ Zip _____

NETRONICS Research & Development Ltd.

333 Litchfield Road, New Milford, CT 06776

TWO LOW-COST AUTOMOBILE PROJECTS

1.

SIMPLE LOW-COST CHARGER KEEPS AN AUTOMOTIVE-TYPE BATTERY IN PEAK SHAPE

BY CASS R. LEWART

THIS simple 12-volt automotive battery booster/trickle charger provides a choice of charging rates to suit battery condition. Set to FULL CHARGE, it will restore a partially discharged battery overnight; when set to TRICKLE CHARGE, it will maintain the battery at peak capacity for an extended time. A built-in LED glows only when the charger is delivering current to the battery. (The circuit is shown in Fig. 1.)

Circuit Operation. The output of *T1* is rectified by diodes *D1* and *D2*. Pulsating dc is delivered to the battery via a cable to the cigarette lighter connector in the vehicle. Switch *S1* is used to

choose between FULL CHARGE (approximately one ampere) and TRICKLE CHARGE (50-mA). Indicator LED1 is in series with its current limiter, *R4*. The fuse protects against short circuits.

Construction. The entire circuit can be mounted in a small metal enclosure using multilug terminal strips to support the components. Point-to-point wiring can be used. The ac line cord and the

output cable should be passed out of the enclosure via grommetted holes. A plug that fits the vehicle's cigarette lighter should be connected to the output cable. Make sure the polarity is correct.

Operation. Plug the ac line cord into a convenient outlet and plug the output cable into the cigarette lighter connector. Select either a FULL or TRICKLE charge via *S1*, and verify that the LED glows in either position of *S1*. If the LED does not glow, clean the contacts on the plug and the cigarette lighter and try again. If this fails, check for a wiring error. Should the battery be completely discharged (dome light does not light

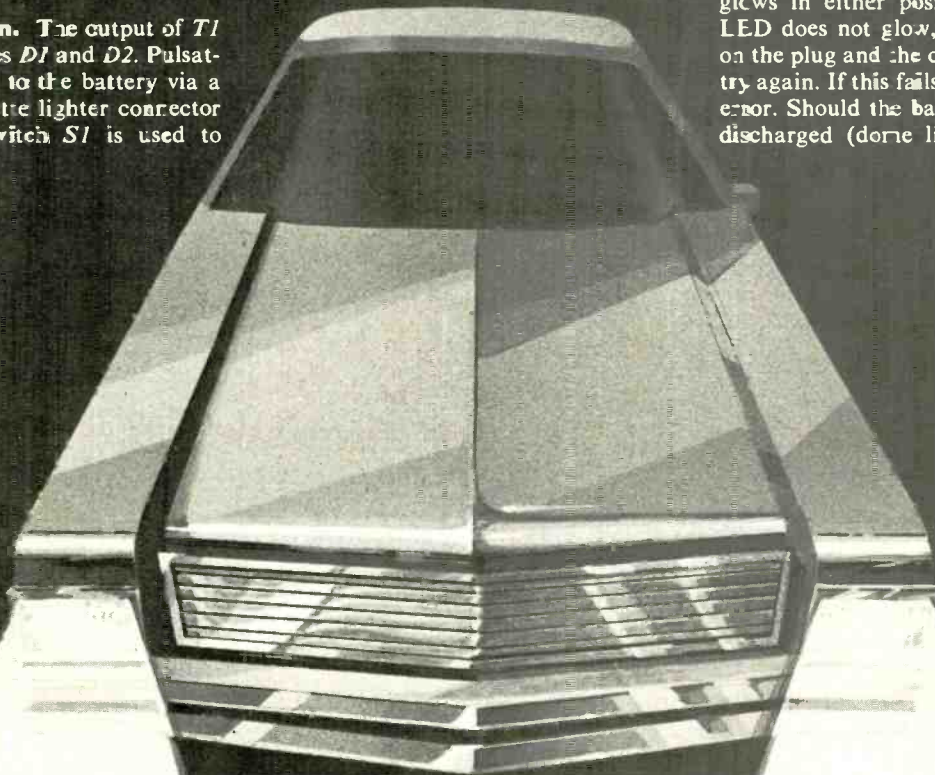
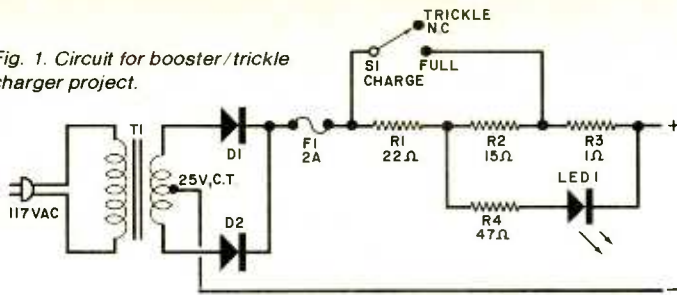

Fig. 1. Circuit for booster/trickle charger project.



R4—47-Ω, 1/2-W resistor
 S1—Spst switch
 T1—25-V, 2-A CT transformer (Radio Shack 273-1512 or similar)
 Misc.—Suitable enclosure, multi-lug terminal strips, line cord, output cable, suitable cigarette lighter plug, mounting hardware

PARTS LIST

- | | |
|---|--|
| D1,D2—3-A, 50-V diode (Radio Shack 276-1141 or similar) | R1—22-Ω, 2-W resistor |
| F1—2-A fuse and holder | R2—15-Ω, 2-W resistor |
| LED1—Red light emitting diode | R3—1-Ω, 10-W resistor (Radio Shack 271-131 or similar) |

up), use the TRICKLE CHARGE position of S1 for one to two hours. Less than 8 to 9 volts from the battery at the end of this time means that it must be replaced. If the voltage is about 12 volts, place S1 in the FULL CHARGE position

2.

ALARM SOUNDS IF YOUR HEADLIGHTS OR PARKING LIGHTS ARE ON WITH THE IGNITION OFF

BY C. R. BALL

HAVE you ever walked away from your car, left your lights on, and returned later to discover that your battery has run down? The circuit described here will end this problem. It will sound an alarm if you turn off your car's ignition while the headlights or parking lights are on. The alarm ceases when the lights are turned off.

Circuit Operation. The circuit, shown in Fig. 1 is based on a 555 timer IC. Diodes D1 and D2 are arranged as an OR gate so that either will pass positive voltage from its anode to IC1. Diode D3 blocks reverse current when the ignition alone is on. When the ignition and either the headlights or parking lights are on, little or no potential difference

exists across the powerpins of IC1, which remains inoperative.

If either the headlight or parking light circuit is alive, and the ignition line is off, the dc circuit for IC1 is complete. The oscillator starts, and sounds a warning tone via the loudspeaker. The tone's frequency may be changed by varying the values of R1, R2, or C1. Resistor R3 sets the loudness, and its value may be altered as desired.

Zener diode ZD1 may be required to provide a threshold to prevent the alarm from operating if there is a small potential difference in the dc supply circuit during normal operation. To determine the necessity and/or value of ZD1, with the headlights and ignition both on, measure the voltage between points H and I. If the voltage is more than 1.4 volts, the zener is required. The zener voltage should be slightly higher than the excess over 1.4 volts. For low voltages, one or more forward-biased silicon diodes can be substituted for the zener. Each silicon diode drops about 0.7 volt.

Construction. The system can be assembled on a small piece of perf board, or on the pc board whose foil pattern is shown in Fig. 2. After completion, the board can be mounted in a small enclosure. Check the polarities of the IC and all diodes before applying power.

The small speaker is connected to the two pads marked S, the pad marked I is connected to the vehicle ignition lead (after the ignition switch), the pad marked H connects to the headlight power line, and the pad marked P goes to the parking light line.

To allow the lights to be used with the ignition off, an spst switch can be connected in series with D3 to defeat the alarm. If this switch is used, make sure that it is clearly identified so that it can be closed for normal operation.

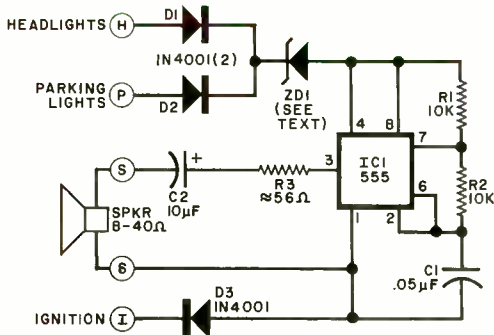

Fig. 1. With ignition off, and the headlights and parking lights on, alarm will sound.

PARTS LIST

- | | |
|---|--|
| C1—0.05-μF, 50-V Mylar capacitor | ZD1—see text |
| C2—10-μF, 50-V electrolytic | Misc.—Suitable enclosure, interconnecting cables, mounting hardware. |
| D1, D2, D3—1N4001 or similar | |
| IC1—555 timer | |
| R1, R2—10,000-Ω, 1/4-watt | |
| R3—selected for volume, nominally 56 ohms | |
| SPKR—3.2-to-8-ohm, 2" speaker | |
- Note: Available from BallABS, Box 703, Duluth, GA 30136; kit of all parts except ZD1 and case (LO-1K) for \$10.50 plus shipping. Also available: pc board (LO-1) for \$2.50, assembled and tested without case (LO-1A) \$25.00.*

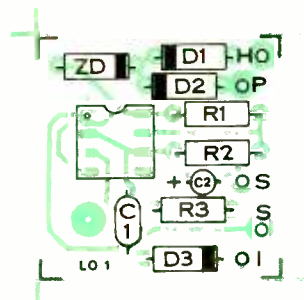
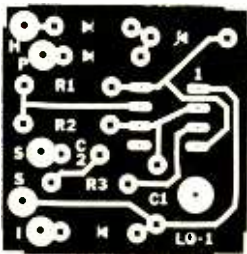

Fig. 2. Etching and drilling guide and component installation is at left.

BY RON REESE

Store and automatically dial telephone numbers



IN THIS article we will develop an automatic telephone dialer based on the RCA 1802 microprocessor. The program works with either the "product board" introduced last month or the Elf II Computer (Giant Board and 4K Memory Board are required). This system will store 32 seven-digit telephone numbers and "dial" them at the touch of a few switches. A relay interfaces the computer to the telephone line. Normal telephone operation is not impaired.

Figure 1 is a simplified diagram of a microcomputer system with eight switches interfaced with an input port to the data bus and a relay driven from a serial output of the CPU. The input port isolates the switches from the data bus until the processor reads them.

More About the RCA 1802. This application of the 1802 processor uses all the elements discussed in the May 1980 article of this series plus two more—the X register and the stack.

X REGISTER. This is a four-bit register used to select any one of the 16 scratch-pad registers for use as a stack pointer. The X register is loaded by an instruction that will be discussed later.

STACK: The stack pointer (specified by the X register) is loaded with a memory address. This location starts the stack, which can be anywhere in memory as long as it is not used by the pro-

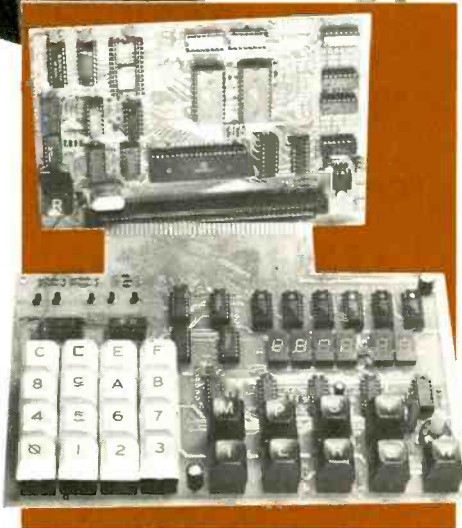

A
COMPUTERIZED
**AUTOMATIC
TELEPHONE
DIALER**

Christopher Hill 1980

gram for other purposes. The stack can be used to store data, perform logic and arithmetic operations, and transmit data to and from the input and output ports.

More Instructions. Eighteen of the 1802's 91 instructions were described in May 1980; eleven more will be introduced here. As before, the instructions will be broken down into categories and presented by the mnemonic, op code, name, and description.

Control Instructions. SEX-EN-Set X. This instruction loads the four-bit X register with the value N. For example, the instruction, E1 (1110 0001), would load 1 (0001) into the X register, making the 16-bit scratch-pad register-1 the stack pointer.

Branch Instructions. Short branch instructions require two bytes of data. The first byte is the op code, and the second is the address to which the processor will branch. We will add only one branch instruction. B2-32_—Short Branch if D=00 (0000 0000). If the D register contains zero, the program will branch to the specified memory location. If D does not contain zero, the program advances to the next instruction in sequence.

Memory Reference. These instructions allow data to be loaded from memory to the D register.

LDN-0N-Load via N. This instruction loads the D register with the byte stored in memory at the address specified by register-N. If register-5 contains 0050 (0000 0000 0101 0000), and memory location 0050 contains FF when the instruction 05 is executed, then FF will be loaded into the D register. There is one restriction to this instruction—N cannot be 0.

LDA-4N-Load Advance. This instruction works like LDN, but after the data is loaded into the D register, the N register is advanced by 1. If, in the previous example, the instruction 45 had been executed instead of 05, then FF would be loaded into the D register the same as before, but register-5 would automatically be advanced to 0051. This instruction is useful when several sequential bytes must be transferred from memory to the D register. N can equal 0 for the LDA instruction.

Register Operations. These instructions perform operations on the sixteen 16-bit scratch pad registers.

GLO-8N-Get Low Register N. Places the data in the low-order half of the register designated by N, into the D register.

INC-1N-Increment Register N. Add 1 to the contents stored in the register specified by N.

Logic Operations. These instructions

perform logic operations on the data in the D register. We use only one of the ten logic instructions.

SHL-FE-Shift Left. This instruction shifts the data in the D register to the left by one bit. The left bit of the data is shifted in the DF register and a 0 is shifted into the right-most bit. If the D register contained 21 (0010 0001), the instruction SHL would produce 42 (0100 0010) in the D register and a 0 in the DF register.

Arithmetic Operations. These instructions perform arithmetic operations on the data in the D register. This application uses two of the instructions.

SMI-FF_—Subtract Memory Immediate. This is a two-byte instruction that subtracts the byte immediately following the FF op code from the contents of the D register. If the D register contained 0F (0000 1111), and the instruction were FF01, the processor would subtract 0000 0001, leaving the result, 0E (0000 1110), in the D register. If the number in the D register is less than the immediate data subtracted from it, a borrow will be generated and the DF bit will be set to logic 0. If the content of the D register is equal to or larger than the immediate byte, then no borrow will be generated and the DF bit will be set to logic 1.

SM-F7-Subtract Memory. SM is a one-byte instruction that involves the

stack in the operation. It is addressed by the stack pointer from the contents of the D register. The result is placed in the D register. Suppose the stack pointer contains the address 00FF, the memory location 00FF contains the byte 02 (0000 0010), and the D register contains 05 (0000 0101). The instruction SM(F7) would subtract 02 (on the stack) from 05 (contents of the D register) and leave the result, 03 (0000 0011), in the D register. The DF bit is effected in the same manner as the SMI instruction.

Input/Output Byte Transfer. These instructions are used to transfer a byte from an input port to memory and the D register or a byte from memory to an output port. We will use only the input instructions in this application.

INP 1-69-Input 1. This instruction transfers a byte from input port 1 to the stack and to the D register.

INP 2-6A, INP 3-6B, INP 4-60, INP 5-6D, INP 6-6E, and INP 7-6F are used to transfer a byte from the respective input port to the stack (memory) and the D register. If the program is run on an Elf II computer, INP 7 can be used to read the input port and INP 2 can be used to read the input port on the Product Board.

Flowcharting the Problem. The first step in programming is to define
(Continued on page 74)

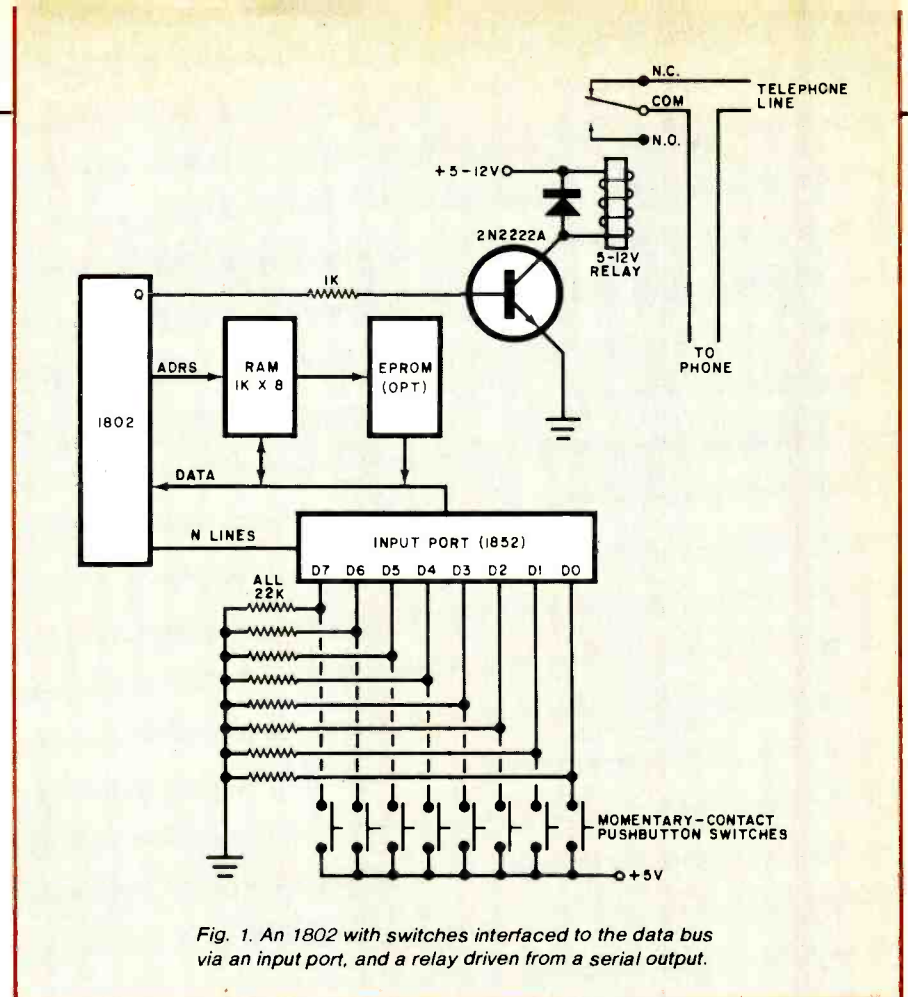

Fig. 1. An 1802 with switches interfaced to the data bus via an input port, and a relay driven from a serial output.

EQUIPMENT AND TRAINING NO OTHER SCHOOL CAN MATCH.

**NTS HOME TRAINING INVITES YOU TO EXPLORE MICROCOMPUTERS,
DIGITAL SYSTEMS AND MORE, WITH STATE-OF-THE-ART EQUIPMENT
YOU ASSEMBLE AND KEEP.**

Without question, microcomputers are the state of the art in electronics. And NTS is the only home study school that enables you to train for this booming field by working with your own production-model microcomputer.

We'll explain the principles of troubleshooting and testing your microcomputer and, best of all, we'll show you how to program it to do what you want.

You'll use a digital multimeter, a digital logic probe and other sophisticated testing gear to learn how to localize problems and solve them.

Send for the full color catalog in the electronics area of your choice—discover *all* the advantages of home study with NTS!

NTS also offers courses in Auto Mechanics, Air Conditioning and Home Appliances. Check card for more information.



We believe that training on production-model equipment, rather than home-made learning devices, makes home study more exciting and relevant. That's why you'll find such gear in most of NTS's electronics programs.

For instance, to learn Color TV Servicing you'll build and keep the 25-inch (diagonal) NTS/HEATH digital color TV.

In Communications Electronics you'll be able to assemble and keep your own NTS/HEATH 2-meter FM transceiver, plus test equipment.

But no matter which program you choose, NTS's Project Method of instruction helps you quickly to acquire practical know-how.



Simulated TV Reception

4.



3.

1. The NTS/Rockwell AIM 65

Microcomputer A single board unit with on-board 20 column alphanumeric printer and 20 character display. A 6502-based unit 4K RAM, expandable.

2. The NTS/KIM-1 Microcomputer A single board unit with 6 digit LED display and on-board 24 key hexadecimal calculator-type keyboard. A 6502 based microcomputer with 1K RAM, expandable.

3. The NTS/HEATH H-89 Microcomputer features floppy disk storage, "smart" video terminal, two Z80 micro-processors, 16K RAM memory, expandable to 48K. **4. The NTS/HEATH GR-2001 Digital Color TV (25" diagonal)** features specialized AGC-SYNC muting, filtered color and new solid-state high voltage tripler rectifier.

NTS NATIONAL TECHNICAL SCHOOLS

TECHNICAL-TRADE TRAINING SINCE 1905
Resident and Home-Study Schools
4000 SO. FIGUEROA ST., LOS ANGELES, CA. 90037

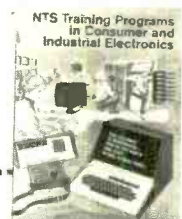

NATIONAL TECHNICAL SCHOOLS

4000 South Figueroa Street Dept. 205-011
Los Angeles, California 90037

Please rush FREE color catalog on course checked below

- | | |
|---|---|
| <input type="checkbox"/> MicroComputers/MicroProcessors | <input type="checkbox"/> Auto Mechanics |
| <input type="checkbox"/> Communications Electronics | <input type="checkbox"/> Air Conditioning |
| <input type="checkbox"/> Digital Electronics | <input type="checkbox"/> Home Appliances |
| <input type="checkbox"/> Industrial Technology | <input type="checkbox"/> Color TV Servicing |

Name _____ Age _____

Address _____

Apt. _____ City _____

State _____ Zip _____

- Check if interested in G.I. information.
 Check if interested ONLY in classroom training in Los Angeles.

the problem, using a flowchart. The flowchart helps to organize the solution to the problem and should describe it in all its aspects.

The flowchart (Fig. 2) should begin with a START block to clearly define its beginning. Referring to the hardware diagram in Fig. 1, we see that the output relay should be normally closed to keep the telephone connected to the line. Therefore, a block labeled RESET Q should follow the start block to de-energize the relay. Since the program requires the use of the stack, that should be initialized next. The input switches should be read via the input port until one of the eight switches is pressed, so a block labelled "Read Input Port" should be followed by the (diamond-shaped) decision block "Is Any Switch Closed?" In practice, the program will loop at this point until a switch is closed. In order to select 32 telephone numbers with only eight switches, all single switch closures and most two-switch combinations are used as valid inputs. The valid input combinations are shown in Fig. 3. After a switch closure is detected, the program should wait for about one second and re-read the switches. This delay allows time for pressing two switches. If it were not there, two-switch combinations would be hard to enter.

This program uses an input code table to determine if an input switch combination is valid and to calculate the address where the telephone number is stored. The input code table is 32 bytes of memory containing the valid combinations. When the switches are read, the switch closures are converted to binary logic levels by the input port. This digital representation of the switch closures is compared to the input code table until a match is found or until the entire table has been searched. This search is indicated in the flowchart. If a match is not found, the program returns to "Read Input Switches"; otherwise it calculates the address of the telephone number.

Next, the first digit of the telephone number is read from memory and is tested to see if it is an "end of number" digit. All telephone numbers must end with an "end of number digit", that is, any of the hex digits A, B, C, D, E, F. This tells the program that no more digits are to be dialed. Thus the telephone number can contain from one to seven digits. When the program detects the "end of number" digit, it branches to "Read Input Port."

If the digit to be dialed is zero, it must be converted to ten before it is dialed. Notice that "0" on a telephone represents ten instead of zero. After this test, the dialing sequence begins.

The dialing technique used in this

Fig. 2. Flowchart for the telephone dialer.

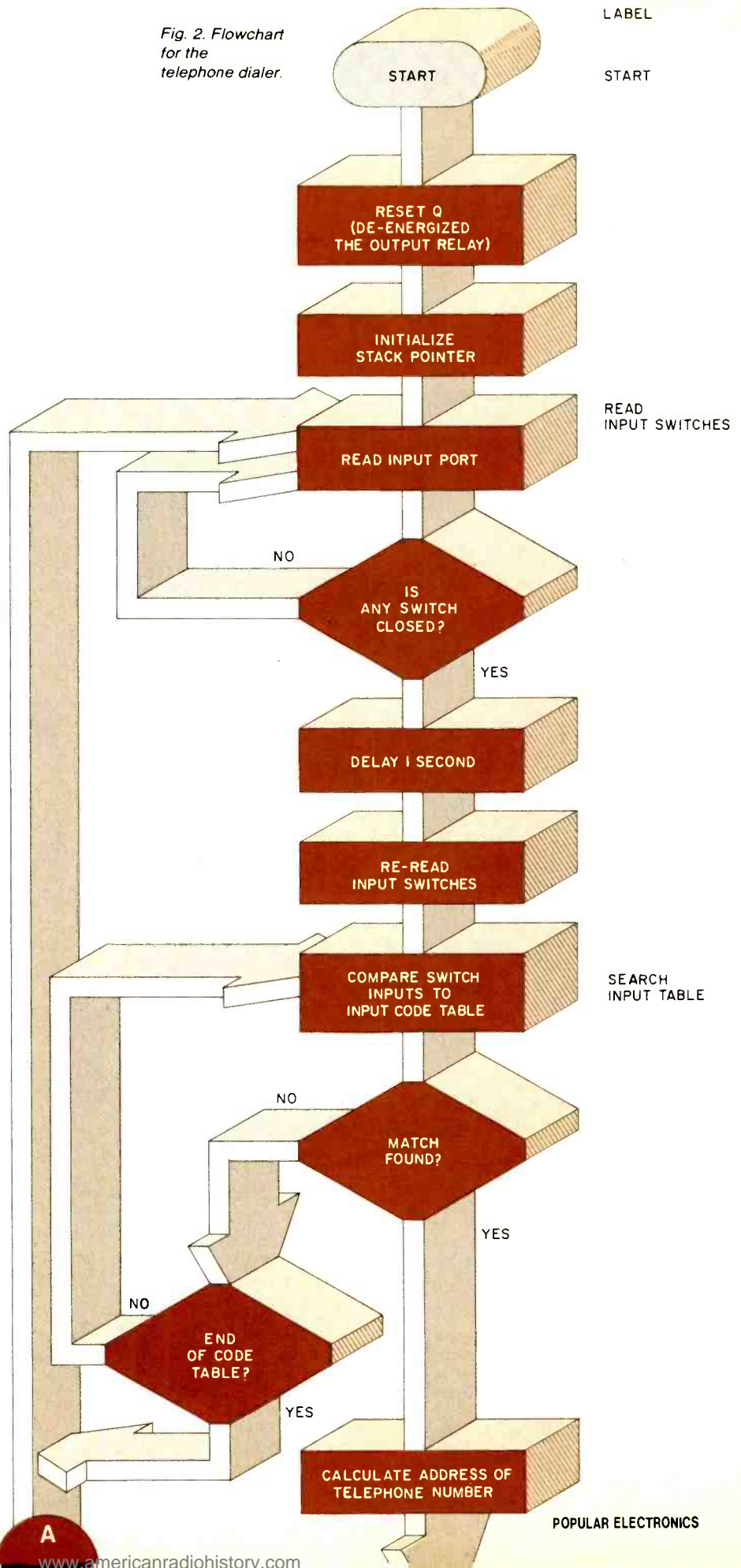

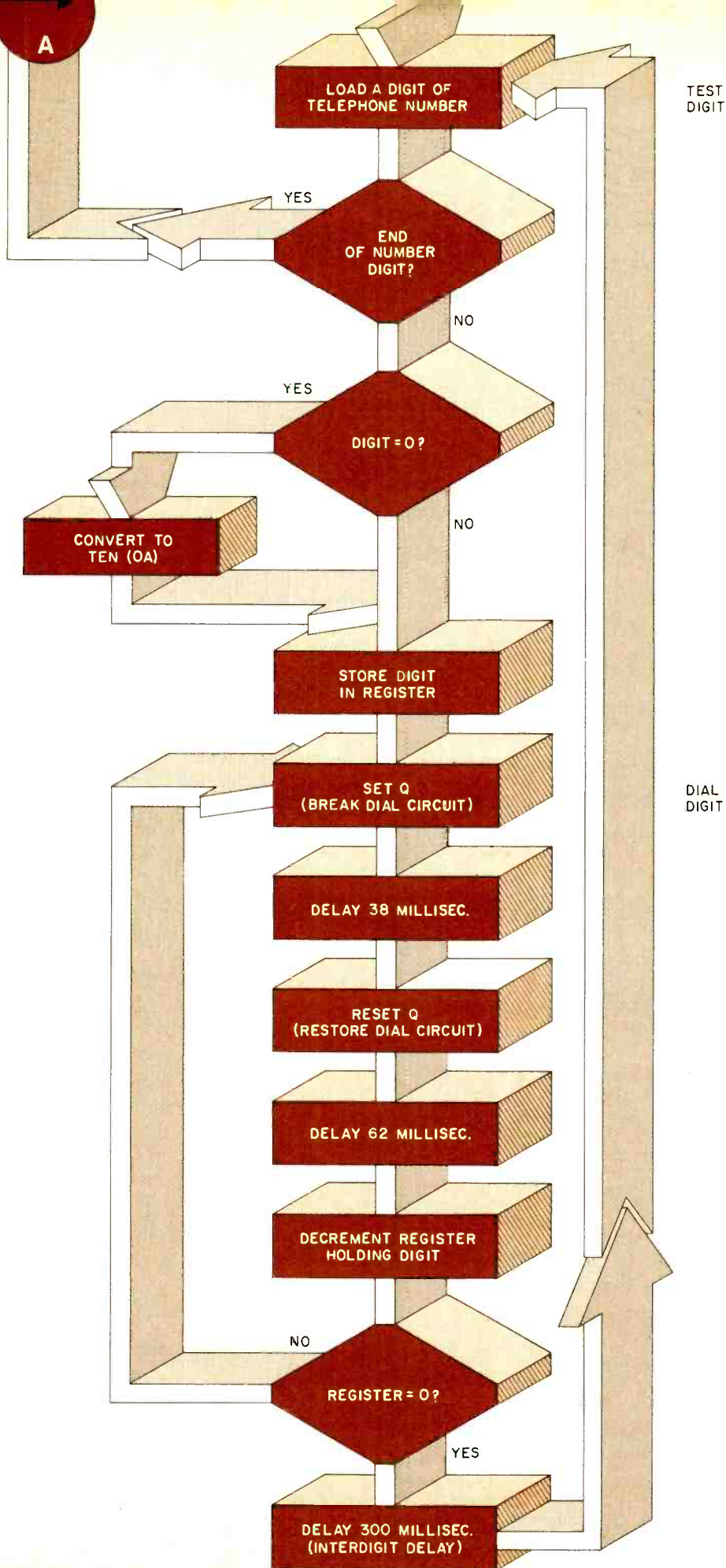

program is referred to as "pulsed dialing" because each digit is dialed by a series of pulses over the phone line. If the digit is "4," the relay will be pulsed four times to dial the digit. Each pulse "breaks" the telephone circuit for 38 milliseconds with a 62-millisecond pause between pulses and a 300-millisecond pause between digits. This is illustrated in Fig. 4. The digit to be dialed is first stored in one of the registers. Then Q is set to break the telephone circuit. Following this block is the 38-millisecond delay. Then Q must be reset and followed by the 62-millisecond delay. This completes on pulse for the digit being dialed. The register containing the digit is decremented by one and then tested for zero. If the result is not zero, the program will branch to "Dial Digit" and send another pulse. This process will continue until the digit has been decremented to zero. After a 300-millisecond interdigit delay, the program will branch to "Test Digit" and the next digit in the number will be dialed or the "End of Number Digit" will be detected which will stop the dialing and return the program to "Read Input Port."

Organizing the Program. After completion of the flowchart, work can begin on the machine language program. The format used to lay out a program was discussed in the first article of this series. A register and Memory Utilization Table, such as shown in Fig. 5, will be helpful in keeping track of register use and memory addresses. It is not always known before a program is written how many registers will be used nor how much memory will be required. As the program is written, register and memory assignments can be made and added to the table as needed. This technique can prevent conflicting use of the registers and memory.

The first register entry in the table will be the program counter (PC) which is register "0" (RO). A stack pointer will be used, so we can make it the next entry. The stack pointer can be any of the remaining 15 registers. Register 1 would be as good as any and should be entered in the table next.

Next come some memory assignments. First, the program will begin at address 0000, so this should be entered in the table. Since the length of the program is not yet known, we should allow plenty of memory.

Now we should specify the location of the stack. If the stack is located at 00FF, there will be 255 locations for the program and input table. This should be adequate. Once we know where the program ends, we will locate the input table somewhere above it.

(Continued overleaf)

telephone dialer

Assigning memory space for the 32 telephone numbers is the next operation. Each number will be allocated eight bytes of memory—seven for the number and one for the end of number digit. To

store 32 numbers, 256 bytes will be needed. Fig. 5 shows that no memory above 00FF has been used, so the numbers can be stored from 0100 to 01FF.

(to be continued.)

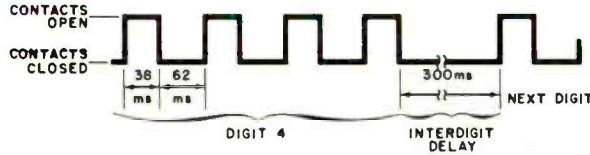

Fig. 4. Specifications for telephone dialing pulses.

Register	Use	Memory	Use
R0	Program counter	0000-00FE	Program area
R1	Stack pointer	0060-007F	Input table
R2	Delay timer	00FF	Stack
R3	Input table pointer	0100-01FF	Number storage
R4	Counter and pointer		
R5	Temporary storage of digit being dialed		

Fig. 5. Register and Memory Utilization Table.

Fig. 3. Valid input combinations. X indicates a closed switch.

8	7	6	5	4	3	2	1	Binary Code	Hex
							X	00000001	01
						X		00000010	02
					X			00000100	04
				X				00001000	08
			X					00010000	10
		X						00100000	20
	X							01000000	40
X								10000000	80
						X	X	00000011	03
					X	X		00000101	05
				X		X		00001001	09
			X			X		00010001	11
		X				X		00100001	21
	X					X		01000001	41
X						X		10000001	81
					X	X		00000110	06
			X		X			00001010	0A
			X	X				00010010	12
		X			X			00100010	22
	X				X			01000010	42
X					X			10000010	82
				X	X			00001100	0C
		X		X				00010100	14
		X	X					00100100	24
	X			X				01000100	44
X				X				10000100	84
		X	X					00011000	18
	X	X						00101000	28
	X		X					01001000	48
X			X					10001000	88
		X	X					00110000	30
	X	X						01010000	50
X		X						10010000	90
	X	X						01100000	60
X	X							10100000	A0
X	X							11000000	C0

UNIVERSAL

COLUMBIA

NOSTALGIA

WARNER BROS.



PARAMOUNT

TVX VCX

20th CENTURY

ALLIED ARTIST

If it's LEGALLY on videocassette, Wonderful World of Video has it! We stock all major General Release and Adult Tapes in Inventory.

PLEASE CHECK BOX AND FILL IN AMOUNT

- SOUPERMAN 64.⁹⁵
- 10 64.⁹⁵
- ALIEN 54.⁹⁵
- JAWS 54.⁹⁵
- DEERHUNTER 69.⁹⁵
- COAL MINERS DAUGHTER 59.⁹⁵ (New Release)

CHECK FORMAT: Beta VHS

- HALLOWEEN 54.⁹⁵
- BUDDING OF BRIE (Adult) 89.⁹⁵
- BABYLON PINK (Adult) 89.⁹⁵
- EROTIC ADVENTURES OF CANDY (Adult) 89.⁹⁵
- CALIFORNIA GIGOLO (Adult) 89.⁹⁵

ALL TAPES 100% GUARANTEED!

Enclosed is my check money order
 VISA MC (cash not accepted)

Subtotal _____

Calif. Res. add 6% tax _____

Postage, handling \$3.00 _____

Total _____

Please send me your: Family Play List
 Adult Play List

Send Order to:
Wonderful World of Video Inc.
 6315 Hollywood Blvd.
 Hollywood, CA 90028

CALL TOLL FREE:
1-800-421-0482
 In California:
 1-213-465-8677

Card # _____
 Exp. Date _____
 Name _____
 Address _____
 City/State/Zip _____
 Signature _____

NOTE: No order can be shipped without a signature!

(I certify that I am of legal age)

California Man Discovers How To Turn His Workshop Into A Great Second-Income Source

Says You Can Do The Same, FREE Booklet Gives Full Description

How many hours a week do you spend in your home workshop or hobby room? Do you consider yourself mechanically inclined, and love to make things?

What would you think of the idea of making an extra \$500, \$1,000, even \$3,000 this very next month?

What's more, what if you could do it every month . . . all year long?

Chances are you can. Right now thousands of folks like you all across the country are doing it. Beating inflation and having fun at the same time!

Some of them simply supplement their incomes, whereas others have since quit their regular jobs to do this full-time.

Before you dismiss this as something too good to be true . . . something that could never happen to you, please allow me to explain. I was skeptical too at first, but I soon became a believer! So will you.

Here's why:

In my position as Director of American Entrepreneurs Association, I am informed of thousands of new ways people are making money every year. Many turn out to be hair-brained schemes, others require such a huge investment that they aren't practical for the majority of folks.

But recently, something crossed my desk unlike anything I'd seen before. I didn't know it at the time, but I was about to discover one of the most exciting opportunities ever uncovered for mechanically inclined people who want to use their special skills to make some extra money!

It was fascinating! This fellow had an easy-to-follow method that he was using to make more money in a month than most folks make in six months. I had to hear more.

Immediately I had my secretary contact the man who had sent me the outline of his idea. After all, it's not often I stumble upon something as hot as this. I was anxious to report it to both the readers of my syndicated column "Inside Small Business" as well as all the members of our organization.

He arrived at my office three days later, and I've got to tell you—what he showed me nearly floored me! I later learned that not only had he been completely truthful (we verify all statements), but he understated the potential. It is, in fact, staggering! And the best part is that virtually anyone who is handy with common

everyday household tools can do it!

I reported this to my readers and AEA members. I gave them all the inside details.

Then a wonderful thing started happening. Folks from all over the country began writing me excitedly about this new-found success.

I wish you could see all the letters . . .

I've made close to \$10,000 the first three months with your new system. Thanks for your advice!

STEVE COHEN, NEW JERSEY

I took your advice. Now (nine months later) I'm independent. I love what I'm doing, and I'm making enough money to buy my own home.

RALPH ALAMA, FLORIDA

Fantastic! I thought retirement was going to be boring. With your new system, I'm really enjoying life. The money is pretty good too. Thanks much.

PETER MARSTON, ILLINOIS

It's so easy to make money this way. I can't believe I never thought of it!

JIM STARNOW, CALIFORNIA

Now I invite you to read about this fascinating fun way to make money in your own workshop. I want you to see for yourself how easy it is to make extra cash with this system. Probably more in a month than most folks make in six months at their regular jobs!

Here's why:

- ★ **You don't need any special skills or training.** That's right. If you are handy with ordinary household tools and are mechanically inclined, you can start profiting from this immediately.
- ★ **It doesn't require a lot of cash to get started.** Although every business opportunity requires some investment, many folks have become very successful in this endeavor with a start-up investment of as little as \$200.
- ★ **It will help you ENJOY life as well as earn extra money.** This is much more than just a way to make some easy money. You will enrich your life by doing something you genuinely enjoy—unlike the vast majority of working people today.
- ★ **You won't have to quit your job.** Your present income can remain undisturbed. Many folks start part-time until they are ready to make a career in this exciting and lucrative field.

But that's not all, because when you use this system you will be able to avoid paying exorbitant taxes too (legally).

You'll see why when you read my FREE report describing this wonderful opportunity.

The amount of money you make with this system is entirely up to you. I cannot promise you'll make a fortune from this; however, I can promise you this: I will show you how you CAN profit from this if you are mechanically inclined and able to follow simple instructions. If it sounds pretty easy, believe me, it is!

I've written a very important booklet describing this new opportunity—and I'd like to send it to you absolutely FREE. No, there's no catch. You risk nothing but the cost of a postage stamp.

If you're interested, here's all you have to do:

1. **Fill in the coupon below and send for my revealing free report today.**
2. Read it twice as soon as you receive it. See how easily you can profit with it.
3. **If you have any questions at that point, simply call our toll-free "Hotline To Success." All your questions will be answered without obligation.**
4. Then, get started turning your workshop into a great second-income source.

It's as simple as that.

Why am I willing to send you this valuable special report free of charge?

Simple. Because I honestly believe that once you read it, act on the system involved and start to make money with it, you will eagerly buy everything else I write, and perhaps even become a member of our exclusive organization.

I honestly hope you'll take this message seriously. There's no risk. All I ask is that you take a look. Then make your own decision.

So right now, cut out the coupon below, fill it out, and mail it to me today. Please mark the front of your envelope "personal" and I'll be sure your free report is rushed to you by return mail.

Your free copy is waiting for you. Order it now.

Sincerely,



Chase Revel

Chase Revel's financial column, "INSIDE SMALL BUSINESS," is syndicated throughout the world. Recently he became a regular on a syndicated TV show, "Good Earth Journal," to be aired this winter in selected cities. In case you haven't heard, Mr. Revel's publications are used extensively at USC and other prominent business schools across the country.

SEND FOR YOUR FREE REPORT TODAY

Chase Revel, 2311 Pontius Avenue, Suite E-291, Los Angeles, CA 90064

O.K., Chase, prove it to me. Send my free report describing how I can **turn my workshop into a great second-income source**, and make as much money in a month as most people make in six months. I understand this special report is mine to keep—with no cost or obligation whatsoever.

Name _____
Address _____ E-291
City _____ State _____ Zip _____

© AEA 1980

electronic games

SPACE-AGE LEISURE ACTIVITY

BY JERRY AND ERIC EIMBINDER

Part 4: Video cartridge games

Our discussion of electronic games concludes with a rundown of the latest video cartridge games.

Video Cartridge Games. The four major contenders in the video cartridge game business are Atari, Magnavox, Mattel and APF Electronics. Their cartridges are not interchangeable. The only source for compatible cartridges is Activision, a company started a year ago by four ex-Atari programmers. Activision makes four cartridges that can be played on Atari systems and will introduce two more, "Skiing" and "Bridge," this month.

The average family will probably be able to afford only one of them and that's unfortunate. Each has cartridges of incredible appeal and individuality. In selecting the cartridges of greatest entertainment value, we evaluated 38 Atari cartridges, 15 Magnavox cartridges and 8 Mattel Intellivision cartridges and selected six Atari, five Magnavox and four Mattel cartridges for listing in the top 15. Eleven cartridges made by APF Electronics were received too late for judging by a control group. The best three cartridges in the APF line, in the opinion of the authors, are "Hangman," "Catena," and "Boxing."

APF Electronics puts a lot of emphasis on playing against the computer. In "Catena," a computer game version of Gabriel's "Othello," one of the options pits the computer against itself (the player sits back and watches).

APF's "Hangman," which also includes "Tic-Tac-Toe" and "Doodle," is well done. "Hangman" can accommodate words up to 10 letters. A message center which comments on a player's moves and a nine-color display enhance the cartridge's appeal.

In "Boxing" a player can be matched against another player or the computer. As in the actual sport, the object is to knock out your opponent or win the most rounds. A knockout is accomplished by landing five consecutive blows to the head without receiving a return punch from the opponent.

Six new Magnavox cartridges were released too late for judging by the control; but one, "Blockout/Breakdown," particularly impressed the authors. "Blockout/Breakdown" is a second-generation "Breakout." While one player tries to break out, the other attempts to rebuild the wall (more fun for the second player who merely watches the action in Atari's "Breakout").

The final standings for the cartridges that were judged are:

1. Adventure (Atari)
 2. Space Invaders (Atari)
 3. Space Battle (Mattel)
 4. Baseball (Mattel)
 5. Football (Mattel)
 6. Superman (Atari)
 7. Football (Magnavox)
 8. Basketball (Atari)
 9. Baseball (Magnavox)
 10. Circus Atari (Atari)
 11. Alpine Skiing (Magnavox)
 12. Sky Diver (Atari)
 13. Thunderball (Magnavox)
 14. War of Nerves (Magnavox)
 15. Math Fun (Mattel)
- "Adventure" (Atari) does not involve combat or racing against the clock. The royal golden goblet has been stolen from the golden castle and you set out to retrieve it. As you travel the kingdom, you seek out objects that can help you in your quest such as keys to open up cas-



Atari Video Computer System

Television set and keyboard controllers not included.

ELECTRONICS BOOK CLUB

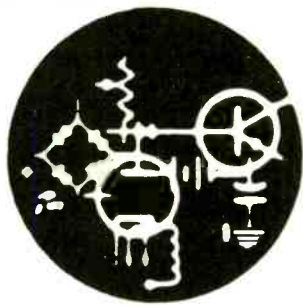

Take **6**
great books
for
\$2⁹⁵

(values to \$99.70)

Into ELECTRONICS?

Start saving now with discounts up to 75% on hundreds of fact-filled volumes . . . PLUS special Members' Bonus Benefits!



Join now, and get a 1981 Electronics Projects Calendar . . . FREE!! (List \$4.95)

7 very good reasons to try Electronics Book Club . . .

- **Reduced Member Prices.** Save up to 75% on books sure to increase your know-how
- **Satisfaction Guaranteed.** All books returnable within 10 days without obligation
- **Club News Bulletins.** All about current selections—mains, alternates, extras—plus bonus offers. Comes 13 times a year with dozens of up-to-the-minute titles you can pick from
- **"Automatic Order."** Do nothing, and the Main selection will be shipped to you automatically! But . . . if you want an Alternate selection—or no books at all—we'll follow the instructions you give on the reply form provided with every News Bulletin
- **Continuing Benefits.** Get a Dividend Certificate with every book purchased after fulfilling Membership obligation, and qualify for discounts on many other volumes
- **Bonus Specials.** Take advantage of sales, events, and added-value promotions
- **Exceptional Quality.** All books are first-rate publisher's editions, filled with useful, up-to-the-minute info

ELECTRONICS BOOK CLUB Blue Ridge Summit, PA 17214

Please accept my Membership in Electronics Book Club and send the 6 volumes circled below, plus a free copy of 1981 Electronics Projects Calendar. I understand the cost of the books selected is \$2.95 (plus shipping/handling). If not satisfied, I may return the books within ten days without obligation and have my Membership cancelled. I agree to purchase 4 or more books at reduced Club prices during the next 12 months, and may resign any time thereafter.

510 806 931 1013 1062 1066 1076 1120
1136 1160 1167 1169 1187 1199 1201 1205
1212 1216 1225 1236 1241 1243 1271 1275

Name _____ Phone _____

Address _____

City _____

State _____ Zip _____

(Valid for new members only. Foreign and Canada add 15%.)

PE-131

THIS MONTH'S SUPER SPECIALS!

Audio & Video

VIDEO	AUDIO
SONY SL 5400 Betamax \$799	TECHNICS RS-M45 Cass Deck \$225
JVC HR-6700 Video Rec \$799	BIC T-2 Cassette Deck \$159
PANA PV 1300 Video Rec \$779	DUAL 606 55 1/2 A/Cart \$219
ZENITH VR-9000 Beta Vid Rec \$699	SANSUI 3900Z Receiver \$269
RCA VE1 250 Video Rec \$775	TECHNICS SA-202 Receiver \$165
RCA VEP-150 Port Vid Rec \$729	SANSUI AU-719 Int Amp \$319
SONY KV-1914 19 Color TV \$439	PIONEER SX-3730 Receiver \$259
PANASONIC CT 9010 19 Col TV \$359	TECHNICS SL 02 Turntable \$109
PANASONIC CT 288 17 Col TV \$279	AKAI UCU-2 Micro Int Amp \$159
	TECHNICS ST1 Tuner \$115

CAR STEREO

PIONEER CASSETTE IN-DASH W/RADIO		JENSEN CASSETTE IN-DASH W/RADIO	
KP-1500	84.90	R 402 receiver	174.90
KP-2500	104.90	R 406 receiver	209.90
KP-4500	119.90	R 210 receiver	229.90
KP-5500	129.90	R 220 receiver	267.90
KP-8500	141.90		
KE-2100	174.90	J 1001 6+9 separates	94.90
KI-3000	209.90	J 1065 6+9 in-tr	62.50
KI-5000	244.90	J 1033 6+9 in-tr II	79.50
KEK-2C	274.90	J 1201 6+9 coil thin	59.90
KP-1500 (stereo cars)	129.90	J 1181 6+9 in-tr	62.50
KP-4502 (stereo cars)	144.90	J 1130 4+10 in-tr II	79.90
KP-8000	134.90	J 1174 6+9 in-tr	62.50
KP10000 (req amp)	154.90	J 1124 6+9 in-tr II	79.95
KP20500 (req amp)	178.50	J 1188 6+9 coil thin	42.95
		J 1069 6+9 coil	40.50
		J 1073 6+9 coil II	59.90
		J 1041 5+9 coil II	49.50

WE ALSO CARRY THE FULL LINE OF CAR STEREO BY PANASONIC, BUSH, DK, MITSUBISHI, CONCORD, SONY, AUDIOVIX AND CRAG

BLANK CASSETTES

AUDIO	VIDEO
AMPEL GRAND MASTER I OR B C90	2.99
BASH PRO II OR III C90	2.99
FUJI EX I OR II C90	2.99
SCOTCH HIGH-LANEXER C90 3PK	4.99
MEMOREX III BIAS C90	2.99
SCOTCH MASTER II OR III C90	3.25
SONY FICOR C90	3.25
SONY LINK C90	3.25
TDK D1 04 MAGNETIZER	16.95
TDK D C60	1.19
TDK D C90	1.08
TDK ADC60	2.45
TDK SAC60	2.15
TDK SAC90	2.99
TDK MA C90 (METAL)	6.29
TDK MA C90 (METAL)	6.29
MAXELL UD, UD90, UD90L	94.90
TOO LOW TO ADVERTISE	
CALL OR WRITE FOR PRICES	

MINIMUM ORDER 12 TAPES—100% GUARANTEED

ACCESSORIES

CAR ACCESSORIES	HEADPHONES
FUZZBUSTER III	99.95
FOX KK RADAR DETECTOR	134.95
FOX KXWB (remote)	109.50
SUPERFOX	224.95
PAGE ALERT 4000	114.95
PAGE ALERT 4444	139.90
THEFT ALERT 500A	89.90
AMBIUSTERION GENERATOR	64.90
PANASONIC TR100P (11" TV)	249.00

WE ALSO STOCK AUDIO TECHNICA, EMPIRE, STARTON. A/C. AT LOWEST PRICES

RECORDS

ALL ROCK, JAZZ & CLASSICAL
 All 9 98 List All 8 98 List All 9 98 List 50¢ additional for cassette or 8-track. MINIMUM ORDER 5 records or tapes
499 549 649 WE STOCK ALL MAJOR LABELS
 HOW TO ORDER: For shipment within 48 hours, send money order, certified check, cashier's check, Master Charge or Visa. (Include card number, expiration date and signature.) Shipping/insurance charge is 5% of total purchase or \$3.95 minimum (\$5.00 additional for orders outside Continental U.S.). N.Y.S. residents add 4% sales tax. C.O.D. All merchandise 100% guaranteed, brand new and factory fresh.

ORDER TOLL FREE (800) 221-8180
 customer Service Hot Line (212) 233-0857

J&R MUSIC WORLD
 23 PARK ROW, NEW YORK, N.Y. 10038 DEPT. PE
 SEND FOR OUR 200 PAGE FREE CATALOG
 CIRCLE NO. 30 ON FREE INFORMATION CARD

electronic games

tles, a sword to help protect you, a magic bridge for crossing through walls and a magnet to help attract objects.

Since you can only carry one object at a time you may want to pass up or drop

let an invading spaceship slip through his defense and reach earth. The player loses when he is hit three times by enemy missiles or when one of the invaders lands on earth.



Magnavox Odyssey 2

objects until you locate the sword. You'll need it to battle three deadly dragons: Yorgle, Rhindle and Grundle. Especially watch out for Rhindle, the fastest of the dragons and the most difficult to outmaneuver. If you don't have the sword, you may be able to outrun him through the mazes. If he catches you, he'll eat you; but you can reincarnate. There's also a troublesome black bat who'll try to steal the object you're carrying and replace it with something else (this could be helpful).

Eventually you'll find the golden key and unlock the golden castle. Then all you have to do is find the golden globe and place it in the golden castle.

"Space Invaders" (Atari) has 36 invading spaceships moving downward toward the earth, launching missiles as they approach. The player returns their fire as he tries to prevent them from landing while simultaneously maneuvering to avoid their missiles.

Although "Space Invaders" offers 112 variations, some players won't get past the basic game which is well thought-out and extremely habit-forming. Many of the variations are slight, such as moving shields (instead of fixed ones) for earth's protection or zig-zagging enemy missiles which really keep the defender on his toes.

Nice touches in "Space Invaders" include the increasing speed at which enemy ships attack as their numbers grow fewer, and emphasis on precision firing. (Rapid, poorly directed firing is actually detrimental since the player cannot fire again until an errant shot leaves the screen.)

The player can increase his score considerably by knocking out the invader's mothership, but going after the mother ship can be a risky tactical decision. If the player spends too much time tracking and firing at the mothership, he may

"Space Invaders" is a truly remarkable achievement and a good indication of Atari's ability to transfer a popular arcade game concept to a cartridge.

"Space Battle" (Mattel) sends five alien squadrons, each possessing attack ships, against your mothership. You have three squadrons of three fighters each to counter the invaders.

As the game begins, you see a radar screen revealing the positions of the enemy squadrons. You decide to engage one of the alien squadrons with one of your fighter wings. Your ships go out to intercept the enemy. As you close with the aliens, you turn off the radar display and take command of one of your fighters. You now view the alien ships through your starship window.

You can set your sights on the enemy ships and fire your lasers. When hit, the enemy fighters explode. Sometimes a chain reaction can destroy a nearby enemy ship as well as the one that was hit. But be careful, the enemy ships fight back. Three hits from them will wipe out your squadron.

If the enemy penetrates your defenses and threatens the mothership, the red alert sounds; at this point, you'll have to recall some of your fighters to protect the mothership. When the situation really becomes serious, a three-stage warning siren is activated. At this time, rescue must be immediate or the mothership will be lost. Should you annihilate all of the enemy squadrons, the battle will be over.

Fairchild, Coleco, RCA and others have dropped out of the video cartridge business. But Atari (Video Computer System), Magnavox (Odyssey 2), Mattel (Intellivision), and APF Electronics (MP1000) are pioneering new ground. All plan stepped-up cartridge development activity during 1981. To the public this mean: "You win turkey." ♦

DATA PROCESSING PROFESSIONALS

The hub of technical innovation is Autologic.

Engineering Opportunities...

DIGITAL ENGINEER

You'll make milestone contributions to the technical development of our graphic process systems. A strong knowledge of microprocessors and peripheral controllers is required and bit slice technique experience is desired. A BSEE and at least 5 years of digital experience will meet our expectations.

ANALOG ENGINEER

There is a real challenge awaiting the engineer who will bring experience in feedback systems, D/A converters, operational amps and power supplies together with a BSEE and 2 to 5 years of experience in these areas of analog circuit design.

TEST ENGINEER

This position involves designing and developing test equipment for A/D sub-systems and testing as well as for software diagnostics for A/D sub-systems and systems. You'll also serve as Technical Liaison among Test, Engineering and Software Departments. To be qualified you'll need an EE and 3 years of logic design experience as well as 2 years involving D/A test equipment, Basic and Fortran programming.

SENIOR MANUFACTURING ENGINEER

You'll have ample opportunity to gain recognition of your talents in the areas of tool and fixture design for PCB, system wiring, mechanical and final assembly. You'll also be involved in methods, work station layout, writing of assembly instructions and equipment justification and procurement. We need a senior level professional with 8 to 10 years of related experience in electronic manufacturing.

SENIOR MECHANICAL QUALITY ENGINEER

Support of precision mechanical inspection will be your responsibility. If you have about 5 to 6 years of experience and a strong knowledge in metal fabrication and PCB's and are ready to take an active position in vendor certification, receiving inspection, MRB, and mechanical engineering liaison activities.

ENGINEERING HARDWARE WRITER

This is an excellent opportunity in an expanding user-documentation department, writing operating and maintenance manuals from hardware design specifications and conferences with our hardware engineers.

AUTOLOGIC has raised the level of technical innovation in computerized phototypesetting systems to significant new heights. The result is our successful sales and growth history recognizing us as a world leader in developing, manufacturing and servicing these systems.

The best talent in engineering, software development, manufacturing and supporting services has contributed to this success. These career opportunities afford you the opportunity to become a part of this dynamic organization.



A degree in computer science would be ideal but equivalent technical experience and the ability to trace digital/analog signals to the chip level on schematic diagrams will satisfy us.

FIELD SERVICE ENGINEER

At least 2 to 4 years of experience working on minicomputers, disc and tape drives, and terminals is required. Ask about our special field service benefits like car and gas allowance. Our field service training program has been certified by the VA for education benefits. Positions available in nation's major cities.

SOFTWARE DEVELOPMENT PROGRAMMERS

Develop and implement new features for existing operating text editing systems and future software-based products. You'll need to know and use PL/M or other PL/1 type languages especially PASCAL assembler and be familiar with systems like the PDP 11/70, PDP 11, NOVA, and

Intel 8080, 8085, or 8086 microprocessors. Projects include composition/typesetting, text editing, font management, compiler or interpreter systems programming, diagnostic programming and real-time systems programming.

MANAGER IN-HOUSE MARKETING

Reporting to the director of marketing, this person will be responsible for developing near and longterm sales and marketing strategies related to in-plant and government markets. We are looking for a degreed and experienced marketing professional with an extensive knowledge of phototypesetting systems and requirements.

REGIONAL IN-PLANT SALES SPECIALIST

You'll participate in and support sales efforts within the region directed at the in-plant segment of typographic composition market. We require experience in sales to businesses having publishing needs in support of their main products, e.g. manuals, catalogs, price lists, advertising, etc.

SUPERVISOR — LIBRARY MAINTENANCE

You will prepare, maintain and control all master font libraries. You should have a typographic/graphic arts background and a thorough knowledge of data processing functions. Supervisory ability is essential.

LIBRARY MAINTENANCE EDITOR

You'll edit, process and maintain characters on all master font libraries. You should have a graphic arts or a related background and be able to work with small detailed graphs. Data processing and terminal operator knowledge would be helpful.

GRAPHIC ARTS EDITOR (CRT Knowledge)

You'll be using sophisticated computer instruction entered by CRT terminal to correct formation of digital alphabetic characters. Graphic arts classwork experience is desirable.

Our convenient San Fernando Valley location is close to all of Southern California's major attractions, from star-filled Hollywood to fun-filled Disneyland, as well as beautiful beaches, mountains and resorts.

BENEFITS...Autologic offers its employees an excellent salary and benefits package that includes medical and dental insurance — vacation after 6 months — and a strong corporate commitment to career development.

To apply or obtain additional information

please call our 24 hour TOLL FREE NUMBER (800) 821-7700 ext. 600 or send your resume to: WAYNE HARRIS

AUTOLOGIC, INC.
1050 Rancho Conejo Blvd.
Newbury Park, CA 91320

An Equal Opportunity Employer M/F

CIRCLE NO. 57 ON FREE INFORMATION CARD

www.americanradiohistory.com

THEY'RE WOOING YOU IN ELECTRONIC LAND!

BY THE PE EDITORIAL STAFF

CHANCES are that you are an electronics engineer, computer professional, electronic technician or planning to hold one of these titles soon. You should know, then, that you're in a seller's market with bright prospects for at least the next decade. In fact, the demand for people with such skills has never been higher.

A 1979 salary survey by the IEEE revealed that the mean income for respondents was \$31,680, with an average of 18.1 years of experience. With salaries rising in leaps and bounds, 1981 income is expected to be substantially higher. Naturally, a variety of factors influence income, such as level of responsibility, product area, and region of the country. For example, if your area of technical competence is in electronic devices, you are likely earning more than someone working in, say, instrumentation (\$35.2M vs. \$32.1M in 1979). If you work in Philadelphia, you're probably earning much more money than a counterpart in Florida (\$37.2M vs. \$29M in 1979).

Today, you don't even require experience to land a job in electronics. It's not unusual for freshly minted electronic engineers or computer science majors to start their first job in the low-\$20,000 bracket. Add a few thousand dollars per year for a master's degree. And you could look at a median starting salary of more than \$30,000 for Ph.Ds.

Not everything always comes up roses for electronic engineers, however. This past summer saw a dip in the demand for high-technology top engineering jobs, though it was still a seller's market. A stronger demand was evident in the fall, however. As seasoned engineers know, supply and demand is cyclical. For instance, it wasn't too many years ago when there were not enough jobs to go around in the engineering field. The picture has changed, though, making recruiters' jobs tougher.

Engineering and computer sci people enjoy one of the highest starting salaries among degree holders. But ten years down the line, they fall behind as compared to incomes of the sales-marketing and accounting grads, you should know.

Furthermore, there's career-maintenance time—keeping up with new technology—that is tougher to pursue owing to its complexities than in nontechnical fields. Nonetheless, career satisfaction is a large part of a person's drive to enter technical fields. For example, Frank Coss of Deutsch, Shea & Evans, Inc., NY, human resources consultants, concluded from a survey of programmers and systems analysts that they show more job satisfaction than any other group of workers they researched.

Job Classifications. In hardware, jobs may be broadly broken down into technicians, engineering technicians, engineering technologists, and engineers.

Engineers (BSEE) are generally involved in circuit and systems design, and research and development. Training generally requires graduation from an engineering course with the BSEE degree. One can specialize in a variety of areas, of course, such as computers, integrated circuits, communications, and so on. Moreover, some colleges or universities, such as MIT, emphasize underlying principles in electronics, while others lean more toward applications.

Following EEs are the BETs or engineering technologists. This training prepares students for circuit design, modifications and applications work, and a few become involved in research. There are proposals out at the IEEE to eliminate calling BET graduates "engineers," but they do indeed perform as engineers at work. A BET graduate pursues a four-year undergraduate course, while getting a BSEE is really a five-year regimen, often squeezed into four years.

An engineering technician does troubleshooting, circuit modifications and, in some instances, even circuit design. Formal training can be had at a two-year community college, a resident technical school, home-study school, or military. The highest certification would be an Associate Degree.

A technician is generally confined to troubleshooting, maintenance and repair. Work might be on consumer electronic equipment—TV receivers, marine radio, etc.—or in commercial areas

such as two-way radios, medical electronic equipment, and so on. Training is most often through a resident technical school, home study school or military. Being lowest on the technical totem pole isn't too bad, though, since many such techs start their own businesses and can earn more than higher-level people in the electronics field.

People in the computer software area are a breed apart. One might be a graduate EE as a software engineer, another a two-year college grad as a computer programmer or systems analyst. More and more, though, are four-year college grads, either specializing in computer science or in information science. The latter leans to business computer applications, with more limited mathematics. Then, of course, one can be a major in math with some computer courses behind them, or a major in business with same, and break into the field without much trouble.

The computer field is the hotter-than-hot field now and in the foreseeable future. There are more than one-million computer systems operating today, a seven-fold increase in six years. And there's no end in sight. The Bureau of Labor Statistics indicates that there are 534,000 programmers and systems analysts today, which is an increase of 25% in only the past two years. *Business Week* notes that the need for programmers could reach 1.5 million by 1990!

With more than 1,000 computer languages around, one might ask which one should be studied. It's probably best to be proficient in two or three major languages, such as FORTRAN, COBOL, or APL, plus Assembly. Most important is a demonstrated ability to learn languages quickly and be able to program well. For example, RPG (Report Program Generator) is an important language for business computers, though few colleges teach it.

If you're planning to enter college in the pursuit of a computer or engineering career, you may be interested in seeking out a computer for counselling. If so, don't overlook "Siggy." This is an acronym for the System of Interactive Guidance and Information developed by the

**APPLICATION ENGINEERS
INDUSTRIAL ROBOTS**

the worlds leading
painting equipment
welding controls,
and growing world
industrial robots.
ve of becoming a
technology robots,
aggressive applica-

**PROGRAMMERS/
ANALYSTS**

Broaden YOUR Base

If you see application variety as your
route to professional fulfillment and
career growth, PMI is for you.

Here you'll find assignments in every
conceivable type and size of business
enterprise.

And here you'll find a group of
growth and development
and most.
Check
your
The

New York

PF
R
C

Boston

Switzer

**DIGITAL
DESIGN
ENGINEERS**

**ENGINEERS
TECHNICIANS
COMPUTER SCIENTISTS**
Aerospace/Electronics/Mechanical
Engineering Disciplines
CALIFORNIA HI
Enjoy small town

**PROGRAMMER
ANALYST**

Avonpo, an international
organization, with its h
New Jersey, has a grow
mer Analyst. This is a
starting new systems to

**COMPUTER
SYSTEMS**

Senior Computer Systems Analyst
Senior Computer Systems Analyst
Senior Computer Systems Analyst
Senior Computer Systems Analyst

**DATA PROCESSING MANAGER
SALARY TO \$35,000**

AVP reporting to President of NY member Inter-
national banking group & responsible for:
All data processing activities including
implementation of recently acquired system
designed to bank's specifications

System me
Relationsh
must have
or comput
environm
Programm
System c
Supervist

This is a g
created depa
Our present
Basic for o
w/peripher
the person

**BAL
PROG/ANALYSTS
\$28-\$38,000**

Rapidly expanding group seeking
solid BAL Programmer/Analyst.
We are a newly formed division of
a major financial co. We are in the
process of identifying those per-
sons with the aptitude to develop
and train staff. Eventually
take on responsibility for
management of our
team. We offer a
growth career
opportunity to
manager.
Box 6

**SR. SYSTEMS
ANALYST**

or diversified manufacturing corporation
in Northern Br
BS/Business A
minimum of 5 y
tion requires
Oil and R/R
ndie severe
ion is esse
ibilities
had nat
led sy
cess
mm
oil
at

**SENIOR
DIGITAL
ENGINEER**

Current
law
s, as well as long range
need for an experienced
andidate must have a min-
hands-on experience in
re, hardware design
minimizing Exposure to
a definite asset.
t have a Bacc

**Reliability
Engineers
Military Electronics**

Career progress
comes fast
the indus

ITT Avionics Divi
oriented Reliabi
expanding opera
campus-like setti

**RELIABILITY
DESIGN
ENGINEERS**

BS
Soi
tho
spe
exp
you
proj
We
envi
hens
dent
To le

**COMPUTER
SERVICE
REPRESENTATIVE**

NYC area. Computer
experience preferred
necessary
Tuesday,
ppointm

(212)

Systems Engineer

As innovative leaders in advanced Distributed
Data Processing

**PROGRAMMERS
COBOL**

Worldwide industrial manufacturer has excellent oppor-
tunities in its Corporate Systems Group located in North-
ern N.J.

Positions require a minimum of 6 months to 2 years
in the COBOL programming environment.

Educational Testing Service of Prince-
ton, NJ, and adopted by at least 26 col-
leges and universities plus junior and
community colleges. Siggy's computer
software helps people identify and ex-
plore their career options.

There are many different avenues you
can travel in developing varied electron-
ics experience and a career. Perhaps you
are interested in the military electronics
area, which is very dependent on how
much money the government allocates.
This is a traditionally good field for elec-
tronics and is expected to continue to be
so. However, overall U.S. defense bud-
gets for the coming year will not come
close to keeping up with inflation. Elec-
tronics and communications research
and development fare much better
(+ 2.5%), though there will still be some
slippage since inflation is expected to be
7% to 10%.

The federal government has computer
jobs, too. And why not, since here's
where some 20% of the computers are.
Just check the Civil Service Commission
hiring lists. One, Computer Specialists
announcement #420, is a non-test exam
that requires at least a substantial train-
ing background. Another is announce-
ment #424 for computer specialists with
engineering or math backgrounds.

Making Your Move. As electronics is
applied to more and more areas of busi-
ness, commerce, industry and the con-
sumer marketplace, the demand for en-
gineers and technicians will undoubtedly
grow. You can cash in on the present
and near-future opportunities by simply
getting an education in electronics, up-
grading your electronics knowledge
through home study courses, seminars,
industry training programs, or, if you're
ready, changing jobs.

For the latter—changing jobs—look
for very substantial real increases in in-
come, at least 20 per cent. If a position
in another part of the country interests
you, do check out living costs in that
area compared to your present location.
Check the fringe benefits package be-
fore accepting the job to weigh what you
will truly gain in added money. Find out
about employee turnover in your area,
too. Note, though, that in the computer
field, job hopping is commonplace, and
turnover is typically high. If you're
investigating joining a company that de-
pends on defense contracts, find out
about the contracts in house. Long-term
ones are better than short-term ones, of
course.

So do peer outside to see if there's a
much better world waiting for you. But
don't simply jump into a new job with-
out learning as much as you can about
your future in the company. ♦

SOLID-STATE DEVELOPMENTS

By Forrest M. Mims

Wire-and-Glass Holdovers from the Pre-Solid-State Age

FOR THE PAST twenty years, solid-state devices have dominated the electronics scene. Yet there are still many *non-solid-state* components around. The two biggest categories of these components are electron tubes and various kinds of lamps. Let's examine some of the most important components in each category and find out how many of them might eventually be replaced by solid-state devices.

Electron Tubes. Contrary to the claims of advertisements, press releases, books, articles and TV programs about modern technology, the electron tube is in many applications alive and well. Your television receiver, for example, might be advertised as "100% solid-state." Actually, the visual images it produces appear on one end of a giant vacuum tube, the venerable *cathode-ray tube* (CRT). The camera in the TV studio also employs a vacuum tube, usually an *image orthicon*.

There are many other applications in which cathode-ray and other types of vacuum tubes play key roles. For example, if you own a home computer, chances are its principal means of presenting information to you is a CRT. If you use a microwave oven, your meals are cooked by the radiation emanating from a vacuum tube called a *magnetron*. And, no doubt, more than once in your life you've been exposed for medical purposes to the penetrating radiation emitted by an *x-ray tube*.

Although solid-state components are now almost universally used in low-to-medium-power electronic equipment, there are still plenty of applications for electron tubes. In high-power switches, radar pulse generators, and the output stages of high-power transmitters, the use of electron tubes is the rule rather than the exception. Interestingly, in one specialized low-to-medium power application, there is a move back to vacuum tubes. Purists and traditionalists alike wax poetic over what they perceive to be the superior sound quality of vacuum-tube, as compared to totally solid-state, audio components.



Fig. 1. RCA TV camera uses solid-state and electron-tube technology.

Illumination. Today, solid-state light-emitting diodes (LEDs) are widely used in numeric-readout and low-power indicator-lamp applications. However, despite a 1967 RCA advertisement which predicted that someday LEDs "may light your home," non-solid-state light sources still dominate both special- and general-purpose lighting.

Closed-cycle gas lasers, neon glow lamps and xenon flash tubes are good examples of special-purpose lamps that have no solid-state counterparts. Although there are many different solid-state lasers, none emit light with the spectral purity or narrow beam divergence of such electron-tube lasers as the helium-neon (HeNe) gas laser. No LED can produce a flash as brilliant as that generated by a xenon strobe lamp. And even the versatile LED cannot outperform the lowly neon glow lamp as a super-simple high-voltage indicator.

The Future. Will any of these non-solid-state components ever be replaced by solid-state devices? The process is already taking place in some cases. For example, some of the latest television cameras employ arrays of light sensitive *charge-coupled devices* (CCDs), instead of image orthicons or similar electron tubes. Other new cameras combine semiconductor and electron-tube technology in a light-sensing tube called the *silicon vidicon*. Figure 1 shows a high-resolution, closed-circuit TV camera with a zoom lens and an automatic-

light-control system. Thanks to its silicon vidicon, the camera can operate over an ambient light range of 400,000:1 and can produce usable images of scenes illuminated by as little as 0.05 foot-candle of ambient light.

Thus far, the CRT, which has survived a 20-year effort to develop a suitable solid-state alternative, is still by far the best video-display device available. Nevertheless, ongoing research in high-resolution, liquid-crystal and LED displays might result in an acceptable, limited-resolution substitute.

The helium-neon gas laser is beginning to receive competition from a new generation of sophisticated semiconductor lasers. These tiny new lasers are much smaller, use less power and are far more efficient than HeNe lasers.

Geiger tubes might one day be replaced by a new generation of efficient solid-state detectors. Several suitable devices have already been developed, but they still are far more expensive than most Geiger tubes.

In the areas of general-purpose lighting, heavy-duty switching, high-power

Fig. 2. The largest (320 lb) water-cooled tube of its kind ever made. (RCA)



radar and radio transmitters, electron tubes are unlikely to be replaced by solid-state devices of similar capabilities, at least in the foreseeable future.

One convincing example of the importance of non-solid-state components is the huge vacuum switching tube shown in Fig. 2. Developed by RCA at a cost of \$600,000, this 320-pound tube can switch 200,000 volts at up to 125 amperes. That's a total power of 25,000,000 watts, roughly equivalent to turning on 300,000 TV sets simultaneously! While operating, this tube dissipates 2,016,000 watts. That's enough power to heat 100 all-electric homes. Excess heat is removed from the tube by a self-contained cooling jacket through which 250 gallons of water are pumped each minute.

It's unlikely that solid-state components will ever be used for *all* applications in electronics. However, newly developed components will continue to take over functions which traditionally have been performed by non-solid-state components. I'll report on any important developments in future columns.

An Intelligent Instrument Panel. A solid-state odometer for automobiles has been developed by National Semiconductor Corporation as part of its Intelligent Instrument Panel program. The odometer consists of a fusible-link bipolar PROM, a 4-bit COP420L microcontroller and a speed sensor.

In operation, the microcontroller counts pulses generated by the speed sensor. When the number of incoming pulses coincides with a permanently stored mileage increment, one bit is programmed into the PROM. Because this mileage information is permanently programmed into the PROM, it is virtually unalterable and therefore tamper-proof. This feature satisfies the requirement of the proposed Federal Motor Vehicle Safety Standard which, if implemented, will require that new cars be equipped with tamper-proof odometers.

The COP420L microcontroller does

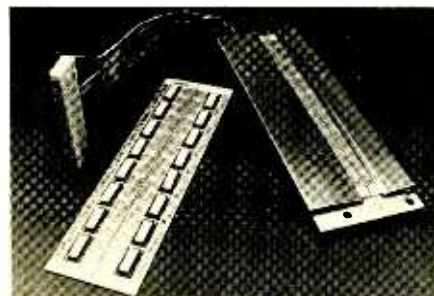

Fig. 3. New thermal printhead from R-Ohm Corp. prints all types of symbols.

double duty by converting the pulses from the speed sensor into the vehicle's road speed. This information and the mileage data are sent to speedometer and odometer displays in the Intelligent Instrument Panel. Both readouts can display information in either English or metric units.

Component News. The Honeywell Corp. Electro-Optics Center has announced an important new development in the field of thermal imagery. Present thermal-imagery systems utilize a mechanical scanning system to divide a scene into bars which are then swept past a single infrared detector. The mechanical scanning components in such a system are bulky and inherently fragile.

Honeywell's development is an integrated array of 1,024 Mercury Cadmium Telluride (HCT) detectors on a single substrate. The substrate is actually a silicon charge-coupled device. HCT detectors respond to infrared radiation at wavelengths of 3 to 5 microns. Potential applications for Honeywell's array include remote sensing from satellites and aircraft, military reconnaissance and portable night-vision equipment.

Thermal printers are used in some data loggers, calculators and microcomputers to provide hard-copy printout on heat-sensitive paper. R-Ohm Corporation (P.O. Box 19515, Irvine, CA 92713) has announced the development of a new thermal printhead that can produce both alphanumeric and graphic information readouts.

Designated the KH101, the new printhead has a single 5-inch wide, one-piece heating element which can produce both lines and solid shapes in addition to numerals and characters. Its printing resolution is 102 dots per inch.

Figure 3 shows a complete KH101 printhead together with an interface connector. Also shown is a KH101 partially disassembled to reveal the sixteen 40-pin chips that contain the printhead's 32-bit I²L drive circuits, shift registers and diode arrays. Specified life of the KH101 is 30×10^6 printing pulses or 18.6 miles (30 km) of paper length, whichever occurs first.

Another National Semiconductor development is the MM57499, a 28-pin chip that contains all the encoding logic necessary to interface a remote keyboard to a CRT terminal. Up to 96 keys can be handled, and only five wire connections are required. Adding a 4-to-12-line decoder (74S154) will expand the number of keys to a maximum of 144.

Do-it-yourself computer hobbyists will be particularly interested in the many features of the MM57499. It includes, for example, *phrase storage* ca-

pability which allows up to 14 key-strokes to be recalled by pressing a single key. Both upper- and lower-case ASCII and a separate digit pad capability are available.

Other features include two-key lock-out to prevent erroneous double entries, manual hold-down repeat and fast automatic repeat. A self-contained baud-rate generator is also included.

The MM57499 is a 5-volt, TTL-compatible chip. National Semiconductor will sell the MM57499 for \$6.15 each in lots of 100. You will have to ask local distributors about single-quantity availability and price.

Incidentally, National Semiconductor has also announced publication of the new editions of its Linear, Voltage Regulator and Audio Handbooks. In recent years these books were available through Radio Shack, but I have heard from a reliable source that Radio Shack will not handle the new editions. These books contain hundreds of pages of invaluable material. Ask your National Semiconductor distributor or mail-order electronic parts companies about availability and cost.

This magazine has published several columns describing construction projects employing LED dot/bar display drivers made by Texas Instruments and National Semiconductor. Chips of this type are also manufactured by several foreign companies. One of the most recent entries is a family of six display drivers made by AEG-Telefunken. Each of these chips is housed in an 8-pin mini-DIP and is able to drive a 5-element LED bargraph display. The family is divided into three pairs, each of which can be combined into a two-chip, 10-element readout driver.

The U237B and U247B are linear response drivers with minimum thresholds of 0.2 volts and, respectively, 100-millivolt and 200-millivolt increments between LEDs. The U257B and U267B have logarithmic rather than linear responses. The U244B and U254B are similar to the U247B and U257B, respectively, but are characterized by gradual rather than sharp transitions between output states. This has the effect of nearly doubling the resolution of the display because an intermediate level is indicated by two simultaneously glowing LEDs.

All six chips in this new family are available for approximately a few dollars each in 1,000-lot quantities. Unit prices will therefore be several dollars each. AEG-Telefunken's address is Route 22, Orr Drive, Sommerville, NJ 08876. Literature describing the new chips can be obtained by writing directly to the company. ♦

EXPERIMENTER'S CORNER

By Forrest M. Mims

Experimenting with a Light Pen—II

IN part one of this two-part series, we discussed the chief differences between light wands and pens. We then designed a basic phototransistor light pen and experimented with a 16-position, light-pen-controlled data-input terminal.

Adding a Bus Register. The data terminal which was described in Part I can be made more compatible with external circuits by adding a register to its 4-bit bus. The register will ignore any logic signals on the bus until a WRITE switch issues a command to load the register with whatever is on the bus.

Figure 1 shows one simple way to add such a register. The register, a 74175 quad D flip-flop, follows the bus data when

its LOAD input is brought to logic one by means of the WRITE switch. The data remains in the register until the WRITE switch is again toggled from HOLD. The contents of the register can be cleared to 0000 by toggling the RESET switch from HOLD to CLEAR.

You'll need to insert three-state transmission gates between the register outputs and the bus. Alternatively, you can use a 74173 4-bit D register with self-contained three-state outputs. This approach is shown schematically in Fig. 2. Note that the 74173 has more control inputs than the 74175. The system clock loads into the 74173 the data present at its inputs when both DATA ENABLE inputs (pins 9 and 10) are grounded by

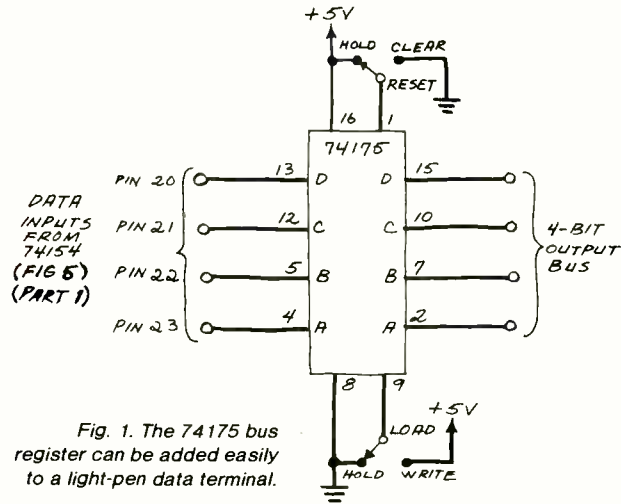

Fig. 1. The 74175 bus register can be added easily to a light-pen data terminal.

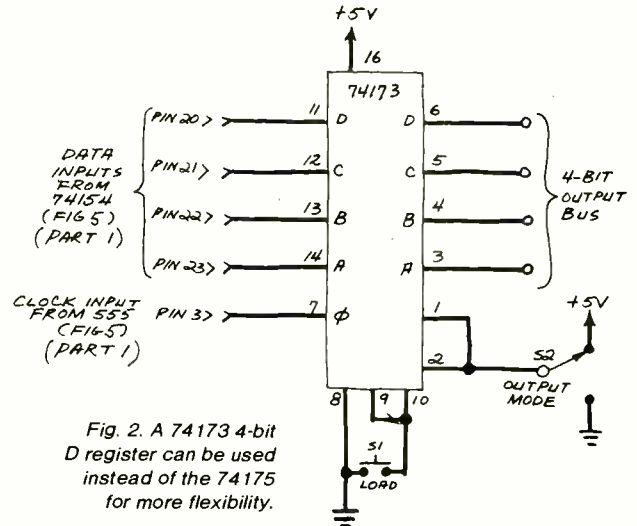

Fig. 2. A 74173 4-bit D register can be used instead of the 74175 for more flexibility.

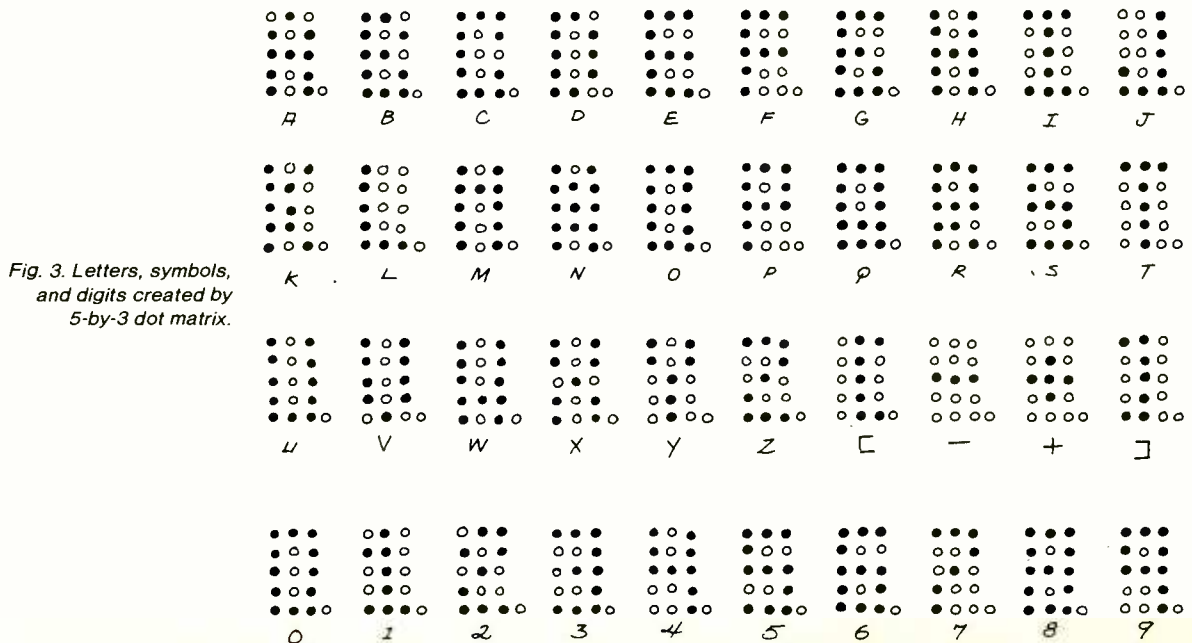

Fig. 3. Letters, symbols, and digits created by 5-by-3 dot matrix.

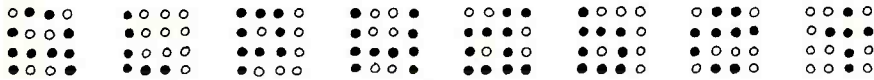

Fig. 4. Upper- and lower-case letters of the alphabet on a 4-by-4 array.

means of *S1*. This means that you must be sure to depress *S1* for at least one clock cycle—which can be a significant interval when the clock rate is very slow.

The outputs of the 74173 and therefore the output bus reflect the data stored in the chip when both OUTPUT CONTROL inputs (pins 1 and 2) are grounded. Should either OUTPUT CONTROL input go to +*V_{cc}*, the outputs enter the high-impedance state and, for practical purposes, the 74173 disconnects itself from the output bus.

A Light-Pen-Controlled LED Display. The basic light-pen data-entry terminal forms the nucleus of a 16-element LED display that can be illuminated in a pattern selected by the light pen.

If, for example, the LEDs are arranged in five rows, four having three LEDs and one having four, then each of the ten decimal numerals plus a decimal point can be formed. Figure 3 shows one possible way to form each decimal numeral or any of the letters of the alphabet on such a display. As you can see, in spite of the limited number of display elements, the legibility and appearance of the characters generated are surprisingly good. Arranging the LEDs in a 4 x 4 array makes possible the display of many graphic symbols and some upper- and some lower-case letters. Figure 4 shows some examples.

Hopefully, you are by now as interested as I've long been in experimenting with a circuit having such capabilities. Assuming that you are already familiar with the basic light-pen data-entry terminal described in Part I, we can now begin modifying that circuit for video-graphics applications.

Two principal requirements must be satisfied. First, the circuit must be able to remember each LED location selected by the light pen. Second, the selected LEDs must be substantially brighter than the unselected LEDs.

The solution to the first problem is simply to add a RAM. The second requirement is trickier. Ideally, only the selected LEDs should glow. That's impossible, however, because all of the LEDs must be sequentially strobed to make them eligible for future selection by the light pen. There are several solutions to this apparent contradiction. You can better understand the one that I chose by referring to the block diagram of the complete light-pen-controlled display in Fig. 5.

If you compare Fig. 5 of this part with the block diagram of the light-pen data-entry terminal (Fig. 5 of Part I), you'll immediately notice several important similarities. For example, the configurations of the clock, counter, decoder, bus and light pen are identical in both circuits.

You will also notice some important additions to the circuit. One major addition is a 1 x 16-bit RAM whose address lines are connected to the 4-bit output bus. Also, a LOAD switch connected to the RAM has been incorporated into the light pen.

When a particular LED has been selected by the light pen, closing the LOAD switch records its new status in the RAM. The RAM is able to keep track of the selected LED because the count supplied to the decoder is equivalent to the address furnished to the RAM.

Notice the AND gate that has been connected to the OR array between the decoder and the LEDs. This gate network permits the LED array to be strobed and therefore to display

Put Professional Knowledge and a
COLLEGE DEGREE
in your Electronics Career through

HOME STUDY

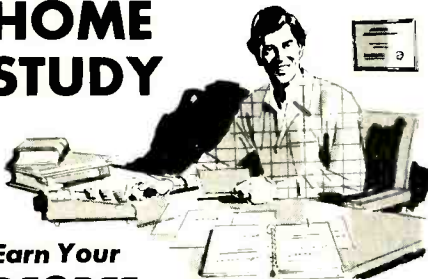

Earn Your DEGREE

No commuting to class. Study at your own pace, while continuing your present job. Learn from easy-to-understand lessons, with help from your home-study instructors whenever you need it.

In the Grantham electronics program, you first earn your A.S.E.T. degree, and then your B.S.E.T. These degrees are accredited by the Accrediting Commission of the National Home Study Council.

Our free bulletin gives full details of the home-study program, the degrees awarded, and the requirements for each degree. Write for Bulletin ET-81.

Grantham College of Engineering
2500 So. LaCienega Blvd.
Los Angeles, California 90034

★ **FREE!** ★



NEW CATALOG OF HARD-TO-FIND PRECISION TOOLS

Jensen's new catalog is jam-packed with more than 2000 quality items. Your single source for hard-to-find precision tools used by electronic technicians, scientists, engineers, instrument mechanics, schools, laboratories and government agencies. This popular catalog also contains Jensen's world-famous line of more than 40 tool kits. Send for your free copy today!

JENSEN TOOLS & ALLOYS
1230 SOUTH PRIEST DRIVE - TEMPE, AZ 85281

CIRCLE NO. 31 ON FREE INFORMATION CARD

Automatic Electronics

HOME ENTERTAINMENT SPECIALS

Teac CX350 Cassette	184.99	Scott PS97XV Turntable	179.99
Koss K4DS Delay	349.99	Atari CX2600 Video	149.99

BLANK TAPES

C-90 UDXL I or II (Cr.)	3.39
C-60 UDXL I or II (Cr.)	2.49
C-90 UD	2.79
C-90 SA (Cr.)	2.99
C-60 SA (Cr.)	2.19
C-90 AD	2.49

ENTIRE SCHWANN CATALOG
ROCK, JAZZ, R&B
(Minimum Order - 4 Records)
All 7.98 List Only 4.85
All 8.98 List Only 5.35
All 9.98 List Only 5.85
Tapes/Cassettes/Tracks Add .40
Rec'd Orders By Mail Only
No Telephone Orders Accepted

PHONO CARTRIDGES

Shure V15 Type IV	102.99
Shure V15 Type III HE	83.99
Shure M97 HE	53.99
Shure M95 HE	34.99
Audio-Technica AT155LC	109.99
Audio-Technica AT140LC	84.99
Audio-Technica AT125LC	46.99
Stanton 881S	77.99
Stanton 681 EES	56.99
Stanton 681 EEE	47.99
Empire 2000Z	54.99
Empire 2000E3	18.99
Pickering KS14000	68.99

HEADPHONES

Koss Pro 4AAA Special	45.99
Koss HVXLC	48.99
Koss HVX	35.99
Sennheiser HD-430	75.99
Sennheiser HD-222	73.99
Sennheiser HD-420	52.99
Audio-Technica ATH-7	99.99

PIONEER Car Stereo PIONEER SPECIAL

KP-4500 Indash Cassette Plus TS-162 DX Speakers	146.99
KPX-9500 Indash	177.99
KP-8500 Indash	142.99
KP-8000 Indash	155.99
KP-7500	179.99
KE-3000 Indash	205.99
KE-5000 Indash	249.99
GM-40 Power Amp	49.99
GM-120 Power Amp	107.99

JENSEN Car Stereo
R-430, R-420, R-410 & R-402
Call for low Automatic prices

BLAUPUNKT Car Stereo
CR-2001 Indash 239.99
CR-2000 Indash 205.99

FREE CATALOG UPON REQUEST

We carry a full line of PIONEER, TECHNICS, AKAI, B.I.C., and TEAC Home Stereo Equipment as well as PIONEER, JENSEN, CLARION, BLAUPUNKT, PANASONIC, CONCORD, MITSUBISHI, and SANYO Car Stereo Equipment.

ORDERING INSTRUCTIONS

All merchandise is Factory Fresh and complete with Manufacturer's Warranty. For immediate shipment, send Certified Check, Money Order, Cashier's Check, or Master Charge or VISA (Send Card Number and Expiration Date). Call us Toll-Free Mon-Fri 9AM-7PM, Sat 10AM-7PM (Eastern Time) for Credit Card orders. Personal Checks are subject to hold for bank clearance. Shipping and Handling charge \$3.50 (Canada, Puerto Rico, Hawaii, Alaska \$7.00). Allow 5-12 days for U.P.S. delivery. For all matters other than in place orders please call us at 212-686-5500. No C.O.D. orders accepted. NY residents must include Sales Tax.

Automatic Electronics
CALL TOLL-FREE 800-223-2706
In N.Y., Hawaii, Alaska, & Canada Call (212)686-5500
1263 Broadway New York, N.Y. 10001

CIRCLE NO. 5 ON FREE INFORMATION CARD

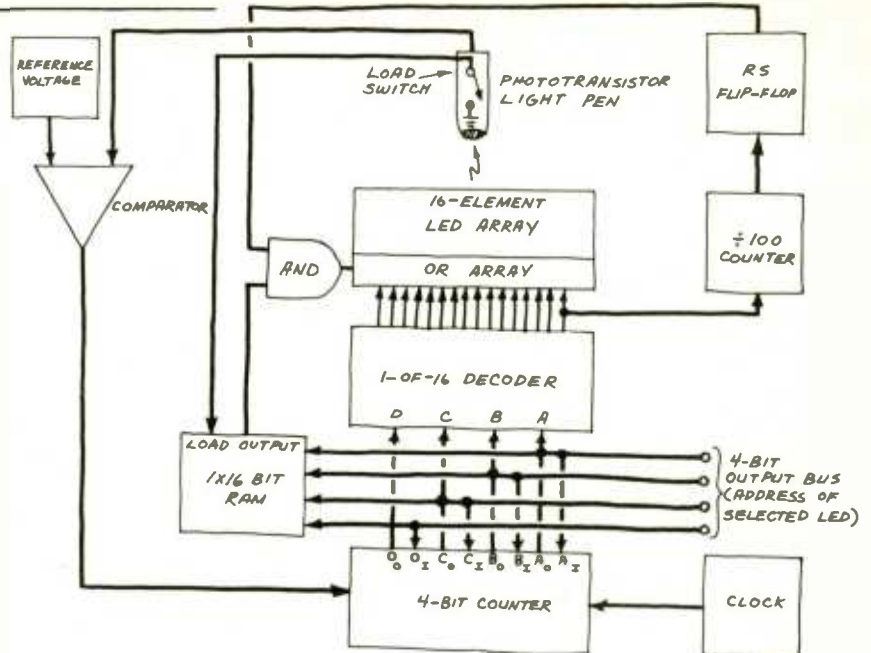

Fig. 5. Block diagram of a light pen controlling a 16-bit LED display.

selected LEDs. Without the assistance of the additional logic, the multiplexing action would be divided equally between the LEDs being sequentially strobed by the scanning circuit and the LEDs selected by the light pen. This means that both the scanned and the selected LEDs would appear equally bright.

This problem is solved by means of a divide-by-100 counter and a set-reset flip-flop. Connecting the flip-flop to the counter results in a combined circuit that is a modified divide-by-10 counter. The output of the modified counter is at logic 0 for ten

clock pulses. It then goes to logic 1 for 90 clock pulses. The cycle then repeats.

The outputs of the RAM and the counter are ANDed and the result ORed with the decoder outputs. This is done so that the LEDs selected by the light pen are strobed 90 times during an interval of 100 clock pulses. All of the LEDs are then strobed 10 times during the remainder of the 100-pulse clock interval. The net effect is that the LEDs selected by the light pen are substantially brighter than the remaining LEDs.

(continued on page 92)

**POLY
PAKS**

PENNY SALE

Buy 1 2.99er
Get 2nd
for 1 Penny More!

25-SLIDE SWITCHES, various shapes, sizes, and types (#2726)	2.99	50 for \$3	10-QUAD PHONO JACKS, 4 RCA jacks on 2 x 1 1/2" Bakelite strip (#6249)	2.99	20 for \$3
50-TRANSISTOR ELECTROLYTICS, epoxy encapsulated, asst values, (#2747)	2.99	100 for \$3	25-RCA PHONO PLUGS, popular audio/speaker plugs, 100% material (#3293)	2.99	50 for \$3
175-HALF WATTERS, 100% color-coded resistors, asst values, (#3046)	2.99	350 for \$3	15-MINI PLUG & CABLE SETS, 3.5mm plug, 6' insulated 2 cond leads, (#6269)	2.99	30 for \$3
20-SLIDE VOLUME CONTROLS, various values & types, for Hi-Fi etc (#3057)	2.99	40 for \$3	200-PRE-FORMED DISCS, caps w/leads for PC use, mixed values, (#2605)	2.99	400 for \$3
50-UPRIGHT ELECTROS, 100%, assorted values & voltages, marked, (#3226)	2.99	100 for \$3	25-PLASTIC POWERS, 25 watt npn & pnp, 50-200 bycho, TD-220, (#6237)	2.99	50 for \$3
20-PANEL SWITCHES, assorted rotary micro slide etc (#6629)	2.99	40 for \$3	100-2 WATT RESISTORS, assorted carbon, films etc, some 5kars (#6238)	2.99	200 for \$3
20-PAIRS-RCA PLUGS & JACKS, popular for Hi-Fi, speakers, etc (#6630)	2.99	40 for \$3	24-LM-340T VOLTAGE REGULATORS, untested TD-220, may incl 5-24V, (#2635)	2.99	48 for \$3
60-IN914 SWITCHING DIODES, 4 nsec axial, glass, untested, (#6632)	2.99	120 for \$3	126-POLYSTYRENE CAPS, assorted types, styles & sizes all good (#2729)	2.99	250 for \$3
4-2N3055 NPN TRANSISTORS, 115 watts, 15 amps TD-3 100% material (#6633)	2.99	8 for \$3	50-POWER TAB TRANSISTORS, plastic NPN TD-220 asst types, untested (#2425)	2.99	100 for \$3
50-THERMISTORS, various types & styles, neg coefficient 100% (#4089)	2.99	100 for \$3	24-SKINNY TRIM POTs multi & single turn asst values & types (#6285)	2.99	48 for \$3
30-INSTRUMENT KNOBS, for half round shafts, some w/pointers, (#6498)	2.99	60 for \$3	75-LONG LEAD DISCS, prime marked caps assorted material, (#2598)	2.99	150 for \$3
10-LINE CORDS, heavy-duty 18 gauge, 6', molded plug, 2-cond (#6499)	2.99	20 for \$3	50-TTLs 7400 series incl gates flip-flops, etc untested, (#6226)	2.99	100 for \$3
10-2N3055 HOBBY TRANSISTORS, manual layout, TD-3, U-test (#6624)	2.99	20 for \$3	5-BRASS LOCKS with key 1 1/2" long for doors, windows, etc (#6253)	2.99	10 for \$3
10C-DTL IC's, mostly dual JK flip flops, marked, 100% prime (#6444)	2.99	200 for \$3	250-MOLEX SOCKETS "on-a-strip" make your own pc sockets, (#6255)	2.99	500 for \$3
35-STEREO INDICATORS, liny red 1.5V bulbs, for Hi-Fi replacement (#6244)	2.99	70 for \$3	50-MINI POTs, pc style single turn, assorted values (#3345)	2.99	100 for \$3
40-800V 1A RECTIFIERS, type IN4006, epoxy axial leads, (#6245)	2.99	80 for \$3	15-JUMBO RED LEDS 3V 10 mA 100% good material red dome lens, (#3369)	2.99	30 for \$3
9-DIGIT READOUTS, flat pak w/bubble mag 120' high 14 pin, (#5558)	2.99	18 for \$3	2-SOUND TRIGGERS, sound activated amp, SCR triggered on 3' board, (#3625)	2.99	4 for \$3
100-PREFORMED 1/2 WATTERS, assorted values precut for PC appl, (#6622)	2.99	200 for \$3	40-TRANSISTOR SOCKETS, assortment may include TD-19.5 66.3 etc (#3845)	2.99	80 for \$3
20-NE-2 BULBS W/RESISTOR, neon plugs right into 110 VAC, (#6620)	2.99	40 for \$3	75-CABLE TIES 4" non-slip white plastic like Ty-wrap (#5218)	2.99	150 for \$3
15-RCA PHONO JACKS, popular Hi-Fi jack on a Bakelite strip, (#6230)	2.99	30 for \$3	150-FEEDTHRU CAPS, assorted types & sizes for RF UHF etc (#5668A)	2.99	300 for \$3
150-4000V RECTIFIERS, IN4000 series may include, 50 to 1000V (#2471)	2.99	100 for \$3	175-1/2 WATT RESISTORS, asst carbon, carbon-films, some 5kars, (#5797A)	2.99	350 for \$3
50-AXIAL ELECTROS, asst values volts sizes What a buy! (#3227)	2.99	100 for \$3	100-PLETTY CAPS, ceramic blocks in assorted sizes & values, (#6221)	2.99	200 for \$3
3-SHIELDED AUDIO CABLES, 2 cond, with RCA plugs at each end, (#6412)	2.99	6 for \$3	100-PC HEATSHRINK slip-over type, shrinks 50%, like Thermo-tit, (#6239)	2.99	200 for \$3
200-PC-SEMICON SPECIAL, assorted semis of all types, untested material (#33001)	2.99	400 for \$3	25-NE-2 BULBS, neon for 110 VAC requires resistor, (incl incl) (#2613)	2.99	50 for \$3
200-PC-FORMED 1/2 WATTERS, popular values, some 5 & 10kars (#6246)	2.99	400 for \$3	100-METALLIC RESISTORS, mostly 1/2 watters asst val 1-5% tol (#6280)	2.99	200 for \$3
30-SCRs & TRIACS, assorted values 10 AMP TD-220 untested (#6337)	2.99	60 for \$3	100-POWERS POWERS 3 to 7 watt power resistors, (#6281)	2.99	200 for \$3
25-TINY SLIDE SWITCH, only 3/32" cube SPDT PC leads (#6385)	2.99	50 for \$3	15-CRYSTALS, assorted types some H6/U, some frequency marked, (#6256)	2.99	30 for \$3
40-EDGE CONNECTORS, asst 4 & 6 pin, 2-sided, pc leads, (#6384)	2.99	80 for \$3	150-SUBMINI I/O TRANSFORMERS, asst may include osc antenna, etc (#6259)	2.99	300 for \$3
6-MINI-MOTORS, Type RES6, 1.5-6 VDC, color-coded wire leads, (#6718)	2.99	12 for \$3	60-SUBMINI DIM RESISTORS, prime resistors, asst values, grab em! (#6261)	2.99	120 for \$3
24-MINI-BULBS, asst voltages & base styles, some colored, (#6757)	2.99	48 for \$3	25-MICRO MINI RED SWITCHES 1" long, for alarms, relay systems, etc (#6263)	2.99	50 for \$3
40-STRAIN RELIEFS, asst types, styles, & sizes (#6756)	2.99	80 for \$3	150-PC-CAPACITOR SPECIAL, asst mylars polys micas etc 100% good, (#6264)	2.99	300 for \$3
6-TIME DELAYS, solid state, asst from 450 msec to 8 Sec, (#6758)	2.99	12 for \$3	10-PUSHBUTTON ALARM SWITCH SPST momentary, NC, w/hardware, (#6267)	2.99	20 for \$3
3-HEAVY DUTY AUTO CHOKE, fitters 12 VDC @ 5A open frame, (#6750)	2.99	6 for \$3	500-PC-HARDWARE SURPRISE (approx) 1 lb asst screws, washers, etc (#6271)	2.99	1000 for \$3
10-5K CONTROLS, thumbwheel type, single-turn, vert mt (#6705)	2.99	20 for \$3	20-9V BATTERY CLIPS, snap connector coded, insulated leads, (#6286)	2.99	40 for \$3
4-CROME PLATED ALARM SWITCH, spst NC momentary (#6742)	2.99	8 for \$3	3-WATCH GUTS 5-function, LED style assorted sizes, untested, (#6287)	2.99	6 for \$3
8-LED LAMPS, 2V red LED in chrome-colored assembly, w/hardware (#5702)	2.99	16 for \$3	5-HEAVY DUTY LINE CORDS, white 2 cond 6 ft 16 gauge, (#6292)	2.99	10 for \$3
8-BAR LIGHTS, GASP on LED chip, 1.5-3 volts, wire leads, (#6158)	2.99	16 for \$3	20-SINGLE PIN LEDS, green, micro style, 3V 10mA, 100% (#6293)	2.99	40 for \$3
4-TAPE HEADS, record/play, stereo & mono w/plugs, 11" leads, (#5973)	2.99	8 for \$3	30-LED/TRANSISTOR SOCKETS "snap-in" 3 pc leads, for TD-5.18.46 etc (#6297)	2.99	60 for \$3
10-RESISTOR LEDS, asst red green & yellow jumbos, 5V, (#6761)	2.99	20 for \$3	200-PRECISION RESISTORS, 1/2W 1% axial (#2428)	2.99	400 for \$3

Send For Our FREE Catalog Today!

Featuring the Largest Selection and the Lowest Prices on a wide variety of quality electronic products, including: Computer Peripherals, Solar Devices, Speakers, Audio Equipment, and much more! Take advantage of our 25 years as America's foremost supplier of discount electronics.

For Faster Service
Order By Phone
1-617-245-3828



- ORDERING INSTRUCTIONS**
- Indicate QTY in front of 2.99ers desired
 - Complete Coupon Section
 - Cut Out Along Dotted Line and Mail Ad to

Poly Paks
P.O. Box 942, PE1
SOUTH LYNNFIELD,
MA. 01940

POLY PAKS

*Same Cat. No.

Total Amount of Order \$ _____
Please Add \$3 for Postage & Handling

NAME _____
ADDRESS _____
CITY _____
STATE _____ ZIP _____
Enclosed is CHECK, MONEY ORDER
Charge my MASTERCARD VISA

ACCT. # _____ EXP. DATE _____
 Send me your FREE catalog

PLUG IN to the savings!

Get Stereo Review and Popular Electronics at whopping discounts!

Stereo Review is the music-lover's best friend. Equipment evaluations help you select the best audio gear for your needs. Reviews of important recordings in every category of music help you select the best to build your library at the least cost. Columns by experts help you understand the music industry, the ins and outs of tapes and equipment and the technical side of audio.

Order one or both magazines. Just complete and return the postage-paid order card today!

With this special introductory offer, you can save up to 41% off the full one-year subscription price of **Popular Electronics**...and a big 50% off on a year of **Stereo Review**!

Popular Electronics is the magazine for the serious electronics buff. Its scientific tests by Hirsch-Houck Laboratories help you select audio equipment. Articles help you with electronics experimenting, DX listening, video and personal computing. And the do-it-yourself electronics projects plans are the best anywhere! It's no wonder **Popular Electronics** is the world's largest selling electronics magazine!

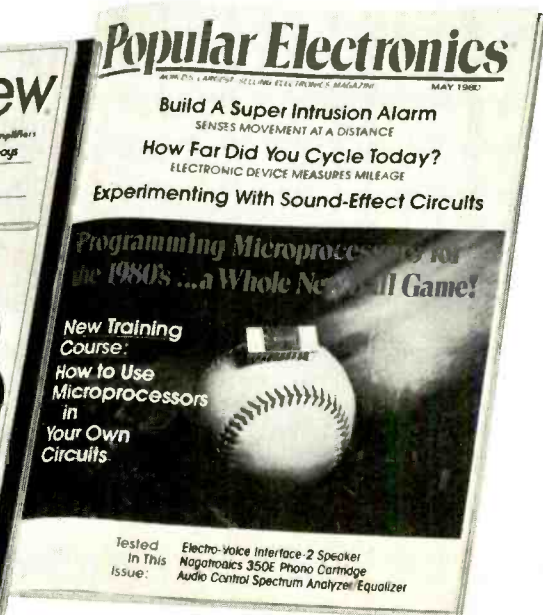

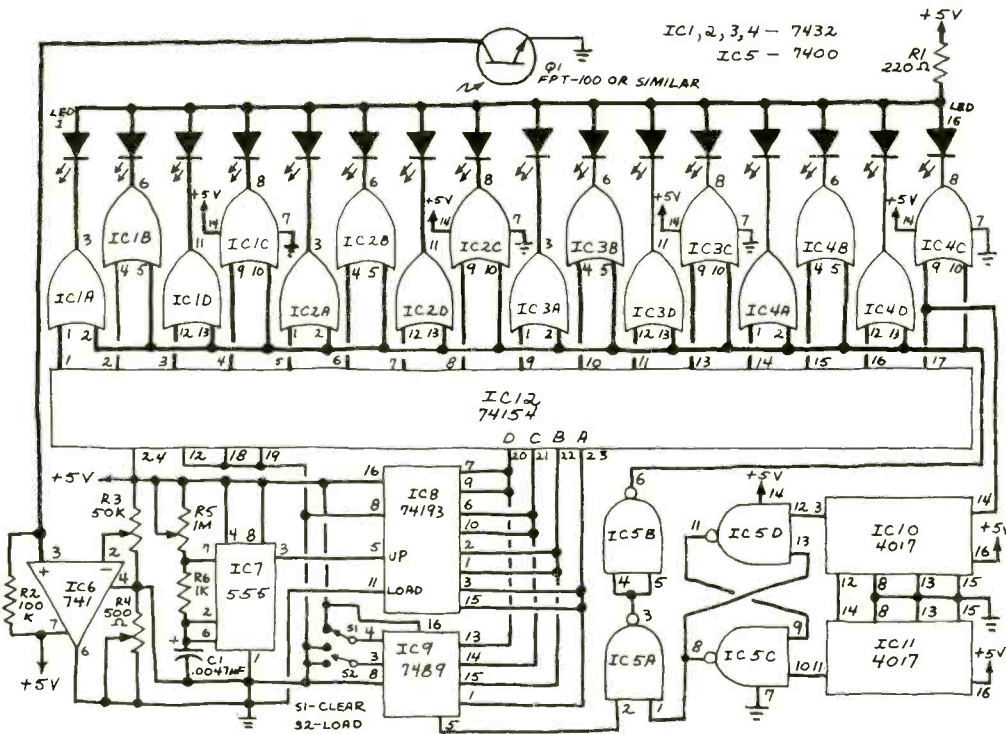

Fig. 6. Complete circuit of a 4-by-4 LED display controlled by a light pen.

It's even possible to extinguish the unselected LEDs for intervals of one second or more by slowing down the clock. The selected LEDs will appear to glow continuously and the other LEDs will blink on every second or so during the scan period.

Figure 6 is the schematic of a practical circuit that corresponds to the block diagram of Fig. 5. Although the circuit appears much more complex than the relatively simple light-pen data-input terminal described in Part 1, that circuit forms

CREATE ANY RHYTHM

new improved memory

PROGRAMMABLE DRUM SET

Our popular Programmable Drum Set's simple programming system allows even first time users to structure bass, tom, snare, wood-block and clave sounds into any rhythm in any time signature. Versatile memory organization provides simultaneous storage of two separate rhythm patterns each with its own bridge rhythm. Bridges are activated from either the control panel touch plate or optional foot switch and are automatically synchronized to the main rhythm. Improved memory circuitry lets the "save" mode hold rhythm patterns for over one year while battery life for normal operation has been extended to several hundred hours.

In easy to assemble kit or fully assembled.

() Send #3750 'Drum Set Kit, \$89.95 plus \$3 shipping enclosed.
 () Send #3750 'Drum Set Assembled, \$154.95 plus \$3 shipping enclosed.
 () Send Free Catalog.

Name: _____
 Address: _____
 City: _____ State: _____ Zip: _____
 VISA: _____ MC: _____ Card No. _____

RA ELECTRONICS, DEPT 1-P, 1020 W WILSHIRE, OKLA CITY, OK 73116

CIRCLE NO. 45 ON FREE INFORMATION CARD

SEE YOUR DEALER TODAY

DEMAND THE ORIGINAL

'Firestik'

The #1 Helically Wire-Wound and Most Copied Antenna In the World!

CITIZEN BAND
 2 METER • MARINE TELEPHONE
 LAND MOBILE TELEPHONE

FIBERGLASS ANTENNAS AND ACCESSORIES.

CORDLESS TELEPHONE ANTENNA INCREASES DISTANCE 5 TO 10 TIMES! NEW MODEL 49 V.I.P.

SPECIAL QUOTES!
 ON 27 TO 1000 MHZ
 FIBERGLASS ANTENNAS
 ANYWHERE IN THE WORLD!

Dealer & Distributor Inquiries Invited
 SEND FOR FREE CATALOG
 Serving the CB and Communications Market Since 1962.

'Firestik' Antenna Company
 2614 East Adams/Phoenix, AZ 85034

Name _____
 Street _____
 City _____
 State _____ Zip _____

See Us In Booth #1407 At The WCES Show In Las Vegas

CIRCLE NO. 62 ON FREE INFORMATION CARD

PARTS MASTERS

STOCKING DISTRIBUTOR

VALHALLA

**4 1/2 DIGIT LAB DMM
 MODEL 4500**
 Accuracy-DC Volts ±.05%
 Resistance ±.1%
 AC Volts ±.25%

HITACHI

**35 MHZ DUAL TRACE
 OSCILLOSCOPE
 MODEL V-352**
 Sensitivity-1mV/div to 5V/div
 Bandwidth-DC to 35 MHz
 Sweep time-0.2µs/div to 0.2s/div

PARTS MASTERS, INC
 P.O. BOX 684 PINEBROOK NJ 07058
 (201) 227-7797

CIRCLE NO. 46 ON FREE INFORMATION CARD

the core of this one. You can verify this for yourself by noting the almost identical connections of the 555 timer, 74193 counter, 74154 decoder and the light pen comprising *Q1* and operational amplifier *IC6*.

The lowest-order bits in each nibble of a 7489 4-by-16-bit RAM (*IC9*) provide a 1-by-16-bit RAM for the circuit. Although three-fourths of this RAM is not utilized, it's always available should you wish to expand the display.

Two series-connected 4017 CMOS decade counters (*IC10* and *IC11*) and an RS flip-flop made from two gates in a 7400 (*IC5C* and *IC5D*) comprise the circuit's modified divide-by-10 counter. The remaining two gates are configured as a gate that ANDs the outputs of the RAM and the divide-by-10 counter. The AND output is ORed with each of the 16 outputs of the 74154. The LEDs are illuminated sequentially.

Modifying the Circuit. There are several modifications that can be made to the circuit that was just presented. You can eliminate counter *IC11* by connecting pin 10 of *IC5* to pin 11 of *IC10*. This will provide divide-by-10 operation, but the unselected LEDs will be strobed once for every nine times that the selected LEDs are strobed.

There are several ways to substitute other memories in place of the 7489 (*IC9*). You can, for instance, use a MOS or CMOS 256-by-1-bit RAM if you prefer. While only the first 16 bits will be used, the remaining 240 will be available for future expansion of the circuit. You can eliminate RAMs entirely by using an array of flip-flops. The resulting circuit, however, will employ more ICs than the RAM version.

A Long-Range Light Pen. During my experiments with the light-pen circuits that have been described in this two-part series, it often occurred to me how convenient it would be to have a long-range light pen. This would not be possible with red LEDs, however, because the optical power typically radiated by red emitters is measured in tens of microwatts. Also, their spectral emission peaks at approximately 670 nm, halfway down the response curve of most phototransistors.

An infrared LED made from gallium arsenide is much more powerful than a red LED. When, for example, a forward current of 20 mA is flowing, an infrared LED might emit more than one milliwatt of optical power. Also, its near-infrared emission corresponds closely to the wavelengths at which a silicon phototransistor exhibits peak response.

On the assumption that an infrared LED should increase the detection range of the light pen, I connected a General Electric 1N6266 near-infrared emitter in series with one of the red LEDs in the display in Fig. 6. The detection range increased from a fraction of an inch to several inches. I then removed the red LED and connected the infrared emitter in its place. This increased the current through the infrared emitter and resulted in a further increase in the detection range.

Of course, visible emitters must be used in light-pen-controlled displays. Therefore, I tried a GE SSL-3 LED which emits both near-infrared and visible green light. This LED, which is no longer manufactured, consists of a gallium arsenide chip coated with an infrared-sensitive phosphor. When forward biased, the chip emits infrared light. This stimulates the phosphor into emitting green light. The result is a visible green beam superimposed upon an invisible infrared beam.

Using the SSL-3 resulted in a light-pen detection range of several inches. But it proved impractical to use an array of such LEDs in the display because the low duty cycle resulted in a barely visible green glow.

My final attempt to extend the light pen's detection range used a simple pnp driver delivering several hundred milliamperes to the LED during each strobe pulse. This resulted in the radiation of enough infrared power to trigger the light pen at a distance of up to ten inches.

The range resulting from the use of infrared LEDs can be further extended by adding a collection lens to the light pen. Theoretically, the detection range will be doubled each time the collection area is doubled. Adding lenses to the infrared emitters is not advisable. This would restrict the detection region of the light pen to sixteen narrow cones of invisible light. The use of only the self-contained lenses of typical infrared LEDs results in a much broader detection region. ♦

Build a low-cost earth terminal and pick up satellite TV.

Get our professional-quality LNA amplifier... the rest is easy!

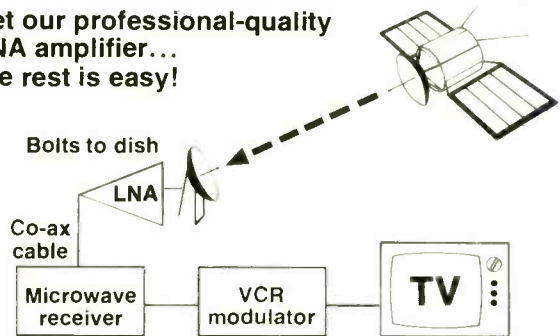

The only sophisticated component you need is a low-noise amplifier to boost the satellite signal.

And now you can buy it directly from the industry leader that supplies the major cable-TV stations.

Assembled systems cost up to \$12,000, but you can build your own for a fraction

of that cost. Order your 120°K LNA from Avantek for only \$795 and we'll send you a complete sourcebook for low-cost system components.

Call or write Avantek, Inc., 3175 Bowers Ave., Santa Clara, CA 95051.

Avantek

Charge by phone: (408) 727-0700 • Ask for LNA order desk.
VISA & Master Card welcome • Allow 30 days for delivery.

CIRCLE NO. 7 ON FREE INFORMATION CARD

Fall '80 TEST EQUIPMENT Electronic Component Catalog

FREE 128 Page Book



We carry the Following:

TEST EQUIPMENT

- B & K
- LEADER
- VIZ
- BECKMAN
- HITACHI
- GLOBAL SPECIALTIES
- DATA PRECISION
- HICKOK

ELECTRONIC COMPONENTS

- JAPANESE & MOTOROLA Transistors
- IC's, FET, Diodes
- Capacitors
- Resistors
- Connectors, Cables

TOOLS

- Weller, Ungar, Xcellite, Vaco, etc.

- Over 10 million components in stock to serve you
- Over 20,000 sq. ft. of warehouse in the East & West
- NO MINIMUM/NO SHIPPING on orders over \$100



FUJI-SVEA®

P.O. Box 40325 Cincinnati OH 45240
Dept. Popular Electronics

CALL TOLL FREE
800-421-2841

Local: 513-874-0220
Telex: 182 392

Name _____ Phone _____

Company _____

Address _____

City _____ State _____ Zip _____

Be an Electrician



**CONSTRUCTION
MAINTENANCE
CONTRACTOR**

Train at home
in spare time

MAKE MORE MONEY! Check out Electrician's wages against the kind of money you make now!

Even before you're ready to go after a full-time job as an electrician, you could be making extra money doing odd jobs for friends and neighbors. And think of the money you'll be able to save doing your own electrical work. Learn to specify and install wiring, operate and control motors and generators, use and maintain transformers and storage batteries.



We show you how to troubleshoot for short circuits, overloads and open wires. You'll be ready to take almost any electrician licensing examination offered by state, city or county. Because opportunities vary from time to time and from one part of the country to another, we encourage you to check on the job market in your area. Mail coupon for free facts and results of survey showing employment success of our graduates.

NO NEED TO QUIT YOUR JOB OR REGULAR SCHOOL

Everything explained in easy-to-understand language with plenty of drawings, diagrams and photos. Tools, materials, test equipment included with course. You learn at your own pace. No time wasted traveling to class.

Teachers are as close as your telephone. No charge! Use our toll-free 24-hour home-study hotline as soon as you enroll. **MAIL COUPON TODAY!**



ELECTRICIAN SCHOOL, Dept. PD0C0
ICS Center, Scranton, PA 18515

Rush free facts that tell how I can train at home in spare time to be an electrician. No obligation, no salesman will call!

NAME.....AGE.....
ADDRESS.....
CITY/STATE/ZIP.....

Save on Calculators

Olympic Sales Co is the largest Hewlett-Packard dealer in the world! ask HP

- HP 41C Scientific 239.95
- Card Reader for 41C 178.95
- Printer for HP-41C 309.95
- Optical WAND for 41C 112.95
- Memory Module for 41C 39.95
- HP-34C Scientific 124.95
- HP-38C Business 124.95
- HP-39C Scientific 98.95
- HP-37E Bus Prog 58.95
- HP-32E Adv Scientific 111.95
- HP-67 Scientific prog 29.95
- HP-67 Scient prog printing 579.95



HP 85 COMPUTER
We have the lowest prices on HP in America and elsewhere. Do not waste money—buy from us and save. HP-85—Graphic Plotters—Letter quality printers—16K Memory modules—Software, etc. (coming soon. 8 models of Disk Drives for HP-85) HP-85 ROM.

"C" stands for continuous memory. We carry an enormous stock of HP goods and HP accessories at all times. One year guarantee by HP on all calculators. 90 days on computers. All units complete.

TEXAS INSTRUMENTS

- TI 58/59 Librarian 33.95
- TI 5040 printer 89.95
- TI 5015 printer 69.95
- TI 5213 printer 160.00
- TI 5215 printer 175.00
- TI 5217 printer 190.00
- TI 5219 printer 205.00
- PC-100C 159.95
- PC-100A 169.95
- TI-95 34.50
- TI-30 17.95
- TI-35 24.75
- TI-59 208.95
- TI-58C 98.95
- TI-57 49.95
- TI-5100 39.95

- Math Marvel 32.95
- MBA 59.95
- Bus Analyst II 43.95
- Bus Analyst I 29.95
- Speak and Spell 58.95
- Speak and Read 66.95
- Speak and Math 73.95
- Language Tutor 159.95
- Business Card 38.50
- Investment Analyst 48.95

SPECIALS Computers at unbeatable prices

APPLE II Computer
Peripherals, accessories, software for immediate delivery and the lowest prices. Call us. We carry a huge inventory of Apple Products: 16K-32K 48K, Disk Drives, Monitors, Graphic Tablets, Pascal, Fortran, DDS, 33 Silntype printers and on and on.



We are now taking orders for Apple III Systems. First come, first served. Call us about Apple III

- TEXAS INSTRUMENTS Computer**
- 99/4 Computer console 689.95
 - Mattel Race Hrsrse Anlysr Comput 119.95
 - 12" Color Monitor 369.95
 - Sony Walkmm/Sndabout Stereo p/lyer 169.95
 - ATARI 800 16K Computer 799.95
 - Sony TRS 300 Walkmm recds/plays 189.95
 - ATARI 400 8K Computer 469.95
 - Crag Transistor doubl capact MI00SE 139.95
 - Mattel Intell TV gme 2609
 - 239.95
 - BSR X 10 Timer 59.95
 - Contlr/ connd 33.95
 - Sharp - S.C.M. - Royal - Victor - Canon - PearlCorder - Sony - RCA

Prices f o b. L.A. Minimum freight & handling charge \$4.95 In CA, add 6% sales tax. Goods subject to availability. We'll beat any advertised price if competitor has goods on hand.

Request our 130 page catalog in writing. Outside CA, toll free 800-421-8045. In CA, Call below #3 incl. Mon - Sat 7AM - 6PM.

OLYMPIC SALES COMPANY, INC.
236 South Oxford Avenue - P.O. Box 74045 - Los Angeles, CA 90004
(213) 381-3911 or (213) 381-1282 - Telex 67-3477

CIRCLE NO. 43 ON FREE INFORMATION CARD

DX LISTENING

By Glenn Hauser

Trends in International Broadcasting

Israel Radio became the first international broadcaster to transmit slow-scan television (SSTV) pictures, in an historic experiment Nov. 2, 1980. Three scenes of Jerusalem were each transmitted three times on five different broadcasts that day, despite the fact that the station was unable to transmit on AM at that time free of distortion. This is an experiment we encouraged in the July "DX Listening," and *Israel Radio* indicated there would be more such tests. It appears unlikely that *Radio Australia* will try it, since their DX program was cancelled.

BBC World Service installed a new studio-based audio processing and compression system as of Sept. 14. While it gives speech more "punch" under difficult reception conditions, it brings up the background noise to a more annoying level for the many listeners who already have clear reception. And despite its worldwide prestige, *BBC WS* has never gotten rid of the sound of clunking microphone switches, something which U.S. broadcast operators avoid without trouble.

Within Great Britain, *BBC* is using digital techniques to feed audio from studios to transmitters, and it has been suggested that the next step forward for international broadcasting should be digital rather than analog transmission direct to the listener. Studio-quality audio akin to that enjoyed by National Public Radio listeners, networked by satellite, would be possible on shortwave! Unfortunately, it could be transmitted, but no one has receivers for it. Moreover, there's another problem—bandwidth. Several contributors to the *Review of International Broadcasting* estimate it would take up to 1.5 MHz for a single digital transmission, much wider than any single ISWBC band. However, a somewhat degraded digital transmission using a quarter of that bandwidth, could fit into the 11-meter band with a minimum of disruption to other stations and still be an improvement over analog audio. And what station has programming more worthy of higher fidelity than the *BBC*?

Stereo on shortwave is another area of experimentation. Since any two fre-

quencies, no matter how close (even independent sidebands with the same center frequency), fade independently, stereo shortwave has never been seriously considered, although one pirate operator reportedly tried it. Some listeners enjoy a stereo effect by employing frequency or antenna diversity. However, once stereo AM broadcasting is underway, there is no reason the same system could not be tried on shortwave, where AM is also the standard transmission mode. Single-hop paths, where signals are strong and fading is minimal, should be the best bet.

There are a lot of unanswered questions about a *Radio Afghanistan* program carried on 19637.15 kHz SSB, most of the time between 0130 and 1930 GMT, and surprisingly heard well in North America. It's presumably to, or from, Afghanistan's "Great Northern Neighbor." One listener, David Crawford, hypothesizes that this and a nearby frequency are actually transmitting stereo; one of them L+R, the other L-R. But such experimentation would seem to be a very low-priority item in relations between Afghanistan and the U.S.S.R.

Most stations on shortwave have a characteristic identification tune, which serves the dual purpose of enabling listeners to tune in the best frequency before programming begins and giving the engineers expendable audio while they switch transmitters and antennas. We are pleased to note that several stations, including *Austrian Radio* and *Radio RSA* have cut the amount of time spent playing their pleasant but repetitive tunes in favor of more programming. All those minutes gained certainly add up, and we hope other stations will follow their example.

Another group of stations is in the vanguard of putting higher priority on programming for the airwaves than on correspondence, as a result of increasingly scarce funding. Instead of sending out QSL (verification) cards on request, as many stations still do, these stations have recently introduced restrictions. *Radio Australia* verifies reports only one month per year (in 1980 it was November). *BBC* does not verify except under special circumstances such as *World*

Radio Club competitions (but that program goes off the air in 1981). *Deutsche Welle* also declines to verify. *Radio Finland* requires comments on programs, rather than technical details, and then sends an "Audience Card." *Radio Nederland*, which frequently introduced new QSL designs, has reduced them to two a year starting in May and November, hoping this will reduce demand. (This will not likely deter the breed of DXer who tries to verify every frequency a station uses, which is certainly an abuse of station courtesy). *Radio Canada International* sends blank QSLs to everyone (but only those) on their mailing list. Those who want them verified must fill them out themselves and send them back to *RCI* for checking, verification and return. *RCI* says only a small fraction of recipients bother to do so. *Radio Sweden* has a system similar to *RCI*, but combines it with audience research by asking some questions on the card.

In October, *Radio Baghdad* reportedly offered a special QSL for the duration of Iraq's war with Iran! Meanwhile, both Iraq and Iran have announced plans to expand their international broadcasting capabilities.

We are happy to report that, as of this writing, the USAF Over-the-Horizon Backscatter radar threat to shortwave listening (detailed in September "DX Listening") had not materialized. The OTHB managers have been made aware that there is a concerned shortwave listening constituency.

Propagation Predictions. Though far from an exact science, shortwave propagation can be foreseen. These sources all approach it in different ways. You can get it by phone any time from Goddard Spaceflight Center, (301) 344-8129. *WWV* has capsule summaries every hour at 18 past, on 2.5, 5, 10, 15 and 20 MHz; *WWVH* at 45 past on 2.5, 5, 10 and 15. Weekly outlooks are included on my *RCI* DX reports, Saturdays in the 2130 broadcast, and Mondays at GMT 0100 and 0400. George Jacobs issues *Mail-a-Prop* every two weeks, at \$25 a year, and sells his new *Shortwave Propagation Handbook* for \$7.95 ppd. in U.S.A., both from Box 1714, Silver Spring, MD 20902. And at least one broadcast DX program gives recommended frequency ranges for the following month—*Radio Sofia*, the last Friday in the 2130 broadcast, repeated Saturday 0430, Monday 0000.

Special-Purpose Broadcast Stations. There is a growing number of limited-range, low-power stations which are for the public, but do not broadcast programming in the usual sense. They

also make challenging DX targets for those outside their intended coverage areas. Operating on 530 and 1610 kHz are *Highway Advisory Radio (HAR)* and *Traveller's Information Service (TIS)* stations, normally running tape-loop messages that repeat every few minutes. They are found near national parks, resorts, airports and highway construction areas, with powers of about 10 watts and deliberately inefficient antennas. A cluster of several HAR stations are synchronized on 530 kHz from Knoxville, TN, in preparation for the 1982 World's

Fair. A TIS station on 530 in Gatlinburg, TN, was picked up as far away as Maryland by Hank Holbrook. *NOAA Weather Radio* now has more than 300 stations across the country broadcasting continuously on one of three frequencies: 162.4, 162.475 and 162.55 MHz. Their potential range expands greatly during intense sporadic E openings. If your FM band is "wide open" for skip, check these frequencies too.

Country by Country. *China.* Learning English is all the rage here, and lots

Hear there and everywhere.



Easy tuning, digital display, professional quality

R-1000

The R-1000 is an amazingly easy-to-operate, high-performance, communications receiver, covering 200 kHz to 30 MHz in 30 bands. This PLL synthesized receiver features a digital frequency display and analog dial, plus a quartz digital clock and timer.

R-1000 FEATURES:

- Covers 200 kHz to 30 MHz continuously.
- 30 bands, each 1 MHz wide.
- Five-digit frequency display with 1-kHz resolution and analog dial with precise gear dial mechanism.
- Built-in 12-hour quartz digital clock with timer to turn on radio for scheduled listening or control a recorder through remote terminal.
- Step attenuator to prevent overload.
- Terminal for external tape recorder.
- Tone control.
- Built-in 4-inch speaker.

- Three IF filters for optimum AM, SSB, CW. 12-kHz and 6-kHz (adaptable to 6-kHz and 2.7-kHz) for AM wide and narrow, and 2.7-kHz filter for high-quality SSB (USB and LSB) and CW reception.
- Dimmer switch to control intensity of S-meter and other panel lights and digital display.
- Effective noise blanker.
- Wire antenna terminals for 200 kHz to 2 MHz and 2 MHz to 30 MHz. Coax terminal for 2 MHz to 30 MHz.
- Voltage selector for 100, 120, 220, and 240 VAC. Also adaptable to operate on 13.8 VDC with optional DCK-1 kit.

OPTIONAL ACCESSORIES:

- SP-100 matching external speaker.
- HS-5 and HS-4 headphones.
- DCK-1 modification kit for 12-VDC operation.



KENWOOD

TRIO-KENWOOD COMMUNICATIONS INC.
1111 WEST WALNUT / COMPTON, CA 90220

SAVE!

MONEY • TIME • FREIGHT

QUALITY STEREO EQUIPMENT AT LOWEST PRICES.

YOUR REQUEST FOR QUOTATION RETURNED SAME DAY.

FACTORY SEALED CARTONS—GUARANTEED AND INSURED.

SAVE ON NAME BRANDS LIKE:

PIONEER	SANSUI
KENWOOD	DYNACO
SHURE	SONY
MARANTZ	KOSS

AND MORE THAN 50 OTHERS BUY THE MODERN WAY BY MAIL—FROM

illinois audio

BANK CARDS ACCEPTED

12 East Delaware

Chicago, Illinois 60611

312-664-0020

800-621-8042

CIRCLE NO. 27 ON FREE INFORMATION CARD

Be an AUTO MECHANIC!



Job opportunities for automobile mechanics will be plentiful in the years ahead according to U.S. Government Dept. of Labor forecast.

Before you finish, you'll learn to tear down the engine, re-line brakes, repair and replace parts for steering, front end, clutch, differential...even transmission, fuel, cooling and electrical system...everything from minor tuneups to major overhauls.

No need to quit your job or school. You learn at your own pace and there's no time wasted going to and from class. Consultants are as close as your telephone. No charge! Use our toll-free 24-hour home study hotline as soon as you enroll! **Make extra money...Save Money, too!** Check out the price of an engine tune-up, carburetor overhaul or brake job.

Then imagine how much ready cash you could save on your own car repairs even before you're half-way through your course. **Maintenance Kit and Tune-up Kit included with course...Yours to use and keep.** Because opportunities vary, we encourage you to check on the job market in your area. Mail coupon for free facts and results of survey showing employment success of our graduates. **MAIL COUPON TODAY!**

ICS ICS Auto Mechanics School, Dept. PD0C0
SINCE 1981 ICS Center, Scranton, Pennsylvania 18515

Rush free facts on how I can learn Auto Mechanics at home in spare time. No obligation. No salesman will call.

NAME _____ AGE _____
 ADDRESS _____
 CITY _____ STATE _____ ZIP _____

dx listening

of lessons are broadcast on local and national stations. A few you might try for, per information from Australian DX News: 0000 GMT on Program I, 15590, 15510, GMT Mon/Wed/Thu/Fri/Sat; also at 0815. At 1000 on Nei Minggu, 4750 kHz; 1130 Wed/Fri on Wulumqi 4500; 1330 Sun-Fri on Lanzhou, 4865 and Fuzhou 4975, 2340; 1400 Mon-Fri on Lasa 4750, 5240, 4931, 7170.

Cuba is the heading, but Ethiopia is the more likely location for a station on 7218 kHz, heard last July at 1657-1745 GMT by Rikard Johansson as he circumnavigated Africa. "*Radio Olanda*" (perhaps the name of the female DJ) carried entertainment in Spanish for Cuban military personnel.

Chile. Two new shortwave stations in the far south have been heard in California. Ron Howard heard *Radio Patagonia Chilena*, Coyhaique, on 6080 from sign-on 1030 (currently 0930 due to DST in Chile); and *Radioemisora Mantantales*, Chile Chico was reported by Bob Hill, testing around 0100-0230 on 6225 (variable to 6260). In the mornings, you might hear instead *Radio One*, Philippines, which has been on 6225, too, instead of its nominal 6170.

Guyana. Those who listen only in the evening seldom hear *Action Radio*, 5950, but it's widely heard after sign-on 0755. Maxfield Greenwood "enjoys" their cockroach powder ads and death notices at 0830; Doug Jaffe recommends "Sunday Songtime" at 0900 for requests with an Indian flavor

Malta is easy to hear thanks to *Deutsche Welle's* relay station (such as 15105 at 0120-0150), but hearing broadcasts in the Maltese language (a mixture of Italian and Arabic) is another matter. Only two shortwave stations have it on their schedule—barely. *BBC* has seven minutes Monday-Friday at 1635-1642 on 15345 and 11680. RAI, Italy, has it at 1430-1455 on 9710 and 7235, but has run this P.S. for the past year: "This transmission is temporarily in Italian because of the unavailability of Maltese-language announcers"! (If you speak Maltese, here's your chance.) And Malta has one other interesting connection. Tom Meijer frequently refers to his audience there, since tapes of Radio Nederland's "Happy Station" are carried on a cable radio network.

Poland. The name change that *Radio Warsaw* made last May to *Radio Polonia* has been explained by Richard E. Wood and Mike Tripka in *Review of International Broadcasting*, as emphasizing contact with the Polish "diaspora," which the word Polonia connotes.

Portugal. In November, we mentioned Radio *Renascenca's* plans for 100-kW shortwave broadcasts. From Andy Sennitt, of the *World Radio-TV*

Handbook, we learn that the frequency to be used is 6155. It happens to be one which has not been used for some time by any powerful station in our evenings.

Surinam. More updating to our November item on *Radio Apintie*. It jumped like a grasshopper around the 60-meter band to find out which frequency would serve it best—4794, 4751, 4950 and 5006 were among them. Power was raised to 4.5 kW, and a service to Surinamese in Holland was begun at 0430-0630 on Thu/Fri/Sat, per Andy Sennitt.

Switzerland. For a few days each month, the *Red Cross Broadcasting Service* carries out broadcasts in several languages, including English. Try 7210 kHz at 0600-0700 GMT on Dec. 29 and 31, Jan. 26 and 28, and Feb. 23 and 25. You might also hear *RCBS* at 0945-1015, Jan. 27 on 21695, 21520, 15305, 9560; Jan. 29 on 21630, 21520, 17830, 15430. Broadcasts at this hour are only in odd-numbered months.

Tristan da Cunha. At the top of the 'wanted' list for almost every North American DX listener is *Tristan Radio*, *ZOE*. On its present schedule of 1900-2200 GMT, Sun/Wed/Fri, however, only those on the East Coast during midwinter have a chance with a darkness path opening up near sign-off. Tom Haskett wrote the station anyway, and received an information sheet which said the station uses 40 watts on 3290 kHz, and has been on the air since 1968. Programs include kid shows, comedy, drama and/or serials, light and pop music, and news; much of it from the BBC and South Africa. They use two Garrard GT-35P record decks, a Sony TC-158D stereo cassette, an FRG-7 receiver fed into a Millbank Electronics MCC MK-111 stereo mixer. We tell you this so you can visualize the studio during your DX catch of a lifetime; it's a bit easier if you visit South Africa. *ZOE* requires items from their own local newscast at 2009 to be quoted by those trying for a QSL.

Updating Listings. The following changes and additions should be made in the "English Broadcasts" listings that appeared in the December issue. To make the corrections as concise as possible, only the GMT, station name, and frequency correction are given.

- 1230-1330, Radio Korea, 7550, 11830, ex-1300
- 1230-1551, WYFR, 17785, not 17845 Sun.
- 1235-1245, V. of Greece, 17830, ex-17835
- 1300-1351, WYFR, 11830, ex-9535
- 1400-1800, WYFR, 15215, ex-11830 and 9535
- 1535-1545, V. of Greece, 17830, ex-17835
- 1600-1630, R. Portugal, 21530, ex-21475

Apple Computer

Complete Microprocessors line, peripherals & Terminals.

APPLE II PLUS, 16K	\$989.00	Disk130K controller	\$575.00
SOROC IQ120	795.00	SOROC IQ140	1395.00
ADM3A, assembled	840.25	TI-99/4	499.00
TI-745	1440.00	TI-810	1715.00

Texas Instruments

Invest. Anal.	49.95	Speak & Spell	\$54.95
TI-55	34.50	Spelling Bee	30.95
Accessories call us		TI Programmer	52.50
TI-58C	87.50	MBA	52.50
PC100C	149.95	TI-5100	37.50
TI-59	208.50	TI-5015	59.00
Dig. Therm.	105.00	TI-5025	61.95
Lang. Tutor	160.00	TI-5040	79.00

HEWLETT-PACKARD

HP-67	\$299.00	HP-41C Prog	238.00
HP-97	579.00	HP 41C Printer	309.00
HP-33C	89.95	HP-41C CRD RDR	177.95
HP-34C	122.00	HP-41C Mem. Module	40.00
HP-38C	122.00	HP-32E	56.00

HP-85 AND ACCESSORY CALL US FOR PRICES

SCM TYPEWRITER SPECIALS

SCM-2200	\$269.00	INTRPID	\$274.00
SCM-2500	279.00	CLASSIC 12	144.00

All units shipped in original cartons with accessories according to manufacturer's specification. Send money orders personal check 12 weeks to clear. In Illinois add 6% sales tax. Add \$4.95 minimum shipping & handling charges per unit. We ship UPS. Subject to availability. Written warranty for specific products can be obtained free upon request. Above prices are for mail order and prepaid only. Prices and specifications subject to change without notice. Send mail orders.

Nabih's, Inc.

519 DAVIS EVANSTON, ILL. 60201 TEL: 312-869-6144



DON'T BLAME THE SOFTWARE!



Power Line Spikes and Hash often cause memory loss or erratic operation. Often floppies, printer & processor interact!

OUR unique ISOLATORS eliminate equipment inteaction AND curb damaging Power Line Spikes, Surges and Hash.

3 filtered 3-prong sockets and integral Spike Suppression. 125 VAC, 15 Amp, 1875 W Total - 1 KW per socket.

ISO-1 ISOLATOR. 3 Filtered Sockets; 1000 Amp 8/20 usec Spike Suppressor \$56.95

ISO-4 ISOLATOR. 6 Filtered Sockets; 1000 Amp 8/20 usec Spike Suppressor \$96.95

ISO-3 SUPER-ISOLATOR. 3 DUAL filtered Sockets; 2000 Amp 8/20 usec Spike Suppressor \$85.95

ISO-7 SUPER-ISOLATOR. 5 DUAL filtered Sockets; 2000 Amp 8/20 usec Spike Suppressor \$139.95

Master-Charge, Visa, American Express
Phone: 1-617-655-1532

Electronic Specialists, Inc.

171 South Main Street, Natick, Mass. 01760
Dept. PE (617) 655-1532

CIRCLE NO. 19 ON FREE INFORMATION CARD

- 1600-1800, AFRTS, add 9700
1705-1755, R. France, Int., add 17795
1800-2100, AFRTS, 11805 and 15345 ex-21570 and 11790
1900-2000, HCJB, 15295, ex-15300
1900-2151, WYFR, 15215, ex-11830
2000-2030, Israel Radio, 15105, 9425, 7412, ex-11610 and 17710.
2000-2130, R. Confusion, 13988 (Dec. 14, Jan. 18)
2030-2100, R. Portugal, 7185 and 9740, ex-11775 and 9605
2100-2200, R. Moscow World Service, 11860 and 9685
2100-2451, WYFR, 15380, ex-11830 and 5985
2130-2200, HCJB, 15295, ex-15180
2130-2200, R. Sofia, 7115, not 9530
2145-2215, Swiss R. Inter., 21585, 9535
2150-2200, R. Free Europe, 9750, 11855, 9565, ex-15245 and 11825 Fri.
2200-2215, R. Japan, 11790 (via Portugal)
2200-2300, R. Moscow World Service, 9610
2200-2300, AFRTS, 15345, not 11790
2230-2300, Israel Radio, 7412, 9009, not 17710 and 15584
2300-2330, R. Vilnius, not 7215
2300-2400, AFRTS, 6030, ex-15430
2300-0200, R. Moscow, 21530, 9800, 7195, 7115, not 15180, 11780, 9530, and 9490
2330-2400, HCJB, 15360, 26020
0000-0030, Israel Radio, 7412, ex-15584
0000-0055, R. Peking, 15125, ex-15120
0000-0100, AFRTS, 6030, not 15345
0030-0100, R. Kiev, 9750, not 9800 and 7215
0100-0125, Israel Radio, 7412, ex-15584
0100-0155, R. Peking, 15125, ex-15120
0130-0300, R. Confusion, 7550 (Dec. 15 and Jan. 19)
0200-0255, R. Peking, 15125, ex-15120
0200-0255, R. Bucharest, ex-0130-0225
0200-0400, VOA, 5995, 9650, 15205
0200-0400, R. Moscow, 21530, 17720, 9800, 9685, 7195, 7115, not 11780, 9635, 9530, 9490
0230-0245, UN Radio, 15685 SSB, ex-15752
0230-0300, R. Lebanon, 15170, not 170
0230-0330, R. Korea, 11810, 15570, ex-0100-0200
0230-0500, HCJB, 11915, ex-11910
0300-0330, R. Portugal, 6185, ex-9765
0300-0330, R. Kiev, 17870, 15240, 15100, 9750, not 11690, 9800, 9735, 9505, 7215, 7150
0300-0355, R. Peking, 15125, not 15120
0330-0430, R. Korea, delete
0351-0358, V. of Yerevan, 15240, 15100, ex-15405 and 15180
0400-0455, R. Peking, 15125, ex-15120
0400-0600, WYFR, 9695, 6070, ex-5985
0400-0600, R. Moscow World Service add 17760, 9800, 7195
0400-0600, R. Moscow, add 15455
0500-0515, Israel Radio, 11960, 9009, not 15584 and 15200
0500-0530, R. Portugal, 9575, ex-9765
0530- , R. Ghana, 4915, not 4195
0530-0550, V. of Germany, add 11705, 6185
0600-0700, AFRTS, not 17765 and 15330
0700-0715, R. Japan, add 15270
0800-0900, R. Korea, 11810, ex-0730-0830

ETCO

CABLE TV CONVERTERS AND OTHER GOOD STUFF!

SMASHING ALL SALES RECORDS - OUR NEW 30 CHANNEL CABLE TV CONVERTER!

Convert cable channels to standard TV. No. 286AE047

39⁹⁵

\$34.95 ea / 5

HOT NEW IMPORT! REMOTE CONTROL 30 CHANNEL CABLE TV CONVERTER!

Remote control TV. No. 286VA275

89⁹⁵

\$79.95 ea / 5
\$74.95 ea / 10

ETCO MKII WIRELESS - THE ULTIMATE CABLE TV CONVERTER!

Set TV to channel 3 and the hang hell! No. 2862A008

189⁰⁰

VIDCOR 2000 CONVERTER ELIMINATES PROBLEMS WHEN TAPING FROM CABLE TV

Recording your VCR. No. 286VA950

89⁹⁵

\$17.50 ea / 10

UNUSUAL FACTORY SURPLUS MID-BAND - SUPER-BAND CABLE TV TUNER

Superband cable channel to a standard TV. No. 286VA342

19⁹⁵

\$17.50 ea / 10

FACTORY SURPLUS UHF TUNERS

Factory surplus UHF tuner. No. 286SU099

4⁹⁵

\$3.95 ea / 10

MINIATURE FM WIRELESS MICROPHONE

Hand held miniature FM wireless microphone. No. 286VA482

29⁹⁵

\$27.50 ea / 5
\$24.95 ea / 10

QUARTER-MILE WIRELESS MICROPHONE & RECEIVER SYSTEM

FCC approved crystal microphone & receiver. All features included. VU meter. No. 286VA093

69⁹⁵

\$49.95 ea / 5

ETCO GENERAL PURPOSE TUBE TESTER

In kit form. Check tubes. No. 286KT148

49⁹⁵

\$49.95 ea / 5
\$19.95 ea / 10

DUMPING! NORELCO ENDLESS LOOP CASSETTES!

3 minutes. No. 286VA605
6 minutes. No. 286VA606

4⁹⁵

\$4.45 ea / 10

IN STOCK - THE MURA CORDLESS TELEPHONE SYSTEM!

400 number. No. 286VA724

144⁸⁸

\$129.95 ea / 5

SALE OF QUARTZ BATTERY OPERATED CLOCK MOVEMENTS!

Accuracy 1 minute per year. No. 286VA561

9⁹⁵

\$8.95 ea / 5
\$24.95 ea / 10

20 AMP REGULATED 12VDC POWER SUPPLY!

12.5 volt. No. 286VA394

59⁸⁸

\$49.95 ea / 5

FREE

OUR LATEST 98 PAGE FASCINATING CATALOG

ETCO

ETCO ELECTRONICS
NORTH COUNTRY SHOPPING CENTER
PLATTSBURGH, N.Y. 12901

Check with our office. Visa & MasterCard OK. 15 days, no C.O.D.'s. Add 15% for UPS & handling (excess refunded). N.Y. State residents add 4% sales tax. Dealer & Export orders invited. Outside phone orders desk nearby close.

Call 1-518-561-8700

CIRCLE NO. 56 ON FREE INFORMATION CARD

www.americanradiohistory.com

JANUARY 1981

BULLET

ELECTRONICS, Inc.
PO Box 401244P Garland TX 75040
214 · 278-3553

The Greatest Breakthrough In Electronic Music Ever!

New! Super Music Maker Kit

Now you can play hundreds of songs using the Bullet Super Music Maker. The unit features a single factory programmed microprocessor IC that comes with 20 pre-programmed short tunes. By adding the additional PROMS (2708's) the system can be expanded to play up to 1000 notes per PROM. Just think... a compact electronic instrument that will play dozens, hundreds or even thousands of selections of music. The kit comes with all electronic components (less the PROM), and a drilled, plated and screened PC Board which measures 4" x 4". The 7 watt amplifier section is on the same PC board and drives an 8 ohm speaker (not included), from a whisper to ear splitting volume. Since the unit works on 12 VDC or 12 VAC*, vehicle or portable operation is possible. What do you get for \$23.50? Everything but a speaker, transformer, case, switches, and PROM. Additional 2708 albums containing popular tunes are available for \$15.00 each or you can program your own PROMS using information provided with the kit instructions. Lists of available PROM albums are available on request. *Note: Unit plays electronic music one note at a time. It is not possible to play chords or a melody with harmony simultaneously.*

Super Music Machine Kit **\$23.50**
DIP Switches (One 8 pos., One 5 pos.) 2.00/set
Molded Plastic Case 6.50

*Unit requires transformer for operation on 117VAC. Transformer should be 12V @ 1A secondary. Not available from Bullet

Sound Effects Kit \$18.50

The SE-01 Sound Effects Kit is a complete kit all you need to build a programmable sound effects machine except a battery and speaker. Our kit is designed to really ring out the TI7647T Sound Chip. Only the SE-01 provides you with additional security that includes a PULSE GENERATOR, MUX OSCILLATOR and COMPARATOR to make more complex sounds a snap. We help you in building the kit with a clear, easy-to-follow construction manual and we show you how to easily program the unit. Other dealers will sell you the chip or a set of parts but you are on your own to do the most difficult part - make neat sounds! Within a short time after you build the SE-01 you can easily create Gunshots, Explosions, Space Sounds, Steam Trains and much more. We think the Bullet SE-01 is the best deal on the market but don't ask us to ask the 15,000 happy SE-01 owners!

Complete Kit With Quality Plated PC Board **\$18.50**
(Less battery & speaker)

7 Watt Audio Amp Kit \$5.95

SMALL SINGLE HYBRID IC AND COMPONENTS FIT ON A 2 x 3" PC BOARD (INCLUDED). RUNS ON 12VDC. GREAT FOR ANY PROJECT THAT NEEDS AN INEXPENSIVE AMP LESS THAN 3% THD @ 5 WATTS. COMPATIBLE WITH SE-01 SOUND KIT

AY3-8910 PROGRAMMABLE SOUND GENERATOR

The AY3-8910 is a 40 pin LSI chip with three oscillators, three amplitude controls, programmable noise generator, three mixers, an envelope generator, and three D/A converters that are controlled by 8 BIT WORDS. No external pots or caps required. This chip hooked to an 8 bit microprocessor chip or Bus (8080, Z80, 6800 etc.) can be software controlled to produce almost any sound. It will play three-note chords, make bangs, whistles, sirens, gunshots, explosions, bells, whines, or grunts. In addition it has provisions to control its own memory chips with two I/O ports. The chip requires +5V @ 75ma and a standard TTL clock oscillator. A truly incredible circuit.

\$14.95 w/Basic Spec Sheet (4 pages)
60 page manual with S-100 interface instructions and several programming examples. \$3.00 extra

TRANSFORMER

200V 4A SCR
Sensitive Gate
7/51.00



A good transformer for TTL linear and smaller computer systems.
Inquiry: 11 Sec #1 150uA
Sec #2 150V, A Sec #3 80uPA
Size 2-3/2" W x 1 1/4" H
Construct with Open Frame W/Aluminum Wire

Order BE1 0005
\$2.95

THE PERFECT TRANSFORMER
117VAC primary 2VAC secondary @ 200ma
Great for all your CMOS or low power TTL projects. PC board mount
99c ea. 3/\$2.50
Size 1 5/8" W x 1 1/2" D x 1 1/2" H



ORDER
XFMR-03

COMPONENTS

*INDICATES ITEM IS HOUSE NUMBERED

301 OP AMP B LEAD CAN	3/100	1130 TAB PNP POWER	3/100
723 1/4 PIN DIP	50	*MC1251 8 PIN DUAL IC	250
741 OP AMP MINI DIP	6/110	1490 BAR GRAPH DRIVER	96
30 000 @ 15V COMPURATOR	2	7805 5V 1A REGULATOR	60
2M402 2MP COMPONENT	1/100	7805 5V 1A REG. TO 10	60
2M628 2 P U 1 W/SPECS	50	LM3911 TEMP. TRANSDUCER	110
LM390 2W AUDIO IC W/SPECS	1/96	IC W/SPECS	50
LM337 DUAL 1 M30BI W/SPECS	2	LM3307 DUAL COMPARATOR IC	49
LM3900 QUAD NORTON AMP	250	555 TIMER IC	39
LM324 QUAD OP AMP	32	*MC1340 QUAD NORTON AMP	75
7812 1A 12V REG	50	MC3340 ELECTRONIC	75
EL OPTO ISOLATOR MINI DIP	60	ALTERNATOR W/SPECS	75
*MEM 631 DUAL GATE MOSFET	50	LEDS	4/89
DIODE PROTECTED SIMILAR	30	JUMBO GREEN	5/89
TO 4073	50	JUMBO RED	5/89
MV1624 VARICAP DIODE 10 PFD	39	MEDIUM RED (1)	15
MS148 VARICAP DIODE	50	MEDIUM GRN OR YELLOW	15
47 PFD NOM. 3:1 RATIO	49	BI POLAR LED	15
LM317T ADJUSTABLE 1A REG	250	TWO COLOR RED/GRN	59

Call or write for FREE catalog.
POLICIES

NO C.O.D.'s SEND CHECK, MONEY ORDER, CREDIT CARD *
ADD 5% FOR SHIPPING. TX. RES. ADD 5% TAX. FOREIGN
ORDERS (EXCEPT CANADA) ADD 10% (20% AIRMAIL)
U.S. FUNDS ONLY
PHONE ORDERS ON MASTER CHARGE & VISA ONLY
(214) 278-3553

AMAZING DEVICES

"((((PHASERS))))"

PPF-1 PHASER PAIN FIELD — This device recently developed and patented in our labs is being evaluated by law enforcement agencies for riot and crowd control. It is now available but soon will come under the jurisdiction of weapons and internal machine control making it unavailable to the public. The device is hand-held and looks like a BUCK ROGERS ray gun. It is hazardous if not used with discretion.

PPF-1 PLANS **\$15.00**

IPG-1 INVISIBLE PAIN FIELD GENERATOR — This amazing, simple hand-held device is about the size of a pack of cigarettes and generates a directional field of moderate to intensive pain in the lower part of the head up to a range of 50'. Device is simple and economical to make.

IPG-1 PLANS **\$8.00** IPG-1K ALL PARTS **\$39.50**

IPG-10 ASSEMBLED & TESTED FOR ANIMAL CONTROL **\$49.50**

LASERS

RUBY LASER RAY PISTOL — Produces highly intense red beam, capable of burning. A hazardous device. PLANS, PARTS, SOURCES **\$15.00**

HIGH POWERED CARBON DIOXIDE BURNING AND CUTTING. Complete plans and all parts sources **\$15.00**

SOLID STATE IR 12 WATTS with built in power supply plans **\$8.00** Complete kit with collimator **\$74.00**

POCKET LASER pulsed, visible red plans **\$7.00**
Complete kit **\$59.80** Also complete plans and parts sources for RUBY, YAG, NEODYMIUM, HeNe ARGON, DYE, NITROGEN and many more lasers.

SECURITY

SNP-2 SNOOPER PHONE — Dial home or office phone while on vacation activating sensitive mike without phone ringing. Excellent property protection and intrusion device.

SNP2 PLANS **\$7.00**

SNP2K ALL PARTS **\$49.50**

SNP20 ASSEMBLED AND TESTED **\$89.50**

LONG RANGE XMTR PLANS **\$6.00**

SEE-IN-THE-DARK PLANS **\$8.00**

DIRECTIONAL SHOTGUN MIKE PLANS **\$7.00**

SUPER SENSITIVE PARABOLIC MIKE PLANS **\$7.00**

SOUND & TELEPHONE OPERATED TAPE RECORDER **\$6.00**

CATALOG ON PLANS, KITS & FINISHED UNITS **\$1.00**

Send check or money order to
SCIENTIFIC SYSTEMS, Dept. Q1, Box 716
AMHERST, N.H. 03031

CIRCLE NO. 52 ON FREE INFORMATION CARD

The world of electronics gee-wizardry

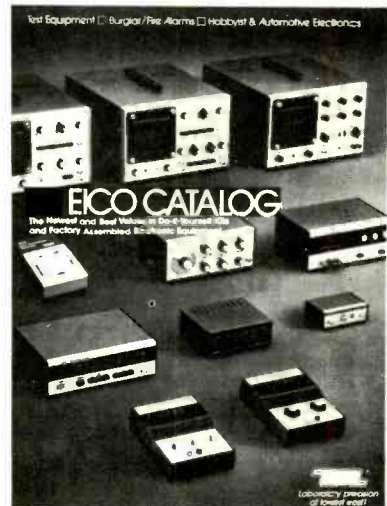

-YOURS FREE.

32-pages of test instruments — from the latest digital multimeters to the famous EICO scopes. Security systems. Automotive and hobbyist products. Kits and assembled. EICO quality. EICO value. For FREE catalog, check reader service card or send 50¢ for first class mail.

EICO® 108 New South Road
Hicksville, N.Y. 11801

CIRCLE NO. 18 ON FREE INFORMATION CARD

Enjoy Satellite TV Now



Better than Cable TV— Over 200 TV and radio services. Why waste money? Learn the whole story and build a video system the family can enjoy. No commercials, FREE movies, sports and Vegas shows — world wide, crystal clear reception connects to any TV set. Big (8 x 11 in.) book loaded with details, photos, plans kits —

TELLS EVERYTHING. Satisfaction Guaranteed.

GLOBAL TV ELECTRONICS

P.O. Box 219-K, Maitland, Florida 32751
Send \$7.95 Today! Add \$2.00 for 1st class (airmail)
or call our 24 hour C.O.D. Rush order line (305) 862-5068

Name _____
Full Address _____

CIRCLE NO. 22 ON FREE INFORMATION CARD

COMMERCIAL OFFICE PRODUCTS CO. QUALITY OFFICE PRODUCTS — AT DISCOUNT PRICES!

HP-97	\$579.95	HP-32E	\$ 54.95
HP-67	299.95	HP-41C	264.95
HP-38C	124.95	Mem. Modules	
HP-37E	59.95	for HP-41C	39.95
HP-33C	89.95	Printer	324.95
HP-34C	124.95	Card Reader	184.95
		Wand	112.95

HP-85 COMPUTER - IN STOCK - Call for Price
We stock Hewlett-Packard Accessories
Please call for price and availability

Texas Instruments

TI-58C	\$ 94.95	TI-30	\$ 14.95
TI-59	209.95	TI-35	21.95
PC-100C	165.95	TI-50	33.95
TI-5040A	79.95	TI-55	33.95
TI-5015	62.95	TI-57	46.95
TI-5100	38.95	Programmer	46.95
TI-5200	45.95	Inv. Analyst	44.95
TI-5213	114.95	Bus. Analyst-I	19.95
TI-5215	125.95	Bus. Analyst-II	Call us
TI-5217	135.95	Business Card	39.95
TI-5219	146.95	Data Card	21.95
TI-5142	129.95	MBA	52.95
Lang Trans	203.95		
Lang Modules	45.95		

ATARI 800 (16K) Personal Computer System **\$849.95**
400 Personal Computer System **\$499.95**

We Welcome Corporate Accounts
Master Charge or Visa accepted
Illinois residents add 6% tax
add \$3.00 shipping & handling charge
CALL OR WRITE FOR FREE CATALOG
Prices & availability subject to change without notice

COMMERCIAL OFFICE PRODUCTS CO.

1000 E. Higgins Rd., Elk Grove Village, IL 60007
CALL TOLL FREE 800-323-0662
In Illinois 312-364-7544

CIRCLE NO. 12 ON FREE INFORMATION CARD

PROJECT OF THE MONTH

Ultra-Simple Power Flasher

BY FORREST M. MIMS

Many high-brilliance light-flasher circuits have been published over the years in this and other electronics magazines. Almost every one of these flashers has employed power transistors or SCRs, components which require heat sinking and careful circuit design.

Figure 1 shows an ultra-simple flasher circuit that I recently built around an FRL-4403 flashing LED, with only a few additional components. It will flash at a typical rate of 3 Hz any lamp whose current and voltage requirements fall within the ratings of the relay's contacts. The particular relay specified in Fig. 1 has contacts that can handle up to 1 ampere at 125 volts. The lamp shown is rated at 150 mA at 6.3 volts.

Incidentally, *FRL* stands for *Flashing Red LED*. The FRL-4403 is a Litronix product (19000 Homestead Road, Vallco Park, Cupertino, CA 95014). This novel LED, which incorporates a flasher integrated circuit, is also available from Radio Shack (stock No. 276-036).

The FRL-4403 LED in the circuit shown in Fig. 1 does *not* produce a visible flash. You can modify the circuit as shown in Fig. 2 if you want the red LED in the FRL-4403 to flash each time the relay coil is energized. Although the LED will flash, it will not be as bright as if it were powered directly from a 5-volt supply. The circuit shown in Fig. 2 might occasionally cease to oscillate. When this occurs, it is necessary to readjust potentiometer *R2*. For this reason, use the circuit shown in Fig. 1 for such applications as emergency beacons in which high reliability is essential.

Both versions of the circuit might operate erratically or even fail to operate if both the oscillator circuit and the flashing lamp are powered by the same battery. These difficulties are due to the large current demand placed on the battery when the lamp is switched on. In some cases, the circuit will oscillate at much higher than its normal rate.

The oscillator portion of each circuit consumes only 20 to 35 milliamperes. Therefore, it's feasible to power it with a

small 6-volt battery if a silicon diode is connected in series with the positive terminal of the battery to drop the voltage to approximately 5 V. A much larger 6-volt lantern battery can be used to power the flashing lamp.

Of course, *both* the oscillator and flashing lamp can be powered from a common supply if it can source a suffi-

ciently large current. You can experiment with different supplies and lamps to determine if you will need more than one supply.

Finally, the circuits presented in Figs. 1 and 2 can both be used to apply power pulses to devices other than lamps. Typical applications include gating power to warning horns, alarm sirens, etc. ◇

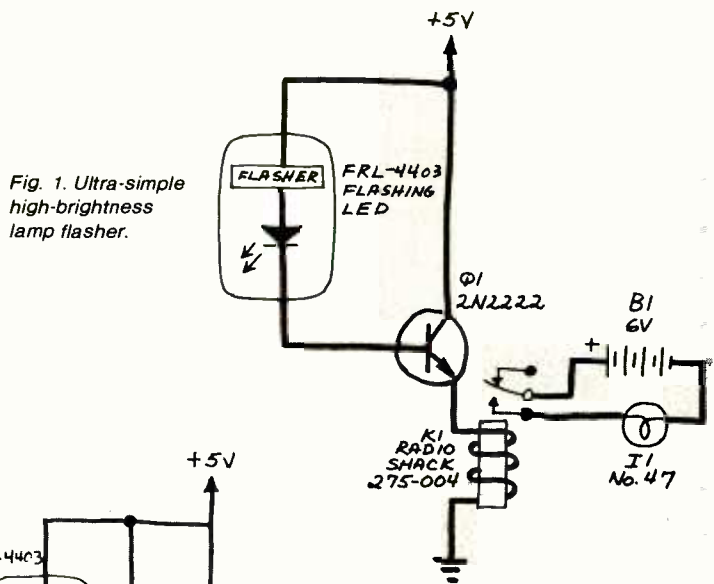

Fig. 1. Ultra-simple high-brightness lamp flasher.

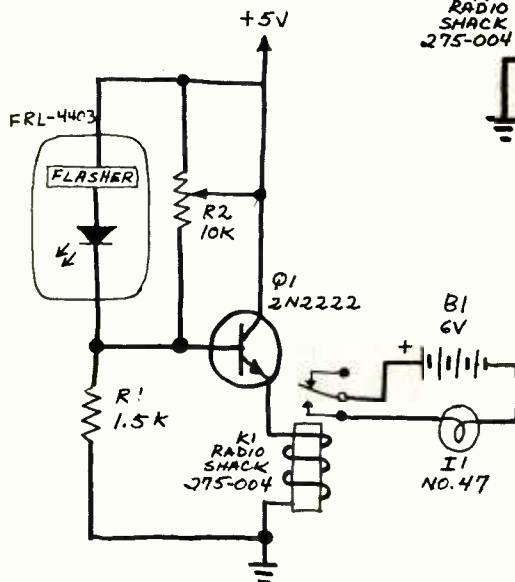



Fig. 2. Relay driver circuit with a flashing LED.

Popular Electronics

ADVERTISERS INDEX

RS no.	ADVERTISER	PAGE no.
4	AP Products	38
3	Apple Computer	Cover 2
61	Audio Dynamics Corp.	60
5	Audiomatic	87
6	Audio-Technica	58
57	Autologic Recruitment	81
7	Avantek	93
9	Beckman-EPG	15
	Bullet Electronics	98
10	Chaney Electronics	102
11	Chase Revel, (AEA)	77
	Classified Advertising	110, 111, 112, 113
41	Cleveland Consumer Computer	103
	Cleveland Institute of Electronics, Inc.	34, 35, 36, 37
12	Commercial Office Products	98
1	Communications Electronics	18
13	Components Express	32
58	Computer Specialties	64
14	Computique	16
15	Digi-Key Corp.	100, 101
16, 17	Dishwasher	2, 21
59	Dynascan Night Sentry	Cover 3
	Edmund Scientific	102
18	EICO	98
19	Electronic Specialists	97
56	ETCO	97
62	Firestik	92
20	Fluke Mfg. Co.	4, 5
	Fuji Svea	93
21	Gladstone Electronics	40
22	Global TV Electronics	98
23	Godbout Electronics, Bill	113
	Grantham College of Engineering	87
24	Hardside	49
25, 26	Heath Co.	28, 45, 46, 47
	ICS Center	94, 96
27	Illinois Audio	96
63	Int'l Components Corp.	115
28	Jameco Electronics	104, 105
29	JDR Microdevices	102
31	Jensen Tools	87
30	J&R Music World	80
	JS & A National Sales Group	1
32	Kenwood	95
33	Koss Corp.	Cover 4
34	Maxell Corp. of America	17
35	3M	6
	MICROCOMPUTER MART	114
37	Micro Ace	42
38	Micro Management Systems	115
39	McIntosh Laboratory, Inc.	16
	Nabih's	97
	National Technical Schools	70, 71, 72, 73
	Netronics, R & D Ltd.	31, 65
	NRI Schools	8, 9, 10, 11
40	Ohio Scientific	13
42	OK Machine & Tool Corp.	59
43	Olympic Sales	94
	Omega Sales Corp.	20
44	Omnisonix, Ltd.	24, 25
45	PAIA Electronics, Inc.	92
60	Panasonic	3
46	Parts Masters	92
47	Poly Paks	88
48	Quest Electronics	109
	Radio Shack	106
49	Regency Electronics	26
51	Riehl Time	23
52	Scientific Systems	98
	The Sharper Image	19
50	Shure Bros.	50
	Sinclair Electronics	51
53	Sperry, A.W.	12
54	TAB Books	79
55	Wonderful World of Video	76

XENON STROBE TUBE & TRIGGER COIL



STROBE LIGHT SCHEMATICS INCLUDED
C24081 \$1.75

LED Flasher Kit



Simple to build kit uses the popular 555 timer IC. Extremely easy to use and green LED. Comes complete with all parts, including the PC board. (By mail only.)
C2384 \$2.49

SOUND EFFECTS GENERATOR BASIC KIT

Now it's possible to build your own sound effects generator without spending a fortune. We supply you with the 1176477 sound chip plus an etched and drilled glass epoxy PC board with schematic and layout instructions. This board makes it simple to build a generator capable of phaser sounds, locomotive, sirens, airplanes, clocks, etc. Does not require DIP switches or other expensive/obscure components. You supply a few standard resistors, capacitors, switches, pots, speaker, 2N2222 transistor and 9V battery.

C23883 BASIC KIT CONTAINING 1176477, PC BOARD AND INSTRUCTIONS. 
ONLY \$5.95

2N2222 TRANSISTOR FOR ABOVE C23884 .39 EACH

ELECTRONIC WARNING FLASHER KITS

Battery operated. (Does not require external power source.)
Battery operated. (Does not require external power source.)
Battery operated. (Does not require external power source.)

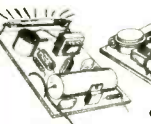

3VDC MODEL
C23207 \$6.95

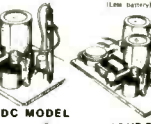

6VDC MODEL
C23808 \$8



12VDC MODEL
C23976 \$10.95

ELECTRONIC STROBOSCOPE KIT

IMMENSE AID FOR TROUBLESHOOTING OR DEMONSTRATING OPTICAL PHENOMENA. OPTICALLY STROBE MOTION OF FANS, WHEELS, PULLEYS, FLYWHEELS, ETC. THE STROBOSCOPE OPERATES FROM STANDARD 115VAC AND FEATURES BRIGHT XENON FLASH TUBE AND IC DESIGN. CONTINUOUSLY VARIABLE FLASH RATE FROM 100-5000RPM. THE KIT COMES WITH ALL COMPONENTS INCLUDING PC BOARD, FLASH GEAR AND RINGS. DOES NOT INCLUDE GEAR. SIZE OF BOARD: 3 1/2" x 4 3/4".
C24070 **SALE \$29.95**

Wheel of Fortune

Popular game piece uses LEDs, resistors & IC to give the effect of a brightly lit ball spinning & finally stopping on a number. Sold in parts.
C23891 \$8.99

120 VAC Xenon Strobe Kit

Complete variable rate strobe light kit. Contains all parts, PC board, instructions and more.
C23871 \$7.50

CHANEY electronics inc.

Minimum order \$5.00
Please include \$1.00 for postage
Visa, MC and COD accepted
Phone orders are welcome

P.O. BOX 27038, DENVER, CO. 80227 (303) 781-5750
Send for our free giant catalog of unique items!!!

CIRCLE NO. 10 ON FREE INFORMATION CARD

CALL OUR TOLL FREE NUMBER
800-538-5000

Guaranteed 24 Hr. Shipment
Call us for volume quotes

**We will beat any competitors prices.
Give us a call and we'll prove it.**

16K RAM SALE

4116 - 200NS

8 FOR 29.95

MEMORY SPECIALS

2101	450ns	2.49	2708	450ns	6.25
2102-1	450ns	.99	2716	450ns	10.95
21L02-1	450ns	1.29	2732	450ns	29.95
2112	450ns	2.99	2650		12.95
2114	450ns	4.35	Z-80		9.95
2114L-3	300ns	4.75	8080A		3.95

THE COMPLETE LS SERIES AT THE BEST PRICES!

74LS00	.32	74LS85	1.23	74LS175	1.09
74LS02	.38	74LS86	.45	74LS191	1.31
74LS04	.35	74LS93	.71	74LS195	1.39
74LS08	.38	74LS95	1.11	74LS221	1.28
74LS10	.32	74LS109	.49	74LS240	1.89
74LS20	.35	74LS138	.79	74LS241	1.89
74LS30	.35	74LS139	.79	74LS244	1.79
74LS32	.39	74LS151	.79	74LS283	1.03
74LS38	.39	74LS153	.79	74LS298	1.24
74LS42	.79	74LS157	.79	74LS367	.99
74LS51	.35	74LS158	.82	74LS368	.99
74LS54	.35	74LS161	.99	74LS373	1.85
74LS73	.44	74LS163	.99	74LS374	1.81
74LS74	.48	74LS174	1.19	74LS377	1.48

DIP SWITCHES

4 position	.99	14 pin	10/1.49
5 position	1.02	16 pin	10/1.69
6 position	1.06	24 pin	4/1.00
7 position	1.09	IMSAI S-100 edge connector solder tail gold	2.49
8 position	1.14		

IC SOCKETS

LINEAR IC'S

LM301V	.34	LM380	1.29	LM747	.79
LM309K	1.49	LM555V	.39	LM1310	1.90
LM311V	.64	LM556	.69	LM1458V	.69
LM317T	2.29	LM565	.99	LM1488	1.39
LM323K	4.95	LM566V	1.49	LM1489	1.39
LM324	.59	LM567V	1.29	LM1800	1.99
LM339	.99	LM723	.49	LM1889	2.49
LM377	2.29	LM741V	.29	LM3900	5.9

VOLTAGE REGULATORS

7805T	.89	7812K	1.39	7905K	1.49
7812T	.89	7905T	.99	7912K	1.49
7805K	1.39	7912T	.99	78L12	.69

V = 8 PIN K = TO-3 T = TO-220

OTHER SPECIALS

2N3055	10/6.99	LM723	10/3.99
95H90	7.99	LM741	10/2.99
8038	3.99	7805	10/7.99
LM380	5/4.59	7812	10/7.99
LM555	10/3.49	RED LED	100/7.99
LM556	5/3.49	GREEN LED	50/6.99
LM565	5.3.99	MAN 72 CA 3"	10/7.99
LM567	4/4.99	MAN 74 CC 3"	10/7.99

TERMS Include \$2.00 for shipping, \$10.00 minimum order. Send SASE for complete catalog.
Bay Area Residents add 8 1/2% sales tax. Calif. Residents add 8% sales tax.

JDR MICRODEVICES, INC.

1101 South Winchester Blvd.
San Jose, California 95128
800-538-5000
408-247-4852

CIRCLE NO. 29 ON FREE INFORMATION CARD

Free!

Edmund Scientific Catalog



Edmund Scientific Catalog

OUR 40th YEAR!

Astronomy, Microscopy, Biofeedback, Weather, Alternate Energy, Binoculars, Optics, Magnets, Magnifiers, Tools, Unique Lighting, Lab Equipment, and much more. Over 4,000 unique and fascinating products. Send for our **FREE** 112-page, colorful 1981 Edmund Scientific Catalog... Today!

Rush me your free catalog!

Name _____
Address _____
City _____
State _____ Zip _____

Clip And Mail Coupon Today To:
Edmund Scientific Co., Dept. 3016 AV02
Edscorp Bldg., Barrington, N.J. 08007

www.americanradiohistory.com

HOT WINTER PRICES ON PERSONAL COMPUTERS AND COMPONENTS.

Look at this!



Ohio Scientific Superboard II \$299

- It's the first complete computer system on a board.
- Superboard II uses the ultra powerful 6502 Microprocessor
- 8K Microsoft BASIC-in-ROM
- 4K static RAM on board, expandable to 8K
- Full 53-key keyboard, with upper and lower case. Plus user expandability.
- Video interface and audio cassette interface.

The Ohio Scientific Superboard II at \$299 — in today's economy — has got to be the best buy by far. It will entertain you with spectacular graphics made possible by its ultra high resolution graphics and super fast BASIC. It will help you in school or industry, as an ultra powerful scientific calculator. Advanced scientific functions and a built-in "immediate" mode allow you to solve complex problems without programming.

The Superboard II can be expanded economically, for business uses, or to remotely control your home appliances and security. Even communicate with other computers.

Read what's been written about Superboard II:

"We heartily recommend Superboard II for the beginner who wants to get into microcomputers with a minimum cost. A real computer with full expandability."

—POPULAR ELECTRONICS, MARCH 1979

"The Superboard II is an excellent choice for the personal computer enthusiast on a budget."

—BYTE, MAY 1979

Look at these easy hardware prices:

610 Board For use with Superboard II and Challenger 1P. 8K static RAM. Expandable to 24K or 32K system total. Accepts up to two mini-floppy disk drives. Requires +5V @ 4.5 amps.	\$ 298
Mini-Floppy Disk Drive Includes Ohio Scientific's PICO DOS software and connector cable. Compatible with 610 expander board. Requires +12V @ 1.5 amps and +5V @ 0.7 amps. (Power supply & cabinet not included.)	299
630 Board Contact us for important details.	229
AC-3P 12" combination black and white TV/video monitor.	159
4KP 4K RAM chip set.	79
PS-005 5V 4.5 amp power supply for Superboard II.	35
PS-003 12V power supply for mini-floppies.	29
CS-600 Metal case for Superboard II, 610 and 630 board and two power supplies. [While stock lasts.]	49
CS-900B Metal case for single floppy disk drive and power supply. [While stock lasts.]	49
AC-12P Wireless remote control system. Includes control console, two lamp modules and two appliance modules, for use with 630 board.	175
AC-17P Home security system. Includes console, fire detector, window protection devices and door unit for use with 630 board.	249
C1P Sams C1P Service manual	8
C4P Sams C4P Service manual	16
C3 Sams Challenger III manual	40

Ohio Scientific and independent suppliers offer hundreds of programs for the Superboard II, in cassette and mini-floppy form.

Freight Policies All orders of \$100 or more are shipped freight prepaid. Orders of less than \$100 please add \$4.00 to cover shipping costs. Ohio residents add 5.5% Sales Tax.



Hours: Call Monday thru Friday, 8:00 AM to 5:00 PM E.D.T.
TOLL FREE: 1-800-321-5805

Guaranteed Shipment

Cleveland Consumer Computers & Components guarantees shipment of computer systems within 48 hours upon receipt of your order. **Our failure to ship within 48 hours entitles you to \$35 of software, FREE.**

To Order: Or to get our free catalog **CALL 1-800-321-5805 TOLL FREE.** Charge your order to your **VISA** or **MASTER CHARGE** account. Ohio residents call: (216) 464-8047. Or write, including your check or money order, to the address listed below.



CLEVELAND CONSUMER COMPUTERS & COMPONENTS

P.O. Box 46627
Cleveland, Ohio 44146

Order Form: CLEVELAND CONSUMER COMPUTERS & COMPONENTS P.O. Box 46627 Cleveland, Ohio 44146

- | | |
|--|---|
| <input type="checkbox"/> Superboard II \$299. | <input type="checkbox"/> 630 Board \$299. |
| <input type="checkbox"/> 610 Board \$298. | <input type="checkbox"/> AC-3P 12" B/W Monitor \$159. |
| <input type="checkbox"/> Mini-Floppy Disk Drive \$299. | <input type="checkbox"/> C1P Sams Manual \$8. |
- [Attach separate sheet for other items.]

NAME _____

ADDRESS: _____

CITY: _____ STATE: _____ ZIP: _____

PHONE: _____

Payment by: VISA _____ MASTER CHARGE _____ MONEY ORDER _____

Credit Card Account # _____

Expires _____ Interbank # [Master Charge] _____

TOTAL CHARGED OR ENCLOSED \$ _____ [Ohio Residents add 5.5% Sales Tax]

Orders of less than \$100, please add \$4.00 to cover shipping costs.

All orders shipped insured UPS unless otherwise requested. FOB Cleveland, Ohio.

National Semiconductor Clock Modules

12VDC AUTOMOTIVE/INSTRUMENT CLOCK

APPLICATIONS:

- In-dash auto clocks
- After-market auto/RV clocks
- Aircraft marine clocks
- 12VDC oper. instr.
- Portable/battery powered instrmnts.

Features: Bright 0.3" green display. Internal crystal time-base. >0.5 sec./day accur. Auto. display brightness control logic. Display color filterable to blue, blue-green, green & yellow. Complete - just add switches and lens.

MA1003 Module \$16.95

MA1023 .7" Low Cost Digital LED Clock Module 8.95
 MA1026 .7" Dig. LED Alarm Clock/Timer 18.95
 MA5036 3" Low Cost Digital LED Clock/Timer 6.95
 MA1002 .5" LED Display Dig. Clock & Xformer 9.95

MICROPROCESSOR COMPONENTS

8080A/8080A SUPPORT DEVICES

INS4004A	CPU	6.50
DP8212	8-Bit Input/Output	3.25
DP8214	Priority Interrupt Control	1.95
DP8216	Bi-Directional Bus Driver	1.40
DP8224	Clock Generator/Driver	3.35
DP8226	Bus Driver	3.49
DP8228	System Controller/Bus Driver	4.95
DP8238	System Controller	5.95
INS8243	I/O Expander for 8 Series	16.95
INS8245	Asynchronous Comm. Element	16.95
DP8251	Prog. Comm. I/O (USART)	7.95
DP8253	Prog. Interval Timer	10.95
DP8255	Prog. Peripheral I/O (PPI)	9.95
DP8256	Prog. DMA Control	19.95
DP8259	Prog. Interrupt Controller	14.95
DP8275	Prog. CRT Controller	49.95
DP8279	Prog. Keyboard/Display Interface	6.95
DP8300	Octal Bus Receiver	14.95
DP8303	System Timing Element	5.95
DP8304	8-Bit Bi-Directional Receiver	3.95
DP8307	8-Bit Bi-Directional Receiver	3.95
DP8308	8-Bit Bi-Directional Receiver	3.95

JOYSTICKS

JS-5K 5K Linear Taper Pots \$5.25
 JS-100K 100K Linear Taper Pots \$4.95
 JVC-40 40K (2) Video Controller in case \$5.95

6800/6800 SUPPORT DEVICES

MC6800	MPU	14.95
MC6802CP	MPU with Clock and RAM	19.95
MC6801AP1	128K Static RAM	4.95
MC6828	Peripheral Interf. Adapt (MC6820)	7.49
MC6829	Priority Interrupt Controller	10.95
MC6830	8-Bit Shift Reg. (MC6820B)	1.95
MC6860	Asynchronous Comm. Adapter	6.95
MC6862	Asynchronous Serial Data Adapter	6.95
MC6869	9600bps Digital MODEM	10.95
MC6880A	9600bps Modulator	12.95
MC6880A	Quad 3-State Bus Trans. (MC6826)	2.95

AC and DC Wall Transformers

(ideal for use with clocks, games, power supplies or any other type of AC or DC application)

Part No.	Input	Output	Price
AC 250	117V/60Hz	12 VAC 250mA	\$3.95
AC 500	117V/60Hz	12 VAC 500mA	\$4.95
AC 1000	117V/60Hz	12 VAC 1 amp	\$5.95
DV9200	117V/60Hz	9 VDC 200mA	\$3.25
DC 900	120V/60Hz	9 VDC 500mA	\$3.95

CONNECTORS

Part No.	Input	Output	Price
DB25P	D-Subminiature Plug		\$2.95
DB25S	D-Subminiature Socket		\$3.50
DB51226	Cover for DB25P/S		\$1.75
UG175/U	P.C. Edge (22/44 Pin)		\$2.95
UG88/U	BNC Plug		\$1.79
UG89/U	BNC Jack		\$3.79
UG175/U	UHF Adapter		\$ 49
SD239	UHF Panel Recp.		\$1.29
PL258	UHF Adapter		\$1.60
PL259	UHF Plug		\$1.60
UG260/U	BNC Plug		\$1.79
UG1094/U	BNC Bulkhead Recp.		\$1.29

TRS-80 16K Conversion Kit

Expand your 4K TRS-80 system to 16K. Kit comes complete with:

- * 8 ea. MM5290 (UPD416/4116) 16K Dyn. Roms (*NS)
- * Documentation for Conversion

TRS-16K2 *150NS \$49.95
 TRS-16K4 *250NS \$39.95

JE610 ASCII Encoded Keyboard Kit

The JE610 ASCII Keyboard Kit can be interfaced into most any computer system. The kit comes complete with an industrial grade keyboard switch assembly (62-keys), IC's, sockets, connector, electronic component and a double-sided printed wiring board. The keyboard assembly requires +5V @ 150mA and -12V @ 10 mA for operation. Features: 60 keys generate the 126 characters, upper and lower case ASCII set. Fully buffered. Two user-definable keys provided for custom applications. Caps lock for upper case only alpha characters. Utilizes a 2376 (40-pin) encoder read-only memory chip. Outputs directly compatible with TTL/DTL or MOS logic arrays. Easy interfacing with a 16-pin dip or 16-pin edge connector. Size: 3 1/2" H x 14 1/2" W x 8 3/4" D

JE610/DTE-AK (as pictured above) . . . \$124.95
 JE610 Kit (62-Key Keyboard, PC Board, & Components (no case)) . . . \$ 79.95
 K62 62-Key Keyboard (Keyboard only) . . . \$ 34.95
 DTE-AK (case only - 3 1/2" H x 14 1/2" W x 8 3/4" D) \$ 49.95

JE600 Hexadeciml Encoder Kit

Full 8-Bit Latched Output 19-Key Keyboard

The JE600 Encoder Keyboard Kit provides two separate hexadeciml digits produced from sequential key entries to allow direct programming for 8-bit microprocessor or 8-bit memory circuits. Three additional keys are provided for user operations with one being bistable operation. Debounce circuit provided for all 19 keys. 9 LED readouts to verify entries. Easy interfacing with standard 16-pin IC connector. Only +5VDC required for operation. Size: 3 1/2" H x 8 1/4" W x 8 3/4" D

JE600/DTE-HK (as pictured above) . . . \$99.95
 JE600 Kit 19-Key Hexadec. Keyboard, PC Board & Cmpnts. (no case) . . . \$59.95
 K19 19-Key Keyboard (Keyboard only) . . . \$14.95
 DTE-HK (case only - 3 1/2" H x 8 1/4" W x 8 3/4" D) \$44.95

CIRCLE NO. 28 ON FREE INFORMATION CARD

National Semiconductor RAM SALE

MM5290N-4 (MK4116/UPD416) . . \$4.95 each
 16K DYNAMIC RAM (250NS)
 (8 EACH \$39.95) (100 EACH \$450.00/lot)

MM5290J-2 (MK4116/UPD416) . . \$6.95 each
 16K DYNAMIC RAM (150NS)
 (8 EACH \$49.95) (100 EACH \$550.00/lot)

MM5298J-3A \$3.25 each
 8K DYNAMIC RAM (LOW HALF OF MM5290J) 200NS
 (8 EACH \$23.95) (100 EACH \$250.00/lot)

MM2114-3 \$5.95 each
 4K STATIC RAM (300NS)
 (8 EACH \$43.95) (100 EACH \$450.00/lot)

MM2114L-3 \$6.25 each
 4K STATIC RAM (LOW POWER 300NS)
 (8 EACH \$44.95) (100 EACH \$475.00/lot)

EPROM Erasing Lamp

- Erases 2708, 2716, 1702A, 5203Q, 5204Q, etc.
- Erases up to 4 chips within 20 minutes.
- Maintains constant exposure distance of one inch.
- Special conductive foam liner eliminates static build-up.
- Built-in safety lock to prevent UV exposure.
- Compact - only 7-5/8" x 2-7/8" x 2"
- Completes with holding tray for 4 chips.

UVS-11E \$79.50

Jumbo 6-Digit Clock Kit

- Four .630" ht. and two .300" ht. common anode displays
- Uses MM5314 clock chip
- Switches for hours, minutes and hold functions
- Hours easily viewable to 30 feet
- Simulated walnut case
- 115VAC operation
- 12 or 24 hour operation
- Includes all components, case and wall transformer
- Size: 6 1/2" x 3-1/8" x 1 1/4"

JE747 \$29.95

6-Digit Clock Kit

- Bright .300 ht. comm. cathode display
- Uses MM5314 clock chip
- Switches for hours, minutes and hold modes
- Hrs. easily viewable to 20 ft.
- Simulated walnut case
- 115 VAC operation
- 12 or 24 hr. operation
- Incl. all components, case & wall transformer
- SI 3 1/2" x 3-1/8" x 1 1/4"

JE701 \$19.95

Regulated Power Supply

Uses LM309K. Heat sink provided. PC board construction. Provides a solid 1 amp @ 5 volts. Can supply up to +5V, +9V and +12V with JE205 Adapter. Includes components, hardware and instructions. Size: 3 1/2" x 5" x 2" H

JE200 \$14.95

ADAPTER BOARD

DC/DC converter with +5V input. Toroidal hi-speed switching XFMR. Short circuit protection. PC board construction. Piggy-back to JE 200 board. Size: 3 1/2" x 2" x 9/16" H

JE205 \$12.95

MICROPROCESSOR CHIPS

280 (180C)	CPU (MK3800N)	13.95
280 (180L)	CPU (MK3800L) (semitr)	15.95
COP1802	CPU	19.95
2950	MPU	16.95
IDA2901ADC	CPU - 4-Bit Slice (Com. Temp. Grade)	19.95
MC5602	MPU w/Clock (60K Bytes Memory)	11.95
INS5020N-4	MPU - 8-Bit (8MHZ)	16.95
INS5020N-4	CPU 59K Ch8-Bit (128bytes RAM)	15.95
INS5040N-4	CPU (256 Bytes RAM)	24.95
INS5040N	CPU - 64 Bytes RAM	24.95
INS5040N	CPU w/Basic Micro Interpreter	29.95
7908	CPU	19.95
INS8000	CPU - 16-Bit	29.95
TMS5900JL	MPU-16-Bit	49.95

SHIFT REGISTERS

MM5020H	Dual 20-Bit Dynamic	4.50
MM5034H	Dual 50-Bit Dynamic	50
MM5054H	Dual 100-Bit Static	50
MM5104H	Dual 64-Bit Accumulator	3.95
MM5102C	256-Bit Dynamic	1.95
MM5013	1024-Bit Dynamic/Accumulator	1.95
MM5016H	5060(12-Bit) Dynamic	49
MM5019H	Octal 80-Bit	9.95
MM5020N	Octal 80-Bit	9.95
2504V (1604A)	1024-Bit Dynamic	3.95
2518H	Hex 32-Bit Static	4.95
2521V	Dual 128-Bit Static	2.95
2524V	512 Bit Dynamic	99
2525	1024-Bit Dynamic	2.95
2527V	Dual 256-Bit Static	2.95
2528V	Dual 200-Bit Static	4.00
2529V	Dual 200-Bit Static	4.00
2529N	Quad 80-Bit Static	2.95
3341PC	Fifo (Dual 80)	6.95

DATA ACQUISITION

AF100-1CN	Universal Active Filter 2.5%	5.95
AF121-1CJ	Touch Tone Low Pass Filter	19.95
TC101	Touch Tone Pass Filter	19.95
LM308AH	Super Gain Op Amp	1.00
LM334Z	Constant Current Source	1.00
LM335Z	Temperature Transducer	1.00
LF356N	JFET Input Op Amp	1.10
LF389N	Sample & Hold Amplifiers	3.95
LM399H	Temp. Comp. Pres. Ref. (50ppm/C)	4.95
DA1008ALCN	8-Bit D/A Converter (1.5LSB)	4.95
DA1008ALCN	8-Bit D/A Converter (0.78% Lin.)	2.25

DESIGNERS' SERIES

Blank Desk-Top Electronic Enclosures

- High strength epoxy molded end pieces in mocha brown finish.
- Sliding rear/bottom panel for service and component accessibility.
- Top / bottom panels .080 thk alum. Alodine type 1200 finish (gold tint color) for best paint adhesion after modification.
- Vented top and bottom panels for cooling efficiency.
- Rigid construction provides unlimited applications.

CONSTRUCTION:

The "DTE" Blank Desk Top Electronic Enclosures are designed to blend and complement today's modern computer equipment and can be used in both industrial and home. The end pieces are precision molded with an internal slot (all around) to accept both top and bottom panels. The panels are then fastened to 1/4" thick tabs inside the end pieces to provide maximum rigidity to the enclosure. For ease of equipment servicing, the rear/bottom panel slides back on slotted tracks while the rest of the enclosure remains intact. Different panel widths may be used while maintaining a common profile outline. The molded end pieces can also be painted to match any panel color scheme.

Enclosure Model No.	Panel Width	PRICE
DTE-8	8.00"	\$29.95
DTE-11	10.65"	\$32.95
DTE-14	14.00"	\$34.95

\$10.00 Min. Order - U.S. Funds Only
 Calif. Residents Add 6% Sales Tax
 Postage - Add 5% plus \$1 Insurance

Spec Sheets - 25¢
 Send 4 Free Postage for your
 FREE 1981 JAMECO CATALOG

PHONE ORDERS WELCOME (415) 592-8097

MAIL ORDER ELECTRONICS - WORLDWIDE
 1355 SHOREWAY ROAD, BELMONT, CA 94002
 PRICES SUBJECT TO CHANGE

The Shack[®] is America's Parts Place![™]

Low Prices and New Items Every Day!

Speed Up Your Wiring with This Cordless Power Wrapping Tool!



Save **23%** Reg. 21.95
16⁸⁸

So Easy! Why Solder Your Digital Projects?

Makes a perfect wrap every time! Unwraps, too. Built-in wire stripper/cutter. Positive indexing assures identical wraps on 0.025" square posts. Weight-balanced for comfort. Trigger-action on/off switch, carbon-steel tip. Jack for adapter/charger (below). Requires 2 nickel cadmium "C" cells. 276-1571 Sale 16.88

AC Adapter/Charger. U.L. listed. 273-1454 5.95

Subminiature LEDs

1⁵⁹ New!
Pkg. of 2

Highly-reflective chrome holders.
Red LED. 276-068 2/1.59
Green LED. 276-069 2/1.59

Cadmium Sulfide Photoresistor



1¹⁹

Wide resistance range—5 megohms (darkness) to 100 ohms (bright light). Max. power dissipation: 200 mW @ 170V. 276-116 1.19

Sound Generator IC



Linear/I²L Device

Save **20%** Reg. 4.49
3⁵⁹

SN76477. Build your own synthesizer and create almost any type of sound—including music, explosions, gunshots, steam whistles. Built-in preamplifier provides line-level output. 28-pin DIP. With applications and data. 276-1765 Sale 3.59

Hall Effect Switching Detectors



1⁹⁸
Pkg. of 3

Electronically senses magnetic field. 750 gauss "on" threshold. 5-16VDC supply. Similar to type 3006ULN. 276-1646 3/1.98

New! Pushbutton Key-Pad Module



16⁹⁵

Produces 12 Touch-Tone[™] Frequencies

1.5x2" face. Requires 3-5VDC @ 16 mA and 3.58 MHz crystal. With applications. specs. 277-1010 16.95

TV Colorburst Crystal. 3.58 MHz. 272-1310 1.99

Touch-Tone is a registered trademark of AT&T

PC Board and IC Breadboard Sockets

Non-Corrosive Contacts for Reliable Connections—Time After Time!



Low As **3²⁹**

A Experimenter's PC Board. Design circuits on a socket, then transfer to PC board. Holes match Archer[®] breadboard sockets. 0.3" center with 550 connecting points. 276-170 3.29

B Modular Breadboard Socket. Standard 0.3" center for use with up to 40-pin ICs. Boards snap together horizontally or vertically and accept #22-30 solid hookup wire. 2 bus strips with 40 tie-points each and 47 rows of 5 connected tie-points. 550 connections. 2 1/2"x6" 276-174 10.95

C Modular Breadboard Socket. Smaller version of above. 270 connections in 2 bus strips of 20 tie-points each with 23 rows of 5 connected tie-points. 2 1/2"x3 3/8" 276-175 6.49

D Mini-Socket. 22 rows of 5 tie-points each plus 2 bus strips with 10 connections each. Interlocks with above. 2 1/2"x1 7/8" 276-176 4.49

Infrared Opto-Coupler



New! **1⁹⁹**

TIL-111. LED optically coupled to NPN phototransistor. 5 ms switching time. 6-pin DIP. 276-132 1.99

TIL-119/4N31. LED coupled to NPN Darlington phototransistor. DC transfer ratio 300% min. @ 10 mA. 6-pin DIP. 276-133 1.99

VMOS Power FETs

New! **2⁴⁹** **1⁵⁹**

A Gate-protected transistors for digital, analog, or RF circuits.

A VN67AF. 15W dissipation. TO-202 case. 276-2071 2.49

B VN10KM. 1W dissipation. TO-92+ case. 276-2070 1.59

12VDC DPST Encapsulated Reed Relay



New! **99¢**

Encased in protective plastic. Designed to fit printed circuit boards. Contacts rated 1/2 amp at 125VAC. 275-229 99¢

Miniature PC Mount DPDT Switches

Save \$1

Low As **99¢** Each

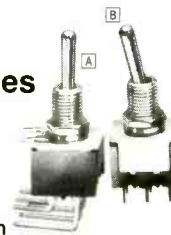

A Designed for right angle PC board mounting. Center "off" Contacts rated 6A @ 125VAC. 275-665 (Reg. 1.99) Sale 99¢

B Straight mount. Contacts rated 6A @ 125VAC. 275-668 (Reg. 2.19) Sale 1.19

12V, 5A Power Transformer

10⁹⁵



For Projects Or Replacement

Quality, heavy-duty type with steel frame for chassis mounting. Solder lug terminals for easy connections. 120VAC, 5A, 60 Hz primary. 4x2x 2 1/2" 273-1513 10.95

4-Digit LCD Timer/Clock Module

New!



24⁹⁵

• Large Half-Inch LCD Display
• 12 or 24-Hour Format

Just add a few parts and a battery, and you have a versatile nine-function, crystal-controlled timekeeper! Built-in backlight, dual time zones, 24-hour alarm, plus stopwatch, sleep, and control timer functions. 2 5/8"x1 1/2". 1.5VDC operation. 277-1007 24.95

Hobby Project Cases

Low As **1⁵⁹**

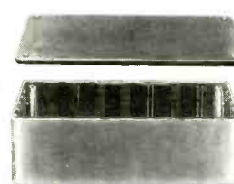

Made of high-impact plastic, with internal slots to hold PC boards. Blue.

4x2x1 3/8" 270-220 1.59
4x2 7/8x1 1/8" 270-221 1.79
4 3/4x2 1/2x1 1/8" 270-222 1.99
6x3 3/8x1 1/8" 270-223 2.59
7 1/2x4 1/8x2 1/8" 270-224 2.99

Coils and Chokes

1⁹⁸ Pkg. of 100

Ideal for audio and RF circuits. Assortment includes PC chokes, inductors, tuned RF coils. 273-1570 100/1.98

Assorted Ferrites

1⁹⁸ Pkg. of 25

For chokes, RF coils, impedance matching transformers. Includes toroids, ferrite beads, cores, slugs. 273-1571 25/1.98

WHY WAIT FOR MAIL ORDER DELIVERY?
IN STOCK NOW AT OUR STORE NEAR YOU!

Radio Shack[®]

A DIVISION OF TANDY CORPORATION • FORT WORTH, TEXAS 76102
OVER 7000 LOCATIONS IN 40 COUNTRIES

Retail prices may vary at individual stores and dealers.

POPULAR ELECTRONICS

Quest

ELECTRONICS

P. O. Box 44300
 Santa Clara, CA 95054

Will call: 2322 Waihs Ave.
 (408) 988-1640

Same day shipment. First line parts only. Factory tested. Guaranteed money back. Quality IC's and other components at factory prices.

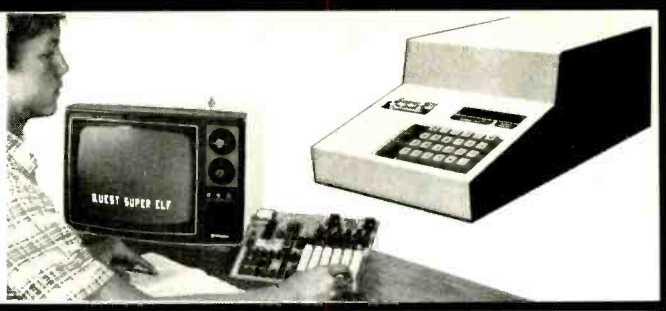

RCA Cosmac 1802 Super Elf Computer \$106.95

Compare features before you decide to buy any other computer. There is no other computer on the market today that has all the desirable benefits of the Super Elf for so little money. The Super Elf is a small single board computer that does many big things. It is an excellent computer for training and for learning programming with its machine language and yet it is easily expanded with additional memory, Full Basic, ASCII Keyboards, video character generation, etc.

Before you buy another small computer, see if it includes the following features: ROM monitor, State and Mode displays, Single step. Optional address displays, Power Supply, Audio Amplifier and Speaker. Fully socketed for all IC's, Real cost of in warranty repairs, Full documentation.

The Super Elf includes a ROM monitor for program loading, editing and execution with SINGLE STEP for program debugging which is not included in others at the same price. With SINGLE STEP you can see the microprocessor chip operating with the unique Quest address and data bus displays before, during and after executing instructions. Also, CPU mode and instruction cycle are decoded and displayed on 8 LED indicators.

An RCA 1861 video graphics chip allows you to connect to your own TV with an inexpensive video modulator to do graphics and games. There is a speaker system included for writing your own music or using many music programs already written. The speaker amplifier may also be used to drive relays for control purposes.

A 24 key HEX keyboard includes 16 HEX keys

Super Expansion Board with Cassette Interface \$89.95

This is truly an astounding value! This board has been designed to allow you to decide how you want it optioned. The Super Expansion Board comes with 4K of low power RAM fully addressable anywhere in 64K with built-in memory protect and a cassette interface. Provisions have been made for all other options on the same board and it fits neatly into the hardware cabinet alongside the Super Elf. The board includes slots for up to 6K of EPROM (2708, 2768, 2716 or TI 2716) and is fully socketed. EPROM can be used for the monitor and Tiny Basic or other purposes.

AIK Super ROM Monitor \$19.95 is available as an on board option in 2708 EPROM which has been preprogrammed with a program loader/editor and error checking multi file cassette read/write software. (relocatable cassette file) another exclusive from Quest. It includes register save and readout, block move capability and video graphics driver with blinking cursor. Break

Announcing Quest Super Basic - SECOND GENERATION

A new enhanced version of Super Basic now available. Quest was the first company worldwide to ship a full size Basic for 1802 Systems. A complete function Super Basic by Ron Kenner including floating point capability with Scientific notation (number range $\pm 17E^{\pm 9}$), 32 bit integer ± 2 billion; multi dim arrays, string arrays, string manipulation, cassette I/O, save and load, basic data and machine language programs; and over 75 statements, functions and operations.

Gremlin Color Video Kit \$69.95
 32 x 16 alphanumeric and graphics, up to 8 colors with 6847 chip, 1K RAM at E000. Plugs into Super Elf 44 pin bus. No high res. graphics. On board RF Modulator Kit \$4.95

18x20 16K Dynamic RAM Kit \$149.00
 Expandable to 32K. Hidden refresh w/clocks up to 4 MHz w/no wait states. Add. 16K RAM \$63.00

Super Elf 44 pin expansion board, 3 female and 1 male bus. Board plus 3 connectors \$22.95

Tiny Basic Extended on Cassette \$15.00 (added commands include Stringy, Array, Cassette I/O etc.)

S-100 4-Slot Expansion \$ 9.95
 Super Monitor VI.1 Source Listing \$15.00

Elf II Adapter Kit \$24.95

Plugs into Elf II providing Super Elf 44 and 50 pin S-100 bus expansion. (With Super Expansion) High and low address displays, state and mode LED's optional \$18.00.

Super Color S-100 Video Kit \$129.95

Expandable to 256 x 192 high resolution color graphics. 6847 with all display modes computer controlled. Memory mapped. 1K RAM expandable to 6K. S-100 bus 1802, 8080, 8085, Z80 etc.

Editor Assembler \$25.00 (Requires minimum of 4K for E/A plus user source)

1802 Tiny Basic Source listing \$19.00
 Super Monitor V2.0/2.1 Source Listing \$20.00

INTEGRATED CIRCUITS

7400TTL	LM323K	5	95	CD4026	2	50	4116 200ns	7	95	CONNECTORS	56 key ASCII keyboard kit	\$67.50
7400N	LM320K	12	150	CD4027	66	66	81416 200ns	49	60	30 pin edge	Fully assembled	77.50
7400N	LM320K	12	150	CD4028	66	66	25138	5	30	44 pin edge	54 key ASCII keyboard kit	77.50
7400N	LM320K	12	150	CD4029	136	136	MM5267	40	100	pin edge	Fully assembled	77.50
7400N	LM320K	12	150	CD4030	45	45	MM5280	3	100	pin edge WW	Enclosure Plastic	70.00
7410N	LM320T-12	135	150	CD4035	135	135	MM5230	9	50		Manual Enclosure	29.95
7410N	LM320T-12	135	150	CD4036	135	135	MM5230	9	50			
7420N	LM324N	140	150	CD4042	85	85	PD141D	3	400			
7420N	LM324N	140	150	CD4043	85	85	PD141D	3	400			
7420N	LM324N	140	150	CD4044	85	85	PD141D	3	400			
7420N	LM324N	140	150	CD4045	85	85	PD141D	3	400			
7420N	LM324N	140	150	CD4046	85	85	PD141D	3	400			
7420N	LM324N	140	150	CD4047	85	85	PD141D	3	400			
7420N	LM324N	140	150	CD4048	85	85	PD141D	3	400			
7420N	LM324N	140	150	CD4049	85	85	PD141D	3	400			
7420N	LM324N	140	150	CD4050	85	85	PD141D	3	400			
7420N	LM324N	140	150	CD4051	85	85	PD141D	3	400			
7420N	LM324N	140	150	CD4052	85	85	PD141D	3	400			
7420N	LM324N	140	150	CD4053	85	85	PD141D	3	400			
7420N	LM324N	140	150	CD4054	85	85	PD141D	3	400			
7420N	LM324N	140	150	CD4055	85	85	PD141D	3	400			
7420N	LM324N	140	150	CD4056	85	85	PD141D	3	400			
7420N	LM324N	140	150	CD4057	85	85	PD141D	3	400			
7420N	LM324N	140	150	CD4058	85	85	PD141D	3	400			
7420N	LM324N	140	150	CD4059	85	85	PD141D	3	400			
7420N	LM324N	140	150	CD4060	85	85	PD141D	3	400			
7420N	LM324N	140	150	CD4061	85	85	PD141D	3	400			
7420N	LM324N	140	150	CD4062	85	85	PD141D	3	400			
7420N	LM324N	140	150	CD4063	85	85	PD141D	3	400			
7420N	LM324N	140	150	CD4064	85	85	PD141D	3	400			
7420N	LM324N	140	150	CD4065	85	85	PD141D	3	400			
7420N	LM324N	140	150	CD4066	85	85	PD141D	3	400			
7420N	LM324N	140	150	CD4067	85	85	PD141D	3	400			
7420N	LM324N	140	150	CD4068	85	85	PD141D	3	400			
7420N	LM324N	140	150	CD4069	85	85	PD141D	3	400			
7420N	LM324N	140	150	CD4070	85	85	PD141D	3	400			
7420N	LM324N	140	150	CD4071	85	85	PD141D	3	400			
7420N	LM324N	140	150	CD4072	85	85	PD141D	3	400			
7420N	LM324N	140	150	CD4073	85	85	PD141D	3	400			
7420N	LM324N	140	150	CD4074	85	85	PD141D	3	400			
7420N	LM324N	140	150	CD4075	85	85	PD141D	3	400			
7420N	LM324N	140	150	CD4076	85	85	PD141D	3	400			
7420N	LM324N	140	150	CD4077	85	85	PD141D	3	400			
7420N	LM324N	140	150	CD4078	85	85	PD141D	3	400			
7420N	LM324N	140	150	CD4079	85	85	PD141D	3	400			
7420N	LM324N	140	150	CD4080	85	85	PD141D	3	400			
7420N	LM324N	140	150	CD4081	85	85	PD141D	3	400			
7420N	LM324N	140	150	CD4082	85	85	PD141D	3	400			
7420N	LM324N	140	150	CD4083	85	85	PD141D	3	400			
7420N	LM324N	140	150	CD4084	85	85	PD141D	3	400			
7420N	LM324N	140	150	CD4085	85	85	PD141D	3	400			
7420N	LM324N	140	150	CD4086	85	85	PD141D	3	400			
7420N	LM324N	140	150	CD4087	85	85	PD141D	3	400			
7420N	LM324N	140	150	CD4088	85	85	PD141D	3	400			
7420N	LM324N	140	150	CD4089	85	85	PD141D	3	400			
7420N	LM324N	140	150	CD4090	85	85	PD141D	3	400			
7420N	LM324N	140	150	CD4091	85	85	PD141D	3	400			
7420N	LM324N	140	150	CD4092	85	85	PD141D	3	400			
7420N	LM324N	140	150	CD4093	85	85	PD141D	3	400			
7420N	LM324N	140	150	CD4094	85	85	PD141D	3	400			
7420N	LM324N	140	150	CD4095	85	85	PD141D	3	400			
7420N	LM324N	140	150	CD4096	85	85	PD141D	3	400			
7420N	LM324N	140	150	CD4097	85	85	PD141D	3	400			
7420N	LM324N	140	150	CD4098	85	85	PD141D	3	400			
7420N	LM324N	140	150	CD4099	85	85	PD141D	3	400			
7420N	LM324N	140	150	CD4100	85	85	PD141D	3	400			
7420N	LM324N	140	150	CD4101	85	85	PD141D	3	400			
7420N	LM324N	140	150	CD4102	85	85	PD141D	3	400			
7420N	LM324N	140	150	CD4103	85	85	PD141D	3	400			
7420N	LM324N	140	150	CD4104	85	85	PD141D	3	400			
7420N	LM324N	140	150	CD4105	85	85	PD141D	3	400			
7420N	LM324N	140	150	CD4106	85	85	PD141D	3	400			
7420N	LM324N	140	150	CD4107	85	85	PD141D	3	400			
7420N	LM324N	140	150	CD4108	85	85	PD141D	3	400			
7420N	LM324N	140	150	CD4109	85	85	PD141D	3	400			
7420N	LM324N	140	150	CD4110	85	85	PD141D	3	400			
7420N	LM324N	140	150	CD4111	85	85	PD141D	3	400			
7420N	LM324N	140	150	CD4112	85	85	PD141D	3	400			
7420N	LM324N	140	150	CD4113	85	85	PD141D	3	400			
7420N	LM324N	140	150	CD4114	85	85	PD141D	3	400			
7420N	LM324N	140	150	CD4115	85	85	PD141D	3	400			
7420N	LM324N	140	150	CD4116	85	85	PD141D	3	400			
7420N	LM324N	140	150	CD4117	85	85	PD141D	3	400			
7420N	LM324N	140	150	CD4118	85	85	PD141D	3	400			
7420N	LM324N	140	150	CD4119	85	85	PD141D	3	400			
7420N	LM324N	140	150	CD4120	85	85	PD141D	3	400			
7420N	LM324N	140	150	CD4121	85	85	PD141D	3	400			
7420N	LM324N	140	150	CD4122	85	85	PD141D	3	400			
7420N	LM324N	140	150	CD4123	85	85	PD141D	3	400			
7420N	LM324N	140	150	CD4124	85	85	PD141D	3				

Electronics Classified

CLASSIFIED RATES: Per Word, 15 Word Minimum. **COMMERCIAL:** \$3.00. **EXPAND-AD:** \$4.50. **DISPLAY:** 1" x 2 1/4", \$370.00. 2" x 2 1/4", \$740.00. 3" x 2 1/4", \$1,110.00. **GENERAL INFORMATION:** Frequency rates and prepayment discounts available. Payment must accompany order except credit card—Am. Ex., Diners, MC, VISA (include exp. date)—or accredited ad agency insertions. Copy subject to publisher's approval; must be typewritten or printed. First word set in caps. Advertisers using P.O. Boxes MUST supply permanent address and telephone number. Orders not acknowledged. They will appear in next available issue after receipt. Closing date: 1st of the 2nd month preceding cover date (e.g., Mar. issue closes Jan. 1). Send order & remittance to: Classified Advertising, Popular Electronics Magazine, 1 Park Avenue, New York, NY 10016. Direct inquiries to (212) 725-3926.

FOR SALE

FREE! Bargain Catalog—I.C.'s, LED's, readouts, fiber optics, calculators parts & kits, semiconductors, parts. Poly Paks, Box 942PE, Lynnfield, Mass. 01940.

GOVERNMENT and industrial surplus receivers, transmitters, sniperscopes, electronic parts. Picture Catalog 25 cents. Meshna, Nahant, Mass. 01908.

ELECTRONIC PARTS, semiconductors, kits, FREE FLYER. Large catalog \$1.00 deposit. BIGELOW ELECTRONICS, Bluffton, Ohio 45817.

RADIO—T.V. Tubes—49 cents each. Send for free catalog. Cornell, 4213 University, San Diego, Calif. 92105.

AMATEUR SCIENTISTS, Electronics Experimenters, Science Fair Students... Construction plans—Complete, including drawings, schematics, parts list with prices and sources... Robot Man—Psychedelic shows—Lasers—Emotion/Lie Detector—Touch Tone Dial—Quadraphonic Adapter—Transistorized Ignition—Burglar Alarm—Sound Meter... over 60 items. Send \$1.00 (no stamps) for complete catalog. Technical Writers Group, Box 5994, University Station, Raleigh, N.C. 27650.

SOUND SYNTHESIZER KITS—Surf \$16.95. Wind \$16.95. Wind Chimes \$22.95. Musical Accessories, many more. Catalog free. PAIA Electronics, Box J14359, Oklahoma City, OK 73114.

TELETYPE EQUIPMENT: Copy Military, Press, Weather, Amateur, Commercial Transmissions Catalog \$1.00 WEATHER MAP RECORDERS: Copy Satellite Photographs, National-Local Weather Maps. Learn How! \$1.00. Atlantic Sales, 3730 Nautilus Ave., Brooklyn, NY 11224. Phone: (212) 372-0349.

BUILD AND SAVE TELEPHONES, TELEVISION, DETECTIVE, BROADCAST Electronics. We sell construction plans with an Engineering Service, Speakerphones, Answering Machines, Carphones, Phonevision, Dialers, Color TV Converters, VTR, Games, \$25 TV Camera, Electron Microscope, Special Effects Generator, Time Base Corrector, Chroma Key, Engineering Courses in Telephone, Integrated Circuits, Detective Electronics, PLUS MUCH MORE, NEW Super Hobby Catalog PLUS year's subscription to Electronic News Letter, \$1.00. Don Britton Enterprises, 6200 Wilshire Blvd., Los Angeles, Calif. 90048.

NAME BRAND Test Equipment. Guaranteed discounts up to 50%. Free catalog. Salen Electronics, Box 82, Skokie, IL 60077.

UNSCRAMBLERS FOR any scanner. Several models available. Free literature. Capri Electronics, 8753T Windom, St. Louis, MO 63114.

UNSCRAMBLERS, seven models available to decode police, ambulance, and fire coded transmissions. Other scanner devices, Tone encoders/decoders, Telephone accessories, etc. Free Catalog. KRYSTAL KITS, Box 445, Bentonville, AR 72712. (501) 273-5340.

POLICE FIRE SCANNERS, crystals, antennas, Cbs, Radar Detectors, HPR, Box 19224, Denver, CO 80219.

PRINTED CIRCUIT supplies, chemicals, tools, artwork, plating solutions. Major credit cards. Catalog \$2.00, refundable. CIRCOLEX, Box 198, Marcy, NY 13403.

RECONDITIONED TEST EQUIPMENT \$1.00 for catalog. WALTER'S TEST EQUIPMENT, 2697 Nickel, San Pablo, CA 94806. (415) 758-1050.

Buy Gov't Surplus SAVE To 85%.

Send 60¢ For Big Bargain Catalog

1000's of Bargains: Surplus, Excess Inventory, Brand Name New Equipment

COMPRESSORS • WINCHES • GEAR MOTORS
TELEPHONES • WELDERS • POWER PLANTS
SURVEYING INSTRUMENTS • ELECTRONICS
FIRE/BURGLAR ALARMS • PAINT GUNS
TARPS • BINOCULARS • TOOL BOXES
HYDRAULICS • AIR TOOLS • PUMPS

SURPLUS CENTER Box 82209-PE Lincoln, Nebraska Zip Code 68501

SATELLITE TV FOR THE HOME

Our receiver lets you get over 75 channels of television directly from earth-orbiting cable TV satellites! HBO, Showtime, super stations, sports and movies from around the world.



Sick of Network TV? Buy Complete or Build our kit and save!

Our 24-channel receiver provides "studio quality" TV reception. Easy to install! Ultra low power consumption! Brilliant color! Works anywhere! FCC licensing no longer required. Order today! Complete details covered in our Home Earth Station manual. Send \$7.95 today (refundable against any purchase), or call:

24-hour C.O.D. Hotline
(305) 869-4283
SPACECOAST RESEARCH
Dept. H, P.O. Box 442, Altamonte Springs, FL 32701

NEW ELECTRONIC PARTS. Continuously stocked. Stamp books catalog. Daytapro Electronics, 3029 N. Wilshire Ln., Arlington Hts., IL 60004

FREE CA3140 OpAmp with order. Send for catalog. KEY ELECTRONICS, Box 3506P, Schenectady, NY 12303.

ELECTRONIC CATALOG. Over 4,500 items. Parts & components. Everything needed by the hobbyist or technician. \$2.00 (U.S. funds) Postage & handling, refundable with first \$15.00 order. T & M Electronics, 472 East Main St., Patchogue, NY 11772. (516) 289-2520.

SPEAKERS SAVE 50%. Build your own speaker system. Write: McGee Radio Electronics, 1901 McGee Street, Kansas City, Missouri 64108.

OSI CHALLENGER 1P—Superboard II. 90 page step-by-step programming manual. \$5.95 + \$1.00 P&H. TIS, Box 921-PE, Los Alamos, NM 87544.

PRINTED CIRCUIT BOARDS, your artwork. Quick delivery. Reasonable. Atlas Circuits, Box 974, Waynesville, NC 28786. (704) 456-3739.

HAMS, CBERS, SWLS, ELECTRONICS BUFFS! Parts, kits and plans now available for Popular Electronics projects. MORSE-A-WORD: Circuit boards \$24.00; Essential parts kit \$99.95; Complete four character kit \$149.95; Eight character kit \$169.95; Wired \$249.95. RTTY READER: Boards \$24.00; Complete kit \$189.95; Wired \$269.95. S&H \$5.00 kits: \$1.50 boards. Use VISA Mastercard. (414) 241-8144. Write for catalog MICROCRAFT, POB 513PE, Thiensville, WI 53092.

CABLE TV UNSCRAMBLERS AND CONVERTERS. Build or buy. Plans and parts. For information send \$2.00. C&D Company, P.O. Box 21, Jenison, MI 49428.

FIBER OPTIC SPECIALS—100 foot spool of fiber \$3.00—Experimenter's kit \$6.00—High Power LED with matched Detector \$10.00—Data Link construction plans (detailed) \$5.00. Catalog with samples \$1.00. FIBERTRONICS, Box 322-A, Primos, PA 19018.

SCRAMBLED TELEVISION—Encoding Decoding. New publication. Complete theory, circuits \$9.95. Workshop, Box 393PEC, Bethpage, NY 11714.

KEYBOARDS—High quality 61-note single or dual contact for the organ or synthesizer you are building. Send for information. Devtronix, Dept. 71, 6101 Warehouse Way, Sacramento, CA 95826

Enjoy Satellite TV Now



Better than Cable TV—Over 200 TV and radio services. Why waste money? Learn the whole story and build a video system the family can enjoy. No commercials, FREE movies, sports and Vegas shows—worldwide, crystal clear reception connects to any TV set. Big (8 x 11 in.) book loaded with details, photos, plans, kits—TELLS EVERYTHING! Satisfaction Guaranteed.

Send \$7.95 TODAY! Add \$2.00 for 1st class (air mail) or call our 24 hour C.O.D. rush order line (305) 862-5068.

GLOBAL TV ELECTRONICS, P.O. Box 219-K, Maitland, Florida 32751

RARE OUT-OF-PRINT ALBUMS. 25,000 in stock (FS). List \$2.00 refundable. Record Warehouse, Box 4617, Dept. PE, Rochester, NY 14613.

Telephone Listening Device

Record telephone conversations in your office or home. Connects between any cassette or tape recorder and your telephone or telephone LINE Starts automatically when phone is answered. Records both sides of phone conversation. Stops recorder when phone is hung up. This device is not an answering service.

Each \$18.95
Qty. Disc Avail.

Super Powerful Wireless Mic

10 times more powerful than other mics. Transmits up to 1/4 mile to any FM radio. Easy to assemble kit. 15V battery (not incl.)

Call (305) 725-1000 or send \$18.95 + \$1.00 shipping per item to USI Corp., P.O. Box PE-2052, Melbourne, FL 32901. COD's accept. For catalog of transmitters, voice scramblers and other specialty items, enclose \$2.00 to USI Corp.

CHEMICALS. Apparatus, Project Books, Wide Selection. Catalog send \$1.00 to Pioneer Corp., 14a Hughey Street, Nashua, NH 03060.

39¢ ADD \$1.50 FOR POSTAGE

30 CHANNEL CABLE TV CONVERTER

ORDER No. 198AE047

PLATTSBURGH, N.Y. 12901
Tel.: (518) 561-8700.

FREE! UNUSUAL 96 PAGE ELECTRONIC PARTS & IDEAS CATALOG!

SHORTWAVE RADIO CONVERTER - Installs in minutes. Hear world wide broadcasts while you drive. Free information, Houston, Box 588, Houston, Mississippi 38851.

FREE CATALOG! Bargains, Parts, ICs, Kits, Musi-Kits, Specials. GODBOUT ELECTRONICS, Bldg. 725E, Oakland Airport, CA 94614.

TEST EQUIPMENT, new and used. Catalog \$1.00. PTI, Box 8756, White Bear Lake, MN 55110.

OVER 1400 MICRO-COMPUTER PRODUCTS. LOWEST PRICES! Send \$2.00 for 1980 112 page mail order catalog to: ELECTRONIC SYSTEMS, Box 21638-PE1, San Jose, CA 95151. (408) 448-0800.

PLANS! BUILD NEGATIVE ION GENERATOR FOR \$35. Schematic, parts list sources, instructions. Only \$4.50. Other plans available. Send \$ARE for list. Lunatrix, Box 891, Yucaipa, CA 92399.

TO RECEIVE COMMERCIAL FREE—unedited movies, night club acts, sporting events. Send \$9.95 for complete detailed easy to follow plans. To: Amateur Microwave Antenna, Dyna-Comp Electronics, Dept. QF-1, P.O. Box 4181, Scottsdale, Arizona 85258.

QUALITY AUDIO COMPONENTS. Multi-Track Equipment. Programmable Calculators. Accessories. Competitive Pricing! Prompt Delivery! Knowledgeable staff! Service Facility! Credit Cards accepted. FREE catalog. SOUND IDEAS. Dept. PE, PO Box 340, Cary, N.C. 27511. 1-800-334-2483 (N.C. 919-467-8462).

SCRAMBLED TELEVISION. Decoder Circuit designs, parts suppliers, theory, technical advice. \$10.00 Money Order only Quest Electronics, Box 1722, Costa Mesa, Ca. 92627.

RF POWER TRANSISTORS TUBES! MRF454 - \$17.00. MRF455A - \$14.00. 8950 - \$6.50. 6LF66MH6 - \$5.50. Catalog available. WESTCOM. 1320 Grand, San Marcos, CA 92069. (714) 744-0728.

SAM'S PHOTOFACT SCHEMATICS. 1-900. \$3.00. Cliff King TV. 2148 N. Garey, Pomona, CA 91767.

ELECTRO-VOICE Hi Fi component loudspeakers. Building your own Speaker System? Use the best Free discount catalog. SONIX. Dept. PE, Box 58, Indian Head, MD 20640. (301) 753-6432.

PRINTED CIRCUIT BOARDS From Schematics, your artwork or ours. Free Drilling and quotes. Assembly services also available. Write: PRODUCTION DEVELOPMENT, 1320 Water Street, Brownsville, PA 15417.

NICKEL-CADMIUM BATTERIES Government Surplus, a must for Wind Generators, Solar, Electric, Homes, Auto. Send \$1.00. INTERPLANTRY, 1535 Cunningham Ave, Merritt Island, FL.

SHORT WAVE LISTENERS! Free new catalog scanners #5 of short wave receivers, digital frequency displays, Collins filters, active All-Band receiving antennas, loop antennas and special DX modifications! Kenwood—Yaesu—Drake—Sony—Panasonic—Grundig, Radio West, 3417 Purer Road, Escondido, CA 92025. (714) 741-2891.

PRINTED CIRCUIT BOARDS—Superb quality at reasonable rates. Large or small volume work, with final drawing and hardware available. Write today for quotes. Hardware Graphics, 123 Calder Dr., Warren, RI 02885.

SATELLITE TELEVISION—New package includes: ANTENNA AIMING DATA computed for your latitude, longitude (plotted by Compusat). Revised listing of U.S. and international geostationary satellites, transponder video frequencies, audio subcarriers, formats, antenna feedline data and more. All for \$10.00. COMPUSAT, 643 South Route 83, Elmhurst, IL 60126.

PRINTED CIRCUIT BOARDS. Custom Etching, reasonable. send your artwork to: GM ENTERPRISES, 28 Hillside Ave., Providence, RI 02906.

PRINTED CIRCUITS

Single or Double Side Plated Through-Circuit Design
Hole - Print and Etch
Prototypes Quantity Discounts

EXENTER CORP. PHONE (703) 550-7585
9022-A Telegraph Road
Lorton, VA 22079

RESISTORS 1/4 WATT 5% CARBON FILM FACTORY FRESH 1.65 per hundred, 12.00 per thousand. Integrated Circuits 4116 Dynamic Ram 8 for 34.00, 2716iii 11.00, 2732iii 37.00. I.C. Sockets, Capacitors, trim pots, Phone Orders Welcome (313) 728-0650. WESTLAND ELECTRONICS, 32425 Ford Rd., Westland, MI 48185.

\$9.95



Digits 6.1mm
Dia. 30mm

LCD DIGITAL CLOCK CALENDAR

Alternating date and time. Great for cars, boats, airplanes. Long life battery. 4 year calendar. One year guarantee. Magnetic pieces for mounting. Other modules and products available.

LCD, Suite E-428, Fifth Avenue
Scottsdale, AZ 85253

COMPUTER EQUIPMENT

SURPLUS COMPUTER PERIPHERALS. Selectric™ I/O typewriter bargains. World's largest selection. Send 25c for bargain-packed flyer. CFR, Box 144, Newton, NH 03858.

RECIPE FOR APPLE KRISP: New Concepts' Apple II Modulator . . . MICRO-VERTER, \$35.00. Better color — sharper images Phone — write. (402) 987-3771. Also modulator kits, monitors, cameras. Dealers welcomed. ATV RESEARCH, 13-P Broadway, Dakota City, NE 68731.

COMPUTERS — 10% Customer discount — APPLE — COMMODORE — ATARI. All accessories/software. Free U.P.S. shipping. B.C. Communications (516) 549-8833

HEALTH TRAINER ACCESSORY ETA3400 programs, terminal plans. C. Oakes, Box 7114, Toronto Ont M5W 1X8. U.S. Inquiries.

RED LED T1-3 4 size. 10 \$1.00, 100 \$8.00, plus \$1.00 p&p. Computronics, 1710 Newport Circle, Suite P, Santa Ana, CA 92705.

MEMOREX FLEXIBLE DISKETTES. WE WILL NOT BE UNDERSOLD!!! Visa, Mastercharge accepted. Call free (800) 235-4137 for prices and information. All orders sent postage paid PACIFIC EXCHANGES, 100 Foothill Blvd., San Luis Obispo, CA 93401

CURRENT - LOOP INTERFACE ADAPTER for your terminal or computer. \$99.00. For specifications write or call: DURACOM, 7300 North Crescent Blvd., Pennsauken, NJ 08110. (609) 662-7295.

POCKET COMPUTER NEWSLETTER. Helpful, Informative. Free information. Sample \$2. PC Newsletter, Dept. PE1, Box 232, Seymour, CT 06483.

6800 MICROCOMPUTER KIT. ONLY \$79.50. 1K bytes ram, 256 bytes rom, keyboard, display, and power supply. For additional information or to order, write: SIERRA ELECTRONICS, Box 5880, Lubbock, Texas 79417.

16K DYNAMIC RAMS 4116 Tested pullout guaranteed. Set of 8. \$25.00. Jim Terry, P.O. Box 61411, Sunnyvale, CA 94088. (408) 733-7299.

LEARN MICROCOMPUTERS on your own computer. Send \$5.00 for 2 complete instruction manuals. Paccom, 14905 NE 40th, Dept. MPE011, Redmond, WA 98052.

PERSONAL COMPUTERS, BUSINESS SYSTEMS, PERIPHERALS, SOFTWARE. Up to 25% discount. Before you buy, call (415) 962-8237. Cubit, 2267 Old Middlefield, Mountain View, CA 94043.

FLOPPY DISK REPAIR. Most major brands. Computer Service Center, 1023 N. La Brea, Hollywood, CA 90033. (213) 851-2226.

AMATEUR RADIO

MADISON DEEP HAM DISCOUNTS. Kenwood, Yaesu, Icom, Drake, Accessories—Stock. FREE flyer. Madison Electronics, 1508-P McKinney, Houston, TX 77002. (713) 658-0268.

AMATEUR RADIO SWL. Icom, Yaesu, Kenwood, all major lines in stock. TOLL FREE (800) 854-6046. Ham Radio Outlet, 2620 W. La Palma, Anaheim, CA 92801.

THE EAVESDROPPER ANTENNA. Your ear to the world's international shortwave broadcast bands (11 through 60 meters). Fully assembled. \$64.50 plus \$2.50 U.P.S. literature available. Visa MasterCard. ANTENNA SUPERMARKET, Dept. PE1, Box 563, Palatine, IL 60067. (312) 359-7092.

RADIO AMATEUR CALLBOOKS 1981 Directories of Radio Amateurs around the world. U.S. Callbook \$20.50; Foreign Callbook \$19.50, shipping included. See your dealer or write for FREE catalog Radio Amateurs Callbook, Dept. PE, 925 Sherwood Dr., Lake Bluff, IL 60044.

OWNER REPAIR OF RADIO EQUIPMENT Book, \$8.70 (Club Discount) K6RQ, 14910 LG Blvd., Los Gatos, CA 95030.

WYOU is for sale — transmitting on 108 FM DIAL will play your tapes, records, TV, etc. on any FM radio in your home. Satisfaction guaranteed \$24.95 - Portosound Co., Box 279, Howard Beach, NY 11414.

C.B. EQUIPMENT

GET MORE CB CHANNELS AND RANGE! Frequency Expanders, boosters, speech processors, interface filters, VOX, how-to-books, plans. Catalog \$1 CB CITY, Box 31500PE, Phoenix, AZ 85046

PALOMAR - PRIDE - ATLAS: Exclusive Repair Facility. Factory trained technicians, all work guaranteed. Palomar Electronics Repair Service, 1320 Grand, San Marcos, CA 92069. (714) 744-0720.

PLANS AND KITS

LASERS HANDBOOK with burning, cutting, Ruby Reds, CO's complete plans, books, and parts. Send \$4.00 to: Famco, Dept. PE, Box 1902, Rochester, NH 03867.

PRINTED CIRCUIT BOARDS, send your sketches or artwork, kit projects, Quick Service, Free Estimates. ELECTRONIC DESIGN CONCEPTS, 2780 Skyline Circle, Memphis, TN 38127

TOP QUALITY SPEAKERS AND KITS. Send \$1.00. Speaker Warehouse, 809 North Route 441, Hollywood, FL 33021.

EXQUISITE ELECTRONIC KITS for beginners and pros. Free brochure. LOGICAL SYSTEMS, 3314 'H' Street, Vancouver, WA 98663.

GIANT SCREEN TV projection system converts any television into 7-foot picture. Lens & instructions \$14.95. (Dealers welcome). Bell Video, 4616 Belair Rd., Baltimore, MD 21206.

ROBOT INFO - Booklet, \$4; basic plans, \$6.50; advanced plans, \$9.45. OMEGA ENTERPRISES INC., 'THE ROBOT PEOPLE' P.O. Box 4143, DEPT PEA, Tulsa, OK 74104.

SOUND EFFECTS SYNTHESIZER. Uses voltage controlled circuits. Amazing quality. Inexpensive. PC Board plus complete plans \$9.95 or send stamp for information. Waveform, 7 Bradford Avenue, Pittsburgh, PA 15205.

Video

cassette

recorders

cameras

tapes

call collect: 714-278-0729

Outside Ca. 800-854-1081

Video Warehouse

ask for our Price List

9514 Chesapeake Dr. San Diego, CA 92123

SINCLAIR ZX80 USERS: Video inverter kit for more readable, white on black display. Conversion takes only minutes. Send \$5.00 to Burnett Electronics, 908 Morris Street, Cincinnati, Ohio 45206.

SATELLITE TELEVISION INFORMATION — Build or buy your own Earth Station. U.S. \$4.00. Satellite Television, RD 3, Oxford, NY 13830.

G.I. RADIOS: Army mainstay from Korea to Viet Nam. PRC-6 Walkie-Talkies, 47-54 MHz FM, \$32.50 pair. Backpack radios, less accessories: PRC-9, 27-38 MHz FM, \$47.50 mint unused; PRC-10, 38-54 MHz FM, \$27.50 checked, \$13.50 repairable. Schematic, accessory, and battery information included. Add \$3.50 shipping. Stephens, Box 591-P, Sandusky, OH 44870.

SATELLITE TELEVISION . . . HOWARD COLEMAN boards to build your own receiver. For more information write . . . ROBERT COLEMAN, Rt. 3, Box 58-APE, Travelers Rest, S.C. 29690.

SUBSCRIPTION TELEVISION EDUCATION MANUAL! Two scrambling/decoding systems, theory, circuits. Decoder dealers listed. \$14.95. ABEX, P.O. Box 26601-P1, San Francisco, CA 94126.

SATELLITE VISION
SATELLITE VISION
SATELLITE VISION

We manufacture the highest spec 3-meter data & video dish in the world 41db gain! We also sell direct. Immediate delivery or you pick up. Complete details including satellite TV information, pricing service and discount schedule. Send \$1.25 for postage & handling.

TIGER TENNAS
P O Box 561
Casselberry, Florida 32707

BUY DIRECT



ANTI-GRAVITY Solid State Electronic Levitation. No moving parts, magnets, gases, exotic fuels. Data, Schematics, Diagrams. 78 pages 8x10 mimeo. \$15 ppd. Guaranteed! A.E.S., Box 132-M, Eureka Springs, Arkansas 72632.

MICROWAVE OVENS save to \$290. Amana, Litton, Norelco, Quasar, Sharp, Toshiba, DECE, 9245 Huebner, San Antonio, 78240.

COMPLETE SOLID STATE Color television recorder-reproducer electronic assembly with power supply. \$24.95. Visa, Master Card, Madison Electronics, Box 217, Madison, Alabama 35758. Telephone 205-837-6658.

AUTOMOTIVE LIQUID-VAPOR SYSTEM. Increased gas mileage and performance! Pays for itself. Plans \$5.00. System \$16.75. Unit guaranteed. Pure Motors Co., Box 8054, Phoenix, AZ 85066.

BUILD AN ORCHESTRA THE OVERS WAY

Preview the world's most advanced Do-It-Yourself Organs, Pianos, Synthesizers, Amps, etc. Send \$6.00 for our famous "Sight & Sound" pack. WE RSI Electronics, Inc., Dept. M2, P.O. Box 5318, 1720 Hempstead Rd., Lancaster, PA 17601.

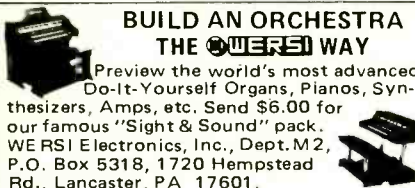

VORG SPEAKER SYSTEM - We really sell great speaker kits at a low price. For catalogue, send 50c to: 2260 Maplewood, Cleveland Heights, OH 44118.

ALARMS

Burglar-Fire Protection

Protect Your Life, Home, Business, Auto, etc.

- Our catalog shows how. Install your own alarm systems and devices and save \$\$\$\$.
- We offer FREE write-in engineering service.

Lowest Prices on Reliable, High-Quality Alarm Systems and Devices

FREE CATALOG

Burdex Security Co. Box 82802-PE Lincoln, Ne. 68501



POLICE DIALER \$29.95. Free burglar alarm equipment catalog. Sasco, 5619P St. John, Kansas City, MO 64123. (816) 483-4612.

BURGLAR, FIRE, CAR! Finest equipment! Save! Free Catalog. Refundable! AAS, 186A Oxmoor Road, B. ham. AL 35209

HIGH FIDELITY

DIAMOND NEEDLES and Stereo Cartridges at Discount prices for Shure, Pickering, Stanton, Empire, Grado, Audio Technica, Osawa, Satin and ADC. Send for free catalog. LYLE CARTRIDGES, Dept. P, Box 69, Kensington Station, Brooklyn, New York 11218. Toll Free 800-221-0906 9AM - 8PM except Sunday.

WANTED

GOLD. Silver, Platinum, Mercury, Tantalum wanted. Highest prices paid by refinery. Ores assayed. Free circular. Mercury Terminal, Norwood, MA 02062.

TUBES

RADIO & T.V. Tubes — 49 cents each. Send for free Catalog. Cornell, 4213 University, San Diego, Calif. 92105.

TUBES "Oldies". Latest Supplies, components, schematics. Catalog Free (stamp appreciated). Steinmetz, 7519-PE Maplewood, Hammond, Ind. 46324.

TUBES-RECEIVING Industrial and Semiconductors Factory Boxed. Free price sheet including TV, Radio and audio parts list. Transietronic, Inc., 1365 39th St., Brooklyn, New York 11218. Telephone: (212) 633-2800. Toll free: 800-221-5802.

ANTIQUA AND OBSOLETE TUBES \$1.00 to \$5.00. \$1.00 for list. Preller T.V., Augusta, AR 72006. (501) 347-2281.

GOVERNMENT SURPLUS

MANUALS for Govt Surplus radios, test sets, scopes. List \$1.00 (cash). Books, 7218 Roanne Drive, Washington, D.C. 20021.

SURPLUS JEEPS — \$19.30!! — **CARS** — \$13.50!! — 650,000 ITEMS!! — **GOVERNMENT SURPLUS!!** — Most COMPREHENSIVE DIRECTORY AVAILABLE tells how, where to buy!! — **YOUR AREA** — \$2 — **MONEYBACK GUARANTEE!!** — "Government Information Services", Department GE-61, Box 99249, San Francisco, California 94109.

GOVERNMENT SURPLUS DIRECTORY. Buy 500,000 items (including Jeeps) . . . low as 2c on dollar! Most complete information available — \$2.00. Surplus Disposal, Box 19107-HA, Washington, DC 20036.

PERSONALS

MAKE FRIENDS WORLDWIDE through international correspondence, illustrated brochure free. Hermes-Verlag, Box 110660 Z, D-1000 Berlin 11, W. Germany.

PENFRIENDS — ENGLAND — USA. through correspondence. Send age, interests. Free reply. Harmony, Box 89PE, Brooklyn, New York, 11235.

CORRESPONDENCE FOR FRIENDSHIP IN PHILIPPINES, MALAYSIA. Free information. AACCP (PE), Box 1542, Canoga Park, Calif. 91304.

INSTRUCTION

UNIVERSITY DEGREES BY MAIL! Bachelors, Masters, Ph.D.'s. Free revealing details. Counseling, Box 317-PE01, Tustin, California 92680.

LEARN WHILE ASLEEP! HYPNOTIZE! Astonishing details, strange catalog free! Autosuggestion, Box 24-2D, Olympia, Washington 98507.

RADIO BROADCASTING. Become DJ, engineer. Start your own station — investment experience unnecessary! Receive free equipment, records. Free details. Broadcasting, Box 130-A1, Paradise, CA 95969.

LEARN ELECTRONIC ORGAN SERVICING at home. Completely revised course covers latest models including digital, LSI's, synthesizers, etc. NILES BRYANT SCHOOL, PO Box 20153, Sacramento, CA 95820.

PASS FCC EXAMS

The Original FCC Tests-Answers exam manual that prepares you at home for FCC First and Second class Radiotelephone licenses. Newly revised multiple-choice exams cover all areas tested on the actual FCC exam. Plus "Self-Study Ability Test" Proven! \$9.95 postpaid. Moneyback Guarantee.

TESTS-ANSWERS FOR FCC FIRST AND SECOND CLASS COMMERCIAL LICENSE

COMMAND PRODUCTIONS Radio Engineering Division P.O. Box 26348 P San Francisco, CA 94126



MEDICAL ELECTRONICS TECHNOLOGY, home study. Troubleshoot medical instruments. University MDC, P.O. Box 124, Pinedale, CA 93650.

YOU CAN NOW EARN A Bachelor, Master, or Doctoral Degree without leaving home. Courses are under faculty guidance. Kensington University, (P.O. Box 2036), 512 E. Wilson, Glendale, CA 91209.

Get your College Degree at Home! Be an ELECTRICAL ENGINEER

Learn at home in spare time. No previous experience needed — just a high school diploma. Now you can get the same training system used by many of the Fortune 500 corporations to train their employees. Fully accredited. College degree awarded with major in Electrical Engineering. Master the technology of electricity and meet the increased demand for trained electrical engineers nationwide. Graduate in as little as two years. Approved for G.I.'s and Veterans. Get free facts now. No obligation. No salesman will call. Send for **FREE FACTS**.

ICS CENTER FOR DEGREE STUDIES, Dept. PD000
ICS College Center, Scranton, PA 18515

Send free facts on how I can get my College Degree in Electrical Engineering at home in spare time.

Name _____ Age _____
Address _____
City/State/Zip _____



LEARN MORSE CODE in 4 hours. \$3.00 to JLS Publications, Box 7866-P, Independence, Ohio 44131.

COLLEGE DEGREES BY SPECIAL EVALUATION of EXISTING Credentials & Job Experience. Fast, Inexpensive (614) 863-1791. Guidance, Box 13151-A1, Columbus, Ohio 43213. Be Specific.

FOR INVENTORS

PATENT AND DEVELOP Your invention. Registered Patent Agent and Licensed Professional Engineer. Send for **FREE PATENT INFORMATION** every inventor should have. Richard L. Miller, P.E., 3612 Woolworth Building, New York, NY 10007, (212) 267-5252.

INVENTIONS WANTED

FREE CONSULTATION • **NO IDEA TOO SMALL**

Disclosure registration. Potential cash or royalties from manufacturers seeking new ideas. For free information on how to register your ideas. Call or write.

AMERICAN INVENTORS CORP.

59 Interstate Dr. Dept PE
West Springfield, MA 01089 (413) 737-5376
A Free Based Service Company

INVENTORS Patent your invention. Free initial consultation. We are registered by the U.S. Government. VICTOR J. EVANS & CO., 4637 Eastern Ave. N.E., Washington, DC 20018. Since 1898.

MANUFACTURER SEEKING Patented, Unpatented Inventions. Generous royalties. Advantek International, 1100 17th NW, Washington, DC 20036.

BUSINESS OPPORTUNITIES

FREE CATALOGS. Repair air conditioning, refrigeration. Tools, supplies, full instructions. Doolin, 2016 Canton, Dallas, Texas 75201.

MECHANICALLY INCLINED individuals desiring ownership of Small Electronics Manufacturing Business — without investment. Write: **BUSINESSES**, 92-K2 Brighton 11th, Brooklyn, New York 11235.

MECHANICALLY INCLINED INDIVIDUALS

Assemble electronic devices in your home. Knowledge, or experience not necessary. Get started in spare time. Above average profits. \$300 - \$600/Wk possible. Sales handled by others. No investment — Write for free details.

ELECTRONIC DEVELOPMENT LAB

Box 1560PE, Pinellas Park, FL 33565

ERASE DEBTS with little-known law — create wealth!! Details FREE — Blueprints: No. EE1, LaGrangeville, NY 12540.

DIGITAL WATCH REPAIR — Learn to repair digital watches — provide service to jewelry and department stores — part time or full time. We supply training — equipment — replacement parts. Zantech, Inc., 77 Shady Lane, Trenton, NJ 08619. (609) 586-5088.

BORROW \$25,000 "OVERNIGHT" Any purpose. Keep indefinitely! Free Report! Success Research, Box 29263-GA, Indianapolis, IN 46229.

FREE BOOK "2042 Unique Proven Enterprises." Fabulous "unknowns," second inflation income. Haylings-M, Carlsbad, CA 92008.

YOU CAN EARN \$1,000 \$3,000 WEEKLY rebuilding CRTs. We train. Lakeside, 4071 Elston, Chicago, Ill 60618. (312) 583-6565.

SPARE TIME FORTUNE in Vinyl Repair. Huge demand creates exceptional profits. We supply everything. Details free. VIP, 2012 Montrose, Chicago, IL 60618.

HOMEWORKERS! Big money stuffing envelopes! Payment in advance. Free Supplies. DEMCO, Box 7055-PE, Columbia, MO 65205.

NEW TAX LOOPHOLES DISCOVERED. Everyone Eligible. Free sample newsletter. Write ULC, Box 179-BA, Clarkston, GA 30021.

BIG MONEY IN BUSINESS PRINTING! 25% COMMISSION PLUS BIGGEST CASH BONUS! Build your own profitable year around business. Show tremendous line of salesbooks, register forms, unit sets, letterheads, envelopes, invoices, statements, business cards and dozens of other printed products. Lowest prices in industry. Something for every business and professional person. Free sales kit includes ad specialties, calendars, signs and ad matches. No experience needed. Our catalogs are easy to understand. We're over 50 but still young and aggressive, so we can show you the road to a very profitable full or part time career. Free sales kit. National Press, Dept. 107, North Chicago, IL 60064.

MAKE DURABLE BUILDING PLASTIC EASILY. Waterproof, Fireproof, Economical. Bays Laboratory, 2086 - 2075 Drive, Cedaredge, CO 81413.

PROJECTION TV . . . Make \$200.00 + per evening assembling Projectors . . . Easy . . . Results equal to \$2,500 projectors . . . Your total cost less than \$15.00 . . . **PLANS, LENS & Dealer's information \$14.00 . . .** Illustrated information FREE . . . Macrocomex, Washington Crossing, PA 18977.

EMPLOYMENT OPPORTUNITIES

ELECTRONICS AVIONICS EMPLOYMENT OPPORTUNITIES. Report on jobs now open. Details FREE. Aviation Employment Information Service, Box 240E, Northport, New York 11768.

MAKE YOUR HOBBY YOUR CAREER! High demand electronic job market! Get unique guide booklet — prepare for exciting, rewarding jobs. Send \$3.95 to: Files, Box 459E, Massapequa, NY 11758.

REPAIRS & SERVICES

TV TUNERS REBUILT. VHF or UHF only \$11.90. Send for free mailing kit. JW Electronics, Box 51A, Bloomington, IN 47402.

ALL T.V. TUNERS repaired \$11.95. Fast, quality work. MIKE'S T.V. TUNER SERVICE, Box 187, Bean Station, TN 37708. (615) 581-6393.

MOTION PICTURE/VIDEO

ORDER SPORTLITE SILENT & SOUND S-8 (some Std 8) ENTERTAINMENT FILMS! Only source for Ali/Frazier I & II fights. Buy Ali/Frazier I Std 8 color 200' reel \$14.95 ea' or Ali/Frazier II 2 Std 8 200' reels (r.t. 17") only \$12.95; Std 8 color \$13.95. Olympic collectors select & save: 70 Olympics Std 8 Eastman color 200' Aquatics (M. Spitz); Gymnasts (O. Korbut); Track & Field: Competitive sports—each a separate film—special \$7.95 ea PPD. S-8 snd features include Top 10 sellers: The Jerk (S. Martin); B. Reynolds in Smokey & the Bandit; Emmanuel (Columbia Pictures); Animal House; The Electric Horseman (Universal)—1-reelers only \$51.95 ea"; 2-reelers \$99.95 PPD. Order today! For video entertainment, your choice of any 1 World Series from 70-79 only \$59.95 ea" or a combination of any 2 on 1 tape \$99.95 ea". Use your Mastercard or Visa; just supply no. expiration date & sign. Add \$2. per reel; **add \$2.50 per tape. Hollywood Gold Video cat. \$1.50; new Univ. 1980 S-8 16mm cat. \$1.50; Columbia VTR cat. \$1.; Sportlite Films, Sports Tapes, Ring Classics, Paramount fliers, Mag Video lists. 50c ea. Univ 8 enter. cat. \$1. SPORTLITE FILMS, Elect-1, Box 24-500, Speedway, IN 46224.

HOBBIES

FREE! BIG BARGAIN CATALOG — NEW EDITION listing thousands of bargains including U.S. & B.N.A. stamps, packets, albums, accessories and supplies. Also, fine stamps from our approval service, buy any or none, return promptly, please. Jamestown Stamp, Dept. E11PE, Jamestown, NY 14701.

3 OLD LIBERTY HEAD NICKELS Only \$1.00. Issued before 1913. Limit 1 set. (Adults only). Plus price lists. Littleton Coins, HL-17, Littleton, NH 03561.

HYPNOTISM

FREE Hypnotism, Self-Hypnosis, Sleep Learning Catalog! Drawer H400, Ruidoso, New Mexico 88345.

RUBBER STAMPS

RUBBER STAMPS, BUSINESS CARDS. Many new products. Catalog, Jackson's, E-100, Brownsville Rd., Mt. Vernon, Ill. 62864.

REAL ESTATE

BIG... NEW... SPRING... CATALOG! Over 2,800 top values coast to coast! UNITED FARM AGENCY, 612-EP West 47th, Kansas City, MO 64112.

BOOKS AND MAGAZINES

THE SUPERMARKET OF ELECTRONICS—thousands of items for sale or trade each month. Free classified ad with subscription. Only \$5.00 to Nuts & Volts, POB 1111-P, Placencia, CA 92670.

PUBLISHERS' OVERSTOCKS, BARGAIN BOOKS, 2,000 titles, all subjects! Free catalog: Hamilton, 98-84 Clapboard, Danbury, CT 06810.

ELECTRONICS BOOKS AVAILABLE. World publishers. Lowest prices. Ask catalogue. Business promotion, Lalpatrai Market, Delhi, India.

ELECTRONIC MUSIC and home recording in Polyphony magazine. Advanced applications, interviews, projects, computer music. Sample \$1.50. Subscription (6 issues), \$8.00 US \$10.00 foreign. POLYPHONY, Box P20305, Okla. City, OK 73156.

MICROFILM EDITIONS AVAILABLE. Copies of POPULAR ELECTRONICS Magazine are available on Microfilm from Xerox University Microfilms, Ann Arbor, MI; microfiche from Bell & Howell, Micro Photo Division, Wooster, OH.

DO-IT-YOURSELF

PROJECTION TV... Convert your TV to project 7 Foot picture. Results equal to \$2,500 projector. Total cost less than \$200. PLANS & LENS \$16.00. Illustrated info. FREE: Macromce, Washington Crossing, PA 18977.

MISCELLANEOUS

MPG INCREASED! Bypass Pollution Devices easily, REVERSIBLY!! Free details — Posco GEE1, Box 300, La-Grangeville, NY 12540.

GASOLINE MILEAGE INCREASED DRAMATICALLY, easily!! Details FREE!! Techneering, Box 12191DD, Norfolk, VA 23502.

MAGIC TRICKS—You can do! Baffle friends. Catalog, \$2.00 Trick, both \$1.00, Abracadabra-LP2, Scotch Plains, New Jersey 07076.

FREE! World's Leading Novelty Catalog, 1600 Jokes, Tricks, Science, Sports, Hobbies, Johnson-Smith, C-24, Mt. Clemens, Mich. 48043.

AUTOMOBILE RE-TUNING FOR MAXIMIZED ECONOMY. Details FREE! Techneering, Box 12191DD, Norfolk, VA 23502.

BEERLOVERS! Save \$1.00 every sixpack — Drink homebrew. Free handbook, Duane's, Department PE011C, 508 Canal, New York, New York 10013.

FREE! World's Leading Novelty Catalog, 1600 Jokes, Tricks, Science, Sports, Hobbies, Johnson-Smith, C-201, Mt. Clemens, MI 48043.

Don't miss your copy!

**1981
STEREO DIRECTORY
& BUYING GUIDE**

Here are the facts you need to make sense out of today's bewildering stereo marketplace. It's over 250 pages of product listings, facts and data, compiled by the best team of experts in the business. Thousands of products are fully described, complete with photographs, manufacturers' descriptions, even latest retail prices!

Order from 1981 Stereo Directory, Dept. 01453, P.O. Box 278, Pratt Station, Brooklyn, NY 11205. Enclose \$3.95* (\$2.95 plus \$1.00 postage and handling). Outside USA \$5.00. *Residents of CA, CC, DC, FL, IL, MA, MO, MI, NY State, UT and VT add applicable sales tax.

BETTER ORDER before we change our minds

You've responded so well to our specials that we've come back with more. Stock up your lab at unprecedented prices, but remember that all quantities are limited; we will not be able to hold these kinds of prices forever. Sorry, due to processing costs we cannot include IC spec sheets, or accept COD/telephone orders on any items other than the 16K dynamic RAMs. IC numbers must include the special -S suffix or you will be charged our regular prices. Parts may be house numbered or dual marked.

LOWEST PRICE EVER!! 16K Dynamic RAMs - 8/\$37

Just what you've come to expect from us: the lowest price ever on 16K dynamic RAMs, backed up with a 1 year warranty. These are top quality, low power, high speed (200 ns) parts that expand memory in TRS-80™ I and II computers as well as machines made by Apple, Exidy, Heath H89, newer PETs, etc. Add \$3 for two dip shifts plus TRS-80™ conversion instructions. Hurry! 16K dynamic RAM prices may never be this low again.

*The RAM is a trademark of the Tandy Corporation.

TTL

7403-S	Quad 2 input OC	21/\$2
7410-S	Triple 3 input NAND	21/\$2
7413-S	4 to 16 line decoder/demux	6/\$2
7438-S	Quad 2 input NAND OC	21/\$2
7444-S	Gray to decimal decoder	8/\$2
7450-S	And-or-invert	21/\$2
7472-S	JK M-S flip flop	21/\$2
7493-S	4 bit binary counter	10/\$2
7496-S	5 bit shift register	12/\$2
74122-S	Retriggerable one-shot	18/\$2
74151-S	8 channel mux	8/\$2
74155-S	Dual 2/4 demux	8/\$2
74159-S	4 to 16 line decoder/demux OC	4/\$2
74161-S	Synchro 4 bit binary counter	8/\$2
74163-S	Synchro 4 bit binary counter	8/\$2
74164-S	8 bit shift register	6/\$2
74190-S	Up/down decade counter	4/\$2
74192-S	Up/down binary counter	4/\$2
74194-S	4 bit bidirectional shift reg	4/\$2
74195-S	4 bit parallel shift register	6/\$2
74198-S	8 bit shift register	4/\$2

CMOS

4012-S	Dual 4 input NAND	12/\$2
4020-S	14 stage counter	4/\$2
4023-S	Triple 3 input NAND	12/\$2
4044-S	Quad R-S latch	4/\$2
4046-S	Phase locked loop	2/\$2
4071-S	Quad 2 input OR	12/\$2
4093-S	Quad 2 in NAND Schmitt trig	4/\$2
4507-S	Quad EX-OR	4/\$2
4510-S	BCD up/down counter	2/\$2

LINEARS

(package type: H = TO99, M = minidip, D = dip, TK = TO66)

201H-S	Improved 301 op amp	10/\$2
308H-S	Micropower op amp	6/\$2
703H-S	RF/IF amp	6/\$2
723D-S	Voltage regulator	6/\$2
741M-S	Compensated op amp	15/\$2
1458M-S	Dual 741	10/\$2
4558M-S	Dual 741	10/\$2
4195TK-S	Dual track 15V reg w/ data	2/\$2

TO-220 NEGATIVE VOLTAGE REGULATORS

7906	-6V regulator	2/\$2
7908	-8V regulator	2/\$2
7912	-12V regulator	2/\$2
7915	-15V regulator	2/\$2
7918	-18V regulator	2/\$2
7924	-24V regulator	2/\$2

Soldertail SOCKETS

8 pin	100/\$5.95
14, 16 & 18 pin	50/\$4.95
20 pin	40/\$4.95
24, 28 pin	30/\$4.95
40 pin	20/\$4.95

JUST IN! 5101L-1 CMOS 1K RAMs • Low Power • 450 ns \$2 each, 10 for \$17.50

Miscellaneous

RCA phono jacks - these are super quality, closed circuit jacks that are the best we've seen in years.

American made	20/\$1.95
2102 low power 1K static RAM	10/\$9.90
General purpose silicon signal diodes	50/\$2
GT5306 NPN darlington, min gain 17000,	
25V 200 mA, TO92 package	100/\$8.95
NPN transistor similar 2N3904	100/\$7.95
PNP transistor similar 2N3906	100/\$8.95
4N28 opto-coupler 6 pin minidip,	
MCT-2/IL-1 pinout	5/\$2
SN76477 complex sound generator	1/\$2.50
MA1003 12V DC clock module w/ case	\$19.95

Opto-isolator Grab Bag - 50 mixed opto-isolators from a major manufacturer. Unmarked 6 and 8 lead minidips include single and dual types with diode, transistor, and darlington outputs. Test them yourself and save! Not recommended for beginners.

50/\$4

TERMS: Cal res add tax. Allow min 5% shipping, excess refunded. Under \$15 add \$2 handling. VISA and Mastercard orders for 16K RAMs call (415) 562-0636, 24 hrs. Please include street address for UPS delivery. Prices subject to change without notice.

FREE CATALOGUE: Find out more about our exceptional product line. For 1st class delivery, add 41c in stamps. Foreign orders add \$2 (refundable with order).

GODBOUT

GODBOUT ELECTRONICS
Bldg. 725, Oakland Airport, CA 94614

CALIFORNIA

OHIO SCIENTIFIC

- HAZELTINE 1420 \$780
- CENTRONICS 779 W TRACTOR \$365
- NEC SPINWRITER \$2250

DATA PRODUCTS MAINTENANCE CORP.
9460 Teilar Ave. El Monte, CA 91731
(213) 573-5991 (714) 994-4180

OHIO SCIENTIFIC MICRO-COMPUTERS

A.A. Office
Equipment Company
2140 American Avenue
Hayward, CA 94545
(415) 782-6110

The Original ByteShop®

1415 W. El Camino Real
Mountain View, CA 94040
(415) 969-5464

ILLINOIS

FARNSWORTH COMPUTER

Apple, Hewlett-Packard
48K Apple II or Plus,
Disk W/C W/3.3 DOS
Sup-R-Mod . . . \$1,695.00
1891 N. Farnsworth Ave.
Aurora, IL 60505 (312) 851-3888

Apple II
TRS-80 SOFTWARE

ATARI® COMPUTER
• PLUS MUCH MORE •

ComputerLand®
Downers Grove

136 Ogden Ave., Downers Plaza
(312) 964-7762
"YOUR PERSONAL COMPUTER STORE"

WASHINGTON

TRS-80 OWNERS

Get the best information available for your computer! Subscribe to the ORIGINAL TRS-80 User Journal. \$16 per year. \$3 for current sample.

80-US JOURNAL
3838 S. Warner Street
Tacoma, WA 98409
VISA/MC (206)475-2219

CONNECTICUT

MULTI Computers & Peripherals Since 1977

BUSINESS

COMPUTER SYSTEMS, INC.
Wide Selection of Computers with Discount Prices

North Star HRZ-32K-D-ASM \$2275
Commodore 2001-32K \$1090
Apple II Plus and 48K \$1190
NEC Spinwriter 5510 or 5530 \$2490
And more!

MBC SYSTEMS INC.
28 Marlborough St.
Portland, CT 06480
(203) 342-2747
TWX Telex 710-428-6345
VISA Are Welcomed • %3 MC

COMPUTER INTERFACES
ANALOG INPUTS
AC REMOTE CONTROL

FOR: Pet • Apple • TRS-80 • AIM 65

Write or call for free catalog. Mention this magazine and receive a coupon for 5% discount on first order.

Connecticut microComputer, Inc.
34 Del Mar Drive, Brookfield, CT 06804
203 775-4595 TWX 710 456-0052

WISCONSIN

OHIO SCIENTIFIC SYSTEMS

CALL TOLL FREE FOR OUR PRICES
(800) 558-0870

or Write For Catalog
FARAGHER & ASSOCIATES
7635 Bluemound
Milwaukee, WI 53213
(414) 258-2588
In Wisconsin

RHODE ISLAND

WHOLESALE COMPUTER PRICES DIRECT TO THE PUBLIC!

Apple • Atari • HP-85 • Intertec • Soroc • TRS-80II • NEC Spinwriter

CALL TOLL FREE
1-800-556-7586

OMEGA Sales Co. 12 Meeting St. Cumberland, RI (401) 722-1027

MEMOREX DISKETTES

Call toll FREE (800) 235-4137
PACIFIC EXCHANGES

3M DISKETTES

Call toll FREE (800) 235-4137
PACIFIC EXCHANGES

NEW HAMPSHIRE

As advertised in 73 Amateur Radio, 80 Microcomputing & Keyboard Microcomputing magazines

TRS-80 Model II 64K
FREE CATALOG \$3400⁰⁰ plus frt.

MAIL ORDER MICROS
Dept. P6 803-924-3041
P.O. Box 427 Marlboro, N.H. 03455

DON'T MISS MICROCOMPUTING
— the encyclopedia of microcomputing

and **80 microcomputing**
— for the users of the TRS-80™

For subscription information write to:
Microcomputing Dept. P6 803-924-3041
80 Pine Street
Marlboro, NH 03455
Attn: Desk

NEW JERSEY

COMPUTER MART OF NEW JERSEY

501 Route 27 Iselin, N.J. 08830
(201) 283-0600

The Microcomputer People™

ECT™
MANUFACTURER OF S-100 PRODUCTS

BUILDING BLOCKS FOR MICROCOMPUTER SYSTEMS. DEDICATED CONTROLLERS AND TEST EQUIPMENT

ELECTRONIC CONTROL TECHNOLOGY, INC.
763 Ramsey Avenue
Hillside, New Jersey 07205
(201) 686-8080

NEW YORK

10% OFF With This Ad! Valid Until 1/1/81

ON TRS-80, APPLE, & ATARI SOFTWARE AND ALL BOOKS
COMPUTER CENTER
31 E. 31st St. N.Y. N.Y. 10016
(212) 889-8130

PENNSYLVANIA

MICROCOMPUTER
• Sales & Service •
Depot repair facilities.
All major brands!
Floppy disks & microcomputers.

CALDWELL COMPUTER CORP.
6720 Rising Sun Ave.
Philadelphia, PA 19111
(215) 742-8900

TEXAS



As a Radio Shack® Authorized Sales Center owned & operated by Pan American Electronics, Inc., we can sell them for less. *No taxes* collected on out-of-state shipments. *We pay shipping & insurance.*

TOLL FREE 800/531-7466
Texas & Main No. 512/581-2765
1117 Conway
Mission, Texas 78572

LOOK!! TRS-80™ Computer Owners

- Brand new Access mini-disk systems:
 - AFD-100
 - Single-drive — \$315
 - Double-drive — \$630
 - Triple-drive — \$945
- 16K-Byte Memory (8 prime 4116 ICs) — \$64.95

Introductory prices good for a limited time only. Prices do not include shipping, or sales tax if applicable.

Call Toll-free 1-800-527-4196
ACCESS UNLIMITED
315 N. Shiloh, Ste. D1 Garland, TX 75042
(214) 494-0796

TEXAS COMPUTER SYSTEMS Radio Shack
Authorized Sales Center, OFFERS LOWEST PRICES on

TRS-80 COMPUTERS

Call TOLL FREE for the BEST PRICES on all Radio Shack® Computers and accessories
• **FREE SHIPPING** on most items
• No out-of-state sales tax charged

NEW—Percom **DOUBLE DENSITY** for Model I. Twice the disk space. Easy to install. no modifications. Copies single density to **DOUBLE DENSITY** to convert existing software. Less than \$200

TOLL FREE 800-351-1473
Texas Residents 915-597-0073
TEXAS COMPUTER SYSTEMS
106 E. 10th, Brady, Tx 76825
Radio Shack® Authorized Sales Center 1791
1981

EAST TEXAS COMPUTERS, INC.

Microcomputer Specialists
Full Line Atari Dealer
Suppliers of Creative Software Products for Your Atari

305 Clemson Drive
Tyler, TX 75703

OPERATION ASSIST

Naico NA-1 audiometer and **Webster-Chicago model 81-1** RMA375 wire recorder. Need schematics and documentation. Dan Dugan, 833 14th St., San Francisco, CA 94114.

Hammarlund model HQ-140-X receiver. Need schematic and operating manual. Brian Todd, 3550 Hollylane, Stevensville, MD 21787.

Supro model S6422TR guitar amplifier. Need schematic. Ed Arnold, 316 Division St., Jackson, TN 38301.

Dejur-Grundig Embassy 2 stenorecorder. Need schematic and operating manual. Andrew Mossberg, 856 N.E. 164 St., Miami Beach, FL 33162.

Colecto Industries electronic challenge game. Need schematic or source for chip ITC 8000-7827. J. Lindeman, 4509 Raton Blvd., Huntsville, AL 35810.

Webcor model WFX157A stereo system. Need schematic, operating and service manuals. Chris Kubida, 8 Winnermere Dr., Fairport, NY 14540.

Zenith model 3000-1 FM/AM multiband radio. Need schematic. John Mairs, 9123 Donna Dear Dr., Springfield, VA 22153.

Grundig model SO-380 stereo. Need schematic and any other information. Richard Hanners, 1212 N. Atherton #9, State College, PA 16801.

Sears model #889.595150 fish flasher depth finder. Need schematic. Ben Stillwell, Crook County High School, Prineville, OR.

Trav-Ler reel-to-reel tape recorder model TT591. Need instruction manual and schematic. Philip Herbst, 140 Castleton Ave., Staten Island, NY 10301.

Knight model Star Roamer shortwave receiver. Need schematic and service manual. Ken Duncan, 3520 S. Oswego Ave., Tulsa, OK 74135.

MODEL II



11% DISCOUNT
Off List
64K 1 DRIVE \$3440.00
No Taxes on Out of State Shipments
Immediate Shipment On Most Items

\$ DISCOUNT \$
TRS-80® DEALER A301
COMPUTER SPECIALISTS

26-3001 4K Color.....\$360.00
26-1145 RS-232 Board.....84.00
26-1140 "O" K Interface.....249.00
26-1160 Mini Disk.....419.00
26-1171 Telephone Modem.....169.00
Fast 100 CPS Centronics 730 Printer.....659.00
Text Quality Centronics 737 Printer.....819.00
CAT Modem.....149.00

1-800-841-0860 Toll Free Order Entry
MICRO MANAGEMENT SYSTEMS, INC.
DOWNTOWN PLAZA SHOPPING CENTER
115 C SECOND AVE. S.W.
CAIRO, GEORGIA 31728
GA. PHONE NO. (912) 377-7120

FREE
COMPUTER
CATALOG
UPON
REQUEST



26-1062 4K I.....\$630.00
26-1062 16K III.....888.00
26-1063 32K III.....
2-Drives. RS232.....2225.00

Largest Inventory in S.E. U.S.A.

CIRCLE NO. 38 ON FREE INFORMATION CARD

LOWEST PRICES FOR PRIME ICs!

74125	\$0.49	74LS172	\$0.36	74LS196	\$1.25	74LS189	\$3.25	74C907	\$0.75	4089	\$2.75	LM741CH	\$0.55
74126	0.49	74LS173	0.55	74LS197	1.25	74LS194	2.16	74C908	1.10	4093	0.99	LM748CN	0.35
74132	0.75	74LS174	1.10	74LS221	1.90	74S200	3.95	74C909	2.15	4099	2.10	LM1489N	0.58
74141	0.79	74LS175	0.34	74LS240	2.25	74S206	4.55	74C910	6.00	4503	0.98	LM1496N	0.69
74145	0.79	74LS176	0.34	74LS241	2.25	74S253	1.15	74C914	1.45	4507	0.99	LM1889N	2.25
74147	1.70	74LS201	0.36	74LS244	2.25	74S257	1.45	74C918	1.40	4508	3.00	LM2111N	1.55
74148	1.29	74LS222	0.36	74LS253	1.01	74S258	1.45	74C925	7.80	4510	1.15	MC1353P	1.55
74150	1.10	74LS256	0.38	74LS257	0.88	74S290	2.75	74C926	7.80	4511	1.25	MC1455P1	0.35
74151	0.59	74LS257	0.36	74LS258	0.86	74S291	3.90	74C927	7.80	4512	1.25	MC1455P1	0.35
74152	0.29	74LS260	0.34	74LS260	0.38	74S289	4.35	74C928	2.80	4516	1.22	MC1456CV	0.95
74153	0.59	74LS262	0.40	74LS266	0.49	74S387	5.70	4518	1.15	4518	1.15	MC1458P1	0.58
74154	1.15	74LS273	0.36	74LS279	0.73	93500	2.00	4519	0.62	4519	0.62	MC1496L	0.99
74155	0.59	74LS283	0.36	74LS283	0.99	93505	2.30	4520	1.15	4520	1.15	MC1709P1	0.28
74156	0.69	74LS284	0.34	74LS290	1.05	93510	3.45	4000	\$0.35	4527	1.57	MC1710CP	0.29
74157	0.64	74LS282	0.82	74LS295	0.99	93512	1.35	4001	0.35	4528	1.50	MC1711CP	0.39
74158	0.64	74LS287	1.05	74LS365	0.66	93513	1.95	4002	0.35	4539	1.35	MC1716IC	0.35
74160	0.87	74LS288	1.05	74LS366	0.66	93516	3.40	4006	1.19	4555	0.89	MC1748CP	0.35
74161	0.67	74LS289	1.05	74LS367	0.66	93541	5.00	4007	0.35	4556	1.09	MC1748CP	0.35
74162	0.87	74LS291	0.34	74LS368	0.66	93542	1.50	4008	1.05	4582	1.09	MC7805CT	1.20
74163	0.87	74LS292	0.34	74LS373	2.25	93543	5.95	4009	0.49	4702	7.10	MC7806CT	1.20
74164	0.87	74LS293	0.34	74LS374	2.25	93546	1.85	4010	0.49	4703	8.75	MC7806CT	1.20
74165	0.87	74LS294	0.34	74LS386	0.53	93562	2.65	4011	0.35	4704	7.30	MC7812CT	1.20
74166	1.22	74LS294	0.45	74LS390	1.89	93562	2.65	4012	0.35	4705	9.25	MC7815CT	1.20
74167	1.25	74LS296	0.52	74LS490	1.89	93562	2.65	4013	0.48	4706	9.75	MC7824CT	1.20
74170	1.58	74LS298	0.48	74LS570	2.45	93562	2.65	4014	1.05	4720	6.95	MC78M12CT	0.77
74171	1.94	74LS298	0.52	74LS570	2.45	93562	2.65	4015	1.05	4723	1.50	MC78451P	0.50
74172	0.89	74LS299	0.48	74LS570	2.45	93562	2.65	4016	0.35	4724	1.50	MC78492P	0.52
74173	0.89	74LS299	0.48	74LS570	2.45	93562	2.65	4017	1.07	4725	3.85	MLM311P1	0.85
74174	0.89	74LS299	0.48	74LS570	2.45	93562	2.65	4018	0.35	4918	1.07	4901A	0.75
74175	0.89	74LS299	0.48	74LS570	2.45	93562	2.65	4019	0.49	4085	1.69	MLM565CP	1.20
74176	0.89	74LS299	0.48	74LS570	2.45	93562	2.65	4020	1.13	4008	0.89	N5568V	0.88
74177	0.89	74LS299	0.48	74LS570	2.45	93562	2.65	4021	1.13	4010	0.90	N5599A	0.89
74178	0.89	74LS299	0.48	74LS570	2.45	93562	2.65	4022	1.05	4016	1.17	N5532A	0.85
74179	0.89	74LS299	0.48	74LS570	2.45	93562	2.65	4023	0.35	4016	1.17	N5501A	6.00
74180	0.89	74LS299	0.48	74LS570	2.45	93562	2.65	4024	0.79	4016	1.17	N5526A	6.00
74181	0.89	74LS299	0.48	74LS570	2.45	93562	2.65	4025	0.35	4013	1.17	N5531V	3.90
74182	0.89	74LS299	0.48	74LS570	2.45	93562	2.65	4026	0.69	4017A	1.15	N5550A	1.00
74183	0.89	74LS299	0.48	74LS570	2.45	93562	2.65	4027	0.88	40175	1.15	N5555V	0.35
74184	0.89	74LS299	0.48	74LS570	2.45	93562	2.65	4028	0.11	40192	1.37	N5556A	0.90
74185	0.89	74LS299	0.48	74LS570	2.45	93562	2.65	4029	0.45	40193	1.37	N5560B	2.50
74186	0.89	74LS299	0.48	74LS570	2.45	93562	2.65	4030	0.25	40194	1.17	N5568A	1.20
74187	0.89	74LS299	0.48	74LS570	2.45	93562	2.65	4031	0.25	40195	1.17	N5568V	1.50
74188	0.89	74LS299	0.48	74LS570	2.45	93562	2.65	4032	0.45	40195	1.17	N5568V	1.50
74189	0.89	74LS299	0.48	74LS570	2.45	93562	2.65	4033	0.95	40195	1.17	N5568V	1.50
74190	0.89	74LS299	0.48	74LS570	2.45	93562	2.65	4034	0.25	40195	1.17	N5568V	1.50
74191	0.89	74LS299	0.48	74LS570	2.45	93562	2.65	4035	0.95	40195	1.17	N5568V	1.50
74192	0.89	74LS299	0.48	74LS570	2.45	93562	2.65	4036	1.10	40195	1.17	N5568V	1.50
74193	0.89	74LS299	0.48	74LS570	2.45	93562	2.65	4037	1.10	40195	1.17	N5568V	1.50
74194	0.89	74LS299	0.48	74LS570	2.45	93562	2.65	4038	1.10	40195	1.17	N5568V	1.50
74195	0.89	74LS299	0.48	74LS570	2.45	93562	2.65	4039	1.10	40195	1.17	N5568V	1.50
74196	0.89	74LS299	0.48	74LS570	2.45	93562	2.65	4040	1.10	40195	1.17	N5568V	1.50
74197	0.89	74LS299	0.48	74LS570	2.45	93562	2.65	4041	1.10	40195	1.17	N5568V	1.50
74198	0.89	74LS299	0.48	74LS570	2.45	93562	2.65	4042	1.10	40195	1.17	N5568V	1.50
74199	0.89	74LS299	0.48	74LS570	2.45	93562	2.65	4043	1.10	40195	1.17	N5568V	1.50
74200	0.89	74LS299	0.48	74LS570	2.45	93562	2.65	4044	1.10	40195	1.17	N5568V	1.50
74201	0.89	74LS299	0.48	74LS570	2.45	93562	2.65	4045	1.10	40195	1.17	N5568V	1.50
74202	0.89	74LS299	0.48	74LS570	2.45	93562	2.65	4046	1.10	40195	1.17	N5568V	1.50
74203	0.89	74LS299	0.48	74LS570	2.45	93562	2.65	4047	1.10	40195	1.17	N5568V	1.50
74204	0.89	74LS299	0.48	74LS570	2.45	93562	2.65	4048	1.10	40195	1.17	N5568V	1.50
74205	0.89	74LS299	0.48	74LS570	2.45	93562	2.65	4049	1.10	40195	1.17	N5568V	1.50
74206	0.89	74LS299	0.48	74LS570	2.45	93562	2.65	4050	1.10	40195	1.17	N5568V	1.50
74207	0.89	74LS299	0.48	74LS570	2.45	93562	2.65	4051	1.10	40195	1.17	N5568V	1.50
74208	0.89	74LS299	0.48	74LS570	2.45	93562	2.65	4052	1.10	40195	1.17	N5568V	1.50
74209	0.89	74LS299	0.48	74LS570	2.45	93562	2.65	4053	1.10	40195	1.17	N5568V	1.50
74210	0.89	74LS299	0.48	74LS570	2.45	93562	2.65	4054	1.10	40195	1.17	N5568V	1.50
74211	0.89	74LS299	0.48	74LS570	2.45	93562	2.65	4055	1.10	40195	1.17	N5568V	1.50
74212	0.89	74LS299	0.48	74LS570	2.45	93562	2.65	4056	1.10	40195	1.17	N5568V	1.50
74213	0.89	74LS299	0.48	74LS570	2.45	93562	2.65	4057	1.10	40195	1.17	N5568V	1.50
74214	0.89	74LS299	0.48	74LS570	2.45	93562	2.65	4058	1.10	40195	1.17	N5568V	1.50
74215	0.89	74LS299	0.48	74LS570	2.45	93562	2.65	4059	1.10	40195	1.17	N5568V	1.50
74216	0.89	74LS299	0.48	74LS570	2.45	93562	2.65	4060	1.10	40195	1.17	N5568V	1.50
74217	0.89	74LS299	0.48	74LS570	2.45	93562	2.65	4061	1.10	40195	1.17	N5568V	1.50
74218	0.89	74LS299	0.48	74LS570	2.45	93562	2.65	4062	1.10	40195	1.17	N5568V	1.50
74219	0.89	74LS299	0.48	74LS570	2.45	93562	2.65	4063	1.10	40195	1.17	N5568V	1.50
74220	0.89	74LS299	0.48	74LS570									

FIVEFOLD GROWTH IN TELECOMMUNICATIONS is expected by the end of the century, according to NASA studies conducted by IT&T and Western Union. Demand for conventional voice services (message-toll and private-line traffic) will predominate, and as much as 25% of all long-distance voice traffic may be carried by satellite, as well as half of all data and video traffic. To meet the demand, satellites with higher capacities and capable of operating in the 20/30-GHz band will be required. This Ka band would provide a frequency range five times that allocated to communications satellites now in use.

MOVIES ARE #1 FOR PRERECORDED video programming, according to a "Home Video Recording and Playback Equipment" report from Venture Development Corp. New and classic movies received the highest ratings in a recent study, drawing 66.5% and 50.2% interest, respectively. Between one-fifth and one-third of those polled expressed interest in PBS series and specials (31.6%), educational courses (24.2%), plays and dramatic specials (23.4%), sports events (23%), and old TV series (22.4%). Do-it-yourself programs that would make the most of the video disk's special freeze-frame, reverse, and random-access features ranked modestly (15.9%). At the bottom of the list were children's programs (9.9%), sports lessons (8.3%), and foreign-language movies (8.1%).

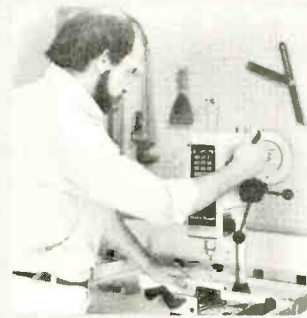

MICROPROCESSOR CONTROL OF POWER TOOLS has come to the consumer market with Black & Decker's new \$180 Model 9413 "electronic" drill press. Supplementing the microprocessor are a touch-sensitive keyboard and LED numeric display. The microprocessor performs a number of functions: maintains the selected (via the keyboard) speed under varying drilling loads; keeps track of drilling depth, updating the display in 0.020" increments; gradually changes speed electronically to prevent the work piece from being jolted; remembers and displays the last speed used when drilling is done; flashes "LOAD" on the display when incorrect drilling speed and pressure are used for prolonged drilling periods; and shuts off the drill when excessive loads are suddenly encountered.

POLICE OFFICER SAFETY can be increased with a device developed by Antenna Specialists. Rescu™ Emergency Location Alerting System enables a mobile-radio-equipped officer to call for help when he's not in his vehicle. In an emergency, the officer presses a button on his compact belt-worn actuator to send an emergency alert and a repeat of his last exact-location voice message via the vehicle's radio to the dispatcher. The system also automatically triggers if the officer wearing the actuator falls or lies prone. The system is currently being evaluated by a number of law-enforcement agencies across the country.

BRITAIN PLANS TO LEGALIZE CB RADIO, perhaps within a year. The "open-channel" CB system proposed by the British Home Office calls for an operating frequency of about 900 MHz and range of 10 miles in open country to minimize interference with TV and other radio services. Supporters of a national CB service, however, criticize selection of 900 MHz on the grounds that transceivers designed for this range would have to cost about \$800 each, thus restricting the market. The National Committee for the Legalization of CB Radio is lobbying for the 41-to-47-MHz band, estimating that a transceiver designed to operate in this band would sell for \$350 to \$425 and make it possible for more enthusiasts to use the new CB service.

FCC MAY UPGRADE LOW-POWER TV TRANSMITTERS known as "translators" to "ministation" status. The proposal, made in September, would give the new service the authority to originate programming. Under the proposal, ministations would be allowed to operate on any vhf or uhf channel that will not interfere with full-service stations. To give the new service a competitive edge, power would be increased from 1 watt to 10 watts on vhf and from 100 watts to 1 kW on uhf. There would be no minimum number of operating hours set, and program origination would be optional. Only one ministation would be permitted per market. Major TV networks would be barred from ownership, while cable-TV operators would have to restrict ownership of ministations to locations outside their franchise areas.

We've just lowered the price of admission.

Your ticket to a live performance just became even more affordable. Because the Koss K/4DS Digital Delay System with built-in amplifier and matching ambience speakers now has a suggested retail price of just \$459. Now that should really be music to your ears! Not since the introduction of stereo has a product so dramatically increased the listening enjoyment of recorded music. With four computerized ideal environment selections—club,

theater, concert hall, and auditorium—the Koss K/4DS Digital Delay System offers the most life-like and realistic portrayal of a live performance you've ever heard. Ask your audio dealer for a live demonstration, or write c/o Virginia Lamm, for more information on the K/4DS or other famous Koss stereophonic and loudspeaker products. Now that the price of admission is so low, you won't want to miss the missing link in stereo.

Suggested retail \$459

© Koss Corp. 1980



KOSS K/4DS Digital Delay System
hearing is believing®

KOSS CORPORATION, 4129 N. Port Washington Ave. Milwaukee, Wisconsin 53212 International Headquarters Milwaukee facilities Canada · France · Germany · Ireland
CIRCLE NO. 33 ON FREE INFORMATION CARD

www.americanradiohistory.com



UL Listed

Someone's always home when the Night Sentry Timer is on duty.

Night Sentry puts electronic timed lighting control where it belongs: on the wall...

Most home security experts agree that one of the most effective deterrents to intruders and burglars is lighting that creates the "lived-in" look while you're away. Now the new Dynascan Night Sentry enables you to easily achieve that lived-in look. Using a micro-computer that does the work of more than 10,000 transistors, it provides automatic control of indoor or outdoor light fixtures, including porch, post, kitchen, bathroom, and bedroom lights.

The amazing micro-computer's "memory" permits automatic self-programming (just use the Night Sentry as a conventional light-switch—after 24 hours, your pattern of light use will be repeated daily thereafter.) You also can program it manually in a matter of seconds! Up to 48 ON-OFF settings per 24-hour period are possible. Installs in minutes with only a screwdriver.

Comparison Chart

FEATURE	NIGHT SENTRY	OTHER TIMERS
1. Automatic programming	YES	NO
2. Manual programming	YES	YES
3. Built-in microprocessor/memory	YES	NO
4. Solid-state reliability	YES	NO
5. Silent operation (no motor)	YES	NO
6. 48 "ON-OFF" selections	YES	SOME MODELS
7. Variable "ON-OFF" times	YES	SOME MODELS
8. Easy pushbutton override	YES	NO
9. Easy 2-wire installation	YES	NO
10. Fits any single or multiple switch box	YES	NO
11. Usable with most standard or decorator switch plates	YES	NO
12. Attractive "low-profile" decorator styling	YES	NO
13. "Soft-start" triples bulb life	YES	NO
14. Available in 3-way model	YES	NO
15. Available in table model with dimmer	YES	NO

Check these "never-before-available" features: No clock motor or gears to become noisy; easy override of program to use as conventional ON-OFF switch (no fumbling behind or under furniture to locate an override button); built-in variability of ON-OFF times to confuse intruders or burglars "casing" your home; usable in single or gang switch boxes; uses existing standard or decorator switch plates; available in 3-way version. Also available: table top model for controlling lamps plugged into wall outlets.

Visit your local hardware, home center, or department store and see the new Night Sentry. Suggested retail price under \$25.

NIGHT SENTRY Timed Light Control

From the people who brought you COBRA Radios and Cordless Telephones

Write for color brochure.

DYNASCAN CORPORATION



6460 W. Cortland St., Chicago, IL 60635

CIRCLE NO. 59 ON FREE INFORMATION CARD

www.americanradiohistory.com