

Popular Electronics®

WORLD'S LARGEST-SELLING ELECTRONICS MAGAZINE

APRIL 1980/95¢

Extra Keyboards for Microcomputers
Build a Vocal "Truth" Analyzer
Adding Triggered Sweep to a Scope

Focus On Hi-Fi Speakers

Experts Challenge the Validity of Measurements

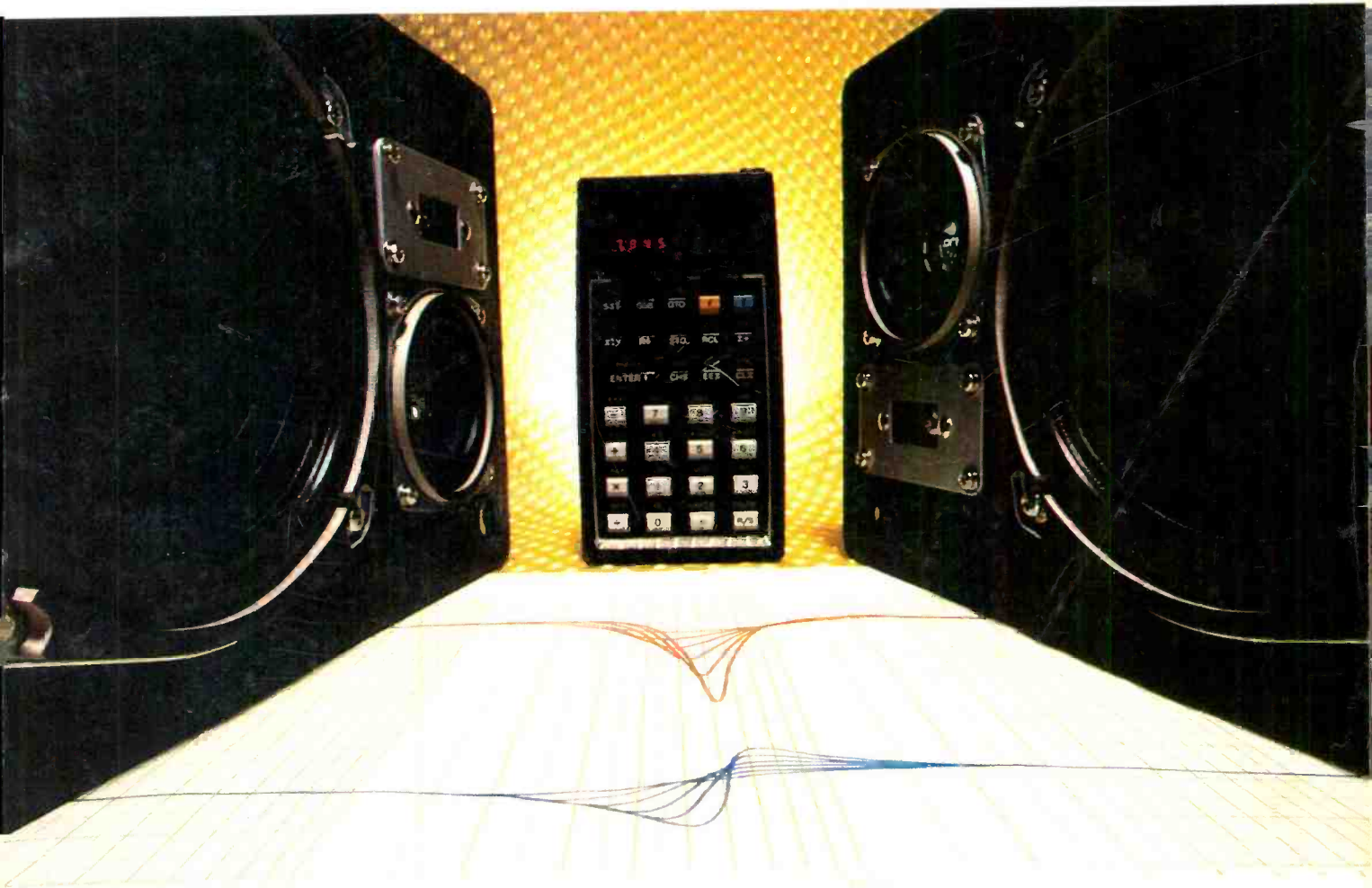

ADVERTISEMENT



Popular Electronics

580956 CIE 0037C096 1410 AUG80
F CHICHI
37 COVINGTON ST
HUNTINGTON STA NY 11746

ca AT-1010 Tonearm
Turntable
S-40 Speakers



What kind of man owns his own computer?

Rather revolutionary, the whole idea of owning your own computer? Not if you're a diplomat, printer, scientist, inventor . . . or a kite designer, too. Today there's Apple Computer. It's designed to be a *personal* computer. To uncomplicate your life. And make you more effective.

It's a wise man who owns an Apple.

If your time means money, Apple can help you make more of it. In an age of specialists, the most successful specialists stay away from uncreative drudgery. That's where Apple comes in.

Apple is a real computer, right to the core. So just like big computers, it manages data, crunches numbers, keeps records, processes your information and prints reports. You concentrate on what you do best. And let Apple do the rest. Apple makes that easy with three programming languages—including Pascal—that let you be your own software expert.

Apple, the computer worth not waiting for.

Time waiting for access to your company's big mainframe is time wasted. What you need in your department —

on your desk — is a computer that answers only to you . . . Apple Computer. It's less expensive than timesharing. More dependable than distributed processing. Far more flexible than centralized EDP. And, at less than \$2500 (as shown), downright affordable.



Visit your local computer store.

You can join the personal computer revolution by visiting the Apple dealer in your neighborhood. We'll give you his name when you call our toll free number (800) 538-9696. In California, (800) 662-9238.

Apple Computer, 10260
Bandle Drive,
Cupertino,
CA 95014.



CIRCLE NO. 5 ON FREE INFORMATION CARD

www.americanradiohistory.com

Friendly Comparison



Can JS&A offer a better telephone answering unit than the first one we introduced? Here's the story of American competition at its finest.

We've seen them all. Every telephone answering unit has its advantages and disadvantages.

So when JS&A selected our first telephone answering unit three years ago and called it the best remote system available, it soon became one of the most popular units on the market. Since 1976, JS&A has sold thousands of them.

SERIOUS COMPETITION

But that was three years ago. It finally took an enterprising company called Olympia to develop and introduce what we would call the first serious competition to our first telephone answerer.

So JS&A had a dilemma. Here we were, with an excellent relationship with a major supplier, and yet our reputation demands that we offer our customers only the most advanced products. Do we continue to carry both units, or do we break off relations completely and introduce a competitive model? To make the decision more difficult, you first have to understand the new technology in the Olympia unit.

A FAIR COMPARISON

The Olympia Master Telephone Recorder is a microprocessor-based system with a few features that make it a more advanced unit than the industry leader.

But to provide a fair comparison, there are a few disadvantages with the Olympia. The Olympia does not have a call counter that tells you at a glance how many calls you've received. And its outgoing announcement is not recorded as fast as with our first unit. But there are so many other features and advanced technology that the Olympia deserves your consideration.

ERASE OR SAVE

Most remote units and the Olympia have remote pagers. When you want to retrieve your messages, simply hold the pager up to the telephone, press a button, and the telephone answering unit rewinds to the start of your first message and plays them back.

That's great. But there was a disadvantage to the others. After you listened to your messages, you could not rewind. If you wanted to rewind to the beginning of the tape, you had to call your unit a second time. That's only a slight problem if you're calling locally from a phone booth, but very costly when you're calling long distance. And if you don't call back right away and rewind, you have another problem. Later, you'll have to listen to all those messages you previously heard because the unit doesn't know where the old messages stop and the new ones start.

The new Olympia Master Recorder has solved that problem. You have a choice. You can either hang up after you've heard your

messages or you can rewind them to the beginning while you're on the phone.

NO MESSAGE/LAST MESSAGE

Let's say you call in and there are no messages for you. The Olympia has a special beep tone that tells you the moment you call in that there is no message. Or let's say there are three messages waiting for you. After the three messages are played back, another beep tone signals you that you've finished your last message. There is no provision like this on any of the popularly priced units.

YOUR OWN TAPE

The Olympia uses one commercially available cassette tape that will last a few years with normal use. Today's most popular unit uses a built-in tape that will last five years, and costs \$17 to replace. With the Olympia unit, you remove the old cassette and pop in the new one which shouldn't cost more than \$2.

TAPE SPEED

It costs time and money to listen to your old messages and to rewind. So the Olympia not only improved the concept by giving you a choice, they also improved the tape rewind speed. Now, when you retrieve your calls, your rewind time is faster than many other systems and as fast as the system we formerly sold.

Not only is the Olympia faster, but it measures only 2 1/4" x 6" x 10" and weighs only 36 ounces. You can place your phone on top of the unit or next to it without cluttering your desk.

We could probably present reasons why the Olympia Master Recorder will pay for itself with just the time you save retrieving messages—but there's more.

SINGLE SYSTEM

You record your outgoing announcement on one track of the cassette tape and you receive your incoming messages on the other side. This single cassette approach reduced the costs of the Olympia below those of the conventional recorders that required two separate record and playback systems. And like other units, when you play back your tape, you hear only your incoming messages—never the outgoing announcement.

To record an outgoing announcement, you simply press the record button and talk into a microphone supplied with the unit. The unit will record a 17 second outgoing announcement and a 30 second incoming message. Our previous unit records a 20 second outgoing announcement and a 30 second incoming message.

AND THEN THERE'S VALUE

Our previous unit sold for \$269.95. The Olympia sells for only \$169.95—a \$100 savings before you even start to use the system.

But don't take our word for it. Order an Olympia from us on our 30-day telephone answering test. Personally see how quickly you can retrieve or rewind your messages without having to call in twice. See how this compact unit fits on your desk. And above all, note the quality and workmanship of this fine piece of equipment.

Then after 30 days of messages, decide if you want to keep your unit. If not, no problem. Just return your unit for a prompt and courteous refund including your \$3.50 postage and handling.

If you decide to keep it, great. You'll own the most advanced unit of its kind. The Olympia Master Recorder is sold exclusively by JS&A. We're America's largest single source of space-age products, and we have sold more telephone answering units than many of our competitors combined. We know the market.

MULTI-NATIONAL CORPORATION

Olympia is a multi-national corporation with eight national factory service and service-by-mail facilities—further assurance that your modest investment is well protected.

To order your Olympia, send a check for **\$169.95** plus \$3.50 postage and handling made payable to JS&A Group, Inc. (Illinois residents add 5% sales tax.) Credit card buyers may call our toll-free number below. We'll send your unit complete with recording microphone, one cassette tape, remote pager, AC adapter, instructions, and a 90-day limited warranty—everything you'll need for your 30-day test.

When we realized that the Olympia was the unit we should market, we called our previous supplier and told them of our decision.

In today's changing times, technology does not stand still. Despite our excellent relationship with our previous supplier, we felt it our obligation to introduce today's most advanced products—even at the risk of losing a valuable supplier.

If you're considering a new telephone answering unit, we can't recommend a better system than the Olympia Master Recorder. Why not order one at no obligation today?

JS&A PRODUCTS
THAT THINK[®]

Dept. PE One JS&A Plaza
Northbrook, Ill. 60062 (312) 564-7000
Call TOLL-FREE 800 323-6400
In Illinois Call (312) 564-7000

© JS&A Group, Inc., 1979



The easiest, least expensive way to generate spectacular multi-color graphics, sharp two-color alphanumeric: Your computer, a color tv set and the Percom Electric Crayon™.

Add the Electric Crayon™ to your system and your keyboard becomes a palette, the tv screen your medium.

You dab and stroke using one-key commands to create dazzling full-color drawings, eye-catching charts and diagrams.

Or you run any of innumerable programs. Your own BASIC language programs that generate dynamic pyrotechnic images, laugh-provoking animations.

From a combined alphanumeric-semi-graphics mode to a high resolution 256- by 192-element full graphics mode, the microprocessor-controlled Electric Crayon™ is capable of generating 10 distinctly different display modes.

Colors are brilliant and true, and up to eight are available depending on the mode.

As shipped, the Electric Crayon™ interfaces a TRS-80* computer. It may be easily

adapted for interfacing to any computer or to an ordinary parallel ASCII keyboard.

But that's not all

The Electric Crayon is not just a color graphics generator/controller.

It is also a complete self-contained control computer. With built-in provision for 1K-byte of on-board program RAM, an EPROM chip for extending EGOST™, its on-board ROM graphics OS, and a dual bidirectional eight-bit port — over and above the computer/keyboard port — for peripherals. The applications are endless.

Shipped with EGOST™, 1K-byte of display memory and a comprehensive user's manual that includes an assembly language listing of EGOST™ and listings of BASIC demo programs, the Electric Crayon™ costs only \$249.95.

Options include:

- LEVEL II BASIC color graphics programs on minidiskette: \$17.95.
- A 34-conductor ribbon cable to interconnect the Electric Crayon™ to a TRS-80*: \$24.95.
- RAM chips for adding refresh memory for higher density graphics modes: \$29.95 per K-byte.
- Electric Crayon™ Sketchpad, a sketching grid of proportioned picture elements (pixels) in a tv aspect ratio. For 128 x 192 or 256 x 192 graphics modes. 11-inch by 17-inch, 25-sheet pads: \$3.95 per pad.

SYSTEM REQUIREMENTS: the video circuitry of the Electric Crayon™ provides direct drive input to a video monitor or modified tv set. An internal up-modulator for rf antenna input may be constructed by adding inexpensive components to the existing video circuitry.

Prices and specifications subject to change without notice.

PERCOM

PERCOM DATA COMPANY, INC.
211 N. KIRBY GARLAND, TEXAS 75042
(214) 272-3421

™ = trademark of Percom Data Company, Inc.

* = trademark of Tandy Radio Shack Corporation which has no relationship to Percom Data Company.

Get into computer color graphics the easy, low-cost way with a Percom Electric Crayon™. Available at Percom dealers nationwide. Call toll-free, **1-800-527-1592**, for the address of your nearest dealer, or to order direct if there is no Percom dealer in your area.

CIRCLE NO. 47 ON FREE INFORMATION CARD

POPULAR ELECTRONICS



About the cover:

This month's loudspeaker focus examines the problems of testing, specifying and evaluating loudspeakers.

Cover photo by Don Carrol

JOE MESICS
Publisher

ARTHUR P. SALSBERG
Editorial Director

HAROLD A. RODGERS
Executive Editor

LESLIE SOLOMON
Technical Director

JOHN R. RIGGS
Managing Editor

EDWARD I. BUXBAUM
Art Director

ALEXANDER W. BURAWA
Features Editor

JOHN J. McVEIGH
Technical Editor

ANDRE DUZANT
Technical Illustrator

CARMEN ROBLES
Production Editor

JEFF NEWMAN
Editorial Assistant

Contributing Editors
Hal Chamberlin, Lee Felsenstein
Glenn Hauser, Julian Hirsch, Forrest Mims

LINDA BLUM
Advertising Service Manager

MARIE MAESTRI
Executive Assistant

EDGAR W. HOPPER
Publishing Director

Focus on Loudspeakers

INTRODUCTION / Harold A. Rodgers	37
THE CONFLICT BETWEEN SOUND AND SPECS	
I. THE OBJECTIVE VIEW / Daniel Queen	38
II. THE SUBJECTIVE VIEW / Robert Berkovitz	41
A 3-WAY DRIVE SYSTEM FOR SPEAKERS / J.F.P. Marchand	46
<i>Active crossover divides the audio spectrum before power amplification.</i>	

Feature Articles

EXTRA KEYBOARDS FOR MICROCOMPUTERS / Adolph A. Mangieri	56
<i>How to add a remote keyboard in tandem with the main board in your computer.</i>	
ENGLISH BROADCASTS AUDIBLE IN NORTH AMERICA / Glenn Hauser	81
COMPUTER CLUB DIRECTORY / PE Staff	88

Construction Articles

HOW TO ADD TRIGGERED SWEEP TO AN OSCILLOSCOPE / David A. Israel	60
<i>Low-cost circuit upgrades performance of your oscilloscope.</i>	
BUILD A VOCAL "TRUTH" ANALYZER / Colleen McNiece and Roger Cota	66
<i>LED-display instrument detects voice stress.</i>	

Columns

STEREO SCENE / Harold A. Rodgers	14
<i>Amplifier Technology, Distribution, Etc.</i>	
EXPERIMENTER'S CORNER / Forrest M. Mims	74
<i>The Photophone Centennial: 1880-1980.</i>	
HOBBY SCENE / John J. McVeigh	77
AMATEUR RADIO / Karl T. Thurber, Jr.	78
<i>Special Clubs for Special Folks.</i>	
COMPUTER BITS / Leslie Solomon	86
<i>3D Graphics.</i>	
SOFTWARE SOURCES / Leslie Solomon	92
PROJECT OF THE MONTH / Forrest M. Mims	94
<i>More on Pseudorandom Number Generators</i>	

Julian Hirsch Audio Reports

DUAL MODEL CS606 TURNTABLE	22
MITSUBISHI MODEL MS-40 SPEAKER	31
AUDIO-TECHNICA MODEL AT-1010 TONEARM	32

Departments

EDITORIAL / Art Salsberg	4
<i>New Electronic Products on the Horizon.</i>	
LETTERS	6
NEW PRODUCTS	8
NEW LITERATURE	12
ELECTRONICS LIBRARY	96
OPERATION ASSIST	105
ADVERTISERS INDEX	107
PERSONAL ELECTRONICS NEWS	112

POPULAR ELECTRONICS (ISSN 0032-4485): Published monthly by Ziff-Davis Publishing Company, at One Park Avenue, New York, NY 10016. Philip B. Korsant, President; Selwyn Taubman, Treasurer; Bertram A. Abrams, Secretary. One year subscription, U.S. and Possessions, \$14.00; Canada, \$17.00; all other countries, \$19.00, cash orders only, payable in U.S. currency. COPYRIGHT © 1980 BY ZIFF-DAVIS PUBLISHING COMPANY. ALL RIGHTS RESERVED.

ZIFF-DAVIS PUBLISHING COMPANY
Editorial and Executive Offices
One Park Avenue, New York, New York 10016
212-725-3500
Joseph E. Mesics
Publisher (725-3568)
Richard F. Govatski
Advertising Manager (725-3939)
Bonnie B. Kaiser
Eastern Adv. Mg., (725-3580)

Midwestern Office
Ted Welch
Suite 1400, 180 N. Michigan Ave.,
Chicago, IL 60601 (312-346-2600)

Western Office
3460 Wilshire Blvd., Los Angeles, CA 90054
213-387-2100

Western Representative: Norm Schindler
Jon Marshall

7050 Owensmouth Ave., #209
Canoga Park, CA 91303 (213-999-1414)

Japan: James Yagi, Oji Palace Aoyama;
6-25, Minami Aoyama, 6 Chome, Minato-Ku,
Tokyo, 407-1930/6821, 582-2851

ZIFF-DAVIS PUBLISHING COMPANY
Philip B. Korsant, President

Furman Hebb, Executive Vice President
Phillip T. Heffernan, Sr. Vice President
Edward D. Muhlfield, Sr. Vice President
Philip Sine, Sr. Vice President

Lawrence Sporn, Vice President, Circulation and Marketing

Richard Friese, Sr. Vice President
Baird Davis, Vice President, Production
George Morrissey, Vice President
Sidney Holtz, Vice President

Albert S. Traina, Vice President
Paul H. Chook, Vice President

Edgar W. Hopper, Jr., Vice President
Robert N. Bavier, Jr., Vice President

Selwyn Taubman, Treasurer
Berram A. Abrams, Secretary

W. Bradford Briggs, Vice Chairman

ZIFF CORPORATION

William Ziff, Chairman

I. Martin Pompadur, President

Hershel B. Sarbin, Executive Vice President

POPULAR ELECTRONICS, April 1980, Volume 17, Number 4. Published monthly at One Park Avenue, New York, NY 10016. One year subscription rate for U.S. and Possessions, \$14.00; Canada, \$17.00; all other countries, \$19.00 (cash orders only, payable in U.S. currency). Application to mail at controlled circulation postage rates is pending at Salem, Illinois 62881. Authorized as second class mail by the Post Office Department, Ottawa, Canada, and for payment of postage in cash.

POPULAR ELECTRONICS including ELECTRONICS WORLD. Trade Mark Registered. Indexed in the Reader's guide to Periodical Literature.

COPYRIGHT © 1980 BY ZIFF-DAVIS PUBLISHING COMPANY. ALL RIGHTS RESERVED.

Ziff-Davis also publishes Boating, Car and Driver, Cycle, Flying, Popular Photography, Skiing, Stereo Review, Electronic Experimenter's Handbook, Tape Recording & Buying Guide, Stereo Directory & Buying Guide, and Communications Handbook.

Editorial correspondence: POPULAR ELECTRONICS, 1 Park Ave., New York, NY 10016. Editorial contributions must be accompanied by return postage and will be handled with reasonable care; however, publisher assumes no responsibility for return or safety of manuscripts, art work, or models submitted.

Forms 3579 and all subscription correspondence; POPULAR ELECTRONICS, Circulation Dept., P.O. Box 2774, Boulder, CO 80302. Please allow at least eight weeks for change of address. Include your old address, enclosing, if possible, an address label from a recent issue.

Permissions. Materials in this publication may not be reproduced in any form without permission. Requests for permission should be directed to Jerry Schneider, Rights and Permissions, Ziff-Davis Publishing Co., One Park Ave., New York, NY 10016.

The publisher has no knowledge of any proprietary rights which will be violated by the making or using of any items disclosed in this issue.



Member Audit Bureau
of Circulations

NEW ELECTRONIC PRODUCTS ON THE HORIZON

The Winter Consumer Electronics Show, where some 950 exhibitors displayed electronic products they hope dealers will buy for resale to you, is over. As far as the introduction of new products was concerned, the Show was unimpressive. Most of the models on display were carryovers from last year's line or warmed-over versions of same. Even the new products shown had a mix of new "for real" and prototype models.

A refreshingly healthy number of computers were on hand, though the only wholly new one was the first general showing of Hewlett-Packard's HP-85 typewriter-size unit (see "New Products" section). Commodore Business Machines demonstrated a few systems that were for show rather than for sale at this time. These included a 16-color video system and a "touch the CRT screen with a finger" input control. We also observed Personal Software's VisCalc™ software program in action, which is also available for use with an Apple II or II-plus computer. It's an impressive program that turns a personal computer into a highly efficient electronic worksheet that organizes and displays information on a screen for business and engineering applications.

Apple introduced "Apple Writer," a software package to convert the Apple II into a word processor (\$75), and "Graphics Tablet," an intelligent graphics input subsystem that's extremely powerful. APF added an expansion interface to its personal computer, while Ohio Scientific, Atari, and Compucolor boosted their software libraries.

Noncomputer microprocessor technology was evident in a number of products. For example, we observed that more voice synthesizing systems are being adopted for general consumer products. Sharp's prototype digital clock tells the time verbally, and a "talking" calculator verbally confirms each key operation; Windert's under-\$100 "Talking Watch" tells the time as well as voicing a brief message; Quasar's prototype microwave oven issued cooking times by "voice"; Texas Instruments added three Solid State Speech™ modules to its "Speak & Spell" learning aids and a new version of S&S is scheduled to be introduced that includes sound effects; and Timely Products, Chicago, demonstrated a \$38 retail door chime with 24 tunes that can be dialed.

A host of electronic handheld and board games were demonstrated by many companies, including a gin card game (Mattel Electronics); a handheld video game cassette system called "Microvision" (Milton Bradley); two-player handheld football and basketball games (Coleco Industries); "Odyssey²," an over-30-games programmable video game system from Magnavox; Waddington's two-player soccer and hockey games; Entex's "Mac Mini-Computer" for children (4K ROM, 1.5K RAM and full keyboard).

A handful of electronic chess and backgammon games was on display, too. Chafitz' "Grand Master" Auto Response Board chess program (Sargon 2.5) was especially interesting as moves need not be keyed to alphanumeric markings or pushbuttons. The system automatically senses chesspiece moves and responses are by lighted LEDs on squares.

Wireless telephones and telephone accessories were clearly upbeat items, with more companies in the field than ever before. These included new wireless entries by Electra, APF and Cobra, among others. Ford Industries introduced its Code-A-Phone 1400 remote command telephone system, which includes a pocket coder that allows the owner to call from any telephone to pick up recorded messages at home. Fracom/Rovaphone's new Rovette® cordless phone system eliminated the traditional whip antenna, with a flexible antenna in the handset coil cord replacing it. And Canada's Dictograph Corp., an intercom maker, has entered a \$100 Phone Controller™ that stores up to 30 different 16-digit numbers for single-touch dialing and has LED phone-number readout and automatic redial, among other features.

Major products in the fields of audio, video cassette, radar, car stereo, et al, were on display, of course, each demonstrating some refinements. These will be covered in other sections of PE over the next few months.

NOW AVAILABLE!

WATT WIZARD™

POWER FACTOR CONTROLLER CUTS THE COST OF RUNNING ELECTRIC APPLIANCES BY AS MUCH AS 50% -- AND YOU CAN EVEN SEE THE SAVINGS!

For over a year now, in magazines and newspapers the world over, there have been enthusiastic write-ups on a remarkable new device that can cut your electric bill while helping the U.S. save huge quantities of fuel.

"The NASA/Nola power saver," wrote a **Popular Science** senior editor, "was developed by Frank Nola at NASA's George C. Marshall Flight Center as an offshoot of a program to reduce power consumption in spacecraft motors. Nola calls it a PFC — power-factor controller. I prefer to call it a power saver, however, because that's what it does."

NASA TESTED IT

According to Clyde S. Jones of NASA, "The device has been tested at Marshall Center on over 40 types of motors, with power savings ranging up to 60%, depending on the loading. The motors tested were both single-phase and three-phase, ranging from 1/2 H.P. to 5 H.P. Most motors will show up to 40-to-50% savings when running lightly loaded or unloaded, and some will show 5-to-7% savings at rated load."

NASA's Technical Support Package showed the test results and noted that "The Power Factor Controller applies to induction type electric motors — the most commonly used type in all major home appliances and the most commonly used by industry."

HOW IT SAVES POWER

Popular Electronics explained it this way: "AC induction motors characteristically run at a nearly constant speed that's fixed by power-line frequency and independent of load and supply voltage. When heavily loaded, the motor draws line current that is nearly in phase with the applied voltage... Under light load conditions, the motor develops less torque by allowing more lag between the voltage and current. This reduces the power factor while leaving the current essentially the same in magnitude.

"Though the low power factor means that conversion of electricity to mechanical power is small, the large current causes considerable (heat) losses in the supply lines and motor windings. This is what reduces efficiency.

"To minimize this waste, Nola's device monitors the motor's power factor and, when it detects light load conditions, it reduces the supply voltage... The current, now more nearly in phase with the voltage, therefore does as much useful work as before, but it and the voltage are smaller, resulting in a net savings of electric power."

THE SAVINGS CAN ADD UP

Like everything else, the cost of electric power keeps going up. Not only is the basic rate you pay going up, the power companies have now added on a "fuel adjustment" charge to help pay for running their generators. In 1980, 1981 and beyond, you'll pay more and more for the privilege of running your electric appliances.

*National Aeronautics and Space Administration
Patent No. 4,052,648*

Right now, the typical consumer pays about \$8 per month to operate a 16.5 cu. ft. frost-free freezer... \$10 to run a 17.5 cu. ft. frost-free refrigerator... \$8.25 for an attic fan operating 12 hours a day... and about \$60 for an air conditioner used during summer months. It's not hard to figure out what you're paying per year just to run **one** of these appliances. And in many parts of the country, the cost is even higher.

That's why Nola's power saver can soon pay for itself, then start reducing your electric bills — the amount of savings, of course, depending on which appliance(s) you use it with.

There's just one catch. Until now, the device has not been **available** — except for industrial models priced at \$80 or more.

INTRODUCING THE WATT WIZARD

Cynex, an American manufacturer of electrical and electronic products and a prime contractor for the U.S. Government, has been licensed by NASA to manufacture Frank Nola's power saver. Cynex calls it the Watt Wizard.

"The Watt Wizard," says Ray Beauchea, the firm's Marketing Director, "regulates the voltage fed into an induction motor, reducing or boosting power as required, when loads go up or down. Simply stated, it makes motors run more efficiently, especially when idling. It reduces motor heat, affording longer motor life and reducing the amount of air conditioning required for cooling (rooms) in summer months. It saves electric power, because kilowatt hours are greatly reduced. And it causes the motor to run quieter."

SIMPLE TO USE

Cynex makes several models of the Watt Wizard (all with solid state design), including the 110 V AC plug-in model we're offering. It's for single phase fractional H.P. motors (less than 1 H.P.) which is the type used in most made-for-the-home freezers, refrigerators, window and attic fans, swimming pool pumps, furnace fans, vacuum cleaners, sewing machines, power drills, etc.

Simply plug the Watt Wizard into any electric outlet, then plug the appliance into the Watt Wizard. There's no wiring required. Unlike some competitor's models (if and when available), the appliance does **not** have to be turned on before being plugged into the power saver. You can leave the appliance — whether on or off — plugged into the Watt Wizard all the time. Or you can move the Watt Wizard to various locations, depending on which appliance is being used. (Better yet, order several Watt Wizards.)

CIRCLE NO. 38 ON FREE INFORMATION CARD



MERCURY 1980 ©

OTHER MODELS AVAILABLE

Air conditioners, washers and dryers require wire-in model. If you lack mechanical skill, you probably need an electrician to install it. We also offer it in 220 VAC single or three-phase.

ADVANCE FEATURES

The Watt Wizard also includes two more unique features. It's fused, so if you accidentally overload the device, it won't burn out. Just change the fuse, which is available at any auto supply store.

And the Watt Wizard features an LED readout, so you can actually tell, at any moment, exactly how much power you're saving — 10%, 20%, 30%, 40% or 50%.

There's a "Power On" light, too. And the Watt Wizard comes with the manufacturer's 1-year limited warranty.

LOW COST — AND A TAX CREDIT

We're offering the Watt Wizard for only **\$39.95**, with **immediate delivery**. Want two? Then it's just **\$37.95** each. Or splurge and get three at **\$34.95** each. Wire-in models for heavy duty motors are **\$6** more for each unit. Add just **\$2.50** postage/handling for each order (not each unit).

And next year, when you fill out your tax return, you can deduct a full 15% energy tax credit — for additional savings.

30-DAY MONEY-BACK GUARANTEE

Try the Watt Wizard for up to 30 days. If not completely satisfied, return it (insured) for a full refund.

The sooner you send for the Watt Wizard, the more you can save on your electric bills. To order, send your check or money order to the address below. Or charge it to your Visa, MasterCard, American Express or Carte Blanche credit card. If using your charge card, you can also order via our toll-free phone number:

800-257-7850

(In New Jersey, Call: 800-322-8650)
N.J. residents, add 5% sales tax.

Or mail your order to:

Dept. P, Lakewood Plaza
Lakewood, N.J. 08701



The Imagination People®

McIntosh

"A Technological Masterpiece..."



McIntosh C 32

"More Than a Preamplifier"

McIntosh has received peerless acclaim from prominent product testing laboratories and outstanding international recognition! You can learn why the "more than a preamplifier" C 32 has been selected for these unique honors.

Send us your name and address and we'll send you the complete product reviews and data on all McIntosh products, copies of the international awards, and a North American FM directory. You will understand why McIntosh product research and development always has the appearance and technological look to the future.

Keep up to date.
Send now - - -

McIntosh Laboratory Inc.
Box 96 East Side Station
Binghamton, NY 13904

Name _____
Address _____
City _____ State _____ Zip _____

If you are in a hurry for your catalog please send the coupon to McIntosh. For non-rush service send the Reader Service Card to the magazine.

CIRCLE NO. 39 ON FREE INFORMATION CARD



Letters

RELAY POWER SAVINGS

"An Experimenter's Guide to Relay Control" in your February issue was an excellent short course, which I clipped out and put in my book of handy circuits. However, there is a way of achieving significant power saving in relay circuits that was not mentioned. I first read about it in an article by John R. Nelson, of Motorola, in *Electronics* magazine, dated Dec. 9, 1976. Essentially, the idea is to reduce the voltage necessary to actuate a voltage by adding the voltage across a charged capacitor to the normal source. Then, once the relay is energized, the source is sufficient to hold it in. Thus, a 26-V relay can be energized from a 12-V supply by adding a charged 15- μ F capacitor in series with the coil and a transistor. When a switch is closed to apply the 12 V, it also turns on the transistor to discharge the capacitor and increase voltage across the coil. Variations in the circuit can be made to suit various relays.—J.M. Burwell, Fort Rucker, AL.

IMPROVED NASA MOTOR CONTROLLER

The designer of the circuit that appeared in my article ("NASA Motor-Control Circuit Cuts Electric Cost," October 1979) has brought to my attention a simple modification which eliminates the need for the cumbersome fixed resistor *R1* (0.02 ohm, 5 watts). With the change (shown below), the only factors

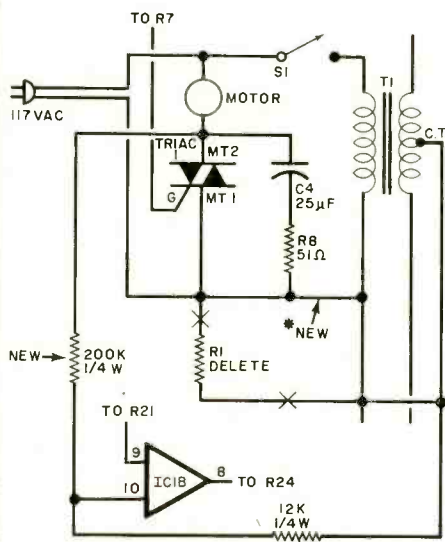

* NOTE: ERRONEOUSLY INCLUDED IN SCHEMATIC OF ORIGINAL CIRCUIT; NOW PART OF MODIFICATION

that limit the size of the motor to be controlled are the current rating of *TRIAC1* and the heat-dissipating capability of the heat sink on which it is actually mounted.

The modified circuit replaces *R1* with a jumper to the bottom of *T1*'s primary and has two new fixed resistors that form a voltage divider between the bottom of the primary and *MT2* of *TRIAC1*. The tap of the voltage divider is connected to the noninverting input of *IC1B* (pin 10). Instead of sampling motor current by means of the voltage drop across *R1*, the modified circuit samples it by means of the voltage drop across the intrinsic resistance of *TRIAC1*. The voltage divider attenuates this voltage to a level below that of the op amp's power supply.—Myles H. Marks, Pittsburg, PA.

REACT TEAMS HEALTHY

The reference in your December "Personal Electronics News" column to REACT's financial needs and recommendations that contributions be sent for our Emergency Fund is most helpful and appreciated. However, we have been advised by a number of our REACT Teams throughout the country that, while our Headquarters operations as REACT International, Inc. are having difficulties, we still have hundreds of local REACT Teams throughout the country which are thriving, growing and serving the public in an increasingly more valuable way every day.

The REACT program is most successful and visible at the local level where we have very active Teams. The Emergency Funding Drive is ending with some success thanks to you and other publishers as well as the outstanding response we have received from local REACT Teams everywhere.—Gerald H. Reese, Managing Director, REACT International, Chicago, IL.

NUCLEAR POWER ADVOCATE

The nuclear power plant illustration on the cover of your January 1980 issue portrays a gloomy nuclear power plant of impending doom. This portrayal is untrue and unwarranted. . . . singles out nuclear power plants as the only source of radiation that the "personal radiation monitor" (PRM) may be used to detect. However, your article lists several other sources of radiation, including "many New England fireplaces." Why not illustrate a New England fireplace on your cover?

The Kemeny commission has reported that the offsite radiation dose attributable to the (Three-Mile Island) incident was so low that any potential health effects will be minimal, leading to a projected cancer-death potential from zero to less than 10. Therefore, when you mentioned the TMI incident and resulting radiation release, you should have included "though very-low-level" just as you did in making reference to radiation emitted from New England fireplaces.—M. L. Nelson, Nuclear Engineer, Babcock and Wilcox Co., Lynchburg, VA.

If one were to illustrate a home on fire with a smoke alarm in the foreground it does not imply that people should not live in homes. The radiation release from TMI was indeed very-low-level.—Ed.

AMBIENCE FOR STEREO

Adding two extra loudspeakers to provide "ambience" via the Hafler system, as described in the "Stereo Scene" in your October 1979 and January 1980 issues, is a

great idea. But the effect can be further improved, using an even simpler setup that works on all stereo recordings and does not require the listener to sit near the center of the room. The rear speakers, connected in parallel with the front ones, should be placed on their backs, facing the ceiling. Their diffuse reflections provide a stronger feeling of spaciousness. Crossing the left to the right and vice versa at the rear prevents the sound from seeming to come from the side walls. The back speakers can be relatively inexpensive and their levels can be controlled by L-pads or simple 5-watt pots with values around 27 ohms.

This system is called "S-cubed" and is used in all General Motors cars having factory-installed stereo radios with the four-speaker option. (Ford and Chrysler are not interchanging L and R at the rear.)—*Daniel Shanefield, Princeton, NJ.*

AUDIO ARTIST CONNECTIONS

On page 61 of the December issue, in the "Audio Artist" article, the gate, source, and drain of Q1 are not marked. The markings given on the component placement on page 62 would not seem to agree logically with the schematic. —*Mike Ringenberger, Martinsville, IN.*

There are two versions of the TO-92 case for FETs. For the one shown in the component layout, the outline is correct and the circuit would work but interchange the labeling of the drain and source.—*Ed.*

PEDOMETER MODIFICATION

Readers who build the "Electronic Pedometer for Joggers" (August 1979) may wish to keep a running tally in miles rather than steps. To do this, simply use the number of miles per step as the constant instead of 1. For example, if you find it takes you 1250 steps to jog a mile, the miles per step would be this number's reciprocal, or 0.0008. To enter this constant, use the key sequence CLR, +, .0008. If your calculator has a reciprocal key, use the sequence CLR, +, 1/x. The calculator can be reset to zero or preset to any number without reentering the constant simply by pressing 0 or entering any other number without pressing CLR or any arithmetic-operation key.—*Stephan Bush, Kingston, NY.*



"The nerve of them, taking the word of their computer against my checkbook stubs."

APRIL 1980

\$140 Gets It All.

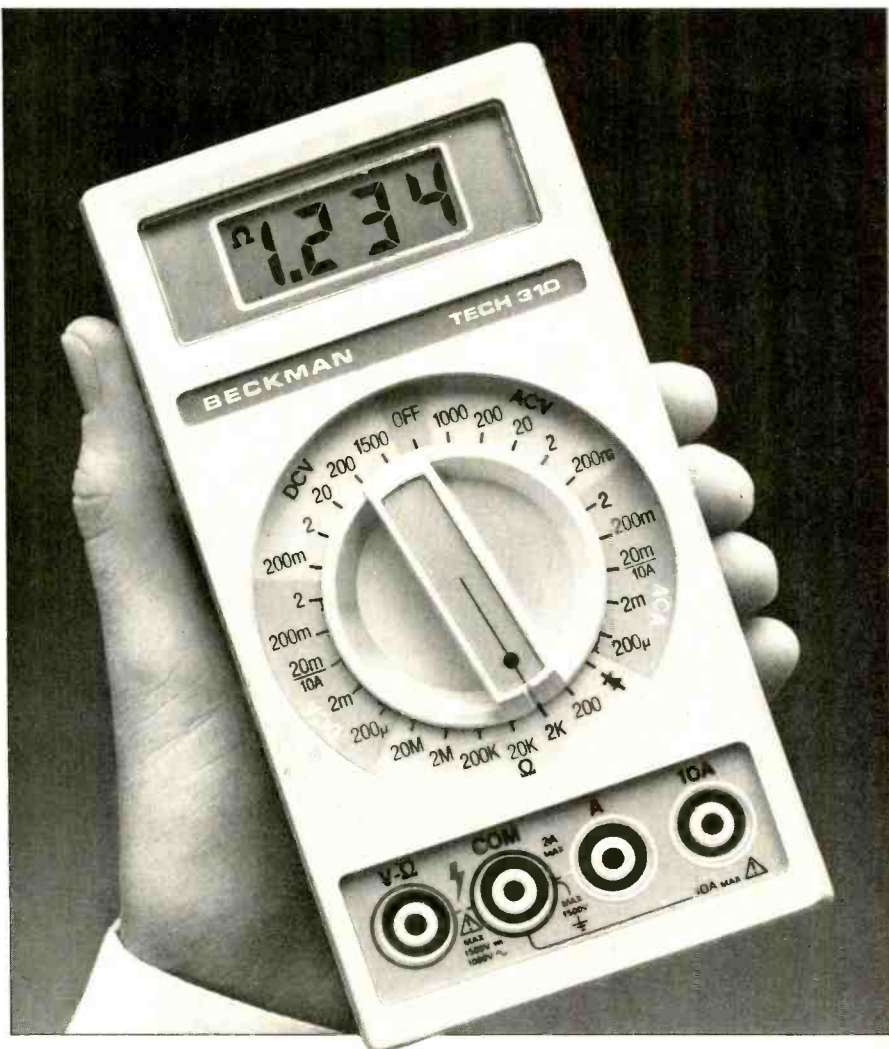

We just knocked down the last reasons for not going digital in a multimeter. Fast continuity measurement. And price.

Beckman's exclusive Insta-Ohms™ feature lets you do continuity checks as fast as the analogs. And Beckman's superior technology and experience let you own this beauty for such a reasonable price.

Of course you get a lot more. Like 7 functions and 29 ranges including 10 amp ac/dc current capability. 0.25% Vdc accuracy. In-circuit resistance measurements and diode/transistor test function. Two years' typical operation from a common 9-volt battery. In other words, all the features you want in one hand-held unit of exceptional good looks and design.

With 1500 Vdc overload protection, 100% instrument burn-in, plus rugged, impact-resistant case, you're assured of the utmost in dependability and long-term accuracy. You get a tough meter that keeps on going, no matter how tough the going gets.

So visit your dealer today and get your hands on the DMM that does it all. Or call (714) 871-4848, ext. 3651 for your nearest distributor.

BECKMAN

CIRCLE NO. 7 ON FREE INFORMATION CARD



New Products

Additional information on new products covered in this section is available from the manufacturers. Either circle the item's code number on the Free Information Card or write to the manufacturer at the address given.

Hewlett-Packard Personal Computer

Hewlett-Packard's new HP-85 computer is a self-contained system that combines a computer, five-inch CRT, alpha keyboard and 20-key numeric pad, a thermal printer, and an H-P tape drive to accommodate H-P



Data Cartridges. Interactive graphics are built-in with a graphics mode for video display and for the printer. The system has 16,000 bytes of read/write memory, with 14,500 bytes available. Memory can be expanded to 32,000 bytes (30,500 available) by plugging in an optional memory module. H-P's BASIC language is said to offer 12-digit accuracy, versatile string operations, convenient editing, 42 predefined functions, four levels of program security and flexible output formatting. The graphics system (with a 256-by-192 dot field) allows data to be plotted, displayed, and preserved on the built-in printer. The keyboard serves four functions: entering alpha data; entering numbers and doing arithmetic operations; program development using "soft" keys; and display, editing, and system control keys. In the alphanumeric mode, the CRT display has a maximum of 16 lines of 32 characters. Four I/O ports permit expansion for disc drives, plotters, etc. Dimensions are 16" W x 18" L x 6" H (40 x 46 x 15.5 cm); weight is 20 lb (9 kg). \$3250.

CIRCLE NO. 84 ON FREE INFORMATION CARD

Bose Ambiance System

The new Bose Spatial Expander[®] is designed to work with the company's Spatial Control Receiver, two 901 Series IV



speakers and two Direct/Reflecting speakers. The Spatial Expander uses a charge-couple device (CCD) time-delay process to delay sound from the rear speakers. The result is said to create a lifelike ambiance without detrimental effects.

CIRCLE NO. 85 ON FREE INFORMATION CARD

Hickok Hand-Held DVOM

The new one-hand-operation LX 304 DVOM from Hickok has a 1/2"-high, 3 1/2-digit LCD display and is claimed to be able to withstand a four-foot drop without loss of accuracy. It features automatic polarity,



zero, and overrange indication; automatic decimal point; battery indicator; and diode and transistor testing capability. It's rated at 0.5% accuracy on dc voltage ranges. Resistance ranges are from 200 ohms to 20 megohms and dc voltage from 200 mV to 1 kV. Current ranges are 200 mA and 1 A; ac voltage ranges are 200 and 600 rms. Test leads store in a built-in closed compartment. \$89.95.

CIRCLE NO. 86 ON FREE INFORMATION CARD

Computer "Electric Crayon"

Percom's new Electric Crayon generates computer-operated color graphics and control on either a color TV receiver or monitor. It includes a ROM operating system, (EGOS[®]) which accepts single-character commands directly from a parallel ASCII keyboard or program generated from a computer. It interfaces with a TRS-80, but can be adapted to any computer. The system has provision for 1K of on-board RAM, an EPROM chip for extending EGOS and a second dual bidirectional 8-bit port for peripherals. Ten display modes include alphanumeric-semigraphics, a second higher-density semigraphics, and eight



graphics modes. Up to eight colors can be generated. With highest density, display resolution is 256 by 192 picture elements. System enclosure is 2 1/2" H x 9" D x 12" W (6.4 x 23 x 30 cm). \$249.95.

CIRCLE NO. 87 ON FREE INFORMATION CARD

Digital Readout AM/FM Receiver

Among the features of Sony's top-of-the-line 55-watt/channel STR-V55 AM/Stereo FM receiver is its frequency synthesis tuning system with a claimed tuning accuracy of better than 0.002% and fluorescent digital frequency readout for both FM and AM. A microprocessor tuning system with "Feather Touch" controls offers four station-selection methods: "Manual" for stepping up or down the FM scale; "Auto" to move up or down scale to the next available station; "Memory Preset" to select one of eight stations entered into memory; and "Memory Scan" to stop for 3.5 sec-



onds at each station in memory. Memory is retained even when power is removed, and provision is made for inserting tiny cards to indicate what stations are in memory. The power amp's pulse power supply is said to keep TIM and IM below 0.02%. In addition, output transistors are claimed to deliver cutoff frequencies between 50 and 80 MHz. Other features include a three-position muting sensitivity level, two tape monitor circuits, a five-LED signal-strength display, a low filter that takes effect at 15 Hz, an audio mute that lowers volume by 20 dB. Dimensions are 5 1/4" H x 17" W x 14 7/8" D (13.5 x 43 x 37 cm); weight is 15 lb (6.8 kg). \$500.

CIRCLE NO. 88 ON FREE INFORMATION CARD

"Intelligent" Printer

The HY-Q 1000[™] by XYMEC, is a daisy-wheel printer for use with computers. It uses five built-in microprocessors and is said to be capable of eliminating the need for much complex computer software. The



printer can be plugged into any computer and will automatically convert simple codes into instructions for right justification, proportional spacing, automatic title centering automatic decimal-point location, and other common text formatting functions. It also has Quadra-Pitch™ (10, 12, or 15 characters per inch, or proportional spacing) up to 198 characters per line, 100 printable characters in five languages, and a choice of 21 different type styles in five different colors. White characters can also be printed on a black background. The printer uses an Olivetti electronic typewriter which can perform various functions by use of a 1024-character memory, including often-used phrases, tabs etc. \$2495.

CIRCLE NO. 89 ON FREE INFORMATION CARD

Selectable-Current Circuit Breaker

Intended for use in building and testing breadboard circuits, the Model 101 Breaker Box, by the Long Range Co., can be varied to trip with currents between 250 mA



and 7.75 A in 250-mA steps. There is also a 10-mA setting for testing "dry" or no-current circuits. The unit reacts to overcurrents of ac or either polarity of dc in about 10 milliseconds. Toggle switches point toward current values selected and a tripped condition is indicated by a lighted red LED.

CIRCLE NO. 91 ON FREE INFORMATION CARD

VCR with 14-Day Programmer

Zenith's new "Video Director-Programmable" VCR (Model VR9700J) is a Beta-format machine that can record up to four programs on four different channels at four different times during a 14-day period. Other features of the five-hour VCR are a weekly repeat which allows a program to

THE WORLD AT YOUR FINGERTIPS



Announcing the world's first affordable information/communication network for personal computers or data terminals

Now you can be at the New York Stock Exchange, the UPI newsroom, the New York Times Consumer Information Library, and dozens of other important places at the touch of your fingertips.

Tomorrow's technology is here right in your own home or office with THE SOURCE, an affordable information/communication utility which gives your personal computer instant nationwide access to dozens of important information resources...

Local and national weather from UPI... airline schedules and reservations... restaurant and entertainment information... sophisticated computer games... nationwide electronic mail system... energy information... up-to-the-minute sports, news, stock market reports, commodity futures... foreign currency reports... educational programs... discount

shopping service... nationwide real estate locator... and much more!

In short, THE SOURCE will revolutionize your personal and business life... and change forever the way you use information.

THE SOURCE supplements your personal computer with unlimited mainframe storage capacity and complete editing, and debugging systems... plus programming in several languages including EXTENDED BASIC, FORTRAN, RPG II, and COBOL.

All this has been designed well within reach of your pocketbook, with charges as low as \$2.75 per connect hour (non-prime time), accessed through a local telephone call.

Now is the time to discover how THE SOURCE can put a world of knowledge and entertainment at your fingertips. Use the coupon below to get complete details free of charge and obligation...

The SOURCE Free Information Request

PE 4/80

Please send me your FREE information guide to THE SOURCE. I understand I am under no obligation.

I currently have a personal computer:

MAKE: _____ MODEL: _____

Please send me information on compatible microcomputers and data terminals including the special low-cost terminal equipment packages offered by THE SOURCE.

NAME: _____

ADDRESS: _____

CITY: _____ STATE: _____ ZIP: _____

For a free demonstration why not drop by one of our over 300 participating retailers.

For more information please mail this coupon to:

Telecomputing Corporation of America ■ 1616 Anderson Road ■ McLean, Virginia 22102.

CIRCLE NO. 60 ON FREE INFORMATION CARD

www.americanradiohistory.com



be recorded once a week until the tape runs out, automatic electronic-pulse indexing, triple-speed play for review of material with a picture on the screen, and remote control with pause/stop action. Audio dub allows sound to be recorded from an outside source onto previously recorded tapes. \$1350.

CIRCLE NO. 92 ON FREE INFORMATION CARD

Mobile Digital Scanner

Regency Electronics' Model "Touch M100" is a digitally synthesized, 10-channel scanning radio for both mobile and home use. It covers the low, amateur and



high vhf bands, and uhf band from 440 MHz to 512 MHz. Features include a search mode that can sample a band for calls, channel-one priority, digital display, scan and search delay, and brightness control for day or night use. Scanning rate is 15 channels/second.

CIRCLE NO. 93 ON FREE INFORMATION CARD

Harman Kardon Adds Dolby HX System

The hk705 cassette deck has been introduced into the Harman Kardon line of separate components. It features Dolby headroom extension (HX), said to improve high-frequency dynamic headroom by 10 dB, as well as Dolby B. The deck is equipped to



handle all current types of tape, including metal. Sendust Alloy tape heads are used, and LED record level indicators are provided. Rated specifications include: 0.04% wow and flutter (NAB wrms); 0.9% THD; 20-19,000 Hz ± 3 dB (metal tape) frequency response; -68 dB S/N (A-weighted, metal tape, Dolby in); channel crosstalk over 65 dB and channel separation over 38 dB. Dimensions are 15.2" W \times 2.9" H \times 12.6" D (385 \times 72.5 \times 320 mm); and weight is 13.7 lb (6.2 kg).

CIRCLE NO. 94 ON FREE INFORMATION CARD

Low-Cost ASCII Keyboards

RCA has introduced two ASCII-encoded keyboards with flexible-membrane key switches that are unitized to prevent liquids or dust from affecting operation. Model VP-601 is a 58-key typewriter-format board, while Model VP-611 has 74 keys with typewriter format plus 16 keys for numeric entry. The switches have positive-press action plus a tone generator to give aural keypress feedback. Boards operate from a single 5-volt dc supply and include a LED power-on indicator. The buffered seven-bit output is TTL and CMOS compatible. The boards also include two-key-rollover circuitry. The VP-601 is \$65; VP-611, \$80.

CIRCLE NO. 95 ON FREE INFORMATION CARD

Loudspeaker Uses New Cone Material

Wharfedale's TSR 110 speaker system uses a vertical-line, linear-phase arrangement with two 200-mm (7.87-in.) bass/midrange drivers operating in conjunction with one 25-mm (0.98-in.) soft-dome tweeter. The two lower drivers operate in tandem in an acoustic-suspension enclo-



sure up to about 300 Hz. Between 300 and 3500 Hz, the upper driver only is energized; there is an 18-dB/octave crossover to the treble unit. The bass/midrange cones are molded of a mineral-filled homopolymer said to have an exceptionally high stiffness-to-weight ratio. A continuously variable treble control adjusts the output in the range from 3000 to 20,000 Hz. Claimed frequency range is 35 to 25,000 Hz, with a power rating of 15 to 140 watts. The walnut-veneer enclosure has a detachable grille and measures 27.5" \times 13.1" \times 13.2" (695 \times 332 \times 335 mm).

CIRCLE NO. 96 ON FREE INFORMATION CARD

Antler Base-Loaded Antennas

Antler's two-way radio "Pro" Line of base-loaded antennas includes four models covering ranges of 30-36 MHz, 36-42 MHz,



45-50 MHz, and 130-174 MHz plus a $\frac{3}{4}$ -wave roof-mount antenna tuned to resonate between 108 and 174 MHz. The latter is for use by city dwellers who have low-clearance problems. The four base-loaded models are provided with cutting charts to obtain accurate frequencies. They are available with a variety of mounting arrangements; shock springs are optional.

CIRCLE NO. 97 ON FREE INFORMATION CARD

Turntable "Flattens" Warps

Onkyo's new CP-1030F turntable is a single-play, fully automatic, direct-drive model with a quartz-lock speed control and a specially designed low-mass carbon-fiber



tonearm said to give optimum results with today's high-compliance cartridges. Low-frequency resonance of the arm and a typical high-compliance cartridge is controlled well enough, according to Onkyo, to allow warped records to be played with a minimum of distortion. In addition, the turntable has a rated signal-to-noise ratio of 75 dB and wow and flutter less than 0.03% (WRMS). Reliability of the unit is said to be enhanced by the use of an additional motor dedicated to tonearm functions. A set of LED indicators show what functions are engaged. \$315.

CIRCLE NO. 98 ON FREE INFORMATION CARD

Digital Encoder Interface

Sensor Technology has introduced an incremental encoder, the Digipot[®], which provides an interface manually with a digi-

Not Just Another Limited Area Motion Detector!

guardex™

Protects Every Square Inch Of Your Building

Turns On Lights Automatically

Powerful Electronic Siren



Low Cost Computerized Burglar Alarm System Home - Office - Business

The Guardex 8000 Alarm System is walnut grained and disguised to look like a small stereo speaker (6 3/4" x 9 3/4" x 8") and weighs less than 6 1/2 pounds.

NO INSTALLATION

Just plug the Guardex 8000 alarm system in, make several simple control adjustments to suit your particular building and it works! There are no other wires to run. This totally self-contained burglar alarm can completely seal off every square inch of the surface of your building. It protects doors, windows, and what most alarms miss... your roof, walls and floors.

HOW CAN ONE SMALL COMPUTER PROTECT MY WHOLE BUILDING?

Guardex 8000 Alarm System works on the principle of audio discrimination. This, put simply, is the process of electronically separating normal everyday sounds, such as voices, telephones, etc. from break-in type noises such as breaking glass, prying metal, or forcing a door open. The Guardex 8000 protects one story homes and offices up to 2000 square feet and open commercial buildings up to 10,000 square feet. The Guardex 9300 with wireless remote sensor capability is available for multi-story homes and offices or single story with more than 2000 square feet. Call the factory for more detailed information.

URNS ON LIGHTS AUTOMATICALLY

When the first break-in type sound is detected, the system will instantly turn on lights, radio, or other electronic equipment that you have plugged into the back of the alarm. These lights or other equipment will remain on for a period of five minutes, then automatically turn off.

POWERFUL ELECTRONIC SIREN

The Guardex 8000 alarm is equipped with a loud built-in siren. If during the five minute period the lights or other electronic equipment has been activated, a second break-in sound is detected, (it can be only a second or two after the first break-in sound) the built-in siren will start blasting for 90 seconds. At the end of approximately 90 seconds the siren will shut off and the alarm listens again. If another break-in sound is heard, the siren will come on for another 90 seconds. If no other break-in sound is detected, the siren will stay off and at the end of the five minute period the lights will shut off and the alarm instantly resets.

The rear control panel contains two standard AC plug receptacles for a table lamp, spot lights, radio, etc.; terminals for connecting optional outside siren and back-up battery (not included); entry delay time control and sensitivity control.



EXIT AND ENTRY DELAY

The Guardex 8000 alarm has a built-in exit delay allowing you approximately one minute to lock up and leave the building before the alarm is armed. When you enter your building you may find that just your normal entering sounds activate the siren. You may delay it from starting for up to 30 seconds by turning up the siren entry delay control.

BATTERY BACK-UP

Burglars rarely cut power. However, to give you total protection from a burglar and possible power failure, our alarm has provisions for a battery back-up. (Batteries not included). 12 volt lantern batteries are available at most hardware stores.

THE BURGLARY PROBLEM

The F.B.I. statistics show that at the present rate, one out of every four Americans are going to be burglarized. That is not a very pleasant fact, but it is true. You have a greater chance of being burglarized than being a victim of a fire or automobile accident. The time is now to help protect yourself and your valuables with a Guardex 8000 alarm system.

OUTSIDE SIREN

The Guardex 8000 alarm is equipped with a loud, built-in siren, but if you desire an additional siren to mount outside or in an area away from the main alarm, they are available with 50 feet of wire for \$24.95. (Connecting terminals are provided on the back of the alarm).

30 DAY NO RISK TRIAL

This is your opportunity to purchase an alarm system directly from the factory for only \$199.95. Try it in your home or business for thirty days without risking one cent. Put our Guardex 8000 alarm to your own test. See for yourself! It will protect every window and door from break-in. If you are not completely satisfied, return the alarm within 30 days for a complete refund. To order your Guardex 8000 alarm, CALL TOLL FREE to charge your credit card or send your check to Guardian Electronics, Inc. in the amount of \$199.95. If you want the optional outside siren, add \$24.94. (California residents add 6% sales tax.)

(If you require more information, call during California business hours, Monday - Friday)



Dealer Inquiries Invited

CALL TOLL FREE
(800) 423-5499

California residents:
(213) 889-1414 collect.

GE GUARDIAN ELECTRONICS, INC.

31133 Via Colinas, Dept. PE. Westlake Village, Calif. 91361

fact:
five new Shure Cartridges
feature the technological
breakthroughs of the V15
Type IV

the
M97
Era IV
Series
phono
cartridges



Shure has written a new chapter in the history of affordable hi-fi by making the space-age technological breakthroughs of the incomparable V15 Type IV available in a complete line of high-performance, moderately-priced cartridges: the M97 Era IV Series Phono Cartridges, available with five different interchangeable stylus configurations to fit every system and every budget.

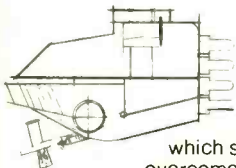

Dynamic Stabilizer—which simultaneously overcomes record-warp caused problems, provides electrostatic neutralization of the record surface, and effectively removes dust and lint from the record.

SIDE-GUARD, which responds to side thrusts on the stylus by withdrawing the entire stylus shank and tip safely into the stylus housing before it can bend.

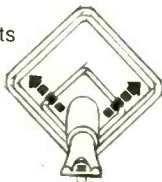

And, the unique telescoped stylus assembly which results in lower effective stylus mass and dramatically improved trackability.

There is even an M97 cartridge that offers the low distortion Hyperelliptical stylus!

NEW! M97 Series Era IV Phono Cartridges... Five new invitations to the new era in hi-fi.

SHURE
 Shure Brothers Inc., 222 Hartrey Ave.,
 Evanston, IL 60204
 In Canada: A. C. Simmonds & Sons Limited
 Outside the U.S. or Canada, write to Shure Brothers
 Inc., Attn: Dept. J6 for information on your local
 Shure distributor.
 Manufacturers of high fidelity components,
 microphones, sound systems and related circuitry.

CIRCLE NO. 53 ON FREE INFORMATION CARD

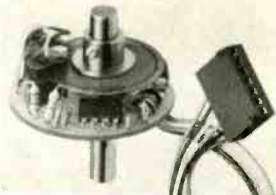

tal system. Connected to an up/down counter, the unit is claimed to offer unlimited resolution in the form of an n-bit word which can be arbitrarily long. The same up/down counter can also be used as a memory for a D/A converter. Direct interfacing to a microprocessor is possible through an I/O routine over two bitlines. Applications include positioning of X/Y tables, N/C machines, inputs to volume controls, or control of stepping motors. \$39.90. Address: Sensor Technology, 21012 Lassen St., Chatsworth, CA 91311.

New Cassette Tapes

RKO Tape Corp. has added Ultrachrome and XD general-purpose tapes to its line of audio cassette tapes. Ultrachrome is said to be a second-generation chromium-dioxide tape with a frequency response flat ± 0.2 dB out to 20 kHz. It is claimed to



equal metal tape in response, distortion and S/N. The XD, according to RKO, is formulated for the musical midrange, where its headroom is said to be 78% greater than average with a significantly higher S/N. Ultrachrome is \$5.76 for C-90, \$3.96 for C-60; XD, \$3.66 and \$2.60 (also available in C-45 at \$2.36).

CIRCLE NO. 99 ON FREE INFORMATION CARD

Analyzer / Equalizer

Soundcraftsmen's new Model AE2420-R "Scan-Alyzer"/Equalizer contains differential comparator circuitry said to be able to measure room equalization with an accuracy of ± 0.1 dB. The equalizer and analyzer sections both use active band-pass filters on octave centers ranging from 30 to 15,360 Hz. Rated boost/cut capability ranges from ± 12 to ± 16 dB in each band, depending on setting of adjacent controls. Harmonic and IM distortion are reported to be less than 0.01%, and S/N, 100 dB, all at 2-V output. In addition, the analyzer section contains its own pink-noise source and a microphone preamp. Dimensions are 5 1/4" H \times 19" W \times 11 1/4" D (13.5 \times 49 \times 29 cm); weight is 20 lb (9.1 kg). \$500.

CIRCLE NO. 100 ON FREE INFORMATION CARD



New Literature

COMPUTER SOFTWARE YELLOW PAGES

All Micro Architect business software for the TRS-80 is listed in the 12-page TRS Yellow Pages guide. Issue 1.4 features a sophisticated data base manager for the TRS-80. Two stamped, long, self-addressed envelopes must accompany request. Address: Micro Architect, 96 Dothan St., Arlington, MA 02174.

CB ANTENNA CATALOG

"Firestik" CB antennas and accessories are described in the company's new product catalog. Featured is the Firestik top-loaded, helically wire-wound fiberglass CB antennas for mobile and base station use. Also included is the company's line of antenna mounts. Address: "Firestik" Antenna Company, 2614 East Adams, Phoenix, AZ 85034.

TECHNICAL HANDBOOK FOR FANS

"The Fan Catalog" is a 92-page handbook (No. EF3) from IMC Magnetics describing over 140 types of propeller and tubaxial airmovers for dc, 60-Hz, 400-Hz, and multi-frequency applications. Capacities range from 13 to 1600 cu ft/min. Complete specifications and dimensions are provided. Address: IMC Marketing Div., 570 Main St., Westbury, NY 11590.

HAMTRONICS KIT CATALOG

The 24-page 1980 catalog from Hamtronics features a variety of kits for the radio amateur or radio service shop person. Included are a 435-MHz transmitting converter, a uhf FM receiver, an AM receiver for aircraft and DX warning, a weather tone alert receiver module, and various linear amplifiers for vhf and uhf. Address: Hamtronics, Inc., 65F Moul Rd., Hilton, NY 14468.

CAR SPEAKER SYSTEMS

A new booklet published by Audiovox, "The Dynamics of Speaker Placement in an Automobile," describes the differences in sound effects which can be obtained by placing speakers in different locations; the matching of speakers to the rest of the system; and how to get optimum sound from car stereo. Address: Audiovox Corp., 150 Marcus Blvd., Hauppauge, NY 11787.

DATA COMMUNICATIONS CALENDAR

The 1980 "Sherry Says" Data Communication Calendar provides pertinent information in the data communications field—major trade shows and conferences and historical events. The calendar is designed to be hung on the wall, and there is space in the squares to write in daily schedule. Address: Corporate Relations Dept. Racial-Milgo, Inc., 8600 N.W. 41st St., Miami, FL 33166.

POPULAR ELECTRONICS

HEAR WHAT YOU'VE BEEN MISSING!

*Listen with a Honeybox™ omnisonic imager™,
a quantum leap forward in stereo reproduction!*

OMNISONIC IMAGERY™ IS HERE!

Our innovative state-of-the-art electronics create a totally unique sound environment never before possible. With Honeybox™, you can now experience the physiological sensation of what amounts to three-dimensional sound reproduction — what we call omnisonic imagery™ — from just two speakers. Sound appears to come from many sources in the listening area, depending on the quality of the signal source. A common reaction is to look about for other speakers. *And you don't have to sit rigidly fixed at a focal point between the speakers to enjoy Honeybox™!*

RETROFITS TO MOST STEREO SYSTEMS

Any unit with a tape monitor facility (internal tape loop) can mate with Honeybox™. It also has a built-in tape monitor button so you don't lose your existing tape monitor facility.

Honeybox™ works on any binaural source — FM, tapes, and records. You can record selections via Honeybox™ and replay them on conventional stereo equipment also.

Now that you've read all about Honeybox™, don't you think it's time to hear one? If we have stimulated your interest in seeking the finest sound reproduction in the purest sense, please ask your dealer for a live demonstration. If you have any questions, or need to know the name of the dealer nearest you, call or write to:

OMNISONIX, LTD.

P. O. Box 307
Wallingford CT U.S.A. 06492
(203) 237-4203

THREE DIMENSIONS IN SOUND!

Stereo without Honeybox™ produces sound from two distinct sources. Music from the speakers arrives at your ear, but most of it falls on the floor. The result is often "muddiness" and loss of presence. Only two dimensions result — volume level and stereo separation.

Stereo with Honeybox™ creates omnisonic imagery™ never before possible. Sound seems to come from the near and far. At times, it surrounds you, and appears to come from behind you and below you. The sound never has a chance to fall to the floor. It is so alive with movement that it envelopes you. Three dimensions — volume level, stereo separation, and omnisonic imagery™ are apparent with Honeybox™.

LIFETIME WARRANTY!

You get a lifetime warranty on the active circuitry, and one year on all other components (excluding case and line cord), provided Honeybox™ is used as intended. If you run over it with a truck, the warranty is void!



Dealers — join our rapidly-growing network. Write to our Sales Dept. for details. Visit our booth at the June C.E.S., Chicago.

Honeybox™, Omnisonic Imager™, Omnisonic Imagery™, and HBX™ are trademarks of Omnisonix, Ltd.

CIRCLE NO. 62 ON FREE INFORMATION CARD



Stereo Scene

By Harold A. Rodgers
Executive Editor

AMPLIFIER TECHNOLOGY, DISTORTION, ETC.

RARELY WILL one find an audible difference in the performance of two neighboring receivers in a line. This applies with particular force to the power amplifier sections. The reasons why the foregoing is true depend on the two fundamental properties of amplifiers: power output and distortion. A higher-powered amplifier is worthwhile only by virtue of the fact that it allows music to be played louder without the peaks being clipped. In typical use, an amplifier—even when driving fairly inefficient speakers—will loaf along at an average power of 1 watt or less. Every now and then, at intervals of a few hundred milliseconds or so, a peak 10 to 20 dB above the average level comes along. To reproduce this properly—that is without limiting and cutting off the top of the waveform—the amplifier must increase its output for an instant by a factor of 10 to 100. Although the intervals during which these demands are made are very short, the ability of the amplifier to satisfy them makes all the difference. Most of the nasty sound that an overdriven amplifier produces is from just such clipping of peaks.

Now let's look at a hypothetical (but representative) line of receivers. Typically, their rated output power might be spaced at something like 25, 40, 60, and 90 watts as we move up in single steps, and very often we would find the spacing even closer. Next, let's change these absolute powers into

decibels—which give a more accurate reflection of auditory effect—using, for convenience, the lowest-powered model as the zero reference. The figures become 0, 2, 3.8, and 5.6 dB. Granted, the power an amplifier can deliver in handling a short peak is considerably more than its steady-state rating. In units of similar design, however, the extra power generally turns out to be a constant percentage of the steady-state ratings, so the difference remains the same when it is expressed in decibels.

It has been rather solidly established that even the most astute listener will not notice level differences in music unless they exceed 3 dB. (Designers of stepped audio attenuators implicitly endorse this view, as such devices rarely have steps smaller than 2 dB between adjacent positions, the control at this point being in effect continuous.) Therefore, it follows that, if we play the same music on any adjacent pair in our hypothetical line of receivers at a level just below clipping, there will be no perceptible difference in loudness. In fact, even if one skips a receiver in the series and listens very carefully, the difference will usually be very slight. There are other factors such as convenience features, a better FM section, or more elaborate tone controls that might make a single step upward worth taking. But as far as power goes, the message is clear: take big jumps or stay where you are.

What About Distortion? Although a few receiver manufacturers make a point of having identical distortion ratings for the power-amplifier sections throughout the line, most give reduced percentages at higher price points. Unfortunately, there is no real ground for considering these reductions significant in audible terms. As a matter of fact, it is questionable whether *any* distortion specifications in today's component amplifiers are audibly meaningful.

First, we can establish fairly easily that small changes in distortion can be ignored completely. We already illustrated that changes in level of a *desired signal* are inconsequential if they are smaller than about 3 dB. Obviously, the same principle applies to distortion. Therefore, given a unit rated at, say, 0.1%, its competitor would have to be rated at 0.07% (3 dB lower) before it could possibly sound any better. (Distortion percentages are, for some reason, calculated on the basis of voltage, not power.) And remember, by ignoring the presence of the test signal, we are being very pessimistic.

The Role of Masking. The presence of the fundamental (the tone being distorted, so to speak) makes any harmonic distortion products even less audible. As shown in the graph, the presence of a 400-Hz tone at a level 80 dB above its own audibility threshold raises the audibility threshold for a 4000-Hz tone (its 10th harmonic) by 20 dB. This is a factor of 100. Studies done directly on the audibility of distortion by Robert Carver and others showed that, under the most severe conditions—broad spectrum crossover distortion and pure tones, the threshold of audibility for distortion was around 0.15%, a level considered almost gross by today's standards. When music is used as a test signal, audibility thresholds consistently rise to something on the order of several percent.

Intermodulation distortion represents what, superficially at least, looks like a more difficult challenge. It can, after all, produce spurious tones that are lower in frequency than the lowest tone present in the test signal. Consequently, it's more difficult to mask. For practical purposes, however, it should be remembered that such tones, if produced by musical fundamentals, will tend to lie in a range where the ear is not terribly sensitive. The same applies to transient intermodulation distortion (TIM), which the work of Walter Jung and others suggests can be detected in steady-state tests if proper methods are used. A better name for the phenomenon might be high-frequency distortion. In any case, it is well to remember that distortion-audibility studies using music include the effects of harmonic, intermodulation, and—if they truly exist—transient distortions. There is no practical way to separate them.

I had hoped at one point to look for ways in which amplifier distortion might be weighted for audibility. On the basis of the admittedly limited research that I did, that step seems quite unnecessary. What sense can it make to rate the relative audibility of influences that are inaudible in the meanest of present-day component amplifiers?

Do Amplifiers All Sound Alike? Not necessarily. They still differ in how much power they can deliver before overload, in internally generated noise, and in ability to tolerate

(Continued on page 20)

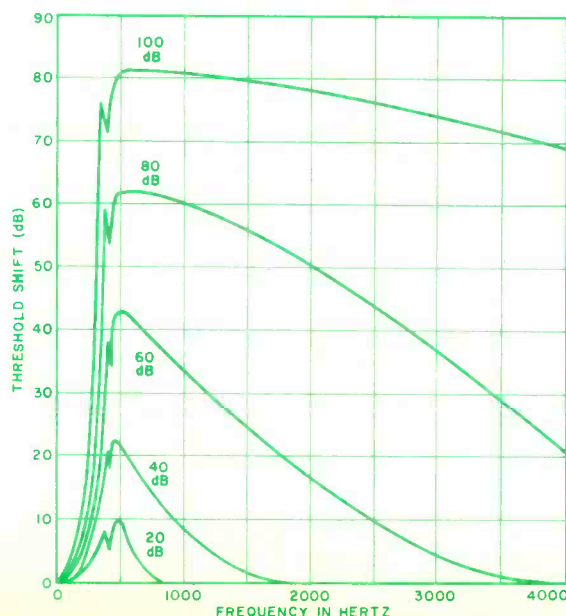

Masking effect of a 400-Hz tone at various levels. The traces indicate how much the audibility threshold is raised at other frequencies when the 400-Hz tone is present.

JBL'S NEW L150: ITS BOTTOM PUTS IT ON TOP.

JBL's new L150 takes you deeper into the low frequencies of music without taking you deeper into your budget.

This short-tower, floor-standing loudspeaker system produces bass with depth, power and transparency that comes incredibly close to a live performance.



A completely new 12" driver was created for the L150. It has an innovative magnetic assembly, the result of years of research at JBL. It

uses a stiff, heavy cone that's been coated with an exclusive camping formulation for optimum mass and density.

And it has an unusually large 3" voice coil, which aids the L150's efficiency and its ability to respond to transients



(peaks, climaxes and sudden spurts) in music.

There's even more to the L150's bottom—a 12" passive radiator. It looks like a driver but it's not. We use it to replace a large volume of air and contribute to the production of true, deep bass. Bass without boom.

If you're impressed with the L150's lows, you'll be equally impressed with its highs and mids. Its powerful 1" high-frequency

dome radiator provides wide dispersion throughout its range. And a 5" midrange transducer handles high volume levels without distorting. The maximum power recommended is 300 watts per channel.

The L150's other attributes include typical JBL accuracy—the kind that recording professionals rely on. Maximum power/flat frequency response. High efficiency. And extraordinary time/phase accuracy.

Before you believe that you can't afford a floor system, listen to an L150. While its bottom is tops, its price isn't.

James B. Lansing Sound, Inc., 8500 Balboa Boulevard, Northridge, CA 91329.

JBL
FIRST WITH THE PROS.



**NRI training in TV
and Audio Servicing
keeps up with the
state of the art.
Now you can learn to
service video cassette
and disc systems.**





You build color TV, hi-fi, professional instruments.

Now, in addition to learning color TV and audio systems servicing, you get state-of-the-art lessons in maintaining and repairing video cassette recorders, and the amazing new video disc players, both mechanical and laser-beam types.

Learn at Home in Your Spare Time

And you learn right at home, at your own convenience, without quitting your job or going to night school. NRI "bite-size" lessons make learning easier... NRI "hands-on" training gives you practical bench experience as you progress. You not only get theory, you actually build and test electronic circuits, a complete audio system, even a color TV.

Build Color TV with Computer Programming

As part of your training in NRI's Master Course in TV/Audio/Video Systems Servicing, you actually assemble and keep NRI's exclusive designed-for-learning 25"

Learn at home at your convenience.

(diagonal) color TV. It's the only one that comes complete with built-in computer tuning that lets you program an entire evening's entertainment. As you build it, you introduce and correct electronic faults, study circuit operation, get practical bench experience that gives you extra confidence.

You also construct a solid-state stereo tuner and amplifier complete with speakers. You even assemble professional-grade test instruments so you know what makes them tick, too. Then you use them in your course, keep them for actual TV and audio servicing work.

NRI Includes the Instruments You Need

You start by building a transistorized volt-ohm meter which you use for basic training in electronic theory. Then you assemble a digital CMOS frequency counter for use with lessons in analog and digital circuitry, FM principles. You also get an integrated circuit TV pattern generator, and an advanced design solid-state 5" triggered-sweep oscilloscope. Use them for learning, then use them for earning.

NRI Training Works... Choice of the Pros

More than 60 years and a million students later, NRI is still first choice in home study schools. A national survey of successful TV repairmen shows that more than half have had home study training, and among them, it's NRI 3 to 1 over any other school.

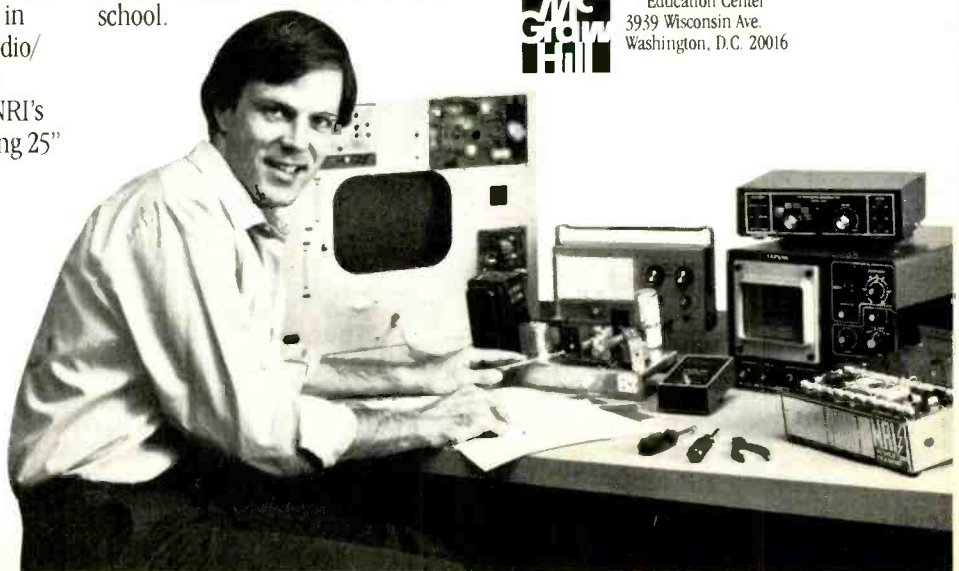

(Summary of survey on request.)

That's because you can't beat the training and you can't beat the value! For hundreds of dollars less than competing schools, NRI gives you both color TV and audio...



Other NRI training includes Computer Technology, Complete Communications Electronics.

and now includes training in video cassette and disc systems. Send for our free catalog and see for yourself why NRI works for you.

Free Catalog... No Salesman Will Call

Send today for our free 100-page catalog which shows all the kits and equipment, complete lesson plans, and convenient time payment plans for courses to fit your needs and budget. Or explore the opportunities in other NRI home study courses like Microcomputers & Microprocessors, CB and Mobile Radio, Aircraft and Marine Radio or Complete Communications. Send the postage-paid card today and get a head start on the state of the art. If card has been removed, write to:



NRI Schools
McGraw-Hill Continuing
Education Center
3939 Wisconsin Ave.
Washington, D.C. 20016

STEREO SCENE *continued*

loads of very low impedance and/or highly reactive character without overloading or becoming unstable. The last point is just now beginning to get the attention it deserves.

Other points of difference include: ruggedness, quality of construction and parts selection, and the ability of automatic protection systems to operate without objectionable effects on sound quality. Designing in such characteristics can generate expenses that appreciably affect the price of the product.

As for distortion, the next time someone tries to frighten or cajole you into considering it as a selling point, tell him you'd rather know how the moon's gravity affects the power-transformer windings. That probably makes more difference. ◇



Audiophile Recordings

ABBEY ROAD, **The Beatles**. Mobile Fidelity MFSL 1-023. Like others in the MFSL Super-disc series, this is a re-release, but with a difference. The original master tape is used, and the new master disc is cut at half speed. To top it all off, disc manufacture is very careful. In this case, the result is a superior rendition of a classic. The new production gives a clear insight into the antediluvian mixing techniques available to the Beatles and, also, into how artistically they used what they had. (Bach got by with some pretty crude instruments, too.) Curiously, the vocal is less prominent than I remember its being in the original production, an effect I noticed on some other Mobile Fidelity discs. Here, that characteristic is especially welcome, as there is a lot of fascinating instrumental.

SONIC FIREWORKS: MUSIC FOR ORGAN, BRASS, AND PERCUSSION, VOLS I, II, **Richard Morris with the Atlanta Brass Ensemble**. Crystal Clear CCS-7010, 7011. This is a direct-mastered production with a big sound. What seems quite unusual about it is that the massiveness and opacity often found in recordings of large, loud ensembles is absent here. Details stand out nicely in even the most heavily scored passages. The playing sounds accurate and spirited, and generally brings the music off well. What seems a bit unfortunate, though, is that most of the works presented are transcriptions. Some were originally for neither organ nor brass, and in the rest one or the other seems grafted on as an afterthought. Surely music composed for organ and brass is not as hard to find as all that.

DON SEBESKY: THREE WORKS FOR JAZZ SOLOISTS AND SYMPHONY ORCHESTRA, **Harry Rabinowitz, with the Royal Philharmonic Orchestra and soloists**. Gryphon G-2-791. Attempts to fuse jazz and symphonic music into a single medium have always been a bit problematic. Somehow the two seem to conflict, each getting in the way of the other. Most of the successful works using such combinations belong properly in one genre or the other: jazz borrowing from symphonic or vice versa. While Sebesky's shows quite a lot of imaginativeness in his approach and generates many delightful minutes of listening, the junctions between music à la Bartok and jazz and music à la Stravinsky and jazz don't seem to work. The transition sounds nonorganic and sometimes almost arbitrary. Most successful, I think is Sebastian's Theme, which comes off as a kind of jazz meditation on material from J. S. Bach. Interestingly, this is the least symphonic-sounding of the three works presented. The recording quality is first-rate, with a nice sense of perspective and depth.

THE BEEGEES MUSIC **Carmen Dragon conducting the Glendale Symphony Orchestra**. Orinda ORC500. This is a pleasant bit of lightweight fluff, prepared with the utmost in professionalism and very neatly recorded via a digital process. It embraces a bit of disco, a bit of rock, a bit of MOR—all with the rough edges polished away by lush orchestral arrangements. "Exciting" does not seem like the word to describe this release. "Entertaining" is more like it.

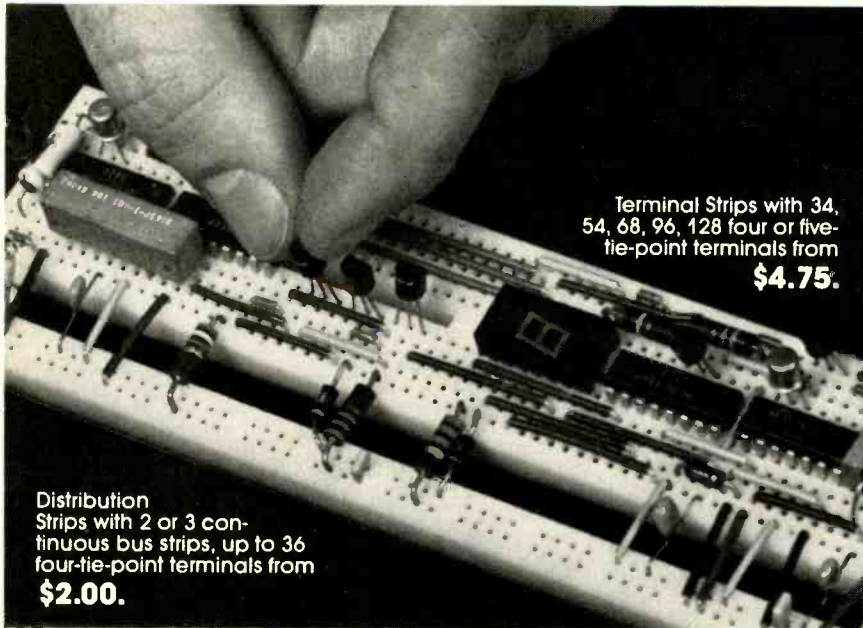

Terminal Strips with 34, 54, 68, 96, 128 four or five-tie-point terminals from **\$4.75.**

Distribution Strips with 2 or 3 continuous bus strips, up to 36 four-tie-point terminals from **\$2.00.**

A P Terminal and Distribution Strips your basic breadboarding building blocks.

Now you can put together as simple or complex a breadboard as you want—and be sure of top quality all the way.

A P Terminal and Distribution Strips give you the world's easiest way to assemble full-performance solderless breadboards of any size or shape.

Our versatile modules come in 11 configurations, all with universal .1"x.1" matrix. They accept all components with leads up to .032" diameter,

connect with any solid wire up to No. 20 AWG. No special patch cords required.

Spring-clip terminals are non-corrosive alloy for superb contact, time after time. Mount permanently with integral non-shorting instant backing or with screws (supplied).

Where to buy? Phone (toll-free) 800-321-9668 for the name of your local A P distributor. And ask for our complete A P catalog, *The Faster and Easier Book*.



"Faster and Easier is what we're all about."



**A P PRODUCTS
INCORPORATED**
1359 W. Jackson St.
Painesville, Ohio 44077
Tel. 216/354-2101
TWX: 810-425-2250

IF YOU WANT AS MUCH FOR YOUR MONEY AS YOU DO FROM YOUR MUSIC.



There are a lot of turntables you can buy for less than \$200. Many of them are fully-automatic. Some of them have Quartz Reference Systems. Others feature sophisticated suspension systems. Or have specially-designed motors to make sure the sound of your turntable doesn't interfere with the sound of music.

But at Pioneer, we believe, that if you're going to pay \$200 for a turntable, you shouldn't just get one of these features. You should get all of them.



PIONEER'S SOPHISTICATED SUSPENSION SYSTEM ELIMINATES SHAKE, RATTLE AND ROLL.

While other turntables with some of these advancements may look the same as the PL-400 on paper, they don't sound at all alike in your home. Because all these advancements act together to keep an imperfect environment, like your home, from getting in the way of perfect sound.

In your home, simply slamming a door can be more jarring to your turntable than it is to you.

Pioneer's PL-400 has a sophisticated suspension system that isolates the platter and tone arm from the rest of

the turntable. Which means you can shake, rattle and roll a lot more with a lot less worry that your turntable is doing the same thing.

The PL-400 also has the world's thinnest direct drive motor. This ultra-thin motor does a lot more than give the PL-400 an ultra-sleek appearance. It keeps the turntable platter perfectly steady at all times. Though platter wobbling isn't a problem that can be easily seen on most turntables, it can be easily heard. It results in shifts of musical pitch. Something the PL-400 is never bothered with.



THE WORLD'S THINNEST DIRECT DRIVE MOTOR ELIMINATES PLATTER WOBBLE.

What's more, the PL-400 also has Quartz control like that found in the finest Swiss watches.

Which means you're guaranteed to get the maximum in rotational accuracy.

So if you want a turntable that sounds great, there's any number you can buy. But if you also want the price to sound great, there's only one.

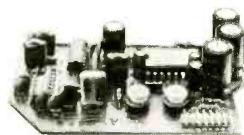

PIONEER'S QUARTZ REFERENCE SYSTEM FOR ACCURACY LIKE THAT FOUND IN THE FINEST SWISS WATCHES.

The fully-automatic Pioneer PL-400. We bring it back alive.

©1980 U.S. Pioneer Electronics Corp., 85 Oxford Drive, Moonachie, N.J. 07074.

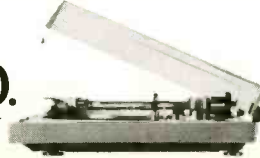
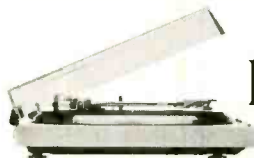

PIONEER'S PL-400. THE ONLY FULLY AUTOMATIC QUARTZ-CONTROLLED TURNTABLE FOR \$199.*

*Manufacturer's suggested retail price. Actual prices established by dealers.

CIRCLE NO. 48 ON FREE INFORMATION CARD

Julian Hirsch Audio Reports



Dual Model CS606 direct-drive single-play turntable with Ultra Low Mass tonearm



The new Dual CS606 is a direct-drive, single-play turntable with automatic shut-down at the end of a record.

It features Dual's ULM (Ultra Low Mass) tonearm, whose exceptionally low 5.5-gram mass can be complemented by an optional Dual/Ortofon ULM55E cartridge. The combined effective mass of the two is 8 grams, a new low for an integrated record player system. Any cartridges weighing between 2 and 9 grams and having standard 1/2-inch mounting centers can be installed in the ULM arm. An additional feature of the CS606's tonearm is its tuned counterweight, which can be adjusted to damp (at least partially) the low-frequency resonance of any cartridge used in the ULM arm.

Springs support the unit on its plastic base, the sides of which are finished in a simulated wood grain. The hinged plastic dust cover is easily removable. Total weight of the Dual CS606 is 14 1/4 lb (6.6 kg). With the cover lowered, it measures 16 3/4" W X 14 1/2" D X 5 3/4" H (421 X 368 X 146 mm). Suggested retail price less cartridge is \$279.95. With the Dual/Ortofon ULM55E cartridge, it is \$390.

General Description. The platter has four rows of stroboscope dots cast into its rim for the 33 1/3- and 45-rpm speeds with power-line frequencies of 50 or 60 Hz. They are lit by an LED mounted next to the outer edge of the platter. A small knob near the platter selects the operating

speed, and another provides a vernier pitch control.

To start the platter rotating, it is only necessary to move the tonearm from its rest. With the cuing lever in its "up" position, the arm can be moved horizontally until a light detent is felt at the lead-in diameter for a 12-inch record (a second detent marks the set-down point for a 7-inch record). The cuing action lowers the tonearm gently. A knob near the cuing lever disables the arm detents. Lifting the arm and returning it to its rest during play shuts off the motor; arm return and shutoff are automatic at the end of a record.

The straight ULM tonearm is constructed of small-diameter tubing and has a headshell designed for minimum mass. As the headshell is not detachable, the tonearm wiring must be connected to the cartridge pins before it is mounted in the arm. The counterweight has a scale around its circumference calibrated from 7 to 14 (apparently the resonant frequency of the internally suspended mass whose position is shifted within the counterweight as its main body is rotated). The instruction booklet includes a chart on which the mass and compliance of any cartridge to be used in the ULM arm can be located. From that information, one can determine the setting of the antiresonance filter that best cancels the increase in output that occurs at the resonant frequency of the stylus system and the effective mass of the arm and cartridge.

The gimbal arm mount has been retained from earlier Dual turntables, along with a side-mounted control that applies

vertical tracking force by means of a spring around the vertical pivot axis. The force scale is calibrated at 0.1 gram intervals from 1.5 to 3 grams. Antiskating with separate scales for conical and elliptical styli is provided.

Test Results. We tested the CS606 with the ULM55E cartridge, which is designed to give its flattest frequency response when loaded by about 400 picofarads across the standard 47,000-ohm termination (this information is not stated anywhere in the instruction manual or the descriptive material on the cartridge). The CS606 tonearm and cable wiring had a capacitance of about 185 picofarads between each signal line and ground, so that preamp input capacitance of 200 to 250 pF should provide an optimum load for the cartridge. That is a fairly common input capacitance for phono circuits, although values range from less than 10 to more than 500 pF.

With the tonearm carefully balanced according to instructions, tracking force was within 0.1 gram of the indicated value. Tracking error was less than 0.5 degree per inch over the playing surface of a 12-inch record. The total effective mass of the arm and cartridge was only 7.5 grams, and the low-frequency resonance was at approximately 13 Hz. Due to the broad tolerances in the measurement, the differences between this and the manufacturer's data cannot be deemed significant.

The counterweight's antiresonator had a moderate effect on the playback output in the vicinity of resonance. In fact, when the antiresonator counterweight was set to 11.5 (the recommended point for this cartridge), it nullified the resonant peak almost completely, but narrowness of the notch left an appreciable rise in output above and below resonance. Measurements of the low-frequency response, made with the antiresonator set to its limits as well as as to the recommended value showed a typical output rise of 6 to 8 dB in the range of 11 to 14 Hz, remaining measurable as high as 25 Hz. In each case, however, the recommended setting gave the maximum reduction of output rise at the exact resonant frequency.

To check the Dual ULM arm with a cartridge more massive than the ULM55E, but highly compliant, we installed a Stanton 881S. This was complicated by the fact that the connecting clips on the tonearm wires were too small for the pins on the 881S. As they could not readily be unsoldered, we soldered larger clips to the original ones. It was also necessary to use one of the two additional counterweights that screw onto the rear of the regular one to balance the 5.7-gram mass of the 881S.

Low-frequency resonance measurements with the Denon 7001-A test record showed a resonant frequency near 10 Hz



NOW FOR \$75. THE WATCH THAT REPLACES EVERYTHING.

Introducing Casio's newest, the C-80 Calculator Chronograph. A watch that figures to replace a lot of other watches. And calculators. And stopwatches.

In fact, it even replaces the age-old myth that a timepiece loaded with talent has to be expensive.

The Casio C-80 is priced at only \$75.

A calculator made for real fingers.

Here's the first calculator chronograph that can be operated easily with your fingertips. No need to use a stylus or pen; the keys are far enough apart that even the broadest fingers can work them.

Now you can add, subtract, multiply, divide—perform chain calculations up to six places, plus decimal. Numbers appear in crisp liquid crystal digits. There's even an indicator that tells you exactly which function is being performed.

Stopwatch, 2 time zones—and more.

The push of a button turns your calculator into a fiercely talented stopwatch. You get 1/100 of a second accuracy, lap times, and up to 59.59 minutes of track-style timekeeping. Timing automatically starts over after the hour.

You also get two time zones; the second zone can be set for 12 or 24-hour time (especially useful for frequent travelers). Hours, minutes and seconds are displayed with reliable ±15 second-a-month quartz precision. AM/PM indicator is always visible.

Press another button, day of the

week and date appear. And another for built-in night light.

Feather-light, yet rugged.

The 1 3/4 oz. case and band are constructed of high impact black plastic. And so lightweight and comfortable, you may not realize that on your wrist you're wearing—among other things—a clever calculator.

Other companies have tried introducing similar watches, only using bulky stainless steel. These steel

mechanical parts to wear out or break. A tough mineral glass crystal prevents scratching. And the tightly fitted case and crystal provide water resistance for every-day use.

Reserve yours now.

You might wonder why you haven't seen this superb chronograph in the stores. The fact is, it isn't going to be in any stores—not for a while.

However, beginning late March 1980, The Sharper Image will be the first people anywhere to take delivery on these exciting Casios. And you can reserve yours now. But please order immediately to be assured of earliest delivery (late March or April). As quantity is limited, orders will be handled on a first come, first served basis.

And as always, The Sharper Image guarantees your satisfaction. If not delighted with your new Casio, simply return it within two weeks for a full and courteous refund. One-year manufacturer's warranty and 15-month (normal use) battery included.



Normal Time Display; hrs./mins./secs. AM/PM, day and 2 time zones.

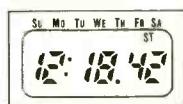

Stopwatch Display; 1/100 sec. timing. Auto start-over at 1 hr. Lap times.

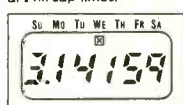

Calculator Display; add, subtract, multiply, divide—to 6 places with decimal.

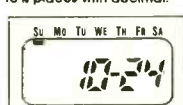

Calendar Display; day/date. Auto end of month adjustment.



versions sacrifice the comfort, lightness, and handsome appearance provided by the latest advanced plastics.

What's more, this Casio chronograph is built incredibly rugged to provide years of reliable service. There are no

ORDER NOW TOLL-FREE

Please order product #134. Credit card holders may use our toll-free number below. Or send check for \$75 plus \$2.50 delivery. Add \$4.50 sales tax in California.

800 227-3436

In California 800 622-0733

THE SHARPER IMAGE™

260 California St., Dept. BI-049
San Francisco, CA 94111
(415) 788-8880

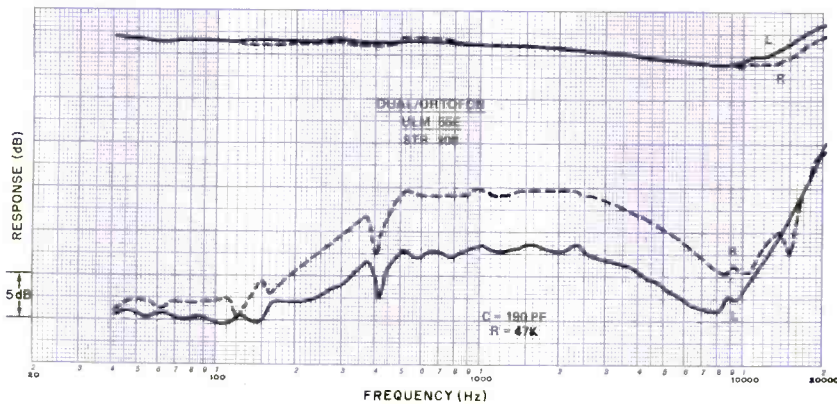

Frequency response and crosstalk for left and right channels.

with the 881S. Since the setting of the antiresonator on the counterweight had an appreciable effect on the apparent resonant frequency, the figures are somewhat in doubt for both cartridges. Some of the antiresonator settings gave a peak around 8 to 9 Hz on the left channel, while the right channel seemed to peak at about 10 Hz. The Shure Audio Obstacle Course-ERA IV low-frequency resonance test gave similar indications. Maximum arm movement occurred from 8 to 10 Hz depending on the antiresonator setting. The antiresonator performed dramatically with this record, a setting of 11 giving best all-around stabilization of the arm.

Turntable flutter was $\pm 0.06\%$ weighted peak (CCIR) and 0.05% weighted rms (JIS), with 5 and 20 Hz dominating the spectrum. Unweighted rumble was -31 dB, measuring a good -60 dB with ARLL weighting. Maximum rumble energy was at about 7 or 8 Hz. Speed could be adjusted over a range of +4.5% to -6% with the vernier knob. The instruction manual says that there are separate pitch controls for each speed, but this appears to be an error. There is only one control and slight re-adjustment may be needed when changing speeds. On our test unit, however, the two speeds were very close to correct at the same setting.

The cuing device worked very smoothly, with negligible outward drift of the tonearm during descent—even with the antiskating at 2.5. End-of-play sequence took only 3.3

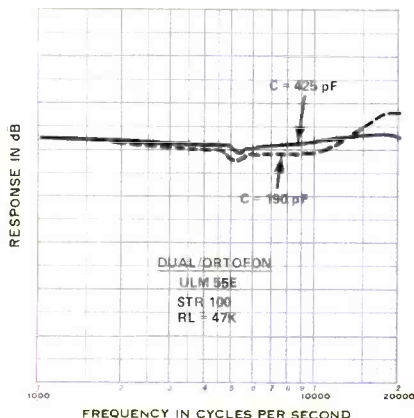

High-end frequency response with CS606 cable capacitance (190 pF) and with 425 pF.

3.3 seconds from automatic arm lift to motor shut-off.

We also took data on the ULM55E cartridge, which, in addition to its very low mass, behaved very well when operated near the upper end of its rated tracking force range. At 1.5 and 1.75 grams, the tracking limits were respectively 60 and 70 micrometers on the German Hi Fi Institute test record. This fell to only 40 micrometers at 1 gram. Tracking distortion with

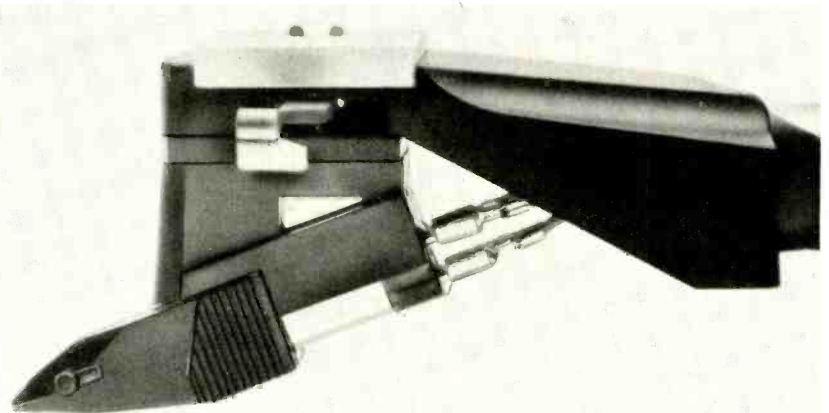

Optional Dual/Ortofon ULM55E cartridge.

Shure TTR102 and 103 records was relatively low, with no evidence of serious mistracking even at the highest levels. At a 1.5-gram force, the cartridge could track everything on the Shure ERA III record, although a touch of strain was evident on level 5 of the sibilant section. The more stringent ERA IV record caused audible mistracking on level 5 of most sections; level 4 usually played without difficulty.

The stylus vertical angle was 24 degrees. Square-wave response on the 1000-Hz square waves of the CBS STR112 record was very clean, with a slight overshoot and a couple of cycles of well-damped ringing at about 20,000 Hz. Frequency response (with the CBS STR100 record) was very flat up to 10,000 Hz and rose to about +3 dB at 20,000 Hz, when the cartridge was terminated by the CS606 cable capacitance (about 190 picofarads) and a 47,000-ohm resistance. A total of about 425 picofarads flattened out the high end very nicely, resulting in a response flat within ± 1 dB from 40 to

20,000 Hz. Channel separation was about 20 dB in the midrange, 25 dB at 10,000 Hz, and 12 dB at 20,000 Hz.

User Comment. The general handling characteristics of the Dual CS606 were excellent. For practical purposes, it can be considered as a "smart" player and easy to use because of its record diameter indexing feature and automatic shutoff.

The tonearm and pickup system give the CS606 the ability to play warped records that are completely unusable on conventional record players. Even a severe warp that would normally throw the pickup into the air will usually give no more than a slight "thump" when it is played, and most warps are undetectable by ear. Some, though not all, of these benefits are retained even when pickups other than the ULM55E are used.

The compliant spring mounting of the record player on its base gives it relatively good immunity to base-conducted vibration that could cause acoustic feedback. Except for a single transmission resonance at about 35 Hz, the CS606 had almost no resonances in the audio range when driven through its mounting feet. We consider its isolation somewhat better than average for a direct-drive turntable.

We found the stroboscope illumination system less than helpful in viewing the 60-Hz 33 $\frac{1}{3}$ -rpm marks. Fluorescent room lighting was better for setting this speed.

Because of the design of the ULM arm, anyone who habitually switches cartridges will find the CS606 more than a little frustrating. The fact that the signal cables are color-coded grey and brown with no channel identification doesn't help, and the connectors are too small for the pins on many cartridges. On the other hand, the ULM55E cartridge offers good value in its price range and is an excellent companion to the ULM tonearm. It comes properly installed and positioned when ordered with the CS606.

In short, the Dual CS606 is first-rate in its concept, construction, and ease of use. With its companion pickup, it offers superb warp-tracking capabilities. To provide that, along with fine overall performance, convenient operation, and a good price is, in our mind, an impressive achievement.

CIRCLE NO. 101 ON FREE INFORMATION CARD
(MORE HIRSCH REPORTS ON PAGE 31)



THE ROADRUNNER ADMM™

Audio Digital Multimeter
FROM **WESTON**

ONLY
\$139

ARE YOU CONFUSED BY ALL THOSE HAND-HELD DIGITAL MULTI-METERS ON THE MARKET? COMPARE PRICE AGAINST FUNCTIONAL FLEXIBILITY AND YOU WILL BE CONVINCED THAT THE WESTON MODEL 6100 ROADRUNNER IS YOUR BEST BUY!

CHECK THESE FEATURES

- 29 Ranges
 - 1mV to 1000VDC
 - 1mV to 750VAC
 - .001 to 2000mADC
 - .001 to 2000mAAC
 - 1ohm to 20Mohms
 - 300VAC protection in ohms and audio
 - Automatic polarity
 - 200 hours battery life
 - 10% "lo-batt" indication
 - 3½ digit LCD .5" display
 - 1, 10, 100mV and 1, 2V threshold pulse detect*
 - 1, 10, 100 Ohm threshold continuity testing*
 - Diode tests*
 - Transistor tests*
 - Capacitor tests*
 - Stuffed PCB tests*
 - RFI shielded
 - X5 analog VOM accuracy
 - Self Calibration
 - Overrange indication
- Rugged case. Built-in stand.

*DENOTES AUDIO RESPONSE™ FUNCTION

FULL LINE OF ACCESSORIES

- | | |
|-----------------------------------|---------------------------------|
| AC Clamp-on Probe . . . \$57.75 | Carrying case \$15.00 |
| Battery Eliminator 15.00 | RF Probe 29.00 |
| Light Meter attachment . . 262.00 | VHF RF Probe 63.00 |
| Temperature Probe (avail. soon) | HV Probe 38.75 |

MODEL	FLUKE 8020A		DATA PRECISION 935				SABTRONICS 2037	
	FLUKE 8024A		BECKMAN 3010				B & K 2815	
	WESTON 6100		FLUKE 8022A					
DC VOLTS	D	D	D	D	D	D	D	D
AC VOLTS	D	D	D	D	D	D	D	D
DC CURRENT	D	D	D	D	D	D	D	D
AC CURRENT	D	D	D	D	D	D	D	D
RESISTANCE	D	D	D	D	D	D	D	D
CONDUCTANCE		D						
DIODE TEST	A	A	D	D	D	D	D	D
LOGIC LEVEL	A	A						
CAPACITANCE	A	A						
CONTINUITY	A	A			D			
TOTAL FUNCTIONS	9	9	7	6	7	6	6	6
PRICE (\$)	139	199	169	129	139	150	150	120

(A) Denotes AUDIBLE function (D) Denotes DISPLAY function

INSTRUMENTATION, INC.
1554 ELMIRA, AURORA, COLORADO 80010
(303) 340-8728 364-8325
CALL COLLECT BUY NOW
SPECIALIZING IN DIGITAL & ANALOG METERS AND MULTIMETERS

CIRCLE NO. 31 ON FREE INFORMATION CARD

INTRODUCING... THE ROAD RUNNER ADMM™

FROM WESTON



AUDIO RESPONSE™ PLUS DIGITAL DISPLAY

- 5 RANGE AUDIBLE SIGNALING FUNCTION
- RUGGED FIELD SERVICE DESIGN
- 0.5" LCD DISPLAY
- 6 FUNCTIONS
- 29 RANGES

WESTON INSTRUMENTS
THE MEASUREMENT PEOPLE®
614 Frelinghuysen Ave.,
Newark, NJ 07114

SANGAMO WESTON
Schlumberger

CIRCLE NO. 57 ON FREE INFORMATION CARD

“If you’re going to learn electronics, you might as well learn it right!”

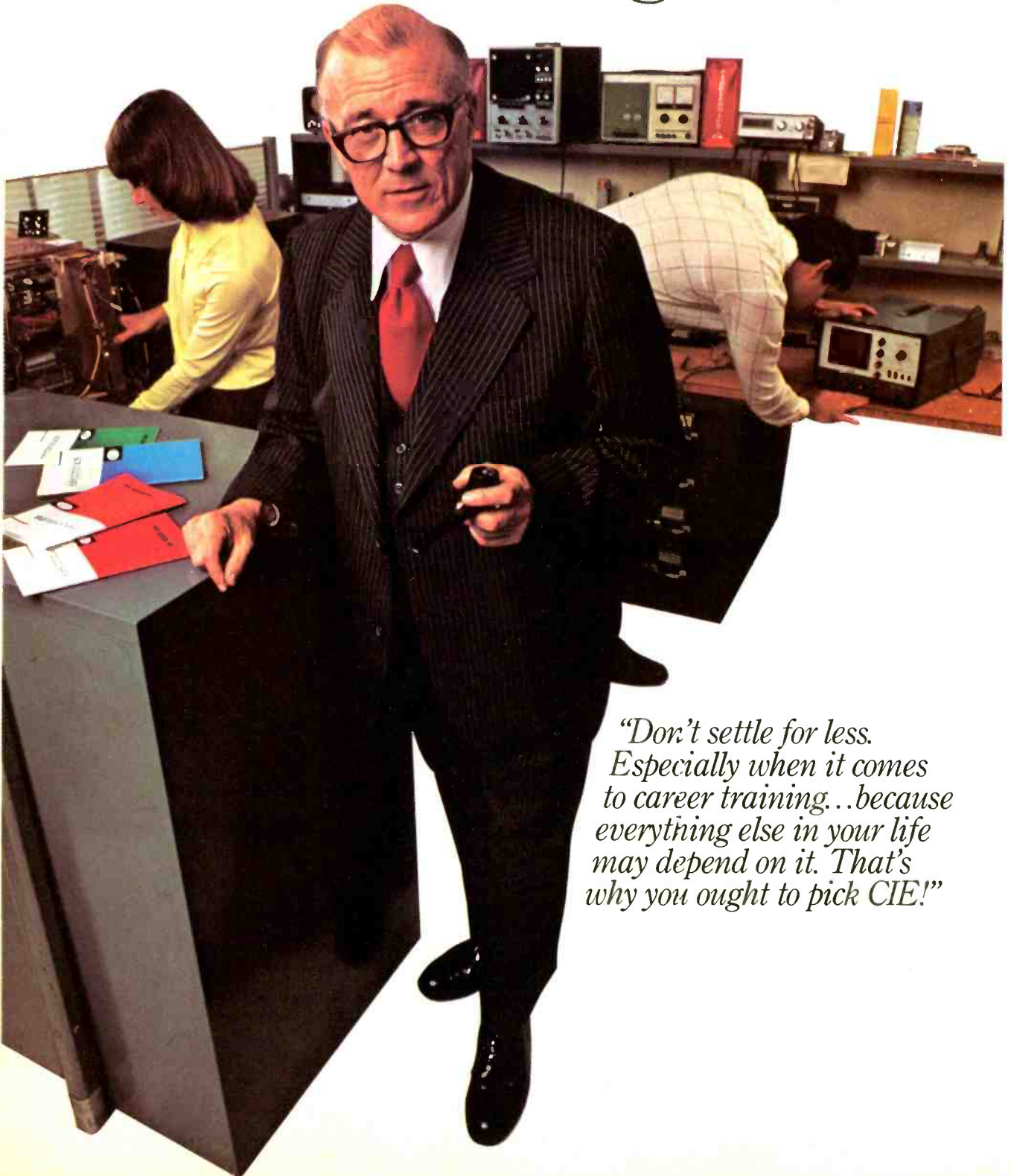

*“Don’t settle for less.
Especially when it comes
to career training...because
everything else in your life
may depend on it. That’s
why you ought to pick CIE!”*

You've probably seen advertisements from other electronics schools. Maybe you think they're all the same. They're not!

CIE is the largest independent home study school in the world that specializes exclusively in electronics.

Meet the Electronics Specialists.

When you pick an electronics school, you're getting ready to invest some time and money. And your whole future depends on the education you get in return.

That's why it makes so much sense to go with number one... with the specialists... with CIE!

There's no such thing as bargain education.

If you talked with some of our graduates, chances are you'd find a lot of them shopped around for their training. Not for the lowest priced but for the best. They pretty much knew what was available when they picked CIE as number one.

We don't promise you the moon. We do promise you a proven way to build valuable career skills. The CIE faculty and staff are dedicated to that. When you graduate, your diploma shows employers you know what you're about. Today, it's pretty hard to put a price on that.

Because we're specialists, we have to stay ahead.

At CIE, we've got a position of leadership to maintain. Here are some of the ways we hang onto it...

Our step-by-step learning includes "hands-on" training.

At CIE, we believe theory is important. And our famous Auto-Programmed® Lessons teach you the principles in logical steps.

But professionals need more than theory. That's why some of our courses train you to use tools of the trade like a 5 MHz triggered-sweep, solid-state oscilloscope you build yourself—and use to practice troubleshooting. Or a Digital Learning Laboratory to apply the digital theory essential to keep pace with electronics in the eighties.

Our specialists offer you personal attention.

Sometimes, you may even have a question about a specific lesson. Fine. Write it down and mail it in. Our experts will answer you promptly in writing. You may even get the specialized knowledge of all the CIE specialists. And the answer you get becomes a part of your permanent reference file. You may find this even better than having a classroom teacher.

Pick the pace that's right for you.

CIE understands people need to learn at their own pace. There's no pressure to keep up... no slow learners hold you back. If you're a beginner, you start with the basics. If you already know some electronics, you move ahead to your own level.

Enjoy the promptness of CIE's "same day" grading cycle.

When we receive your lesson before noon Monday through Saturday, we grade it and mail it back—the same day. You find out quickly how well you're doing!

CIE can prepare you for your FCC License.

For some electronics jobs, you must have your FCC License. For others, employers often consider it a mark in your favor. Either way, it's government-certified proof of your specific knowledge and skills!

More than half of CIE's courses prepare you to pass the government-administered exam. In continuing surveys, nearly 4 out of 5 CIE graduates who take the exam get their Licenses!

For professionals only.

CIE training is not for the hobbyist. It's for people who are willing to roll up their sleeves and go to work... to build a career. The work can be hard, sure. But the benefits are worth it.

Send for more details and a FREE school catalog.

Mail the card today. If it's gone, cut out and mail the coupon. You'll get a FREE school catalog plus complete information on independent home study. For your convenience, we'll try to have a CIE representative contact you to answer any questions you may have.

Mail the card or the coupon or write CIE (mentioning name and date of this magazine) at: 1776 East 17th Street, Cleveland, Ohio 44114.



CIE **Cleveland Institute of Electronics, Inc.**
1776 East 17th Street, Cleveland, Ohio 44114

Accredited Member National Home Study Council

YES... I want the best of everything! Send me my FREE CIE school catalog—including details about troubleshooting courses—plus my FREE package of home study information. PE-12

Print Name _____

Address _____ Apt. _____

City _____

State _____ Zip _____

Age _____ Phone (area code) _____

Check box for G.I. Bill information: Veteran Active Duty

MAIL TODAY!

1 GHz For Only \$139.95

8 Digits • 1 PPM TCXO • Factory Wired 500 MHz or 1 GHz

\$139⁹⁵
5510 WIRED
50 Hz to 1 GHz

\$109⁹⁵
5500 WIRED
50 Hz to 512 MHz



• 1 Hz Resolution to 50 MHz.

- 1 Meg Ohm, 50 Ohm, BNC Inputs
- 15 MV Sensitivity at 250 MHz Typ.

With the introduction of the 5510 DSI has filled a long standing void in the frequency counter market place. You now have the choice of selecting a 512 MHz model 5500 for \$110 or for only \$30.00 more you can buy an 8 digit 1 GHz counter model 5510. With this 1 GHz capability, the new world of 960 MHz is immediately available to you. Both the 5500 and 5510 are available with a rechargeable battery pack which includes the AC adapter and battery charger for one low price. Whether you select the 5500 or the 5510, you will receive the best price to quality features ratio in the industry. No wonder DSI has become one of the world's largest manufacturers of freq. counters.

1.2 GHz Only \$199⁹⁵
5612 KIT

512 MHz Only \$169⁹⁵
5600 KIT

- 10 MHz Proportional Oven
- .2 PPM 10° to 40° C Time Base
- .1 Hz Resolution to 50 MHz.
- External 10 MHz inputs outputs.
- 9 Bright .5 inch LED Readouts.
- 100% Factory Tested
- Kits 95% Factory Assembled.
- 50 Ohm, 1 Meg, BNC Inputs
- 10 MV Sensitivity at 250 MHz Typ.



Whether you select a 5600, 5612 Kit with 95% of the assembly completed by DSI or select a factory wired and calibrated frequency counter, you can count on DSI to solve all those difficult bench or field problems from measuring audio signals to checking a 960 MHz mobil radio (model 5612), servicing a VTR, trouble shooting a PLL signal in a TV or FM radio, etc. The 5600 or 5612 has the sensitivity and accuracy to meet any FCC landmobile, broadcast, RF, or telecommunications requirements. DSI offers a 10 HR rechargeable battery pack (BA56) option, and an audio multiplier (AM56) which will allow you to resolve a 1/1000 Hz signal in only ten seconds or 1/100 Hz signal in one second. DSI 5600 series offers just the right instrument for all your communication RF, TV servicing and industrial testing needs.

FOR INFORMATION — DEALER LOCATION — ORDERS — OEM
CALL 800-854-2049 CALIFORNIA RESIDENTS CALL 800-542-6253

Model	Price	Frequency Range Typ	Accuracy Over Temperature	Sensitivity Typ			Number of Readouts	Power Requirements	Size H W D
				100MHz-500MHz	50-100MHz	250-450MHz			
5600A-Kit	\$169.95	50Hz-550MHz	Proportional Oven .2 PPM 10° - 40°C	10-25mv	10-15mv	15-50mv	9	*115 VAC or 8.2-14.5 VDC	3 1/4" x 3 1/2" x 9"
5600A-Wired	\$199.95			10-25mv	10-15mv	15-50mv			
5612Kit	\$199.95	50Hz-1.2 GHz	Proportional Oven .2 PPM 10° - 40°C	10-25mv	10-15mv	15-50mv	9	*115 VAC or 8.2-14.5 VDC	3 1/4" x 9 1/2" x 9"
5612 Wired	\$239.95			10-25mv	10-15mv	15-50mv			
5500 Wired	\$109.95	50Hz-512MHz	TCXO 1 PPM 17° - 40°C	10-25mv	15-25mv	25-75mv	8	115 VAC or 8.2-14.5 VDC or NICAD PAK	1 1/2" x 5" x 5 1/2"
5510 Wired	\$139.95	50Hz-1GHz		10-25mv	15-25mv	25-75mv			

Factory wired units carry 1 year limited warranty kits carry a 90 day limited warranty.
Prices and/or specifications subject to change without notice or obligation.

With AC-9 Adapter

Prices effective
March 1, 1980

- 5510 Wired 139.95
- 5500 Wired 109.95
- 5510/BAC Wired 164.95
- 5500/BAC Wired 134.95
- T600 BNC ANT (all models) 7.95
- AC-9 AC Adapter(all models) 7.95
- LC 5000 169.95

INTERNAL BAT. ONLY AC-9 NOT REQUIRED



DSI INSTRUMENTS, INC.
9550 Chesapeake Drive
San Diego, California 92123
(714) 565-8402

TERMS: MC — VISA — AE — CHECK — M.O. — COD
in U.S. Funds. Please add 10% to a maximum of \$10.00
for shipping, handling and insurance. Orders outside
of USA & Canada, please add \$20.00 additional to
cover air shipment. California residents add 6% Sales Tax
CIRCLE NO. 20 ON FREE INFORMATION CARD

www.americanradiohistory.com

- 5612 Kit 199.95
- 5612 Wired 239.95
- 5600A Kit 169.95
- 5600A Wired 199.95
- BA56 Rechargeable
- 10 Hr. Bat. Pack 29.95
- AM-56 Audio Multiplier
- .001 Hz Resolution 34.95

Mitsubishi Model MS-40

three-way, floor-standing speaker system



Heading Mitsubishi's line of speaker systems is the floor-standing Model MS-40. Its 12" (30-cm)

diameter woofer is housed in a sealed enclosure and operates up to 600 Hz, where there is a 12-dB/octave crossover to a 4" (10-cm) midrange cone driver housed in a sealed subenclosure. The second crossover is to a 1½" (4-cm) dome driver at 5 kHz with an 18-dB/octave slope.

The handsome walnut-veneered enclosure measures 34⁵/₈" H X 15³/₈" W X 14⁵/₁₆" D (88 X 39 X 36.3 cm) and weighs 77 lb (35 kg). Suggested retail price is \$550.

General Description. The woofer is located about a third of the way up the front panel of the enclosure; the midrange and high-frequency drivers are positioned slightly off the vertical center line of the speaker board. Manufactured in mirror-image pairs, the speaker systems are designed for left- and right-channel operation, with the off-center drivers positioned toward the center of the listening area. Near the high-frequency drivers is a small panel with switches to adjust the levels of the two high-frequency drivers in 2-dB

steps from +2 to -4 dB and a small red LED that comes on when the system is driven to excessive levels.

The dark brown grille cloth is stretched on a wooden frame, the whole held in place by plastic snaps and supported ¾" (19.1 mm) away from the front panel. The front panel is free of bevels or recesses, and the drivers are mounted flush with its front surface to minimize diffraction effects. Spring-loaded connecting clips and a recessed pushbutton switch for resetting the system's protective circuit are located on the rear panel.

The protective circuit monitors the current passing through the drivers. Should this current become excessive, the circuit operates a fast-acting relay that greatly reduces the volume and simultaneously lights the LED on the front panel.

Nominal system impedance is rated at 6 ohms and, by IEC standards, the system can handle up to 150 watts without damage. Rated sound pressure level (SPL) is 87 dB at a distance of 1 meter with 1 watt of driving power.

One of the more novel features of the MS-40 is its honeycomb woofer construction. The honeycomb is formed of aluminum foil 20 micrometers thick, and each "cell" is ¾" (4.8 mm) wide and ⅛" (3.2 mm) deep. Bonded to each side of the honeycomb is a layer of glass-fiber reinforced plastic 100 micrometers thick. The complete structure forms a straight-sided cone that is far more rigid and lighter than paper. However, internal losses are similar to those of paper, damping the internal resonances that can occur with metallic cone materials. Mitsubishi's computer analysis of the cone indicates that it is far less subject to flexural vibration than a paper cone of similar dimensions. Additionally, the construction gives immunity to atmospheric changes that can affect the physical characteristics of paper.

Set within a cone-like recess formed by its butyl rubber edge suspension, the dome tweeter is claimed to give excellent dispersion qualities. Almost the entire interior of the MS-40 cabinet is filled with sound absorbent material, as is the midrange driver subenclosure.

Laboratory Measurements. When we spliced the semireverberant-field frequency response of the MS-40 to its close-miked bass response, the result was an unusually flat, smooth curve that varied only about ± 1.5 dB from 40 Hz to 20 kHz. A broad bass rise of about 2 dB occurred at 60 Hz, a slightly smaller rise at 1 kHz. There was a slight but definite upward

slope of the curve from about 4 to 20 kHz, where the output was up some 3 dB relative to the midrange level.

Slight departures from flatness of this magnitude are usually considered to be within the measurement tolerances of our test method and would hardly be worthy of mention. In this case, however, we were especially interested to note that the typical frequency-response curves published in Mitsubishi brochures for the speaker system had exactly the same features, specifically a bump at 1 kHz and the high-frequency rise. (Since it was made in a very large anechoic chamber, Mitsubishi's bass curve could not be expected to match ours exactly.)

The dome tweeter had exceptionally wide horizontal dispersion, with the measured curves from the left and right speaker systems differing by less than 2 dB all the way up to 20 kHz. (The microphone was on the axis of the left system and about 30° off the axis of the right speaker.) Less than the indicated range was available from the level adjustment controls, which boosted the output by about 1 dB and cut it by 1.5 to 2 dB at the extreme settings. Only frequencies above 5 kHz were affected by the treble control, while the midrange control operated between 600 Hz and 5 kHz. As might be expected, the audible effect of these switches was very subtle.

Impedance was correctly rated at 6 ohms, which was the measured minimum impedance at 100 Hz and 1.3 kHz, and above 10 kHz. Impedance maxima were 30 ohms at 40 Hz and 22 ohms at 500 Hz. Speaker sensitivity, 89 dB at a 1-meter distance with a driving signal of 2.83 volts of random noise in an octave centered at 1 kHz, was relatively high for an acoustic-suspension speaker system.

Low-frequency distortion, at a 2.83-volt level (1 watt into 8 ohms) was very low in the midbass range: 0.13% at 100 Hz to 0.5% at 50 Hz, rising to 3.2% at 35 Hz and 6.3% at 30 Hz. A 10-dB power increase resulted in distortion readings ranging from 0.28% at 100 Hz to 0.89% at 50 Hz and to 6.3% at 35 Hz. The toneburst response was generally good, being relatively free of ringing and other distortions over the full range of the system and fairly independent of microphone positioning.

User Comment. The Mitsubishi MS-40 is a very fine system, with very low distortion and smooth, extended frequency response that is rare in loudspeakers. Listening to a pair of MS-40s for some time, we tried to identify a sound quality that would particularly characterize them, but never found any.

Because of their weight, we were not tempted to move the MS-40s around to judge the effect, if any, of their asymmetrical driver placement on the sound. We would expect it to be minimal at best, since the high-frequency/midrange driver axis is less than 2½" (63.5 mm) off the center axis of the front panel. In view of the emphasis Mitsubishi places on the flat, nonbeveled speaker board and flush-mounted drivers, it seemed strange to find the grille, with its wooden frame, supported in front of the speaker board so as

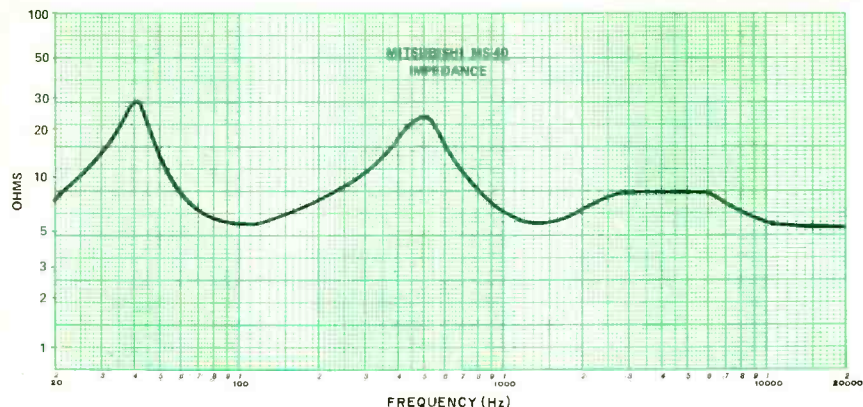

Impedance curve shows rated 6 ohms at 100 Hz and 1.3 kHz and above 10 kHz.

to place a $\frac{3}{4}$ " wide slot along each side of the speaker front. The effects of this, if any, were not audible to us, nor did we hear any change in sound with the grille in place and removed; but it does suggest that some of the other "steps" taken to

minimize diffraction may not have been entirely necessary.

We found the MS-40 to be a relatively uncolored speaker system, whose neutrality, though a virtue to a purist, might not appeal to a listener who prefers such pop-

ular colorations as a soft, heavy bass or sizzling highs. The low bass is certainly all there, but it is tightly controlled, and the treble is clear without being "tinkly."

We checked out the overload protection system with a moderate-powered amplifier (70 watts per channel) which, when driven beyond clipping, shut down both speaker systems. The acoustic levels were, at that point, well in excess of what was tolerable. Under reasonable conditions of drive, the system is capable of generous acoustic output. Sounds can be heard after the relay has operated, but they are weak and distorted. A push on the reset button on the rear of the cabinet restores normal operation, leaving the speaker system in good condition.

Our overall assessment of the Mitsubishi MS-40 is that it is a high-caliber speaker system with unusually low coloration and very good dynamic range. Its price seems reasonable in light of its performance both in our lab and under actual listening conditions.

CIRCLE NO. 102 ON FREE INFORMATION CARD

Audio-Technica Model AT-1010 tonearm features adjustable damping device

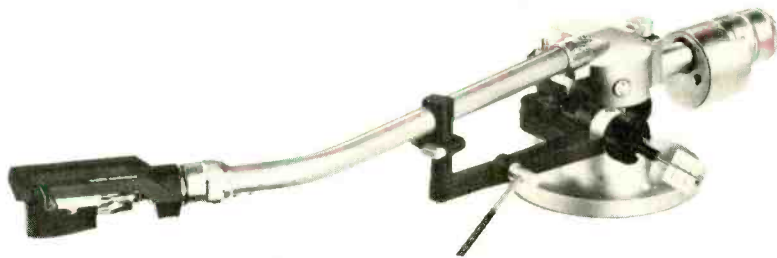

Designed to enable a cartridge to trace the most difficult recorded passages, the Audio-Technica AT-1010 tonearm is

free from many of the limitations normally imposed by interactions between cartridge and arm. One of its special features is an adjustable damping device for controlling the effect of low-frequency arm/cartridge resonance. The tonearm's shape and its relationship to the pivot axes are designed to minimize warp wow and frequency intermodulation (FIM) distortions that can be generated when record warps alter the normal tracking geometry.

A template simplifies locating the arm base relative to the center of the turntable. Other installation aids included are used

for setting stylus overhang for minimum tracking error and tilting the cartridge so that its stylus is perpendicular to the surface of the record. The headshell accepts almost any cartridge that has $\frac{1}{2}$ " (12.7-mm) mounting centers and weighs between 4 and 14 grams (14 to 24 grams for a cartridge mounted in its own headshell). The headshell is the standard 4-pin plugin type with locking ring. Suggested retail price is \$350.

General Description. The J-shaped aluminum tonearm tube is about $9\frac{1}{2}$ " (241.3 mm) long, from pivot to turntable center, and moves on precision ball bearings. Made of die-cast magnesium alloy, the MS-10 headshell has a rubber-covered top to damp out resonant modes. Position of the plug in the end of the shell can be

adjusted over a range of at least 3 mm, by loosening a setscrew, to permit setting stylus overhang.

Unlike most headshells, that of the MS-10 is not slotted. Instead, it has three pairs of tapped holes for the cartridge mounting screws. Normally, the center pair of holes is used, but if correct stylus position cannot be reached by adjusting plug position, one of the other sets of holes will make this possible.

The arm tube is located above the vertical pivots, to locate the stylus of a correctly installed cartridge in the plane of the pivots when playing a record. This minimizes warp wow and any change of vertical stylus angle that might occur when the pickup rides over a record warp.

The counterweight carries the tracking-force scale, calibrated from 0 to 2.5 grams at 0.1-gram intervals, and is threaded onto the rear extension of the arm tube. The rear of the arm tube is elastically isolated from the front portion. Hence, the suspended mass can supply antiresonant compensation for the main low-frequency resonance between total effective arm/cartridge mass and the compliance of the cantilever mount. A small knob on top of the arm pivot structure provides adjustable damping of the low-frequency resonance, apparently varying the stiffness of the elastic coupling between the two sections of the tube.

Extending to one side of the pivot is a balance weight that compensates for any lateral unbalance that might cause a side torque on the arm if the turntable is not leveled. Balance weight position is determined by total head shell and cartridge mass. Within the lateral balance weight is another "gyrobalance" weight that can be shifted vertically to alter the vertical swing

period of the arm. Its function is to minimize the up and down motion of the arm when playing warped records. As Audio-Technica points out, neither the lateral nor the gyrobalance would be needed, nor would they have any effect, if the turntable were level and the record were unwarped, but they serve a useful purpose in the more usual case where neither ideal condition exists.

Antiskating compensation is applied to the tonearm by a pivoted lever extending from the right side of the base. A weight on the lever can be set for elliptical, line-contact, or spherical stylus shapes, and the entire assembly rotates to set a number that matches the tracking force opposite an index mark. Angular position of the weight changes with arm location on the record. We assume that the operating principle of the Audio-Technica device is similar to the "weight-on-a-string" mechanisms used on other tonearms.

The arm-lift cueing lever, on a support that extends forward of the arm base, raises and lowers the tonearm with a very smooth, damped motion in both directions. The arm rest is built into the forward part of the support and includes a lock button to prevent the arm from being accidentally dislodged.

Although installing a tonearm on a motorboard is rarely easy, accessories supplied with the AT-1010 make this a relatively foolproof operation. A template

locates the base of the arm, which can be fastened to the motorboard with wood screws or bolts and nuts (both supplied). We suggest making the clearance hole for the arm post a little larger than the indicated 23 mm, since only a limited range of cartridge adjustment is possible when setting stylus overhang. Final arm position is set with the aid of a plastic gauge inserted into the socket in the end of the arm and located exactly over the turntable center spindle. Arm height is adjustable over a considerable range to accommodate almost any cartridge and turntable dimensions. When arm and headshell have been installed, the shell is rotated with the aid of another plastic gauge to make the stylus perpendicular to the record, as viewed from the front.

The signal cable assembly furnished with the AT-1010 has a plug that securely locks into a socket at the bottom of the arm post. At the free ends of the cable are high-quality gold-plated phono plugs. Audio-Technica points out that all wiring in the arm and cables is made of high-conductivity sterling silver, and all internal electrical contacts are gold-plated.

Laboratory Measurements. We installed the AT-1010 on a good-quality turntable, with an ADCOM XC-LT moving-coil cartridge in the headshell. We followed the instructions carefully and setup procedure went smoothly. Tracking force was set to

the 1.8 grams needed by the cartridge.

Tracking-force scale calibrations were accurate within 5% to 8% over the full range of adjustment, with a typical error of less than 0.1 gram. Rated at 1.5° maximum, the tracking error reached that value at radii of 3" and 6" (76.2 and 152.4 mm). More to the point, the error was always less than 0.5°/in. of radius and over much of the record was too small to measure.

Antiskating compensation had to be set to its maximum of 2.5 grams to give equal distortion in both channels when we operated the cartridge at a 1.8-gram vertical force. The setting is not critical, but like most antiskating systems this one should be set slightly higher than the tracking force. The cueing device worked with exceptional smoothness, partly because of the slight time delay between movement of the lever and first motion of the arm. It is impossible to move the arm suddenly with this system. However, there was a moderate outward drift during descent, caused by antiskating torque. About 14 seconds of a record was repeated each time the arm was raised and lowered with the cueing device.

Effective arm mass, less cartridge, was about 18 grams, which is an average figure for tonearms of conventional design. We measured the low-frequency arm/cartridge resonance with the adjustable damping set to minimum and maximum limits and observed no change in resonance

NEW!

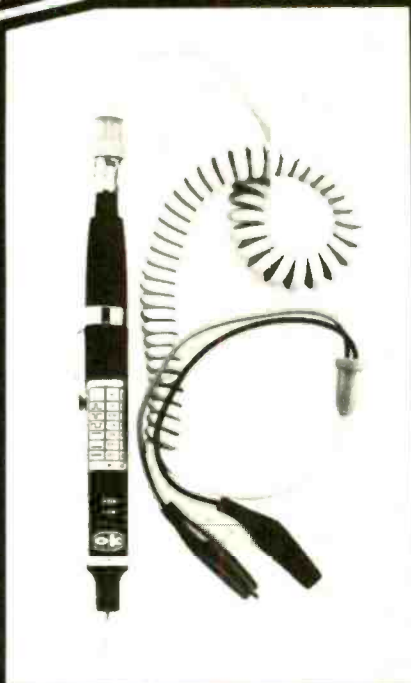

PRB-1 DIGITAL LOGIC PROBE

Compatible with DTL, TTL, CMOS, MOS and Microprocessors using a 4 to 15V power supply. Thresholds automatically programmed. Automatic resetting memory. No adjustment required. Visual indication of logic levels, using LED's to show high, low, bad level or open circuit logic and pulses. Highly sophisticated, shirt pocket portable (protective tip cap and removable coil cord).

\$36⁹⁵*

- DC to > 50 MHz
- 10 Nsec. pulse response
- 120 K Ω impedance
- Automatic pulse stretching to 50 Msec.
- Automatic resetting memory
- Open circuit detection
- Automatic threshold resetting
- Compatible with all logic families 4-15 VDC
- Range extended to 15-25 VDC with optional PA-1 adapter
- Supply O.V.P. to \pm 70 VDC
- No switches/no calibration

* ADD \$2.00 FOR SHIPPING
(N. Y. CITY AND STATE RESIDENTS ADD TAX)

○ **OK MACHINE & TOOL CORPORATION**

3455 Conner St., Bronx, N.Y. 10475 (212) 994-6600 / Telex 125091

CIRCLE NO. 41 ON FREE INFORMATION CARD

response, which was at about 9 Hz and had an amplitude of about 5 dB. Capacitance to ground in the arm and cable wiring was about 90 picofarads per channel, and the interchannel capacitance was a low 2 picofarads.

User Comment. If one were to judge the AT-1010 tonearm solely from the measurements we have described, there would appear to be little to distinguish it from most other arms, many of them less costly. The workmanship of the Audio-Technica arm is exemplary, but one chooses a tonearm for how effectively it permits records to be played, not merely for its styling or construction.

We played a number of records with the combination of the AT-1010 arm and the ADCOM cartridge, and they certainly sounded excellent. This was inconclusive, since the cartridge was also new to us, and undoubtedly had more to do with the final sound than did the arm.

Since the design of the AT-1010 places unusual emphasis on control of arm motion when playing warped records, and under the influence of the low-frequency arm/cartridge resonance, we concentrated on those performance aspects. The results of our tests were, to say the least, surprising and gratifying.

The variable damping control had no effect on the *measured* output in the vicinity of resonance or on visible displacement

of the arm or sound when we played our collection of badly warped records. The same comment applies to the adjustment of the lateral balance and gyrobalance weights, neither of which had any detectable effect on the system. (Of course, we carefully leveled our turntable before making our tests, which would account for the lack of measurable, visible, or audible effects. These features are built into the tonearm to deal with less-than-ideal conditions, as when the turntable is not level.)

We did not expect the tonearm to cope too effectively with our badly warped records, that in the past have tossed every combination with effective mass comparable to the AT-1010 and ADCOM completely off the disc. Most often, the AT-1010 behaved as though the warp was simply not present. It lifted to follow the warp, and seemed to cling to the record as it descended the trailing side. Usually, not even a "thump" was heard from the speakers. Clearly, the damping was highly effective, and the 9-Hz resonance frequency was close to the optimum for tracking most record warps. Warps we used ranged from a once per revolution with a 10-mm amplitude to shorter warps that imparted a quick but violent "jiggle" to the pickup.

To isolate as much as possible the properties of the arm from those of the cartridge, we substituted an Audio-Technica AT-25, a highly compliant cartridge in

its own headshell that tracks at 1 gram and could be expected to significantly lower arm resonance (we did not measure resonance with this cartridge). Results were almost identical, although there was more visible arm motion every time it passed a warp and an occasional backward skipping of one groove under the influence of the antiskating torque. However, no tonearm and cartridge combination with an effective mass of more than 20 grams had ever been able to play these records without groove jumping or an audible wow.

Our conclusion, then, is that the geometry of the AT-1010 arm—including the various balance devices, relationship of the stylus to the vertical pivot axis, and any damping supplied by the decoupled rear section of the arm—gives this tonearm an above-average ability to play difficult records. Although we were unable to detect any variation in the arm's performance over the full range of adjustment of these damping and control features, it is possible that under some circumstances they could have made a difference. In any case, it is reassuring to know that, even with random settings of most of its adjustments, and with cartridges of high or low compliance, the AT-1010 can give superior tracking of less-than-perfect records. This arm's price carries with it a corresponding level of performance.

CIRCLE NO. 103 ON FREE INFORMATION CARD

THE BIG PLUS + Graphic Equalizer

ASSEMBLED
\$200

KIT
\$120

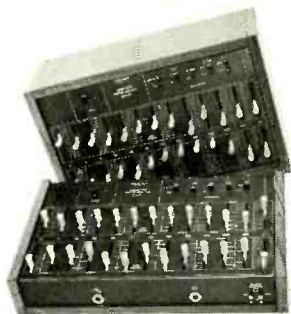

LOADED with Quality Features!

- Stereo . . . Eleven Bands Per Channel • Extremely Low Noise & Distortion • LED Peak Indicators • Center Detent ("flat") sliders • Built-in "record" Switching • Line and Microphone Level Inputs/Outputs • Regulated Power Supply • Fully Guaranteed • Horizontal or Vertical Cabinets • Kit or Fully Assembled • Plus Much, Much More!

Absolutely equals or exceeds overall performance and features of any graphic equalizer made today!

AARON-GAVIN INSTRUMENTS, INC.

17231 Corla Avenue Tustin, California 92680

Yes! I've enclosed \$_____, RUSH me: assembled equalizers at \$200.00 p.p.d. cabinet send brochure
 unassembled equalizer kits at \$120.00 p.p.d. Horizontal (flat) Vertical (up-right)
 California residents include 6% sales tax
 Name _____ Visa & Master Charge orders accepted
 Address _____ Card No. _____
 City _____ State _____ Zip _____ Date _____ Bank _____
 No. _____

Dealer inquiries invited

CIRCLE NO. 2 ON FREE INFORMATION CARD

YOU CAN TAKE IT WITH YOU!

Quality Sound takes
to the road . . . the sky . . .
and the ocean!



MK I & IIB

DIMENSION LAB SERIES

We wrote the book on miniature speakers, from Design to Production! Our five models speak for themselves in total performance, styling, and features that are found in no other speakers . . . such as, Solid Walnut Cabinetry, full 12 db cross-over network, a specially designed cone with our exclusive rubber surround, and a deep throw speaker basket. These are just a few of the reasons why our Bass is unequaled in the industry. "Dimension Minis" are Proven best by listening test."

Come in for a demonstration and judge for yourself.

See and Hear the New Dimension in Sound at
Your Local Stereo Dealer.

DIMENSION

819 S. Kraemer • Placentia, CA 92670
(714) 630-5440

Representative and Dealer Inquiries Welcome



CIRCLE NO. 15 ON FREE INFORMATION CARD

PRODUCT GALLERY

A. MIX-IN! This new Salton Drink Mixer gives you the latitude of a bartender or soda fountain specialist. It means business with a high speed commercial quality motor. Very simple and safe. Operates on AC. #51549 \$19.95 (2.65)†

B. SHEEPSKIN THROW for your car seat. Choose beige or dark brown plush. Each measures approximately 27" x 40", has straps and loops to keep it from slipping. Beige #51561 \$49.95 (3.50) Brown Plush #51557 \$49.95 (3.50)

C. MUSICAL CHRONOGRAPH plays "Oh, Susannah" when you set the alarm. It's a watch, a stopwatch, a calendar and an alarm. Chimes every hour on the hour if you wish. Shows time, date and features a 6 digit stopwatch function. By Marcel. LCD display, dial light. #51568 \$79.95 (2.40)†

D. COMPRESSOR PUMP. Could be quite a lifesaver if you have a low tire, or it could be a breath-saver for inflatable boats, toys, pools, etc. All packed inside a molded plastic carrying case. Features include a pressure gauge for accurate air filling. Just plug it into your car lighter! #45094 \$49.95 (3.05)†

E. SAFETY COMBINATION. A smoke and burglar alarm in one portable unit. Just hang the unit over the door, and activate the on/off switch. Separate alarms distinguish smoke from intrusion. Low battery signal, loud 85 decibel horn. 4" x 3" x 6". By Wells Fargo. #45092 \$39.95 (1.95)†

F. CAR VACUUM plugs into the cigarette lighter of your car. From that point you'll be able to reach front and back seats and floors! The unit is 17½" long and the set includes 3 attachments. #51555 \$21.95 (3.30)†

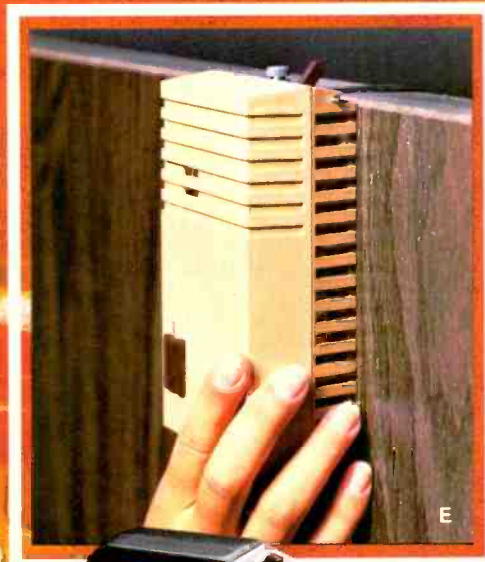

PRODUCT GALLERY Call Toll Free 800-558-8990

Order by phone!

SEND ORDERS TO:
 Giftmaster Dept. ZE 40
 P.O. Box 1692
 3825 W. Green Tree Rd.
 Milwaukee, WI 53201

Allow 3-4 weeks for delivery.

ITEM NO.	QTY.	UNIT COST	SHIPPING & HANDLING	TOTAL

CHECK METHOD OF PAYMENT
 Check or Money Order
 Diners Club Master Charge
 American Express Visa

Make check payable to Giftmaster, Inc.
 Credit card orders without your signature and expiration date cannot be processed.

Credit Card No. _____ Exp. Date _____
 Telephone No. () _____
 Signature _____

Sub Total \$ _____
 Add appropriate state sales tax. _____
TOTAL \$ _____

ZE 40

() Price in parenthesis indicates shipping charge. Please add to unit cost of item.

†Warranty available

no loose ends

Computer, floppy, smart terminal, 16K RAM. \$1595*



H89 All-In-One Computer

Heath takes the risk out of selecting a balanced computer system. Now, video terminal, floppy, keyboard and 8-bit computer are brought together in one self-contained, compact unit. Nothing hangs out.

Two Z80's

The personal computer has never been simpler. Or smarter. Two Z80 microprocessors mean terminal never shares power with computer, as do most desk-top units. So this terminal is capable of a multitude of high-speed functions, all controllable by keyboard or software.

100K bytes storage

Built-in floppy disk system gives you fast access to programs and data. Each 5¼-inch diskette has 100K bytes of storage area, enough to hold entire files. The All-In-One comes with 16K RAM, expandable to 48K.

Innovative software

The All-In-One Computer runs programs written in MICROSOFT™ BASIC™ and Assembly Languages. And it accepts all current software written for the popular Heathkit H8 Computer, including scores of practical programs for home and business.

Learn by building

What better way to learn about computers than to build one yourself? Like all Heath electronic kits, it comes to you with its own easy-to-follow assembly manual and a nationwide network of service centers to assure smooth sailing.

FREE CATALOG



Complete details on Heathkit Computers and nearly 400 other Heath electronic kits for your home, work or pleasure are in the new Heathkit Catalog. Send for yours today or pick one up at your Heathkit Electronic Center.

*\$1195 without floppy. Mail order kit price, F.O.B. Benton Harbor, MI. Heathkit Products are also sold and serviced at Heathkit Electronic Centers (Units of Veritechnology Electronics Corporation) in major cities throughout the U.S. See your white pages. Prices subject to change without notice.

Heathkit®

HEATH COMPANY, DEPT. 010-644, BENTON HARBOR, MI 49022

CIRCLE NO. 25 ON FREE INFORMATION CARD

www.americanradiohistory.com

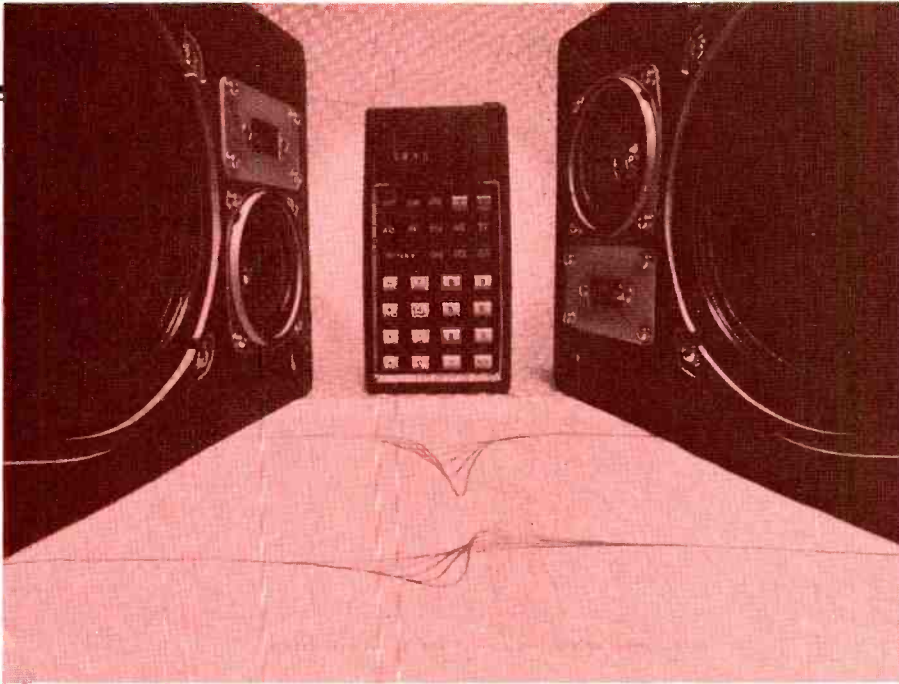

Focus On

LOUDSPEAKERS

● Enveloping audio transducers in an air of mystery seems almost a time-honored tradition. Loudspeakers, phono cartridges, and, to a lesser extent, microphones are often viewed as though their selection and use involved some kind of ineffable magic not to be understood by mortals or—worse—quantified.

Loudspeakers, are the most mysterious of the lot, for while measurements are dutifully made and data published, meaningful correlation between these and the sound of the product seem most notably absent. Though the idea may horrify some, it is not unreasonable to select, say, a power amplifier on the basis of its specs. But only a devoted optimist would buy a loudspeaker that way.

The first two articles of this Focus are aimed at applying some science to the loudspeaker conundrum, hoping to find out how the present situation came about and how it may be altered in the future. Two highly qualified authors discuss, each in the light of his own expertise and point of view, the problems of quantifying and predicting the audible performance of loudspeakers. Neither has fully resolved matters; in fact, while each does provide some answers, new questions seem far more numerous. Both point out, however, some interesting directions for exploration.

Part III of this section is a construction project for a three-way electronic crossover.—*Harold A. Rodgers, Executive Editor*

The Conflict Between Sound and Specs

BY DANIEL QUEEN

Daniel Queen Associates, Chicago, IL

I. The Objective View

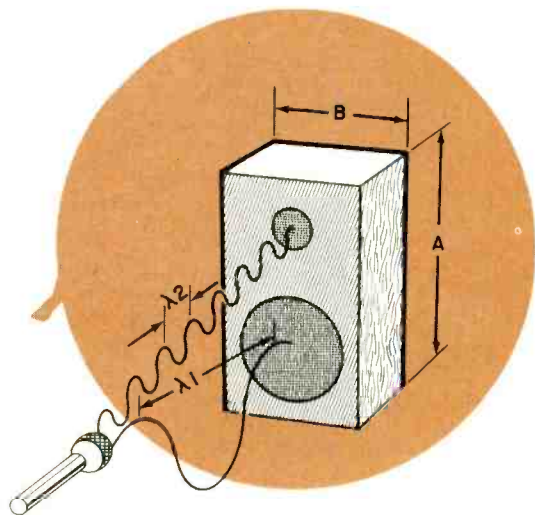

Fig. 1. The microphone is in the far field for the short-wavelength (λ_2) radiation of the tweeter. But when λ_1 , the wavelength of the woofer radiation is comparable with cabinet dimensions A and B, the microphone is in the near field. Balance between the drivers can be falsified by such microphone placement.

RARELY can the audible performance of a loudspeaker be accurately deduced from its published specifications or any of the measurements customarily made. Normally any correlation between the two appears more accidental than otherwise. It seems ironic, therefore, that controversy surrounds a point as abstruse as amplifier slew rate when seemingly elementary matters of measuring frequency response and distortion in loudspeakers are far from settled.

One way to measure the effective performance of a loudspeaker would be to place the microphones in the ears of a listener. But what listener? And in what listening room? Such questions make a loudspeaker more difficult to measure than an amplifier, recorder, or even a turntable and phono cartridge. In fact, the loudspeaker measurement encompasses most of the problems of those components and several more.

Frequency Response. A loudspeaker is analogous to an antenna. In fact, the laws defining the radiation patterns of the two are virtually identical. Nevertheless, the loudspeaker, for several reasons, is the more complex device.

While an antenna radiates a narrow band of frequencies into a fairly well-defined space, a loudspeaker must radiate any frequency in a 10-octave band into a room that may have one of a myriad of shapes and sizes. An antenna equivalent to a loudspeaker would be designed to operate on any tower with constant gain from 1.0 MHz to 1.0 GHz—i.e., broadcast to microwave—without varying its coverage pattern.

Obviously, then, the on-axis data usually given by manufacturers are only expedient simplifications. At best, they are useful only to compare loudspeakers for production quality control; at worst, they can seriously mislead the prospective buyer. To come even close to characterizing a speaker, a great many more measurements are needed.

To measure any one quantity, or variable, it is necessary to concentrate on it alone, holding all others constant. Those held constant are called parameters. In an electrical measurement, parameters may include characteristics such as supply voltage, ambient temperature and humidity, and load impedance. Parameters of loudspeaker measurement, in addition to these, include boundary conditions, positions of the speaker and sensing device, measurement time, and even the size and shape of the sensing device.

Traditional practice has minimized boundary conditions by measuring in an anechoic chamber. In such an environment, reflections are of negligible amplitude. Next, on the assumption that listeners will place themselves on the central axis of the loudspeaker, an on-axis microphone position is chosen. Such conditions should yield measurements which can be reproduced at many different facilities and which, though limited in the information they provide, can be applied to any loudspeaker.

However, the next assumption is that a single measuring distance may be used—usually three meters (or 10 ft. in some U.S. specifications) from the face of the loudspeaker. In the often published EIA sensitivity specification, the measurement at this distance is then extrapolated to 30 feet. Implicit in this extrapolation is

both the realization and the disregard by the writers of the EIA standard that three meters is not in the "far field" of a loudspeaker whose dimensions are appreciable fractions of that distance. Thus, another parameter is introduced: the size of the loudspeaker. To properly understand its importance, we must first examine another concept.

Sound Fields. There are three ways to look at the sound fields in the path from a loudspeaker to a listener. The first depends on the loudspeaker and listener themselves and the second on the environment (boundary conditions) in which they are placed. The loudspeaker and listener have a *near field* and a *far field*. The size of these fields as a function of distance increases with wavelength. (See Fig. 1.) At any one frequency and in one direction from the source, it can be determined whether one is in the near or the far field. In the absence of reflections, output will change inconsistently with increasing distance in the near field, whereas in the far field it will drop 6 dB per doubling of distance (more precisely, 20 dB for a tenfold increase). Thus, the disregarded assumption in the EIA specification is that a near-field measurement of a loudspeaker can be extrapolated to the far field.

The second way to describe sound fields is in terms of the environment in which the loudspeaker and listener are placed. Three fields are generated: the direct, the early-reflected, and the late-reflected fields. The direct field is formed of rays directly from the speaker that the listener intercepts (or might intercept) before they are reflected. This is the only field present in a perfect anechoic chamber. The early and late reflected fields are defined in relation to characteristics of human hearing. A reflection arriving late enough to be heard as distinct echo is described as late; if early enough to seem fused with the direct sound, it is described as early. (See Fig. 2)

A third set of fields—the spatial fields—is also defined by the boundary conditions. They are categorized by the segment of a sphere through which sound can radiate from (or towards) the device under measurement. Mounted in the center of an ideal anechoic chamber, it radiates into a free field, 4π - or full-space. A speaker set in an infinite wall radiates into 2π - or half-space; at a wall-floor intersection it works into π - or *quarter-space*; in a corner, it would radiate into eighth-space. This is shown in Fig. 3. If there are an infinite number of reflections from random directions, it radiates into a perfect reverberant-field, full-space. Like the near field, the spatial fields are also functions of wavelength and radiator size.

What Measurements to Use. "Anechoic" free-field measurement is based on the idea that only the direct-field is of importance in listening. In contrast, the method of frequency-response measurement called "power response", made in a true or calculated reverberant field, assumes that only the reflected sound is important. It also does not differentiate between the early and late-reflection fields. But a measurement system should be based on correspondence to the actual listening situation. Are we sensitive to direct sound, early sound, or late sound? Do we listen to a loud-

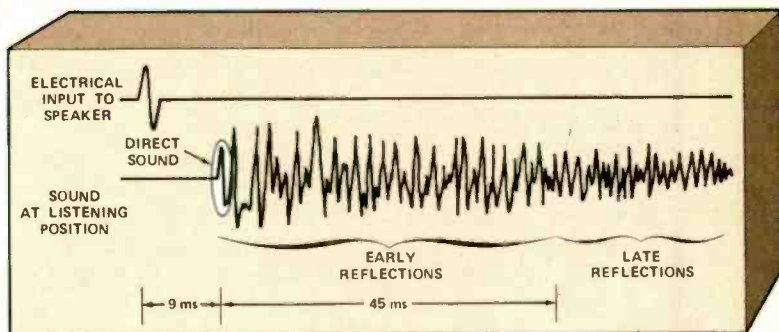

Fig. 2. A single-cycle input to a speaker in a normally "live" room produces a drawn-out train of impulses as numerous room reflections reach the measuring microphone.

speaker in its near field or its far field? In a half-space or full-space? Unfortunately, the answer is: all of the above. Although acoustical scientists differ as to relative importance of these fields, they agree that the listening experience involves them all.

There is no question that much of the directional information of the loudspeaker comes from its direct field and early reflections. In living-room size listening spaces, it is also possible that much of the perceived spectral balance of the loudspeaker comes from the direct field and the early sound that dominate such a room to the relative exclusion of late sound. On the other hand, in a large space, there is a great deal of late sound and relatively few early reflections. Thus, a loudspeaker which sounds pleasant in a small room

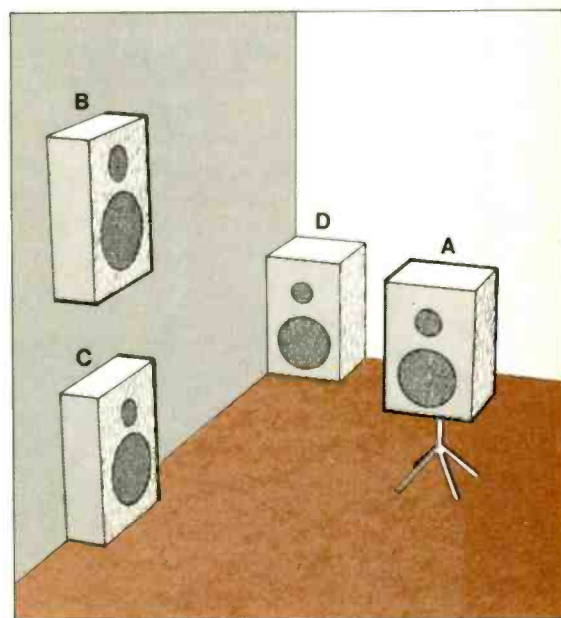

Fig. 3. Spatial fields of a loudspeaker. Loudspeaker A radiates into full-space, B into half-space, C into quarter-space, and D into eighth-space. These designations are approximate in that the dimensions of the drivers are ignored. In a practical case, D, for example, may have its response altered by positioning of the woofer in eighth-space, while the tweeter (because of its dimensions) is in full-space.

may be very poor in an auditorium, and vice versa.

In regard to distance, a very small loudspeaker system would almost always be listened to in the far field. However, larger systems may actually be intended to be heard in the near field. This would certainly be true of large planar or panel-type speakers used in small rooms. Thus, by juggling all these parameters, one can generate a plethora of efficiency and frequency-response data for a loudspeaker. A manufacturer could possibly be tempted to publish the best curve he dared and adjust measuring parameters to produce that curve. However, a more useful approach would be to base the choice of parameters on the design of the speaker and the intended listening conditions.

Distortion. Distortion products are generally unwanted frequencies elicited in response to a test signal. If one regards the task of quantifying them as a special type of frequency response measurement, the problems are at once apparent. All of the difficulties already mentioned apply, along with a few more that can cause distortion products to be temporally or spatially displaced with respect to the test signal. Worse yet, some, like turbulence noise in a bass vent, contain many incoherent frequencies so that there are few clues as to where to look for them in the spectrum.

Time delay is representative of distortion that is position-sensitive. A loudspeaker can have its drivers fixed on a panel with respect to one another so that the time of sound arrival is constant with frequency at an on-axis position. Yet there may be serious time errors as one moves to either side. Similarly, frequency modulation (FM) distortion, which occurs when a driver radiating a high frequency is moved back and forth by a low frequency and thus varies the high frequency by Doppler effect, can be substantial on-axis but less off-axis. If the listener receives a large amount of early sound reflected from all directions toward which the loudspeaker radiates, on-axis measurement of FM may not match the real listening conditions.

Distortion arising from cone motion causes another problem. Frequency response is usually measured at small signal levels. However, the loudspeaker must radiate large signals too. A good frequency response for small signals may deteriorate as power increases, or distortion may rise to the point where the

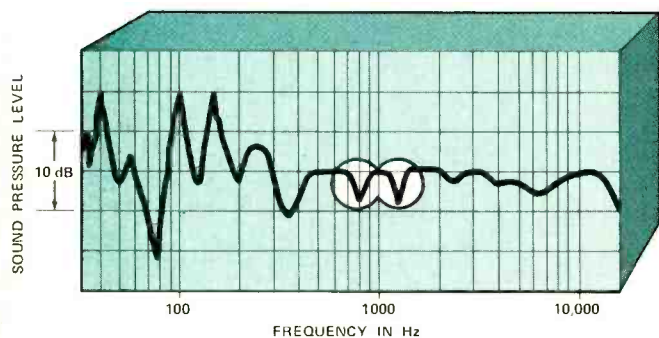

Fig. 4. Human hearing is rather tolerant of frequency-response variations at low frequencies and might often let peaks and dips below 200 Hz pass unnoticed. Smaller dips (unshaded area) in the midrange would be far more disturbing.

response at some frequencies is no longer useful.

Perhaps the nondirectionality of bass frequencies will free us of positional problems—but is such output really nondirectional? Certainly, if we attach a tire pump to the room and increase the static pressure, the pressure will equalize quickly throughout the room. That would be the dc, 0 hertz, or infinite wavelength condition. But as wavelengths approach finite size, directional effects occur. The question is: the finite size of what? The cone . . . the baffle . . . the wall behind? Again, the answer is all of the above.

Often, the bass characteristics of a loudspeaker are measured in the near-field. It can be shown that where wavelengths are substantially larger than the dimensions of the speaker in the cabinet, the near-field and far-field response are essentially equivalent. However, a microphone in the near field of a woofer must be very close to the cone. The limitation to very small cone excursions as a result of this positioning rules out measuring the large-signal properties of the loudspeaker. Furthermore, radiation from a vent or spurious emissions from the cabinet walls will not be included in the measurement. It becomes necessary to make measurements of all of these sources, both in amplitude and phase, and then to mathematically calculate the total radiated power. This is particularly complicated when the near-field technique is used to measure distortion. If the microphone is far enough from the cone to allow full excursion at the fundamental frequency, it may be in far field for the distortion products, which have smaller wavelengths. Differences in the distortion from vents or cabinet sides will also become difficult or tedious to calculate.

The Test Signal. Once a satisfactory set of testing parameters has been decided upon, it is necessary to make a choice of input signal. This is a critical matter, for a poorly chosen test signal can make interpretation of the results difficult or impossible.

For example, if a frequency-response test is made in a free-field environment, a swept sine wave is an adequate test signal. However, in a reverberant field, a sinusoidal signal would superimpose the standing waves of the room on the speaker response. A warble tone or broadband noise signal would overcome this difficulty; but, as both of these signals vary with time, averaging is required. Not only will it be necessary to decide upon the details of the averaging (time constant, etc.), but also the bandwidth covered by the warble or the noise. The goal is to smooth out variations contributed by the room while preserving the salient features of the loudspeaker.

Most reverberant-field responses, such as those called power responses, are made with long averaging times in one-third octave bands. The rationale is that third-octave bands are close to what is called critical bands of masking. These are interpreted as the bandwidth of noise in which an equal-power pure tone would be just detectable by a human listener. Unfortunately, critical bands have been shown to be considerably narrower than third-octave bands particularly in the region where hearing is most sensitive (roughly 800 Hz to 5 kHz). To make measurements that would accurately reflect variations in the narrowest critical bands, it

would be necessary to use one-tenth octave noise bands. Figure 4 shows that, while fairly large variations in the upper bass frequencies may pass undetected, our hearing is very intolerant of variations in the 800-to-5000-Hz range.

Similarly, any analysis of absolute phase and time differences—or any other variables—must be related to the detectability of these variations by human ears in the listening room. The analysis must indicate how this detectability will vary with the positions of the listener and loudspeaker in the room.

The Input Side. So far, we have only discussed the speaker's output, but interface with an amplifier is also a necessity. The usual measure of this interface is the loudspeaker impedance, which is often cited as a single figure. However, it is well-known that this impedance varies substantially with frequency and, more important, becomes more or less reactive. Thus, an amplifier may be confronted with a resistive load at some portions of the range and almost purely reactive loads over other portions. Depending on the amplifier design, such variations may cause such ills as pre-

ture clipping, distortion, and instability. It is possible, therefore, that a loudspeaker will sound excellent with one amplifier and raucus with another not capable of withstanding severe impedance variations. A complete impedance curve, then, would show not only the magnitude of the impedance but its phase as well.

In Conclusion. It might be tempting to conclude that quantitative specification of loudspeaker performance is virtually impossible, but the truth is that the process is merely very difficult. Most manufacturers' literature has little significance. Nevertheless, many of the shortcomings of these data are known and can be overcome. As measurements now being made in loudspeaker development laboratories are correlated with subjective responses, the relations between these hitherto mutually exclusive domains are becoming better known. Thus, the correct parameters for loudspeaker measurement will gradually become known and reflected in standardized measurements. Given this, it will eventually become possible to publish specifications that indeed indicate the subjective quality of a loudspeaker system. ♦

II. BY ROBERT BERKOVITZ Teledyne Acoustic Research, Norwood, MA

The Subjective View

FOR MOST listeners, high-fidelity music reproduction means duplicating the sensation of being at an actual performance. This is usually what we remember about the first time we heard high-fidelity equipment: realism. But realism cannot be measured; it is subjective, inside the listener. It is the feeling that the experience we are having corresponds to another, earlier experience that is being duplicated.

Sooner or later, most seekers after high-fidelity music reproduction discover that different loudspeakers of reputable manufacturers reproduce what should be the same sounds quite differently. Some decide to judge which is the best to buy by listening and comparing the realism of one speaker system to that of another. Others equate realism with accuracy—that is, objectively measurable fidelity—and try to choose the loudspeaker they are going to buy by comparing published specifications, which means, most often, frequency response.

Anyone trying to make a purchasing decision on the basis of manufacturers' published specifications needs a good sense of humor. One speaker system, listed at \$7000, is said to have a frequency response from 25 to 18,000 Hz, ± 2 dB. These are good specs, but a darned high price. And how about one that goes from 26 to 25,000 Hz, ± 2 dB, and costs only \$150? Another spans 27 to 25,000 Hz, no dB, for \$149; you save a dollar over the closest competition, but lose a hertz and get no dB. Yet another, for \$2200, responds from 13 to 52,000 Hz—that's right, 52,000. How can they do it for so much less than \$7000? Probably by leaving out the number of plus or minus dB.

Measurements vs Reality. Listeners want specifications, and so they get them—the best that manufacturers can provide. But do frequency-response measurements have anything to do with the way in which loudspeaker systems are used by their owners? To measure the frequency response of a loudspeaker, it is fed an electric signal containing all audible frequencies in exactly equal amounts. A microphone picks up the output of the loudspeaker and delivers a corresponding electric signal to measuring equipment. If the loudspeaker reproduces signals accurately, then the measuring equipment will show equal levels at all audible frequencies. At least, that is the idea expressed in its simplest form.

Even without much technical understanding, one soon notices that frequency-response data from manufacturers is always quite impressive. Lower-priced speaker systems show a little less bass or treble than higher-priced units, but still seem nearly perfect. If these published data are correct, all loudspeakers should sound alike. Why don't they?

Without a doubt, engineers learn a great deal about

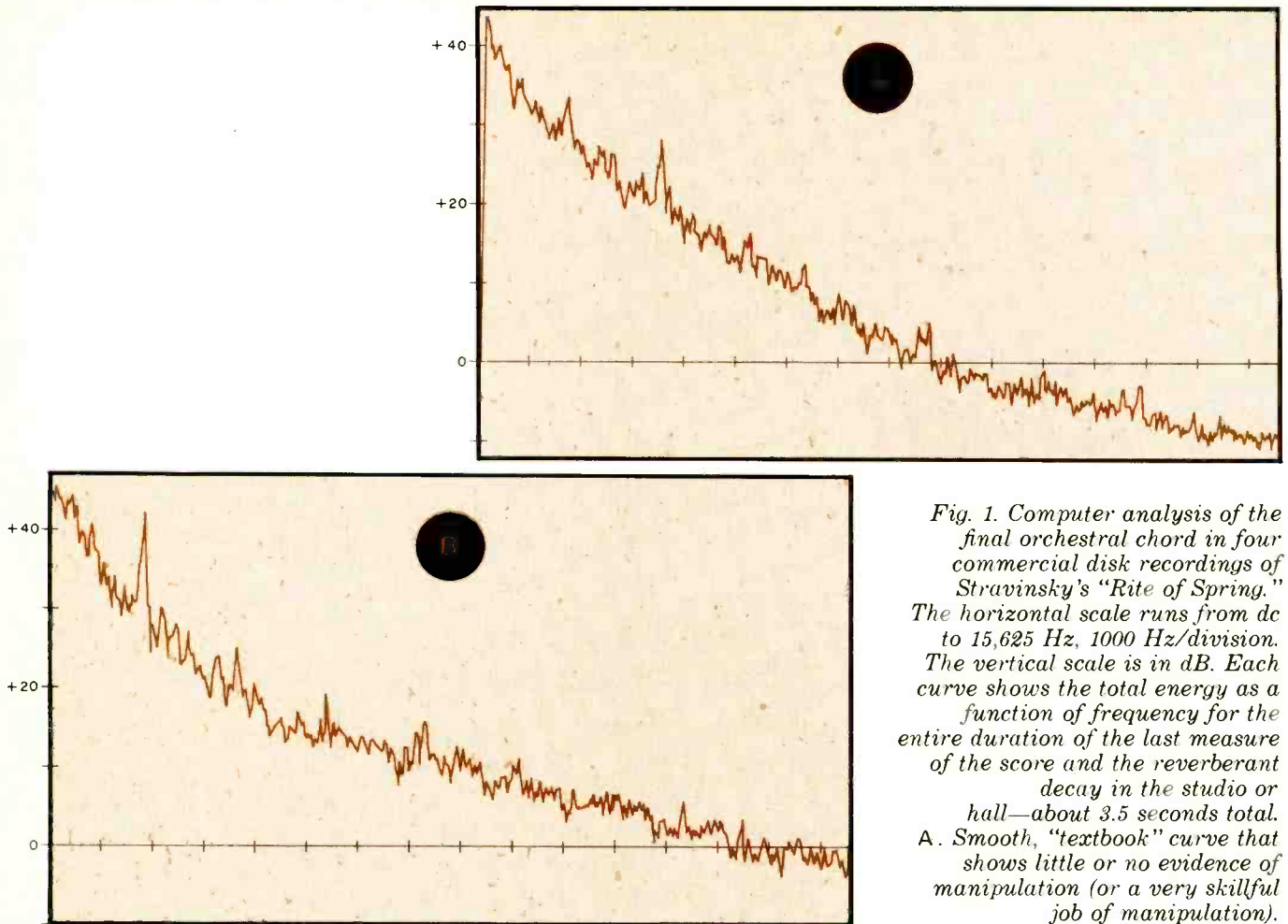

Fig. 1. Computer analysis of the final orchestral chord in four commercial disk recordings of Stravinsky's "Rite of Spring." The horizontal scale runs from dc to 15,625 Hz, 1000 Hz/division. The vertical scale is in dB. Each curve shows the total energy as a function of frequency for the entire duration of the last measure of the score and the reverberant decay in the studio or hall—about 3.5 seconds total. A. Smooth, "textbook" curve that shows little or no evidence of manipulation (or a very skillful job of manipulation).

loudspeakers by measuring them during development. But typical engineering data tell listeners very little about how a loudspeaker is likely to sound. Here is a partial list of reasons:

1. Frequency-response measurements are usually made with a microphone directly in front of and one meter away from the loudspeaker. With this positioning it is often possible for even a small movement of the microphone to affect the frequency-response curve. Listeners normally are much farther away and, because of stereo placement, at an angle of at least 15 to 20 degrees to the speaker's center line.

2. Measurements are made on single speakers despite the fact that they are used in pairs. Driver layout and cabinet shape can make listening to two speakers different from listening to one.

3. Human ears, unlike test microphones, are not omnidirectional. Causing various frequencies to arrive at the listener's head from different directions will make loudspeakers sound different, but the microphone will not notice.

4. Listeners, because they have two ears, can analyze sounds and extract information that test microphones cannot detect—the direction from which a sound seems to come and the distance and apparent size of its source.

5. Some frequency-response measurements are made in typical listening rooms or special reverberant

rooms that integrate the sound power radiated by the loudspeaker in all directions. Such measurements "homogenize" the direct and reverberant sound reaching the microphone, losing a distinction that materially affects listening quality.

6. Engineering measurements made in typical test chambers fail to indicate the effects of interaction between a speaker system and the room in which it will be used. These include interference by sound reflected from the wall behind the speaker and the influence of side-wall, floor and ceiling reflections on the size of the sonic image.

The list can be extended, but it is long enough to make this point: engineers spend much of their time and effort measuring the *loudspeaker*, while listeners are most interested in the *sound field* created by the loudspeaker under typical listening conditions. Manufacturers' frequency-response measurements can be quite correct without telling much about how a loudspeaker will sound. Moreover, it is probably impossible to find out how a loudspeaker will sound on an objective, scientific basis, using the types of measurement—computerized or not—upon which almost all manufacturers depend. Indeed, most computer-made loudspeaker measurements reveal nothing that engineers are unable to learn with conventional analog equipment. They simply provide the same data more quickly, conveniently, or elegantly.

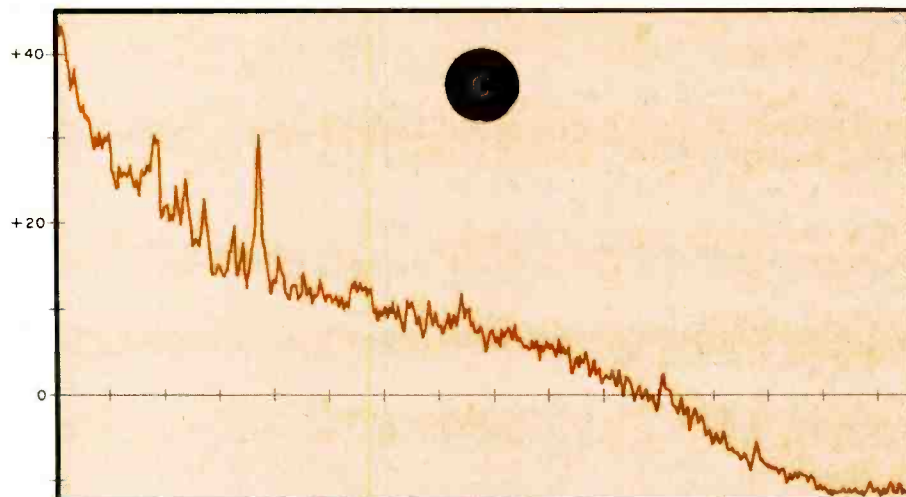

B. Smooth curve showing evidence of high-frequency boost. Relative level at 10,000 Hz is about 10 dB higher than in A. Curve apparently breaks at about 5500 Hz.

C. Odd shape appears to be result of substantial high-frequency boost between 5000 and 12,000 Hz. Steep descent at low frequencies implies some bass boost.

D. Remarkable spectrum shows strong, precisely spaced brass instrument overtones and a surprising amount of high-frequency emphasis compared to other recordings. Alignment with other curves at low frequencies shows about 20-dB boost at 15,000 Hz.

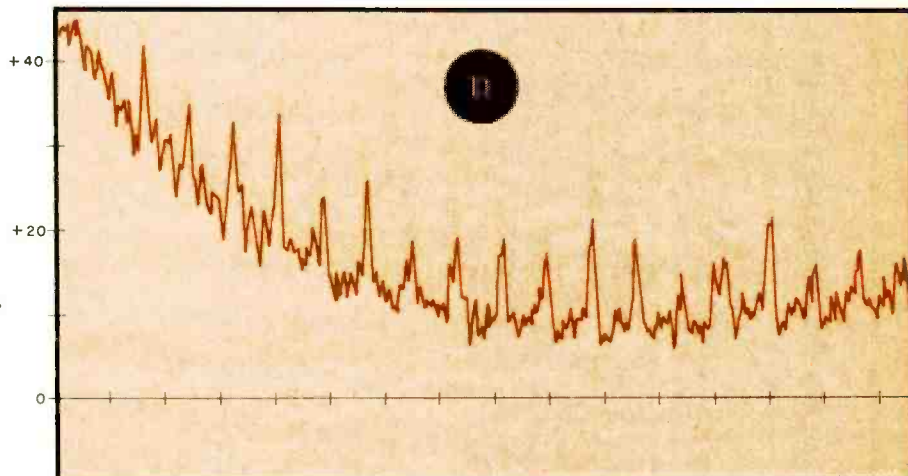

A "Thought Experiment." If objective measurements cannot tell which loudspeaker is nearest to perfection, can listening tests give the answer? Before taking up this question, let's try to define the problem in a simple, scientific way.

Suppose that we had a *perfect* high-fidelity system. How would we know? We could set up microphones in our listening room and play a recording; while we played it, we would re-record it. Then we would compare the original recording with our recording of the recording. If we could hear absolutely no difference between the two recordings, we would have to conclude that our high-fidelity system was perfect. One problem remains. Where do we get the recording with which to begin?

Let's change the rules a bit to see if we can come closer to a practical answer, at least in our imaginary laboratory. Suppose that a soundproof wall is built across the middle of a large room, and a hole the size of a loudspeaker system is cut through it. We place musicians on one side of the wall and a listener on the other. When the musicians play, the purest high-fidelity sound—the real thing—comes through the hole and the listener hears it. Two holes can be used for stereo. Next, we put a speaker system into the hole, closing it, and connect a microphone, facing the musicians, through an amplifier to the loudspeaker, which faces the listener. The reproduction is perfect when the lis-

tener cannot tell the difference between the loudspeaker and the hole in the wall.

This is as far as the analogy is usually taken, but let's go one step further. Suppose we dismiss the musicians and substitute a recording made when the microphone was in place, played through the same kind of loudspeaker as we have mounted in the wall. Now the listener has to tell whether the loudspeaker is reproducing itself or live music. Would it work?

Probably not. We might come close, but there would be no way to tell how close. The problem concerns the size of the hole in the wall and the size of the microphone. Since the microphone is only about an inch in diameter, it picks up only a tiny sample of the sound field produced by the musicians or the loudspeaker. In fact, the sample is so restricted that it tells us nothing about the direction from which various frequencies arrive or where they go next. The sound level at one point in space is all that the microphone can relate to us. Unfortunately, the sound field on the other side of the wall is far too complicated for accurate representation by such a tiny sample.

Radiation from the loudspeaker develops in a complete, three-dimensional pattern, some frequencies in one direction and other frequencies all around, some mainly to the right and left and others only forward, but none of this has anything to do with the original sound. The directional information can't be coming from the

microphone; the loudspeaker just makes it all up! Unless the radiation pattern of the loudspeaker exactly matches that of the source, we will never be able to carry out our experiment successfully.

Why Does High Fidelity Work? After all this, it must be said that *some* recordings, played through *some* loudspeakers, sound realistic enough to make one's hair stand on end. If measurements are not going to give us the answer and tell us which speaker system is most accurate, we may have to go back to subjective listening comparisons, using good high-fidelity recordings. But we are assuming that recordings can be made accurately just as we assumed, at first, that loudspeakers can be measured accurately. A recording can be considered a measurement of a performance. How do the people who make a commercial recording know when it is accurate . . . or inaccurate? Simply: they listen to the master tape through loudspeakers and change the frequency response of the recording until they think it *sounds* right.

Without information about the record we are playing, there is no way to know how a loudspeaker should sound. The kind of information we want is hardly likely to be printed on album covers; but, with a little time and skill, we can let a computer analyze the frequency content of different recordings and compare them to each other, if not to an absolute standard. The results, shown in Fig. 1, will not encourage perfectionists, but they do indicate the danger of assuming that one's favorite "test record" can be a reliable index of objective loudspeaker performance.

Measuring the sound produced by musical instruments is no easier than measuring the sound coming from a loudspeaker. So many factors other than uniform frequency response enter into a listener's judgment of the realism of the result that the producer in the recording studio, even with access to the most elaborate and expensive apparatus, must rely on manipula-

tion to obtain a result he finds acceptable. Yet some of the manipulations on records are undoubtedly unacceptable to many serious music listeners. Perhaps more could be accomplished by improved microphone design or more careful positioning of microphones at recording sessions. Until better understanding of some of the objective problems of music recording and reproduction is achieved, however, equalization is likely to remain the most economical yet powerful tool the producer can use to adjust the sound of a recording.

Spatial Hearing and Cross-Correlation. The solution to the loudspeaker puzzle probably does not lie in improving existing methods of measurement, but rather in devising new, more meaningful ways of obtaining and interpreting data about loudspeakers. Given a good loudspeaker to begin with, the listener who is so inclined can easily manipulate its frequency response with tone controls or an equalizer. What is much harder to change—and may be the invariant property that gives a loudspeaker system its acoustic identity—is the way in which its three-dimensional radiation pattern interacts with the listener's auditory system. We need a better understanding of those properties of a loudspeaker's radiation that are used by a listener's brain to tell something about the size, shape, distance and direction of the sound being reproduced.

The human hearing system locates the direction of a source of sound in several ways. One is by estimating the time interval between the arrival of a sound at one ear and its arrival at the other ear. Nobody knows exactly how this is done in the brain, but one widely believed idea is that the process involves something called a "correlation matrix"—a web of nerves interconnected in such a way as to continuously monitor the incoming energy at each frequency for matching variations in level. As proposed by Jeffress and Licklider, distinguished researchers in this field who independently suggested ways such a system might work, the

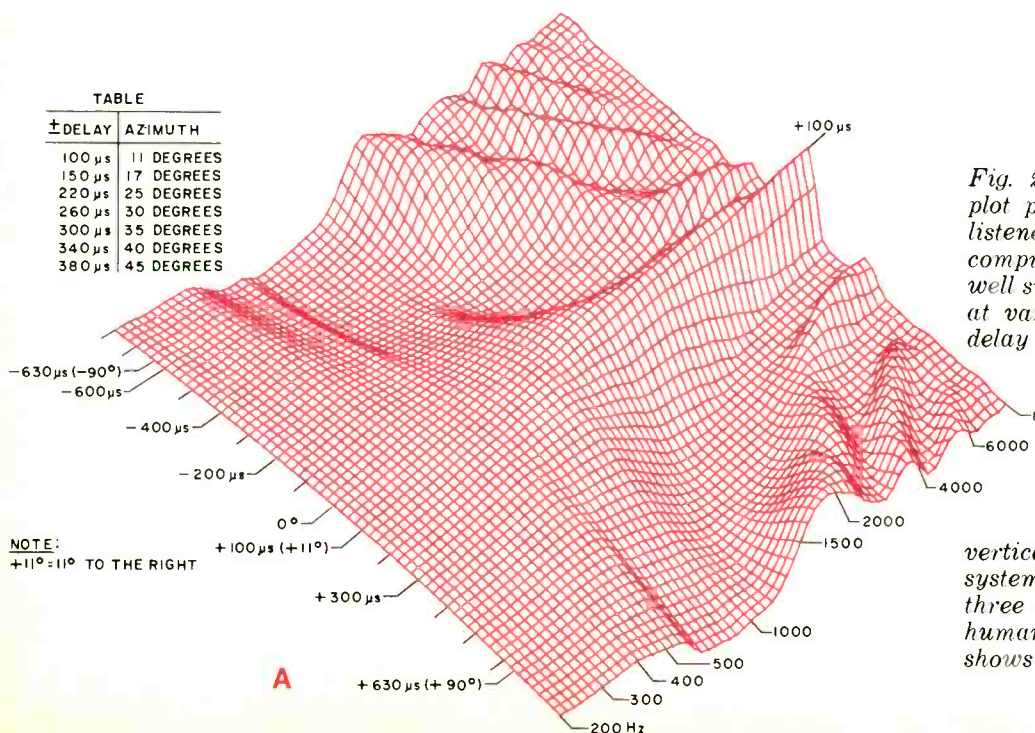

Fig. 2. Examples of kind of plot produced by AR's "robot listener" system. Automatic computer drawing shows how well signals at both ears match at varying time delays. Zero delay would correspond to source directly in front of listener; 90° to right or left would produce a peak at ± 630 microseconds.

Speaker system A has drivers aligned vertically on front of cabinet; system B uses driver units on three cabinet sides. Like the human hearing system, A shows little directional infor-

correlation matrix has a number of output taps corresponding to different amounts of time delay. At a given frequency, the highest output is obtained from the tap corresponding to the delay time of either the left or right ear signal that gives the best match of the two.

My colleagues and I have experimented with an artificial human head, with specially constructed microphones implanted inside ears modelled after those human beings. The microphones' output is linked to a laboratory computer (and associated peripheral equipment) programmed to simulate some of the known properties of the inner ear and the neural networks in the human brain that analyze auditory data. We can interrogate our robot listener to ask it to draw a picture of what it has heard. Figure 2 shows one kind of picture produced in this way. The plot represents the cross-correlation of the signals received by the two "ears" as a function of frequency, after the individual signals have been processed to account for the response of the basilar membrane, a part of the inner ear. A trained observer will see that various features of the human hearing mechanism are indeed present in the computer simulation. Comparison of the model's data to data from experiments with human listeners confirms that our biological sensors and signal-processing networks closely approach the ideal efficiency that could be expected of such a system. The sensitivity is surprising. In some experiments, human hearing has proved capable of finding the azimuth of a sound source to within less than one degree.

Nonlinear Processing in Hearing. Despite its extreme sensitivity to some characteristics of sounds, the ear transforms and alters the incoming signal very early in the auditory process. One change is the separation of a sound into its constituent frequencies, that is, spectral analysis. Another is half-wave rectification, which probably takes place after frequency analysis. These changes would destroy little actual information

tion, i.e., no prominent single peak at low frequencies. Above 300 Hz, localization improves, then becomes unclear again at about 1500 Hz due to competing peaks at sides. At higher frequencies, central peak again predominates, locates speaker system at 11° to the robot listener's right.

Speaker system B shows localization shifts at lower frequencies and diffuse localization at higher frequencies. The effect resembles that produced by strong reflections in a hall.



Artificial head used at AR and many other laboratories is made by Neumann, German manufacturer of professional condenser microphones. Units are built with specially designed coupling chambers between ear canal and microphone capsule, to match electrical output as closely as possible to acoustical signal at human eardrum.

about a sound but would possibly assist localization. Transmission of information in the central nervous system, where processing takes place, appears to be statistically oriented, rather than discrete and quantitatively precise as in a computer.

The significance of these nonlinear effects in music reproduction is not common knowledge, except to readers of specialized journals and texts on the subject. However, the importance of such effects should be clear to anyone who has heard an "ambience" or "time-delay" system. Without being able to add any genuine information at all, such systems, often by mere

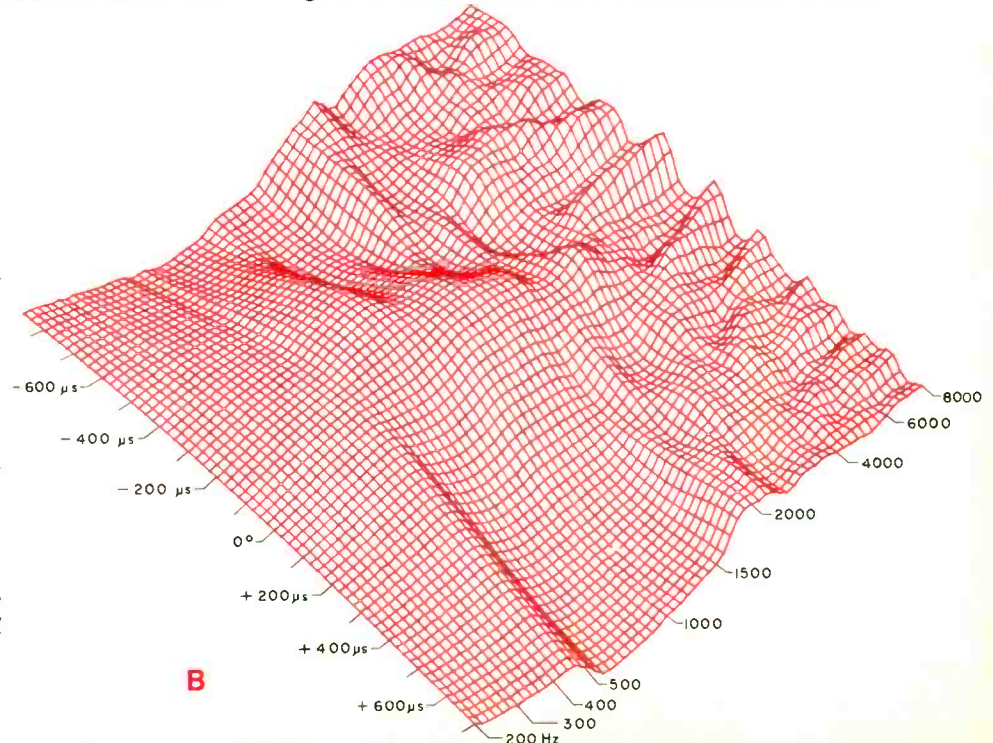

delayed repetition of the original sound through added speakers, impressively augment the subjective impression of realism. Some listeners have observed that a mediocre system with "time-delay" can be more satisfying than a high-quality system without such an accessory, despite the fact that the additional sound can only *decrease* the objective accuracy with which the recording is reproduced.

The Future. For some years, at least, progress in audio might depend on the work of neurophysiologists and psychologists, rather than on refinement of hardware along conventional lines. Eventually perhaps, the results will justify the application of their hard-won knowledge to our special concern by bringing everyone

greater pleasure and enjoyment from music. The search for improved understanding is also one of the most exciting and potentially rewarding applications of computers and digital simulation to audio. By applying techniques from the field of artificial intelligence—feature detection and pattern recognition—we may soon be able to make objective measurements of the spatial fields generated by a loudspeaker in terms of a listener's perception. When we are able to measure such qualities objectively, we can begin to design speaker systems in which these variables are controlled. This, in turn, would give us much greater control over the listener's subjective impression—which is, as we said at the outset, the fundamental principle of high-fidelity music reproduction. ◇

A 3-Way Drive System for Speakers

Active crossover divides the audio spectrum for individual drivers before power amplification

BY J.F.P. MARCHAND

IN TRADITIONAL multiway loudspeaker systems, the division of the driving signal into frequency ranges suitable for the several drivers is performed after power amplification. The crossover or dividing network is composed of a set of passive components—inductors, capacitors, and resistors—interposed between the power amplifier output terminals and the input terminals of the individual transducers.

From the point of view of economy, this approach is advantageous, but it is not without difficulties. One is that the dividing network must handle appreciable power. This means that the passive components (the inductors are most problematic) must behave in a linear manner at high current levels if distortion products are not to be generated. Optimal design often raises the cost of the passive components and causes some of the economic advantage to evaporate.

Another drawback of particular concern to the home constructor is that a high-level network capable of performing well with the drivers to which it is added can be very difficult to design. The reason is that most tables and formulas for the filter-section design are based on the assumption that the network will be terminated by a purely resistive load, while the driver impedances usually contain significant, frequency-dependent reactive components.

Clearly, it would be advantageous to eliminate this problem. We can do this with no loss of performance by multiamping the system and taking advantage of the fact that the power amplifiers act as buffers between the filters and the drivers. Another benefit is that, with

several power amplifiers sharing the load, the demands made on each of them are less stringent than when a single unit must do the whole job. For example, since bass frequencies cannot intermodulate with treble frequencies in loud passages, a particularly audible form of distortion is minimized. Also, the bass power amp can have a relatively low slew rate and cause no problems, as it will not see rapidly changing signals. A treble amp, on the other hand, can have a low damping factor, with less feedback and fewer problems.

The Filters. A schematic diagram of the active crossover for one audio channel appears in Fig. 1. While other types of filters can give good results in this application, the 18-dB/octave active Butterworth filters used here offer a desirable combination of steep slopes and good phase response. Rolling off the drivers rapidly helps to suppress any anomalous behavior they may exhibit as the extremes of their useful ranges are approached. Using as sharp a network as this between a power amplifier and the drivers is often avoided because of expense. In a design of this type, however, the extra cost is minimal.

Quad operational amplifiers *IC1* and *IC2* are the central elements of the filters. Integrated circuits *IC1A*, *IC1B*, *IC1D*, and their associated components and *IC1C*, *IC2A*, *IC2B*, and their associated components comprise two active filters with ultimate slopes of 12 dB/octave. The first filter separates the high frequencies from the low and middle frequencies. The second

(Continued on page 48)

PARTS LIST

- C1—13,000- μ F, 50-volt electrolytic
 C2,C10,C12*,C15*,C17*,C18—1- μ F,
 50-volt radial-lead electrolytic
 C3,C4,C9—1000-pF, 5% polystyrene
 C5,C6,C7,C8,C16—10,000-pF, 5% poly-
 styrene
 C11,C14*,C20*—47- μ F, 50-volt radial-
 lead electrolytic
 C13*,C19,C21*—470- μ F, 25-volt radial-
 lead electrolytic
 C22 through C28—0.1- μ F disc ceramic
 D1,D2—6.8-volt, 1-watt zener diode
 F1—1-ampere fast-blow fuse
 IC1,IC2—LM324N, TL074CN, or simi-
 lar quad operational amplifier
 IC3*,IC4*—LM379S dual six-watt au-
 dio amplifier
 J1—RCA phono jack
 Q1*,Q3*—TIP31 npn power transistor
 Q2*,Q4*—TIP30 pnp power transistor
 The following, unless otherwise specified,
 are 1/4-watt, 5%, carbon-film resistors.
 R1,R32—1000 ohms
 R2,R3,R4,R6,R8,R10,R12,R13,R24*,
 R25*,R31*—100,000 ohms
 R5,R7,R11,R14,R15,R16,R17—68,000
 ohms
 R9—51,000 ohms
 R18,R23*,R30*,R33—10,000 ohms
 R19*,R22*,R28*,R29*—150,000 ohms
 R20*,R21*—5.1 ohms, 1/2-watt, carbon-
 composition
 R26—22,000 ohms
 R27*—4700 ohms
 R34,R35—10,000-ohm, pc-mount, lin-
 ear-taper potentiometer
 RECT1—6-ampere, 100-PIV modular
 bridge rectifier
 S1—Spst toggle switch
 T1—24-volt, 2-ampere transformer
 (Stancor No. P-8617 or equivalent)
 Misc—Printed circuit board, heat sinks
 (four Thermalloy No. 6070 or equiva-
 lent, two Thermalloy No. 6072 or equiva-
 lent), line cord and strain relief, fuse-
 holder, circuit board standoffs, hard-
 ware, hookup wire, shielded cable, etc.
 Note—An etched and drilled glass-epoxy
 printed circuit board is available for
 \$15.00 from Marchand Electronics,
 Inc., 1334 Robin Hood Lane, Webster,
 NY 14580. New York residents, please
 add 7% state sales tax.

Fig. 1. Schematic diagram of the active crossover for one audio channel. Further power amplification may be added if desired.

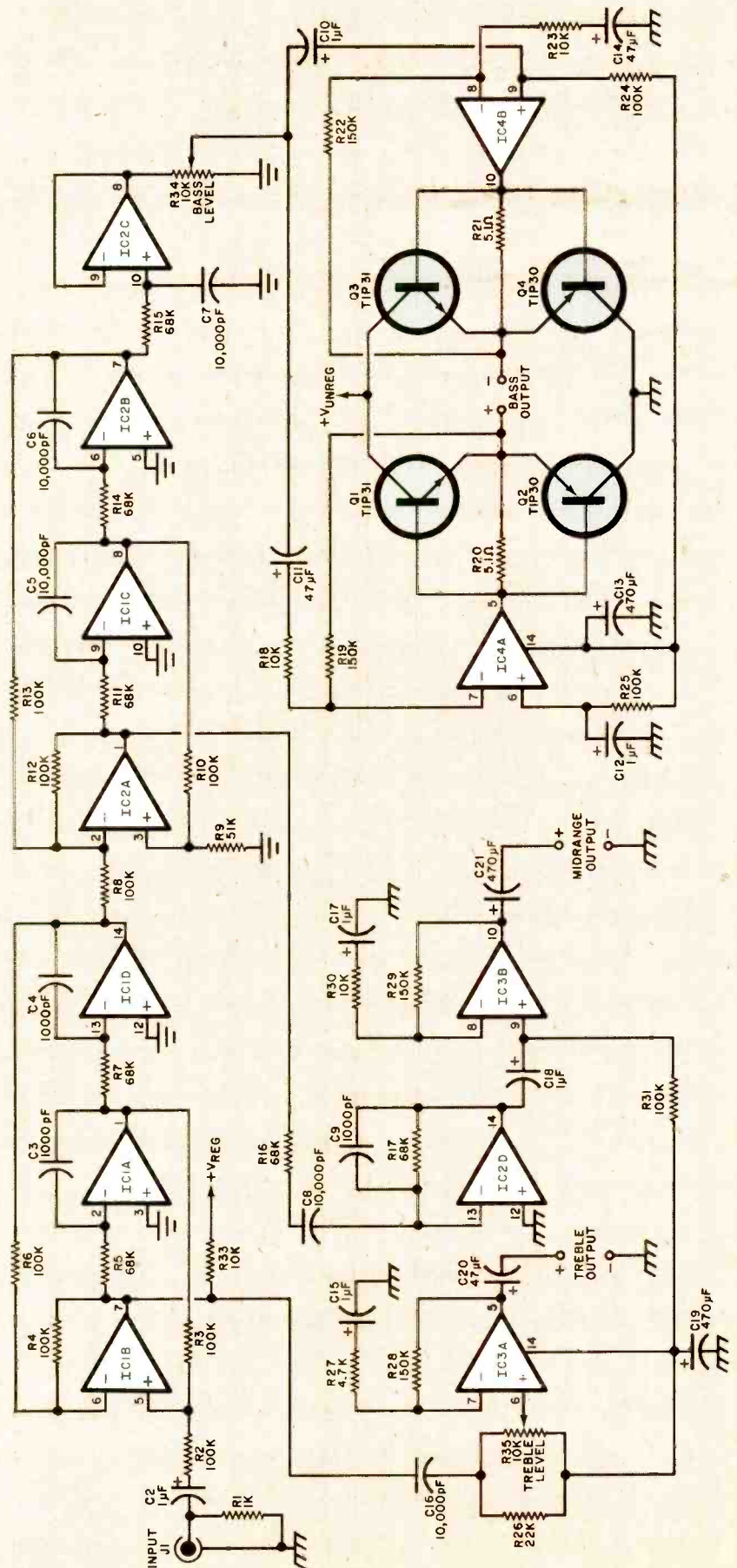

then divides the low and middle frequencies. The high, middle, and low frequencies, which appear at the outputs of IC1B, IC2A, and IC2B, respectively, are fed to passive high-pass and low-pass filters C16, R26, and R35 and C7, R15 and to active band-pass filter C8, R16, C9, R17, and IC2D.

These last circuits are first-order filters having ultimate slopes of 6 dB/octave. Because the second- and first-order filters are cascaded, the resulting ultimate slope is 18 dB/octave.

The values of capacitance and resistance which determine the low and high crossover frequencies have the following relationships:

$$C_{high} = C3 = C4 = C16 / 10$$

$$C_{low} = C5 = C6 = C7$$

$$R_{high} = R5 = R7 = 10 (R26 \parallel R35)$$

$$R_{low} = R11 = R14 = R15$$

The values of R_{high} and R_{low} in kilohms and of C_{high} and C_{low} in picofarads are determined from the equations: $R = 10^9 / 6.28fC$ and $C = 10^9 / 6.28fR$. Choose a convenient value of capacitance, say 100,000 pF for a low crossover, 10,000 pF for a high one. Then calculate the necessary resistor values. A negative value for R26 means that R35 is too low to allow it and R26 in parallel to reach the desired resistance. Repeat the calculation with a larger value for C.

The specified op amps are sufficiently fast to give good performance. However, anyone concerned about transient intermodulation (TIM) distortion may substitute a pin-compatible IC, such as type TL074CN, which has a higher slew limit.

To use the project with two-way systems, make f_{high} and f_{low} equal. The bandpass output should be left floating as there is no midrange driver.

Power Amplifiers. The choice of power amplifiers for a triamped system depends on the efficiency and power-handling capabilities of the drivers, the crossover frequencies and how loud you want the music to be. Generally, you will want to use the best quality amplifiers you can afford; but, as noted earlier, factors that influence the high-frequency performance of the bass amp are unimportant. Similarly, damping factor, dc coupling, and other parameters or features that relate to low-frequency performance are not critical in the treble and midrange amps.

To decide how much power each of the amplifiers

must have, start with the reasonably conservative assumption that music has equal power in each of the 10 audible octaves. With your chosen crossover frequencies in mind, determine how many octaves each driver will handle. The number of octaves is given by the relation $N = \log_{10} (f_2/f_1) / \log_{10} 2$, where f_1 and f_2 are the lower and upper limits, respectively, of the passband allocated to a particular driver. (This is a formidable looking calculation, but it can be performed easily on most scientific calculators.) A driver handling five octaves would get 50% of the system power; one handling three octaves would get 30%, etc.

If an appropriate calculator is not available, draw a chart, marking octave boundaries at 20, 40, 80, 160 Hz etc., and note which bands contain your crossover frequencies. Then you can get an approximate idea of how many octaves are reproduced by each driver. Obviously, this method is not exact, but you are not likely to find power amplifiers in exactly the sizes you need anyway.

A constructor who can be satisfied with a modest amount of power at distortion levels that are adequate but not state-of-the-art can build the power amplifiers included in Fig. 1. These are built around two National LM379s, dual 6-watt integrated power amplifiers, which require few additional components and have built-in thermal protection. Integrated circuits IC3A and IC3B are the amplifiers for the high and middle frequencies. They are connected as standard noninverting operational amplifiers and the outputs are capacitively coupled to the loudspeakers via C20 and C21.

To satisfy the higher power requirement of the low-frequency channel, IC4 is arranged as a balanced amplifier with booster transistors Q1, Q2, Q3 and Q4. The op amps are arranged as an inverting and a noninverting amplifier, differentially driving the bass loudspeaker. This doubles the maximum voltage across the loudspeaker, yielding four times the power. The booster transistors handle the doubled output current. All three amplifiers are designed for 8-ohm drivers.

Power Supply. Power for the filters and power amplifiers can be provided by the supply shown schematically in Fig. 2. A simple bridge rectifier and filter capacitor provide 35 volts dc at no load. As the LM 379 is relatively insensitive to power-supply ripple, no additional filtering is required.

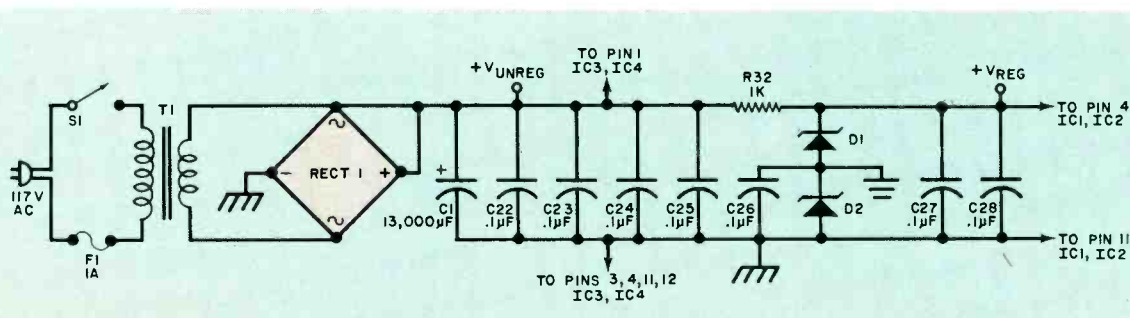

Fig. 2. Schematic diagram of a power supply for the filters and amplifiers. Capacitors supply filtering and zener diodes regulation for various voltages.

Supply voltages for *IC1* and *IC2* are provided by the 6.8-volt zener diodes, *D1* and *D2*. Capacitors *C22* through *C28* provide power-supply decoupling. Power amplifiers *IC3* and *IC4* require high-frequency power-supply decoupling to prevent ultrasonic oscillation. This decoupling is provided by *C22* through *C25*. These disc ceramic capacitors are mounted in pairs close to the LM379 integrated circuits.

Note that two distinct ground symbols are employed in the two schematic diagrams. This is so because the power supply is single-ended. The "earth ground" symbol is employed as the input and output signal ground and the negative supply line for the ICs. The "chassis ground" symbol signifies an artificial ground for operational amplifiers *IC1* and *IC2* that is at a dc level equal to one half the regulated supply voltage. It is derived by means of the voltage-dropping action of zener diodes *D1* and *D2*.

The gains of the low and high channels can be adjusted with potentiometers *R34* and *R35*. With the wipers of these controls at the center of their travel, the gains of all amplifiers are approximately 15. An input sine wave of 460 mV rms will then result in full power output.

Construction. The assembly of the project is relatively straightforward. All parts except the 24-volt power transformer are mounted on a single 5½-X-6½-inch printed circuit board. The full-size etching and drilling guide for this board appears in Fig. 3. A complementary parts placement guide is reproduced in Fig. 4. When inserting electrolytic capacitors, diodes, transistors and integrated circuits, be sure to observe proper polarity.

Resistors *R2* through *R17* and *R26* and capacitors *C3* through *C9* and *C16* determine the crossover frequencies. For best performance, these components should have a tolerance of no more than ±5%. Polystyrene capacitors are specified but other low-loss precision types, can be substituted.

Transistors *Q1* through *Q4* are mounted on Thermalloy No. 6070 or similar heatsinks with suitable mounting hardware. Cooling for the LM379 ICs is accomplished by mounting them directly on Thermalloy No. 6072 or similar heatsinks with two No. 4-40 machine screws. The holes in these heatsinks do not line up with the threads in the ICs, so two holes spaced 1 inch (2.54 cm) apart must be drilled in the heatsinks. Pin 1 of the power ICs is marked with a small white dot on the

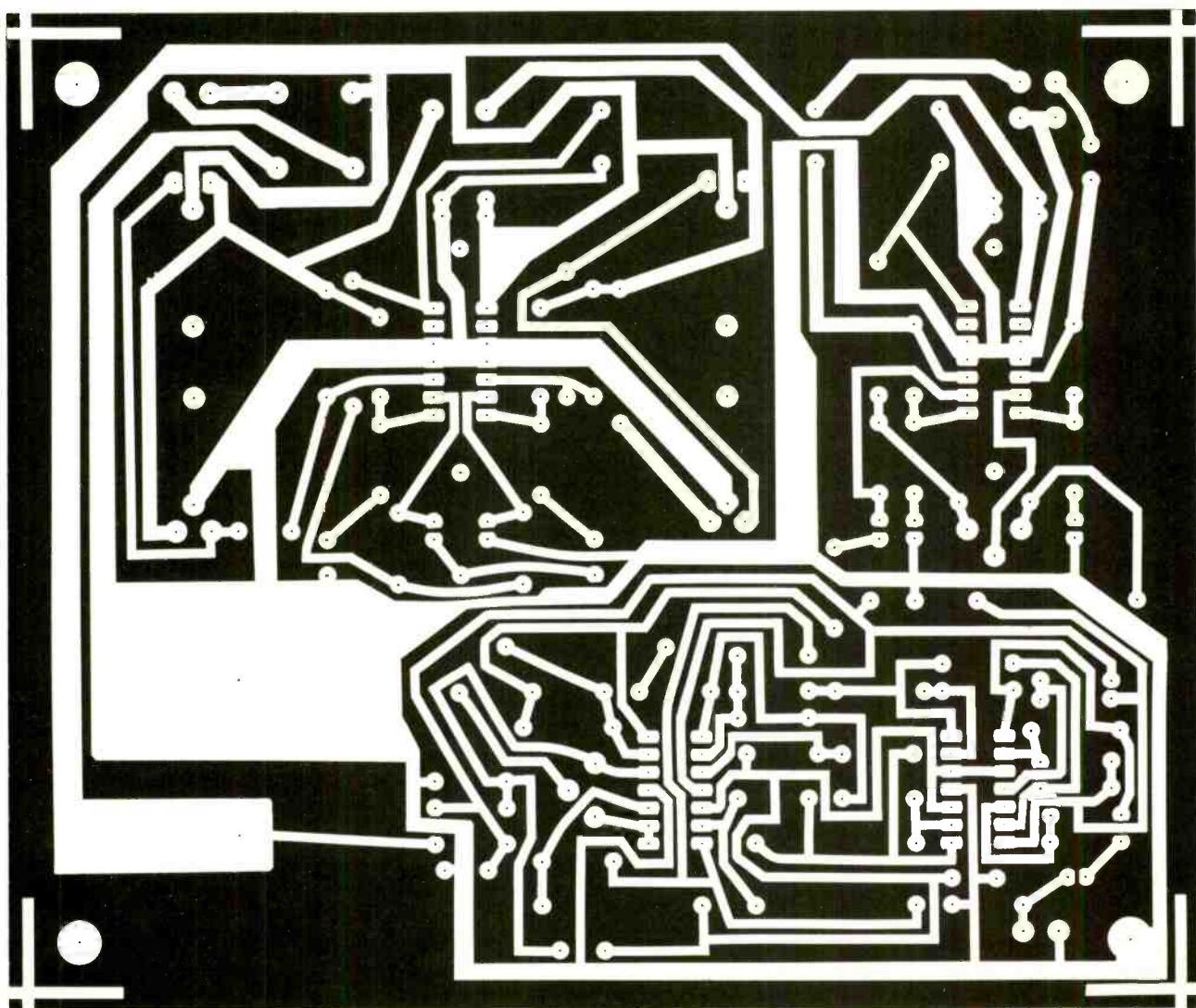

Fig. 3. Actual-size etching and drilling guide for printed circuit board.

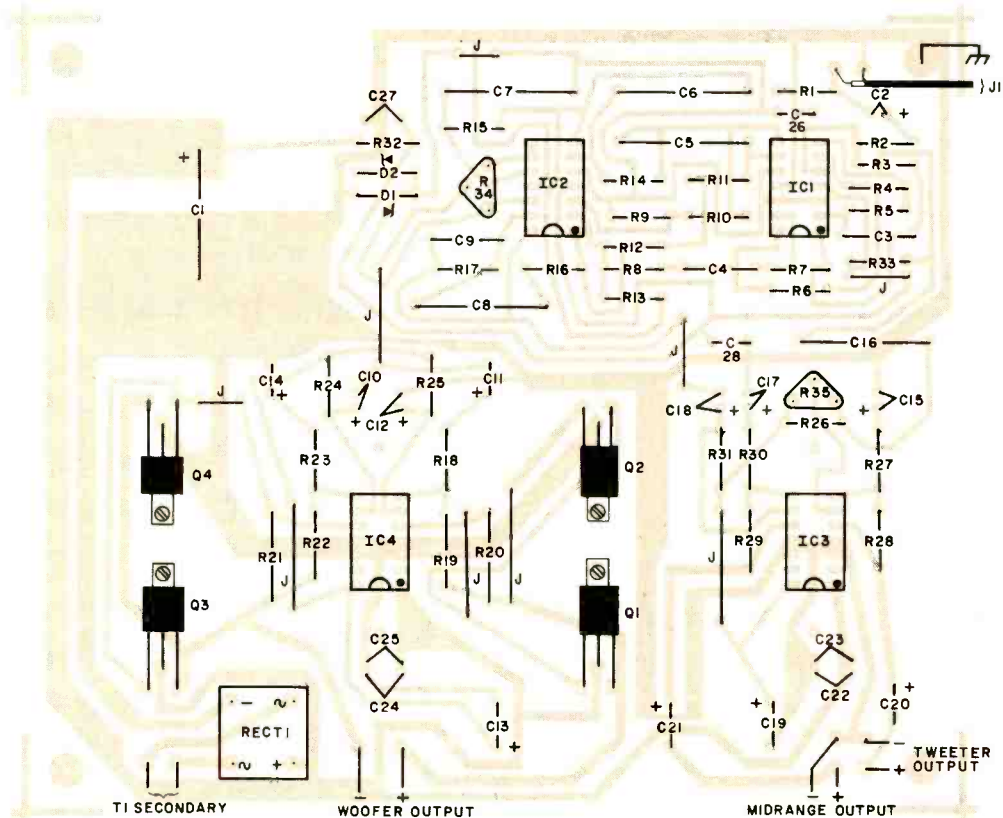

Fig. 4. Component layout diagram for the printed circuit board. Transistors Q1 through Q4 are mounted on heat sinks.

underside of the package. The large filter capacitor, C1, is mounted on the board with standard hardware.

Should you decide to use other power amplifiers, IC3 and IC4, Q1 through Q4, and their associated components (see parts list) can be omitted. Outputs for the external amplifiers can be taken from the solder pads intended to accommodate pins 6 and 9 of IC3 (high and mid frequencies) and pin 7 or 9 of IC4 (low frequencies). Use shielded cable with phono jacks and the shield grounded only at the jacks. Keep cables short, adding 100-ohm buffer resistors if needed to prevent oscillation.

If you use the on-board power amps, it will be convenient to mount the entire project inside the loudspeaker enclosure. Potentiometers R34 and R35 can be mounted in place of the original crossover controls, and the fuse holder, input connector, and on-off switch can be installed on the rear of the enclosure. To allow adequate ventilation, mount the circuit board as low in the box as possible, positioning it so that damping material does not interfere with air circulation. Leads to the pots and speakers should be twisted together.

To use the project with external power amps, it will be necessary to fabricate some form of enclosure. The controls, input and output connectors, fuse holder, and on-off switch can be mounted on one of its panels.

Power-supply components T1, B1, C1 are more than adequate for two stereo channels of filtration. Decoupling capacitors C22 through C25 can be omitted, but a

separate zener-diode regulator section should be used for each channel. The loudspeaker system will have to be fitted with a separate set of connectors for each driver. If desired, the drivers can be protected by individual fuses of appropriate ratings.

Setting it Up. Whichever arrangement you use, pay careful attention to the polarity of the drivers, sometimes indicated with a red dot meaning "plus" (+). Some authorities feel that, with 18-dB/octave crossovers, the best phase response near the crossover frequencies is achieved by connecting adjacent drivers out of phase. You may want to experiment to see which arrangement gives you the best results.

In some cases, coupling the amplifier directly to a woofer will increase damping to the point where a small amount of bass response is lost. This can be cured by connecting a small resistor, generally 1 ohm or less, in series with the driver. To protect the speaker drivers from transients, be sure that the power amps are turned on *after* the crossover is powered and turned off *before* crossover power is removed.

Once you are certain that the project is operating correctly, make all necessary corrections and set the level controls for flattest frequency response. The improvement in the sound of your speakers will not be earth-shaking but should be clearly audible. Many listeners who use tri-amping report clearer, tighter sound with reduced distortion. ◇

AFTER 500 PLAYS OUR HIGH FIDELITY TAPE STILL DELIVERS HIGH FIDELITY.

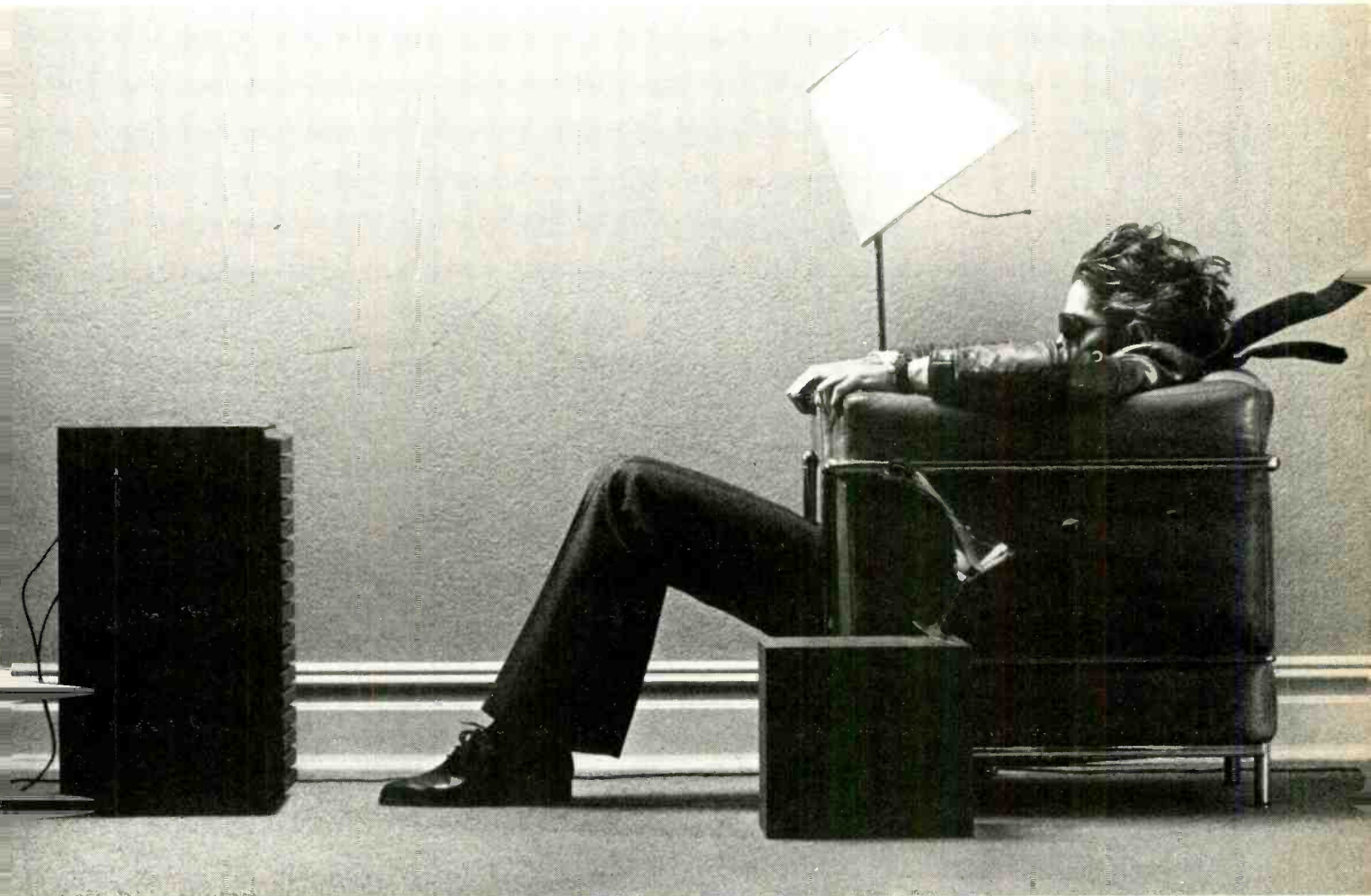

If your old favorites don't sound as good as they used to, the problem could be your recording tape.

Some tapes show their age more than others. And when a tape ages prematurely, the music on it does too.

What can happen is, the oxide particles that are bound onto tape loosen and fall off, taking some of your music with them.

At Maxell, we've developed a binding process that helps to prevent this. When oxide particles are bound onto our tape, they stay put. And so does your music.

So even after a Maxell recording is 500 plays old, you'll swear it's not a play over five.

maxell
IT'S WORTH IT.

Maxell Corporation of America, 60 Oxford Drive, Moonachie, N.J. 07074

CIRCLE NO. 36 ON FREE INFORMATION CARD

APRIL 1980

51

www.americanradiohistory.com

**THESE ARE NOT
HOME-MADE TRAINING DEVICES.
THESE ARE PRODUCTION MODEL
MICRO-SYSTEMS.
NO OTHER HOME STUDY SCHOOL
OFFERS THEM EXCEPT NTS.**





IN FACT, NTS ELECTRONICS PROGRAMS INCLUDE THE WIDEST ARRAY OF SOLID-STATE AND DIGITAL EQUIPMENT EVER OFFERED BY ANY HOME STUDY SCHOOL.

Now, for the first time, you can learn all about microcomputers by working with your own production model at home. We'll explain the principles of troubleshooting and testing this remarkable instrument and, best of all, we'll show you how to program it to do what you want.

It's the perfect opportunity for you to learn BASIC high level language programming *and* assembly language programming.

Then, to learn how to localize microcomputer problems and solve them, you'll experiment and test with a digital multimeter and other testing gear.

But most important, you get to assemble and work with today's most sophisticated microcomputers, not home-made training devices. We believe this makes learning a lot more relevant and exciting.

In fact, production-model equipment is featured in all 14 NTS electronics programs.

Our Color TV servicing program boasts the NTS/HEATH digital color TV (25" diagonal) you actually build and keep.

In Audio Electronics, you build and keep an NTS/HEATH digital stereo receiver with 70 watts per channel.

Whichever NTS electronics program you choose, you can count on working with much the same kind of equipment you'll encounter in the field.

Find out more in our full color catalog on the program of your choice.

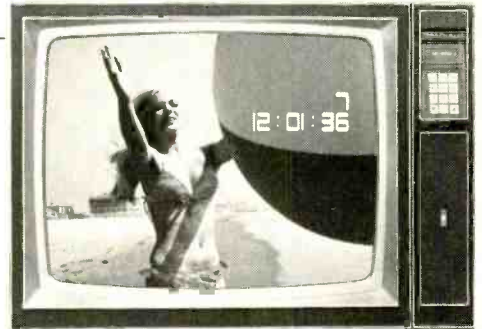

Simulated TV Reception

NTS also offers course in Auto Mechanics, Air Conditioning and Home Appliances. Check card for more information.



1. **The NTS/HEATH H-89 Microcomputer** features floppy disk storage, "smart" video terminal, two Z80 microprocessors, 16K RAM memory, expandable to 48K. Available in NTS's Master Course in Microcomputers.
2. **The NTS/Rockwell AIM 65 Microcomputer** A single board unit featuring an on-board 20 column alphanumeric printer with 20 character display. A 6502-based unit 4K RAM, expandable. Available in NTS's Microprocessor Technology Course.
3. **The NTS/KIM-1 Microcomputer** A single board unit featuring a 6 digit LED display with an on-board 24 key hexadecimal calculator-type keyboard. A 6502 based microcomputer with 1K of RAM memory, expandable. Available in NTS's Master Course in Electronic and Industrial Technology.

**NO OBLIGATION. NO SALESMAN WILL CALL.
APPROVED FOR VETERAN TRAINING.**

NATIONAL TECHNICAL SCHOOLS

TECHNICAL-TRADE TRAINING SINCE 1905
Resident and Home-Study Schools
4000 South Figueroa St., Los Angeles, Calif. 90037



NATIONAL TECHNICAL SCHOOLS

4000 South Figueroa Street. Dept. 205-040
Los Angeles, California 90037

Please rush FREE color catalog on course checked below

- | | |
|---|--|
| <input type="checkbox"/> MicroComputers/MicroProcessors | <input type="checkbox"/> Audio Electronics |
| <input type="checkbox"/> Communications Electronics | <input type="checkbox"/> Auto Mechanics |
| <input type="checkbox"/> Digital Electronics | <input type="checkbox"/> Air Conditioning |
| <input type="checkbox"/> Color TV Servicing | <input type="checkbox"/> Home Appliances |

Name _____ Age _____

Address _____

Apt. _____ City _____

State _____ Zip _____

- Check if interested in G.I. information.
 Check if interested ONLY in classroom training in Los Angeles.



Extra Keyboards for Microcomputers

BY ADOLPH A. MANGIERI

A keyboard can be connected directly in tandem with the main board of most computers to expand operating versatility.

AN ADDITIONAL keypad or keyboard in tandem with the main keyboard of a computer can have a myriad of uses. A small numeric keypad can be convenient for entering arithmetic data and allows players to enter game moves easily. A full typewriter keyboard duplicating the main one makes one computer setup almost as useful as two for group use and instruction. In any case, a second keyboard, can be used for remote data entry.

The tandem keyboard connects directly to the computer keyboard matrix lines and requires no additional components. Once the warranty on your computer expires, there is no reason why you should not open the cabinet and bring out the keyboard matrix lines. It's both safe and simple. Details are given here for the Radio Shack TRS-80 com-

puter, but the modification can be applied to many other makes.

Circuit Operation. Most computer keyboards employ normally-open spst keyswitches wired with keyboard characters assigned to row and column lines of a matrix. As shown in the diagram, the TRS-80 keyboard is arranged as an 8 X 8 matrix. The eight D0 through D7 column lines connect to column line output buffers (not shown) that, in turn, connect to the data bus. The eight A0 through A7 row lines are driven by row-line buffers connected to the address bus. Each intersection of the matrix has an spst keyswitch, as shown for column lines D0 and D7. When the A key is pressed, row line A0 and column line D1 are connected to each other to generate an output on column line D1 and the

appearance of character A on the monitor screen.

To add a remote keypad or a full keyboard in tandem, you merely carry out the required row and column lines to the switches of the remote keyboard. Just how the computer encodes key closure is not material. In the TRS-80, encoding of the keyboard is accomplished with a program in ROM. (See the TRS-80 Microcomputer Technical Reference Manual for details.) Many computers employ a chip encoded keyboard.

The only consideration to be taken into account when connecting a tandem keyboard into an existing microcomputer system is whether cable capacitance and stray pickup will affect computer operation. Fortunately, almost any keyboard can tolerate several feet of connecting cable to the tandem keyboard.

(continued on page 58)

EXTRA KEYBOARDS *continued*

Before you install the connecting socket on the computer, make temporary connections to a row and column line to determine whether this method is suitable for your keyboard. Once you have determined that your computer can, indeed, tolerate a tandem keyboard, you can proceed to modify it.

Cable Connections. Open the TRS-80's cabinet, following instructions detailed in the Technical Reference Manual. Carefully raise the keyboard to avoid any strain on the short ribbon cable that connects the two boards. Pull off the board spacers and set the keyboard on its keytops in front of the cabinet with the main circuit board riding loosely in the bottom half of the cabinet. Although the CPU and several other MOS devices wired into the circuit are largely protected from static discharge, it still pays to observe standard handling precautions when working with MOS circuits.

Locate the eight column line resistors, which are clearly identified on the keyboard. Mark the solder pad at the lower end of each resistor with its associated column line. You may or may not be able to locate row lines at row-line buffers because some buffers were interchanged in some keyboard models. A better approach would be to identify row lines directly at the key terminals.

For the TRS-80, touch the negative (COM) lead of an ohmmeter set to a medium range, to limit current, to column line D1 at the lower end of resistor *R5* and the other test lead to either terminal of keyswitch A (see board labelling). If you obtain a zero resistance reading, the remaining terminal is row line A0; but if resistance is infinite, the terminal being tested is row line A0. Label the solder pad as A0. Similarly, select other keys and locate all row lines. Keyboard ground is line 19 on the board's interconnect cable. Line 1 is at the extreme edge of the keyboard. Trace ground to a convenient solder pad location.

Decide how you wish to route a cable from the computer's or terminal's cabinet. There is ample unused space at the edges of the keyboard in the TRS-80 for installation of an internal disconnect. For a clean cable exit away from heat sinks and main-board adjustment pots, locate the disconnect at the front edge and pass the cable through the front.

A 16-pin DIP socket that mates with a DIP patchcord is very easy to install. When not in use, the exposed male pins at the other end of the patchcord can be protected with a DIP socket. Less easily

installed is a male IDC (insulation displacement connector) made up of Wire Wrap posts inserted on the keyboard to allow use of female IDC patchcords. Also, IDC cables are more rugged, easy to assemble and patch end-to-end with homemade adapters.

Cover the main circuit board to exclude debris and solder splatter. With a wood-block backup, drill the keyboard to accept the 16-pin socket, using p-pattern board retained with double-stick tape as a drilling template. For the male IDC, drill 0.042" (1.1-mm) holes to accept 20 Vector No. T46-5-9 wrap posts. For front exit, position the disconnect as far from the edge as possible, but do not drill into board traces! Normally, the male IDC is formed using the No. MB45-20 perforated alignment block to back up the board and maintain the installed pins perpendicular. However, to use this block, you must remove both boards from the cabinet to obtain clearance. Lacking the alignment block, use a hardwood block for board backup, keeping it very close to the pin. If you remove the main board from the cabinet, do not disturb trimpots on it.

Use a Vector No. P205 board-pin insertion tool to install No. T46-5-9 wrap posts for the male IDC. This tool eases installation of pins with cross bars in alignment as required to accept a female IDC plug. Lacking this tool, over-drill board holes slightly to ease pin

insertion and install using longnose pliers. Wire the connections to the marked row and column lines. Use the four extra wires on the 20-conductor IDC cable as a ground screen. Assign the outermost and two intermediate conductors to ground. Check soldered connections for presence of solder splatter and excessive solder. Install the keyboard into the cabinet and straighten any misaligned wrap posts on the top with longnose pliers.

Install a 12" (305-mm) cable for front exit. Fabricate the IDC cable using Vector No. KS2-20 20-pin female IDC plugs and mating cable No. KW2-20-10. Press the IDC plug onto the end of the cable using a smooth-acting vise or use the P187 IDC fixture. For a longer cable run, make a second 24" (610-mm) cable and fabricate a male IDC adaptor to join IDC cables end to end. Cut the top half or long end of the No. T46-5-9 wrap post down to 1/4" (6.4 mm), round off the burr and install posts on a small piece of perforated board. Note: you can face IDC plugs the same way or one up and one down on a cable. If you use a cable-splice adaptor in lieu of changing the entire cable, you must use the adaptor in every setup because cable line transpositions occur at the splice.

Keyboard Assembly. Inexpensive surplus desktop calculator keyboards as shown in the photos are suitable for tan-

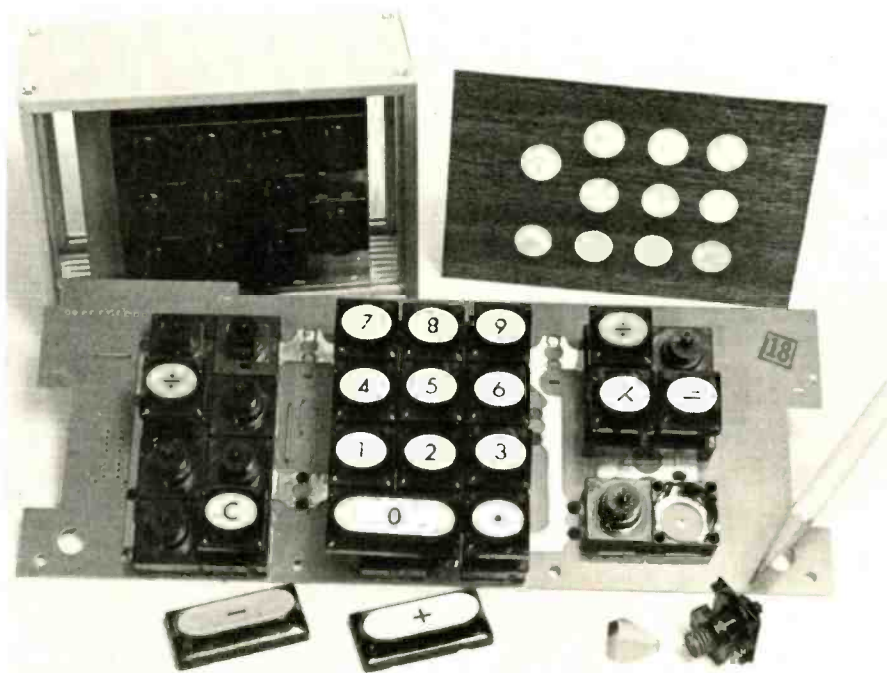

Desktop calculator keyboard can be cut apart to make smaller keypads. The pencil at right points to removed top part of keyswitch. Topside brass stampings form part of switch and key strings.

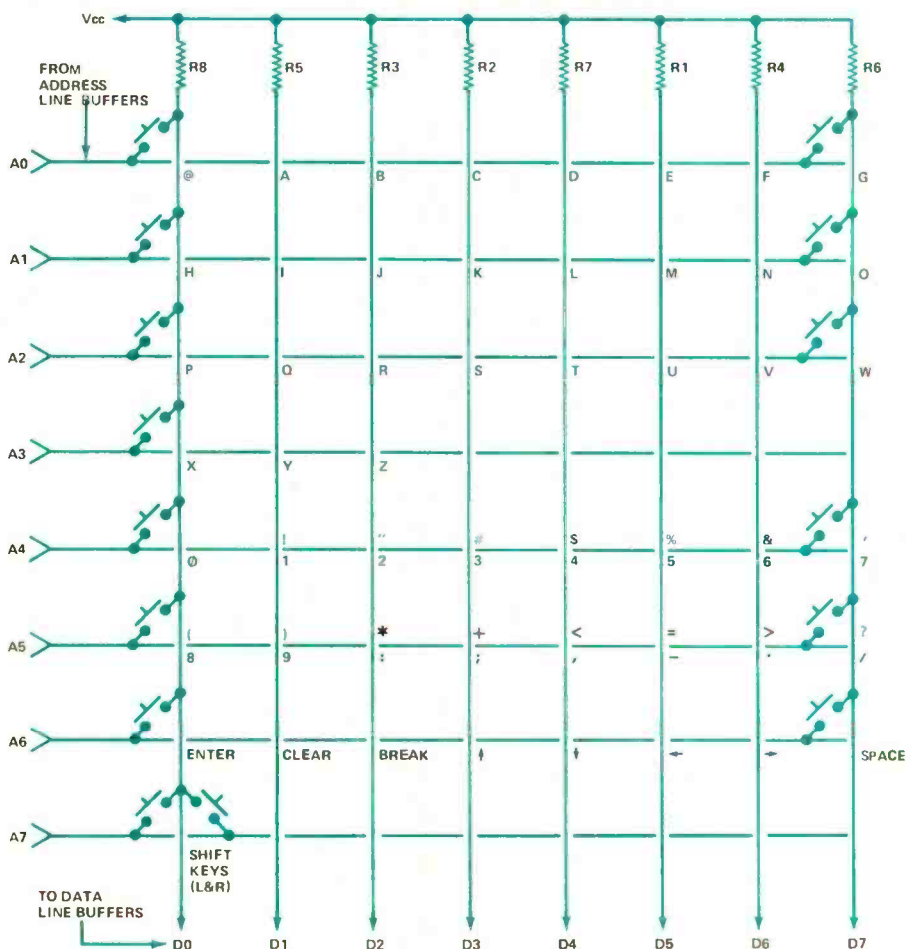

Schematic shows 8 × 8 matrix layout of the TRS-80 keyboard, which is typical of boards of this type. A keyswitch is located at each intersection of the matrix to generate an output for a specific character.

dem hookups and require only slight alterations. The key bodies are thermally staked to the phenolic board, and one terminal of each switch is available on the bottom. A top-side circuit made up of thin brass stampings serves as switch contacts and interconnecting lines to form key strings that have a common connection. The top portion of each switch is removable to reveal the working parts and snap-action disc.

Let us implement a numeric keypad for the TRS-80. From the keyboard matrix diagram, keys 0 through 7 require a 1 × 7 matrix or key string, with the common side of the switches connected to row line A4 and the isolated side of the switches connected to the column lines. Keys 8, 9, and decimal point require a 1 × 3 key string, with the common side of the switches connected to row line A4 and the isolated side of the switches connected to the column lines. Keys 8, 9, and decimal point require a 1 × 3 key string, with the

common side of the switches connected to row line A5 and remaining switch terminals connected to column lines D0, D1, and D6. The numeric set of this keyboard was a 1 × 10 key string, with keys 8, 9, and decimal point at one end of the string.

To separate the required 1 × 3 key string, cut off four plastic nubs on the bottom and remove the number 7 key body. Use a fine-toothed, broken-off hacksaw blade to cut the metal band alongside key 8 and remove the top part of the switch body. Sparingly, apply epoxy cement to the plastic pegs of the key body and install using a clamp for a tight fit. Clean switch parts with alcohol and reassemble the switch.

Trim and install the keypad in a small case. The numeric keypad shown is housed in a Vector No. W20-46-31B Multi-Mod case. The trimmed keypad slides into case-card grooves. Punch holes in the panel using a Greenlee chassis punch to pass the key shanks.

Using the full keyboard, install in the Vector No. 51X-1 aluminum frame. Trim the keyboard to length to fit frame grooves and cut a top panel to size. Secure the keyboard to the punched panel using four machine screws and extra nuts for spacing. Finally, mark key-switch terminals with the required row and column lines and wire to an IDC male connector or DIP socket. The aluminum frame accepts the M6088-3-1 perforated bottom plate; otherwise, cut a plate to size and install.

Assign extra keys to any desired matrix character or command. Six keys already wired in a 1 × 6 key string provide hex letters A through F. With some trace cutting, remaining keys can be assigned to the TRS-80 T-Bug monitor commands. Two keys on this keyboard were latching on/off switches. We removed the top part and snap disk from two switches of a spare keyboard and installed them in the on/off switch bodies. Then we relabelled keytops.

Keyswitches on a full typewriter keyboard are usually fully isolated, normally-open spst types, but check before you buy. The surplus typewriter keyboard may differ in some respects and may contain extra keys and keytop label variations. With some relabelling of keys, these make excellent tandem keyboards that allow a student and instructor to operate the same computer from different locations.

The possibility of connecting several additional keyboards in tandem may occur to some readers. However, you cannot run long lengths of ribbon cable with wild abandon. Our tandem keyboard was tested using 10' (about 3 meters) of KW2-20 ribbon cable with four lines assigned as a ground screen. This is not good practice because the lengthy cable is not adequately buffered and is not fully ground-planed. Also, its lines are not terminated. The TRS-80 performed satisfactorily but in all likelihood with a reduction in noise margin. It is recommended that cable length be limited to 4' or 5' (1.2 to 1.5 m) and no more than required in any case.

Conclusion. From the foregoing, you can readily see that adding a keyboard in tandem with one in an existing computer system or terminal is a relatively simple matter. Although we used a Radio Shack TRS-80 computer to demonstrate how to perform the modification, the procedure is readily adaptable to most other types of personal computer systems. ◇

BY DAVID A. ISRAEL

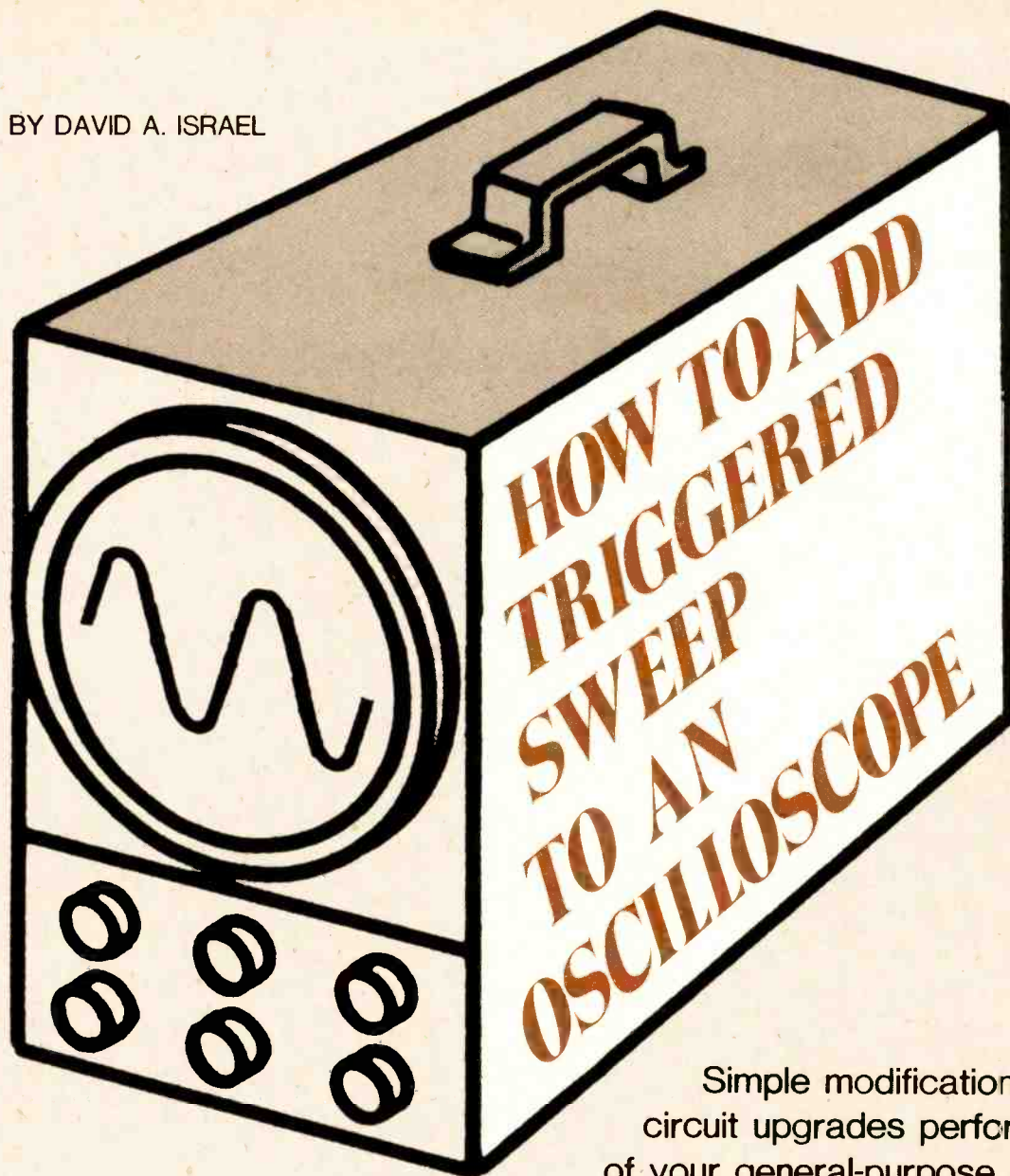

Simple modification
circuit upgrades performance
of your general-purpose instrument

IF YOU ARE still struggling along with an old, service-type recurrent-sweep oscilloscope, your instrument is woefully inadequate for modern needs. However, one can upgrade such a general-purpose scope's performance at relatively little cost simply by adding the high-performance triggered-sweep circuit described here. In comparison with an earlier triggered-sweep add-on (POPULAR ELECTRONICS, May 1978), the new circuit is much faster and triggering sensitivity does not interact with output amplitude among other benefits.

This circuit can be added to most scopes to produce calibrated triggered sweeps at speeds from 0.5 s to 0.5 μ s/division in the standard 1-2-5 format. In addition to manual trigger-level selec-

tion, it features free-run capability with automatic triggering, and adjustable input-stage gain and frequency response for easy triggering on low-level and noisy signals. A LED tells you when a sweep is being generated. Cost is about \$35.

About the Circuit. The heart of the circuit, shown in Fig. 1, is field-effect current regulator *CR1*. This device adjusts its resistance to provide a constant current with only slight regard (within limits) to the voltage applied across it.

Since the rate of change in voltage across timing capacitor C_T is directly proportional to the current flow, keeping the charging current constant causes the capacitor voltage to rise linearly. Applying this linear ramp waveform to

the horizontal axis of the scope makes the electronic beam move equal distances across the CRT screen in equal time increments. The sweep rate is also inversely proportional to the value of C_T . Therefore, to obtain varying sweep rates, the charging current is kept constant, while the value of C_T is changed.

The input of *IC1* is isolated from dc by *C1*, while *D1* and *D2* clamp excessive-amplitude signals. Resistors *R4* and *R5* provide biasing for *IC1* so that the output can symmetrically vary within the supply range. Stage gain for *IC1* is either $\times 10$ through *R2* or $\times 1$ through *R3*. When *S2* switches in *C3*, stage bandwidth is limited to allow reliable triggering on slow input signals on which high-frequency noise is superimposed.

Ion Fountain™

YOUR ULTIMATE AIR FRESHENING/
IONIZING SYSTEM. TOP QUALITY.
LOW PRICE. STATE OF THE ART.



Breakthrough. The new Ion Fountain™ is in a class by itself. This negative ion generator gives you power to saturate your home or office with billions of refreshing ions. Without fans or any moving parts it puts out a pleasant breeze. A pure flow of ions pours from the top like water from a fountain, filling your room. The result? Your air feels like fresh ocean air—pure, crisp, and wonderfully charged.

The price? **Only \$79.95.** That's a price breakthrough because no other company can offer you a unit with higher ion output or better quality than the Ion Fountain™, even at triple our price.

HOW CAN WE DO IT?

Six years of experience helps. Plus a lot of ingenuity, aggressive research and a personal commitment to give our customers the best we can.

UTP Ion Research Center is a branch of our educational publishing company. And our commitment in publishing to give birth to new ideas and methods that enrich humanity is part of the Ion Research Center too. We're in business to serve you and your environmental needs.

WHAT ARE IONS?

Ions are electrically charged atoms in the air with either a positive or negative charge. The sun and cosmic rays as well as lightning and fast-moving water (like waterfalls, surf) generate trillions of negative ions every day. The more negatively ionized the air, the fresher and more alive it is. Air pollution, artificially controlled climates (with air conditioning and heating) and electronic equipment all produce excess positive ions, depriving the air of these small negative air ions and creating dead "stuffy" air.

WHAT'S THE SOLUTION?

Our rapid-growth technology, which sometimes takes its toll on the quality of our air, has also come up with the solution. Following Nature's model of the thunderstorm which uses a high electrical charge to purify, revitalize and stimulate the air, the UTP Air Energizer has been developed imitating this process. Both the thunderstorm and the Air Energizer fill the air with negative ions, restoring the natural electrical balance to the polluted, energy-depleted air. But the Ion Fountain can be used indoors in the home, office, workshop, laboratory, etc., keeping a fresh supply of ionized oxygen available night and day. This new breakthrough in fresh air control is not a cover-up

which masks or deodorizes. The unit actually removes the dust, smoke, bacteria and pollen particles from the air by attaching ions to them and causing them to sink to the earth where they can be vacuumed up rather than inhaled. At the same time ions electrically stimulate the energy-stripped air.

YOUR CHOICE OF TWO TOP-QUALITY UNITS!

There's only one unit that's better than the Ion Fountain. That's our own Executive System Four™. It sells for \$159. It has an even higher ion output. Plus! Our special **Dial-An-Ion** feature allows you to adjust the ion output anywhere from low to high. Not everyone knows that the need for ions varies. A large smoky room will require higher output than a small room. And some people want fewer ions while sleeping than while working. The new Executive System Four is our answer to this need for output flexibility.

FACTS YOU NEED TO KNOW The Ion Fountain™—System Five

Ion density: 430,000 ions per cm³/sec. at 1 meter. 1.55 million ions per cm³ at 50 cms.
Use: Large room or office—9000 cu. ft.
Warranty: 1 year
Output voltage: 15KV
Ozone: Less than 2 parts per billion
Dimensions: 5 3/8" x 4 1/4" x 2 3/8"

Executive System Four™

Ion density: Low to maximum of 540,000 ions per cm³ at 1 meter. 1.6 x 10⁶ ions per cm³ at 50 cms.
Output voltage: 15KV
Ozone: Less than 2 parts per billion
Dimensions: 11" x 5" x 4"
Use: Large room or office 10,000 cu. ft.
Warranty: 1 year

If the Executive System Four is better, why did we bring out the Ion Fountain? Not everybody is willing to pay \$159 for an air ionizing unit, no matter how good it is. Just like not everyone drives Rolls Royces. Most drive less expensive cars. The Executive System Four is for the person who wants the

absolute best quality and doesn't mind paying a little extra to get it. If you want highest ion output, flexibility, and a beautiful oak paneled case, buy the Executive System Four.

If you want something at half the price of the Executive System Four, but still better than any other units costing up to \$250, buy the Ion Fountain.

HOW TO GET ONE

To place your order now just send a check for \$79.95 plus \$3 shipping for the Ion Fountain. Or send \$159 plus \$4 shipping for the Executive System Four. Tell us your full street address as we cannot ship to Post Office boxes. (California residents add 6% sales tax.)

Our unit is dependable and trouble-free, but if by rare chance any problems occur our service-by-mail center sends off your unit within 24 hours of receipt or sends a replacement so you are not without fresh air and can enjoy your dust-free environment. And each Air Energizer is backed by a full one-year limited warranty.

HOW TO GET ONE FAST

Credit card holders can call our toll-free number below. Order a unit now and if you are not satisfied with its effects within 10 days simply return it for a full cash refund. Order your Air Energizer today.

UTP

Read "The Golden Egg"

University of the Trees Press
ION RESEARCH CENTER, Dept. PE4
Box 644 BOULDER CREEK, CA95006
Call Toll-Free . . . 800-538-0750
In California call (408) 338-6663
Send check or use your Master Charge,
Visa or American Express card.

DETECT YOUR IONS

This simple but accurate detector instantly gives you a reading of ion intensity.
The Econometer . . . (Pen Size) . . . \$7.50
[If ordering separately include \$2.00 for shipping.]

SURVIVAL! Spirulina is a new wonder food supplement higher in protein than any other natural source. Very high in other nutrients too. Find out how you can be a commissioned representative of the Light Force Family and distribute Spirulina in either bulk or as special vitamin supplements. Generous commissions and opportunities available. **Phone or write for your free information. (408) 338-9436.** Please do not use the toll-free number for information.

Comparator *IC2* determines the actual trigger point on the input waveform. Two modes of operation are selectable via *S4*. In *NORM*, the *IC1* signal is compared with a dc voltage set by *TRIG LEVEL* control *R7*. When the voltage at the + input of *IC2* exceeds that at its - input, *IC2*'s output swings positive, and vice versa. Resistor *R10* adds positive feedback to the circuit, and the approximately 0.5-volt hysteresis prevents generation of multiple outputs with noisy input signals.

In *AUTO*, *R7* is switched out of the circuit and is replaced by *R11* and *C4*. Now, *IC2* operates as an astable multivibrator at approximately 50 Hz in the absence of an input signal. This provides a constant scope trace base line for operator convenience and allows dc input levels to be measured.

When a greater than 50-Hz signal is

applied to the input, *IC2* automatically synchronizes to the input signal. With *S4* set to *NORM*, *S3* selects triggering on either the positive or the negative slope of the input waveform. When *S4* is set to *AUTO*, *S3* has no effect.

The remainder of the circuit controls the charging and discharging of *C_T* to produce the sweep waveform. When the circuit is quiescent (not triggered), the not-Q output of *IC3* is high and *Q1* conducts to discharge *C_T* and prevent recharging as long as not-Q is high. Note that not-Q also sets the J input of *IC3* to high. Since the K input is tied to ground, the flip-flop must change states on the next clock input.

When the positive-going edge of the trigger pulse is applied to the CK input of *IC3*, the flip-flop changes states. Now, *Q1* cuts off and allows *C_T* to charge through *CR1* to produce a linear sweep.

When not-Q goes low, *Q* goes high and *TRIGGERED LED1* comes on to signal that triggering has occurred. The J and K inputs of *IC3* are now both low, and the flip-flop is immune to any trigger pulses that might occur in the sweep.

The selected *C_T* capacitor charges until the voltage across it just exceeds the voltage at the *R15/R16* junction. When this occurs, comparator *IC4*, whose output has been at near ground potential, generates a positive reset pulse for *IC3*. This forces *IC3* back into quiescence, turning off *LED1* and turning on *Q1* to rapidly discharge *C_T*. As *C_T* rapidly discharges, the scope's electron beam rapidly retraces to the starting position on the left side of the scope CRT screen.

Construction. With the exception of *S1* through *S5*, *R7*, and *LED1*, which mount

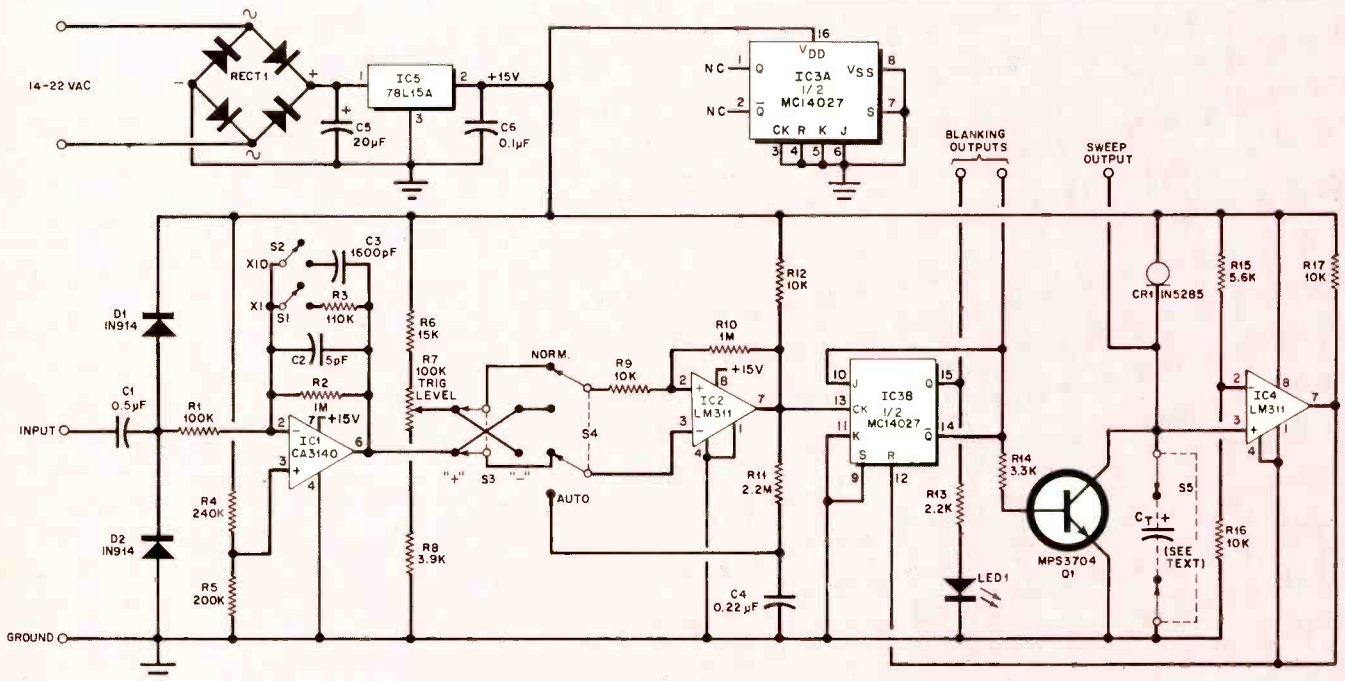

Fig. 1. A linear ramp is generated across the timing capacitor by the current regulator *CR1*.

PARTS LIST

C1—0.5- μ F, 600-V
 C2—5-pF ceramic
 C3—1600-pF ceramic
 C4—0.22- μ F, 50-V miniature monolithic
 C5—20- μ F, 35-V electrolytic
 C6—0.1- μ F, 50-V miniature monolithic
 C_T—Timing capacitor (see text)
 CR1—1N5285 field-effect current-regulating diode, 0.27 mA (Motorola)
 D1, D2—1N914
 IC1—CA3140S MOS bipolar op amp
 IC2, IC4—LM311N comparator
 IC3—MCI4027CP dual J-K flip-flop
 IC5—78L15A 15-V voltage regulator

LED1—Discrete LED
 Q1—MPS3704 general-purpose npn small-signal transistor (or similar)
 RECT1—50-PIV, 1-ampere modular bridge rectifier
 The following are 1/4-watt, 5% fixed resistors unless otherwise noted:
 R1—100,000 ohms
 R2, R10—1 megohm
 R3—110,000 ohms
 R4—240,000 ohms
 R5—200,000 ohms
 R6—15,000 ohms

R7—100,000-ohm linear-taper potentiometer
 R8—3900 ohms
 R9, R12, R16, R17—10,000 ohms
 R11—2.2 megohms
 R13—2200 ohms
 R14—3300 ohms
 R15—5600 ohms
 S1, S2—Miniature spst switch
 S3, S4—Miniature dpdt switch
 S5—2-pole, 2-23 position rotary selector switch (Centralab PA-4003 or similar)
 Misc.—Pc board, mounting hardware, knobs, LED panel-mount adapter.

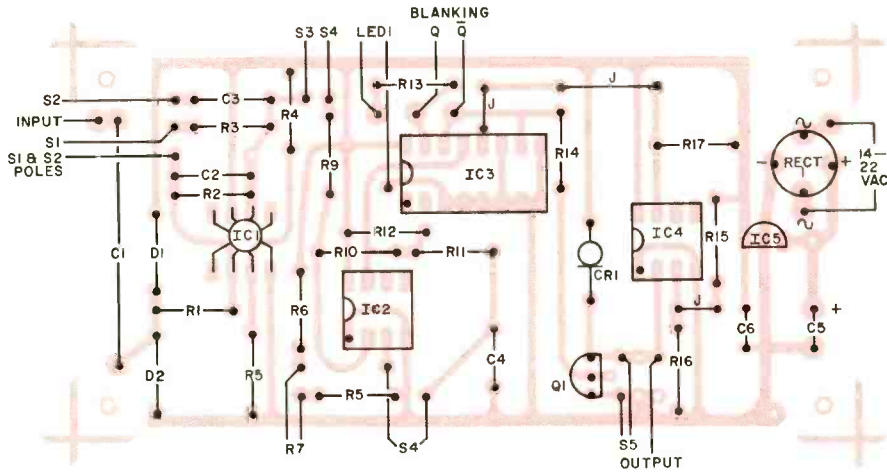
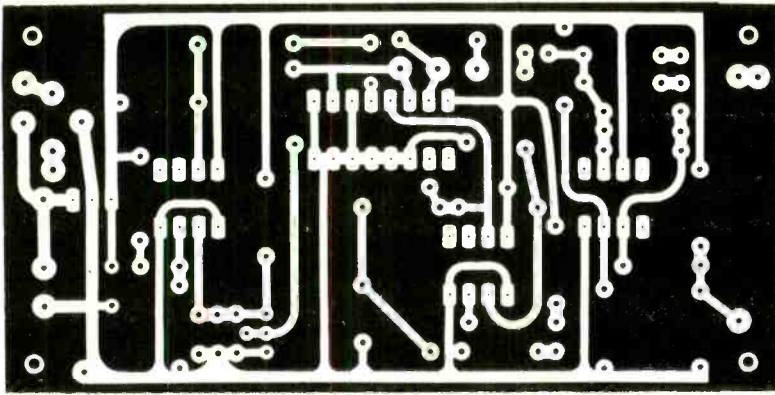

Fig. 2. An actual-size etching and drilling guide for a printed-circuit board is shown at top. Below it is guide for component placement.

on the scope's front panel, all components mount on a small printed-circuit board. An actual-size etching and drilling guide for the board is shown in Fig. 2. During installation of the components on the board, be sure to observe the proper polarities and orientations of the diodes, CR1, and ICs. Also, be sure to observe the safe handling procedures for IC1 and IC3, which are MOS devices.

The C_T timing capacitors mount directly on SWEEP SPEED switch S5. No values are given for these capacitors in the Parts List since they are hand selected to minimize cost while providing the necessary accuracy. More about this under Calibration.

The circuit board is best mounted inside the scope, although a separate case can be used if desired. Inside the scope, try to locate the board as far as possible from heat-producing components. Unless you wish to retain the recurrent-sweep generator in the scope, disable this circuit and remove the associated controls from the front panel. When mounting the TRIG LEVEL control, switches, and LED1 on the panel, it may

be necessary to drill additional holes to accommodate them.

You may wish to use a rotary switch on TRIG LEVEL control R7 for S4 instead of a miniature toggle switch. This will allow you to turn R7 to one end of its travel to switch the circuit to AUTO. Also, if you wish to avoid drilling holes in your scope, S1 and S2 can be replaced by a double-pole, four-position rotary switch.

If your scope has a +18- to +30-volt power supply, you can omit RECT1 and connect the dc supply to the input of IC5. Alternatively, you can use a small filament transformer rated at 14 to 22 volts rms to supply power. The circuit draws typically 20 to 25 mA.

The pickoff point for the trigger signal depends on the scope being modified. Ideally, it should be at a point in the scope's vertical amplifier after the input attenuator and any gain controls so that the input voltage varies over a limited range, in the region of 0.5 to 20 volts peak-peak. (Refer to the schematic diagram of your scope.) In some cases, the scope manufacturer will make this easy for you by using such a point as a source

of sync signal to the recurrent sweep.

Your scope may have a horizontal mode selector that provides sync from + and - slopes of input signals, as well as from the 60-Hz line and external sources. This type of selector is an ideal trigger pickoff point and provides switch-selectable trigger signals. If such a switch is present, S3 in the project is redundant and can be eliminated. It is very useful to have the capability to connect the input of the trigger circuit directly to the external input jack because in some cases the poor response of the scope's vertical amplifier will severely limit trigger generator performance at high frequencies.

Connect the sweep output to the input of the scope's horizontal amplifier. Direct coupling works best. With capacitive coupling, you will have to keep recentering the trace as the average dc level of the sweep waveform varies with changing proportions of sweep period and repetition rate for different signals. In some cases, the coupling capacitor at the input of the scope's horizontal amplifier can be removed if it is not blocking a dc bias level that will be fed into the sweep circuit. The sweep output of the trigger circuit is designed to be connected to a typical horizontal amplifier that has a 1-megohm or greater input impedance. Lower impedances will shunt charging current from C_T and generate a nonlinear sweep waveform.

If the circuit you are driving has less than 1-megohm input impedance, use a buffer amplifier between it and the trigger sweep. A CA3130 op amp connected in a standard voltage-follower configuration, powered from the existing single 15-volt supply, will do.

The Q and not-Q outputs of IC3 should go to pads for connection to the Z-axis circuit of the scope to provide retrace blanking. The not-Q output is at 0 volt during the sweep and switches to +15 volts during retrace, while the Q output is complementary to this. Choose the output that is correct for your scope. Again, dc coupling is preferred if available in your scope. Capacitive coupling will differentiate the blanking pulse. While you may get satisfactory retrace blanking, the beam can recover its brightness before beginning the next sweep, resulting in a vertical line at the left side of the trace. Also, when sweep begins, the blanking signal switches state rapidly, causing the coupling capacitor to charge in the opposite direction and resulting in undesirable intensification of the trace.

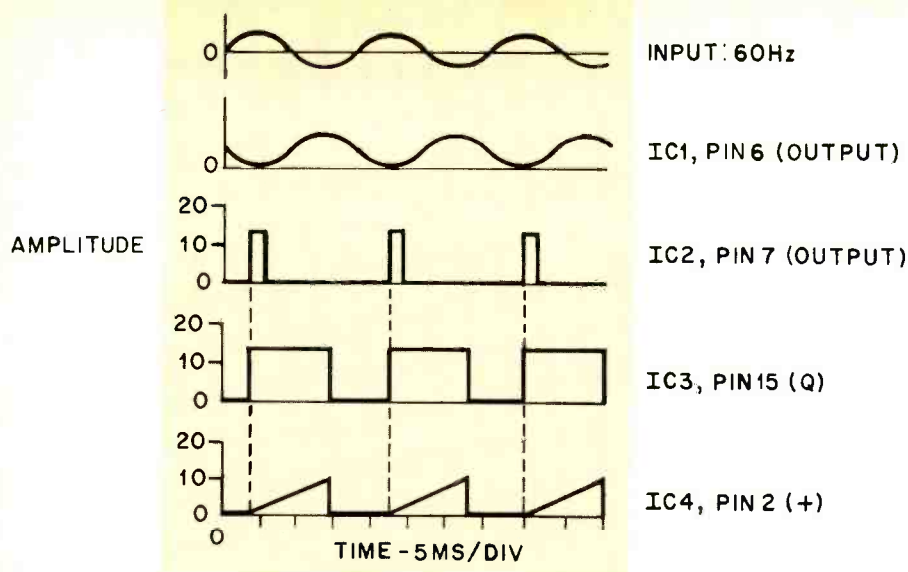

Fig. 3. Representative waveforms to be used in troubleshooting, with $S1$ on $X1$, $S2$ open, $S3$ on $+$, $S4$ on $NORMAL$, $R7$ three-quarters CCW and the timing capacitor selected for 1 ms/div .

The last problem can be reduced by first passing the blanking signal through one coupling capacitor to differentiate it and then diode clipping the unwanted half of the resulting waveform and finally connecting this signal to the Z-axis coupling capacitor.

A word of caution: In many scopes, the coupling capacitor is connected directly to the grid or cathode circuit of the CRT, which may be operating at 1000 or more volts. Do NOT attempt to bypass this capacitor or serious damage will result. A coupling capacitor can be removed from the circuit *only* if it is not blocking a dc bias voltage.

Test and Calibration. Temporarily connect a $1\text{-}\mu\text{F}$ tantalum capacitor across the C_T terminals, observing polarity. Turn on the scope and adjust for a moderate-intensity dot in the middle of the screen. Apply power to the sweep circuit. Set $S4$ to $AUTO$; a horizontal baseline trace should appear on the CRT and the TRIGGERED LED should come on. With this value of capacitor, the trace and LED indicator should flicker rapidly at the same rate.

If a trace does not appear, check the scope's BRIGHTNESS control and for $+15$ volts on the trigger-sweep bus. Representative waveforms for trouble-shooting are shown in Fig. 3. In this test, $S1$ is set to $\times 1$, $S2$ is open, $S3$ is at $+$, $S4$ is set to $NORMAL$, $R7$ is three-quarters CCW , and C_T is selected for 1 ms/division .

Using this setup, apply a 1-volt, 60-Hz sine-wave signal to the scope's vertical input. The sweep should automatically lock onto this signal and a steady display of three to four cycles should be seen on-screen. Check for any obvious nonlinearities. Rotate TRIG LEVEL control $R7$; the trace should disappear and reappear and the trigger level should vary up and down one side of the sine wave. Also note the change in the sensitivity of $R7$ when ATTENUATOR $S1$ is switched from $\times 1$ to $\times 10$.

Center the scope trace and note its length. Before you can calibrate the sweep for a given time per unit length, overall length of the sweep must be set to a given repeatable value. (To ensure that the sweep is not inadvertently adjusted after calibration, the horizontal-gain control can be mounted inside the scope, or it can be replaced with a pair of fixed resistors.)

Adjust the length of the trace to fill the screen. In some cases, the frequency response of the scope's horizontal amplifier may roll off at a lower frequency than those generated by this circuit at the highest sweep speeds, resulting in a shorter trace. You can compensate for this by setting the horizontal gain so that the trace is longer than the width of the screen at slow speeds. This will not affect accuracy at any speed, since each range is individually calibrated.

To calibrate the sweep, you need a source of reasonable-accuracy (1% will

do) square waves. A crystal-controlled timebase is ideal. You can also use a signal generator and frequency counter.

Before starting, wire the pc board terminals to the rotor connections of SWEEP SPEED selector $S5$, using a length of two-conductor cable that will be appropriate for the physical layout of your scope. It is important that you do this before calibration because the capacitance of the cable will be in parallel with the selected timing capacitors and at the highest sweep speeds will comprise a large portion of the timing capacitance.

Begin calibration at the highest sweep speed and work down. With the capacitance of the cable serving as the timing capacitor, feed a 1-MHz square wave to the scope's input. Adjust the trigger and scope controls for a stable, centered display. To obtain a stable display with low-bandwidth scopes, the vertical amplifier may have to be bypassed with the sweep circuit input connected directly to the signal source. Experiment with several different capacitors connected to the switch until you find the value that produces a sweep speed closest to the desired $0.5\text{ }\mu\text{s/division}$ but not slower than this. That is, one cycle should occupy two divisions or slightly more. Unless you have a large number of capacitors on hand, you will find that the best way to obtain the exact capacitance value needed will be to parallel one capacitor with a lower-value capacitor until you obtain the desired display. Do your measuring between corresponding points in different cycles of the waveform. Do not, for example, measure between a rising and a falling edge of one cycle or of consecutive cycles. By following this rule, you will avoid errors introduced by asymmetry in the signal source and splaying or overshoot of the trace itself. For best results, choose two points separated by about six or eight divisions and equally spaced from the center line of the scope screen.

In the same manner, select the remaining timing capacitors, soldering them to the lugs of $S5$ as you proceed. The next value should produce a $1\text{-}\mu\text{s/division}$ sweep speed, then $2\text{ }\mu\text{s/division}$, $5\text{ }\mu\text{s/division}$, etc., in the 1-2-5 format. For values larger than $0.5\text{ }\mu\text{F}$ or so, use high-quality tantalum capacitors and take care to observe polarity.

Operating Hints. The triggered-sweep circuit is very easy to use. For most applications, leave the input amplifier selector set to $\times 10$ and set the mode

switch to AUTO. Then set the number of cycles of the waveform you wish to view with SPEED selector S5. The period of any waveform can be obtained directly from the screen as the time it takes the beam to "write" one cycle, while the frequency is the reciprocal of this time.

Obtaining a stable display of a fraction of a repetitive waveform cycle is also easy. First, adjust the scope's vertical-gain, brightness, and centering controls for a stable display of several cycles. Set S4 to NORM and adjust R7 until the beginning of the portion of interest is at the left side of the screen.

Large-amplitude signals may drive IC1 into saturation, causing clipping and an apparent reduction in the range of the TRIG LEVEL control. If you cannot position the waveform properly, close S1 to reduce the gain of the input op amp stage to unity.

Once the waveform is positioned, increase sweep speed until desired magnification is reached. Advance the brightness as necessary. When using very high-speed sweeps with relatively low-repetition-rate triggers, the scope beam and TRIGGERED LED will be very dim or appear to be off even when a sweep

is present. This is due to the very low duty cycles in these situations.

As mentioned previously, bandwidth and/or noise limitations of the vertical amplifiers of some low-cost scopes may make triggering on high-frequency signals jittery at best or even impossible. In some of these cases (CMOS or TTL logic running in the low megahertz-range, for example), where signal amplitudes are in the 1-to-20-volt range and circuit loading tolerance is not too critical, the trigger signal can be routed directly to the input of the scope sweep circuit.

Another situation in which the best choice of trigger source is not immediately obvious occurs when you are looking for 60-Hz line noise. For example, if you are checking the output of a dc power supply with 1 or 2 mV of ripple, there will often be insufficient gain in the scope's vertical amplifier to yield a clean trigger pulse and the sweep will run free. However, since the ripple will occur exactly at the power-line frequency or a whole-number multiple thereof, syncing the sweep to the 60-Hz line will provide a rock-steady trace.

Providing a trigger-source selector

switch that can disconnect the input of the sweep circuit from the vertical amplifier and connect it to an internal line-voltage source simplifies sweep syncing. The pickoff point can be the secondary of any low-voltage transformer in your scope.

If you wish to gate an external device, such as an oscillator, in sync with the sweep generator, a CMOS-compatible signal is available at the Q output of IC3, which is at 0 volt during retrace and +15 volts during sweep. The inverse of this is present at not-Q. In some applications, you may wish to sweep an external oscillator directly, using the sweep output of the circuit. Use a buffer amplifier if necessary to prevent excessive loading by low-impedance inputs.

Summing Up. By substituting the high-performance triggered sweep described here for the recurrent sweep in an older scope, you can upgrade the instrument to permit better waveform analysis as needed for examining modern circuits. Cost is modest and installation is fairly simple. It will also enable you to hold off on purchase of a costly modern scope for a while longer. ♦

Price Without Sacrifice.

HITACHI V-302 & V-152

Put a proven Hitachi dual-trace oscilloscope on your bench for as little as \$695. Our V-152 15MHz model includes unprecedented sensitivity (1 mV/div.)...10X sweep magnification...front panel XY operation...trace rotation...Z-axis input...and more. Need greater bandwidth? Our V-302 model is the only 30MHz dual-trace scope with signal delay line priced under \$1000, with all the above features, to make your testing operations fast, easy, and accurate. Reliability is exceptional, too. (As you'd expect from a manufacturer with over 20 years of experience "outscoping" the competition.) So exceptional, in fact, that Hitachi quality is backed by a 2-year warranty...the longest in the industry. Whether you use it for teaching or repairs, for video, audio, or computer testing, you can't find more scope for your dollar than at Hitachi. Write for more details.

Hitachi...The measure of quality.

- V-152 15 MHz Dual Trace . . . \$695*
 - V-302 30 MHz Dual Trace . . . \$945*
- *Probes included.



HITACHI
Hitachi Denshi America, Ltd.
175 Crossways Park West
Woodbury, NY 11797
(516) 921-7200



CIRCLE NO. 28 ON FREE INFORMATION CARD

BUILD A VOCAL "TRUTH" ANALYZER

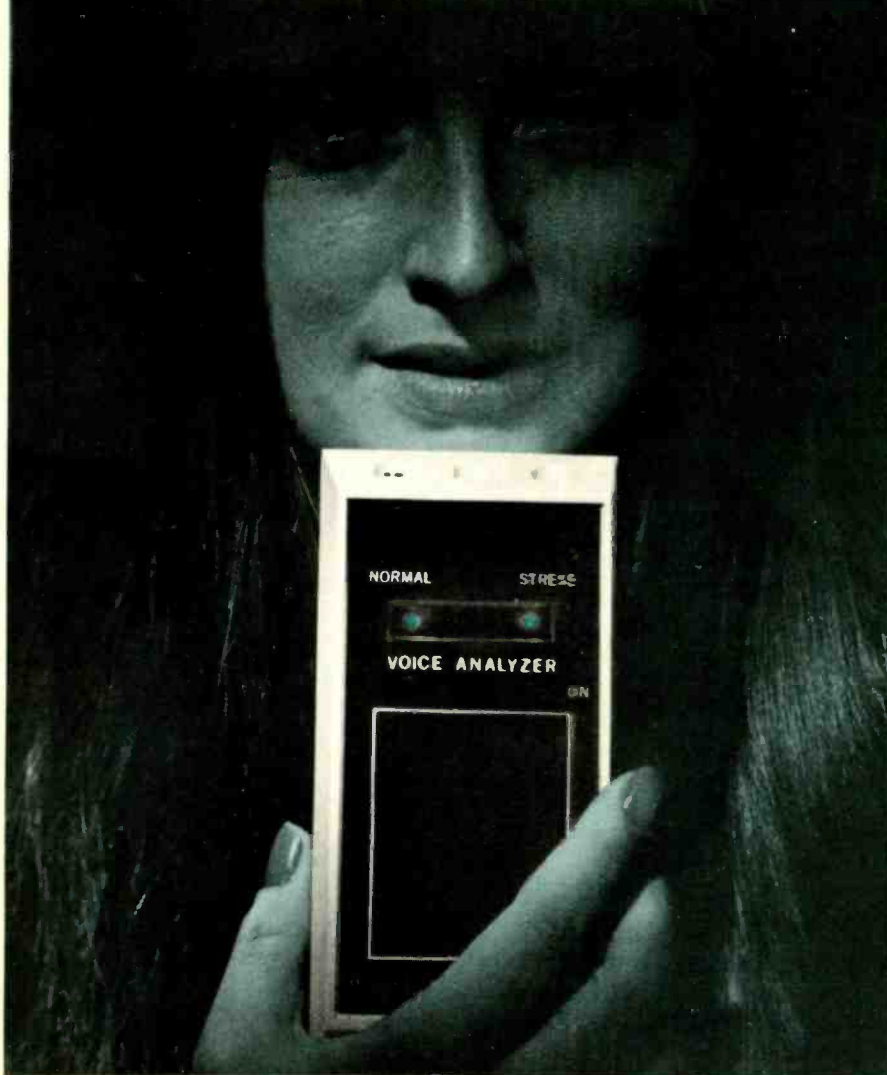

BY COLLEEN McNEICE
AND ROGER COTA

Hand-held LED-
display instrument
is said to detect
voice stress

SO-CALLED "electronic lie detectors" have become controversial items. Some workers in the fields of security and law-enforcement swear by them, while others (including some psychologists) hold that the principles on which the devices are based are ill-founded and unscientific. Still other individuals denounce the application of lie detectors as an invasion of privacy.

Actually, the best that these detectors can do is measure psychological

stress. Even then, the measurement is indirect. Basically, the device makes its determination by sensing an effect of one type or another that many researchers believe is an accurate indicator of stress. Validation studies have been used to compile an impressive record of successes, but it should be remembered that a high degree of interpretational skill is required and there is always an appreciable probability for error in using such an instrument.

One popular indicator of stress has been the relative amplitude of certain vocal modulations in a person's speech. The Voice Stress Analyzer described here is a small, readily portable unit. It is designed to operate on the principles pioneered by Dektor and other companies in the field whose products have received wide acceptance.

Basic Theory. Extensive military research and wartime counterintelligence work have yielded several theories and devices that have been used during interrogation in an attempt to separate truth from falsehood. One of these theories is that human voices, which have fundamental frequencies ranging from about 90 to 200 Hz, are normally modulated by an 8-to-12-Hz "microtremor" signal. The latter's effect is usually masked by other voice components; but, according to these researchers, reasonably simple electronic circuitry can detect and measure the microtremors.

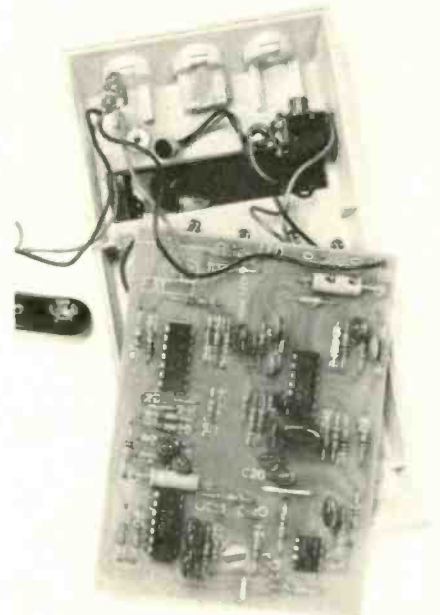

LEDs are positioned in window area, miniature microphone is put in center cutout at top of case.

(continued on page 68)

Reel Versatility At a Cassette Deck Price. The New Realistic® Upgrader.

Upgrading is for music lovers who can hear the difference. For them, Radio Shack has made "the difference" affordable . . . for example 30-28,000 Hz (± 3 dB) frequency response, extended dynamic range, low distortion, low noise — you get it all in the easy-to-be-creative open reel format. Tape handling is no problem because the TR-3000 is totally logic controlled. A pushbutton-activated solenoid system controls all tape movement — you can switch functions instantly, without tape spills or snarls. Pause and mute controls even let you edit, electronically, as you record.

The TR-3000 has three motors. A precision servo-controlled capstan motor reduces wow and flutter to less than 0.06% WRMS. And two high-torque reel motors maintain constant tape tension for smooth, fast winding. Separate play, record and erase heads give you "off-the-tape" monitoring. Individual mike and line input controls work like a built-in mixer. High/low bias and EQ switches for an optimum match with any tape. $7\frac{1}{2}$ and $3\frac{3}{4}$ ips speeds. And lots more. Realistically priced at only \$499.95.* Check its superb sound and specs at one of our 7000 locations today!



Radio Shack®

The Nationwide Supermarket of Sound®

*Retail price may vary at individual stores and dealers, Cat. No. 14-700. Illustrated metal reels an extra option.

VOCAL ANALYZER *continued*

When a person is under stress, says the theory, normal vocal microtremors diminish greatly in amplitude. The autonomic nervous system, preparing the body for emergency reactions, causes the pupils to dilate, blood to rush away from the limbs, and the muscles to tense. Since the vocal chords are principally muscular tissue, they, too, tighten and decrease the amplitude of microtremors. Thus, it is claimed, measuring the relative amplitude of vocal microtremors gives an indication of stress. The waveform of a human voice with microtremor, indicating no or very little stress, is shown in Fig. 1A, its spectral content in Fig. 1B.

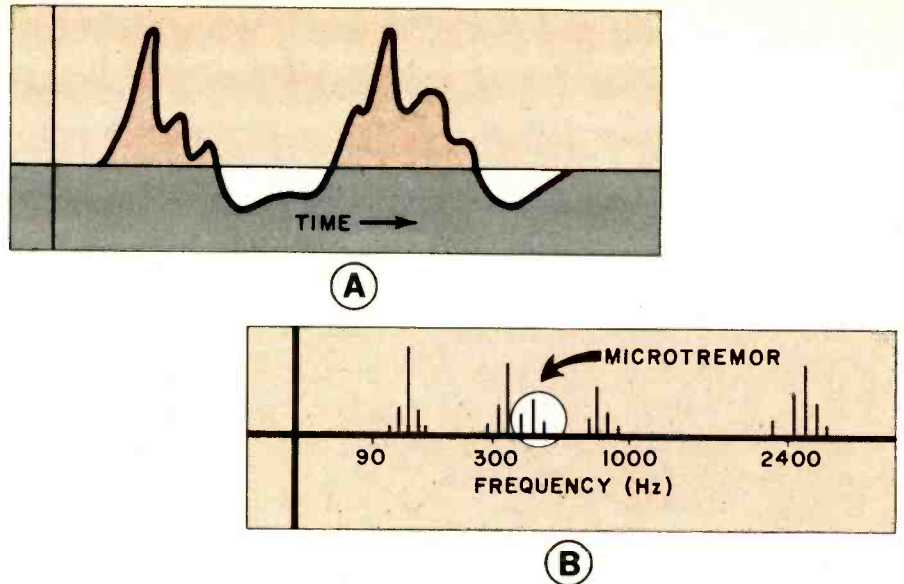

Fig. 1. Waveform of the human voice with microtremors is shown at (A), spectral content of voice is at (B).

System Operation. Basic operation of the Voice Stress Analyzer is shown in Fig. 2, while Fig. 3 illustrates typical waveforms (not drawn to scale) that occur in the circuit.

The input voice signal in Fig. 3A illustrates the somewhat closer peak spacing attributed to microtremors as compared with the "normal" spacing of the peaks in the voice signal. After amplification, the composite voice signal goes to a voice-frequency bandpass filter to remove extraneous noise. Then the signal input is half-wave rectified. In a 150-Hz low-pass filter, the higher voice frequencies are attenuated, leaving only the lower frequencies, including those of the microtremors (Fig. 3B). The positive-going output then toggles a Schmitt trigger (Fig. 3C) to produce a squared-off waveform. The latter is suitable for toggling a one-shot multivibrator that then

produces the 1.5-ms pulses shown in Fig. 3D.

As the 8-to-12-Hz microtremor modulates the fundamental, spacing between pulses changes. Pulses from the one-shot then pass through a 20-Hz low-pass filter and an 8-to-12-Hz filter, after which it is rectified and integrated to form a smooth voltage. This signal may rise above a preset threshold when the microtremors are closely spaced, in a manner similar to that of the vertical-sync scheme used in a TV receiver. When the integrated output is above the threshold, it causes the LEDs to come on in a particular sequence (Fig. 3E).

The Circuit. Figures 4 and 5 illustrate the complete schematic diagram of the Voice Stress Analyzer. The IC2D circuit (Fig. 5) supplies the ground tap required by the op amps. Resistors *R1* and *R2* and capacitor *C1* provide power from battery *B1* for the condenser microphone. Jack *J1* is a transfer type that disconnects *MIC* when an external audio source is plugged into it. (The external source can be a telephone pickup, dynamic microphone, or output from a tape recorder.)

Audio amplifier *IC1A* operates close to its open-loop gain whose output goes to the *IC1B* bandpass-filter circuit. Recti-

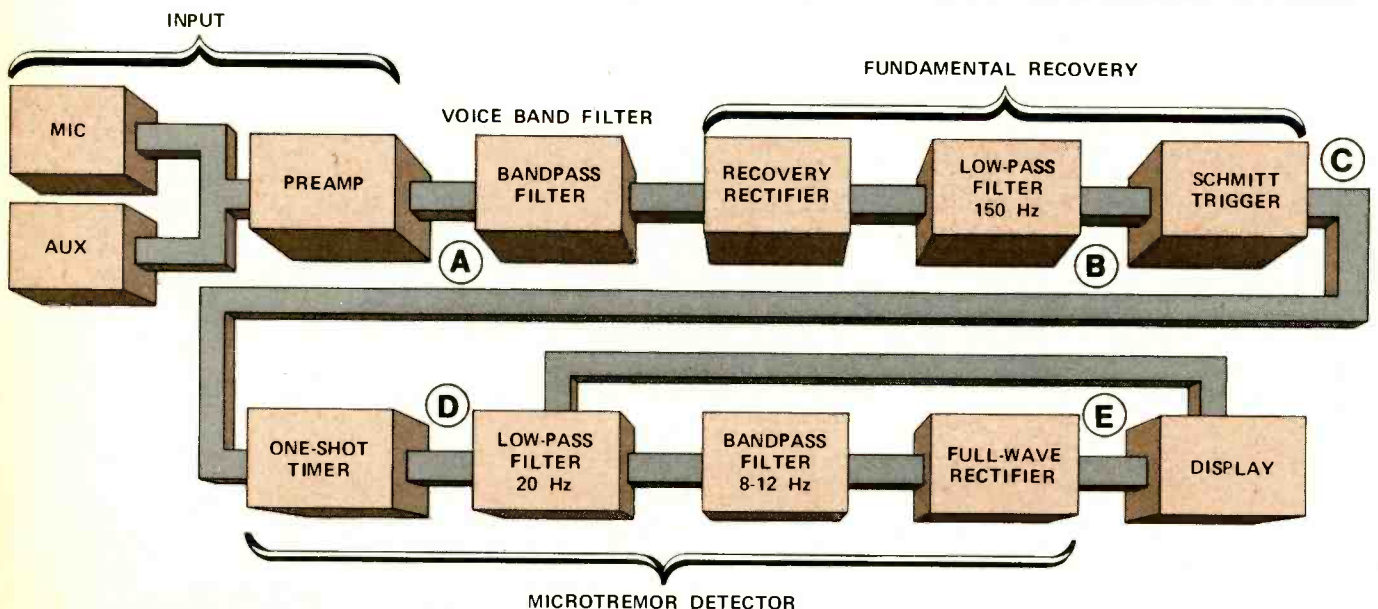

Fig. 2. The analyzer circuit is designed to extract the 8-to-12-Hz microtremor from the voice input and use the resultant signal to turn on a LED display.

fier *D1* half-wave rectifies the signal to recover the fundamental modulating frequency. Higher harmonics are removed by *IC1C*, an 18-dB/octave filter that passes only those frequency components below 150 Hz.

Schmitt-trigger circuit *IC1D* converts the recovered fundamental into steep rising and falling edges that are suitable for driving timer *IC4*. As shown in Fig. 3C and D, the Schmitt trigger's sharp rise time toggles the timer, which produces a 1.5-ms pulse.

The generated pulse train goes through low-pass filter *IC2A* to remove the waveform's sharp edges and amplify any frequencies below 20 Hz. Bandpass filter *IC2B* is "tuned" to the 8-to-12-Hz microtremor frequency and amplifies any signal within this range.

Full-wave rectifier *IC3A/IC3B* accepts this signal and produces a dc output voltage that is proportional to the amplitude of the microtremor (Fig. 3E). This voltage is developed across *C19*, which is constantly being discharged by time-constant resistor *R32*.

Display drivers *IC3C* and *IC3D* are

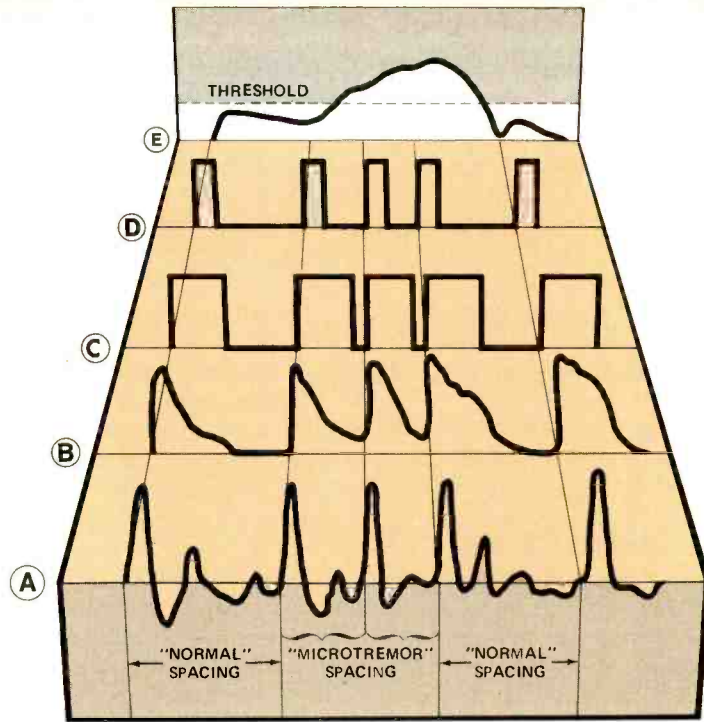

Fig. 3. Typical waveforms within the analyzer. According to the authors, the "trick" lies in detecting the presence of the narrower microtremor peak spacing within the voice frequencies. Integrated one-shot pulses derived from these signals are used to toggle the readouts.

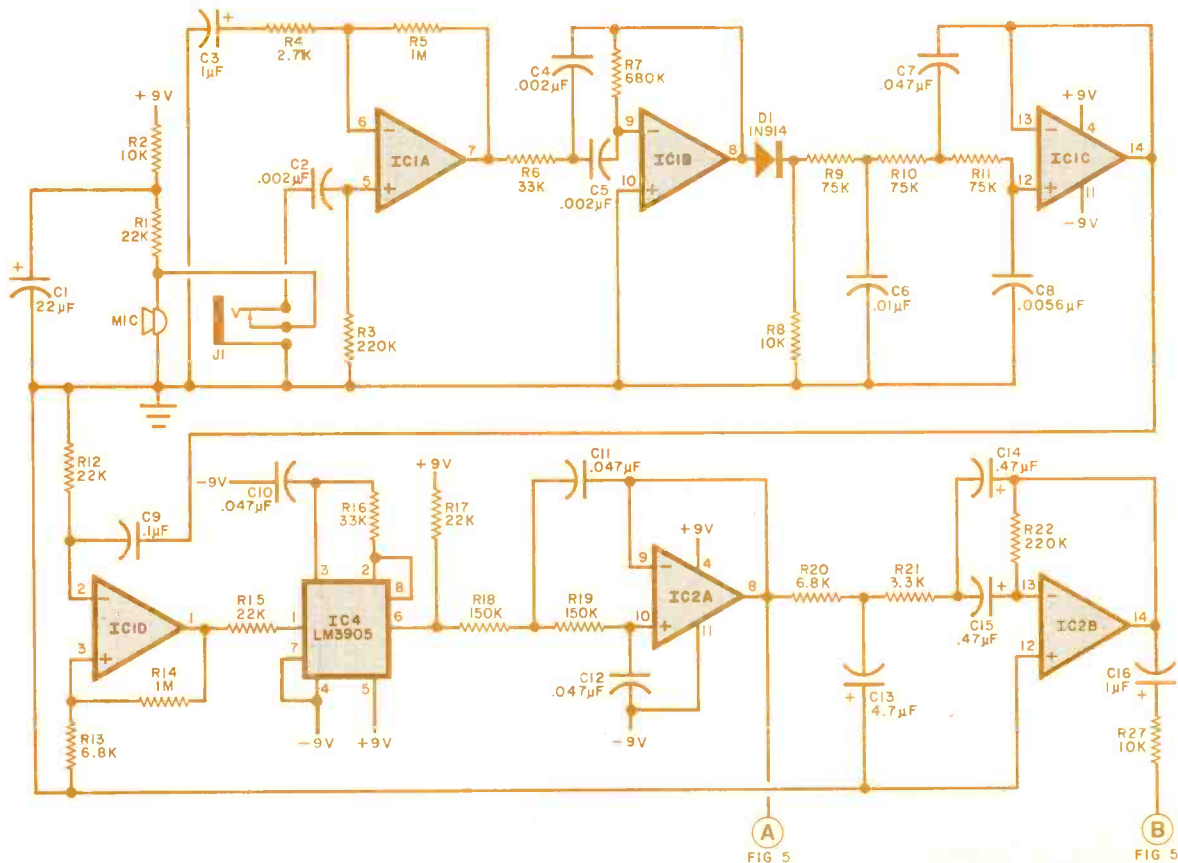

Fig. 4. The voice processing circuits of the analyzer result in 20-Hz signals from *IC2A* and 8-to-12-Hz signals from *IC2B*. These signals drive the rectifier/display section shown in Fig. 5.

connected as comparators, using the voltage generated across $R33$, $R34$, and $R35$ as the reference. The comparators then drive the LEDs. When $LED1$ comes on, presence of microtremors is indicated, meaning no stress. When these frequencies are missing, $LED4$ comes on to indicate high stress. As microtremors come and go, $LED2$ and $LED3$ come on.

The display also receives a control signal from the 20-Hz filter that turns off the LEDs when no input signal is present, conserving battery life.

Construction. Using the actual-size etching and drilling guide shown in Fig. 6, the Analyzer was designed to fit in a calculator-type case. Referring to the component-placement guide in Fig. 6, mount the components in their respective locations, taking care to properly orient the diodes, polarized capacitors, ICs, and LEDs. When installing compo-

nents on pc board, be sure to properly orient diodes, LEDs, ICs, and electrolytic capacitors, as shown in the component placement guide.

With exception of the microphone, auxiliary input jack, power switch, and battery, all components mount directly on the circuit board. The microphone and auxiliary jacks mount in holes at the top of the plastic case. (Make certain that the pickup end of the microphone points outward.) Mount the power switch on the upper surface of the case, below the display window and label its ON position with a dry-transfer lettering kit. Connect and solder the positive lead of $B1$'s battery connector to the hole A-pad on the circuit board, the negative lead to the hole B-pad.

Examine the jack and schematic diagram and connect and solder lengths of hookup wire from the jack's lugs to the appropriate E, F, and G pads on the circuit board. If you choose a recharge-

able battery for $B1$, mount a suitable power jack on the plastic case and wire it to the battery.

Now, use a dry-transfer lettering kit to label the LEDs in the display. Label $LED1$ NORMAL and $LED4$ STRESS. Leave transitional $LED2$ and $LED3$ without legends. This completes construction.

Construction. Using the actual-size controls, it should be operational as soon as power is turned on. As you speak into the microphone, you should note that the LEDs flicker, with the NORMAL LED on most of the time.

A number of tests were performed on the Voice Stress Analyzer by one of the authors. Using the audio from a TV-network news broadcast, it was noted that when the newscaster spoke, the NORMAL LED was on most of the time. When actors and actresses were speaking their roles, basically the same results were observed. However, when

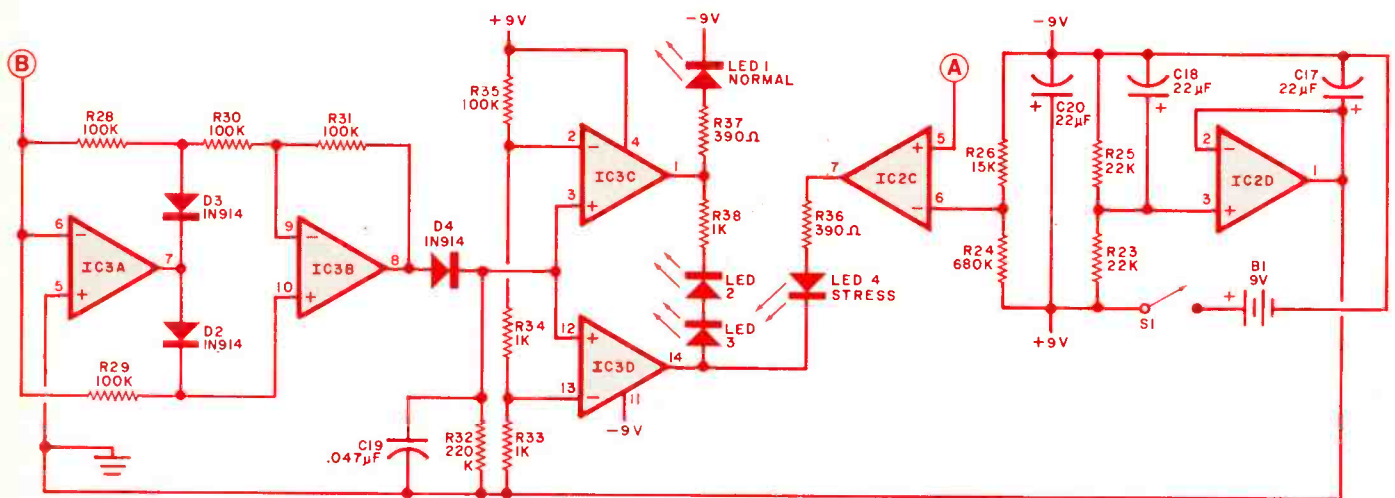

Fig. 5. The 8-to-12-Hz signals are rectified in $IC3A$ and $IC3B$, integrated in $C19$ and used to turn on a comparator ($IC3C$, $IC3D$) that causes the LED (s) to glow. $IC2C$ shuts down the LEDs when there is no 20-Hz signal, while $IC2D$ creates a bipolar supply from a single 9-volt battery.

PARTS LIST

$B1$ —9-volt battery
 $C1$, $C17$, $C18$, $C20$ —22- μ F, 16-volt tantalum
 $C2$, $C4$, $C5$ —0.002- μ F, 100-volt Mylar
 $C3$, $C16$ —1- μ F, 100-volt electrolytic
 $C6$ —0.01- μ F, 100-volt Mylar
 $C7$, $C10$, $C11$, $C12$, $C19$ —0.047- μ F, 100-volt Mylar
 $C8$ —0.0056- μ F, 100-volt Mylar
 $C9$ —0.1- μ F, 100-volt Mylar
 $C13$ —4.7- μ F, 35-volt tantalum
 $C14$, $C15$ —0.47- μ F, 35-volt, tantalum
 $D1$ through $D4$ —1N914
 $IC1$, $IC2$, $IC3$ —LM324 quad op amp
 $IC4$ —LM3905 precision timer
 $J1$ —subminiature phone jack with switch

$LED1$ through $LED4$ —red LED
 The following are $\frac{1}{4}$ -watt 5% resistors:
 $R1$, $R12$, $R15$, $R17$, $R23$, $R25$ —22,000 ohms
 $R2$, $R8$, $R27$ —10,000 ohms
 $R3$, $R22$, $R32$ —220,000 ohms
 $R4$ —2700 ohms
 $R5$, $R14$ —1 megohm
 $R6$, $R16$ —33,000 ohms
 $R7$, $R24$ —680,000 ohms
 $R9$, $R10$, $R11$ —75,000 ohms
 $R13$, $R20$ —6800 ohms
 $R18$, $R19$ —150,000 ohms
 $R21$ —3300 ohms
 $R26$ —15,000 ohms
 $R28$ through $R31$, $R35$ —100,000 ohms
 $R33$, $R34$, $R38$ —1000 ohms

$R36$, $R37$ —390 ohms
 Misc.—suitable enclosure, battery clip, hook up wire, mounting hardware, etc.

Note: The following is available from Logical Systems, 3314 H St., Vancouver, WA 98663 (Tel: 206-694-7905): complete kit including microphone, battery clip, pc board, case, and manual for \$79.00. Also available separately: etched and drilled pc board at \$9.00; hand-held case, battery clip with power jack and condenser microphone at \$18.00. Please add \$3.50 for postage/handling. Washington state residents, please add 5.1% sales tax. Allow four weeks for delivery.

WHAT'S NEW IN HOME ELECTRONICS?



Find out in the latest Heathkit Catalog. It's filled with exciting kits in every price range, all easy to assemble, all at build-it-yourself savings.

Discover the fun you and your family can have building your own home computer, stereo system, color TV. Discover the

pride of saying, "I built it myself." It's easier than you think.

Send today for your FREE Heathkit Catalog.



Heathkit®

If coupon is missing, write
Heath Co., Dept. 010-642,
Benton Harbor, MI 49022

Send For FREE Catalog Today!

**Send to: Heath Co. Dept. 010-642,
Benton Harbor, MI 49022**

Send my free Heathkit Catalog now.
I am not currently receiving your
catalog.

Name _____

Address _____

City _____ State _____

CL-724B _____ Zip _____

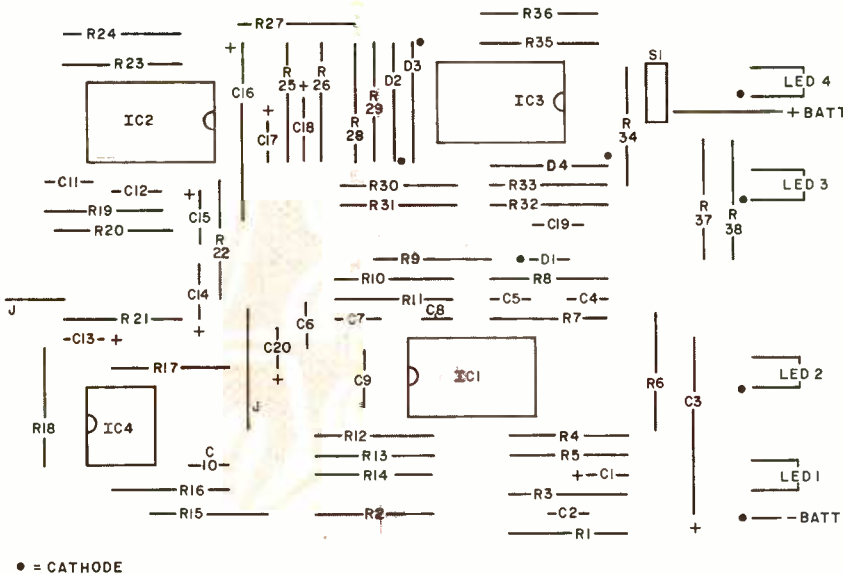

• = CATHODE

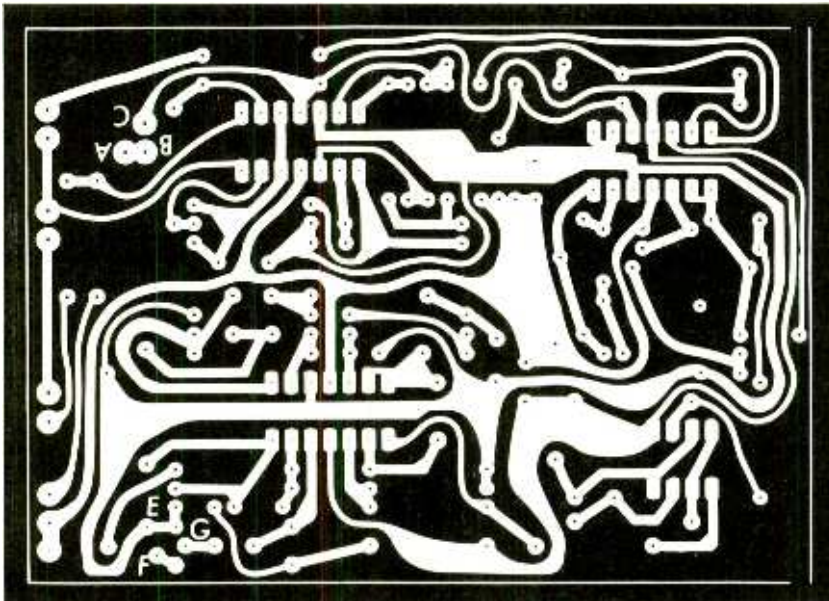

Fig. 6. Actual-size foil pattern and component placement guide for the voice analyzer. Be sure to observe polarities of electrolytic capacitors and diodes and orientation of ICs.

various advertising announcers' voices were monitored, it was interesting to note that the other LEDs had a tendency to flicker on, with the STRESS LED coming on quite often. The same was true when monitoring a number of phone-in radio programs. Finally, a number of situations were rigged, using various people as test subjects, all instructed to lie in answer to certain questions. The results were inconclusive. The results might have been pointedly different if the subjects being monitored were not aware that vocal stress tests were being conducted. Too, it should be kept in mind that voice characteristics differ among different people and even with the same

person over a short period of time.

Psychologists at one U.S. university have stated that there is no conclusive evidence that microtremors actually exist in the vocal chords. One report, prepared by a psychologist on behalf of the U.S. Army's Land Warfare Laboratory at Aberdeen Proving Ground, concluded that results obtained with voice stress devices are "no better than chance." Moreover, American Civil Liberties Union suits have been presented alleging such devices constitute invasion of privacy.

Whether or not voice stress analyzers do what is claimed of them is a debatable point. However, they are interesting devices with which to experiment. ◇

When quality counts

Do not be fooled by the low prices, these brand new lab quality frequency counters have important advantages over instruments costing much more. The models 7010 and 8010 are not old counters repackaged but 100% new designs using the latest LSI state-of-the-art circuitry. With only 4 IC's, our new 7010 offers a host of features including 10 Hz to 600 MHz operation, 9 digit display, 3 gate times and more. This outperforms units using 10-15 IC's at several times the size and power consumption. The older designs using many more parts increase the possibility of failure and complexity of troubleshooting. Look closely at our impressive specifications and note you can buy these lab quality counters for similar or less money than hobby quality units with TV xtal time bases and plastic cases!

Both the new 7010 and 8010 have new amplifier circuits with amazingly flat frequency response and improved dynamic range. Sensitivity is excellent and charted below for all frequencies covered by the instruments.

Both counters use a modern, no warm up, 10 MHz TCXO [temperature compensated xtal oscillator] time base with external clock capability - no economical 3.579545 MHz TV xtal.

Quality metal cases with machine screws and heavy gauge black anodized aluminum provide RF shielding, light weight and are rugged and attractive - not economical plastic.

For improved resolution there are 3 gate times on the 7010 and 8 gate times on the 8010 with rapid display update. For example, the 10 second gate time on either model will update the continuous display every 10.2 seconds. Some competitive counters offering a 10 second gate time may require 20 seconds between display updates.

The 7010 and 8010 carry a 100% parts and labor guarantee for a full year. No "limited" guarantee here! Fast service when you need it too, 90% of all serviced instruments are on the way back to the user within two business days.

We have earned a reputation for state-of-the-art designs, quality products, fast service and honest advertising. All of our products are manufactured and shipped from our modern 13,000 square foot facility in Ft. Lauderdale, Florida.

When quality counts...count on Optoelectronics.

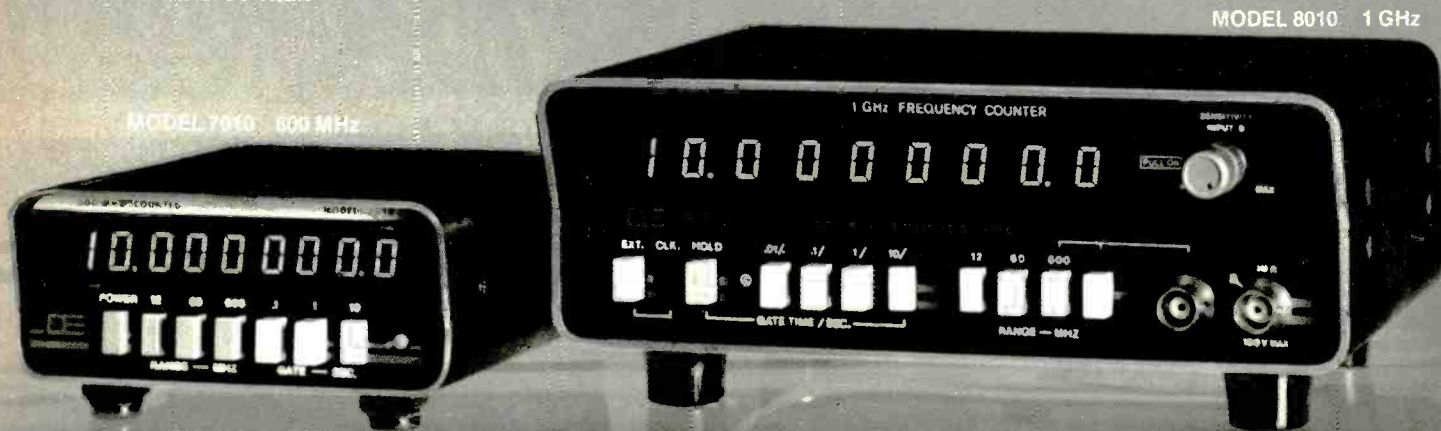

MODEL 7010 600 MHz

MODEL 8010 1 GHz

- 100% U.S.A. FACTORY ASSEMBLED
- 100% PARTS & LABOR YEAR GUARANTEE
- CERTIFIED NBS TRACEABLE CALIBRATION
- EXTERNAL CLOCK INPUT
- DISPLAY HOLD FUNCTION
- 9 RED LED DIGITS 4" HIGH
- .1 Hz RESOLUTION
- 0.1 PPM 10 MHz TCXO TIME BASE
- LAB/PORTABLE-AC ADAPTER INCLUDED
- 1 MEGOHM & 50 OHM INPUTS
- STATE-OF-THE-ART LSI DESIGNS
- COMPREHENSIVE USER MANUAL PROVIDED

● COMPACT SIZES—7010- 1-3/4" Hx4-1/4" Wx5-1/4" D 8010- 3" Hx7-1/2" Wx6-1/2" D

MODEL	S PRICE	RANGE 10Hz to	LED DIGITS	SENSITIVITY			HI-Z INPUT 10Hz - 60 MHz	GATE TIMES	RESOLUTION			TCXO TIME BASE		EXT CLOCK INPUT	NI-CAD BATT PACK
				25-250 MHz	250-450 MHz	450 MHz-1GHz			12 MHz	60 MHz	MAX FREQ.	20-40°C	FREQ.		
7010	145.00	600 MHz	9	5-20 mV	10-30 mV	30-40 mV to 600 MHz	1-1.50 SEC	.1 Hz	1 Hz	10 Hz to 600 MHz	1 PPM 0.1 PPM	10 MHz	YES OPTION \$25.	YES OPTION \$15.	
*7010.1	225.00														
8010	325.00	1 GHz	9	1-10 mV	5-20 mV	10-25 mV	18.01-20 SEC	.1 Hz	1 Hz	10 Hz to 1 GHz	1 PPM 0.1 PPM	10 MHz	YES STD	YES OPTION \$30.	
*8010.1	405.00														

* Has precision 0.1 PPM TCXO time base.

MODEL 7010

#7010 600 MHz Counter - 1 PPM TCXO \$145.00
#7010.1 600 MHz Counter - 0.1 PPM TCXO \$225.00

OPTIONS

#Ni-Cad-701 Ni-Cad Battery Pack & charging circuitry
Installs inside unit \$ 15.00
#EC-70 External Clock input, 10 MHz \$ 25.00
#CC-70 Carry Case, Padded Black Vinyl \$ 9.95

MODEL 8010

#8010 1 GHz Counter - 1 PPM TCXO \$325.00
#8010.1 1 GHz Counter - 0.1 PPM TCXO \$405.00
#8010.1-13 1.3 GHz Counter - 0.1 PPM TCXO \$495.00

OPTIONS

#Ni-Cad-801 Ni-Cad Battery Pack & charging circuitry
Installs inside unit \$ 39.00
#CC-80 Carry Case, Padded Black Vinyl \$ 9.95

ACCESSORIES

#TA-100 Telescope Ant with Right Angle BNC \$ 9.95
#P-100 Probe, 50 ohm, 1x \$13.95
#P-101 Probe, Lo-Pass, Audio Usage \$16.95
#P-102 Probe, Hi-Z, General Purpose \$16.95

CIRCLE NO. 43 ON FREE INFORMATION CARD



ORDER FACTORY DIRECT • CALL TOLL FREE
Optoelectronics inc 1-800-327-5912
 5821 N.E. 14th Avenue, Fort Lauderdale, Florida 33334 FROM FLORIDA (305) 771-2051/2

TERMS: Orders to U.S. and Canada, add 5% for shipping, handling and insurance to a maximum of \$10.00. All other orders add 10%. C.O.D. collection fee \$1.00. Orders under \$15.00 add extra \$1.00 handling. Regular checks must clear before order is shipped. Florida residents add 4% sales tax.

TRUTH TABLE QUIZ

BY ROBERT P. BALIN

A TRUTH Table indicates how a gate or combination of gates, responds when level 0 and level 1 signals are applied to its inputs. The table present the kind of concise picture of a circuit's characteristics that we need to apply it to solving logic problems.

To test your ability for making a truth table, determine if the output at D on each of the circuits (1-10) below is a 1 or a 0 for each of the seven arrangements shown in the table at top left. The answers are in the truth table at bottom of page.

TRUTH TABLE												
INPUT			CIRCUIT									
A	B	C	1	2	3	4	5	6	7	8	9	10
1	0	0										
0	1	0										
0	0	1										
1	1	0										
1	0	1										
0	1	1										
1	1	1										

1.
 2.
 3.
 4.
 5.
 6.
 7.
 8.
 9.
 10.

ANSWERS:

1	1	0	1	1	0	1	1	1	1	1	1	L	L	L
1	0	0	0	1	0	1	0	1	1	1	1	L	L	0
0	0	1	0	0	1	1	1	1	1	1	1	L	0	L
0	1	0	1	1	1	1	1	1	1	1	1	0	L	L
1	1	0	1	1	1	1	1	1	1	1	1	0	L	0
1	0	1	1	1	1	1	1	1	1	1	1	0	L	0
0	1	1	1	1	1	1	1	1	1	1	1	0	L	0
1	1	1	1	1	1	1	1	1	1	1	1	0	L	0
A	B	C	1	2	3	4	5	6	7	8	9	10		

PURonizer



AIR PURIFICATION FOR THE HOME!

A new appliance, the PURonizer, is able to remove odors, smoke, bacteria, dust, and pollen; refresh the air and restore a natural electrical balance. We offer safe current limited 15,000 volts, more voltage than units costing 3 times our price.

WE HAVE OPTIONS

We feature interchangeable ion emitter systems. Our PURonizer comes complete with both a high output bronze emitter fuzz and a long lasting stainless steel emitter needle. We have plant adapter cords available to improve the growth of your plant as well as ionizing the air. Also available is a unique four-way adapter, allowing the use of remote emitters.

THE IONIZER OF THE FUTURE

Our Ion Research engineers are developing new high gain emitters. The Emitter systems of the future will adapt to any PURonizer.

USE 30 DAYS, NO OBLIGATION

Our PURonizer is backed by a 30 day satisfaction guarantee and one year's warranty on parts/labor.

To order your PURonizer send check or money order to the address below:

PROFESSIONAL ION GENERATORS

319 Spruce Street
 Redwood City, CA 94061
 Phone (415) 366-8754

Send me **PURonizers at \$78.00 ea.**
 Calif. residents add 6% sales tax. **We**
 pay postage.

Name _____

Address _____

City _____

State _____ Zip _____

CIRCLE NO. 50 ON FREE INFORMATION CARD

Experimenter's Corner

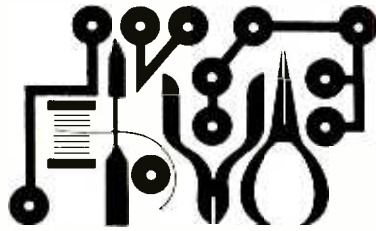

By Forrest M. Mims

THE PHOTOPHONE CENTENNIAL: 1880-1980

HAVE YOU ever talked over a sunbeam? I hope every reader of this column will do just that during 1980, for this is the centennial year of the invention of light-wave communications.

On February 19, 1880, Alexander Graham Bell and Sumner Tainter, Bell's lab assistant, became the first men to transmit voice over a beam of reflected sunlight. One kind of transmitter they developed, shown in Fig. 1, was a thin, silvered mirror attached to one end of a hollow cylinder. Sound waves were directed against the mirror through a speaking tube. The resulting vibrations of the mirror caused a reflected beam of sunlight to become more or less divergent. The net result was an amplitude-modulated light beam.

Bell's receiver consisted of a series of selenium cells mounted in the focus of a parabolic reflector and connected in series with a telephone receiver and a battery. Figure 2 shows one of Bell's early optical receivers.

Bell called his invention the *photophone*. In June of 1880, he and Tainter transmitted intelligible voice from the top of the Franklin School in Washington, D.C. to Bell's laboratory at 1325 L Street, a distance of 213 meters. Later Bell and Tainter were granted several patents covering the photophone and its variations. Until his death in 1922, Bell considered the photophone to be his most important invention, more important even than the telephone.

If you would like more information about the photophone, I've written a detailed paper on the subject which appears in the Spring edition of *Optics News*, a publication of the Optical Society of America (available at well-stocked libraries). Also, if you happen to be in Washington, D.C. this spring or summer, stop by Explorer's Hall, the museum of the National Geographic Society at 17th and M Streets, N.W., to see their excellent photophone centennial exhibit. It was constructed by Bell Telephone Laboratories, and traces the history of light-wave communications from the photophone to today's glass-fiber communication links.

Alexander Graham Bell played a pioneering role in the early history of the National Geographic Society. His grandson, Dr. Melville Bell Grosvenor, is Editor Emeritus of the *National Geographic*. Several

years ago, when I met with Dr. Grosvenor to propose a photophone-centennial exhibit, his interest perked up considerably when I pulled a homemade photophone from my briefcase. He scurried out onto the balcony to catch a few rays of sunlight, and we were soon communicating over his grandfather's invention.

That was a very exciting moment for me, and one I hope to share with you by means of this column. You can be "on the air" in a matter of minutes with an aluminum-foil-and-cardboard transmitter and a receiver made from a solar cell and a portable amplifier! With your own photophone, you'll never be without an entertaining and educational gadget to demonstrate for friends, neighbors, scout troops and school classes. Indoors, at night, or when clouds obscure the sun, you can use light from an artificial source. I've used many kinds of flashlights, a helium-neon laser, infrared LEDs and a continuously operating (CW) injection laser with good results. Interested? Here are some details.

Photophone Transmitters. Bell and Tainter devised many ways to modulate a light beam, but the simplest is the use of a flexible mirror. My favorite photophone transmitter, shown in Fig. 3, is a 25-mm diameter, ultra-thin glass mirror cemented to one end of a 1" (25.4 mm) diameter aluminum tube. The mirror is catalog number 30,626, available from Edmund Scientific Company (300 Edscorp Bldg., Barrington, NJ 08007).

A larger mirror will give more range, but suitable glass mirrors are hard to find and are very fragile. Bell solved this problem by using a system of lenses to collect more light than would otherwise be intercepted by the mirror alone (see Fig. 1). You can take this approach also, but a suitable alternative is the use of a mirror fabricated from aluminum foil or aluminized Mylar.

A powerful transmitter can be made by taping a sheet of foil or Mylar over one end of a metal can from which both ends have been removed. The Mylar is easier to attach and forms a highly desirable flat, drum-like surface. Unfortunately, aluminized Mylar, at least the type which I've used, is not quite as reflective as aluminum foil. A simple test shows that about 5% of incident sunlight passes through the thin film of aluminum deposited on the Mylar and is therefore not available for reflection.

Aluminum foil is almost perfectly reflective, but it tears easily. Another problem with foil is the difficulty of obtaining a perfectly flat surface. Both of these problems can be partially alleviated by crossing strips of masking tape across the dull side of a sheet of foil (use four strips) and centering the shiny side of the foil out over the end of the can. The tape reduces tearing, keeps the foil reasonably flat and improves the sound quality by damping out resonances.

Instead of a metal can, the Mylar or foil can be taped over a 4" to 6" (10-cm to 15.25-cm) diameter hole cut in a square of corrugated cardboard. This method works well with foil because it results in less chance of tearing.

You can experiment with other kinds of transmitters. Several years ago, at a hot-air balloon competition in New Mexico, Otis Imboden, a *National Geographic* photographer, and I experimented with a large foil-covered board he was using to reflect sunlight at balloon crews that were shadowed by the huge bags of hot air rising above them.

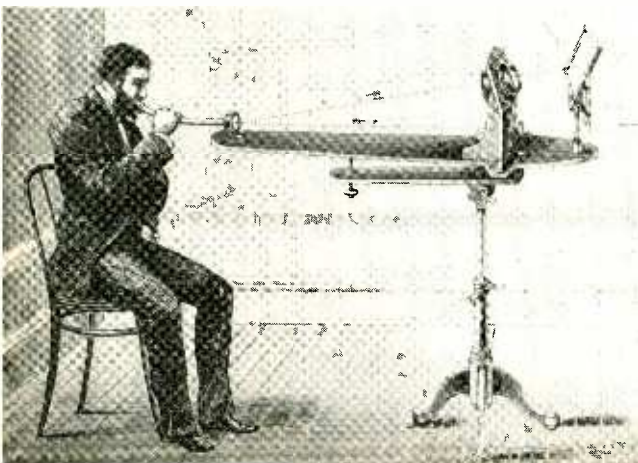

Fig. 1. The photophone transmitter used by Bell and Tainter in their historic experiment of 1880.

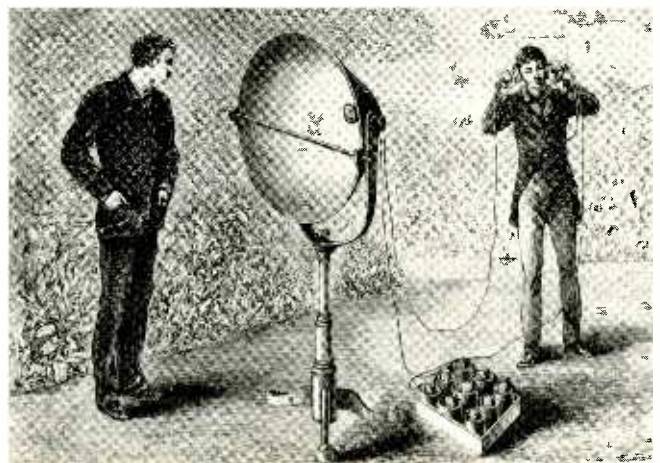

Fig. 2. A photophone receiver of 1880. The detector is the cylindrical object in the reflector.

We found that we were able to send voice messages to a nearby receiver simply by talking near the reflector. Later, we gave a receiver to a balloon crew. Otis spoke to the pilot with the help of his reflector while the balloon was in tethered flight.

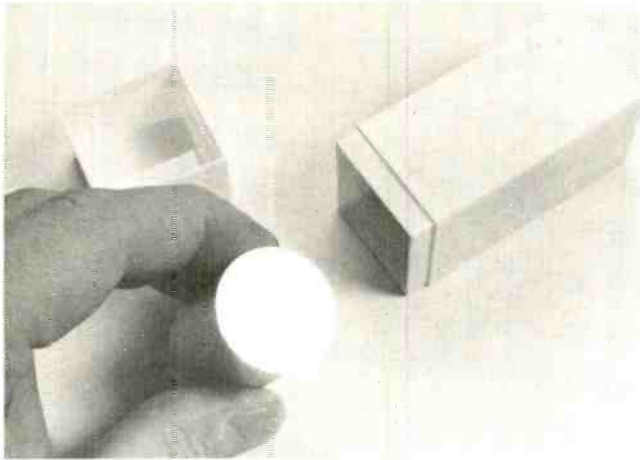

Fig. 3. A photophone transmitter is easily made using a 25-mm diam. mirror cemented to an aluminum tube.

Passive transmitters like those described thus far work fine, but you can make an electronic photophone transmitter by cementing a thin glass mirror to the rim of the cone of a miniature speaker. Refer to the Edmund Scientific catalog for suitable mirrors. This technique results in very high quality voice transmission and allows one person to conduct photophone tests unassisted because the transmitter can be driven by signals from the earphone or external speaker jack of a portable radio or tape player.

Photophone Receivers. Bell and Tainter experienced considerable difficulty making selenium detectors for their photophone experiments, but today you can purchase for a few dollars a silicon solar cell that's considerably more sensitive and easier to use. I prefer silicon solar cells for photophone receivers because their large surface area (the larger the better) reduces or eliminates entirely the need for collecting lenses or reflectors for short-range experiments. When a lens or reflector is used to increase communications range, the greater area of the detector does away in large part with the alignment difficulties associated with the use of small detectors such as phototransistors.

An ultra-simple receiver can be made by connecting a silicon solar cell directly to the microphone input of an audio amplifier. Figure 4 is the schematic of a circuit with plenty of gain that works quite well. Rather than building an amplifier, you can salvage one from a discarded cassette recorder or purchase a factory-assembled amplifier module from one of the dealers who advertise in this magazine.

Silicon solar cells are very thin and are easily broken. One way to protect a cell is to install it in a clear plastic box or container like that

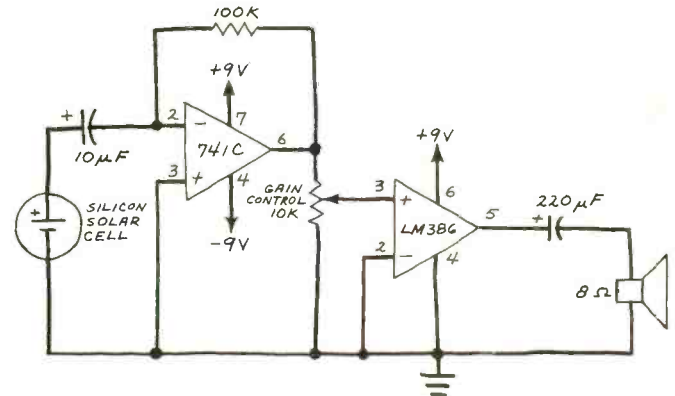

Fig. 4. Schematic of a high-gain photophone receiver.

BATTERY-WRAP

WIRE WRAPPING TOOL

MODEL BW-2630

- POSITIVE INDEXING
- ANTI-OVERWRAPPING
- BITS AVAILABLE FOR AWG 26, 28 & 30
- BATTERY OPERATED
- LIGHT WEIGHT

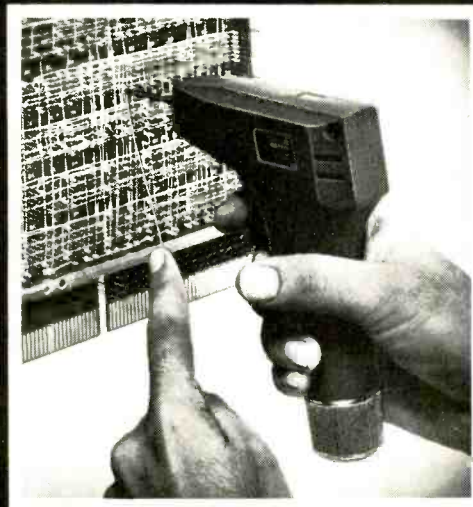

\$19⁸⁵*

BATTERIES AND BIT NOT INCLUDED

U.S.A. FOREIGN PATENTS PENDING



BW-2630	BATTERY-WRAP TOOL	\$19.85
BT-30	BIT FOR AWG 30	\$ 3.95
BT-2628	BIT FOR AWG 26 & 28	\$ 7.95
RB-20	TWO NI-CAD BATTERIES	\$10.75

OK MACHINE & TOOL CORPORATION

3455 CONNER STREET, BRONX, N.Y. 10475, U.S.A.

PHONE (212) 994-6600 • TELEX: 125091

*MINIMUM BILLING \$25.00 / ADD SHIPPING CHARGE \$2.00 / NEW YORK CITY / STATE RESIDENTS ADD APPLICABLE TAX.

CIRCLE NO. 40 ON FREE INFORMATION CARD

www.americanradiohistory.com

in which a typical cell is packaged when sold. A layer of plastic foam behind the cell will cushion it from shock, and a small notch or hole can be easily formed for the leads.

Some solar cells are supplied with wire leads. Others are not. If you must attach your own leads, use a small, low-wattage iron with a well-tinned tip. For best results, use tinned wrapping wire for leads. Most silicon cells have electrodes on the front and back surfaces. Solder the back electrode first by forming a small puddle of solder near an edge of the cell and then holding the stripped end of a wire lead in the solder until it cools.

The front electrode is usually in the form of a thin strip and requires more care. Touch the tip of the iron to the electrode and, after a second or two, apply enough solder to form a small bump or ridge. Then reheat the solder and position the second wire lead along the electrode. Hold the lead in place until the solder cools.

The leads, particularly the one soldered to the front electrode, must be protected from excessive strain. One way to do this is to attach the leads directly to the cell's protective housing with glue or miniature solder lugs. A shielded cable can then be connected to the leads or lugs.

Your mounting problems will be simplified if you install the cell in a reflector or behind a lens. Alignment of the receiver will be much easier if you use the reflector rather than a lens. Various types of reflectors are available from Edmund Scientific, but I prefer to modify ordinary flashlights. For example, the reflector in a typical 6-volt lantern has plenty of room for two solar cells connected in series and mounted back-to-back. The battery compartment has more than enough space for a modular amplifier, miniature speaker, battery, switch, gain control and phone jack.

Figure 5 shows a photophone receiver and a LED voice transmitter installed in 6-volt lanterns (Burgess "Dolphin" brand). I made the receiver in 1966, and it's worked fine ever since. The solar cells are secured in place, perpendicular to the axis of the reflector, by wrapping their leads around the protruding shoulder at the small opening in the reflector. While this mounting method might appear to be very flimsy, my cells have survived a trip around the world (including a one-year stint in Vietnam) and numerous field tests of various

light-wave communications devices. The cells simply bounce upon their leads when the receiver is dropped or jostled.

I recommend one or more silicon solar cells for your photophone receiver, but you can use selenium cells, phototransistors or photodiodes instead. Keep in mind that small detectors will require external optics for best results and might be difficult to align.

Range Testing. For initial photophone tests, leave the receiver with a friend and walk 25 paces in the direction of your shadow. Then,



Fig. 5. Photophone receiver (left) and LED voice transmitter installed in 6-volt lantern lights. Note the position of the two back-to-back solar cells in the receiver's reflector.

while facing the receiver, point the transmitter toward the ground in front of you until the sun's reflection is visible as a bright spot. It's a simple procedure to slowly move the spot toward the receiver by following the spot of light along the ground.

It's helpful to place the receiver in a shaded location so the reflected spot will be easier to see. A trick I usually employ is to place a large red bicycle reflector next to the receiver. When the reflector lights up, the transmitter is on target. Here's another tip: placing the receiver *inside* a building and directing the transmitter beam through a window makes for an impressive demonstration because the voice of the person at the transmitter can be heard only via the light beam and *not* by the propagation of sound waves through the air.

While testing a photophone, you'll soon discover some difficulty in keeping the reflected spot of sunlight trained on the receiver. One way to stay on target is to rest the transmitter against a fixed object like a tree, fence post, or building. A better way is to mount the transmitter on a photographer's tripod. Of course, the receiver must be kept in a fixed location. You'll also need to make frequent adjustments to compensate for the earth's rotation, which manifests itself as the apparent continuous motion of the sun.

Once you have an operational photophone, you'll probably want to determine its maximum transmitting range. For long-range tests, a tripod is essential. An electronic transmitter (i.e., a speaker with attached mirror) is very helpful also, because one person can perform the test unaided. It's very easy to achieve a range of 100 meters or more. For ranges of one kilometer or more, the photophone receiver I described in the February 1976 issue of *POPULAR ELECTRONICS* is ideal. This receiver uses a large glass reflector installed in a special cabinet complete with amplifier and solar cell. Though very difficult to align, the receiver has exceptional sensitivity. If you don't have this article in your back issues, you can find it at a library. It's also in the 1980 *ELECTRONIC EXPERIMENTER'S HANDBOOK*.

In Conclusion. The photophone will allow you to explore the fascinating world of light-beam communications. However, remember one word of caution. Always avoid staring at the bright reflection of sunlight from photophone transmitters! Protect your eyes by wearing sunglasses with optical-quality glass lenses and by looking away from the transmitter mirror. ◇

T.I./M.M.I. 74LS240 74LS241 74LS243 74LS244 74LS373 74LS374 \$245 LIMIT 10 EACH	2708 1024X8 EPROM \$745 ↑ 450ns AMD, SGS	16K STATIC RAM S-100 MEMORY ADD-ON ** FULLY STATIC OPERATION ** USES 2114 TYPE STATIC RAMS ** +8 VDC INPUT AT LESS THAN 2 AMPS ** BANK SELECT AVAILABLE BY BANK POINT AND BANK BYTE ** PHANTOM LINE CAPABILITY ** ADDRESSABLE IN 4K BLOCKS IN 4K INCREMENTS ** LED INDICATORS FOR BOARD/BANK ** SOLDER MASK ON BOTH SIDES OF BOARD ASSEMBLED & TESTED \$269.00
IN STOCK 74S373 74S374 \$325	4116 16Kx1 Static RAM MEMORY ADD-ON FOR THE TRS-80 OR APPLE II 8 for \$59.95 to 450ns	2716 16K EPROM \$27.95 T1, HIT, INT 450ns single+5V
2114L 1024x4 Static RAM \$4.75 450 ns	8038C VCO Waveform Gen. w/Sine \$265	S-100 16K ADD-ON BARE BOARD \$28.95 WITH DOCUMENTATION AND DETAILED INSTRUCTION BOOK
CONCORD COMPUTER COMPONENTS 1971 SOUTH STATE COLLEGE ANAHEIM, CA. 92806 VISA- MASTER CHARGE (714) 937-0637 CHECK OR M.O. NO C.O.D. We stock and sell over 12,000 types of semi-conductors.		LOGIC PROBE KIT \$17.95

CIRCLE NO. 13 ON FREE INFORMATION CARD



By John McVeigh,
Technical Editor

DEGAUSSING

Q. A while ago, a friend showed me some interesting visual effects that he could create by placing a magnet near the screen of his black-and-white television. Unfortunately, I tried the same thing with my color receiver, and now I am stuck with a pink-purple splotch on my screen. Why was the effect of the magnet permanent on my receiver, and what can be done to correct the problem (short of replacing the picture tube)?—Fred Martin, Woodstock, NY.

A. The effects that your friend created on his monochrome picture tube were due to the deflection of electrons streaming from the cathode of the CRT to the screen. This deflection was caused by the external magnetic field generated by the bar magnet. The patterns which appeared on the screen are similar to those created when a magnet is slipped under a sheet of paper upon which iron filings have been sprinkled.

The reason why the monochrome CRT was not permanently affected and the color tube

was lies in the fundamental difference between the two devices. A monochrome tube employs only one electron beam and one set of phosphor dots, all of which glow the same color. In a color tube, however, there are three sets of dots, each glowing a different color, and each excited by a separate beam of electrons.

It is essential for proper image reproduction that each electron beam in a color tube strike only its respective color dots. There are two separate means employed in color picture tubes to achieve this end. First, each individual beam is adjusted so that it converges at each of the shadow mask holes at the proper angle. A *convergence* network is charged with this responsibility. Second, a purity adjustment ensures that all three beams pass through the exact deflection center of the yoke so that they are equally deflected and line up with the array of holes spaced across the screen. Essentially, the convergence network bundles the electron beams together and the purity network centers the bundle on the triads of dot holes.

Extreme accuracy in the deflection of the electron beams is required. Unfortunately, any extraneous magnetic field in the neighborhood of the color picture tube can affect the electron beams and prevent them from reaching their appropriate color phosphor dots. In operation, residual magnetization of the metallic structure around the color tube that causes color splotches can build up. (That's what the problem is with your picture tube.) The cure for this is *degaussing*. When this is done, an alternating magnetic field derived from the 60-Hz ac line is set up in the vicinity of the picture tube. It demagnetizes the tube in much the same manner that the heads of tape decks are demagnetized for optimal performance.

In most color televisions of recent vintage, there is an automatic degaussing circuit which functions in the following manner. When power is first applied to the receiver, alternating current flows through a thermistor and a coil wound around the periphery of the screen. An alternating magnetic field is set up around the coil which neutralizes any residual magnetization in the vicinity of the picture tube. The current causes self-heating of the thermistor, whose coefficient is positive. As the temperature of the thermistor increases, its resistance increases to the point that practically no current flows through the coil. The alternating magnetic field collapses as the current through the coil decreases. Thus, a brief degaussing process occurs each time the receiver is turned on from a cold start.

If your receiver has such a degaussing circuit, it obviously is not functioning properly. Otherwise the color splotches would have disappeared the first time that power was removed from the receiver and reapplied a few minutes later. The most likely cause of a malfunctioning automatic degausser is a failed thermistor.

If your receiver lacks such a circuit, you can either build or buy a degaussing coil. Commercial degaussers are relatively inexpensive (about \$8.00) and are available from most electronic supply stores. Also, most television repairmen keep one on hand and will gladly perform degaussing for you. A degaussing coil can be fashioned by winding approximately 400 turns of No. 20 or No. 22 enameled copper wire on a circular form 12 inches (30.4 cm) in diameter. The coil should be soldered to an ac line cord and the connections insulated with heat-shrink tubing or PVC electrical tape. Degaussing is performed by plugging the line cord into an ac power socket, bringing the coil near the front of the picture tube, and moving the coil around the screen. The coil should then be slowly withdrawn from the screen to a distance of perhaps ten feet. Power should then—and only then—be removed from the degaussing coil.

This procedure should clear up your pink-purple splotch without any need for replacing the picture tube, and allow you to continue experimenting with the magnetic deflection of electron beams without permanently affecting color reception.

Have a problem or question in circuitry, components, parts availability, etc? Send it to the Hobby Scene Editor, POPULAR ELECTRONICS, One Park Ave., New York, N.Y. 10016. Though all letters can't be answered individually, those with wide interest will be published.

TRAIN TRANSFORMER POWER SUPPLY

Q. I have an HO power pack that's not being used on my layout. Is it possible to use it as a variable-voltage power supply as is? If not, can it be modified for such an application? The power pack is rated at 12 volts dc output at 1 ampere maximum.—Robert Grisson, Dotham, AL.

A. Most HO power packs consist of a transformer, a rectifier, a rheostat and a circuit breaker. No filter capacitors are employed because pulsating dc is applied across the track rails. To use this type of power pack as a variable-voltage supply for electronic projects, it must be modified to include filtering and some efficient method of varying the output voltage.

Shown in the figure is a circuit that can be constructed using a portion of the original power pack and some additional components. The stepdown transformer is that

included in the stock power pack. If the pack's rectifiers are silicon diodes, they can be used as is. If not, replace them with a modular bridge rectifier. Voltage regulator IC1 and R1 and R2 take the place of the power pack's rheostat. Together they form a source of variable, regulated voltage whose amplitude is determined by the setting of R2.

The LM317K is housed in a TO-3 package that must be heat sunked but electrically isolated from the chassis. Employ a mica washer and silicone thermal compound to accomplish this. If adequately heat sunked, the regulator will be able to deliver the rated current of your transformer (1 ampere) on a continuous basis. Assuming the transformer secondary is rated at 12.6 volts rms, the maximum voltage available at the output terminal will exceed 12 volts. It might reassure you to know that the LM317 includes current limiting, thermal-overload and safe-area protection.

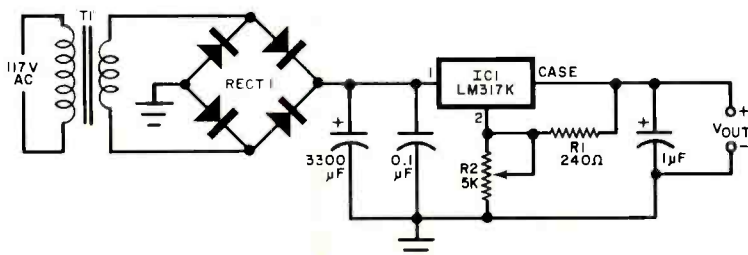

definitely not for novices

Dr. Dobb's Journal is the serious micro-computer journal of systems and software. You won't find games and never-ending tutorials on "How to Program in Basic" in *DDJ*. You will find useful information—algorithms, code for compilers, operating systems, editors, debuggers, hardware evaluations, comparisons of architectures—all presented in a straightforward, direct fashion.

If you are an expert who is serious about microcomputers you should be reading *Dr. Dobb's Journal*. Buy it at your local computer store or subscribe. No need to send money now, just send us your name, address, and zip and we'll bill you later. \$15 for one year (10 issues).

Dr. Dobb's Journal

P.O. Box E, Dept. G9, Menlo Park, CA 94025

Amusements for men and machines

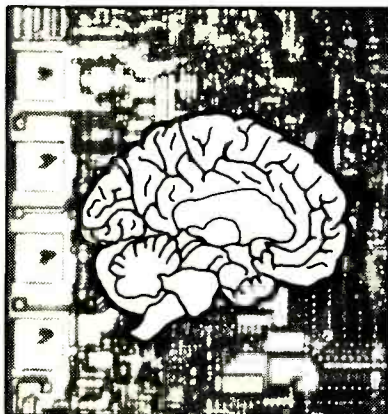

Photo: Intel

Recreational COMPUTING

The magazine for the imaginative small computer user.

Published bi-monthly, \$10/year. Complete the form below or send us your name and address. We'll bill you.

Recreational Computing,
P.O. Box E, Dept. G9, Menlo Park, CA 94025

Name _____

Address _____

City _____

State _____ Zip _____

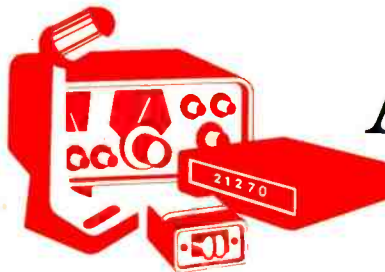

Amateur Radio

By Karl T. Thurber, Jr., W8FX/4

SPECIAL CLUBS FOR SPECIAL FOLKS

AMATEUR radio is a many-faceted hobby whose aspects include DXing, ragchewing, QRP (low-power) operation, certificate-chasing, vhf experimentation, two-way television communications, and radioteletype, among many others. Dozens of clubs cater to these special ham interests. Let's take a look at some of them.

The 10-10 Net. The current increase in sunspot activity (Solar Cycle No. 21 is now peaking) has been accompanied by a dramatic surge in interest in the 10-meter band. Many newcomers to ham radio have only recently discovered the band's potential, but oldtimers have known about the potential of 10 meters for many years. Interest in 10 has been kept alive between cycle peaks by members of the Ten-Ten International Net, a far-flung organization of dedicated 10-meter operators whose motto is "Use and Enjoy Ten Meters." The club originated in Southern California during the early sixties. At that time, the group was a traffic-handling net in the San Dimas area. As conditions on 10 meters deteriorated following cycle 19's decay, the group decided that there was little need for a traffic net on the band. Still, the little group wanted to stay in touch and convened its net every night at 10 p.m. PST on

28.8 MHz. Thus, the name "Ten-Ten" was born ("on 10 at 10").

The net has grown immensely and has become a worldwide club with a membership in five digits. The members have one thing in common. That is their goal of keeping the band active even in years of low sunspot activity when other services might be tempted to convert portions of the band's wide-open spaces to their own uses. Ten-Ten members also consider the club a fraternal organization whose emphasis is assistance to fellow hams and service to the public.

To become a member, one must be active on 10 meters. The prospective member contacts 10 club members, obtaining from each his distinctive "10-10" identification number and other details of the contact. The list of contacts, along with a small service fee, is submitted to a district manager who issues a membership certificate and an ID number for use in future exchanges with other members and prospective members.

The club also publishes a news bulletin and has a far-reaching awards program conducted in cooperation with its more than 100 active local chapters. The program, which is very popular among "certificate hunters," includes a series of 10-10 net contests, Bar and Plaque awards (for specific numbers of



A membership certificate for ARRL's Old Times Club.

QSOs with fellow members), and Worked-All-States (WAS) certificates. Members who contact 500 qualifying 10-10 stations can become honorary Vice Presidents in the exclusive "International 500 Club."

Ten-Ten International has a national organization, but its main activities are decentralized to the district managers who run the membership and activity programs for their districts (broken down by U.S. call area), and to the independent chapters, most of which have their own unique awards programs. To join in the fun, simply get on 10, work the required 10 contacts, and inquire as to the name and address of your district manager. Send in your contact list and fee, and you're in business with this highly popular group.

QRP Amateur Radio Club International.

This club caters to the large segment of the ham fraternity that enjoys running low power. The QRP-ARC-I, as it is called, was formed in 1961 to further the interests of QRP operators—those who limit their input power levels to 100 watts CW or 200 watts PEP on SSB. You can join the club as a full member if you run QRP power levels or as an associate if you regularly run higher power levels but also have a serious interest in low-power or even QRP_p (low-low-power) operations using 5 watts or less. Dues in the club are a modest \$3 per year and include a subscription to a quarterly newsletter. Membership details can be obtained by writing to the Secretary/Treasurer, Joseph C. Szempias, W8JKB, 2359 Woodford Ave., Toledo, OH 43605.

The group very actively promotes low-power operations by on-the-air contests and awards. The QRP-ARC-I sponsors a very large operating awards program, the objective of which is to demonstrate that the use of limited power levels reduces QRM (interference) on the ham bands, yet still allows full enjoyment of the hobby. As a result, the club issues a number of interesting awards, many of which parallel regular ARRL (American Radio Relay League) operating awards. The QRP members chase such certificates as the WAC-QRP (worked all continents, low-power), WAS-QRP (worked all states), DXCC-QRP (worked 100 countries), and several other very specialized awards. The latter include QRP-25 (working 25 club members) and the WAS-QRP_p (working all states using 5 watts or less). Besides the challenging awards program, the club also holds informal "QSO parties" each month, an annual formal contest, and other activities of special interest to the low-power operator.

The SWL (shortwave listener) isn't forgotten in the QRP-ARC-I's plans. SWLs can qualify for any of the club's awards on a stations-heard basis. Also, hams can use SWL reception reports in lieu of two-way QSL card confirmations in applying for the various achievement awards and certificates.

The Quarter Century Wireless Association.

This one's for you if you've been involved in amateur radio for longer than you might otherwise care to remember. The club limits its membership to amateurs who were first licensed at least 25 years ago, though not necessarily continuously licensed for the whole period. The Quarter Century Wireless Association or QCWA was formed in the New York area in 1947 by 54 charter members. It quickly spread and enlarged its membership

to form chapters across the country. The QCWA is based on the fellowship and respect of one "old timer" for another, and tries to keep its membership on a very personal, fraternal basis through its many local chapters. The chapters are active, holding meetings, luncheons and brunches at which local problems and interests are discussed. These are often held in conjunction with local hamfests, swap meets and conventions. QCWA also conducts a weekly on-the-air

QCWA provides, you'll find that membership dues are reasonable (\$14 for a 3-year period plus a one-time \$3 initial registration fee). More information can be obtained by writing to the Quarter Century Wireless Association, 1409 Cooper Dr., Irving, TX 75061.

International Fox-Tango Club. This is a really unusual amateur club—a sort of "mutual aid society" of individuals who have bought or have an interest in amateur gear

This 70-watt Ten-Tec transceiver is popular with Novices and is also good for low-power operation. It has a built-in vfo and instant band change.

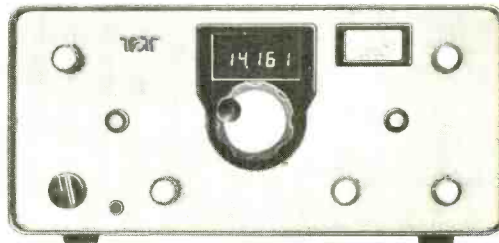

get-together for the exchange of club activity information among the chapters. A national meeting is held once a year, as is the QCWA "QSO party" which brings together on the air several hundred members who compete for the greatest number of contacts with fellow old-timers. The club also publishes a well-written, interesting and often nostalgic journal, *QCWA News*, which keeps members informed on national and chapter activities and provides a vehicle for keeping old on-the-air friends in touch with each other.

If you're interested in the kind of fellowship

manufactured by the Yaesu Musen Co. The club's sole purpose is to enhance the effectiveness of its members' use of Yaesu Equipment by providing a medium for the exchange of information. It was founded in 1971 primarily to trade information on the popular Yaesu FT-101 (hence the name Fox-Tango). Its members are scattered throughout the world, so a conventional club organization isn't practical. The club therefore holds no meetings and elects no officers.

Members trade information about their gear mainly by means of the *FT Newsletter*,

BUILD A MASTERPIECE OF SOUND

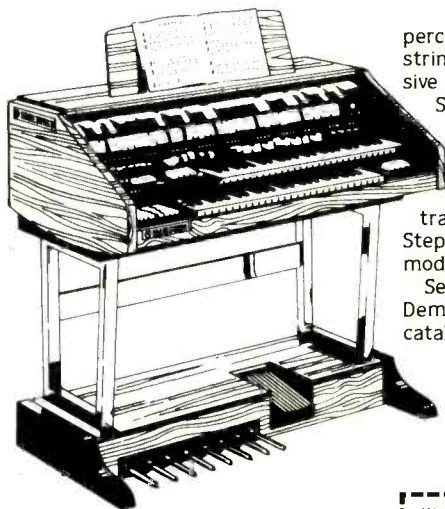

percussion and sustain. Wersi's famous string orchestra and bass guitar. Exclusive Sound Computer for 32-128 "One Stop Sounds" (total organ presets). Transposer. And lots more.

Build your own masterpiece of sound. No technical knowledge required. Just follow the clearly illustrated, easy to understand instructions. Step by step. Choose from at least 10 models. (Also factory assembled.)

Send \$6.00 with coupon for your Wersi Demo-Package (LP with 104-page color catalog).



Wersi has combined select features of the electronic music field, added its own creations and years of research by top engineers and musicians, to produce an incomparable line of organs.

Space-age technology. True-to-life voicing with full drawbar system. Polyphonic

Wersi Electronics, Inc. Dept. 11 1720 Hempstead Road Lancaster, PA 17601	Wersi Organs & Kits Dept. 11 14104 E. Firestone Blvd Santa Fe Springs, CA 90670
---	--

Enclosed is \$6.00 for my Demo-Package (LP with 104-page color catalog.)

Name _____
Address _____
City _____ State _____ Zip _____



THE ONE-STOP
MUSIC SHOP
AT WHOLESALE PRICES

**THIS MONTH'S
SUPER SPECIALS!**

CAR STEREO

SANYO CASSETTE IN-DASH WITH RADIO		PIONEER CASSETTE IN-DASH WITH RADIO	
FT-1458	\$259.90	KP-4000	\$129.90
FT-2400	224.90	KP-3500	144.90
FT-489	139.90	KP-5005	144.90
FT-545	154.90	KP-8000	154.90
FT-1490-2	164.90	KP-8005	154.90
FT-1455	169.90	KP-8500	179.90
FT-642	84.90	KE-2000	184.90
FT-644	109.90	KE-2005	209.90
		KE-3000	234.90
		KE-5000	274.90
		KPX-9000	184.90
		KPX-9500	209.90

JENSEN

J1001 (6x9 Separates)	594.50	KP-272	\$69.90
J1065 (6x9 Triax-50 Watts)	62.50	KP-292	79.90
J1033 (6x9 Triax II-100 Watts)	78.50	KP-373	84.90
J1101 (4x10 Triax-45 Watts)	62.50	KP-250	104.90
J1130 (4x10 Triax II-50 Watts)	78.50	KP-500	129.90
J1174 (5x7 Triax-50 Watts)	62.50	KP-575	89.90
J1124 (5x7 Triax II-75 Watts)	78.50	KP-66G	89.90
J1069 (6x9 Coax-45 Watts)	39.50	KP-77G	114.90
J1037 (6x9 Coax II-90 Watts)	58.50	KP-88G	109.90
J1077 (5x7 Coax-45 Watts)	39.50	KPR-600	129.90
J1041 (5x7 Coax II-75 Watts)	48.50	KP-707G	164.90

We carry the full line of car equipment by such names as Sanyo, Craig, Marantz, Pioneer, Jensen & Audiovox. Write for free catalog.

BLANK TAPES

CASSETTE TAPES		REEL-TO-REEL TAPES	
Ampex Grand Master II C-90	3.11	Scotch 272 1800 FT	4.35
Ampex Grand Master I C-90	2.79	Scotch 207 1800 FT	5.19
BA5F Pro I or III C-90	2.99	TDK L-1800 1800 FT	5.22
Fuji FX I or II C-90	2.99		
Scotch Lp Noise C-90/3 Ph	4.99	VIDEO TAPES	
Scotch Master III C-90	2.79	BETA FORMAT	
Sony UNK C-90	1.64	TDK L-500 (2 Hour)	12.95
Sony HFX C-90	2.35	Sony L-500 (2 Hour)	12.95
Sony Ferrichrome C-90	3.28	Fuji L-500 (2 Hour)	12.95
TDK D C-60	1.19	Scotch L-500 (2 Hour)	12.50
TDK D C-90	2.10	Sony L-750 (3 Hour)	17.50
TDK D C-120	2.99	VHS FORMAT	
TDK D C-180	4.99	Maxell T-120 (4 Hour)	14.95
TDK AD C-60	1.68	TDK T-120 (4 Hour)	14.95
TDK AD C-90	2.45	JVC T-120 (4 Hour)	14.95
TDK AD G-120	4.48	Fuji T-120 (4 Hour)	14.95
TDK SA C-60	2.15	Scotch VK 250 (4 Hour)	14.95
TDK SA C-90	3.18		

MINIMUM ORDER 12 TAPES-100% GUARANTEED
Call or write for super low prices on Maxell tapes.

CARTRIDGES

audio-technica		SHURE	
AT 2055	134.95	V15 Type IV	89.90
AT 1555	89.95	V15 Type III	64.90
AT 145A	49.95	M95HE	34.90
AT 125A	39.95	M95ED	29.90
AT-10	12.95	M95ED	20.50
STANTON		PICKERING	
8815	79.95	XSV/5000	89.90
881EE-S	59.95	XSV/3000	45.90
881EE	49.95	XVI/5750	34.90
880EE	27.95	XVI/925	24.50
500E	14.95	XVI/5400	21.50
EMPIRE		PIAC	
20002	54.50		9.90
20001	29.50		
2000E/III	18.50		
EDR-9	114.50		

ACCESSORIES

DISCWASHER		HEADPHONES	
Complete System	10.95	Koss Pro AAA	39.90
Discul	34.95	Koss Pro AAAA	46.50
Discorganizer	8.95	Koss HV1C	34.90
IR or 03 Retill	10.95	Koss HVVA	31.50
Zerostat Anti-static Gun	14.95	Sennheiser HD434	42.50
SC-1 Stylus Cleaner	4.95	Sennheiser HD424	64.50
Discfloat	11.95	Sennheiser HD420	49.50
Footbrusher III Radar Detector	87.90	Sennheiser HD430	72.50
Beam Box FM-6 Antenna	34.50		
Beam Box FM-10 Antenna	64.50		

RECORDS

Pop, Rock, Jazz, R&B	
All 7.98 List	\$4.99
All 8.98 List	\$5.49
All 9.98 List	\$5.99

50¢ additional for cassette or 8-track, please specify.
Minimum order: \$25.90

WE STOCK THE COMPLETE SCHWANN CATALOG.
HOW TO ORDER: For immediate shipment, send money order or certified check. Two weeks delay on personal checks. Please add \$3.50 per order for shipping & handling (\$6.50 for orders outside continental U.S.). N.Y.S. residents add tax. Payment must be in U.S. dollars only. No C.O.D.'s. All merchandise 100% guaranteed, brand new & factory fresh.



33 PARK ROW, DEPT. PE, NEW YORK, N.Y. 10038
TO ORDER: CALL MON-SAT 9AM-6PM EASTERN TIME
TOLL FREE (800) 221-8180
ALL OTHER MATTERS: CALL (212) 732-8600

CALL OR WRITE FOR FREE 160 PAGE CATALOG

the club bulletin that is published ten times each year. The bulletin deals with a variety of equipment-related issues such as modifications, improvements, manufacturers service notes, schematic and pictorial diagrams, troubleshooting and servicing techniques, and reviews of new gear. Recently, the Fox-Tango Net was established to expedite the timely exchange of information between club members. Of course, one doesn't have to be a member or an owner of Yaesu gear to participate in the on-the-air net.

The club also operates a technical committee to respond to members' requests for

with whoever responds to the call.

Another popular ARRL group is the *Old Timers Club*, which issues a handsome membership certificate to any amateur radio operator who held an amateur license 20 or more years ago. One applies for membership by certifying to the ARRL the year he held his first license and the callsign he had then. As with RCCers, OTC members may sign "OTC" after their calls to indicate their seniority and membership in the club. The OTC is different from the QCWA; the former is a casual, honorary group, while the latter holds regular meetings and social events.



The Fox-Tango Club was originally started to exchange information on the popular Yaesu FT-101 transceiver. Shown here are members of Yaesu's more contemporary 301 equipment series.

data and assistance in servicing their gear. In addition, the Fox-Tango group operates a purchasing service which enables members to buy communications equipment and accessories at a discount. The purchasing service also tries to make available hard-to-find Japanese replacement transistors, parts kits, and small items necessary to making the many modifications and improvements suggested by members. The club publishes a catalog of these components known as a "green sheet" for its members.

Dues in the Fox-Tango organization are \$6 on a calendar-year basis. For more information, write to the club c/o Milton Lowens, N4ML, 248 Lake Dora Dr., W. Palm Beach, FL 33411. For the record, the club welcomes Citizens Band members who are seriously interested in amateur radio, but won't provide any information about the illegal conversion or use of Yaesu ham gear on CB frequencies. There is no relationship to the CB group having a similar name.

ARRL Operating Clubs. To make amateur radio more challenging, to improve public service contributions, and to enhance operating skills, the American Radio Relay League sponsors a number of operating "clubs." Although several of these bestow an honorary club membership on the applicant, the clubs are not regular organizations in the sense that they don't elect officers or hold meetings.

One of the groups most easily joined is the *Rag Chewers Club*. It's an especially easy one for the beginner. All one has to do is converse with another ham for 30 minutes or more and report this fact to ARRL headquarters (211 W. Main St., Newington, CT 06111). The League will promptly issue a membership certificate. The RCC, of course, is designed to promote interesting, meaningful contacts, something beyond the "hello-goodbye" QSO too often occurring on amateur frequencies. Many club members "tail-end" their CQ calls with the letters "RCC" to indicate that they'd like to "chew the rag" a bit

One has to handle a substantial amount of message traffic to qualify for the *Brass Pounders League*. To achieve BPL status, an amateur must pass a certain amount of radio traffic each month on the ham bands and report his totals to the ARRL Section Communications Manager (SCM). The SCM keeps score and in turn reports traffic totals for his section to headquarters, making a list of those who qualify for BPL. Results are published in the League's monthly magazine, *QST*. Each time an amateur qualifies, he is awarded a BPL certificate. A special medallion is issued the third time. The certificate can be earned by club and multi-operator stations handling traffic, but the medallion is available only to individual amateurs who must personally handle the traffic to qualify. This award goes a long way in promoting the public-service capabilities of ham radio.

A real honor is to be nominated for membership in the *A-1 Operator's Club*. An amateur cannot apply for this one. Rather, his skills as a first-class operator are spontaneously identified by any two operators who already hold A-1 membership. Starting as a CW operators' group in the 1930's, the membership of the A-1 Operator's Club now includes people in many different phases of amateur radio. Some of the nomination criteria include on-the-air procedures, judgement and courtesy, code-copying ability, and general operating considerations. These four factors encompass one's entire posture as an amateur radio operator and include both technical skills and "radio personality."

Besides these club activities, the ARRL also sponsors a number of operating awards and certificates, such as Worked-All-States, Worked-All-Continents, the Satellite DX Achievement, 6-Meter 600 Club, and the DX Century Club awards, to mention but a few. The League also promotes a number of contests and other activities during the year.

No matter what a particular amateur's interests are, there's almost certainly a specialty group or achievement club that's just right for him.

English Broadcasts Audible in No. America

by Glenn Hauser

TIME EST	TIME UTC/GMT	STATION	QUAL.	FREQUENCIES, kHz
4:00-4:15 a.m.	0900-0915	BBC	A	11955, 9640, 9510, 6195
4:00-4:15 a.m.	0900-0915	R. Japan	B	9505
4:00-4:30 a.m.	0900-0930	NSB, Tokyo	C	6115 (exc. Sun.)
4:00-4:30 a.m.	0900-0930	V. of Vietnam	C	12033, 10040
4:00-5:30 a.m.	0900-1030	R. Australia	B	9670
4:00-6:00 a.m.	0900-1100	AFRTS-Washington	A	11805, 9700, 9660, 9585, 6030
4:15-6:00 a.m.	0915-1100	BBC	C	17790, 17695
4:30-5:30 a.m.	0930-1030	V. of Germany	C	17780
5:00-5:05 a.m.	1000-1005	UN Radio	A	15245, 9565, (Sat. only)
5:00-5:30 a.m.	1000-1030	R. Japan	B	9505
5:00-5:30 a.m.	1000-1030	R. Korea	C	11725, 9580, 9525 (frequent changes)
5:00-5:30 a.m.	1000-1030	V. of Vietnam	C	12033, 10040
5:00-fade out	1000	R. Australia	B	6045, 5995
5:00-11:02 a.m.	1000-1602	ABC, Perth	B	9610
5:30-6:30 a.m.	1030-1130	Sri Lanka Br. Corp.	C	17850, 15120, 11835 (not all Eng.)
5:30-7:00 a.m.	1030-1200	V. of Asia, Taiwan	D	5980 (Sun 1030-1040) (time varies)
5:55-6:55 a.m.	1055-1155	R. Thailand	C	11905, 9655
6:00-6:15 a.m.	1100-1115	R. Japan	B	9505
6:00-6:56 a.m.	1100-1156	R. RSA	C	25790, 21535
6:00-7:45 a.m.	1100-1245	TWR-Bonaire	A	15255 (Sat-1330, Sun-1415)
6:00-7:50 a.m.	1100-1250	R. Pyongyang	C	9977
6:00-8:00 a.m.	1100-1300	R. Australia	A	9580
6:00-8:30 a.m.	1100-1330	BBC	A-B	25650, 21710, 21660, 21550, (11775, 1100-1130 + 1300-1330 only) 11750, 9510, 6195
6:00-9:00 a.m.	1100-1400	R. Moscow	B	17810, 15150, 15130, 12010, 9600 (Cuba)
6:00-9:00 a.m.	1100-1400	4VEH, Haiti	B	11835, 9770
6:00-10:00 a.m.	1100-1500	VOA	A	11715, 9565
6:00-11:00 a.m.	1100-1600	AFRTS-Washington	A	15430, 15330, 11805, 9700
6:30-6:50 a.m.	1130-1150	R. National Angola	D	11955, 9535, 7245
6:30-6:45 a.m.	1130-1145	R.R.I. Yogyakarta	C	5046
6:30-9:00 a.m.	1130-1400	CBC Northern Service	B	9625, 6065, (not all English)
7:00-7:15 a.m.	1200-1215	Vatican R.	B	21485
7:00-7:15 a.m.	1200-1215	R. Japan	B	9505
7:00-7:15 a.m.	1200-1215	V. of Kampuchean People	C	11938, 9694
7:00-7:30 a.m.	1200-1230	Kol Israel	C	25640, 25625, 17615, 17560
7:00-7:30 a.m.	1200-1230	R. Tashkent	C	11785, 9600, 9540, 6025 (freq. changes)
7:00-7:45 a.m.	1200-1245	V. of Germany	B	21600, 17875, 17765, 15410
7:00-7:45 a.m.	1200-1245	R. Berlin International	C	21540, 21465, 17700, 15165
7:00-7:55 a.m.	1200-1255	R. Peking	B	15520 or 9820
7:00-8:00 a.m.	1200-1300	V. of Turkey	C	17820, 11800
7:00-8:00 a.m.	1200-1300	HCB, Ecuador	A	26020, 15115, 11740
7:15-7:30 a.m.	1215-1230	V. of Greece	B	21570, 17830, 11730
7:20-7:50 a.m.	1220-1250	R. Ulan Bator, Mongolia	D	12068, 9553 or 6383 (not Sun and Mon.)
7:30-7:55 a.m.	1230-1255	Austrian R.	C	21655
7:30-7:55 a.m.	1230-1255	R. Tirana	D	11965, 9515
7:30-8:00 a.m.	1230-1300	R. Sweden	C	21690
7:30-8:00 a.m.	1230-1300	BBC (English by radio)	C	21695
7:30-10:51 a.m.	1230-1551	WYFR, Family Radio	A	21615, 17845 (Sun. only)
8:00-8:15 a.m.	1300-1315	R. Japan	B	9505
8:00-8:30 a.m.	1300-1330	R. Finland	B	15400
8:00-9:00 a.m.	1300-1400	R. Australia	A	11705, 9770, 6080
8:00-9:30 a.m.	1300-1430	HCB, Ecuador	A	26020, 17890, 15115, 11740
8:00-10:50 a.m.	1300-1550	R. RSA	B	25790, 21535, 15220
8:15-8:45 a.m.	1315-1345	Swiss R. International	C	21570, 21520
8:30-9:20 a.m.	1330-1420	R. Nederland	C	17605
8:30-9:30 a.m.	1330-1430	R. Finland	B	15400 (Sun. only)
8:30-10:00 a.m.	1330-1500	All India R.	C	15335, 11810
8:30-11:00 a.m.	1330-1600	BBC	B-C	25650, 21710, 21660, 21550, 15400 (from 1430), 15070
8:57-11:55 a.m.	1357-1655	V. of Philippines	D	11950, 9579 (Sun-1555)
9:00-9:30 a.m.	1400-1430	R. Japan	B	9505
9:00-9:30 a.m.	1400-1430	R. Sweden	B	21615
9:00-9:30 a.m.	1400-1430	R. Norway	B	21730, 17840 (Sun. only)
9:00-9:30 a.m.	1400-1430	V. Rev. Party, N. Korea	D	4557, 4109
9:00-9:30 a.m.	1400-1430	R. Tashkent	C	11785, 9600, 9540, 6025 (frequent changes)
9:00-9:45 a.m.	1400-1445	R. Berlin International	C	21540, 21465, 17700
9:00-10:00 a.m.	1400-1500	R. Moscow	B	17810, 15150, 15130, 12070, 12010, 11790, 9790, 9600 (Cuba), 9580, 7170
9:00-10:00 a.m.	1400-1500	V. of Indonesia	C	15200, 11789
9:00-12:30 a.m.	1400-1730	R. Australia	C	17795, 9770
9:00 a.m.-7:00 p.m.	1400-2400	CBC Northern Service	B	11720, 9625 (not all English)
9:30-10:00 a.m.	1430-1500	R. Finland	B	15400, 21475
9:30-10:25 a.m.	1430-1525	R. Nederland	B	21480, 17855
9:30-11:00 a.m.	1430-1600	HCB, Ecuador	A	26020, 17890, 15115
9:30-11:00 a.m.	1430-1600	Burma Br. Ser.	D	5985, 5040

DISCOUNT PRICES!

**Top Quality
Money-Back Guarantee
All Factory Prime**

MICROPROCESSOR IC'S

Z-80	895	6800	6.75
Z-80A	1095	6802	11.50
8080A	5.50	6502	9.50
8085A	11.95	6504	9.50
Z8001	189.00	6505	9.50
Z8002	139.00	2901	8.95

MICROPROCESSOR SUPPORT IC'S

8212	2.49	Z80-PIO	6.95
8214	3.90	Z80A-PIO	8.25
8216	2.49	Z80-CTC	6.95
8224	2.95	Z80A-CTC	8.25
8226	2.25	Z80-DMA	24.95
8228	4.75	Z80A-DMA	32.95
8238	4.90	Z80-SIO-0	33.95
8251	5.95	Z80A-SIO-0	37.95
8253	19.50	Z80-SIO-1	33.95
8255	5.70	Z80Z-SIO/1	37.95
8257	19.50	Z80-SIO/2	33.95
8259	19.50	Z80A-SIO/2	37.95
6810	4.75	6860	8.95
6820	3.90	6520	6.75
6821	3.90	6522	9.75
6850	4.10	6532	19.95
6852	3.90	6551	13.75

MEMORY • RAMS • PROMS • EPROMS

2114L-450 ns	4.50	2101-450 ns	1.95
2114L-200 ns	5.95	21L02-250 ns	1.10
4044-450 ns	4.25	21L02-450 ns	.99
4116-200 ns	7.95	2111-450 ns	2.95
4116-150 ns	12.95	2112-450 ns	1.95
4096-5	3.50	2147-85 ns	19.95
MCM 6604 AC	3.50	2708-450 ns	8.95
AM 9060 CDC	2.95	2716-450 ns	25.95
5101-3	4.95	2732-450 ns	79.95

SOUND GENERATORS

SN76477	Complex Sound Generator	2.49
AY-3-8910	GI Sound Gen (Add \$3.00 for manual) 64 Pgs.	11.95

UARTS

AY-5-1013A	3.95	AY-3-1015A	5.10
AY-3-1014A	6.50	TR1602A	3.50

LINEAR

LM 301N-8	32	LM 340T Series	1.15
LM 301AH	32	LM 367N-8	.99
LM 307N-8	25	LM 393N-8	.99
LM 307H	25	LM 3900N-14	.99
LM 308H	75	LM 3909N-8	58
LM 311N-8	59	LM 7390C-14	.99
LM 319H	90	LM 741CN-14	1.15
LM 320K Series	1.35	LM 747CN-14	.59
LM 320T Series	1.15	RC 1555NB-8	1.25
LM 323K	4.95	CA 4250CH	.95
LM 339N-14	98	CA 3130T	2.25
LM 340K Series	1.35	LM 4136N-14	.95
		LM 368T	1.25

SOCKETS

	Wire Wrap #3			Wire Wrap #3			
	Profile	Gold	Tin	Profile	Gold	Tin	
8 Pin	14	49	29	22 Pin	28	99	69
14 Pin	16	57	37	22 Pin	16	99	70
16 Pin	20	61	41	24 Pin	36	110	85
18 Pin	10	89	59	28 Pin	39	139	110
20 Pin	28	99	69	40 Pin	55	175	140

SPECIALS OF THE MONTH

While Supply Lasts

ECL 10146L RAM 1024Kx29 ns	6.95
AM 3705 PMOS 8-Ch Multiplexer	8.95
MM 500H Dual 25-Bit Shift Register	4.9
TR1671 Asyn/Sync Receiver - Transmitter	16.95
95H90 Hi-Speed Div 10/11 Prescaler	10.95
MCT6 Dual Opto Isolator 1500V	.99
ICL 7107 CPL 3 1/2-Digit A/D Conv LED	11.50
AY-5-2376 Keyboard Encoder: 88 Keys	10.50
AY-5-3600 Keyboard Encoder: 90 Keys	9.95
1488 or 1489 Liner Driver/Receiver	9.9
18-Pin Low Profile Sockets End Stackable	1.10

HOW TO ORDER - Pay by check, credit card, or C.O.D. Foreign pay in U.S. Funds. Order by phone or mail \$10.00 minimum. Prices valid thru last day of cover date. Shipping - \$2.00 for the first 2 lbs. For surface add 35¢ for ea. add'l lb. For air add 70¢ for each add'l lb. Foreign - Add 10% for shipping and handling. C.O.D. add \$1.85. Guaranteed satisfaction or your money back. We reserve the right to limit quantities. Some items subject to prior sale. We are not responsible for typos. SEND FOR OUR FREE FLYER! Contains complete list of 741,500 IC's



**Components
Express, Inc.**
1380 E. Edinger, Unit PE
Santa Ana, CA 92705
(714) 558-3972
"Have you kissed your computer lately?"

CIRCLE NO. 11 ON FREE INFORMATION CARD

GET YOURS FREE



PMA's 1980 CATALOG
NEW IDEAS IN MUSICAL ELECTRONICS

PLEASE RUSH MY FREE 1980 CATALOG

name _____

address _____

city _____ state _____ zip _____

PMA ELECTRONICS, Dept. 4 - P1020 W. Wilshire, Oklahoma City, OK 73115

CIRCLE NO. 44 ON FREE INFORMATION CARD

It's a musical instrument!

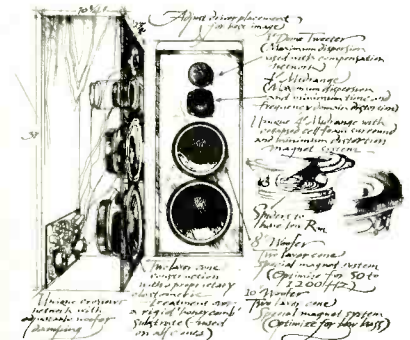

The handcrafted Speakerlab Thirties featuring the patented Nestorovic Woofer System™ are unlike any speakers you've ever heard. Find out about Speakerlab's innovative speakers, kits, and raw speakers. You can save up to 50% when you build them yourself.

Read about all the details in our free catalog. Send for yours today!

name _____ 180

address _____

city _____ state _____

zip _____

Speakerlab
Dept. 180 735 N. Northlake Way
Seattle, Washington 98103

9:30 a.m.-5:00 p.m.	1430-2200	UN Radio	A	21670, 15410, 26020 (when in session)
9:35-10:20 a.m.	1435-1520	R. Nepal	D	3425 or 7105 or 9590
10:00-10:15 a.m.	1500-1515	R. Japan	C	9505
10:00-11:00 a.m.	1500-1600	V. of Rev. Ethiopia	D	9560
10:00-11:00 a.m.	1500-1600	BBC	B	17830, 15260 (Sat, Sun)
10:00-11:00 a.m.	1500-1600	R. Moscow	B	12070, 12010, 11570, 11790, 9790, 9580, 7170
10:00-12:30 a.m.	1500-1730	BSHKJ, Jordan	D	9560
10:15-10:30 a.m.	1515-1530	V. of Greece	B	17830, 15125, 11730 (first & last not Tues.)
10:30-11:00 a.m.	1530-1600	R. Afghanistan	D	4775
10:30-11:00 a.m.	1530-1600	R. Yugoslavia	C	15300, 15240
10:30-11:00 a.m.	1530-1600	Swiss R. International	B	21570
10:30-11:15 a.m.	1530-1615	NSB, Tokyo	C	9595, 6055 (exc. Sun)
10:30-11:30 a.m.	1530-1630	V. of Vietnam	C	12033, 10040
10:30 a.m.-5:00 p.m.	1530-2200	R. Moscow (via Cuba)	A	11860
10:45-11:00 a.m.	1545-1600	R. Canada International	A	21695, 17820, 15325
11:00-11:15 a.m.	1600-1615	R. Japan	C	9505
11:00-11:15 a.m.	1600-1615	R. Pakistan	C	21755, 21635, 21486, 17910, 17660
11:00-11:30 a.m.	1600-1630	R. Korea	B	11830, 9720
11:00-11:30 a.m.	1600-1630	R. Norway	B	15345 (Sun only)
11:00-12:00 a.m.	1600-1700	R. Moscow	B	15210, 12070, 12010, 11870, 11790, 9790, 9580, 7170
11:00 a.m.-12:09 p.m.	1600-1709	BBC	B	21710, 21550, 17885
11:00 a.m.-1:00 p.m.	1600-1800	AFRTS-Washington	A	17765, 15430, 15330, 11805
11:00 a.m.-6:00 p.m.	1600-2300	VOA	A	26040, 21485, 17870, 17710, 15445, (15410 to 2200)
11:30 a.m.	1630	R. Singapore	C	11940 (fade-in time varies)
11:45-12:00 a.m.	1645-1700	R. Canada International	A	21695, 17820, 15325
12:00-12:15 p.m.	1700-1715	R. Japan	C	9505
12:00-12:15 p.m.	1700-1715	Vatican R.	B	17900
12:00-12:30 p.m.	1700-1730	R. Pakistan	C	15470, 11675
12:00-1:00 p.m.	1700-1800	HCB, Ecuador	B	26020, 21480, 17790 (frequent changes)
12:00-1:00 p.m.	1700-1800	WYFR, Family Radio	A	21615, 15160
12:00-1:00 p.m.	1700-1800	R. Moscow	B	15210, 12070, 12010, 11870, 11790, 9790, 9580, 9500, 7170
12:00 p.m.-12:30 a.m.	1700-0530	R. New Zealand	C	17860, 15345
12:05-12:55 p.m.	1705-1755	R. France International	B	21620, 21580, 21515 (from April 1605-1655)
12:05-12:50 p.m.	1705-1750	BRT, Belgium	C	17730 (from April, 1605-1650)
12:09-12:45 p.m.	1709-1745	BBC	B	17830, 15260 (Sat & Sun only)
12:45-3:00 p.m.	1745-2000	BBC	C	15400, 15070, 12095 (11820 from 1800)
12:45-5:30 p.m.	1745-2230	All India R.	C	11620
1:00-1:15 p.m.	1800-1815	R. Japan	B	9505
1:00-1:30 p.m.	1800-1830	R. Canada International	B	17820, 15260
1:00-1:30 p.m.	1800-1830	R. Norway	C	17755 (Sun only)
1:00-1:45 p.m.	1800-1845	R. Korea	C	15255, 11830
1:00-2:00 p.m.	1800-1900	R. Moscow	B	15210, 12070, 12050, 12010, 11870, 11790, 9790, 9500, 7170
1:00-2:00 p.m.	1800-1900	WYFR, Family Radio	A	21615, 15425
1:00-2:00 p.m.	1800-1900	V. of Nigeria	C	15119, 15185
1:00-2:00 p.m.	1800-1900	R. Uganda	C	15250
1:00-3:00 p.m.	1800-2000	R. Australia	C	11800, 9580, 9505
1:00-4:00 p.m.	1800-2100	R. Kuwait	C	11665 (frequent changes)
1:00-5:00 p.m.	1800-2200	B.S.K. Saudi Arabia	C	11854
1:00-5:00 p.m.	1800-2200	AFRTS Washington	A	21570, 17765, 15430, 15345, 15330
1:15-1:45 p.m.	1815-1845	Swiss R. International	C	21585, 17830, 17760, 15125
1:15-2:15 p.m.	1815-1915	R. Bangladesh	D	15285, 11765 (both vary, freq. changes)
1:30-1:35 p.m.	1830-1835	UN Radio	A	21670, 19505 SSB, 15410 (Fri)
1:30-2:00 p.m.	1830-1900	V. of Revolution, Guinea	B	15308 (varies) (Mon and Fri)
1:45-2:15 p.m.	1845-1915	Sri Lanka Br. Corp.	C	17850, 15120, 15115, 11870
2:00-2:10 p.m.	1900-1910	R. Tahiti	C	15170, 11825 (exc. Sun)
2:00-2:15 p.m.	1900-1915	R. Japan	C	15270
2:00-2:30 p.m.	1900-1930	R. Canada International	A	17760, 15325, 11905
2:00-2:30 p.m.	1900-1930	R. Afghanistan	B	17820, 15260
2:00-3:00 p.m.	1900-2000	HCB, Ecuador	C	15075 (frequent changes)
2:00-3:00 p.m.	1900-2000	R. Moscow	C	26020, 21480, 17885, 15295 (freq. changes)
2:00-3:00 p.m.	1900-2000	R. Moscow	B	15210, 12050, 12010, 11870, 11790, 9790, 9500, 7170
2:00-5:00 p.m.	1900-2200	WYFR, Family Radio	A	21615, 15125, 15130
2:30-3:30 p.m.	1930-2030	V. of Iran	C	9022 (frequent changes)
3:00-3:15 p.m.	2000-2015	R. Japan	B	15270
3:00-3:30 p.m.	2000-2030	R. Algiers	C	11810, 11646 or 11615, 9610 (frequent changes)
3:00-3:30 p.m.	2000-2030	R. Canada International	A	17820, 17760, 15325, 11905
3:00-3:30 p.m.	2000-2030	Kol Israel	B	21675, 17645, 11655
3:00-4:00 p.m.	2000-2100	R. Moscow	B	15210, 15180, 12050, 12010, 11870, 11790, 9500, 7170
3:00-4:15 p.m.	2000-2115	BBC	A	21710, 17840, 15260, 15070, 6175
3:10-4:40 p.m.	2010-2140	R. Habana Cuba	A	11920
3:30-4:20 p.m.	2030-2120	R. Nederland	B	21640, 17695, 17605, 15220, 11730
3:30-4:30 p.m.	2030-2130	V. of Vietnam	C	12033, 10040
3:30-4:30 p.m.	2030-2130	V. Turkey	C	11955, 9550
3:50-4:40 p.m.	2050-2140	R. Habana Cuba	C	17750, 9770
4:00-4:15 p.m.	2100-2115	R. Japan	B	15270
4:00-4:45 p.m.	2100-2145	R. Nacional, Venezuela	C	15400 (irr; time + freq. vary)
4:00-4:50 p.m.	2100-2150	R. RSA	B	21535, 17780, 15155
4:00-5:00 p.m.	2100-2200	V. of Nigeria	C	15185, 15119
4:00-5:00 p.m.	2100-2200	R. Moscow	B	17720, 15180, 12050, 12010, 9500

reprint series

Many important articles covering a variety of interests in the broad field of electronics are published in POPULAR ELECTRONICS. Reprints of selected articles and test reports are now available in the event that you missed some you would like to have for reference or study purposes—or for projects you wish to build. Reprints are only \$2 each; \$1 for those marked with an asterisk. Minimum order \$5.

Special articles

- 40854 How The New FTC Hi-Fi Rules Affect You
- 40855 How To Evaluate Tape Recording Specs
- 40856 A New Standard For FM Tuner Measurements
- 40964 Build The Hi-Fi/TV Audio Minder
- 41097 Upgrading Your Old Stereo FM Tuner System & Expanders
- 41098 Build An Audio Comander
- 41099 How FM Tuners Work, Part I
- 41100* How FM Tuners Work, Part II
- 41303* Build A Super Filter
- 41304 Build A Disco Preamp-Mixer
- 41305 Build A Stereo Roto Blender

COMPUTER

- 40860 How To Select A Microcomputer
- 40861 Ins & Outs Of Computers For Beginners
- 40966 Introducing Speechlab—The First Hobbyist Vocal Interface For A Computer
- 41306 Cassette Control For TRS-80 Computer
- 41308 Computer Bubble Memories

COSMAC "ELF" SERIES

- 40857 Low Cost Experimenter's Microcomputer
- 40858 Experimenter's Microcomputer/With Hardware Improvements & More Programming Details
- 40859 Microcomputer/How To Expand Memory, Plus More Programs
- 40870 Build The Pixie Graphic Display
- 41101 Expanding Elf II
- 41307 Tic-Tac-Toe For Elf Computer

COMMUNICATIONS

- 40862 CB Specifications Made Easy
- 40863* How To Choose CB Base Station Antennas
- 40965 Build Morse-A-Letter
- 41102 Choosing A Mobile CB Antenna

OTHER

- 40867 How To Design Your Own Power Supplies
- 40868 The Care & Feeding Of NiCd Batteries
- 40869 Build A Gas & Fume Detector
- 40963* Six CMOS Circuits For Experimenters
- 40967 Programming Calculators For Fun and Games
- 40968* Zap New Life Into Dead NiCd Batteries
- 41103 How To Design TTL Digital Systems
- 41104 Build An Autoranging Digital Capacitance Meter
- 41309 Use Low Cost Digital Equipment
- 41310 Energy Leak Detector
- 41311 An A/D Converter
- 41312 Security Focus (2 Articles)
- 41313 Universal Electronic Timer
- 41314 MPH Car "Cruisalert"

LEARNING ELECTRONIC THEORY WITH CALCULATORS SERIES

- 40864 Basic Equations and OHM's Law
- 40865 Reactance, Time Constants And AC Calculations
- 40866 RC Coupling, Basic Amplifier Calculations, and RLC Relationship

*Reprints are \$2 each, \$1 for those marked with asterisk. Minimum order \$5.

POPULAR ELECTRONICS REPRINTS

P.O. Box 278, Pratt Station
Brooklyn, New York 11205

Please send the reprints listed.

Reprint #	Quan.	Reprint #	Quan.

@\$1.00 _____ @\$2.00 _____

TOTAL ENCLOSED \$ _____ †
(MINIMUM ORDER \$5.00)

Print Name _____

Address _____

City _____

State _____ Zip _____

† Residents of CA, CO, DC, FL, IL, MI, MO, NY STATE, and VT add applicable sales tax. Outside U.S.A. add \$2.00 per order.

8:30-9:25 p.m.	0130-0225	R. Bucharest	C	11940, 11840, 11735, 9690, 9570, 5990
8:30-9:30 p.m.	0130-0230	R. Japan	C	21640, 17825, 17725, 15270
8:45-9:15 p.m.	0145-0215	Swiss R. International	B	15305, 11715, 9725, 6135
9:00-9:15 p.m.	0200-0215	R. Japan	C	17755
9:00-9:25 p.m.	0000-0225	Kol Israel	A	15585, 11637, 9815
9:00-9:25 p.m.	0200-0225	R. Warsaw	C	15120, 11815, 9525, 7270, 7145, 6135, 6095
9:00-9:30 p.m.	0200-0230	R. Canada International	A	11940, 11845, 5960
9:00-9:30 p.m.	0200-0230	R. Norway	B	9645, 9550, 6185 (Mon only)
9:00-9:30 p.m.	0200-0230	R. Budapest	B	17710, 15225, 11910, 9835, 9585, 6105 (not Mon)
9:00-9:50 p.m.	0200-0250	R. RSA	B	17770, 15220, 15155, 11900
9:00-9:55 p.m.	0200-0255	R. Peking	B	17680, 15600, 15120
9:00-10:05 p.m.	0200-0305	TIFC, Costa Rica	C	9645, 5055
9:00-10:30 p.m.	0200-0330	R. Cairo	B	12050, 9475
9:00-11:00 p.m.	0200-0400	R. Moscow	A	17720, 15455, 15180, 15140, 12050, 12010, 11860, 11780, 11735, 9710, 9700, 9610, 9530, 9490
9:00-11:30 p.m.	0200-0430	AFRTS-Washington	A	21570, 17765, 11790, 6030
9:15-9:30 p.m.	0215-0230	V. of Greece	B	11730, 9650, 9515
9:30-9:45 p.m.	0230-0245	R. Pakistan	C	21590, 17830
9:30-9:55 p.m.	0230-0255	R. Tirana	B	9750, 7120
9:30-10:00 p.m.	0230-0300	R. Lebanon	D	11785 (frequent changes)
9:30-10:00 p.m.	0230-0300	R. Sweden	C	11705, 9695
9:30-10:15 p.m.	0230-0315	R. Berlin International	C	11975, 9730
9:30-10:25 p.m.	0230-0325	R. Nederland	A	9590, 6165
9:30-10:30 p.m.	0230-0330	BBC	A	11750, 9580, 9410, 7325, 6175, 6120, 5975
9:30-12:00 p.m.	0230-0500	HCJB, Ecuador	A	15115, 11910, 9745
9:37-9:45 p.m.	0237-0245	UN Radio	A	15240, 10869-55 B, 7768.5-55B, 6035
10:00-10:15 p.m.	0300-0315	R. Japan	C	17755
10:00-10:25 p.m.	0300-0325	R. Warsaw	C	15120, 11815, 9525, 7270, 7145, 6135, 6095
10:00-10:30 p.m.	0300-0330	R. Canada International	A	11940, 11845, 11770, 9535, 5960
10:00-10:30 p.m.	0300-0330	R. Portugal	B	11925, 6025 (Mon-0320)
10:00-10:30 p.m.	0300-0330	R. Budapest	B	17710, 15225, 11910, 9835, 9585, 6105
10:00-10:30 p.m.	0300-0330	R. Kiev	B	17870, 15100, 11965, 11790, 11770, 9580
10:00-10:50 p.m.	0300-0350	V. of Free China	C	17890, 15345, 15270
10:00-10:55 p.m.	0300-0355	R. Prague	B	11990, 9740, 9540, 7345, 5930
10:00-10:55 p.m.	0300-0355	R. Peking	B	17680, 15300, 12055, 11685
10:00-11:00 p.m.	0300-0400	RAE, Argentina	C	9690 (Tue-Sat)
10:00-11:00 p.m.	0300-0400	Radiobrás, Brazil	A	15290
10:00-11:00 p.m.	0300-0400	R. Baghdad	C	11935
10:00-11:15 p.m.	0300-0415	R. Uganda	B	(irregular)
10:00-11:25 p.m.	0300-0425	R. RSA	B	11900, 9585, 7270, 5980, 4990
10:00-11:30 p.m.	0300-0430	R. Cultural, Guatemala	B	3300
10:00 p.m.-1:00 a.m.	0300-0600	HIRVO, Honduras	B	4820
10:00 p.m.-2:30 a.m.	0300-0730	VOA	A	17865, 15240, 9670, 5995
10:30-10:55 p.m.	0330-0355	R. Tirana	B	7300, 6200
10:30-10:55 p.m.	0330-0355	Austrian Radio	C	9770, 5945
10:30-11:00 p.m.	0330-0400	R. Australia	B	17795
10:30-11:15 p.m.	0330-0415	R. Berlin International	B	11975, 11890, 5955
10:30-11:45 p.m.	0330-0445	BBC	A	9410, 6175, 5975
10:30-11:00 p.m.	0330-0400	R. Finland	C	9645, 11755
10:30-12:00 p.m.	0330-0500	R. Tanzania	D	15435
10:30 p.m.-1:00 a.m.	0330-0600	R. Habana Cuba	A	11760, 11725
10:51-10:58 p.m.	0351-0358	V. of Yerevan	C	15265, 11690, 9735, 9505 (Sun, Wed, Thu, Sat)
11:00-11:15 p.m.	0400-0415	R. Japan	C	17755
11:00-11:15 p.m.	0400-0415	R. Budapest	B	17710, 15225, 11910, 9835, 9585, 6105 (Wed & Sat) (Mon-0430)
11:00-11:30 p.m.	0400-0430	R. Bucharest	C	11940, 11840, 11735, 9690, 9570, 5990
11:00-11:30 p.m.	0400-0430	R. Canada International	A	11845, 11770, 5960
11:00-11:30 p.m.	0400-0430	R. Norway	B	9550, 6185 (Mon only)
11:00-11:45 p.m.	0400-0445	R. Korea	C	15570, 11820
11:00-11:55 p.m.	0400-0455	R. Peking	B	17680, 15300, 12055, 11685
11:00-12:00 p.m.	0400-0500	R. Moscow	B	17870, 15455, 15180, 15140, 12050, 11960, 9580
11:00-12:00 p.m.	0400-0500	R. Australia	B	17795, 15320
11:00 p.m.-1:00 a.m.	0400-0600	R. Moscow	B	11790, 11770, 9610, 9530, 9490
11:30-11:55 p.m.	0430-0455	Austrian R.	B	15260
11:30-12:00 p.m.	0430-0500	Swiss R. International	B	15305, 9725
11:30-12:00 p.m.	0430-0500	R. Sofia	B	9530 (frequent changes)
11:30 p.m.-2:00 a.m.	0430-0700	AFRTS-Washington	A	15330, 11790, 6030
11:45 p.m.-12:45 a.m.	0445-0545	BBC	A	9510, 6175, 5975
11:55 p.m.-1:00 a.m.	0455-0600	V. of Nigeria	B	7255
12:00-12:15 a.m.	0500-0515	Kol Israel	B	17815, 15585, 15105, 11638
12:00-12:15 a.m.	0500-0515	R. Japan	C	15270
12:00-12:30 a.m.	0500-0530	R. Portugal	B	11925, 6025 (Mon-0520)
12:00-1:00 a.m.	0500-0600	R. Australia	C	21680, 17890, 17870, 17725
12:00-1:00 a.m.	0500-0600	HCJB, Ecuador	B	15115, 11910, 9745, 6095
12:00-3:00 a.m.	0500-0800	R. Moscow	B	15470, 15455, 12050, 12010, 11960, 9790, 9580
12:00-6:00 a.m.	0500-1100	V. of Cuba	B	600
12:15-1:15 a.m.	0515-0615	Spanish Foreign R.	B	11880, 9630
12:22-12:30 a.m.	0522-0530	UN Radio	A	9540, 6055 (Sat)

12:30-12:50 a.m.	0530 0550	V. of Germany	A	11905, 11785, 9650, 9545, 6185, 5960
12:30-1:25 a.m.	0530-0625	R. Newland	A	9715, 6165
12:30-2:30 a.m.	0530-0730	R. New Zealand	C	17860, 6105
12:45-1:00 a.m.	0545-0600	UN Radio	A	9540, 6055 (Sat)
12:45-2:30 a.m.	0545-0730	BBC	B	15070, 11955, 11860, 9640, 9510, 6175
1:00-1:15 a.m.	0600-0615	R. Japan	C	15270
1:00-1:30 a.m.	0600-0630	R. Norway	B	9645 (Mon Only)
1:00-1:30 a.m.	0600-0630	R. Australia	C	21680, 21525, 17725, 17755, 15240
1:00-2:00 a.m.	0600-0700	RAE, Argentina	C	9690 (Tue., Sat.)
1:00-2:00 a.m.	0600-0700	HCB, Ecuador	A	11910, 9745, 6095
1:00-2:00 a.m.	0600-0700	R. RSA	C	21535, 17780, 15220
1:15-1:30 a.m.	0615-0630	R. Canada International	B	11735, 9730, 9655, 6140 (Mon-Fri)
1:25-3:55 a.m.	0625-0855	V. of Malaysia	C	15295, 12350, 9750
1:30-2:00 a.m.	0630-0700	R. Australia	B	21680, 17725, 15240, 9670
1:45-2:00 a.m.	0645-0700	R. Canada International	B	11735, 9730, 9655, 6140 (Mon-Fri)
1:57-4:55 a.m.	0657-0955	V. of Philippines	C	11950, 9579
2:00-2:15 a.m.	0700-0715	R. Japan	C	15270
2:00-3:00 a.m.	0700-0800	Xandir Malta	D	9670 (Sat only)
2:00-3:00 a.m.	0700-0800	V. of Vietnam	C	10010, 9840, 7512
2:00-4:30 a.m.	0700-0900	R. Australia	B	21680, 17725, 11740, 9670, 9570
2:07-2:15 a.m.	0707-0715	UN Radio	A	11840, 6135 (Sat)
2:30-2:45 a.m.	0730-0745	UN Radio	A	11840, 6135 (Sat)
2:30-3:25 a.m.	0730-0825	R. Nederland	B	9770, 9715
2:30-4:00 a.m.	0730-0900	BBC	B	15070, 11955, 9640, 9510
2:30-6:30 a.m.	0730-1130	R. New Zealand	C	11945, 6105
2:55 a.m. fade	0755	Action Radio, Guyana	C	5950
3:00-3:15 a.m.	0800-0815	R. Japan	B	9505
3:30-4:25 a.m.	0830-0925	R. Nederland	B	9715
3:30-5:00 a.m.	0830-1000	FEBC, Philippines	C	11765 or 11890

Explanatory Notes.

1. Times in first column are EST. For AST, add 1 hour. CST, subtract 1 hour. MST, subtract 2 hours, PST, subtract 3 hours. Days of week are in GMT.
2. Quality. A—strong signal and very reliable reception. B—regular reception. C—occasional reception under favorable conditions. D—rarely audible. These ratings are for locations in the central USA. European and African stations are in general, more reliably received in eastern North America. Asian and Pacific stations are more reliably received in western North America. North American stations are received well except in areas too close to the transmitter site.
3. The information in this listing is correct to press time. However, frequencies and schedules are constantly changing. Listen to "R.M. Digest" on R. Canada International for late changes, Sunday at 1807; 1915 (to Europe). GMT Mondays at 0117 and 0317; and Wednesdays at 2140.
4. R.—Radio; V.—Voice



SOLAR

Dual Time Alarm Chronograph

With 3-year rechargeable battery, full 12-hour precision stopwatch, 24-hour alarm... all at an affordable price!

Featuring:

- Famous Quartz Accuracy
- Dual Time Zone
- 3 Year Rechargeable Battery
- Electronic Calendar
- Full Chronograph With 1/10 Second Precision
- Continuous Liquid Display
- Night Light For Evening Viewing

Lowest priced Solar Powered Alarm Chronograph ever offered **\$4995**

Now, we have combined all the features of our best selling Dual Time Alarm Chronograph with an outstanding new feature—SOLAR POWER! A combination that Seiko or Citizen can't match, even at \$200.00 more.

Check the value you get for \$49.95

- **Powerful Solar Recharger**—Fully recharges itself even in artificial light. Power that is guaranteed for three full years with life expectancy of many more. You can forget troublesome battery changes!
- **Dual Time**—Set this world traveller for your home time and the time of any other city in the world... at the touch of a button. An easily read flag tells you which time you're viewing. Shows hour, minute, and day of the week in both time zones, plus running seconds or date.
- **24 Hour Alarm**—Loud alarm can be preset for any minute of the day or night. Constantly read indicator lets you know when the alarm is set.
- **Full Chronograph**—With 1/10 second precision, add time and split time. Add time lets you time everything from a telephone call to a trip... up to 12 full hours. Split time stops the timing so you can note the interim for lap time. Automatically resumes original timing after a few seconds. Shown: 12 hrs. 59 minutes. 59.8 seconds.



- **Flashback Feature**—Lets you go from chronograph time to regular time and back again... without losing elapsed time on chronograph.
- **Quartz Accuracy**—To ± 5 seconds a month.
- Continuously Shows:**
 - Hours, Minutes, Seconds
 - Or, date can replace seconds if you choose
 - Day-Of-Week Flag
 - AM/PM Indicator



- **Water Resistant Credibility**—Our watch is splash-proof. It resists splashes and spills. Don't be misled by claims of water resistance. No Alarm Chronograph on the market today meets the recognized three atmospheres test (90 ft. of water).
 - **Beautiful Styling**—With bold new case design featuring extra large mode buttons for easier setting. Available with handsome stainless steel bracelet with snap fastener guaranteed to fit comfortably.
 - **Quality Gold Plating**—Optional Goldtone model now available with long lasting 5 micron gold plating.
- Easy to order.** Call our Toll Free Number below or fill in the convenient order form. 15 day return option if not completely satisfied. Three-year warranty on rechargeable solar battery. One year factory warranty on watch. Comes to you in an attractive gift box. Order yours today!

MEDIA MARKETING, INC.

10155-9 Plano Rd. • Dallas, TX 75238

Yes please send me _____ Solar Dual Time Alarm Chronograph(s) at \$49.95 each, plus \$2.50 postage and handling. Texas residents add 5% tax.

Silvertone Goldtone \$59.95

Name _____

Address _____

City _____

State _____ Zip _____

Check or Money Order enclosed.

Charge to: Master Charge Expires _____

Visa

Account # _____

Signature _____

ORDER TOLL FREE 1-800-527-7066

PE-04B In Texas Call 1-214-349-3120 ©MMI 1979

CIRCLE NO. 37 ON FREE INFORMATION CARD

CB, AMATEUR or COMMERCIAL COMMUNICATIONS

Hustler has the antenna you're looking for!

Mobile or base station. Whatever your needs, Hustler has the quality for exceptional mechanical and electrical performance. The result of unique engineering expertise and innovation, respected throughout the industry.

For outstanding antenna quality, look to Hustler! See your dealer or write:



3275 North B Ave
Kissimmee, Florida 32741

Clearly the choice of those who know quality.



CIRCLE NO. 29 ON FREE INFORMATION CARD

GRAPHIC EQUALIZER KIT — \$100

'offers equalization capabilities of more expensive commercial built units at just a fraction of the cost.'
Len Feldman in R-E.



12 bands per channel
0.02% distortion • 92-100dB S/N
solid walnut unfinished ends
more in available, or send \$2.50
(refundable) for review, schematic,
and assembly manual
M/C. Visa orders may be phoned to
(303) 669-1567



SYMMETRIC SOUND SYSTEMS
DEPT. B

912 Knobcove Fl., Loveland, CO 80537

CIRCLE NO. 54 ON FREE INFORMATION CARD

Computer Club Directory

Alabama

Birmingham Microprocessor Group
774 Twin Branch Dr.
Birmingham, AL 35226
Att: Joe Callaway

North Alabama Computer Club
1409 Blevins Gap Rd. S.E.
Huntsville, AL 35802
Att: Jack Crenshaw

Alaska

Anchorage Computer Group
364 Sixth St.
Ft. Richardson, AK 99505
Att: Constantine T. Papas

California

The Apple Core
POB 4816, Main Post Office
San Francisco, CA 94101
Att: Scot Kamins

Association for Educational Data
Dept. of Education
6401 Linda Vista Rd.
San Diego, CA 92111
Att: Dr. Jane D. Gawronski

Bay Area Microprocessor
Users Group (BAMUG)
1211 Santa Clara Ave.
Alameda, CA 94501
Att: Timothy O'Hare

Bay Area Micro Group
4565 Black Ave.
Pleasanton, CA 94566

Beverly Hills HS Computer Club
241 San Marino Dr.
Beverly Hills, CA 90212

Calculator Lib: The Liberated Calculator
Users Club
POB 2151
Oxnard, CA 93034
Att: Gene Hegedus

California Computer Society
POB 9459
North Hollywood, CA 91609
Att: Sheila Clark

Computer Organization of Los Angeles
POB 43677
Los Angeles, CA 90043

Computer Guild
POB 255232
Sacramento, CA 95825

Computer Information Organization, Inc.
POB 158
San Luis Rey, CA 92068
Att: Bill McLaughlin

Compucolor-Intercolor Users Group
5250 Van Nuys Blvd.
Van Nuys, CA 91401
Att: Stan Pro

Computer Phreagues United
2090 Cross St.
Seaside, CA 93955
Att: Mac McCormick

Diablo Professional Users Group
321 Golf Club Rd.
Pleasant Hill, CA 94523
Att: R. Hendrickson

Glendale College Computer Club
1500 N. Verdugo Rd.
Glendale, CA 91208
Att: R. Unterman

Homebrew Computer Club
POB 626
Mountview, CA 94042
Att: Robert Reiling

Inland Computer Society
POB 55052
Riverside, CA 92517
Att: Tom Munnecke

Jim McCord
330 Vereda Legenda
Goleta, CA 93017

Litton Calculator/Computer Club
Litton Guidance and Control Systems
Ms 78/31
5500 Canoga Ave.
Woodland Hills, CA 91364

LLLRA Hobbyist Group
35 West Essen St.
Stockton, CA 95204
Att: Charles D. Hoover

LO*OP Center
8099 La Plaza
Cotati, CA 94928

North Orange County Computer Club
POB 3603
Orange, CA 92665

29 Palms Area Group
Box 3558 C&E Schools M.C.B.
29 Palms, CA 92278
Att: Sgt. Wesley Isgrigg
or
13-C Copper Drive M.C.B.
29 Palms, CA 92278
Att: Sgt. Stanley E. Herr

PPC
2541 W. Camden Pl.
Santa Ana, CA 92704
Att: Richard J. Nelson

Pomona Group
4155 Oak Hollow Rd.
Claremont, CA 91711
Att: Al Sutton

Proteus
1690 Woodside Rd. #219
Redwood City, CA 94061

Robot Builder
208 Via Colorin
Palos Verdes Estates, CA 90274
Att: Michael Westvig

Sacramento Minicomputer Users Group
Box 741
Citrus Heights, CA 95610

Sacramento Microcomputers Users Group
POB 161513
Sacramento, CA 95816

San Gabriel SCCS
400 S. Catalina Ave.
Pasadena, CA 91106
Att: Dan Erikson

San Luis Obispo Micro-Computer Club
439B Marsh St.
San Luis Obispo, CA 93401

Santa Barbara Computer Group
210 Barrunca, Apt. 2
Santa Barbara, CA 93101
Att: Glenn A. McComb

Santa Barbara Nameless Computer Club
1445 La Clima Rd.
Santa Barbara, CA 93101
Att: Doug Penrod

Solus, The Sol Users Society
POB 23471
San Jose, CA 95153

6800 Computer Club
POB 18081
San Jose, CA 95158
Att: Ray Boaz

Southern California Computer Society
POB 987
South Pasadena, CA 91030

Southern California Computer Society
Box 54751
Los Angeles, CA 90054

UCLA Computer Club
3514 Boelter Hall
UCLA
Los Angeles, CA 90024

Valley Chapter, SCCS
5652 Lemona Ave.
Van Nuys, CA 91411
Att: R. Stuart Gibbs

Ventura County Computer Society
POB 525
Port Hueneme, CA 93041

Colorado

Denver Amateur Computer Society
POB 6338
Denver, CO 80206

Connecticut

Bridgeport Area Society for Involved Computerist
(BASIC)
12 Wildwood Dr.
Trumbull, CT 06611
Att: Al Song

The Computer Club
6 Maureen Dr.
Simsbury, CT 06070
Att: Harold Bender

Connecticut Microists
60111 Wendy Lane
Westport, CT 06881
Att: George Ahmuty

The Southern New England Computer Society
267 Willow St.
New Haven, CT 06511
Att: Arthur Downes

University of Hartford Microcomputer Club
College of English, Dana Hall
200 Broomfield Ave.
West Hartford, CT 06117

District of Columbia

Washington Amateur Computer Society
4201 Massachusetts Ave.
Apt. 168W
Washington, DC 20016
Att: Robert Jones

Florida

Central Florida Computer Club
2821 Sunset Rd.
Apopka, FL 32703
Att: John W. Neil

Fort Lauderdale Computer Club
11080 N.W. 39th St.
Coral Springs, FL 33065
Att: Roberto Denis

Indian River Computer Society
FIT Elect. Eng. Dept.
Country Club Rd.
Melbourne, FL 32901
Att: Frank Canova

Jacksonville Computer Club
Regency East Office Park
9951 Atlantic Blvd. Suite 326
Jacksonville, FL 32211

Microcomputer Society of Florida
POB 3284 Downtown Station
Tampa, FL 33604

Ocala Computer Hobbyist Club
32 Denton Blvd., NW #72
Fort Walton Beach, FL 32548
Att: Loretta R. Guske

South Florida Computer Group
410 NW 117 St.
Miami, FL 33168

Space Coast Microcomputer Club
1825 Canal Ct.
Merritt Island, FL 32952
Att: Ray O. Lockwood

Tallahassee Amateur Computer Society
RT 14, Box 351-116
Tallahassee, FL 32952
Att: Larry Hughes

University of Florida Amateur Computer Society
EE Dept. Rm 234, Larsen Hall
Gainesville, FL 32611

Georgia

Atlanta Area Microcomputer Hobbyist Club
421-Ridgecrest Road
Atlanta, GA 30307
Att: Jim Dunion

Atlanta Area Microcomputer Hobbyist Group
POB 33140
Atlanta, GA 30332

Hawaii

Aloha Computer Club, Inc.
POB 4470
Honolulu, HI 96813
Att: Bob Holz

Aloha Computer Club
94-360 Hokuala Street
Apt. 187
Mililani Town, HI 96789

Honolulu Apple Users Society
98-451-A Kaahumanu St.
Area, HI 96701
Att: Bill Mark

Idaho

CSPCC
205 Foster, Apt. 2
Coeur d'Alene, ID 83814

Illinois

Altair Chicago
517 Talcott Rd.
Park Ridge, IL 60068

CACHE (Chicago Area Computer Hobbyist's
Exchange)
POB 36
Vernon Hills, IL 60061
Att: Bill Precht

CACHE (Chicago Area Computer Hobbyist's
Exchange)
POB 52
South Holland, IL 60473

Chicago Microcomputer User's Group
1102 S. Edison
Lombard, IL 60148
Att: Bill Precht

Chicago Users Group
195 Ivy Lane
Highland Park, IL 60035

ICE Nine Inc.
POB 291
Western Springs, IL 60558
Att: R.A. Hoekstra

Microcomputer APL Enthusiasts
POB 574 NUMS
303 E. Chicago Ave.
Chicago, IL 60611

Quad City Computer Club
421½ 7th Ave.
Rock Island, IL 61201

SCCS 5063
14904 S. Calis Ave.
Posen, IL 60469
Att: Roy Emerson

SPC-12 Users Club
7706 W. Gregory
Chicago, IL 60656
Att: Manuel C. Martinez

Indiana

Apple I Library
51625 Chestnut Rd.
Granger, IN 46530
Att: Joe Torzeski

Beta Iota Tau (Computer Fraternity)
R.H.I.T.
Box 420
Terre Haute, IN 47803
Att: Richard R. Petke

Floyd County Computer Enthusiasts
RR#2, POB 446A
New Albany, IN 47150
Att: Nathan Engle

Hoosier Amateur Computer and L. Kluge Society
111 S. College Ave.
Bloomington, IN 47401
Att: Ray Borill

Indianapolis Small Systems Group
54 Sherry Lane
Brownsburg, IN 46112

Louisville Area Computer Club
115 Edgemont Dr.
New Albany, IN 40218

Purdue University Computer Hobbyist Club
(PUNCH)
Rm. 67, Electrical Engineering Bldg. Purdue Univ.
West Lafayette, IN 47907
Att: Tom Gille

Iowa

Eastern Iowa Computer Club
6026 Underwood Ave. SW
Cedar Rapids, IA 52404

Eastern Iowa Computer Club
POB 164
Hiawatha, IA 52233

Quad City Computer Club
2155 W. 30 St.
Davenport, IA 52804
Att: Cecil Fretwell

Kansas

The Computer Network of Kansas City
1251 Kansas Ave.
Kansas City, KS 66105
Att: Harold J. Schwartz

South Central Kansas Amateur Computer
Association
1504 N. St. Clair
Wichita, KS 67203

Kentucky

Louisville Area Users of Micro-Computers
POB 18065
Louisville, KY 40218

Louisiana

Crescent City Computer Club
Box 1901
University of New Orleans
New Orleans, LA 70122

New Orleans Computer Club
1119 Pennsylvania Ave.
Slidell, LA 70458
Att: Emile Alline

Maryland

Chesapeake Microcomputer Club, Inc.
POB 87
Silver Springs, MD
Att: Rich Kuzmack

For more
information on
advertised
products,
equipment
tested, etc.,
circle
appropriate
number on
postpaid
Free
Information
Card.



Level II, 16K
TRS-80* \$669.⁰⁰

Keypad not included.

*A trademark of Radio Shack and Tandy Corp.

Smart Terminal Package...

Level II, 4K; CAT MODEM; RS-232C Port;
Parallel Printer Port; ST80 UC Term Software.

\$899.⁰⁰

TO ORDER:
1-800-258-1790

HARDSIDE

QUESTIONS:
(603) 673-5144

6 South Street, Milford, NH 03055

CIRCLE NO. 24 ON FREE INFORMATION CARD

ASK FOR OUR FREE CATALOG!

PUT THE REAL LIFE ACTION OF OUR TOWN IN YOUR SHIRT POCKET!

Six channels of local as it happens excitement packed inside "the smallest high-performance scanner package in the world." Four bands of scanning action! 15 channels per second scanning! Big scanner features like built-in Scan Delay, Channel Lockouts and Manual Channel selection. Patented Track Tuning on UHF bands. The Four-Six ThinScan™ is small enough to slip easily into a shirt pocket or purse. Now you can take all the excitement of police, fire and emergency broadcasts anywhere you go.

Measures 2 3/4 x 6 1/2 x 1". Rubber ducky antenna included. Frequency range: 33-47, 152-164, 450-508 MHz. List price is \$179.95, but from Communications Electronics™ your cost is only \$119.00. These accessories are also available for your Four-Six ThinScan™ scanner: SP50 AC Adapter \$12.00; SP51 Battery Charger \$12.00; SP57 Carrying case with belt clip \$15.00; B-4 1.2 V. AAA NiCad's (pack of 4) \$15.00; A-135cc Crystal certificate \$4.00 each. Add \$5.00 per scanner for U.P.S. ground shipping in the continental U.S. or \$9.00 for even faster U.P.S. air shipping. Add \$3.00 for all accessories ordered at the same time. Order now by credit card. Call our number below.



Bearcat
FOUR-SIX THINSCAN™

COMMUNICATIONS ELECTRONICS™

854 Phoenix □ Box 1002 □ Ann Arbor, Michigan 48106 U.S.A.
Call TOLL-FREE (800) 521-4414 or outside U.S.A. (313) 994-4444
CIRCLE NO. 1 ON FREE INFORMATION CARD

SAVE!

MONEY • TIME • FREIGHT

QUALITY STEREO EQUIPMENT AT LOWEST PRICES.

YOUR REQUEST FOR QUOTATION RETURNED SAME DAY.

FACTORY SEALED CARTONS—GUARANTEED AND INSURED.

SAVE ON NAME BRANDS LIKE:

PIONEER	SANSUI
KENWOOD	DYNACO
SHURE	SONY
MARANTZ	KOSS

AND MORE THAN 50 OTHERS BUY THE MODERN WAY BY MAIL—FROM

illinois audio

BANK CARDS ACCEPTED

12 East Delaware
Chicago, Illinois 60611
312-664-0020

CIRCLE NO. 30 ON FREE INFORMATION CARD

Massachusetts

The Alcove Computer Club
230 Main St.
North Reading, MA 01864

The Boston Computer Society
17 Chestnut St.
Boston, MA 02108
Att: Jonathan Rotenburg

Boston Area Group
21 Sunset Ave.
North Reading, MA 01864

The New England Computer Society
POB 198
Bedford, MA 01730
Att: Dave Day or Dave Milton

TRS Club
96 Dotham St.
Arlington, MA 02174
Att: Poi K. Pow

Michigan

Ann Arbor Computing Club
1485 Newport Rd.
Ann Arbor, MI 48103
Att: Roger Gregory

Computer Hobbyist Around Lansing
4307 Mar Moor Dr.
Lansing, MI 48917
Att: Joyce & Marvin Church

Detroit Area Club
45466 Cluster
Utica, MI 48087
Att: Dennis Siemitt

Jackson Hams and Hackers Commonwealth Association
209 E. Washington St.
Jackson, MI 49201

Mid-Michigan Microgroup
13121 Tucker Dr.
Dewitt, MI 48820
Att: William T. Serviss

Semco
20,000 Great Oak Circle S.
Mount Clemens, MI
Att: Dick Weir

Minnesota

Advanced Technology Research Association
POB 456
Minneapolis, MN 55440

Minnesota Computer Society
POB 35317
Minneapolis, MN 55435
Att: Jean Rice

Resource Access Center
3010 4th Ave. S.
Minneapolis, MN 55408
Att: R. Koplou

Small Computer Engineering Association of Minnesota
POB 4244
St. Paul, MN 55104
Att: Mike Young

Southeast Minnesota Amateur Computer Club
2212 N.W. 17th Ave.
Rochester, MN 55408

XXX-11
514 S. 9th St.
Moorhead, MN 56560
Att: C.R. Corner

Montana

Flathead Computer Society
Box 236
Lakeside, MT 59922
Att: Ernest G. Brooner

Missoula Amateur Computer Club
2203 E. Crescent
Missoula, MT 59801
Att: David Eggebraaten

Nebraska

Mid-America Computer Hobbyist
POB 13303
Omaha, NE 68113
Att: Thomas F. Smith

Scampus
2215-A Walker Dr.
Omaha, NE 68123
Att: Tom Bohon

Nevada

Northern Nevada Computer Club
c/o UNSCC
POB 9068
Reno, NV 89507
Att: Al Brady

Southern Nevada Personal Computing Society (SNPCS)
1405 Lucilee St.
Las Vegas, NV 89101
Att: Edna H. Wells

New Hampshire

Nashua Area Computer Club
181 Cupress Lane
Nashua, NH 03060
Att: Dwayne Jeffries

New Jersey

Amateur Computer Group of New Jersey
1776 Raritan Rd.
Scotch Plains, NJ 07076
Att: Sol Libes

Computer Group of South Jersey (New)
503 West New Jersey Ave.
Somers Point, NJ 07076
Att: David Jones

Holmdel Microprocessor Club
Bell Tel. Labs.
Rm 3D 317
Holmdel, NJ 07733
Att: Fred Horney

New Jersey Apple Users Group
Computer Lab. of N.J.
141 Rt. 46
Budd Lake, NJ 07828
Att: Dan Fischier

New Jersey Club
37 Brook Dr.
Dover, NJ 07801
Att: Bruce C. Dallard

Northern New Jersey Amateur Computer Group
593 New York Ave.
Lyndhurst, NJ 07071
Att: Murray Dwight

New Mexico

Albuquerque Area Computer Club
POB 866
Corrales, NM 87048
Att: Gary Tack

New York

AEC Transfer
8 Gedney Way / 147 Fostertown Rd.
Newburgh, NY 12550
Att: William Callahan Jr.

Buffalo Group
355 South Creek Dr.
Depew, NY 14043
Att: Chuck Fischer

Capital Area Microcomputer Society
Box 348, Ridge Rd.
Scotia, NY 12302
Att: Stanley L. Mathes

Computer Hobbyists in Processing (CHIPS)
POB 4840
General Electric Co. GSP3-16
Syracuse, NY 13221
Att: Dave Flagg or Jerry Green

Electronotes
1 Pheasant Lane
Ithaca, NY 14850
Att: Bernie Hutchins

Ithaca Computer Group
204 Dyden Rd
Ithaca, NY 14850
Att: Steve Edelman

Long Island Computer Association
POB 864
Jamaica, NY 11431

Long Island Computer Association
36 Irene Ln. E
Plainview, NY 11803
Att: Aileen Harrison

Long Island Computer Club
Popular Electronics
One Park Ave
New York, NY 10016

Long Island Computer Users Society
(LICUS)
POB 322
East Northport, NY 11731
Att: John Vollers

New York Amateur Computer Club
106 Bedford St.
New York, NY 10014

New York Amateur Computer Club
POB 106
Church Street Station
New York, NY 10007
Att: Bob Schwartz or John Frederick

New York City Micro Hobbyist Group
375 Riverside Dr. Apt 1E
New York, NY 10025
Att: Robert Schwartz

Niagara Regional Computer Group (NRCG)
355 S. Creek Dr.
Depew, NY 14043
Att: Chuck Fisher

Rochester Area Microcomputer Society (RAMS)
POB D
Rochester, NY 14609
Att: Glen Alexander

Rome Area Computer Enthusiasts (RACE)
RD 1, W. Carter Rd.
Rome, NY 13440
Att: Michael Troutman

Stony Brook Homebrew Computer Club
College of Eng. and Applied Science
State University of New York
Stony Brook, NY 11794
Att: Dr. Ludwig Braun

Students Cybernetic Laboratory (SCYL)
RFD Box 260
Chaffee, NY 14030
Att: A.E. Adams

Westchester Amateur Computer Society
41 Colby Ave.
Rye, NY 10580
Att: Harold Shair

Westchester Fairfield Amateur Computer Society
RR1, Box 198
Pound Ridge, NY 10576

North Carolina
Triad Amateur Computer Society
3202 Winchester Dr.
Greensboro, NC 27406
Att: Doug Drye

Triangle Amateur Computer Club
POB 17523
Raleigh, NC 27609
Att: Russell O. Lyday

North Dakota
 Fargo-Moorhead Computer Club (FMCC)
POB 2017
 Fargo, ND 58102
Att: Dan Kay

Ohio
Amateur Computer Society of Columbus Ohio
(ACSCO)
Computer Data Systems
1372 Grandview Ave.
Columbus, OH 43212
Att: Fred Hatfield

Amateur Computer Society of Columbus
408 Thurber Drive West #6
Columbus, OH 43215
Att: Walter Marvin

The Cleveland Digital Group
8650 Harvard Ave
Cleveland, OH 44105
Att: David A. Rolnicki

Computer Evaluate Trade
POB 104
Tipp City, OH 45371
Att: Charles Tyzzer

Dayton Computer Club
8668 Sturbridge Ave.
Cincinnati, OH 45200
Att: Doug Address

Dayton Microcomputer Association
2629 Ridge Ave.
Dayton, OH 45414
Att: Jack Steele

Goodyear Computer Club
Goodyear T&R Company
Akron, OH 44316
Att: J.F. Derry, D-109E Pit 1

Kim Users Group
7656 Broadview Rd, Apt 201
Parma, OH 44134
Att: Erick Rehnke

Midwest Alliance of Computer Clubs
POB 83
Brecksville, OH 44141
Att: Gary Coleman

SR-52 Users Group
9459 Taylorsville Rd
Dayton, OH 45424
Att: Richard C. Vanderburgh

Tri-State Computer Club
508 Colony Dr.
Wheelersburg, OH 45694
Att: Douglas Troughton

Universe Unlimited Group
11981 Forest Ave.
Cleveland, OH 44120

Oklahoma
Central Oklahoma Amateur Computing Association
(CENOACA)
POB 2213
Norman, OK 73070
Att: Lee Lilly or Don Holyoke

The Tulsa Computer Society
POB 1133
Tulsa, OK 74101
Att: Jerry Henshaw

Oklahoma City Club
2412 S.W. 45th
Oklahoma City, OK 73119
Att: Bill Cowden

Oregon
N.W. Pet User's Group
2134 N.E. 45th Ave.
Portland, OR 97213
Att: John F. Jones

Portland Computer Club
2814 N.E. 40th Street
Portland, OR 97212
Att: Bill Marsh

Portland Computer Society
4032 S.E. Grant
Portland, OR 97214
Att: Percy G. Wood

Portland Computer Society
1003 Garland Street, Apt 4
Woodburn, OR 97071

Southwest OMSI Computer Club
Southwest Oregon Museum of Science & Industry
27 E. 5th Avenue
POB 1052
Eugene, OR 97401

The Directory will be concluded next month. To have your club listed, send information to Computer Club Directory, POPULAR ELECTRONICS, One Park Ave., New York, NY 10016.

They look expensive.
They sound expensive.
But they're not because you
build them yourself.

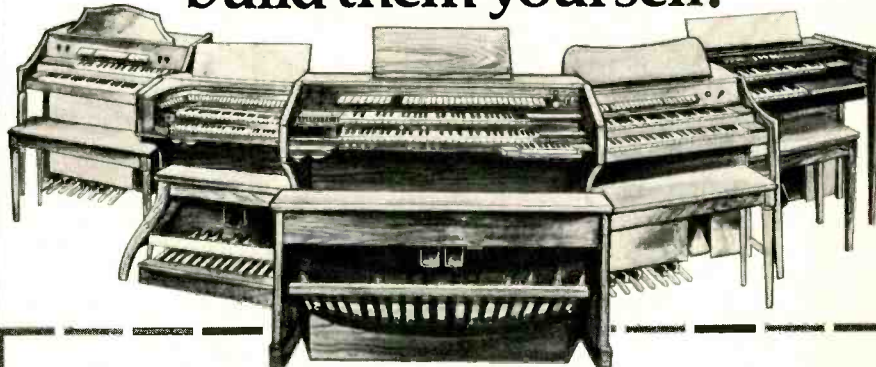

The Magnificent Schober Electronic Organs.

Imagine the pride and joy of owning one of the world's great organs. And for up to 50% less than an instrument of comparable sound and quality. Schober organ kits come in 5 different styles and sizes to fit your musical taste and budget.

Mail this coupon today for free information.

The Schober Organ Corp., Dept. PE-89
43 West 61st Street, New York, N.Y. 10023

Send me free catalog.

Name _____

Address _____

City _____ State _____ Zip _____

CIRCLE NO. 52 ON FREE INFORMATION CARD

trigger fast soldering action

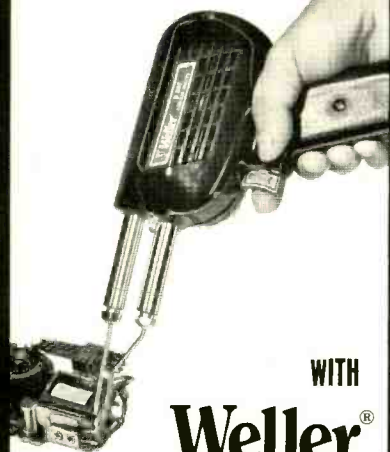

WITH

Weller[®]

COMFORT-GRIP GUNS

Dual-action trigger permits instant choice of 2 heats in all Weller's professional quality guns, the most comfortable, best-balanced units... anywhere. Pre-focused light for hard-to-see work areas like TV or under-dash auto service. Premium copper tips get up to temp faster... pre-tinned for instant soldering. Cutting or smoothing tips also, UL-listed and factory pre-tested. Models for any service including solid-state. Guns alone or kits with case, spare tips, and accessories.



Ask your
local
distributor
or write...



The Cooper Group
Electronics Division

WELLER[®], WISS[®], XCELITE[®]

PO BOX 728, APEX NORTH CAROLINA 27502, 919/362-7511
CIRCLE NO. 14 ON FREE INFORMATION CARD



Soft ware Sources

Leslie Solomon
Technical Director

TRS-80 Dialer/Timer. This TRS-80 Level-II BASIC program holds up to 500 names and telephone numbers in 16K, or 30 names and numbers in 4K. The cable that normally goes to the cassette remote jack is used to pulse the interface relay. The computer displays the name, number and area code of the party selected, then displays each digit as it is dialed. After contacting the remote party, hitting ENTER starts timing and displaying the call by the second. At the end of the call, the user inserts rate and computer displays time and charge. \$10 from Blechman Enterprises, 7217 Bernadine Ave., Canoga Park, CA 91307 (Tel: 213-346-7024).

Text Processor. The Master Text Processor, for the Apple II and Apple Plus systems contains a mailing list and programmable form letter writer. It requires 32K of RAM and one or two disk drives. It features user-defined formatting, automatic line length adjust, and text merging, and includes change, insert, delete, text formatting, sentence merger, string location and word/phrase replacement. \$139.95 from CMA dealers. Charles Mann and Assoc., Micro Software Div., 7594 San Remo Trail, Yucca Valley, CA 92284 (Tel: 714-365-9718).

CP/M SBASIC. SBASIC (structured BASIC) is a pre-compiler offering the power of structured programming for conventional BASIC. SBASIC provides additional statements for program control. These include IF...FIN, UNLESS...FIN, WHEN...FIN, ELSE...FIN, FOR...FIN, REPEAT UNTIL...FIN, REPEAT WHILE...FIN, UNTIL...FIN, WHILE...FIN, SELECT...FIN, CONDITIONAL...FIN, PROCEDURE...FIN, and PERFORM. Thus, SBASIC allows the user to write exactly what is meant without GOTO's or THEN's. CP/M diskette is \$50, BASIC source listing is \$35. Ultimate Computer Systems, 313 Meadow Lane, Hastings, MI 49058 (Tel: 616-945-5334).

TRS-80 Pencil Pal. If you use the Electric Pencil on your TRS-80, then the addition of Pencil Pal allows automatic merging of letters with an address file. It is entirely compatible with lower-case modifications. One or two fields within the address file may be used to select letters to be printed. \$35 on cassette with documentation, or \$5 for documentation alone. MicroComputer Specialists, P.O. Box 11295, Elkins Park, PA 19117, (Tel: 215-635-2473).

Z8000 FP Package. This package provides a unified set of floating-point support subroutines for any Z8002. 32-bit binary floating-point format is used to provide fast arithmetic operations, integer-float and float-integer conversions, float-ASCII string representation, and ASCII string-float conversions. Precision is between 6 and 7 digits and exponent range is 1E-20 to 1E+20. The package is ROMable, and requires 1412 bytes and 50 bytes of stack RAM. \$99.95 from Hemenway Associates, Inc., 101 Tremont St., Suite 208, Boston, MA 02108 (Tel: 617-426-1931).

Fantasy Software. The game called "Morloc's Tower" was designed for a PET with 20K, TRS-80 Level II with 16K, and Apple II with 32K and Applesoft in ROM. The game features a maze of 30 rooms, all displayed on screen, in the search for the elusive wizard, Morloc the Mad. It has full graphics and 18 real-time commands. All forms of "magic" things appear on the screen—monsters, rings, swords, amulets, etc. There are three levels of difficulty that can be played. \$14.95 from Byte Shops or Automated Simulations, P.O. Box 4232, Mountain View, CA 94040 (Tel: 415-964-8021).

Medical Package. This program handles all details of billing, insurance forms, treatment records, and many reports including charge and payment entry, patient statements, Blue Cross billings, Medicare submittals and remittances, commercial insurance billing, collection accounting and dunning, patient processing, numeric or alphabetic patient listing, CPT-4 procedure and ICDA-9 diagnostic code reports, aged accounts receivables, third party accounting and reconciliation, and transaction reporting. Program is available on 8" or various mini-floppies. Storage capacity of two-disk (8") single-density system: on Disk B, 1200 patient records and 2100 treatment/payment records; on Disk A, 1000 CPT codes and charges, 1000 diagnostic codes, and 2000 third-party billing records. Graham-Dorian Software Systems, Inc., 211 N. Broadway, Wichita, KS 67202.

Atari and TI 99/4 Games. New line of software includes: for the Atari, All Star Baseball 6401, Wall Street Challenge 6402, Mind Master 6403, Strategy Packs I 6404 and II 6405, and Skill Builder 6406; and for the TI system, Tournament Brick Bat 9401, Wall Street Challenge 9402, Wildcatting 9403, Strategy Pack I 9404, Mind Master 9405 and Skill Builder I 9406. Image Computer Products, Inc., 615 Academy Drive, Northbrook, IL 60062 (Tel: 312-564-5060).

Apple Circuit Design. This electronic design package for the Apple II with Applesoft in ROM and 48K of RAM features 84 different formulas for use in circuit analysis. There are 11 formulas for dc, 30 for ac, 20 for designing filters, 4 for vacuum tubes and 8 for transistors. The set of 84 is completed with 11 formulas covering miscellaneous areas. High-resolution graphics of the filters are shown. All programs are self-prompting. In diskette form for \$99.95. Korsmeyer Electronic Design, 9612 Chevy Chase, Huntington Beach, CA 92646 (Tel: 714-964-4346).

THE MICROCOMPUTER MART

COMPUTER RETAIL STORES

MICROCOMPUTER MART RATE: 1" x 1 Column (1-5/8") \$125. 1-1/2" x 1 Column (1-5/8") \$187.50. 2" x 1 Column (1-5/8") \$250.00. For frequency rates, please inquire. **GENERAL INFORMATION:** Advertising copy must be typewritten or clearly printed. Payment must accompany copy except when ads are billed on credit cards—American Express, Diners Club, Master Charge, VISA (supply Expiration date)—or when ads are placed by accredited advertising agencies. Ads are not acknowledged. They will appear in the first issue to go to press after closing date. Closing date: 1st of the 2nd month preceding cover date (for example, April issue closes February 1st). Send order and remittance to MicroComputerMart, POPULAR ELECTRONICS, One Park Avenue, New York, NY 10016. For inquiries, contact (212) 725-3485.

MICHIGAN

5 1/4" + 8" Diskettes, \$2.99 ea. (Boxes of 10)
 O.S.I. II-DEM 48K, AMCAP Software,
 Reg. \$3,874, Now \$2,995
 CROMEMCO SYS-3, 64K, Dual Sided 8"
 Reg. \$6,990, Now \$5,695.
 Other Discounts as well. Shipping Extra.
 Rt. 1, Box 193
 Berrien Springs
 Michigan 49103
 (616) 429-3034



NEW JERSEY

**COMPUTER MART
 OF NEW JERSEY**
 501 Route 27
 Iselin, N.J. 08830
 (201) 283-0600



The
**Microcomputer
 People®**

ILLINOIS

*midwest
 microcomputer*

- All your business & personal computer needs.
- Extensive Software & Peripherals Stock.

708 S. Main St.
 Lombard, IL 60148
 (312) 495-9889

CALIFORNIA

**The Original
 ByteShop®**
 1415 W. El Camino Real
 Mountain View, CA 94040
 (415) 969-5464

FREE! software catalog for Apple II

SALES • SERVICE • LEASING
 of
 APPLE • ATARI • DEC
 Plus all PERIPHERALS & SUPPLIES
 Open Tuesday through Sunday
 VISA and MASTERCHARGE

RAINBOW COMPUTING, INC.
 9719 Reseda Blvd.
 Northridge, Ca 91324
 (213) 349-5560

**OHIO SCIENTIFIC
 MICRO-COMPUTERS**
 A.A. Office
 Equipment Company
 15296 E. 14th St.
 San Leandro, CA 94578
 (415) 357-1737

FLORIDA

**MICROCOMPUTER
 SYSTEMS, INC.**

The Computer Supermarket
 offering quality computer systems for business, home and educational uses.

APPLE - TI - ALTOS
 GIMIX - SWTPC - EXIDY
 144 S. Dale Mabry Hwy
 Tampa, FL 33609
 (813) 879-4301, 879-4225

GEORGIA

Radio Shack® DEALER
COMPUTER CENTER
**MICRO MANAGEMENT
 SYSTEMS**



Up to 15% Discount
 on TRS-80's

We have the highly reliable
 Lobo Disk Drive in stock!

Mini-Mail—Downtown Shopping Center
 Cairo, Georgia 31728
 (912) 377-7210

OHIO

BAND-ORCH, INC.
**Complete Ohio
 Scientific Line**
 337 East State Street
 Alliance, Ohio 44601
 (216) 821-2600
 VISA/Master Charge

PENNSYLVANIA

**PET: Atari; Compu Think;
 Diskettes at Discount Prices**

AB Computers
 115 E. Stump Road
 Montgomeryville, PA 18936
 (215) 699-5826

TEXAS



As a Radio Shack® Authorized Sales Center owned & operated by Pan American Electronics, Inc., we can sell them for less. No taxes collected on out-of-state shipments. We pay shipping & insurance.

TOLL FREE 800/531-7466
 Texas & Main No.
 512/581-2765
 1117 Conway
 Mission, Texas 78572

**LOOK!!
 TRS-80* Computer Owners
 MEGASAVINGS!**

* trademarks of Tandy Radio Shack Corporation

- Brand new Percom mini-disk systems: Single-Drive — \$325; Double-Drive — \$650; Triple-Drive — \$975.
- 16K-Byte Memory: 8prime 4116 ICs — \$64.95

Introductory prices good for a limited time only. Prices do not include shipping, or sales tax if applicable.

CALL Toll-free 1-800-527-4196

ACCESS UNLIMITED
 315 N. Shiloh - Ste. D1 - Garland, TX 75042
(214) 494-0206

COMPUTER RETAILERS
 * Your computer store ad in **THE MICRO-COMPUTER MART** will enable you to reach **POPULAR ELECTRONICS'** Electronic Activist audience... an audience that utilizes microcomputer equipment for business AND personal purposes. For further details, call (212) 725-3485.

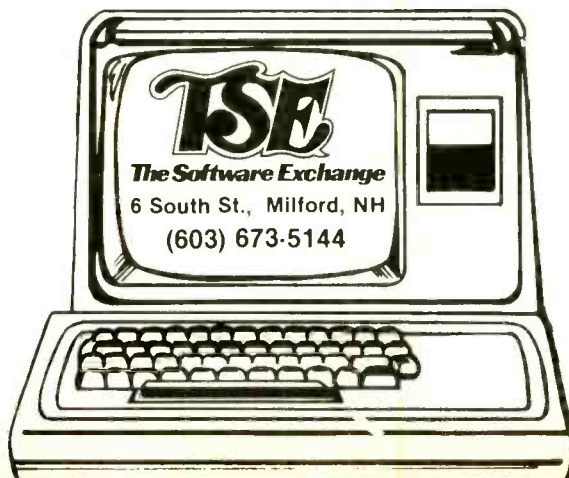

- Galactic Empire \$14.95
- Star Trek III.4 \$14.95
- Alien Invasion \$9.95
- Sargon II \$29.95
- Cribbage Level I or II \$7.95
- Taipan \$9.95
- Tycoon \$9.95
- Kriegspiel \$7.95
- 9 Games for Pre-Schoolers \$9.95
- Snake Eggs \$14.95
- Amazin Mazes \$7.95
- Kamikaze \$7.95
- Lost Dutchman's Gold ... \$9.95
- Secrets of the Tarot \$9.95
- Biorhythms \$4.95
- Personal Finance \$9.95
- Typing Tutor \$19.95
- RPN Calculator \$9.95
- Histogram/
 Scattergram \$9.95
- Electronics Assistant \$9.95
- Ham Radio \$9.95
- Basic Statistics \$9.95
- Level III Basic \$49.95
- APL 80 \$49.95

TOLL FREE (ORDERS ONLY) 800-258-1790

PROJECT OF THE MONTH

More on Pseudorandom Number Generators

BY FORREST M. MIMS

THE Project of the Month in the December 1979 issue of POPULAR ELECTRONICS was a random number generator made from an LM331 voltage-to-frequency converter and a 4017 decade counter/decoder. After describing the circuit, I presented results of 100 trials and concluded "If the results were perfectly random, each of the ten LEDs would be selected an equal number of times or ten times each for a sample of 100 trials."

Readers Warner Clements and Thomas D. Martin were quick to catch the error in this conclusion. Quoting from Mr. Clements's letter, "Suppose the device were an absolutely perfect random number generator, in accord with theory. Then, what would be the probability that, in a run of 100 generated numbers, you'd get ten of each digit? Mims's statement sets the probability at unity. But in reality the probability is 1/42,423,000. Mims thus overestimates the probability by more than four billion percent."

Fortunately the operation of the circuit was unaffected by my statistical misconception. Both Messrs. Clements and Martin observed that the results given in the column are, in Mr. Clements' words, "... random enough for any practical purpose."

Mr. Martin explained some statistical concepts and plotted the results given in the December column on a probability chart. The results tend to indicate the lack of any statistical bias on the part of the original circuit, but, as Mr. Martin said, "This fact does not indicate an absence of bias either, only that your sample is not much different from some other samples taken from data that has been previously tested."

I very much appreciate the help these readers have provided. Since random number generation is so important, this encore column gives some additional circuits.

Coin Tossor. Figure 1 is a CMOS coin tosser which lights, with virtually the same probability, either of two LEDs. The oscillator, which is made from the two gates, operates at a frequency of about 1 MHz. Pressing *S1* for a second or two allows the oscillator to run, which in turn toggles the flip-flop at a rate far too fast to second guess which LED will glow when switch *S1* is released.

If you use red LEDs, label one heads and the other tails (or label one left and the other right). You can avoid labels by using a red LED and a green LED. Furthermore, you can add an additional element of chance by inserting a cadmium sulfide photoresistor between *R1* and point "x".

Subtle variations in the light striking the cell will alter the oscillator frequency.

Pseudorandom Number Generator. If you can't find an LM331 for use in the December 1979 Project of the Month, try the circuit shown in Fig. 2. Although this circuit won't exhibit wheel-of-fortune operation (that is, press the button and all LEDs glow; release the button and the LED cycle gradually slows until only one remains on), it produces results that are just as random.

The oscillator portion of Fig. 2 is identical to the oscillator shown in Fig. 1. The remainder of the circuit is identical to the

decade counter/decoder section of the December circuit.

Label the LEDs 0 through 9 (or 1 through 10). To operate the pseudorandom number generator, press *S1* for a second or two to activate the oscillator. All the LEDs will glow as they are scanned sequentially by the decoder. When *S1* is released, one of the LEDs remains on.

You can modify this circuit for digital readout by substituting a BCD counter/decoder and a seven-segment LED or liquid crystal display for the 4017 and its string of LEDs. Current consumption is low, so the circuit will operate for a long time when powered by a 9-volt alkaline cell. ♦

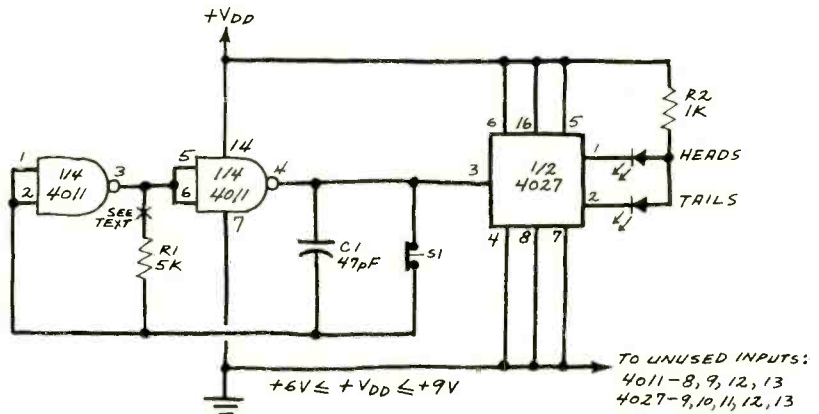

Fig. 1. Schematic diagram for a coin tosser using CMOS circuitry.

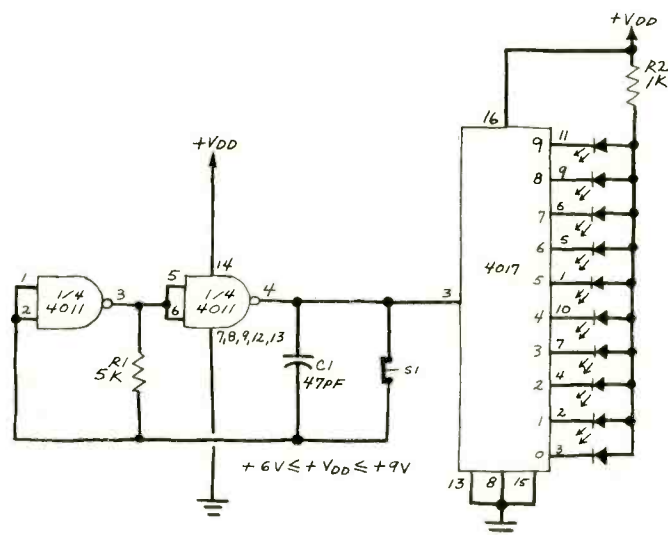

Fig. 2. Circuit for a pseudorandom number generator.

DIGI-KEY TOLL FREE 1-800-346-6674

MINN., AK., HI. RESIDENTS 218-681-6674

DON'T FORGET OUR DISCOUNTS WHEN COMPARING PRICES I.C.'S • RESISTORS • TRANSISTORS • CAPACITORS • DIODES • I.C. SOCKETS & PINS • SWITCHES
CLOCK MODULES • OPTOELECTRONICS • BREADBOARD & TESTING DEVICES • DRAFTING SUPPLIES
DATA BOOKS • HEAT SINKS • WIRE • TOOLS ... AND MORE ... WRITE FOR FREE CATALOG ...

TEXAS INSTRUMENTS I.C. SOCKETS

SOLDER TAIL DIP SOCKETS

Low profile design for maximum insertion force
Resilient contact points
Your Choice - TIN OR GOLD
Minimum 15 microinch gold plating (gold sockets)
TEXAS INSTRUMENTS QUALITY



TIN INLAY SOLDER TAIL
Series C-85 Min. 150 Microinch Tin

Part No.	Description	1	10	100
C8501	8 pin solder tail	10	85	800
C8502	14 pin solder tail	15	120	1100
C8516	18 pin solder tail	20	170	1600
C8520	20 pin solder tail	25	210	2000
C8524	24 pin solder tail	35	310	3000
C8528	28 pin solder tail	50	450	4500
C8532	32 pin solder tail	75	700	7000

GOLD INLAY SOLDER TAIL
Series C-95 Min. 75 Microinch Gold Plating

Part No.	Description	1	10	100
C9501	8 pin solder tail	10	85	800
C9502	14 pin solder tail	15	120	1100
C9516	18 pin solder tail	20	170	1600
C9520	20 pin solder tail	25	210	2000
C9524	24 pin solder tail	35	310	3000
C9528	28 pin solder tail	50	450	4500
C9532	32 pin solder tail	75	700	7000

WIRE WRAP DIP SOCKETS

Standard profile
Integral mounting and packaging capabilities
Contact diameter - .015"
Through-hole mounting
Roctac dual-in-line leads



TIN PLATED WIRE WRAP
Series C-11 Min. 150 Microinch Tin

Part No.	Description	1	10	100
C1101	8 pin wire wrap	10	85	800
C1102	14 pin wire wrap	15	120	1100
C1104	18 pin wire wrap	20	170	1600
C1106	20 pin wire wrap	25	210	2000
C1108	24 pin wire wrap	35	310	3000
C1110	28 pin wire wrap	50	450	4500
C1112	32 pin wire wrap	75	700	7000

GOLD INLAY WIRE WRAP
Series C-11 Min. 75 Microinch Gold Plating

Part No.	Description	1	10	100
C1101	8 pin wire wrap	10	85	800
C1102	14 pin wire wrap	15	120	1100
C1104	18 pin wire wrap	20	170	1600
C1106	20 pin wire wrap	25	210	2000
C1108	24 pin wire wrap	35	310	3000
C1110	28 pin wire wrap	50	450	4500
C1112	32 pin wire wrap	75	700	7000

MOLDEX I.C. SOCKET PINS
Series C-20 Min. 38.20 I.S.M. 275.00 I.S.M.



TEXAS INSTRUMENTS GOLD EDGEBOARD CONNECTORS

Solder Tab Solder Eye

RELIABLE, COST-EFFICIENT CONTACT DESIGN

50 (Wire) Ws to 75 (Solder Tail) inches makes gold inlay over a nickel diffusion barrier.
Copper-nickel Ni-Cr 50% Au plating.
Bifurcated contact points.
Preformed, cantilever spring design.
Contacts are user removable.

H4 SERIES .100" x .200" EDGEBOARD CONNECTORS

Part No.	Description	1	10	100
H4010	10 pin	10	85	800
H4012	12 pin	15	120	1100
H4014	14 pin	20	170	1600
H4016	16 pin	25	210	2000
H4018	18 pin	35	310	3000
H4020	20 pin	50	450	4500
H4022	22 pin	75	700	7000
H4024	24 pin	100	950	9500
H4026	26 pin	150	1400	14000
H4028	28 pin	200	1900	19000
H4030	30 pin	250	2400	24000
H4032	32 pin	350	3300	33000
H4034	34 pin	500	4700	47000
H4036	36 pin	750	7000	70000
H4038	38 pin	1000	9500	95000
H4040	40 pin	1500	14000	140000
H4042	42 pin	2000	19000	190000
H4044	44 pin	2500	24000	240000
H4046	46 pin	3500	33000	330000
H4048	48 pin	5000	47000	470000
H4050	50 pin	7500	70000	700000

H4 SERIES .125" x .250" EDGEBOARD CONNECTORS

Part No.	Description	1	10	100
H4050	50 pin	7500	70000	700000
H4052	52 pin	10000	95000	950000
H4054	54 pin	15000	140000	1400000
H4056	56 pin	20000	190000	1900000
H4058	58 pin	25000	240000	2400000
H4060	60 pin	35000	330000	3300000
H4062	62 pin	50000	470000	4700000
H4064	64 pin	75000	700000	7000000
H4066	66 pin	100000	950000	9500000
H4068	68 pin	150000	1400000	14000000
H4070	70 pin	200000	1900000	19000000
H4072	72 pin	250000	2400000	24000000
H4074	74 pin	350000	3300000	33000000
H4076	76 pin	500000	4700000	47000000
H4078	78 pin	750000	7000000	70000000
H4080	80 pin	1000000	9500000	95000000

H4 SERIES .150" x .350" EDGEBOARD CONNECTORS

Part No.	Description	1	10	100
H4080	80 pin	1000000	9500000	95000000
H4082	82 pin	1500000	14000000	140000000
H4084	84 pin	2000000	19000000	190000000
H4086	86 pin	2500000	24000000	240000000
H4088	88 pin	3500000	33000000	330000000
H4090	90 pin	5000000	47000000	470000000
H4092	92 pin	7500000	70000000	700000000
H4094	94 pin	10000000	95000000	950000000
H4096	96 pin	15000000	140000000	1400000000
H4098	98 pin	20000000	190000000	1900000000
H4100	100 pin	25000000	240000000	2400000000

TIME-TEMPERATURE PROGRAMMABLE MODULE USER PROGRAMMABLE FOR:

- 12 or 24 Hour Cycles
- 1 and 2°C. It will verify any number of temperature ranges
- 1 and 2°C. in 1/2 hour cycles
- 50/60 Hz Line Frequency operation



FEATURES

- Onset of 12 or 24 Hour Cycles with red LEDs
- Min. alarm, Onset and alarm - On LED indicators
- 1 minute temperature range time, 1 second alarm, 1 second time range
- Exclusive On-Off switch option available to simplify hook-up
- Leads per wire labeling
- Time of onset delay mode, with temperature display of each of several
- Timing for measurement and cycles of temperature in range of 40°C to 100°C
- Multiple temperature sensors may be used
- Power fail condition indicated by flashing
- In addition to Onset and alarm, switching of small to medium A.C. loads
- Automatic switching point to simplify hook-up

THE "PROGRAMMABLE" CLOCK MODULE USER PROGRAMMABLE FOR:

- 12 or 24 Hour Cycles
- 1 and 2°C. in 1/2 hour cycles
- 50/60 Hz Line Frequency operation



FEATURES

- Display brightness can be controlled by an induction of 5000 potentiometer
- Will support continuous loads by controlling an induction of 500 potentiometer
- Onset of 12 or 24 Hour Cycles with red LEDs
- Min. alarm, Onset and alarm - On LED indicators
- 1 minute temperature range time, 1 second alarm, 1 second time range
- Exclusive On-Off switch option available to simplify hook-up
- Leads per wire labeling
- Timing for measurement and cycles of temperature in range of 40°C to 100°C
- Multiple temperature sensors may be used
- Power fail condition indicated by flashing
- In addition to Onset and alarm, switching of small to medium A.C. loads
- Automatic switching point to simplify hook-up

THE "PROGRAMMABLE" CLOCK MODULE USER PROGRAMMABLE FOR:

- 12 or 24 Hour Cycles
- 1 and 2°C. in 1/2 hour cycles
- 50/60 Hz Line Frequency operation



FEATURES

- Display brightness can be controlled by an induction of 5000 potentiometer
- Will support continuous loads by controlling an induction of 500 potentiometer
- Onset of 12 or 24 Hour Cycles with red LEDs
- Min. alarm, Onset and alarm - On LED indicators
- 1 minute temperature range time, 1 second alarm, 1 second time range
- Exclusive On-Off switch option available to simplify hook-up
- Leads per wire labeling
- Timing for measurement and cycles of temperature in range of 40°C to 100°C
- Multiple temperature sensors may be used
- Power fail condition indicated by flashing
- In addition to Onset and alarm, switching of small to medium A.C. loads
- Automatic switching point to simplify hook-up

INTEGRATED CIRCUITS

Part No.	Description	1	10	100
7401N	2N7401N	25	200	2000
7402N	2N7402N	25	200	2000
7403N	2N7403N	25	200	2000
7404N	2N7404N	25	200	2000
7405N	2N7405N	25	200	2000
7406N	2N7406N	25	200	2000
7407N	2N7407N	25	200	2000
7408N	2N7408N	25	200	2000
7409N	2N7409N	25	200	2000
7410N	2N7410N	25	200	2000
7411N	2N7411N	25	200	2000
7412N	2N7412N	25	200	2000
7413N	2N7413N	25	200	2000
7414N	2N7414N	25	200	2000
7415N	2N7415N	25	200	2000
7416N	2N7416N	25	200	2000
7417N	2N7417N	25	200	2000
7418N	2N7418N	25	200	2000
7419N	2N7419N	25	200	2000
7420N	2N7420N	25	200	2000
7421N	2N7421N	25	200	2000
7422N	2N7422N	25	200	2000
7423N	2N7423N	25	200	2000
7424N	2N7424N	25	200	2000
7425N	2N7425N	25	200	2000
7426N	2N7426N	25	200	2000
7427N	2N7427N	25	200	2000
7428N	2N7428N	25	200	2000
7429N	2N7429N	25	200	2000
7430N	2N7430N	25	200	2000
7431N	2N7431N	25	200	2000
7432N	2N7432N	25	200	2000
7433N	2N7433N	25	200	2000
7434N	2N7434N	25	200	2000
7435N	2N7435N	25	200	2000
7436N	2N7436N	25	200	2000
7437N	2N7437N	25	200	2000
7438N	2N7438N	25	200	2000
7439N	2N7439N	25	200	2000
7440N	2N7440N	25	200	2000
7441N	2N7441N	25	200	2000
7442N	2N7442N	25	200	2000
7443N	2N7443N	25	200	2000
7444N	2N7444N	25	200	2000
7445N	2N7445N	25	200	2000
7446N	2N7446N	25	200	2000
7447N	2N7447N	25	200	2000
7448N	2N7448N	25	200	2000
7449N	2N7449N	25	200	2000
7450N	2N7450N	25	200	2000
7451N	2N7451N	25	200	2000
7452N	2N7452N	25	200	2000
7453N	2N7453N	25	200	2000
7454N	2N7454N	25	200	2000
7455N	2N7455N	25	200	2000
7456N	2N7456N	25	200	2000
7457N	2N7457N	25	200	2000
7458N	2N7458N	25	200	2000
7459N	2N7459N	25	200	2000
7460N	2N7460N	25	200	2000
7461N	2N7461N	25	200	2000
7462N	2N7462N	25	200	2000
7463N	2N7463N	25	200	2000
7464N	2N7464N	25	200	2000
7465N	2N7465N	25	200	2000
7466N	2N7466N	25	200	2000
7467N	2N7467N	25	200	2000
7468N	2N7468N	25	200	2000
7469N	2N7469N	25	200	2000
7470N	2N7470N	25	200	2000
7471N	2N7471N	25	200	2000
7472N	2N7472N	25	200	2000
7473N	2N7473N	25	200	2000
7474N	2N7474N	25	200	2000
7475N	2N7475N	25	200	2000
7476N	2N7476N	25	200	2000
7477N	2N7477N	25	200	2000
7478N	2N7478N	25	200	2000
7479N	2N7479N	25	200	2000
7480N	2N7480N	25	200	2000
7481N	2N7481N	25	200	2000
7482N	2N7482N	25	200	2000
7483N	2N7483N	25	200	2000
7484N	2N7484N	25	200	2000
7485N	2N7485N	25	200	2000
7486N	2N7486N	25	200	2000
7487N	2N7487N	25	200	2000
7488N	2N7488N	25	200	2000
7489N	2N7489N	25	200	2000
7490N	2N7490N	25	200	2000
7491N	2N7491N	25	200	2000
7492N	2N7492N	25	200	2000
7493N	2N7493N	25	200	2000
7494N	2N7494N	25	200	2000
7495N	2N7495N	25	200	2000
7496N	2N7496N	25	200	2000
7497N	2N7497N	25	200	2000
7498N	2N7498N	25	200	2000
7499N	2N7499N	25	200	2000
7500N	2N7500N	25	200	2000

WIRE WRAPPING

Standard profile
Integral mounting and packaging capabilities
Contact diameter - .015"
Through-hole mounting
Roctac dual-in-line leads

TIN PLATED WIRE WRAP
Series C-11 Min. 150 Microinch Tin

Part No.	Description	1	10	100
C1101	8 pin wire wrap	10	85	800
C1102	14 pin wire wrap	15</		

BULLET PO BOX 401244P GARLAND TEXAS 75040 ELECTRONICS

SE-01 Sound Effects Kit 17.50

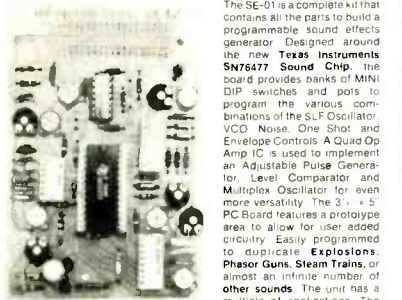

The SE-01 is a complete kit that contains all the parts to build a programmable sound effects generator. Designed around the new Texas Instruments SN76477 Sound Chip, the board provides banks of MINI DIP switches and pots to program the various combinations of the SLF Oscillator, VCO Noise One Shot and Envelope Controls. A Quad Op Amp IC is used to implement an Adjustable Pulse Generator, Level Comparator and Multiplex Oscillator for even more versatility. The 3" x 5" PCB features a prototype area to allow for user added circuitry. Easily programmed to duplicate Explosions, Phasors Guns, Steam Trains, or almost an infinite number of other sounds. The unit has a multiple of applications. The low price includes all parts, assembly manual, programming charts, and detailed 76477 chip specifications. It runs on a 9V battery (not included). On board 100mA amp will drive a small speaker directly, or the unit can be connected to your stereo with incredible results! (Speaker not included).

- 76477 CHIP IS INCLUDED. EXTRA CHIPS \$2.95 EACH
- \$17.50 LESS SPEAKER & BATTERY

From T.I.: TL490 BAR/DOT DRIVER IC. Drives 10 LEDs with adjustable analog steps. Units are cascadable up to 10 (100 steps). Drives LED's directly. Great for voltage, current, or audio displays. Similar in features to LM3914 with specs and circuit notes.

2.95 NEW! **AY-3-8910 Bang**

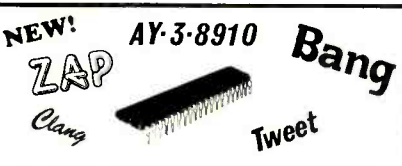

AY-3-8910 PROGRAMMABLE SOUND GENERATOR
The AY-3-8910 is a 40 pin LSI chip with three oscillators, three amplitude controls, programmable noise generator, three mixers, an envelope generator, and three D/A converters that are controlled by 8 BIT WORDS. No external pots or caps required. This chip hooked to an 8 bit microprocessor chip or Buss (8080, Z80, 6800 etc) can be software controlled to produce almost any sound. It will play three note chords, make bangs, whistles, sirens, gunshots, explosions, bleets, whines, or grunts. In addition, it has provisions to control its own memory chips with two IO ports. The chip requires +5V @ 75mA and a standard TTL clock oscillator. A truly incredible circuit.

\$14.95 W/Basic Spec Sheet (4 pages)
60 page manual with 8-1000 interface instructions and several programming examples. **\$3.00 extra**

POTENTIOMETER ASSORTMENT
A mix of new, panel mount 3/8" bushing pots in various values. Some dual some with switches. **10/2.00**

1/2W RESISTOR ASSORTMENT
A good mix of 5% and 10% values in both full lead and PC lead devices. All new, first quality. (Ass't) **200 pieces 2.00**

SLIDE SWITCH ASSORTMENT
An outstanding bargain includes miniature and standard sizes and multi-position units. All new first quality, name brand switches. Try one pack and you'll reorder more. **SPECIAL - 12 for \$1.20 (Assortment)**

PARTS		7 WATT AUDIO AMP KIT	
301 OP AMP 1 LEAD CAN	214.00	SMALL SINGLE HYBRID IC AND COMPONENTS FIT ON A 2" x 2" PCB BOARD INCLUDED. RUNS ON 10VDC. GREAT FOR ANY PROJECT THAT NEEDS AN AMPLIFYING AMP. LESS THAN 24 HOURS TO WAIT'S. COMPATIBLE WITH SE-01 SOUND KIT \$5.95	50
723 14 PIN DIP	39	TUNES SYNTHESIZER	50
1374 FEI INPUT 241 MINI DIP	31.10	The AY-3-8910 is a MOS microcomputer synthesizer of preprogrammed tunes for applications in toys, music boxes, and door chimes. The standard device has a set of 25 different popular and classical tunes. In addition there are 3 chimes including a total of 25 tunes.	50
30,000 @ 15V COMPUTER GRADE	2.10	FEATURES	50
2N4402 PNP COMPLEMENT	61.00	• Minimal external components	50
2N6028 P N T. W/SPECS	50	• Automatic switching off signal at end of tune for power saving	50
LM380 2W AUDIO IC W/SPECS	1.09	• Envelope control to give organ or piano quality	50
LM307DUAL LM380 W/SPECS	2.50	• Sequential tune mode	50
LM3900 QUAD NOTION AMP	65	• 4 door chimes when used as door chime	50
LM324 QUAD OP AMP	15.00	• Operation with tunes in external PROM if required (2708)	50
7812 1A 12V REG	95	• Single supply (5V) operation	50
7815 VOLT REG 1A 15V	100	• 100% duty cycle	50
IC-1 OPTO ISOLATOR MINI DIP	1.00	• 100% duty cycle	50
MEM 821 DUAL GATE MOSFET	1.00	• 100% duty cycle	50
DIC0E PROTECTED, SIMILAR TO 40673	50	• 100% duty cycle	50
M1762 VARICAP DIODE 10 PFD	50	• 100% duty cycle	50
IN5118 VARICAP DIODE	40	• 100% duty cycle	50
17 PFD NOW 25 MAR10	40	• 100% duty cycle	50
IN4733 1A 200V DIODE	15.00	• 100% duty cycle	50
M1301 TAB PNP POWER	21.00	• 100% duty cycle	50
MICROMIM F.M.F. DISC IC	50	• 100% duty cycle	50

*INDICATES ITEM IS HOUSE NUMBERED

LEDS

JUMBO GREEN	4.99
JUMBO RED	5.99
MEDIUM ORG OR YELLOW	15
BIPOLAR LED	15
TWO COLOR RED/GRN	50

- NO C.O.D.'S
 - SEND CHECK M.O. OR CHARGE CARD NO
 - PHONE ORDERS ACCEPTED ON VISA AND MASTERCARD ONLY
 - ADD \$5 FOR SHIPPING
 - TX RES. ADD 5% STATE SALES TAX
 - FOREIGN ORDERS ADD 10% (EXCEPT CANADA) (20% AIRMAIL) U.S. FUNDS ONLY
- (214) 278-3553**



Electronics Library

STEREO TROUBLESHOOTING & REPAIR MANUAL

by Paul Owens

This is an interesting book on stereo electronic servicing if one is seeking a broad look at the subject. Unfortunately, there are few areas that are covered in sufficient depth to live up to the title's promise. Yes, there are some detailed descriptions of how output circuits work, on FM decoders, etc. But not enough from either a theoretical or practical vantage point to give one sufficient confidence to tackle real models on a bench. Half the book is taken up by basic information for the tyro, while the other half doesn't leave enough pages to do justice to the complex subject of troubleshooting sophisticated circuitry. It is nicely illustrated, though. The overall result is a feeling of spotty coverage that could only be overcome if the author had twice as many pages to work with.

Published by Reston Publishing Co., Inc. Reston, Va. Hard cover. 246 pages. \$16.95.

THE A TO Z BOOK OF COMPUTER GAMES

By Thomas C. McIntyre

This collection of 26 BASIC programs for playing video games was designed to teach the reader how a program is developed, culminating in listings one can copy. Thus, it is not merely a technical book or a listing of programs. The best of both are illustrated for learning and fun. Programs include information on what the challenge is, how to approach developing the program, how the game works, what the program contains, how to alter or modify the existing program, and how the program relates to other programs. Among the games presented are poker, blackjack, solitaire, battleship, golf, roulette, etc. Some games can be played against the computer, some against one opponent, and some against more than one opponent.

Published by Tab Books, Blue Ridge Summit, PA 17214. 308 pages. \$12.95 hard cover, \$7.95 soft cover.

HANDBOOK OF ELECTRONIC FORMULAS, SYMBOLS AND DEFINITIONS

by John R. Brand

Contained in this book are thousands of electronic formulas, symbols, and definitions for modern passive and active analog circuits. Its alphabetical format permits one to locate information quickly without first having to look it up in an index. For even easier location of desired information, the book is divided into three main sections: passive circuits (Section 1), transistor circuits (Section 2), and operational-amplifier circuits (Section 3). Separate appendices list 5% component-value ratios that give maximum and minimum values for a desired mean value.

Published by Van Nostrand Reinhold, 135 W. 50 St., New York, NY 10020. Hard cover. 359 pages. \$15.95.

SOUND EFFECTS GENERATOR BASIC KIT
NOW CHANEY ELECTRONICS MAKES IT POSSIBLE TO BUILD YOUR OWN SOUND EFFECTS GENERATOR WITHOUT SPENDING A FORTUNE. WE SUPPLY YOU WITH THE 1176477 SOUND CHIP PLUS AN ETCHED AND DRILLED GLASS EPOXY PCB BOARD WITH SCHEMATIC AND LAYOUT INSTRUCTIONS. THIS BOARD MAKES IT SIMPLE TO BUILD A GENERATOR CAPABLE OF PHASOR SOUNDS, LOGICMATIC, SIRENS, AIRPLANES, GLOCKS, ETC. DOES NOT REQUIRE DIP SWITCHES OR OTHER EXPENSIVE/UNUSUAL COMPONENTS. YOU SUPPLY ONLY A FEW STANDARD RESISTORS, CAPACITORS, SWITCHES, POTS, SPEAKERS, 2N2222 TRANSISTOR AND 9V BATTERY. BASIC KIT CONTAINING 1176477, PCB BOARD AND INSTRUCTIONS ONLY \$5.95

2N2222 TRANSISTOR FOR ABOVE C2388A .39 EACH
IF YOU HAVE ALREADY PURCHASED THE 1176477 CHIP YOU MAY BUY THE PCB BOARD AND INSTRUCTIONS ONLY. C2388B \$4.00

LATCH SLAVE TRIGGER KIT
WE SUPPLY ALL THE COMPONENTS TO BUILD A LATCH SLAVE TRIGGER WHICH WILL FIRE YOUR SLAVE STROBE WHEN YOU TRIGGER YOUR MASTER STROBE. C2388B \$1.50

LED Flasher Kit
How to build a LED Flasher using the popular 555 timer IC. Includes a 100K resistor and a green LED. Comes complete with parts in holding the PCB board. (9V battery not included). C2387 \$2.49

6VDC Xenon Flasher Kit
Battery operated Xenon flasher. Simple to use. Comes with all parts & PCB board. (9V battery not included). C2388B \$8.00

120 VAC Xenon Strobe Kit
Complete xenon strobe kit. Includes all parts & PCB board. (9V battery not included). C2387 \$7.50

LED Panel Mounting Kit
C2387 \$1.00

OPTO ISOLATORS
1111 TEXAS INST. 1114 TEXAS INST. 1115 TEXAS INST. 1117 DCL 717

12 sets for \$1.00

RO170 Rectifier
Power 1000V P-25 amp. C2387A 5 for \$1.00
100 for \$15.00

GE Sub-C Nid
1-20 PPF MINIMATURE ADJUSTABLE CAPACITOR C24083 50¢

Tube Specials
2 for \$1.00

Alco Knob
2 for \$1.00

Horse-shoe Tube
3 for \$3.95

CHANEY electronics inc.
P.O. BOX 27038, DENVER, CO. 80227 (303) 781-5750
Send for our free giant catalog of unique items!!!
CIRCLE NO. 8 ON FREE INFORMATION CARD

Save on Calculators

HEWLETT PACKARD

Model	Your Cost
HP-41C Scient	\$244.95
Card Reader/41C	159.95
Printer/41C	289.95
HP-34C Scient	124.95
HP-38C Bus	124.95
HP-39C Bus	99.95
HP-33C Scient	99.95
HP-33E Scient	74.95
HP-37E Bus prog	62.95
HP-32E Adv Scient	58.95
HP-31E Scient	42.95
HP-67 Scient Prog	299.95
HP-97 Scient Print	579.95
HP-92 Bus Print	399.95

*C stands for continuous memory

We carry an enormous stock of HP accessories. All units come complete. One year guarantee by HP.

TEXAS INSTRUMENTS

Model	Price	TI-5225	Call Us
TI-59	\$209.95	TI Prog Thermostat	99.95
PI000C	146.95	TI Transistor It speaks	Call Us
TI-58C	92.95	TI Computer 99.4	Best Deal
TI-57	18.95	TI Programmer	52.95
TI-55	35.95	MBA	58.95
TI-5040	94.94	Business Card	35.95
TI-5025	79.95	Speak & Spell	59.95
TI-5015	62.95		
TI-5100	45.95	Huge inventory of TI accessories on hand at all times. guarantee by TI	

SPECIALS

320 Sanyo watches to choose from

Digiana SS	149.95	Sony new 1981 Betamax SL5600	retail \$1550.00
Carrier type "Tank"	177.95	Sony Betamax SL1400	1095.00
Musical Alarm Chronograph SS	179.95	RCA new Selectivon V16225 mhw	new features retail \$1400.00
Worldtime alarmprint calndr SS	179.95	SDNY all TV mods. best deal	Call Us
Calculator Watch Alarm SS	259.95	Craig Translator. best deal	Call Us
Digital Chronograph SS	99.95	NAVTRONIC flight computers	Call Us
Alarm Chronograph SS	149.95	"Casio calculator watch	New 49.95
Sony Alarm Chronograph SS	179.95	"Mattel new Horse Race Comput	best of market
Memory Bank Calendar SS	149.95	All model Dictating	99.95
Alarm Digital Watch	119.95	machines	Call Us
Multi Alarm goldtone	179.95	"Place your order now for	May-June delivery
Divers 500 Ft quartz 60581	199.95		
TI watches 70 models also Casio and Juvenia watches			

Prices are 10 b. 1A. Add \$4.95 for shipping/handheld calcs in USA. CA residents add 8% sales tax. We will beat any advertised price if the competition has the goods on hand. Goods subject to availability. Ask for 130page catalog. Call Monday thru Saturday 7AM-6PM. Outside of CA toll free 800-421-8045. In CA. Call below *.

OLYMPIC SALES COMPANY, INC.
216 South Oxford Avenue • P.O. Box 74545 • Los Angeles, CA 90004
(213) 381-3911 or (213) 381-1202 • Telex 67-3477

CIRCLE NO. 42 ON FREE INFORMATION CARD

Now get OHIO SCIENTIFIC personal computer products with guaranteed, quick, mail order delivery.

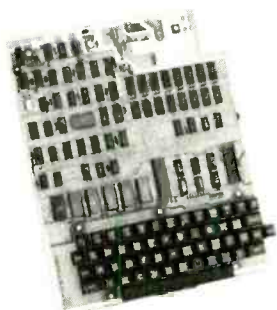

ONLY \$279

Ohio Scientific Superboard II

The first complete computer system on a board. Includes keyboard, video display and audio cassette interface. 8K BASIC-in-ROM; 4K RAM. Requires power supply + 5V at 3 Amp.

"We heartily recommend Superboard II for the beginner who wants to get into microcomputers with a minimum cost. A real computer with full expandability."
POPULAR ELECTRONICS, MARCH, 1979

"The Superboard II is an excellent choice for the personal computer enthusiast on a budget."
BYTE, MAY, 1979

Ohio Scientific C1P Series.

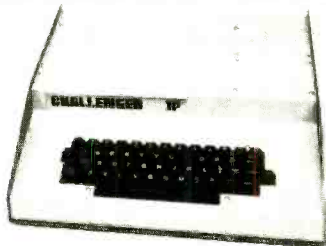

The Challenger 1P. The best bargain in personal computer anywhere! 8K BASIC-in-ROM. 4K RAM. Cassette based with 53-key keyboard. B&W video display, 30 rows x 30 columns. Upper and lower case. **\$349.** C1P with 8K RAM \$399.

Ohio Scientific C1P MF. Mini-floppy version of the C1P. 8K BASIC-in-ROM. 12K RAM. Fully expandable. **\$995.** C1P MF with 20K RAM and OS-65D software \$1198.

SOFTWARE

Cassettes		MDMS Personal Calendar/Address Book	\$29.00
Add Game	\$ 6.00	Home Control I	\$29.00
BASIC Tutor Series	\$29.00	DAC I Music Generation	\$39.00
Function Grapher	\$ 6.00	Baseball I & II, Golf, Bowling, Hockey	\$39.00
Address Book	\$ 8.00	Poker, Black Jack, Spades, Hearts, more	\$29.00
Programmable Calculator	\$12.00	Tiger Tank, Space Attack, Etch-A-Sketch, more	\$29.00
Savings Account	\$ 6.00	Star Wars, Zulu 3, High Noon, more	\$29.00
Baseball I	\$ 6.00	Monster, Kite, Tree	
Battleship	\$ 6.00	Little Pigs, Humpty Dumpty and more	\$29.00
Bowling	\$ 6.00	[2 Disk Set]	\$29.00
Destroyer	\$ 6.00	When ordering, specify Challenger 1P, 4P or 8P	
Space War	\$ 6.00		
Star Trek	\$ 6.00		
Tiger Tank	\$12.00		
Disks			
MDMS Education System	\$29.00		
MDMS Aux File Systems	\$29.00		
MDMS Checking and Savings Account	\$29.00		

Many, many more software systems are available to you. See our catalog for complete listings.

Accessories

AC-3P 12" B/W monitor, TV	\$ 125
AC-15P 12" Color monitor	\$ 450
AC-16P 2-8 Axis Joysticks with cable	\$ 39
AC-11P Answer/Organize 300 baud modem with cable	\$ 199
AC-17P Home Security Starter Set. 1 fire detector, 2 window alarms, 1 door unit.	\$ 249
AC-18P 8 1/2" aluminum paper printer. Upper/lower case.	\$ 695
AC-9TP Centronics 799 110cps tractor feed, business printer with interface	\$ 1250
AC-12P AC-Remote starter set. Console. 2 lamp modules, 2 appliance modules, OS 65D home control operating system	\$ 175
Disk Drives	
CD 3P Single 5" mini floppy	\$ 499
CD 2P Dual 8" Disk with interface and OS-65D DOS	\$ 1599
Power Supplies	
PS 1. 5-volt @ 3 amps regulated. For use with Superboard II	\$ 29
Boards (Assembled and tested)	
CM 9P. 24K Static.	\$ 399
610. 8K Static. Expandable to 24K and dual mini-floppy controller.	\$ 298
CA-14A. Votrax® voice synthesizer.	\$ 399
CA-15 Universal Telephone Interface, rotary or touch tone	\$ 499
CA-15V UTI with Votrax®	\$ 799
CM-6 48K Dynamic memory board.	\$ 499
4KP. 4K static RAM kit	\$ 69
CA12. 96 line parallel I/O	\$ 175
Books:	
How to Program Microcomputers, By William Barden	\$ 8.95
Basic and Personal Computer By Dwyer & Critchfield	\$12.95
Howard Sams C1P Service Manual	\$ 7.95
Howard Sams C4P Service Manual	\$15.95

Freight Policies

All orders of \$100 or more are shipped freight prepaid. Orders of less than \$100 please add \$4.00 to cover shipping costs. Ohio Residents add 5.5% Sales Tax.

Guaranteed Shipment Cleveland Consumer Computers & Components guarantees shipment of computer systems within 48 hours upon receipt of your order. **Our failure to ship within 48 hours entitles you to \$35 of software, FREE.**

Ohio Scientific C4P Series.



The Challenger 4P. A 4-slot computer with one open slot. Highly sophisticated 16 color video display, 32 rows x 64 columns, upper and lower case. 8K BASIC-in-ROM 8K RAM. 200-20KHz programmable tone generator. AC remote interface. Expandable to 32K RAM and two mini-floppy drives. **\$698.**

The Challenger 4P MF. Mini Floppy version of the 4P. Two to three times faster than competitors. More I/O built-in than any other in its class. 24K RAM. Real time clock. Modem interface. Printer interface. Foreground/Background operation and much, much more. **\$1695.**

Ohio Scientific 8P Series.



Challenger 8P. Ohio Scientific's mainframe-class. Personal computer. 8 slots with 6 open. Cassette based with 8K BASIC-in-ROM. 8K static RAM, expandable to 32K RAM, and dual 8-inch floppy disk drive. **\$895.**

Challenger 8P DF. A top of the line personal and small business computer. 32K RAM, expandable to 48K. Features dual 8" floppy disk drives. Audio output 200 20KHz. DAC for voice generation. Keypad interfaces. Joystick (2) interfaces. AC Remote. Real Time Clock. Printer & Modem interfaces. And more. **\$2597.**

To Order:

Or to get our free catalog
CALL 1-800-321-5805 TOLL FREE.
Charge your order to your
VISA or MASTER CHARGE ACCOUNT
Ohio Residents Call: (216) 464-8047.
Or write, including your check or money order, to the address listed below.



Hours:

Call Monday thru Friday
8:00 AM to 5:00 PM E.S.T.



**CLEVELAND CONSUMER
COMPUTERS & COMPONENTS**
P.O. Box 46431
Cleveland, Ohio 44146

**TO ORDER: CALL
1-800-321-5805
TOLL FREE**

7400 TTL

SN7400N .30	SN7470N .29	SN74160N .89
SN7401N .20	SN7471N .35	SN74161N .89
SN7402N .20	SN7472N .49	SN74162N .95
SN7403N .20	SN7473N .35	SN74163N .89
SN7404N .25	SN7474N 5.00	SN74164N .89
SN7405N .20	SN7475N .50	SN74165N .89
SN7406N .20	SN7476N .59	SN74166N .95
SN7407N .29	SN7477N .69	SN74167N .95
SN7408N .20	SN7478N .89	SN74170N 1.59
SN7409N .20	SN7479N .35	SN74171N 6.00
SN7410N .18	SN7480N .50	SN74172N 1.25
SN7411N .25	SN7481N .69	SN74173N 1.25
SN7412N .25	SN7482N .69	SN74174N 1.00
SN7413N .25	SN7483N .59	SN74175N 1.00
SN7414N .40	SN7484N .43	SN74176N .79
SN7415N .70	SN7485N .43	SN74177N .79
SN7416N .25	SN7486N .65	SN74179N .95
SN7417N .25	SN7487N .65	SN74180N .79
SN7420N .20	SN7489N .65	SN74181N 1.95
SN7421N .29	SN7490N 3.00	SN74182N .79
SN7422N .39	SN7491N 1.25	SN74184N 1.95
SN7423N .25	SN7492N .35	SN74185N 1.95
SN7425N .29	SN7493N .59	SN74186N 5.95
SN7426N .29	SN7494N 1.95	SN74188N 3.95
SN7427N .25	SN7495N .35	SN74190N 1.25
SN7429N .39	SN7496N .59	SN74191N 1.00
SN7430N .20	SN7497N .35	SN74192N .79
SN7432N .25	SN7498N .49	SN74193N .79
SN7437N .25	SN7499N .49	SN74194N .89
SN7438N .40	SN7500N .75	SN74195N .69
SN7439N .25	SN7501N .75	SN74196N .89
SN7440N .20	SN7502N .75	SN74197N .89
SN7441N .89	SN7503N 2.95	SN74198N 1.49
SN7442N .59	SN7504N 2.95	SN74199N 1.49
SN7443N .25	SN7505N 4.95	SN74200N 1.95
SN7444N .75	SN7506N .75	SN74201N .99
SN7445N .75	SN7507N 1.95	SN74202N .79
SN7446N .69	SN7508N 1.29	SN74203N 2.25
SN7447N .59	SN7509N 1.29	SN74204N 1.95
SN7448N .79	SN7510N .59	SN74205N 3.95
SN7450N .20	SN7511N .59	SN74206N .69
SN7451N .20	SN7512N .59	SN74207N .69
SN7452N .20	SN7513N .59	SN74208N .69
SN7453N .20	SN7514N 1.50	SN74209N .69
SN7454N .75	SN7515N .75	SN74210N .69
SN7455A .25	SN7516N .75	SN74211N 1.95
SN7460N .20	SN7517N .65	SN74212N 1.95

CMOS

CD4001 .39	CD4071 .49	CD4077 .55
CD4002 .39	CD4072 .49	CD4078 .49
CD4003 .119	CD4073 .139	CD4079 .49
CD4007 .25	CD4081 .39	CD4082 .39
CD4009 .49	CD4083 .39	CD4084 .39
CD4010 .49	CD4085 .39	CD4086 .39
CD4011 .39	CD4087 .119	CD4088 .119
CD4012 .25	CD4089 .149	CD4090 .149
CD4013 .49	CD4091 .149	CD4092 .149
CD4014 .39	CD4093 .149	CD4094 .149
CD4015 .119	CD4095 .149	CD4096 .149
CD4016 .59	CD4097 .250	CD4098 .139
CD4017 .119	CD4099 .139	CD4100 .139
CD4018 .99	CD4101 .99	CD4102 .99
CD4019 .49	CD4103 .69	CD4104 .69
CD4020 .119	CD4105 .119	CD4106 .119
CD4021 .39	CD4107 .119	CD4108 .119
CD4022 .119	CD4109 .295	CD4110 .295
CD4023 .29	CD4111 .295	CD4112 .295
CD4024 .79	CD4113 .295	CD4114 .295
CD4025 .23	CD4115 .79	CD4116 .79
CD4026 .295	CD4117 .79	CD4118 .79
CD4027 .39	CD4119 .45	CD4120 .45

74000

74C00 .39	74C163 .249
74C01 .39	74C164 .249
74C04 .45	74C173 .260
74C08 .49	74C192 .249
74C10 .39	74C193 .249
74C14 .195	74C194 .249
74C20 .39	74C197 .249
74C30 .39	74C199 .249
74C42 .195	74C200 .249
74C48 .249	74C201 .249
74C73 .89	74C202 .249
74C74 .89	74C203 .249

LINEAR

LM106H .99	LM731N .79
LM100H .80	LM732N/H .55
LM301CN/H .35	LM733N .100
LM302H .35	LM734N .119
LM304H 1.00	LM735N .35
LM305H .60	LM741-14N .39
LM307CN/H .35	LM747N/H .79
LM308CN/H .35	LM748N/H .39
LM309H 1.10	LM749N .79
LM309K 1.25	LM750N/H .59
LM310CN 1.95	LM751N .95
LM311N/H .90	LM752N .95
LM312H 1.95	LM753N .95
LM317K 6.50	LM754N 1.95
LM318CN/H 1.50	LM755N 4.00
LM319N 1.30	LM756N 1.25
LM320K-6 1.35	LM757N .95
LM320K-12 1.35	LM758N 1.25
LM320K-15 1.35	LM759N 1.49
LM320K-18 1.35	LM760N (340) 5.99
LM320K-24 1.35	LM761N 1.49
LM320T-5 1.25	LM762N 1.25
LM320T-8 1.25	LM763N 1.25
LM320T-12 1.25	LM764N 1.25
LM320T-15 1.25	LM765N 1.25
LM320T-18 1.25	LM766N 1.25
LM320T-24 1.25	LM767N 1.25
LM323K-5 5.95	LM768N 1.25
LM324N 1.49	LM769N 1.25
LM339N .99	LM770N 1.25
LM340K-5 1.35	LM771N 1.25
LM340K-6 1.35	LM772N 1.25
LM340K-8 1.35	LM773N 1.25
LM340K-12 1.35	LM774N 1.25
LM340K-15 1.35	LM775N 1.25

741500TTL

74L500 .35	74L513N 1.05
74L501 .35	74L514N 1.05
74L502 .35	74L515N 1.05
74L503 .35	74L516N 1.05
74L504 .35	74L517N 1.05
74L505 .35	74L518N 1.05
74L506 .35	74L519N 1.05
74L507 .35	74L520N 1.05
74L508 .35	74L521N 1.05
74L509 .35	74L522N 1.05
74L510 .35	74L523N 1.05
74L511 .35	74L524N 1.05
74L512 .35	74L525N 1.05
74L513 .35	74L526N 1.05
74L514 .35	74L527N 1.05
74L515 .35	74L528N 1.05
74L516 .35	74L529N 1.05
74L517 .35	74L530N 1.05
74L518 .35	74L531N 1.05
74L519 .35	74L532N 1.05
74L520 .35	74L533N 1.05
74L521 .35	74L534N 1.05
74L522 .35	74L535N 1.05
74L523 .35	74L536N 1.05
74L524 .35	74L537N 1.05
74L525 .35	74L538N 1.05
74L526 .35	74L539N 1.05
74L527 .35	74L540N 1.05
74L528 .35	74L541N 1.05
74L529 .35	74L542N 1.05
74L530 .35	74L543N 1.05
74L531 .35	74L544N 1.05
74L532 .35	74L545N 1.05
74L533 .35	74L546N 1.05
74L534 .35	74L547N 1.05
74L535 .35	74L548N 1.05
74L536 .35	74L549N 1.05
74L537 .35	74L550N 1.05
74L538 .35	74L551N 1.05
74L539 .35	74L552N 1.05
74L540 .35	74L553N 1.05
74L541 .35	74L554N 1.05
74L542 .35	74L555N 1.05
74L543 .35	74L556N 1.05
74L544 .35	74L557N 1.05
74L545 .35	74L558N 1.05
74L546 .35	74L559N 1.05
74L547 .35	74L560N 1.05
74L548 .35	74L561N 1.05
74L549 .35	74L562N 1.05
74L550 .35	74L563N 1.05
74L551 .35	74L564N 1.05
74L552 .35	74L565N 1.05
74L553 .35	74L566N 1.05
74L554 .35	74L567N 1.05
74L555 .35	74L568N 1.05
74L556 .35	74L569N 1.05
74L557 .35	74L570N 1.05
74L558 .35	74L571N 1.05
74L559 .35	74L572N 1.05
74L560 .35	74L573N 1.05
74L561 .35	74L574N 1.05
74L562 .35	74L575N 1.05
74L563 .35	74L576N 1.05
74L564 .35	74L577N 1.05
74L565 .35	74L578N 1.05
74L566 .35	74L579N 1.05
74L567 .35	74L580N 1.05
74L568 .35	74L581N 1.05
74L569 .35	74L582N 1.05
74L570 .35	74L583N 1.05
74L571 .35	74L584N 1.05
74L572 .35	74L585N 1.05
74L573 .35	74L586N 1.05
74L574 .35	74L587N 1.05
74L575 .35	74L588N 1.05
74L576 .35	74L589N 1.05
74L577 .35	74L590N 1.05
74L578 .35	74L591N 1.05
74L579 .35	74L592N 1.05
74L580 .35	74L593N 1.05
74L581 .35	74L594N 1.05
74L582 .35	74L595N 1.05
74L583 .35	74L596N 1.05
74L584 .35	74L597N 1.05
74L585 .35	74L598N 1.05
74L586 .35	74L599N 1.05
74L587 .35	74L600N 1.05
74L588 .35	74L601N 1.05
74L589 .35	74L602N 1.05
74L590 .35	74L603N 1.05
74L591 .35	74L604N 1.05
74L592 .35	74L605N 1.05
74L593 .35	74L606N 1.05
74L594 .35	74L607N 1.05
74L595 .35	74L608N 1.05
74L596 .35	74L609N 1.05
74L597 .35	74L610N 1.05
74L598 .35	74L611N 1.05
74L599 .35	74L612N 1.05
74L600 .35	74L613N 1.05
74L601 .35	74L614N 1.05
74L602 .35	74L615N 1.05
74L603 .35	74L616N 1.05
74L604 .35	74L617N 1.05
74L605 .35	74L618N 1.05
74L606 .35	74L619N 1.05
74L607 .35	74L620N 1.05
74L608 .35	74L621N 1.05
74L609 .35	74L622N 1.05
74L610 .35	74L623N 1.05
74L611 .35	74L624N 1.05
74L612 .35	74L625N 1.05
74L613 .35	74L626N 1.05
74L614 .35	74L627N 1.05
74L615 .35	74L628N 1.05
74L616 .35	74L629N 1.05
74L617 .35	74L630N 1.05
74L618 .35	74L631N 1.05
74L619 .35	74L632N 1.05
74L620 .35	74L633N 1.05
74L621 .35	74L634N 1.05
74L622 .35	74L635N 1.05
74L623 .35	74L636N 1.05
74L624 .35	74L637N 1.05
74L625 .35	74L638N 1.05
74L626 .35	74L639N 1.05
74L627 .35	74L640N 1.05
74L628 .35	74L641N 1.05
74L629 .35	74L642N 1.05
74L630 .35	74L643N 1.05
74L631 .35	74L644N 1.05
74L632 .35	74L645N 1.05
74L633 .35	74L646N 1.05
74L634 .35	74L647N 1.05
74L635 .35	74L648N 1.05
74L636 .35	74L649N 1.05
74L637 .35	74L650N 1.05
74L638 .35	74L651N 1.05
74L639 .35	74L652N 1.05
74L640 .35	74L653N 1.05
74L641 .35	74L654N 1.05
74L642 .35	74L655N 1.05
74L643 .35	74L656N 1.05
74L644 .35	74L657N 1.05
74L645 .35	74L658N 1.05
74L646 .35	74L659N 1.05
74L647 .35	74L660N 1.05
74L648 .35	74L661N 1.05
74L649 .35	74L662N 1.05
74L650 .35	74L663N 1.05
74L651 .35	74L664N 1.05
74L652 .35	74L665N 1.05
74L653 .35	74L666N 1.05
74L654 .35	74L667N 1.05
74L655 .35	74L668N 1.05
74L656 .35	74L669N 1.05
74L657 .35	74L670N 1.05
74L658 .35	74L671N 1.05
74L659 .35	74L672N 1.05
74L660 .35	74L673N 1.05
74L661 .35	74L674N 1.05
74L662 .35	74L675N 1.05
74L663 .35	74L676N 1.05
74L664 .35	74L677N 1.05
74L665 .35	74L678N 1.05
74L666 .35	74L679N 1.05
74L667 .35	74L680N 1.05
74L668 .35	74L681N 1.05
74L669 .35	74L682N 1.05
74L670 .35	74L683N 1.05
74L671 .35	74L684N 1.05
74L672 .35	74L685N 1.05
74L673 .35	74L686N 1.05
74L674 .35	74L687N 1.05
74L675 .35	74L688N 1.05
74L676 .35	74L689N 1.05
74L677 .35	74L690N 1.05
74L678 .35	74L691N 1.05
74L679 .35	74L692N 1.05
74L680 .35	74L693N 1.05
74L681 .35	74L694N 1.05
74L682 .35	74L695N 1.05
74L683 .35	74L696N 1.05
74L684 .35	74L697N 1.05
74L685 .35	74L698N 1.05
74L686 .35	74L699N 1.05
74L687 .35	74L700N 1.05
74L688 .35	74L701N 1.05
74L689 .35	74L702N 1.05
74L690 .35	74L703N 1.05
74L691 .35	74L704N 1.05
74L692 .35	74L705N 1.05
74L693 .35	74L706N 1.05
74L694 .35	74L707N 1.05
74L695 .35	74L708N 1.05
74L696 .35	74L709N 1.05
74L697 .35	74L710N 1.05</

MINIATURE SCREWDRIVER

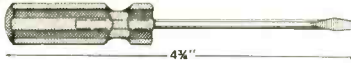

RUGGED CONSTRUCTION
1000+ OF USES - 1/8" TIP 2/\$1.00

MAGNETIC RETRIEVER TOOL



Picks up elusive metal parts or tools
in hard-to-reach places.
EXTENDS TO 26 3/4" - ROTATES 360°
STRONG, LIFETIME MAGNET

MRT-2281 \$3.95

CONTINENTAL SPECIALTIES

LOGIC PROBE KIT

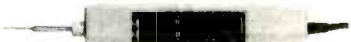

SPECIFICATIONS

Input Impedance: 300,000 Ohms.
Thresholds: "Lo" 30% Vcc - "Hi" 70% Vcc
Maximum Speed: 300 nsec., 1.5MHz
Input Protection: ±50VDC continuous 117VAC
for 15 sec.
Power: 30mA @5V - 40mA @ 15V - 25V max.
reverse voltage protected. 36" cable with color
coded clips included.
Operating Temp.: 0-50°C.
Dimensions: 5.8L x 1.0W x 0.7D in.
(147 x 25 x 18mm)
Weight: 30 oz. (85 gm)
LPK-1 \$21.95/Kit

Proto Clips

14-PIN CLIP	PC-14	\$ 4.50
16-PIN CLIP	PC-16	\$ 4.75
24-PIN CLIP	PC-24	\$10.00
40-PIN CLIP	PC-40	\$16.00

Proto Boards

PB-6	\$17.95
PB-100	19.95
PB-101	22.95
PB-102	26.95
PB-103	44.95
PB-104	55.95
PB-203	99.95
PB-203A	155.00
PB-203A-Kit	131.00

Jumbo 6-Digit Clock Kit

- Four .630"ht. and two .300"ht. common anode displays
- Uses MMS314 clock chip
- Switches for hours, minutes and hold functions
- Hours easily viewable to 30 feet
- Simulated walnut case
- 115VAC operation
- 12 or 24 hour operation
- Includes all components, case and wall transformer
- Size: 6 3/4" x 3 3/8" x 1 3/4"

JE747 \$29.95

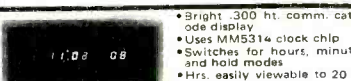

JE701

6-Digit Clock Kit \$19.95

Regulated Power Supply

Uses LM309K. Heat sink provided. PC board construction. Provides a solid 1 amp @ 5 volts. Can supply up to ±5V, ±9V and ±12V with JE205 Adapter. Includes components, hardware and instructions. Size: 3 1/2" x 5" x 2 1/4"

JE200 \$14.95

ADAPTER BOARD
- Adapts to JE200 -
±5V, ±9V and ±12V

DC/DC converter with +5V input. Toroidal hi-speed switching XMF8. Short circuit protection. PC board construction. Piggy-back to JE 200 board. Size: 3 1/2" x 2" x 9/16" H

JE205 \$12.95

MICROPROCESSOR COMPONENTS

3800A/8000A SUPPORT DEVICES		MICROPROCESSOR MANUALS	
8080A CPU	\$ 7.95	M-280 User Manual	\$7.50
8212 8-Bit Input/Output	3.25	M-CDP1802 User Manual	7.50
8214 Priority Interrupt Control	5.95	M-2650 User Manual	5.00
8216 8-Directional Bus Driver	3.49		
8224 Clock Generator/Driver	3.95		
8226 Bus Driver	3.49		
8228 System Controller/Bus Driver	4.95		
8238 System Controller	3.95		
8251 Prog. Comm. I/O (USART)	7.95		
8253 Prog. Interval Timer	14.95		
8255 Prog. Paraph. I/O (PPI)	9.95		
8257 Prog. DMA Control	19.95		
8259 Prog. Interrupt Control	19.95		
6800/6800A SUPPORT DEVICES		ROM'S	
MC6800 MPU	\$14.95	2513(2140) Character Generator/Upper case	\$9.95
MC6802CP MPU with Clock and Ram	24.95	2513(3021) Character Generator(lower case)	9.95
MC6810API 128KB Static Ram	5.95	2516 Character Generator	10.95
MC6821 Paraph. Inter. Adapt (MC6820)	7.49	MMS230N 2048-Bit Read Only Memory	1.95
MC6828 Priority Interrupt Controller	12.95		
MC6830L8 1024x8 Bit ROM (MC68A30-B)	14.95		
MC6850 Asynchronous Comm. Adapter	7.95		
MC6852 Synchronous Serial Data Adapter	9.95		
MC6860 6-500 bps Digital MODEM	12.95		
MC6862 2400 bps Modulator	14.95		
MC6880 Quad 3 State Bus Trans (MC8T26)	2.25		
MC6880A	15.95		
MICROPROCESSOR CHIPS - MISCELLANEOUS		RAM'S	
Z8017003 CPU	\$13.95	1101 256K1 Static	\$1.49
Z8014(280-1) CPU	15.95	1103 1024K1 Dynamic	.95
CDP1802 CPU	19.95	2101(8101) 256K1 Static	3.95
2650 MPU	19.95	2102 1024K1 Static	.95
8502 CPU	11.95	2102 1024K1 Static	1.95
8503 8-Bit MPU w/clock, RAM, I/O lines	9.95	2112 256K4 Static MOS	4.95
P8085 CPU	19.95	2114 1024K4 Static 450ms low power	10.95
TMS9900UL 16-Bit MPU w/hardware multiply & divide	49.95	2114-3 1024K4 Static 300ms low power	11.95
		2115 256K4 Static	7.95
		2116 1024K4 Static 450ms low power	10.95
		2117 16384K1 Dynamic 16 pin 250ns	4.95
		2118 16384K1 Dynamic 16 pin 250ns	9.95
		2119 16384K1 Dynamic 16 pin 250ns	9.95
		2120 16384K1 Dynamic 16 pin 250ns	9.95
		2121 16384K1 Dynamic 16 pin 250ns	9.95
		2122 16384K1 Dynamic 16 pin 250ns	9.95
		2123 16384K1 Dynamic 16 pin 250ns	9.95
		2124 16384K1 Dynamic 16 pin 250ns	9.95
		2125 16384K1 Dynamic 16 pin 250ns	9.95
		2126 16384K1 Dynamic 16 pin 250ns	9.95
		2127 16384K1 Dynamic 16 pin 250ns	9.95
		2128 16384K1 Dynamic 16 pin 250ns	9.95
		2129 16384K1 Dynamic 16 pin 250ns	9.95
		2130 16384K1 Dynamic 16 pin 250ns	9.95
		2131 16384K1 Dynamic 16 pin 250ns	9.95
		2132 16384K1 Dynamic 16 pin 250ns	9.95
		2133 16384K1 Dynamic 16 pin 250ns	9.95
		2134 16384K1 Dynamic 16 pin 250ns	9.95
		2135 16384K1 Dynamic 16 pin 250ns	9.95
		2136 16384K1 Dynamic 16 pin 250ns	9.95
		2137 16384K1 Dynamic 16 pin 250ns	9.95
		2138 16384K1 Dynamic 16 pin 250ns	9.95
		2139 16384K1 Dynamic 16 pin 250ns	9.95
		2140 16384K1 Dynamic 16 pin 250ns	9.95
		2141 16384K1 Dynamic 16 pin 250ns	9.95
		2142 16384K1 Dynamic 16 pin 250ns	9.95
		2143 16384K1 Dynamic 16 pin 250ns	9.95
		2144 16384K1 Dynamic 16 pin 250ns	9.95
		2145 16384K1 Dynamic 16 pin 250ns	9.95
		2146 16384K1 Dynamic 16 pin 250ns	9.95
		2147 16384K1 Dynamic 16 pin 250ns	9.95
		2148 16384K1 Dynamic 16 pin 250ns	9.95
		2149 16384K1 Dynamic 16 pin 250ns	9.95
		2150 16384K1 Dynamic 16 pin 250ns	9.95
		2151 16384K1 Dynamic 16 pin 250ns	9.95
		2152 16384K1 Dynamic 16 pin 250ns	9.95
		2153 16384K1 Dynamic 16 pin 250ns	9.95
		2154 16384K1 Dynamic 16 pin 250ns	9.95
		2155 16384K1 Dynamic 16 pin 250ns	9.95
		2156 16384K1 Dynamic 16 pin 250ns	9.95
		2157 16384K1 Dynamic 16 pin 250ns	9.95
		2158 16384K1 Dynamic 16 pin 250ns	9.95
		2159 16384K1 Dynamic 16 pin 250ns	9.95
		2160 16384K1 Dynamic 16 pin 250ns	9.95
		2161 16384K1 Dynamic 16 pin 250ns	9.95
		2162 16384K1 Dynamic 16 pin 250ns	9.95
		2163 16384K1 Dynamic 16 pin 250ns	9.95
		2164 16384K1 Dynamic 16 pin 250ns	9.95
		2165 16384K1 Dynamic 16 pin 250ns	9.95
		2166 16384K1 Dynamic 16 pin 250ns	9.95
		2167 16384K1 Dynamic 16 pin 250ns	9.95
		2168 16384K1 Dynamic 16 pin 250ns	9.95
		2169 16384K1 Dynamic 16 pin 250ns	9.95
		2170 16384K1 Dynamic 16 pin 250ns	9.95
		2171 16384K1 Dynamic 16 pin 250ns	9.95
		2172 16384K1 Dynamic 16 pin 250ns	9.95
		2173 16384K1 Dynamic 16 pin 250ns	9.95
		2174 16384K1 Dynamic 16 pin 250ns	9.95
		2175 16384K1 Dynamic 16 pin 250ns	9.95
		2176 16384K1 Dynamic 16 pin 250ns	9.95
		2177 16384K1 Dynamic 16 pin 250ns	9.95
		2178 16384K1 Dynamic 16 pin 250ns	9.95
		2179 16384K1 Dynamic 16 pin 250ns	9.95
		2180 16384K1 Dynamic 16 pin 250ns	9.95
		2181 16384K1 Dynamic 16 pin 250ns	9.95
		2182 16384K1 Dynamic 16 pin 250ns	9.95
		2183 16384K1 Dynamic 16 pin 250ns	9.95
		2184 16384K1 Dynamic 16 pin 250ns	9.95
		2185 16384K1 Dynamic 16 pin 250ns	9.95
		2186 16384K1 Dynamic 16 pin 250ns	9.95
		2187 16384K1 Dynamic 16 pin 250ns	9.95
		2188 16384K1 Dynamic 16 pin 250ns	9.95
		2189 16384K1 Dynamic 16 pin 250ns	9.95
		2190 16384K1 Dynamic 16 pin 250ns	9.95
		2191 16384K1 Dynamic 16 pin 250ns	9.95
		2192 16384K1 Dynamic 16 pin 250ns	9.95
		2193 16384K1 Dynamic 16 pin 250ns	9.95
		2194 16384K1 Dynamic 16 pin 250ns	9.95
		2195 16384K1 Dynamic 16 pin 250ns	9.95
		2196 16384K1 Dynamic 16 pin 250ns	9.95
		2197 16384K1 Dynamic 16 pin 250ns	9.95
		2198 16384K1 Dynamic 16 pin 250ns	9.95
		2199 16384K1 Dynamic 16 pin 250ns	9.95
		2200 16384K1 Dynamic 16 pin 250ns	9.95
		2201 16384K1 Dynamic 16 pin 250ns	9.95
		2202 16384K1 Dynamic 16 pin 250ns	9.95
		2203 16384K1 Dynamic 16 pin 250ns	9.95
		2204 16384K1 Dynamic 16 pin 250ns	9.95
		2205 16384K1 Dynamic 16 pin 250ns	9.95
		2206 16384K1 Dynamic 16 pin 250ns	9.95
		2207 16384K1 Dynamic 16 pin 250ns	9.95
		2208 16384K1 Dynamic 16 pin 250ns	9.95
		2209 16384K1 Dynamic 16 pin 250ns	9.95
		2210 16384K1 Dynamic 16 pin 250ns	9.95
		2211 16384K1 Dynamic 16 pin 250ns	9.95
		2212 16384K1 Dynamic 16 pin 250ns	9.95
		2213 16384K1 Dynamic 16 pin 250ns	9.95
		2214 16384K1 Dynamic 16 pin 250ns	9.95
		2215 16384K1 Dynamic 16 pin 250ns	9.95
		2216 16384K1 Dynamic 16 pin 250ns	9.95
		2217 16384K1 Dynamic 16 pin 250ns	9.95
		2218 16384K1 Dynamic 16 pin 250ns	9.95
		2219 16384K1 Dynamic 16 pin 250ns	9.95
		2220 16384K1 Dynamic 16 pin 250ns	9.95
		2221 16384K1 Dynamic 16 pin 250ns	9.95
		2222 16384K1 Dynamic 16 pin 250ns	9.95
		2223 16384K1 Dynamic 16 pin 250ns	9.95
		2224 16384K1 Dynamic 16 pin 250ns	9.95
		2225 16384K1 Dynamic 16 pin 250ns	9.95
		2226 16384K1 Dynamic 16 pin 250ns	9.95
		2227 16384K1 Dynamic 16 pin 250ns	9.95
		2228 16384K1 Dynamic 16 pin 250ns	9.95
		2229 16384K1 Dynamic 16 pin 250ns	9.95
		2230 16384K1 Dynamic 16 pin 250ns	9.95
		2231 16384K1 Dynamic 16 pin 250ns	9.95
		2232 16384K1 Dynamic 16 pin 250ns	9.95
		2233 16384K1 Dynamic 16 pin 250ns	9.95
		2234 16384K1 Dynamic 16 pin 250ns	9.95
		2235 16384K1 Dynamic 16 pin 250ns	9.95
		2236 16384K1 Dynamic 16 pin 250ns	9.95
		2237 16384K1 Dynamic 16 pin 250ns	9.95
		2238 16384K1 Dynamic 16 pin 250ns	9.95
		2239 16384K1 Dynamic 16 pin 250ns	9.95
		2240 16384K1 Dynamic 16 pin 250ns	9.95
		2241 16384K1 Dynamic 16 pin 250ns	9.95
		2242 16384K1 Dynamic 16 pin 250ns	9.95
		2243 16384K1 Dynamic 16 pin 250ns	9.95
		2244 16384K1 Dynamic 16 pin 250ns	9.95
		2245 16384K1 Dynamic 16 pin 250ns	9.95
		2246 16384K1 Dynamic 16 pin 250ns	9.95
		2247 16384K1 Dynamic 16 pin 250ns	9.95
		2248 16384K1 Dynamic 16 pin 250ns	9.95
		2249 16384K1 Dynamic 16 pin 250ns	9.95
		2250 16384K1 Dynamic 16 pin 250ns	9.95

JE600 HEXADECIMAL ENCODER KIT

FEATURES:

- Full 8 bit latched output for micro processor use
- 3 User Define keys with one being di-stable operation
- Debounce circuit provided for all 19 keys
- LED readout to verify entries
- Easy interfacing with standard 16 pin IC connector
- Only -5VDC required for operation

FULL 8 BIT LATCHED OUTPUT - 19 KEYBOARD

The JE600 Encoder Keyboard provides two separate hexadecimal digit displays produced from sequential key entries to allow direct programming for a bit microprocessor or 8 bit memory circuits. Three (3) additional keys are provided for user operations with one having a bistable output available. The outputs are latched and monitored with LED readouts. Also included is a key entry strobe.

JE600 \$59.95
Hexadecimal Keypad only \$14.95

DIGITAL THERMOMETER KIT

FEATURES:

- Dual sensors - switching control for indoor/outdoor or dual monitoring
- Continuous LED 8" ht. display
- Range -42 to 199.9°F / 40°C to 100°C
- Accuracy ± 1° nominal
- Set for Fahrenheit or Celsius reading
- Sim. waitout case - AC wall adapter incl.
- Size: 3 1/4" x 6 5/8" W x 1 3/8" D

JE300 \$39.95

62-Key ASCII Encoded Keyboard Kit

FEATURES:

- 60 Keys generate the full 128 characters, upper and lower case ASCII set
- Fully buffered
- 2 user-definable keys provided for custom applications

Active Electronic Sales Corp.



Z8001 \$195.00 16 Bit CPU with segmented address space to 8 Megabytes

Z8002 \$150.00 16 Bit CPU with non segmented address space to 64K bytes

Z8000DB \$1500.00 A complete single board Z8000 microcomputer system. Contains the Z8002 microprocessor, 16K words of dynamic RAM, 2K word monitor PROM, dual serial interfaces, four counter/timers and 32 programmable parallel I/O lines.

**All Products Stocked in Depth
Largest Zilog Inventory**

Z80-CPU	2.5 MHz	\$ 9.95	Z80-DMA	2.5 MHz	\$26.85
Z80A-CPU	4.0 MHz	11.95	Z80A-DMA	4.0 MHz	33.60
Z80-PIO	2.5 MHz	7.20	Z80-SIO/D	2.5 MHz	36.00
Z80A-PIO	4.0 MHz	8.40	Z80A-SIO/O	4.0 MHz	39.50
Z80-CTC	2.5 MHz	7.20	Z80-SIO/1	2.5 MHz	36.00
Z80A-CTC	4.0 MHz	8.40	Z80A-SIO/1	4.0 MHz	39.50
			Z80-SIO/2	2.5 MHz	36.00
			Z80A-SIO/2	4.0 MHz	39.50

MICROPROCESSOR CHIP SETS

Part No.	Price	Part No.	Price	Part No.	Price
8080A	\$5.95	6800	\$6.95	6502	\$9.95
8085	12.95	6802	11.95	6504	9.95
				6505	9.95
8212	2.95	6810	3.95		
8214	3.95	6820	3.95	6520	6.95
8216	2.95	6821	3.95	6522	9.95
8224	3.45	6850	4.25	6532	13.95
8226	2.25	6852	3.95	6551	13.95
8228	4.98				
8238	4.98				
8251	6.95				
8253	14.95				
8255	5.75				
8257	10.95				
8259	14.95				

16K MOS DYNAMIC RAM's (16 PIN)

416-5 (300ns)	9.95
416-4 (250ns)	10.95
416-3 (200ns)	11.95

Over 200K pieces in stock

METAL POWER TRANSISTORS

Homotaxial — Best Quality

2N3054	.65	60V	NPN	TO-66
2N3055	.69	70V	NPN	TO-3
2N3442	1.50	160V	NPN	TO-3
2N3771	1.95	50V	NPN	TO-3
2N3772	1.95	100V	NPN	TO-3
2N3773	2.50	160V	NPN	TO-3

Universal SCR

C106D	.34	400V	5.0 AMP	TO-220
-------	-----	------	---------	--------

EPROM'S

C2708	1K x 8	450 ns	\$ 9.95
TMS2716	16K (2K x 8)	450 ns	\$24.95
(3 power supplies) T.I. Version			
C2716/TMS2516	16K (2K x 8)	450 ns	\$29.95
(Single 5V supply — Intel version)			

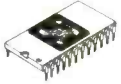

MOS MEMORIES

MOS Static RAM's

Part No.		Price
2101	1K (256 x 4) 350ns 22 PIN	\$1.95
2102LFPC	1K (1K x 1) Low Power 350ns 16 PIN	1.19
2102LHPC	1K (1K x 1) Low Power High Performance 250ns 16 PIN	1.29
2102-1PC	1K (1K x 1) 450ns 16 PIN	0.94
2102-2PC	1K (1K x 1) 650ns 16 PIN	0.89
P2111-25	1K (256 x 4) 250ns 18 PIN	2.25
P2112-35	1K (256 x 4) 350ns 18 PIN	2.25
2114L	Low Power 4K (1024 x 4) 300 ns	5.95

MOS Dynamic RAM's

TMS4060-30	4K (4K x 1) 300ns 22 PIN	2.95
TMS4060-20	4K (4K x 1) 200ns 22 PIN	3.95

UART's

AY5-1013A	0 to 40K BAUD 40 PIN	4.50
AY3-1015	0 to 30K BAUD 40 PIN Single 5V supply	5.50

1K CMOS RAM

5101	1K (256 x 4) 450ns 22 PIN Low Power	3.95
------	-------------------------------------	------

4K CMOS RAM

P4315-45L	4K (4K x 1) 450ns 18 PIN	14.95
-----------	--------------------------	-------

SHIFT REGISTERS

3341PC	FIFO 700 KHz	4.95
3341APC	FIFO 1 MHz	5.50
3342PC	64 Bit Shift Register	4.95
3347PC	80 Bit Shift Register	4.95

ECL RAM

10410ADC/HM2106	256 x 1 Bit Fully Decoded 15ns 16 PIN	Special 1.95
-----------------	---------------------------------------	--------------

LINEAR I.C.'s

LM301N-8	.34	LM739CN-14	1.29
LM307N-8	.29	LM741CN-8	.49
LM308CH	.95	LM747CN-14	.59
LM311N-8	.59	LM748CN-8	.39
LM324N	.59	TBA810DAS	1.29
LM339N	.99	LM1458N-8	.49
LM348N-14	.55	LM1488N-14	.69
LM358N-8	.99	LM1489N-14	.69
LM555N-8	.59	LM3403N-14	.99
LM556N-14	.49	LM3900N	.59
LM723CN-14	.49	LM4136N-14	.99
LM725CN-8	1.25		

Special of the Month

EPROM

C2708-65/4708-6 \$6.90

1K (1K x 8) 650 ns



1980 IC MASTER

JUST RELEASED over 2700 PAGES

Complete integrated circuit data selector. Master guide to the latest I.C.'s including microprocessors and consumer circuits. 45,000 device types listed. 5,000 new device types added. Complete new section on MPU boards & Systems.

Free Quarterly Updates

Special \$59.95



SOUND & MUSIC GENERATOR I.C.

Creates almost any type of sound, from music to gunshots and explosions. High level op amp output. 28 pin DIP. Operates from one 9V battery. With data.

"Lowest Price Offered Anywhere"

SN76477N (.600" centers)	\$2.49
SN76477NF (.400" centers)	\$2.29

New small package

MICROCOMPUTER BOARDS

NEC MICROCOMPUTERS	Rockwell International
TK80A \$299.00	AIM65 \$375.00

Based on the 8080A the board has both 1K RAM and 1K electrically erasable PROM expandable to 4K x 8 and 8K x 8 on board. Complete with keyboard with 25 real keys and 8 bright 500' digits for display

As a learning aid AIM65 gives you an assembled, tested and warranted P8502 based microcomputer system with a full sized keyboard, an alphanumeric 20 character display and uniquely, an alphanumeric 20 column thermal printer. An on board Advanced Interface Monitor program provides extensive control and program development functions: 1K RAM.

TEXAS INSTRUMENTS

Low Profile Sockets

Lowest prices anywhere for the highest quality, an unbeatable combination. Over one million pieces in stock.

Contacts	Price	Contacts	Price
8 PIN	.08	22 PIN	.22
14 PIN	.12	24 PIN	.24
16 PIN	.14	28 PIN	.28
18 PIN	.18	40 PIN	.40
20 PIN	.20		

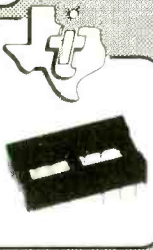

Synertek® SYM-1 \$239.00

Fully assembled, tested, documented and expandable. Powerful 6502 8-bit microprocessor. 6-digit hex LED display. KIM-1 hardware compatibility. Single plus 5V power requirements.

Texas Instruments TM990/189 \$333.00

A complete learning aid that in conjunction with the Tutorial Text offers hands on experience with microprocessors. I/O, memory and assembly language programming. Offers advanced features such as 45 key alphanumeric keyboard, a powerful instruction set, multiply and divide vectored interrupts, single bit I/O manipulation parallel I/O and 7 addressing modes.

L.E.D. LAMPS

LED209	T-1 3 mm Red	.09
LED211	T-1 3 mm Green	.19
LED212	T-1 3 mm Yellow	.14
LED220	T-1 5 mm Red	.11
LED222	T-1 5 mm Green	.24
LED224	T-1 5 mm Yellow	.16

DISPLAYS

FND357	375	Common Cathode	1.09
FND367	360	Common Cathode (high brightness)	1.29
FND500	500	Common Anode	1.09
FND507	500	Common Anode	1.09
FND560	500	Common Cathode (high brightness)	1.29
FND567	500	Common Anode (high brightness)	1.29
DL704	300	Common Cathode	1.29
DL707	300	Common Anode	1.29
DL747	630	Common Anode	2.29

ISOLATORS

ILD74	Dual Opto Isolator	1500V	1.29
ILO74	Quad Opto Isolator	1500V	3.95
MCT6	Dual Opto Isolator	1500V	1.29
TIL111	Opto Coupler	1500V	.69
4N26	Opto Isolator	2500V	.59
4N28	Opto Isolator	500V	.59
4N29	Opto Isolator	2500V	.69
4N32	Opto Isolator	2500V	.69

Active Electronic Sales Corp.

P.O. BOX 1035 FRAMINGHAM, MASSACHUSETTS 01701

Over-the-counter sales. 12 Mercer Rd., Natick, Mass 01760
Behind Zayres on Rte. 9
Telephone Orders & Enquiries (617) 879-0077

MINIMUM ORDER \$10.00 + ADD \$2.00 TO COVER POSTAGE & HANDLING

Foreign customers please remit payment on an international bank draft or international postal money order in American dollars.

IN CANADA

5651 FERRIER ST. MONTREAL QUEBEC H4P 2K5 Tel.: (514) 731-7441	4800 DUFFERIN ST. DOWNSVIEW, ONTARIO M3H 5S9 Tel.: (416) 661-1115	BAXTER CENTRE 1050 BAXTER ROAD OTTAWA, ONTARIO K2C 3P2 Tel.: (613) 820-9471	3070 KINGSWAY VANCOUVER, B.C. V5R 5J7 Tel.: (604) 438-3321
---	---	---	--



Operation Assist

If you need information on outdated or rare equipment—a schematic, parts list, etc.—another reader might be able to assist. Simply send a postcard to Operation Assist! POPULAR ELECTRONICS, 1 Park Ave., New York, NY 10016. For those who can help readers, please respond directly to them. They'll appreciate it. (Only those items regarding equipment not available from normal sources are published.)

Hallcrafters SX 110 amateur band receiver. Need operation and alignment manual. Carroll W. Moore, 818 Ash St., Poplar Bluff, MO 63901.

Heathkit model OP-1 oscilloscope. Need operating manual and calibration data. Franklin P. Bull, Rt. 1, Box 165, East Jordan, MI 49727.

Crosley model 9-419M-1LD TV and model T-3R3 radio. Need schematics and parts list. Raymond Friend, 236 W. Pearl St., Butler, PA 16001.

Rauland model W-861 audio power amplifier. Need schematic and parts list. Neville Mair, 741 E. 213 St., Apt. #1, Bronx, NY 10467.

Lamda model LYD-5-062 power supply. Need operating instructions. R. Davy, 7816 No. 47th Ave., Glendale, AZ 85301.

Bozen model DB-230 amplifier. Need schematic and operation manual. P. Terezyk, Box 340, New York, NY 10036.

Marconiphone model T26AG radio and **Seeburg** model 3W-1 wall box jukebox. Need service manuals and schematics. Edward H. Joseph, 20701 Reef Lane, Huntington Beach, CA 92646.

Solar Manufacturing Corp., models CE and CB-1-60 testers. Need schematics and user information. Jeff Lucas, 2253 Coral Sea Dr., Youngstown, OH 44511.

Motorola model 40-200 AM CB transceiver. Need operation manual, owner's manual, and diagram circuits. Teguh Baktiardi, Jalan Tamblong No. 5, Bandung, Indonesia.

Harman-Kardon model 820 FM stereo receiver. Need manual, schematics and any other information. Michael Holman, 6825 W. 16 Dr., Hialeah, FL 33014.

Teac model A-1500 recorder. Need schematic and operation manual. William J. Crevola, 304 Beaumont Drive, Vista, CA 92083.

Baker Audio Associates, model TF-2220 AM/FM receiver. Need schematics and any information available. David Woodard, 3-B Township Dr., Oakwood, GA 30566.

Sears Silvertone model 101.835 shortwave radio. Need schematic and alignment information. Mike Piper, 6132 Holland St., Arvada, CO 80004.

Sanyo model #34401 stereo reel-to-reel tape recorder. Need owner's manual and/or schematic. W. Erwin, 760 Brentwood Dr., Reno, NV 89502.

Knight model KG-200 dc oscilloscope. Need schematic and owner's manual. Nguyen D. Hoan, 6021 Factor Ave., Azusa, CA 91702.

Contex model 6706, 25-40-MHz linear amplifier. Need parts list and schematic. Robert Sweerus, 251 McCosh Road, Upper Montclair, NJ 07043.

Heathkit IM12 harmonic distortion meter. Need schematic and manual. Ernest Koenderink, 9 Begonia Straat, 2565 SP, The Hague, Netherlands.

General Radio Co., model 650A impedance bridge. Need operation manual and schematic. James B. Powell, 300 Cellier Blvd., Napa, CA 94558.

Winston Electronic Inc., model 820 dynamic sweep circuit analyzer. Need operation manual and schematic. Luther Mayberry, 3112 5th St., Union Gap, WA 98903.

Calibration Standards Corp., model DC-200B precision dc voltmeter. Need manual and/or schematic. José E. Cordero, Box 4522, San Juan, PR 00936.

General Electric model 4ST2A02 oscilloscope. Need operating manual and schematic. Doug McDermott, 24 Tuxedo Tr. Pk., Rome, NY 13440.

Johnson Viking Valiant-1 transmitter kit. Need assembly instructions. John S. Anderson, 4267 Coronado Ave., San Diego, CA 92107.

Eico model 425 oscilloscope, RCA WV-97A Senior Voltphymyst and **Hallcrafters** S120 receiver. Need schematics and/or operating instructions. Kenneth W. Hillis, BTC K-9, Eielson AFB, AK 99702.

Knight KG-50 AM-FM stereo tuner and KG-250 stereo amplifier. Need schematic, alignment and service manuals. Gregory P. Widin, 1644 Eldridge Ave. W., St. Paul, MN 55113.

Dumont model 185-A electronic switch. Need schematic and operation manual. **Solar** model CB-1 capacitor analyzer. Schematic needed. Mark D. Pickerill, 80 Desmond Rd., Salinas, CA 93907.

Symphonic model 235001 AM/FM stereo. Need schematic and part number of replacement PWR transformer. Leon Weston, Box 13, Winthrop, ME 04364.

Craig Corp., model 6403 video tape recorder. Need service manual and schematic. Fred W. Kaylor, Box 400, 1250 Turner St., Auburn, ME 04210.

Knight KG-790 AM/FM tuner, **JVC** model CHR-250 UB 8-track recorder, **Dual/BSR** model 1219 turntable. Need service/maintenance manuals. Charles T. Huth, 146 Schonardt St., Tiffin, OH 44883.

Buyers Worldwide Are Clamoring For Our 1¢ MORE GETS U 2

40-TWO WATT RESISTORS, carbo-films, carbons, some 5'sers, (#456)	1.29	80 for 1.30
50-TERMINAL STRIPS, ass'd solder and screw types, 2 lugs & up, (#334)	1.29	100 for 1.30
1-WATCH GUTS, LED, who knows how good, micro-digital bonanza, (#5115)	1.29	2 for 1.30
10-1000V 1A RECTIFIERS, 1N4007, epoxy case, axial leads, (#5926)	1.29	20 for 1.30
6-25 WATT PLASTIC POWER, 2N6100 series, TO-220, 200vcbco, 3A, (#1786)	1.29	12 for 1.30
4-CALCULATOR AC JACKS, 3 terminals, takes mini plug, (#2316)	1.29	8 for 1.30
65-PRE-FORM 1/4 WATTERS, pop.ular values, for PC appl., (#2444)	1.29	130 for 1.30
40-LOW NOISE RESISTORS, 1/8 & 1/2 W, oxide & magnetic film, (#220)	1.29	80 for 1.30
40pc-SEMI-CON SURPRISE, ass't: zeners, diodes, etc, untested, (#226)	1.29	80 for 1.30
20-TRANSISTOR ELECTROLYTICS, ass't: voltages, from 5-100 mfd, (#453)	1.29	40 for 1.30
1-LASCR OPTO COUPLER, type H11C3, mini dip, (#5790)	1.29	2 for 1.30
10-UPRIGHT ELECTROS, 100% ass't'd values and voltages, (#5900)	1.29	20 for 1.30
2-GE 3W AUDIO AMP, type PA-263 IC, chip, mono, (#1522)	1.29	4 for 1.30
1-MERCURY TILT SWITCH, N.C. rated 24VDC @ .05A, w/leads, (#5686)	1.29	2 for 1.30
50-CAP SPECIAL, ass't: values in mylar, mica, ceramic, disc, etc, (#3775)	1.29	100 for 1.30
40-FEEDTHRU CAPACITORS, used for hams, RF, UHF circuitry, (#5668)	1.29	80 for 1.30
40-PLASTIC TRANSISTORS, ass't'd untested and hobby, (#2604A)	1.29	80 for 1.30
2-CELL BATTERY HOLDER, 9V, for AA size cells, with 9V clip (#6365)	1.29	4 for 1.30
4-12 VOLT LAMPS, w/leads, popular voltage, 100's of uses, (#5942)	1.29	8 for 1.30
1-12 VDC SOLENOID, similar to Guardian 16-P, w/plunger, 3/4" stroke, (#6013)	1.29	2 for 1.30
10-AXIAL ELECTROS, assorted values and capacitance, (#5901)	1.29	20 for 1.30
10-POWER TAB TRANSISTORS, NPN, plastic, TO-220, (#5629)	1.29	20 for 1.30
6-PRECISION TRIM POTS, ass't'd singles and multi-truns, untested, (#3389)	1.29	12 for 1.30
20-1N4148, 4 NANO, SWITCHING DIODE, axial leads 10mA, 100%, (#3000)	1.29	40 for 1.30
20-ASSORTED IC SOCKETS, 24, 28, & 40 pin sockets on G-10 board, (#6357)	1.29	20 for 1.30
4-PUSHBUTTON ALARM SWITCH, 125 VAC 1A SPST, NC, (#5289)	1.29	8 for 1.30
6-CABLE & PLUG SET, 2 cond. 2.5mm mini plug w/6 polarized cable, (#5737)	1.29	12 for 1.30
10-RESISTOR NETWORKS, assorted values in dips and singles, (#5699)	1.29	20 for 1.30
5-ASSORTED EDGE CONNECTORS, mixed 4 & 6 pin, double-sided, (#6362)	1.29	10 for 1.30



HY-GAIN ONE ARM BANDIT MIKES

Only
\$14.99
2 FOR \$15

Take one hand command of your mobile or base rig with Hy-Gain's One Arm Bandit Mike ON/OFF, VOLUME, SQUELCH, CHANNEL SELECTOR, SPEAKER and DIGITAL DISPLAY all conveniently located where your fingers do the talking. Comes with 6 ft. multi-conductor, color coded, coiled cable (separate) for easy integration into any type of rig. Size 4 1/2" x 2 1/2" x 1 1/2". Wt. 9oz. No. 92CU5886

2-DOUBLE SIDED PC BOARDS, 3 1/2" x 12" high quality G-10 glass, (#5694)	1.29	4 for 1.30
10-TUBULAR CAPACITORS, ass't'd 100mfd to 1mf to 600 WVDC, (#35A219)	1.29	120 for 1.30
6-MICRO MINI REED SWITCHES, 1" long, for alarms, relays, etc., (#1258)	1.29	12 for 1.30
10-TANTALUM ELECTROS, ass't'd mini, axial, hermetically sealed, (#5848)	1.29	20 for 1.30
50-DISC TYPE CAPS, incl: NPO, hi-Q, mylar, ceramics, ass't'd values, (#437)	1.29	100 for 1.30
60-COILS & CHOKES, ass't'd RF, OSC, IF, parasitic types, (#35A297)	1.29	120 for 1.30
6-SWITCHCRAFT PHONO JACKS, hi-Q, chassis mount, teflon base, (#5119)	1.29	12 for 1.30
30-SUBMINI IF TRANSFORMERS, ass't: slug tuned, shielded, (#35A9)	1.29	60 for 1.30
40-ADJUSTABLE FERRITE CORES, center cut for hex adjust, (#5701)	1.29	80 for 1.30
10-PC TRIMPOTS, screwdriver adjust, assorted values, (#3346)	1.29	20 for 1.30
25-4" CABLE TIES, plastic, like Ty-wrap style, (#5217)	1.29	2 for 1.30
5-CRYSTALS, may include: CB, ham various shapes and sizes, (#5716)	1.29	10 for 1.30
3-MICRO SWITCHES, SPST, NO contacts, plunger style, solder tabs, (#5785)	1.29	6 for 1.30
65-MOLEX SOCKETS, "on-a-strip", for 8-40 pin ICs, (#1609)	1.29	130 for 1.30
6-PAIRS 9V BATTERY CLIPS, w/red & black color-coded leads, (#2852)	1.29	12 for 1.30
6-1M340T VOLTAGE REGULATORS, 5 to 24 volts, TO-220, (#5897)	1.29	12 for 1.30
40-POLYSTYRENE CAPACITORS, ass't'd values and voltages, (#1052)	1.29	80 for 1.30
15-THERMISTORS, resistors that change with the temperature, (#2048)	1.29	30 for 1.30
65-1/2 WATT RESISTORS, ass't'd values, metal film, marked, (#5797)	1.29	130 for 1.30
10-MODULAR SWITCHES, Centralab "push-on" type, up to SPDT, (#3150)	1.29	20 for 1.30
5- "MOTORS MOTORS", small, high speed, ass't'd sizes, 3-6VDC, (#2551)	1.29	10 for 1.30
50-MICAS ass't: sizes-n-shapes, incl. "silvers" 100', (#373)	1.29	100 for 1.30
10-TRANSISTOR SOCKETS, for npn and pnp types, (#3845)	1.29	20 for 1.30
4-HOBBY VOLTAGE REGULATORS, LM-309, 320, 340's, TO-3, (#3330A)	1.29	8 for 1.30
12-PANEL SWITCHES, assorted slides, rotaries, modulators, etc, (#295)	1.29	24 for 1.30
60-RESISTOR SPECIAL, 1/2 to 1 watt, carbons, carbo-films, etc, (#3589)	1.29	120 for 1.30
65-HALF WATT RESISTORS, assorted carbons, carbo-films, various values, (#454)	1.29	130 for 1.30
15-HUMBUCKER CONTROLS, assorted values, manufacturers dump, (#3807)	1.29	30 for 1.30
1-POWER TAB TRIAC 100% prime, 400V 10A TO-220, (#6216)	1.29	2 for 1.30

'FLIP-OVER' DIGITAL CLOCK

\$6.99 each

- 115 VAC Operation
- Built-In Alarm Function With 24 Hour Dial Indicator
- 1/4" High White Numerals



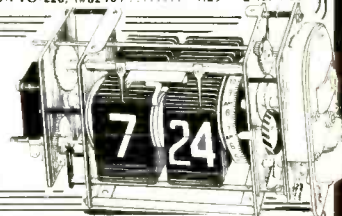















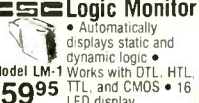













Cat. No. 92CU6336



50-PRECISION RESISTORS, 1/2, 1, & 2 watts, 1%, assorted types, (#363)	1.29	100 for 1.30
60-CERAMIC CAPS, ass't'd val. & styles, incl: tubular, NPO's, etc., (#590)	1.29	120 for 1.30
30-MOLEX CONNECTORS, nylon, ass't'd styles, colors, & # of cond, (#5835)	1.29	60 for 1.30
4-ROCKER SWITCHES, DPDT, solder evellet terminals, (#3302)	1.29	8 for 1.30
1-RELAY, BARCOCK 6VDC, SPST, plastic case (#5807)	1.29	2 for 1.30
4-THERMAL RESISTERS, epoxy sealed, metal clad, break at 257 F, axial, (#6367)	1.29	8 for 1.30
50-1N4000 RECTIFIERS, epoxy, axial leads, untested, (#2594)	1.29	100 for 1.30
30pc-HEAT SHRINK, Thermo-fit, shrinks 50%, (#5248)	1.29	60 for 1.30
25-DI's, 100% prime, ass't'd flip flops, etc., marked, (#3709)	1.29	20 for 1.30
10-MAN-3's, 7 segment, w/bubble magnifier, 100% material, (#3842)	1.29	20 for 1.30
4-PL-259 COAX PLUG, mates to SO-239, Amphenol, (#5221)	1.29	8 for 1.30
1-LITE SENSITIVE UNIJUNCTION TRANSISTOR, programmable, (#5719)	1.29	2 for 1.30
100-PRE-FORMED 1/4 WATTERS, popular values, some 5 & 10 %ers, (#1060)	1.29	200 for 1.30
4-PHOTO ELECTRIC DARLINGTON TRANSISTORS, (#3276)	1.29	8 for 1.30
40-POWER RESISTORS, assorted types, includes 2 to 10 watters, (#228)	1.29	80 for 1.30
15-NE-2 LAMPS, neon red, for 110VAC, less resistor, (#1435)	1.29	30 for 1.30
30-"CRIMP-ON" TERMINALS, rings and spades, for # 12-20 wire, (#3955)	1.29	100 for 1.30
50-ONE-WATT RESISTORS, popular assort, some 5'sers, 100's of uses, (#3844)	1.29	100 for 1.30
30-FT. WIRE-WRAP WIRE, 30 ga, g, insulated, continuous length, (#3803)	1.29	60 for 1.30
6-SPDT MICRO SLIDE SWITCH, only 3/7" cube, for PC mount, (#3429)	1.29	12 for 1.30
10-PR-RC PLUGS & JACKS, for audio, speakers, etc., (#402)	1.29	20 for 1.30
5-2N3055 HOBBS TRANSISTORS, TO-3, (#3771)	1.29	10 for 1.30
6-SINGLE PIN MICRO GREEN LEDS, 3V, 10 mils, "pin heads", 100%, (#6126)	1.29	12 for 1.30
6-JUMBO RED LEDS, 1.5-3 V @ 10 mA, 100% material, 100's of uses, (#2135)	1.29	12 for 1.30
6-MAGNETIC DISCS, shatter-resistant Plastalloy, 13 1/16" dia., (#609)	1.29	12 for 1.30
5-PHOTO CELLS, vector 900, disc type, R-2K ohm (dark) w/leads, (#6135)	1.29	12 for 1.30
1-12VDC SPDT RELAY, 180 ohm coil, 25 mA, 1x1x1 1/2", sealed (#5937)	1.29	2 for 1.30
10-VOLUME CONTROLS, ass't: values, audio, and switch too!, (#592)	1.29	20 for 1.30
60-PREFORMED DISC CAPS, handy assortment of values, marked, (#1181)	1.29	120 for 1.30

SEND FOR FREE CATALOG
POLY PAKS
P.O. BOX 942-E4
SO LYNNFIELD, MA 01940

HOW TO ORDER
We honor MASTERCARD, VISA, check, and COD. (25% down). Order by phone or mail. Minimum order \$8. Please state Cat. No. & description, name & month of magazine. Foreign Customers: \$5. Foreign add \$10 US funds. Excess will be returned. TERMS: add postage. RATED: Nat. 30. Phone: (617) 245-3828

DIGITAL MULTIMETERS Sinclair PDM35 Reg. \$69.95 Hickok LX303 \$69.50 	MURAPHONE Cordless Telephone System Reg. \$89.95 \$74.95 	Portable VOM Multitester Model MAX100 Reg. \$150.00 Model VMS20 \$19.95 • 20 KΩ VDC • 10 KΩ VAC 	100 MHz 8-Digit Counter Model MAX100 Reg. \$150.00 • 20 Hz to 100 MHz range • LED display • Fully automatic \$127.50 	6" x 9" 3-Way Speaker • 20 oz. ceramic magnet Model BP2000-69TR \$14.95 ea. 	
BK PRECISION 3 1/2-Digit Portable DMM Model 2800 	Beckman TECH310 Portable DMM Model 2800 \$130. 	HICKOK Digital CB In-Line Tester Model 388 \$169.95 Reg. \$399.00 	ESLogic Monitor • Automatically displays static and dynamic logic • Works with TTL, HTL, TTL, and CMOS • 16 LED display Model LM-1 \$59.95 Model 1400 \$199.95 	Telephone Answering Model 1500 \$249.95 Call Control Reg. \$349.95 Model 1400 \$199.95 	FREE 8 pc. Tool Set (value \$14.95) with \$200.00 purchase from this ad. 
Portable Oscilloscopes 15 MHz Dual Trace Triggered Miniscope Model MS-15 Reg. \$319.00 \$369.95 Model MS-215 \$435.00 	Function Generator Model 2001 Reg. \$185.95 \$157.95 • Sine, square, triangle, and separate TTL square wave output • Frequency range: 1Hz-100KHz 	Attache Style Tool Case Model TC100/ST \$471 \$279.95 	Weller Xcelite Service Master Tool Kit Model 99-SM Reg. \$69.95 \$47.50 	Wahl Cordless Soldering Iron Model 7800 \$29.95 	Miniature High Fidelity 3-Way Stereo Speakers Model HF-9 \$69.50 PR Reg. \$149.95 
ESLogic Probe • Compact circuit powered • Detects pulses as short as 50 μSec • DTL TTL HTL CMOS compatibility Model LP-1 \$44.95 	Proto Preassembled Boards Model PB-104 Fully assembled breadboard contains four QT-593 sockets, seven QT-59B bus strips and four 5-way binding posts. \$49.95 	ESProto Board with Built-in Power Supplies • Regulated • Short-proof Reg. \$154.95 \$129.95 Model PB-203A 	ES 3 1/2-Digit 0.1% Digital Capacitance Meter Model 3001 • 9 ranges from 1999 pF to 199.9 μF • 0.1% of reading accuracy Reg. \$190.00 \$170 	Thermal-Spot Circuit Tester Model 5800 \$29.95 	In-Dash Car Stereos 8-Track Tape Player with AM/FM/MPX Radio Model C-777 \$52.50 
RC Circuit Box • 36 resistors (15 1/2 to 10 MΩ) • 18 capacitors (100 pF to 0.22 μF) Reg. \$49.95 \$42. includes test leads VIZ Model WC 412A 	Magnifier Lamp Precision ground and polished magnification lens. Model MG10A \$49.95 	30 MHz LEADER Dual Trace with Delay Line Model L80-520 \$89.95 	ES 30 MHz Portable Frequency Counter Reg. \$130.00 \$65. Model 1827 	BSR X-10 4 Pc. Standard Starter Kit • One (1) Standard Command Reg. \$87.95 Console • Two (2) Lamp Modules • One (1) Appliance \$79.50 Model 5 Pc. Ultrasonic Starter Kit • One (1) Deluxe Ultrasonic Reg. \$102.95 Command Console • One (1) Hand Held Remote Unit • Two (2) Lamp Modules • One (1) Appliance Unit Lamp Module \$14.50 Standard Command Console \$36.00 Appliance Module \$14.50 Ultrasonic Command Console \$59.95 VIZ System Module \$14.50 with hand held remote 	Cassette Tape Player with AM/FM/MPX Radio Model CAS-888 \$57.50 
Chess Challenger 7 Reg. \$110.00 Model BBC \$79.95 	Weller Controlled Output Soldering Station Model WTCPN Reg. \$77.50 \$49.95 	Stereo Power Booster Model POW-40 • 40W stereo \$24.95 	FORDHAM 855 Conklin St. Farmingdale, N.Y. 11735 ADD FOR SHIPPING AND INSURANCE to \$ 250.00 \$ 3.50 \$251.00 to 500.00 5.00 \$501.00 to 750.00 7.50 \$751.00 to 1000.00 10.00 over 1000.00 12.50 C.O.D. extra N.Y. State residents add appropriate sales tax. TOLL FREE (800) 645-9518 in N.Y. State call (516) 752-0050		

Free!

Edmund Scientific Catalog



Explore Astronomy, Biofeedback, Optics, Lasers, Magnets, Weather, Magnifiers, Microscopes, Photography... Over 4,000 Fascinating Products in Our **FREE** 100 page color Catalog! Send for your **FREE** Edmund Scientific Catalog, Today! 38 Years Of Service!

Yes! Rush me your **FREE** catalog!

Name _____
 Address _____
 City _____
 State _____ Zip _____

Clip and Mail Coupon Today to:
 Edmund Scientific Co., Dept. 2020 AV04
 Edscorp Bldg., Barrington, N.J. 08007
 No. 156 ©1980 Edmund Scientific Co.

comptique TEXAS INSTRUMENTS electronic calculators TI 35 NEW \$24.95 TI-50 33.50 TI-55 34.95 TI-58C NEW 109.95 TI-59 209.95 TI-58/59 Libraries 28.95 TI-30SP 17.95 PC-100C 146.95 TI-1750 19.95 TI 5015 64.95 TI 5040 94.95 TI-5100 \$39.95 Programmer 48.95 MBA 59.95 Business Analyst I 21.95 Business Analyst II 39.95 Business Card NEW 39.95 Language Translator NEW 279.95 Digital Thermostat NEW 104.95 Speak & Spell 65.00 Chrono Alarm 806-31 39.95 World Time Alarm-Chrono 807-3 89.95	comptique TI HOME COMPUTER 99/4 ... \$1150.00 APF IMAGINATION MACHINE ... 495.00 apple computer 16K MEMORY ... 999.95 SHARP 6200 NEW EXECUTIVE ... 99.95 5813 NEW/PROGRAMMABLE ... 34.95 5100 NEW LCD Alphanumeric ... 89.95 BSB SYSTEM X-10 COMMAND ... 39.95 Each Module 14.95	comptique HEWLETT PACKARD INTRODUCING THE HP-85! HP 67 \$299.95 HP 92 399.95 HP 97 584.95 HP 33C NEW 109.95 HP 34C NEW 124.95 HP 38C NEW 124.95 HP 31E 41.95 HP 32E 54.95 HP 33E 73.95 HP 37E 59.95 HP 38E 94.95 HP 41C NEW CALL HP 85 . NEW . 3250.00 The HP-85 is a powerful BASIC language computer complete with keyboard, CRT display, printer, and tape drive - all in one compact unit.
ATARI 400 \$599.95 800 (STARTER SYSTEM) 999.95 CASIO ML-81 49.95 FX-68 27.95 CHESS CHALLENGER "7" 89.95 ALSO: Canon, Seiko, Craig, Sanyo, Mattel, Pearlorder, Record-a-Call, Code-a-Phone, and many others. All at GREAT PRICES!	comptique 3211 SOUTH HARBOR BOULEVARD, SANTA ANA, CA 92704 • 6 Stores in California CALL TOLL FREE (800) 854-0523 (outside CA) • (714) 549-7373 (within CA). PERSONAL ELECTRONICS AT PROFESSIONAL DISCOUNTS	

ADVERTISERS INDEX

READER SERVICE NO.	ADVERTISER	PAGE NO.
2	Aaron-Gavin Instruments	34
3	Active Electronics Sales Corp.	101
4	Anconra Corporation	100
5	Apple Computer	Cover 2
6	AP Products	20
7	Beckman Instruments	7
	Bullet Electronics	96
8	Chaney Electronics	96
	Classified Advertising	108, 109, 110, 111
9	Cleveland Consumer Computer	97
	Cleveland Institute of Electronics, Inc.	26, 27, 28, 29
1	Communications Electronics	90
10	Communications Technology Group	111
11	Components Express, Inc.	81
12	Computique	106
13	Concord Computer Components	76
14	Cooper Group, The	92
15	Custom Craft	34
17	Delta Electronics	107
18	Digi-Key Corp.	95
19	Discwasher	Cover 4
20	DSI Instruments, Inc.	30
	Edmund Scientific Co.	106
	Fordham Radio Supply	106
21	General Engines Company	111
22	Godbout Electronics, Bill Grantham College of Engineering	107
23	Guardian Electronics	83
24	Hardside	89
61	Hardside, TSE	93
25	Heath Co.	36
26	Heath Co.	71
27	Hewlett Packard	Cover 3
28	Hitachi Instrument	65
29	Hustler	85
30	Illinois Audio	90
31	Instrumentation, Inc.	100
32	International Components Corp.	100
33	Jameco Electronics	98, 99
34	JBL	15
35	J&R Music World JS & A National Sales Group	80
36	Maxell Corp. of America	51
	MICROCOMPUTER MART	93
37	Media Marketing	85
38	Mercury International	5
39	McIntosh Laboratory, Inc.	6
	National Technical Schools	52, 53, 54, 55
	Netronics R & D Ltd.	57
	Netronics R & D Ltd.	87
	NRI Schools	16, 17, 18, 19
40	OK Machine & Tool Corp.	75
41	OK Machine & Tool Corp.	33
42	Olympic Sales	96
62	Omnisonix	13
43	Opto electronics	72
44	PAIA Electronics, Inc.	82
45	PAL "Firestik" Antenna Corp.	83
46	Peoples' Computer Co.	78
47	Percom Data Company, Inc.	2
48	Pioneer Electronics	21
49	Poly Paks	105
50	Progen	73
51	Quest Electronics	102
	Radio Shack	67
52	Schober Organ Corp. Sharper Image, The	91
53	Shure Brothers Speakerlab, Inc.	23
54	Symmetric Sound System	12
60	The Source	82
55	University of the Trees, Press	9
56	Werisi Electronics	61
57	Weston Instruments	79
		25

SOLDERTAIL SOCKET SPECIAL!

14 pin 50/\$4.95; 24 pin 30/\$4.95;
 16 pin 50/\$4.95; 28 pin 30/\$4.95;
 18 pin 50/\$4.95; 40 pin 20/\$4.95.
 20 pin 40/\$4.95;

OTHER SPECIALS:

Gen purp NPN xisistors (sim 2N3904) 100/\$7.95
 Gen purp PNP xisistors (sim 2N3906) 100/\$8.95
 IMSAI spacinq S-100 soldertail edge connectors 2/\$5

MA1003 12V DC AUTO CLOCK MODULE WITH MATCHING CASE: \$19.95

MUSICIANS ! MUSICIANS

Build your own preamps, tone controls, mini-amps, ring modulators, mixers, and much more with the book **Electronic Projects for Musicians**. Written with the beginner in mind by Craig Anderton, whose articles have appeared in *Popular Electronics*, *Modern Recording*, *Guitar Player* and many other magazines. Now in its 3rd printing. **\$7.95** softcover.

Also available by the same author: **Home Recording for Musicians**. Demystifies the art of making quality recordings at home: covers audio basics, mixers, mikes, special effects, noise reduction, projects, and more. **\$9.95** softcover.

NOTE: WE SUPPLY PARTS KITS FOR THE PROJECTS IN CRAIG'S BOOKS AND IN HIS MONTHLY GUITAR PLAYER COLUMN (FROM COMPRESSORS TO PHASE SHIFTERS) AT A PRICE THAT'S MUSIC TO YOUR EARS. DO IT YOURSELF AND SAVE! SEND FOR OUR CATALOG TODAY.

EIGHT 16K DYNAMIC RAMS: \$87.20

Expand memory in TRS-80* I and II, as well as machines made by Apple, Exidy, Heath H89, newer PETS, etc. Low power, 250 ns (4 MHz). Add \$3 for 2 dip shunts plus TRS-80* installation instructions.

*TRS-80 is a trademark of the Tandy Corporation.

SEND FOR OUR CATALOG TODAY !

TERMS: Cal res add tax. Allow 5% shipping, excess refunded. VISA/Mastercharge call (415) 562-0636 24 hours. COD OK with street address for UPS. Special prices good through cover month of magazine while supplies last; other prices are subject to change without notice. Add \$1 handling to orders under \$15.

GODBOUT
 GODBOUT ELECTRONICS
 Bldg. 725, Oakland Airport, CA 94614

CIRCLE NO. 22 ON FREE INFORMATION CARD

Convert Your Car Into A Concert Hall!



AM-FM MULTIPLEX \$19.95 \$100 STEREO AUTO RADIO

FACTORY CLOSEOUT! — One of America's largest independent manufacturers of automobile radios has given up which we announced in Nov. 1979 *Radio Electronics* & *Popular Electronics* magazines). We've been fortunate in acquiring more of the last auto radios in production. These are AM-FM-MPX Stereo sets... designed for new cars. All are tested 100% operational and come with knobs & 5 push buttons. Ideal for installing in your auto, van, camper, boat or any other place 12 VDC is available.

NEWS ITEM! — Auto stereo has become as sophisticated as home hi-fi — and nearly as expensive. You can spend \$300 for simple components — which means stereo can be out of reach for many folks and 2nd cars. If you want a stereo sound system, you can start with the purchase of a \$100 radio for only a mere \$19.95 at Delta. The radios are designed for small interior of your car that has the combination of the hard plastic and soft upholstered surfaces. It is the perfect radio for a top-sounding stereo system.

Quality Speakers
 For Above Radios — Surplus Prices

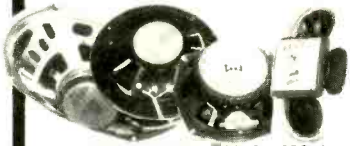

- 60010P
- 5730P
- 60013P
- 60014P
- 60011P
- 60026P

Size	Type	Ohms	Watts	Magnet	Mfg. Ctrs.	Each
9x6	Oval	8	10	2-3/4" Rd.	6 1/2 x 4 3/4"	\$7.95
6	Round	8	3	2-3/8" Rd.	5-5/8"	5.95
5	Round 4 & 8	12	3"	Rd.	3-7/8"	7.95
5	Round 4 & 8	12	3-1/4"	Rd.	3-7/8"	9.95
4x6	Oval	8	10	2-5/8" Sq.	5 1/4 x 3"	5.95
4x6	Oval	8	10	2-3/8" Rd.	5 1/4 x 3"	5.95

** High compliance stereo speakers

14.95 AM-FM
 \$2 Shpg. BUY OF A LIFETIME
 AUTOMATIC RADIO-FM SAME RADIO as above except it is not stereo! Excellent FM reception; picks up stations with weak signals; Complete with metal top plate, push buttons and front bezels.
 No. 5745P

Mail Order Address

FREE
 120-PG. 'SURPLUS' CATALOG

DELTA ELECTRONICS

176 SECOND AVE.
 WALTHAM, MASS 02151
 Minimum Order \$8.00
TEL. (617) 388-4705

BANKAMERICAN VISA master charge

When in our area, northwestern Mass. or southern N.H. visit our retail at 7 Oakland St., Amherst, Mass.

CIRCLE NO. 17 ON FREE INFORMATION CARD

Electronics Classified

REGULAR CLASSIFIED: COMMERCIAL RATE: For firms or individuals offering commercial products or services, \$2.75 per word. Minimum order \$41.25. **EX-PAND-AD® CLASSIFIED RATE:** \$4.10 per word. Minimum order \$61.50. Frequency discount: 5% for 6 months; 10% for 12 months paid in advance. **PERSONAL RATE:** For individuals with a personal item to buy or sell, \$1.60 per word. No minimum! **DISPLAY CLASSIFIED:** 1" by 1 column (2-1/4" wide), \$330. 2" by 1 column, \$660.00. 3" by 1 column, \$990.00. Advertiser to supply film positives. For frequency rates, please inquire. **GENERAL INFORMATION:** Ad copy must be typewritten or clearly printed. Payment must accompany copy except when ads are to be billed on credit cards — American Express, Diners Club, Master Charge, VISA (supply expiration date) — or when ads are placed by accredited advertising agencies. First word in all ads set in caps. All copy subject to publisher's approval. All advertisers using Post Office Boxes in their addresses **MUST** supply publisher with permanent address and telephone number before ad can be run. Advertisements will not be published which advertise or promote the use of devices for the surreptitious interception of communications. Ads are not acknowledged. They will appear in first issue to go to press after closing date. Closing Date: 1st of the 2nd month preceding cover date (for example, March issue closes January 1st). Send order and remittance to Classified Advertising, **POPULAR ELECTRONICS**, One Park Avenue, New York, N.Y. 10016. For inquiries, contact Linda Lemberg at (212) 725-7686.

FOR SALE

FREE! Bargain Catalog — I.C.'s, LED's, readouts, fiber optics, calculators parts & kits, semiconductors, parts. Poly Paks, Box 942PE, Lynnfield, Mass. 01940.

GOVERNMENT and industrial surplus receivers, transmitters, snooperscopes, electronic parts, Picture Catalog 25 cents. Meshna, Nahant, Mass. 01908.

LOWEST Prices Electronic Parts. Confidential Catalog Free. KNAPP, 4750 96th St N., St. Petersburg, FL 33708.

ELECTRONIC PARTS, semiconductors, kits. **FREE FLYER.** Large catalog \$1.00 deposit. BIGELOW ELECTRONICS, Bluffton, Ohio 45817.

RADIO — T.V. Tubes — 49 cents each. Send for free catalog. Cornell, 4213 University, San Diego, Calif. 92105.

AMATEUR SCIENTISTS, Electronics Experimenters, Science Fair Students . . . Construction plans — Complete, including drawings, schematics, parts list with prices and sources . . . Robot Man — Psychedelic shows — Lasers — Emotion/Lie Detector — Touch Tone Dial — Quadraphonic Adapter — Transistorized Ignition — Burglar Alarm — Sound Meter . . . over 60 items. Send \$1.00 (no stamps) for complete catalog. Technical Writers Group, Box 5994, University Station, Raleigh, N.C. 27650.

SOUND SYNTHESIZER KITS — Surf \$16.95. Wind \$16.95. Wind Chimes \$22.95. Musical Accessories, many more. Catalog free. PAIA Electronics, Box J14359, Oklahoma City, OK 73114.

TELETYPE EQUIPMENT: Copy Military, Press, Weather, Amateur, Commercial Transmissions. Catalog \$1.00. **WEATHER MAP RECORDERS:** Copy Satellite Photographs, National-Local Weather Maps. Learn How! \$1.00. Atlantic Sales, 3730 Nautilus Ave., Brooklyn, NY 11224. Phone: (212) 372-0349.

WHOLESALE C.B., Scanners, Antennas, Crystals: Special cut, \$4.95. Monitor \$3.95. Send make, model, frequency. G. Enterprises, Box 461P, Clearfield, UT 84015.

BUILD AND SAVE TELEPHONES, TELEVISION, DETECTIVE, BROADCAST Electronics. We sell construction plans with an Engineering Service. Speakerphones, Answering Machines, Carphones, Phonevision, Dialers, Color TV Converters, VTR, Games, \$25 TV Camera, Electron Microscope, Special Effects Generator, Time Base Corrector, Chroma Key, Engineering Courses in Telephone, Integrated Circuits, Detective Electronics. **PLUS MUCH MORE.** NEW Super Hobby Catalog PLUS year's subscription to Electronic News Letter, \$1.00. Don Britton Enterprises, 6200 Wilshire Blvd., Los Angeles, Calif. 90048.

NAME BRAND Test Equipment. Guaranteed discounts up to 50%. Free catalog. Salen Electronics, Box 82, Skokie, IL 60077.

SpeakerGuts.



The absolute latest in advanced speaker technology. Wave Aperture™ Drivers. The Patented Nestrovic Woofer System™ raw speaker components selected for their excellence. Horns, crossovers, subwoofers, woofers, midranges, horn and dome tweeters. Over 30 in all. Build your own speaker system and we'll provide top quality speakers and design information. Send for FREE 48 page color catalog from the largest, most experienced speaker kit manufacturer in the world. **DON'T DELAY. Write today!**

Speakerlab®
Dept. 176 735 N. Northlake Way
Seattle, Washington 98103

UNSCRAMBLE CODED MESSAGES from Police, Fire and Medical Channels. Same day service. Satisfaction guaranteed. Don Nobles Electronics, Inc., Rt. 7, Box 610, Hot Springs, Arkansas 71901. (501) 623-6027.

UNSCRAMBLERS for any scanner. Several models available. Free literature. Capri Electronics, 8753T Windom, St. Louis, MO 63114.

UNSCRAMBLERS, seven models available to decode police, ambulance, and fire coded transmissions. Other scanner devices. Tone encoders decoders. Telephone accessories, etc. Free Catalog. KRYSTAL KITS, Box 445, Bentonville, AR 72712. (501) 273-5340.

POLICE/FIRE SCANNERS, crystals, antennas, CBs, Radar Detectors. HPR, Box 19224, Denver, CO 80219.

CB RADIOS, VHF-UHF Scanners, Crystal, Antennas, Radar Detectors. Wholesale. Southland, Box 3591, Baytown, TX 77520.

PRINTED CIRCUIT supplies, chemicals, tools, artwork, plating solutions. Major credit cards. Catalog \$2.00, refundable. CIRCOLEX, Box 198, Marcy, NY 13403.

RECONDITIONED TEST EQUIPMENT \$1.00 for catalog. WALTER'S TEST EQUIPMENT, 2697 Nickel, San Pablo, CA 94806, (415) 758-1050.

NEGATIVE ION GENERATORS AND ACCESSORIES. (Kits). Fascinating details — \$1.00. Golden Enterprises, Box 1282-PE, Glendale, Arizona 85311.

Telephone Listening Device

Record telephone conversations in your office or home. Connects between any cassette or tape recorder and your telephone or telephone LINE. Starts automatically when phone is answered. Records both sides of phone conversation. Stops recorder when phone is hung up. This device is not an answering service.



Each \$18.95
Qty. Disc Avail.

Super Powerful Wireless Mic

10 times more powerful than other mics. Transmits up to 1/4 mile to any FM radio. Easy to assemble kit. 15V battery (not incl.)

Call (305) 725-1000 or send \$18.95 + \$1.00 shipping per item to USI Corp., P.O. Box PE-2052, Melbourne, FL 32901. COD's accept. For catalog of transmitters, voice scramblers and other specialty items, enclose \$2.00 to USI Corp.

EXQUISITE ELECTRONICS KITS for beginners and pros. Free brochure. LOGICAL SYSTEMS, 3314 'H' St., Vancouver, Washington 98663.

NEW CATALOG of low cost electronic parts. Send for FREE copy. ALL ELECTRONICS CORP., Dept. F, 905 S. Vermont Ave., Los Angeles, CA 90006.

FIX CB RADIOS for yourself, friends or profit. Complete manual now \$10.95 from A.P. SYSTEMS, P.O. Box 488 PE, Milford, PA 18337. (717) 686-5900.

New Morse-A-Word Code Reader



IDEAL FOR BEGINNERS, SWL'S AND AMATEURS. CONNECTS TO YOUR RECEIVER SPEAKER. FULL EIGHT CHARACTER READOUT. ORDER MAWF \$249.95, KIT \$169.95. SEND CHECK OR MONEY ORDER. USE YOUR VISA OR MASTER CHARGE. ADD \$3.50 FOR SHIPPING.

Microcraft Corporation Tel.: 414-241-8144
P.O. Box 513 PE, Thiensville, Wisconsin 53092

SATELLITE TV FOR THE HOME

Our receiver lets you get over 75 channels of television directly from earth-orbiting cable TV satellites: HBO, Showtime, super stations, sports and movies from around the world.

Sick of Network TV? Buy Complete or Build our kit and save!

Our 24-channel receiver provides "studio quality" TV reception. Easy to install! Ultra low power consumption! Brilliant color! Works anywhere! FCC licensing no longer required. **Order today!** Complete details covered in our Home Earth Station manual. Send \$7.95 today (refundable against any purchase), or call:

24-hour C.O.D. Hotline
(305) 869-4283
SPACECOAST RESEARCH
Dept. H, P.O. Box 442, Altamonte Springs, FL 32701



TREMENDOUS BUYS In New And Gov't Surplus Equipment

Dial Telephone "SUPER BUY"

* Save us the labor costs of cleaning and polishing and save \$555 on standard dial telephones. Work on any commercial system. Complete. (no parts missing) in good working order. Your choice of desk or wall models. These are take-outs from commercial service (not toys) - instructions furnished.

Wall Model - 715 MF

Desk Model - 715 PE

\$7.95

PRICE EACH

PREPARED IN U.S.A.

Does not include HAWAII, ALASKA & P.R.

FREE CATALOG shows BIG SAVINGS ON:

- ELECTRONICS • ELECTRICAL • ALARM SYSTEMS • TELEPHONES • PUMPS
- BINOCULARS • GEAR MOTORS • WINCHES • SURVIVING INSTRUMENTS
- GENERATORS • COMPRESSORS • HYDRAULICS • POWER TOOLS • WELDERS
- POWER PLANTS • CHEMICAL SPRAYING • TARPOLING • MANY OTHERS

Surplus Center Box 82209-PE Lincoln, Ne. 68501

NEW ELECTRONIC PARTS. Continuously stocked. Stamp brings catalog. Daytapro Electronics, 3029 N. Wilshire Ln, Arlington Hts., IL 60004.

LOUD AND CLEAR.

Read all about the K—the amazing speaker that has the power to reproduce even the lowest bass notes—loud and clear. Features the brilliant cornerhorn design with Speakerlab innovations like Magnar™ damped horn drivers. One of the only kits available for this unique loudspeaker. Read about K's and all the other great Speakerlab speakers and parts in our free catalog.

Speakerlab®

To get yours, write
SPEAKERLAB Dept. 177
735 N. Northlake Way
Seattle, WA 98103

SATELLITE TELEVISION — MOVIES, SPORTS, etc. Build or buy earth station. Send \$3.00 for information. Satellite T.V., Box 140, Oxford, NY 13830.

RF POWER TRANSISTORS — MRF 455A — \$17.95, MRF 454A — \$24.95, 2N 5591 — \$8.90, 2N 6084 — \$14.50, more. TV, audio, radio, VTR transistors, IC's, diodes, SG 613 — \$5.90, STK 013 — \$8.40, AN 239 — \$4.90, more. Send for free catalog. B & D Enterprises, P.O. Box 32, Mt. Jewett, PA 16740. (814) 837-6820. 24 hours.

SCANNER CRYSTALS \$2.85. PLL conversion crystals \$4.00. 50c P&H. Diversified Marketing, 2010 So. 139th Cir., Omaha, NE 68144.

DISCOUNT C.B., SCANNERS, ACCESSORIES. Free Catalog Crystals: CB, Ham, Scanneff. All freqs. Same day service. XTALS, Box 42-E, Prospect Hts., IL 60070.

TRS-80 USERS™. We have hardware and software. Write for current list. HARTMANN-LANG, Box 693, Chatham, NJ 07928.

NEW FALL 1980 TEST EQUIPMENT CATALOG AVAILABLE. 108 pages of quality used equipment. Write for free copy. Tucker Electronics Co., Box 401060, Garland, TX 75040.

PRINTED CIRCUIT BOARDS, your artwork. Quick delivery. Reasonable. Atlas Circuits, Box 974, Waynesville, NC 28786. (704) 456-3739.

FREE CA3140 OpAmp with every order. All top quality merchandise. Send for bargain catalog. KEY ELECTRONICS, Box 3506P, Schenectady, NY 12303.

TEST EQUIPMENT, new and used. Catalog \$1.00. PTI, Box 8756, White Bear Lake, MN 55110.

ELECTRONIC CATALOG Free. Over 300 pages. Parts, schematics, etc. Everything needed by the hobbyist or technician. T & M Electronics, 472 East Main St., Patchogue, NY 11772. (516) 289-2520.

RECORDS — TAPES! Discounts to 73%. All labels; no purchase obligations; newsletter; discount dividend certificates. 100% guarantees. Free details. Discount Music Club, 650 Main St., Dept. 5-0380, New Rochelle, NY 10801.

New Subsonic Filter is required for optimum bass response in your system.



ACE AUDIO CO.,
532 5th St., East
N'thp't, NY 11731

FREE CATALOG

SOLAR CELLS. 4v, 4 inch diameter, 2 amps \$8.75, 10 for \$85.00 plus \$5.00 shipping. Foster, 1742 Dowd, St. Louis, MO 63136. (314) 522-6667.

QUIZZES AND GAMES FOR TRS-80. Quizzes include Math, English, Sports. Wizards Arsenal, Box 20183, Lansing, MI 48901.

DIGITAL AUTO COMPASS, eight LED direction indicators, three digit heading readout. Information \$1.00; complete plans \$3.50. TS Research, 2301 East Ball Road, c/o Office, Anaheim, CA 92806.

CATALOG OF UNUSUAL CB ITEMS. Repairs, modifications, range boosters. \$1 (refundable). CB CITY, Box 1030PE, Woodland Hills, CA 91365.

NEVER LEAVE YOUR HEADLIGHTS ON AGAIN! Transistorized buzzer kit warns you! All parts included! \$3.75, add 40c postage. Electronic Innovations, 1105-7B-N Main Street, Gainesville, FL 32601.

SHORTWAVE LISTENERS SPECIAL. Yaesu FRG-7 regularly \$370.00. Ross Distributing Special Price \$270.00. FOB Preston. Ross Distributing Company, 78 South State, Preston, ID 83263. (208) 852-0830.

SATELLITE T.V.
HOME VIDEO RECEIVERS, ANTENNAS AND LOW NOISE AMPLIFIERS. WE MFG. THE LATEST IN ADVANCED TECHNOLOGY SYSTEMS WHICH COMBINE HIGH PERFORMANCE AND LOW COST. SEND \$7.95 (REFUNDED WITH ORDER) FOR OUR INFORMATION PACKAGE TO
NORSAT SYSTEMS BOX 232 SURREY B.C. CANADA V3T 4W8

PROGRAM 2708 EPROMS with the TRS-80. Schematic and software \$5.00. David Tipping, Box 400, Northford, CT 06472.

POLICE SCANNERS — WHOLESALE PRICES. Over 25 models. Bearcat 300 — \$379.95. Regency M 100 — \$229.95. Bearcat 220 & 250 — \$269.95. Same day shipping. VISA/MC. (415) 573-1624. Free catalog. Write: Scanners Unlimited, 1326 El Camino Real, Belmont, CA 94002.

GUARANTEED TEST EQUIPMENT. Surplus at surplus prices. List \$2.00 Refundable. Jack Watts Co., Box 25, Corona, CA 91720.

LOGIC ANALYZER OR TIMING DIAGRAM. Convert any scope \$10.00. Complete information, schematic, P-C Layout & parts list \$4.95. P.O. Box 93, Kensington, MD 20795. EDP Marketplace.

ELECTRONIC PERCUSSION use with Amplifier Synthesizer. Musical Instruments, \$1.00. P.O. Box 15538, Tulsa, OK 74112.

MAKE IT



Audiokit 62, 6 in/2 out pro mic mixer perfect for live recording. Can be assembled in just hours. Features treble, bass, pan, cue, echo, gain control on all inputs. Kit . . . \$265. Assembled . . . \$395. Send check or money order to: Audiomarketing, 652 Glenbrook Rd., Stamford, CT 06906 or call us Toll Free at 800-243-2598.

SPEAKERS, CROSSOVERS, ENCLOSURES, parts to build superb systems. Send \$1.00 for list #80. ACL, P.O. Box 5246, Willowick, OH 44094.

RESISTORS 1/2W, 1/4W 5% CF. 03c. No minimums. Send for stocklist. JR Industries, 5834-A Swancreek, Toledo, OH 43614.

LOWEST Prices Electronic Parts, Confidential Catalog Free. KNAPP, 4750 96th St. N., St. Petersburg, FL 33708.

SAVE 50%. Build your own speaker system. Write: McGee Radio Electronics, 1901 McGee Street, Kansas City, Missouri 64108.

PLANS AND KITS

AMAZING ELECTRONIC PRODUCTS

LASERS SUPER POWERED, RIFLE, PISTOL, POCKET. SEE IN DARK. PYRO. TECHNICAL DE-BUGGING. UNCRAMBLERS. GIANT TESLA. STUNWAND. TV DISRUPTER. ENERGY PRODUCING. SCIENTIFIC DETECTION. ELECTRIFYING. CHEMICAL. ULTRASONIC. CB, AERO, AUTO AND MECH DEVICES. HUNDREDS MORE. ALL NEW PLUS INFO UNLTD PARTS SERVICE.

INFORMATION unlimited
CATALOG \$1 Dept. E8, Box 716, Amherst, NH 03031

FREE KIT Catalog contains Test and Experimenter's Equipment. Dage Scientific Instruments, Box 1054P, Livermore, CA 94550.

TIGER 500 SIMPLI-KIT

FOR THE DO-IT-YOURSELFER
NOW! a high quality CD ELECTRONIC IGNITION SYSTEM in kit form.

Contains all components and solder to build complete Solid-State Electronic CD Ignition System for your car. Assembly requires less than 3 hours.

- Increases MPG 15%
- Increases horsepower 15%
- Plugs and Points last 50,000 miles
- Eliminates 4 or 5 tune-ups
- Instant starting, any weather
- Dual system switch

Fits only 12 volt neg. ground
Only \$26.95 postpaid

T-T-T Star Corporation
P.O. Box 1727 Grand Junction, Colorado 81501

PRINTED CIRCUIT Boards from sketch or artwork. Kit projects. Free details. DANOCINTHS Inc., Box 261, Westland, MI 48185.

ELECTRONICS KITS: For information, send 50c. GI Kits, Box 2329, Garland, TX 75041.

HI FI STEREO AMPLIFIER. Build your own, at half market price! Info \$1.00. Otech, P.O. Box 1245, Des Plaines, IL 60018.

SPEAKERPLANS — Build ANY size speakers without special tools, experience. FOOLPROOF, illustrated instructions, parts sources. 80% SAVINGS! Rush \$4. SPEAKERPLANS, 334 Pursel, Phillipsburg, NJ 08865.

BUGS. Build professional miniature FM transmitters. Plans \$5.00. Money-Back Guarantee. PCEP Enterprises, Box 837-B, New York, NY 10004.

NEW-UNSCRAMBLER PLANS. State of art integrated circuit design. Fits all scanners. Complete plans, \$3.95. Innovative Marketing, Box 7577, Huntington, WV 25777.

GIANT SCREEN TV Projection System converts any television into 7 foot picture. Lens & Instruction \$14.00. Guaranteed. Bell Video, 4616 Belair Rd., Baltimore, MD 21206.

PERSONALIZED DOORBELL, programmable tunes, drives speaker directly. Plans \$3.95. Lering, 832 Lyford, Wheaton, IL 60187.

TOP QUALITY SPEAKERS AND KITS. Send \$1.00. Speaker Warehouse, 809 North Route 441, Hollywood, FL 33021.

FIBER OPTIC EXPERIMENTER'S KIT. Includes fiber, cable, tools and instructions. Send \$6.00 to: FIBERTRONICS, Box 322, Primos, PA 19018.

LASER PLANS using laser diode 1-1200 watts (specify) \$4.00. Brochure 50c. LASERTRONICS (3), 12320 SW Spring, Portland, OR 97225.

PROJECTION TV . . . Convert your TV to project 7 Foot picture. Results equal to \$2,500 projector. Total cost less than \$20.00. PLANS & LENS \$16.00. Illustrated info. FREE: Macromcomg, Washington Crossing, PA 18977.

TELEPHONES & PARTS

TELEPHONES UNLIMITED, EQUIPMENT SUPPLIES, ALL TYPES. REGULAR, KEYED, MODULAR. Catalog call (714) 563-5555 or mail \$1.00 refundable. Box 1147E, San Diego, CA 92112.

ALARMS

Burglar-Fire Protection

Protect Your Life, Home, Business, Auto, etc.

- Our catalog shows how. Install your own alarm systems and devices and save \$\$\$\$.
- We offer FREE write-in engineering service.

FREE CATALOG Lowest Prices on Reliable, High-Quality Alarm Systems and Devices

Burdex Security Co. Box 82802-PE Lincoln, Ne. 68501

POLICE DIALER \$29.95. Free burglar alarm equipment catalog. Sasco, 5619P St. John, Kansas City, MO 64123. (816) 483-4612.

BURGLAR, FIRE, CAR! Finest equipment! Save! Catalog, Decal, 50c. Refundable! AAS, 186A Oxmoor Road, B'ham, AL 35209.

HIGH FIDELITY

DIAMOND NEEDLES and Stereo Cartridges at Discount prices for Shure, Pickering, Stanton, Empire, Grado, Audio Technica, Osawa, Satin and ADC. Send for free catalog. LYLE CARTRIDGES, Dept. P, Box 69, Kensington Station, Brooklyn, New York 11218. Toll Free 800-221-0906 9AM - 8PM except Sunday.

HOBBIES

..... GREAT OUTDOOR FUN.

SEARCH ELECTRONICALLY FOR . . . gold, silver, coins and relics with White's Electronics mineral metal detectors. Pays for itself. U.S. Patented. For your nearest dealer and free catalog
CALL TOLL FREE
1-800-547-6911



White's Electronics, Inc. Dept. PE-0
Sweet Home, OR 97386.....

NEW 1980 LEATHERCRAFT CATALOG! 100 pages of over 2100 genuine leather kits, tools, supplies. Easy way to make extra money in your spare time. Send 50c for postage and handling to: Tandy Leather Company, P.O. Box 791, Dept. PEC-4, Fort Worth, TX 76101.

WANTED

GOLD, Silver, Platinum, Mercury, Tantalum wanted. Highest prices paid by refinery. Ores assayed. Free circular. Mercury Terminal, Norwood, MA 02062.

TUBES

TUBES: "Oldies", Latest, Supplies, components, schematics. Catalog Free (stamp appreciated). Steinmetz, 7519-PE Maplewood, Hammond, Ind. 46324.

TUBES-RECEIVING, Industrial and Semiconductors Factory Boxed. Free price sheet including TV, Radio and audio parts list. Transletronic, Inc., 1365 39th St., Brooklyn, New York 11218. Telephone: (212) 633-2800. Toll free: 800-221-5802.

RADIO & T.V. Tubes — 49 cents each. Send for free Catalog. Cornell, 4213 University, San Diego, Calif. 92105.

RADIO AND TV TUBES 1938 to 1978 \$1.00 ea. PRELLER TV, Augusta, AR 72006. (501) 347-2281.

GOVERNMENT SURPLUS

MANUALS for Govt Surplus radios, test sets, scopes. List \$1.00 (cash). Books, 7218 Roanne Drive, Washington, D.C. 20021.

JEEPS — \$19.30!! — CARS — \$13.50!! — 650,000 ITEMS!! — GOVERNMENT SURPLUS!! — Most COMPREHENSIVE DIRECTORY AVAILABLE tells how, where to buy!! — YOUR AREA — \$2. — MONEYBACK GUARANTEE!! — "Government Information Services", Department GE-16, Box 99249, San Francisco, California 94109.

GOVERNMENT SURPLUS. Buy your Area. How, Where. Send \$2.00. Surplus, 615-PE Headquarters Building, Washington, D.C. 20036.

JEEPS ... \$18.88!! ... 675,000 Items! Buy In Your Area! How! Where! — "Moneyback GUARANTEED 1980 Government SURPLUS Directory" — Including: "Buy G-Lands," — "G-Oil/G-Gas LOTTERIES," — \$2.00. GSURPLUS, Box 2009-N, Syracuse, NY 13220.

PERSONALS

MAKE FRIENDS WORLDWIDE through international correspondence, illustrated brochure free. Hermes-Verlag, Box 110660/Z. D-1000 Berlin 11, W. Germany.

MAILORDER SUCCESS! Interested? Free expose. TWP-V, Box 6226, Toledo, Ohio 43614.

LOFTINESS MUSIC? Connoisseur's recommendations—\$2. Box 5600, Jacksonville, FL 32207.

PENFRIENDS — ENGLAND — USA, through correspondence. Send age, interests. Free reply. Harmony, Box IPE, Brooklyn, New York 11223.

INSTRUCTION

UNIVERSITY DEGREES BY MAIL! Bachelors, Masters, Ph.D's. Free revealing details. Counseling, Box 317-PE04, Tustin, California 92680.

LEARN WHILE ASLEEP! HYPNOTIZE! Astonishing details, strange catalog free! Autosuggestion, Box 24-ZD, Olympia, Washington 98507.

RADIO BROADCASTING: Become DJ, engineer. Start your own station — investment/experience unnecessary! Receive free equipment, records. Free details. Broadcasting, Box 130-A4, Paradise, CA 95969.

LEARN ELECTRONIC ORGAN SERVICING at home. Completely revised course covers latest models including digital, LSI's, synthesizers, etc. NILES BRYANT SCHOOL, PO Box 20153, Sacramento, CA 95820.

FIX CB RADIOS for yourself, friends or profit. Complete manual now \$10.95 from A.P. SYSTEMS, Box 488P, Milford, PA 18337. (717) 686-5900.

PASS FCC EXAMS

The Original FCC Tests—Answers exam manual that prepares you at home for FCC First and Second class Radiotelephone licenses. Newly revised multiple choice exams cover all areas tested on the actual FCC exam. Plus "Self-Study Ability Test" Proven! \$9.95 postpaid. Moneyback Guarantee.

TESTS—ANSWERS FOR FCC FIRST AND SECOND CLASS COMMERCIAL LICENSE

Command Productions
Radio Engineering Division
P.O. Box 26348 P
San Francisco, CA 94126

MEDICAL ELECTRONICS TECHNICIAN. Join the medical team. Troubleshoot EKG's, EEG's, Ultrasound, etc. Learn a prestigious profession at home. University REM-E, PO Box 9622, Fresno, CA 93793.

COLLEGE DEGREES BY MAIL! No classes. Fast. Economical. Accredited. FREE Revealing details. Success, Box 13151-R4, Columbus, Ohio 43213.

HAMS: ADVANCED CLASS TEST GUIDE! Accurate! Send \$11.50 to Dick Bash - KL71HP, Box 382, San Leandro, CA 94577.

AVIONICS Aircraft Electronics. Accredited School. Excellent Employment Opportunities. Aero Technicians, P.O. Box 7PE, Rexburg, ID 83440.

FOR INVENTORS

NEW! "Patenting Your Invention Yourself!" \$29.95. Registered Patent Attorney, 7400 ZD Benjamin Franklin Sta., Washington, DC 20044.

PATENT AND DEVELOP Your invention. Registered Patent Agent and Licensed Professional Engineer, Send for FREE PATENT INFORMATION every inventor should have. Richard L. Miller, P.E., 3612 Woolworth Building, New York, NY 10007. (212) 267-5252.

INVENTIONS WANTED

FREE CONSULTATION • NO IDEA TOO SMALL

Disclosure registration. Potential cash or royalties from manufacturers seeking new ideas. For free information on how to register your ideas. Call or write:

AMERICAN INVENTORS CORP.

59 Interstate Dr. Dept PE
West Springfield, MA 01089 (413) 737-5376
A Fee Based Service Company

INVENTORS Patent your invention. Free initial consultation. We are registered by the U.S. Government. VICTOR J. EVANS & CO., 4637 Eastern Ave. N.E., Washington, DC 20018. Since 1898.

LEARN HOW TO OFFER YOUR INVENTION for sale or license. Free booklet outlines procedures, royalty rates, requirements. Kessler Sales Corporation, C-254, Fremont, OH 43420.

CHEAP PROTECTION for your ideas. Inventor's Logbook. Verification format, permanent binding; moneyback guarantee. \$14.95. JorJan, Box 405PE, Ellensburg, WA 98926.

PATENT ENTERPRISES, LTD. — A patent clinic. Protect your invention first at low, low flat fees! FREE brochure on selling your idea. PATENT ENTERPRISES, LTD., Suite 2815-G, 30 Rockefeller Plaza, New York, NY 10020. (212) 246-6583.

BUSINESS OPPORTUNITIES

I MADE \$40,000.00 Year by Mailorder! Helped others make money! Details 25c. Torrey, Box 318-NN, Ypsilanti, Michigan 48197.

FREE CATALOGS. Repair air conditioning, refrigeration. Tools, supplies, full instructions. Doolin, 2016 Canton, Dallas, Texas 75201.

NEW LUXURY CAR WITHOUT COST! Free Report. Co-dex-ZZ, Box 6073, Toledo, Ohio 43614. (419) 865-5657.

MECHANICALLY INCLINED individuals desiring ownership of Small Electronics Manufacturing Business — without investment. Write: BUSINESSES, 92-K2 Brighton 11th, Brooklyn, New York 11235.

MILLIONS in Mail!!! Free Secrets. Transworld-17, Box 6226, Toledo, OH 43614.

MECHANICALLY INCLINED INDIVIDUALS

Assemble electronic devices in your home. Knowledge, or experience not necessary. Get started in spare time. Above average profits. \$300 - \$600 Wk possible. Sales handled by others. No investment — Write for free details.

ELECTRONIC DEVELOPMENT LAB

Box 1560PE, Pinellas Park, FL 33565

ERASE DEBTS with little-known law — create wealth! Details FREE — Blueprints, No. EE4, Box 100, LaGrangeville, NY 12540.

BIG MONEY! Interested? Free disclosure. Febre-V, Box 6073, Toledo, Ohio 43614. (419) 865-5657.

MAKE MONEY AT HOME building electronic circuits. Over 45 different projects including burglar alarms, telephone hold button, color organs, digital clocks, etc. You buy parts wholesale. Send \$1.00 for catalog or send \$9.95 for complete book of schematics and layouts of all our projects. PPG, 14725 Oxnard, Van Nuys, CA 91411.

FREE Inflation-Beater Book '2042 Unique, Proven Enterprises': "Fabulous 'Little Knowns.'" Work home! Haylings-S, Carlsbad, CA 92008.

\$600/THOUSAND STUFFING ENVELOPES! For details write: Kingwood House-PE4, Box 5071, Kingwood, TX 77339.

EXCELLENT PROFIT! Assembling low cost big screen TV and sound. Plans or kits. \$1.00 refundable. Doug's TV, 3448 Agate Court, Carson, NV 89701.

EARN HUNDREDS WEEKLY Stuffing Envelopes; stamps, materials supplied free. Rush stamped envelope. Star, Box 8527, Fort Worth, TX 76112.

DIGITAL WATCH REPAIR — Learn to repair digital watches — provide service to jewelry and department stores — part time or full time. We supply training — equipment — replacement parts. Zantech, Inc., 13 Greentree Rd., Trenton, NJ 08619. (606) 586-5088.

JAPANESE ELECTRONIC EXPORTERS - 800 available, 96 address labels. Australian Dollars 15. Overseas only. Diggerman Enterprises, Box 33, Coramba 2466 Australia.

\$500.00 THOUSAND mailing our circulars. Details free. Essex House, 7011B Lennox, Van Nuys, CA 91405.

\$100,000 YEARLY! Startling mail order discovery! Executive type business. Spare time. Free secrets! Treasure-4R, Morrison, CO 80465.

EMPLOYMENT OPPORTUNITIES

ELECTRONICS/AVIONICS EMPLOYMENT OPPORTUNITIES. Report on jobs now open. Details FREE. Aviation Employment Information Service, Box 240E, Northport, New York 11768.

INSTANT CASH COMMISSIONS Full or part time. Free sales kit features America's largest line low-priced Business, Printing, Advertising Specialties, Signs, Calendars and other necessities used daily by business people. Profitable repeat order. No experience. No investment. No collections or deliveries. Write today. National Press, Dept. 041, North Chicago, IL 60064.

DO-IT-YOURSELF

AUDIO/ANALOG/SYNTHESIS. Plans, parts, kits, etc. for the most exciting sound projects ever. Get on our mailing list, send 25c to: CFR Associates Inc., Newton, N.H. 03858.

125 WAYS TO IMPROVE YOUR GAS MILEAGE! Latest tips & techniques on how to increase gas mileage 15% to 35%. Instructions \$9.95-Money Back Guarantee. Fuel Expanders, P.O. Box 17711, Irvine, CA 92715.

EXPERIMENTERS — STUDENTS — HOBBYISTS. Do-It-Yourself Construction Plans!! Test Equipment, Biopotential Projects, Telephone, and More. Send for Catalog and FREE Power Supply Plan! Jabberwock Engineering, Box 2192, Downey, CA 90242.

DAMAGED VINYL OR LEATHER. New repair kit makes undetectable repairs on all vinyl or leather. Mix and match color, then use exclusive grain duplicator for exact pattern match. \$5.99. Mobeus Marketing, Box 5, Niagara University, Niagara Falls, NY 14109.

REAL ESTATE

BIG ... FREE ... SUMMER CATALOG! Over 2,700 top value coast to coast!! UNITED FARM AGENCY, 612-EP, West 47th, Kansas City, MO 64112.

MOTION PICTURE/VIDEO FILMS

SPORTLITE FILMS FEATURES new Universal-8 S-8 Sound Entertainment Films! Paul Newman plays the coach in "Slapshot", pro hockey action, 400' selected scenes S-8 color/snd. Burt Reynolds "Smokey & the Bandit." "Jaws II" (sequel to Jaws I), great white shark attacks teens in 10 sailboats. "Dracula" Laurence Olivier as vampire hunter, stylish new production ... ea. 400' S-8 color/snd—Sportlite price \$46.75 ea* (\$55. regular)—good until April 17, 1980. Woody Woodpecker cartoons "Dippy Diplomat" & "Fair Weather Friends" + Chilly Willy the shivering Pelican, in "I'm Cold", ea. 200' reel S-8 col/snd. \$28.95* (reg. \$32.95). Orig. "Jaws I" with R. Shaw, R. Scheider, 200' S-8 snd (over 10' run time) \$28.50*. Columbia Pro Sports Action snd films. Super Bowl XII (Denver/Dallas); '74-'73 NBA Champ, Bsktball; official film of '78 World Series (Dodgers/Yaniks), ea. 400' S-8 col/snd (list \$59.95 ea) Sportlite price \$53.95 ea del.—limited offer. Penny Pinchers: Mjr league baseball: '72 All-Star Game, 200' Std 8 color only \$4.95*; '71 World Series (Pittsburgh (Clemente)/ Baltimore) Std 8 B&W 200' silent \$3.95*; '70 World Cup Soccer (Germany/Italy) Std 8 color 200' \$3.95* *Add \$1.50 per film on snd; 90c on penny pinchers. Ill. res. + 6% tax. Hollywood Gold Video movie cat. 50 pg, \$1.50; Univ. S-8 film cat. \$1.25; Columbia film cat. \$1.25; Columbia VTR cat. 75c; Paramount features 40c; asst brochures, Sportlite. Ring Classics, Cloud 9, 40c ea. SPORTLITE FILMS, Elect-4, Box 24-500, Speedway, IN 46224.

BOOKS AND MAGAZINES

VIDEO SOURCE BOOK - Your guide to 15,000 prerecorded video programs — 700 pages — easy-to-use. \$19.95. Moneyback guarantee. Check or money order to: NVC, P.O. Box 3, Dept. 10PE, Sunnyvale, NY 11791. Master Charge and VISA only CALL NOW TOLL-FREE, 800-824-7888, Calif. 800-852-7777, ask for op. 909.

ELECTRONIC MUSIC and home recording in Polyphony magazine. Advanced applications, interviews, projects, computer music. Sample \$1.50. Subscription (6 issues), \$8.00 US/\$10.00 foreign. POLYPHONY, Box P20305, Okla. City, OK 73156.

Linda Aays
Check it out!

Leader LB0-507A 20 MHz
Reg. 580.00/ Call

Hickok 15 MHz Triggered
Reg. 565.00/399.00

Hickok 15 MHz Dual Trace
Reg. 795.00/599.00

Hickok 30 MHz Dual Trace
Reg. 1,149.00/869.00

NLS Mini Scope 15 MHz
Reg. 318.00/ Call

NLS Mini Scope 15 MHz Dual Trace
Reg. 435.00/ Call

NLS Mini Scope 30 MHz Dual Trace
Reg. 559.00/ Call

Leader LB0508 20 MHz Dual Trace
Reg. 770.00/ Call

Hickok Model LX303 Meter 66.95

CSC Logic Monitor Model LM-1 Call

Hickok Function Generator
Reg. 225.00/169.95

Beckman LCD Meter Model 300, 99.95 Model 310, 129.95

Platt Tool Case
Reg. 89.95/59.95

Weller Xcelite Service Master Model 99SM 39.95 Roll Kit Model 99PR 15.95

Weller Elect. Soldering Station EC2000 Reg. 125.00/99.95 EC1000 Reg. 99.95/75.95

CSC Logic Probe LP-1 39.95

Leader LB0520 30 MHz Dual Trace
Reg. 1,050.00/ Call

B&K Scope 1432P 15 MHz Dual Trace
Reg. 840.00/ Call

CSC PS-500 Prescaler Call

CSC 100 MHz Counter Call

CSC Max 50 Counter Call

CSC Max 550 Counter Call

Hickok Model 440 Semiconductor Curve Tracer
Reg. 235.00/179.95

Frequency counters, oscilloscopes, signal generators, multimeters, tools, and probes are among hundreds of products available. Large inventory of Tektronix, Hewlett-Packard, General Radio, Fluke, and Bontoon available with replacement parts as well. Master Charge — Visa Cards accepted. Come in, call or write for free brochures 9AM - 9PM Monday through Friday. Export inquiries invited.

CTG Communications Technology Group, Incorporated

448 Merrick Road, Oceanside, N. Y. 11572 U.S.A. (516) 536-5724
Communications for Worldwide Use Telex 640-488/TWX 510-225-7536

CIRCLE NO. 10 ON FREE INFORMATION CARD

PROTECT YOUR AUTOMOBILE FROM THEFT! Free information. Fleming Sales, 3304 Tanterra Circle, Dept. PE4, Brookeville, MD 20729.

INFLATION AND RECESSION ARE HERE. Learn how to financially protect your family. "Gain Control of Your Money" - a new manual that shows how to analyze finances and gain power over inflation. Moneyback guarantee. \$4.95 to East Enterprises, Dept. E1, 10030 N. Blaney, Cupertino, CA 95014.

MICROCOMPUTER BOOKS. Over 100 titles from beginner to advanced. Guides, games, business applications, programming texts, much more, chosen for accuracy and readability. Free catalog. BITS, INC., Dept. P, Box 428, Peterborough, NH 03458.

SKYVISION—The monthly magazine of home satellite television reception. 12 monthly issues only \$12.00. Send to: Skyvision, P.O. Box 10017, Chicago, IL 60610.

RUBBER STAMPS

RUBBER STAMPS, BUSINESS CARDS. Many new products. Catalog. Jackson's, E-100, Brownsville Rd., Mt. Vernon, Ill. 62864.

HYPNOTISM

FREE Hypnotism. Self-Hypnosis. Sleep Learning Catalog! Drawer H400, Ruidoso, New Mexico 88345.

MISCELLANEOUS

MPG INCREASED! Bypass Pollution Devices easily. **REVERSIBLY!!** Free details — Posco GEE4, Box 300, La-Grangeville, NY 12540.

GASOLINE MILEAGE INCREASED DRAMATICALLY, easily!! Details **FREE!!** Techneering, Box 12191D, Norfolk, VA 23502.

GAS GADGETS DO THEY WORK OR NOT? Which ones do as advertised, which ones are RIP-OFFS. Receive your copy "GASAVERS NEWSLETTER" before you buy one. Plus product evaluations on those that work. Send \$2.00. Fuelxpanders, P.O. Box 17711, Irvine, CA 92715.

BACK ISSUES AVAILABLE...

Popular Electronics Magazine

IF YOU'VE MISSED ANY OF THE PREVIOUSLY PUBLISHED ISSUES OF POPULAR ELECTRONICS MAGAZINE, A WIDE SELECTION IS STILL AVAILABLE. COPIES MAY BE ORDERED FOR ISSUES PUBLISHED DURING THE PAST 12 MONTHS. IN THE EVENT A PARTICULAR ISSUE ORDERED IS OUT OF PRINT YOUR PAYMENT WILL BE RETURNED PROMPTLY.

Order by mailing \$3.00 per copy (postage & handling included) to Popular Electronics, P.O. Box 278, Pratt Station, Brooklyn, N.Y.

(Outside U.S.A. copies are \$4.00 each.)

Please be sure to enclose payment and identify the specific issues you wish to receive.

BEAT HIGH GAS PRICES!



FREE Booklet

Electrify Your Bike!

PEDALPOWER exciting new bike drive tames tough hills. Be independent. Shop when you want. Fits all Bikes, Adult Trikes. Installs in minutes. Thousands sold. Recharges overnight. Travels 100 miles for a dime. Get your exercise without strain. Pedal easily with motor engaged to help improve your health. Visit friends. Travel to work or ride for fun. Starts without pedaling. Noiseless, nonpolluting. Virtually maintenance-free operation!

CALL TOLL FREE 800-257-7955*

For Free Booklet and Special Offer or write:
General Engines Co.
5705 Mantua Blvd. Sewell, NJ 08080

* In AK, HI, NJ call collect (609) 468-0270



CIRCLE NO. 21 ON FREE INFORMATION CARD

PRIVATE USE SATELLITE TV MOVES AHEAD. Since the FCC deregulated receive-only earth stations last fall, more and more people who own apartment buildings, condominiums, motels, hospitals, etc. have shown interest in having their own stations to receive TV from satellites. Now, on the East and West Coasts and in the Southern Tier of states, where a 5-meter (16.4 ft) dish is necessary for flawless reception, systems sell for \$16,500 installed from Channel One, Inc. (Newton, MA 02168). In the middle of the U.S., a smaller system will do and the price goes down to \$13,500. In either case, the customer must provide a concrete base for the antenna. Since large installations must use a separate receiver for each channel delivered, about \$5000 will buy the additional splitting, receiving, and modulating equipment for each channel. Channel One estimates that, amortized over five years, the cost of a four-channel satellite receiving system, including program fees, would be about \$7/month/unit for a 175-unit condominium. If you're wondering what you can see and hear with such a system, RCA's SAT-COM 1 alone carries over 10,000 motion pictures, plus other cable TV programming.

A TOLL-FREE HOT LINE FOR ANTENNA SERVICE has been set up by Antenna Inc., Cleveland manufacturer of antennas and accessories for land mobile and CB radios. By calling 1-800-321-4700 (216-464-7075 in Ohio), customers can get questions answered and technical aid.

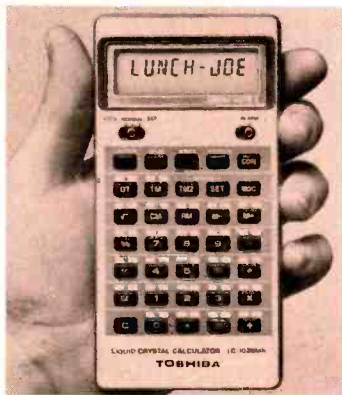

CALCULATOR PERFORMS AS ELECTRONIC DIARY.

Toshiba's Memo Note II is an alphanumeric pocket calculator with alarm that stores messages for recall up to a year later. With 30 alphanumeric memories, the device stores reminder messages for alarm alert on a desired date and time. Thus, at a specific time on a certain day, the calculator might announce (with an alarm) the message: DADS-BIRTH; the telephone: 326-0383; the date/time: 10-30/3:30 PM. In addition to scheduling appointments, anniversaries, and notes for a year's time, the Memo Note II has stored in its preprogrammed memory the equivalent time in 26 cities in different time zones around the world. It is also possible to link up to four alarm times to one message for, say, taking pills during the course of a day. P. S. It can also be used as a calculator.

TOTALLY AUTOMATED FACSIMILE SERVICE which resolves incompatibility of machines and offers rate categories not affected by distance is the promise of FAXPAK, the new nationwide facsimile transmission service of ITT Domestic Transmission Systems. ITT's front-end processors perform speed code and protocol translation necessary to let any facsimile machine talk to any other machine. FAXPAK's computer also allows a user to "broadcast" one document to several different terminals with a single transmission. Business day-time, per-minute terminal connection charges are 16 cents for delivery within 15 minutes and 10 cents for delivery within two hours. Night and weekend rates are lower.

VIDEOTAPE CASSETTE COPY PIRATES face a tougher future if Composite Video, Oklahoma City, OK, has its way. The company's Videoguard VG-350 encoder, available in PAL and NTSC standards, is reported to protect all 1/2" and 3/4" video cassette tapes. Its color process amplifier and sync generator strip all blanking, sync, and burst signals from the master VTR playback and replaces them with new signals. The sync generator restores incoming signal amplitude and level to proper standards. Moreover, it's claimed to defeat the latest VTR sync circuits without causing vertical roll. Attempts at pirating will result in a muted blank picture with no audio (Sony Beta 1/2" and 3/4" formats); loss of sync and tracking control (4-hour mode 1/2" VHS-type VCRs); and loss of tracking control with head switching (2-hour mode VHS-type VCRs and 3/4" Panasonic and JVC models).

NEW STANDARDS ON MICROPHONE POLARITY or phase have been issued by the Electronic Industries Association. Including an up-to-date scheme for marking polarity on three-terminal microphone connectors and new procedures in verifying polarity and establishing the polarity of an existing dynamic or moving microphone, "Polarity or Phase of Microphones for Broadcasting, Recording and Sound Reinforcement" (RS-221-A) is available from EIA, 2001 Eye Street, N.W., Washington, D.C. 20006 at \$3.00 per copy. One can also request a free Catalog of EIA and JEDEC Standards and Engineering Publications at the same time.



THE HP-41C. A CALCULATOR. A SYSTEM. A WHOLE NEW STANDARD.

The HP-41C has more than any handheld calculator HP has ever offered. More capability. More ease-of-use features. And, never before offered, plug-in options, including Memory Modules, Card Reader, Printer, The Optical Wand, and Application Modules.

Truly, the HP-41C represents a new standard of design for all handheld calculators.

THE CALCULATOR

It features over 130 functions and offers up to 400 lines of program memory or 63 data storage registers—expandable to 319 registers or up to 2,000 lines. And for power, ease-of-use and efficiency—RPN Logic.

It communicates. The HP-41C's alphanumeric capability gives you error messages, operational prompts and function names in understandable words or abbreviations.

"Customize" it. Reassign any standard function, any programs you've written, or programs provided in the Application Modules—to any keyboard location you want. (Blank keyboard overlays let you notate these assignments.)

Continuous memory. Even when turned off, the HP-41C retains all your programs, data and key assignments.

Enhanced programmability. The alpha capability lets you label programs and prompt for proper inputs. The HP-41C also features: up to 6 levels of subroutines; 10 conditional, and 56 internal flags; specific loop control; indirect addressing; local and global branching.

THE SYSTEM.

Memory Modules. Can increase capacity to 319 registers or up to 2,000 lines of program memory.

"Extra smart" Card Reader. Lets you preserve programs, data and HP-41C organizational information on magnetic cards for use at a later date. Prompts for proper operation.

The Printer. Quiet, thermal operation. Prints all the HP-41C upper and lower case alpha characters, and lets you create your own special characters. Does high resolution plotting routines.

The Optical Wand. Enters bar encoded programs and/or data. The wand and all HP-41C software, in bar-coded form, available mid-1980.

Application Modules. A growing library of preprogrammed solutions to a wide range of problems: 16 plug-in Application Modules (available now or within 1980). Plus, 40 software solutions books and a User's Library with thousands of programs.

HP-41C Application Modules

Statistics	Surveying
Financial Decisions	Clinical Lab &
Circuit Analysis	Nuclear Medicine
Securities	Stress Analysis
Real Estate	Navigation
Aviation	Thermal &
Machine Design	Transport Science
Games	Structural Analysis
Mathematics	Home Management

A WHOLE NEW STANDARD.

HP-41C is a synthesis of the latest state-of-the-art technology and HP human engineering. It's powerful, easy-to-use and flexible enough to solve a multitude of problems. It comes complete with reference and training materials—and it's backed by a full range of software.

The HP-41C—no wonder it's a whole new standard in personal calculators. And at just \$295* for the handheld unit, it delivers unprecedented capability for the money.

For the address of your HP dealer, CALL TOLL-FREE 800-648-4711 except from Alaska or Hawaii. In Nevada, 800-992-5710. For details, send the attached coupon or write: Hewlett-Packard, 1000 N.E. Circle Blvd., Corvallis, OR 97330, Dept. 254Q.



HEWLETT PACKARD

HEWLETT-PACKARD

Dept. 254Q
1000 N.E. Circle Blvd.
Corvallis, OR 97330

Please send details on HP-41C.

NAME _____

TITLE _____

COMPANY _____

ADDRESS _____

CITY _____

STATE _____ ZIP _____

*Suggested retail price excluding applicable state and local taxes—Continental U.S.A., Alaska and Hawaii.

610/01

Better Than Any Pusher

**No matter how fine the fibers or how soft the “plush”
—everything other than the Discwasher system is a pusher.**

**Pushers only line up dirt and microdust into an even line of
contamination. Run your pusher off the record at a tangent—
and you spread these particles into a tangent line. And micro-
dust becomes permanently welded into vinyl by a tracking
stylus.**

**Only the Discwasher system has the patented micro-
tipped fibers which are directional—slanted—to pick
up, hold and thus remove particles from your discs.
These same directional fibers also remove fluid
and solubilized contaminants by capillary
action.**

**The superior record cleaner—
better than any pusher.**

 **discwasher[®], inc.**
1407 N. PROVIDENCE RD.
COLUMBIA, MISSOURI 65201

**Now Available with DC-1
Pad Cleaner at no extra charge.**