

# Popular Electronics®

WORLD'S LARGEST-SELLING ELECTRONICS MAGAZINE

AUGUST 1979/\$1.25

## New, Exciting Low-Cost Projects

- For Joggers: Electronic Pedometer
- For Motorists: Low-Fuel Warning Buzzer
- For Boating: Portable Gas-Leak Meter
- For Basements: Sump Pump Switch/Alarm

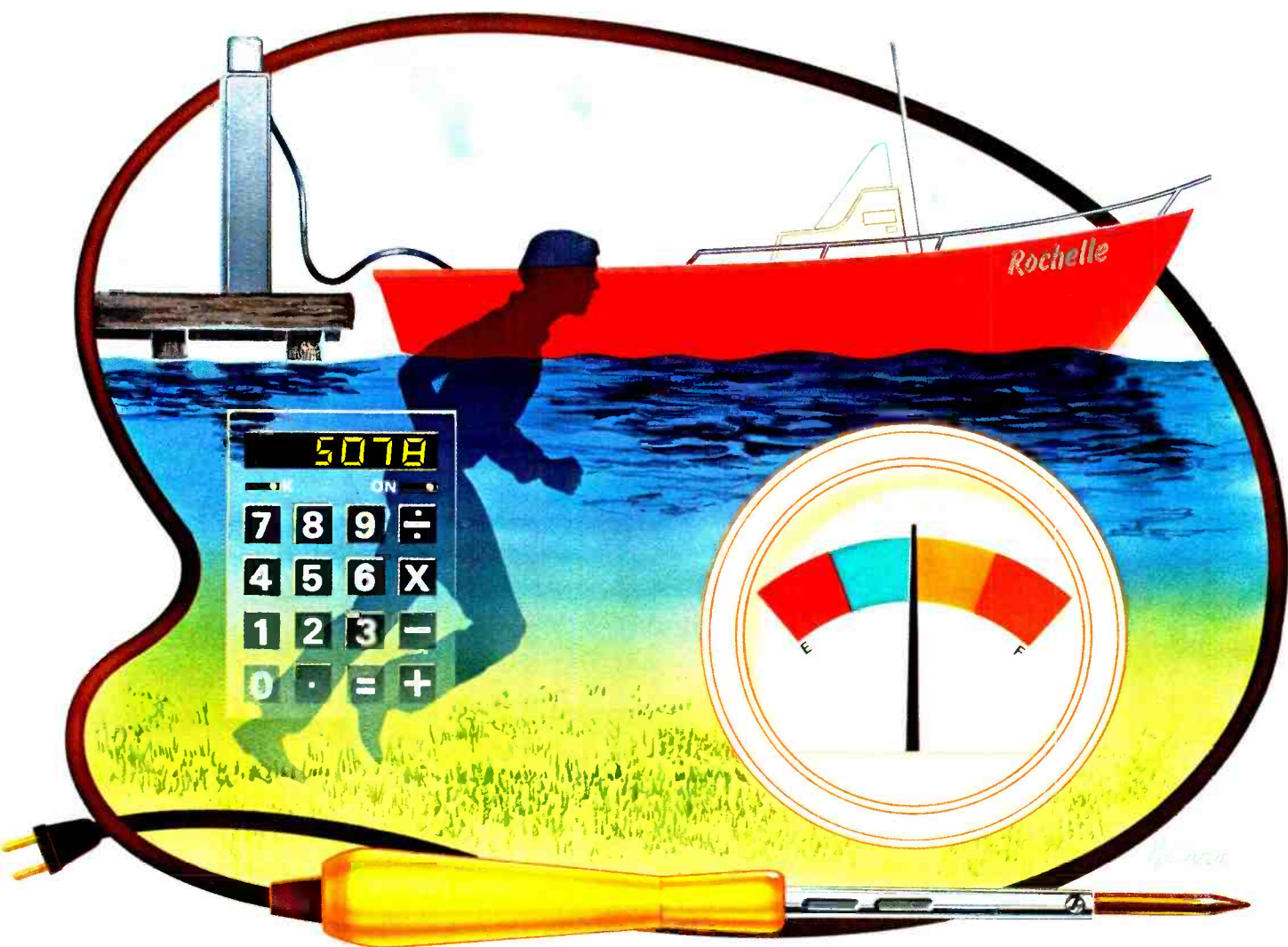

ST460 Speaker System  
HE Phono Cartridge  
r II Model 4 Personal Computer

660696 KRK B6122R99 6410 DEC79

# no loose ends

All-In-One: computer, floppy, I/O, 16K RAM. \$1595\*



## New Heathkit® H89 All-In-One Computer

Heath takes the risk out of selecting a balanced computer system. Now, video terminal, floppy, keyboard and 8-bit computer are brought together in one self-contained, compact unit. Nothing hangs out.

### Two Z80's

The personal computer has never been simpler. Or smarter. Two Z80 microprocessors mean terminal never shares power with computer, as do most desk-top units. So this terminal is capable of a multitude of high-speed functions, all controllable by keyboard or software.

\*\$1195 without floppy. Mail order kit price, F.O.B. Benton Harbor, MI. Also available at Heathkit Electronic Centers at slightly higher prices. Prices subject to change without notice.

### 102K bytes storage

Built-in floppy disk system gives you fast access to programs and data. Each 5¼-inch diskette has more than 102K bytes of storage area, enough to hold entire files. The All-In-One comes with 16K RAM, expandable to 48K.

### Hundreds of uses at home or work

The All-In-One Computer runs programs written in MICROSOFT™ BASIC and ASSEMBLER Languages. And it accepts all current software written for the popular Heathkit H8 computer. You can choose from scores of practical programs for home and business.

### Learn by building

What better way to learn about computers than to build one yourself? The All-In-One is available in easy-to-build kit form, as well as completely assembled. Like all Heath electronic kits, it comes to you with its own easy-to-follow assembly manual and a nationwide network of service centers to assure smooth sailing.

### FREE CATALOG



For complete details on the Heathkit H89 All-In-One Computer and nearly 400 other electronic kits for your home, work or pleasure, send today for the latest Heathkit Catalog of values.

# Heathkit®

HEATH COMPANY, DEPT. 010-560, BENTON HARBOR, MI 49022

CIRCLE NO. 5 ON FREE INFORMATION CARD

CP-165



# No-Fault Radar

*If you've ever been caught by radar or if you own a radar detector, please read this important message.*

JS&A has never offered a radar detector.

As our president put it, "A radar detector is a flagrant anti-police device that does nothing but permit abuse of our traffic laws."

Although many devices were presented to JS&A, none were acceptable. Despite all of our efforts, our president stood firm. "Our company will not, under any circumstances, sell radar detectors."

For three years we saw radar detectors—some good, some bad—but because of our president's policy, we were unable to offer a single unit. We saw the units go to both X and K bands; we saw the police develop radar jamming devices; and we saw the FCC prohibit these jamming devices. We followed with great envy as other companies sold thousands of them while JS&A stood firm on its decision not to sell them.

In January of 1979, our president was traveling on an interstate highway at 55 miles per hour. Other cars were passing him.

As he approached the top of a hill, he neglected to pay attention to his speedometer. As he rolled down the hill his speed increased to 63 MPH. At the bottom of the hill was a police radar trap.

He was apprehended and charged with exceeding the speed limit by eight miles per hour. He was taken to a Justice of the Peace who was in the barber shop, so our president had to wait until he finished. Finally there was a quick trial and a fine was paid.

Our president was four hours late. He felt that he was treated like a common criminal despite his good driving record and he lost very valuable time.

## ATTITUDE CHANGES

This small incident created an entire change in his attitude. Our president saw for the first time that even law-abiding citizens are subject to the inequities of radar justice. He saw that the law-abiding citizen must also be protected from the abuses of radar power when unfairly used.

And when he studied the entire situation, our president realized something very frightening for all motorists. Many police departments have quotas imposed on them to realize either federal or state funds. They must issue a

certain amount of tickets to qualify. With more and more motorists using radar detectors and CB's, police must strictly enforce speed limits to reach their quotas. Now, even law-abiding motorists, who might make a slight mistake, are more vulnerable to speeding violations.

## NEW MEMORANDUM

In a recent memorandum our president stated, "Due to the changing nature of police radar, JS&A may offer radar detectors as part of its program if presented within the quality image of our company and if the product represents a truly unique radar detector product."

With the green light to find a radar detector, our product selection group was prepared. They had brochures from practically every manufacturer in the world. And they eventually selected what even our president thought was the most professional and well-designed unit available.

## HIDDEN ANTENNA

Manufactured by a company called Chicago Radar, the unit consists of two parts—one that is hidden behind your grill, and the other under your dash. There's nothing on top of your dash board to indicate that you've got a radar detector and the system is difficult for anybody to steal. The unit under your dash is attached with a self-adhesive Velcro material so there's no screws or installation to worry about.

The control unit has two lights—one to indicate that the unit is on, and the other to indicate that your car is under radar surveillance. There is also an audible alarm that will sound. But at night, when the light is all that you need, you can switch off the audible sound.

The control unit plugs into your cigarette lighter. The radar antenna is placed behind your grill. Just pull into any service station and the mechanic can easily install the entire system. The Velcro material and mounting brackets are all provided.

## AMPLIFIED SENSING

The antenna is one of the keys to the unit's high performance. Instead of the square-shaped dish antennas, the Chicago Radar version is a round cylinder. It tends to sense the radar signals sooner and around curves and hills because of its unique design.

The unit responds to both police radar bands X and K and uses all solid-state computer technology in its design.

We urge you to test our selection of what we feel to be the nation's finest radar detector. Order one from JS&A. When you receive it, drive to your nearest service station or CB dealer and have them install your unit. The antenna installs with just a few brackets and the control unit attaches under your dash with the Velcro material.

Then use it for 30 days. During that time, count the number of radar traps you encounter. On the 30th day, turn off your unit as you travel. See how naked and unprotected you feel.

## 40 DAYS PROOF

If for any reason you are not completely satisfied, just return your unit within our 40-day trial period and we'll gladly send you a prompt and courteous refund.

To order your system, send **\$179.95** plus \$3.00 for postage and handling to the address shown below. (Illinois residents, please add 5% sales tax.) Credit card buyers may call our toll-free number below. By return mail, you'll receive the complete system, all cables, Velcro material, instructions and a 90-day limited warranty.

The patented unit is precision crafted by Chicago Radar—one of the most respected names in radar detection systems. JS&A is America's largest single source of space-age products—further assurance that your modest investment is well protected.

We firmly support our police departments and their efforts, but if they are encouraged to use radar to maintain quotas, the law abiding consumer has no choice but to protect himself. Start today. Order your unit now at no obligation.

**JS&A** PRODUCTS  
THAT THINK®

Dept. PE One JS&A Plaza  
Northbrook, Ill. 60062 (312) 564-7000  
Call TOLL-FREE ..... 800 323-6400  
In Illinois Call ..... (312) 564-7000  
© JS&A Group, Inc., 1979

# ANNOUNCING AMERICA'S ONLY LAND, SEA AND AIR SCANNER.

*Only the incredible, new, no-crystal Bearcat 220 Scanner tunes in all the real excitement of the entire AM aircraft band—plus every FM public service frequency—with pushbutton ease.*



Now. Tune in all the real excitement of the wild blue yonder, at the touch of a button.

The new, no-crystal Bearcat 220 Scanner searches and tunes in the entire aircraft band. Jets at 30,000 feet. All the tense tower talk. Everything is pre-programmed in space-age memory banks.

Only the 7-band Bearcat 220 Scanner also brings home every public service frequency, too. Pre-programmed Marine frequencies. Police action. Fire calls. Weather warnings. You name it.

The new Bearcat 220 has all the features and quality Bearcat Scanners are famous for. Track tuning. Decimal display readout. Automatic Search. Selective Scan Display. Automatic squelch and lockout. Priority. And much, much more.

After all, Bearcat invented Scanning. And we'll stop at nothing to bring you all the excitement—of land, sea, and air.

## BEARCAT® 220 SCANNER

*Follow the leader to real excitement.*

Electra Copyright 1979 Electra Company • Division of Masco Corp. of Indiana • 300 East County Line Road, Cumberland, Indiana 46229

CIRCLE NO. 20 ON FREE INFORMATION CARD

POPULAR ELECTRONICS

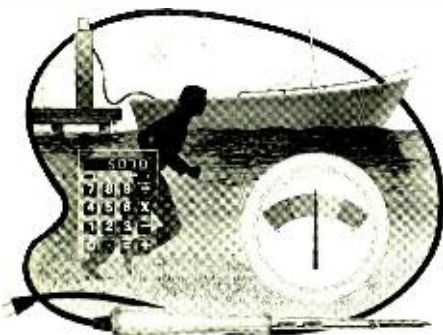

About the cover:

A soldering iron and a few inexpensive parts can be used to make some especially useful devices to add safety and convenience to your lives.

Cover Art by George Kelvin

## Feature Articles

- SCANNER BEAM PINPOINTS THE ACTION!** / Robert Graye \_\_\_\_\_ 44  
*Make-it-yourself antenna for improved reception of public service bands.*
- SIMPLE TRS-80 PROGRAMS SOLVE ELECTRONICS CALCULATIONS** / Roy Babylon \_\_\_\_\_ 47  
*BASIC program for Ohm's law, resonance and inductive formulas.*
- THE ART OF EQUALIZATION** / Ethan Winer \_\_\_\_\_ 49  
*An expert tells how to achieve that special recorded "sound."*

## Construction Articles

- FOUR LOW-COST PROJECTS FOR YOUR FAMILY'S CONVENIENCE & SAFETY**
- SOLID-STATE LEVEL-SENSING SWITCH FOR SUMP PUMPS** / Philip Windolph \_\_\_\_\_ 31
- VEHICLE LOW-FUEL INDICATOR** / Bradley Albing \_\_\_\_\_ 34
- PORTABLE GAS LEAK METER** / Cass Lewart \_\_\_\_\_ 41
- ELECTRONIC PODEMETER FOR JOGGERS** / Andrew A. Modla \_\_\_\_\_ 42
- BUILD A SPEAKER PROTECTION CIRCUIT** / Mike Rogalski \_\_\_\_\_ 54
- SPACE-AGE ELECTRONIC PROJECTS FOR BOATS, Part 2** / Harold Wright \_\_\_\_\_ 55  
*How to build bilge alarms, a tachometer, and protection circuits.*

## Columns

- STEREO SCENE** / Ralph Hodges \_\_\_\_\_ 20  
*Recording as Nature Intended.*
- EXPERIMENTER'S CORNER** / Forrest M. Mims \_\_\_\_\_ 60  
*IC Interval Timers.*
- HOBBY SCENE** / John J. McVeigh \_\_\_\_\_ 66
- DX LISTENING** / Glenn Hauser \_\_\_\_\_ 70  
*WARC-79*
- SOFTWARE SOURCES** / Leslie Solomon \_\_\_\_\_ 73
- COMPUTER BITS** / Leslie Solomon \_\_\_\_\_ 74  
*Windows in the CRT.*
- PROJECT OF THE MONTH** / Forrest M. Mims \_\_\_\_\_ 78  
*A "Matchbox" LED Oscilloscope.*

## Julian Hirsch Audio Reports

- FISHER MODEL ST460 SPEAKER SYSTEM** \_\_\_\_\_ 23
- SHURE M95HE STEREO PHONO CARTRIDGE** \_\_\_\_\_ 24
- LECTROTECH MODEL PPI-400** \_\_\_\_\_ 25

## Electronic Product Test Report

- COMPUCOLOR II MODEL 4 PERSONAL COMPUTER SYSTEM** \_\_\_\_\_ 67

## Departments

- EDITORIAL** / Art Salsberg \_\_\_\_\_ 4  
*The TV Piggybacking Furor.*
- LETTERS** \_\_\_\_\_ 6
- NEW PRODUCTS** \_\_\_\_\_ 8
- NEW LITERATURE** \_\_\_\_\_ 15
- OPERATION ASSIST** \_\_\_\_\_ 94
- ADVERTISERS INDEX** \_\_\_\_\_ 97
- PERSONAL ELECTRONICS NEWS** \_\_\_\_\_ 98

POPULAR ELECTRONICS (ISSN 0032-4485). Published monthly by Ziff-Davis Publishing Company, at One Park Avenue, New York, NY 10016. Philip B. Korsant, President, Selwyn Taubman, Treasurer, Philip Sine, Secretary. One year subscription, U.S. and Possessions, \$13.00, Canada, \$16.00, all other countries, \$18.00, cash orders only, payable in U.S. currency. COPYRIGHT © BY ZIFF-DAVIS PUBLISHING COMPANY. ALL RIGHTS RESERVED

**JOSEPH E. MESICS**  
*Publisher*

**ARTHUR P. SALSBERG**  
*Editorial Director*

**LESLIE SOLOMON**  
*Technical Director*

**JOHN J. McVEIGH**  
*Technical Editor*

**JOHN R. RIGGS**  
*Managing Editor*

**HAROLD A. RODGERS**  
*Senior Editor*

**ALEXANDER W. BURAWA**  
*Features Editor*

**EDWARD I. BUXBAUM**  
*Art Director*

**ANDRE DUZANT**  
*Technical Illustrator*

**CARMEN VELAZQUEZ**  
*Production Editor*

*Contributing Editors*  
**Hal Chamberlin, Lou Garner, Glenn Hauser**  
**Julian Hirsch, Ralph Hodges, Forrest Mims**

**JEFF NEWMAN**  
*Assistant to the Editor*

**LINDA BLUM**  
*Advertising Service Manager*

**MARIE MAESTRI**  
*Executive Assistant*

**EDGAR W. HOPPER**  
*Publishing Director*

ZIFF-DAVIS PUBLISHING COMPANY  
Editorial and Executive Offices  
One Park Avenue, New York, New York 10016  
212-725-3500

Joseph E. Mesics (725-3568)  
John J. Corton (725-3578)  
Bonnie B. Kaiser (725-3580)

Midwestern Office  
Suite 1400, 180 N. Michigan Ave.  
Chicago, IL 60601 (312-346-2600)

Western Office  
9025 Wilshire Boulevard, Beverly Hills, CA 90211  
213-273-8050.

Western Representative, Norm Schindler  
7050 Owensmouth Ave. #209  
Canoga Park, CA 91303 (213-999-1414)

Japan, James Yagi, Oji Palace Aoyama,  
6-25 Minami Aoyama, 6 Chome, Minato-Ku,  
Tokyo, 407-1930/6821 582-2851

ZIFF-DAVIS PUBLISHING COMPANY  
Philip B. Korsant, President  
Furman Hebb, Executive Vice President  
Phillip T. Helfferan, Sr. Vice President  
Edward D. Muhlfeld, Sr. Vice President  
Philip Sine, Sr. Vice President, Secretary  
Lawrence Sporn, Sr. Vice President, Circulation and Marketing  
Bard Davis, Vice President, Production  
George Morrissey, Vice President  
Sydney H. Rogers, Vice President  
Sidney Holtz, Vice President  
Albert S. Traina, Vice President  
Paul H. Chook, Vice President  
Edgar W. Hopper, Vice President  
Robert N. Bavler, Jr., Vice President  
Selwyn Taubman, Treasurer  
  
W. Bradford Briggs, Vice Chairman

ZIFF CORPORATION  
William Ziff, Chairman  
I. Martin Pompadur, President  
Hershel B. Sarbin, Executive Vice President

POPULAR ELECTRONICS August 1979, Volume 16 Number 2. Published monthly at One Park Avenue, New York, NY 10016. One year subscription rate for U.S. and Possessions \$13.00, Canada, \$16.00, all other countries, \$18.00 (cash orders only, payable in U.S. currency). Second Class postage paid at New York, NY and at additional mailing offices. Authorized as second class mail by the Post Office Department, Ottawa, Canada, and for payment of postage in cash.

POPULAR ELECTRONICS including ELECTRONICS WORLD, Trade Mark Registered. Indexed in the Reader's Guide to Periodical Literature.

COPYRIGHT © 1979 BY ZIFF-DAVIS PUBLISHING COMPANY. ALL RIGHTS RESERVED.

Ziff-Davis also publishes Boating, Car and Driver, Cycle, Flying, Popular Photography, Skiing, Stereo Review, Electronic Experimenter's Handbook, Tape Recording & Buying Guide, Stereo Directory & Buying Guide, and Communications Handbook.

Material in this publication may not be reproduced in any form without permission. Requests for permission should be directed to Jerry Schneider, Rights and Permissions, Ziff-Davis Publishing Co., One Park Ave., New York, NY 10016.

**Editorial correspondence:** POPULAR ELECTRONICS, 1 Park Ave., New York, NY 10016. Editorial contributions must be accompanied by return postage and will be handled with reasonable care, however, publisher assumes no responsibility for return or safety of manuscripts, art work, or models.

**Forms 3579 and all subscription correspondence:** POPULAR ELECTRONICS, Circulation Dept., P.O. Box 2774, Boulder, CO 80302. Please allow at least eight weeks for change of address. Include your old address, enclosing, if possible, an address label from a recent issue.

The publisher has no knowledge of any proprietary rights which will be violated by the making or using of any items disclosed in this issue.



Member Audit Bureau  
of Circulations



## Editorial

### THE TV PIGGYBACKING FUROR

In what appears to be a David vs. Goliath contest, Texas Instruments, with inspirational support from RCA, is attempting to have rules on Class I devices for TV amended to include a Class II category. This would permit legal sale of stand-alone r-f modulators to be used for computers and peripherals. Such a change in the present interface rule that requires r-f modulators to be FCC type approved together with signal-source equipment is vociferously opposed by Radio Shack, Apple, Commodore, and Interact, among personal computer makers.

TI says, essentially, that it's unfair to make a buyer purchase a video monitor when he could just as easily use an existing TV receiver if only the FCC would OK the use of separate r-f modulators. Other computer makers, who are already marketing personal computers, cry "foul," saying, in a nutshell, that such approval would give TI an unfair marketing advantage. Moreover, they point out that this would also cause increased interference with radio and TV reception.

TI also requested a temporary permit to go ahead with the separate r-f modulator concept while the FCC's bureaucratic wheels turn ever so slowly to reply to the company's initial request for changing the rules. (Note: the FCC has yet to act on a similar request by RCA made about two years ago.) The National Association of Broadcasters (NAB) observes that this second request amounts to trying to solve a private marketplace problem by changing the rules.

With the foregoing as background, let's examine the pro's and con's of the rules change proposal. [I'll ignore the waiver request entirely because (1) it indeed gives a company not yet in the field an unfair advantage and (2) since the Part 15 radiation standards are under active review, it's possible that the "temporary" r-f modulators will not be in line with new standards.]

From a typical consumer's viewpoint, using a separate modulator to connect a computer to one's own TV receiver would likely appear to be an ideal opportunity to save substantial monies. Given the fact that computers are great noise generators, however, it is possible that interference within the household and on nearby neighbors' receivers would be objectionable. Furthermore, using a home TV receiver as information display equipment results in lowered video quality under the best of circumstances when compared to video monitors.

Nevertheless, the possibility of employing a legalized separate r-f modulator is an appealing one, and should be pursued. I firmly believe, though, that the FCC should not rush into making a positive decision on this without setting signal radiation standards that we can live with in the future. On the other hand, it's unfair to penalize manufacturers by the foot-dragging procedures practiced by the FCC.

RCA, by the way, has pointed out that the TI request for an r-f modulator physically separated from computers is not the same as its petition for a rules change that relates to all-in-one-package video disk and tape machines. So the company suggests *three* classifications: the present Class I TV devices that require type approval, a second classification for built-in r-f modulators, and a third for stand-alone modulators. (How come RCA and other TV makers don't incorporate video jacks in their TV receivers, which would make these rules change requests moot?)

Since this is written in May, I hopefully will learn more about all this at the Consumer Electronics Show in Chicago in June.

*Art Salsberg*

# Don't take our word for it.

"We can heartily recommend the Superboard II computer system for the beginner who wants to get into microcomputers with a minimum of cost. Moreover, this is a 'real' computer with full expandability."

*Popular Electronics March, 1979*

"(Their) new Challenger 1P weighs in at \$279 and provides a remarkable amount of computing for this incredible price."

*Kilobaud Microcomputing February, 1979*

"Over the past four years we have taken delivery on over 25 computer systems. Only two have worked totally glitch free and without adjustment as they came out of the carton: The Tektronic 4051 (at \$7,000 the most expensive computer we tested) and the Ohio Scientific Superboard II (at \$279 the least expensive) . . . The Superboard II and companion C1P deserve your serious consideration."

*Creative Computing January, 1979*

"The Superboard II and its fully dressed companion the Challenger 1P series incorporate all the fundamental necessities of a personal computer at a very attractive price. With the expansion capabilities provided, this series becomes a very formidable competitor in the home computer area."

*Interface Age April, 1979*

"The graphics available permit some really dramatic effects and are relatively simple to program . . . The fact that the system can be easily expanded to include a floppy means that while you are starting out with a low-cost minimal system, you don't have to throw it away when you are ready to go on to more complex computer functions. Everything is there that you need; you simply build on to what you already have. You don't have to worry about trading off existing equipment to get the system that will really do what you want it to do. At \$279, Superboard II is a tough act to follow."

*Radio Electronics June, 1979*

"The Superboard II is an excellent choice for the personal computer enthusiast on a budget."

*Byte May, 1979*

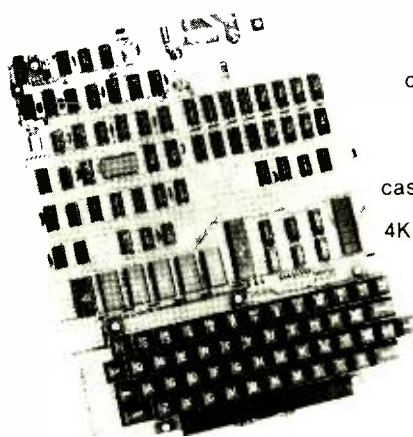

## **SUPERBOARD II** **\$279.00**

The world's first complete computer system on a board including full keyboard, video display, audio cassette interface, 8K BASIC-in-ROM and 4K RAM. Expandable. Requires +5V at 3 amp power supply.



## **C1P \$349.00**

Complete with enclosure and power supply. All features of Superboard II. Easy to expand to more memory and floppy disk.

## **C1P MF \$995.00**

The first floppy disk based computer system the world has ever seen for under \$1,000. 8K BASIC-in-ROM, 12K RAM. Expandable to 32K RAM.



# **OHIO SCIENTIFIC**

1333 S. CHILLICOTHE RD., AURORA, OHIO 44202 (216) 562-3101

See your Ohio Scientific dealer for full details.

CIRCLE NO. 41 ON FREE INFORMATION CARD

# McIntosh

"A Technological Masterpiece..."



McIntosh C 32

"More Than a Preamplifier"

McIntosh has received peerless acclaim from prominent product testing laboratories and outstanding international recognition! You can learn why the "more than a preamplifier" C 32 has been selected for these unique honors.

Send us your name and address and we'll send you the complete product reviews and data on all McIntosh products, copies of the international awards, and a North American FM directory. You will understand why McIntosh product research and development always has the appearance and technological look to the future.

Keep up to date.  
Send now - - -

McIntosh Laboratory Inc.  
Box 96 East Side Station  
Binghamton, NY 13904

Name \_\_\_\_\_

Address \_\_\_\_\_

City \_\_\_\_\_ State \_\_\_\_\_ Zip \_\_\_\_\_

If you are in a hurry for your catalog please send the coupon to McIntosh. For non-rush service send the Reader Service Card to the magazine.

CIRCLE NO. 35 ON FREE INFORMATION CARD

## Letters

### SOLENOID THAT ISN'T

We at Eumig thank POPULAR ELECTRONICS for the fine review regarding our Metropolitan CCD cassette deck in the May 1979 issue. We did, however, note an error regarding the deck's transport in the "User Comment" section: "The solenoid-operated transport is astonishingly silent. We heard none of the thumps or clunks usually associated with solenoid operation." You then go on to state that there is a "motor" sound instead of a solenoid sound.

As a point of information, the reason solenoids are not heard is that there are no solenoids. The motor sound is heard because the head mounting assembly is step-motor engaged, using the same motor that governs fast forward and rewind. —Tom Bensen, Eumig (U.S.A.) Inc., Great Neck, NY

### MAKING A BETTER WINDOW?

The window comparator circuit shown above has fewer parts and has better input protection than that shown in Fig. 5 of the May

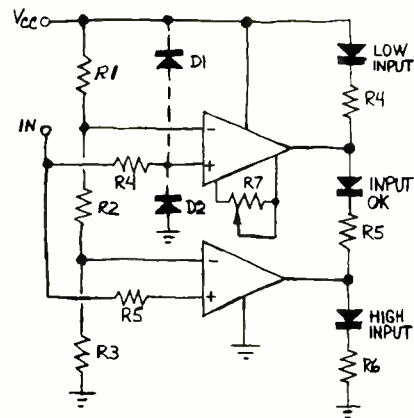

1979 "Experimenter's Corner." Resistors  $R1$ ,  $R2$ , and  $R3$  form the reference voltage source with the upper limit defined by  $V_{CC}/(R2 + R3)/(R1 + R2 + R3)$  and the lower limit defined by  $V_{CC}R3/(R1 + R2 + R3)$ . For small windows,  $R2$  determines the window opening. For very small windows, on the order of 0 to 15 mV,  $R2$  can be eliminated and the opening can be adjusted via  $R7$ . Resistors  $R4$  and  $R5$  protect the inputs from excessive current during accidental inputs exceeding  $V_{CC}$  or ground. Diode limiting can be added from the inputs to  $V_{CC}$  and ground, using  $D1$  and  $D2$ .

System stability is a function of  $V_{CC}$  stability and op-amp drifts. For 741s and 747s,  $V_{CC}$  should be between 8 and 30 volts. FET-input op-amps lend themselves well to this application. Resistors  $R4$ ,  $R5$ , and  $R6$  limit LED current and should be chosen to allow about 10 mA. —Glenn Fasnacht, Lakewood, OH.

### MOPED TURN INDICATORS

Many thanks for "Solid-State Turn Indicators for Mopeds" (May 1979). The article was clearly written. The project will almost certainly prevent accidents because blinking lights are easier to see and interpret. Also, the project is small enough to easily mount on all mopeds. —Bill Saehler, Minnesota City, MN.

While looking over the moped turn-indicator article, I noticed that  $D4$  and  $C3$  are not switched out of the power circuit by  $S1$ . While this is not particularly important when the de-

vice is connected to a moped generator, if a battery is used, as suggested in the article, it would quickly discharge to the zener voltage. To obviate this, I would rewire the circuit as shown below.

Note, too, that by substituting a dpdt (center-off) switch for  $S1$  several advantages arise. Diodes  $D3$  and  $D4$  are eliminated, light assemblies do not have to be insulated from the frame, and return wiring from the lamps to the switch is not required. —Roy F. Gordon, Hampton, VA.

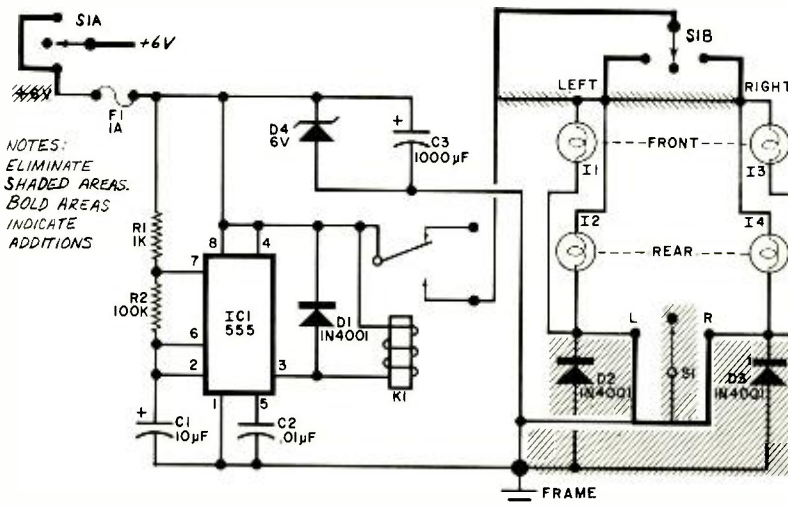

NOTES:  
ELIMINATE  
SHADED AREAS.  
BOLD AREAS  
INDICATE  
ADDITIONS



# Introducing the Troubleshooter.

Six functions and 24 ranges for \$129\* make the jump from Analog to Digital more affordable than ever.

We call our new hand-held 8022A DMM the Troubleshooter. It combines the basic performance features you want with all the advantages that give digital DMM's the edge over analog—0.25% basic dc accuracy, a rugged, reliable design, a razor sharp 3½-digit LCD readout, small size and light weight.

**Measure for measure you won't find a better value.** Six functions—high and low ohms, ac and dc voltage and current (24 ranges in all) make the Troubleshooter a 13 ounce (0.37 kg) package of excellent measurement value. This kind of value wasn't possible until our custom CMOS LSI single chip design made hand-held DMM's an affordable reality and Fluke the industry leader.

**Here's something new that won't shock you.** Fluke's exclusive probe design features finger guards on the probe and shrouded connections to discourage accidental contact with circuit voltages.

**You won't find a more rugged or reliable hand-held DMM.** There's a lot more to building a high-quality hand-held DMM than you might suspect. The case has to survive bumps, scrapes, and scuffs. The LCD readout must withstand the extremes of humid-

\*U.S. Price Only



ity, temperature, and vibration. Function switches need to perform reliably through thousands of cycles. And electrical circuitry must survive both physical shock and electrical overloads.

We built the 8022A to withstand all these tortures—with a rugged impact resistant plastic case, a custom LCD display, reliable push-buttons instead of rotary switches and over 20% of the components devoted to overload protection.

**Take the next step.** Contact the Fluke office, representative or authorized distributor in your area. In the U.S., CALL TOLL FREE (800) 426-0361. (For resi-

dents in Alaska, Hawaii, and Washington, the number is (206) 774-2481.)

In Europe, contact: Fluke (Nederland) B.V., P.O. Box 5053, Tilburg, The Netherlands. Telephone (013) 673973. Telex 52237.

Ask about the new 8022A. And while you're at it, check into the 8020A Analyst, the improved version of our \$169\* DMM. It boasts Fluke's exclusive conductance capability for high resistance measurements and 0.1% measurement accuracy.

Both instruments are available at your distributor from stock.

For immediate response, fill out the attached coupon.

**FLUKE**®

CIRCLE NO. 21 ON FREE INFORMATION CARD

John Fluke Mfg. Co., Inc.  
P.O. Box 43210  
Mountlake Terrace, WA 98043

- Please send 8022A Troubleshooter data.
- Please send the 8020A Analyst specs.
- Please have a salesman call.

Name \_\_\_\_\_

Title \_\_\_\_\_ Mail Stop \_\_\_\_\_

Company \_\_\_\_\_

Address \_\_\_\_\_

City \_\_\_\_\_ State \_\_\_\_\_ Zip \_\_\_\_\_

Telephone ( ) \_\_\_\_\_ Ext. \_\_\_\_\_

PF 8/79

**NEW MARK III**  
9 Steps 4 Colors  
**LED VU**



Stereo level indicator kit with arc-shape display panel!! This Mark III LED level indicator is a new design PC board with an arc-shape 4 colors LED display (change color from red, yellow, green and the peak output indicated by rose red). The power range is very large, from -30dB to +5dB. The Mark III indicator is applicable to 1 watt - 200 watts amplifier operating voltage is 3V - 9V DC at max 400 MA. The circuit uses 10 LEDs per channel. It is very easy to connect to the amplifier. Just hook up with the speaker output!

**IN KIT FORM \$18.50**

**60W + 60W**  
**STEREO AMPLIFIER**



**COMPLETED UNIT—NOT A KIT!**

OCL pre amp. & power stereo amp. with bass, middle, treble 3-way tone control. Fully assembled and tested, ready to work. Total harmonic distortion less than 0.5% at full power. Output maximum is 60 watts per channel at 8Ω. Power supply is 24 - 36V AC or DC. Complete unit

Assembled \$49.50 ea.

Power transformer

\$ 8.50 ea.

**5W AUDIO AMP KIT**

2 LM 380 with Volume Control  
Power Supply 6 ~ 18V DC

**ONLY \$6.00 EACH**

**100W CLASS A POWER AMP KIT**

Dynamic Bias Class "A" circuit design makes this unit unique in its class. Crystal clear, 100 watts power output will satisfy the most picky fans. A perfect combination with the TA-1020 low T.I.M. stereo pre-amp. Specifications: \*Output power: 100W RMS into 8-ohm/125W RMS into 4-ohm \*Frequency response: 10Hz-100KHz \*T.H.D.: less than 0.008% \*S/N ratio: better than 80dB \*Input sensitivity: 1V max.

\*Power supply:  
±40V @ 5 amp.  
TA-1000 KIT  
\$51.95

Power transformer  
\$15.00 each



**LOW TIM DC STEREO PRE-AMP KIT TA-10-20**

Incorporates brand-new D.C. design that gives a frequency response from 0Hz-100KHz ±0.5dB! Added features like tone defeat and loudness control let you tailor your own frequency response. Independent I.C. regulated power supplies to eliminate power fluctuation! Specifications: \*THD less than .005% \*T.I.M. less than .005% \*Frequency response: DC to 100KHz ±0.5dB \*RIAA deviation: ±0.2dB \*S/N ratio: better than 70dB \*Sensitivity: Phono 2MV 47K/Aux. 100MV 100K \*Output level: 1.3V \*Max output:

15V \*Tone control: bass +10dB @ 50Hz/treble +10dB @ 15Hz \*Power supply: ±24 D.C. @ 0.5A  
Kit comes with regulated power supply, all you need is a 48V C.T. transformer @ 0.5A

**ONLY \$44.50**  
X'former \$4.50



**WE SELL ALL KINDS OF**  
**ELECTRONIC PARTS & KITS**

**PLEASE SEND \$2.00**  
**FOR DETAIL CATALOGUE**

**YOU MAY FIND OUR 2-PAGE AD**  
**IN EVERY ISSUE OF**  
**RADIO ELECTRONICS**

**RETAIL STORE OPEN TO PUBLIC**  
**MONDAY THRU SATURDAY**  
**10 a.m. - 7 p.m.**

**FORMULA INTERNATIONAL INC.**  
12503 CRENSHAW BOULEVARD  
HAWTHORNE, CA 90250  
(213) 679-5162 or (213) 973-1921

All items subject to prior sale.  
Prices subject to change without notice.

CIRCLE NO. 23 ON FREE INFORMATION CARD



# New Products

Additional information on new products covered in this section is available from the manufacturers. Either circle the item's code number on the Free Information Card or write to the manufacturer at the address given.

## KEF Model 101 Loudspeaker

The Model 101 loudspeaker by KEF Electronics has a total volume of only 0.25 cu. ft. and is designed for bookshelf placement. A computer is used to match the two

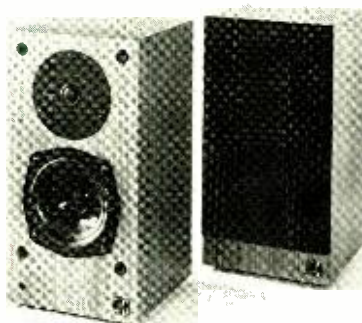

drivers—a 25-mm (1") tweeter and a 110-mm (4 1/4") woofer—and the crossover network as well. The speaker is rated to accept the output of an amplifier up to 100 watts and has an automatic protection system to prevent overdriving. Maximum output level is said to be 98 dB SPL. Sold in matched pairs with teak or walnut finish and a brown fabric grille.

CIRCLE NO. 88 ON FREE INFORMATION CARD

## Low-Cost µC Printer

Radio Shack has introduced an inexpensive printer that produces low-cost hard copy on 2 1/4" (60.3-cm) wide aluminum-coated paper. The TRS-80 Quick Printer II

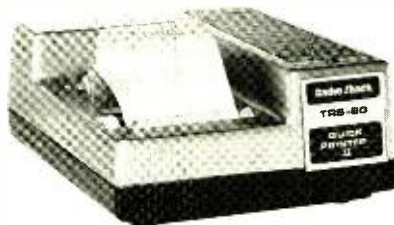

prints upper- and lower-case, double-size, and double-spaced characters to allow special effects such as titling pages and printing headings. Automatic "wrap-around" prevents data loss due to overflow when text exceeds maximum line length. Printer software is selectable for 16 or 32 characters/line and produces 120 lines/minute (64 characters/second). The 96-character, 5 × 7 dot-matrix characters are a modified ASCII subset. Vertical spacing is 6 lines/inch. All 32 ASCII codes can be produced, as well as codes for the printed characters. Although designed for use with Radio Shack's Level II TRS-80 systems, the printer can also be used with other computers. Measures 9 1/4"W × 6 3/4"D × 3 5/16"H. \$219.00.

CIRCLE NO. 89 ON FREE INFORMATION CARD

## Digital Capacitance Meter

A new digital capacitance meter has been introduced by Data Precision Corp. The 3 1/2-digit Model 938 has a rated measuring range of 0.1 pF to 1999 µF in eight switchable ranges, with a basic accuracy of 0.1%. Range selection is via pushbutton switches handily located along the left side of the case. A zero-adjust control with a ±20 pF range is provided for compensat-



ing for stray capacitance of test leads. Measurements appear on a 0.5" (12.7-mm) high liquid crystal display. An internal fuse prevents instrument damage from charged capacitors and should the test leads be inadvertently connected across a voltage source. Uses a single 9-volt alkaline battery. \$149.00

CIRCLE NO. 91 ON FREE INFORMATION CARD

## AM/SSB Mobile CB Transceiver

The Model 7001 is the most precise AM/SSB CB mobile transceiver in Midland's Precision Series. It features: RF Attenuator switch; RF GAIN, CLARIFIER, SQUELCH, and MIC GAIN controls; LED transmit/receive (TX/RX) indicator; DIM, CB/PA, LSB/AM/USB mode selector, NB & ANL, and TONE switches. A two-digit, green seven-

(Continued on page 12)

# PULSEMAKER

**It's a digital signal injector.  
And it thinks for itself.**

It may look like a logic probe... but our DP-1 Digital Pulser is a lot more unique. This handheld, circuit-powered instrument is actually a miniature pulse generator built to speed digital troubleshooting.

Touch it to a circuit, and DP-1 automatically senses the logic state. So when you push the button, out comes one perfect pulse—preset to the logic family you're working with—of the proper polarity to force the state the other way. Hold the button down for a second and it starts injecting a 100pps pulse train. With all the punch you need—up to 100 mA.

Think what a help that can be when your logic circuit is doing something illogical. (And just in case you do something illogical, we've included reverse-polarity and short-circuit protection, as well.)

It's smart to save time with a DP-1. At \$74.95\*, it's a smart buy, too.

**Smarter tools for testing  
and design.**

CONTINENTAL SPECIALTIES CORPORATION



70 Fulton Terrace, New Haven, CT 06509 (203) 624-3103, TWX 710-465-1227  
OTHER OFFICES: San Francisco (415) 421-8872, TWX 910-372-7992  
Europe: CSC UK LTD. Phone Seffron-Walder 0799-21682, TLX 817477  
Canada: Ben Finkler Ltd., Ontario

Call toll-free for details **1-800-243-6077**

\*Suggested US resale. Available at selected local distributors.  
Prices, specifications subject to change without notice.  
© 1979 Continental Specialties Corporation  
CIRCLE NO. 13 ON FREE INFORMATION CARD

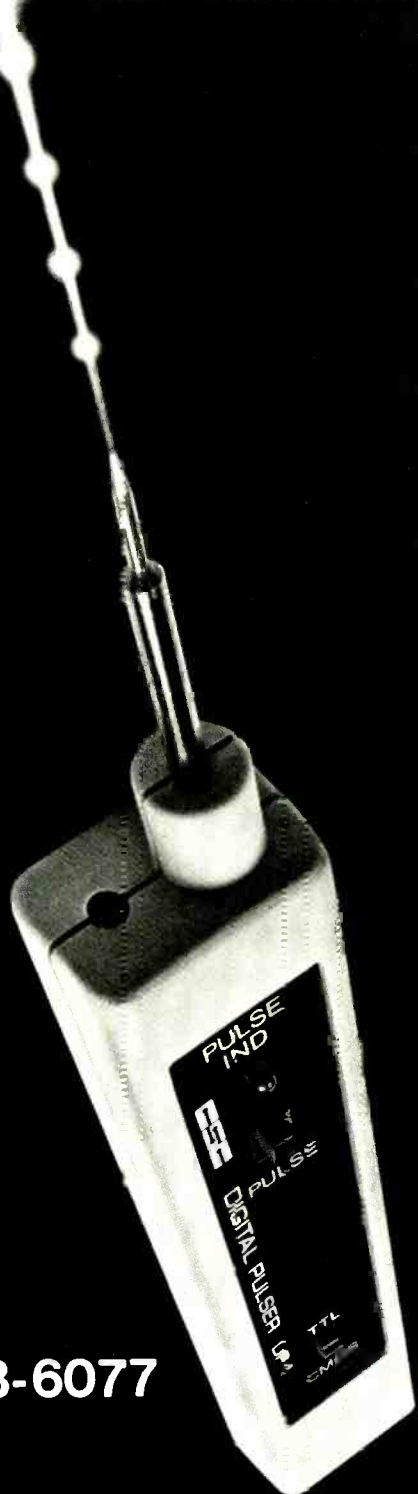

The craftsmen at Realtime™ have done something quite unusual. They've created a dramatically thin, rugged alarm chronograph for under \$250.

In fact, way under \$250.

And while they've trimmed their timepiece's profile to a slim 9mm, they have done it without sacrificing a single feature, or compromising quality.

We have yet to see an alarm chronograph that even approaches the value of this superb new product, either in a store or offered through the mail.

### Microcomputer technology pushed to the limit.

It's truly remarkable the amount of information you can now carry on your wrist, especially when you consider it's within a piece of jewelry no bulkier than an ordinary, slim wristwatch.

With this chronograph, you have bright liquid crystal digits always telling you the time of day. In hours, minutes and seconds (with accuracy to ± 5 seconds a month).

What's more, you can even program the hours, minutes and seconds for any other time zone you wish for immediate recall, thanks to Realtime's dual time-zone feature.

### 5 POPULAR ALARM CHRONOGRAPHS COMPARE THINNESS.



Texas Instruments (\$125) 12.00 mm  
 Advance (\$100) 11.5 mm  
 Citizen (\$225) 11.0 mm  
 Seiko (\$250) 10.5 mm  
 Realtime (\$99) 9.0 mm

It's a multitasking wrist alarm too. You may set it to beep-beep you in both time zones, and at precisely the minute you choose.

And because of Realtime's "PM" indicator, you won't be setting your alarm for the evening when you had intended to set it for the morning.

Is it Monday in New York? Or Tuesday in Hong Kong? You'll never have to ask that question

**TIME MODE**

- Switches chronograph from normal time mode to stopwatch operation ("ST"), to second time zone ("T2"), to alarm setting ("AL").
- This flag comes on with second time zone data and alarm setting.
- Flag shows correct day of week in each time zone.
- Appears between 12 noon and midnight in normal time mode. Also works in conjunction with alarm setting.
- Even when switching back for a time check, stopwatch function continues uninterrupted.
- Events can be timed for up to 12 indicated hours. Beyond that, hour display starts over at "1" without interruption.
- Colon flashes when split time is displayed. Indicates time is still accumulating.
- Moving flag records 1/10 seconds. Face shown reads: 9 hours, 59 minutes and 36.4 seconds.

**STOPWATCH MODE**

- Continuous display of hours, minutes and seconds for two time zones. In second time zone mode, "T2" flag appears.
- Rolls off every second. Or changes to the date. Built-in 4-year auto calendar adjusts to end of month.
- Flag shows alarm set. This audible reminder beep-beeps for 1 minute on the exact minute of its setting. It returns 24 hours later.
- Resets time, date, alarm, day of week and month. Also silences alarm.
- Starts and stops the count. If depressed during split time display, freezes the count—allowing automatic changeover to total elapsed time display.
- Resets stopwatch to zero for next event. Also activates 6-second split time display anytime during the count.

again. The day of the week is always displayed. To see the date, simply flick a button. When the sun's down, press another and the Realtime's face is instantly illuminated.

# FINALLY. AN ALARM ALL FUNCTIONS

And just as quickly as you recalled the date, you can set into motion a full-featured stopwatch. By the way, this stopwatch doesn't just count to 59 minutes like many other chronographs do—but up to 12 hours or more. It also precisely cleaves every second into tenths.

You may record split times, lap times or freeze the figures anytime. You may even alternate between your stopwatch functions and normal time ones without concern; by activating one mode, you don't interrupt the other.

**\$99 buys an honest design**

We wish you had a Realltime alarm chronograph in your hands right now. You'd see and feel the difference a 100% solid stainless steel case makes. (Most other comparably priced chronographs are chrome plated and not solid stainless.) Realltime's back and bracelet are also solid stainless. And every one of those bracelet links is double stamped to produce the exact size and taper required. Each link is then ground and polished. (We defy anyone to find workmanship like this, elsewhere at this price.)

You'll also notice there's no front speaker grill on this alarm chronograph; it doesn't need one. The alarm sound emanates from the rear of the case. Many other chronographs, in trying to look like Seiko with its front-mounted speaker, cleverly paste on printed front grills. These are functionless; they are just imitation. Everything you see on your Realltime chronograph is there for function, not for show.

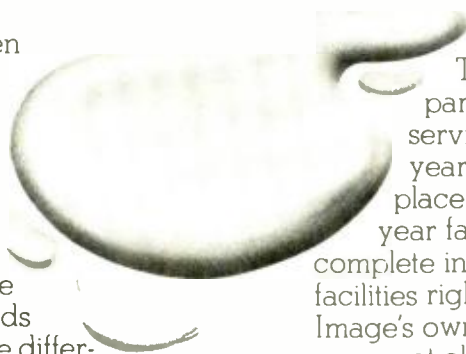

**Water? Don't you worry.**

The Realltime's face crystal isn't plastic like most chronographs you see. It's tough rock crystal. And not only is it hard enough to resist scratches, but it is fitted so tightly to the case that the chronograph has passed water immersion tests of up to 100 feet. We know of no other chronograph—at any price—that can offer you this security.

This chronograph also has no moving parts to break down, and it is unlikely that servicing will ever be required even after years of hard use. It comes with batteries in place (easily changed by any jeweler), a one-year factory warranty from its manufacturer, complete instructions, convenient service-by-mail facilities right here in the U.S., and The Sharper Image's own guarantee to customers: if for any reason at all, you are not completely delighted with your purchase, please return it within two weeks for a complete and courteous refund.

**ORDER NOW. TOLL-FREE.**

- Credit card holders may use our toll-free ordering number, for quickest delivery. Or send check for \$99 plus \$1.50 delivery. Add \$5.94 tax in CA.
- **(800) 227-3436**
- In California (800) 622-0733

**THE SHARPER IMAGE™**

260 California St., Dept. RA—  
San Francisco, CA 94111  
(415) 788-4747  
©1979 The Sharper Image

**CHRONOGRAPH WITH AND NO FAT.**



# The Best Deal In Car Stereo

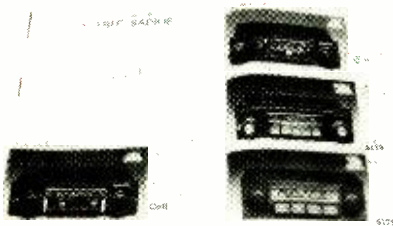

## Our FREE Catalog

The 76 page CRUTCHFIELD catalog is nationally recognized as the best source for car stereo product and installation information. It contains all you need to know to buy and install the ideal system for your car.

And it's FREE! Act now and you'll have it in just a few days.

- Over 200 car stereo products at discount prices
- All the specification, dimension and feature charts you'll need
- The best products in car stereo, including Blaupunkt, Clarion, Craig, Concord, Jensen, Marantz, Panasonic, Pioneer, Sanyo, and many more!
- Illustrated installation articles

Fill out the coupon and send right away for your FREE catalog. Or if you can't wait, call TOLL-FREE:

# 800-446-7924

In Virginia call 800-552-3961

Illustrated: Pioneer's new KE-2002 in-dash AM/FM stereocassette car stereo featuring electronic tuning and high fidelity specifications, TS-168 6 1/2" three-way speakers with exponential horns

**PIONEER**

**YES!**  
Rush me a  
FREE Catalog  
by First Class Mail

Name \_\_\_\_\_

Address \_\_\_\_\_

City \_\_\_\_\_

State \_\_\_\_\_

Zip \_\_\_\_\_

# CRUTCHFIELD

1 Crutchfield Park, P.O. Caller 1, Department E  
Charlottesville, Virginia 22906

## NEW PRODUCTS (Continued)

segment LED display shows the channel tuned, and a large illuminated meter displays relative signal strength and transmitter output power. Specifications: less than



0.7  $\mu$ V for 10 dB (S + N)/N sensitivity; 60-dB adjacent-channel selectivity and desensitization; 3 watts at 10% distortion audio output power into 8 ohms; 4 watts maximum, 3.6 watts minimum carrier power with no modulation; -65-dB spurious emissions; -40-dB transmitter, -45-dB receiver hum and noise. \$319.95.

CIRCLE NO. 92 ON FREE INFORMATION CARD



chined steel drive gears, dual transformer circuitry, power braking, a control unit with illuminated meter readout, and low-voltage operation. \$224.95.

## Bose Spatial-Control Receiver

Designed to complement Bose 901 Direct/Reflecting speakers, but usable with other speakers as well, the Spatial Control Receiver contains equalization for the 901's and "source and room compensation" controls that function in lieu of tone controls. In addition, it is capable of directing mid and high frequencies to either the inner or outer banks of reflected drivers of the 901's, narrowing or widening the stereo image at the listener's option. Bass is directed equally to all drivers at all times. The unit contains four main power amplifiers and two secondary amplifiers for driving headphones. Strapped in pairs, the large amps are rated at 100 watts per channel into 8 ohms, 20 Hz to 20 kHz, with no more than 0.09% THD. The FM section is said to achieve 50 dB of quieting in stereo with an input signal of just over 36 dBf. \$799.

CIRCLE NO. 94 ON FREE INFORMATION CARD

## Compact Electric Drill

Wahl Clipper Corporation's "Iso-Tip" is a compact electric drill that's said to be ideal for circuit board revision, solder removal,



and lead hole cleaning, among other jobs. It runs at about 9000 rpm and accommodates drills and burrs with shank size up to 1/8". Less than 5" long (excluding drill bit), the Iso-Tip is small enough to use at close quarters. The device is housed in high-impact plastic and is equipped with a 10' power cord, as well as a collet chuck, four collets and two drill bits.

CIRCLE NO. 93 ON FREE INFORMATION CARD

## Anixter-Mark CB Antenna Upgrader

Anixter-Mark's "Little Devil" adapter is designed to allow CBers to upgrade to a higher-performance antenna without requiring a new mount or cable assembly. The base loading coil merely unscrews from the present antenna and the Little Devil



(Continued on page 14)

## Antenna Rotor System

The new Ham IV from Cornell-Dubilier Electric Corp. is an antenna rotor system for large communication arrays with maximum wind load areas of 15 sq ft when tower mounted. Includes such features as ma-

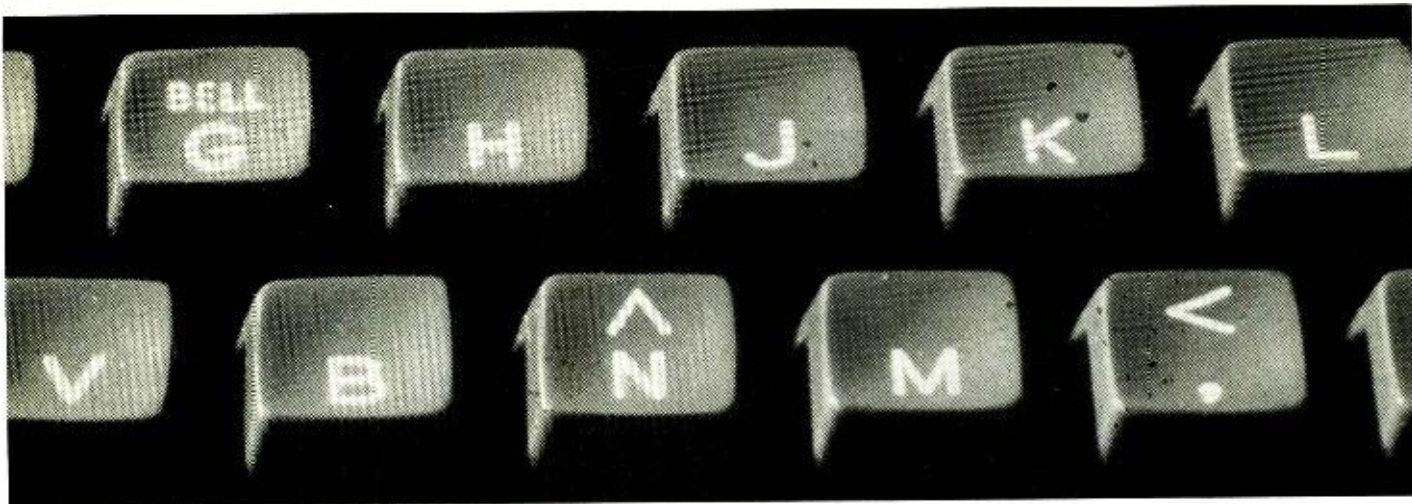

# Using a computer is easy... for onComputing readers.

Read onComputing to find out . . .

- What a micro-computer can do
- How to get started
- What's new in personal computers
- Where to buy your computer
- How to use your computer

The editors of **onComputing** realize that much of the material written about computers is not at all suited to the person who just wants to use a computer as a tool for business, education, home entertainment, laboratory work, or other applications. **onComputing** is dedicated to helping the computer user understand the capabilities of a microcomputer—in non-technical language.

**onComputing** is entertaining and informative. It contains practical articles on how to get started, including what you'll need for your application and what it will cost. It features book reviews, product reviews, information on what's

new in personal computers, where to buy a personal computer, and—how to use it.

**onComputing** is a totally new publication. It is issued quarterly and contains articles from some of the best known names as well as from competent amateurs. It is edited and produced under the guidance of an experienced staff of computer experts. The articles in **onComputing** have never appeared in any other publication. They are all fresh, informative, and valuable reading for anyone interested in using a computer—for fun or profit!

**onComputing**<sup>™</sup>  
GUIDE TO PERSONAL COMPUTING

Start your subscription today.

EVERY THREE MONTHS **onComputing** will bring the latest developments in the field of personal computing: use, applications, books, selection—all in an easy-to-read style.

© onComputing, Inc. 1979

**onComputing** Subscription Department, P.O. Box 307, Martinsville, NJ 08836

REGULAR subscription rate.

U.S. 1 yr. (4 issues) ☞ \$8.50    Canada & Mexico 1 yr. (4 issues) ☞ \$10.00

FOREIGN (to expedite service, please remit in U.S. funds drawn on a U.S. bank.)

Europe (and all other countries, except above) 1 yr. ☞ \$12.00—surface delivery

Bill VISA    Bill Master Charge    Bill me (North America only)

Card Number \_\_\_\_\_ Expiration \_\_\_\_\_

Signature \_\_\_\_\_

Name (Please print) \_\_\_\_\_

Street/Apartment Number \_\_\_\_\_

City \_\_\_\_\_

State/Province/Country \_\_\_\_\_

Postal Code \_\_\_\_\_

7389

CIRCLE NO. 11 ON FREE INFORMATION CARD

## Grandfather's Clock Was Never Like This!

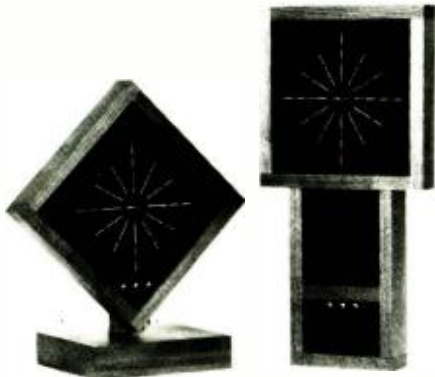

If you love contemporary design but want the more traditional, here is *the* clock for you. In creating our own version of the ever popular Grandfather Clock, we use the electronic eye to display each second, minute, and hour, and also the simulated pendulum motion.

The diagonal model which has no simulated pendulum is available for wall mounting or with base as a desk clock.

Our synthesized sounds composed of tic toc, modified Westminster Chimes and Bongs are available for any **AMELECT** clock. The chimes and bongs are composed of six frequencies, providing realistic bell sounds. They are totally within clock cabinet.

The **AMELECT** clocks, cabinets may be your choice of Cherry, Mahogany, Maple, or Walnut hardwoods.

	Assembled	Kit	Base
CL7401A Diagonal	\$79.50	\$59.50	\$9.60
CL7402 Grandpa	\$99.50	\$75.50	
Chimes	\$45.00	\$39.00	

Shipping and Handling, \$3.50

To order write or call

Allow 4 to 6 weeks for delivery

# AMELECT

INCORPORATED

Postoffice Box 367

GOODLAND, INDIANA 47948

Phone 219-297-3320

## NEW PRODUCTS (Continued)

screws into its place. All of the popular accessories can be used with the Little Devil, which has a  $\frac{3}{4}$ "-24 thread. The mount and cable from the old antenna installation can still be used, saving on that part of the system. The adapter can be used with both trunk and lip mounts.

CIRCLE NO. 95 ON FREE INFORMATION CARD

## Programmable Clock Radio

General Electric announced the first AM/FM programmable digital standard broadcast clock radio, "The Great Awakening" Model 4880. It has a programming keyboard for entering a variety of time and operating functions. For example, two people



can wake up at different times to different stations without resetting, or the two systems can be used for weekday/weekend wake-up times. Further, one can fall asleep listening to one station and wake up to a completely different station. Memory capability to store six radio stations, instantly recallable by touching a button, is built in. Also all timekeeping and memory information is protected by battery back-up during power outages. \$116.95.

CIRCLE NO. 96 ON FREE INFORMATION CARD

## Automotive Speaker Adapter

East Coast Enterprises has introduced "Adapt-A-Sound," a device that matches a standard 6" by 9" automotive loudspeaker to the 4" by 10" mounting locations provided in some of the newer, space-efficient



cars. The adapter is said to cause little or no loss of sound quality. A snap-in mounting spring designed to fit all 4" by 10" locations is claimed to simplify and facilitate installation. Address: East Coast Enterprises, Inc., P.O. Box 639664, Miami, FL 33163.

## Sansui Integrated Amplifier

A slew rate of 200 V/microsecond (said to reduce transient intermodulation to vanishing point) is given as one of the premier specifications of the Sansui AU-919 integrated amplifier. The direct-coupled amplifier, which is equipped with protective circuitry designed to limit dc at speaker terminals to a safe value, is rated to deliver at least 100 watts per channel to an 8-ohm load, 5 Hz to 20 kHz, with no more than 0.008% THD. The phono equalization amplifier of the preamp section includes inputs for moving-coil and fixed-coil pickups. With the latter, it is said to yield a signal-to-noise ratio of 90 dB. Rated accuracy of EQ is  $\pm 0.2$  dB, 20 Hz to 20 kHz. \$800.

CIRCLE NO. 97 ON FREE INFORMATION CARD

## Desoldering Tool for Mini-Boards

Hunter Associates is offering the Model GSS Desoldering Tool, which is intended for use on miniature and microminiature circuit boards and modules. Operating by



means of compressed air, the tool creates suction in its tip, with the high-pressure air flow causing a continuous self-cleaning action as well. Air can be supplied either from a pressurized line or by an ordinary foot pump. The tool has a tip 2.4 mm in diameter with a 1.2-mm vent. \$39.95.

CIRCLE NO. 98 ON FREE INFORMATION CARD

## Debounce Switch

Cincinnati ElectroSystems' new Debounce Switch provides a convenient method for clocking logic circuits without contact bounce. A pushbutton switch, when operated, generates a choice of positive or negative 10- $\mu$ s pulse or a level change. This latest addition to the company's Black Box series of laboratory instruments measures 4"  $\times$  2 $\frac{7}{8}$ "  $\times$  1 $\frac{9}{16}$ " (102  $\times$  73  $\times$  40 mm). It is designed to be powered from virtually any 5- to 15-volt external dc source. \$7.95. Address: Cincinnati ElectroSystems Inc., 469 Ward's Corner Rd., Loveland, OH 45140.





## New Literature

### HEATH INSTRUMENT CATALOG

Described in a 35-page catalog is the complete Heath-Schlumberger line of instruments. Included are: computer systems, distortion analyzers, frequency counters, generators, individual learning programs, testers, oscilloscopes, power supplies, recorders, TV service, and accessories. Products are illustrated and full specifications are given. Address: Heath/Schlumberger Instruments, Benton Harbor, MI 49022.

### NEWSLETTER FOR ELECTRONIC GUITARISTS/MUSICIANS

*Device, the Newsletter for the Electronic Guitarist/Musician*, is a monthly publication for musicians involved in today's technology. Co-edited by Craig Anderton and Roger Clay, subjects regularly covered include reviews of musical equipment, construction articles, interviews, features on circuit design and reader opinion polls. Rates are \$15/year (USA), \$16 (Canada/Mexico) and \$18 (International). A free sample issue is available from *Device*, P.O. Box C, Carmichael, CA 95608.

### GOULD OSCILLOSCOPE BULLETIN

Rugged, lightweight professional oscilloscopes with standard features usually found in more expensive instruments are described in a new four-page illustrated bulletin from Gould. The listing includes three dual-trace and one true dual-beam scopes that range in price from \$595 to \$995. For a free copy of Form No. 449-7, contact: Marketing Services, Gould Inc., Instruments Div., 3631 Perkins Ave., Cleveland, OH 44115.

### RADIO SHACK MICROCOMPUTER CATALOG

The TRS-80 Microcomputer Catalog #RSC-2 is offered by Radio Shack. The 20-page catalog includes current information on the TRS-80 microcomputer, its peripherals and accessories with descriptions, application ideas and specifications. A general section explains what a computer is, what it can do, "Who can use the TRS-80," and "Why the TRS-80?" The catalog then describes the TRS-80 System, Level-I and Level-II Basic Language, and the peripheral equipment available for use with the TRS-80 including its expansion interface, Mini-Disk System, printers, interfaces, manuals and TRS-80 System Desk. Address: Radio Shack, 1400 One Tandy Center, Fort Worth, TX 76102.

### AKAI STEREO COMPONENT CATALOG

Akai's 56-page catalog describes its full line of stereo components, including tape decks, turntables, receivers, amplifiers, tuners, loud-speaker systems, an equipment cabinet, a mic/line mixer and stereo accessories. The catalog has information on product features, specifications, and color photos of each model, plus a glossary to explain specifications and provide stereo terminology. Address: Catalog, Akai America, Ltd., P.O. Box 6010, Compton, CA 90224.

### ANTENNA INCORPORATED CATALOG

An expanded Land Mobile Antenna catalog for commercial two-way communications

systems is offered by Antenna Incorporated. The catalog includes several new antenna models and provides reference material in chart format, enabling the reader to match antenna frequency range and model number with the desired type of antenna mount. Included are: 100- and 200-watt low-band vhf antennas; 100-, 150- and 200-watt, 3-dB gain, high-band vhf antennas; 100-watt and 150-watt, 5-dB gain collinear uhf antennas; 1/4-wavelength models; heavy-duty mobile antennas for use between 25 and 54 MHz; "disguise" bowl-mount models and base station antennas. Address: Antenna Incorporated, 26301 Richmond Road, Cleveland, OH 44146.

# WE DARE YOU

Stop reading. And start listening. It's that simple.

Even with today's tape technology, there's no such thing as an ideal tape for every machine. Only what's best for *you*. Which depends only on the sound *you* like and the response of *your* deck.

Compare specs if you wish — we'll match ours against anyone else's. But we honestly think you'll be more impressed by comparing the *sound* of our FX-I or II to that of any other premium cassette.

Visit your audio dealer and take the Fuji challenge.

# FUJI

Magnetic Tape Division  
of Fuji Photo Film U.S.A., Inc.  
350 Fifth Avenue,  
New York, New York 10001

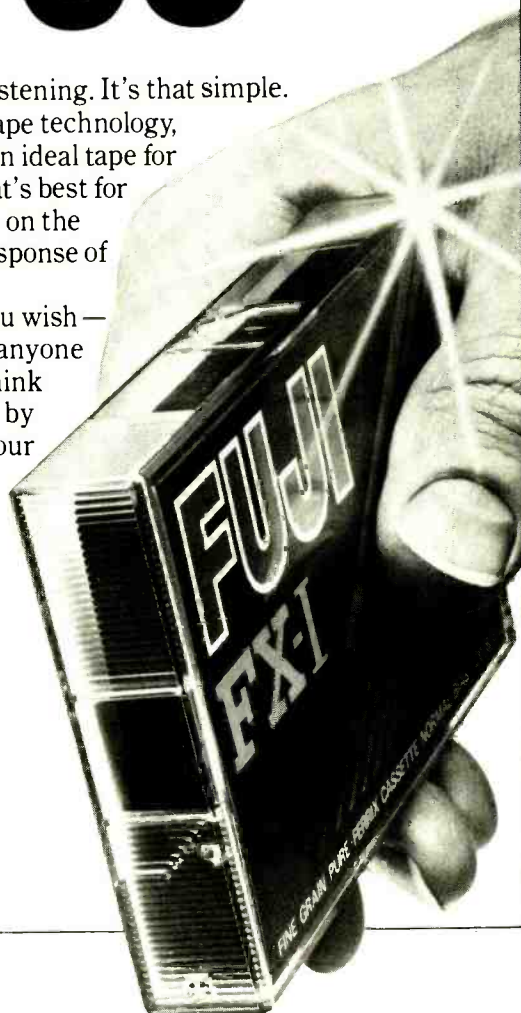

CIRCLE NO. 24 ON FREE INFORMATION CARD

# Now NRI makes it TV/Audio home

**Side-by-side equipment comparison of NRI and two other leading schools shows what you get for what you pay. When you have to pay as much as \$905 more for another school's course, you should carefully consider your tuition investment.**

When you sit down and try to pick out the school that's best for you, it gets

to be a problem. Catalogs are radically different and some are not too clear as to what you actually get for your money. So NRI has done a lot of the work for you. And put the prices right up front so you can make your own judgment.

Of course, we can't compare everything. Lesson clarity and content vary. What one covers here, another covers there...or not at all. The material one school breaks down into eight lessons may be four at another. And the qualifications and abilities of instructors are another question.

## One Million Students, Over 65 Years' Experience

So we can only tell you what NRI has to offer. We've been in education since 1914, starting as a radio school six years before commercial broadcasting was even on the scene. Since then, we've kept right up with the times, improving techniques, adding material, creating new courses to help people improve their skills and income.

Early on, we learned to keep our lessons compact...thoroughly covering a subject, but not so much that students would be overwhelmed. We call them "bite-size" lessons because they're easy to digest.

## Learn by Doing with "Hands-on" Training

And, we pioneered the concept of "hands-on" training. NRI goes far beyond theory and textbooks to give our students actual bench experience and prepare them for the realities of electronic servicing. Every piece of equipment in our Master Course in TV and Audio Servicing is designed for learning.

You build your own big-screen TV, the only one complete with computer tuning that lets you program an entire evening's entertainment...a solid-state

	NRI	SCHOOL A	SCHOOL B
<b>COURSE TITLE</b>	Master Course in TV, Audio, and Video System Servicing	Master Course in Color TV Servicing	Electronics Technology and Advanced Troubleshooting I & II
<b>CASH PRICE (terms available)</b>	\$1,375	\$1539	\$2280
<b>TV SET</b>	NRI designed-for-learning kit. 25" (diagonal) color TV with built-in computer programming and cabinet	Heathkit GR-2001 25" (diagonal) color TV (cabinet extra)	Zenith model G4020W 19" (diagonal) color TV (fully assembled)
<b>OSCILLOSCOPE</b>	NRI designed-for-learning kit. 5" (8 x 10 cm) triggered sweep	Heathkit IO-4541 5" (8 x 10 cm) triggered sweep (not given until after graduation)	Heathkit IO-4541 5" (8 x 10 cm) triggered sweep
<b>COLOR BAR GENERATOR</b>	NRI designed-for-learning kit. 10 patterns	Elenco SG-200 (kit) 10 patterns	Elenco SG-200 (fully assembled) 10 patterns
<b>FREQUENCY COUNTER</b>	NRI designed-for-learning kit. Complimentary metal oxide semiconductor digital type		
<b>METER</b>	NRI designed-for-learning kit. Transistorized AC/DC volt-ohm meter	Heathkit (part of TV kit) DC only; 1K Ohm, volt	Private label multimeter
<b>AUDIO</b>	NRI designed-for-learning kit. Solid-state stereo AM/FM receiver with cabinet and speakers	Private label pocket transistor AM radio kit and AM-FM-SW solid-state portable radio kit	
<b>TRAINER</b>	NRI Discovery Lab	Breadboard	Experimental Electronics Lab
<b>MISCELLANEOUS EQUIPMENT</b>	Digital logic probe built into TV set	EICO Digital Logic Probe	

All data as shown in each school's catalog as of April 1, 1979.



Learn as you build with "hands-on" training.

# easy to compare study courses.

stereo tuner and amplifier with speakers ... your own oscilloscope, digital frequency counter, and other instruments you use in your course, use later to service TV's, audio equipment, and video tape units.

The point is, none of this equipment is hobby-kit or commercial assembly line units with lessons "retrofitted" to what was at hand. NRI has designed each so you get invaluable training and experience you just can't get any other way. As you build, you study operation of circuitry, see how sections interact, perform "power-on" experiments only possible with NRI. This total training is exclusive with NRI... no other school, home study or resident, offers it.

## Instructors Who Know Their Business

NRI instructors are thoroughly qualified, with both technical and educational experience. Most of them helped develop NRI courses, lessons, and equipment, so they really know what they're talking about. They're interested in their students, always ready to help with a question, a problem... give good advice to help you reach your goals.

It's instructors and training like this that have made NRI the choice of professional TV servicemen who have taken home study courses. As a national survey shows (summary on request), they recommend NRI by a majority of three to one over any other school.

So how does NRI give you all this and still cost so little? We keep costs down by designing our own training kits, eliminating the middleman's profit on hobby kits or commercial units. And by offering our training by mail only. We have no sales force, no commissions to pay. You make up your mind in your own time, without pressure, let the facts speak for themselves. We pass these savings on to you in the form of lower tuitions, more equipment, carefully designed courses and effective lessons.

## Send for Free Catalog, No Salesman Will Call

Send for our free catalog today and get all the details. See every piece of equipment and kit you get... a complete listing of fully described lessons... explanations of each and every experiment you perform. Read about NRI's background and qualifications... career opportunities... what NRI graduates say about their training... costs and monthly payment plans for the courses that interest you. Then compare NRI value and results and make your decision. Like the million that have gone before you, we think you'll choose NRI. Send the card today.



Build and keep 2-meter transceiver, test equipment for a communications career.

## Or check out NRI value-training in Computer or Communications/ CB Equipment Servicing.

NRI's new Microcomputer and Microprocessor course trains you to be the complete computer technician, at home with both hardware and software. As you learn, you build your own advanced technology microcomputer, get "hands-on" experience in servicing and programming. Or you may want to look into the expanding world of communications

...mobile  
radio, CB,

microwave, commercial broadcasting, and more. NRI can help you as you build and experiment with your own digitally synthesized 2-meter transceiver. For facts on these and other NRI home study courses, check the postage-paid card and mail today. If card is missing, write to:



**NRI Schools**  
McGraw-Hill Continuing  
Education Center  
3939 Wisconsin Avenue  
Washington, D.C. 20016





# Stereo Scene

By Ralph Hodges

## RECORDING AS NATURE INTENDED

IT WAS to be a typical recording session (details of time and place are not pertinent to this discussion), and once it began, our little party of journalists took just five minutes to zero in on the best seats from which to hear the orchestra. What we heard as the music unfolded was indeed magnificent. As I sat, spellbound by the glorious sound, I could almost visualize my own microphones hanging there just so far off the floor and just the right distance from the front desks of musicians.

However, that wasn't where the mikes were at all! For one thing, instead of the two or perhaps three I had visualized, there were some two dozen (neither the producer nor the engineer could recall the exact number) and they were strewn around the orchestra like raisins in a fruit cake. The treatment of French horns was particularly puzzling. Sound-reflecting panels had been erected a short distance behind them, which seemed logical because the bell of the horn faces to the rear and the back wall of the stage reflects the sound out to the audience.

Since the recording team had brought the orchestra off the stage and out into what would be the audience seating area—a very common practice in U. S. orchestra recording—something was needed to take the place of the stage's enclosure. What seemed less logical was that the mikes were not in front of the horns but behind them, a few feet away from the reflecting panels. Now if God intended the French horn to be heard with its bell pointing away from the listener or the microphone, what were mikes doing behind the horns and in line with the bell openings? Certainly the sound in the control room did nothing to throw light on the matter.

I suppose I have heard worse emanating from a set of monitors, but that's not saying much. When, for example,

the producer wanted to make sure the brass did not drown out the strings, he had the engineer turn up the string mikes—often to the point where the violins became shrill caricatures of themselves. With microphones sprinkled hither and yon throughout the orchestra, there were no landmarks by which a listener could get his bearings in the stereo image. Perhaps this was just as well, for a more plausible perspective that churned and twisted as this one did (because of the continual changes in instrumental balance that were being dialed in), might have caused motion sickness. The tympani were getting into all the microphones, thus losing their crispness and much of the “snap” of their impact. It was discouraging to realize that this sound was the product for which many dollars per minute were being spent, when you could walk 30 steps into the hall and hear how wrong it all was.

**Miking the Space.** A reaction against this sort of recording technique has been underway for some time now. As a concept it might be termed “miking the space.” Instead of trying to pick up 40 violins, 25 violas, 20 cellos, 10 string basses, 2 oboes, etc., you adopt the outlook that you're going to try to capture every acoustic event that takes place in an area of, say, 80 by 40 feet—the sort of area a symphony orchestra might occupy. The nature of the acoustic event doesn't matter—it might be a concert of music, a tap-dancing competition, a game of dice, or a fly buzzing around. What matters is that the event as recorded sounds natural; that it seems to occupy the amount of space that it did in reality; and that its aural perspectives are preserved. If something is happening in the rear or over to the left, the sound should come from there when the finished recording is played back.

Of course, this is not the sort of recording technique you use if you are trying to cover up deficiencies in the performance or flatter the sound in some way. What actually takes place is what the microphones hear and the tape preserves, warts and all. Nor is it a technique that is easy to bring off in every environment. But if you accept the idea that the space need not be a nice neat rectangle as long as your performing forces can be squeezed into it, and if you realize in advance that the minimum number of microphones required is usually best, with additional microphones often proving detrimental, you can usually manage something.

Here is a procedure I very often find helpful, although like everything in audio, it is fallible. First consider the recording environment, because it will determine the character of the reverberation present on the finished tape. A small auditorium, for example, is usually less reverberant than a stone church. This means that microphones can usually be placed a bit farther away from the performers without loss of clarity. An advantage can be realized here when working with very few microphones, because a more distant mike means less variation in performer-to-mike distance for any given performer and fewer problems with balance. If the performers know how to balance themselves, the recording will be balanced.

A church may require closer miking if reverberation is not to interfere with clarity. In this case, you might want to try more closely spaced mikes and group the performers in an arc around them; in other words, the “space” you're defining now becomes a rough semicircle instead of a rectangle. These suggestions are performe very general; every recording situation is a cut-and-try proposition.

**Setting Up.** Once the mikes are roughly placed (and before the performers arrive), send your assistant to stage center and have him move forward and back, continuously announcing his distance from an imaginary line connecting the microphones. When the monitor system yields what seems to you the most pleasing balance between the sound coming directly from him and the reverberation his voice sets up in the environment, you've established an approximate “subjective distance” for the performance—subjective because you will usually find that he is somewhat closer to the mikes than he sounds to be. Have him mark his position on the stage floor

# POLICE RADAR MEETS ITS MATCH.



## With GUL's Micro Scan, you can own a high-technology radar detector for only \$79.

Your radar detector should do two things well: give you as much advance warning of police radar as possible, and screen out false signals. And few competitive units are able to perform both these functions well. However, the GUL G-73, developed by B.E.L. Laboratories represents a breakthrough in both sensitivity and false signal rejection in a compact, well-designed case.

### Road Superiority.

The 10-year researched GUL has been tested numerous times against such units as the Fuzzbuster XK, the Whistler XK and the XK Snooper. In separate tests conducted by the Canadian Tire Corporation and Motor Consumer Report, the GUL demonstrated a detection distance significantly greater on both X and K bands, than all three competitors. Its nondirectional elliptical horn antenna receives these signals from front, back, and sides, and is even sensitive enough to detect the new short pulse KR-11 radar. Signals of less than .01 millionths of a volt (ranging from 9.445-24.445 GHz) are sufficient to trigger the alert signal and provide valuable warnings when approaching hills and curves. An adjustable gain control

A good driving record makes for lower insurance rates and prevents possible loss of your driver's license. GUL can help protect yours. It may even pay for itself within the first year of use, depending upon your driving habits.

knob lets you optimize GUL's sensitivity for both city and country conditions.

### Doesn't Cry "Wolf."

The GUL takes full advantage of modern integrated circuit technology to provide a capability of more than 100 transistors. Many competitive units try to get by with

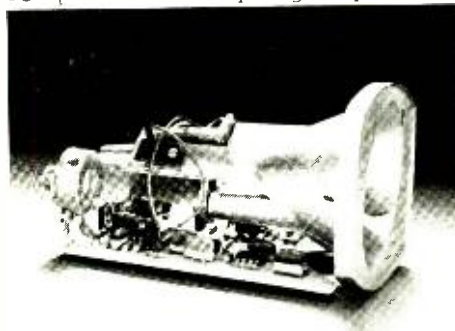

as few as 20 transistors and they just don't work as well. GUL's sophisticated circuitry is completely shielded by a diecast and extruded aluminum case. This not only provides a better wearing case than the often used plastic ones, but also protects the input terminals from stray signals, the most common cause of false alarms. In addition, the GUL uses an internal voltage regulator, commutating filter, and

synchronous detector to reduce power consumption to a minimum and provide a more stable gain setting—features usually found only in units costing twice as much.

### Two Warnings You Can't Miss.

The GUL uses a double warning system. Both a tone and light come on in the presence of radar. And both remain on until radar is gone. You're never lulled into a false sense of security by a tone that sounds once and then goes off. And you can control the tone with a front-mounted on/off switch.

### Quick Installation.

The GUL detector is one of the most compact units available, measuring only 4"x3"x4½", and weighing just 20 oz. Its aluminum case is finished in glare-free matte black and comes with its bracket in place. To mount, simply take the adhesive Velcro pad, peel off the back, and adhere it to the top of your dashboard. The bottom of the bracket has a matching Velcro foot which anchors your unit securely on top of the dash. It plugs into your cigarette lighter. That's all there is to it. The same Velcro mounting also allows for easy removal in seconds to prevent theft. The small size GUL will fit into any glove compartment.

### Try It Yourself.

Order the new GUL detector today. Better yet, road test it yourself. See how comforting it is to observe police radar when it's observing you. If you don't find it to be the best electronic counter-intelligence you can have for \$79, simply mail it back. Your GUL comes with The Sharper Image two-week return privilege and a manufacturer's 120-day warranty.

### ORDER NOW TOLL-FREE

Call the toll-free ordering number below and charge it to your credit card or send check for \$79 plus \$2.50 delivery. (add \$4.74 tax in CA).

**(800) 227-3436**

In California (800) 622-0733

**THE SHARPER IMAGE™**

260 California St., Dept. GL—  
San Francisco, CA 94111  
(415) 788-4747

with a strip of that indispensable silver tape.

Then, while he faces forward and talks continuously, have him move left and right on a traverse that approximately encompasses the width you expect the performing group to occupy on stage. If at any time during his traverse his voice seems to recede, have him move forward until the original sense of distance is restored and mark that position with tape. (And, of course, have him move back appropriately if his voice seems to approach the microphones.) When this process is over you will have established a base line for the front row of performers. Ultimately you'll be able to move them slightly forward or back of this line to establish final balances.

Finally, your assistant should cavort around the performing area stamping his feet, clapping his hands, and making as much noise as possible, but never stepping forward of the base line. As he does his act, you should get a vivid sense of continuous movement within a well-defined space. The space may not sound quite like the area blocked out on stage, but it should seem plausible.

**The Inevitable Little Things.** By this time you should be in pretty good shape for the arrival of the performers, who it is to be hoped will give you a few minutes of run-through so you can set final balances. If the environment is reverberant and you have had to mike fairly closely, you may find that sibilants are exaggerated in vocals. Raising the mikes somewhat and instructing the performers *not* to sing at the mikes but instead straight out into the presumed audience is the usual remedy.

A frequent problem that can be baffling unless you're prepared for it is the initial sound reflection that comes from the performer, caroms off the floor just in front of him, and reaches the microphone an instant after the direct sound. As a rule this is the strongest reflection you'll have to deal with, and it can have an appreciable influence on the sound. The easiest remedy is a sound absorber at the exact bounce point. Church-pew cushions can be highly recommended as absorbers. Do not, however, overdo the treatment at first. Start with a single cushion at the bounce point—which can be easily worked out when you consider that the angle of reflection will equal the angle of incidence—and work up from there as necessary.

If the performance calls upon the performers to move—or if they move whether required or not—you have a special problem. Practical stereo microphone setups simply do not respond to movement as two ears attached to a human head do. To get the most natural-sounding effect, you will probably have to discuss their movements with them in advance, using the subjective-distance base line as a guide. Even then there are likely to be difficulties.

**. . . and it works.** You may not believe it now, but with luck, application, and a mere two microphones, it is possible to get startlingly credible and satisfactory results with this basic technique, as many brilliant tapes produced by persevering amateurs have shown. Even large-studio professional recordists, who sometimes seem incapable of believing, have inadvertently proven it. Here, an anecdote might serve. It may be apocryphal in some details, but I believe it to be true in the overall sense.

Back shortly before the era of stereo, a major label had proposed to do an LP of excerpts from *Swan Lake* with a well-known orchestra. Evidently, the production was to be a quick and easy job just to fulfill contractual agreements. But

there was a hitch—the orchestra was going to be on tour on the date for which the session was scheduled, and the engineers knew nothing about miking the hall in which the recording would have to be made. Worse yet, there was no time to experiment.

This was an intimidating state of affairs because recording engineers and the particular hall had had a long history of enmity. Engineers had found the place prone to echoes, lack of clarity, unfortunate balances, and almost any other sonic ill you can name. The only statement that could be made in the hall's favor was that expert listeners have long found it to be one of the most thrilling and satisfactory environments in the world for listening to symphonic music. In the end, not knowing what else to do, the engineers hung a single microphone above the orchestra on stage and crossed their fingers.

The recording that resulted was peculiar in a number of respects. The strings sounded like strings instead of strident implements of aural torture; you could sense that the brasses could totally overpower them unless held in check by the conductor; and the instruments in the back of the orchestra actually sounded more distant than those in the front. The bass drum was a special revelation; when it went off, you knew something had really hit you—right in the gut. In short, the record had a signal on it that actually managed to represent a symphony orchestra with some plausibility.

And this recording sold—not immediately or in great numbers, but strongly and steadily. The company, convinced it had discovered a hitherto secret love affair between the American record-buying public and *Swan Lake*, some years later issued a two-LP stereo set of excerpts played by the same orchestra. This time, however, the engineers were on familiar ground and were able to fuss around with mikes and mike placements to their hearts' content. Imagine their surprise when the new, much more lavishly produced recording didn't sell.

As adamant as my ears may be on this point, I can't prove that the differences in recording technique alone account for the wide variation in sales between the two versions. But I suspect that anyone who has no investment in the status quo in recording will prefer the results of simple miking over the multi-mike "forest" technique, at least for classical music, given the chance to compare. If you have the opportunity, try it for yourself. ◇

★ **FREE!** ★



### NEW CATALOG OF HARD-TO-FIND PRECISION TOOLS

Jensen's new catalog is jam-packed with more than 2000 quality items. Your single source for hard-to-find precision tools used by electronic technicians, scientists, engineers, instrument mechanics, schools, laboratories and government agencies. This popular catalog also contains Jensen's world-famous line of more than 40 tool kits. Send for your free copy today!

 **JENSEN TOOLS & ALLOYS**  
1230 SOUTH PRIEST DRIVE - TEMPE, A.Z. 85281

CIRCLE NO. 33 ON FREE INFORMATION CARD

# Julian Hirsch Audio Reports



## Fisher Model ST460 Speaker System



The Model ST460 from Fisher is a floor-standing three-way speaker system whose

salient characteristic is high efficiency, which permits it to develop very high output levels when driven by low-to-moderate-power amplifiers. Bass frequencies are propagated by a 15" (38.1-cm) woofer that operates at frequencies up to about 1000 Hz, where a pair of 5" (12.7-cm) cone-type midrange drivers take over. There is a second crossover at 5000 Hz to a single horn-loaded tweeter with a nominal 3" (7.5-cm) mouth diameter. Both crossovers have symmetrical, 12-dB/octave slopes.

Overall size of the ST460 is 29¼" × 18¼" × 14 9/16" (74.3 × 46.4 × 37 cm) and weight is 53 lb. Suggested retail price is \$389.95, or with genuine walnut veneer finish as the Model ST461 for \$409.95.

**General Description.** The drivers are mounted symmetrically on the front of the cabinet, with the woofer at the bottom in its own approximately 4-cu-ft ducted-port enclosure. The two midrange drivers are side by side above the woofer with the tweeter centered above them. At the top of the cabinet is a control panel with sepa-

rate three-position switches for adjusting the levels of the midrange and high-frequency drivers over a range of ± 3 dB. A pushbutton near the controls resets the circuit breaker that protects the system against overloads. The front of the speaker is covered by removable, acoustically transparent cloth.

### Laboratory Measurements. We

made our basic measurements on the ST460 with the system's midrange and tweeter level controls in their 0-dB (center) positions. The frequency response curve obtained in the reverberant field of our testing room was spliced to a woofer response curve taken with close microphone spacing. The latter includes the separately measured contribution of the port radiation at very low frequencies, corrected for the relative radiating areas of the port and the driven cone.

As a rule, even a 12" woofer might be expected to show cone breakup, beaming, and other undesirable effects at an operating frequency as high as 1 kHz. We were not too surprised, therefore, to find response irregularities and a general drop in output from the ST460's 15" woofer beyond about 500 Hz.

Maximum bass output was reached at frequencies between 70 and 90 Hz, falling off steeply at lower frequencies. Contribution of the port is mostly at frequencies below 40 Hz; while it is effective to a degree between 20 and 40 Hz, the average output in this octave is far below that of the upper-bass. Above 100 Hz, the output dropped off smoothly and gradually to a minimum at 1000 Hz of 10 dB below the maximum bass level. Beyond 1000 Hz, the output again rose gradually to

## Performance Specifications

Specification	Rating	Measured
Frequency response	40-20,000 Hz ± 10 dB	48-18,000 Hz ± 5 dB 20-19,000 Hz ± 10 dB
Efficiency (avg SPL at 1 meter, 1 watt)	92 dB	92 dB
Recommended amplifier power	25-130 watts	Confirmed
Peak distortion-free SPL with stereo pair in typical room	112 dB	Not checked
Crossover frequencies	1000 and 5000 Hz	Confirmed
Woofer diameter	15"	Confirmed
Voice coil	2"	Not checked
Loading	Ducted reflex	Confirmed
Midrange (size/type)	Two 5" cones	Confirmed
Voice coil diameter	9/16"	Not checked
Tweeter (size/type)	3" horn	2" mount diam.
Nominal impedance	8 ohms	Confirmed
Enclosure dimensions	29¼" × 18¼" × 14 9/16"	Confirmed
Weight	53 pounds	Confirmed

about +5 dB between 7000 and 16,000 Hz and fell off sharply at about 18,000 Hz. Overall frequency response (with the controls centered) was  $\pm 5$  dB from 48 to 19,000 Hz, well within Fisher's ratings. Tweeter dispersion was quite good.

The ST460's high efficiency was demonstrated by its ability to produce a 92-dB sound pressure level (SPL) at a distance of 1 meter when driven by 2.83 volts of random noise in an octave centered at 1000 Hz. The toneburst response was uniformly good, with no signs of prolonged ringing or spurious output frequencies. Impedance averaged about 8 ohms, reaching a maximum of about 30 ohms at the 65-Hz bass resonance and a minimum of 6 ohms at 750 Hz. Bass distortion at a 1-watt input was less than 1% from 100 to 50 Hz, and only 7% at 30 Hz. At a 10-watt input, distortion measured less than 2% down to about 50 Hz and climbed to 14% at 30 Hz.

**User Comment.** We listened to a stereo pair of the Fisher ST460 speakers mounted on stands that raised them about 7" above the floor—an arrangement that, while not critical, seems to enhance the sound of many speakers. What we heard sounded clean, with a generally good frequency balance that correlated well

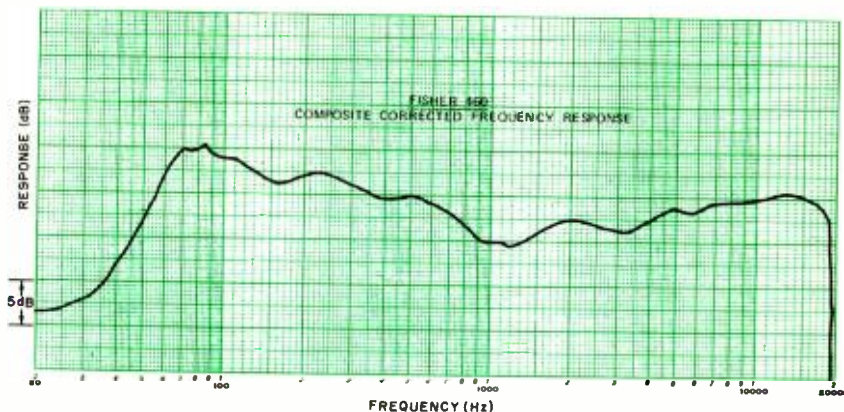

*Composite corrected frequency response for ST460 Speaker System.*

with what we had measured. Occasionally, we experienced a heaviness in male speaking voices and in some musical material. We attribute this to the emphasis in bass response around 80 Hz. Although some of the low-frequency performance is based on psychoacoustic illusion, it is convincing enough to give an overall impression of very solid bass.

Clearly, the balance of compromises (a component of all loudspeaker design) has been tipped in favor of disco and rock music in the case of the ST460. The frequency response gives a little extra "punch" to the bass and "sizzle" to the treble, without weakening the midrange to an extent that would cloud vocals. And while the

CIRCLE NO. 101 ON FREE INFORMATION CARD

system's performance with classical music might not suit the most demanding listeners, it is more than adequate for its intended application.

One characteristic of the ST460 that will probably have a special appeal to the rock and disco listener is its ability to conserve amplifier power. We were able to drive the system to ear-shattering levels with a 20-watt amplifier. On the other hand, the system took the output of a 200-watt amplifier right in stride. By most standards, the ST460 would not be considered cheap, but if the potential saving in amplifier power is taken into account, along with the level of musical performance offered, it seems like quite an economical speaker.



## Shure M95HE Stereo Phono Cartridge



The Model M95-ED stereo cartridge has occupied the position just below the

V-15 Type III in Shure's product line,

filling the gap between the moderately priced M91 series and the deluxe V-15 series. Although priced only slightly above the M91, the M95 cartridge was designed for a somewhat flatter high-frequency response.

When Shure introduced the top-of-the-line Model V-15 Type IV phono cartridge last year, one of its features was a hyperelliptical stylus shape derived from the hyperbolic stylus previously developed for the M24H (CD-4) cartridge. This type of stylus has an extended contact area against the groove wall and a small radius that gives it excellent high-frequency tracking ability. It occupies the same position in the Shure products that the Shibata and its derivatives do in the lines of other manufacturers.

The new M95HE consists of an M95 body fitted with the new N95HE stylus. The diamond tip of the stylus is identical to that of the V-15 Type IV. According to Shure, it makes a reduction of as much as 25% in harmonic and intermodulation distortion compared to the elliptical stylus used in the M95ED. Since the M95 cartridge is electromagnetically similar to the



V-15 series, it would appear that adding the N95HE stylus to the M95 body might result in a cartridge that has many of the special qualities of the V-15 Type IV but at a substantially lower price.

The M95HE is designed to track at forces from 0.75 to 1.5 grams. Shure's "trackability" ratings rank it a close second to the V-15 Type IV. Since the body is that of a standard M95ED, owners of that cartridge can upgrade to an M95HE at any time by merely plugging in a new N95HE stylus assembly. The M95HE costs \$89.50, the N95HE stylus \$34.00.

**Laboratory Measurements.** We tested the M95HE in the tonearm of a Thorens Model TD-115C record player at the maximum tracking force of 1.5 grams. The electrical load was 47,000 ohms in parallel with 500 picofarads. Shure recommends capacitance between 400 and 500 pF, (more than most turntables and preamps supply), but response measurements with both values showed that 500 pF yielded flatter overall response.

The cartridge's output was 4.75 mV/channel at a 3.54-cm/s velocity. Channel levels balanced within 0.9 dB. The vertical stylus angle, measured with a CBS STR160 record, was 26°. Frequency response and channel separation were measured with CBS STR100, JVC TRS-1007, and B&K QR-2009 test records. In addition, we measured the separation at a number of spot frequencies with an Audio-Technica AT-6605 record.

Frequency response differences between the records were relatively minor. With the STR100 record, response was flat within  $\pm 1$  dB from 40 to 16,000 Hz falling to about -6 dB at 20,000 Hz. Channel separation readings fell into two groups. The CBS and B&K records revealed less separation than the JVC and Audio-Technica records, which were fairly similar. The midrange separation was 22 to 23 dB with the first two discs and 30 to 35 dB with the other two. At 10,000 Hz, the

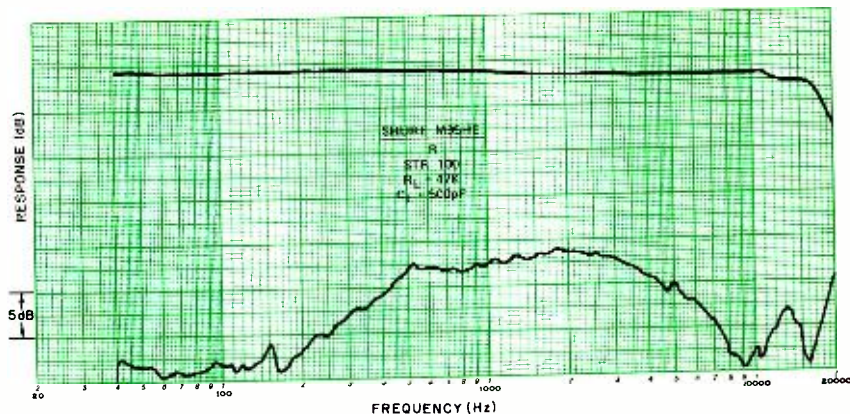

*Frequency response and crosstalk for M95HE Stereo Phono Cartridge.*

separation was 28 to 30 dB with all but the B&K record, which gave a 20-dB reading. At 20,000 Hz, the CBS and B&K records gave respective separation readings of 17.5 and 15 dB, while the JVC and Audio-Technica records showed a 22-dB separation.

The low-frequency resonance in the low-mass Thorens tonearm (14 grams effective mass, including the 6.3 grams of the cartridge) was at 10 Hz, with an amplitude of about 7 dB. Tracking distortion was measured with Shure's TTR102 (400- and 4000-Hz intermodulation distortion) and TTR103 (10.8-kHz tone bursts at a 270-Hz repetition rate) test records. The IM readings with the TTR102 increased from 2% or 3% at low levels to 6% to 8% at velocities in the 22- to 27-cm/s range. With the tracking force reduced to 1 gram, the cartridge mistracked severely above 22 cm/s. The repetition rate distortion with the TTR103 record was extremely low (Shure cartridges have consistently been outstanding in this test), increasing from 0.63% to 0.84% as the velocity increased from 15 to 30 cm/s.

Subjective tracking of the M95HE was judged with Shure "Audio Obstacle Course" records. As with the TTR103, we have found that Shure cartridges tend to be among the best in their ability to track these very-high-velocity musical selections without audible distortion. The M95HE was no exception, handling everything on the

ERA III record without difficulty and revealing only a trace of "hardness" on the highest levels of the bells and combined harp and flute sections of the ERA IV record.

**User Comment.** While it is easy to distinguish between a low-priced cartridge and a high-priced one by listening or measurement, differences tend to become more elusive when comparing cartridges of similar overall quality. Consequently, we found no dramatic audible differences between Shure's M95ED and M95HE cartridges. Their measured performance was similar, too, although most of the differences did favor the M95HE. Of course, we could not measure record wear, which should be appreciably lower with the greater contact area of the hyperelliptical stylus.

The M95HE supplements, but does not supplant, the M95ED in the Shure line. Anyone about to replace a worn stylus on the M95ED would do well to choose an N95HE, but it would be harder to justify replacing a good N95ED stylus with the N95HE just to modernize. While these two siblings can be distinguished on the basis of audible and measured performance, it is the family resemblance that prevails. It may be that reduced record wear, a fairly intangible factor hard to confirm through measurement, will tip the balance in favor of the M95HE.

CIRCLE NO 102 ON FREE INFORMATION CARD

## Lectrotech Model PPI-400 Dual-channel Peak Power Indicator

POPULAR ELECTRONICS



THE Lectrotech Model PPI-400 dual-channel, LED peak-power indicator is suitable

for monitoring the outputs of a stereo or two mono power amplifiers. It indicates power levels over a 30-dB range on two vertical columns of LEDs. A range switch provides 18 calibration points for the 0-dB level (six power levels at impedances of 4, 8, and 16 ohms). The indicator can also be calibrated to any other power or impedance over a very wide range by connecting appropriate resistances across terminals on the rear apron. The 0-dB power level can be set anywhere from 3 to 1250 watts at 8 ohms or over a different power range for impedances between 2 and 35 ohms.

The device can be connected across the speaker outputs of an amplifier or across the input terminals of the speaker systems themselves. It measures 14"W × 8"D × 3 3/4"H (35.6 × 20.3 × 9.5 cm) and weighs 3.5 lb (1.6 kg). Suggested retail price is \$129.95 (plus \$24.95 for optional No. LWC-1 walnut cabinet).

**General Description.** Each column of power indicators consists of eight calibrated LEDs. The bottom four are green LEDs and are labelled -30, -28, -24, and -12 dB. The next two are yellow LEDs and are labelled -9 and -6 dB. Finally, the two top LEDs are red and are labelled -3 and 0 dB. If the red LEDs flash during operation, it can be assumed that the amplifier is being overdriven or is being driven too close to its limits. This, of course, assumes that 0 dB corresponds to the amplifier's rated maximum output power.

The seven-position range switch has six positions calibrated in watts full-scale from 25 to 800 at a 4-ohm impedance. Separate inner scales are used for 8- and 16-ohm loads, with 0-dB power levels corresponding to 12.5 to 400 watts full-scale at 8 ohms and 6.25 to 200 watts full-scale at 16 ohms. The seventh position, labelled Aux, can be used with the optional calibration procedure to set the 0-dB sensitivity for almost any power and impedance level one wishes.

The Model PPI-400 is shipped from the factory with its calibration terminals connected together by jumper links and the Aux sensitivity set for 6.25 watts into 4 ohms for a 0-dB level indication. (This is 6 dB more sensitive than the lowest standard range.) By replacing the links with suitable resistances, their values determined according to a formula given in the own-

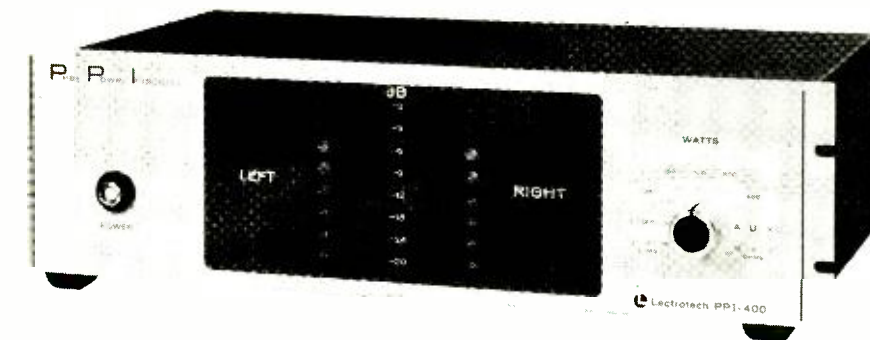

er's manual, the 0-dB sensitivity can be set as desired.

Although the accuracy of the 0-dB calibration depends on the accuracy of the resistors, the relationship between it and other power-level LEDs is fixed by the internal design of the Model PPI-400. (Precision resistors are available from Lectrotech.) Since the two channels are fully independent of each other, it is possible to set each for a different 0-dB reference.

**Laboratory Measurements.** We connected the Model PPI-400 across the output of an amplifier capable of developing the 60 volts or so required to activate its highest level LEDs. We then drove both channels in parallel to check the device's tracking.

The accuracy of the LED displays was checked at 1000 Hz. At each setting of the range switch, we increased the signal level until each of the LEDs in turn began to glow at its maximum brightness. The actual voltage applied to the device was then measured with an accurate meter and converted to an equivalent power level. Since the LEDs are not driven by a flip-flop or similar circuit, there was some ambiguity as to exactly when each LED was just on. The LEDs began to glow well below the level that produced full brightness, which resulted in an uncertainty factor of a couple of decibels when reading the display. In every case, however, the two channels behaved in identical manner.

The readings we obtained were consistently low. (The indicated power was less than the actual power.) If we had elected to use the point at which a LED first began to glow as our measuring criterion, the error would have been even greater. The error was not significant in any case, measuring about 1 dB and a maximum of 2 or 3 dB near the -24-dB indicator.

We measured the response of the

device with 1000-Hz tone-burst signals. As we changed the duty cycle from continuous to 4 cycles on and 128 cycles off, the error did not exceed 1 dB. Sensitivity was up about 0.7 dB at 20 Hz and down 4.4 dB at 20,000 Hz, relative to 1000 Hz.

**User Comment.** In view of its intended application as a peak-power indicator (not a meter), the errors we observed in the Model PPI-400 are of no significant import. The device does a fine job of displaying the actual operating signal levels—both average, shown by the number of LEDs lighted during any passage, and peak. (Even the briefest peak registers visibly on the display.)

The PPI-400 is easy to connect into an audio system, and its LED displays are clearly visible and easy to interpret even from a distance.

The owner's manual refers to the use of the Model PPI-400 as a speaker-system phasing checker. This is not entirely accurate, since all it can check is a polarity reversal of the two sets of signal leads coming from the amplifier to the speaker systems and to the device itself. Actual phasing of the connections at the speaker systems can have no effect on the behavior of the Model PPI-400.

A power-on indicator in the Model PPI-400 would have been a welcome addition. Its absence, for example, caused us to unwittingly leave the device powered for days on end. But even leaving it powered continuously, the PPI-400 operated coolly, even under full-load conditions.

In sum, this was one of the most versatile and inexpensive peak-power indicators we have used. It is attractive, flexible, and does exactly what it is supposed to do. Such a device can be an educational addition to an audio system.

CIRCLE NO. 103 ON FREE INFORMATION CARD

# If you can carry on a tradition...



Marine Corps tradition is one of strength and pride. And, as a Marine, you learn to carry it on. You learn an important job skill

from those who know their trade. You sharpen your confidence with tough physical training. And, then, you walk with pride. Because you've earned a part in

the tradition of the Corps. Find out more about us. Mail the card or call 800-423-2500, toll free. In California, 300-252-0241.

## Maybe you can be one of us.



The Few.  
The Proud.  
The Marines

CIRCLE NO. 51 ON FREE INFORMATION CARD

[www.americanradiohistory.com](http://www.americanradiohistory.com)



AC—DC Operation  
 BNC Inputs 1 Meg Direct 50 Ohms Prescaled  
 8 Large .4" LED Readouts  
 Auto Decimal Point & Zero Blanking  
 1 Year Limited Warranty Parts & Labor  
 100% Factory Assembled in U.S.A.

**\$149<sup>95</sup>**

MODEL 500 HH  
 50 Hz — 500 MHz  
 Without Battery Capability

MODEL 100 HH  
 50 Hz — 100 MHz

**\$99<sup>95</sup>**

Without Battery Capability

**SAVE \$5<sup>00</sup>**

With Battery Capability

MODEL 500 HH .. \$169.95

MODEL 100 HH .. \$119.95

The 100 HH and 500 HH hand held frequency counters represent a significant new advancement, utilizing the latest LSI design . . . and because it's a DSI innovation, you know it obsoletes any competitive makes, both in price and performance. No longer do you have to sacrifice accuracy, ultra small readouts and poor resolution to get a calculator size instrument. Both the 100 HH and 500 HH have eight .4 inch LED digits — 1 Hz resolution — direct in only 1 sec. or 10 Hz in .1 sec. — 1 PPM TCXO time base. These counters are perfect for all applications be it mobile, hilltop, marine or bench work. (800—854-2049) (800—542-6253)

**FREQUENCY COUNTER CONSUMER DATA COMPARISON CHART**

MANUFACTURER	MODEL	SUG. STD. LIST PRICE	FREQUENCY RANGE	TYPE OF TIME BASE	ACCURACY OVER TEMPERATURE		SENSITIVITY			DIGITS		PRE-SCALE INPUT RESOLUTION	
					17° - 40°C	0° - 40°C	100 Hz - 25 MHz	50 MHz - 250 MHz	250 MHz - 450 MHz	No.	SIZE IN INCHES	.1 SEC	1 SEC
DSI INSTRUMENTS	100 HH	\$ 99.95	50Hz-100MHz	TCXO	1 PPM	2 PPM	25 MV	NA	NA	8	.4	100 Hz	10 Hz
DSI INSTRUMENTS	500 HH	\$149.95	50Hz-550MHz	TCXO	1 PPM	2 PPM	25 MV	20 MV	30 MV	8	.4	100 Hz	10 Hz
CSC‡	MAX-550	\$149.95	1kHz-550MHz	Non-Compensated	3 PPM @ 25°C	8 PPM	500 MV*	250 MV	250 MV	6	.1	NA	1 kHz
OPTOELECTRONICS	OPT-7000	\$139.95	10Hz-600MHz	TCXO	1.8 PPM	3.2 PPM	NS	NS	NS	7	.4	1 kHz	100 Hz

\* 1 KHz - 50 MHz ‡ Continental Specialties Corp.

The specifications and prices included in the above chart are as published in manufacturer's literature and advertisements appearing in early 1979. DSI INSTRUMENTS only assumes responsibility for their own specifications.

100 HH . . . \$ 99.95 W/Battery Pack . . . \$119.95  
 500 HH . . . \$149.95 W/Battery Pack . . . \$169.95

Prices and/or specifications subject to change without notice or obligation.

These prices include factory installed rechargeable NiCad battery packs.



**DSI INSTRUMENTS, INC.**  
 7924 Ronson Road, Dept. G  
 San Diego, California 92111

CIRCLE NO. 15 ON FREE INFORMATION CARD

www.americanradiohistory.com

T-500 Ant. . . . . \$ 7.95  
 AC-9 Battery Eliminator . . . . . \$ 7.95

TERMS: MC - VISA - AE - Check - M.O. - COD in U.S. Funds  
 Please add 10% to a maximum of \$10.00 for shipping, handling and Insurance. Orders outside of USA & Canada, please add \$20.00 addition to cover air shipment. California residents add 6% Sales Tax.

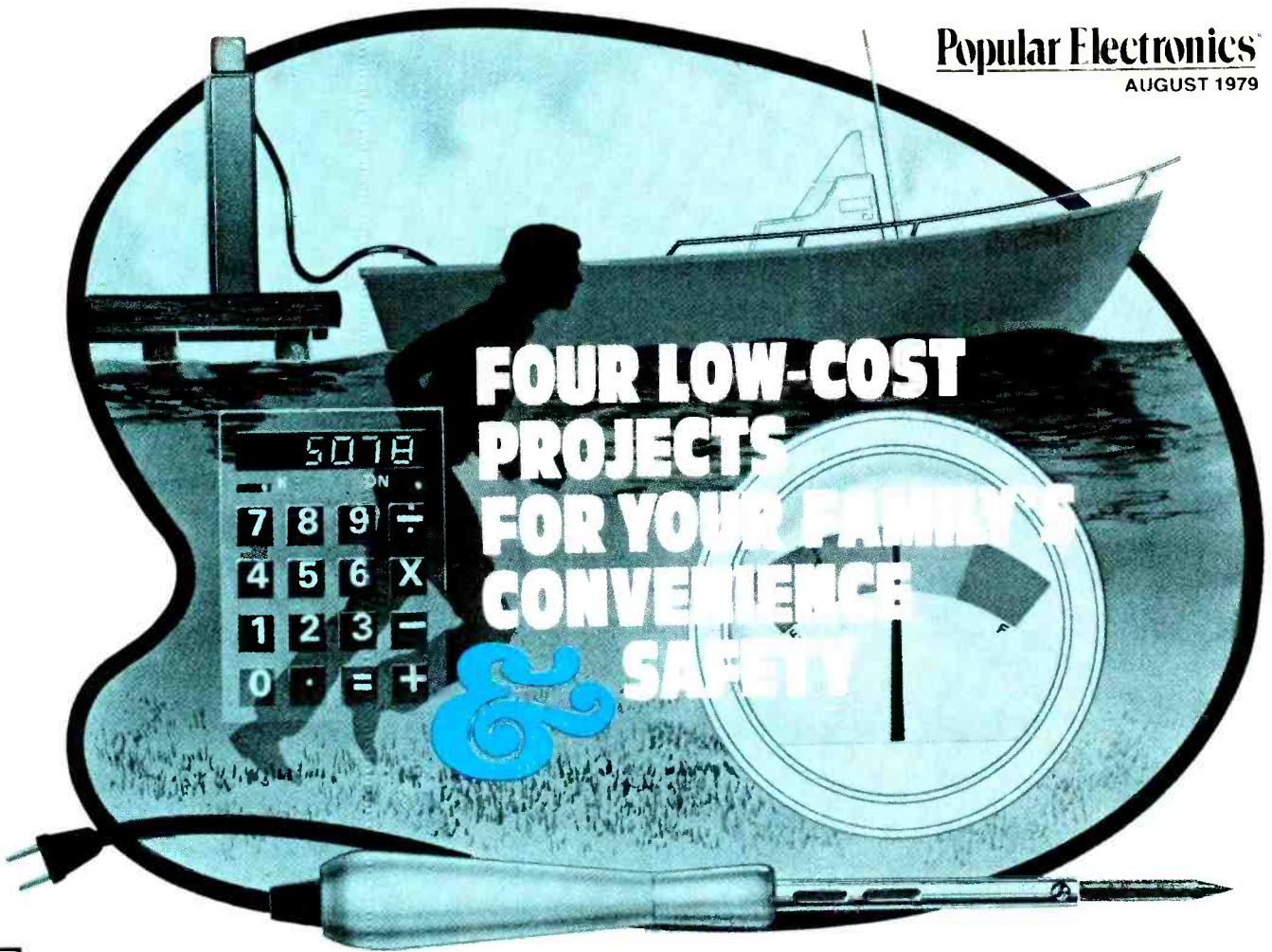

## Solid-state level-sensing switch for sump pumps

By Phillip Windolph

**A** FLOODED basement is a minor household disaster. That's why most homeowners whose basements are prone to flooding install sump pumps. Some, however, have discovered to their chagrin that the pump somehow fails to operate when it is most needed. In many instances of failure, the pump itself is actually in perfect working order. Rather, it is the water-detecting actuator switch that's the culprit, never sending a turn-on command to the pump.

Here's a simple, dependable circuit to replace the often-unreliable (usually mechanical) switch supplied as part of the pump assembly. It will automatically activate the pump when the water level reaches the level of a pump trigger probe. Once activated, the pump will re-

main energized until the water level falls below a keep-alive probe. If the pump fails or cannot keep the water in check, an optional alarm will sound as the water level reaches a trigger probe specifically for that purpose. The project can be powered either by batteries or the ac line. Inexpensive components are employed, most of which will be found in any well-stocked junk box.

**About the Circuit.** The Electronic Sump Pump Switch is shown schematically in the figure. Positive voltage from the power supply is applied to the COMMON probe via resistors *R1* and *R2*. (This and all other probes are stiff wires or metal rods suspended above and extending to different levels in the sump.)

*Replaces often-unreliable pump switch and sounds alert if water level continues to rise or pump isn't working*

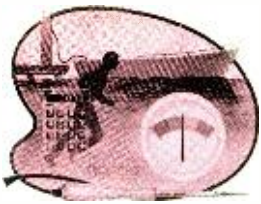

## Low-cost Projects continued...

As can be seen in the figure, the COMMON probe extends almost to the bottom of the sump. Any water entering the sump comes into contact with this probe, but as yet nothing which would cause activation of the pump happens.

As the water level in the sump rises, the KEEP-ALIVE probe touches the water, but this still does not activate the pump. If the water reaches the level of the PUMP TRIGGER probe, current can flow from the positive supply voltage terminal through R1, R2, the water in the sump, R5 and finally into the base of Q3. This transistor then turns on and provides base current for Q4. When Q4 conducts, it energizes the coil of relay K1.

Once this relay is energized, the normally open contacts are closed and two things happen. Line current is able to flow through the coil of K2, a heavy-duty ac relay. Also, the path between the KEEP-ALIVE probe and the base of Q3 is completed. Energizing K2 provides line

voltage across S01 for the pump. If the sump pump is connected to the socket, it will be activated and will start to pump the water out of the sump.

As the water level drops, the conductive path provided by the water in the sump between the COMMON and PUMP TRIGGER probes will be interrupted. However, current will continue to reach the base of Q3 via the KEEP-ALIVE probe, R7, and one set of contacts of relay K1. Because this probe extends almost to the bottom of the sump, relays K1 and K2 remain energized (as does the pump motor) until practically all of the water has been evacuated. When the water level drops below the free end of the KEEP-ALIVE probe, Q3 is deprived of base current and is cut off. This causes Q4 to stop conducting, deenergizing K1, K2 and the pump motor.

If the pump motor fails or cannot cope with the amount of water entering the sump, the water level will rise above the

PUMP TRIGGER and KEEP ALIVE probes and eventually reach the ALARM TRIGGER probe. This probe is part of the optional alarm circuit and should be mounted near the top of the sump. Although the alarm circuit is independent of the pump controller, it is a valuable addition to the project.

The alarm circuit closely resembles that of the pump controller and operates in a similar manner. Water reaching the ALARM TRIGGER probe provides a path for current to reach the base of Q1. This transistor begins to conduct and provides base drive for Q2. Transistor Q2 then conducts and completes the circuit for audible alarm A1, which alerts the homeowner to the fact that water in the sump has risen to a critically high level. He can then try to get the pump working

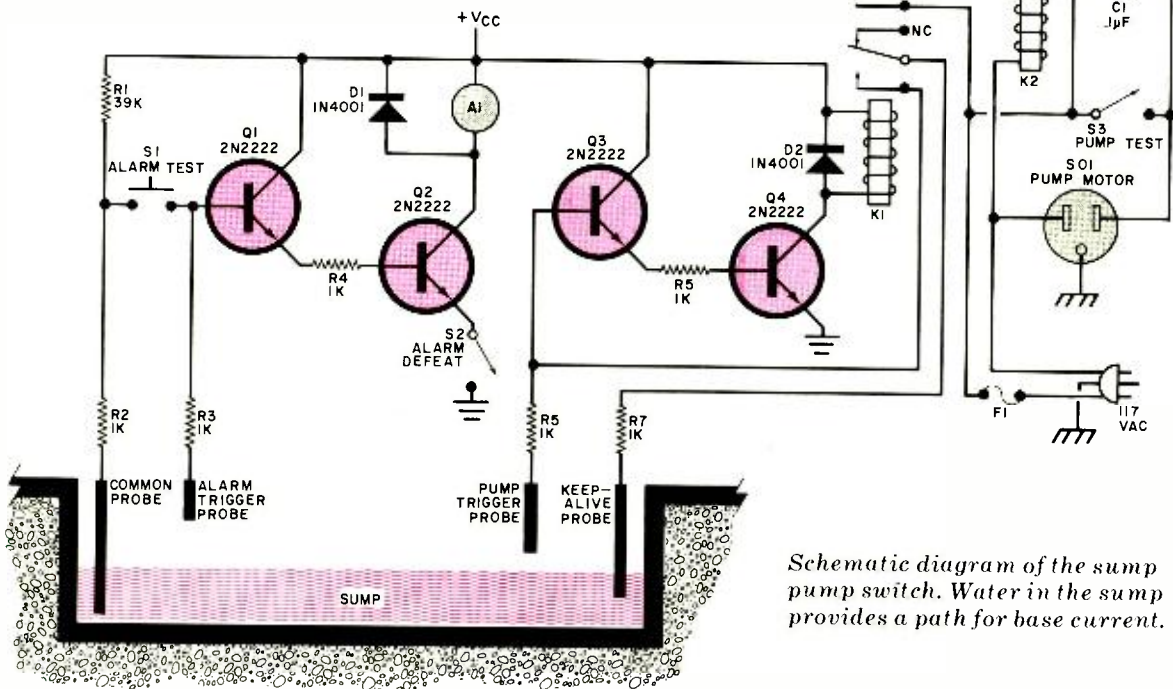

Schematic diagram of the sump pump switch. Water in the sump provides a path for base current.

### PARTS LIST

A1—Dc-energized buzzer, bell, Sonalert™ or similar audible alarm\*  
 C1—0.1- $\mu$ F, 1000-volt disc ceramic  
 D1, D2—1N4001 rectifier  
 F1—Fast-blow fuse\*  
 K1—Dc-energized relay\*  
 K2—117-volt relay\*  
 Q1 through Q4—2N2222 or similar npn switching transistor\*

The following are 1/4-watt, 10% tolerance carbon-composition resistors:  
 R1—39,000 ohms\*  
 R2 through R7—1000 ohms\*  
 S1—Normally open pushbutton switch  
 S2—Miniature spst toggle switch  
 S3—Spst toggle switch\*

S01—Ac power socket  
 Misc—Line-powered, regulated or battery dc supply\*; suitable enclosure; barrier terminal strip; perforated board; fuseholder; line cord; metal rods or stiff, solid-conductor wire; hookup wire; solder; self-tapping and machine hardware, etc.

\*See text.

or, if necessary, bail the water out of the sump manually.

Two switches are associated with the alarm circuit and one switch is included in the pump controller. These switches provide test facilities for the alarm and pump (*S1* and *S3*, respectively) and the ability to silence the alarm (*S2*). The currents handled by *S1* and *S2* are relatively small, so miniature components can be used in these locations. Switch *S3*, however, as well as the contacts of *K2* must be capable of handling the current demanded by the pump motor, so use heavy-duty components.

The author employed a solenoid/spring-type buzzer as his prototype's audible alarm. Diode *D1* is connected across the buzzer to protect *Q2* from inductive spikes generated by the buzzer. Other types of alarms can be used, some of which will not require the inclusion of *D1*. A Sonalert™ or similar audio oscillator will not necessitate diode protection for *Q2*, but an alarm bell will.

Which type of audible alarm you choose is largely a matter of personal preference and parts availability. Similarly, there is a great deal of leeway in the choice of components *Q1* through *Q4* and *R1* through *R7*. General-purpose 2N2222 transistors are suggested in the parts list. Just about any low-power npn transistor is suitable for use as *Q1* and *Q3*. Exactly which transistor types are acceptable for use as *Q2* and *Q4* depends on the audible alarm and relay (*K1*) used. If the current demand of either load is fairly low, say, 300 mA or less, a general-purpose component such as type 2N2222 can be used as a relay or alarm driver.

However, if a load draws more than 300 mA, a higher-power driver will have to be used. A good rule of thumb is to use a transistor with a collector current rating that is double the current required by the alarm or relay coil. The author employed a sensitive 6-volt relay for *K1* (Sigma No. 70R4T-6DC), which permitted the use of a low-power npn driver. Diode *D2* was included to protect the relay driver from inductive spikes.

The values specified for the fixed resistors (*R1* through *R7*) are nominal ones. Substitutions can be made freely if you want to use components you have on hand. However, do not make the fixed resistances so low that they tax the base current ratings of the transistors employed in the project.

Either a line-powered or battery supply can be used for the project. The exact value of supply voltage is not critical

and can be chosen to accommodate a particular dc relay (*K1*). Practical supply voltages range from 6 to 15 volts. Although it is not necessary, voltage regulation is desirable in a line-powered supply. The widespread availability of voltage regulator ICs makes the inclusion of regulation simple and inexpensive.

If the alarm circuit is included in the project, battery power enjoys a significant advantage over a line-powered supply—it will still provide power to the project if the commercial power line is blacked out. Of course, if line power is not available, the pump motor will not be activated, even though *K1* will be energized. The alarm circuit, however, will be activated if the water in the sump rises to the level of the ALARM TRIGGER probe. This will alert the homeowner that water is accumulating and had best be bailed out before any damage occurs. Also, when neither the alarm nor pump controller circuit is triggered, practically no current is drawn from the battery supply. If nonrechargeable batteries are used to power the project, long operational life can be expected.

**Construction.** The circuit is relatively simple, which suggests the use of perforated board and point-to-point wiring techniques. Remote mounting of the alarm and pump controller circuits will simplify any future servicing. If this is done, the circuit board, relays, switches and power supply can be housed in a suitable enclosure which can be installed at some convenient location.

A four-terminal barrier strip can be mounted on the control box for the leads running to the sump probes. These probes can be fashioned from either metal rods or lengths of solid No. 12 or No. 14 copper wire and should be mounted rigidly above the sump. The probes are of varying length, with the COMMON probe extending almost to the bottom of the sump, the KEEP-ALIVE probe extending almost as deeply, the PUMP TRIGGER probe reaching about halfway down, and the ALARM TRIGGER probe extending only a short distance into the sump. Suitable lengths of hookup wire should be soldered to the probes and routed to the barrier terminal strip on the control box.

When constructing the control box, be sure to observe the polarities of all semiconductors and, if a line-powered supply is built in, of electrolytic capacitors. Use the minimum amount of solder and heat consistent with making good connections. Take special care in wiring the

117-volt ac portions of the project so that no shock hazard is present.

**Checkout and Installation.** After the control box has been wired, connect short lengths of hookup wire to the barrier terminal strip. Remove a portion of the insulation from the free end of each wire. Next, fill a drinking glass or measuring cup with water and place the wire connected to the COMMON probe terminal into the water. Place the wire connected to the KEEP-ALIVE probe terminal into the water. (Keep these and all probes from touching each other to realistically simulate actual operation. No damage will occur, however, if the probes accidentally come into contact.) Activation of the pump controller, indicated by a click as the relays are energized, should not yet happen.

Now insert the wire connected to the PUMP TRIGGER probe terminal into the water. You should hear a click as the relays are energized. If desired, a lamp can be connected to power socket *S01* and the line cord connected to the power line (assuming this has not yet been done). The lamp will then indicate that the relays are energized and that line power is reaching socket *S01*.

Remove the PUMP TRIGGER wire from the water. The relays should remain energized and no click should be heard. Then remove the KEEP ALIVE wire from the water. At this time, the relays should drop out and a click heard. Finally, insert the ALARM TRIGGER wire into the water. The alarm should sound and remain on until the wire is removed from the water.

Press the ALARM TEST pushbutton and keep it depressed. The alarm should sound and remain activated until the ALARM DEFEAT switch is opened. The operation of the PUMP TEST switch can be checked by closing it and observing whether the load connected to socket *S01* receives line power.

Once it has been determined that the control box is functioning properly, a permanent installation can be made. Mount the control box at some convenient point and interconnect it with the sump probes and pump motor. Be sure to bypass the stock pump-activating switch as it is no longer needed. As a final check, you can quickly fill the sump with water. The alarm should sound until the pump has lowered the water level beyond the reach of the ALARM TRIGGER probe. The pump should remain on until the KEEP ALIVE probe is no longer immersed, at which point nearly all of the water will have been taken out. ◇

*(Projects continued overleaf)*

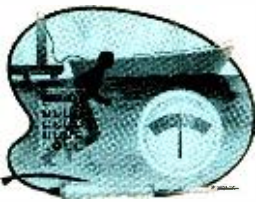

*Low-cost Projects continued...*

## 2. Vehicle low-fuel indicator

*Alarm sounds when level in vehicle fuel tank drops to a predetermined level*

**R**UNNING out of gas can be an exasperating experience. The low-fuel indicator described here can help you avoid this situation. It will sound an alarm when the fuel level in your gas tank reaches a predetermined minimum. This level can be preset by a simple potentiometer adjustment.

**Circuit Operation.** In most vehicles, the fuel-level sensor is a float-controlled potentiometer (sender) wired in series with the dashboard-mounted fuel gauge (meter) and connected between the chassis and +12-volt line as shown in Fig. 1. As the fuel level changes, the resistance changes, making the meter indication change.

The voltage level thus generated across the fuel-level sensor can be tapped off (at the meter) and, as shown in Fig. 2, applied through a low-pass filter *R8-C4* so that the voltage across *C4* is the average across the sender. This low-pass filter also eliminates any rapid voltage fluctuations due to gasoline sloshing and a bouncing sensor float, or

By Bradley Albing

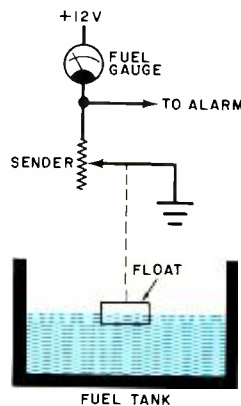

Fig. 1. Typical fuel-gauge circuit.

voltage transients generated by the switching voltage regulator as used in some vehicles.

The *C4* voltage is applied to the non-inverting (+) input of comparator *IC1*, and rises with decreasing fuel in the tank. When this voltage exceeds the *R4*

preset voltage on the inverting (-) input, the output of *IC1* (pin 6) goes high.

This voltage (approximately 9 volts) is high enough to cause zener diode *D6* to conduct and turn on transistor *Q1*. When turned on, this transistor draws current through audible alarm *A1*, and turns on optional indicator *LED1*.

As long as the fuel level is low, the output of *IC1* remains high. To silence the alarm until the tank is filled, CANCEL switch *S1* is depressed to trigger *SCR1*. When triggered, the SCR brings the junction of *R5-D6* (the input to *Q1*) down to approximately 2.2 volts, which is not high enough to cause *D6* to conduct and activate the alarm circuit. Since the SCR is powered by dc, it will remain turned on as long as the *IC1* output is high (the fuel level is low).

As long as *SCR1* is conducting, there will be about 1.2 volts (two diode drops) across *D7* and *D8*, enough to turn on *Q2* and cause *LED2* to operate. This LED is a special type that incorporates a built-in flasher circuit that makes the LED flash at a 2.5-Hz rate as long as the LED is

*(Continued on page 40)*

Cable on author's prototype has connector for +12 volts, ground and tank sender unit.

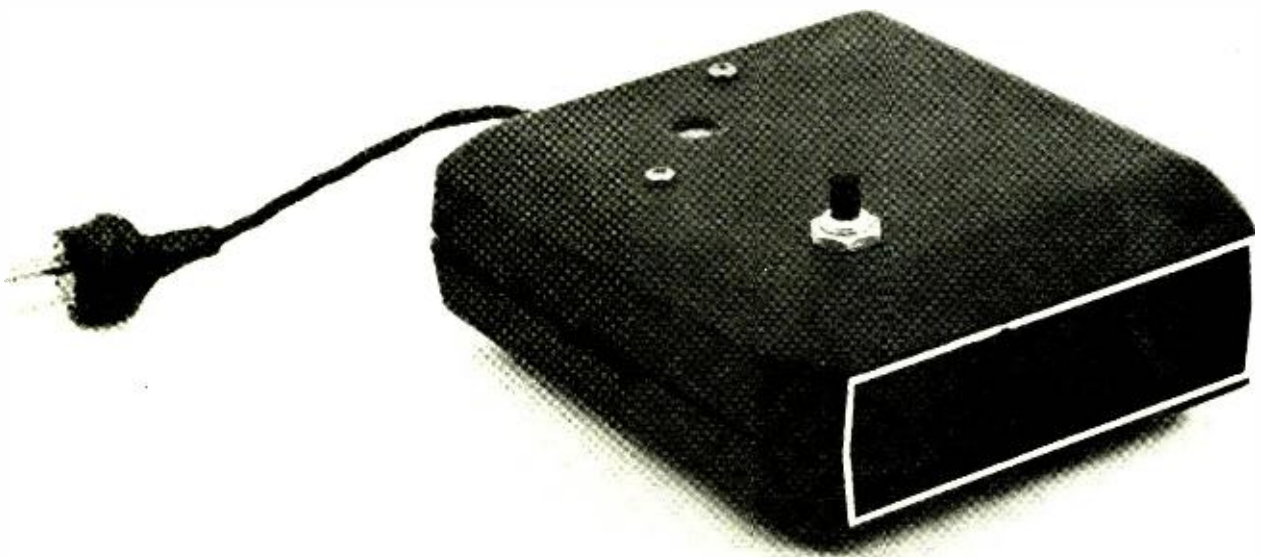



## PARTS LIST

- A1—Sonalert, buzzer or other 12-volt alarm (Radio Shack 273-060 or similar)  
 C1, C2—100- $\mu$ F, 25-V aluminum electrolytic  
 C3, C5—0.1- $\mu$ F, 25-V disc or Mylar  
 C4—300- $\mu$ F, 15-V tantalum electrolytic  
 D1, D7, D8—1N914  
 D2—1N5742, 18-V, 400-mW zener  
 D3, D4, D9—1N751A, 5.1-V, 400-mW zener  
 D5—1N4001  
 D6—1N5732, 6.8-V, 400-mW zener  
 ICI—3140E op amp  
 LED1—red LED  
 LED2—Litronix FRL-4403 flashing LED (Radio Shack 276-036)  
 Q1—2N3053 or similar  
 Q2—2N3904 or similar  
 The following are 1/4-watt, 10% tol. resistors:  
 R1, R11—100 ohms  
 R2—33 ohms  
 R3, R5, R12—470 ohms  
 R6—10 megohms  
 R7—470,000 ohms  
 R8—33,000 ohms  
 R9—330 ohms  
 R10—10,000 ohms  
 R13—820 ohms  
 R14—200 ohms  
 R4—25,000 ohm potentiometer  
 SCR1—2N5062  
 S1—normally open pushbutton switch  
 Misc.—Suitable enclosure (Radio Shack 270-285 or similar), interconnecting leads, mounting hardware  
 Note: The pc board (LF-2) is available for \$4.50 plus \$1 postage/handling from BFA Electronics, P.O. Box 212, Northfield, OH 44067. Ohio residents please add sales tax.

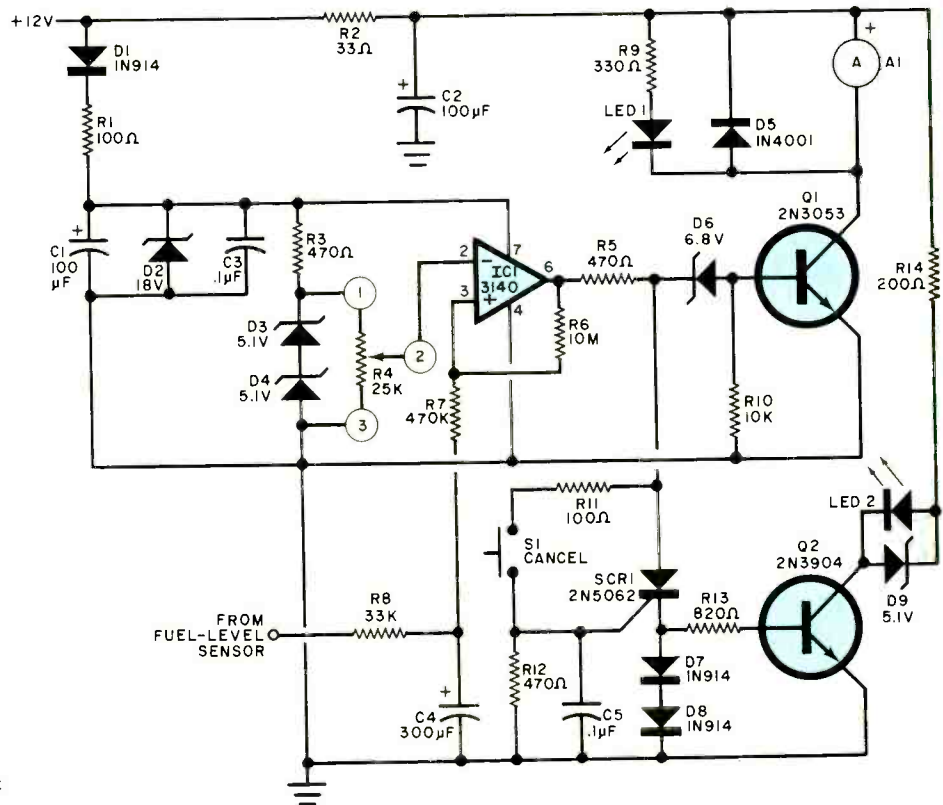
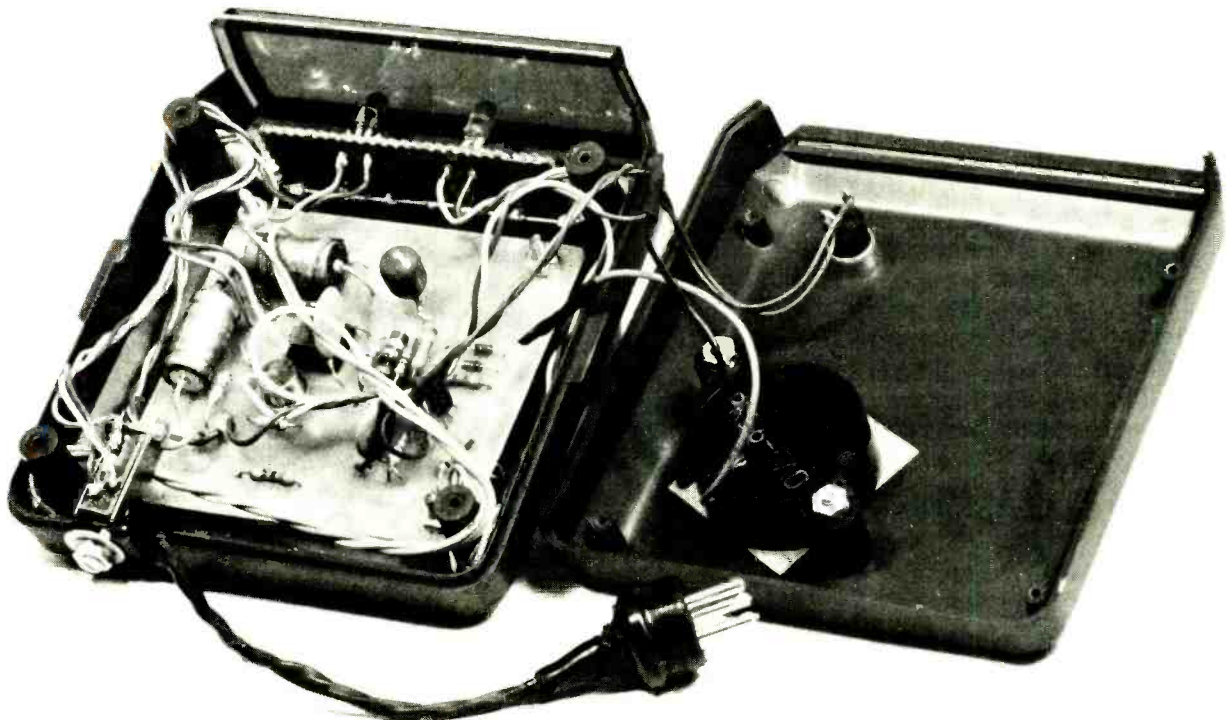

Fig. 2. Comparator IC1 turns on when fuel drops below some predetermined level, and sounds the alarm. The SCR circuit energizes a flashing LED during the Cancel mode.

Printed circuit board mounted in prototype with alarm and CANCEL switch on top.



---

# At CIE, you get electronics career training from specialists.

**If you're interested in learning how to fix air conditioners, service cars or install heating systems – talk to some other school. But if you're serious about electronics, come to CIE – The Electronics Specialists.**

---

*John E. Cunningham*

**Special Projects Director  
Cleveland Institute of Electronics**

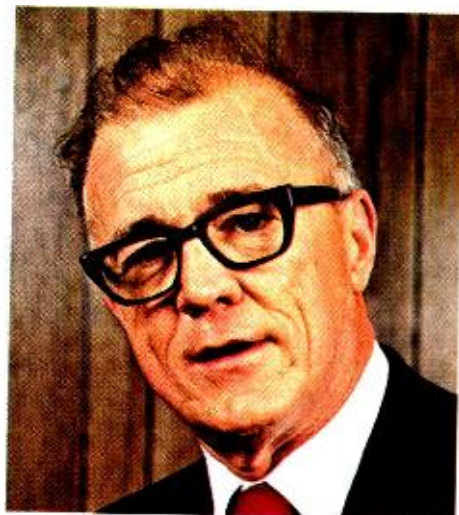

**M**y father always told me that there were certain advantages to putting all your eggs in one basket. "John," he said, "learn to do one important thing better than anyone else, and you'll always be in demand."

I believe he was right. Today is the age of specialization. And I think that's a very good thing.

Consider doctors. You wouldn't expect your family doctor to perform open heart surgery or your dentist to set a broken bone, either. Would you?

For these things, you'd want a specialist. And you'd trust him. Because you'd know if he weren't any good, he'd be out of business.

**Why trust your education and career future to anything less than a specialist?**

You shouldn't. And you certainly don't have to.

FACT: CIE is the largest independent home study school in the world that specializes exclusively in electronics.

We have to be good at it because we put all our eggs in one basket: electronics. If we hadn't done a good job, we'd have closed our doors long ago.

**Specialists aren't for everyone.**

I'll tell it to you straight. If you think electronics would make a nice hobby, check with other schools.

But if you think you have the cool – and want the training it takes – to make sure that a sound blackout during a prime time TV show will be corrected in seconds – then answer this ad. You'll probably find CIE has a course that's just right for you!

**At CIE, we combine theory and practice. You learn the best of both.**

Learning electronics is a lot more than memorizing a laundry list of facts about circuits and transistors. Electronics is interesting because it's based on some fairly recent scientific discoveries. It's built on ideas. So, look for a program that starts with ideas – and builds on them.

That's what happens with CIE's Auto-Programmed® Lessons. Each lesson uses world-famous "programmed learning" methods to teach you important principles. You explore them, master them completely... before you start to apply them!

But beyond theory, some of our courses come fully equipped with the electronics gear to actually let you perform hundreds of checking, testing and analyzing projects.

In fact, depending on the course you take, you'll do most of the basic things professionals do every day – things like servicing a beauty of a Zenith color TV set... or studying a variety of screen display patterns with the help of a color bar generator.

Plus there's a professional quality oscilloscope you build and use to "see" and "read" the characteristic waveform patterns of electronic equipment.

**You work with experienced specialists.**

When you send us a completed lesson, you can be sure it will be reviewed and graded by a trained electronics instructor, backed by a team of technical specialists. If you need specialized help, you get it fast... in writing from the faculty specialists best qualified to handle your question.

**People who have known us a long time, think of us as the "FCC License School."**

We don't mind. We have a fine record of preparing people to take... and pass... the government-administered FCC License exams. In fact, in continuing surveys nearly 4 out of 5 of our graduates who take

the exams get their Licenses. You may already know that an FCC License is needed for some careers in electronics – and it can be a valuable credential anytime.

**Find out more! Mail this card for your FREE CATALOG today!**

If the card is gone, cut out and mail the coupon.

I'll send you a copy of CIE's FREE school catalog, along with a complete package of independent home study information.

For your convenience, I'll try to arrange for a CIE representative to contact you to answer any questions you may have.

Remember, if you are serious about learning electronics... or building upon your present skills, your best bet is to go with the electronics specialists – CIE. Mail the card or coupon today or write CIE (and mention the name and date of this magazine), 1776 East 17th Street, Cleveland, Ohio 44114.



Patterns shown on TV and oscilloscope screens are simulated.

**CIE** Cleveland Institute of Electronics, Inc.  
1776 East 17th Street, Cleveland, Ohio 44114  
Accredited Member National Home Study Council

**YES...** John, I want to learn from the specialists in electronics – CIE. Send me my FREE CIE school catalog – including details about troubleshooting courses – plus my FREE package of home study information. PE-95

Print Name \_\_\_\_\_  
Address \_\_\_\_\_ Apt. \_\_\_\_\_  
City \_\_\_\_\_  
State \_\_\_\_\_ Zip \_\_\_\_\_  
Age \_\_\_\_\_ Phone (area code) \_\_\_\_\_

Check box for G.I. Bill information:  Veteran  Active Duty

**Mail today!**

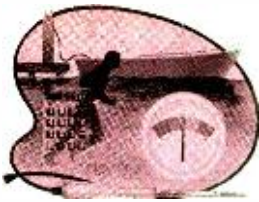

## Low-cost Projects continued...

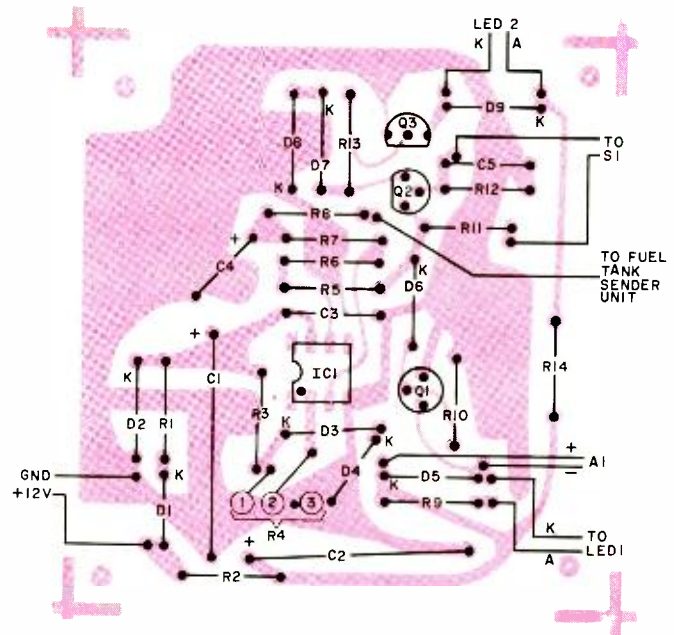

Fig. 3. Actual-size etching and drilling guide is shown at left. Component placement guide is above.

powered. The maximum voltage permitted across this special LED is 6 volts, hence the presence of 5.1-volt zener diode *D9*.

The incoming dc power line is noise decoupled by *R1*, *C1* and *C3*. Zener diode *D2* clamps any transients to a maximum of 18 volts while diode *D1* makes sure that the correct polarity is supplied to *IC1*. Filter *R2-C2* decouples the power line to the alarm and indicator circuit. Diode *D5* clamps any voltage spikes that may occur if an inductive load, such as a buzzer, is used as the alarm. Resistor *R6*, connected between the output of *IC1* (pin 6) and the noninverting (+) input, adds a small amount of positive feedback to give the comparator a little hysteresis and speed up the transition from low to high. This also reduces the likelihood of comparator oscillation.

**Construction.** The circuit may be constructed on perf board, Wire-Wrapped, or on a pc board such as that

shown in Fig. 3 along with the component installation.

The two LED indicators, CANCEL switch *S1*, level-select potentiometer *R4*, and the selected audible alarm are not mounted on the pc board.

The finished pc board can be mounted within a selected enclosure that will also mount the off-board components. Power can be derived from any +12-volt source that becomes active when the vehicle ignition key is operated. The ground can be any convenient metal element that is solidly connected to the vehicle chassis.

You will have to locate the dashboard end of the fuel sensor lead. Test this lead by measuring the voltage across it with various levels of fuel. Usually, the lower the fuel level, the higher the voltage. It is possible for this voltage to vary due to the action of the vehicle switching voltage regulator (if your vehicle uses one) so this must be considered.

If you have any doubt as to the type

and wiring of the fuel-level sensor in your vehicle, consult the vehicle repair manual.

**Calibration.** There are two ways to calibrate the system. The first is to wait until the fuel level is down to the selected low level, then adjust *R4* until the alarm sounds off.

The second approach is to disconnect the fuel gauge from its feed line to the fuel sender but leave the lead connected to the low-fuel alarm, then connect a resistor-substitution box between the fuel gauge and ground (as a substitute for the fuel sender). Adjust the value of the resistor until the fuel gauge indicates the desired level. Adjust *R4* to sound the alarm at that point. Disconnect the resistor box and replace the fuel sender line.

Once the fuel-level turn-on point has been determined, depress *S1* to silence the alarm. After the tank is filled, the alarm will be reset until the fuel level drops below the predetermined point. ◇

# 3. Portable gas leak meter

*Ultra-sensitive instrument gives quantitative indication of natural gas, propane, fuel vapors, etc.*

**T**OXIC and explosive gases are an ever-present danger in our modern society. They include natural gas, propane, fuel vapors, and invisible and odorless carbon monoxide.

The ultra-sensitive gas-leak detector presented here indicates the quantitative presence of these gases and enables one to track down and pinpoint the source of a gas leak by observing the unit's meter indication. Moreover, it is a portable, battery-powered model for use in boats, automobiles, at campsites, or in any other location where ac power is not available. (An ac-operated noxious gas detector with an audible alarm for preset gas levels was described in a project that appeared in POPULAR ELECTRONICS, August 1976.)

**Circuit Operation.** The gas sensor, GS1 in Fig. 1, consists of an electrically heated tin-oxide pellet that changes resistance when exposed to carbon monoxide, hydrogen, propane, alcohol, gasoline vapor, and other oxygen-reducing gases. Power for the circuit can be obtained from either six D cells, preferably rechargeable, connected in series or from an optional 9-volt battery eliminator. Regulator IC1 reduces the available 9-volt level to the 5 volts required by the circuit. Optional LED1 is a 9-volt power-on indicator.

Current from the regulator heats gas sensor GS1's semiconductor pellet. The sensor, R4, R7, and R8 are arranged in a bridge configuration. The null indicator consists of M1 and R6, while D1 and D2

serve as protection for M1. Overall circuit sensitivity is determined by the value of resistor R5, while S2 provides a BATT. TEST function.

Once the bridge is balanced, by NULL potentiometer R8, any change in the resistance of GS1 will create an unbalanced condition. When this occurs, the meter's pointer swings up-scale, by an amount proportional to the change in resistance of GS1.

**Construction.** With the exception of GS1, J1, M1, B1, R8, S1, and S2, the circuit can be assembled on a piece of perforated board. Select an enclosure large enough to accommodate the board and all off-board components, including B1 and its holder.

## TIMEGLOW

**NEW Digital Electronic Alarm Clock Systems and Clock/radio Modules in RED, GREEN, or BLUE**

Timeglow Company Ltd. — A company exclusively devoted to electronic time "movements"

Our prices are **LOWEST** because we specialize in time systems. All merchandise 100% guaranteed.

Now you can make a digital clock anywhere and in any color you want. Step by step instructions provided for systems. Only soldering iron and solder needed for easy assembly.



TG 1002 R12-S Complete kit except case

**Functional Features TG 1001 and TG 1002**

- Available in two display sizes: TG 1001, 6" (15mm) and TG 1002, 9" (23mm)
- High efficiency "RED", "GREEN" and "YELLOW" LED display
- User programmable 12/24 hr., 50/60 Hz. fixed or flashing color indicator
- On board alarm oscillator
- P.A.M. Color Alarm "OH" LED indicators
- Multiple 7-minute snooze counter
- Direct drive LED display - no RFI
- 24 hr. alarm with ON-OFF control
- Display flashes after power has been interrupted for more than 2 seconds
- Inoperative to temporary loss of power (2 sec.)
- Easy to use slow, fast and seconds time set controls
- One finger 59-minute sleep counter setting
- Four display modes (TIME, SECONDS, ALARM and SLEEP)
- Leading zero blanking
- External brightness control capability
- On board radio switch for clock radio applications
- Pulsating 2 kHz alarm tone output
- Operates from single winding transformer

**Functional Features TG 1003**

- User programmable 12 or 24 hr. and fixed or flashing color indicators.
- Digit size 3" (7.5 mm), 4 digit fluorescent indicator panel
- Hours, minutes, seconds set controls.
- Hours, minutes, seconds reset control with on the hour signal output (1024 Hz, 1 sec.)
- Speaker included
- Operates from 12 VDC supply.
- Lockout of time setting when display is "off" with display mode select
- Automotive display brightness control logic
- Crystal controlled oscillator (4,194,304 KHz)
- Bright 0.3" vacuum fluorescent display filterable to Blue, Green and Yellow.
- Protected against automotive voltage transients and battery reversal.
- Convenient no roll over time setting controls at 1 Hz rate.
- Leading zero blanking

**Functional Features TG 1004**

- LCD 4" (10mm) 4 digit display
- AM, PM indicator (for 12 hr. only), WK (wake time) and TM (sleep time) indicators
- 12 or 24 hr. available
- User programmable fixed or flashing color
- On board alarm oscillator
- Multiple 7 minute snooze counter
- 24 hr. alarm with on-off control
- 59 minute sleep counter setting
- Convenient no roll over time setting controls at 1 Hz rate on hours and minutes
- Hours, minutes reset control with on the hour signal output
- Crystal controlled oscillator of 32.768 KHz
- Leading zero blanking

**TG 1005** — A 12 or 24 hr clock module featuring 4 digit, 6" (15mm), vacuum fluorescent display filterable to Blue, Green or Yellow. Other features similar to TG 1001.

**Digital Electronic Alarm Clock System**

(Complete kit except case)

QTY	ITEM NUMBER	DESCRIPTION	**PRICE
	TG 1001 R12-S	LED Red, 12 hr., 6" (15mm) system	\$ 9.95
	TG 1001 R24-S	LED Red, 24 hr., 6" (15mm) system	11.50
	TG 1002 R12-S	LED Red, 12 hr., 9" (23mm) system	11.50
	TG 1002 R24-S	LED Red, 24 hr., 9" (23mm) system	13.00
	TG 1001 G12-S	LED Green, 12 hr., 6" (15mm) system	12.50
	TG 1001 G24-S	LED Green, 24 hr., 6" (15mm) system	14.00
	TG 1001 Y12-S	LED Yellow, 12 hr., 6" (15mm) system	12.50
	TG 1001 Y24-S	LED Yellow, 24 hr., 6" (15mm) system	14.00
	TG 1003 B-S	VF Blue, 12 or 24 hr. 3" (7.5mm) system, 12VDC, Case, switches & speaker inc.	19.95
	TG 1004 12-S	LCD, 12 hr., 4" (10mm) system includes switches & speaker	19.95
	TG 1004 24-S	LCD, 24 hr., 4" (10mm) system includes switches & speaker	19.95
	TG 1005 12-S	VF, 12 hr., 6" (15mm) system	12.50
	TG 1005 24-S	VF, 24 hr., 6" (15mm) system	14.00

**Clock (radio) Module only**

QTY	ITEM NUMBER	DESCRIPTION	**PRICE
	TG 1001 R12	LED Red, 12 hr., 6" (15mm) module	\$ 6.95
	TG 1001 R24	LED Red, 24 hr., 6" (15mm) module	7.75
	TG 1002 R12	LED Red, 12 hr., 6" (15mm) module	8.50
	TG 1002 R24	LED Red, 24 hr., 6" (15mm) module	9.25
	TG 1001 G12	LED Green, 12 hr., 6" (15mm) module	9.50
	TG 1001 G24	LED Green, 24 hr., 6" (15mm) module	10.25
	TG 1001 Y12	LED Yellow, 12 hr., 6" (15mm) module	9.50
	TG 1001 Y24	LED Yellow, 24 hr., 6" (15mm) module	10.25
	TG 1003	VF, 12 or 24 hr. module, 3" (7.5mm) speaker included (no switches, no case)	14.95
	TG 1004 12	LCD, 12 hr., 4" (10mm) module	17.95
	TG 1004 24	LCD, 24 hr., 4" (10mm) module	17.95
	TG 1005 12	VF, 12 hr., 6" (15mm) module	9.50
	TG 1005 24	VF, 24 hr., 6" (15mm) module	10.25

\*For TG 1001 and TG 1002 modules and systems, only the 24 hr. modules have optional 12/24 hr. capability.  
\*\*After a 4 month introductory period, prices will increase starting Dec. 1, 1979, for systems with \$2.00 and for modules with \$1.50 per item. Accessories prices will remain the same.

**Accessories**

QTY	ITEM NUMBER	DESCRIPTION	PRICE
	TG 100	Fast and slow set, seconds and alarm on-off switch	\$1.00
	TG 101	Snooze and alarm set switch	1.00
	TG 100 LE/VF	Transformer 120V	2.00
	TG 200 LE/VF	Transformer 220V	3.00
	TG 300	Speaker for alarm	1.00
	TG 400	Line cord 120V	1.00
	TG 401	Line cord 220V (Europe)	2.00
	TG 500	Case for TG 1003 (3" x 2" x 2")	5.95

**Shipping and Handling Charges**

For clock systems add \$2.50 per system. For modules and accessories (except transformers) add \$1.00 per order.  
For transformers add \$1.00 per transformer.  
For orders over \$100.00 - no charge.  
We ship worldwide - Add 20% for overseas orders. Prices subject to change without notice.  
To order, call or send check/money order with order form to: Microgram, Inc. 14320 Saratoga-Sunnyvale Road Saratoga, CA 95070 U.S.A. Tel: (408) 867-5659 TWX/TELEX: 910-590-9000 Microgram

Name \_\_\_\_\_ Phone \_\_\_\_\_  
 Address \_\_\_\_\_ City \_\_\_\_\_ State \_\_\_\_\_ Zip \_\_\_\_\_  
 Charge card number VISA/MC \_\_\_\_\_ Exp. Date \_\_\_\_\_  
 For MC include 4-digit interbank number \_\_\_\_\_ Signature \_\_\_\_\_

Total price of items checked above \_\_\_\_\_  
 Calif. residents add 6% sales tax \_\_\_\_\_  
 Shipping & handling charges \_\_\_\_\_  
 Total check or money order \_\_\_\_\_

OEM customers: Large discounts available.

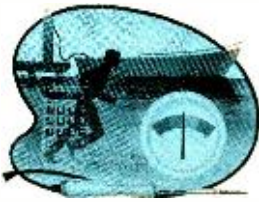

## Low-cost Projects continued...

Mount the meter movement on one side of the enclosure's front panel, the remaining off-board components (except *B1* and *J1*) on the other side of the panel. The battery holder and optional battery-eliminator/charger jack *J1* are best mounted on the rear wall of the en-

er, set *S1* to ON and *S2* to BATT. TEST, and make a note of the point on the meter's scale at which the pointer comes to rest. Turn off the power and carefully remove the cover from the meter's face. Use a felt marker to identify the battery-test point on the meter's scale.

*S2* to RUN and, in a neutral atmosphere, adjust NULL control *R8* until the meter indicates zero. Now, place a drop of alcohol or gasoline on a finger and approach the sensor. The meter pointer should swing up-scale. Move the finger away from the sensor; it will take a min-

### PARTS LIST

- B1—Six D cells in series
  - D1, D2—Germanium diode (1N34A or similar)
  - GS1—Model 812 gas sensor
  - IC1—5-volt regulator (Radio Shack No. 276-1770 or similar)
  - J1—Normally closed miniature phone jack (Radio Shack No. 274-281 or similar)
  - LED1—Red light emitting diode
  - M1—50- $\mu$ A meter (Radio Shack No. 22-051, No substitute)
  - R1—1000-ohm, 1/2-W, 10% resistor
  - R2—22,000-ohm, 1/2-W, 10% resistor
  - R3, R7—4700-ohm, 1/2-W, 10% resistor
  - R4—15,000-ohm, 1/2-W, 10% resistor
  - R5—2700-ohm, 1/2-W, 10% resistor
  - R6—2200-ohm, 1/2-W, 10% resistor
  - R8—10,000-ohm linear potentiometer
  - S1—Spst switch
  - S2—Dpdt switch
  - Misc.—7-pin miniature tube socket; battery holder; enclosure; 9-volt dc calculator-type ac adapter (optional); machine hardware; hookup wire; solder; etc.
- \*Available for \$7.50 postpaid from Southwest Technical Products Dept., PE-2, 219 W. Rhapsody, San Antonio, TX 78216.

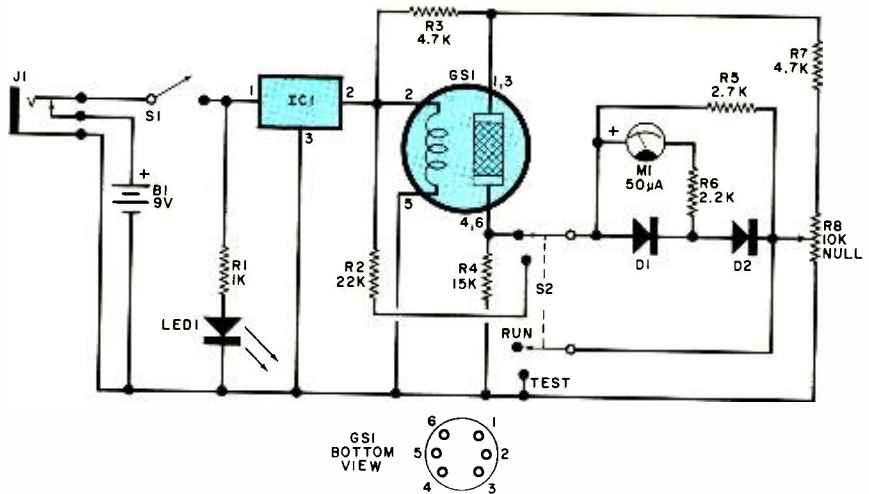

Fig. 1. The gas sensor forms one arm of a Wheatstone bridge. Pins 1, 2 and 3 can be interchanged with pins 4, 5 and 6. Once bridge is balanced by *R8*, a change in resistance of *GS1* will cause meter pointer to swing upscale.

closure. If desired, *GS1* can be mounted either directly on the front panel or in a separate housing, the latter fitted with a cable to connect it to the main enclosure. The sensor itself takes a miniature 7-pin tube socket.

After the project is assembled, install a fresh set of D cells in the battery hold-

**Operation.** Set *S1* to ON and allow the sensor to heat up for about two minutes. Set *S2* to BATT. TEST and check that sufficient voltage is available from the battery. (A set of fresh D cells will last about 20 hours. An external 9-volt battery-eliminator/charger can be used.)

After the sensor has warmed up, set

ute or so for the sensor to settle back for the next measurement. Readjustment of *R8* may be necessary occasionally. If setting time is too long, change *R7* to 1000 ohms.

When looking for a gas leak, note locations where the meter swings up-scale to narrow down the location. ◇

# 4 Electronic pedometer for joggers

By Andrew A. Modia

*How to convert a calculator into a pedometer to record distance covered while walking or jogging.*

**A**N INEXPENSIVE pocket calculator can be converted to operate as an electronic pedometer to keep an on-going tally of the number of steps taken while walking and jogging. Then, with a

simple conversion, you can use the calculator to determine the number of yards, meters, miles, or kilometers travelled. Although the conversion described here is "hard wired" into the cal-

culator, you sacrifice none of the calculator's basic built-in capability.

**Calculator Conversion.** The first thing you must do is determine whether

or not your calculator has a built-in constant function. To do this, press CLEAR, 1, +, 1, =, =. If your calculator has the necessary constant function, the display should read 3 and should increment by 1 for each additional operation of the = key. Having established the fact that your calculator does indeed have the constant function, you can proceed with the conversion.

Conversion of the calculator consists in simply wiring a foot-operated switch across the = key. First, carefully open the calculator's case and locate the contacts for the = key. Then solder a 5' (1.5-meter) or so length of 26-gauge flexible stranded wire to each = switch contact. Insulate the soldered connections with a layer of electrical tape.

Now, test your hookups in the following manner. Turn on the calculator and key in 1, +, 1. Touch together and separate the free ends of the wires two times. With the first touch, the display should read 2 and with the second, 3. If the test checks out properly, turn off the calculator and reassemble it, routing the wires out through the side of the case. If necessary, use a sharp knife to cut a slot to allow the wires to exit the case. No other modification is necessary.

**Footswitch Fabrication.** As shown in the drawing, the footswitch is fabricated from a commercially available "air-pillow" foam insole. Begin by cutting a 1" (25.4-cm) square away from the center of the heel area of the insole. Cement a square of copper-coated Mylar or any other flexible conductive material over the cutout on both sides of the insole, conductive surfaces face-to-face.

Solder the free ends of the flexible wires from the calculator to the conductive material. Then cover the "switch" assembly with duct or other durable tape to keep out dirt and moisture.

Slide the insole into your shoe and put on the shoe. Turn on the calculator and

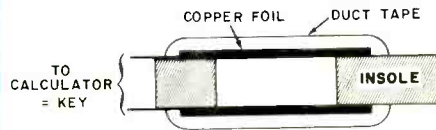

*Place copper foil on each side of insole hole and insulate with tape.*

key in 1, +, 1. Now, as you walk around the display should read 2, then 3, then 4, etc., as you successively put weight on the switch shoe with each step. If you do not obtain these results, turn off the cal-

culator and carefully check out the switch arrangement.

**Determining Distance.** Every time you use the pedometer, you must first key in 1, +, 1. Thereafter, the calculator increments the display by 1 for each step taken by the shoe in which the switch is installed. To determine how far you have run or walked, you must find out how many steps you take in a given measured distance (mile, kilometer, etc.). You must, therefore, measure off the "control" distance and walk or run it to determine how many steps are required to cover the course.

Let us assume you wish to know how many miles you have walked and have previously determined that it takes you 1056 steps to walk a mile. (Note that a step is two strides. If the switch is in your right shoe, a step is completed every time you set down your right foot.) Now, subtract 1 from the total displayed by the calculator. This is necessary because the first step you take will register 2. If we assume you stopped at 7200 steps, simply divide this number by 1056 your "control" number, using the calculator to obtain the number of miles walked. Therefore,  $7200/1056 = 6.82$  miles. ◊

**NEW!**



## PRB-1 DIGITAL LOGIC PROBE

Compatible with DTL, TTL, CMOS, MOS and Microprocessors using a 4 to 15V power supply. Thresholds automatically programmed. Automatic resetting memory. No adjustment required. Visual indication of logic levels, using LED's to show high, low, bad level or open circuit logic and pulses. Highly sophisticated, shirt pocket portable (protective tip cap and removable coil cord).

- DC to > 50 MHz
- 10 Nsec. pulse response
- 120 K  $\Omega$  impedance
- Automatic pulse stretching to 50 Msec.
- Automatic resetting memory
- Open circuit detection
- Automatic threshold resetting
- Compatible with all logic families 4-15 VDC
- Range extended to 15-25 VDC with optional PA-1 adapter
- Supply O.V.P. to  $\pm 70$  VDC
- No switches/no calibration

**\$36<sup>95</sup>\***

\* ADD \$2.00 FOR SHIPPING (N. Y. CITY AND STATE RESIDENTS ADD TAX)

**OK MACHINE & TOOL CORPORATION**

3455 Conner St., Bronx, N.Y. 10475 (212) 994-6600 / Telex 125091

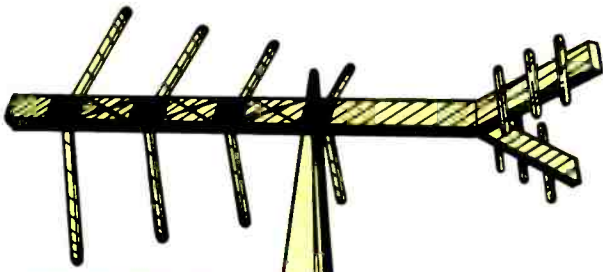

BY ROBERT GROVE

Make-it-yourself  
antenna  
improves reception  
of  
public services

**G**OOD RADIO reception depends as much on a good antenna as it does on a "hot" radio receiver. This is especially true with modern public-safety-band vhf/uhf scanning monitors, which almost invariably have high sensitivities in the range of  $0.5 \mu\text{V}$  or better. Aside from the usual whip antenna supplied with the scanning monitor, there are few commercially made antennas available for working vhf and uhf.

Fortunately, there is an alternative to a commercially made vhf/uhf antenna. A standard TV antenna can be "tailored" to provide excellent reception on the public safety bands. In this article, we will describe how this can be done and give you some idea of how the modified TV antenna stacks up against a popular high-performance discone antenna.

**Antenna Theory.** The standard whip antenna supplied with scanning monitors is generally adequate for city-wide reception of repeaters and base stations. However, when an external antenna is connected to the scanner to improve weak-signal reception, *all* signal

**SCANNER  
BEAM  
PINPOINTS  
THE  
ACTION!**



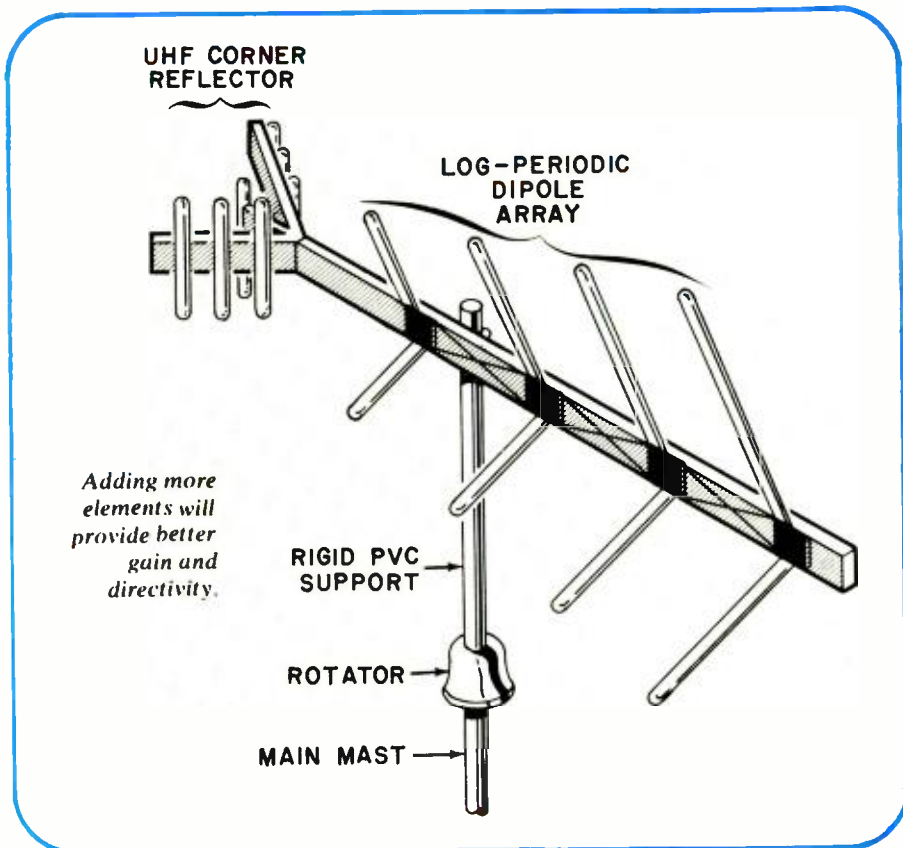

levels increase dramatically—including the levels of local signals. This can lead to problems. The most serious forms of scanning monitor interference are front-end overloading and intermodulation distortion, recognized by their frequent recurrence throughout the tuning range of the receiver. Images from aircraft communication and FM and TV signals that pop up in the middle of the public safety bands are another problem.

The problems that plague the public-safety-band listener are especially severe in metropolitan areas. The problem is compounded with the use of omnidirectional ground-plane antennas that respond equally well in all directions. What is really needed to maximize reception is a beam antenna with high forward gain and greatly limited side and rear gain. Such an antenna can be aimed at the transmitting source to zero in on that single signal to the virtual exclusion of other signals that can interfere with and mask the desired signal.

A few modifications to a low-cost TV antenna can produce an excellent beam antenna for vhf/uhf public-safety-band monitoring. We modified a Radio Shack "Super Color Special" (similar to the Model VU-90) antenna for our purposes. The results we obtained were so satisfactory that no further experimentation was necessary.

The TV antenna employs a log-periodic design in which every element is cross-connected to the feed line. The antenna is actually a series of center-fed dipoles, each slightly different in length to resonate at a slightly different frequency. The dipoles are connected to a common feedline. The response of the elements is related to the logarithm of the frequency; hence, the name log-periodic dipole array.

Electrically, elements that are not resonant at the frequency to which a receiver is tuned at any given moment behave like directors and reflectors. This endows the antenna array with both directivity and gain. The elements of a log-periodic antenna are incrementally shortened from the longest wavelength at the lowest frequency to the shortest wavelength at the highest frequency, which gives the antenna a characteristic V-shaped outline.

Each dipole is used at two frequencies—its resonant half-wave ( $\lambda/2$ ) frequency and its three-half-wave ( $3\lambda/2$ ) frequency. Hence, the longest element performs on 140 and 420 MHz, while the shortest element performs on 174 and 522 MHz. Also, because of the large diameter of the elements, compared to their length, the dipoles are very broadband. This makes the modified antenna usable over a range from well below 130

to beyond 174 Mhz in its  $\lambda/2$  mode and from below 400 to beyond 550 MHz in its  $3\lambda/2$  mode.

With the antenna erected, you will note that its elements are angled forward. This is done to merge the front lobes of the characteristic cloverleaf pattern that occurs on any  $3\lambda/2$  dipole. The result is that the directivity of the antenna is considerably increased.

When used for TV only applications, the Radio Shack Super Color Special (as well as the Model VU-90) antenna offers an average gain of 4 to 6 dB (about 1 S unit) over a single dipole. Its front-to-back ratio is around 12 dB. Antennas with more elements will provide better gain and directivity figures.

Because the feed impedance for the antenna is approximately 300 ohms or less, a standard 4:1 TV Balun matching transformer is required between the antenna and the coaxial line you will be using. You need not concern yourself about the impedance of the feed line; either 50- or 75-ohm coax will work fine. For cable runs in excess of 50' (15.2 m), use RG-8/U foam dielectric coax. Although new dry 300-ohm twin-lead feed cable is low in losses, when it gets old, wet, and cracked, it causes more problems than it is worth. It is for this reason that coaxial cable is recommended industry-wide for two-way radio communication and commercial TV signal distribution systems.

**Modification.** Referring to the drawing, saw off the entire boom section that contains the 6" (15.2-cm) elements in front of the corner reflector. Be careful to avoid damaging the longer element closest to the reflector (this element is connected to the antenna's cross-feed system) or any of the reflector elements.

Next, cut the longest pair of angled elements to a length of 20" (50.8 cm) on each side of the boom. This 40" (101.6-cm) dipole is now cut for 140 and 420 MHz. Now, cut the shortest pair of angled elements to 16" (40.6 cm) on each side of the boom. This 32" (81.2-cm) dipole is now cut for 170 and 510 MHz.

Once the longest and shortest elements are trimmed to size, the remaining elements can be proportionately trimmed so that the outline of the antenna will have a characteristic V shape. You simply place a straightedge on each side of the antenna so that it touches the extreme ends of the cut elements and locate the cut points for the remaining elements. In the case of the Super Color Special and Model VU-90 antennas, the

# Eye-level Weight Watcher

**Separate digital readout puts your exact weight right before your eyes.**

Your present scale gives you a number for every five pounds - and a line for the pounds in between. To make matters worse, the needle's at your feet.

Our scale puts your weight where your eyes are—in bold, red, easy-to-read numbers. It's marvelous! You step on the scale and your weight's right there. A visual record of the pounds you shed.

The readout unit mounts with either self-adhesive clips or screws. The color's soft white. The physical size of the scale unit is 10.5" x 10.5" x 2.5" and the digital readout unit is 4.75" x 3" x 1.25". Try it on a 15-day money back guarantee. Call toll free to charge it to any national credit card or send your check for \$49.95 plus \$5.50 shipping and handling to Douglas Dunhill. (Ill. residents add sales tax.) Complete with four AA batteries. Watching your weight's never been easier or as nice.

**Call Toll-Free  
800-621-5554**

Illinois residents please call 800-972-5858  
(In operation 24 hours, 7 days a week)



- Computer controlled electronic accuracy
- Automatically adjusts to zero
- 300 lb. capacity
- A fraction of the price of doctor-type pedestal scales without a digital readout

**Douglas Dunhill**  
INC. AFFORDABLE QUALITY

Dept. 53-2378  
Ten Douglas Dunhill Drive, Oak Forest, IL 60452  
© Douglas Dunhill Inc. 1979



third and second longest elements will be 17" (43.2-cm) and 18" (45.4-cm) long, respectively, on each side of the log periodic array's boom.

Trim the longer corner reflector elements so that each of them is 16" long. Then lift the antenna to locate its new center of balance. Drill two new 1/4" (6.35-mm) holes, properly spaced, through the boom to accommodate the U bolt that fastens the antenna to its mast. Make certain that these holes are drilled to permit the antenna to be oriented so that its elements point up and down after mast mounting. Also, make certain that the U-bolt hardware does not touch the aluminum wire that cross-connects the elements.

Mount the antenna on a 36" (0.91-m) length of 1 1/4" (31.8-mm) outer-diameter rigid PVC pipe. Do *not* substitute a metal pipe because it will interfere with the signal path. The metal mast should be at least  $\lambda/4$  away from the longest antenna element. (Rigid PVC pipe can be obtained from any building supply house and many hardware stores.)

Mount the antenna and PVC pipe support on a rotator, following the cable-routing instructions faithfully. Connect the Balun transformer to the antenna and the coax feed line to the Balun. Then coat the connections with silicone adhesive to weatherproof them.

**How It Performs.** We made comparison checks between the modified TV antenna and an excellent commercially available vhf/uhf discone monitor antenna. Signals that were barely readable on vhf with the discone antenna came in substantially stronger with the modified beam antenna. More important was the fact that signals from the back of the antenna were noticeably reduced and those off to the sides were deeply attenuated with the beam, all of which contribute to a reduction in interference and an overall improvement in reception. The modified beam performed even better on uhf than it did on vhf. Signals improved from "barely-discernable" to "full-quieting."

Our experience with the modified beam makes it clear that this antenna is an excellent choice for listeners who are plagued by strong nearby transmitters and experience weak incoming signals. The modified beam even has the added advantage that it works well on the 2-meter amateur radio band; just be careful to avoid pumping more than a few watts into the Balun to avoid overheating. Happy listening. ◇

# SIMPLE TRS-80 PROGRAMS SOLVE ELECTRONICS CALCULATIONS

BY ROY BABYLON

**T**HE FOLLOWING programs were designed to be run on a Level-1 TRS-80 microcomputer having 4K of memory. All the programs are self-prompting when run and are also readily adaptable to any other BASIC. (The square-root subroutine can be eliminated if your particular BASIC has a built-in square-root function.)

**Ohm's Law.** This program, shown in Table 1, is fairly short and has no sub-routines. Line 40 selects the unknown resistance, voltage, current or power. Lines 70 through 100 are used to deter-

mine the unknown resistance; lines 110 through 130 are for current, while lines 145 through 160 are used to determine the voltage. Once the current (I) and resistance (R) have been determined, line 295 displays the wattage.

**Resonance.** The program shown in Table 2 can determine frequency of a tuned circuit when C and L are known, or can determine either C or L if the desired resonant frequency and one of these two elements are known. The program will also determine the Q of a series or parallel tuned circuit, bandwidth

and/or the impedance. The square-root subroutine used in determining resonant frequency is called at line 220.

**Inductive Formulas.** Table 3 illustrates a program that will determine instantaneous voltage, inductance of a single-layer coil, inductive/resistive time constant, the values of series and/or parallel inductors, the Q of a coil, inductive reactance and impedance of an inductive/resistive circuit. The only subroutine used (square root) is called at line 720, with this subroutine residing at line 30000.

**Table 1—Ohm's Law**

```

15 CLS
20 P.T.(20);"OHM'S LAW FORMULAS"
30 P."SELECT NUMBER FOR DESIRED FUNCTION"
40 IN."RESISTANCE=R, CURRENT=C, VOLTAGE=V,
POWER=P";A
60 IF A=R, G.70
62 IF A=C, G.110
65 IF A=V, G.145
67 IF A=P, G.180
70 IN."ENTER VOLTAGE IN VOLTS";E
80 IN."ENTER CURRENT IN AMPERES";I
100 P."THE RESISTANCE EQUALS";E/I;" OHMS"
105 END
110 IN."ENTER VOLTAGE IN VOLTS";E
120 IN."ENTER RESISTANCE IN OHMS";R
130 P."THE CURRENT IS EQUAL TO";E/R;" AMPERES"
140 END
145 IN."ENTER CURRENT IN AMPERES";I
150 IN."ENTER RESISTANCE IN OHMS";R
160 P."THE VOLTAGE IS ";I*R;" VOLTS WITH ";R;" OHMS
AND ";I;" AMPERES"
170 END
180 IN."ENTER MISSING VARIABLE R,I,E";B
190 IF B=R, G.210
195 IF B=I, G.240
200 IF B=E, G.270
210 IN."ENTER CURRENT (I)";I
220 IN."ENTER VOLTAGE (E)";E
230 P=I*E
235 G.295
240 IN."ENTER VOLTAGE (E)";E
250 IN."ENTER RESISTANCE (R)";R
260 P=(E*E)/R
265 G.295
270 IN."ENTER CURRENT (I)";I
280 IN."ENTER RESISTANCE (R)";R
290 P=(I*I)*R
295 P."THE POWER IS ";P;" WATTS"
300 END
    
```

**Table 2—Resonance (Tuned Circuits)**

```

5 CLS
10 P.T.(15);"VARIOUS FORMULAS
ON RESONANT FREQUENCY"
20 P."ENTER NUMBER OF DESIRED FUNCTION";
#1"
30 P."RESONANT FREQUENCY (FO) #2"
40 P."UNKNOWN INDUCTANCE (L) #3"
50 P."UNKNOWN CAPACITOR (C) #4"
60 P."Q OF SERIES OR PARALLEL CIRCUIT (Q) #5"
70 P."BANDWIDTH (BW) #6"
80 P."IMPEDANCE, SERIES OR PARALLEL (Z)
90 IN."UNKNOWN FACTOR IS NUMBER ";U
100 IF U=1,G.170
110 IF U=2,G.240
120 IF U=3,G.280
130 IF U=4,G.320
140 IF U=5,G.360
150 IF U=6,G.520
170 IN."ENTER VALUE OF INDUCTOR IN MILLIHENRIES";L
180 IN."ENTER VALUE OF CAPACITOR IN MICROFARADS";C
210 X=(L/1E3)*(C/1E6)
220 GOS.30030
230 P."THE RESONANT FREQUENCY IS ";.159/Y;" HERTZ"
235 END
240 IN."ENTER RESONANT FREQUENCY (FO) DESIRED";F
250 IN."ENTER CAPACITOR VALUE IN MICROFARADS";C
260 L=.0254/(F*F)*(C/1E6)
270 P."THE INDUCTOR NEEDED IS ";L*1000;" MILLIHENRIES"
275 END
280 IN."ENTER RESONANT FREQUENCY DESIRED ";F
290 IN."ENTER INDUCTOR VALUE IN MILLIHENRIES ";L
300 C=.0254/(F*F)*(L/1E3)
310 P."THE CAPACITOR NEEDED IS ";C*1E6;" MICROFARADS"
315 END
320 IN."ENTER THE REACTANCE (XC OR XL) IN OHMS";X
330 IN."ENTER THE SERIES RESISTANCE IN OHMS";R
340 P."THE Q OF THE CIRCUIT IS ";X/R;" UNITS"
350 END
360 IN."ENTER UNKNOWN, Q=Q, FO=F, BW=B";X
370 IF X=Q,G.400
    
```

```

380 IF X=F,G.440
390 IF X=B,G.480
400 IN."ENTER FO IN HERTZ";F
410 IN."ENTER BW (F2-F1) IN HERTZ";B
420 P."THE Q IS EQUAL TO ";F/B;" UNITS"
430 END
440 IN."ENTER THE Q OF THE CIRCUIT";Q
450 IN."ENTER THE BW (F2-F1) IN HERTZ";B
460 P."THE RESONANT FREQUENCY (FO)
    IS ";Q*B;" HERTZ"
470 END
480 IN."ENTER RESONANT FREQUENCY (FO) IN HERTZ";F
490 IN."ENTER THE Q VALUE";Q
500 P."THE BANDWIDTH IS ";F/Q;" HERTZ"
510 END
520 IN."ENTER VALUE OF INDUCTOR IN MILLIHENRIES";L
530 IN."ENTER FREQUENCY IN HERTZ";F
535 IN."ENTER RESISTOR VALUE IN OHMS";R
540 P."AT SERIES RESONANCE, XL AND XC CANCEL
    THEREFORE Z=";R
550 P="(6.28)*(F)*(L/1E3)
560 Q=P/R
570 P."THE PARALLEL IMPEDANCE IS EQUAL
    TO ";P*Q;" OHMS"
580 END
30000 END
30010 REM *SQUARE ROOT* INPUT X, OUTPUT Y
30020 REM ALSO USES W & Z INTERNALLY
30030 IF X=O T. Y=O:RET.
30040 IF X > O T. 30060
30050 P."ROOT OF NEGATIVE NUMBER?":STOP
30060 Y=X*.5:Z=O
30070 W=(X/Y-Y)*.5
30080 IF (W=O) + (W=Z) T. RET.
30090 Y=Y+W :Z=W:G.30070

```

**Table 3—Inductive Formulas**

```

2 CLS
10 P."AFTER EACH SOLUTION, PRESS R. ENTER
    TO BEGIN."
15 P.T.(15)"VARIOUS INDUCTIVE FORMULAS"
20 P."ENTER THE NUMBER NFXT TO DESIRED
    FUNCTION"
30 P."INSTANTANEOUS VOLTAGE
40 P."INDUCTANCE OF A SINGLE LAYER COIL #1"
50 P."INDUCTIVE/RESISTIVE TIME CONSTANT #2"
60 P."SERIES AND PARALLEL INDUCTORS #3"
70 P."Q OF A COIL #4"
80 P."INDUCTIVE REACTANCE (XL) #5"
90 P."IMPEDANCE OF INDUCTIVE/RESISTIVE CIRCUIT #6"
100 IN."FORMULA DESIRED";F #7"
110 IF F=1 G.160
120 IF F=2 G.220
130 IF F=3 G.280
140 IF F=4 G.320
144 IF F=5 G.570
145 IF F=6 G.640
146 IF F=7 G.690
160 IN."ENTER VALUE OF INDUCTANCE IN HENRIES";L
170 IN."ENTER CHANGE IN CURRENT (I2-I1) IN AMPS";I
180 IN."ENTER CHANGE IN TIME (T2-T1) IN SECONDS";T
190 E=L*(I/T)
200 P."THE VOLTAGE DEVELOPED IS";E;"VOLTS"
210 END
220 IN."ENTER NUMBER OF TURNS";N
230 IN."ENTER RADIUS OF COIL IN INCHES";R
240 IN."ENTER LENGTH OF COIL IN INCHES";D
250 L=(N*R)*(N*R)/(9*R)+(10*D)
260 P."THE INDUCTANCE IS";L;"MICROHENRIES"

```

```

270 END
280 IN."ENTER THE VALUE OF INDUCTANCE
    IN HENRIES";L
290 IN."ENTER THE VALUE OF RESISTANCE
    IN OHMS";R
300 T=L/R
310 P."THE TIME CONSTANT IS";T;"SECONDS"
315 END
320 IN."ENTER THE NUMBER OF INDUCTORS";B
330 IF B=2 G.360
340 IF B=3 G.420
350 IF B=4 G.490
360 IN."ENTER VALUE OF L1 IN HENRIES";A
370 IN."ENTER VALUE OF L2 IN HENRIES";B
380 C=A+B
390 P."THE TOTAL SERIES INDUCTANCE IS";C;"HENRIES"
400 D=(1/A)+(1/B)
405 P."THE TOTAL PARALLEL INDUCTANCE
    IS";1/D;"HENRIES"
410 END
420 IN."ENTER VALUE OF L1 IN HENRIES";A
430 IN."ENTER VALUE OF L2 IN HENRIES";B
440 IN."ENTER VALUE OF L3 IN HENRIES";C
450 D=(1/A)+(1/B)+(1/C)
460 P."THE TOTAL INDUCTANCE IN SERIES
    IS";A+B+C;"HENRIES"
470 P."THE TOTAL INDUCTANCE IN PARALLEL
    IS";1/D;"HENRIES"
480 END
490 IN."ENTER VALUE OF L1 IN HENRIES";A
500 IN."ENTER VALUE OF L2 IN HENRIES";B
510 IN."ENTER VALUE OF L3 IN HENRIES";C
520 IN."ENTER VALUE OF L4 IN HENRIES";D
530 E=(1/A)+(1/B)+(1/C)+(1/D)
550 P."THE TOTAL PARALLEL INDUCTANCE
    IS";1/E;"HENRIES"
540 P."THE TOTAL SERIES INDUCTANCE
    IS";A+B+C+D;"HENRIES"
555 END
570 IN."ENTER INDUCTOR VALUE IN HENRIES";L
580 IN."ENTER THE FREQUENCY IN HERTZ";H
590 IN."ENTER RESISTOR VALUE IN OHMS";R
600 X=6.28*H*L
610 Q=X/R
620 P."THE REACTANCE OF THE CIRCUIT
    IS";X;"OHMS WITH A Q OF";Q
630 END
640 IN."ENTER THE VALUE OF INDUCTOR IN
    MILLIHENRIES";L
650 IN."ENTER THE FREQUENCY IN HERTZ";H
660 X=(6.28)*(H)*(L/1000)
670 P."THE REACTANCE OF THE CIRCUIT IS";X;"OHMS"
680 END
690 IN."ENTER THE VALUE OF INDUCTIVE REACTANCE
    IN OHMS";P
700 IN."ENTER THE VALUE OF RESISTANCE
    IN OHMS";R
710 X=(P*P)+(R*R)
720 GOS. 30030
730 P."THE IMPEDANCE OF THE CIRCUIT IS";Y;"OHMS"
740 END
30000 END
30010 REM *SQUARE ROOT* INPUT X, OUTPUT Y
30020 REM ALSO USES W AND Z INTERNALLY
30030 IF X=O T. Y=O :RET.
30040 IF X > O T. 30060
30050 P."ROOT OF A NEGATIVE NUMBER?":STOP
30060 Y=X*.5 :Z=O
30070 W=(X/Y-Y)*.5
30080 IF (W=O)+(W=Z) T. RET.
30090 Y=Y+W :Z=W :G.30070

```



# The Art of EQUALIZATION

---

---

*An expert tells how to “sweeten”  
instruments and achieve  
that special recorded “sound”*

---

BY ETHAN WINER

¶ A growing number of audio enthusiasts are using equalizers to shape a stereo system’s frequency response, whether to “adjust” a room or for creative recording purposes.

¶ An equalizer is nothing more than a device to allow frequency response of an audio signal path to be adjusted in some way. Thus, conventional bass and treble controls qualify as charter members of the club. More often, however, the term implies equipment that is more complex and sophisticated, such as that used by a mixing engineer. Let’s take a look at some of the reasons equalization (EQ) is useful and how its implementation has developed into a high art.

¶ Standard bass and treble tone controls are broadband devices that have greatest effect at the frequency extremes; that is, the highest highs and the lowest lows.

While this is fine for touching up reproduction, it is of virtually no help in correcting for narrowband colorations, which are often highly disturbing. For example, a peak in the response of an audio system in the low-to-middle treble region can produce a shrill or scratchy quality that a normal treble control cannot effectively tame. Turning down the control enough to eliminate the shrillness kills too much of the highest treble, robbing music of clarity and sparkle. Similarly, using a bass control to correct tubbiness or muddy bass response also falls short of success. Turning the control down to relieve such midbass exaggeration would simply remove the deepest frequencies so important to life-like reproduction, while perhaps still allowing some muddiness to persist. There’s got to be a better way—and there is.

*(continued overleaf)*

Fig. 1. Layout of a typical front panel for an equalizer. Note that it has controls for treble, midrange, and bass as well as a 3-position low-cut filter.

**Enter the Graphic Equalizer.** The graphic equalizer has become very popular in recent years. It is called "graphic" because, as the front-panel sliders are adjusted, their positions give an approximate display of the resultant frequency response. Each of the five to ten or more frequency bands into which the audible spectrum is divided by these devices is adjustable via its own boost/cut control. Instead of broad adjustments of treble, bass, and maybe the midrange (presence), we now have independent control over the low bass, midbass and high bass, low midrange, etc.

If we attack that shrill midtreble emphasis with an octave-band graphic equalizer, we should be able, more or less, to correct for only the troublesome peak. We'll have to settle for "more or less" because it is highly unlikely that any response anomaly could correspond exactly to the adjustments of even a ten-band device. Therefore, many professional sound contractors, recording studios and audio enthusiasts seeking precise results use the even greater resolution afforded by 1/3-octave equalization. The 1/3-octave graphics usually have 27 or so bands, and can, when teamed up with the proper measuring equipment, be used to make just about any high-quality speaker system flat to within a dB or so over much of the audible range. But there's much more to EQ than simply correcting nonideal loudspeakers or listening rooms.

**EQ In the Studio.** Now, let's look at the professional recording studio with its abundant knobs, lights, and buttons. This is where the multiple original tracks are adjusted in level and equalized before being mixed together to comprise the final two-track product. The key phrase is "before being mixed." Whereas the home listener can alter the program only in its entirety, the recording engineer can—and must—equalize sounds picked up by each microphone separately. The tool of choice for this ap-

plication is yet another equalizer referred to by many as the "console type." Virtually all professional mixing consoles use this sort of device, with one available for each mike or line input. Additional equalizers are often devoted to echo and reverb lines.

A typical front panel for such an equalizer (Fig. 1) shows that we're back to the bass-mid-and-treble format. But there are no less than five different frequency choices for treble, eight for midrange, and another five for bass. In addition, a 3-position low-cut filter is provided, as is an in/out switch for instant comparison of "before" and "after." Here we have a device that can exercise control over fifteen different frequency ranges and also be made small enough to fit in quantity into a single mixing board. (A large console will have some 30 or more of these, so size is an important factor.) Though all 15 frequencies cannot be adjusted simultaneously as with the graphic, this rarely is needed in a "one-for-each-mike" situation. Besides, you can always "patch-in" a graphic if you absolutely have to.

The last control, the PEAK/SHELF switch, changes the basic shape of the response curve being created. This is shown in Fig. 2, where in both cases treble frequency has been set to 3.2 KHz and 12 dB of boost is applied. The upper curve represents the switch in the PEAK position while the lower curve shows a SHELF. Notice that, while the treble peak affects mainly the specified frequency, there is still some influence on nearby frequencies, whether boosting or cutting. In the SHELF position, the boost or cut reaches its maximum at that frequency and remains there for all higher frequencies. The same principle applies to the bass control. The boost or cut reaches maximum at the named frequency but instead continues downward thereafter. The midrange has no shelf capability, but more expensive consoles generally have a second, additional midrange control for added flexibility. Fig. 3 contains bass shelf cuts at four different frequencies. Fig. 4 illustrates the effect of varying the bandwidth of a midrange dip. Bandwidth? Well now we're talking about the "parametric equalizer," the most recent addition to the EQ machine family.

**Parametric Power.** In a sense, the parametric equalizer is the most powerful of the equalizer types, allowing continuous adjustment of all equalization parameters (hence the name). It is

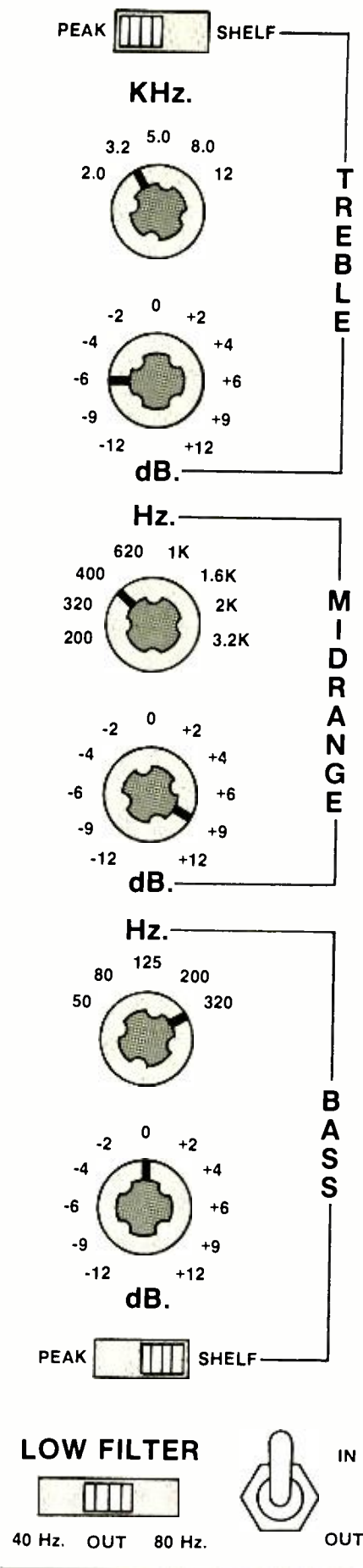

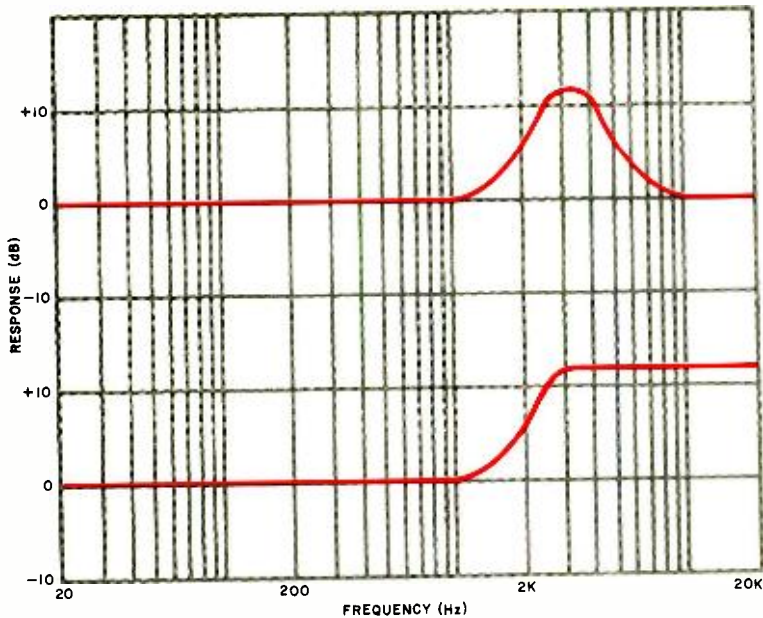

Fig. 2. The top switch in Fig. 1 changes the basic shape of the response as shown here to a peak (top) or shelf (bottom).

structured similarly to the console equalizer, but there are differences worth elaborating. First, and probably most important, all controls of a parametric are continuously adjustable. Potentiometers, rather than discrete, switch-related resistors, are employed as the tuning elements, allowing a choice of virtually any center frequency. Boost and cut controls are also continuous and typically offer a range of  $\pm 20$  dB, more than is characteristic of other equalizer types.

Another important difference is the inclusion of a bandwidth control. It was explained previously that in boosting or cutting a peak, the effect "spills over" to adjacent frequencies. How far away from the indicated center this influence

extends is determined by the setting of the bandwidth control. When set to NARROW, it allows only a small range of frequencies to be influenced. This is particularly useful for suppressing ringing or removing extraneous tones from, say, drums without changing the basic sound character. On the other side of the coin, this narrowband setting can be used to emphasize a single tone and can often effectively "purify" a muddy-sounding tom tom. Of course, this is not a substitute for proper tuning of the drums, but when all else fails. . . .

Except when dealing with drums and perhaps some tuned percussion instruments like triangles or cowbells, narrow-bandwidth boosts should usually be

avoided because unpleasant resonances or other bad effects may show up when the mix is heard on different speakers. In fact, most recording studios have alternate speaker systems available for making instant comparisons.

Broad-bandwidth settings accentuate a larger range of frequencies. Parametric equalizers are inherently peaking rather than shelving devices, but a wide setting can reasonably approximate a shelf. Do not confuse peaking with boosting, though. Peaking refers only to the shape of the curve, not to whether it is being boosted or attenuated.

All this newfound versatility, however, is not without some potential drawbacks. Probably the most obvious is the lack of precise repeatability. Since the operating controls are continuously variable, it may be difficult to recreate settings exactly to perhaps undo something you later don't like. Another factor is noise. Parametric equalizer designs generally use more op amps per frequency band than do graphic and console types. This means that cumulative noise can be more of a problem, especially when large amounts of boost are used. Distortion can build up in a similar fashion, though the latest high-slew, low-noise FET input op amps are bringing both of these factors under better control. Still, most commercially available units have a switch to bypass each band or section if it's not needed.

While studios have not unanimously traded in all their old equalizers for parametrics, many have added at least one or two. And some of the newer mixing boards are showing up with equalizers having a sweepable midrange band or a two-position switch for sharp or broad peak shape selection. So a few of the

Fig. 3. Response curves show changes for bass shelf cuts at four different frequencies.

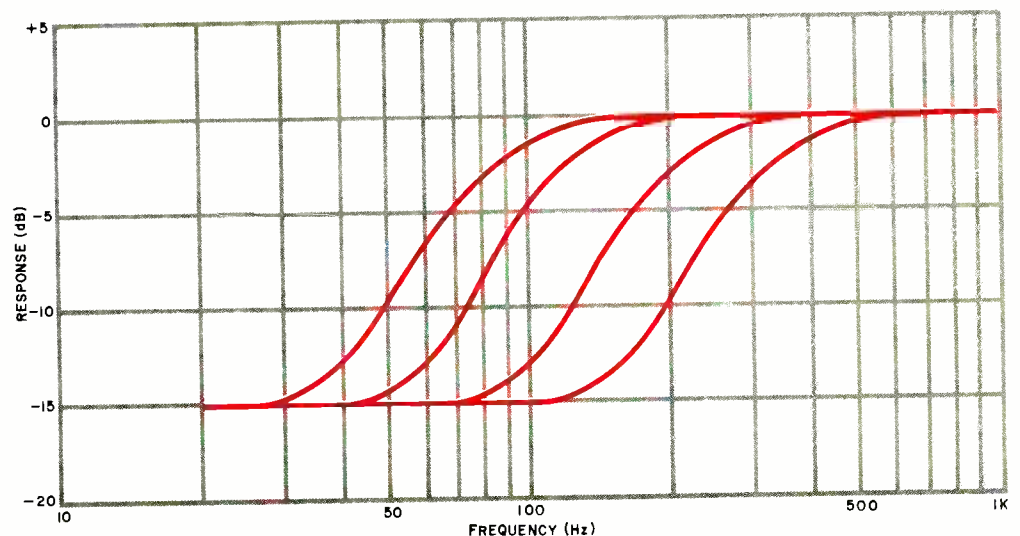

conveniences are added without having to go to a full parametric design.

Now that we've looked at the different types of devices and know how they operate, how can we use EQ to best advantage? When and how would a professional recording engineer use it? Well, first we should note that equalization can be used in two basic ways: as a tool and for personal taste.

**EQ As A Tool.** If you reflect on the task of a recording engineer, the idea that he is going to run into problems in his work will not seem surprising. The difficulties encountered may lie in the areas of instrumental balances, equipment overload, signal-to-noise ratio, and frequency response, to name a few possibilities. When the problem can be traced to frequency response—and quite a few can—the equalizer becomes an extremely valuable tool.

For example, one problem that occurs regularly is caused by the "proximity effect," a bass boost that happens when using a directional microphone in close-miked situations. Here, the low filter would be your best bet. First, it will attenuate the excessive low-frequency signal before it enters the actual EQ circuitry, minimizing the chance of overload; second, it will leave the bass control free for other uses if needed. (If the mike has its own switchable low-cut filter built in, using that to keep the unwanted frequencies out of the preamp as well will give even more overload protection.)

Another proper occasion to use the low filter is when recording vocals close-up. Not only because of the proximity effect just mentioned, but also to minimize "popping" P's, which contain a lot of low-frequency energy. Moreover, rumble and low-frequency mud can enter

your recordings owing to extraneous vibrations such as walking on non-concrete floors, operating air conditioners, and the like.

Treble is often accentuated to increase clarity or to enhance the presence of a vocal or string part that might otherwise be lost in the mix. Horns, cymbals, acoustic guitars and many other instruments can also be greatly enhanced in this way, but the engineer must know where the formants (the most important characteristic frequencies for the various instruments) lie. Boosting high treble on an instrument with little output in that region will do nothing but add hiss. In fact, when dealing with such an instrument, it is often possible to make a substantial improvement in the signal-to-noise ratio by carefully reducing the unnecessary high-frequency bandwidth with treble control on each channel for frequencies beyond the range of interest. This is most effective when done in mixdown, as tape hiss will also be reduced. For this same reason, when treble *boost* is employed, it is usually best applied ahead of the recorder.

EQ can also help to correct for poor room acoustics. Recording live, even the most accurate mike may not capture that terrific sound you hear when you stand right next to the instrument. Close-miking may help, but in many cases this is impractical since many instruments do not radiate sound from a single point source.

Consider a grand piano, string bass, xylophone, or gong. All of these radiate sound from a large surface area, leaving no single mike position that would be close to all parts of the source. Such large instruments require a more distant microphone placement if a well-balanced pickup is to be had. Unfortu-

nately, as the distance between source and mike increases, acoustics of the room begin to affect the sound. This isn't always bad—a good room might add a warmth and character unobtainable in any other manner. But when a close-up sound with lots of presence is desired, equalization in the form of treble boost or midrange cut can often do the trick.

**Seasoning To Taste.** While no one yet has found a definitive way to tell what sounds good and what doesn't, recording engineers have developed various techniques for emphasizing what they consider to be the more pleasant qualities of musical sounds. In fact, many engineers pride themselves on "getting their own sound." This is an area of taste, so naturally there are no hard, fast rules to apply. Some good starting points can be established, though, as follows. Generally speaking, you would boost treble for clarity or presence (the midrange can affect this too), and bass for fullness or punch. Sometimes it seems that no matter how much top or bottom you add, something is still not right. Often what is involved is one or more unpleasant resonances caused, as mentioned earlier, by either microphone characteristics or placement, or even by bad qualities within the instrument itself, especially if it is out of adjustment or of low quality. Eliminating these midrange resonances will often improve the sound and may minimize a need to boost highs and/or lows.

To find these magic EQ settings, start by turning off all but the principal microphone that can pick up the instrument you're working with. If it's the snare drum, for example, shut off the tom and kick mikes. They'll interact later anyway, but the less you need to concern your-

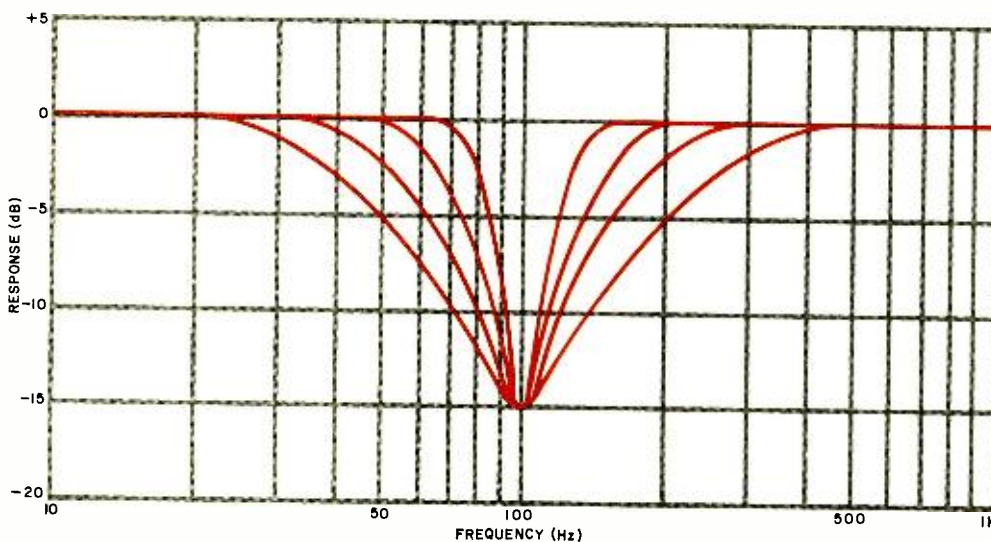

*Fig. 4. Response curves showing the effect of varying the bandwidth of a midrange dip.*



The chart given below lists some common instruments with frequencies at which boost or cut can be effectively applied to cure various problems or obtain certain effects. Indicated frequencies are necessarily approximate, as no two instruments sound exactly alike. The column marked "comments" gives cautions or observations based on experience. They should be taken as guidelines rather than prescriptions, for every situation is different and every recordist has his own sonic goals.

A few general hints may contribute to the effective use of equalization: (1) Your

## SPECIFIC INSTRUMENTS AND THEIR CHARACTERISTIC FREQUENCIES

memory is shorter than you think; return to a flat setting now and then to remind yourself where you began.

(2) Make side-by-side comparisons against commercial releases; this will help you in judging overall blend.

(3) You can tailor the sound of an instru-

ment only so far without losing its identity; every instrument can't be full, deep, bright, sparkly, etc., all at once. Leave some room for contrast.

(4) Take a break once in a while. Critical listening tends to numb one's senses after awhile, especially if you like to run monitors at high levels. Sounds may appear very different to you the next morning.

(5) Don't be afraid to experiment. If you can't find just what you want with equalization, try moving the mike a little; if that won't work, move the instrument. But, most of all, keep trying.

### COMMON FREQUENCIES FOR EQUALIZATION

Instrument	Cutting	Boosting	Additional Comments
Human Voice	Scratchy at 2 kHz. Nasal at 1 kHz. Popping p's below 80 Hz.	Hot at 8 or 12 kHz. Clarity above 3 kHz. Body at 200-400 Hz.	Tend towards thin when blending many voices.
Piano	Tinny at 1-2 kHz. Boomy at 320 Hz.	Presence at 5 kHz. Bottom at 125 Hz.	Not too much bottom when mixing with rhythm section.
Electric guitar	Muddy below 80 Hz	Clarity at 3.2 kHz. Bottom at 125 Hz.	
Acoustic guitar	Tinny at 2-3.2 kHz. Boomy at 200 Hz.	Sparkle above 5 kHz. Full at 125 Hz.	
Electric bass	Tinny at 1 kHz. Boomy at 125 Hz.	Growl at 620 Hz. Bottom below 80 Hz.	Sound varies greatly depending on type of strings used.
String bass	Hollow at 620 Hz. Boomy at 200 Hz.	Slap at 3.2-5 kHz. Bottom below 125 Hz	
Snare drum	Annoying at 1 kHz.	Crisp above 2 kHz. Full at 125 Hz. Deep at 80 Hz.	Also try adjusting tightness of snare wires.
Kick drum	Floppy at 620 Hz. Boomy below 80 Hz.	Slap at 3.2-5 kHz. Bottom at 80-125 Hz.	Usually recorded with front drum head removed. Place blanket inside of drum resting against head.
Tom toms	Boomy at 320 Hz.	Slap at 3.2-5 kHz. Bottom at 80-200 Hz.	Tuning head tension is extremely important.
Cymbals, bells, tambourines	Annoying at 1 kHz.	Sparkle above 5 kHz.	Record these instruments at conservative levels, especially at slower tape speeds.
Horns and strings	Scratchy at 3.2 kHz Honky at 1 kHz. Muddy below 125 Hz	Hot at 8 or 12 kHz. Clarity above 2 kHz Lush at 320-400 Hz.	

self with now, the better. Next, try boosting some different midrange frequencies, adding at least 10 or 15 dB, to make the changes obvious. Where you start will naturally depend on the instrument. Since physical resonances of instruments usually fall between, say, 100 Hz and 1 or 2 kHz, these frequencies are likely starting points. After determining which one sounds the *worst*, return to the flat setting momentarily to allow your ears to readjust, and then cut the chosen frequency in small steps until the

optimum point is reached. The same general plan can work for boosting, although then you'd be looking for frequencies that make the sound better when boosted.

When adding treble or bass, be sure the controls are doing what you expect them to. If you don't obtain an appreciable improvement, move on to a different frequency. Remember, a lot of boost at the extreme low end can route excessive infrasonic energy to the loudspeakers, which could damage them. Similar-

ly, too much ultrasonic content can damage tweeters and overload the tape deck. Even with VU meter indicators in the black, safety is not guaranteed; limited meter frequency response sometimes prevents them from giving a true picture. Also, VU meters tend to miss sharp transients from drums and other percussion instruments; the pointer simply cannot move fast enough. Pre-emphasis within the deck also can aggravate the situation, so be particularly careful at the slower tape speeds. ◇

# BUILD A Speaker Protection Circuit

BY MIKE ROGALSKI

**A**FTER LONG periods of listening to reproduced music played at a high volume level, it's not uncommon for one's hearing to become insensitive to average loud sounds. As a result, the listener often turns up the gain to compensate for this diminished sensory perception.

The best way to protect our hearing ability—and do a good turn for our speaker systems—is to put an upper limit on the decibel level our sound systems can generate. This is precisely what the automatic audio-overload/speaker-protection circuit described here does.

There are, of course, many circuits that use zener diodes and SCRs to shunt power to dummy loads. Most act too fast, however. This causes important dynamics such as drum rolls, cymbal crashes, and trumpet blasts to get "crunched." A slow-acting threshold sensor that has built-in hysteresis and a comparator circuit would be excellent for providing automatic level limiting, but it requires a power supply. The speaker-protection system here, on the other hand, is far simpler in circuitry, self-powered, automatic in action, and connects directly between the power amplifier and the speaker system it is to protect. It is also inexpensive to build.

**About the Circuit.** The output from the power amplifier to the speaker-protection circuit is shown in Fig. 1. (The rectifier diodes should have a forward resistance of approximately 600 ohms to introduce minimal signal distortion.) The signal then goes to the normally-closed relay contacts and out to the speaker system.

At high signal levels, the charging circuit consisting of  $R1$  and  $C1$  generates sufficient voltage levels to energize  $K1$  and open its contacts. When  $K1$  energizes,  $R2$  is connected in series with the speaker system to drop the sound level. Then, when the input signal level drops,  $K1$  de-energizes

and its contacts automatically close, removing  $R2$  from the circuit.

**Construction.** The simplicity of the protection circuit lends itself to just about any method of construction desired. For those who wish to use printed-circuit construction, an actual-size etching-and-drilling guide and components-placement diagram are given in Fig. 2. Once wired, this compact pc assembly can be permanently mounted inside the speaker system's enclosure or connected directly to the speaker terminals.

Relay  $K1$  should have a dc coil resistance of about 100 ohms and a dc pull-in rating of at least 2 volts less

than the required rms voltage cutout point of the speaker system. This allows for the voltage drop across the rectifier circuit. The diodes and capacitors should have twice the peak voltage rating of the signal passing through them. The components specified in Fig. 1 are for a 4- and an 8-watt unit and will protect a speaker system rated at 5 to 10 watts with a 20% derating factor for safety.

Resistor  $R1$  can be bypassed to move the operating point of  $K1$  down to 4 watts.

**Adjustment.** Make certain that the common of each amplifier output circuit is connected to the common of the speaker protector and observe proper speaker phasing when connecting the device into your audio system. With a relay whose coil resistance is about 100 ohms, the circuit shown in Fig. 1 will cut out at 4, 8, or 12 watts if the value of  $R1$  is 0, 50, or 100 ohms, respectively. Since the circuit is basically a voltage divider, doubling the value of  $R1$ , shifts the rms point 50% higher. You can also experiment with the value of  $R2$  to obtain the low level desired.  $\diamond$

## PARTS LIST

$C1$ —100- $\mu$ F, 50-volt electrolytic  
 $D1$  thru  $D4$ —Silicon rectifier diode (see text)  
 $K1$ —Spst relay with 100-ohm dc-resistance coil (American Zetler No. A 535-11-2 or similar) (see text)  
 $R1$ —Value depends on power protection level: 0 ohms for 4 watts; 50 ohms for 8 watts; 100 ohms for 12 watts  
 $R2$ —50-ohm, 1/2-watt resistor  
 Note: The following items are available from Micro Sound, 1012 Disston St., Philadelphia, PA 19111: Pc board for \$3.00; board and all components (state  $R1$  wattage) for \$10.00 postpaid.

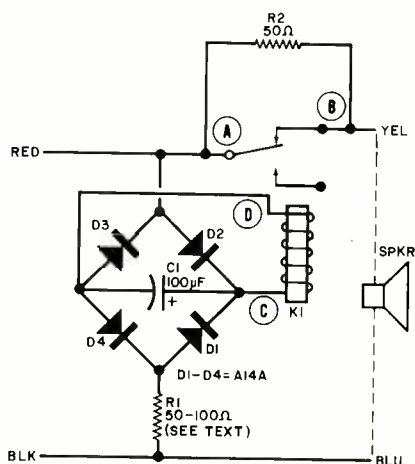

Fig. 1. The self-powered circuit, left, automatically reduces speaker level when peaks occur.

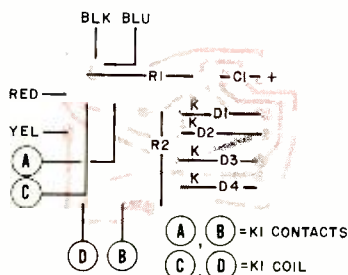
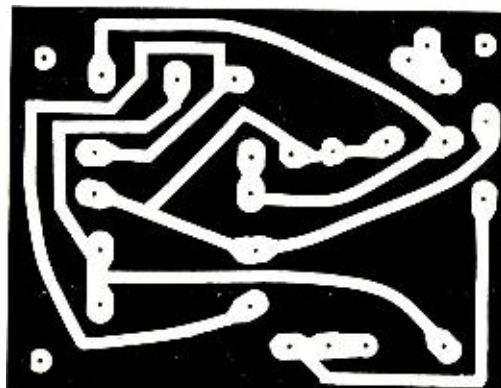

Fig. 2. Actual-size etching and drilling guide, right; component placement above.



# SPACE-AGE ELECTRONIC PROJECTS FOR BOATS *part two*



**L**AST MONTH, we showed you various ways to use the LM3914 dot/bar display driver in instruments for your boat, new approaches to water-level detection, and a rudder-angle indicator. In this second and final part, concentration is on bilge-water warning systems, electrical-system transient protection, and a unique digital tachometer.

**Bilge Alarm.** There are a number of ways to provide bilge-water warning. One of the simplest is the float-actuated-switch system shown in Fig. 10. Here, a sealed tube containing a reed switch is surrounded by a float with a built-in magnet. The float rides up and down the tube with increasing and decreasing water level, closing and opening the switch's contacts.

With the actuating switch assembly placed low in the bilge, the float lifts with rising water level. At some predetermined point, the contacts of the reed switch close and the alarm sounds or/and an indicator light comes on. Alternatively, the system can be rigged to automatically turn on the bilge pump as well as sound an alert.

There is nothing electronic about the system shown in Fig. 10, but it is so sim-

ple that it is just about foolproof. While you can fabricate your own float switch if you wish, it is hardly worth the effort because all-plastic units for boats are available from marine hardware stores at low cost.

A second bilge alarm is shown in Fig. 11. Here, a pair of electrodes is sealed in an insulating housing that is mounted low in the bilge. A small screen surrounds the probe-like elements to prevent bridging by debris.

In fabricating the probe shown in Fig. 11, two small brass bolts are mounted on a small disc of insulating board and are connected through a pair of resistors to a water-tight cable that goes to the instrument panel. The disc fits one end of a  $\frac{3}{4}$ " (19.1-mm) plastic plumbing fitting. Then the whole rear of the assembly is filled with epoxy to seal in the probe ends, resistors, and cable connections. When potting is finished, there should be no place, except at the probe tips, where moisture can bridge the circuit.

When water bridges the probe tips, the SCR fires and actuates the alarm. The Sonalert alarm will continue to sound, even after the water level drops below the point where it bridges the probe tips, until the switch is opened. To

Projects in this concluding part cover a bilge-water alarm, a tachometer and voltage-transient protection

rearm the alarm, simply close the switch.

A third type of bilge alarm is illustrated in Fig. 12. This system is designed for boats with multiple bilge spaces that are separated by watertight bulkheads. An audible alarm and a visual indicator to tell you which bilge has water in it are required in this system.

The sensors in this circuit are LM1830 fluid-detector ICs. When water bridges the probes, the output of the associated IC goes high and turns on the pair of transistors connected to it. Output connections to the transistor switches are arranged so that water entering any bilge space and bridging its probes will activate the Sonalert but will light only the LED labelled for that bilge. You can duplicate the circuit for each bilge to be protected. The only thing in common among the circuits is the Sonalert.

Shown in Fig. 12 is a method for marking the safety panel area where the LEDs are mounted. Using the layout shown, you know instantly which of the bilges is leaking (by its lighted LED) when the alarm sounds.

The transistors can be replaced by a DIP transistor array, provided the outputs can sink enough current to drive the Sonalert. You can use a high-power alarm sounder by replacing the Sonalert with a relay whose contacts can handle the bigger alarm's current. If you use this arrangement, be sure to install a protective diode across the relay's coil.

**Tachometer.** The circuit shown in Fig. 13 consists of a basic 0-to-2.4-volt meter system and a frequency-to-voltage (f/v) converter. The voltmeter portion made up of IC1 and IC2 features 20 divisions, each represented by a LED. The IC3 f/v converter accepts varying-frequency pulses from the engine's ignition points and converts them into proportional dc voltages with constant updating.

Using a system like that shown makes possible an economical solid-state alternative to the traditional analog meter. It is free from parallax errors and is much easier to read and interpret than the analog meter, too. At night, readability increases, and the red emission of the LEDs has little effect on night vision.

The two LED drivers are cascaded by connecting mode pin 9 of IC1 to pin 1 of IC2. Pin 9 of IC2 connects to pin 11 to produce dot operation. Internal IC operation requires R1 to be connected across LED9 (pin 11 of IC1) to obtain proper operation. Resistor R2 sets the

scale of IC1 to half the voltmeter range. Because 1.2 volts should be generated across it, this resistor should have a 1% or better tolerance. Also, since 2.4 volts is generated across it, R3 should be rated at 1% or better tolerance. These re-

sistors also program the ICs to deliver 10 mA to each LED.

A charge-pump frequency-to-voltage (f/v) converter, high-gain op-amp/comparator, and an uncommitted output transistor are contained in IC3 (Fig. 14).

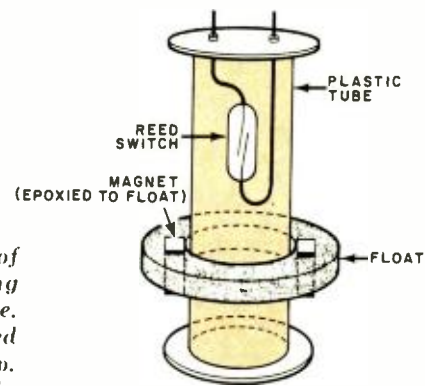

Fig. 10. A simple type of bilge-water warning system is shown here. Details of float-actuated switch are at top. Circuit in center simply actuates LED or alarm, while that at bottom turns on bilge pump at the same time.

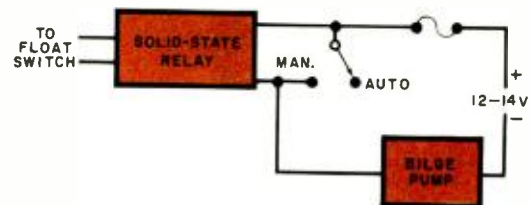
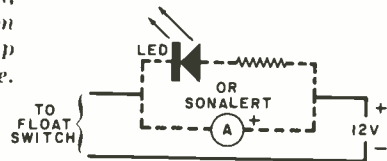
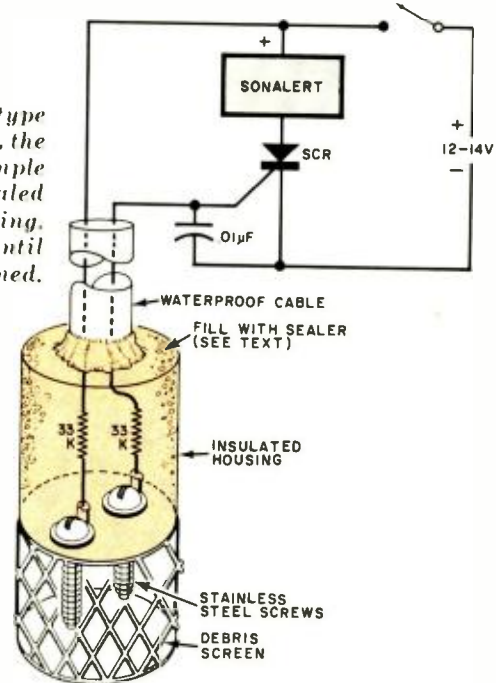

Fig. 11. In this type of bilge alarm, the electrodes are simple steel screws sealed in insulated housing. Alarm sounds until switch is opened.



A Schmitt-trigger device is used for the input. It features a built-in hysteresis to provide clean switching if noise is present on the input signal. In the 14-pin DIP LM2917N version of the IC, an internal zener diode also maintains calibration stability.

In Fig. 13,  $R_5$ ,  $R_6$ , and  $C_1$  condition the input signal from the points. A stable-temperature-characteristic capacitor must be used for  $C_2$ , which is the timing capacitor for the charge pump. Potentiometer  $R_9$  serves as the discharge path and doubles as the scale calibration control. Charge-pump filtering is provided by  $C_3$ . The uncommitted emitter of the internal output transistor is connected to  $R_{10}$ .

The input signal for the voltmeter is taken from  $R_{10}$ 's wiper. This allows the output of the tach section to be matched to the voltmeter's full-scale range. (Although this could be accomplished via  $R_9$ , better linearity is possible when the full output of the tach circuit is used and then reduced in level to match the requirements of the voltmeter.) Biasing for the internal op amp is obtained with  $R_7$  and  $D_2$ .

There are a number of ways to assemble the tach. The LEDs can be arranged in a vertical column, with the highest rpm at the top, or you can opt for

### PARTS LIST (Fig. 12)

- A1—Sonalert SC628 or similar
- C1—0.05- $\mu$ F disc capacitor
- C2—0.002- $\mu$ F disc capacitor
- C3—10- $\mu$ F, 6-V electrolytic
- IC1—LM1830 (National)
- LED1—Bright red LED
- Q1, Q2—2N2222 transistor
- R1—2200-ohm,  $\frac{1}{2}$ -W resistor
- R2—To suit LED current

### PARTS LIST (Fig. 13)

- C1, C2—0.02- $\mu$ F capacitor
- C3—1- $\mu$ F, 12-V electrolytic
- D1—18-V zener (see text)
- D2—1N914
- IC1, IC2—LM3914 Dot/Bar Driver (National)
- IC3—LM2917N 14-pin F/V Converter (National)
- IC4—10-V, 0.5-A positive regulator
- LED1 through LED20—Bright red LED
- R1, R6—20,000-ohm,  $\frac{1}{2}$ -W resistor
- R2—1100-ohm, 1%,  $\frac{1}{2}$ -W resistor
- R3—2400-ohm, 1%,  $\frac{1}{2}$ -W resistor
- R4—10-ohm resistor (see text)
- R5, R7—10,000-ohm,  $\frac{1}{2}$ -W resistor
- R8—470-ohm,  $\frac{1}{2}$ -W resistor
- R9—100,000-ohm, multi-turn pot
- R10—10,000-ohm, multi-turn pot

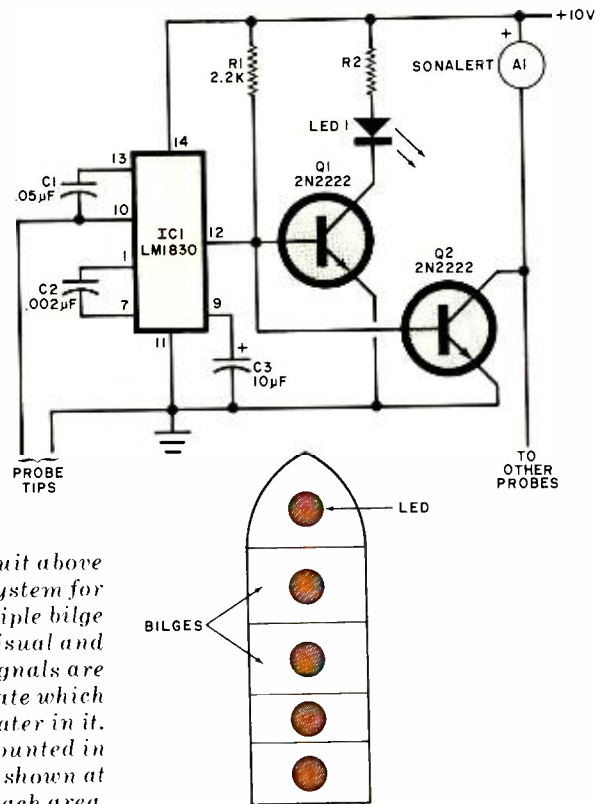

Fig. 12. Circuit above is an alarm system for boat with multiple bilge spaces. Visual and audible signals are used to indicate which bilge has water in it. LEDs are mounted in diagram as shown at right to show each area.

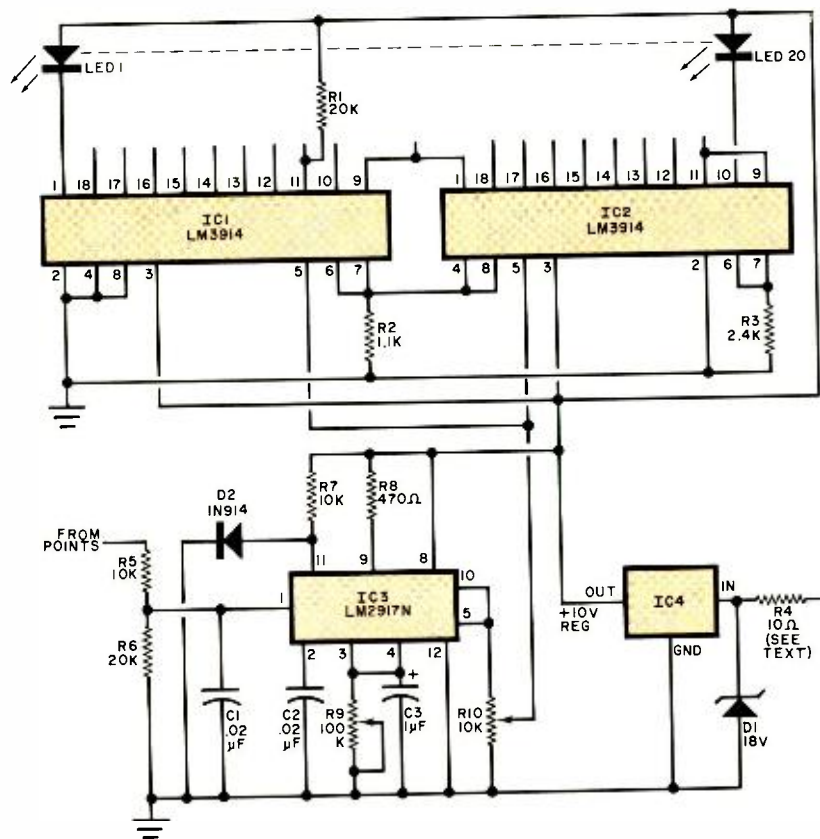

Fig. 13. Circuit for converting pulses from ignition points to voltages which activate LEDs from 1 to 20 to indicate speed.

the more familiar circular arrangement.

When assembling the project, it is best to slightly recess the LEDs behind a red filter to avoid effects of washout in brightlight. Use high-luminosity LEDs instead of the commonly available "standard" LEDs. Finally, to assure maximum contrast and eliminate reflections as much as possible, apply a coat of matte black paint on all surfaces behind the LEDs and the front panel or bezel into which the red filter is set.

Wiring is not critical. However, it is important that you observe the common ground point near pin 2 of IC1.

There is a considerable variation in the range requirements for a tachometer for inboard boat engines. Commercial analog tachs are scaled for 6000 rpm and supplied with links to adapt them to all types of engines. With the tach described here, the top end of the range can be chosen to suit the requirements of any given engine.

A 4-cycle engine fires each cylinder once every two revolutions. An 8-cylinder engine running at 4000 rpm would fire  $4 \times 4000$  or 16,000 times per minute. This is equivalent to a tach input frequency of 266.67 Hz. For a 6-cylinder engine operating at 4000 rpm, there are three pulses per revolution, which is equivalent to an input frequency of 200 Hz. Note that this is a linear relationship and can be plotted as shown in Fig. 15.

Following is the calibration procedure for a 6-cylinder engine with LED20 indicating 4400 rpm. Apply 15 volts from a bench-type power supply to the power leads of the tach. Next, connect the output of a square-wave generator to the tach's input through a 0.1- $\mu$ F capacitor. Using a frequency counter, set the generator for a high-level output of 220 Hz. Set R9 near maximum resistance. Using a high-impedance voltmeter, connected between pin 5 of IC1 and ground, adjust R10 for a 2.4-volt reading. This should turn on LED20. Adjust R9 until LED19 extinguishes and LED20 is at full brilliance. There is some overlap built into the dot drivers so that one LED fades out as the next LED comes on. Slowly reduce the frequency of the generator while observing both the tach display and frequency counter to check the linearity of the tach's scale. It will not be perfect, but it will be better than a quick glance at a standard analog meter.

The calibration procedure for an 8-cylinder engine will be the same as that for the 6-cylinder engine above. The only difference is that you start with a generator frequency of 293.3 Hz.

Fig. 14. A charge-pump f/v converter, op-amp/comparator, output transistor and zener diode are contained in LM2917N IC.

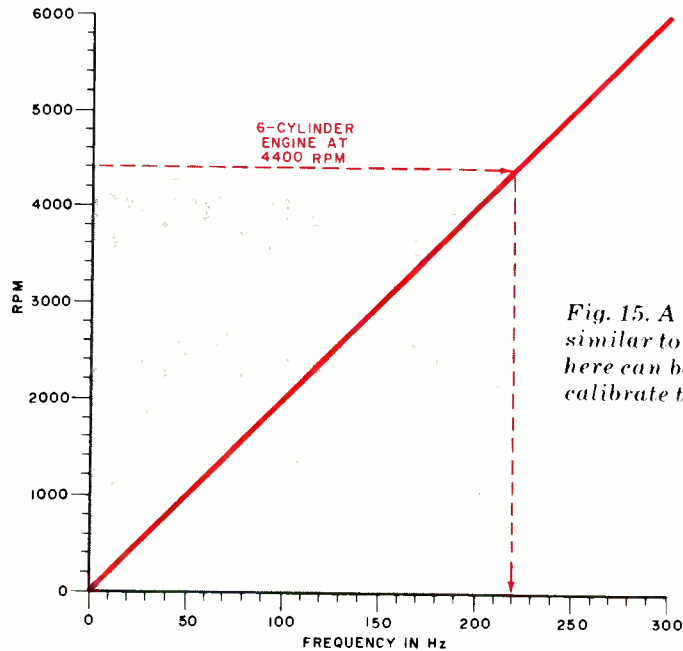
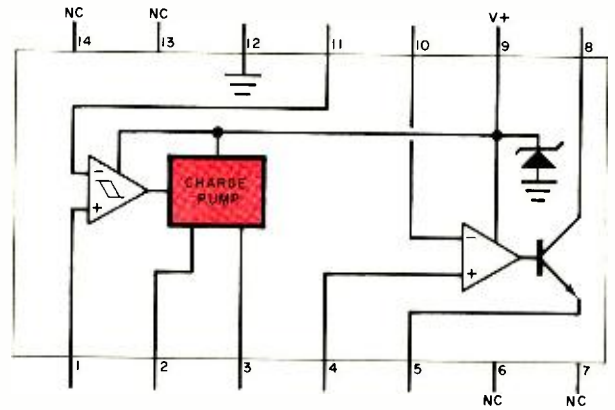

Fig. 15. A linear plot similar to that shown here can be drawn to calibrate tachometer.

Fig. 16 Tachometer add-on is used to identify critical cruising speed.

#### PARTS LIST (Fig. 16)

- C1—100- $\mu$ F, 12-V electrolytic
- R1—100-ohm, 1/2-W resistor
- R2—1000-ohm, 1/2-W resistor
- R3—470-ohm, 1/2-W resistor

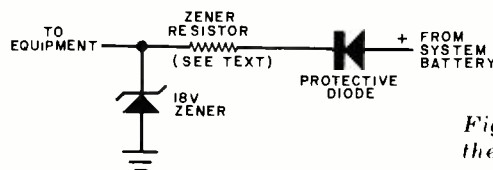
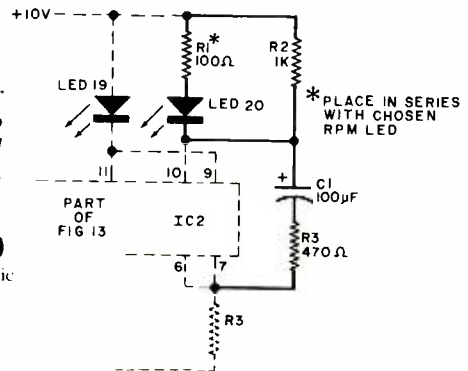

Fig. 17. A series diode is used in the positive supply for reverse voltage protection as shown here.

If your finished tach has a tendency to flicker at low rpm, increase the value of C3. Do not overdo this because if the value is raised to 2  $\mu$ F, the flicker will be reduced, but at higher speeds there may be a tendency for adjacent LEDs to flicker back and forth as a low-frequency oscillation sets in. Of course, a rough running engine is going to produce lots of flicker, which can serve as a reminder to have your engine tuned. The value of C3 is a compromise. Once you install the tach, it is a good idea to have it checked against a good-quality tachometer.

The circuit shown in Fig. 16 is a useful add-on for the tach. It can be used to identify the critical cruising rpm where fuel economy is at its best or as an over-rpm warning. The LED in the string to which it is connected will flash on and off when the indicated rpm is reached. The flash range is quite narrow. Bear in mind, therefore, that this circuit may not be usable as an attention getter with a rough-running engine. The rpms would be traversing the flash point too rapidly for the circuit to go into action.

**Transient Protection.** Any mobile electrical system, including that in a boat, can suffer from voltage transients of many kinds. Some transients are capable of destroying solid-state components and systems. Hence, it pays to have adequate transient protection.

There are simple ways to give a large measure of transient protection to home-built projects. GE's MOV transient protectors is one simple way. A second method is shown in Fig. 13, where 10-ohm resistor R4 and 18-volt zener diode D1 protect the power input line. If the circuit is to take care of a blown regulator, where 18 volts may be on the line continuously, the division of dissipated power between the zener diode and resistor must be calculated. Once breakdown occurs, the circuit will be carrying well over 1 ampere of current. This means that the power (wattage) ratings of the resistor and diode must be calculated.

Reverse voltage protection is a simple matter of installing a series diode in the +V line, with the diode's anode connected to the + input, as shown in Fig. 17. Each subsystem should be individually protected, both for transients and reverse voltages, to assure maximum security against failure. Of course, one heavy-duty zener-diode circuit can be used for an entire instrument group to handle steady-state overvoltage conditions, but smaller suppressor circuits should still be used on each board.  $\diamond$

AUGUST 1979

## Introducing . . . The Solar Alarm Chronometer

- Light Energized
- Electronic Quartz Accuracy
- 24 hour alarm

**A personal alarm  
and time system  
powered by light.**



**Only  
\$49.95**

You can't wear a more accurate watch. Plus this new LCD chronometer has a built in 24-hour alarm and personal reminder system. And you no longer have to worry about batteries failing because this watch is constantly being recharged by light. A true scientific break thru.

### Forget about losing time

The time base is a finely tuned quartz crystal, trimmed by the manufacturer electronically to an accuracy of 5 seconds per month. And the manufacturer stands behind this accuracy with a one year limited warranty plus a 5 year replacement warrant on the micro-rechargeable energy cells.

### Who is the Manufacturer

U.I.T. has been the innovator in the digital watch industry for years. U.I.T. is the prime manufacturer, assembler and importer of LCD watches. U.I.T. has been the pioneers of solar powered watches where "light energy" recharges micro-energy cells contained in the watch. A system so efficient they are able to offer the unheard of 5 year warranty.

### Forget about batteries

The new solar-alarm is powered by micro-energy cells which are constantly being recharged from available light. Not just solar light but ordinary room light. You never need to worry about batteries.

### Forget about changing technology

This solar-alarm watch uses all of the

latest technology in electronics and engineering. The programmed time measuring features include hours, minutes, and pulsating seconds plus the month and date displayed instantly with the touch of a button. The large liquid crystal display constantly shows the time in large easy to read numerals. A special night light command button illuminates the dial for night viewing.

### Forget about being late

The most unique function of this solar chronometer is the alarm system. The 24 hour alarm system is easy to set without disturbing the time function. And it sounds with a pleasant electronic beep precisely at the pre-set time. Your own personal alarm system will automatically beep you at the right time for "on-time" punctuality, so important with today's busy schedules. You may never be late again.

### Test it for 2,592,000 seconds

Take 30 full days (2,592,000 seconds) to confirm the accuracy and utility of this fine timepiece. If you doubt the quality, merely return it for a full refund.

If you have been looking for that special opportunity to own a chronometer of the future here is your chance! Available in silver or gold tone with fashion flex band. All U.I.T. timepieces feature ultra-thin design, rugged shock proof engineering and water resistant construction. The solar-alarm watch is priced at \$49.95 each plus \$2.50 shipping & handling. (IL. residents add 5% sales tax).

**CAMBRIDGE  
INTERNATIONAL, Inc.**

8700 Waukegan Road, Morton Grove, Illinois 60053 (312) 966-5510

Dept. PE9

**Credit card customers call operator #219 toll free  
800-241-8444 (In Ga. call 1-800-323-9123)**

Clip & mail to: Cambridge International, Inc. Dept. PE9  
8700 Waukegan Rd., Morton Grove, Ill. 60053

- Please send me \_\_\_\_\_ Solar-Alarm Watches at \$49.95 each plus \$2.50 shipping & handling. I understand that I may return my purchase within 30 days for full refund.
- silver tone     gold tone
- Check or MO enclosed.    Change to:  Visa     Master Charge

Account # \_\_\_\_\_ Exp Date \_\_\_\_\_  
Name \_\_\_\_\_  
Address \_\_\_\_\_  
City \_\_\_\_\_ State \_\_\_\_\_ Zip \_\_\_\_\_  
Signature \_\_\_\_\_

© Cambridge International, Inc. 1978

204

CIRCLE NO. 52 ON FREE INFORMATION CARD

59

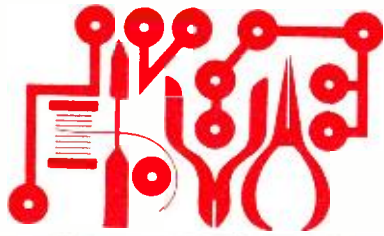

# Experimenter's Corner

By Forrest M Mims

## IC INTERVAL TIMERS

**A**N INTERVAL timer is a circuit that provides an output pulse of predetermined width at periodic intervals. This can be readily accomplished using any one of several timer ICs available to today's electronic experimenter. Many IC timers, such as the well-known 555, are not only capable of such astable operation but can also function as monostable multivibrators or "one-shots."

Figure 1 is a timing diagram comparing the operation of a monostable to that of an interval timer. Note that a one-shot timer is designed to activate an external device or circuit for or after a fixed period. An interval timer, on the other hand, provides uniform output pulses at an adjustable interval.

You are probably already familiar with numerous applications for conventional one-shot timers. Common examples include automatic switches that extinguish the headlights of a car a minute or so after the ignition is turned off, delayed-action intrusion alarms, switch debouncers, kitchen and dark-room timers, etc.

Although the applications for interval timers are not as numerous, they include two that are particularly interesting: time-lapse photography and time-lapse sound recordings.

You have probably seen many examples of time-lapse photography—the opening of a flower, formation of clouds, construction of a building, etc. Time-lapse sound recordings can store periodic samples of data encoded as an audio tone as well as simply capture ambient sounds. In the latter category, an interesting possibility is to compress a 24-hour history of the sounds at a busy street corner into a one-minute recording. Another is entertaining your family or friends at a party by sampling brief segments of a record, radio program or conversation and playing back the string of sound "snapshots."

Of course, time-lapse photography and sound recordings are not the only applications for interval timers. Before you've

finished reading this column, you will probably have thought of several more.

**Basic 555 One-Shot.** Although most experimenters have assembled either breadboard or permanent circuits that use a 555 timer, many do not fully understand how this IC works. For those of you in this category, the following paragraphs will provide a quick overview of the monostable operation of the 555. If you're already familiar with 555 basics, you can skip ahead to the next section.

Figure 2 is a simplified block diagram of a 555 connected as a monostable or one-shot timer. The key sections of the 555 are the two comparators, VC1 and VC2. They sense when the timing capacitor (C1) has charged or discharged to a predetermined level.

To understand how the 555 works, assume the circuit in Figure 2 is "off." This means the control flip-flop is reset and Q1 is on. Capacitor C1 is therefore short circuited by Q1 and cannot charge. The output of the circuit (pin 3) is low. A negative pulse applied to the TRIGGER input (pin 2) momentarily causes the output of comparator VC2 to go high, setting the control flip-flop. This cuts off Q1, which allows C1 to charge exponentially at a rate determined by the values of C1 and R1. During this period, the output at pin 3 is high.

Notice the three series-connected 5000-ohm resistors in the 555. These resistors form a voltage divider that biases the noninverting input of comparator VC2 at one-third of the supply voltage and that of comparator VC1 at two-thirds of the supply voltage. When the voltage across C1 reaches two-thirds of the supply voltage, the output of comparator VC1 goes high and resets the control flip-flop. This turns Q1 on and shorts out C1. The output at pin 3 returns to ground and remains there until the entire timing cycle is repeated. This is

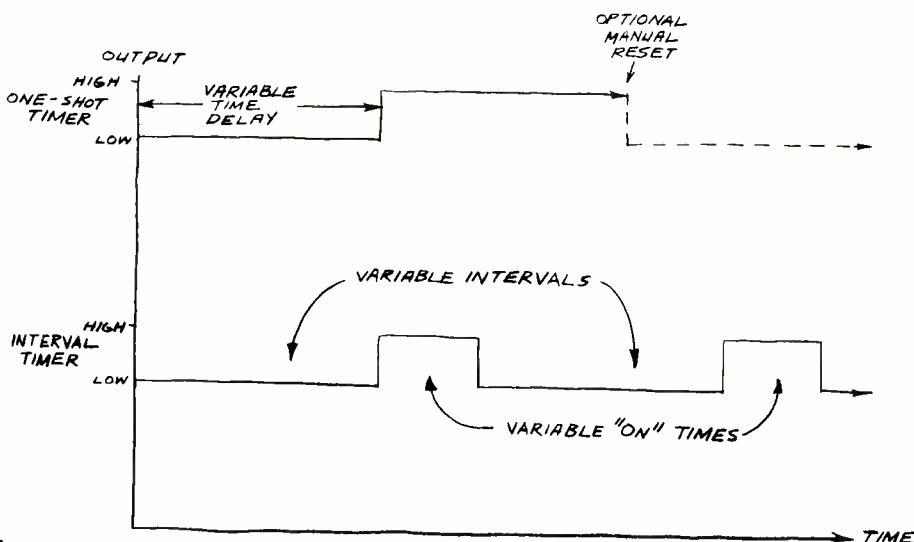

Fig. 1. Timing diagrams of the output waveforms generated by monostable multivibrator or one-shot (top) and interval timer (bottom).



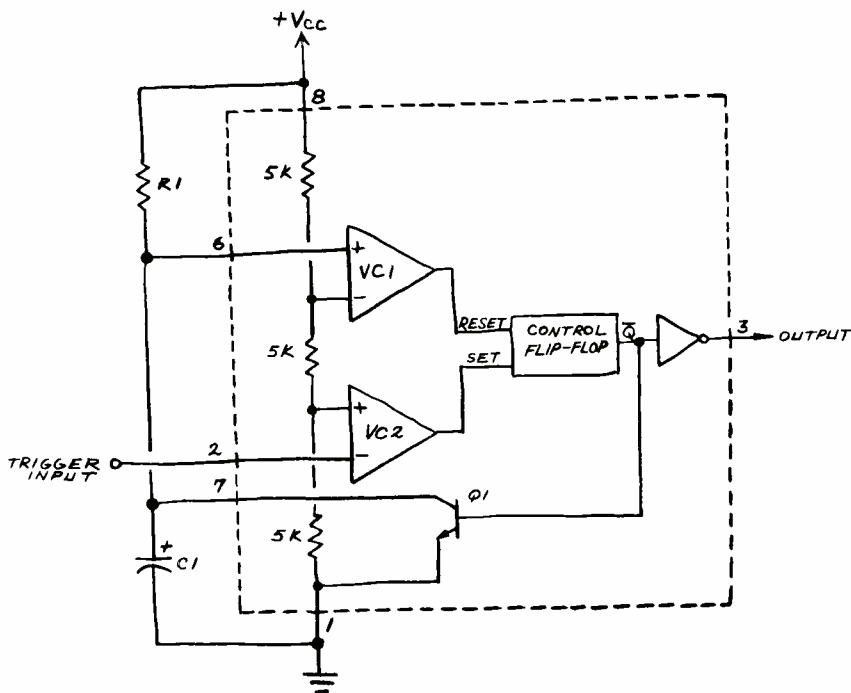

Fig. 2. Simplified functional diagram displays inner workings of a 555 timer IC. External components  $R1$  and  $C1$  control timer's period.

accomplished by applying a new trigger pulse at pin 2.

This explanation should give you some insight into the operation of the 555 in its monostable mode. It should now be obvious that you can easily select the time delay by the proper choice of components for  $R1$  and  $C1$ . If long delays (more than several minutes) are to be obtained, it's important to use a component with extremely low leakage for  $C1$ . Otherwise, the capacitor will never be able to charge as it should and the circuit will not function properly.

**555 Interval Timer.** A 555 monostable can function only as a single-delay timer. A reset pulse is required to initiate a new delay period. An interval timer, however, can be made by connecting the output of a 555 operated as a free-running (astable) oscillator to the TRIGGER input of a 555 monostable. The period of oscillation of the astable will determine the interval time. The  $RC$  time constant of the monostable will determine the duration of the output pulse that follows each timing interval.

Figure 3 shows the schematic of a working dual-555 interval timer. Interval times (determined by the values of  $R1$  and  $C1$ ) of up to several minutes are achievable with the values shown. Note that the output pulse from the first 555 is directly coupled into the input of the 555 monostable. The output of the monostable is connected to a low-voltage relay coil through  $D1$ . Diode  $D2$  shorts out the powerful inductive kick produced across the relay coil when current to it is interrupted, thereby protecting the 555's output stage from damage.

The values of  $R3$  and  $C2$  determine how long the relay is energized after each timing interval. Those specified keep the relay energized for almost exactly 5 seconds (4.98 seconds for the breadboard circuit I built). Change the value of  $R3$  or  $C2$  or both to obtain different times.

The relay contacts can be used to switch many different circuits or devices on or off. Figure 3, for example, shows the normally-off contacts connected to the switch jack of a tape recorder. This jack is commonly found adjacent to the microphone jack on many cassette recorders. It allows the recorder

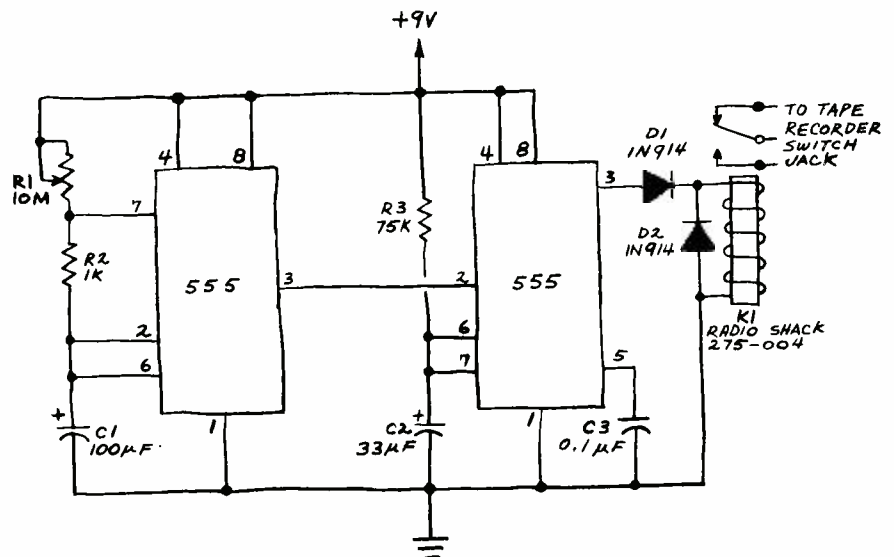

Fig. 3. Interval timer employs one 555 as an astable multivibrator to trigger a second IC operating as a monostable. Relay  $K1$  keys external circuit.

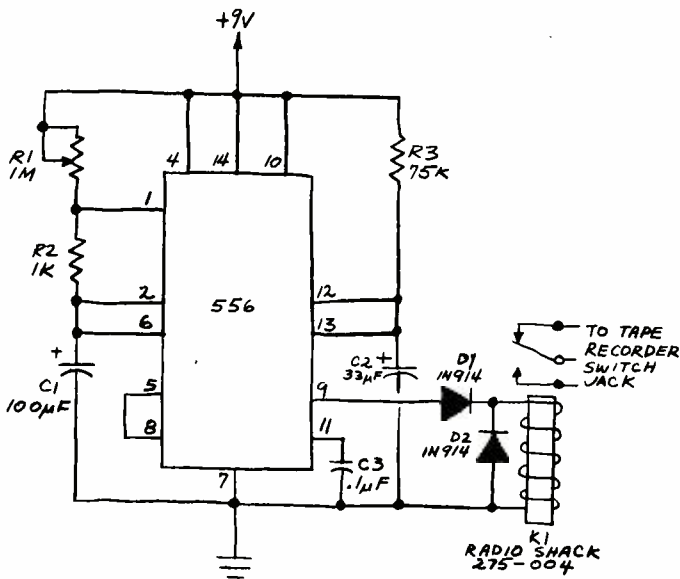

Fig. 4. This circuit, which employs a 556 dual timer, is functionally identical to the one shown in Fig. 3.

to be turned on and off remotely by means of a small switch such as one mounted on the case of the microphone.

If you want to connect the relay to a tape recorder, use an appropriate plug. You'll have to improvise when connecting the relay contacts to other equipment or circuits. (A few words of caution—never connect the relay to a circuit that exceeds the maximum ratings for the relay's contacts. Also, never switch ac line power with an unenclosed relay. Personally, I prefer to play it safe with low-voltage applications only.)

**556 Interval Timer.** The 556 is a pair of 555 timers on a single silicon chip. The circuit in Figure 3, as you might suspect, can be readily assembled with a single 556 dual timer rather than separate 555's. Figure 4 shows the functionally identical circuit.

**XR-2240/555 Long-Duration Timer.** Because of leakage in the timing capacitor, the maximum period of a 555 operated as an astable oscillator is usually limited to several

minutes. The XR-2240 (or XR-2340) is a specialized IC timer that incorporates a self-contained flip-flop divider chain to increase the length of the fundamental time delay by a factor of up to 255. Because the output of each flip-flop in the chain is directly accessible, many different time intervals can be selected without having to alter the values of the circuit's timing capacitor and resistor.

Figure 5 is the schematic of a long-duration, programmable interval timer made from an XR-2240 connected as an astable oscillator and a 555 operated as a monostable. Timing components  $R1$  and  $C1$  control the oscillation rate of the XR-2240. The values shown give an adjustable interval  $T$  of up to about 100 seconds. The outputs at pins 1 through 8 allow you to select multiples of  $T$  ranging from 1 to 128. Therefore, selecting pin 8 will give you a time delay of up to  $128 \times 100$  seconds or more than 200 minutes!

The selected output of the XR-2240 is inverted by  $Q1$  and coupled through  $C4$  to the 555 monostable, a circuit essentially identical to the monostable in Figure 3. The timing period of the monostable is controlled by the time constant  $R6 C5$ .

The XR-2240/555 interval timer is far more versatile than the dual 555 or 556 version because intervals of several hours can easily be obtained. Calibrating the circuit, however, can pose problems if you attempt to perform the operation when output pin 8 is selected. Calibration is much easier if you select output pin 1. If, for example, you want a timing interval of one hour (3600 seconds), adjust  $R1$  until the interval at pin 1 is 28.13 seconds. Pin 8 will then output a pulse at  $128 \times 28.13$  seconds or every 3600 seconds.

Incidentally, it's possible to select various combinations of XR-2240 outputs to achieve any time interval of from  $T$  to  $255T$  when the chip is operated in its triggered, monostable mode. However, this procedure does not give the desired results when the astable mode is used.

It might be possible to obtain the full versatility of the XR-2240 by operating the chip in its one-shot mode and triggering it externally. The XR-2240 would continue to trigger the 555 one-shot to provide the brief "on" time after each interval. The time delay would be selected by shorting combinations of outputs to a common bus. The delay would be the sum of the delays of the selected outputs. Thus, outputs  $4T$ ,  $8T$  and  $128T$  will give a total delay of  $4 + 8 + 128$  or  $140T$ .

I'll leave the details to those readers who like challenges. See the XR-2240 data sheet for design tips.  $\diamond$

Fig. 5. Long-duration, programmable interval timer employs XR-2240 as an astable and 555 as a monostable. Relay K1 keys external circuit.

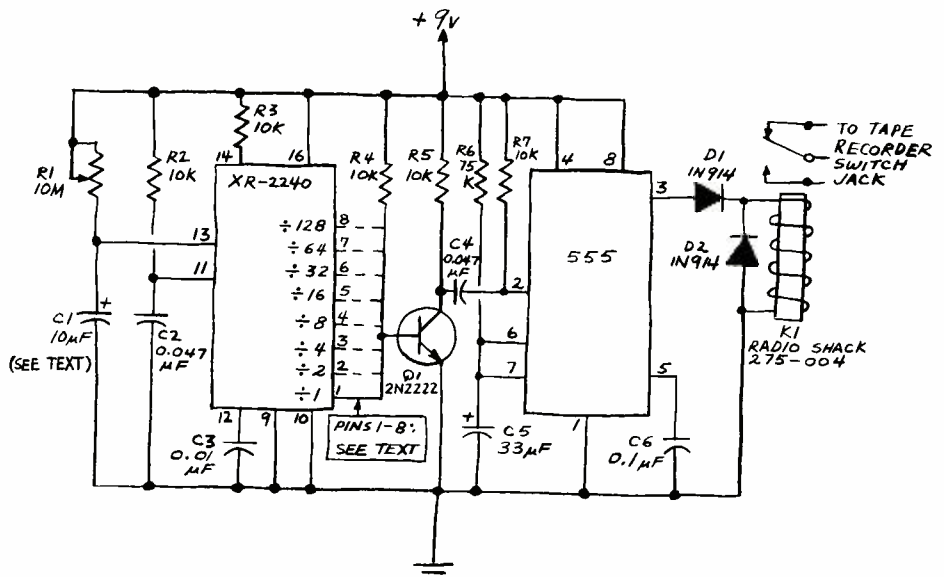

Build better value with world-famous  
Heathkit Electronic Products

SEND FOR YOUR NEW

# FREE HEATHKIT CATALOG



Read about the world's largest selection of fun-to-build, money-saving electronic kits — plus educational programs so effective they're guaranteed!

Every Heathkit product is quality designed and engineered, and gives you extra value because you build it yourself. Our world-famous instruction manuals take you step-by-step from unpacking the kit to final plug-in. They're marvels of technical accuracy and thoroughness. Find out about the pride, satisfaction and savings you can get by building your own electronic kits. Send for your catalog today!

Nearly 400 quality electronic kits including:

- Hobby and Business Computers • Color TV • Stereo Components • Amateur Radio Gear • Test Instruments • Marine Instruments • Aircraft Instrumentation • Security • R/C Modeling • Other Instruments • Tools...

NEW! One-Button Dialer

NEW! All-in-One Computer System  
Desktop computer with Terminal, Floppy Disk, and Keyboard in one compact unit.

Kitbuilding is easy and fun for the whole family...send for your new

# FREE HEATHKIT CATALOG TODAY

TODAY

**yes** Send me my FREE Heathkit Catalog. I am not currently receiving your catalogs.  
Heath Company, Dept. 010-560, Benton Harbor, MI 49022

Name \_\_\_\_\_  
Address \_\_\_\_\_  
City \_\_\_\_\_ Zip \_\_\_\_\_ PC-132  
State \_\_\_\_\_  
POPULAR ELECTRONICS

010-560  
49022

FREE CATALOG!

ALL THAT'S NEW IN THE WORLD OF KITS

Nearly 400 fun-to-build money-saving electronic kits your family will enjoy for years to come.

## The world of electronics gee-wizardry

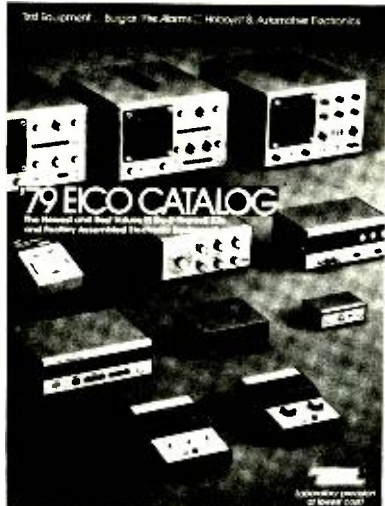

### -YOURS FREE.

32-pages of test instruments—from the latest digital multimeters to the famous EICO scopes. Security systems. Automotive and hobbyist products. Kits and assembled. EICO quality. EICO value. For FREE catalog, check reader service card or send 50¢ for first class mail.

**EICO**® 108 New South Road  
Hicksville, N.Y. 11801

CIRCLE NO. 19 ON FREE INFORMATION CARD

## Put Professional Knowledge and a COLLEGE DEGREE in your Electronics Career through HOME STUDY



### Earn Your DEGREE

by correspondence, while continuing your present job. No commuting to class. Study at your own pace. Learn from complete and explicit lesson materials, with additional assistance from our home-study instructors. Advance as fast as you wish, but take all the time you need to master each topic.

The Grantham electronics degree program begins with basics, leads first to the A.S.E.T. degree, and then to the B.S.E.T. degree. Our free bulletin gives complete details of the program itself, the degrees awarded, the requirements for each degree, and how to enroll. (We are located at 2500 S. LaCienega Bl., Los Angeles, Calif.) Write to our mailing address shown below for Bulletin E-79.

**Grantham College of Engineering**  
P. O. Box 35499  
Los Angeles, California 90035

Worldwide Career Training thru Home Study  
CIRCLE NO. 27 ON FREE INFORMATION CARD

# Hobby Scene



By John McVeigh, Technical Editor

## ANTENNA LENGTH CALCULATIONS

*Q. I am writing with reference to your article, "Choosing a Mobile CB Antenna," which appeared in the April 1978 issue. In the article, it was stated that at CB frequencies, a vertical half-wave dipole would have a length of 5.2 meters. Using the formula  $\lambda = c/f$ , with  $c = 2.9971 \times 10^8$  m/s (speed of light in air) and  $f = 27.0$  MHz, I come up with  $\lambda = 11.10$  meters, or a half-wavelength of 5.55 meters. Working backwards, I find the frequency corresponding to a half-wavelength of 5.2 meters to be 28.818 MHz, which isn't even close to actual CB frequencies. Could you explain to me why this difference exists? I have searched through my technical references, but have been unable to come up with an answer. —Jim Sloat, Calgary, Alberta, Canada.*

**A.** Your calculations are correct, but the length of a "half-wave" antenna is not exactly one half-wavelength. Rather, a resonant dipole has an electrical length of one half-wavelength. The length of conductor required for a resonant antenna depends on several factors, including the ratio of its length to its diameter. The smaller the ratio (the thicker the conductor), the shorter the antenna for a given electrical length. Practically speaking, the diameter of the conductor accounts for a 2-to-5-percent shortening.

The end effect also reduces antenna length. That is, the strain insulators and wire loops wound on the insulators (in the case of a dipole) contribute a small amount of capacitance, which lowers the resonant frequency. To compensate, the antenna must be shortened by a few percent.

Finally, your calculations are based on a frequency of 27.0 MHz. Generally, an antenna will best cover a range of frequencies when it is tuned to the center frequency. For the 40-channel Citizens Band, which extends from 26.965 to 27.405 MHz, channel 19 at 27.185 MHz is the median frequency. That's 0.185

MHz above the frequency you used in your calculations and further explains the disparity between my statement and your result.

## RFI

*Q. I have amateur and CB radio equipment as well as an audio system. Whenever I'm recording an 8-track or cassette tape and using one of my rigs, my transmissions come through the stereo system and are recorded on the tape. All the components are well grounded, and I've inserted low-pass filters at the outputs of the transmitters. The problem still exists. What can I do to cure it? —Bill Columa, KA4DAP, Rocky Mount, NC.*

**A.** The space we have here is far too small to permit a detailed discussion of the RFI problem, but what basically happens is this. At some point in the audio system r-f enters and is rectified (detected), giving up the information used to amplitude modulate it. The detected audio is then processed by the rest of the system, which cannot distinguish between it and the desired audio signals.

The key to solving an RFI problem is to locate the point of entry and treat it with shielding and/or filtering. I wrote a comprehensive article on the RFI problem for the May 1977 issue of our sister publication *Stereo Review*. That article contained a methodical, step-by-step procedure for eliminating RFI, and I suggest you either locate that issue or order a reprint for the article (ask for Reprint No. 21) at a cost of \$1.50 from Stereo Review Reprints, Box 278, Pratt Station, Brooklyn, NY 11205. Residents of CA, CO, DC, FL, IL, MI, MO, NY, TX, or VT must add applicable sales tax. P.S.—I don't get royalties on reprint sales!

Have a problem or question in circuitry, components, parts availability, etc? Send it to the Hobby Scene Editor, POPULAR ELECTRONICS, One Park Ave., New York, N.Y. 10016. Though all letters can't be answered individually, those with wide interest will be published.

POPULAR ELECTRONICS



# Product Test Report

## CompuColor II Model 4 Personal Computer System



Has full graphics  
and built-in floppy-  
diskette drive

**A**MONG THE few small computing systems that provide color graphics is the CompuColor II from CompuColor Corp. (Address: 5965 Peachtree Corners East, Norcross, GA 30071; Tel: 404-449-5861). Several versions of this computer are available, offering a variety of optional RAM, keyboards, single and multiple disk drives, etc. These are basically two-package systems consisting of a 13" (33 cm) diagonal color monitor and disk drive in one and a keyboard/computer system in the other package. The two are interconnected via a single 30" (76.2 cm) long multiconductor flat ribbon cable.

We evaluated the Model 4 version of the CompuColor II, configured with 16K of user-available RAM and a single 5¼" floppy-disk drive. The optional 101-key Model 101 Extended Keyboard was substituted for the Standard 72-key keyboard. In addition to the standard 72 keys, the Extended Keyboard has a separate four-function calculator-type cluster, and a cluster of editing keys. (There is also an optional Deluxe keyboard with

117 keys and offering extended plotting capabilities available at extra cost).

The keyboard/computer package measures 19" (48.3 cm) wide by 7" (178 mm) deep and slopes from 4" (102 mm) high at the rear to 2" (51 mm) at the front. The monitor/disk drive package measures 18" wide by 15" deep by 13" high (457 x 381 x 330 mm). Price of the Model 4 with a Standard Keyboard is \$1695, plus \$135 when substituting the Model 101 Extended Keyboard.

**Technical Details.** The computer is based on an 8080A operated with a 2- $\mu$ s cycle time. It can support up to 65K of memory, and has on-board space for 32K. There is 16K of ROM in which are the operating system and BASIC, and sockets are provided for additional 8K of ROM. The system is designed to use up to 480 I/O ports, 30 of which are implemented in the standard computer. This number includes an RS-232C serial port for printer or modem, with a broad selection of baud rates.

The graphics display features an 8-



**fact:**  
**it's easy to upgrade  
your M95 cartridge  
and gain dramatic  
freedom from  
distortion**

One of the critically acclaimed advances introduced in Shure's incomparable V15 Type IV phono cartridge is its revolutionary and unique distortion-reducing Hyperelliptical diamond stylus.

The Hyperelliptical stylus contacts the groove in a "footprint" that is narrower than both the Biradial (Elliptical) and the long-contact shapes such as the Hyperbolic. The performance features of this new tip geometry are now available to owners of M95ED or M95G cartridges by simply upgrading either with a Model N95HE Hyperelliptical stylus.

You'll find the cost extraordinarily low—but the difference in sound will be immediately apparent. The new stylus takes only seconds to install with a simple, no-tools procedure.

The Hyperelliptical stylus is also available in a brand new, ultra-flat frequency response, high trackability cartridge: the M95HE. Write for free brochure (AL600).

## N95HE Improvement Stylus



Shure Brothers Inc.  
222 Hartrey Ave., Evanston, IL 60204  
In Canada:

A. C. Simmonds & Sons Limited

MANUFACTURERS OF  
HIGH FIDELITY COMPONENTS,  
MICROPHONES, SOUND SYSTEMS AND  
RELATED CIRCUITRY.  
CIRCLE NO. 47 ON FREE INFORMATION CARD

color selection on a 10" by 7" (254 x 178 mm) usable screen area. The 128 x 128 graphics is refreshed at power-line frequency. Alphanumerics consist of 32 lines of 64 characters/line for small-size capital letters or 16 lines of 64 characters/line with large-size caps. Lower-case letters are not included, but 64 spe-

cial graphic symbols are.

Conventional 40-track diskettes are used with an average access time of 40 ms for 40 tracks, while average latency is 200 ms. Data transfer rate is 76.8K bits per second, with a diskette storage capacity of 51.2K bits per side (both sides usable).

The basic keyboard is standard ASCII four-level with 192 codes. It uses gold crossbar keyswitches of commercial quality. CPU reset and automatic diskette loading keys are included.

In software, a complete disk operating system as well as disk BASIC are in ROM. The BASIC is similar to most other disk BASICs and has 32 statements and commands, 19 mathematical functions, nine string-manipulation functions, and 12 disk-file commands. Calculations are to five decimal places.

The operating system has 31 CONTROL-plus-key commands, 31 ESCAPE-plus-key codes, and 12 graphic-plot commands. There is also a full complement of CRT Terminal commands as well as full-function foreground/background color selection along with 15 plot commands. This wide variety of commands gives the user control over every possible function of the computer.

Most of the keys are assigned two functions. Switching from one function to the other is via the CAPS LOCK key. Some keys are used in conjunction with the CONTROL and ESC keys. Those keys that permit color changes are color coded with their respective colors.

A 50-pin bus connector (located on the rear) provides all addresses, data, clocks, etc., to allow the Compucolor to be extended with any upcoming peripherals. Also located on the rear apron is a connector for RS-232C signals. This latter port can also be used for a printer or modem. Each connector is fully described in the manual.

A large loose-leaf-type "Programming and Reference Manual" is supplied with the system. This manual contains 10

**THE BIG PLUS +  
Graphic Equalizer**

ASSEMBLED  
**\$189<sup>95</sup>**

KIT  
**\$99<sup>95</sup>**



**LOADED with Quality Features!**

- Stereo . . . Eleven Bands Per Channel • Extremely Low Noise & Distortion • LED Peak Indicators • Center Detent ("flat") sliders • Built-in "record" Switching • Line and Microphone Level Inputs/Outputs • Regulated Power Supply • Fully Guaranteed • Horizontal or Vertical Cabinets • Kit or Fully Assembled • Plus Much, Much More!

**Absolutely equals or exceeds overall performance and features of any graphic equalizer made today!**

AARON-GAVIN INSTRUMENTS, INC. 714-957-8710  
17231 Corla Avenue Tustin, California 92680

Yes! I've enclosed \$ \_\_\_\_\_; RUSH me:  
 \_\_\_\_\_ assembled equalizers at \$189.95, p.p.d.  cabinet  send brochure  Rack  Mount  
 \_\_\_\_\_ unassembled equalizer kits at \$99.95, p.p.d.  Horizontal (flat)  Vertical (up-right)  
 California residents include 6% sales tax

Visa & Master Charge orders accepted

Name \_\_\_\_\_ Card No. \_\_\_\_\_  
 Address \_\_\_\_\_ Exp. \_\_\_\_\_  
 City \_\_\_\_\_ State \_\_\_\_\_ Zip \_\_\_\_\_ Date \_\_\_\_\_ Bank \_\_\_\_\_ No. \_\_\_\_\_

Dealer inquiries invited  
CIRCLE NO. 3 ON FREE INFORMATION CARD

**For more information on advertised products, equipment tested, etc., circle appropriate number on postpaid Free Information Card.**

**ATTENTION! Radio-Shack and Heath Kit Owners!**

<p><b>Centronics 779-1</b></p>  <p><b>\$954.00</b></p>	<p><b>Anadex DP-8000</b></p>  <p><b>\$995.00</b></p>	<p><b>Texas Instrument 810 Printer</b></p>  <p><b>\$1599.00</b></p>	<p><b>Hazeltine 1400</b></p>  <p><b>\$699.00</b></p>	<p><b>Centronics Micro-Printer</b></p>  <p><b>\$495.00</b></p>
--	---	--	--	---



**SYNCHRO-SOUND**  
The Computer People  
193-25 Jamaica Avenue, Jamaica, New York 11423  
212/460-7067 TWX 710-582-5886

ENTERPRISES, INC.

Hours 9-4 Daily and Saturday

Visit our new showroom Working units on display  
BankAmericard Master Charge

sections that cover full details for using the BASIC language (and covers programming examples), print formatting, and machine-level interfaces for the disk BASIC. The disk-manipulation system is spelled out in detail, as are all color and graphics techniques and the file control system (FCS).

The Manual concludes with seven appendixes that contain in-depth discussions of the disk BASIC, file control system, CRT commands, internal features of the computer, an ASCII value table, and the Compucolor alphanumeric and graphic character set, along with other documentation.

**User Report.** The Compucolor is a complete computer. Simply unpack the two sections, interconnect them via the flat ribbon cable, plug the line cord into an ac outlet and turn on the power. That's all there is to getting the system up and ready to go in either the operating system or BASIC.

To use a diskette, simply insert the diskette in the drive, close the drive door, and press the AUTO key on the keyboard. In just a couple of seconds, the disk "menu" pops up on the screen.

The graphics display was clean and sharp with bright colors. The overall quality of the graphics was excellent due to good convergence and the fact that the monitor bandwidth is better than that of a conventional color-TV receiver. One of the major advantages of the color monitor is that optically disturbing moire patterns (from nearby TV transmitters on adjacent channels or local or mobile hams and CBers) are not seen on-screen. Also, this approach provides an apparent increase in bandwidth since the monitor is not bandwidth-limited by r-f or sound circuits. The Compucolor "Sampler" program on diskette demonstrates the system's graphics capability.

The keyboard was a dream to operate. It has a positive professional "feel" and operated flawlessly.

Having had experience with other BASICs, we found Compucolor's version easy to use. It is a fast BASIC and is broad enough to easily adapt to programs written in other BASICs, except where unique symbols are used.

After working some of the programming examples given in the Manual, we typed in several game programs incorporating color graphics. This is quite easy to do, as a single keystroke can be used to change colors, flash symbols, invert and do other formerly difficult graphics "tricks." These keystrokes can

be written into the program.

We also adapted a couple of simple business programs to the color format, making them much easier to read and interpret. Credits and debits for example, are much easier to follow when they are color-coded.

The bottom line here is that the addition of color to a video display does make working and playing with a computer much more pleasant and exciting.

Compucolor is supporting its system with lots of software (diskettes), includ-

ing a large variety of color games, text editor, assembler, and several money-management programs.

In our opinion, the Compucolor II is an excellent choice for a computer system to start and stay with for home use. It is very flexible, thanks to its built-in disk drive, and has sufficient on-board memory to handle just about any length programs. This is a lot of computer for the money. —Leslie Solomon, Technical Director

CIRCLE NO 104 ON FREE INFORMATION CARD



## The DMM you've wanted: Quality and performance at a low, low cost

**A surprisingly low \$69.95.** Surprising because you get the type of performance you've wanted but expected to pay much more for.

### Quality, Performance and Accuracy

The 2010A offers you long-term accuracy with a laser-trimmed resistor network, a stable bandgap reference element, and single-chip LSI circuitry. With 31 ranges and 6 functions, you can measure AC or DC volts from 100  $\mu$ V to 1000V; AC and DC current from 0.1  $\mu$ A all the way to 10 A; resistance from 0.1  $\Omega$  to 20 M $\Omega$ . Typical DCV and Ohms accuracy is 0.1%  $\pm$  1 digit. Easy-to-read 3 1/2 digit LED's with 9mm numerals and automatic decimal point.

### Extra features for greater convenience and flexibility

- Unique X10 multiplier switch gives you convenient selection of the next higher decade. Hi-Low Power Ohms capability gives you three high-ohm ranges that supply enough voltage to turn on a semiconductor junction. You use the three low-ohm ranges for in-circuit resistance measurements.
- Wide Frequency Response: 40 Hz to 40 kHz bandwidth lets you measure audio through ultrasonic AC signals.
- Touch-and-Hold Capability (with optional probe) lets you hold readings as long as you wish so you can make measurements in hard-to-reach places without taking your eyes off the probe tip.

- And More: automatic polarity and zeroing; overrange indication; overload protection on all ranges.

This compact unit is powered by 4 "C" cells (not included) so that you can take your laboratory benchtop unit anywhere with you.

### Kit or Factory-Assembled

Either is a tremendous value. Complete kit only \$69.95; assemble it yourself with our easy-to-follow instructions. Or, for only \$99.50, Sabtronics will ship your 2010A factory-assembled and calibrated.

Whether you're a professional or a hobbyist (or both): When quality, accuracy, and price count, you should check out the 2010A DMM for yourself. Order one today for a full 10 days to inspect it; if you're not completely satisfied, merely return it in its original condition for a prompt and courteous refund of purchase price. Call with your Master Charge or Visa number or write the address below.

**2010A Kit: \$69.95 (plus \$4.00 S&H)**  
**2010A Assembled: \$99.50 (plus \$4.00 S&H)**

**AC-115 Adaptor: \$7.50**

**NB-120 Nickel Cadmium Batteries: \$17.00**

**THP-20 Touch and Hold Probe: \$18.00**

*Making Performance Affordable*

**sabtronics**   
INTERNATIONAL INC.

13426 Floyd Circle M/S 24 Dallas, Texas 75243  
Telephone 214/783-0994

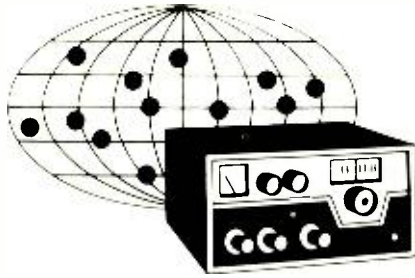

# DX Listening

By Glenn Hauser

## WARC -79

**T**HIS FALL, the World Administrative Radio Conference (WARC) in Geneva will reallocate the entire radio spectrum, in keeping with anticipated needs through the end of the century. Of prime concern to DX listeners is the proposed reallocation of the shortwave spectrum to allow more space for broadcasting.

Fixed (point-to-point) communication has largely switched to satellites in the past 15 years. This trend will no doubt continue. At the same time, the relatively small shortwave broadcast bands have become overloaded to about three times their capacity. This is why co- and adjacent-channel interference has become the rule rather than the exception. It would appear, then, that the natural solution would be to turn over a portion of the fixed bands to broadcasting. But it's not that simple. There are many other claimants to the hf spectrum (such as Amateur Radio), and different countries have different priorities.

For the past few years, the FCC has sponsored a series of meetings by the International Broadcasting Service Group, to help it determine exactly what should be the US position at WARC. In April, the IBSG issued its final proposal and disbanded, its mission completed.

The world is divided into three broad regions for allocation purposes. Region 1 includes Europe, Africa, the Mideast, and the USSR. Region 2 consists of North and South America. Region 3 is comprised of the rest of the world, which includes Asia and the Pacific.

The IBSG proposes that international broadcasting between 5.8 and 22 MHz should be expanded by 93% in Region 2, and 80% elsewhere, very nearly a doubling of available in-band space, from the present total of 2350 kilohertz to 3940 kilohertz.

Since Third World countries hold the balance of power at WARC, the US position also proposes a 60% expansion of bands for tropical broadcasting by adding five new tropical bands in the 3-to-14-MHz range and making all tropical bands, new and old, exclusively for tropical instead of international broadcasting. No changes are proposed between 3.0 and 5.8 MHz, either in tropical or international bands. The five proposed new tropical bands, totalling an addition of 300 kHz are: 5850 to 5900 kHz, 7500 to 7550 kHz, 9825 to 9875 kHz, 11,500 to 11,550 kHz, and 13,900 to 14,000 kHz. These are adjacent, or almost adjacent, to existing or newly proposed international broadcasting bands, for the convenience of listeners, receiver designers, and existing transmitting equipment.

In the proposed new international broadcasting band allocations, all existing bands (except 25 MHz) are expanded, and two totally new bands are added. These new bands would further relieve congestion on adjacent bands and make better use of prevailing maximum useable frequencies. This

expansion totals 1290 kilohertz, as follows:

Proposed (kHz)	Present (kHz)
5900-6200	5950-6200
7250-7500	7100-7300 (not Region 1)
9375-9825	9500-9775
11550-12000	11700-11975
13600-13850	none
15100-15700	15100-15450
17600-17900	17700-17900
19750-19990	none
21450-21800	21450-21750
25850-26100	25600-26100

The US position calls for selective sharing between fixed services and broadcasting in all added band space. However, it is not considered likely such sharing will be adopted by the Conference this fall.

The US position also urges, but does not give a specific date for, adoption of single sideband for international broadcasting. But this change is not likely in the near future. Also being considered are power limits of 50 kW for domestic operations and either 250 or 500 kW for international operations. While this may seem excessive, it is realistic. There are already some instances of a full 1000 kW and even 1250 kW being used in some situations.

Our thanks to Lawrence E. Magne, member of the IBSG, for supplying this information.

**Moscow via Cuba.** The USSR has long been the target of American broadcasts from such nearby countries as Greece, Germany, and Britain. Now, more than 20 years after the triumph of the socialist revolution in Cuba, *Radio Moscow* has begun transmitting in English to North America via Cuba.

We first noted the foregoing arrangement on April 22, Lenin's 109th birthday, as the "newscasts" reminded us every half hour.

The Moscow signals were and are the strongest on the bands during the daytime. This, combined with their steady strength even during ionospheric disturbances that block direct reception from the USSR, made it obvious that a relay was in use. *Radio Moscow* characteristically made no public announcement of the new relay, nor has it ever been publicly admitted that some of its other broadcasts to North America are relayed via Bulgaria.

Why wasn't the Cuban connection made use of long ago? Cuba has been making full use of its shortwave facilities, but there has always been a shortage of power and spare parts, and there has been no reliable way of feeding the Moscow audio to Cuba. Now, however, Cuba has a satellite link with Moscow and finds it advantageous to dedicate one of its



transmitters to Soviet broadcasts to North America. In return, a Soviet transmitter is dedicated to Cuba's broadcasts to the Mediterranean area.

*Radio Moscow* thus becomes the international broadcaster with the most hours per day beamed to North America, surpassing the BBC by far. And with this Cuban relay on one good frequency at a time, we may hope that *Radio Moscow* will no longer find it necessary to use a dozen different frequencies on direct broadcasts from the USSR.

**Publications.** For a list of club publications and services, send a legal-size SASE with 28¢ postage to ANARC, 557 N. Madison Ave., Pasadena, CA 91101.

*FRENDX*, the shortwave broadcast journal, provides a great deal of timely schedule, logging, and QSL information plus receiver reviews and nontechnical articles. Sample \$1, subscription \$13, from NASWA, Box 13, Liberty, IN 47353.

*Review of International Broadcasting*, a monthly listeners' magazine emphasizing free discussion of programming and issues affecting the DX listening hobby (an approach lacking in other publications) is \$1 a sample or \$12 a year from Glenn Hauser, Radio WUOT, Knoxville, TN 37916.

*The World in My Ears*, is a new book by well-known New Zealand DX listener Arthur Cushen, who, despite blindness, has been very successful in shortwave, to the point of being knighted. For information, contact Cushen direct, at 212 Earn St., Invercargill, New Zealand.

**August BBC World Service.** Among the many fine BBC

programmes planned this month are these (dates and times GMT): "Play of the Week," August 5 at 0030 and 1130 presents the winning entry in the World Service Drama Competition. "On Their Majesties Most Secret Service," four programs on the history of British espionage, Saturdays at 1130, Tuesdays at 2030, Wednesdays at 0230. "The Art of the Whodunit," on the history of detective fiction, Saturdays at 0815 and 1315, Sundays at 2015, Mondays at 0315. "Venice Preserved," week of August 20, Monday at 0945 and 2130, Thursday at 1430. Week of August 27 at same times, "Pompeii." Week of August 26, Sunday at 1830, Monday at 0100, Tuesday at 1345, "A Thurber Carnival." "Behind Every Great Man . . .," Saturdays at 0430, Mondays at 0815 and 2315. (Subject to change).

**Updating Listings.** The following changes and additions should be made in the "English Broadcasts" listings that appeared in the June issue:

GMT	Station	Frequencies, changes
1000-1030	R. Korea	11725, 9580
1000-1300	R. Moscow	9600 (via Cuba)
1000-1602	ABC, Perth	9610
1030-1300	CBC Northern Service	9625, 6065 not 11720
1100-1115	R. Pakistan	21655, 17662
1100-1330	BBC	add 21660; 11775 at 1100-1130 & 1300-1330 only
1100-1500	R. Moscow	delete



Get A GNOME  
the original micro-synthesizer

John Simonton's time-proven design provides two envelope generators VCA, VCO & VCF in a low cost, easy to use package.

Use alone with its built-in ribbon controller or modify to use with guitar, electronic piano, polytonic keyboards, etc.

The perfect introduction to electronic music and best of all, the Gnome is only \$59.95 in easy to assemble kit form. Is it any wonder why we've sold thousands?

- ( ) Send GNOME MICRO-SYNTHESIZER Kit (\$59.95 plus \$2.00 postage)
- ( ) GNOME MICRO-SYNTHESIZER (Fully Assembled) \$100.00 plus \$2 postage
- ( ) Send FREE CATALOG

name: \_\_\_\_\_  
address: \_\_\_\_\_  
city: \_\_\_\_\_ state: \_\_\_\_\_ zip: \_\_\_\_\_

BAC/VISA MC card no. \_\_\_\_\_  
DEPT. 8P  
1020 W. WILSHIRE, OKLAHOMA CITY, OK 73116  
CIRCLE NO. 43 ON FREE INFORMATION CARD

## Build The World's Most Powerful 8-Bit Computer

### Featuring The Famous Intel 8085!

# Explorer/85™

Starting for just \$129.95 you can now build yourself a sophisticated, state-of-the-art computer that can be expanded to the level suitable for industrial, business and commercial use. You learn as you go . . . in small, easy-to-understand, inexpensive levels!

- Features Intel 8085 cpu/100% compatible with 8080A software!
- Onboard S-100 bus (up to 6 slots)!
- Onboard RAM and ROM expansion!
- Built-in deluxe 2K Monitor/Operating ROM!
- Cassette/RS 232 or 20 mA J-1/2 8-bit parallel I/O and timer all on beginner's Level "A" system!

EXPLORER/85 gives you a big computer. Features immediately, without turning you into an appliance operator, doomed to run pre-developed software for life. Simply connect EXPLORER to a terminal, video monitor or tv set and 8 volt power supply and start running programs the very first night! Level "A" teaches you machine language and computer fundamentals. It lets you run exercise programs including programs to examine the cpu registers, examine memory, fill memory, move memory and make up games. You can load and play back these programs on an ordinary tape cassette—and display your efforts on a tv screen, video monitor or printer. (\$8.95 RF modulator required for tv use.) The simplified architecture of the Intel 8085 makes EXPLORER far easier to understand than computers using the older, more complex but less powerful 8080A. Then when you're ready, EXPLORER can be expanded—by you—to rival the power of any 8-bit computer on earth. Or you can customize it to perform a dedicated task. Thanks to onboard prototyping, RAM and ROM expansion capabilities.

**LEVEL "A" SPECIFICATIONS**  
EXPLORER's Level "A" system features an advanced Intel 8085 cpu which is 50% faster than its 8080A predecessor yet 100% compatible with 8080A software which, you'll discover, exists by the ton. Big computer features include an 8355 ROM with 2K deluxe monitor/operating system which has two programmable 8-bit bi-directional parallel I/O ports, built-in cassette interface with tape control circuitry to allow labeling cassette tapes and commands which include: "display contents of memory," "run at user location (go to)," "insert data," "move contents of memory," "examine registers individually or all," "fill command (to fill the contents of memory with any variable), automatic baud rate selection, programmable characters per line display output format and more!" An 8155 RAM—1/2 chip contains 256 bytes of RAM, two programmable 8-bit bi-directional and one programmable 6-bit bi-directional I/O ports plus programmable 14-bit binary counter/timer, user interrupt and reset switches. Onboard expansion provisions exist for up to six S-100 boards, 4K of RAM and 8K of ROM. PROM or EPROM

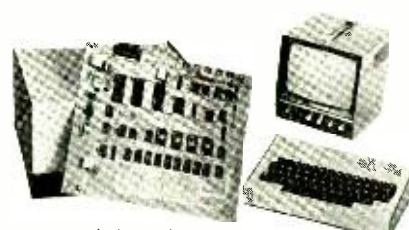

As featured in POPULAR ELECTRONICS  
EXPLORER/85 shown with Video Monitor and Keyboard/Video Terminal

**CHOICE OF HEX KEYPAD OR TERMINAL INPUT**  
If you plan to customize EXPLORER for dedicated use, we recommend that you order hex keypad input. But, if you are planning to go whole hog and blow EXPLORER up into a full size state-of-the-art system with 8K or extended basic (coming soon) up to 64K of memory, floppy disks, telephone interface, printers, and all sorts of S-100 plug-ins—you'll be better off with the Keyboard/Video Terminal input. The \$149.95 EXPLORER Keyboard/Video Terminal includes full ASCII decoding with 128 ASCII upper/lower case set, 96 printable characters, onboard regulators and selectable display formats—32x16 for tv set or 64x16 for video monitor (not included).

**EXPAND EXPLORER, LEVEL-BY-LEVEL**  
Level "B", at \$49.95 adds S-100 signals plus onboard RAM/ROM decoding includes all parts necessary to generate the signals for S-100 bus accessories. Just add two S-100 bus connectors and you have a complete S-100 compatible computer with a world of add-ons at your fingertips. Choose from hundreds of products to satisfy your individual needs. Level "B" kit also includes the address decoders for onboard RAM and ROM expansion, which are addressable anywhere in the 65K field.

Level "C" expansion, at \$39.95 expands the S-100 bus to allow a total of six S-100 cards to be plugged into EXPLORER's motherboard and contained in EXPLORER's steel cabinet. Includes all hardware mounting brackets, board guides, etc. Just add the number of S-100 bus connectors you need.  
Level "D" expansion, at \$69.95 gives you 4K of onboard static RAM utilizing 2114 IC's. Your board will also accept four 2715 EPROM's, which can be purchased separately. You now have an advanced mainframe that can be customized with the peripherals of your choice to fit any (or all) specific requirements. Each level of EXPLORER is separately regulated for the ultimate in stability. Factory service is available from Netronics. Order your EXPLORER today!

ORDER FROM THIS COUPON TODAY!

Netronics R&D Ltd., Dept. 8, 333 Litchfield Road, New Milford, CT 06676

<input type="checkbox"/> Level "A" EXPLORER/85 kit (specify 0 terminal or hex keypad input), \$129.95 plus \$3 p&h	<input type="checkbox"/> Deluxe Steel Cabinet for EXPLORER/85 \$39.95 plus \$3 p&h
<input type="checkbox"/> Power Supply kit 5 amp, ±8 volt \$34.95 plus \$2 p&h	<input type="checkbox"/> Deluxe Steel Cabinet for Keyboard/Video Terminal \$19.95 plus \$2.50 p&h
<input type="checkbox"/> Intel 8085 User's Manual \$7.50 p&h	<input type="checkbox"/> RF Modulator kit, \$8.95 p&h
<input type="checkbox"/> ASCII Keyboard/Video Terminal kit, \$149.95 plus \$3 p&h	<input type="checkbox"/> Total Enclosed (Conn res. add tax) \$_____
<input type="checkbox"/> Hex Keypad kit for hex version, \$69.95 plus \$2 p&h	<input type="checkbox"/> VISA <input type="checkbox"/> Master Charge Exp. Date _____
<input type="checkbox"/> Level "B" S-100/Onboard RAM/ROM Decoder kit (less S-100 connectors) \$49.95 plus \$2 p&h	Account # _____
<input type="checkbox"/> Level "C" S-100 S-Card Expander kit (less connectors), \$39.95 plus \$2 p&h	<b>PHONE ORDERS CALL (203) 354-9375</b>
<input type="checkbox"/> S-100 Bus Connectors (gold) \$4.95 each.	Print Name _____
<input type="checkbox"/> Level "D" 4K Onboard RAM kit \$69.95 plus \$2 p&h	Address _____
	City _____
	State _____ Zip _____

DEALER INQUIRIES INVITED

CIRCLE NO. 40 ON FREE INFORMATION CARD

1200-1255	R. Peking	9820, not 11685	2305-2320	Austrian R.	12015, 9770, 5945 (Sun.), not 0300-0315
1215-1230	V. of Greece	17785, not 17830 and 15345	2330-2400	R. Finland	11800 not 11735
1220-1250	R. Ulan Bator	9575 not 6383	0000-0030	R. Can. Int.	5960
1230-1255	Austrian R.	17860, not 21530	0000-0100	VOA	not 25990
1230-1300	R. Sweden	21690, 21615, not 21700	0000-0100	R. Sofia	15330
1300-2300	CBC Northern Service	11720, 9625, not from 1030	0000-0500	FEBC, Philippines	17810
1330-2200	R. Moscow	11840 (via Cuba)	0015-0100	BRT, Belgium	11715, not 6080
1400-1430	R. Norway	21730, not 15175	0030-0100	R. Sweden	15290, not 11905
1400-1600	AFRTS	15430, not 15425	0030-0100	R. Kiev	15525, 11735, 9800
1430-1500	R. Finland	17785, not 21475	0100-0120	RAI, Italy	11800, not 11810
1500-1600	V. of Rev. Ethiopia	9560, not 9615	0100-0130	R. Can. Int.	17820, not 11940
1500-1700	R. Moscow	delete	0100-0145	R. Berlin International	11970 not 11805
1515-1530	V. of Greece	not 15345	0100-0430	AFRTS	17765, not 25620
1530-1600	R. Yugoslavia	add 15295	0100-0500	WYFR	9715, not 5985
1530-1630	V. of Vietnam	15012, 14990, not 12035 and 9840	0130-0155	Austrian R.	5945, not 6155
1600-1615	R. Pakistan	21755, 21545, not 21735 and 21595	0130-0200	R. Budapest	17710, 15225 (Wed & Fri)
1600-1630	R. Korea	add 11830, not 9780, 9640, 7150	0130-0230	R. Japan	15270, not 15195
1600-1800	VOA	add 25880	0200-0230	R. Can. Int.	11940, not 9535
1610-1655	BRT Belgium	21475 and 17745, not 17740	0200-0230	R. Norway	add 11870
1700-1800	HCJB, Ecuador	17765, not 17890	0200-0300	R. Budapest	add 17710, 15225, not 15220
1700-2300	WYFR	17845	0200-0300	R. Moscow	add 12030, 9600
1800-1830	R. Korea	15255, 11830, not 9780 or 9720	0215-0230	R. Bras	15290, not 15280
1800-1900	V. of Nigeria	15185, 15120 not 11770, not to 1930	0230-0300	V. of Greece	9655, not 9760
1800-0815	R. New Zealand	17860	0230-0300	R. Lebanon	15285, not 15440
1830-1900	R. Nationale, Guinea	15310 (varies) Mon & Fri only	0230-0300	R. Korea	15350
1900-1915	R. Japan	15270, not 15105	0230-0300	R. Sweden	15290, not 9695
1900-1930	R. Can. Int.	not 11905	0230-0315	R. Berlin International	11970, not 11805
1900-2000	HCJB, Ecuador	not to 2030	0300-0330	R. Can. Int.	11940, not 9605
2000-2015	R. Japan	15270, not 15105	0300-0330	R. Budapest	add 17710, 15225, not 15220
2000-2030	R. Korea	delete	0300-0330	R. Kiev	11830, 11735, 9800
2000-2030	V. of Islamic Rev., Iran	9139, not 9022	0300-0400	UBC Uganda	delete
2000-2030	R. Can. Int.	15325, not 17875 or 11855	0300-0400	R. Moscow	add 12030, 9600
2100-2115	R. Japan	15270, not 15105	0300-0700	VOA	add 17865
2100-2200	V. of Nigeria	15185, 15120	0330-0355	Austrian R.	5945, not 6155
2100-2300	CBC Radio	17820, 15325 (Mon-Fri), not 17875, not 2200-2300	0330-0450	R. Habana	not 11725
2115-0815	R. New Zealand	delete	0400-0415	R. Budapest	add 17710, 15225, not 15220
2130-2200	R. Can. Int.	17780 and 11940, not 17875, 17820, 15325, 11945	0400-0430	R. Budapest	17710, 15225, etc. (Mon. only)
2130-2200	HCJB, Ecuador	21480, 17790, 15295	0400-0430	R. Can. Int.	add 11845
2130-2200	R. Sofia	15135, 11750, not 11920, 11860	0400-0445	FEBA, Seychelles	11805
2200-2400	AFRTS	17765, not 25620	0430-0455	Austrian R.	15260, not 5945
2300-2330	BBC	not 5975	0430-0500	R. Sofia	11750, not 11860
2300-2330	R. Sweden	15290, 11705, not 15205, 9695, 9690	0430-0500	R. Korea	15345, 9755
2300-2330	R. Vilnius	15525, 11735	0430-0700	AFRTS	9755, not 15330, 9685
2300-2330	R. Korea	17860, 15385, 15345	0455-0630	V. of Nigeria	15185, 15120, 7275 or 7255, not 0555-0835
2300-2400	FEBC, Philippines	15450	0500-0515	R. Japan	15270, not 15105
2300-2400	VOA	not 25990	0530-0550	V. of Germany	11905, not 6100
			0600-0615	R. Japan	15270, not 15105
			0615-0630)	R. Canada	11960 and 9635, not 11845,
			0645-0700)	International	11775, 9590, 6045
			0630-0700	R. Korea	delete
			0700-0715	R. Japan	15270, not 15105
			0755-fade	Action Radio, Guyana	5950
			0800-1000	FEBC, Philippines	11765

Note: Frequencies not referred to in a given entry are still correct at presstime. This is a listing of changes only, not giving complete frequency list for any particular transmission. ◇



# Software Sources

By Leslie Solomon  
Technical Director

**6502 Operating System.** EXOS (Extended Operating System) for 6502 computers comes in a 4K 2708 PROM and has 20 commands including display, enter, math, memory test, find, fill, move, compare, speed change, load/dump a hex formatted MUST tape, verify, and several "go to" commands. The program is compatible with all MOS Technology TIM systems, or other 6502 computers. Price is \$150. Also available is DATE (Disassembler-Assembler Trace Editor). Source programs can be entered, assembled, edited, traced and disassembled. The trace mode executes the user program one instruction at a time, displays MPU registers, the instruction and the MOST mnemonics. \$150. Both programs \$295. CGRS Mi-

crotech, Box 368, Southampton, PA 18966 (Tel: 215-757-0284).

**Jolt Stuff.** ERAC (Editor and Resident Assembler Controller) was designed for users of ROM version of the Jolt resident assembler (\$C900-CFFF). ERAC allows source text and object code to be placed anywhere in RAM. Residing in 2K starting at \$0800, 1000 or A800, ERAC is an extension of the RAP. A paper tape is available for \$5, manual \$4.50, and source of \$0800 version is \$12.50. LEDIP (Line Editor Program) is a 1.1K line-oriented text editor that can be expanded. It will output source text suitable for usage with the PROM Jolt Resident assembler (\$E800-EFFF). Paper tape is \$2.75, manual \$3.25, cross assembly \$5. For further information, send \$1 to the 6502 Program Exchange, 2920 Moana, Reno, NV 89509.

**8080/Z80 Macro Assembler.** This 14K assembler includes a linking loader, library manager and cross-reference facility and assembles over 1000 lines per minute. It supports the Intel standard macro facility and the number of nesting macros is limited only by memory. Code is assembled in relocatable modules. Conditionals may be nested to 255 levels. Other features include comment blocks, variable input radix from base-2 to base-16, titles and subtitles, variable page size, octal or hex listings, PRINTX for printing

assembly or diagnostic messages, and PHASE/DEPHASE to allow code to reside in one area of memory but operate in another. It accepts both 8080 and Z80 opcodes. Price is \$200. Microsoft, 10800 NE Eighth, Suite 819, Bellevue, WA 98004 (Tel: 206-455-8080).

**TRS-80 Solar Package.** The SUNGRAPH program calculates and plots the sun's local elevation and azimuth for any location on the Earth. It uses TRS-80 Level-II

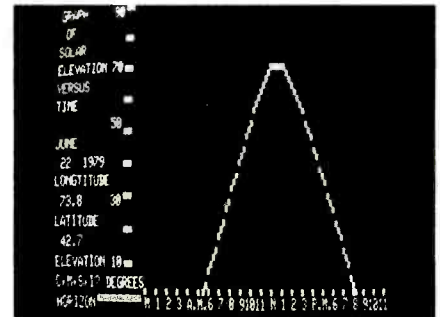

BASIC, and requires 13K storage. Options include graphs of elevation vs time of day, azimuth vs time of day, maximum elevation vs date and elevation at a specified azimuth and date. Save options allow the graph to be stored on cassette. Cassette is \$49, disk is \$75. Solartek, Box 298, Guilderland, NY, 12084.

## THE MICROCOMPUTER MART

### COMPUTER RETAIL STORES

Advertisement

#### CALIFORNIA

**Omega Microcomputers**  
Quality Personal-Business Systems  
Apple 11—Alpha Micro  
3535 Torrance Boulevard  
Suite 10  
Torrance, CA 90503  
(213) 370-9456

**Rainbow Computing**  
Complete Apple 11 Line  
1073 White Oak Avenue  
Granada Hills, CA 91344  
(213) 360-2171

#### COLORADO

**Byte Shop**  
Complete Apple 11 Line  
3464 Acoma Street  
Englewood, CO 80110  
(303) 761-6232

#### FLORIDA

**Computer Age, Inc.**  
Service, Support, Professionalism  
At A Very Affordable Price  
1308 North Federal Highway  
Pompano Beach, FLA 33062  
(305) 689-3233

**Computer Center Of The Palm Beaches**  
The Microcomputer Specialists  
2827 Exchange Court  
West Palm Beach, FLA 33409  
(305) 689-3233

**Sara Tech Electronics Inc.**  
Discounts On All Major Brands  
400 Base Avenue  
Suite 225  
P.O. Box 692  
Venice, FLA 33515  
(813) 485-3559

#### GEORGIA

**Graham Business Computer**  
Featuring Full Line Ohio Scientific  
5725 Buford Highway  
Suite 216  
Atlanta, GA 30340  
(404) 457-8450

#### MARYLAND

**Comm. Center, Inc.**  
Exidy Sorcerer  
Call Toll Free  
Laurel Plaza—Ret. 198  
Laurel, MD 20810  
(800) 638-4486

**Computers Unlimited, Inc.**  
Tomorrow's Technology Today  
907 York Road  
Towson, MD 21204  
(301) 321-1553

#### MICHIGAN

**Computer Center**  
Business Systems/Personal Systems  
28251 Ford Road  
Garden City, MI 48135  
(313) 422-2570

**The Computer Mart**  
We will Not Be Undersold  
560 W. 14 Mile Road  
Clawson, MI 48017  
(313) 288-0040

#### NEW JERSEY

**Computer Mart of New Jersey**  
The Microcomputer People (R)  
501 Route 27  
Iselin, NJ 08830  
(201) 283-0600

#### OHIO

**Band-Orch, Inc.**  
Complete Ohio Scientific Line  
337 East State Street  
Alliance, Ohio 44601  
(216) 821-2600

#### PENNSYLVANIA

**Personal Computer Corp.**  
First in Pennsylvania  
Frazer Mall  
Lancaster Avenue and Route 352  
Frazer, PA 19355  
(215) 647-8453

**Ripley Computers**  
Affordable Computers For  
Business/Churches/Home/Personal  
126 N. Main Street  
Souderton, PA 18964  
(215) 723-1509

#### WASHINGTON

**P.S.C. - Computer Systems**  
Business And Personal Software Systems  
546 North 6th  
Walla Walla, WA 99362  
(509) 529-9331

Dealers: For information about how to have your store listed in THE MICROCOMPUTER MART, please contact:  
POPULAR ELECTRONICS, One Park Ave., New York, N.Y. 10016 • (212) 725-3568.

name \_\_\_\_\_

address \_\_\_\_\_

city \_\_\_\_\_

state \_\_\_\_\_

zip \_\_\_\_\_

## MAIL THIS COUPON AND WE'LL SEND YOU THE BEST SPEAKER CATALOG YOU EVER READ!

No kidding. Speakerlab's catalog took longer to write than some of our competitors have been in business. In fact, we created an industry by "building great kits so you can afford great speakers." Our catalog is an invaluable



manual of speaker function and design. And, it will introduce you to the finest speaker kits made anywhere...with the strongest money-back guarantee. Find out for yourself...FREE, FREE, that is. Mail the coupon now.

# Speakerlab®

Dept. 8 PE, 735 N. Northlake Way  
Seattle, WA 98103

### SEE YOUR DEALER TODAY

DEMAND THE ORIGINAL

## 'Firestik'

"THE FUEL-SEEKER"

THE #1 WIRE-WOUND AND MOST  
COPIED ANTENNA IN THE WORLD!

Rugged, Shatterproof Fiberglass

Antennas and accessories for marine, RV, truck, auto, van and motorcycles, etc.  
Four Colors: Silver-Gray, Black, Red, and White

Our 17th Year Serving the CB & Communications Market

SEND FOR FREE CATALOG



LIMITED OFFER — USA ONLY

Get this nine-inch 'Firestik'® Antenna Wars decal in four beautiful colors on a PAL T-shirt. See your dealer today or send \$3.00 to:

**PAL** 2614 East Adams, Phoenix, Az, 85034

Name \_\_\_\_\_

Street \_\_\_\_\_

City \_\_\_\_\_

State \_\_\_\_\_

Zip \_\_\_\_\_

Dealer & Distributor Inquiries Invited

**5-YEAR REPLACEMENT WARRANTY**

CIRCLE NO. 44 ON FREE INFORMATION CARD



# Computer Bits

By Leslie Solomon  
Technical Director

## WINDOWS IN THE CRT

THE MOST common way to communicate with a computer today is via a plug-in or a separate video terminal. The ordinary video terminal forms a single "window," in which all you can see is one piece of data at a time as it appears in sequential order on the screen. Recently, we had the opportunity to work with a very special graphics display system called the "Screensplitter" from Micro Diversions, Inc. (8455-D Tyco Rd., Vienna, VA 22180 Tel: 703-827-0888). This novel plug-in video module is not limited to a single window (see photo). Rather, the user can create, under software control, almost any number of data-display windows, each with its own independent display.

Individual windows in the Screensplitter can be sized, labelled, and framed as desired. Furthermore, frame and window can be made to flash, display in reverse video, clear, scroll, and use any

character as a blinking or nonblinking cursor. The window package is contained in an EPROM and has 20 user-callable functions. You can, for example, run a BASIC program and display each subroutine in its own window. Or you can display different data in different windows. You can even move the windows around at will.

If you are doing assembly-language programming, one window can be used as a real-time clock, another to display run time, and others to display register contents or anything else you desire. Debugging information can be contained in its own window. For game playing, you can create as many windows as required. Too, some windows can be dedicated strictly to graphics.

The Screensplitter does not preclude operation as a single window with 40 lines of 80 characters each. Bear in mind, however, that this dense a display

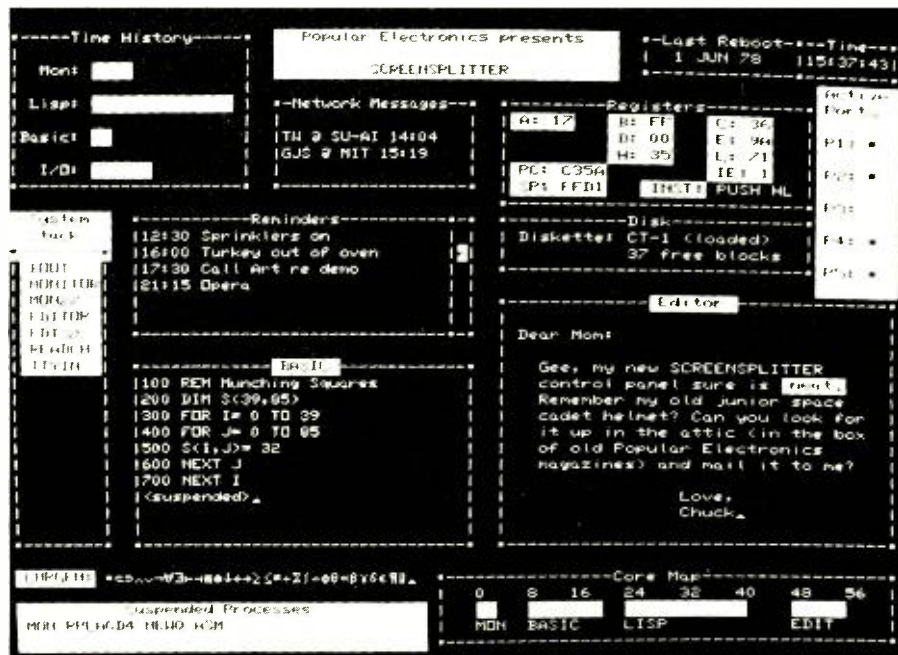

The Screensplitter can generate almost any number of independent "windows" contingent on the needs of the user.

POPULAR ELECTRONICS

requires a video monitor with at least a 10-MHz bandwidth.

The Screensplitter occupies a single S-100 bus slot. It contains its own 4K of RAM that is memory mapped into the address space so that it can be accessed if you wish to use the window package.

**Pascal Microengine.** This new computer contains 64K of RAM, two RS-232C ports, two parallel ports, and a floppy-disk controller with DMA. It features self-test diagnostics, Pascal compiler, BASIC compiler, file manager, screen-oriented editor, debugger, and graphics package. Available options include a floppy-disk subsystem, printer, and terminal. Cost at this writing is \$1995. Address: Computer Interface Technology, 2080 South Grand, Grand Center, Santa Ana, CA (Tel: 714-979-9920).

**Pet S-100 Interface.** The Betsi Interface/Motherboard contains all logic required for interfacing S-100 boards to the Pet microcomputer. It connects directly to the Pet's expansion connector and has four S-100 slots. It does not interfere with the Pet's parallel or IEEE ports. The board also contains a dynamic memory controller that permits use of a 32K RAM board. There are also sockets and decoding circuitry for 8K of 2716 PROM. Price is \$119.00 for the kit, which includes one S-100 connector, or \$165.00 assembled and with four S-100 connectors. Address: Forethought Products, P.O. Box 8066, Coburg, OR 97401 (Tel: 503-485-8575).

**S-100 Video Board.** The new ALTR-2480 is a 24-line by 80-character S-100-bus video display board. It features upper- and lower-case characters plus graphics. The system also has byte mapping (4K by eight), built-in read/write refresh, 2716 user-programmable EPROM, external/internal sync, normal/inverse/blink control, 500-ns access time, and direct drive for a CRT monitor. Using "Transparent Memory," the CPU can access the refresh memory at any time, the display is glitch-free, and the CPU is never interrupted. No reliance is placed on the peculiar characteristics of a particular CPU. A multiplexing technique permits nonconflicting access by both CRT controller and CPU. Price is \$295.00. Address: Matrox Electronic Systems, Ltd., 2795 Bates Rd., Montreal, Quebec, Canada H3S 1B5 (Tel: 514-481-6838/735-1182).

(continued on page 76)

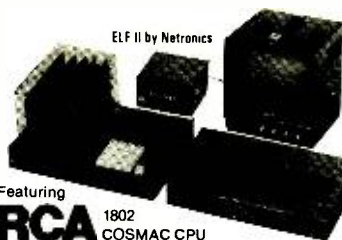

Featuring  
**RCA 1802 COSMAC CPU**

Own a powerful home computer system, starting for just \$99.95—a price that gets you up and running the very first night... with your own TV for a video display. \$99.95 ELF II includes RCA 1802 8-bit microprocessor addressable to 64k bytes with DMA, interrupt, 16 registers, ALU, 256 byte RAM, full hex keyboard, two digit hex output display, stable crystal clock for timing purposes, RCA 1861 video IC to display your programs on any video monitor or TV screen and 5-shot plug-in expansion bus (less connectors) to expand ELF II into a giant!

**ELF II Explodes Into A Giant!**

Master ELF II's \$99.95 capabilities, then expand with GIANT BOARD... KLUGE BOARD... 4k RAM BOARDS... TINY BASIC... ASCII KEYBOARD... LIGHT PEN... ELF-BUG MONITOR... COLOR GRAPHICS & MUSIC SYSTEM... TEXT EDITOR... ASSEMBLER... DISASSEMBLER... VIDED DISPLAY BOARD... and—

**More Breakthroughs Coming Soon!**

Soon to be introduced: ELF II special application kits that give you the hardware and software you need to use ELF II for specialized purposes such as a telephone dialer... industrial controller... home photography... security system... police alert... motor controller... station output monitor on a conveyor belt assembly line... and some new, super-fantastic games!

Also coming soon: PRDM Programmer... A.D. D.A Converter Controller Board... and more! Unlike some heavily advertised hobby computers, ELF II doesn't limit you to pre-recorded programs. With ELF II you learn computing from the ground up... from machine language to assembly language to BASIC... in quick, clear and easy steps. ELF II is a powerful computing tool, but one that you can master with the same ease you once mastered a slide rule or pocket calculator.

**Master This Computer In A Flash!**

Regardless of how minimal your computer background is now, you can learn to program an ELF II in almost no time at all. Our *Short Course On Microprocessor & Computer Programming*—written in non-technical language—guides you through each of the RCA COSMAC 1802's capabilities, so you'll understand everything ELF II can do... and how to get ELF II to do it! Don't worry if you've been stumped by computer books before. The *Short Course* represents a major advance in literary clarity in the computer field. You don't have to be a computer engineer in order to understand it. Keyed to ELF II, it's loaded with "hands on" illustrations. When you're finished with the *Short Course*, neither ELF II nor the RCA 1802 will hold any mysteries for you.

In fact, not only will you now be able to use a personal computer creatively, you'll also be able to read magazines such as BYTE... INTERFACE AGE... PDPULAR ELECTRONICS and PERSONAL COMPUTING and fully understand the articles. And, you'll understand how to expand ELF II to give you the exact capabilities you need!

If you work with large computers, ELF II and the *Short Course* will help you understand what they're doing.

**Get Started For Just \$99.95, Complete!**

\$99.95 ELF II includes all the hardware and software you need to start writing and running programs at home, displaying video graphics on your TV screen and designing circuits using a microprocessor—the very first night—even if you've never used a computer before.

ELF II connects directly to the video input of your TV set, without any additional hardware. Dr. with an \$8.95 RF modulator (see coupon below), you can connect ELF II to your TV's antenna terminals instead.

ELF II has been designed to play all the video games you want, including a fascinating new target/misile gun game that was developed specifically for ELF II. But games are only the icing on the cake. The real value of ELF II is that it gives you a chance to write machine language programs—and machine language is the fundamental language of all computers. Of course, machine language is only a starting point. You can also program ELF II with assembly language and tiny BASIC. But ELF II's machine language capability gives you a chance to develop a working knowledge of computers that you can't get from running only

**Write and run programs—the very first night—even if you've never used a computer before!**

You're up and running with video graphics for just \$99.95 — then use low cost add-ons to create your own personal system that rivals home computers sold for 5-times ELF II's low price!

pre-recorded tape cassettes.

**ELF II Gives You The Power To Make Things Happen!**

Expanded, ELF II can give you more power to make things happen in the real world than heavily advertised home computers that sell for a lot more money. Thanks to an ongoing commitment to develop the RCA 1802 for home computer use, the ELF II products—being introduced by Netronics—keep you right on the outer fringe of today's small computer technology. It's a perfect computer for engineering, business, industrial, scientific and personal applications.

Plug in the **GIANT BOARD** to record and play back programs, edit and debug programs, communicate with remote devices and make things happen in the outside world. Add **Kluge (prototyping) Board** and you can use ELF II to solve special problems such as operating a complex alarm system or controlling a printing press. Add **4k RAM Boards** to write longer programs, store more information and solve more sophisticated problems.

ELF II add-ons already include the **ELF II Light Pen** and the amazing **ELF-BUG Monitor**—two extremely recent breakthroughs that have not yet been duplicated by any other manufacturer.

The **ELF-BUG Monitor** lets you debug programs with lightning speed because the key to debugging is to know what's inside the registers of the microprocessor. And, with the **ELF-BUG Monitor**, instead of single stepping through your programs, you can now display the entire contents of the registers on your TV screen. You find out immediately what's going on and can make any necessary changes.

The incredible **ELF II Light Pen** lets you write or draw anything you want on a TV screen with just a wave of the "magic wand." Netronics has also introduced the **ELF II Color Graphics & Music System**—more breakthroughs that ELF II owners were the first to enjoy!

**ELF II Tiny BASIC**

Ultimately, ELF II understands only machine language—the fundamental coding required by all computers. But, to simplify your relationship with ELF II, we've introduced an **ELF II Tiny BASIC** that makes communicating with ELF II a breeze.

**Tiny BASIC** saves you the time of having to code your individual instructions in machine language for ELF II. Instead, you simply type instructions on a keyboard—PRINT, RUN, LOAD, ETC. Your **Tiny BASIC** program automatically translates them into machine language for ELF II. Then it translates ELF II's output back into simple words and symbols for you.

**Now Available! Text Editor, Assembler, Disassembler And A New Video Display Board!**

The **Text Editor** gives you word processing ability and the ability to edit programs or text while it is displayed on your video monitor. Lines and characters may be quickly inserted, deleted or changed. Add a printer and ELF II can type letters for you—error free—plus print names and addresses from your mailing list!

**ELF II's Assembler** translates assembly language programs into hexadecimal machine code for ELF II use. The Assembler features mnemonic abbreviations rather than numerics so that the instructions on your programs are easier to read—this is a big help in catching errors.

**ELF II's Disassembler** takes machine code programs and produces assembly language source listings. This helps you understand the programs you are working with and improve them when required.

The new **ELF II Video Display Board** lets you generate a sharp, professional 32 or 64 character by 16 line upper and lower case display on your TV screen or video monitor—dramatically improving your unexpanded \$99.95 ELF II. When you get into longer programs, the Video Display Board is a real blessing!

**Ask Not What Your Computer Can Do... But WHAT CAN IT DO FOR YOU?**

Don't be trapped into buying an expensive dinosaur, simply because you can afford it. ELF II is more advanced and more fun to use than big name computers that cost a lot more money. With ELF II you learn to write and run your own programs. You're not just a keypunch operator. No matter what your interests are, ELF II is the fastest way to get into computers. Order from the coupon below!

**Netronics R&D Ltd., Dept PE-8**  
333 Litchfield Road, New Milford, CT 06776

**Yes! I want my own computer! Please rush me—**

RCA COSMAC ELF II language, it's a learning breakthrough for engineers and laymen kit at \$99.95 plus \$3 postage and handling (requires 6.3 to 8 volt AC power)

Power Supply (required) \$4.95 postpaid

RCA 1802 User's Manual \$5 postpaid

Tom Pittman's *Short Course On Microprocessor & Computer Programming* teaches you just about everything there is to know about ELF II or any RCA 1802 computer. Written in non-technical language, it's a learning breakthrough for engineers and laymen \$17.00 plus \$1 p&h

4k Static RAM kit. Addressable to any 4k page to 64k. \$89.95 plus \$3 p&h

Gold plated 86-pin connectors (one required for each plug-in board) \$5.70 ea. postpaid

Expansion Power Supply (required when adding 4k RAM) \$34.95 plus \$2 p&h

Professional ASCII Keyboard kit with 128 ASCII upper/lower case set, 96 printable characters, onboard regulator, parity logic selection and choice of 4 hand shaking signals to mate with almost any computer. \$64.95 plus \$2 p&h

Deluxe metal cabinet for ASCII Keyboard. \$19.95 plus \$2.50 p&h

Video Display Board kit lets you generate a sharp professional 32 or 64 character by 16 line upper and lower case display on your TV screen or video monitor—dramatically improving your unexpanded \$99.95 ELF II (if it's inside ASCII Keyboard cabinet) \$89.95 plus \$2.50 p&h

ELF II Tiny BASIC on cassette tape. Commands include SAVE LOAD X X (-) I

**PHONE ORDERS ACCEPTED!**  
Call (203) 354-9375

Total Enclosed \$ \_\_\_\_\_  
(Conn. res. add tax)

**CHARGE IT!** Exp. Date \_\_\_\_\_  
 Visa  Master Charge  
(Bank # \_\_\_\_\_)

Account # \_\_\_\_\_

26 variables A-Z LET IF/THEN INPUT PRINT GO TO GO SUB RETURN END REM CLEAR LIST RUN, PLOT, PECK POKE. Comes fully documented and includes alphanumeric generator required to display alphanumeric characters directly on your TV screen with out additional hardware. Also plays hex back-to-plus a drawing game that uses ELF II's hex keyboard as a joy stick. 4k memory required. \$14.95 postpaid

Tom Pittman's *Short Course on Tiny Basic* for ELF II \$5 postpaid

ELF-BUG™ Deluxe System Monitor on cassette tape. Allows displaying the contents of all registers on your TV at any point in your program. Also displays 24 bytes of memory with full addresses, blinking cursor and auto scrolling. A must for the serious programmer! \$14.95 postpaid

Text Editor on cassette tape gives you the ability to insert, delete or edit lines and words from your programs while they are displayed on your video monitor. (Add printer and you can use ELF II to type error free letters plus insert names and addresses from your mailing list) \$19.95 postpaid

Assembler on cassette tape translates assembly language programs into hexadecimal machine code for ELF II use. Mnemonic abbreviations for instructions (rather than numerics) make programs easier to read and help prevent errors. \$19.95 postpaid

Disassembler on cassette tape takes machine code programs and produces assembly language source listings to help you understand and improve your programs. \$19.95 on cassette tape

**SAVE \$9.95**—Text Editor, Assembler & Disassembler purchased together only **\$49.95!** (Require Video Display Board plus 4k memory.)

ELF II Light Pen, assembled & tested \$7.95 plus \$1 p&h

ELF II Color Graphics & Music System Board kit \$49.95 plus \$2 p&h

ELF II connects directly to the video input of your TV set without additional hardware. To connect ELF II to your antenna terminals instead, order **RF Modulator**, \$8.95 postpaid.

**Coming Soon!** A.D. D.A Converter Controller Board and more!

Print Name \_\_\_\_\_  
Address \_\_\_\_\_  
City \_\_\_\_\_  
State \_\_\_\_\_ Zip \_\_\_\_\_

**DEALER INQUIRIES INVITED**

CIRCLE NO. 39 ON FREE INFORMATION CARD

AUGUST 1979

www.americanradiohistory.com

75

Use Quick-Wedge to fasten leads, wire in panelights, connect test equipment, install components

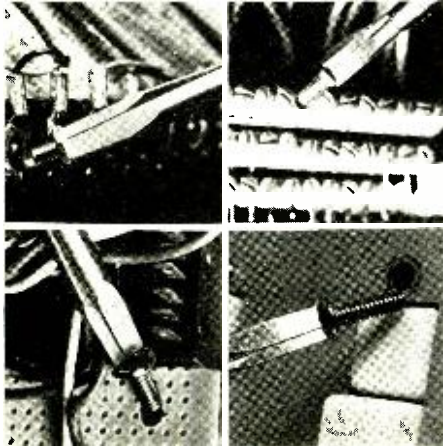

They do all that ordinary screwdrivers do, PLUS they hold and start the screw



**QUICK-WEDGE** 17 sizes  
Screw-holding screwdrivers

Unconditionally guaranteed.  
BUY A SET TODAY

See your dealer or write to:  
Kedman Company, P.O. Box 25667,  
Salt Lake City, Utah 84125

CIRCLE NO. 34 ON FREE INFORMATION CARD

Best price and delivery on . . .

## Exidy Sorcerer®

— call us —



# SAVE

15% on  
NORTH STAR  
CROMEMCO and  
other S-100 Systems

10% OFF  
RADIO SHACK TRS-80  
and accessories (full warranty)

Complete line of printers and  
disk systems for TRS-80

— WRITE FOR FREE CATALOG

### MiniMicroMart, Inc.

1618 James Street, Syracuse NY 13203  
PHONE: (315) 422-6666 TWX 710 541-0431  
CIRCLE NO. 38 ON FREE INFORMATION CARD

## COMPUTER BITS

(continued from page 75)

**S-100 Extender Board.** A 7-segment display logic probe and a pulse-catcher LED, whose brightness corresponds to the duty cycle of the pulse stream, are used in the new TB-2 Extender Board kit from Mullen. The board features a general-purpose "kluge" area for circuit development. This section is provided with its own on-board 5-volt, 1-ampere regulator that also powers the logic probe. Other features include power supply links for current measurement, labelled S-100-bus edge connector, and gold-plated connector contacts. Price is \$35.00. Address: Mullen Computer Products, P.O. Box 6214, Hayward, CA 94545 (Tel: 415-783-2866).

**S-100 to IEEE Interface.** The P&T 488 Interface Board permits the broad spectrum of S-100-bus computers to directly interface with instruments and peripherals that operate on the IEEE 488-1975 Standard Digital Interface for Programmable Instrumentation. The board comes with 488 cable assembly. Software is distributed as source code in machine-readable form. An integral "Bit-wiggler" tape interface is used for reading software with a conventional cassette tape recorder. Price is \$250.00 in kit, \$325.00 in wired form. Address Pickles & Trout, P.O. Box 1206, Goleta, CA 93017 (Tel: 805-967-9563).

**New Printers In Town.** The Model DP-8000 hard-copy printer from Anadex prints 80-character lines at 112 character/second (84 lines/minute). Printing is bidirectional, via sprocket feed. Alphanumerics are formed from a 9 x 7 dot matrix. The complete 96-character ASCII set is available. Basic ASCII inputs include RS-232C, 20/60-mA current loop, and parallel-bit/serial character, the last synchronous at high strobe rates. Three data lines of FIFO buffer storage are available, and data can be accepted continuously or in bursts. Serial ASCII is adjustable to 9600 baud. Up to 1000 characters/second can be fed into the input. Address: Anadex, Inc., 9825 DeSoto Ave., Chatsworth, CA 91311 (Tel: 213-998-8010).

Bowmar's Model TP-3150 thermal printer requires no ribbons or ink. It has an 18-character capacity and uses a 5 x 5 solid-state dot-matrix print head. Print direction and character rotation are user

# TAPE DISCOUNTS

Minimum order 10 tapes



CASSETTES			
SAC-60	2.22	ADC-120	3.76
SAC-90	3.04	DC-45	1.19
ADC-45	1.82	DC-60	1.38
ADC-90	1.78	DC-90	1.75
ADC-90	2.88	DC-120	2.40
		DC-180	3.06

8 TRACK			
D-45	1.80	AD-45	2.29
D-90	2.22	AD-90	2.90

VIDEO CASSETTES			
VT-120, 4 hr.	19.25	VT-60, 2 hr.	14.50



MASTER I			
C-50	2.59	C-90	2.99
MASTER II/III			
C-50	2.99	C-90	3.39
HIGHLANDER			
C-45	.97	C-90	1.69
C-50	1.10	C-120	2.79
DYNARANGE			
SC-45	1.89	SC-90	1.89
		SC-90	2.59

VIDEO CASSETTE			
BETA L-500	19.25	L-250	9.95
VHS VK-120, 4 hr.	18.60	VK-60, 2 hr.	14.25

Lifetime Product Guarantee FREE CATALOG  
Order shipped 1-3 days. Add \$2.50 ship. & hdg. per 10 tapes. N.Y.S. Res. add sales tax. No C.O.D.S.

### CONSUMERS CO

P.O. Box 590 Dept P011  
481 Yonkers N.Y. 10551 Phone: (914) 864-2909

CIRCLE NO. 12 ON FREE INFORMATION CARD

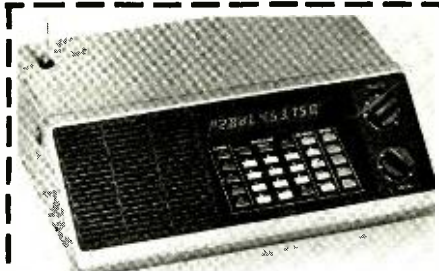

Thousands of Communications Electronics customers own a BEARCAT® SCANNER. But since we've introduced the Bearcat® 250 crystalline 15,600 frequency, 50 channel synthesized scanner, our specifications have been improved:

#### Sensitivity

0.4 microvolts for 12dB SINAD on VHF bands, UHF band slightly less

#### Selectivity

Better than -60dB @ ±25 KHz

#### Audio Output

At least 2.0 Watts rms

#### Audio Quality

The BC-250 audio is more noise-free and suffers less distortion than comparable models by a margin of 10dB or more.

#### Image Rejection

The BC-250 rejects image frequencies by at least 8dB better in all bands than comparable models.

This month, we've got a special price on the Bearcat® 250. Now, you can own this fantastic professional monitor for only \$269.00. That's a savings of over \$80.00.

To start Bearcating, Master Charge and Visa card holders may call and order toll free 800-521-4414. Outside the U.S. and Michigan dial 313-994-4441. To order by mail, send \$269.00 plus \$5.00 for U.S. U.P.S. shipping. Foreign orders invited at slightly higher cost. Mail your orders or requests for a free catalog completely describing all Bearcat® scanners to: Communications Electronics, Box 1002, Dept. HF1, Ann Arbor, Michigan 48106 U.S.A. Bearcat® is a registered trademark of Masco Corporation of Indiana. Copyright ©1978 Communications Electronics

CIRCLE NO. 1 ON FREE INFORMATION CARD

BLANK TAPES		REEL-TO-REEL	
<b>CASSETTE TAPES</b> Ampex Grand Master II C-90 \$3.11 Ampex Grand Master I C-90 \$2.78 BASF Stereo C-90 \$2.68 BASF Professional II or III C-90 \$2.99 Maxell UD C-90 \$2.97 Maxell UDXL I or II C-90 \$2.50 Maxell UDXL II or III C-90 \$2.57 Scotch tape bases (Dynarange C-90 7 3/8" \$4.99) Scotch Master II or III C-90 \$3.29 Sony Ferraferrame C-90 \$3.11 TDK D C-90 \$1.20 TDK D C-120 \$1.68 TDK D C-180 \$2.39 TDK AD C-90 \$2.57 TDK AD C-90 \$2.57 TDK SA C-90 \$3.18 TDK SA C-90 \$3.18		<b>VIDEO TAPES</b> <b>BETA FORMAT</b> TDK L-500 (2 Hour) \$13.75 Sony L-750 (3 Hour) \$8.99 Sony L-800 (2 Hour) \$13.95 Scotch L-600 (2 Hour) \$13.50 Smith L-600 (2 Hour) \$13.95 Ampex L-800 (2 Hour) \$12.95 <b>VHS FORMAT</b> Scotch VCR-200 (4 Hour) \$17.95 JVC T-120 (4 Hour) \$10.75 TDK T-120 (4 Hour) \$9.50 Fuji T-120 (4 Hour) \$17.95 RCA VK-200 (4 Hour) \$18.95 RCA VK-125 (4 Hour) \$14.95 Panasonic NV-120 (2 Hour) \$18.95 Panasonic NVT-40 (4 Hour) \$14.95	

Minimum Order 12 Tapes — 100% Guaranteed

CARTRIDGES		SHURE	
<b>audio-technica</b> AT 20 SS \$129.50 AT 15 SS \$89.90 AT 14 SA \$48.95 AT 12 SA \$4.90 AT 10 \$2.00 <b>STANTON</b> SMS \$72.50 MH5EE5 \$55.00 6BEE5 \$42.90 5BEE5 \$24.90 5ME \$12.90 <b>EMPIRE</b> 2000Z \$59.90 2000 \$31.50 2000E \$19.50 4000H \$29.90		M95HE \$34.95 V15 TYPE IV \$39.95 V15 TYPE III \$54.95 M95D \$79.75 M44E \$20.95 M70E \$13.90 <b>PICKERING</b> KSV3000 \$49.95 XV15/100E \$39.95 XV15/750E \$32.50 XV15/25E \$22.77 XV15/400E \$22.45	

HEADPHONES		KOSS	
<b>SENNHEISER</b> HD-420 \$50.88 HD-430 \$74.40 HD-400 \$26.28 HD-414 \$44.98 HD-424 \$45.28 <b>PROK</b> PRO 4AA \$39.90 PRO 4 AAA \$49.00 HW1 \$29.97 HWLLC \$35.97 K-6A \$19.97			

HOW TO ORDER: For shipment within 48 hours, send money order or certified check. Two weeks delay on personal checks. Please add \$3.50 per order for shipping & handling. \$6.50 for orders outside U.S., H.V.S. residents add tax. No C.O.D.'s. All merchandise 100% guaranteed, brand new & factory fresh.

**J&R MUSIC WORLD**  
 33 PARK ROW, DEPT. FE, NEW YORK, N.Y. 10038  
**ORDER TOLL FREE (800) 221-8180**  
 CALL OR WRITE FOR FREE 120 PAGE CATALOG  
 CIRCLE NO. 31 ON FREE INFORMATION CARD

controllable. ASCII data can be synchronous parallel or asynchronous serial. The printer accepts the 64 standard ASCII characters and ignores all other codes. Price is \$270.00. Address: Bowmar Instrument Corp., Commercial Products Div., 8000 Bluffton Rd., Fort Wayne, IN 46809.

A bidirectional printer from Printer Terminals operates at 75 lines/minute and offers a choice of 7 x 9 or 9 x 9 dot-matrix print capability. It can print up to four copies simultaneously. The full 96-character, upper-and-lower-case ASCII set, plus triple-wide character font, are available. The operator can choose either 80- or 132-character lines. Included are RS-232C and parallel interfaces and 2K of memory for full-page dump. The printer is designed to accommodate roll paper, combination pin form and roll, and tractor feed. Price is \$1395.00. Address: Printer Terminals Corp., P.O. Box 535, Ramona, CA 92065 (Tel: 714-789-5200).

**Single-Board Microcomputer.**

The 90F/MPS microcomputer from Quay is based on the Z80 and contains multidensity-DMA floppy-disk controller. It can accommodate up to 65K of dynamic RAM, 14K of EPROM with programmer, and 1K of static RAM. Up to four 8-bit programmable I/O ports are available. There are also four programmable counter/timer channels and an RS-232C or 20-mA serial port, the latter with selectable baud rates. A resident PROM system monitor contains debug capabilities. With 16K of dynamic RAM and two parallel ports, price is \$1295.00. Address: Quay Corp., P.O. Box 386, Freehold, NJ 07728 (Tel: 201-681-8700).

**S-100/Telephone Interface.**

The MK-II transceiver board from MK Enterprises interfaces an S-100 bus to the telephone line and uses Touch-Tone frequencies. On incoming calls, vectored interrupts allow for ring detection and DTMF signalling. This permits calling the computer and using the telephone pushbuttons for entry. A 4-bit input post allows additional data to be transferred coincident with decoded DTMF. On outgoing calls, the board operates at telephone company speeds. A 4-bit output port allows supervision of trunk interface equipment (DAA). Single tones can be generated. Price is \$425.00. Address: MK Enterprises, 8911 Norwick Rd., Richmond, VA (Tel: 804-740-8380).

**BEST IN NEW ELECTRONICS BOOKS!**

Design, Bld & Pgrm Yr Own Wkg Computer Sys 308 p.	\$7.95
Master Hdbk of 1001 MORE Practical Elect. Ckts 700 p.	\$12.95
Handbook of Electrical Noise Msmnt & Technology 280 p.	\$6.95
Microprocessor Cookbook 266 p., 124 il.	\$5.95
How To Build Your Own Working Robot Pet 238 p., 86 il.	\$6.95
Practical Electrical Installation, Repr & Rewiring 406 p.	\$7.95
Radio Control Handbook—4th Edition 420 p., 315 il.	\$9.95
The Giant Book of Amateur Radio Antennas 462 p., 255 il.	\$8.95
How To Build Your Own Working 16-Bit Microcomputer 96 p.	\$3.95
Electronic Designer's Handbook—3rd Edition 350 p., 278 il.	\$9.95
Electrical Hdbk for RVs, Campers, Vans, Boats & Trailers \$3.95	
Making and Using Electricity From the Sun 144 p., 85 il.	\$5.95
Lasers, The Light Fantastic 294 p., 158 il.	\$6.95
The Power Supply Handbook 420 p., 292 il.	\$7.95
The Complete Handbook of Robotics 364 p., 137 il.	\$7.95
Artificial Intelligence 252 p., 118 il.	\$7.95
Hdbk of Remote Control & Automation Tech 294 p., 250 il.	\$7.95
Install Your Own Home or Mobile Electric Power Plant 252 p.	\$5.95
Design & Build Your Own Custom TV Games 546 p., 244 il.	\$9.95
Computerist's Handy Manual 64 p., 39 il.	\$2.25
Digital Interfacing With an Analog World 406 p., 277 il.	\$8.95
How to Select & Install Your Own Speakers 238 p., 131 il.	\$5.95
All About Telephones 192 p., 140 il.	\$4.95
Understanding Electronics 182 p., 265 il.	\$4.95
24 Tested, Ready-To-Run Game Programs in BASIC 266 p.	\$5.95
Amateur Radio License Study Gde For Novice, Tech, & Gen Class \$6.95	
Direct Current Motors—Characteristics & App 252 p., 170 il.	\$14.95
Design, Build & Test Complete Speaker Sys 336 p., 189 il.	\$7.95
Color TV Trouble Factbook—Prob & Sol-4th Ed. 434 p., 617 il.	\$7.95
Radio Control Manual—Sys, Circ, Constr-3rd Ed 256 p., 197 il.	\$5.95
First Class Commercial FCC License Study Guide 392 p.	\$7.95
How to Build & Use Low-Cost Hydrophones 140 p., 37 il.	\$4.95
Programs in BASIC for Electronic Eng. Tech. & Experim \$4.95	
Illus Dictionary of Microcomputer Terminology 322 p., 150 il.	\$7.95
Computerist's Handy Databook Dictionary 96 p., 42 il.	\$3.95
303 Dynamic Electronic Circuits 308 p., 303 il.	\$6.95
Install E Thing Electronic in Cars, Boats, Planes, Trucks & RV's \$7.95	
The BASIC Cookbook 140 p., 49 il.	\$4.95
Antenna Construction Hdbk for Ham, CB & SWL 238 p., 132 il.	\$5.95
Radar Detector Handy Manual 80 p., 63 il.	\$2.25
How to Repair Video Games 270 p., 182 il.	\$7.95
How to Cast Small Metal and Rubber Parts 144 p., 132 il.	\$5.95
TV Field & Bench Servicer's Handbook 208 p., 165 il.	\$6.95
Cut Your Elect Bld & Install Your Own Emerg Power System \$2.95	
Instrument & Control Sys Engineering Hdbk 434 p., 184 il.	\$19.95
Beginner's Guide to Designing/Building Transistor Radios \$4.95	
Automotive Air Conditioning Hdbk—Install, Maint./Repair \$6.95	
The Master Handbook of Electrical Wiring 406 p., 289 il.	\$6.95
Understand Sound, Video, & Film Recording 140 p., 74 il.	\$5.95
Towers International FET Selector 140 p., 97 il.	\$4.95
Beginner's Guide to Computers/Microprocessors—with proj \$5.95	
Design & Build Electronic Instrumentation 420 p., 210 il.	\$9.95
How to Repair Movie & Slide Projectors 304 p., 270 il.	\$7.95
Towers International Transistor Selector—2nd Ed 200 p.	\$6.95
Closed-Circuit TV Installation, Maint., & Repair 294 p., 220 il.	\$8.95
Build-It Book of Solar Heating Projects 196 p., 111 il.	\$4.95
Solar Flare Monitor & Propagation Forecast Hdbk 196 p.	\$6.95
57 Practical Programs and Games in BASIC 210 p., 64 il.	\$7.95
Beginner's Guide to Microprocessors 182 p., 106 il.	\$5.95
Modern Electronics Math 686 p., 424 il.	\$11.95
Ham Radio Incentive Licensing Gde—2nd Ed 154 p., 70 il.	\$4.95
Hearing Aid Handbook 336 p., 224 il.	\$8.95
Programming Microprocessors 280 p., 105 il.	\$6.95
Build Your Own Working Robot 238 p., 117 il.	\$5.95
The "Computer" Book 322 p., 224 il.	\$7.95
Mimprocessors: From Calculators to Computers 192 p., 67 il.	\$5.95
Master Transistor/IC Substitution Handbook 518 p., 165 il.	\$7.95
CBer's Handy Manual of Base Stations 96 p., 55 il.	\$2.50
Complete Hdbk of Public Address Sound Sys 272 p., 148 il.	\$7.95
Modern Transistor Radios 64 p., 112 il.	\$2.50
Modern Crystal Radios (Make and Use Series) 64 p., 101 il.	\$2.50
Home Brew HF VHF Antenna Handbook 210 p., 143 il.	\$5.95
Microwave Oven Service & Repair 420 p., 210 il.	\$9.95
IC Function Locator 224 p., 28 il.	\$5.95
CBer's Handy Manual of SSB 80 p., 42 il.	\$2.25
Beginner's Guide to Making Electronic Gadgets \$4.95	
Fire & Theft Security Systems—2nd Edition 192 p., 114 il.	\$5.95
Modern Digital Communications 308 p., 122 il.	\$6.95
Practical CB Radio T'shooting/Repair 2nd Ed 406 p., 169 il.	\$7.95
Microprocessor Program for Computer Hobbyists \$8.95	
Illus Dict of Broadcast-CATV-Telecommunications 420 p.	\$8.95
Hdbk of Marine Electronic & Electrical Sys 546 p., 338 il.	\$9.95
Linear IC Applications Handbook 280 p., 184 il.	\$6.95
Build-It Book of Optoelectronic Projects 238 p., 175 il.	\$5.95
Photo Guide to AM/FM Stereo Repair 288 p., 281 il.	\$7.95
Servicing Medical & Bioelectronic Equipment 350 p., 165 il.	\$8.95
Solid-State Motor Controls 322 p., 162 il.	\$8.95
How to Use AF & RF Signal Generators 238 p., 162 il.	\$5.95
Model Railroad Electronics 308 p., 224 il.	\$5.95
The ABC Book of Hi-Fi/Audio Projects 182 p., 131 il.	\$4.95
Repair Small Gasoline Engines, 2nd Ed 392 p., 251 il.	\$6.95
88 Practical Op Amp Circuits You Can Build 140 p., 120 il.	\$4.95
Restoring and Collecting Antique Reed Organs 320 p., 124 il.	\$8.95
How to Build Metal/Treasure Locators 140 p., 58 il.	\$3.95
Build-It Book of Digital Electronic Timepieces 294 p., 209 il.	\$6.95
C.E.T. License Handbook, 2nd Edition 448 p., 381 il.	\$9.95
Third Class FCC License Study Guide 322 p., 88 il.	\$6.95
Practical Solid-State DC Power Supplies 196 p., 151 il.	\$6.95
106 Easy Electronics Proj. Beyond the Transistor 244 p.	\$5.95
How to Repair Home Kitchen Appliances 294 p., 205 il.	\$5.95
Transistor Ignition Systems 252 p., 162 il.	\$5.95
Understanding & Using Modern Signal Generators 294 p.	\$6.95
Color TV Case Histories Illustrated—Vol 2, 352 p., 243 il.	\$7.95
Microphones—How They Work & How to Use Them 224 p.	\$5.95
Master Handbook of Digital Logic Applications 392 p., 308 il.	\$7.95
Amateur Radio Nov Class Lic Study Gde—2nd Ed 192 p., 25 il.	\$5.95
CBer's Handybook of Simple Hobby Projects 168 p., 114 il.	\$3.95
Display Electronics 252 p., 195 il.	\$5.95
Complete Handbook of Slow Scan TV 305 p., 169 il.	\$9.95
CMOS Databook 280 p., 270 il.	\$6.95
Broadcast Engineering & Maintenance Hdbk 532 p.	\$19.95
Amateur Radio General Class License Study Gde—2nd Ed \$7.95	
Optoelectronics Guidebook 196 p., 120 il.	\$5.95
Impedance 196 p., 90 il.	\$5.95
Switching Regulators & Power Supplies 252 p., 128 il.	\$6.95

SEND NO MONEY! We'll invoice you on 10-DAY FREE TRIAL. Clip entire ad to order. 100% guaranteed or your money refunded.

**TAB BOOKS** DEPT. PE-79 BLUE RIDGE SUMMIT PA 17214

CIRCLE NO. 50 ON FREE INFORMATION CARD

**SAVE!**  
 MONEY • TIME • FREIGHT  
 QUALITY STEREO EQUIPMENT AT LOWEST PRICES.  
 YOUR REQUEST FOR QUOTATION RETURNED SAME DAY.  
 FACTORY SEALED CARTONS—GUARANTEED AND INSURED.  
 SAVE ON NAME BRANDS LIKE:  
 PIONEER SANSUI  
 KENWOOD DYNACO  
 SHURE SONY  
 MARANTZ KOSS  
 AND MORE THAN 50 OTHERS  
 BUY THE MODERN WAY  
 BY MAIL—FROM  
**illinois audio**  
 12 East Delaware  
 Chicago, Illinois 60611  
 312-664-0020  
 CIRCLE NO. 28 ON FREE INFORMATION CARD

## A "MATCHBOX" LED OSCILLOSCOPE

**R**EGULAR readers of the Experiment-er's Corner are by now familiar with the design of simple solid-state oscilloscopes that employ an array of LEDs for a screen. Thanks to the new LM3914 dot/bar display driver, the design of such a scope can be simplified considerably. The result is a scope small enough to fit inside a pocket matchbox!

Figure 1 is the schematic diagram of a compact LED scope that uses only three ICs and consumes only 15 mA. Operation of the circuit is fairly straightforward, especially if you're already familiar with solid-

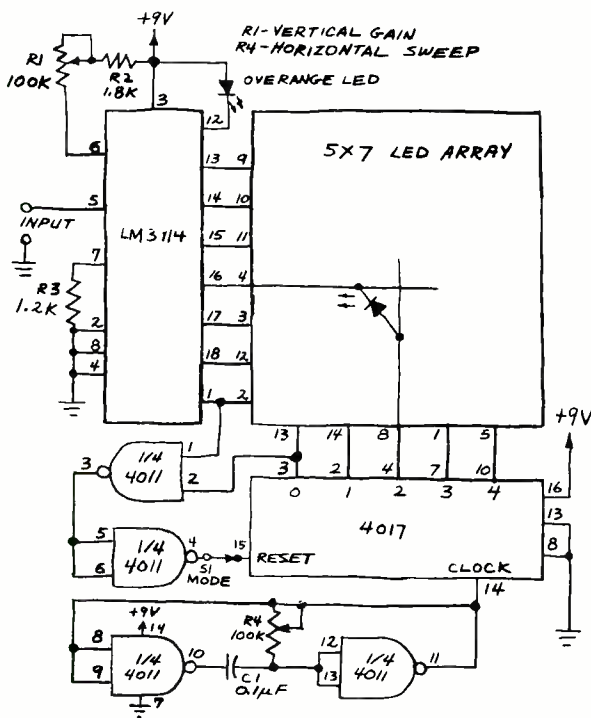

Fig. 1. Schematic diagram of matchbox LED oscilloscope.

is determined by the values of  $R_4$  and  $C_1$ . The 4017 counter is unique in that it includes a 1-of-10 decoder. This eliminates the need for a separate decoder IC. Furthermore, because the activated output of the 4017 goes high when all other outputs remain low, the 4017 can be connected to the anode of an LED.

The remaining two gates in the 4011 form an AND gate that provides an automatic trigger. When MODE switch  $S_1$  is closed, the gate resets (clears) the 4017 if the input voltage has sufficient amplitude to activate the lowest-order output of the LM3914 at the same time that the lowest-order counter output is high. This feature makes it relatively easy to freeze the waveform being displayed.

The "screen" of the scope is a single  $5 \times 7$  dot-matrix LED display (Monsanto MAN-2A, Texas Instruments TIL305, Litronix DL-57 or equivalent). Although 35 LEDs provide very limited resolution at best, with experience it's possible to visualize square and triangle waves being displayed on the readout.

In case you're wondering where the current limiting resistors of the LED display are, they are not necessary! The LM3914 includes a novel feature that permits the current at the selected output to be externally programmed by a single resistor  $R_3$  connected to pin 7. This pin provides a reference voltage of 1.2 to 1.3 volts, and the current through  $R_3$  is 1/10 the LED current. According to Ohm's law, the current flowing through a resistor is the quotient of the voltage across the resistor divided by the resistance in ohms. The current through  $R_3$  is therefore 1 mA, which means that the LED current is 10 mA.

Figure 2 is a photograph of a miniature,

state scope basics.

The incoming waveform is applied directly to pin 5 of the LM3914, where its instantaneous amplitude is detected by a voltage divider/comparator chain. Decoding logic then drives one of the LM3914 outputs low.

Any LED in the row connected to the selected output is then eligible to glow. The remaining requirement is a positive voltage at the LED's anode. This is obtained from a horizontal sweep circuit made from a 4011 quad NAND gate and a 4017 Johnson counter.

The 4011 performs two important functions, one of which is to provide a stream of clock pulses. This is accomplished by two gates connected as a free-running or astable oscillator. The frequency of oscillation

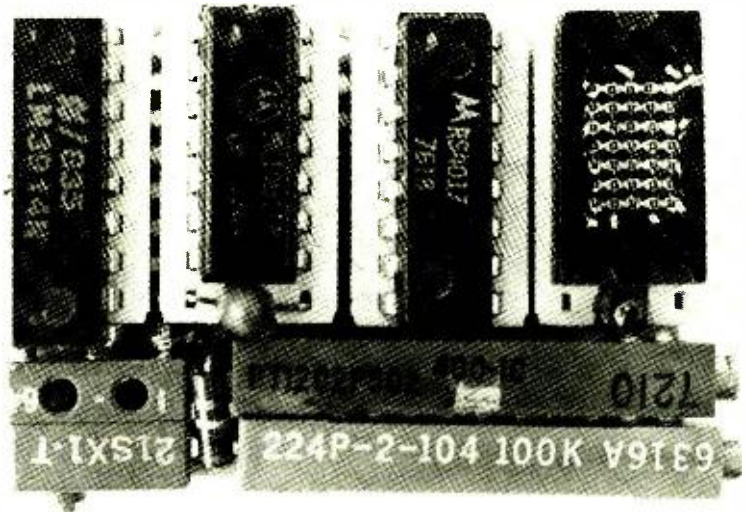

Fig. 2. Photograph of the wrapped-wire prototype LED oscilloscope assembled on a small piece of perforated board about  $1.2'' \times 1.2''$ .



**Project of the Month** *continued*

Wire-Wrapped prototype scope that I assembled on a perforated board measuring 1.2" x 1.9" (about 3 cm x 5 cm). Notice that pins 9 and 10 of the LM 3914 extend over the lower end of the socket. The small capacitor installed in the two unused pin positions of the 4011 socket is C1. The overrange LED is installed below the 5 x 7 LED array. Components R1, R4 and S1 are attached to the circuit board with cyanoacrylate adhesive. I used a miniature Micro Switch™ pushbutton switch as S1 because I had one on hand, but any other spst switch is suitable.

Some typical display patterns I have obtained are shown in Fig. 3. Often, the displayed pattern will bear little resemblance to the actual wave. Sometimes it's easier to visually integrate the approximate shape of a wave by switching off the automatic trigger and adjusting R4 until the waveform slowly parades across the display.

For some interesting visual effects, try connecting a radio or audio amplifier to the

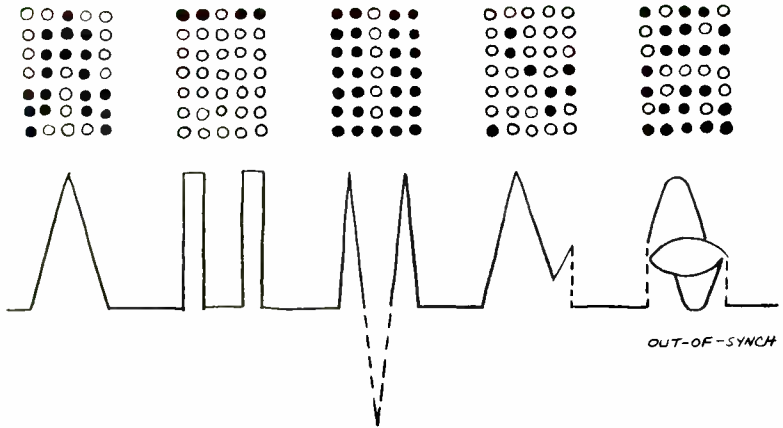

*Fig. 3. Some typical display patterns obtained on a 35-element LED scope. Sometimes, the pattern bears little resemblance to the actual wave.*

input of the scope. Music and voice signals will stimulate a dynamic, miniaturized light show. For best results, leave the trigger switch off.

Finally, remember that it's relatively easy to expand the scope's display. You

can add a second 5 x 7 display or make a 10 x 10 display from individual LEDs or 10-element LED bars. If you're really ambitious, you can add additional LM3914's and 4017's and make a scope having 20 x 20 or more LEDs. ◇

# THERE'S A BETTER WAY TO GO.

Energy shortages tell us we have to change our driving style.

Now! It doesn't mean we have to go back to horse and buggy days. But it does mean we have to make

every drop of gas give us the most go for our money. Anyone with horse sense knows that a well-tuned car gets better mileage, and in times of fuel shortages, better mileage means a lot.

The Mark Ten B Capacitive Discharge System keeps your car in better tune so it burns less gas.

Using Mark Ten B is more than horse sense. It's the

smart move under the hood, helping a nation survive an energy crisis and keeping you on the road. Delta Mark Ten. The best way to go.

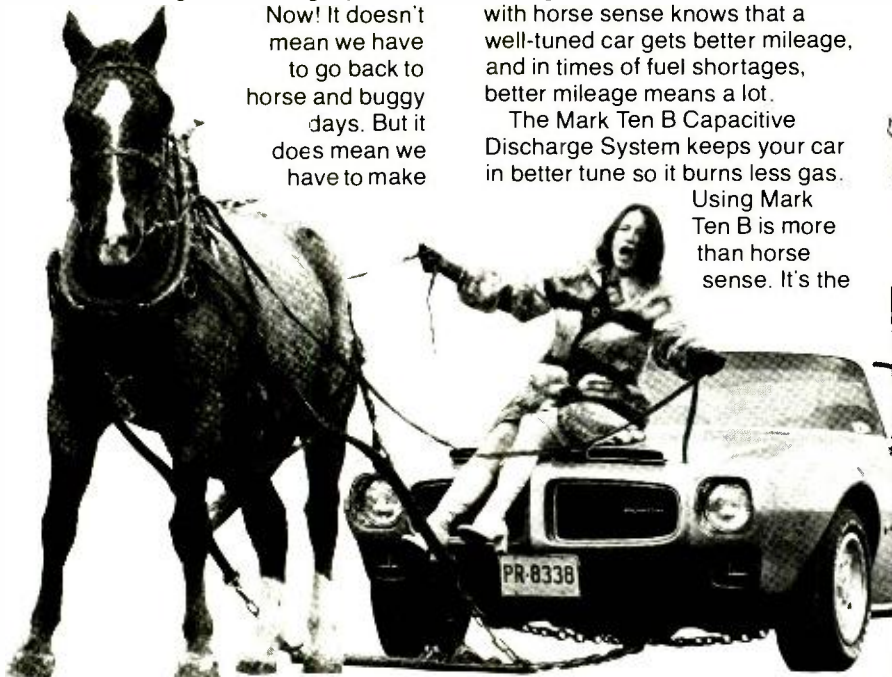

**DELTA PRODUCTS, INC.**  
 One Delta Way, Dept. PE  
 Grand Junction, Colo. 81501  
 (303) 242-9000

I want to know more about Mark Ten CDI's. Send me complete no-nonsense information on how they can improve the performance of my car.

Name \_\_\_\_\_  
 Address \_\_\_\_\_  
 City \_\_\_\_\_ State \_\_\_\_\_ Zip \_\_\_\_\_



# Active Electronic Sales Corp.

### E PROM'S

**Special of the Month**

1702A-6 ~~\$6.95~~ \$4.45  
256 x 8 1.5 uS

2708 \$9.95  
1K x 8 450 NS

### MICROCOMPUTER BOARDS

#### SYM-1 MICROCOMPUTER BOARD

- Hardware compatibility with KIM-1
- Standard interfaces include audio cassette with remote control, 8080 8 bytes second KIM-1 and 185 bytes second (SYM 1) cassette format, TV and RS232C system expansion bus, TV K2 expansion board interface, four I/O buffers, and an oscilloscope single-line display.
- Single +5V power requirements

**SYM-1 \$329.00**

#### NEC MICROCOMPUTER TK-80A

- The TK-80A is a complete microcomputer on a board based on the industry standard 8080A. The board has both 1K RAM and 1K EPROM. It is expandable to 8K x 8 and 8K x 8 respectively on board. It also features 300 or 1200 baud cassette interface, the Kenac, Gfx type, and three 8-Bit Programmable I/O Ports (2 lines). Keypad with 25 treatys (only a printed calculator keypad) and 8 bright 7-seg. digits for display are also included.

**TK-80A \$299.00**



**Rockwell International AIM65**

AIM 65 features on-board thermal printer and alphanumeric display and a terminal-style keyboard. It has an addressing capability up to 65K bytes and comes with a user-dedicated 1K RAM. Two installed 4K ROMs hold a powerful Advanced Interface Monitor program and three spare sockets are included to expand on-board ROM or PROM up to 20K bytes. An application Connector provides for attaching a TV and one or two audio cassette recorders and gives external access to the user-dedicated general purpose I/O lines. Also included as standard are a comprehensive AIM 65 User's Manual, a handy pocket reference card and an RS500 Hardware Manual, an RS500 Programming Manual and an AIM 65 schematic. AIM 65 is packaged on two compact modules. The circuit module is 12 inches wide and 10 inches long, the keyboard module is 12 inches wide and 4 inches long. They are connected by a detachable cable.

**AIM65 \$375.00**

#### MULTIBUS MEMORY

LARGE SCALE MULTIBUS MEMORY MEMORY ONLY

SIZE (BYTES)	MUPRO PRODUCT NUMBER	INTEL EQUIV. PART NUMBER	PRICE
16K	MBC-016/8	SBC-016	\$ 715
32K	MBC-032/8	SBC-032	1125
64K	MBC-048/8	SBC-048	1475
128K	MBC-064/8	SBC-064	1795
32K	MBC-032/16	SBC-032	1125
64K	MBC-064/16	SBC-064	1795

### MICROPROCESSOR CHIPS CPU'S

Part No.	Price	Part No.	Price
8080A	5.50	8255	4.95
3085	12.95	8257	10.95
6800	7.95	8259	14.95

### INTERFACE SUPPORT CIRCUITS

Part No.	Price	Part No.	Price
8212	1.98	8255	4.95
8214	3.95	8257	10.95
8216	1.98	8259	14.95
8224	2.75		
8226	1.98	6810	3.95
8228	3.98	6820	3.95
8238	3.98	6821	3.95
8251	5.50	6850	4.95
8253	14.95	6852	4.95

### MOS Static RAM's

Part No.	Price
2101 1K 22 PIN	<del>\$2.45</del> \$2.39
2102LFPC 1K 350NS (Low Power)	<del>\$1.49</del> \$1.14
2102-1PC 1K 450NS	<del>\$0.98</del> 0.94
2114 4K (1K x 4) 300NS	<del>\$6.89</del> \$6.75
2114 4K (1K x 4) 450NS	\$6.50

### MOS Dynamic RAM's

Part No.	Price
4K 4027 4K (4K x 1) 300NS 16 PIN	\$2.95
16K 416-3 16K (16K x 1) 200NS 16PIN	\$9.95
16K 416-5 16K (16K x 1) 300NS 16PIN	\$7.95

### UART's

Part No.	Price
AY5-1013A	<del>\$4.50</del> \$4.25
AY3-1015	<del>\$5.50</del> \$5.25

### 1K CMOS RAM

Part No.	Price
5101 450NS (Low Power)	<del>\$4.95</del> \$4.50



### Zilog

Z80 CTC	\$10.90
Z80A CTC	\$13.10
Z80 DMA	\$32.20
Z80 CPU	\$13.60
Z80A CPU	\$16.20
Z80 PIO	\$10.90
Z80A PIO	\$13.10
Z80 SIO/0	\$45.00
Z80A SIO/0	\$50.00
Z80 SIO/1	\$45.00
Z80A SIO/1	\$50.00
Z80 SIO/2	\$45.00
Z80A SIO/2	\$50.00

### Texas Instruments Low Profile Sockets

Finest Quality Socket available in the world. Nobody can match Texas Instruments quality — a unique combination of I.C. technology and multi-metal expertise.

Over one million pieces in stock

Contacts	Price	Contacts	Price
8 PIN	.08	22 PIN	.22
14 PIN	.12	24 PIN	.24
16 PIN	.14	28 PIN	.28
18 PIN	.18	40 PIN	.40
20 PIN	.20		



### Features.....

**BRAND NEW!**  
1979 **2500** pages  
**IC MASTER**

Complete integrated circuit data selector. Master guide to the latest I.C.'s including microprocessors and consumer circuits.

Free Quarterly Updates **\$39.95**



### L.E.D. LAMPS

LED209	T-1 3mm Red	.09
LED211	T-1 3mm Green	.14
LED212	T-1 3mm Yellow	.13
LED220	T-1 3/4 5mm Red	.11
LED222	T-1 3/4 5mm Green	.15
LED224	T-1 3/4 5mm Yellow	.14

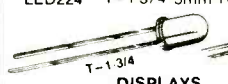

### DISPLAYS

FND357	375	Common Cathode	\$1.45	\$1.09
FND500	500	Common Cathode	\$1.80	\$1.09
FND507	500	Common Anode	\$2.00	\$1.09
FND567	500	Common Anode	\$2.00	\$1.29
DL747	630	Common Anode	\$2.95	\$2.49
DL704	300	Common Cathode	\$3.00	\$1.29
DL707	300	Common Anode	\$3.00	\$1.29

### ISOLATORS

TIL112	Opto Isolator 1500V	\$0.50	\$0.49
MCT6	Dual Opto Isolator 1500V	\$3.00	\$1.29

### LINEAR I.C.'S

LM324N	.49	Quad Op Amp	
LM339N	.49	Quad Comparator	
LM555N-8	.29	Timer	
LM556N-14	.59	Dual Timer	
LM723CN	.36	Voltage Regulator	
LM723CH	.39	Voltage Regulator	
LM741CH	.37	Op Amp	
LM741CN-8	.24	Op Amp	
LM1458N-8	.49	Dual Op Amp	
RC4558N-8	.45	Dual Op Amp	



## Active Electronic Sales Corp.

P.O. BOX 1035 FRAMINGHAM, MASSACHUSETTS 01701

Over-the-counter sales,  
12 Mercer Rd., Natick, Mass 01760  
Behind Zayres on Rte. 9  
Telephone Orders & Enquiries (617)879-0077

IN CANADA

5651 FERRIER ST. 4800 DUFFERIN ST. BAXTER CENTRE  
MONTREAL, QUEBEC 1050 BAXTER ROAD  
H4P 2K5 M3H 5S9 OTTAWA, ONTARIO  
Tel: (514)735-6425 Tel: (416)661-1115 K2C 3P2  
Tel: (613)820-9471

MINIMUM ORDER \$10.00 • ADD \$2.00 TO COVER POSTAGE & HANDLING

Foreign customers please remit payment on an international bank draft or international postal money order in American dollars.





# Radio Shack: No. 1 Parts Place

## Low Prices and New Items Everyday!

Top-quality devices, fully functional, carefully inspected. Guaranteed to meet all specifications, both electrically and mechanically. All are made by well-known American manufacturers, and all have to pass manufacturer's quality control procedures. These are not rejects, not fallouts, not seconds. In fact, there are none better on the market! Always count on Radio Shack for the finest quality electronic parts!

### TTL and CMOS Logic ICs

Full-Spec Devices  
Direct from  
Motorola and  
National Semiconductor



Type	Cat. No.	ONLY
7400	276-1801	49¢
7402	276-1811	49¢
7404	276-1802	49¢
7441	276-1804	99¢
7447	276-1805	99¢
7448	276-1816	99¢
7473	276-1803	49¢
7474	276-1818	59¢
7475	276-1806	89¢
7476	276-1813	59¢
7490	276-1808	89¢
7492	276-1819	89¢
74154	276-1834	1.39
74192	276-1831	1.19
74193	276-1820	1.19
4001	276-2401	69¢
4011	276-2411	69¢
4012	276-2412	79¢
4013	276-2413	99¢
4017	276-2417	1.69
4020	276-2420	1.69
4021	276-2421	1.69
4023	276-2423	69¢
4027	276-2427	99¢
4028	276-2428	1.29
4046	276-2446	1.69
4049	276-2449	79¢
4050	276-2450	79¢
4051	276-2451	1.49
4066	276-2466	1.39
4070	276-2470	79¢
4511	276-2447	1.69
4518	276-2490	1.49
4543	276-2491	1.99

### SN-76477 Sound/Music Synthesizer IC



**2.99** Featured in Oct. Popular Electronics

Creates almost any type of sound — music to "gunshots"! Built-in audio amp. Includes 2 VCO's, LF osc., noise gen., filter, 2 mixers, envelope modulator, logic circuit. 28-pin DIP. With data/applications circuits. 276-1765 ..... 2.99

### Mercury Tilt Switch

- Hermetically Sealed
- Perfect for Alarm Circuits



**89¢** Actual Size!

Subminiature position-detecting switch for use in projects or special applications. Switch is normally closed when upright, opens when tilted more than 45°. Rated 100mA at 24VDC. 275-025 ..... 89¢

### 15 Ceramic Trimmers

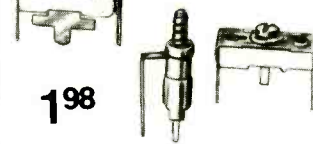

Assorted low-loss RF trimmer capacitors. May include both compression and piston types rated up to 500VDC with maximum capacity values of 3 to 100 pF. 272-805 ..... Pkg. of 15/1.98

### Top-Quality IC and PCB Accessories



- A** PC Board. Mounts two 14 or 16-pin ICs or sockets for bread boarding. Copper clad 2 1/2 x 5 x 1 1/16". 276-151 ..... 2.99
- B** PC Board. Mounts single 14 or 16-pin IC or socket. 276-024 ..... Pkg. of 2/99¢ Sale 2.89
- C** 16-Pin IC Test Clip. 276-1951 ..... 1.29
- D** 16-Pin DIP Header. With snap-on cover. 276-1980 ..... 1.99
- E** 8-Position DIP Switch. 275-1301 ..... 1.49
- F** 4-Position DIP Switch. (Not shown.) 275-1304 ..... 1.49
- G** Vertical 16-pin Socket. For LED displays. 276-1986 ..... 1.49
- H** 16-Pin DIP Jumper Cable. 18" long 276-1976 ..... 3.99

### DPDT Dual Inline Relay **449**

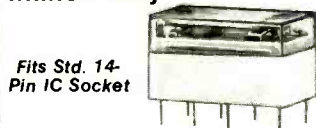

Fits Std. 14-Pin IC Socket

Subminiature relay is designed for use with TTL or CMOS circuitry. Contacts rated 1A at 125VAC. Coil requires 5VDC. Coil resistance, 50 ohms. 275-215 ..... 4.49

### MC14553 3-Digit BCD Counter IC

For Low-Cost Digital Readout

CMOS chip replaces over 8 separate IC's in a digital display circuit. Input pulse shaping. Master reset pin. 16-pin DIP. 276-2498 ..... 3.49

### RAM Memory ICs

Under 450 nS Access Time

2102 1024 x 1 Array. Low-cost static memory chip. 16-pin DIP. Buy 8 and save!  
276-2501 ..... 2.49 Ea. or 8/14.95  
2114L 1024 x 4 Array. NMOS static RAM. 18-pin DIP.  
276-2504 ..... New Low Price 10.99

### Handheld 6-Digit Frequency Counter

Reg. 99.95 **49.95**

- Lead Zero Blanking
- 100 Hz Up to 45 MHz
- kHz and MHz Decimals

Accuracy is 3 ppm at 25°C or less than 30 Hz at 10 MHz. Overload-protected 1-meg input. Sensitivity, 30 mV up to 30 MHz. 3x4 1/2". With mini-rod antenna, leads, case, instructions. Requires 9V battery. 22-351 ..... Sale 49.95  
AC Adapter. U.L. listed 65-731 ..... 4.95



### Digital IC Logic Probe **24.95**

Multi-Logic Family Compatibility from 5-15VDC

Detects one-shot low repetition rate, narrow pulses scopes miss. Combines level detector, pulse detector and pulse stretcher. Hi-LED indicates logic "1". Lo-LED logic "0". Pulse LED displays pulse transitions to 300 nanoseconds, blinks at 3 Hz for high-frequency signals (up to 1.5 MHz). With cables. 22-300 ..... 24.95



### Custom Printed Circuit Board Kit



Everything you need for making high-quality custom PC boards. 276-1576 ..... 7.95  
Extra Resist Pen. 276-1530 ..... 1.29  
Extra Etching Solution. 276-1535 ..... 2.19

### Computer Data Manuals & Semiconductor Handbook

- A** Intel 8080/8085 Programming Manual. Handy reference for programming with Intel's assembly language. 62-1377 ..... 3.95
- B** Intel Memory Design Handbook. Explains use of Intel's memory components and support circuits in systems. 62-1378 ..... 3.95
- C** Intel Data Catalog. 928 pages of specifications on most of Intel's standard microcomputer-related products. 62-1379 ..... 4.95
- D** Semiconductor Reference and Application Handbook. Complete specs and applications for popular IC transistors, diodes. 276-4002 ..... Sale 99¢

### NEW LEDs



- Tri-Color
- Red Flasher

**A** Displays red, green, yellow. Uniform light output of 0.6 mcd. Forward voltage: 2.2VDC. Max. current: 25mA. T1-1/4 case style. 276-035 ..... 1.39  
**B** Operates directly from 5VDC power source. Pulse rate: 3Hz. Max. current: 20mA at 5VDC. 276-036 ..... 1.29



### Digital Project Accessories

- A** Bezel with Lens. High-contrast filter for LED displays. 3 9/16" x 1 1/2" lens opening. 270-301 ..... 3.95
- B** Deluxe Molded Display Case. Red lens. Mount up to four 0.8" or eight 0.3" LED digits. With brackets. 1 1/2" x 3 3/4" x 4 7/8". 270-285 ..... 3.95
- C** Max 1003 Clock Case. For car clock modules. Accepts 3 pushbutton switches (not inc.). With brackets, blue lens. 3 1/2" x 2 1/2" x 2 1/2". 270-303 ..... 5.95

### Molded Connectors



Rated 8A @ 250V. Standard. 093" pin diameter.

Fig	Pins	Type	Cat No.	Each	Fig	Pins	Type	Cat No.	Each
A	4	Male	274-224	99¢	B	4	Female	274-234	99¢
A	6	Male	274-226	1.19	B	6	Female	274-236	1.19
A	9	Male	274-229	1.39	B	9	Female	274-239	1.39
A	12	Male	274-232	1.49	B	12	Female	274-242	1.49

2-Pin Male & Female, (Not shown) 274-222 ..... Pair 89¢

**WHY WAIT FOR MAIL ORDER DELIVERY?  
IN STOCK NOW AT OUR STORE NEAR YOU!**

Prices may vary at individual stores and dealers

# Radio Shack®

A DIVISION OF TANDY CORPORATION • FORT WORTH, TEXAS 76102  
OVER 7000 LOCATIONS IN NINE COUNTRIES

# Poly Paks<sup>®</sup>

## ECONOMY MINDED INFLATION FIGHTING

# SALE



**\$9.99**

Cat. No. 92CU5853

**DIAL DESK TELEPHONE**

Guaranteed Satisfaction



**\$9.95**

**GEL/SEL ENERGY PAKS**

Portable Power at Poly Pak's Prices! Brand New. 4V @ 2.6 Amp. Hr. Gel Cell storage battery. Units consist of gelled electrolyte, enclosed in hermetically sealed plastic, for years of dependable service. Compact, only 3 1/2" x 2 3/8" x 1 5/16" in size! Stack 'em to produce 8V, 12V, 24V... or increase the amperage up and away! Use 'em for Burglar Alarms, Intrusion Detectors, Ham, Mobile, or Solar Storage Applications. Cat. No. 92CU5788

It's Stacked Energy!  
4V RECHARGEABLE



**\$39.95**

Cat. No. 92CU4007

**STEREO AM-FM-MPX TUNER/AMPLIFIER**

Slide volume, bass, treble, balance controls!  
2 & 4 speaker systems!



**\$49.95**

**12VDC 10 AMP POWER SUPPLY**

- Wired
- Regulated

Converts 115VAC to 12VDC at 10 Amps fully regulated! Supplies up to 15 Amp surge. Dual transistor regulation with Motorola 2N2055 and 2N2770 for maximum dependability. Less than 100mV ripple, regulation better than 5%. Extra large heat sink for ULTRA COOL regulation. Front panel on/off switch, fuse, and indicator lamp for fingertip control. 8 1/2" x 6 1/2" x 4 high. Wt. 9 lbs. Cat. No. 92CU5541



**\$9.95**

**HY GAIN LED CLOCK KIT\***

- Panel or case design
- 3 PC set

\*Kit consists of a 3 pc set, transformer, junction switches on a board, and a National MA1012-12A digital clock module with all parts and IC chip mounted on a 3" x 1 3/8" G-10 pc board. The RED filtered module measures 3" x 3/4" x 3/16". The PC board module is mounted in a bakelite frame 3 7/8" x 1 3/4" x 1/8" with 2 holes for easy panel mounting. (3 1/2" on centers). Cat. No. 92CU5463

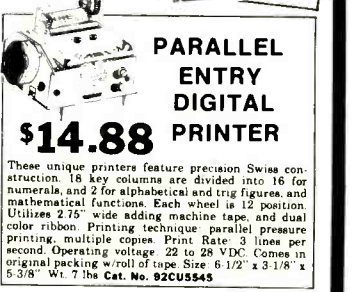

**\$14.88**

**PARALLEL ENTRY DIGITAL PRINTER**

These unique printers feature precision Swiss construction. 18 key columns are divided into 16 for numerals, and 2 for alphabetical and trig figures, and mathematical functions. Each wheel in 12 position. Utilizes 2 7/8" wide adding machine tape, and dual color ribbon. Printing technique: parallel pressure printing, multiple copies. Print Rate: 3 lines per second. Operating voltage: 22 to 28 VDC. Comes in original packing w/roll of tape. Size: 6 1/2" x 3 1/8" x 5 3/8". Wt. 7 lbs. Cat. No. 92CU5545



**\$8.88**

**HANDY COMPUTER MULTIMETER**

- 1000 ohms per volt
- 1% precision, movement diode protected against burnout. Measures DC volts 0-15-150-1000; AC volts 0-15-150-1000; DC current 0-100ma; resistance 0-1000. Sensitivity 1000 ohms/volt AC-DC. Uses penlite cell, not included. Size 2 1/2" x 3 1/2" x 1 3/4". Wt. 5 ozs. Cat. No. 3921



**\$9.95**

**40 channel CB ONE ARM BANDIT BY hy-gain**

- Single-Handed Operation Leaves "One For The Road"
- All Controls Contained in The Mike

Now, take one hand command of all 40 ch's with the One Arm Bandit, the set which works in the mike! All the controls you need to function for as the dash, are placed in the Palm of Your Hand: OFF/ON, VOLUME, SQUELCH, CHANNEL SELECTOR, and DISPLAY, as well as the SPEAKER itself are all conveniently located where your fingers do the talking. Cat. No. 92CU5866



**\$1.29**

**"CRIMP-ON" PL-259 COAX PLUG 4 for \$1.29**

Cat. No. 92CU5696

Quick, Easy plier crimping. No Soldering! Strip insulation, squeeze. Mate to SO-239. For RG58/U - 59/U.



**\$9.99**

**40 CHANNEL CB BOARD**

Only \$9.99

Poly Paks buys up factory close out from Hy Gain so you gettin' Boards have: Heatsinked 9 Watt Amp. Chip, RF and Mod. Transistor and National Semi MM series P.I.L. May be used for 10 meter conversion. See 6 month series 4 B to D in 73 Mag. The parts alone make it an offer you can't refuse. Cat. No. 92CU5860



**\$12.50**

**HIGH POWER 300 CFM BLOWER**

Imagine a 300 CFM blower worth \$33.00 at a special purchase for economy savings. Powerful, dynamically balanced. Motor specs: 115vac 2.2 Amps. Housing: Wheel 5 1/2" diameter, 2 1/2" deep, housing diameter 7 1/2" 3/8" deep. FLANGE 4" square. INLET 3 5/16" 2 1/2". All black steel construction. 1 1/2" long, 115vac wire with lugs. Use for home, shop and industry. Wt. 12 lbs. Removed from equipment. Cat. No. 92CU5165

**HEAVY DUTY**

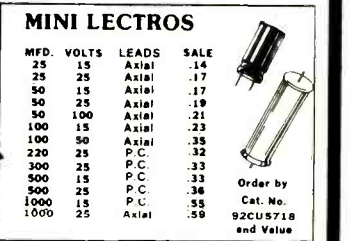

**MINI LECTROS**

MFD.	VOLTS	LEADS	SALE
25	15	Axial	.14
25	25	Axial	.17
50	15	Axial	.17
50	25	Axial	.19
50	100	Axial	.21
100	15	Axial	.23
100	50	Axial	.35
220	25	P.C.	.32
300	25	P.C.	.33
300	15	P.C.	.33
500	25	P.C.	.36
1000	15	P.C.	.55
1000	25	Axial	.58

Order by Cat. No. 92CU5718 and Value

**1N4000 Epoxy Rectifiers**

Cat. No.	Type	Volts	10 for	Sale
2377	1N4001	50	10 for	\$ .75
2378	1N4002	100	10 for	.85
2379	1N4003	200	10 for	.95
2380	1N4004	400	10 for	1.19
2381	1N4005	600	10 for	1.39
2382	1N4006	800	10 for	1.49
2383	1N4007	1000	10 for	1.59



**\$2.95 Ea**

**3 ELEMENT 120 VAC HOTPLATE**

2 for \$5

This Top Quality, Multi-Purpose Hotplate features, Built-in Thermostat, Neon "Red" AC Indicator Lamp, and 1/8" Textured Glass Surface for even heat distribution. Generates up to 150°C. 120 watts. Use for photographic applications, laboratory work, aquarium heater, plants, etc. Size: 10 3/8" x 5 3/8" x 1 1/8". Wt. 1 lb. 2 oz. Cat. No. 92CU5723

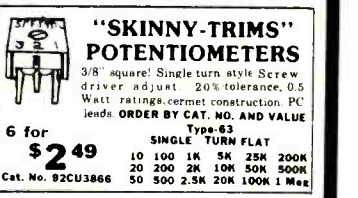

**\$2.49**

**"SKINNY-TRIMS" POTENTIOMETERS**

3/8" square! Single turn style. Screw driver adjust. 20% tolerance. 0.5 Watt ratings. ceramic construction. PC leads. ORDER BY CAT. NO. AND VALUE

Type-63	SINGLE TURN FLAT
10	100 1K 5K 25K 200K
20	200 2K 10K 50K 500K
50	500 2.5K 20K 100K 1Meg

6 for \$2.49  
Cat. No. 92CU3866

**2000 DEGREE SOLAR FURNACE** Only \$595

**Giant Fresnel Flat Magnifying Lens**

It's different! It's unusual! Magnifies like a lens, yet it's flat! A series of small concentric grooves extend from the center to the edge of the lens, acting like a giant prism. Each groove bends the light waves that hit it, acting like a conventional convex lens. Lightweight, inexpensive, and extremely short focal length of 12". Harness the sun's energy with the fresnel lens and a simple wooden frame! Focus the sun on any flammable object and watch it burst into flames within seconds! Size 11" square, 3/32" thick. Optically perfect. Wt. 1 lb. Cat. No. 92CU5338



**\$2.98**

**ULTRASONIC TRANSDUCER**

Perfect for diagnosis of projects including remote control, alarms, etc. Sends and receives 1" diameter 3/4" deep, with standard RTA type phono jack. Wt. 4 oz. Cat. No. 92CU5757



**\$2.50**

**"TIE-PIN" CONDENSER MIKE**

Only 3/4" Dia. x 1 1/2" omnidirectional. Frequency response 20-20,000 Hz. Less tie pin or lapel clip. 600 ohm impedance. 1.5 VDC. Cat. No. 92-3730



**\$1.49**

**LED WATCH GUTS**

(Ladies) 3 for \$3 (Men's)  
Cat. No. 92CU115C Cat. No. 92CU115B

**HOW TO ORDER**

When ordering, always use catalog number, type no., the name of the magazine you are ordering from and the month.

**LEDs**

Order by Cat. No.	Color	Your Choice
1788	MICRO TOPNAT RED	20 for \$2.49
1942	MED YELLOW STUBBY	
1802	MICRO SINGLE PIN RED	
2135	JUMBO RED	
2138	JUMBO GREEN	
2139	MICRO RED	
2790	JUMBO RED CLEAR	

**"BEEM-O-LIGHT" LASER DIODES**

Rated 5-9 Watts  
Wavelength 904 nm  
No. 92CU3508

Switches Sale  
3668 2 .77  
3669 3 .88  
3621 4 .99  
3670 5 1.19  
5164 6 1.95  
3672 10 2.50

**"INCHER" READOUT**

Only \$1 each

To be exact 0.8" of an inch. COMMON CATHODE, direct replacement for Litronics 747. Left decimal .5V @ 8 mils per segment. Red. Cat. No. 92CU3327

**DIP SWITCHES**

Order by Cat. No.

**POLY PAKS<sup>®</sup>**

COD & MAY BE 'PHONED!

P.O. BOX 942-E8  
SO. LYNNFIELD, MA 01940

Terms: Add Postage  
Phone: (617) 245-3828  
Retail: 16-18 Del Carmine St.  
**MINIMUM ORDER: \$8** Wakefield, MA

Rated: Net 30











**HICKOK 3 1/2 Digit Mini-Multimeter**

- 100 mV DC F.S. Sensitivity
- 19 Ranges and Functions
- 200 Hours 9V Battery Life
- Auto Zero, Polarity, Overrange Indication

**Model LX 303**

**SENCORE TV-VTR-MATV and Video Analyzer**

**Model VA48**

**\$875.00** Reg. \$975.00

**100 MHz 8-Digit Counter** **\$119.00**

70 MHz x 10 MHz Range • LED Display • Auto Stop

New Available **PS500 500MHZ Prescaler \$52.95**

**CODE-A-PHONE Telephone Answering Devices**

**\$249.95** Model 1500

**Model 1400 \$199.95** Wiremate Command

**BSR Changer Accessories \$29.95**

**Model BSR 124**

**BK PRECISION 3 1/2-Digit Portable DMM**

- Overload Protection
- Battery mV AC Indication
- 3 High LED Displays
- Auto Zeroing

**Model 2800**

Complete with test leads operating manual and spare fuses **\$85**

**Model 2810 \$110.50**

**Ungar Heat Gun \$46.50**

**Reg. \$65.00**

**Weller Xcelite**

**Model 955M**

**\$42.95**

**Service Master Attache Style Tool Kit**

**MODEL TC 100-ST**

**\$269.95** Reg. \$278.00

**Logic Monitor**

- Automatics Backup state and dynamic logic
- Works with DTL, HTL, TTL and CMOS Logic
- Cost saving design

**Model LM 1** **\$52.95** complete

**WAHL NEW ISO-TIP "Quick Charge"**

**Model 7800**

**\$27.95**

**6" x 9" 3-Way Speaker**

**Model 7800**

**\$14.95**

**15 MHz Mini Oscilloscope**

**Model MS 15**

**Reg. \$318.00**

**\$269.95**

Battery or line operation • Automatic and line sync modes • Power consumption less than 15 W

**NOW AVAILABLE**

Dual Trace Version **Model MS 215** Reg. \$434.00 **\$369.95**

**Weller Roll Kit \$15.95**

**Model 999P**

**platt Attach Tool Case with 2 Removable Pallets**

**Model 600T**

**\$65.00** Reg. \$79.00

**HICKOK Function Generator**

**Model 270**

**\$169.15**

**Trace Scope Model 1432P**

Reg. \$180.00

**\$663.** with probes

**BK PRECISION 15MHz 3" Dual Portable**

**Model 1432P**

**\$663.** with probes

**Logic Probe**

**Model LP 1**

**\$40.00** complete

- Compact - hand held
- Delivers 100mA at 30V
- Mini - 1/2" diameter, 90/110/115/220

**LEADER Instruments Corp. 20 MHz. Dual Trace**

**Model L80 508** Reg. \$169.95

**\$654.50** with accessories

- Add. channel modes on CH 1 & CH 2
- Front panel X-Y operation
- 1.75" Spine view

**BK PRECISION SUPER SPECIAL**

**Model 1827**

**In-Dash AM/FM 8 Track Stereo**

**C 777**

**\$52.50**

**HICKOK Trace Scope Model 1432P**

Reg. \$180.00

**\$663.** with probes

**Weller Controlled Output Soldering Station**

**Model 2910**

**\$45.00** Reg. \$75.00 Model WTCP-N

**SENCORE POCKET CRICKET TRANSISTOR/FFT TESTER**

**Reg. \$125.00**

**\$99.95** TF 40

**Magnifier LAMP**

**Model MG 10A**

**\$49.50**

**700 Series**

Precision ground and precision manufacturing. Uses 22.19 Copper Electroplated

**30MHz Portable Frequency Counter**

**Reg. \$120.00**

**\$59.95**

**AM/FM Cassette Stereo**

**CAS 888**

**\$57.50**

**BK PRECISION Substitution Box \$51**

**Model 2910**

**Call TOLL FREE (800) 645-9518**

Free VISA MasterCard • Bank America • C.O.D. • Check • Money Order

Add \$3.00 for shipping and insurance

C.O.D. • Extra New York State Residents add approx sales tax

**"We Will Beat Any Advertised Price"**

**FORDHAM**

855 R Franklin St. • Farmingdale, N.Y. 11735

CIRCLE NO. 22 ON FREE INFORMATION CARD

**DIODES (DIODE CLAMPED)**

Model	Prv	2A	6A	25A	100V	250V	500V	1000V
8001	25	4023	25	4039	25	74631	25	
1002	22	4026	25	4034	26	74613	1.50	
1007	27	4025	22	4022	25	74610	1.20	
1009	35	4027	45	4518	1.00	74610	1.20	
1010	35	4036	50	4526	1.00	74615	1.20	
1011	22	4029	86	74620	27	602173	1.20	
4012	70	4048	96	74627	97	7461134	1.20	
5015	1.20	4042	67	74118	8	601715	1.20	
1016	1.00	4042	67	59110	11	90116	1.20	
4017	34	4043	86	74623	72	601712	1.20	
5018	1.00	4044	71	59113	90	59116	1.20	
4019	36	4051	41	59113	90	746113	1.20	
1020	1.00	4063	4.10	74614	40	746113	1.20	
4021	1.10	1.54	1.20	74616	70			
4022	1.10	4066	70	74620	95			

**PRINTED CIRCUIT BOARD**

4" x 6" DOUBLE SIDED EPOXY BOARD 1/16" thick \$ 5.60 ea. 5/52 60

**7 WATT LD-65 LASER DIODE IR \$8.95**

LD-65 LASER DIODE IR 1.5W 650nm

LD-65 LASER DIODE IR 1.5W 650nm

LD-65 LASER DIODE IR 1.5W 650nm

LD-65 LASER DIODE IR 1.5W 650nm

LD-65 LASER DIODE IR 1.5W 650nm

LD-65 LASER DIODE IR 1.5W 650nm

LD-65 LASER DIODE IR 1.5W 650nm

LD-65 LASER DIODE IR 1.5W 650nm

LD-65 LASER DIODE IR 1.5W 650nm

**TRANSISTOR SPECIALS**

Model	Prv	2A	6A	25A	100V	250V	500V	1000V
MRF 8004	4	CB HF Transistor	NPN	\$ 1.00				
2N3141	NP	RE TO 18			\$ 1.30			
2N3142	NP	RE TO 18			\$ 1.30			
2N3143	NP	RE TO 18			\$ 1.30			
2N3144	NP	RE TO 18			\$ 1.30			
2N3145	NP	RE TO 18			\$ 1.30			
2N3146	NP	RE TO 18			\$ 1.30			
2N3147	NP	RE TO 18			\$ 1.30			
2N3148	NP	RE TO 18			\$ 1.30			
2N3149	NP	RE TO 18			\$ 1.30			
2N3150	NP	RE TO 18			\$ 1.30			
2N3151	NP	RE TO 18			\$ 1.30			
2N3152	NP	RE TO 18			\$ 1.30			
2N3153	NP	RE TO 18			\$ 1.30			
2N3154	NP	RE TO 18			\$ 1.30			
2N3155	NP	RE TO 18			\$ 1.30			
2N3156	NP	RE TO 18			\$ 1.30			
2N3157	NP	RE TO 18			\$ 1.30			
2N3158	NP	RE TO 18			\$ 1.30			
2N3159	NP	RE TO 18			\$ 1.30			
2N3160	NP	RE TO 18			\$ 1.30			

**Full Wave Bridges**

Prv	2A	6A	25A
100	1.43	1.43	1.43
200	1.82	1.37	2.20
400	1.04	1.65	3.20
600	1.32	1.92	4.40

**DIP SOCKETS**

Model	Prv	2A	6A	25A
14 PIN	7.94	17.75	25	35
14 PIN	7.94	17.75	25	35
14 PIN	7.94	17.75	25	35
18 PIN	2.4	30	40	60
18 PIN	2.5	30	40	60

**WE SHIP OVER 95% OF OUR ORDERS THE DAY WE RECEIVE THEM**

CIRCLE NO. 48 ON FREE INFORMATION CARD

www.americanradiohistory.com

## PET 2001 PERSONAL COMPUTER

Quite portable, very affordable and unbelievably versatile, the PET computer may very well be a lifetime investment....

**\$595**

2001 4K bytes memory

2001-8 Computer 8K bytes with integral cassette and calculator type keyboard. \$795.00  
 2001-16N Computer 16K bytes, large keyboard w/separate numeric pad and graphics on keys. \$995.00  
 2001-16B Computer As above but standard typewriter keyboard. No graphics. \$795.00  
 2001-32N Computer Identical to 2001-16N except has 32K bytes of memory. \$1195.00  
 2001-32B Computer Identical to 2001-16B except has 32K bytes of memory. \$1195.00  
 2021 Printer 80 column dot matrix electrostatic printer. Full graphics capability. \$549.00  
 2022 Printer 80 column dot matrix printer with plain paper or forms handling tractor feed. Has full graphics. \$995.00  
 2023 Printer 80 column dot matrix printer, plain paper printer with full graphics. \$849.00  
 2040 Floppy Disk Dual drive intelligent mini floppy system. 343K net user storage. \$1295.00  
 2041 Floppy Disk Single drive intelligent mini floppy with 171.5K net user storage. \$595.00  
 CZN External Cassette Cassette player/recorder to use with PET 2001/8/16/32. \$95.00  
 MANUAL User Manual 160 page covering all facets of user operation, programming and I/O for PET computers. \$9.95

### 1802 SERIES

1802LE \$8.90 1854LE \$8.50  
 1822LE 8.05 1856LE 1.10  
 1824LE 3.55 1857LE 1.10  
 1852LE 1.30 1858LE 1.10  
 1853LE 1.45 1859LE 1.45

## 8038CP

Function Generator IC  
\$3.90 each

## 2708

8K EPROM  
\$10.50 ea or 10 for \$8.90 ea

## SYM-1

The Complete MICRO-Computer System  
\$269.00

KTM-2 CRT/TV Kbd Term \$349

## FUNCTION GENERATOR KIT

### XR2206KB

OPERATES ON EITHER  
 \* SINGLE 12V SUPPLY  
 \* ±5V SPLIT SUPPLY  
 INCLUDES ALL PARTS  
 TO BE MOUNTED ON  
 PCB BOARD.

\$19.95

POWER SUPPLY  
 NOT INCLUDED

## KIM-1 MICROCOMPUTER

Fully Assembled & Tested  
 \$179.00

Including Documentation

## Rockwell AIM 65

The Head-Start in Computers

20 Column Dot Matrix Printer  
 20 Column Alphanumeric Display  
 Terminal Style Keyboard

A65-100 1K Static RAM \$375.00  
 A65-400 4K Static RAM 450.00  
 A65-010 Assembler ROM 85.00  
 A65-020 BASIC Interpreter on two ROMs 100.00

DOCUMENTATION (Furnished with AIM 65 100 or 400 computer) includes AIM65 Summary Card, Schematic, Program Monitor Listing, and User's Guide and RG500 Programmer Ref Card. Manual and Hardware Manual \$200.00

## POWER SUPPLIES FROM ADETECH POWER

Model	Vdc	Amps	Model	Vdc	Amps
APS 5.3	5	3.0	APS 5.6	5	6.0
APS 12.1.6	12	1.6	APS 12.4	12	5.0
APS 15.1.5	15	1.5	APS 15.3	15	3.0
APS 24.1	24	1.0	APS 24.2.2	24	2.2

1.9 10 up 25 up \$35.50 \$34.00 \$31.75 1.9 10 up 25 up \$58.00 \$56.50 \$51.80

## FLUKE

\$129 NEW

MODEL 8020A MODEL 8022A

\$169

## HICKOK LX 303 DIGITAL MULTIMETER

Compact, Accurate, Dependable. With easy-to-read 7 1/2 digit liquid crystal display for convenient use in any kind of light. Weighs only 8 ounces. Operates up to 200 hrs on a single 9 volt battery. Nineteen ranges including 200mV to 1000V DC, 100 to 10 Megohms, 100 and 1000 VAC ranges, 10uA and 10mA ranges. Excellent overload protection, color coordinated case and color coded panel.

\$74.95

## HYBRID AUDIO POWER AMPLIFIERS

P/N	Power	* Matching Transformer
SI-1010G(10W)	\$ 6.95	TR10 \$ 7.90
SI-1020G(20W)	\$13.95	TR20 \$10.90
A-SI-8(Socket for above)		.95
SI-1030G(30W)	\$19.00	TR30 \$12.90
SI-1050G(50W)	\$27.80	TR50 \$17.90
A-SI-10(Socket for above)		.95

\* Note: One Transformer can power two audio amplifiers.

## EXAR

ICL7106V(LCD) \$29.95 ICL7107(LED) \$24.95

## NEW 30 MEGAHERTZ

Model	Description	Price
MS-230	Dual Trace 30 MEGAHERTZ	\$559.00
MS-215	Dual Trace 15 MEGAHERTZ	\$435.00
MS-15	Single Trace 15 MEGAHERTZ	\$318.00

PORTABLE, DUAL TRACE MINI-SCOPE

PORTABLE and LIGHT WEIGHT 41-140 3.5 ins (2" H) x 6.4" (W) x 3.0" (D) \$149.00  
 MS-15/215 3 ins (2" H) x 6.4" (W) x 3.0" (D) \$118.00

OPTIONS:  
 Leather Case (MS-15/215) \$45.00  
 10 tape 1/2" Protote (10 Megahertz Input) \$24.50  
 Leather Case (MS-230) \$45.00

## 5% CARBON FILM RESISTORS

1/4 Watt \$1.69 per 100  
 1/2 Watt \$1.79 per 100

All values from 10 $\Omega$  to 10M $\Omega$  - Only in multiples of 100 pieces per value

## ACRONA

Send your check or money order to:  
 P.O. Box 2208P, Culver City, CA 90230, California residents add 6% sales tax. Minimum Order: \$10.00. Add \$1.00 to cover postage and handling. Master Charge and Visa welcomed. Please include your charge card number, interbank number and expiration date. PHONE ORDERS (213) 641-4064

TUCSON	CULVER CITY	SANTA ANA	PORTLAND
4518 E. Broadway Tucson, AZ 85711 (602) 881-2348	11800 Jefferson Blvd Culver City, CA 90230 (213) 390-3595	Sanja Ave., CA 92705 (602) 881-2348	1120 N. 8th Ave Portland, OR 97220 (503) 254-5541

CANADA & A.C.	SUNNYVALE	ATLANTA	HOUSTON
5636 Flanders Ct. Van Nuys, CA 91410 Tel: (818) 708-0707	1054 E. Camino Real Sunnyvale, CA 94087 (408) 243-4121	3330 Piedmont Rd., N.E. Atlanta, GA 30305 (404) 261-7100	2649 Richmond Houston, TX 77058 (713) 529-3489

## FAIRCHILD RED LED LAMPS

#FLV5057 Medium Size Clear Case RE-EMITTING These are not restocked off-spec units as sold by some of our competition. These are factory prime first quality new units

10 FOR \$119  
 50 FOR \$495

"WE BOUGHT 250,000 PCS."

## "THE COLOSSUS"

### FAIRCHILD SUPER JUMBO LED READOUT

A full .80 inch character. The biggest readout we have ever sold! Super efficient. Compare at up to \$2.95 each from others!

YOUR CHOICE \$1.49 EA  
 FND 847 Common Anode  
 FND 850 Common Cathode (6 for \$6.95)

## NATIONAL SEMICONDUCTOR JUMBO CLOCK MODULE

MILITARY TIME FORMAT! MA1008D BRAND NEW!

ASSEMBLED NOT A KIT!

\$495  
 \$795

REG. \$9.95  
 ADD \$1.95 FOR AC XFMR

PERFECT FOR USE WITH A TIMEBASE.

COMPARE AT UP TO TWICE OUR PRICE!  
**MANUFACTURER'S CLOSEOUT!**

## 16K DYNAMIC RAM CHIP

WORKS IN TRS-80 OR APPLE II

16K X 1 Bits. 16 Pin Package. Same as Moxtek 4116-4. 250 NS access. 410 NS cycle time. Our best price yet for this state of the art RAM. 32K and 64K RAM boards using this chip are readily available. These are new, fully guaranteed devices by a major mfg. VERY LIMITED STOCK!

"MAGAZINE SPECIAL" — 8 For \$79.50

## EXPERIMENTER'S CRYSTAL

262, 144KHZ This frequency is 2 to the 18th power. Easily divided down to any power of 2, and even to 1HZ. New by CTS-Knight A \$5 value.

\$1.25 each  
 4.00 MHZ — \$1.75

## TOSHIBA POWER AUDIO AMP

5.8 Watt RMS Typical Output. 50 to 30,000 Hz  $\pm$  3 DB. For CB's, tape decks, PA's, etc. Works off of a single supply voltage from 10.5 to 18 VDC. 10 Pin plastic DIP with special built in heat sink tab. Perfect for use on 12VDC. With Data.

## FAIRCHILD PNP "SUPER TRANSISTOR"

2N4402 TO-92 Plastic Silicon PNP Driver High Current VCEO=40 HFE=50 to 150 at 150 MA FT=150 MHZ A Super BEEFED-UP Version of the 2N3906

8 FOR \$1

## G.I. FULL WAVE BRIDGE

4 AMP 600 PIV  
 3/4 IN. Square  
 With Lugs, #LM-1  
 75c ea. 3 For \$2

## MOTOROLA POWER TRIAC

TO-220 CASE  
 15 AMP 400 PRV  
 SPECIAL 89¢ each  
 5 FOR \$3.95

## COMPLEMENTARY POWER TRANSISTORS

SILICON NPN AND PNP. TO-220 CASE. VCEO = 40V PD = 30 WATTS FOR AUDIO POWER AMPS, ETC.

TIP29 - NPN  
 TIP30 - PNP

YOUR CHOICE  
 3 FOR \$1

## FET SALE!

2N4304. Brand New N Channel Junction Fet BVGDD-30V IDSS=15 MA Typ. 1500 uMHOS TO-18 Plastic Case Mfg by Teledyne.

6 FOR \$1

## EXPERIMENTER'S HEATING PLATE

Large Manufacturers Surplus 5 1/2" x 10". In. Made of 3/8 in. tempered glass with heating element laminated on back. Works off 120 VAC. Protected by thermostat and two thermal fuses. Rated 120 Watts. Use for any heating applications. Perfect for heating ferric chloride to increase PC board etching efficiency. Units are brand new, non-submersible.

WHILE THEY LAST — \$2.99 each

### ANNOUNCEMENT:

To better serve our customers we are splitting Digital Research Corp of Texas into two operating sections. PARTS AND COMPUTERS. We feel this change will allow us to offer you lower prices, better service, and many more new products. Continue to order parts, clock modules etc from DRR P O Box 401247 Garland, TX 75040. To order computer parts and computer kits order from Digital Research Computers P O Box 401565 Garland, TX 75040.

# Digital Research: Parts

(OF TEXAS)  
 P.O. BOX 401247 GARLAND, TEXAS 75040 • (214) 271-2461

TERMS: Add 50¢ postage, we pay balance. Orders under \$15 add 75¢ handling. No C.O.D. We accept Visa, MasterCard, and American Express cards. Tex. Res. add 5% Tax. Foreign orders (except Canada) add 20% P & H. 90 Day Money Back Guarantee on all items.

www.americanradiohistory.com

## ABOUT YOUR SUBSCRIPTION

Your subscription to POPULAR ELECTRONICS is maintained on one of the world's most modern, efficient computer systems, and if you're like 99% of our subscribers, you'll never have any reason to complain about your subscription service.

We have found that when complaints do arise, the majority of them occur because people have written their names or addresses differently at different times. For example, if your subscription were listed under "William Jones, Cedar Lane, Middletown, Arizona," and you were to renew it as "Bill Jones, Cedar Lane, Middletown, Arizona," our computer would think that two separate subscriptions were involved, and it would start sending you two copies of POPULAR ELECTRONICS each month. Other examples of combinations of names that would confuse the computer would include: John Henry Smith and Henry Smith; and Mrs. Joseph Jones and Mary Jones. Minor differences in addresses can also lead to difficulties. For example, to the computer, 100 Second St. is not the same as 100 2nd St.

So, please, when you write us about your subscription, be sure to enclose the mailing label from the cover of the magazine—or else copy your name and address exactly as they appear on the mailing label. This will greatly reduce any chance of error, and we will be able to service your request much more quickly.

# SPECIAL Summer sale

Prices good from July 15 thru Aug. 31. Quantities are limited — order now and save!

## MA1003 CLOCK MODULE \$16.50 \$13.20

20% off our very best clock module. Internal xtal timebase, fluorescent readouts, full documentation, simple assembly (add 2 time-set switches and 12V DC — you're ready to go!) and much more. Matching case w/ mounting hardware & optical filter: \$5.95. Hurry — clock prices may never be this low again.

## 16K MEMORY EXPANSION CHIP SET \$109 \$87.20

20% off one of our all-time best sellers. For Radio Shack-80, Exidy Sorcerer, Apple computers. 250 ns access time, low power parts, DIP shunts included. 1 year limited warranty, and easy-to-follow instructions that make memory expansion a snap.

## MORE MEMORY FOR YOUR MONEY

We're offering low power 21L02 1K static memory chips, guaranteed to run with any 2 MHz system, at the very low price of 10/\$9.90... that's less than 1¢ per byte! Stock up now, we can't predict how much longer we'll have these prime parts available for sale.

TERMS: Cal. res. add tax. Allow 5% shipping, excess refunded, orders under \$15 add \$1 handling. VISA/Mastercharge call 24 hr. order desk at (415) 562-0636. COD OK with street address for UPS.

# GODBOUT

BILL GODBOUT ELECTRONICS  
BOX 2355, OAKLAND AIRPORT, CA 94614

FREE FLYER: Whether you're a computer user, electronic musician, experimenter, or mad scientist, we have bargains for you... and they're all listed in our flyer (including lots of specials that are too provocative to put in family magazines such as this). Send us your name and address; add 41¢ in stamps for 1st class delivery.

CIRCLE NO. 26 ON FREE INFORMATION CARD

## H8 EXTENDER BOARD KIT

Brand new from Mullen Computer Products. This kit really takes the hassle out of testing or troubleshooting the popular Heath H8 computer. Includes jumper links in supply lines for insertion of fuses, Ammeters, current limiters, etc. **\$39**

## LOW POWER, FULLY STATIC COMPUTER MEMORY — NOW BANK SELECT VERSIONS!

Econoram™ are generally available as unkits (sockets, bypass caps pre-soldered in place, assembled and tested, or qualified under the Certified System Component (CSC) high-reliability program.

Our BANK SELECT boards are perfect for Alpha Micro Systems, Marinchip, and similar S-100 machines. Low power, two independently selectable banks.

We've been providing top quality memory (without charging top dollar) for over 5 years — see your computer store or our flyer for more information.

Name	Bus	Speed	Unkit	Asm	CSC
8K ECONORAM IIA™	S-100	4 MHz	\$149	\$179	\$239
16K ECONORAM IV™	S-100	4 MHz	\$295	\$329	\$429
12K ECONORAM VI™	H8	2 MHz	\$200	\$270	N/A
24K ECONORAM VII™	S-100	4 MHz	\$445	\$485	\$605
32K ECONORAM IX™	Dig Gro	4 MHz	\$559	\$639	N/A
32K ECONORAM X™	S-100	4 MHz	\$599	\$649	\$789
32K ECONORAM XI™	SBC	4 MHz	N/A	N/A	\$1050

## • NEW! BANK SELECT ECONORAMS

16K ECONORAM XII-16	S-100	4 MHz	\$369	\$419	\$519
24K ECONORAM XII™-24	S-100	4 MHz	\$479	\$539	\$649
32K ECONORAM XIII™	S-100	4 MHz	\$629	\$699	\$849

## NEW! • FULL FUNCTION S-100 I/O BOARD \$189 unkit, \$249 assm

Our new I/O board gives you unparalleled flexibility and operating convenience. Includes dual LSI hardware UARTS, precision Baud rates up to 19.2 Kbaud, operation with 2 and 4 MHz systems, and much more — at an amazingly low price. Before you buy an I/O board, write for complete specs and you'll see why we think you'll choose ours over any other.

### Wheel of Fortune Kit

Popular game device uses LEDs, transistors & IC to give the effect of a bright red ball spinning around numbers. Unit emits a clicking sound as ball spins and finally stops on a number. Incl. all parts, faceplate & P-C board.

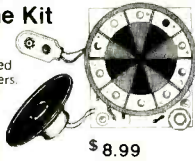

\$8.99

### T.V. Game Special

Reject "Video Olympiad" TV game units. Play 3 exciting color TV games, with on-screen digital scoring and realistic sound effects. You repair and save!

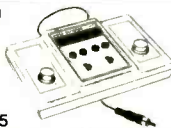

\$8.95

### Electronic Warning Flasher Kit

This battery operated device continuously emits bursts of intense light. Great for bicyclists, skiers, boaters & campers. Comes with all parts, quality PC board and easy-to-understand instructions. Uses high-output xenon flash tube which flashes 2 times per second when batteries are fresh.



\$6.95

### Strobe Kit

Complete variable rate strobe light kit. Contains all parts, line cord, PC board and instructions. 117V.

\$7.50

### 6KV Trigger

COIL. To fire xenon flash tubes. w/ schematics.

89¢

### Strobe Tube Assortment

Brand new factory prime strobe tubes. 5 tubes. w/ schematics.

\$3.00

### Walkie Talkie

Reject units. Complete crystal controlled units w/ built-in antennas. Most are easy to fix.

\$2.95



### Calculator

Complete 4 function portable calculators w/ % key and constant function. Fix them and save.

2 for \$5.98



• Minimum order: \$5.00  
• Please include \$1.00 for postage  
• VISA, MC and COD accepted  
• Phone orders are welcome

P.O. BOX 27038, DENVER, CO. 80227 (303) 781-5750

Send for our free giant catalog of unique items!!!

## BEAT HIGH GAS PRICES!



CALL FREE  
800-257-7955



### ELECTRIFY YOUR BIKE!

PEDALPOWER exciting new bike drive tames tough hills. Be independent. Shop when you want. Fits all Bikes, Adult Trikes. Installs in minutes. Thousands sold. Recharges overnight. Travels 100 miles for a dime.

### MONEY BACK GUARANTEE.

Call toll free: 800-257-7955\*

Or send today for

FREE ILLUSTRATED PEDALPOWER BOOKLET  
Plus free information on complete line of Electric Cars, Electric Bikes and Trikes.

General Engines Co.  
Mantua Blvd.  
Sewell, N.J. 08080

\*In N.L. Alaska, or HI. Call Collect: (609) 468-0270

CIRCLE NO. 25 ON FREE INFORMATION CARD

## MICROWORLD™

### BRINGING INFORMATION TECHNOLOGY TO YOUR DOORSTEP

- ✓ Quality Microcomputer Products
- ✓ Good Delivery
- ✓ Prices You Can Afford



(reg. \$1599)

**\$1349** Double density  
**HORIZON I KIT**

Heath Data Systems Printer	\$ 895
IP-125 Printer by Integral Data	\$ 749
TI-810 Impact Printer	\$1695
Soroc IQ 120 Video Terminal	\$ 795
Hazeltine 1500 Video Terminal	\$ 995
Mime Terminal	\$ 742
Novation CAT Modem	\$ 199
Hitachi 9" Monitor	\$ 184

place your order TOLL FREE

**1-800-528-1418**

## MICROWORLD™

1425 W. 12th Place  
Tempe, AZ 85281  
602-894-1193



CIRCLE NO. 37 ON FREE INFORMATION CARD

# Operation Assist

If you need information on outdated or rare equipment—a schematic parts list etc.—another reader might be able to assist. Simply send a postcard to Operation Assist POPULAR ELECTRONICS 1 Park Ave. New York NY 10016. For those who can help readers please respond directly to them. They'll appreciate it. (Only those items regarding equipment not available from normal sources are published.)

**Eico** model 720 amateur transmitter and universal modulator driver 730. Need operation manuals. Linford Fevrier, C/O Radio St. Lucia, Box 660, Castries, St. Lucia

**Dumont Fairchild** model 766 oscilloscope with type 76-02 dual trace and type 74-13A delayed sweep plug-ins. Schematics. Gary Montgomery, 1011 Westwood Dr., Elkview, WV 25071

**Dumont** type 280 oscillograph. Service manual. **RCA** model #WT-509A. Data manual needed. **Realistic** tape deck, model #T130. Schematic diagram and service manual needed. George Warren, 8 Danus Ct., So. Boston, MA 02127

**U.S. Navy** model TS-810/U digital calibrator. Schematic and technical manual. Joel M. Rubin, Box 819, Berkeley, CA 94701.

**Marconiphone** model T26A radio. Schematic and conversion data to 115 volts/60 cycles needed. Eddie Joseph, 20701 Reef Ln, Huntington Beach, CA 92646

**Heathkit** receiver model AR-3. Schematic and assembly alignment manual. David Carpenter, 2717 E. 4th St., Tucson, AZ 85716

**B&K** model 650 tube tester with model 610 and model TC-615 adapter panels. Tube test set-up chart needed. Larry Delahooke, Box 7423, Rochester, NY 14615

**Jerrold** 900B sweep generator. Operation and service man-

ual needed. Henry Koll, 4140 West 58th St., Chicago, IL 60629.

**Cal Kit** synthesize oscilloscope pattern generator. P.C. board, manual or schematic. R. Herbison, Box 108, Errington, B.C., Can. V0R-1V0.

**Channel Master** model 6601 stereo. Need schematic. James H. Bryan, 500 Benton Dr., Mt. Zion, IL 62549.

**Magnavox** model ICV400 television camera and processor. Schematic and service manual needed. G. Amandes, 506 Lake St., Crystal Lake, IL 60014.

**Lavoie** model LA545 oscilloscope. Need schematics and maintenance information. William B. Rossman, 274-28th Ave., Longview, WA 98632.

**Zenith** model L514W clock radio. Need volume and tuning knobs and snooze alarm button. Ted Liszewski, 182 Farview Ave., Paramus, NJ 07652

**RCA** model 118 AM radio. Need schematic and tubes 80, 41, 6B7, 6D6 and 6A7. Barry Maxfield, 431 E. 500 St., Pleasant Grove, UT 84062.

**Redcor** 990100-200 power supply and **Dynamics** 504 dc micromultimeter. Instructions and schematic. Jim Barcus, 12605-11th Ave., N., Plymouth, MN 55441

**RCA** model V-215 Victrola. Schematic needed. Craig Massey, RR 1, Box 205, Blue Springs, MO 64015.

**Leardo** model AMR-1 receiver. Schematic and parts list needed. Navy Department model TN-5010/FRR502 tuner. Schematic needed. David Carlson, 3081 Ursula, Aurora, CO 80011.

**Halicrafters** model S-120 shortwave radio. Need operation manual. Sean A. Devitt, 2237 Wharton Rd., Glenside, PA 19038

**Bell** model T-337 tape recorder. Operation manual and information on parts. Don Lachey, 80 N. Frankfort St., Minster, OH 45865.

**Webco** model. EP2302-1 tape recorder. Need oscillator coil.

Gerald K. Schultz, 4616 Buffalo Trail, Amarillo, TX 79109.

**Accurate Instruments** model 157 tube tester. Need operating instructions. Steve Rubin, 4903 N. Kimball, Chicago, IL 60625.

**Halicrafters** model S-40 receiver. Schematic diagram needed. Nathan Meyers, Box 22265, San Diego, CA 92122.

**Advent** model 1000A video beam projector. **Honeywell** model 333 portable DVM. Schematic and alignment instructions needed. Wolfgang S. Wiedemann, 239 Harmon Circle, Keesler AFB, MS 39531.

**Crosley** model 7H3 broadcast shortwave receiver. Need schematic and operating manual. David Leupp, 222 W. Grove Ave., Apt. 3, Rantoul, IL 61866.

**Halicrafters** model S38B receiver. Need instruction manual and schematics. Lonnie L. Hataway, Jr., 21-441D Citrus Ave., Elmendorf AFB, AK 99506

**Mercury** model 201 tube tester. Need tube setup chart and schematic. Ken Layton, 194 1/2 E. State, Apt. 8C, Olympia, WA 98506.

**Halicrafters** model HT40 transmitter. Need schematic and instruction manual. Vince Curtis, 226 Tremont Ave., Greensburg, PA 15601.

**Trymetrics** model 4000 P DVM and model 500A DVM plug-in. Need manual and schematic. Francis Grosz, 3620 Canal St., New Orleans, LA 70119.

**Hammarlund** model BC779 receiver. Operating manual, service manual, parts list and schematic. Mike Christodolou, 18 Lei Dr., Lexington Park, MD 20653.

**Scott** serial #1052 manne radio. Need service manual and schematic. Frank B. Hawley, 253 West Rock Ave., New Haven, CT 06515

**Stromberg-Carlson Co., Ltd.**, type 5788 oscilloscope. Need any information. John Greenland, Box 138, Kelligrews, Newfoundland, AOA 270

**Accurate Instrument Co.**, model 154 VOM. Need schematic. Lee W. Hannahs, 4544 Barden Rd., Coleman, MI 48618.

**Hickok** model 550X mutual conductance multi-tester. Tube chart and manual. Mike Galinski, 645 Lindsay St., St. Laurent, Quebec, Can. H4L 2R1.

**Radio Shack** model EC421 calculator. Need operation instructions. Leo E. Smith, Box 945, Veteran's Home, Yountville, CA 94599.

**Teac** model A-4010SU tape deck with model RA-40SU record amplifier. Schematic and service information. Norm Satterstrom, 212 W. Collier Dr., #207, Lombard, IL 60148.

**Yaesu Musen** type YO-100 monitor scope. Manual, schematic and source of information. A. C. Guimaraes, Cisterna de Cuma 47 Fale, Portugal

**Friden** model SW8 comptometer. Operating and service manual. **General Electric** model M8635A stereo receiver. Schematics, parts list and operating instructions. Todd Carter, 2671 Greentree Ct., Jenison, MI 49428.

**Gonsel** model GR212 receiver. Need schematic and alignment instructions. Arthur D. Cox, 1507 Gannon Dr., Sacramento, CA 95825

**Sears** model 5177, chassis #528, 62123 color TV. Need schematic. John Baldwin, 203 6th Av., N.E., Waseca, MN 56093

**Sun** model 550 ignition analyzer oscilloscope. Need schematic and cables. D. Smith, 3561 Marian Dr., Trenton, MI 48183.

**RBM** scanning monitor receiver. Need schematic and any other information. James Hall, Rt. 3, Box 281A, Staunton, VA 24401

**Eversonic** model HA-23CB CB radio. Need schematic. Randy Stanley, 5317 Lawrence Dr., Wilmington, NC 28405

**Dumont** model 304-H, serial #10416 oscilloscope. Operating instructions. John H. Carroll, 210 E. Lincoln Ave., McDonald, PA 15057.

**Echo Fonic** model 109-B echo chamber. Operation manual and schematic. **Phico** model 18 radio. Schematic and parts list needed. Nicholas I. Oshana Jr., 187 Morningside Dr., Bristol, CT 06010.

**Eico** model HF-20 pre-amplifier needed. W.S. Reynolds, 733 Plantation Circle, Roanoke, VA 24019.

For faster service USE ZIP CODE on all mail

TOWNE DUMPE VISIT OUR NEWEST STORE @ WOODCO PLAZA MANCHESTER N.H.

PHONE ORDERS WELCOME - (603) 531-5774 - BANKAMERICARD - MASTER CHARGE - AMERICAN EXPRESS ACCEPTED

**\$138.88 Brand-Name Speaker Kits**  
More in our free catalog

Another kit fit for full sound reproduction. 3-way "Bookshelf" system. 10" rear-firing passive rad, 8" MR (W), 3 1/2" superhorn piezoT. Freq resp 30 Hz to 25 KHz, power 10/90 RMS Watts. Size: 19 1/2" H x 11 1/2" W x 7 1/2" D. List price over \$500/pair. Our price is \$138.88/pair. 9130224 .96lbs/pr

**4-WAY SPEAKER** SAVE UP TO 80%

**119.88 pair**  
**BIG BRAND NAME**

Super Cabinet 8" woofer/mid-range passive radiator. 2-4" super horn, Piezo tweeters, terminals, grill cloth, wires, acoustic damping material, hardware, & instructions etc. Freq. resp. is 30 Hz to 25,000 Hz., 75 watts max. power. Sh. Wt. 98 Lbs. (3 Pkgs)

Use this great speaker system for big band speakers, monitor speakers, all around music speakers or with "DISCO" Systems. Don't Delay! These will go fast. Seconds. Nicks, Chips, Cab. is structurally sound. You finish & save.

9110123. \$119.88/pr. \$1,998.88/20 pr.

**POWER SUPPLY KIT**  
INPUT 115 VOLTS  
16 HZ

We supply all electrical and electronic parts, you supply labor & mechanical parts, tools & case

Battery Charger 12VDC, 20A, 20 Lbs 7C70005 (20A) \$19.50  
Battery Charger 12VDC, 15A, 15 Lbs 9C0089 (15A) \$14.50  
Ni-Cad Battery Charger Kit, Super Buy! Up to 35VDC, 500Ma. Sh. Wt. 5 Lbs. 7C70243 \$6.00  
Logic P.S. Kit, 5V, 1A, Reg'ed. \$6.00 7C70267

5 TO 24VDC Reg'd & adjustable, 5 amps. Sh. Wt. 15 Lbs. 6M160301 \$14.88

Use Your BA-MC or AE for telephone orders. No C.O.D.'s please.  
Please add POSTAGE - 1 Lb. or More Post.

VISIT OUR CATALOG SHOWROOM 119 FOSTER ST., PEABODY

**ALARM STUFF** New PKG Stuff  
\*Ult-Sonic Mot. Det. 8D30336 \$49.50  
\*Touch Switch Al 8M10475 \$6.88  
\*Touch Switch Al/Hom 8M10474 \$7.88  
\*Al. Wireless Xmitter 8S20110 \$14.88  
\*Al. Wireless Rec. 8S20111 \$14.88  
\* " " 6" Bell Rec. 9S20198 \$12.88  
\*1 1/2" Light Sen. Sw. 7C70281 \$4.88  
\*Patio Door Al. 8S20251 \$1.50  
\*Buzzers 3.6, 12.24 VDC \$1.25  
\*Door/Window Grd. 8M10512 \$2.88  
\*CB Alarm R8K30263 \$4.38  
\*Elec. Bike Al. 7S70456 \$7.50

**BITS & PIECES**  
\*Latching Sw. 15A 8F20204 \$2.88  
\*Al. Bd. Latch 8K30267 \$2.88  
\*Key Sw. (SPST) 9D0157 \$4.88  
\*Key Sw. (SP3T) R7C70103 \$1.25  
\*Elec. Bike Al. 7S70456 \$7.50

**9" VIDEO MONITOR \$49.88**  
**MOTOROLA COMPUTER Monitors R., U.E., Runs off 12 VDC. .8A. Scans Vert. Rotate Yoke, scans Horiz. . Sold as is you chg. & save. Qty. Ltd. Motorola No. 69VP106-Q01.. Size. 9w x 8 1/2 d x 8 1/4 h. Wtdata. Sh. Wt. 15lb. D9130269 \$49.88**

**COMPUTER SURPLUS**

**COMPUTER STUFF**  
\*I/O Printer (Daisy W.) 9320247 \$168.88  
\*9" Vid. Mon. (Contract) You repair & save Data supplied 91380154 \$38.88  
\*33 ASR TTY 9320083 \$348.88  
\*33 RO TTY 9320088 \$248.88  
\*MD 70 Singer Pr. 932088 \$348.88  
\*5" Muffin fan 8T0532 \$8.88  
\*ASCII Keyboard cons. 8W0584 \$68.88  
\*Comp. I/O Term. 6NB60336 \$39.88  
\*Viatron Stuff (Get FREE Catalog)  
\*IBM NOVA Terminals \$748.88 & up  
\*TTY Stuff \$28.88 & up  
\*Cassette recorders \$48.88 & up  
\*Card cages \$5.00 & up  
\*Dual 5" Disp. Mon. 7NB0252 \$29.88

Send orders to  
**B&F ENTERPRISES**  
Dept. P-8  
119 Foster Street  
Peabody, MA 01960  
(617) 531-5774

WHERE SURPLUS REIGNS SUPREME

CIRCLE NO. 10 ON FREE INFORMATION CARD

# Electronics Classified

**REGULAR CLASSIFIED: COMMERCIAL RATE:** For firms or individuals offering commercial products or services. \$2.50 per word. Minimum order \$37.50. **EXPAND-AD™ CLASSIFIED RATE:** \$3.75 per word. Minimum order \$56.25. Frequency discount: 5% for 6 months; 10% for 12 months paid in advance. **PERSONAL RATE:** For individuals with a personal item to buy or sell, \$1.50 per word. No minimum! **DISPLAY CLASSIFIED:** 1" by 1 column (2-1/4" wide), \$300. 2" by 1 column, \$600.00. 3" by 1 column, \$900.00. Advertiser to supply film positives. For frequency rates, please inquire. **GENERAL INFORMATION:** Ad copy must be typewritten or clearly printed. Payment must accompany copy except when ads are to be billed on credit cards — American Express, Diners Club, Master Charge, VISA (supply expiration date) — or when ads are placed by accredited advertising agencies. First word in all ads set in caps. All copy subject to publisher's approval. All advertisers using Post Office Boxes in their addresses **MUST** supply publisher with permanent address and telephone number before ad can be run. Advertisements will not be published which advertise or promote the use of devices for the surreptitious interception of communications. Ads are not acknowledged. They will appear in first issue to go to press after closing date. Closing Date: 1st of the 2nd month preceding cover date (for example, March issue closes January 1st). Send order and remittance to Classified Advertising, **POPULAR ELECTRONICS**, One Park Avenue, New York, N.Y. 10016. For inquiries, contact Linda Lemberg at (212) 725-3924.

## FOR SALE

**FREE! Bargain Catalog**—I.C.'s, LED's, readouts, fiber optics, calculators parts & kits, semiconductors, parts, Poly Paks, Box 942PE, Lynnfield, Mass. 01940.

**GOVERNMENT and industrial surplus receivers, transmitters, sniperscopes, electronic parts, Picture Catalog** 25 cents. Meshna, Nahant, Mass. 01908.

**LOWEST Prices Electronic Parts.** Confidential Catalog Free. KNAPP, 4750 96th St N., St. Petersburg, FL 33708.

**ELECTRONIC PARTS, semiconductors, kits. FREE FLYER** Large catalog \$1.00 deposit. **BIGELOW ELECTRONICS**, Bluffton, Ohio 45817.

**RADIO—T.V. Tubes—36 cents each.** Send for free catalog. Cornell, 4213 University, San Diego, Calif. 92105.

**AMATEUR SCIENTISTS.** Electronics Experimenters. Science Fair Students... Construction plans — Complete, including drawings, schematics, parts list with prices and sources... Robot Man — Psychedelic shows — Lasers — Emotion/Lie Detector — Touch Tone Dial — Quadraphonic Adapter — Transistorized Ignition — Burglar Alarm — Sound Meter... over 60 items. Send \$1.00 (no stamps) for complete catalog. Technical Writers Group, Box 5994, University Station, Raleigh, N.C. 27650.

**SOUND SYNTHESIZER KITS**—Surf \$14.95, Wind \$14.95, Wind Chimes \$19.95, Musical Accessories, many more. Catalog free. PAIA Electronics, Box J14359, Oklahoma City, OK 73114.

**HEAR POLICE | FIRE Dispatchers!** Catalog shows exclusive directories of "confidential" channels, scanners. Send postage stamp. Communications, Box 56-PE, Commack, N.Y. 11725.

**TELETYPE EQUIPMENT:** Copy Military, Press, Weather, Amateur, Commercial Transmissions. Catalog \$1.00 **WEATHER MAP RECORDERS:** Copy Satellite Photographs, National-Local Weather Maps. Learn How! \$1.00. Atlantic Sales, 3730 Nautlius Ave., Brooklyn, NY 11224. Phone: (212) 372-0349.

**WHOLESALE C.B., Scanners, Antennas.** Catalog 25 cents. Crystals: Special cut, \$4.95. Monitor \$3.95. Send make, model, frequency. G. Enterprises, Box 461P, Clearfield, UT 84015.

**BUILD AND SAVE TELEPHONES, TELEVISION, DETECTIVE, BROADCAST Electronics.** We sell construction plans with an Engineering Service. Speakerphones, Answering Machines, Carphones, Phonevision, Dialers, Color TV Converters, VTR, Games, \$25 TV Camera, Electron Microscope, Special Effects Generator, Time Base Corrector, Chroma Key, Engineering Courses in Telephone, Integrated Circuits, Detective Electronics. **PLUS MUCH MORE.** NEW Super Hobby Catalog **PLUS** year's subscription to Electronic News Letter, \$1.00. Don Britton Enterprises, 6200 Wilshire Blvd., Los Angeles, Calif. 90048.

**NAME BRAND TEST EQUIPMENT** at discount prices. 72 page catalogue free. Write: Dept. PE, North American Electronics, 1468 West 25th Street, Cleveland, OH 44113.

**UNSCRAMBLERS FOR any scanner.** Several models available. Free literature. Capri Electronics, 8753T Windom, St. Louis, MO 63114.

**UNSCRAMBLER KIT.** Tunes all scramble frequencies, may be built-in most scanners, 2-3/4 x 2-1/4 X 1/2. \$19.95. Factory built Code-Breaker. \$29.95. Free Catalog; **KRYSTAL KITS**, Box 445, Bentonville, Ark. 72712, (501) 273-5340.

**B&K Test Equipment.** Free catalog, Free Shipping, Dinosaur discounts. Spacatron-AX, 948 Prospect, Elmhurst, IL 60126.

**BUILD THE ARTISAN ELECTRONIC ORGAN...** The 20th century successor to the classic pipe organ. Kits feature modular construction, with logic controlled stops and RAM Pre-Set Memory System. Be an ar-ti-san. Write for our free brochure. AOK Manufacturing, Inc., Box 445, Kenmore, WA 98028.

**NAME BRAND Test Equipment.** Up to 50% discount. Free catalog. Salen Electronics, Box 82, Skokie, Illinois 60077.

## SpeakerGuts.

The absolute latest in advanced speaker technology *Wave Aperture™ Drivers, the Patented Nestroic Woofer System.* raw speaker components selected for their excellence: Horns, crossovers, subwoolers, woofers, midranges, horn and dome tweeters. Over 30 in all. Build your own speaker system and we'll provide top quality speakers and design information. Send for FREE 48 page color catalog from the largest, most experienced speaker kit manufacturer in the world. **DON'T DELAY Write today!**



Dept. APE, 735 N. Northlake Way  
Seattle, Washington 98103

**POLICE/FIRE SCANNERS.** crystals, antennas, CBs, Radar Detectors HPR, Box 19224, Denver, CO 80219.

**CB RADIOS, VHF-UHF Scanners, Crystal, Antennas, Radar Detectors.** Wholesale, Southland, Box 3591, Baytown, TX 77520.

**UNSCRAMBLE CODED MESSAGES** from Police, Fire and Medical Channels. Same day service. Satisfaction guaranteed. Don Nobles Electronics, Inc., Rt. 7, Box 265B, Hot Springs, Arkansas 71901. (501) 623-6027.

**MONTHLY PICTURE FLYER.** Quality Surplus Electronic parts. Low Prices. Star-Tronics, Box 683, McMinnville, OR 97128.

**PRINTED CIRCUIT supplies, chemicals, tools, artwork, plating solutions.** Major credit cards. Catalog \$1.00, refundable. CIRCOCLEX, Box 198, Marcy, NY 13403.

**RECONDITIONED TEST EQUIPMENT \$1.00** for catalog. **WALTER'S TEST EQUIPMENT.** 2697 Nickel, San Pablo, CA 94806, (415) 758-1050.

**NEGATIVE ION GENERATORS AND ACCESSORIES.** (Kits). Fascinating details—\$1.00. Golden Enterprises, Box 1282-PE, Glendale, Arizona 85311

**Super Powerful Wireless Mic**  
10 times more powerful than other mics  
Transmits up to 1/2 mile on any FM radio  
Easy to assemble kit 15V battery (not incl.)  
Call (305) 725-1000 or send \$18.95 + \$1.00 shipping to USI Corp., P.O. Box PE-2052, Melbourne, FL 32901. COD's accept. For catalog of transmitters, voice scramblers and other specialty items, enclose \$2.00 to USI Corp.



**\$18.95**  
JUL 85 542

**TRANSISTORS, IC's, RF-Power, for communications, TV, audio repairs.** 2SC756A - \$2.00, 2SC1307 - \$2.15, 2N6084 - \$14.50, STK439 - \$8.75. Many more. Free catalog. B&D Enterprises, Box 32, Mt. Jewett, PA 16740. (814) 837-6820.

**New Morse-A-Word Code Reader**



IDEAL FOR BEGINNERS AND ADVANCED. CONNECTS TO YOUR RECEIVER/SPEAKER AND HIGH CHARACTER READOUT. ORDER MADE \$29.95. NET \$169.95. SEND CHECK OR MONEY ORDER. USE YOUR VISA OR MASTER CHARGE. ADD \$3.50 FOR SHIPPING.

Microcraft Corporation  
P.O. Box 813, Thiensville, Wisconsin 53082

**RECEIVE FREQUENCY ADAPTOR.** converts your receiver to digital readout. Davis Electronics, 636 Sheridan, Tonawanda, NY 14150. 1-716-874-5848.

**PRINTED CIRCUIT BOARDS,** your artwork, 45¢ sq. in. single sided, 60¢ sq. in. double sided. Mail your order now, or send for free details. Digitronics, P.O. Box 2494, Toledo, OH 43606.

**LOW COST ELECTRONIC PARTS!!!** Send for FREE flyer. ALL ELECTRONICS CORP., 905 S. Vermont Ave., Dept. F, Los Angeles, CA 90006.

**DB-100—ADJACENT CHANNEL FILTER**—most incredible filter ever offered to civilian market. Replaces any 455 K.C.I.F. filter to increase selectivity up to 100 DB's. Works on any receiver, transceiver, etc., using .455 K.C.I.F. Free fact sheet, or send \$29.95. SSB Publications, Box 960, Hyannis, MA 02601

**SCANNERS: WHOLESALE PRICES!** Bearcat 220 — \$329.95; Regency K500 — \$329.95; Bearcat 250 — \$279.95; plus 20 other models at similar discounts from the nation's scanner specialist. VISA/Mastercharge okay. Phone: (415) 573-1624. Free catalog. Write, Scanners Unlimited, 1326 El Camino Real, Belmont, California 94002.

**ELECTRONIC TEST EQUIPMENT.** Free catalog. E. French, PO Box 249, Aurora, IL 60507.

**ROBOTS FOR SALE.** Radio controlled for promotions, advertisement, etc. Send \$1.00 for information to: Connecticut Marketing, 70 Russell Avenue, Plainville, CT 06062.

**LATEST AND BEST** in electronic components, books and supplies. Write for big free catalogue. TRI-TEK, 7808 N 27 Ave., Phoenix, AZ 85021.

**BARGAINS GALORE!** Monthly swap sheet for radio collectors, hams, experimenters, etc. Send long SASE for sample. Electronics Trader, Box 2377, Argus, CA 93562.

**AUDIO NOISE REDUCTION KIT — 318 SILENCER** for tapes, records, FM. Free brochure. LOGICAL SYSTEMS, 3314 'H' St., Vancouver, Washington 98663.

**PRINTED CIRCUIT BOARDS,** double, single-sided. From schematic, sketch, finished artwork. We design computer interface prototypes. WEB Printed Circuits, P.O. Box 3851, Kingsport, Tenn. 37664.

**ANTENNA ACCESSORIES CATALOG** for Hams, CBers and Home TV innovators has application data. Send 15¢ stamp to: Dept. PE2, Unadilla/Reyco, Box 280, East Syracuse, NY 13057.

**SATELLITE TV**  
**GET 50 CHANNELS!**  
It's all true! No matter where you live receive movies, sports, pay television sports from around the world, 24 hour programming! Crystal clear reception! For complete information, sources and design information send \$7.95



**SPACECOAST RESEARCH**  
Dept. D, P.O. Box 442, Altamonte Springs, FL 32701

New Technology!

**DOLBY DECODER** now available assembled or as kit. Comprehensive review. PAE Integrex, Box 747, Havertown, PA 19083.

## TUBES

**RADIO & T.V. Tubes—36 cents each.** Send for free Catalog. Cornell, 4213 University, San Diego, Calif. 92105.

**TUBES: "Oldies", Latest.** Supplies, components, schematics. Catalog Free (stamp appreciated). Steinmetz, 7519-PE Maplewood, Hammond, Ind. 46324.

TUBES-RECEIVING, Industrial and Semiconductors Factory Boxed. Free price sheet including TV, Radio and audio parts list. Translertonic, Inc., 1365 39th St., Brooklyn, New York 11218. Telephone: (212) 633-2800. Toll free: 800-221-5802.

RADIO AND TV TUBES 1938 to 1978 \$1.00 ea. PRELLER TV, Augusta, AR 72006. (501) 347-2281.

## PLANS AND KITS

TOP QUALITY IMPORTED KITS, IC's, foreign transistors. Free catalog. International Electronics, Box 567, Williamsville, NY 14221.

ELECTRONICS KITS: For information, send self addressed stamped envelope. GI Kits, Box 2329, Garland, TX 75041.

**AMAZING ELECTRONIC PRODUCTS**

LASERS SUPER POWERED, RIFLE, PISTOL, POCKET SEE IN DARK PYRO TECHNICAL DE-BUGGING UNCRAMBLERS GIANT TESLA STUNWAND TV DISRUPTER ENERGY PRODUCING SCIENTIFIC DETECTION ELECTRICIFYING CHEMICAL ULTRASONIC CB, AERO, AUTO AND MECH DEVICES. HUNDREDS MORE ALL NEW PLUS INFO UNLTD PARTS SERVICE

**INFORMATION unlimited**

CATALOG #1 Dept. E8, Box 716, Amherst, NH 03031

FREE KIT Catalog contains Test and Experimenters' Equipment. Dage Scientific Instruments, Box 1054P, Livermore, CA 94550.



**TIGER 500 SIMPLI-KIT**

**FOR THE DO-IT-YOURSELFER**

**NOW! a high quality CD ELECTRONIC IGNITION SYSTEM in kit form.**

Contains all components and solder to build complete Solid-State Electronic CD Ignition System for your car. Assembly requires less than 3 hours

- Increases MPG 15%
- Eliminates 4 or 5 tune-ups
- Increases horsepower 15%
- Instant starting, any weather
- Plugs and Points last 50,000 miles
- Dual system switch

Fits only 12 volt neg. ground  
Only \$26.95 postpaid

**Tri-Star Corporation**  
P.O. Box 1727 Grand Junction, Colorado 81501

## BUILD YOUR OWN SYMPHONY OF SOUND!

It's fun and easy - takes just minutes a day! Complete kits for organs, pianos, strings, rhythms, amplifiers, synthesizers. Also factory assembled. 104-page catalog \$2.00



**Wersi Electronics, Inc.**  
Dept. ZD, 1720 Hempstead Road  
Lancaster, PA 17601

TV-OSCILLOSCOPE CONVERTER externally adapts TV into audio frequency oscilloscope. Info. \$1.00. Plans \$7.50, with P.C. \$15.00, complete kit \$60.00. Evolutionics, Box 855-J, San Rafael, CA 94902.

PRINTED CIRCUIT Boards from sketch or artwork. Kit projects. Free details. DANOCINTHS Inc., Box 261, Westland, MI 48185.

TELETYPEWRITER USERS: Unique solid state time delay relay. Reduces energy and maintenance costs. Information 50¢, Plans \$5.00, with P.C. \$10.00. KEITH RYAN, Box 3103-P, Ottawa, CANADA, KIP 6H7. U.S. Inquiries.

TESLA COIL - 40" SPARKS! Plans \$7.50. Information 75 cents. Huntington Electronics, Box 2009-P, Huntington, Conn. 06484.

TAPE - SLIDE. Synchronizer, multiprojector, lap-dissolve plans, \$5.50. Audiovisual group, \$8.50. Millers, 1896 Maywood, S. Euclid, OH 44121.

BUILD DIGITAL DIAL for AM Broadcast Receivers. Simple - Inexpensive - Accurate. Uses Standard components. Information/Schematic/Layout - \$3.95. W.M. Whitley, 5603 Lemonwood, Austin, Texas 78731.

UNIQUE DEVICES FOR STEREO, etc. Catalog \$1. Lusus, 31W251 Rte. 64, West Chicago, IL 60185.

WIRELESS FM MICROPHONE, electronic siren, 10 watt alarm. Kits \$5.25 each. Electrokit, Box 568, Milford, MA 01757.

SPEAKERPLANS - Build ANY size speakers without special tools, experience FOOLPROOF, illustrated instructions, parts sources. 80% SAVINGS! Rush \$4. SPEAKERPLANS, 275 Main, Stirling, NJ 07980.

## TELEPHONES & PARTS

TELEPHONES UNLIMITED, EQUIPMENT SUPPLIES. ALL TYPES, REGULAR, KEYED, MODULAR. FREE CATALOG. Call now toll free. (800) 824-7888. In California (800) 852-7777. Alaska-Hawaii (800) 824-7919. Ask for operator 738.

OMAK PHONE CENTER. All types of telephones - keyed, modular and decorator. Catalog \$1.00 (refundable). Box 38, Beardstown, IL 62618. (217) 323-3963.

## ALARMS

QUALITY BURGLAR-FIRE ALARM EQUIPMENT at discount prices. Free Catalog! Steffens, Box 624K, Cranford, N.J. 07016.

**Burglar - Fire - Smoke Alarm Catalog**

- Billions of dollars lost annually due to lack of protective warning alarms.

**FREE CATALOG** Shows you how to protect your home, business and person. Wholesale prices. Do-it-yourself. Free engineering service.



**Burdox Security Co.**

Box 82802 PE-089 Lincoln, Ne. 68501

GUIDE TO CHOOSING AND INSTALLING AUTO BURGLAR ALARMS. Send \$6.95 to: Auto Securities, P.O. Box 22487, Honolulu, Hawaii 96822.

PROFESSIONAL Quality Alarm systems for your home. For free catalogue, write: EAC, Electronics Department, Box 7881A, Colorado Springs, CO 80933.

## HIGH FIDELITY

DIAMOND NEEDLES and Stereo Cartridges at Discount prices for Shure, Pickering, Stanton, Empire, Grado and ADC. Send for free catalog. LYLE CARTRIDGES, Dept. P, Box 69, Kensington Station, Brooklyn, New York 11218. For Fast Service call Toll Free 800-221-0906

LOWEST PRICES on stereo components. BOSE, SAE, DBX and more. Dynamic Sound, Box 168(B), Starkville, MS 39759. (601) 323-0750. 1 PM - 9 PM.

## WANTED

GOLD, Silver, Platinum, Mercury, Tantalum wanted. Highest prices paid by refinery. Ores assayed. Free circular. Mercury Terminal, Norwood, MA 02062.

## PERSONALS

MAKE FRIENDS WORLDWIDE through international correspondence. illustrated brochure free. Hermes-Verlag, Box 110660/Z, D-1000 Berlin 11, W. Germany.

## INSTRUCTION

UNIVERSITY DEGREES BY MAIL! Bachelors, Masters, Ph.D's. Free revealing details. Counseling, Box 317-PE08, Tustin, California 92680.

LEARN WHILE ASLEEP! HYPNOTIZE! Astonishing details, strange catalog free! Autosuggestion, Box 24-ZD, Olympia, Washington 98507.

INTENSIVE 5 week course for Broadcast Engineers. FCC First Class license. Student rooms at the school. Radio Engineering Inc., 61 N. Pineapple Ave., Sarasota, FL 33577

1979 "TESTS - ANSWERS" for FCC First Class License. Plus - "Self Study Ability Test." Proven! \$9.95 Unconditional Moneyback Guarantee. Command Productions, Box 26348-P, San Francisco, CA 94126.

RADIO BROADCASTING: Become DJ, engineer. Start your own station - investment experience unnecessary! Receive free equipment, records. Free details. Broadcasting, Box 130-A8, Paradise, CA 95969.

FCC LICENSE over 1200 questions, answers, discussions, illustrations. 3rd, 2nd, 1st, phone, radar, broadcast, endorsements. \$14.95. SPECIFIC SKILLS INTERNATIONALE Inc., P.O. Box 1233, Cocoa, Florida 32922. Mastercharge/VISA.

UNIVERSITY DEGREES BY MAIL!!! Bachelor's, Master's, Doctorates. Free Information. Careers, Department Education, Box 10068, Washington, DC 20018.

EARN HIGH SCHOOL DIPLOMA, spare time. College-recognized. Credits given for previous courses, job experience. Low tuition. Exams repeated free. Individual counseling. State registered. Cambridge Academy, Dept. PE-1, 409 E. Osceola, Stuart, Florida 33494 Toll-free 1-800-327-8103.

LOANS - Former bank executive explains how to obtain loans from banks, other lenders. \$3.00. Businessman's supplement \$2.00. Sylvan Press, P.O. Box 18212, San Jose, CA 95158.

## GOVERNMENT SURPLUS

MANUALS for Govt Surplus radios, test sets, scopes. List 50 cents (coin). Books, 7218 Roanne Drive, Washington, D.C. 20021.

JEEPS-\$59.30!! - CARS-\$33.50!! - 200,000 ITEMS!! - GOVERNMENT SURPLUS - Most COMPREHENSIVE DIRECTORY AVAILABLE tells how, where to buy - YOUR AREA - \$2.00 - MONEYBACK GUARANTEE - Government Information Services, Department GE-80, Box 99249, San Francisco, California 94109.

GOVERNMENT SURPLUS. Buy your Area. How, where. Send \$2.00. SURPLUS HEADQUARTERS BUILDING, Box 30177-PE, Washington, D.C. 20014

"GOVERNMENT SURPLUS DIRECTORY" Buy 500,000 items (including Jeeps) ... low as 2¢ on dollar! Most complete information available - \$2.00 (guaranteed). Surplus Disposal, Box 19107-HH, Washington, DC 20036

## FOR INVENTORS

PATENT AND DEVELOP Your invention. Registered Patent Agent and Licensed Professional Engineer. Send for FREE PATENT INFORMATION every inventor should have. Richard L. Miller, P.E., 3612 Woolworth Building, New York, NY 10007. (212) 267-5252.

## INVENTIONS WANTED

FREE CONSULTATION • NO IDEA TOO SMALL  
Disclosure protection. Cash or royalties from manufacturers seeking new ideas. For free information on how to protect your ideas Call or Write

**American Inventors Corp.**  
59 Interstate Dr Dept PE  
West Springfield, MA 01089 (413) 737-5376  
A Fee Based Service Company

UNPATENTED IDEAS AND INVENTIONS can be sent directly to companies as an external submission. If a company is interested, help with the drafting and filing of a patent application is usually given. Send \$3.00 for: procedure outline, external submission form copies, guide for corporation addresses and interests; to: Submissions Dept., P.O. Box 55, Rochester, MN 55901.

MR. INVENTOR: America's foremost development firm offers a complete service. For free details, write: Charles S. Prince Co., Inc., Empire State Building, Suite 3308-E, N.Y.C. 10001.

## BUSINESS OPPORTUNITIES

ERASE DEBTS with little-known law—create wealth!! Details FREE—Blueprints, No. EE8, Box 900, Bronx, NY 10471.

I MADE \$40,000.00 Year by Mailorder! Helped others make money! Torrey, Box 318-NN, Ypsilanti, Michigan 48197.

NEW LUXURY CAR WITHOUT COST! Free Report. Codex-ZZ, Box 6073, Toledo, Ohio 43614. (419) 865-5657.



MECHANICALLY INCLINED individuals desiring ownership of Small Electronics Manufacturing Business — without investment. Write: **BUSINESSES**, 92-K2 Brighton 11th, Brooklyn, New York 11235.

MILLIONS in Mail!!! Free Secrets. Transworld-17, Box 6226, Toledo, OH 43614.

### MECHANICALLY INCLINED INDIVIDUALS

Assemble electronic devices in your home. Investment, knowledge, or experience not necessary. Get started in spare time. Above average profits. \$300 - \$600/Wk possible. Sales handled by others. Write for free details.

### ELECTRONIC DEVELOPMENT LAB

Drawer 1560 PE, Pinellas Park, FL 33565.

**BEAT THE RACES!** Free Booklet! "Unlimited Lifetime Income From Thoroughbreds-Harness". Elias, Box 47BB, Brooklyn, NY 11219.

**EARN EXTRA MONEY** — Homeworkers Needed Stuffing Envelopes! Free Details. Write Jadeway, Box 186-ZD, Gaines, MI 48436.

**FREE CATALOGS** Repair air conditioning, refrigeration. Tools, supplies, full instructions. Doolin, 2016 Canton, Dallas, Texas 75201.

**\$1200.00 MONTHLY** Correcting Pupils' Lessons!!! Start Immediately. Free Report. Send self-addressed stamped envelope. Home, Box 98201-SJXR, San Diego, CA 92109.

**QUALITY ELECTRONICS MANUFACTURER** offering exclusive marketing areas to persons with dental/medical, electronics, and/or professional background. Dealerships for sales and installation of innovative electronic products. Unlimited growth with complete factory support. Send confidential resume to Scott Ritchie, EEC, 797 Industrial Court, Bloomfield Hills, Michigan 48013.

**GET RICH SLOWLY!** How to operate your own profitable service business. Years of information and experience condensed in one easy-to-understand guide. \$9.95. ESI, 4500 East Speedway #33, Tucson, Arizona 85712.

**WIN AT FOOTBALL!** We beat the points spread an incredible 70% last 11 years! CBS-TV called us No. 1 football prediction newsletter! Guaranteed winner! Free: game by game record last 4 years. Winners Sports, 5711-S 14th Ave., Brooklyn, NY 11219.

**EARN \$1000 STUFFING 1000 ENVELOPES!** Money back guaranteed. Details \$1.00. D. Fraser, 208 S. 4TH, DeSoto, MO 63020.

**BORROW \$25,000 "OVERNIGHT."** Any purpose. Keep indefinitely! Free Report! Success Research, Box 29263-GH, Indianapolis, Indiana 46229.

**BECOME A CONSULTANT.** Earn \$20-\$40/hr. being in business for yourself. For detailed information on starting or expanding your own engineering consulting business, write: Dr. S. Tomczak, ST&A, Dept. PO, Box 480530, Los Angeles, CA 90048.

### EMPLOYMENT OPPORTUNITIES

**ELECTRONICS AVIONICS EMPLOYMENT OPPORTUNITIES.** Report on jobs now open. Details FREE. Aviation Employment Information Service, Box 240E, Northport, New York 11768.

**RADIO-TV JOBS.** Stations hiring nationwide! Free details: "Job Leads", 1680-PG Vine, Hollywood, CA 90028.

**ELECTRONICS INSTRUCTORS.** Challenging career opportunity with advancement with fully accredited electronics schools. Prefer at least 4-5 years industry experience. Very satisfying environment working with young people. Send resume to: United Electronics Institute, 1201 E Atlantic Blvd., Pompano Beach, Florida 33060. Or call: Mr. Gold 1-800-327-1110 for national placement. Equal Opportunity Employer.

### DO-IT-YOURSELF

**AUDIO ANALOG SYNTHESIS.** Plans, parts, kits, etc for the most exciting sound projects ever. Get on our mailing list, send 25¢ to: CFR Associates Inc., Newton, N.H. 03858.

**COMPLETE LINE** Security Systems for home, Business. Send self addressed, stamped envelope. Darbar, Box 1147E, San Diego, CA 92112.

**ELECTRICAL:** testers, books, tools, supplies. Do It Yourself professional. Free 108 page catalog. Bluffton Products, Dept. A, Box 87, Bluffton, OH 45817

### REAL ESTATE

**BIG ... FREE ... FALL CATALOG!** Over 2,600 top values coast to coast!! UNITED FARM AGENCY, 612-EP, West 47th, Kansas City, MO 64112

AUGUST 1979

### MICROCOMPUTERS

TRS-80 MICRO COMPUTERS by Radio Shack\* at 15% discount! Also have software for business systems Micro Management Systems, Cairo, GA 31728. (912) 377-7120.

### RUBBER STAMPS

**RUBBER STAMPS, BUSINESS CARDS.** Many new products. Catalog. Jackson's, E-100, Brownsville Rd., Mt. Vernon, Ill. 62864.

### BOOKS AND MAGAZINES

**FREE book prophet Elijah** coming before Christ! Wonderful bible evidence. MEGIDDO Mission, Dept. 64, 481 Thurston Rd., Rochester, N.Y. 14619.

**POPULAR ELECTRONICS INDEXES** For 1977 now available. Prepared in cooperation with the Editors of "P.E.;" this index contains hundreds of references to product tests, construction projects, circuit tips and theory and is an essential companion to your magazine collection. 1977 Edition. \$1.50 per copy. All editions from 1972 onward still available at the same price. Add \$.25 per order for postage and handling. \$5.00 per copy, foreign orders. INDEX, 6195 Deer Path, Manassas, Va. 22110.

### UNDERSTANDING CALCULATOR MATH

224 pages \$3.95 Order #LCB3321 Check or money order Texas Instruments, P.O. Box 3640 M/S84 Dept PE879 Dallas Texas 75285 Add sales tax where applicable



### TEXAS INSTRUMENTS

INCORPORATED

**"OWNER REPAIR OF AMATEUR RADIO EQUIPMENT"** Book, \$7.95, K6RQ, 14910 LG Blvd., Los Gatos, CA 95030.

**CB TECHNICIANS** — now available — SSB Engineering Practice Manual. Most comprehensive book on how to modify and expand any CB radio for maximum performance and range. Includes the newest PLL radios. Free fact sheet or send \$14.95. SSB Publications, Box 960, Hyannis, MA 02601

### HYPNOTISM

**FREE Hypnotism, Self-Hypnosis, Sleep Learning Catalog!** Drawer H400, Ruidoso, New Mexico 88345.

### MOTION PICTURE/VIDEO FILMS

**VIDEO MOVIES:** all ratings. Beta, VHS Bought, Sold, Rent, ed VCR's, Blank tapes, Supplies. Cat. \$1.00 (deductible). (201) 572-1222. Devoe, P.O. Box 593, Edison, NJ 08817.

**DISCOUNT VIDEO TAPES.** Adult movies Free price list. VTR, Box 234, Herald, CA 95638. (209) 748-2616.

**JUST OUT OF THIS WORLD!** "Superman" (Christopher Reeves) S-8 color, sound: "Buck Rogers" (Gil Gerard) special effects space age movies. 200 S-8 Eastman color mag snd. only \$29.95 ea. both \$57. "Superman" also avail in 400 S-8 col. snd format. \$48.95 ea special. Add \$1.25 ea postage. Spend Father's Day Gift Dollars — order Alfred Hitchcock's "Frenzy" — scenes from the big picture. "Incredible Shrinking Man" (Journey into the unknown). S-8 B W 200' and \$17.95 ea + 90¢ ship. Other price selections: Abbott and Costello in Who's On First (baseball classic) 200 S-8 B W snd. \$18.95, 100 footer, \$14.95. Stay at home & enjoy movies! Watch Walter Matthau in "Fail Safe" & Jimmy Stewart in "Mr. Smith Goes to Washington" 400 S-8 B W snd only \$35.95 ea PPD. Summertime Music — Thoroughly Modern Millie. Sweet Charity, Jesus Christ Superstar, 400' color S-8 and features priced to sell out @ \$42.95 ea PPD. Limited offer while stock lasts. Mail order today! New Universal 64-pg glossy catalog. \$1.25. Columbia. Sportlite. Ring Classics. Universal order forms. 40¢ ea. SPORTLITE FILMS. Elect-8 79, Box 24-500, Speedway, IN 46224

### MISCELLANEOUS

**MPG INCREASED!** Bypass Pollution Devices easily. REVERSIBLE!! Free details — Posco GEE8, 453 W 256, NYC 10471.

**NEW CAR FREE YEARLY!** Free information! Super-Car Publications, Box 28101-N, St. Louis, MO 63119.

**GASOLINE MILEAGE INCREASED DRAMATICALLY!** Simplified retuning methods. Details FREE! Techeering, Box 12191 PE, Norfolk, VA 23502.

# Popular Electronics

## ADVERTISERS INDEX

READER SERVICE NO.	ADVERTISER	PAGE NO.
3	Aaron-Gavin Instruments	.68
4	Active Electronics Sales Corp.	.81
6	Amelect, Inc.	.67
7	American Antenna	Cover 4
8	Anrona Corp.	.92
2	AP Products, Inc.	Cover 3
10 B & F Enterprises		.94
52	Cambridge International, Inc.	.59
	Chaney Electronics	.93
	Cleveland Institute of Electronics, Inc.	.36, 37, 38, 39
1	Communications Electronics	.76
12	Consumers Company	.76
13	Continental Specialties Corp.	.9
	Crutchfield Corp.	.12
16	Delta Products, Inc.	.79
17	Digi-Key Corp.	.87
	Digital Research Corp.	.92
18	Douglas Dunhill	.46
15	DSI Instruments, Inc.	.30
19	EICO	.66
20	Electra Co.	.2
21	Fluke	.7
22	Fordham Radio Supply	.91
23	Formula International	.8
24	Fuji Photo Film USA, Inc.	.15
25	General Engines Co.	.93
26	Godbout Electronics, Bill	.93
27	Grantham College of Engineering	.66
5	Heath Co.	.63, 64, 65
28	Illinois Audio	.77
29	Integrated Circuits	.82
30	International Components Corp.	.90
31	J & R Music World	.77
32	Jameco Electronics	.88, 89
	JS & A National Sales Group	.1
33	Jensen Tools and Alloys	.22
34	Kedman Company	.76
35	McIntosh Laboratory, Inc.	.6
	Micro Computer Mart	.73
37	Micro World	.93
38	Mini Micro Mart	.76
39	Netronics R & D Ltd.	.75
40	Netronics R & D Ltd.	.71
	NRI Schools	.16, 17, 18, 19
41	Ohio Scientific Instrument	.5
42	OK Machine & Tool Corp.	.43
11	onComputing	.13
43	PAIA Electronics, Inc.	.71
44	PAL "Firestik" Antenna Corp.	.74
45	Poly Paks	.84
46	Quest Electronics	.80
	Radio Shack	.83
	Sabtronics International, Inc.	.69
	Sharper Image, The	.10, 11, 21
47	Shure Brothers Inc.	.14
48	Solid State Sales	.91
	Speakerlab, Inc.	.74
	Synchro Sound	.68
50	Tab Books	.77
36	Timeglow Company	.41
51	U.S. Marine Corp.	.27, 28, 29

GM deletes "standard" radios in a settlement of the auto sound antitrust suit filed against it in March by members of the Custom Automotive Sound Association (CASA). Under terms of the settlement, General Motors will offer the delete option on the standard radios of all of its recently introduced X-body cars. Moreover, GM will permit dealers to exchange a Delco radio in these cars for credit against purchase of any GM part. (Former policy restricted exchange credit only toward purchase of another Delco radio.) GM also agreed not to standardize Delco radios in any additional models through the end of the 1983 model year. Thereafter, if GM intends to extend radio standardization, it will furnish CASA with at least four months notice.

A home energy-saving system has been developed by William Lamb (No. Hollywood, CA), pioneer in the development of silicon solar cells. It consists of a lightweight panel of 36 cells that are capable of developing 16 volts to charge a 12-volt storage battery at a 1.5-ampere/hr rate. Enough power is available from a single panel system to operate a low-power 12" monochrome TV receiver. The glass surface of each cell is toughened and backed by a special chemical compound that makes it practically impervious to hammer blows and all kinds of weather. Virtually maintenance-free, the system costs nothing to operate. Also, its modular design permits quick expansion of the system at any time. Price of a 36-cell system is \$325.

Microwave-oven market growth could be hampered unless frequencies near 10 GHz are allocated for cooking, according to Litton Microwave Cooking. As a result, Litton will try to bypass a recent FCC ruling by taking its case to the World Administrative Radio Conference (WARC) to be held in Geneva in September. The FCC, currently considering a proposal for a common-carrier data network based in part on local 10-GHz radio facilities, said microwave-oven use in those bands is "incompatible with existing and planned services for both bands." Resolutions adopted at WARC will be submitted to participating governments for

approval. If the U.S. Senate approves WARC resolutions including the change Litton seeks, it would overturn the FCC ruling, since Senate approval would have treaty status.

A computer marathon record is claimed by a group of Holy Cross high-school students in San Antonio, TX. The 311 students who took part in 8½-day around-the-clock training sessions believe their accomplishment deserves mention in record books. Instructor Dennis Doose suggested the training marathon after students voluntarily began staying after class to use the school's TRS-80 microcomputer. Radio Shack, manufacturer of the TRS-80, agreed to lend the school 22 additional microcomputers for the event.

A talking Language Translator, utilizing speech synthesis and offering solid-state modules for various languages, was announced by Texas Instruments. Designed as an aid in communicating in a foreign country and for language students in learning to pronounce a foreign language, it is programmed with a vocabulary of words and phrases selected for everyday use. The translator has the ability to form thousands of spoken phrases by linking together its spoken vocabulary words. Each module will contain about 1000 words of which half will be spoken and displayed and half will be displayed only. Prices will be about \$250 for the Language Translator and \$50 for each language module.

The deaf can read TV dialog with a new device soon to be marketed by Sears, Roebuck and Co. Next year, ABC-TV, NBC-TV, and Public Service Broadcasting will be airing about 20 hours of programs with special encoding. When decoded, dialog will appear on-screen in caption form with the aid of the decoding device. Captioning information will not appear on the screen if no decoder is used. For the past eight years, the department of Health, Education and Welfare (HEW) has paid for the research that has culminated in the development of captioned programs.



# CREATE!

**You don't waste a second on "mechanics" with A P All-Circuit Evaluators.**

You figure out the circuit you want, then plug it in for testing. You decide to improve your layout, and you make your moves as quickly as you think them up. There's just no faster or easier way to build and test

circuits and circuit ideas.

But just because breadboarding is now such a cinch, don't get the idea that you don't have electronic integrity. Our solderless plug-in tie points are made of a special non-corroding alloy. Use them as often as you like.

How many tie points do you need? Our smallest ACE has 728, our

largest has 3,648. And all of them accept all DIP sizes.

Everything is quality all the way. You can even see the difference in our harder, shinier plastic matrix.

See for yourself. Phone (toll-free) 800-321-9668 for the address of your nearby A P Products dealer. And ask for our complete A P catalog, The Faster and Easier Book.



**A P PRODUCTS  
INCORPORATED**

Box 110 • 72 Corwin Drive  
Painesville, Ohio 44077  
Tel. 216/354-2101  
TWX: 810-425-2250

**Faster and Easier is what we're all about.**

CIRCLE NO. 2 ON FREE INFORMATION CARD

[www.americanradiohistory.com](http://www.americanradiohistory.com)

# THE K40 SPEECH PROCESSOR

**The K40  
Speech Processor.**  
So unique it's patented.  
So good its guaranteed  
to out-perform any  
microphone on any radio.

**CLIPS  
ANYWHERE  
WITHOUT A CLIP!**

Molded four-pole internal magnet clamps instantly to any steel surface. Steering column, metal dash, roof top, or the side of your CB radio. No groping for your mounting clip.

**PROCESSES  
SPEECH WITH A  
COMPUTER CIRCUIT!**

It's its own computer—it automatically monitors your speech and adjusts it in micro-second increments pumping so much db gain into your speech that you get 400% more power than a standard mike.

**Double Guarantee**

**GUARANTEE I:**  
The K40 Speech Processor is guaranteed to outperform any microphone it replaces or return it for a complete and full refund within 7 days from the K40 Dealer that installed and tuned it.

**GUARANTEE II:**  
Unconditionally guaranteed for 12 months. Guaranteed against cracking, chipping, or rusting. Guaranteed against mechanical failure. Guaranteed against electrical failure. No exclusions. No gimmicks. For a full 12 months.

**SOUND SENSITIVE  
2 INCHES OR 2  
FEET!**

A microphone so sensitive it will select your voice and process your speech no matter how close or far you are from the microphone.

**TWO MICS  
WITH ONE  
SWITCH!**

Switch up for a high-pitched transmission for cutting congested city traffic. Switch down for a mellow base in open, uncluttered rural areas.

**NOISE  
CANCELLING**

Pull the Processor directly to your mouth and speak directly into the mic. The Processor adjusts to your voice—and blanks out *all* the cab noise while you're speaking. Automatically.

**FRESH CHARGE  
WITH NO  
BATTERIES!**

Patented electronic storage system recharges while you listen to the radio. It provides a fresh electrical charge every time you squeeze the trigger. You never replace batteries.

**\$42.50\***

American Antenna Elgin, IL 60120

\*suggested retail.

CIRCLE NO. 7 ON FREE INFORMATION CARD

SOLD AND SERVICED EXCLUSIVELY BY 3,500 REGISTERED K40 DEALERS THROUGHOUT THE U.S. AND CANADA

[www.americanradiohistory.com](http://www.americanradiohistory.com)