

16-PAGE BONUS ON HOME COMPUTERS

Popular Electronics®

WORLD'S LARGEST-SELLING ELECTRONICS MAGAZINE DECEMBER 1977/\$1.25

BREAKTHROUGH PROJECT!

Using Existing House Wiring for Computer Remote Control

Build an Electronic Horse-Race Game

How FM Tuners Work

Wire-Wrapping Techniques

Computer Stores — A NEW RETAILING PHENOMENON

Test Reports

Pioneer RT-707 Open-Reel Stereo Tape Recorder

Phase Linear 5000 Stereo FM Tuner

Stanton 881S Stereo Phono Cartridge

Sparkomatic CB-2040 AM CB Mobile Transceiver

Sabtronics 2000 3 1/2 Digit Multimeter

POWER YOUR PROJECTS WITH SOLAR ENERGY!

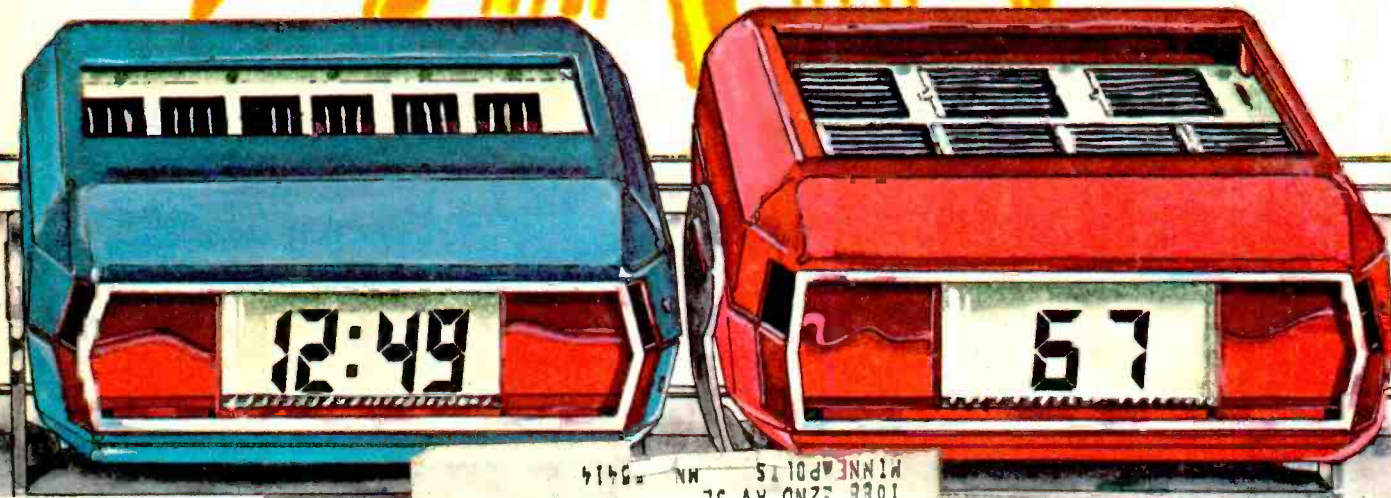

MINNEAPOLIS, MN 55414
1066 22ND AV SE
KENNETH J LINES
12
450684 LNE 10882099 0410 JAN79

METER PROJECTS
TO

AUTOMATICALLY RECHARGE BATTERIES.



1402-14278

Popular Electronics

12

0

100%

The Cobra 50XLR CB has it all. AM/FM Stereo. Cassette. And CB. All in one compact unit. All engineered to bring you the same loud and clear sound Cobra is famous for.

The remote mike houses the channel selector, squelch control, and channel indicator. So all you need for talking CB is right there in your hand. The cassette player features through the dial loading and four-way fader control.

Because they're only five inches deep, there's a Cobra in-dash radio to fit almost any car with little or no modification to the dash. This feature, plus the step-by-step Installation Manual and Universal

Installation Kit makes them the easiest in-dash radios to install. And our Nationwide network of Authorized Service Centers makes them the easiest to service.

There are four Cobra in-dash models to choose from including AM/FM/Stereo/8-track/CB. But no matter which you choose you can be sure of getting the best sounding radio going. The ultimate car radio.

The Cobra.



Punches through loud and clear.

Cobra Communications Products
DYNASCAN CORPORATION
6460 W. Cortland St., Chicago, Illinois 60635

Write for color brochure
EXPORTERS: Empire • Plainview, N.Y. • CANADA: Atlas Electronics • Toronto
Subject to FCC type acceptance

CIRCLE NO. 7 ON FREE INFORMATION CARD

THE ULTIMATE CAR RADIO.





Button-free Micro Recorder

A new micro recorder that turns on at the sound of your voice may revolutionize the entire personal recording industry.

The idea is simple yet the results are very dramatic. Olympus, the famous precision camera company, has developed the world's first voice-activated micro cassette recorder—the Olympus SD.

RECORD WITHOUT BUTTONS

The unit has an optional voice activation switch (VA switch) that automatically turns on your recorder at the sound of your voice. If you drive in your car or do dictation in your office, just talk to your unit. It does the rest. It will turn on to record your comments and turn off when you stop talking.

The VA switch has a three-position sensitivity control. You can set it for low sensitivity while driving your car so only the close proximity of your voice will turn it on. In the middle sensitivity position, you could use the unit in conferences or for dictation in your office. In the high sensitivity position, you could even leave the unit in your desk and it would record all the sounds in your office—perfect for private detectives.

The VA switch has other advantages. It makes your tapes more efficient by making them last longer since your unit turns off during long pauses. So the unit's sixty minute tapes might be the equivalent of seventy or eighty minutes on other systems.

ACCESSORY MODULES

The VA switch is one of a series of small modules that plug into the bottom of the SD, thus expanding the recording system. These modules include an AM or FM radio module that plays music and news directly into your unit, a power amplifier and speaker that play back your tapes with high fidelity for conferences or personal music enjoyment, a telephone pick up that will record both sides of a phone conversation and a clip-on microphone for conferences or speeches. There are also a separate transcriber, foot pedal and headset available for your secretary.

MOTOR DRIVE BREAKTHROUGH

The Olympus SD has several new recording breakthroughs. The first is the new coreless motor. Conventional motors require a wire-wound long, solid core. In the Olympus coreless motor, the windings are on the outside or stationary part of the motor making it flatter, yet it has greater initial torque and more consistent speed than any conventional unit. Because of the coreless design, the entire SD unit is lighter, flatter, and easier to carry. There is less vibration, noise and power consumption so your batteries last longer and your recordings sound cleaner.

RECORDING HEAD QUALITY

The unit uses ferrite for its recording heads—the same material used in precision studio recorders. This extremely hard, diamond-like material will never wear out and prevents oxide build-up on the heads. You have top recording quality without wear.

NEW MICROPHONE TECHNOLOGY

The new built-in electret condenser microphone with automatic level control is also a

major design advance. Through new electronic circuitry, the impedance of the microphone remains constant, thus passing on the natural sound quality of all frequencies without distortion. The result is a clear recording with an extremely low signal to noise ratio so you won't hear objectionable background hissing or humming.



Just plug in the VA switch and you can operate the SD without pressing its record and pause controls. The basic unit measures only 7/8"x 2 1/2"x 5 1/2" and the VA switch adds another inch to its length.

VERY RUGGED UNIT

With all its quality and breakthrough features, the Olympus did not lose touch with reality—namely, that personal recorders get dropped, stepped on and damaged. Even if you're careful, there's always a chance you may drop or damage your unit.

The Olympus SD was built with both special cushioning features and component design that literally permit you to abuse your unit while still maintaining the same recording quality. The most sensitive component has always been the motor. If a conventional unit is dropped, even a slight motor core misalignment will noticeably affect performance. With the Olympus SD motor, there is no core, so core misalignment is impossible. Olympus also maintains a prompt service-by-mail facility if service should ever be required. Just slip your 12 ounce recorder in its handy mailer and it's on its way. Service should never be required but it's always good to know that your unit is solidly backed by a responsible service organization.

AUTO SHUT-OFF

Some units have automatic shut-off at the end of a cassette during the record mode. So does the SD. But the SD also has this feature on playback, thus preventing tape stretching and battery waste. And when the unit does shut off, it's practically silent and does not attract attention.

QUALITY FEATURES

The tape is capstan driven—the best drive available in cassette recorders. It can play eleven hours on a set of two penlight batteries and optional rechargeable batteries are also available. The Olympus sixty minute cassette (30 minutes per side) costs only \$2.99 compared to \$4.99 and \$5.99 for other brands. This gives you the lowest cost per minute recording of any system available.

JS&A offers you the most important breakthrough product in micro cassette recording. Olympus' voice activation switch, its new coreless motor, ferrite tape heads and electret microphone mean both quality, value and advanced technology—years ahead of all others. And the price of the Olympus SD is actually less than many of today's more popular brands that do not yet have the SD's innovations.

Olympus is the company that invented the micro recorder in 1969. Since then, they have licensed dozens of other companies to produce them—yet no unit compares with the Olympus. JS&A is America's largest single source of space-age products and a company that has brought to market the most advanced new products of this decade. We feel the SD is one of them.

But don't take our word for it. We suggest you order just the Olympus SD and the VA switch. Then use the system for thirty days. Take it with you to work, keep it in your pocket when you travel, and use it to dictate your notes. Compare the Olympus to every other unit on the market and read all the consumer reports on recording devices. Then after thirty days, decide whether or not the Olympus will quickly pay for itself in convenience and in actual time savings. If not, then return your unit for a prompt and courteous refund. If you decide to keep the SD you will positively own the best personal recorder sold today at any price. Then you can order any of the additional accessories available with the system from our inventory. Remember, there is no obligation, no postage and handling and you take absolutely no risk.

To order your unit and VA switch send \$269.90 (Illinois residents add 5% sales tax) to the address shown below or credit card buyers call our toll-free number below. By return mail we will send you your Olympus SD, VA switch and one year limited warranty. Or you may order any of the other items listed below.

The Olympus SD with its VA switch represents a major new innovation in personal recording—the voice-activated recorder. Order one at no obligation today.

Olympus SD with one tape \$239.95
VA switch alone 29.95
Box of 12 additional tapes @\$2.99 ea . . 35.88
(accessory list sent with unit)

JS&A NATIONAL SALES GROUP

Dept. P.E. One JS&A Plaza
Northbrook, Ill. 60062 (312) 564-9000
CALL TOLL-FREE 800 323-6400
In Illinois call (312) 498-6900

© JS&A Group, Inc., 1977

Talk to our Computer... and it will talk back!

(Plainly speaking, it's only from the Digital Group.)

Now, your Digital Group computer becomes more than a silent partner. You can vocally command your computer... it will listen... and it will talk back to you. How? With the introduction of the exciting new Digital Group/Votrax Voice Synthesizer.

All this is possible because the Digital Group/Votrax Voice Synthesizer has an unlimited vocabulary, with 64 "human sources" that can be combined and recombined to form words and languages. Imagine your own computer glibly spouting English, Latin, Spanish, Russian, Japanese and more. The average English words require only 100 bytes of memory!

Programming the Digital Group/Votrax Voice Synthesizer

The Digital Group/Votrax Voice Synthesizer is supplied with demonstration and diagnostic software which will permit preliminary assembly. Assembler listings of source code are also included.

We have additional software available at nominal cost:

- "Talking Basic" — \$10. MAXI-Basic output converted to English.
- "Talking CW" — \$10. For impressing your HAM buddies. Requires the forthcoming HAM interface card.
- "Latin and Spanish Talking" — \$10. Hear the computer repeat letters and words typed in Latin or Spanish.
- Demonstration Tape — \$5. A sample of audio tape and a complete explanation of the system.

Bonus: A basic input circuit is included that may be programmed to understand a small vocabulary of voice commands.

Unlimited Applications

Consider these possibilities:

- An aid for the blind, with the Voice Synthesizer supplementing a CRT display
- Economy — voice input and output of digital coordinates where light would be "lost" (night vision)

- Student terminals
- HAM radio repeater telemetry systems
- Student language pronunciation learning

Talk Price

Actually, we should be shouting this one. The Digital Group/Votrax Voice Synthesizer, with all its capabilities, is only \$495 kit or \$595 assembled and tested. That's language anybody can understand.

O.K., you've listened briefly to what we have to say about the new Digital Group/Votrax Voice Synthesizer. But we can keep right on talking! Write or call today for all the details — music to your ears.

the digital group

po box 6528 denver, colorado 80206 (303) 777-7133

Coming Next Month

NEW ELECTRONIC GAMES FOR 1978

FM TUNER PRODUCT DIRECTORY

THE SPECTRUM ANALYZER

TEST REPORTS

- Yamaha 2020 Stereo FM/AM Receiver
- Optonica RT-3535 Cassette Deck
- dbx 128 Dynamic Range Enhancer
- E. F. Johnson 4360 CB AM Mobile Transceiver
- Sencore DVM 37 Digital Multimeter

Cover Art by Frank Bolle

POPULAR ELECTRONICS, December 1977, Volume 12, Number 6. Published monthly at One Park Avenue, New York, NY 10016. One year subscription rate for U.S. and Possessions, \$12.00; Canada, \$15.00; all other countries, \$17.00 (cash orders only, payable in U.S. currency). Second Class postage paid at New York, NY and at additional mailing offices. Authorized as second class mail by the Post Office Department, Ottawa, Canada, and for payment of postage in cash.

POPULAR ELECTRONICS including ELECTRONICS WORLD, Trade Mark Registered. Indexed in the Reader's Guide to Periodical Literature.

COPYRIGHT © 1977 BY ZIFF-DAVIS PUBLISHING COMPANY. ALL RIGHTS RESERVED.

Ziff-Davis also publishes Boating, Car and Driver, Cycle, Flying, Modern Bride, Popular Photography, Skiing and Stereo Review.

Material in this publication may not be reproduced in any form without permission. Requests for permission should be directed to Jerry Schneider, Rights and Permissions, Ziff-Davis Publishing Co., One Park Ave., New York, NY 10016.

Editorial correspondence: POPULAR ELECTRONICS, 1 Park Ave., New York, NY 10016. Editorial contributions must be accompanied by return postage and will be handled with reasonable care; however, publisher assumes no responsibility for return or safety of manuscripts, art work, or models.

Forms 3579 and all subscription correspondence: POPULAR ELECTRONICS, Circulation Dept., P.O. Box 2774, Boulder, CO 80302. Please allow at least eight weeks for change of address. Include your old address, enclosing, if possible, an address label from a recent issue.

The publisher has no knowledge of any proprietary rights which will be violated by the making or using of any items disclosed in this issue.



Feature Articles

- 23 **WHAT NEXT IN HIGH FIDELITY?** / *Julian Hirsch*
- 48 **HOW FM TUNERS WORK** / *Julian Hirsch*
- 74 **WIRE-WRAPPING TECHNIQUES FOR COMPUTER HOBBYISTS** / *Adolph Mangieri*

Construction Articles

- 41 **POWER YOUR PROJECTS WITH SOLAR ENERGY!** / *Bill Green*
Digital clock and thermometer use light to recharge batteries.
- 52 **TO THE ELECTRONIC RACES!** / *James Barbarello*
An exciting LED game for two players.
- 80 **MODEL RAILROAD SOUND SYNTHESIZER** / *Harold Wright*

Special Focus on Home Computers

- 57 **BASIC GUIDE TO COMPUTER BUYING**
- 60 **USING EXISTING HOUSE WIRING FOR COMPUTER REMOTE CONTROL, PART I** / *Dan Sokol, Gary Muhonen, and Joel Miller*
- 66 **HOW TO INTERFACE MICROPROCESSORS** / *Ralph Tenny*
- 70 **COMPUTER STORES: A NEW RETAILING PHENOMENON** / *Sherman Wantz*
- 72 **QUICK HEX-DECIMAL CONVERSIONS** / *Raymond J. Bell*

Columns

- 20 **STEREO SCENE** / *Ralph Hodges*
The Mysterious West.
- 84 **SOLID STATE** / *Lou Garner*
One Circuit/Many Gifts.
- 90 **EXPERIMENTER'S CORNER**
Read/Write Memories, Part 1.
- 116 **CB SCENE** / *Gary Garcia*
Rules Enforcement Game Plan.
- 118 **COMPUTER BITS** / *Leslie Solomon*
Potpourri from Here and There.

Julian Hirsch Audio Reports

- 30 **PIONEER MODEL RT-707 BIDIRECTIONAL TAPE DECK**
- 32 **PHASE LINEAR MODEL 5000 FM TUNER**
- 34 **STANTON MODEL 881S PHONO CARTRIDGE**

Electronic Product Test Reports

- 98 **SPARKOMATIC MODEL CB 2040 CB AM MOBILE TRANSCEIVER**
- 99 **SABTRONICS MODEL 2000 DIGITAL MULTIMETER KIT**

Departments

- 4 **EDITORIAL** / *Art Salsberg*
Electronics 1978.
- 6 **LETTERS**
- 6 **OUT OF TUNE**
"How to Convert a 'Four Banger' for Stopwatch Functions" (August 1977);
"Build a Digital Camera Shutter Timer" (August 1977)
- 8 **NEW PRODUCTS**
- 15 **NEW LITERATURE**
- 127 **ELECTRONICS LIBRARY**
- 128 **OPERATION ASSIST**
- 130 **EDITORIAL INDEX TO VOLUMES 11 & 12 (1977)**

JOSEPH E. MESICS
Publisher

ARTHUR P. SALSBERG
Editorial Director

LESLIE SOLOMON
Technical Editor

JOHN R. RIGGS
Managing Editor

IVAN BERGER
Senior Editor

ALEXANDER W. BURAWA
Features Editor

EDWARD I. BUXBAUM
Art Director

JOHN McVEIGH
Associate Editor

ANDRE DUZANT
Technical Illustrator

CLAUDIA TAFARO
Production Editor

DORIS A. MATTHEWS
Editorial Assistant

Contributing Editors
Hal Chamberlin, Lou Garner, Glenn Hauser
Julian Hirsch, Ralph Hodges
Forrest Mims, Wilfred Scherer

JOSEPH E. HALLORAN
Advertising Director

JOHN J. CORTON
Advertising Sales

LINDA BLUM
Advertising Service Manager

PEGI McENEANEY
Executive Assistant

EDGAR W. HOPPER
Publishing Director

ZIFF-DAVIS PUBLISHING COMPANY
Editorial and Executive Offices
One Park Avenue New York, New York 10016
212-725-3500

Hershel B. Sarbin, President
Philip Korsant, Executive Vice President
Furman Hebb, Executive Vice President
John R. Emery, Sr. Vice President, Finance and Treasurer
Philip T. Heffernan, Sr. Vice President
Edward D. Muhfeld, Sr. Vice President, Sports Division
Philip Sine, Sr. Vice President
Frank Pomerantz, Vice President, Creative Services
Arthur W. Bulzow, Vice President, Production
Lawrence Sporn, Vice President, Circulation
George Morrissey, Vice President
Sydney H. Rogers, Vice President
Sidney Holtz, Vice President
Albert S. Traina, Vice President
Paul H. Chook, Vice President
Edgar W. Hopper, Vice President
Robert N. Bavler, Jr., Vice President
Charles B. Seton, Secretary

William Ziff, Chairman
W. Bradford Briggs, Vice Chairman

Midwestern Office
The Patis Group, 4761 West Touhy Ave.,
Lincolnwood, Illinois 60466, 312 679-1100
Thomas Hockney, Michael Neri, Gerald E. Wolfe
Western Office
9025 Wilshire Boulevard, Beverly Hills, CA 90211
213-273-8050, BRADshaw 2-1161
Western Advertising Manager: Bud Dean
Japan: James Yagi
Oji Paice Aoyama, 6-25, Minami Aoyama
6 Chome, Minato-Ku, Tokyo 407-1930/6821,
582-2851

Editorial

ELECTRONICS 1978

As in recent years, 1978 should bear new electronics fruit for electronics enthusiasts. Here are some educated guesses of what is expected to bloom next year, as well as some seeds that will be planted. Of course, much depends on which way the wind blows—the traditional “out” for weather forecasters.

Video. *Video tape recorders, which flopped in the consumer market some 12 years ago, promise to gain a strong toehold in 1978. Sony's 1977 “Betamax” sales proved that the public is ripe for VTR's. Now, with many new manufacturers entering this field, combined with a four-hour video tape cartridge and the price down to \$1000, sales should really gain momentum. *The video disk, which, in 1976, appeared to be a certainty for 1977, simply didn't make it. It may not in '78, either, because there is a lack of software. *Look for moderately priced microwave TV equipment for the electronics hobbyist to open up a whole new world of viewing and listening.

Communications. *In the CB radio field, expect the U.S. Coast Guard to change its view on not monitoring CB radio communications. It always struck me as a rather arrogant stance anyway, given the great number of boaters who utilize this form of low-cost radio communications. *There are many potential changes brewing in communications, but they have to wait until the conclusion of the World Administrative Radio Conference in 1979. Future possibilities include reservation of 21 new channels to ensure growth of AM radio.

Audio. *The number of direct-to-disc recordings will likely increase as more and more audio enthusiasts return to their roots and seek better sound quality. Eliminating the multi-track tape recorder from the recording process can produce a disc with superior sonic qualities. Try “Direct From Cleveland” by Lorin Maazel/The Cleveland Orchestra and “Big Band Jazz,” direct-discs distributed by Discwasher and Audio Technica, respectively, as examples of how this process can show off your hi-fi system to good advantage. It's unlikely that direct-cut discs will be big business in the sense that conventionally produced LP's are today owing to some drawbacks: \$12 to \$16 price, musicians' errors cannot be edited, special effects cannot be created by remixing. But, I believe that there are enough people out there who will pay a premium price for the superior raw audio quality of non-gimmicked recordings. *I don't expect 1978 to be the year for pulse-code-modulation tape recorders to enter the consumer hi-fi component marketplace, but there will certainly be increased research toward this end. Interestingly, Mitsubishi has introduced a professional PCM tape machine which is said to have no crosstalk and no wow and flutter. There is, however, a PCM tape machine available for an audio application with a novel twist—Superscope's **PIANOCORDER™**. As a modern successor to the old piano roll, it adds recording capability and can be installed on any conventional piano. The tape play/recorder system with relays to actuate piano keys, provides a truly live performance, capturing the nuances of the actual pianist. I tried it; it works. (But on replay of my performance, I now know why they laugh when I sit down at the piano.) With pre-recorded digitalized tapes of “masters” to be available, here's a chance for piano owners to have “live” mini-concerts in their homes.

Computers. As the number of experienced users of home computer systems increases, the desirability of owning a floppy disk machine will grow. Sales of this data-storage machine, whether full-size or minifloppy, should really blossom in '78.

Miscellaneous. There are a host of other trends that should come to fruition in 1978, such as a skyrocketing growth of programmable video games and non-video electronic games; enhanced sound of music in automobiles; more and more color TV receivers with automatic control functions and electronic tuning; microprocessors in automobiles for uses such as the “miles-to-empty” digital display in Lincoln's Mark V, electronics for fuel and spark control, etc.

Clearly, we will all be the beneficiaries of new advances in electronics in the coming year, for convenience and for sheer fun.

Best Wishes for a Joyous Holiday Season

Understanding Digital Electronics

New teach-yourself courses

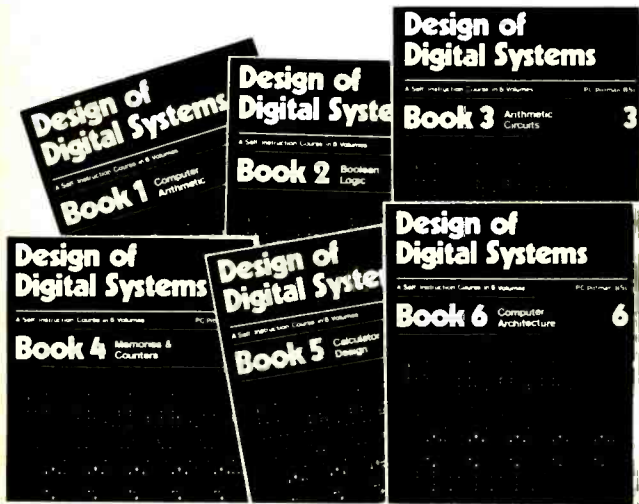

Design of Digital Systems is written for the engineer seeking to learn more about digital electronics. Its six volumes — each 11-1/2" x 8-1/4" are packed with information, diagrams and questions designed to lead you step-by-step through number systems and Boolean algebra to memories, counters and simple arithmetic circuits, and finally to a complete understanding of the design and operation of calculators and computers.

The contents of Design of Digital Systems include:

- Book 1** Octal, hexadecimal and binary number systems; conversion between number systems; representation of negative numbers; complementary systems; binary multiplication and division.
- Book 2** OR and AND functions; logic gates; NOT, exclusive-OR, NAND, NOR and exclusive-NOR functions; multiple input gates; truth tables; De Morgans Laws; canonical forms; logic conventions; Karnaugh mapping; three-state and wired logic.
- Book 3** Half adders and full adders; subtractors; serial and parallel adders; processors and arithmetic logic units (ALUs); multiplication and division systems.
- Book 4** Flip flops; shift registers; asynchronous and synchronous counters; ring, Johnson and exclusive-OR feedback counters; random access memories (RAMs) and read only memories (ROMs).
- Book 5** Structure of calculators; keyboard encoding; decoding display data; register systems; control unit; program ROM; address decoding; instruction sets; instruction decoding; control program structure.
- Book 6** Central processing unit (CPU); memory organization; character representation; program storage; address modes; input/output systems; program interrupts; interrupt priorities; programming; assemblers; computers; executive programs; operating systems and time sharing.

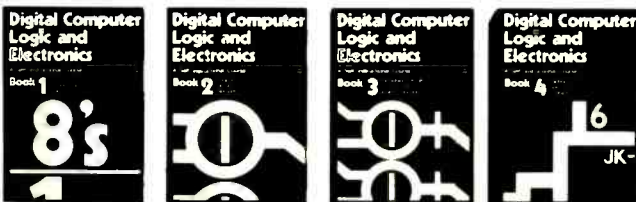

Digital Computer Logic and Electronics is designed for the beginner. No mathematical knowledge other than simple arithmetic is assumed, though the student should have an aptitude for logical thought. It consists of four volumes — each 11-1/2" x 8-1/4" — and serves as an introduction to the subject of digital electronics. Everyone can learn from it — designer, executive, scientist, student, engineer.

Contents include: Binary, octal and decimal number systems; conversion between number systems; AND, OR, NOR and NAND gates and inverters; Boolean algebra and truth tables; De Morgans Laws; design of logic circuits using NOR gates; R-S and J-K flip flops; binary counters, shift registers and half adders.

In the years ahead the products of digital electronics technology will play an important part in your life. Calculators and digital watches are already commonplace. Tomorrow a digital display could show your automobile speed and gas consumption; you could be calling people by entering their name into a telephone which would automatically look up their number and dial it for you.

These courses were written by experts in electronics and learning systems so that you could teach yourself the theory and application of digital logic. Learning by self-instruction has the advantages of being faster and more thorough than classroom learning. You work at your own pace and must respond by answering questions on each new piece of information before proceeding.

After completing these courses you will have broadened your career prospects and increased your fundamental understanding of the rapidly changing technological world around you.

The six volumes of Design of Digital Systems cost only: **\$19⁸⁸**

And the four volumes of Digital Computer Logic and Electronics cost only: **\$14⁸⁸**

But if you buy both courses, the total cost is only: **\$29⁹⁰**

a saving of over: **\$5⁰⁰**

SEVEN-DAY MONEY-BACK GUARANTEE: If you are not satisfied with your Cambridge course, return it within 7 days for a full refund.

To order your books, complete the order form below and send it together with your check or money order to GFN Industries, Inc., 6 Commercial Street, Hicksville, N.Y. 11801.

To: GFN INDUSTRIES, INC.
 6 COMMERCIAL STREET, HICKSVILLE, NY 11801

Please send me:

Sets of Design of Digital Systems \$19.88 _____

Sets of Digital Computer Logic & Electronics \$14.88 _____

Sets of both courses \$29.90 _____

Sales tax (N.Y. residents) _____

Shipping and handling \$2.50 per set _____

Enclosed is check/mo (payable to GFN Industries, Inc.)

Total \$ _____

Name _____

Address _____

City/State/Zip _____

Prices include overseas surface mail postage. PE-12B



Letters

USE THE OLD APPROXIMATIONS

I am sure you provided a service for many readers with the discussion in "Accurate Milliammeters On a Budget" (June 1977). As an

old Ham, I wonder why you did not give the old approximations for shunt calculations and for determining the internal resistance of a meter movement. They yield results whose scalar accuracy is better than that of the meters themselves.—D. Conover, WA6MVZ, La Mesa, CA.

The ones presented are more accurate, though both provide results more accurate than meters themselves.

SHORTWAVE-LISTENING BOOSTER

Your articles on shortwave listening and reports on SW receivers are excellent. I am just getting started as an SWL'er, and POPULAR

ELECTRONICS is helping me a great deal in my new hobby. Please keep Harry L. Helms's articles, the DX Listening column, and Shortwave Broadcasts Charts coming. —Paul Semenza, Tarrytown, NY.

TRANSPOSING BITS

In the "Pixie Graphics Display" article (July 1977), if the data pins on the 1861 IC are transposed, the bits will be displayed with the LSB first and the MSB last. This arrangement will be a little easier to use when calculating a display from software or an A/D converter. Just transpose D7 and D0, D6 and D1, D5 and D2, and D4 and D3.—Richard DeLombard, Huron, OH.

TVT-6 DISPLAY UNCROWDING

We built a "TVT-6 Video Display" unit (July 1977) and interfaced it with a KIM microcomputer. While following your published debugging instructions, we noted that our video monitor was displaying letters that were not complete because they were crowded together. Signal tracing revealed that the LOAD signal was okay but the CLOCK signal presented only 3 cycles/ μ s instead of the specified 6 cycles/ μ s. I tried replacing C5 with a smaller value of capacitance, with the result that the display was greatly improved. After some cut-and-try experimenting, we ended up with a 390-pF value and a perfect display. Anyone who runs into a similar problem with one of these video-display units might want to take note of our experience. —David A. Byrd, Memphis, TN.

ENLARGER REGULATOR PRECAUTION

Since your enlarger voltage-regulator project in the November 1977 issue is specifically aimed at the color darkroom worker, it would be well to point out that this regulator cannot be used with some enlarger color heads that have built-in filtration. Such heads usually have low-voltage, high-intensity lamps and transformer power supplies. Use of a dc supply, like that shown for the regulator in the November issue, can result in damage to the transformer. —Bennett Evans, New York, NY.

Out of Tune

In "How to Convert a 'Four Banger' for Stopwatch Functions" (August 1977), the IC2 and IC3 designations are shown transposed in Fig. 2. The Fig. 1 schematic diagram is correct.

In the Parts List in "Build a Digital Camera Shutter Timer" (August 1977), DIS1 through DIS5 are described as common-anode displays; they are actually common-cathode displays.

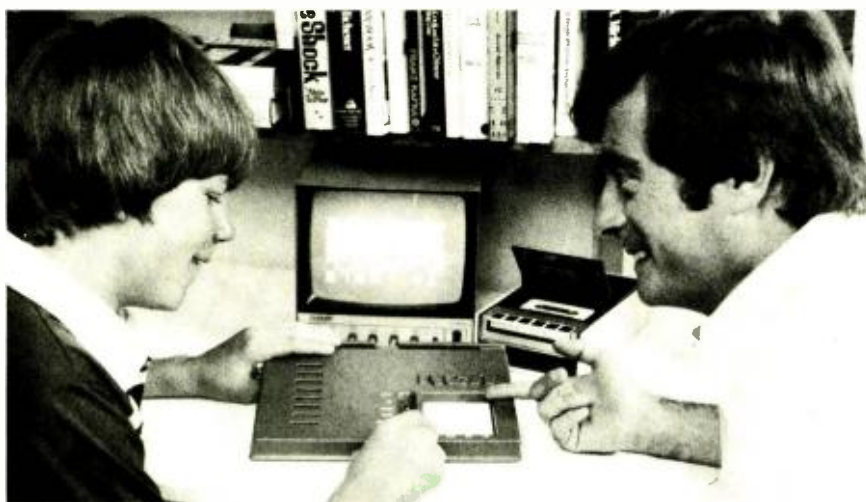

COSMAC VIP

The computer you can build for the whole family to enjoy.

RCA's new low-cost Video Interface Processor lets you create and play video games, generate graphics, and develop microprocessor control functions. And it's just \$275.*

Here is an elegant computer-on-a-card. Compact. Clean. Uncluttered. Yet powerful. And the whole idea behind it is fun. For the most serious hobbyist or any member of the family who can get into the challenge, entertainment and education it offers.

The COSMAC VIP is easy to program. And has its own interpretive language to make programs simple to create.

The VIP is supplied in kit form, with a cookbook written by hobbyists for hobbyists. It contains complete instructions for assembly, set-up and

operation. And it includes programs for twenty games. Some strictly fun. Some educational. All ready to load and record into your cassette.

Then all you have to do is hook your VIP up to a video monitor or your B/W TV through an rf modulator.

The VIP computer kit is available through these Distributors: American Used Computer Corporation, Arrow Electronics, Inc., Cramer Electronics, Inc., Hamilton-Avnet Electronics, Schweber Electronics Corp., Semiconductor Specialists, Inc., and Taylor Electric Co.

For additional information write RCA Solid State, VIP Marketing, Box 3200, Somerville, NJ 08876.

*Suggested retail price, optional with Oistributors.

RCA

The Sinclair PDM35.

A personal digital multimeter for only \$49.⁹⁵

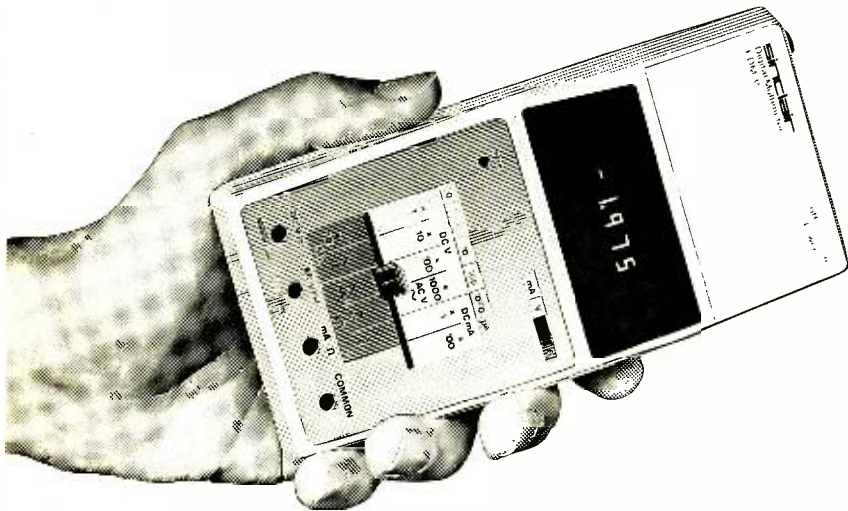

Technical specification

DC Volts (4 ranges)

Range: 1 mV to 1000 V.
Accuracy of reading: 1.0% ± 1 count.
Note: 10 MΩ input impedance.

AC Volts (40 Hz-5 kHz)

Range: 1 V to 500 V.
Accuracy of reading: 1.0% ± 2 counts.

DC Current (6 ranges)

Range: 1 nA to 200 mA.
Accuracy of reading: 1.0% ± 1 count.
Note: Max. resolution 0.1 nA.

Resistance (5 ranges)

Range: 1Ω to 20 MΩ.
Accuracy of reading: 1.5% ± 1 count.
Also provides 5 junction-test ranges.

Dimensions: 6 in x 3 in x 1 1/2 in.

Weight: 6 1/2 oz.

Power supply: 9 V battery or Sinclair AC adapter.

Sockets: Standard 4 mm for resilient plugs.

Options: AC adapter for 117 V 60 Hz power. De-luxe padded carrying wallet. 30 kV probe.

The Sinclair credentials

Sinclair have pioneered a whole range of electronic world-firsts – from programmable pocket calculators to miniature TVs. The PDM35 embodies six years' experience in digital multimeter design, in which time Sinclair have become one of the world's largest producers.

Tried, tested, ready to go!

The Sinclair PDM35 comes to you fully built, tested, calibrated and guaranteed. It comes complete with leads and test prods, operating instructions and a carrying wallet. And getting one couldn't be easier. Just fill in the coupon, enclose a cheque/ PO for the correct amount (usual 10-day money-back undertaking, of course), and send it to us.

We'll mail your PDM35 by return!

Sinclair Radionics Inc, Galleria,
115 East 57th Street, New York, N.Y.
10022, U.S.A.

Now everyone can afford to own a digital multimeter

A digital multimeter used to mean an expensive, bulky piece of equipment.

The Sinclair PDM35 changes that. It's got all the functions and features you want in a digital multimeter, yet they're neatly packaged in a rugged but light pocket-size case, ready to go anywhere.

The Sinclair PDM35 gives you all the benefits of an ordinary digital multimeter – quick clear readings, high accuracy and resolution, high input impedance. Yet at \$49.95 it costs less than you'd expect to pay for an analog meter!

The Sinclair PDM35 is tailor-made for anyone who needs to make rapid measurements. Development engineers, field service engineers, lab technicians, computer specialists, radio and electronic hobbyists will find it ideal.

With its rugged construction and battery operation, the PDM35 is perfectly suited for hand work in the field, while its angled display and optional AC power facility make it just as useful on the bench.

What you get with a PDM35

3 1/2 digit resolution.

Sharp, bright, easily read LED display, reading to ± 1.999.

Automatic polarity selection.

Resolution of 1 mV and 0.1 nA (0.0001 μA).

Direct reading of semiconductor forward voltages at 5 different currents.

Resistance measured up to 20 MΩ.

1% of reading accuracy.

Operation from replaceable battery or AC adapter.
Industry standard 10 MΩ input impedance.

Compare it with an analog meter!

The PDM35's 1% of reading compares with 3% of full scale for a comparable analog meter. That makes it around 5 times more accurate on average.

The PDM35 will resolve 1 mV against around 10 mV for a comparable analog meter – and resolution on current is over 1000 times greater.

The PDM35's DC input impedance of 10 MΩ is 50 times higher than a 20 kΩ/volt analog meter on the 10 V range.

The PDM35 gives precise digital readings. So there's no need to interpret ambiguous scales, no parallax errors. There's no need to reverse leads for negative readings. There's no delicate meter movement to damage. And you can resolve current as low as 0.1 nA and measure transistor and diode junctions over 5 decades of current.

To: Sinclair Radionics Inc, Galleria, 115 East 57th Street, New York, N.Y. 10022, U.S.A.

Please send me _____ (qty) PDM35(s)
@ \$49.95 plus \$1.05 postage and
insurance each: _____ \$ _____

_____ (qty) De-luxe padded
carrying case(s) @ \$4.95 each: _____ \$ _____

_____ (qty) AC adapter(s) @ \$4.95
each: _____ \$ _____

I enclose check/MO order made out to Sinclair
Radionics Inc (indicate total order value).
Add 4% sales tax for NYS deliveries: _____ \$ _____

I understand that if I am not completely satisfied
with my PDM35, I may return it within ten days
for a full cash refund.

Name: _____

Address: _____

City: _____

State: _____

Zip: _____

Sinclair
World leaders in fingertip electronics



New Products

Additional information on new products covered in this section is available from the manufacturers. Either circle the item's code number on the Reader Service Card inside the back cover or write to the manufacturer at the address given.

H-P PRINTING CALCULATOR

Hewlett-Packard's new HP-19C is the first pocket-sized programmable calculator with a built-in printer. The model is key-stroke programmable, with 98 fully-merged program steps, continuous memory, full editing and



programming functions, 30 data-storage registers, and a thermal printer, as well as an LED display. Programming features include 10 addressable labels, indirect addressing, and three subroutine levels, as well as back-step, insert/delete, single-step, pause, and a total of 10 decision tests. The printer may be set to print out the calculations, to list the program, or to print only when called for by a key or a list function. For further information, write Inquiries Manager, Hewlett-Packard Co., 1507 Page Mill Road, Palo Alto, CA 94304.

HEATHKIT DIGITAL BATHROOM SCALE

Heath's Model GD-1186 "Digit-Scale" reads from 0 to 300 lb, in increments of 0.2 lb, on a detachable LED digital display. The scale uses a strain-gauge transducer rather than conventional springs, weights or pins. It can also be zeroed for weighing small items, and extra cable is supplied to allow the read-out to be mounted at eye level or on any

handy surface. Power is from six "C" cells (not included). Kit price, \$99.95; assembled, \$139.95

CIRCLE NO. 90 ON FREE INFORMATION CARD

COLT CB AM TRANSCEIVER

An exceptionally small, 40-channel Citizens Band mobile transceiver, measuring only 4.5" wide by 1.4" high has been announced by Colt Communications. The Model 350 fea-



tures a LED digital channel display, volume, squelch, transmit lamp, variable-intensity LED indicators for signal strength and r-f output, and automatic noise limiting and noise blanking. \$199.95

CIRCLE NO. 87 ON FREE INFORMATION CARD

FISHER AM/STEREO FM RECEIVER

At the top of the new Fisher receiver line is the Studio Standard RS1080, an AM/stereo FM receiver with a continuous power output rating of 170 watts per channel into 8 ohms, with no more than 0.08% THD. Other specifications are: less than 0.03% THD at normal listening levels and IHF usable FM sensitivity, 1.6 microvolts (9.3 dBf). In addition to Baxandall treble and bass tone controls, a "tuned bass extender" can boost bass at either 45 or 80 Hz. There's also a tone-control defeat switch and high and low filter switches. The



volume control has 21 calibrated dB steps. Other features include an FM front end with 5-gang tuning, PLL multiplex decoder, FM Dolby switch, front-panel tape jacks, and three meters for channel center, signal strength and multipath. \$999.95.

CIRCLE NO. 88 ON FREE INFORMATION CARD

CSC DIGITAL PULSER PROBE

The Continental Specialities Corp. Model DP-1 digital pulser can monitor the circuit node under test and then preset its dual output circuitry to pulse the node in the reverse polarity. The probe delivers a 50-mA pulse in the CMOS mode or 100-mA pulse in the TTL mode, sufficient to toggle most lines without

requiring isolation of the circuit being tested. Power for the probe is obtained from the circuit under test to assure logic-level compatibility. A switch is provided for selecting the appropriate thresholds to trigger either TTL or CMOS circuits. The PULSE button can be mo-



mentarily pressed to deliver a single pulse, or it can be held down to deliver a train of pulses. A LED blinks once to indicate a single pulse and remains on to indicate a train of pulses. Probe tips are interchangeable with optional tips and accessories. \$74.95.

CIRCLE NO. 89 ON FREE INFORMATION CARD

TECHNICS DIRECT-DRIVE TURNTABLE

Technics by Panasonic introduces its new Model SL-2000 direct-drive turntable. Among its features are an IC-controlled servo motor, computer-analyzed tonearm, direct-reading antiskating device, an illuminated stroboscope, and independent pitch controls for 33 $\frac{1}{3}$ and 45 rpm. The tonearm base is die-



cast zinc, and Insulation Fiber Board is included to help control feedback. Audio isolation in the turntable feet is also used toward this end. Wow and flutter are rated at 0.045% wrms and rumble at -70 dB DIN B. Pitch controls can vary the motor speed by 10%.

CIRCLE NO. 91 ON FREE INFORMATION CARD

CB POWER PACK/TRANSCEIVER CASE

Kendon Manufacturing Co.'s CB Power-Mate is a combination transceiver carrying case and power pack. It is made of high-impact ABS plastic and accommodates nine zinc-carbon, alkaline, or NiCd C cells. A built-in meter indicates battery condition. The CB Power-Mate includes a 63-inch (1.6-m) whip antenna tuned to 27 MHz, a carrying strap,

POPULAR ELECTRONICS

What you should expect from a \$700 DC amp and matching tuner. Waveform fidelity.

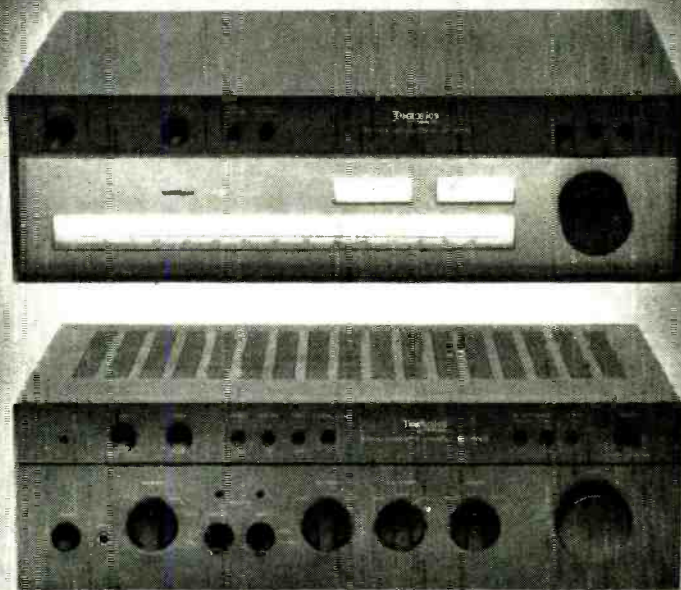

Introducing the 8080 Series. Technics integrated DC amp and matching tuner. Two remarkable components with waveform fidelity: The ability to reproduce sound waves. Square waves. Even tone burst signals. It's the only kind of performance you should expect from an integrated amp and tuner. Especially for \$700*.

To create an amp that would accurately amplify waveforms, we took some unusual steps with the SU-8080. Like eliminating all coupling capacitors and thereby eliminating a major source of phase shift, noise and distortion. Another step toward waveform fidelity is a frequency response of DC~100 kHz ± 1 dB.

And to complement our conventional DC integrated amp, we added an extremely quiet phono equalizer complete with Technics own ultra-low-noise transistors. The result: An increased phono S/N ratio of 100 dB at 10 mV with sharply reduced circuit and transistor noise especially when compared to conventional amps. We also added some unconventional controls. Like a subsonic filter in the phono equalizer and a four-step phono impedance selector.

Equally impressive is the performance of our ST-8080 tuner. To boost sensitivity while greatly reducing interference signal levels, there are two RF stages with low-loss, 4-pole, dual-gate junction FETs as well as a

linear FM variable tuning capacitor. At the same time, Technics-developed flat group delay filters increase selectivity without increasing distortion.

There's also a new Phase Locked Loop IC in the MPX circuit as well as a pilot signal canceler for razor-sharp cancellation of the 19 kHz pilot signal and ruler-flat high-end response: 20Hz to 18 kHz (+0.2 dB, -0.8 dB).

Now that you know what waveform fidelity means in a DC amp and tuner, take a look at what waveform fidelity means in their specs.

SU-8080 Amp. POWER OUTPUT: 72 watts per channel min. RMS into 8 ohms from 20 Hz to 20 kHz with no more than 0.02% total harmonic distortion. S/N (IHF A): 115 dB. PHONO S/N (IHF A): 100 dB (10 mV).

ST-8080 Tuner. 50 dB QUIETING SENSITIVITY: Mono 13.6 dB. Stereo 34.3 dB. SELECTIVITY: 85 dB. THD: Mono 0.15%. Stereo 0.3%. CAPTURE RATIO: 1.0 dB.

Technics EC80 Series. A rare combination of audio technology. A new standard of audio excellence.

*Technics recommended prices: SU-8080 is \$449.95 and ST-8080 is \$249.95, but actual retail prices will be set by dealers.

Technics Professional Series
by Panasonic

and universal hardware that allows fast hook-up to most 23- or 40-channel mobile transceivers.

CIRCLE NO 92 ON FREE INFORMATION CARD

LEAK SPEAKER SYSTEM

Rank Hi-Fi has introduced the Leak 3050, a time-delay-compensated, two-way speaker system with acoustic-suspension woofer. The system crosses over above 4 kHz to a 3/4" (19 mm) dome tweeter with response to 22 kHz (-3 dB). The bass is handled by two, 6.7" (170 mm) drivers in a well-damped air-suspension cabinet, with response down 3 dB at 48 Hz. The tweeter is mounted a precisely calculated distance behind the plane of the woofer panel, so that its harmonics will arrive at the ear in step with the fundamental frequencies from the woofer/midrange drivers. Nominal impedance is 8 ohms, and sensitivity is rated at 85 dB SPL at 1 meter for a 1-watt input. Recommended amplifier power is between 12 and 60 watts/channel, rms; power handling is rated at 50 watts by DIN standards. The system measures 25 1/4"H x 11 3/4"W x 13 3/4"D (64 x 30 x 35 cm) and weighs 42 lb (19 kg).

CIRCLE NO 93 ON FREE INFORMATION CARD

SENCORE NONCONTACT SIGNAL PROBE

A closed-loop signal pickup probe for frequency counters is available from Sencore. The "Snoop Loop," which requires no direct connection to the signal source being measured, connects directly to a 50-ohm input ca-



ble. It can be used to "snoop back" along the signal path into low-level circuit areas, and can even be placed directly over oscillator coils without upsetting the oscillator's operating frequency, according to the manufacturer. \$9.95

CIRCLE NO 94 ON FREE INFORMATION CARD

HALLICRAFTERS 2-METER TRANSCEIVER

The Hallicrafters H2M-1000 is a two-meter amateur transceiver with PLL frequency synthesis that operates in FM, USB, LSB, and CW modes. In the FM mode, it provides 800-channel coverage in 5-kHz steps with VXO variation of ± 7 in SSB/CW. Other features include a simplex mode, repeater offsets of

(Continued on page 14)

There's an iCOM for Everyone at these Computer Stores...

ALABAMA

Computerland
Huntsville
(205) 539-1200

ARIZONA

Byte Shop of Arizona
Tempe
(602) 894-1129

CALIFORNIA

Byte Shop
Computer Store
San Rafael
(415) 457-9311

Byte Shop
Fresno
(209) 485-2417

Byte Shop Computer
Store of Diablo Valley
Walnut
(415) 993-6252

Computerland
of Hayward
Hayward
(415) 538-8080

Computerland of
Saddleback Valley
Mission Viejo
(714) 770-0131

Computerland
of San Diego
San Diego
(714) 560-9912

Computerland of
San Tustin
Tustin
(714) 544-0542

Computerland
of West L.A.
Inglewood
(213) 776-8080

The Computer Room
San Jose
(408) 226-8384

Byte Shop
Computer Store
Santa Clara
(408) 249-4221

Byte Shop
Computer Store
Santa Barbara
(805) 966-2538

Byte Shop III
of San Jose
San Jose
(408) 377-4685

Byte Shop
of Thousand Oaks
Thousand Oaks
(805) 497-9595

Tech-Mart
Tarzana
(213) 344-0153

Byte Shop of Tarzana
Tarzana
(213) 343-3919

Byte Shop of Pasadena
Pasadena
(213) 684-3311

Byte Shop of Lawndale
Lawndale
(213) 371-2421

Byte Shop
of Westminster
Westminster
(714) 894-9131

Orange County
Computer Center
Costa Mesa
(714) 646-0221

The Computer Mart
Orange
(714) 633-1222

Byte Shop of San Diego
San Diego
(714) 565-8008

Byte Shop of Hayward
Hayward
(415) 537-2983

Micro Computer Center
Anaheim
(714) 527-8080

COLORADO
Prime Radix
Denver
(303) 573-5942

Byte Shop
Boulder
(303) 449-6233

FLORIDA

Byte Shop of Miami
Miami
(305) 264-2983

Byte Shop
of Ft. Lauderdale
Ft. Lauderdale
(305) 561-2983

HAWAII

Capacity, Inc.
Maui
(808) 575-2930

ILLINOIS

The Itty Bitty Machine
Company
Evanston
(312) 328-6800

Bits and Bytes
Computer Store
Posen
(312) 389-7112

Computerland
of Arlington Heights
Arlington Heights
(312) 255-6488

Littipute Computer Mart
Skokie
(312) 674-1383

The Numbers Racket
Champaign
(217) 352-5435

Champaign Computer
Company
Champaign
(217) 359-5883

INDIANA

Byte Shop
The Data Group Inc.
Indianapolis
(317) 842-2983

KENTUCKY

Cybertronics
Louisville
(502) 499-1551

Computerland
of Louisville
Louisville
(502) 425-8308

LOUISIANA

Southern
Electronics, Inc.
Shreveport
(318) 222-8795

Computer Shoppe, Inc.
Metairie
(504) 454-6600

MARYLAND

The Computer
Workshop, Inc.
Rockville
(301) 468-0455

Computerland
of Rockville
Rockville
(301) 948-7676

MASSACHUSETTS

Computer Mart, Inc.
Waltham
(617) 899-4540

American Used
Computer Corporation
Boston
(617) 261-1100

MICHIGAN

General Computer
Troy
(313) 362-0022

Computer Mart
Royal Oak
(313) 576-0900

MINNESOTA

Microprogramming, Inc.
Burnsville
(612) 894-3510

Computer Depot
Minneapolis
(612) 927-5601

NORTH CAROLINA

Digital Dynamics
Corporation
Charlotte
(704) 374-1527

NEW HAMPSHIRE

Computer Mart of
New Hampshire
Nashua
(603) 883-2386

NEW JERSEY

Computer Mart of
New Jersey
Iselin
(201) 283-0600

Computerland
of Morristown
Morristown
(201) 539-4077

NEW YORK

Synchro Sound
Enterprises
Hollis
(212) 468-7067

Computerland
of Tonawanda
Tonawanda
(716) 836-6511

Computerland of Ithaca
Ithaca
(607) 277-4888

Computer Shoppe
Middle Island
(516) 732-4446

PENNSYLVANIA

Byte Shop of
Philadelphia
Bryn Mawr
(215) 525-7712

Personal Computer
Corporation
Frazier
(215) 647-8463

SOUTH CAROLINA

Carolina Computers
Columbia
(803) 798-7524

TEXAS

Micro Store (0010)
Arlington
(817) 461-6081

Microstore
Richardson
(214) 231-1096

Microtex, Inc.
Houston
(713) 780-7477

Electrotex
Houston
(713) 526-3456

Computer World
Arlington
(817) 469-1502

Computer
Terminal Store
El Paso
(915) 532-1777

Computer Shop
San Antonio
(512) 828-0553

The KA Computer Store
Dallas
(214) 634-7870

WISCONSIN

Madison
Computer Store
Madison
(608) 255-5552

CANADA

Computer Mart Ltd
Toronto, Ontario
(416) 484-9708

Computer Place
Toronto, Ontario
(416) 598-0262

iocom® **MICROPERIPHERALS**™

6741 Variel Ave., Canoga Park, CA 91303 U.S.A. • (213) 348-1391 TWX 910-494-2788

a division of Pertec Computer Corporation

**Rich Man, Poor Man, Merchant, Physician,
Teacher, Lawyer, Student, Musician....**



There's an iCOM Floppy Disk System for Everyone!

More Uses

People from every walk of life are adding iCOM® Floppy Disks to their microcomputers for such diverse tasks as payroll, inventory control, mailing lists, game playing, record keeping, parts ordering . . .

We've uncovered some innovative applications, too: The sailboat architect who puts equations and algorithms on an iCOM disk to test his nautical theories; the student who has automated a bowling alley; the iCOM dealer who designed an environmental control system for a university.

More Speed

These users have found iCOM floppies to be much faster and more versatile than cassette or paper tape.

With iCOM, programs can be loaded in seconds; files updated in minutes; hundreds of programs can be stored on a single disk.



More Models

iCOM has Frugal Floppies™, Dual Floppies, Microfloppies™ (using the new 5 1/4" diskette), and other new approaches to floppy disk systems. Each is hardware and software compatible with Altair™, IMSAI, Poly 88, Sol-20 and other microcomputers using the Altair S-100 bus format.



More Software

Then there's iCOM's famous software: Powerful field-proven FDOS-II with macro-assembler, string-oriented text editor, and file manager. Plus easy-to-use compatible 8K Disk BASIC. Each with super features such as: named variable length files, auto-file create, open and close, multiple merge and delete . . . and more.

More Backup

We've been building floppies for microcomputers for more than 3 years. Long before the rest. Thousands of systems are operating perfectly in the field. And we're part of Pertec Computer Corporation, one of the largest manufacturers of peripherals, microsystems, data entry products and data processing systems. We'll be around whenever you need us.

More Dealers

Maybe not in quantity, but in quality. We've chosen our dealer network carefully to assure you of assistance every step of the way. Our prices are right. Our delivery is fast. Our dealers are experienced and knowledgeable.

Must Reading

Our free booklet, "What a Floppy Disk Can Do for You" is must reading. Send for yours today or visit your dealer.

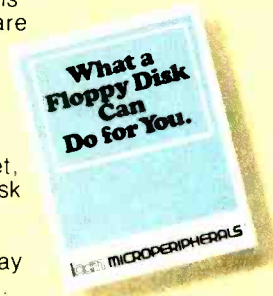

iCOM® MICROPERIPHERALS®

a division of Pertec Computer Corporation

CIRCLE NO. 23 ON FREE INFORMATION CARD

©1977, Pertec Computer Corporation
6741 Variel Ave., Canoga Park, CA 91303 U.S.A.
Tel. (213) 348-1391 TWX 910-494-2788

Introducing Apple II.



The home computer that's ready to work, play and grow with you.

Clear the kitchen table. Bring in the color T.V. Plug in your new Apple II,* and connect any standard cassette recorder/player. Now you're ready for an evening of discovery in the new world of personal computers.

Only Apple II makes it that easy. It's a complete, ready to use computer—not a kit. At \$1298, it includes features you won't find on other personal computers costing twice as much.



Features such as video graphics in 15 colors. And a built-in memory capacity of 8K bytes ROM and 4K bytes RAM—with room for lots more. But you don't even need to know a RAM from a ROM to use and enjoy Apple II. It's the first personal computer with a fast version of BASIC—the English-like programming language—permanently built in. That means you can begin running your Apple II the first evening, entering your own instructions and watching them work, even if you've had no previous computer experience.

The familiar typewriter-style keyboard makes communication easy. And your programs and data can be stored on (and retrieved from) audio cassettes, using the built-in cassette interface, so you can swap with other Apple II users. This and other peripherals—optional equipment on most personal computers, at hundreds of dollars extra cost—are built into Apple II. And it's designed to keep up with changing technology, to expand easily whenever you need it to.

As an educational tool, Apple II is a sound investment. You can program it to tutor your children in most any subject, such as spelling,

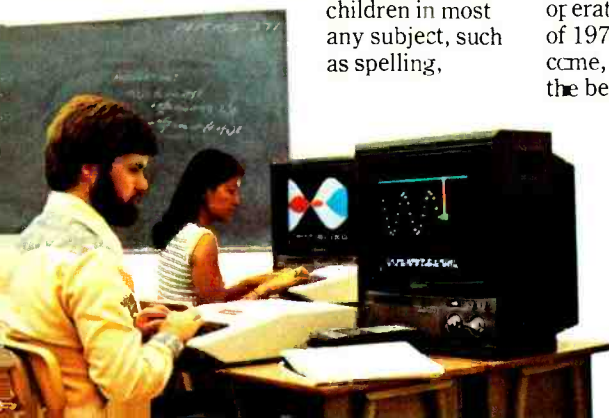

history or math. But the biggest benefit—no matter *how* you use Apple II—is that you and your family increase your familiarity with the computer itself. The more you experiment with it, the more you discover about its potential.

Start by playing PONG. Then invent your own games using the input keyboard, game paddles and built-in speaker. As you experiment you'll acquire new programming skills which will open up new ways to use your Apple II. You'll learn to "paint" dazzling color displays using the unique color graphics commands in Apple BASIC, and write programs to create beautiful kaleidoscopic designs.

As you master Apple BASIC, you'll be able to organize, index and store data on household finances, income tax, recipes, and record collections. You can learn to chart your biorhythms, balance your checking account, even control your home environment. Apple II will go as far as your imagination can take it.

Best of all, Apple II is designed to grow with you. As your skill and experience with computing increase, you may want to add new Apple peripherals. For example, a refined, more sophisticated BASIC language is being developed for advanced scientific and



mathematical applications. And in addition to the built-in audio, video and game interfaces, there's room for eight plug-in options such as a prototyping board for experimenting with interfaces to other equipment; a serial board for connecting teletype, printer and other terminals; a parallel interface for communicating with a printer or another computer; an EPROM board for storing programs permanently; and a modem board communications interface. A floppy disk interface with software and complete operating systems will be available at the end of 1977. And there are many more options to come, because Apple II was designed from the beginning to accommodate increased power and capability as your requirements change.

If you'd like to see for yourself how easy it is to use and enjoy Apple II, visit your local dealer for a demonstration and a copy of our

Apple II™ is a completely self-contained computer system with BASIC in ROM, color graphics, ASCII keyboard, lightweight, efficient switching power supply and molded case. It is supplied with BASIC in ROM, up to 48K bytes of RAM, and with cassette tape, video and game I/O interfaces built-in. Also included are two game paddles and a demonstration cassette.

SPECIFICATIONS

- **Microprocessor:** 6502 (1 MHz).
- **Video Display:** Memory mapped, 5 modes—all Software-selectable:
 - Text—40 characters/line, 24 lines upper case.
 - Color graphics—40h x 48v, 15 colors
 - High-resolution graphics—280h x 192v; black, white, violet, green (16K RAM minimum required)
 - Both graphics modes can be selected to include 4 lines of text at the bottom of the display area.
 - Completely transparent memory access. All color generation done digitally.
- **Memory:** up to 48K bytes on-board RAM (4K supplied)
 - Uses either 4K or new 16K dynamic memory chips
 - Up to 12K ROM (8K supplied)
- **Software**
 - Fast extended Integer BASIC in ROM with color graphics commands
 - Extensive monitor in ROM
- **I/O**
 - 1500 bps cassette interface
 - 8-slot motherboard
 - Apple game I/O connector
 - ASCII keyboard port
 - Speaker
 - Composite video output



Apple II is also available in board-only form for the do-it-yourself hobbyist. Has all of the features of the Apple II system, but does not include case, keyboard, power supply or game paddles. \$798.

PONG is a trademark of Atari Inc.

*Apple II plugs into any standard TV using an inexpensive modulator (not supplied).

detailed brochure. Or write Apple Computer Inc., 20863 Stevens Creek Blvd., Cupertino, California 95014.

CIRCLE NO. 78 ON FREE INFORMATION CARD



apple computer inc.™

www.americanradiohistory.com

Para-Power (Parametric Equalizers by SAE)

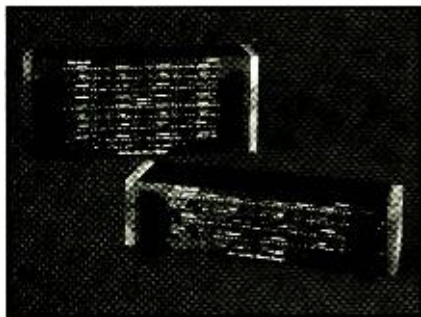

SAE has long been involved in the field of tone equalization. From our pioneering efforts in variable turn over tone controls to our more recent advancements in graphic equalizers, we have continually searched for and developed more flexible and responsive tone networks. From these efforts comes a new powerful tool in tone equalization — the Parametric Equalizer. Now you have the power of precise control.

Our 2800 Dual Four-Band and 1800 Dual Two-Band Parametrics offer you controls that not only cut and boost, but also vary the bandwidth and tune the center frequency of any segment of the audio range. With this unique flexibility, any problem can be overcome precisely, and any effect created precisely.

With either of these equalizers, you have the power to correct any listening environment or overcome any listening problems that you are faced with. Whether you need a third octave notch filter, tailored bandwidth to resurrect a vocalist, or a tailored cut to bury an overbearing bass, the control flexibility of Parametric Equalizers can fill these needs and many more. And of course, as with all SAE products, they offer the highest in sonic performance and quality of construction.

For Complete Information Write:

SAE
Scientific Audio Electronics, Inc.
P.O. Box 60271 Terminal Annex, Los Angeles, CA 90060

NEW PRODUCTS

(Continued from page 10)

±600 kHz and ±1 MHz, LED frequency display (six digits in FM mode, five digits in SSB), S/r-f and discriminator meters, standard and slow agc, built-in VOX, receiver-incremental tuning, noise blanker, mike gain



control, and ac or dc operation. R-f power output exceeds 10 watts in high-power mode, and is one watt in low-power mode.

CIRCLE NO 95 ON FREE INFORMATION CARD

SOUNDCRAFTSMEN POWER AMPLIFIER

The Soundcraftsmen MA5002 power amplifier is said to deliver 250 watts per channel into 8 ohms at less than 0.1% THD, using a new type of circuit—class "H." According to Soundcraftsmen, its "variproportional" circuit anticipates power demands and supplies only the amount of power required by the input signal voltage. It's claimed that this reduces the dissipation of energy as heat loss and increases efficiency. The "new Class" amplifier requires about 40% less input power

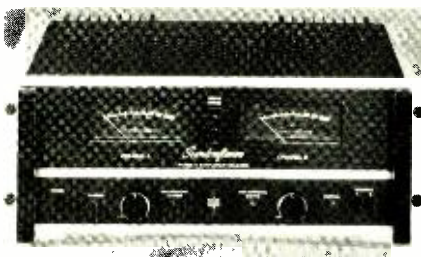

er at the one-third-power point used in FTC power amplifier tests and needs no cooling fan. The amplifier also features overload circuits with automatic reset, LED clipping indicators, VU meters with three ranges, and switching for two pairs of speaker systems.

CIRCLE NO 96 ON FREE INFORMATION CARD

OLYMPUS MICROCASSETTE RECORDER

Olympus introduces the PearlCorder SD, a second-generation pocket-size microcassette recorder with capstan drive. It uses Olympus' 60-minute microcassettes. Operating life from two AA alkaline cells is claimed to be 11 hours of continuous recording time. Its control line-up includes cue, rewind, fast forward, and pause. A coreless motor maximizes speed constancy. A ferrite head is claimed to provide a record/playback frequency range of 300 to 7000 Hz. The recorder is designed to accept a number of accessories, including an external amplifier/speaker, AM and FM tuner modules, voice actua-



tor, tie-clip microphone, and remote adaptor. \$240 for the basic recorder; \$260 for Standard SD combination.

CIRCLE NO 97 ON FREE INFORMATION CARD

B&K-PRECISION AUTOTRANSFORMER

B&K-Precision announces its Model TR-100 combination isolation/autotransformer for bench use. Three isolated and three direct outlets are available simultaneously, providing high, medium, and low (130, 115, and 105 volts ac) line voltages. The isolated outlets



are rated at 400 VA continuous, while the direct outlets are rated at 500 VA. The TR-100 allows safe testing of transformerless equipment, eliminating a potential shock hazard, and can be used to vary the line voltage applied to an electrical device or instrument under test. The adjustment range is from 105 to 130 volts ac. \$55.

CIRCLE NO 98 ON FREE INFORMATION CARD

ANTLER CB BASE ANTENNA

The new Antler Antennas Model B-12 is an omnidirectional gain antenna designed for CB use on 40 channels. It is said to have an extremely low SWR, claimed by the manufacturer to be less than 1.1:1.0. The antenna has an 8'4" (2.5-m) maximum radiator above a three-element drooping ground plane and a 6'3" (2.2-m) turning radius. It is rated at 50 ohms and is vertically polarized. A vhf connector is provided to mate with the standard PL-259 coaxial fitting found on most CB transceivers. The antenna is made of heavy-walled, step-tapered seamless aluminum tubing and a reinforced base mast to bear up to high wind-loading conditions. \$36.95.

CIRCLE NO 99 ON FREE INFORMATION CARD

Learn digital computer

NRI is the only school to train you at home on a real digital computer.

Learn computer design, construction, maintenance and programming techniques on your own programmable digital computer.

Qualified technicians are urgently needed for careers in the exciting new field of digital and computer electronics . . . and the best way to learn digital logic and operations is now available to you in NRI's Complete Computer Electronics Course.

This exclusive course trains you at home on your own digital computer! This is no beginner's "logic trainer", but a complete programmable digital computer that contains a memory and is fully automatic. You build it yourself and use it to define and flow-chart a program, code your program, store your program and data in the memory bank. Press the start button and the computer solves your problem and

displays the result instantly.

The NRI digital computer is one of 10 kits you receive in the NRI Complete Computer Electronics Course. You build and use your own TVOM, and experiment with NRI's exclusive Electronics Lab. You perform hundreds of experiments, building hundreds of circuits, learning organization, operation, trouble-shooting and programming.

New NRI Memory Expansion Kit

The Model 832 NRI Digital Computer now comes with a new Memory Expansion Kit. Installed and checked out in 45 minutes, it doubles the size of the computer's memory, significantly increasing the scope and depth of your knowledge of digital computers and programming. With the large-scale IC's you get the only home training in machine language programming . . . experience essential to trouble-shooting digital computers.

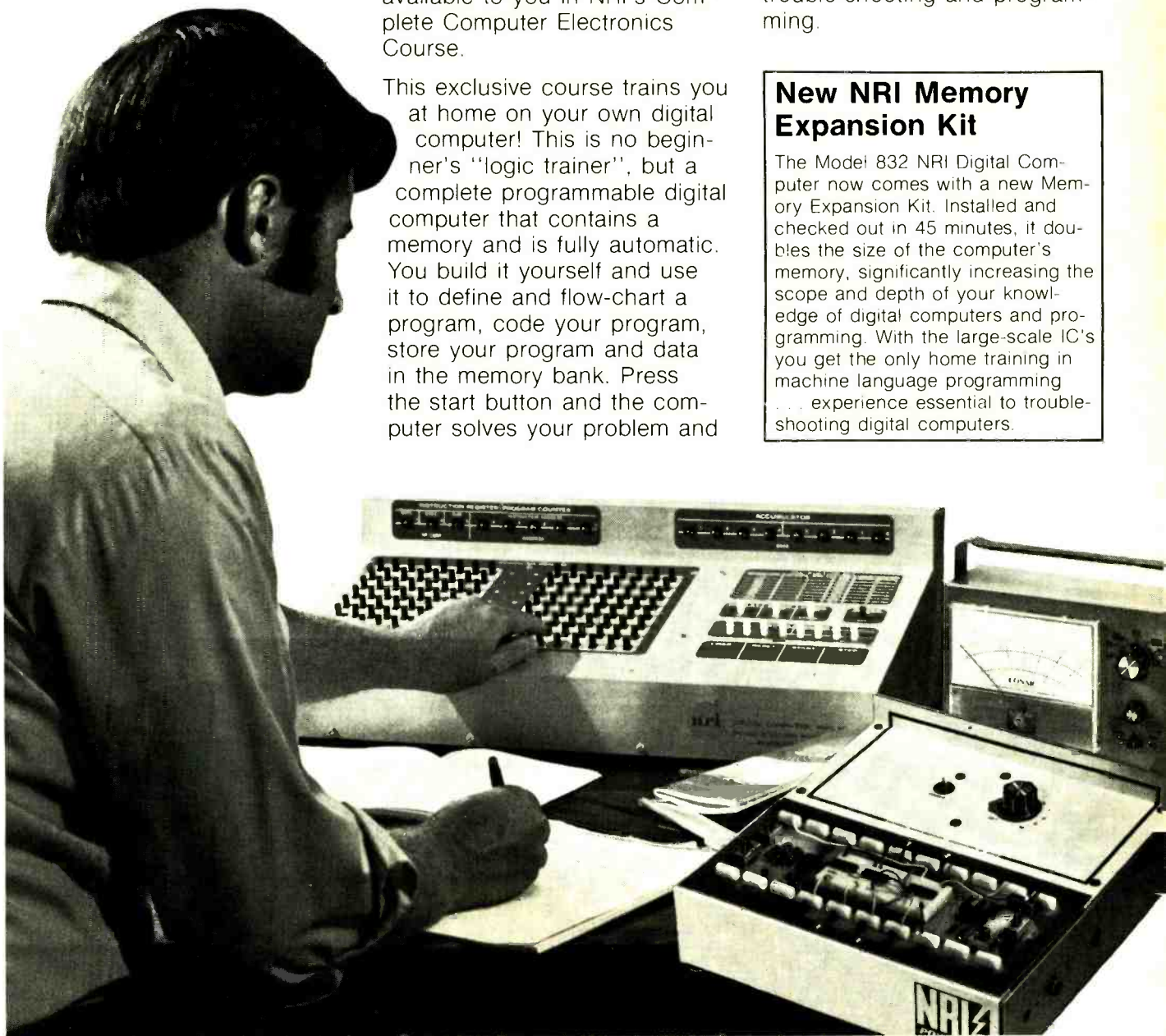

electronics at home.

NRI offers you five TV/Audio Servicing Courses

NRI can train you at home to service Color TV equipment and audio systems. You can choose from 5 courses, starting with a 48-lesson basic course, up to a Master Color TV/Audio Course, complete with designed-for-learning 25" diagonal solid state color TV and a 4-speaker SQ™ Quadraphonic Audio System. NRI gives you both TV and Audio servicing for hundreds of dollars less than the two courses as offered by another home study school.

All courses are available with low down payment and convenient monthly payments. All courses



provide professional tools and "Power-On" equipment along with NRI kits engineered for training. With the Master Course, for instance, you build

your own 5" wide-band triggered sweep solid state oscilloscope, digital color TV pattern generator, CMOS digital frequency counter, and NRI electronics Discovery Lab.



*Trademark of CBS Inc

NRI's Complete Communications Course includes your own 400-channel VHF transceiver

NRI's Complete Communications Course will train you at home for one of the thousands of service and maintenance jobs opening in CB; AM and FM transmission and reception; TV broadcasting; microwave, teletype, radar, mobile, aircraft, and marine electronics. The complete program includes 48 lessons, 9 special reference texts, and 10 training kits. Included are: your own "designed-for-learning" 400-channel VHF transceiver; electronics Discovery Lab™; CMOS digital frequency counter; and more. You also get your all



important FCC Radio-telephone License, or you get your money back.



CB Specialist Course also available



NRI also offers a 37-lesson course in CB Servicing with your own CB Transceiver, AC power supply, and multimeter. Also included are 8 reference texts and 14 coaching units to make it easy to get your Commercial Radiotelephone FCC License.

You pay less for NRI training and you get more for your money.

NRI employs no salesmen, pays no commissions. We pass the savings on to you in reduced tuitions and extras in the way of professional equipment, testing instruments, etc. You can pay more, but you can't get better training.

More than one million students have enrolled with NRI in 62 years.

Mail the insert card and discover for yourself why NRI is the recognized leader in home training. Do it today and get started on that new career. No salesman will call.

If card is missing write:

NRI NRI SCHOOLS
 McGraw-Hill Continuing
 Education Center
 3939 Wisconsin Avenue
 Washington, D.C. 20016



Stereo Scene

By Ralph Hodges

THE MYSTERIOUS WEST

WHEN it comes to cassettes, or even to magnetic tape in general, the Far East has been much less mysterious than the Far West—western Europe, in other words. One doesn't hear much from the Common Market countries about what we in the U.S. and elsewhere are doing with the cassette, which was after all conceived and developed in the Netherlands. And we are in fact doing a great deal with it: Dolbyizing it, chromium-dioxidizing it, and generally trying to turn it into a super-audiophile medium, which is not what its originators had in mind.

On a recent visit to BASF in southwest Germany, a touring group of press people, of which I was one, got a first-hand look—albeit a very brief one—at the environment into which the cassette was born and nurtured through infancy. We, or at least I, encountered a few surprises. I had been led to expect a market dominated much more than is the case here by "compact" music systems and carry-around portable machines. The surprise was in seeing the inclusion of refinements one would not normally anticipate on a widespread basis in such mundane hardware. Dolby B-type noise reduction and chromium-dioxide bias and equalization are common in this seemingly modest equipment. In fact, the Germans are quite high on chrome and the Dolby system, despite their origins abroad, and many tape and equipment manufacturers assume its use in specifying product performance, just as here.

BASF has enormous research and manufacturing resources in Europe, and its present small share of the U.S. market does not really represent its true strength. So it was with interest that we explored what products and philosophies are being readied by BASF to convert the U.S. consumer to a pro-Europe outlook in general (and a pro-BASF view in particular).

Chromium Dioxide. BASF intends to stick with chromium-dioxide tape

through thick and thin, and to combat the claims made for the "chrome-substitute" tapes (Maxell UDXL II and TDK SA being the most prominent) as vigorously as possible. Figure 1 presents some of the data on which the company bases its decision. It seems that German radio broadcasters have cooperated over the years in compiling statistical data on the dynamic range of recorded (presumably on disc) program material. In Fig. 1, BASF has plotted these dynamic-range requirements according to frequency, and overlaid the plot with the dynamic-range capabilities of various tapes. The crosshatched area represents the requirements for uncritical music, while indicated points on the right hand vertical scale show the very-high-frequency demands of certain special cases. All the tapes have been biased at their theoretic-

cally optimum points, and their maximum output levels (MOL's) at 333 Hz, referred to the 3 percent distortion point, have been arbitrarily set at 0 dB.

The first thing to note is that the BASF professional open-reel tape, operating at 15 ips, almost exactly "fits" the requirements of "very critical music" from the lowest to the highest frequencies indicated, whereas all the cassette samples fall far short at the highest frequencies. However, they encounter no apparent difficulties at middle and low frequencies, where they are approximately equal. The best of the high-frequency performers, BASF's brand new Chromdioxid Super, reflects the company's view that the extreme high frequencies are where cassette improvements should be happening—an opinion that no one who has done much cassette recording is likely to dispute.

One thing that does *not* show up in these data is chromium dioxide's much talked-about MOL limitations at middle and low frequencies. When queried about this, the BASF people responded that MOL for these frequencies is really only a function of oxide-coating thickness—a statement that is quite in line with current tape-recording theory. However, what then is to be made of all the reported measurements showing chromium dioxide as several dB deficient in

Fig. 1. How dynamic ranges of various tapes "fit" dynamic-range requirements of different types of music according to BASF's data.

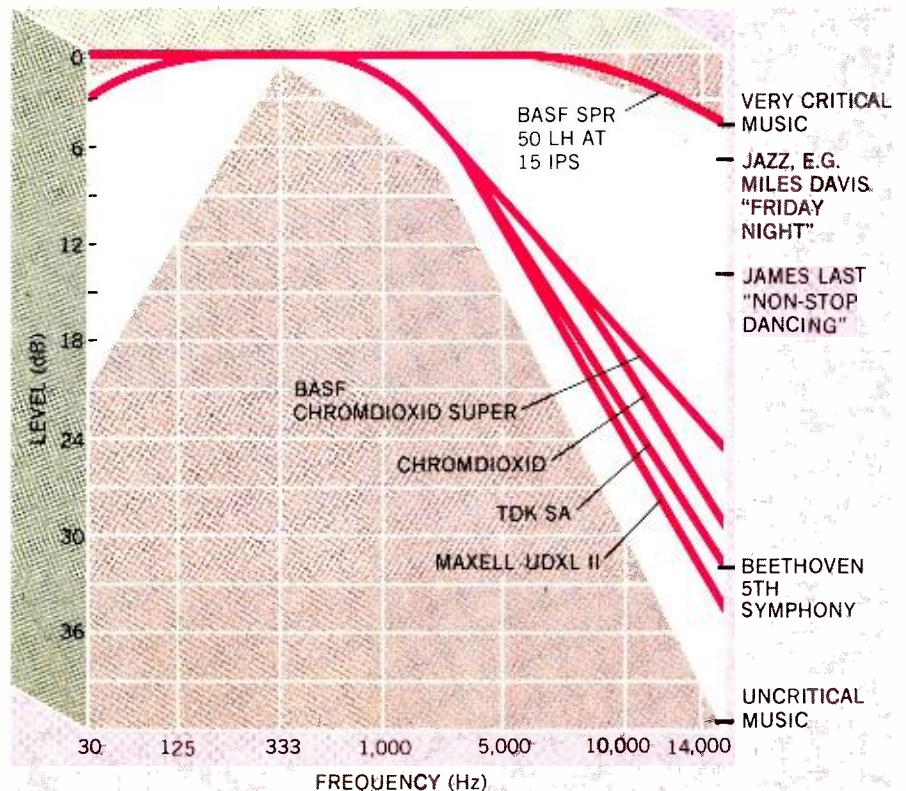

WHY THE FIRST HIGH POWERED RECEIVER IS STILL THE BEST HIGH POWERED RECEIVER.

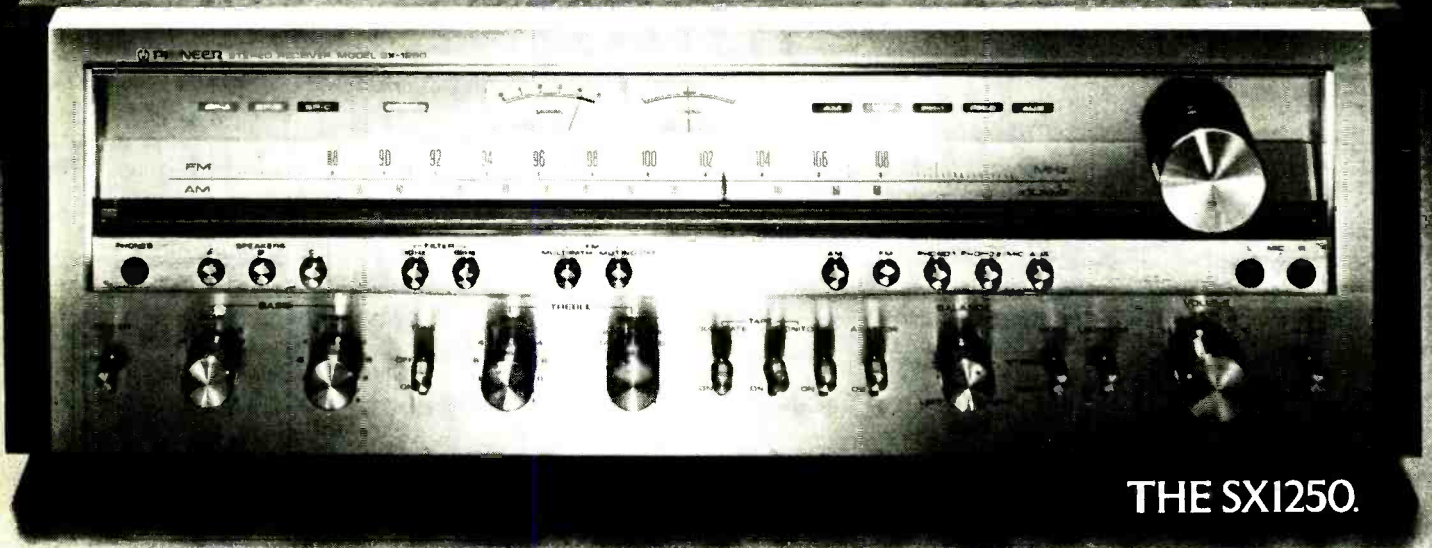

THE SX1250.

WHEN YOU'RE NOT IN A RUSH TO CATCH UP, YOU'VE GOT THE TIME TO BUILD THINGS RIGHT.

When Pioneer first introduced the 160 watt* SX 1250 last year, it prompted our competitors to hastily introduce a bevy of high powered receivers.

Unlike the others, however, the SX 1250 wasn't a rush job. And the time and care that went into it can both be seen and heard.

Inside the SX 1250, for example, you'll find that we took the time to shield every critical section. So spurious signals from one section can't leak into another. And dirt and dust can't get in to affect performance. So the SX 1250 not only produces crisp, interference-free sound when it's new, but still sounds great as it grows old.

In our power supply, instead of finding a conventional transformer, you'll find a heavier, more advanced toroidal-core transformer. It's

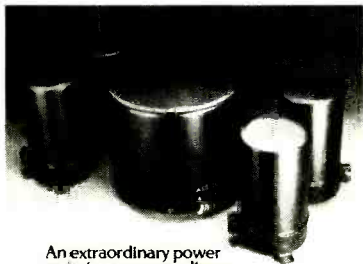

An extraordinary power supply, for an extraordinary amount of power.

find that we took the time to shield every critical section. So spurious signals from one section can't leak into another. And dirt and dust can't get in to affect performance. So the SX 1250 not only produces

less susceptible to voltage variations. And less likely to leak noise. Which means you get a cleaner, clearer sound.

And where most high powered receivers come with a three, or four gang variable capacitor for FM tuning, the SX 1250 features a *five* gang zinc plated variable capacitor that cleans up FM reception much better. And helps to pull in stations that some three or four gang capacitors can't even touch.

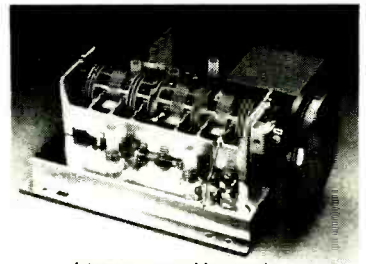

A five gang variable capacitor for FM reception that never varies.

Obviously, these are only a few of the refinements that went into the SX 1250. But given just these few things, it should come as no surprise that the SX 1250 even weighs more than most of our competitors' high powered offerings.

So before you run out and buy just any high powered receiver, consider all the time and engineering that went into the SX 1250. And weigh your decision carefully.

High Fidelity Components
PIONEER
WE BRING IT BACK ALIVE.

©1977 U.S. Pioneer Electronics, 85 Oxford Drive, Moonachie, New Jersey 07074

*160 watts per channel minimum RMS continuous power output at 8 ohms, from 20 to 20,000 Hz, with no more than 0.1% total harmonic distortion.

long-wavelength MOL? Underbiasing of the tape machine would offer an explanation, but BASF has other data indicating that most cassette decks are quite close to optimum bias for CrO₂. I guess we'll have to await clarification on this.

Head Wear. Another damning charge that has been levelled against CrO₂ is its purported tendency to accelerate tape-head wear. BASF most vigorously disputes that accusation, and Fig. 2 graphs their test results for BASF chrome versus one of the leading chromium-dioxide "substitutes" employing an alloy head made of Philips' Recovac material.

The results indicate that the substitute is actually somewhat more abrasive under the test conditions used, but the company spokesman hastened to assure us that neither tape wears heads at a rate that could be considered significant, and that a cassette deck's head could be expected to outlast its mechanicals in almost every case. Furthermore, he stated that the oxide material itself is not the overwhelming factor in head wear. The binder system, surface polish, and the proper orientation of the needle-shaped oxide particles play a major role as well.

To me, all of this sounds very plausible. But, again, it does not exactly square with reports I have heard from one or two major cassette-machine manufacturers (and proponents of chromium dioxide) to the effect that head wear is a factor in machines returned for servicing—one that has encouraged periodic investigations into new head materials. This wear, I should say, was not attributed only to CrO₂, but was said to be brought on by almost any tape a consumer might use.

Metal tapes. In late spring of this year, 3M/Scotch announced its intention to market a cassette tape employing a pure metal magnetic particle (as compared to the traditional metal-oxide one). This did not come as a complete surprise; research into pure metal tapes on the part of several tape manufacturers has been an open secret for years. The big question has been which manufacturer will be first. According to BASF, the introductions from the leaders (principally 3M, TDK, Philips, and BASF) will occur almost simultaneously. But it appears that all metal tapes will not be the same.

Metal tapes have the potential for vastly increased MOL's at all audio frequencies. An improvement of 10 dB

across the frequency board has been suggested as a reasonable expectation. In general, these tapes also involve a much higher coercive force than currently available products, and this will call for a greatly increased bias current in the tape heads used for recording.

It's typically the case with magnetic tape that a manufacturer has some choice as to where he will take his dynamic-range benefits. BASF says that, in the light of the data presented in Fig. 1, it will design its metal tape to concentrate on increased high frequency dynamic range, leaving the longer-wavelength capacity pretty much as it now stands with present-day tapes. But high-frequency dynamic range is foreseen, at 1 7/8 ips, to virtually equal that of the professional tape of Fig. 1 at 15 ips—a breathtaking prospect!

The heavy bias requirements of metal tape has been a worry to its developers; heads that will not saturate magnetically or even overheat under these conditions are not easy to come by. BASF's answer to this is the Sendust-alloy head introduced by JVC last year. From all reports, the Sendust head exhibits remarkable linearity over a wide dynamic range, which is exactly what is needed. But it is also said by some to be troublesomely nonlinear at very low signal levels. Possibly the metal-tape application with its high bias currents is able to get around this problem. Certainly BASF does not admit to encountering any such difficulty. Again, only time will tell.

Fig. 2. Head wear vs. running time for BASF CrO₂ cassette and ferric CrO₂ "substitute."

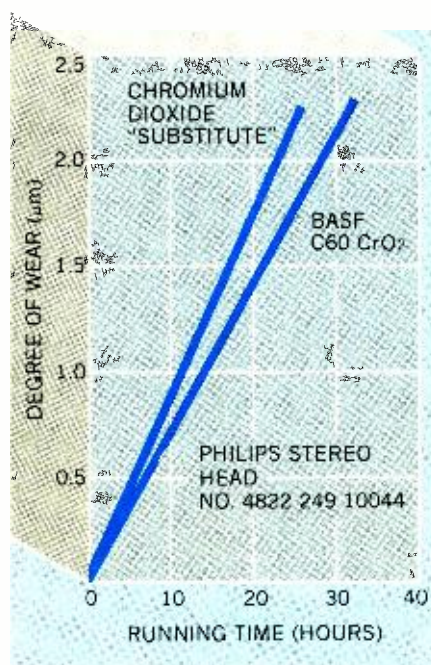

On to Video. Although details are still a little sketchy, BASF is reportedly testing prototype versions of a videotape camera that will be able to compete in all physical respects with current photographic motion-picture cameras, while adding the capability of "instant playback." The camera records the tape linearly (as opposed to a helical-scan system). One end of the 8-millimeter tape enclosed within the tape cartridge is withdrawn and fed into the camera's mechanism at a rate of 120 ips. When the tape ends, the mechanism reverses almost instantaneously and begins laying down a parallel recorded track in the opposite direction. This forward-reverse process continues until more than forty-eight parallel tracks have been laid down on the tape.

The potential appeal of such a system, at least in the U.S. market, is an unknown quantity.

It's obvious that videotape cannot yet compete with photographic processes in terms of picture quality. Image resolution and color values will be comparable, at best, to what you can get from your TV set with the finest program material, which can be most satisfactory of course. Nor, as yet, is there any practical way to edit a videotape such as BASF is proposing. In addition, reports from this country indicate that most videotape users within the U.S. market use their equipment almost exclusively for off-the-air recording of TV broadcasts, for which a camera is unnecessary.

If the BASF playback equipment for these videotapes is attractively priced (as seems likely), and if the company is prepared for the hard grind of warming up and selling an uninitiated consumer-ship, success is certainly within reach. On the positive side, BASF expects its major opponent in this area to be Kodak, which is reported to be gearing up for a competing system with the help of its magnetic-products experts based in France. If Kodak is casting hungry glances at this market, and if Polaroid is beginning to become (as murmurs indicate) more than a little interested, a truly fine free-for-all could take place in very short order.

The Crystal Ball. There is, I believe, no way in which a handful of jet-lagged journalists could plumb all the mysteries of Europe and its attitudes toward and plans for the U.S. audio-video market. But they seem, as always, to be highly ambitious, although now tempered with a conservatism born of experience. ◇



Audio Reports

WHAT NEXT IN HIGH FIDELITY?

AT YEAR'S END, it is customary to make predictions of things to come. In the case of high-fidelity components, this calls for an exceptionally large, high-definition crystal ball, plus a willingness to speculate openly with little likelihood that one will be more accurate than random chance allows. I will nonetheless venture some guesses as to the direction of audio developments in the near future.

Firstly, let us identify the basic problem areas, in which genuine breakthroughs could make a significant improvement in sound quality:

(1) *Speaker Systems*. If there is anything in the controversial world of hi-fi on which almost everyone will agree, it is that the speaker system is the weakest link in the audio chain. (I say *almost* because I personally think that the recording itself, and the acoustic properties of the listening room, have as much to do with the realism of the final sound as any of the system components.)

Although the fundamental theory of the speaker system has been well-known for at least a half century, and there has been no lack of effort on the part of hundreds of talented engineers over the years, there have been remarkably few *really* new speaker developments for several decades. The "sameness" of most contemporary speaker systems, both in basic design and sound character, is perhaps their most striking feature. This is not really a bad thing, of course, since the plateau of sound quality on which the speaker industry finds itself is very high indeed, by comparison to only a few years ago.

On the other hand, no speaker system I have heard so far sounds identical to real, live music. True, in isolated cases, using specially prepared program material and with exceptional care in controlling the listening environment, it has been possible to do a remarkably accurate job of simulating a live music source. But this is very much the exception, so that you and I, in our homes, enjoy at best a pallid imitation of the "real thing," consoling ourselves with floor-shaking bass, sizzling highs, pin-point stereo directionality, and other hi-fi accoutrements that are notably lacking in much real music.

The problem, in a nutshell, is that no one really knows what a speaker system should do to produce "real" sound. There are as many theories as there are serious workers in the field, plus a goodly number of

fanciful notions from less qualified people. Perhaps one of these days someone will establish beyond a reasonable doubt what properties a speaker system must have to create a convincing illusion of reality (if, indeed, that is within the capability of the speaker at all). Once that has been determined, I have no doubt that speaker systems meeting those requirements will soon be forthcoming.

(2) *Phono Cartridges*. It is not surprising that the other electromechanical transducer in a typical audio system shares top billing with the speaker system in the lineup of hi-fi miscreants. Both are given impossible tasks to perform and then proceed to do their jobs with fantastic success.

One of the keys to successful phono cartridge performance is actually outside the cartridge itself. It is in the manner in which a specially shaped diamond stylus traces the undulations in a spiral groove pressed into a vinyl disc. It is mind-boggling to consider what the stylus goes through as it follows the groove modulation, gyrating through a full 360°, at rates up to 20,000 times per second (up to 45,000 times per second on discrete four-channel discs). Simply maintaining contact with the record is no small achievement for the stylus during its wild ride. Since any loss of contact with the groove walls produces some of the most unmistakable and unpleasant distortion in all of audio, anyone who ever listens to a record must appreciate how successfully the stylus fulfills its mission.

More is required for really accurate record reproduction, however. The stylus path must accurately duplicate the motion of the cutting stylus that made the original master disc. If the playback stylus ventures off in a different direction from time to time, even though still riding on the record, the result is distortion. Sad to say, this is the normal condition in record playing. The record is cut with a chisel-edged stylus, and played with one having rounded contact surfaces. There is no way for the latter to follow the exact path of the former. A closer approximation is possible when the contact radius of the playback stylus is made very small, approaching the fine edge of the cutting stylus. This was the rationale for the development of the widely used elliptical stylus shape. The Shibata and other special stylus designs, required for playing the ultrasonic frequencies on CD-4

discrete four-channel discs, offered even more promise for accurate tracing of stereo records. They are quite expensive, but several companies have announced cartridges with modified forms of these stylus shapes that give improved stereo performance without the full cost penalty of the CD-4 shape. (The Stanton Model 881S, reviewed this month, is a typical example.)

Since many records are "predistorted" to compensate in part for the tracing limitations of a conical stylus, it may well be that an extreme elliptical shape, or a modified CD-4 stylus shape, will produce more playback distortion than a simple conical stylus. Nevertheless, this distortion, unlike that from mistracking, is rarely disturbing, and the improved high-frequency performance of the special stylus shapes may often justify their use.

The next problem faced by the cartridge is transferring the stylus motion to its voltage generator. This is usually done through a stiff, light cantilever with the stylus at its free end. Many of the important differences between cartridges are in the design of this small, almost invisible part. The actual generating system (moving iron, moving coil, etc.) is the least important consideration, since there are really no significant differences, from the listener's standpoint, between any of the systems currently in use.

If you have guessed that major advances in record-playing technology are unlikely to appear in the near future, you are probably right. What is needed is probably a totally new system, such as one in which the information is sorted digitally on the disc, or a pickup that does not contact the record physically, such as one using a laser beam. Either of these offers at least the possibility of a major improvement in record-playing quality, in contrast to the rather subtle, usually marginal, improvements resulting from the many "new" cartridges that appear. I see little likelihood that either of these radical innovations will become a commercial reality in the near future, though.

(3) *Tape Recorders.* Like record players, today's tape decks do the impossible, seemingly with ease and at a relatively modest cost. (If you doubt that, take a good look at—and listen to—a modern cassette deck.) Cassette tapes have been responsible for much of this progress, and the pattern seems likely to continue for some time. The ferric powder tapes that have been under development by several manufacturers, and should soon be ready for the market, represent a greater advance beyond chromium-dioxide tape than the latter did beyond the ordinary ferric-oxide tapes of five years ago. I can conceive of high-quality cassette decks that will fully rival present-day open-reel decks in their headroom, noise, distortion, and frequency response characteristics. Perhaps this will not occur in 1978, but it is visible on the horizon.

Open-reel tape technology, as it applies to home use, really has no need of improvement. Smaller machines, like the Pioneer Model RT-707 tested this month, may help open-reel to keep its place in deluxe home music systems. We will certainly see digital tape recording grow in professional applications. (It is already available, though at a rather high price.) The possibility of making tape recordings with arbitrarily great dynamic range and arbitrarily low distortion

is too attractive to be ignored, however, and I have no doubt that eventually the advanced amateur recordist will be able to buy a digital tape recorder surpassing anything presently available. It is hardly likely that this will be a factor in the home market for a few years, however.

As for the Elcaset, I find my crystal ball rather uninformative. So far, there have been no signs of this new tape format's making any real inroads into the cassette or open-reel markets, or even carving out its own niche. We have to wait and see what happens.

(4) *The Electronic Components.* Without meaning to slight the efforts of the many engineers working on "new and improved" amplifiers, tuners, and receivers, we can hardly expect to see a substantive improvement in the sound qualities of these components. They are all so much better than the program material or the other parts of the hi-fi reproduction system that further reduction in distortion, of any kind, is a fruitless exercise. Of course, that will in no way hinder the development of new products, some of which may even have hitherto unimagined features. We fully expect to be impressed by them as they make their appearance, but we do not expect them to sound much different.

(5) *The Influence of Computers.* More accurately, this should be called the application of microprocessor technology to home entertainment products. This is a far larger field than can be covered here, spanning the range from digitally tuned, or programmed TV receivers and video games to the ADC Accutrac turntables and the new Sherwood Micro CPU 100 FM tuner. The latter two items are of special interest to us as audio enthusiasts. They represent early efforts to marry the memory and control abilities of a microprocessor to standard audio components.

As those who have followed audio developments should know, the Accutrac system allows the bands recorded on a phonograph record to be played in any sequence, according to a program entered into its digital memory. Using an optical sensing system in the cartridge, it counts the unrecorded spaces between bands as the motor-driven tonearm passes over the record. In its initial version, this was an expensive direct-drive record player, but the newest Accutrac model is half the price of the original. In addition to its track-selection ability, it can change records in either direction by transferring previously played discs from the platter to the stack on the spindle! Clearly, the possibilities of this technique are virtually limitless, and we can expect the price of such record players to drop appreciably as time goes on.

A somewhat similar concept is used by Optonica in one of its cassette decks to skip unwanted segments of recorded tapes. So far, it has not been carried to the same degree of refinement as the Accutrac record players, but there is no reason why it cannot be, and it probably will.

As for the Sherwood tuner, this \$2000 unit is far beyond the means of most audiophiles. Its computer memory controls the frequency synthesizer that tunes it, and can be programmed to display the call letters of any stations on any of its approximately 50 channels. Not many people will spend \$2000 for an FM tuner, no matter how fine its performance, merely

Tandy COMPUTERS

A DIVISION OF TANDY CORPORATION

ANNOUNCING

GRAND OPENING

MOST COMPLETE LINE OF MICROCOMPUTERS AND ACCESSORIES

PLACE YOUR ORDER TODAY — CALL TOLL-FREE — 800-433-1679



RADIO SHACK



SOUTHWEST TECHNICAL PRODUCTS



CPU's — Alpha Micro, ICOM, IMSAI, Polymorphics, Processor Technology, T.D.L., Vector Graphics, Equinox

“POPULAR BRANDS” CARRIED



DISCS — ICOM, Digital Systems, IMSAI, Microplis, North Star, Polymorphics, Processor Technology, Shugart, Smoke Signal, SWTP, Persci, Extensys



VIDEO BRAIN

TERMINALS — Beehive, Lear Siegler, SOROC, SWTP, Informer

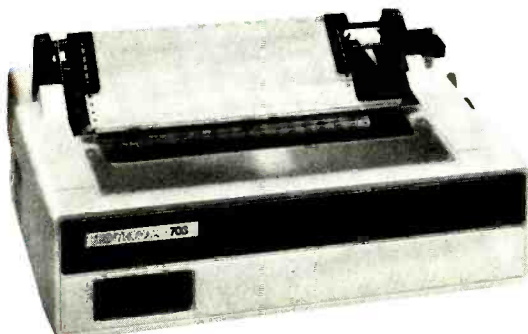

PRINTERS — Centronics, Okidata, Practical Automation, SWTP, Diablo, IMSAI

**Complete Line of Parts and Accessories!
Call for Special Prices! 800-433-1679**

Mail To: TANDY COMPUTERS
P.O. Box 2936, Fort Worth, Texas 76102

P12

*Please Send Me TANDY COMPUTERS
Full-Line 1978 Catalog*

PLEASE PRINT

Name _____ Apt. _____

Street _____

City _____ State _____ Zip _____

At CIE, you get electronics career training from specialists.

If you're interested in learning how to fix air conditioners, service cars or install heating systems – talk to some other school. But if you're serious about electronics, come to CIE – The Electronics Specialists.

John E. Cunningham

**Special Projects Director
Cleveland Institute of Electronics**

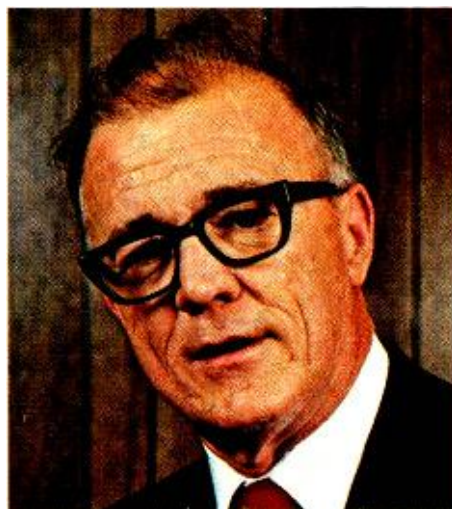

My father always told me that there were certain advantages to putting all your eggs in one basket. "John," he said, "learn to do one important thing better than anyone else, and you'll always be in demand."

I believe he was right. Today is the age of specialization. And I think that's a very good thing.

Consider doctors. You wouldn't expect your family doctor to perform open heart surgery or your dentist to set a broken bone, either. Would you?

For these things, you'd want a specialist. And you'd trust him. Because you'd know if he weren't any good, he'd be out of business.

Why trust your education and career future to anything less than a specialist?

You shouldn't. And you certainly don't have to.

FACT: CIE is the largest independent home study school in the world that specializes exclusively in electronics.

We have to be good at it because we put all our eggs in one basket: electronics. If we hadn't done a good job, we'd have closed our doors long ago.

Specialists aren't for everyone.

I'll tell it to you straight. If you think electronics would make a nice hobby, check with other schools.

But if you think you have the cool—and want the training it takes—to make sure that a sound blackout during a prime time TV show will be corrected in seconds—then answer this ad. You'll probably find CIE has a course that's just right for you!

At CIE, we combine theory and practice. You learn the best of both.

Learning electronics is a lot more than memorizing a laundry list of facts about circuits and transistors. Electronics is interesting because it's based on some fairly recent scientific discoveries. It's built on ideas. So, look for a program that starts with ideas—and builds on them.

That's what happens with CIE's Auto-Programmed® Lessons. Each lesson uses world-famous "programmed learning" methods to teach you important principles. You explore them, master them completely... before you start to apply them!

But beyond theory, some of our courses come fully equipped with the electronics gear to actually let you perform hundreds of checking, testing and analyzing projects.

In fact, depending on the course you take, you'll do most of the basic things professionals do every day—things like servicing a beauty of a Zenith color TV set... or studying a variety of screen display patterns with the help of a color bar generator.

Plus there's a professional quality oscilloscope you build and use to "see" and "read" the characteristic waveform patterns of electronic equipment.

You work with experienced specialists.

When you send us a completed lesson, you can be sure it will be reviewed and graded by a trained electronics instructor, backed by a team of technical specialists. If you need specialized help, you get it fast... in writing from the faculty specialists best qualified to handle your question.

People who have known us a long time, think of us as the "FCC License School."

We don't mind. We have a fine record of preparing people to take... and pass... the government-administered FCC License exams. In fact, in continuing surveys nearly 4 out of 5 of our graduates who take

the exams get their Licenses. You may already know that an FCC License is needed for some careers in electronics—and it can be a valuable credential anytime.

Find out more! Mail this card for your FREE CATALOG today!

If the card is gone, cut out and mail the coupon.

I'll send you a copy of CIE's FREE school catalog, along with a complete package of independent home study information.

For your convenience, I'll try to arrange for a CIE representative to contact you to answer any questions you may have.

Remember, if you are serious about learning electronics... or building upon your present skills, your best bet is to go with the electronics specialists—CIE. Mail the card or coupon today or write CIE (and mention the name and date of this magazine), 1776 East 17th Street, Cleveland, Ohio 44114.



Patterns shown on TV and oscilloscope screens are simulated.

CIE Cleveland Institute of Electronics, Inc.
1776 East 17th Street, Cleveland, Ohio 44114
Accredited Member National Home Study Council

YES... John, I want to learn from the specialists in electronics—CIE. Send me my FREE CIE school catalog—including details about troubleshooting courses—plus my FREE package of home study information. PE-48

Print Name _____

Address _____ Apt. _____

City _____

State _____ Zip _____

Age _____ Phone (area code) _____

Check box for G.I. Bill information: Veteran Active Duty

Mail today!

to get such a convenience feature, but the rate at which microprocessor prices are dropping makes it inevitable that this and other equally remarkable facilities will eventually be available at a fraction of their present prices.

Everyone is free to imagine the automatic control features he or she would like to see in a stereo receiver or any other home-entertainment audio device. It is a safe bet that anything you might envisage, and lots more, will ultimately be designed into audio components in almost all price brackets. These features may not make the system sound appreciably better, but they will certainly make it more fun for all of us to use!



PIONEER MODEL RT-707 BIDIRECTIONAL TAPE DECK

Moderately priced, open-reel machine features compact design and four tapeheads.

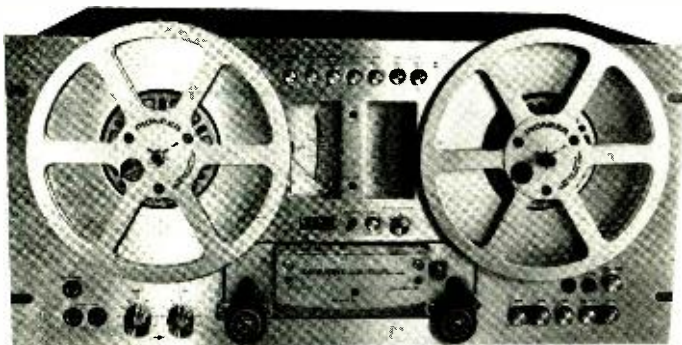

The new quarter-track, open-reel stereo tape deck from Pioneer, the Model RT-707, isn't much more

costly than a good-quality cassette deck, yet it offers playback capability in both directions of tape motion. The three-motor, solenoid-actuated transport contains four tape heads, three of which provide full erase, record, and playback capabilities in the forward direction. The fourth tape head is for playback only in the reverse direction. The direction of tape motion can be selected manually or automatically, the latter with conducting foil on the tape leader.

The deck measures 19"W × 14"D × 9"H (48 × 35.6 × 35.6 × 23 cm) and weighs 43.6 lb (19.8 kg). It accommodates 7" (17.8-cm) diameter tape reels. Nationally advertised value is \$575. (The deck is also available without the reverse-play capability as the Model RT-701 for \$525.)

General Description. The capstan is driven by a direct-drive ac servo motor similar to the motors used in deluxe record turntables. This eliminates the need for belts and pulleys in the transport drive mechanism. Each tape reel hub has its own six-pole induction motor.

An interesting feature of this tape deck is an "Auto-Repeat" system that

changes from reverse to forward play when the index counter returns to 0000 and the REPEAT button is engaged. Although this is not the same as the memory rewind used in some cassette decks (it operates only in the reverse-play mode, not in high-speed rewind), it and the foil sensing system allow a tape or any portion of it to be repeated indefinitely.

In spite of the deck's rather compact panel (which is slotted for rack mounting should one wish to do so), most of which is occupied by the tape reels, there is a full complement of controls. The controls are grouped for logical operation and good accessibility.

The tape is loaded in a straight line across the tape heads after two tension-

ing arms have been locked in their upward positions. Although there is a tension arm and a pinch roller on both sides of the head assembly, a single capstan drives the tape in both directions. Available speeds are 7½ and 3¾ ips (19 and 9.5 cm/s). The direct-drive motor changes speed and reverses direction of rotation almost instantly when the controls are operated.

Pushbutton switches located to the right of the head assembly control the transport mechanism through solenoid actuators. They include the usual forward and reverse high-speed functions, a PLAY button with separate REC (record) interlock button, and a STOP button. There are also a fast-acting PAUSE control and two tape direction selector buttons. The latter have illuminated arrows to indicate the direction of tape motion. (The deck can be controlled by a timer switch in the power line for unattended recording and playback.)

At the lower left of the panel are two microphone jacks and a stereo headphone jack. Near the jacks are MIC and LINE recording level controls, each a concentric pair for the two channels. The two sources can be mixed. Just above the tape heads are the reset button for the tape counter, REPEAT button, and a center-detented PITCH control that per-

Record/playback response with Scotch 206 tape using "LH" for bias in both cases and "LH" and "STD" for equalization.

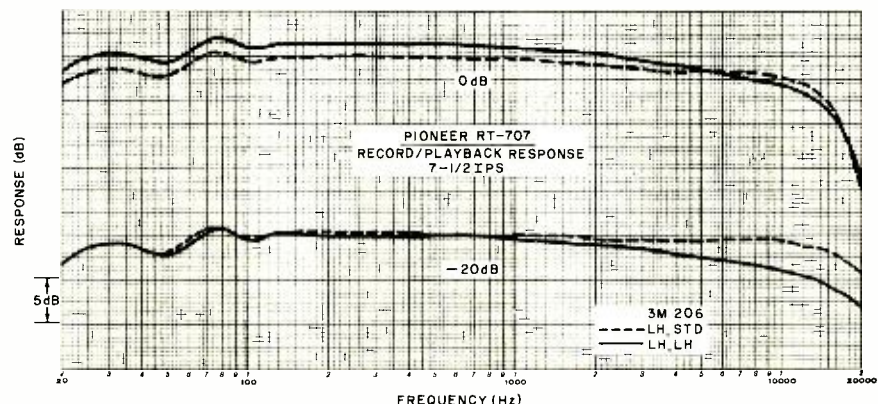

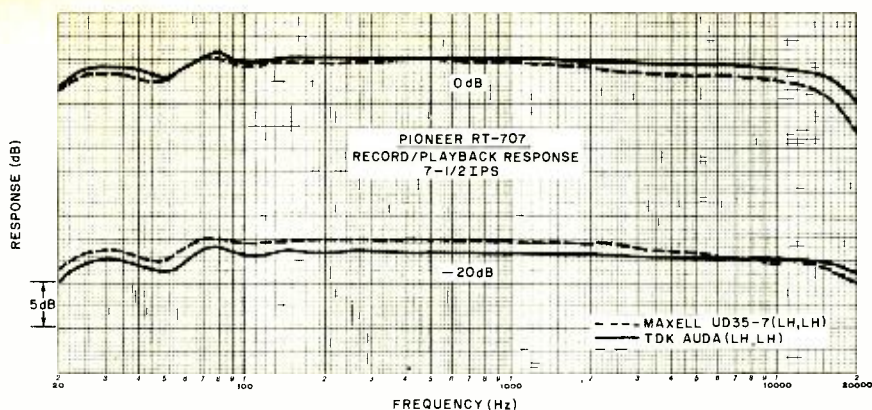

Record/playback response with TDK Audua and Maxell UD35-7 tapes with "LH" bias and equalization.

mits the speed of the capstan motor to be varied over a nominal $\pm 6\%$ range during playback only. Screwdriver access holes in the tape head cover make it easy to adjust the azimuth of the recording and two playback heads.

At the top of the panel, between the tape reels, are seven pushbutton switches. These control POWER, SPEED, TAPE/SOURCE monitoring, BIAS and EQ (equalization) with STD and LH positions, and REC MODE. There are two switches for the latter, and they must be engaged to record on either or both channels and make it possible to record on one channel while playing back on the other for special effects.

Below the buttons are two large illuminated level meters with vertically oriented scales. Between the meters are red REC and green PAUSE LED's.

On the rear panel of the deck are the line input and output jacks and two control shafts for setting the playback levels. Each control has a detented reference point. The controls allow adjustment of the playback output level above and below the reference points. There is also a single accessory ac outlet on the deck's rear panel.

The tape deck is supplied with a metal take-up reel, signal cables, head cleaning kit, splicing tape, and sensing tape.

Laboratory Measurements. Although the instruction manual supplied with the deck states that performance specifications are based on the use of Scotch 206 tape, our test deck had been set up for TDK Audua tape. Most of our test were made with both tapes, as well as other tapes of comparable quality. The differences between the tapes were not great.

A LINE input of 35 mV or a MIC input of 0.18 mV produced a 0-dB recording level at maximum gain. With the controls on the deck's rear panel set to their detented points, the playback outputs were 580 mV with the TDK and 450 mV with

the Scotch tapes. At the maximum control settings, these figures were 800 and 700 mV, respectively.

The playback frequency response, measured with the Ampex 31331-01 tape at $3\frac{3}{4}$ ips, was within ± 1.5 dB over the 50-to-7500-Hz range of the tape. The frequency response at $7\frac{1}{2}$ ips, using the Ampex 31321-04 tape, was within ± 0.5 dB from 50 to 5000 Hz in the forward direction. It rose to +2.5 dB at 15,000 Hz. In the reverse direction, the response was flatter and was within ± 0.5 dB from 50 to 15,000 Hz.

The instruction manual lists recommended settings for the recording BIAS and EQ switches for many types of tape. These were correct for TDK Audua tape. However, in the case of Scotch 206 tape, it was necessary for us to use the STD instead of the LH setting of the EQ switch to obtain the flattest response. (We assume "LH" means the "low-noise/high-output" term generally used for premium tape.) Using LH bias and equalization with TDK tape, the record/playback frequency response at $3\frac{3}{4}$ ips was down 4 dB at 30 and 14,000 Hz at a -20-dB recording level. At a 0-dB recording level, tape saturation reduced the high-frequency output to -4 dB at 10,000 Hz. At $7\frac{1}{2}$ ips, the -20-dB response was within ± 2 dB from 20 to 24,500 Hz, while at 0 dB, it was within ± 2 dB from 20 to 18,000 Hz.

When we used the Scotch tape with STD equalization, which applies a higher recording level at high frequencies, the $7\frac{1}{2}$ -ips frequency response at -20 dB was down 3 dB at 20 and 18,000 Hz and down 5 dB at 20,000 Hz. With LH bias and equalization, Maxell UD35-7 tape yielded roughly similar results. By a small margin, Memorex Quantum tape delivered the widest overall frequency response, within ± 1.5 dB from 20 to 23,000 Hz and ± 3 dB from 20 to 29,000 Hz. Impressive as these figures are, the audible differences between the various tapes were very slight.

At a 0-dB recording level and $7\frac{1}{2}$ -ips tape speed, the playback distortion was about 0.23% with Memorex and TDK tapes and 0.34% with Scotch tape. The reference 3% distortion level was reached with inputs of +14, +12, and +12 dB, respectively. The S/N ratios relative to these input levels were very similar for the tapes used during the tests, although the actual numbers depended on the weighting curve used for the measurements. By a very small margin, Scotch 206 tape gave the best overall S/N performance, measuring 65 dB unweighted, 69.5 dB with IEC A weighting, and 66.7 dB with CCIR weighting. This is very substantially better than the manufacturer's 58-dB spec. At $3\frac{3}{4}$ ips, each of these figures was down by about 3 dB. Through the microphone input and at maximum gain, the S/N was down 8 dB, but at normal gain settings, there was negligible degradation of noise performance on microphones.

The unweighted rms flutter was 0.08% at $3\frac{3}{4}$ ips and 0.065% at $7\frac{1}{2}$ ips in a combined record/playback measurement. The wow was less than the 0.01% residual of our test tape. Using Ampex flutter test tapes, the flutter in the forward direction was 0.09% at both speeds. In the reverse direction, when the capstan was on the "supply" reel side of the heads, it was 0.17% and 0.12% at $3\frac{3}{4}$ and $7\frac{1}{2}$ ips, respectively.

The playback speed was exactly the same as the recording speed when the PITCH control knob was centered. The full vernier control range was from +9.2% to -7.6%, which is even wider than the semitone range claimed. In fast forward, the transport moved 1800' (550 m) of tape from end to end in 89 seconds. In rewind, it required 102 seconds.

The meters were calibrated so that 0 dB corresponded to a recorded flux level of approximately 180 nWb/m (nanowebers/meter). The ballistic response of the meters was slightly slower than VU standards. The meters indicated 90% of steady state on 0.3-second tone bursts. The fixed headphone level was fairly good, using 200-ohm phones.

User Comment. The electrical performance of the Model RT-707 is typical of moderately priced open-reel tape decks. At $7\frac{1}{2}$ ips, the headroom of the deck over the entire audio range is adequate for high-quality live recording without the compression that limits the successful use of cassette recorders for the same purpose. The $3\frac{3}{4}$ -ips performance of this deck is comparable to that of a medium-priced cassette deck.

Although the very complete and informative instruction manual suggests BIAS and EQ switch settings for a number of tapes, it wisely adds that different settings should be tried if the sound is not to the user's liking. We recommend beginning with the suggested settings and recording interstation hiss from an FM tuner at a fairly low level of -10 dB or so. With the monitor button, alternately listen to the incoming signal and the play-

back from the tape. At its optimum settings, the tape deck is capable of virtually perfect recording and playback of this very demanding test signal. If there is any appreciable difference between the input and output, try other switch settings to determine the best operating conditions for a given tape.

Ease of installation of the Model RT-707 is a key factor in the appeal of this deck, as compared to many other

open-reel tape recorders and decks. With cassette decks becoming larger and Elcaset decks larger still, the surprisingly compact Model RT-707 comes into direct competition with these tape formats insofar as size is concerned. The Model RT-707 is easy to use, requires no critical adjustments, and proves that open-reel tape is still a part of the consumer hi-fi scene.

CIRCLE NO 101 ON FREE INFORMATION CARD

PHASE LINEAR MODEL 5000 FM TUNER

Built-in expander increases dynamic range of program material.

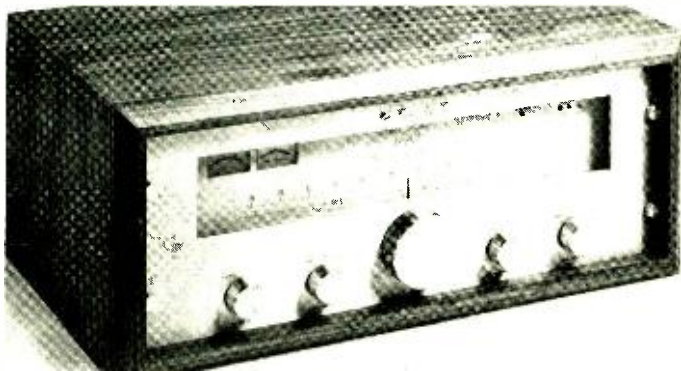

Some years ago, Phase Linear began to introduce audio components that had some then unique

noise-reduction and dynamic-range restoration systems. The first was a pre-amplifier, which was followed by an add-on accessory that could be used with just about any amplifier or receiver. The recently introduced Model 5000 FM tuner follows in this tradition, featuring its own unique noise-reduction and dynamics restoration system.

The Model 5000 is obviously styled as a companion to Phase Linear's Model 4000 preamplifier and Model 400 basic power amplifier, sharing the same front panel size and finish. Although its 19"W x 7"H (48.3 x 17.8 cm) panel is larger than would be expected on an FM tuner, the 10" (25.4-cm) depth allows for easy mounting on shallow shelves and in shallow cabinets. In spite of its size, the tuner weighs only 17 lb (7.7 kg). Its nationally advertised value is \$500.

General Description. Phase Linear did not supply a schematic diagram or even a description of the circuits in the tuner. However, a block diagram in the user's manual that accompanies the tuner indicates the use of a phase-locked-loop (PLL) multiplex decoder and an IC that combines the i-f amplifier, lim-

iter, and quadrature detector circuits on a single chip.

As befits a tuner with an oversized front panel, the Model 5000 has one of the longest dial scales we have ever seen. It measures some 10¼" (26 cm) of calibrated scale in all. Its frequencies are marked at the 200-kHz intervals used in the U.S., with the short lines at only the odd-value frequencies. Presumably, the dial pointer will be directly aligned with one of the marks whenever a station is tuned. There are also a longer accented line at every megahertz interval and a numerical calibration at 2-MHz intervals.

The tuning scale is on a satin-gold

subpanel that matches the finish of the main panel. A large glass window covers the dial, tuning meters, and a four-LED display. The meters indicate relative signal strength and center-channel tuning. One of the LED's is used to indicate STEREO reception, while the other three LED's are used as a multipath indicator. The ZERO LED in the multipath indicator system glows when there is negligible multipath distortion on the signal. The MAX LED comes on when severe multipath distortion is experienced. Obviously, the center LED in the display comes on to indicate multipath conditions between the two limits.

The tuning knob operates a smooth flywheel mechanism. Its 2¼" (5.7-cm) diameter is quite large. This knob is centered below the dial window on the front panel. Flanking it are four smaller knobs labelled POWER, EXPANDER, MUTING (threshold), and STEREO/MONO MODE.

The unique EXPANDER feature is designed to complement, as much as possible, the compressor characteristics used in FM broadcasting to restore some of the lost dynamics of the program. (FM stations typically apply some degree of compression or peak limiting to prevent excessive deviation while retaining a reasonably high average signal

Noise and sensitivity curves for FM section of tuner.

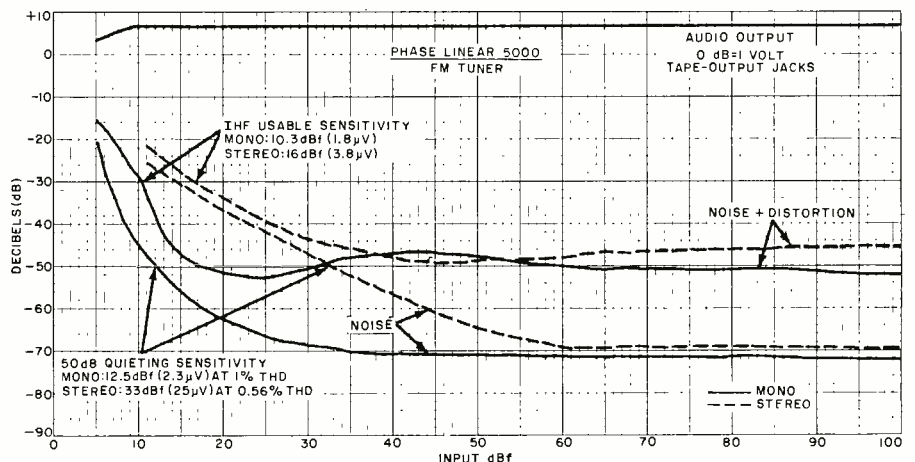

modulation level.) In addition to OFF, the EXPANDER switch has settings for 4 and 9 dB of expansion.

The rear apron of the tuner has two sets of audio outputs. One is at a nominal 2-volt fixed level and the other is adjustable from 2 volts down, the latter via a pair of small knob controls positioned just below the output jacks. The fixed outputs are meant to be used for off-the-air tape recording.

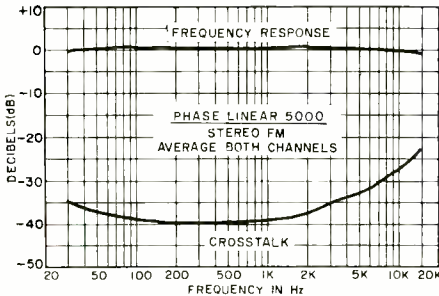

Frequency and crosstalk averaged for both channels.

Two slide switches, one to dim the illumination of the tuning dial and the other to permit selection of either 75 or 25 μ s deemphasis (25 μ s is required when using an external Dolby noise reduction adapter), are also on the rear apron. Other items on the rear apron include antenna terminals for 300- and 75-ohm antennas and a coaxial connector for 75-ohm antennas.

Laboratory Measurements. The IHF sensitivity of the tuner measured 10.3 dBf (1.8 μ V) in mono and 16 dBf (3.8 μ V) in stereo. The 50-dB quieting sensitivity measured 12.5 dBf (2.3 μ V) and 33 dBf (25 μ V) in mono and stereo, respectively. All the measured sensitivities were better than the tuner's rated performance by a comfortable margin.

The output signal-to-noise (S/N) ratio of the tuner with a 65-dBf (1000- μ V) input was 71.5 dB in mono and 69 dB in stereo, which is also better than rated. The only specification the tuner failed wholly to meet was that of distortion, which is rated at 0.2% in mono and 0.3% in stereo. Within the normal tuning conditions indicated on the center-channel meter, the lowest distortion was 0.3% in mono and 0.48% in stereo, at a 65-dBf input. By tuning outside the center area of the meter scale (which also caused the multipath lights to glow), the distortion could be reduced to between 0.1% and 0.2%, but this is obviously not a normal operating condition for this or any other tuner.

The stereo performance of the tuner

was good. Its frequency response was within 1 dB overall from 30 to 15,000 Hz. Channel separation was 38 to 40 dB through much of the audible range and was a good 34.5 dB at 30 Hz and 23 dB at 15,000 Hz. The 19-kHz pilot carrier was 70 dB down in the audio outputs. The stereo distortion, with L - R modulation, was 0.7% at 100 Hz, 0.4% at 1000 Hz, and 0.08% at 6000 Hz. Tuner hum was a very low -76 dB.

The stereo switching threshold was at about 9 dBf (1.5 μ V). The muting threshold could be adjusted to any value up to 42 dBf (70 μ V). The capture ratio was outstandingly low: about 1 dB at 45 dBf (100 μ V) and 0.8 dB at 65 dBf. AM rejection was no more than fair (50 dB) at 45 dBf, but it improved to a good 64 dB at 65 dBf. Image rejection, specified as 110 dB (the limit of our test facility), was obviously greater than that, since we could find no trace of an image response. The alternate-channel selectivity was 55 dB above the signal frequency and 67 dB below it, for an average of 61 dB. Adjacent channel selectivity was 4.9 dB.

We judged the expander and multipath indicator features by listening, since conventional measurements are not practical with such features.

User Comment. In general, the "handling" properties of the tuner were excellent. The tuning mechanism was silky smooth, and the muting action was free of noise bursts when passing through a signal. The multipath indicators were disappointing, however, since at no time did they indicate multipath distortion on any of the 50 or so stations receivable at our test location. (Past experience with oscilloscope multipath indicators has shown us that many of these stations have severe multipath distortion and most have some.)

Although a highly resolved dial is used on the Phase Linear 5000, the dial on our test sample indicated about 100 kHz higher than the station frequency. Such an error on most tuners would rightly be considered negligible, since the pointer width itself often corresponds to 200 kHz or so. This was probably due to an improperly set pointer, or to a shift of pointer position during shipment, narrowly preventing our sample from being the most accurate nondigital tuner (in respect to frequency calibration) that we have seen.

The minuscule discrepancies between the distortion measurements we obtained and the published figures probably indicate a misalignment in the tuner

trigger fast soldering action

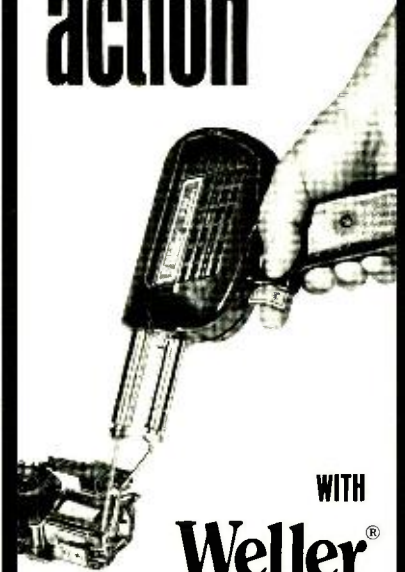

WITH
Weller[®]

COMFORT-GRIP GUNS

Dual-action trigger permits instant choice of 2 heats in all Weller's professional quality guns, the most comfortable, best-balanced units anywhere. Pre-focused light for hard-to-see work areas like TV or under-dash auto service. Premium copper tips get up to temp faster... pre-tinned for instant soldering. Cutting or smoothing tips also, UL-listed and factory pre-tested. Models for any service including solid state. Guns alone or kits with case, spare tips, and accessories.

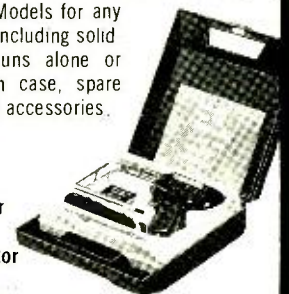

Ask your
local
distributor
or write

**Weller-Xcelite
Electronics Division**



The Cooper Group

P. O. BOX 728,
APEX, NORTH CAROLINA 27502

CIRCLE NO. 67 ON FREE INFORMATION CARD

circuits. In any event, they make no difference to the human ear. Furthermore, measurements were less than the distortions inherent in FM programs. Although they prevent us from classifying the Model 4000 as a "super tuner," another sample might earn this name.

The expander circuit proved to be effective and worthwhile. In the 4-dB setting, it raises the average and high-level modulation quite audibly, but does not appear to affect the low-level program or the background noise. The 9-dB setting appears to provide no further increase in audio level. At first, we thought the expander was not functioning properly. However, during quiet moments in the program, when we switched from 4 to 9 dB, there was a definite drop in the audi-

ble background noise level. Presumably, this drop of nominally 5 dB, combined with the expansion boost of 4 dB yields an added 9 dB of dynamic range in reception. There was no audible sign of the expander's operation, such as noise "swishes," and we preferred to listen with the full 9-dB expansion.

Phase Linear does state that the operating characteristics of the Model 5000's expander are optimized for FM reception conditions, and that it should not be used with any other type of expander, such as the Peak Unlimiter and Downward Expander in the company's Model 4000 preamplifier. Although this might appear to add redundancy to a system made up entirely of Phase Linear units, it really adds versatility, since the other

signal processing circuits are optimized for disc recording conditions.

In sum, the principal *special* attraction of the Model 5000 is its expander. As we have said, this works very well indeed. In other respects, the Model 5000 is not significantly different (neither better or worse) than a number of good, not inexpensive FM tuners on today's market. If the expander seems like a trivial feature (it is not), remember that much of Phase Linear's reputation has been based on the ability of its signal-processing devices to make an existing signal sound *better*, instead of merely to pass the signal through without any degradation of its quality. This is precisely what the Model 5000 can do.

CIRCLE NO 102 ON FREE INFORMATION CARD

STANTON MODEL 881S PHONO CARTRIDGE

New Stanton transducer merits its top-of-line position.



Stanton's whole stereo cartridge line has for some time been headed by the company's "Calibration

Standard" models. These phono cartridges are designed to give flat frequency response, wide channel separation, and low distortion, while remaining rugged enough to be used in professional recording and broadcast studios. The 881 series cartridges were Stanton's Calibration Standards until the recent announcement of the new Model 881S cartridge.

Although the Model 881S physically resembles other cartridges in the Stanton line, even to including a hinged dust brush as part of the removable stylus assembly (to remove surface dust from the record), it is a totally redesigned product. For example, instead of the moving-iron transducer principle used in other Stanton cartridges, the Model 881S employs a moving-magnet principle. Although its stylus is physically interchangeable with some of the company's other products, it will operate properly only in the 881S body.

Each Model 881S cartridge is supplied with calibration data (not a curve) that shows the variation in response over the audio frequency range, the output voltage, and the inductance and resistance of its coils. A small metal "pill box" is provided, for storing extra styli. (As with other Stanton cartridges, 1- and 2.7-mil styli are available for using the Model 881S to play mono LP and 78-rpm discs.) Nationally advertised value is \$150.

General Description. The stylus cantilever carries a tiny magnet formed from a rare-earth metal. The magnet is said to be 10 times stronger than conventional magnets of the same size. Because of the extra energy provided by the magnet, the coils of the Model 881S cartridge have fewer turns and lower inductance than those used in other model cartridges. This makes the Model 881S less sensitive to the effects of loading capacitance, which can have a

considerable effect on the high-frequency response of most phono cartridges. At the same time, the output voltage of the new cartridge is maintained at a high level (nominally 0.9 mV/cm/s).

At the other end of the stylus cantilever is a nude diamond "Stereohedron" stylus, the design of which is derived from the special styli developed for playing CD-4 discs. The Stereohedron has a greater contact area along the sides of the record groove than an elliptical stylus. This reduces record wear while providing superior high-frequency tracking ability.

The effective mass of the stylus system is rated at only 0.2 milligram. The rated tracking force is 1 gram ± 0.25 gram. As with other brush-equipped Stanton cartridges, the Model 881S must be operated at a 1-gram greater downward force to overcome the upward force of the brush and bring the stylus into contact with the record. In a typical installation, the tonearm would

Left and right response and crosstalk using CBS STR100 record.

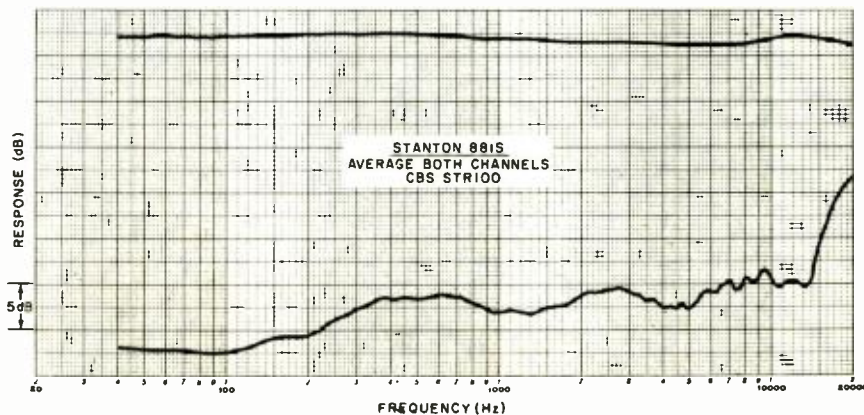

Chances are, someone you know just bought a professional 3½ digit DMM kit for less than \$70.



Thousands of people have already bought the Sabtronics Model 2000 . . . for two main reasons. First, its incredible accuracy, range and professional features. And second, the incredibly low price of \$69.95.

People everywhere appreciate this bench/portable multi-meter. They depend on its basic DCV accuracy of 0.1% ± 1 digit, its readings to ±1999 and its five functions giving 28 ranges, overload protection and 100% overrange

The 2000 is automatically appealing to hobbyist and professional alike. With automatic overrange indication, automatic polarity, even automatic zeroing.

Best of all, it's easy to assemble. All the parts you'll need, including the high-impact case, come right along with the clear, step-by-step instructions.

The result is a professional quality 3½ digit DMM that you could have paid a lot more than \$69.95 for possibly receiving a lot less. But this one's from Sabtronics, specialists in digital technology.

Maybe you should order yours before you turn the page.



Made in U.S.A.

sabtronics

INTERNATIONAL INC.

P.O. Box 64683 Dallas, Texas 75206 (214) 369-7310

GUARANTEE:

Our guarantee to you; examine the 2000 DMM kit for 10 days. If you're not satisfied, return it unassembled for a full refund of purchase price.

SPECIFICATIONS:

DC volts in 5 ranges. 100µV to 1000V
 AC volts in 5 ranges. 100µV to 1000V
 DC current in 6 ranges. 100nA to 2A
 AC current in 6 ranges: 100nA to 2A
 Resistance: 0.1Ω to 20MΩ in 6 ranges
 AC frequency response: 40Hz to 50KHz
 9mm (.36") LED display
 Input impedance: 10MΩ
 Size: 8"W x 6.5"D x 3"H
 (203W x 165D x 76H mm)

Power requirements: 4 "C" cells (not included)

To: Sabtronics International, Inc. P.O. Box 64683, Dallas, TX 75206	PE-12
Please send me _____ Sabtronics Model 2000 DMM kit(s) at \$69.95 each.	_____ subtotal
Shipping and handling, \$5.00 per unit* _____	_____ subtotal
Texas Residents Add Sales Tax _____	
TOTAL enclosed _____	
Name _____	
Street Address _____	
City _____	
State _____ Zip _____	
*USA only Canada \$6.50. All other countries, \$10.00 (surface mail)	

Popular Electronics

Reprint series

Many important articles covering a variety of interests in the broad field of electronics are published in POPULAR ELECTRONICS. Reprints of selected articles and test reports are now available in the event that you missed some you would like to have for reference or study purposes—or for projects you wish to build. Reprints in this series are only \$1 each (*75¢ for those marked with an asterisk.) Minimum order is \$2.

SPECIAL ARTICLES

AUDIO

1. How The New FTC Hi-Fi Rules Affect You
2. How To Evaluate Tape Recording Specs
3. A New Standard For FM Tuner Measurements

COMPUTER

7. How To Select A Microcomputer
 8. Ins & Outs Of Computers For Beginners
- COSMAC "ELF" SERIES (Reprint #'s 4, 5, 6, & 17)
4. Low Cost Experimenter's Microcomputer
 5. Experimenter's Microcomputer/With Hardware Improvements & More Programming Details
 6. Microcomputer/How To Expand Memory, Plus More Programs
 17. Build The Pixie Graphic Display

CB RADIO

9. CB Specifications Made Easy
10. How To Choose CB Base Station Antennas

OTHER

14. How To Design Your Own Power Supplies
 15. The Care & Feeding Of NiCd Batteries
 16. Build A Gas & Fume Detector
- LEARNING ELECTRONIC THEORY WITH CALCULATORS SERIES (Reprint #'s 11, 12, & 13)
11. Basic Equations and OHM's Law
 12. Reactance, Time Constants And AC Calculations
 13. RC Coupling, Basic Amplifier Calculations, and RLC Relationship

TEST REPORTS

AUDIO

18. ADC Accutrac 4000 Record Player
- 19.* Empire Model 698 Manual Turntable
20. Kenwood Model 600 Integrated Stereo Amplifier
- 21.* MXR Stereo Graphic Equalizer

- 22.* Nakamichi Model 500 Stereo Cassette Deck
23. Onkyo Model TX-4500 AM/Stereo FM Receiver
- 24.* Ortofon MC20 Moving Coil Phono Cartridge
- 25.* Pickering Model XV-15/625E Stereo Phono Cartridge
26. Pioneer Model CT-F8282 Stereo Cassette Deck
27. Radio Shack "Realistic" Model STA-2000 AM/Stereo FM Receiver
28. Rotel RX-7707 AM/ Stereo FM Receiver
29. Sansui Model TU-9900 AM/Stereo FM Tuner
- 30.* Shure Model M24H Stereo Phono Cartridge
- 31.* Sony Model TA-4650 V-FET Stereo Power Amplifier
- 32.* Spectro Acoustics Model 210 Stereo Graphic Equalizer
- 33.* Stanton Model 681EEE Stereo Phono Cartridge
34. Teac Model PC-10 Portable Stereo Cassette Deck
- 35.* Technics Model SB-6000A Linear Phase Speaker System
- 36.* Thorens Model TD-126C Record Player

COMMUNICATIONS

- 37.* Cobra Model 29XLR 40-Ch. AM CB Mobile Transceiver
- 38.* Drake Model SSR-1 AM/SSB Communications Receiver
- 39.* Kenwood Model TS-820 Amateur Radio Transceiver
- 40.* Kris Model XL-50 40-Ch. AM CB Mobile Transceiver
- 41.* President Model "Washington" 40-Ch. AM/SSB CB Base Station
42. Yaesu Model FRG-7 AM/SSB Communications Receiver

TEST INSTRUMENTS

- 43.* B&K-Precision Model 280 Digital Multimeter
- 44.* B&K-Precision Model 1471B Dual-Trace Scope
- 45.* Ballantine Model 1010A Dual-Trace Scope
- 46.* Fluke Model 8020A Digital Multimeter
- 47.* Hewlett-Packard Model 280 Digital Multimeter
- 48.* Sencore Model DVM-32 Digital Multimeter
- 49.* Sencore Model TF-70 Portable Transistor Tester
- 50.* Triplet Model 60 Analog Multimeter

*REPRINTS MARKED WITH ASTERISK 75¢; ALL OTHERS \$1.00. MINIMUM ORDER \$2.00.

Popular Electronics Information Center, Consumer Products Division, 595 Broadway, New York, N.Y. 10012.

Please send the reprints listed below:
75¢ Each

Reprint #	Quan.	Reprint #	Quan.

\$1.00 Each

Reprint #	Quan.	Reprint #	Quan.

NUMBER OF REPRINTS ORDERED:
@ 75¢ _____ @ \$1.00 _____

TOTAL ENCLOSED \$ _____
(MINIMUM ORDER \$2.00)

Print Name _____
Address _____
City _____
State _____ Zip _____
†Residents of CA, CO, FL, IL, MI, MO, NY STATE, DC and TX add applicable sales tax. Outside U.S.A. add \$1.00 per order.

PE-127

Understanding more about music... can be as easy as listening to your favorite recordings

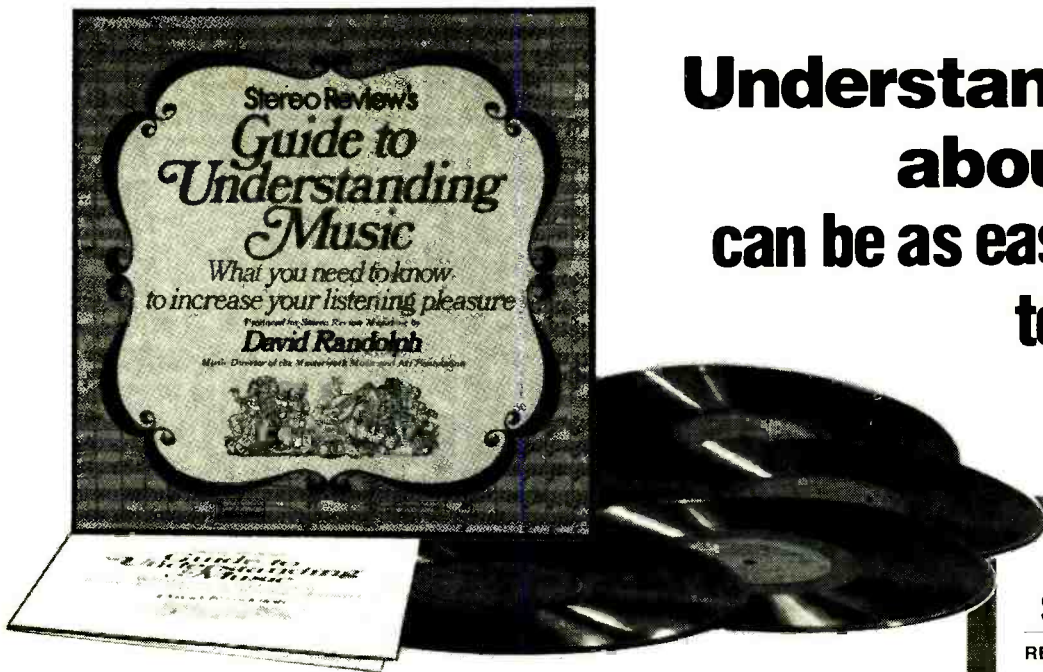

An important set of recordings created to help you expand your understanding of music

This unique four-disc album is interesting, easy to comprehend, and instructive. It is the first project of its kind to approach the understanding of music through its basic elements:

rhythm... melody... harmony... texture

If you have wanted to know more about music—or simply to *enjoy* it more—Stereo Review's GUIDE TO UNDERSTANDING MUSIC will be the most rewarding step you can take in that direction.

Written and narrated exclusively for Stereo Review by David Randolph, Music Director of the Masterwork Music and Art Foundation, this fascinating set of stereo records will help you become a more sophisticated, more knowledgeable listener—and a more completely satisfied one as well. It will give you an "ear for music" you never thought you had.

In the GUIDE TO UNDERSTANDING MUSIC, David Randolph first discusses, by means of recorded narration, how the composer uses and unifies all the basic musical elements. After each musical point is made in the narration, a musical *demonstration* of the point under discussion is provided. Thus you become a part of the creative musical process by listening, by understanding, by seeing how music's "raw materials" are employed by composers and performers to attain their highest level of expressivity and communication through *musical form*.

FOUR STEREO RECORDS

RECORD I

The Elements of Music
1. Rhythm 3. Harmony
2. Melody 4. Texture

RECORD II

Sense and Sensation in Music
(The Instruments of the Orchestra)—How Music Is Unified

RECORD III

Form in Music — Words and Music

RECORD IV

Can Music Tell a Story or Paint a Picture?—The Interpretation of Music

Over 200 Musical examples

which have been carefully chosen from among thousands of recordings by major record companies as the best illustrations of musical points made in the recorded narration. In addition, supplementary musical demonstrations were specially recorded for this album.

Booklet enclosed

The accompanying booklet is a valuable complement to the album. It presents David Randolph's straightforward professional approach to music, and shares the insights and understanding of his many years of experience in bringing music to listeners—as well as advice on how you can make the best use of the album.

If you already have some knowledge of music, the *Guide to Understanding Music* can expand and enrich that knowledge. If you've always wanted to understand music but have been discouraged because it looked too difficult and time-consuming, the *Guide to Understanding Music* can show you how easily and quickly you can make yourself at home with any music.

Charge your order to



This exclusive four-disc recording is just . . .

\$21.98 Postpaid

for all four 33 1/3 rpm stereo long-play records, a price made possible by the availability of the consultative and production facilities of Stereo Review and its staff. Under ordinary auspices, a work of this nature and importance would cost much more.

GUM, CONSUMER PRODUCTS DIVISION, 595 Broadway, New York, N.Y. 10012

Please send Guide To Understanding Music @ \$21.95, postpaid (\$26.98 outside U.S.A.)

Enclosed is \$ _____ Residents of CA, CO, FL, IL, MI, MO, NY STATE, DC AND TX add applicable sales tax

CHARGE:

American Express Master Charge
 BankAmericard Diners Club

Print Name _____

Address _____

Signature _____

City _____

Account # _____

State _____

Exp. Date _____

Zip _____

Master Charge Interbank # (4 #'s over your name) _____

be set for an indicated 2-gram downward force to yield a 1-gram force in operation. If desired, the brush can be removed, in which case, the force adjustment is performed as with any cartridge.

Laboratory Measurements. The Model 881S phono cartridge was tested in the tonearm of a typical medium-priced record player. We loaded the cartridge with 47,000 ohms in parallel with 290 pF of capacitance. (Rated nominally at 275 pF.)

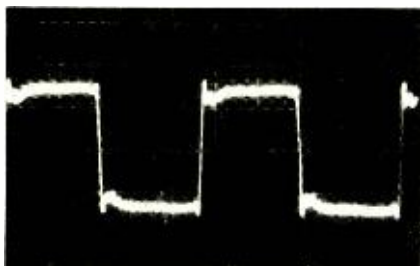

Square-wave response using CBS STR112 test record.

The standard level bands of the CBS STR100 record (3.54 cm/s at 1000 Hz) produced an output of 4.3 mV from one channel, and 4.7 mV from the other. The channel unbalance of 0.8 dB was well within Stanton's 1 dB tolerance. The vertical tracking angle of the stylus was 22°. Preliminary tracking tests revealed that the cartridge was well above average in this respect. The 30 cm/s, 1000-Hz tones on the Fairchild 101 record were playable at a tracking force of only 0.5 grams. There was some distortion, in the form of peak clipping, but this was not improved by higher forces. This indicates that the recorded amplitude was beyond the design limits of the cartridge.

At 32 Hz, the very high levels of the Cook Series 60 record were played at 0.4 gram, suggesting the very high compliance of the cartridge's stylus system. Finally, the 300-Hz tones of the German Hi Fi Institute record could be played through the 80-micron level at 0.5 gram and through the maximum level of 100 microns at 0.75 gram.

The cartridge produced a frequency response that was flat within ± 1 dB from 40 to 20,000 Hz. Cutting the load capacitance in half had a negligible effect on the overall response. Increasing it to more than 500 pF produced a slight peak at 10,000 Hz and a drop in output at higher frequencies. However, the overall ± 2.5 -dB variation from 40 to 20,000 Hz was still very good. Clearly, the cartridge is not dependent on a critical load impedance for its fine frequency response.

The channel separation was between

20 and 35 dB over the full frequency range from 40 to 20,000 Hz. The low-frequency response in the record player's tonearm was at 8 Hz, with an amplitude of about 10 dB. The square-wave response from the CBS STR112 record was excellent, with only a slight overshoot and negligible ringing.

We measured the tracking distortion of the cartridge with the Shure TTR-102 test record for IM distortion and the Shure TTR-103 record for high-frequency tracking of shaped 10.8-kHz tone bursts. At the rated 1-gram force, the IM distortion was about 2% at lower velocities (7 cm/s) and only 5% at the maximum of 27.1 cm/s. Most cartridges begin to exhibit severe mistracking at the highest levels on this record, especially near the lower part of their tracking force range, but the Model 881S never mistracked. On the 10.8-kHz tone bursts, the repetition-rated distortion was about the same as we have measured on many other good cartridges.

For a subjective judgment of the tracking ability of the cartridge, we played the Shure "Audio Obstacle Course-Era III" record. In this test, the cartridge lived up to expectations, tracking all levels of all selections on the record without audible mistracking at its minimum rated force of 0.75 gram (except the highest level of a bass drum, which required 1 gram).

User Comment. For extended listening tests, we installed the cartridge in the tonearm of a Dual Model 701 record player and operated it at 0.75 gram. We never sensed any strain or incipient mistracking at this force.

The brush was removed at one point in our evaluation and rather than risk damaging the stylus to replace it, we left it off for the remainder of the evaluation.

This is one of the most neutral and uncolored cartridges we have listened to. It sounds as flat as its frequency response curve implies and has an impressive freedom from audible tracking distortions of any kind. It provided a revelation when listening to some of our older, well-worn discs, providing a freshness in their sound that we had not suspected was there. It is quite probable that this was due, at least in part, to the Stereohedron stylus, which rides lower in the groove than a conical or elliptical stylus and thus contacts a portion of the groove modulation that has not previously been damaged by stylus contact. Whatever the explanation, we feel that the Model 881S merits its place at the top of the Stanton line.

CIRCLE NO. 105 ON FREE INFORMATION CARD

Jim-pak AUTHORIZED DEALERS

electronic components

ALABAMA	
Mobile	Lafayette Radio Electronics
CALIFORNIA	
Berkeley	Al Lasher Electronics
Monterey	Zackit
Palo Alto	Zack Electronics
Sacramento	The Radio Place
Sacramento	Zackit
San Carlos	J&H Outlet Store
San Francisco	Zack Electronics
Sunnyvale	Sunnyvale Electronics
Vallejo	Zackit
Walnut Creek	Byte Shop Computer Store
FLORIDA	
Tampa	Microcomputer Systems
GEORGIA	
Atlanta	Atlanta Computer Mart
HAWAII	
Aiea	Delcoms Hawaii
Honolulu	Integrated Circuit Supply
ILLINOIS	
Evanston	Itty Bitty Machine Co.
INDIANA	
East Chicago	Acro Electronics Corp.
Hammond	Quantum Computer Works
LOUISIANA	
Baton Rouge	Davis Electronic Supply Co.
MARYLAND	
Baltimore	Computer Workshop of Baltimore
Rockville	Computer Workshop
MASSACHUSETTS	
Medford	Tufts Electronics
MICHIGAN	
Lansing	Fulton Radio Supply Co.
MINNESOTA	
Duluth	Northwest Radio of Duluth
Eagan	Dacom Amateur Radio Ctr.
MISSOURI	
Parkville	Computer Workshop of Kansas City
MONTANA	
Billings	Conley Radio Supply
NEBRASKA	
Lincoln	Altair Computer Center
NEW JERSEY	
Hoboken	Hoboken Computer Works
NEW YORK	
Albany	Fort Orange Electronics
New York	Computer Mart of New York
New York	The Computer Store
Troy	Trojan Electronics
White Plains	The Computer Corner
OHIO	
Cincinnati	Digital Design
OKLAHOMA	
Oklahoma City	Bits, Bytes & Micros
OREGON	
Beaverton	Altair Computer Center
PENNSYLVANIA	
Murrysville	Computer Workshop of Pittsburgh
RHODE ISLAND	
Cranston	Jabbour Electronics City
Pawtucket	Jabbour Electronics City
TENNESSEE	
Memphis	Sere-Rose & Spencer Electronics
Oak Ridge	Computer Denn
TEXAS	
Dallas	Computer Shops Inc.
Houston	Altair Computer Center
Houston	Interactive Computers
VIRGINIA	
Alexandria	Computer Hardware Store
Springfield	Computer Workshop of Northern Virginia
WASHINGTON	
Bellevue	Altair Computer Center
Longview	Progress Electronics
WEST VIRGINIA	
Morgantown	The Computer Corner
Morgantown	Electro Distributing Co.
CANADA	
Alberta, Calgary	The Computer Shop
FOREIGN	
France, Paris	Computer Boutique

VISIT YOUR **Jim-pak** DEALER TODAY!
electronic components

JIM-PAK, 1021 HOWARD AVENUE,
SAN CARLOS, CALIFORNIA 94070

ATTENTION DEALERS:

Announcing

Jim-pak[®]

electronic components

One-Stop Component Center

★ Over 200 quality items including integrated circuits, resistors, diodes, transistors, capacitors, connectors, switches, sockets, LEDs and Data Books covering all JIM-PAK[®] items.

★ Immediate delivery on all orders

★ Store display racks available

★ Stock rotation and return policy

★ Direct mail program available from list of active electronic buyers in dealers' area.

★ National advertising campaign in leading electronics magazines to include list of qualifying dealers

★ Nationally known manufacturers' products at prices every dealer can afford

★ Guaranteed products

★ Standard industry part numbers



A component line of proven sellers developed for the independent dealer. Ideal for computer shops, school stores, electronic dealers, hobby shops, or any location where there is a potential market for electronic sales.

A product line which supplies most of your needs from one distributor with a reputation for fast and efficient service. Attractive and compact display racks make initial installation of the JIM-PAK[®] line easy.

Your customers deserve the best. Now you can profitably retail name brand components at competitive prices. Be the first in your area to announce and sell the JIM-PAK[®] line. Write or call today.

Jim-pak[®]
electronic components

FOR MORE INFORMATION AND PRICING SCHEDULE CONTACT:

a division of James Electronics, 1021 Howard Avenue, San Carlos, California 94070, (415) 592-8037

CIRCLE NO. 28 ON FREE INFORMATION CARD

www.americanradiohistory.com

The Touch by Regency is the first fully synthesized, 16 channel scanner to put over 15,000 radio frequencies at the command of a fingertip.

It not only opens you up to a whole new world of action, it gives you plenty of features to play with as well.

For example, The Touch will never allow you to miss a severe weather warning. No matter what frequency you're tuned to. Simply set Channel 16 to the National Weather Service alert mode, if available in your

area. The Touch automatically cuts into any severe weather broadcast.

In other words, it'll interrupt a raging fire to bring you news of a threatening tornado.

Here's another overriding feature. The Touch lets you set up Channel 1 as a priority receiver; and it samples that frequency every 1.2 seconds. So you won't miss any calls on your favorite channel.

Other points: there's no complicated programming to do. No crystals to buy. Simply

tap out the frequency number you want, and you're there.

Or scan for action on your 16 possible stored frequencies by merely touching SC. Or search for the unknown by tapping SS. It's that easy.

And when you find new action, The Touch tells you exactly what you've found in the LED display.

The Touch by Regency. See it at your dealer's.

**The Touch by Regency.
The Ultimate Scanner.**



**It can interrupt
a thrilling fire to bring you
a frightening tornado.**

POWER YOUR PROJECTS WITH SOLAR ENERGY!

DIGITAL CLOCK AND THERMOMETER PROJECTS USE SUN OR ARTIFICIAL LIGHT TO AUTOMATICALLY RECHARGE BATTERIES.

THE IDEA of building a simple solar-cell power supply for small appliances in your home is not as far-fetched as you might think. Here is a supply that can deliver 10 volts dc at 100 mA for one hour. Alternatively, it can deliver 10 mA for 11 hours. The power capability of the supply is sufficient to drive a transistor radio, emergency light, smoke detector, and other types of low-to-medium-power devices.

To illustrate typical uses of the solar-cell power supply, this article also presents construction details for a digital clock calendar and a digital thermometer. Both projects employ CMOS IC's and liquid-crystal displays to minimize the drain on the solar-cell power supply. The two projects employ variations of the basic solar array to recharge (either by sunlight or artificial lighting) their internal nickel-cadmium cells.

Solar Cells. Silicon solar cells are photovoltaic light sensors that convert incidental light directly into electrical energy. Solar cells have been used in all the earth satellites and space probes to keep the internal batteries "topped up." Such solar cells have formed the exterior "skin" of many satellites; and in other cases, such as the Skylab, they have been on "wings." They have also been used to power electronic equipment far from a convenient source of power.

The impinging photons of light energy break a valence bond within the pn junction area of the silicon cell and create electron-hole pairs that cause a potential difference across the cell. The cells are designed to maximize the light-sensitive nature of the pn junction. Those used in the projects in this article are shallow-diffused types that have a special blue coating to enhance the re-

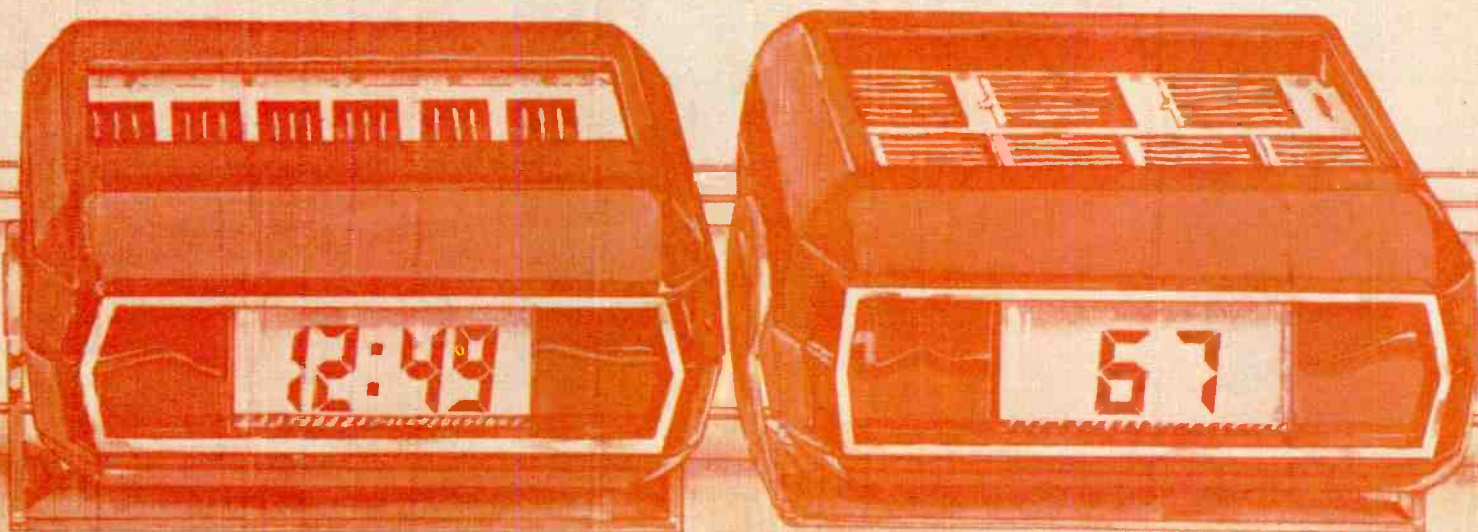

sponse at the blue end of the visible-light spectrum. The emission-distribution and response curves of some light sources and sensors are illustrated in Fig. 1.

When coupled with some device (such as a rechargeable battery) that can store the electrical energy generated by a solar cell, the system can be used to power many different electrical and electronic devices at essentially no cost but the original investment. At night, the solar-cell array can be placed near a bright incandescent lamp to reclaim energy that would otherwise be wasted.

Solar-Cell Power Supply. This ba-

sic solar-charged power supply consists of up to 26 silicon solar cells, the actual number depending on the desired output voltage. The system can deliver up to 40 mA in bright sunlight. If all 26 cells are used, the terminal potential will be 10 volts (see Parts Lists for Solar-Cell Array).

The fully-charged NiCd cells used in this circuit can deliver about 100 mA of current for an hour (10 mA per hour for 11 hours, for a total of 110 mAh). Two or more of these supplies can be connected in parallel to deliver more current. Alternatively, two or more supplies can be connected in series to provide a higher output voltage.

Approximately 13 hours of exposure at a distance of about 8" (20.3 cm) from a 100-watt incandescent lamp or about five hours in direct sunlight should be sufficient to fully recharge the NiCd cells. If you live in a bright, sunlit area of the country, take care to prevent overcharging that can damage the NiCd cells. The maximum continuous charging rate to the cells in the supply should be limited to 10 mA.

Construction. The supply can be assembled on a single-sided printed circuit board, the etching and drilling and component-placement guides for which are shown in Fig. 2. In this supply, the full complement of solar cells and nickel-cadmium cells is used.

Each solar cell has its light-sensitive surface finished in a deep blue color, with silver leads just under the surface and a thin metallic "land" along one edge. The upper metal land is the negative terminal.

The solar cells must be epoxied to the blank side of the pc board, making certain that the positive metal land on the bottom side of each cell is facing toward the large hole through the board at each solar cell location. Use a low-wattage soldering iron and fine solder for the wiring operation. Start from the diode end and very carefully solder a thin lead from the positive side of the adjacent solar cell to the pad at the diode's anode. Continue working very carefully with the soldering iron and interconnect each of the solar cells as follows. Solder a thin wire to the negative terminal of the cell. Pass this wire through the small hole near the cell and solder it to the positive terminal of the next cell through the large hole in the board. Repeat this procedure until all 26 cells are wired in series, with the final piece of wire connected to the negative terminal of the last cell at one end and to the "-" pad on the pc board at the other end.

Once all solar cells have been wired, you can test the array by connecting a dc voltmeter from the positive to the negative pads on the board and exposing the array to a bright source of light. The voltmeter should indicate at least 10 volts, depending on the brightness of the light source and the distance between the cells and source. Covering the solar-cell array with your hand should cause the pointer to swing downscale.

The positive terminal of each NiCd cell is identified by a small "+" or a "ring" at one end. Bear this polarity scheme in mind when you install the NiCd cells on the pc board.

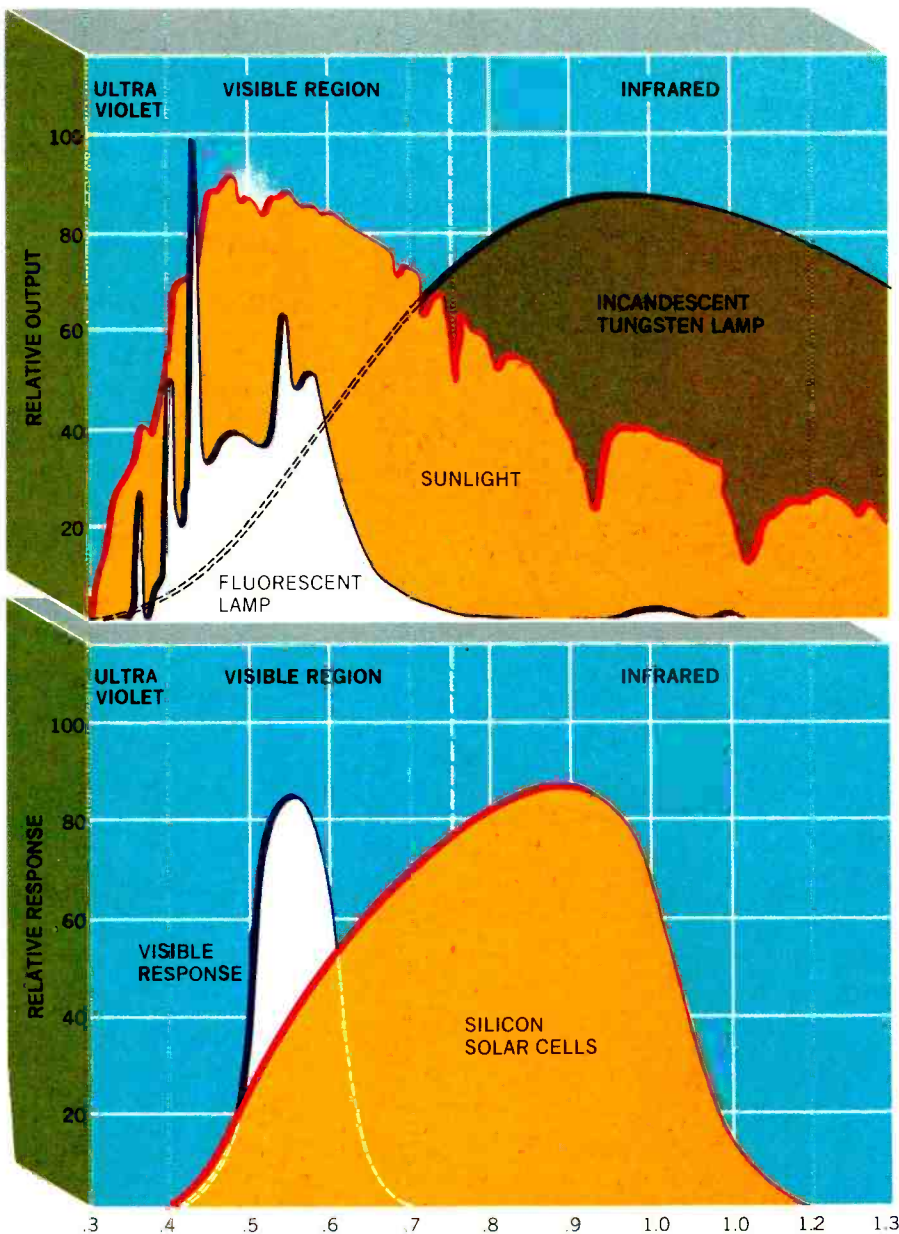

Fig. 1. Emission-distribution of some light sources compared to responses curves of some sensors.

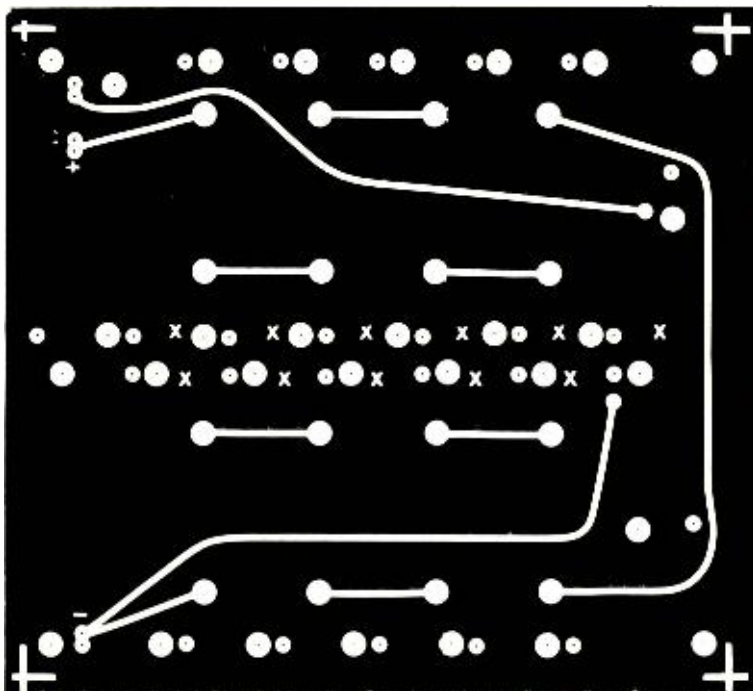
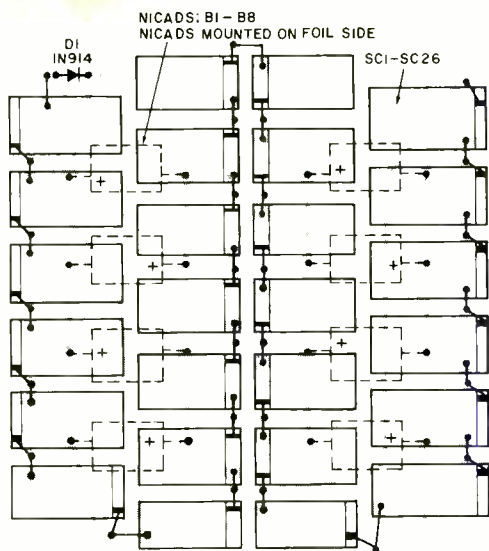

Fig. 2. Basic solar power supply with solar cells on nonfoil side of board and nickel-cadmium cells on foil side.

SOLAR-CELL ARRAY PARTS LIST

- B1 through B8—100-mAh nickel-cadmium cell
- D1—1N914 diode
- SC1 through SC26—Sc-50 silicon solar cell
- Misc.—Printed circuit board; epoxy cement; hookup wire; solder; etc.

Place the pc board assembly solar cell side down on your work surface and pretin with solder the pads to which the NiCd cells connect. Then pretin the ter-

CLOCK/CALENDAR PARTS LIST

- B1,B2,B3—100-mAh nickel-cadmium cell (GE No. GCF100ST, rated at 1.2 V at 100 mAh, or similar)
- C1—100-pF disc capacitor
- C2—5-to-30-pF trimmer capacitor
- C3—47- μ F, 6-V electrolytic capacitor
- D1,D2—1N914 diode
- DIS1—MLC200 liquid-crystal display (Motorola)
- IC1—MC14440 LCD watch/clock (Motorola)
- IC2—MC14584B hex Schmitt trigger (Motorola)
- The following resistors are 1/4-W, 10%:
 - R1—82,000 ohms
 - R2,R3,R4—1 megohm
 - R5,R8—100,000 ohms
 - R6,R11—470,000 ohms
 - R7—4700 ohms
 - R9—10 megohms
 - R10—560,000 ohms
- S1,S2,S3—Normally open spst pushbutton switch
- S4—Normally closed spst pushbutton switch
- SC1 through SC11—Sc-50 silicon solar cell (0.4" \times 0.4", rated at 40 mA at 0.4 volt)
- XTAL—32,768-Hz crystal (miniature)
- Misc.—Printed circuit boards (3); sockets for IC's and LCD; suitable enclosure; etc.

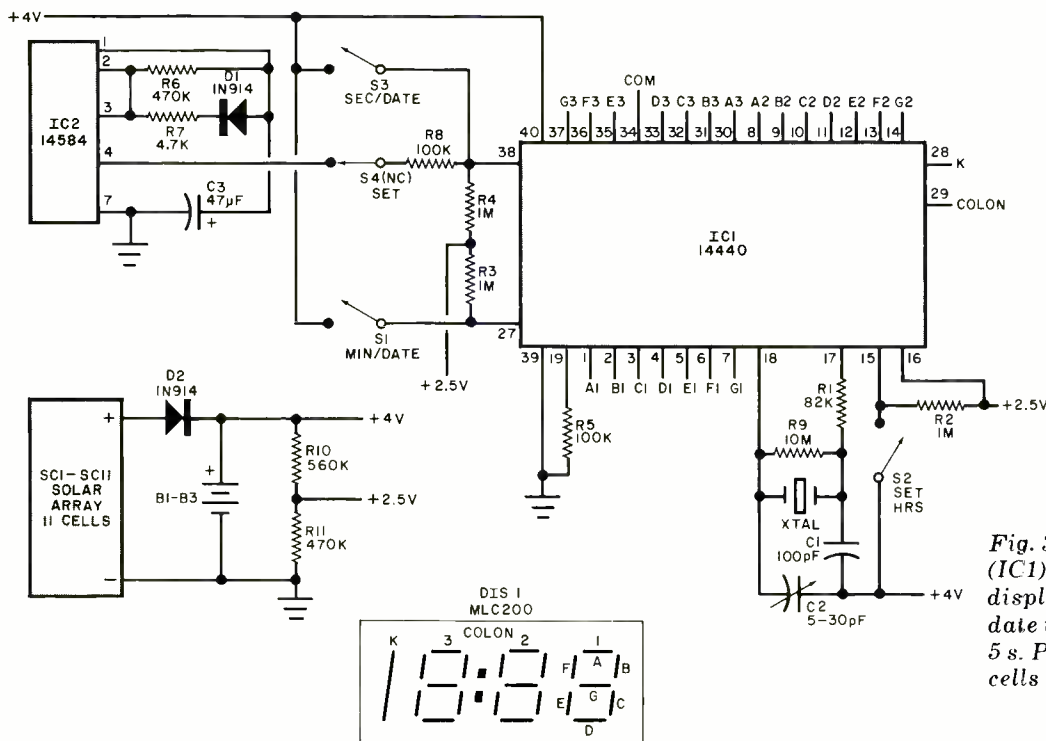

Fig. 3. Clock/calendar chip (IC1) drives liquid-crystal display. Oscillator causes date to appear about every 5 s. Power is from 3 NiCd cells powered by solar array.

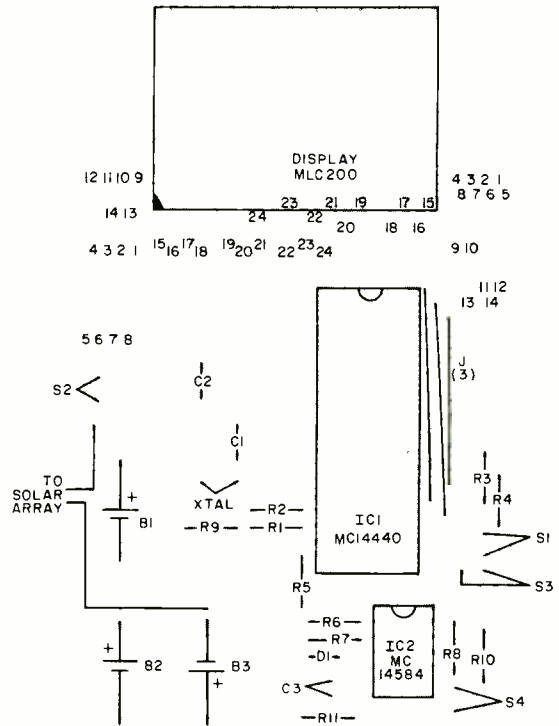
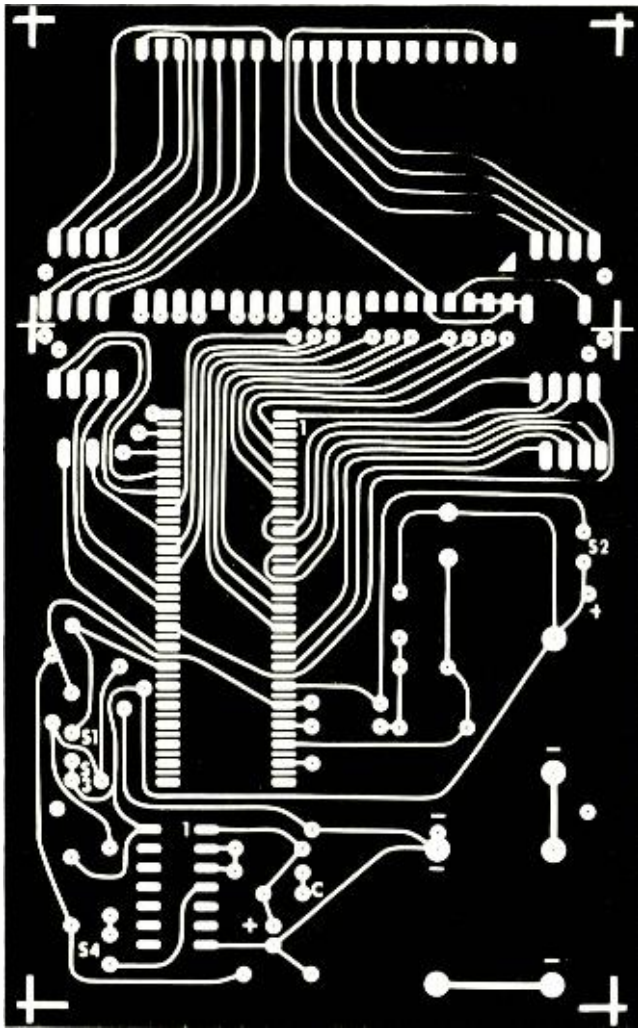

Fig. 4. Actual-size foil pattern for the clock main and display board is at left. Component layout is shown above. After completing the board, carefully separate the two parts.

minal tabs for all NiCd cells. Now, position the first cell on the pc board as shown in Fig. 2 and apply soldering heat to the top of one terminal tab to "reflow" the solder on tab and pc pad. Do not allow the cell to move until the solder sets. Then reflow solder the other cell tab to its pc pad. Continue this reflow soldering procedure until all NiCd cells are mounted on the pc board. When you are finished wiring in the NiCd cells, double check to make sure that they are properly polarized. Then install and solder into place diode *D1*, making sure that the cathode end goes to the pad labelled "C" on the board.

Finally, solder lengths of red and black insulated stranded 28-gauge hook-up wire to the positive and negative output pads on the board. These leads should be long enough to reach from the solar-cell power supply to the equipment the supply is to power. Twist the wires together to form a pair.

The power supply can be placed in a window or near bright indoor lighting and connected to the equipment it is to drive. It is important that you keep the supply in a location where it will receive enough

light to keep the NiCd cells charged and provide enough current to make up for the power used by the equipment being powered by the supply.

Solar-Powered Clock. A CMOS/liquid-crystal-display clock, such as the one shown schematically in Fig. 3, is a useful solar-powered project. Its current demand is as low as 25 μ A. If its solar-cell array is given an occasional exposure to sunlight, the clock should operate for a very long time without attention or a battery charge.

How It Works. Clock chip *IC1* contains all the electronics required to drive a liquid-crystal display and to count the time and date. The crystal (*XTAL*) sets the internal oscillator to a frequency of 32,768 Hz for accurate timekeeping. Trimmer capacitor *C2* permits slight adjustment of the oscillator's frequency to maximize precision.

Integrated circuit *IC2* forms a one-shot multivibrator that delivers a short pulse every five seconds or so to trigger the *IC1* date demand input so that the date will be automatically displayed. The

network consisting of *R10* and *R11* divides the basic 4-volt dc line down to 2.5 volts as required by some elements within the clock chip.

Construction. The clock and its associated solar-cell array can be assembled on three separate pc boards, one for the solar-cell array, another for the basic clock circuit, and the third for the display. The solar-cell array can be assembled in a similar manner to that described for the basic array of Fig. 2 using only 11 solar cells and the series diode. Use the solar cell areas labelled with an X on Fig. 2 and do not install the NiCd cells on this board.

The etching and drilling and component-placement guides for the two clock boards are shown in Fig. 4. The liquid-crystal display mounts on a strip-type socket so that the small black wedge in the front of the display is positioned toward the small wedge on the conductor pattern of the board.

On the main board, install the resistors, capacitors, three jumper wires, and diode *D1*. Take care to observe the proper polarities of *D1* and *C3*. The cathode

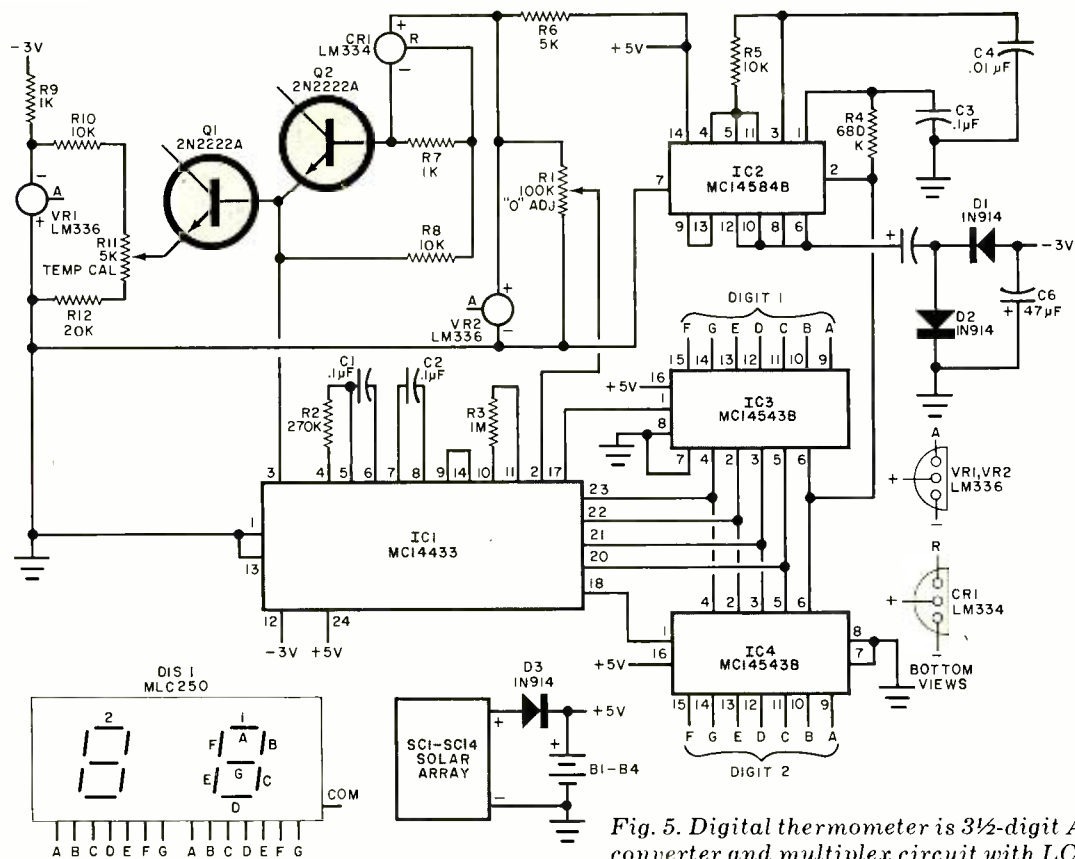

Fig. 5. Digital thermometer is 3½-digit A/D converter and multiplex circuit with LCD.

THERMOMETER PARTS LIST

end of *D1* goes to the pad labelled C on the foil. Then install the crystal. Connect suitable insulated hookup wire leads for the four switches and the solar-cell array. Sockets are recommended for *IC1* and *IC2*, although they are not necessary. Install the two IC's last, taking care to orient them properly and observing the accepted procedures for handling MOS devices.

Note that the display and main boards have similar round copper pads near their edges. Insert a bare wire into each pad on the display board and solder into place. Then place the conductor side of the display board against the main board, the latter foil side down. Insert the two bare wires just installed in the display board through the mating holes in the main board. Firmly press the two boards together and solder the wires into place on the main board. (The row of pads on the display board should be slightly below the foil side of the main board.) Using thin wire and insulated tubing as necessary, interconnect the mating numbered pads between both printed circuit boards.

The three NiCd cells (*B1*, *B2*, *B3*) are installed on the main board using the solder reflow technique described above. Observe the polarities of each cell. Once installed, the cells can be initially charged using the solar-cell array

B1 through *B4*—100-mAh nickel-cadmium cells (GE No. GCF250ST or similar)
C1, *C2*, *C3*—0.1- μ F, 6-V capacitor
C4—0.01- μ F, 6-V capacitor
C5, *C6*—47- μ F, 6-V electrolytic capacitor
CR1—LM334 current regulator (National)
D1, *D2*, *D3*—1N914 diode
DIS1—MLC250 liquid crystal display (Motorola)
IC1—MC14433 3½-digit A/D converter (Motorola)
IC2—MC14584 hex Schmitt trigger (Motorola)
IC3, *IC4*—MC14543B BCD-to-7-segment latch/decode/drive (Motorola)
Q1, *Q2*—2N2222A transistor
R1—100,000-ohm, 10-turn trimmer potentiometer

R2—270,000-ohm, ¼-W resistor
R3—1-megohm, ¼-W resistor
R4—680,000-ohm, ¼-W resistor
R5—10,000-ohm, ¼-W resistor
R6—5000-ohm, 1% metal-film resistor
R7, *R9*—1000-ohm, 1% metal-film resistor
R8, *R10*—10,000-ohm, 1% metal-film resistor
R11—5000-ohm, 10-turn trimmer potentiometer
R12—20,000-ohm, 1% metal-film resistor
VR1, *VR2*—LM336 voltage regulator (National Semiconductor)
SC1 through *SC14*—SC-100 silicon solar cell (0.8" × 0.8", rated at 80 mA at 0.4 volt)
 Misc.—Printed circuit boards (3); suitable enclosure (Radio Shack No. 270-285 or similar); sockets for IC's and LCD; machine hardware; hookup wire; solder; etc.

or a dc power supply adjusted to deliver 100 mA for 1 hour and 20 minutes. In either case, the cells must be charged before attempting to calibrate and set the clock. Once the cells are charged, connect a frequency counter to the junction of the crystal and *R9* and the positive-voltage lead and then adjust trimmer capacitor *C2* for an indication of 32,768 Hz. If you do not have a frequency counter, use the timing intervals broadcast by WWV or CHU to adjust *C2*.

The clock can be mounted in any enclosure large enough to accommodate the circuit boards. Install the four switches on the rear panel of the enclosure.

Mount the solar-cell array where its light-sensitive surface can be exposed to light through a cutout on the top of the enclosure.

Switch *S1* is used to set the minutes when the hours displays indicate 12 and the date when the hours indicate any figures other than 12. Switch *S2* is used for setting the hours. Switch *S3* is used for displaying the seconds and date on demand and, when held closed, allows the clock to display the seconds count-off. Releasing *S3* allows the clock to display the date for about 3 seconds. Switch *S4* is used to disconnect the timer from demand when setting the time. When the

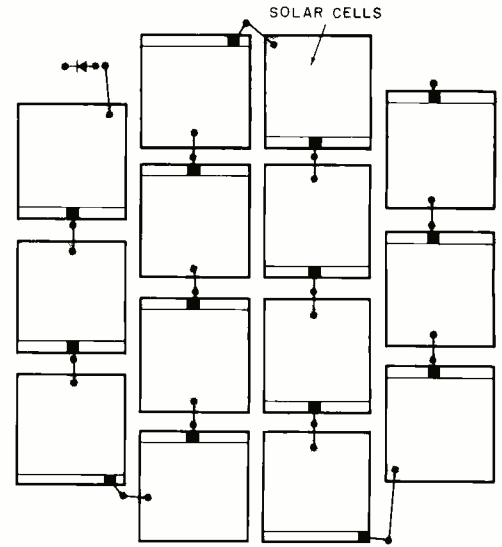
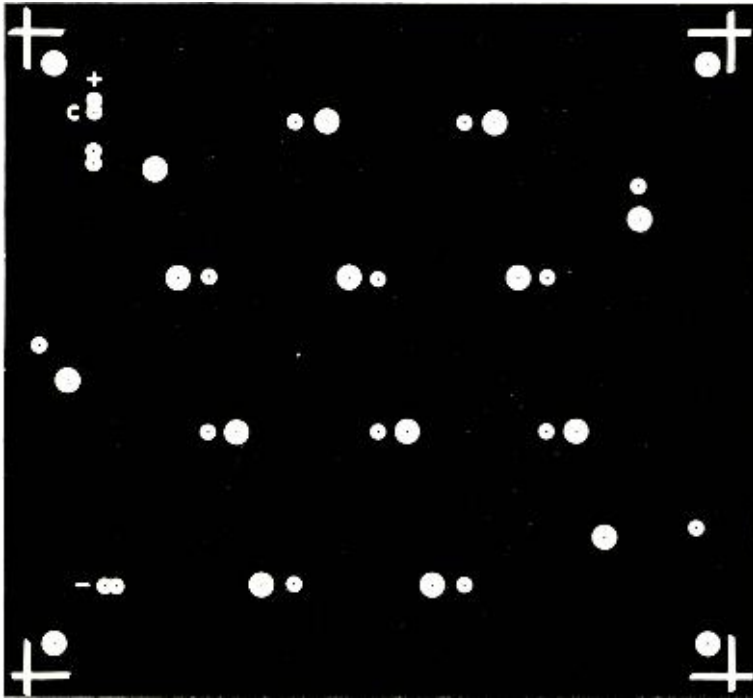

Fig. 6. Foil pattern and solar cell installation for the thermometer power supply.

clock is first turned on, the hours indicated are for AM, which must be kept in mind when setting the date.

To set the time, use *S2* to set the hours to any display but 12 and use *S1* to set the date. Operate *S3* to set the hours to 12 and *S1* to set the minutes. Use *S2* to set the hours and then depress *S3* to start timekeeping. Remember to keep *S4* depressed during the time setting and until *S3* is operated.

A Solar-Powered Thermometer.

The liquid-crystal display thermometer shown schematically in Fig. 5 is essentially a digital voltmeter that has a temperature-to-voltage converter as its input. Two digits of °C or °F are displayed.

How It Works. Analog-to-digital converter integrated circuit *IC1* has multiplexed outputs, which require BCD-to-seven-segment latch/decoder/driver integrated circuits *IC3* and *IC4* to interface to the liquid-crystal display. Hex Schmitt-trigger *IC2* is designed as an oscillator that generates the clock signal required to drive the LCD and to simultaneously generate -3 volts dc (using *C5*, *D2*, *D1*, and *C6* as the RC timing elements) for the temperature converter and *IC1*.

Voltage dividers *VR1* and *VR2* provide a constant 2.5 volts to the temperature converter over varying battery-voltage levels. Current regulator *CR1* produces a constant current through *Q1*, whose base-emitter junction is used to sense the temperature. Temperature

compensation for *CR1* (to provide stable current over a wide temperature range) is provided by *Q2*, *R7*, and *R8*. Note that 1% metal-film resistors are used in the converter to reduce drift over the temperature range of the system. Trimmer potentiometer *R1* is used to remove errors so that the system can produce accurate indications at 0° C and 32° F. The system is calibrated for accurate indications in either °C or °F by adjusting *R11*.

The thermometer uses CMOS IC's to keep its current drain to less than 3 mA. Since the system is powered from 200-mA NiCd cells, the thermometer can operate for about three days on fully charged cells. The solar cells used in this circuit can deliver about 80 mA in bright sunlight. About 5 hours and 20 minutes of bright sunlight or about 13 hours at a distance of 8' from a 100-watt incandescent lamp are required to fully recharge the NiCd cells.

Construction. Three circuit boards are required for the thermometer, as was the case with the clock/calendar. Shown in Fig. 6 are the etching and drilling and components-placement guides for the solar-cell array board, while Fig. 7 illustrates the guides for the main and display boards.

Install all passive components on the main circuit board, taking care to observe the proper polarities of *C5* and *C6*. Install *D1* and *D2*, again observing polarities, with the cathodes in each case going to the pads labelled C. Sockets are recommended for the IC's, but

they are not necessary. Install *VR1*, *VR2* and *CR1*, observing the lead designations shown in Fig. 5. Install the IC's last, observing the proper orientations and using accepted procedures for handling MOS devices.

Transistor *Q2* can be installed directly on the board, while temperature-sensing transistor *Q1* can be mounted on the board, or it can be connected to the board via a twisted hookup wire pair if you wish to locate the sensor in a remote area.

Mount *IC3* and *IC4* on the display board as shown in Fig. 7. Install the LCD so that it straddles the two IC's, orienting it so that the small black wedge in the lower left aligns with the wedge on the board. Use a strip-type socket for the liquid crystal display.

Fasten together and interconnect the display and main board assemblies as described above for the clock/calendar.

Install the four NiCd cells as shown in Fig. 7, observing the proper polarities for the cells. Then charge the cells using the solar-cell array or a dc power supply adjusted to deliver 200 mA (about 1 hour and 20 minutes).

Calibration. Connect a voltmeter between pin 2 of *IC1* and circuit ground. Adjust *R1* for an indication of 0.46 volt for °C or 0.25 volt for °F. Use an accurate thermometer, positioned close to the main circuit board, to adjust *R11* so that both the thermometer and digital equivalent give the same indication. Allow the thermometer to stabilize be-

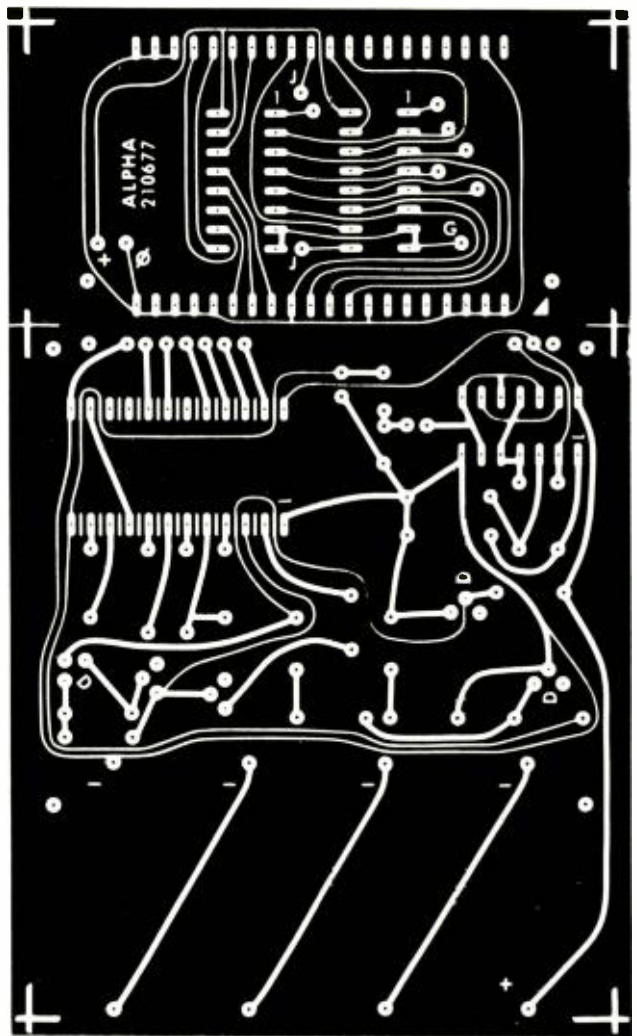
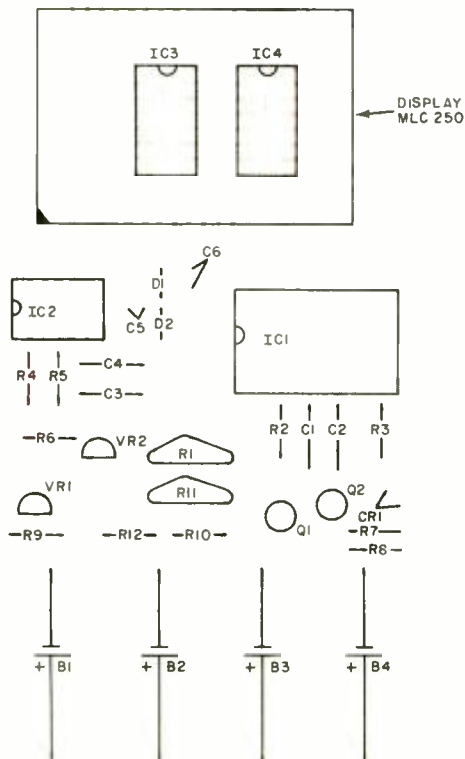

Fig. 7. Thermometer foil pattern is at right. Component placement above. Note NiCd cells.

fore performing this step. Note that potentiometer *R11* can be adjusted to obtain two "accurate" indications.

Once *R11* has been adjusted, warm up the case of *Q1* and observe the display. If the temperature indication goes up, *R11* is correctly adjusted. If the indicated temperature goes down as *Q1* is heated, change the adjustment of *R11* to the other "correct" position.

The solar-cell array can be mounted in a cutout in the upper surface of the enclosure selected to house the circuit. Alternatively, it can be located remotely and interconnected to the thermometer

KIT AVAILABILITY

The following are available from Alpha Electronics, P.O. Box 1005, Merritt Island, FL 32952 (Tel.: 305-632-5534): No. SPS-1 solar power supply kit at \$45 plus \$2 for postage and handling; No. SCK-1 solar clock/calendar kit at \$79.95 plus \$3.50 postage and handling; No. STK-1 solar thermometer kit at \$89.95 plus \$3.50 postage and handling. Also available separately: No. SC-50 solar cells at \$1.25 each; No. SC-100 solar cells at \$2.00 each; 110-mAh NiCd cells at \$3.00 each; 200-mAh NiCd cells at \$3.80 each; No. 290777 pc board for solar power supply and clock power supply for \$5.00; No. 280777 main and display pc boards for clock/calendar for \$8.00; No. 230677 pc board for thermometer power supply for \$5.00; No. 220677 main and display pc boards for thermometer for \$8.00.

via a twisted-pair cable. The low temperature is determined by the liquid-crystal display and is approximately -5°C , while the upper limit is about 60°C .

Now you can let light charge the batteries of these and other projects to relieve you from dependence on electrical recharging or battery replacement. \diamond

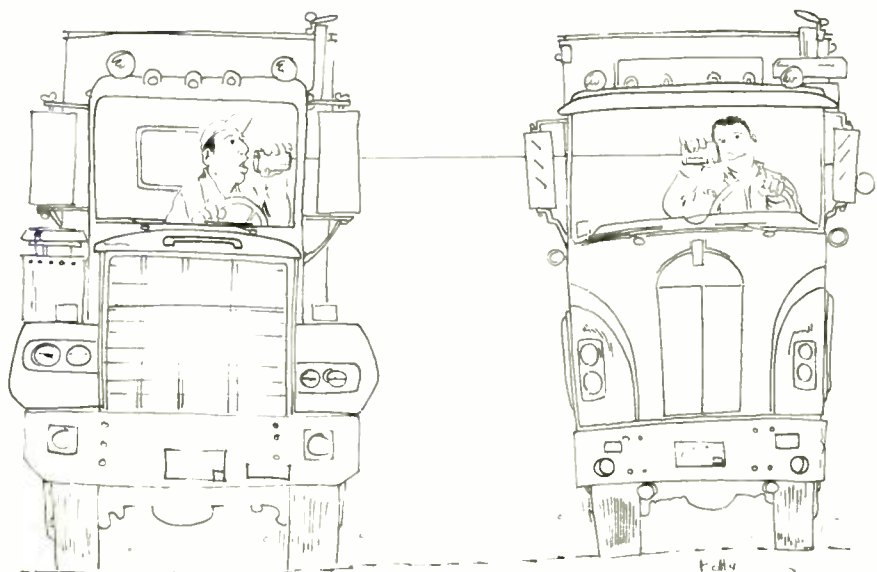

"Hey, big buddy. That's a big 10-4!"

HOW FM TUNERS WORK



PART 1

Basic fundamentals of how they work—the front end, and the i-f section.

BY JULIAN HIRSCH

AS A SEPARATE component or as a part of a stereo receiver, the FM tuner is the principal source of stereo program material for many people. Frequency modulation (FM) broadcasting is noted for its wide frequency range, low distortion, and low noise; it is a true high-fidelity transmission medium. These qualities are characteristic of FM broadcasting, but they are not intrinsic to the basic system.

Frequency Modulation Basics. Commercial FM broadcasting achieves its special qualities because it is a wide-band system in which the maximum deviation from the channel center frequency is several times the highest audio modulating frequency. In fact, 100% modulation of an FM broadcast transmitter, whose audio bandwidth is nominally 15 kHz, corresponds to a frequency deviation of ± 75 kHz. It might appear that a tuner bandwidth of 150 kHz would be quite sufficient for a 75-kHz deviation and that the 200-kHz spacing between

channel assignments would give an ample safety margin for possible mistuning or for occasional overmodulation peaks (which are not supposed to occur). There are some other factors to consider, however.

Unlike AM, where each modulating frequency creates a single pair of sidebands around the carrier and where the theoretical bandwidth of the signal is twice the highest modulating frequency, an FM signal in theory is composed of an infinite number of sidebands. The first-order sidebands, like those of an AM signal, are spaced from the carrier frequency by the amount of the modulating frequency. If the modulation index (the ratio of deviation to modulating frequency) is small, the spectrum of an FM signal looks exactly like that of an AM signal. (The phasing of the sidebands is different, but that does not appear in a spectrum analysis.)

As the modulation level is increased, additional pairs of sidebands appear above and below the FM carrier fre-

quency. Each is spaced from its neighbors by the amount of the modulation frequency and for a time may decrease gradually in amplitude as one looks farther and farther from the carrier frequency. The situation becomes more complex as the deviation is increased, but it is plain that the spectrum width of an FM signal is not established as simply as it is for AM.

We used our audio spectrum analyzer to display the spectrum of an actual fre-

Fig. 1. A 100-MHz carrier frequency modulated by 2000 Hz.

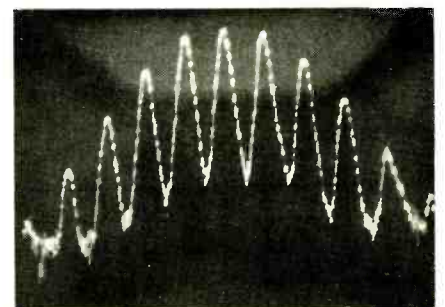

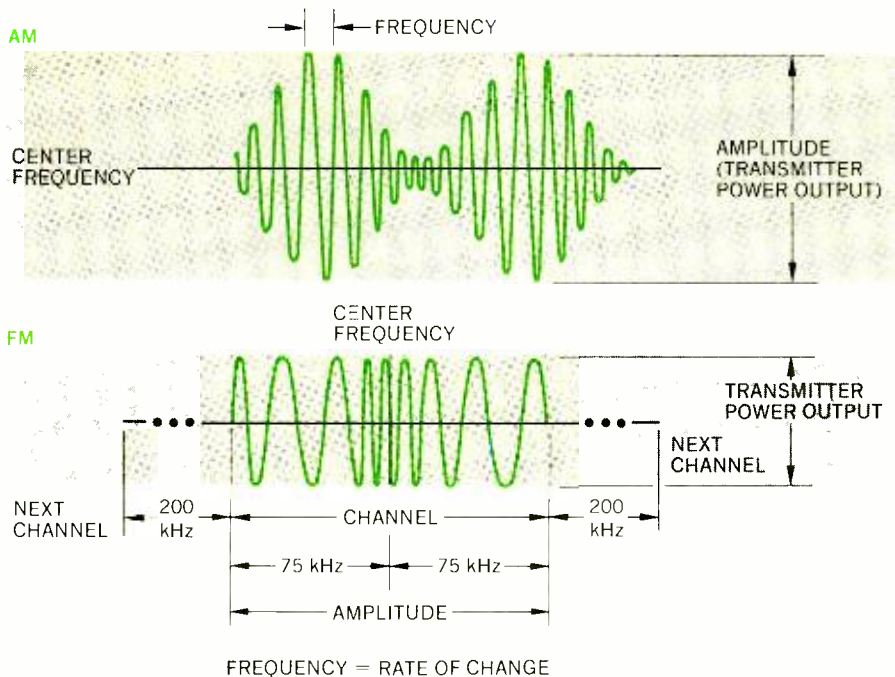

Comparison of amplitude modulation with frequency modulation.

frequency-modulated r-f signal. A standard FM signal generator, operating at about 100 MHz, was heterodyned down to about 30 kHz, which is within the range of our Hewlett-Packard Model 3580A spectrum analyzer. The frequency (horizontal) scale in Fig. 1 is 2000 Hz/division and the carrier is being modulated by a 2000-Hz audio signal, with a deviation of between 2000 and 3000 Hz. Note that the sidebands are spaced at 2000-Hz intervals and decrease in amplitude as one moves away from the carrier frequency. (The vertical, or amplitude, scale is 10 dB/division.)

If the spectrum had been for an AM signal, only the first pair of sidebands, those closest to the carrier, would have been visible and the total signal bandwidth would have been 4000 Hz. With FM, the bandwidth must be defined in terms of the allowable sideband amplitude. For example, if sidebands more than 20 dB below the carrier level are ignored, the signal bandwidth would be 8000 Hz. However, if components down to -50 dB are included, the bandwidth becomes 16,000 Hz. This is in spite of the fact that the maximum carrier deviation is less than 3000 Hz. Fortunately, the higher-order sidebands, under the conditions that exist in FM broadcasting, fall off quite rapidly so that interference between stations 200 kHz apart does not occur in practice. Any sidebands that extend into the adjacent channel are attenuated by the tuner's selectivity and have little or no effect on the quality of the received signal.

Inside an FM Tuner. In the FM tuner, broadcast transmissions between 88 and 108 MHz are converted to a 10.7-MHz intermediate frequency (i-f). The i-f amplifier provides most of the tuner's gain. It also has limiting to remove amplitude modulation from the received signal; and the tuner's detector (ratio detector or some form of discriminator) converts the frequency modulations to an audio signal. Almost all FM detectors are capable of responding in some degree to AM; hence, it is necessary to remove any AM from the signal.

The source of the AM component in the FM signal is partly from external atmospheric or man-made interference and partly a component of the random noise that exists in every electrical circuit and is greatly amplified by the tuner's high-gain circuits. One of the most important sources of AM in an FM signal is "multipath" interference, caused by the arrival of the same transmission from different directions at slightly different times. This can cause a particularly unpleasant form of distortion if the tuner is able to respond to AM.

The amplified and limited FM signal is detected by a discriminator whose output waveform is essentially the same as that which modulated the transmitter. Most FM tuners use a ratio detector for this purpose. The ratio detector is inherently insensitive (but not totally immune) to AM, which simplifies the task of the limiters. The Foster-Seely discriminator, not often seen nowadays, is much less resistant to AM. Other types of detectors include the quadrature detector (available in a single IC chip together with the i-f amplifier and limiter) and the pulse counter detector. Each of these circuits has its advantages and disadvantages and all give good performance.

If the FM broadcast is monophonic, the output of the detector is the audio program, ready to be amplified and sent on to the amplifier that drives the speaker systems. If it is a stereo transmission, considerable additional processing is necessary to recover the two program channels. The detector output with a stereo signal is a composite signal that

Many paths to the receiving antenna can cause multipath distortion.

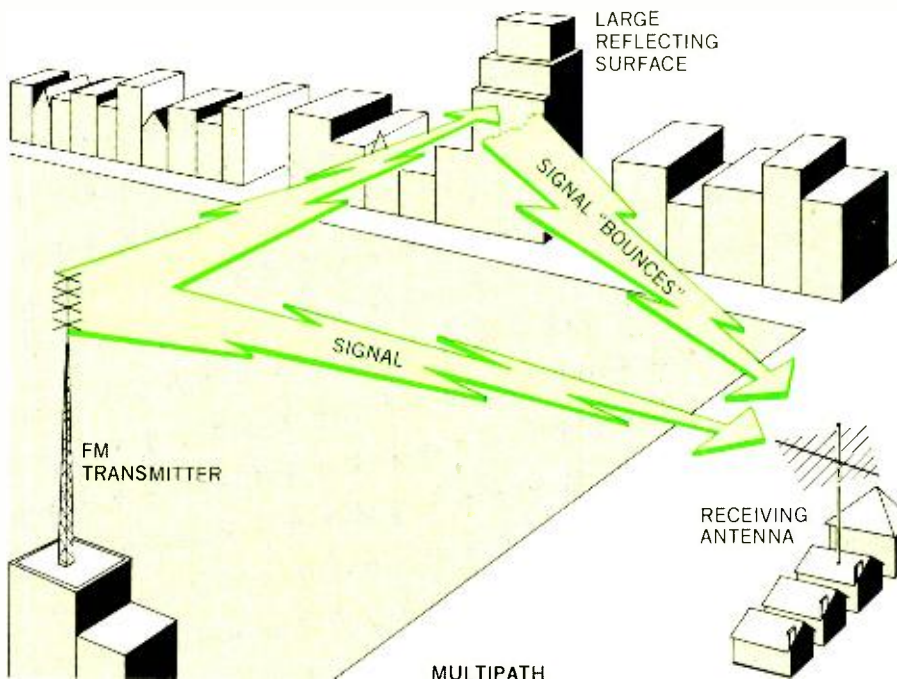

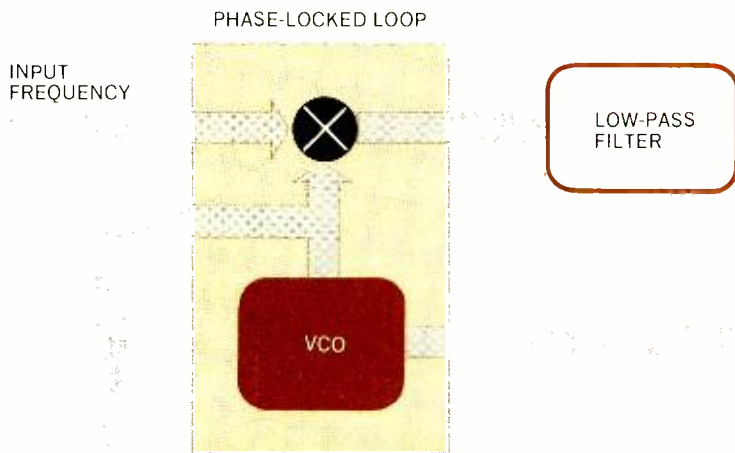

In typical phase-locked loop (PLL), an internal voltage-controlled oscillator is locked to a harmonic of the input frequency. In FM detector, the filter output is audio difference between input frequency and vco.

contains the basic 50-to-15,000-Hz audio band (which is in mono form and itself consists of the sum of the two channels, or L+R), a 19-kHz pilot carrier, and a double-sideband signal about a 38-kHz suppressed subcarrier. This signal contains the difference of the stereo channels (L-R).

After processing in the multiplex demodulator, the L + R and L - R signals are recovered and can be combined in a resistive matrix. The addition and subtraction of these signals results in separation of the left and right program channel signals. Each signal is then deemphasized by a simple RC network that has a 75- μ s time constant that rolls off the response at a 6-dB/octave rate above 2100 Hz (complementing a similar boost at the transmitter) to yield a flat overall frequency response. This emphasis/deemphasis technique is used to reduce the noise in the received signal.

These fundamental processes occur in every FM tuner, although the circuit details may vary considerably. Now, let us examine an FM tuner from its antenna to its audio outputs and see how each function is performed and how they affect the specifications and listening quality of the tuner.

The "Front End". The "front end" is the portion of a tuner that translates the signals in the 88-to-108-MHz band to the 10.7-MHz i-f range. It normally has an r-f amplifier, a mixer or frequency converter, and a tunable local oscillator. A multi-section tuning capacitor resonates several LC circuits to the same frequency as the tuning is adjusted. The greater the number of tuned circuits in the front end, the better the tuner's ability to discriminate against out-of-band interference, such as image or i-f re-

sponses, as well as to resist overload from signals within the FM band itself.

Even though most tuners have only one r-f amplifier stage, it is possible to use more than one tuned circuit at the input and output of the amplifier, coupled in such a way as to improve the rejection of out-of-band frequencies. A few tuners have two r-f stages that can support a larger number of tuned circuits as well as provide additional gain at the signal frequency. Front-end gain, incidentally, is not a critical factor in determining the ultimate sensitivity of a tuner, since many tuners with a single r-f stage can approach the limits imposed by thermal noise in the 300-ohm impedance of the antenna system. Sensitivity, in the sense of noise-free reception of weak signals, is more a property of the i-f and limiter sections than of the front end.

You can judge the front-end selectivity of a tuner by counting the number of sections in the tuning capacitor. Manufacturers are quick to point out their use of multigang capacitors as evidence of the out-of-band rejection capability of their tuners. The practical minimum is three sections, one each for the r-f, mixer, and local-oscillator stages. Additional sections imply the use of more than one tuned circuit ahead of the mixer. One deluxe tuner has a seven-section capacitor, but most high quality models get along well with five sections. If the tuner has an AM section, be careful that the corresponding sections of the AM front end are not lumped in with the total number of advertised capacitor sections.

Early solid-state FM tuners used bipolar transistors in their r-f and mixer stages. They were easily overloaded by strong signals, resulting in spurious responses that gave transistorized tuners an unsavory reputation. Sometimes an

antenna attenuator switch was provided to allow the level of the incoming signal to be reduced by 20 dB or so in strong-signal areas. The development of the field-effect transistor (FET) solved the overloading problem, with the result that modern tuners are less subject to spurious responses from overloading than were their vacuum-tube ancestors. Virtually every modern FM tuner uses a FET in its r-f stage, and most use another FET in the mixer stage as well.

Local-oscillator frequency drift was a problem with many vacuum-tube tuners, where it was aggravated by the heat from the tubes. Drift is really a characteristic of the passive components of the oscillator (principally the coil and capacitors in its frequency determining circuit), rather than of the tubes or transistors. Almost from the beginning, transistor oscillators were less plagued by drift than their tube counterparts, and automatic frequency control disappeared from the high-fidelity tuner scene for a few years. Recently, however, a few tuners and receivers have appeared with afc, although it is rarely needed to correct for drift. The reason for its inclusion in an inherently stable tuner is to minimize tuning errors. A variation on this system uses the tuning knob as a sensor. The tuning knob picks up hum or disturbs the balance of a capacitive bridge when it is touched. This disables the afc circuit. Once a station has been tuned in, even though it is not tuned in accurately, releasing the knob lets the afc take over final tuning. Even so, reasonable care is still necessary during tuning.

A few tuners are not tuned by physical variable capacitors. By using voltage-variable capacitance diodes called "Varactors," a number of tuned circuits can be tracked as they are tuned simultaneously by a single dc control voltage that usually comes from a potentiometer driven by a conventional tuning mechanism. Voltage-controlled tuning also simplifies pushbutton selection of preselected channels. Another feature of some voltage-tuned systems is the use of a dc voltmeter to replace the conventional dial scale, since the control voltage is uniquely related to the oscillator frequency.

In spite of its apparent convenience, voltage tuning has not achieved wide popularity. One reason for this is that it is much more difficult to build in the necessary stability (although it can be made almost as good as a mechanical tuning capacitor system). The voltage-tuned capacitors are silicon diodes operated with reverse bias, and they must be

properly matched for tracking of the various tuned circuits. Thermal drift of capacitance also can be a problem. The somewhat paradoxical result is that this tuning system, although potentially inexpensive, is limited to a few of the more expensive home audio products.

Synthesized tuners have been available for several years. The details of their synthesizer circuits, as well as the method of station selection, differ widely among the various models. In all of them, however, the stability and accuracy of the local oscillator are determined by a single quartz crystal oscillator. Most do not have conventional tuning dials (which are obviously not needed), but indicate the frequency on a digital numeric display. This is not to be confused with conventionally tuned tuners and receivers in which a frequency counter reads the local oscillator frequency, subtracts 10.7 MHz from it, and displays the tuned frequency on a digital display. In this case, the digital system serves only as a highly accurate and expensive substitute for a tuning dial. In most true synthesized receivers or tuners, channel selection is by means of punched plastic cards or a keyboard.

The I-f Section. After conversion to 10.7 MHz, the signal from the front end passes through a series of selective filters, usually employing ceramic ele-

ments. Isolation, impedance matching, and some gain are often provided by single-stage transistor amplifiers between the filter sections, with the bulk of the i-f gain coming from an IC amplifier following the filters.

The i-f filters are responsible for the tuner's selectivity (ability to reject other signals close in frequency to the desired channel) and for its distortion and stereo channel-separation characteristics. The "ideal" response of the i-f filter would be a flat top that is at least 150 kHz wide, with steep skirts to reject interference from stations on nearby channels. Another requirement, especially important for stereo reception, is that all signals within the passband of the filter be subject to the same time delay. In other words, the phase relationships between the various components of a stereo signal should not change as it passes through the i-f section.

Unfortunately, it is not possible to make a filter with ideal amplitude and phase characteristics, so that some sort of compromise is necessary. As we have seen, the FM sidebands may extend, at low levels, beyond the nominal 150-kHz channel width. To accommodate them, the usual practice is to make the response of the filter slightly wider than 150 kHz and to design the filter for good phase characteristics. The latter is generally obtained by sacrificing some

of the ideal steep-skirted, flat-topped shape of the response curve.

Almost universally, FM i-f filters use ceramic elements whose piezoelectric properties allow them to function as mechanical resonators with electrical inputs and outputs. Two or three pairs of filters are usually used to provide better skirt selectivity. A few years ago, quartz crystal filters were used in the same way, but it was found that equivalent results could be obtained from less expensive ceramic elements. In a few high-priced tuners, multipole LC filters are used, either to replace ceramic types or in addition to them in separate "wide-band" i-f amplifiers. They allow the designer to tailor the phase and amplitude response to suit his goals. If properly designed and used, they can deliver the highest performance possible at present, in terms of low distortion and good channel separation.

All modern i-f filters, whether of LC, quartz, or ceramic construction, share the advantage of being permanently adjusted and aligned. Until five or six years ago, i-f selectivity was usually obtained with a series of double-tuned transformers that could not match the performance of a good fixed filter and required periodic realignment.

The necessary i-f gain can be obtained from one or more IC stages, although a few tuners still employ several stages that use discrete transistors. A boon to the designer of low-to-moderate-priced tuners, is the availability of specialized FM IC's that include many functions on a single chip.

Sometimes, it is possible to see the impact of a specific piece of improved hardware on tuner performance. A good example is the phase-locked-loop (PLL) multiplex demodulator IC that is widely used in tuners of all prices. The PLL eliminates most of the critical components and adjustments that were formerly necessary to set up the stereo separation of a tuner. As a result, channel separation is dramatically improved in today's tuners and receivers over those of only two or three years ago, and it does not degrade with time. The early user of the PLL could justifiably claim that it was responsible for his product's exceptional stereo performance, but today almost everyone uses similar devices.

The concluding part of this article next month will discuss stereomodulation and demodulation and include a buying guide listing of FM tuners including specifications and features. ◇

The voltage-controlled oscillator can be locked into any multiple of the crystal frequency. Divide-by-n block simulates tuning dial.

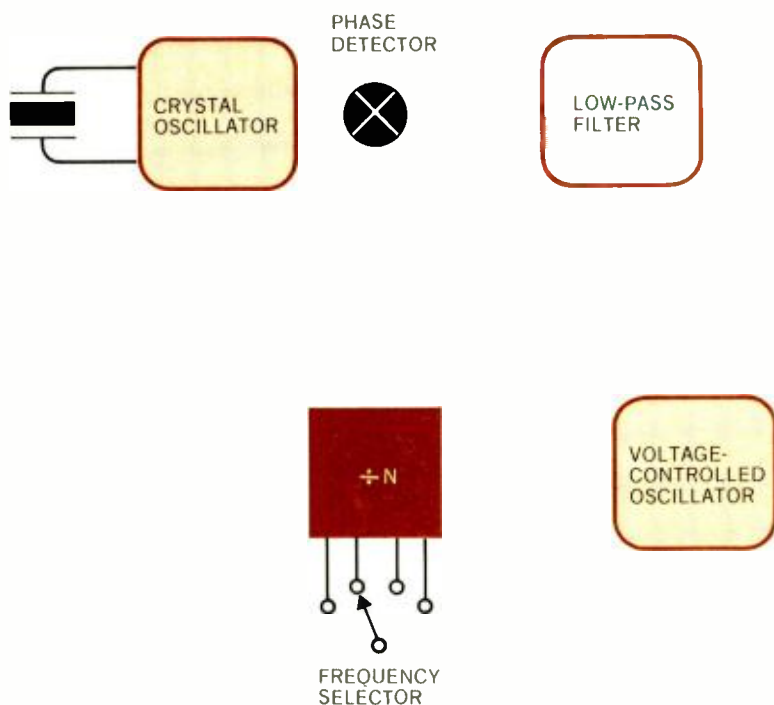



TO THE ELECTRONIC RACES!

An exciting LED game to test the abilities of two players.

BY JAMES BARBARELLO

AGILITY, strategy, competition and luck—the classic ingredients of a race—are found in the electronic game, “To The Races.” Designed for two players, the project has a race track formed from two rows of nine LED’s each. Readily available CMOS digital and 556 dual timer IC’s, and standard LED’s are used in the game’s circuitry. Four “C” cells form a power source. Total construction cost is about \$25.

At the outset of a race, a RESET switch is closed and each contestant’s START LED glows. Then four control LED’s (one pair at each playing position) start blinking. Below each control LED, a pushbutton switch is mounted, one labelled SAFE BET and the other A CHANCE. The LED above the SAFE BET switch

blinks about once every 3 seconds, and the LED above the A CHANCE LED about three times that rate. These LED’s remain on for approximately ¼ second.

If a contestant closes one of the two pushbutton switches while the corresponding LED is glowing, he advances one position. This is indicated by the darkening of the LED at the position previously occupied and the turning on of the adjacent LED. The faster flash rate of the LED above the A CHANCE switch permits much quicker progression around the track, but a penalty is associated with the switch’s use. If it is depressed while the corresponding LED is dark, that player’s circuitry is reset and he is sent back to the starting position.

No such penalty is associated with the

SAFE BET switch. Therefore, you must choose between the two pushbuttons wisely. You might want to take a chance initially and pull ahead. Once you have established an early lead, you can play it safe and use only the SAFE BET switch. The first contestant to reach the FINISH position is the winner. At that point, his opponent’s pushbuttons are disabled, so no further moves can be made.

About the Circuit. The schematic diagram of To The Races is shown in Fig. 1. One half of IC1, a 556 dual timer, operates in the astable mode and provides clock pulses for control LED’s LED3 and LED4, which correspond to the SAFE BET switches (S3 and S4). Clock signals for LED1 and LED2, which

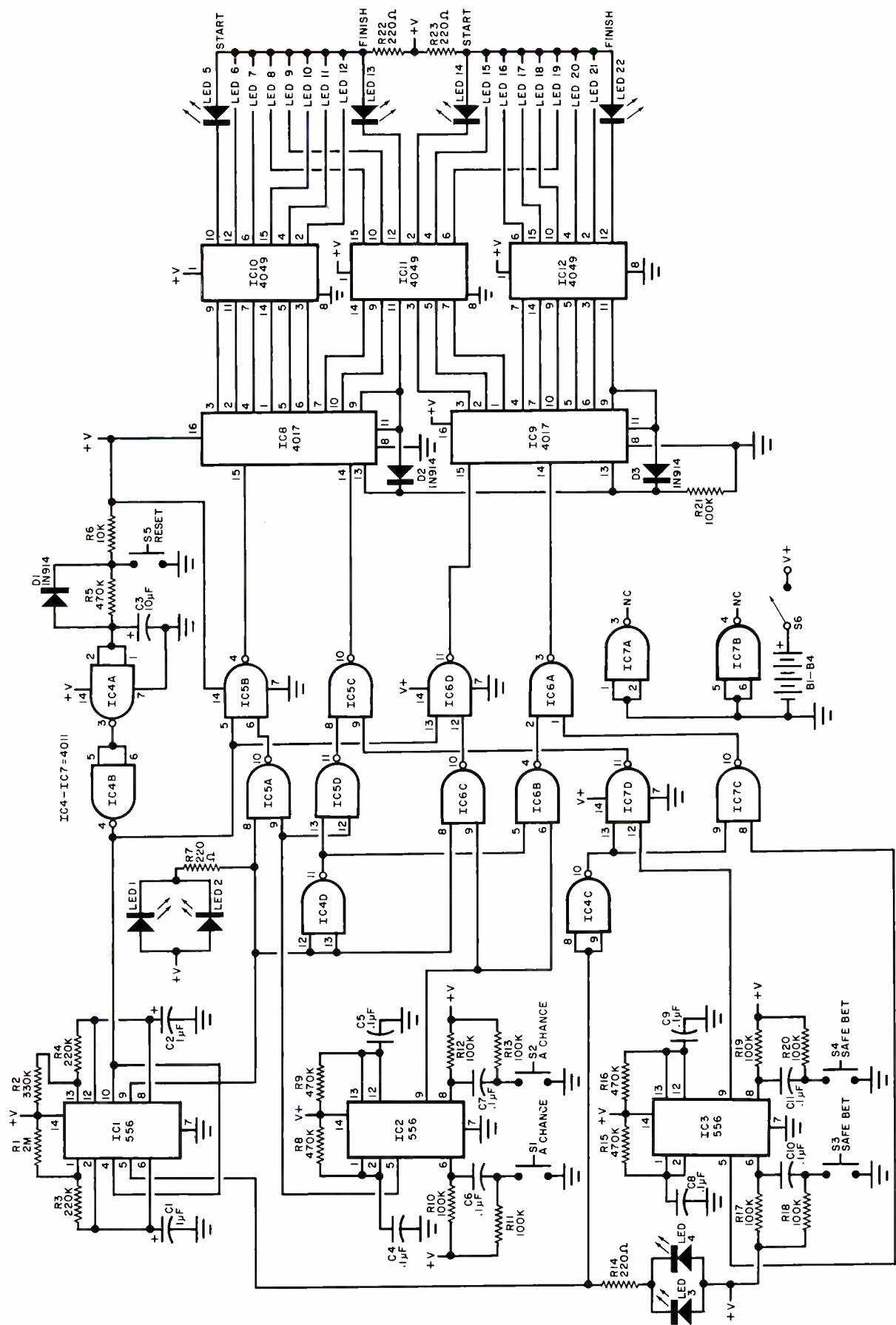
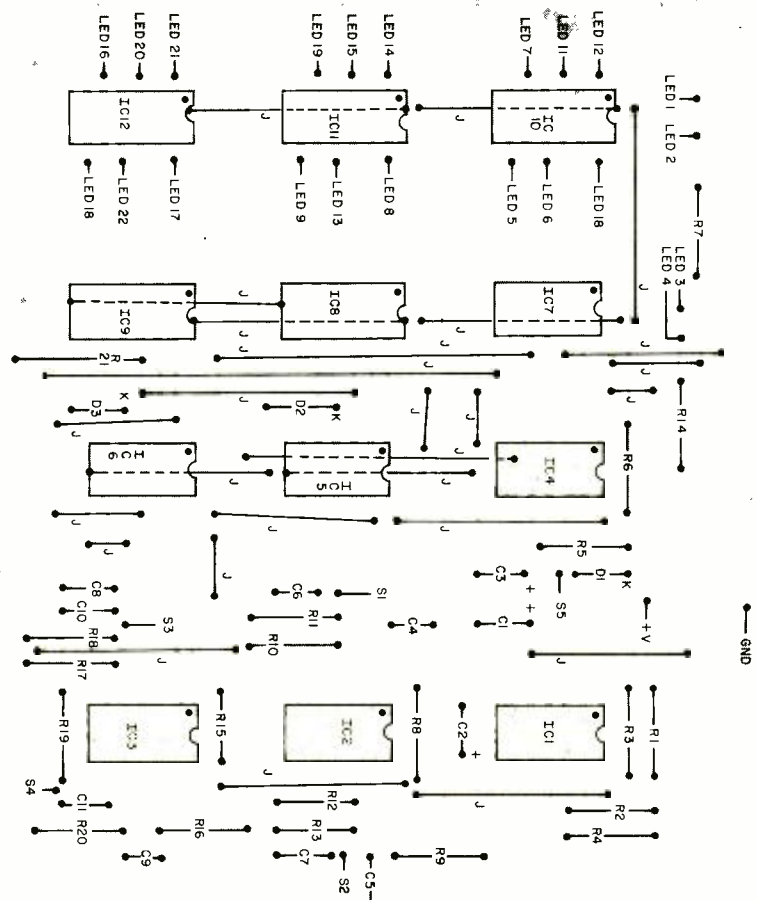

Fig. 1. Schematic of "To The Races" shows how circuit works. For Parts List, see next page.

PARTS LIST

B1 through B4—1½-V "C" cell
 C1, C2—1-μF, 25-V electrolytic capacitor
 C3—10-μF, 25-V electrolytic capacitor
 C4 through C11—0.1-μF disc ceramic capacitor
 D1 through D3—1N914 silicon diode
 IC1 through IC3—556 dual timer
 IC4 through IC7—4011 quad 2-input NAND gate
 IC8, IC9—4017 decade counter/decoder
 IC10 through IC12—4049 hex inverting buffer/converter
 LED1 through LED22—20-mA red LED (TIL-32, or equivalent)
 The following are ¼-watt, 10% tolerance carbon resistors:
 R1—2 megohms
 R2—330,000 ohms
 R3, R4—220,000 ohms
 R5, R8, R9, R15, R16—470,000 ohms
 R6—10,000 ohms
 R7, R14, R22, R23—220 ohms
 R10 through R13, R17 through R21—100,000 ohms
 S1 through S5—Normally open, momentary-contact pushbutton switch
 S6—Spst toggle switch
 Misc.—Battery holder, 14- and 16-pin DIP IC sockets, LED holders (NSL001) or rubber grommets, suitable enclosure, printed circuit or perforated board, hookup wire, solder, etc.
 Note: The enclosure used, Model DMC-1, is available from Continental Specialties Corp., 44 Kendall Street, Box 1942, New Haven, CT 06509.



correspond to A CHANCE switches S1 and S2, are generated by the other half of IC1, also operating in the astable mode. These clock signals are inverted by IC4D and IC4C, respectively. Contact debouncing for the A CHANCE and SAFE BET switches is performed by the four monostable multivibrators comprising dual timers IC2 and IC3, respectively.

NAND gates IC4A and IC4B form a noninverting buffer on the RESET line. When RESET switch S5 is closed, C3 rapidly discharges through D1, causing IC1, IC8, and IC9 to reset. Opening S5 allows C3 to charge through R5 and R6. When the voltage across the capacitor reaches the logic one threshold (one half the 6-volt supply voltage), the output of IC4B goes high, enabling the previously reset IC's. Capacitor charging time is about two seconds. This delay allows one contestant to reset the game and prepare for play so that neither contestant gains an initial advantage.

If S1 (A CHANCE) is closed while pin 9 of IC1 is low and LED1 and LED2 are glowing, a pulse is transmitted through NAND gates IC5C and IC5D to pin 14, the CLOCK input of IC8, a 4017 CMOS decade counter/decoder. If pin 9 of IC1 is high and LED1 and LED2 dark when

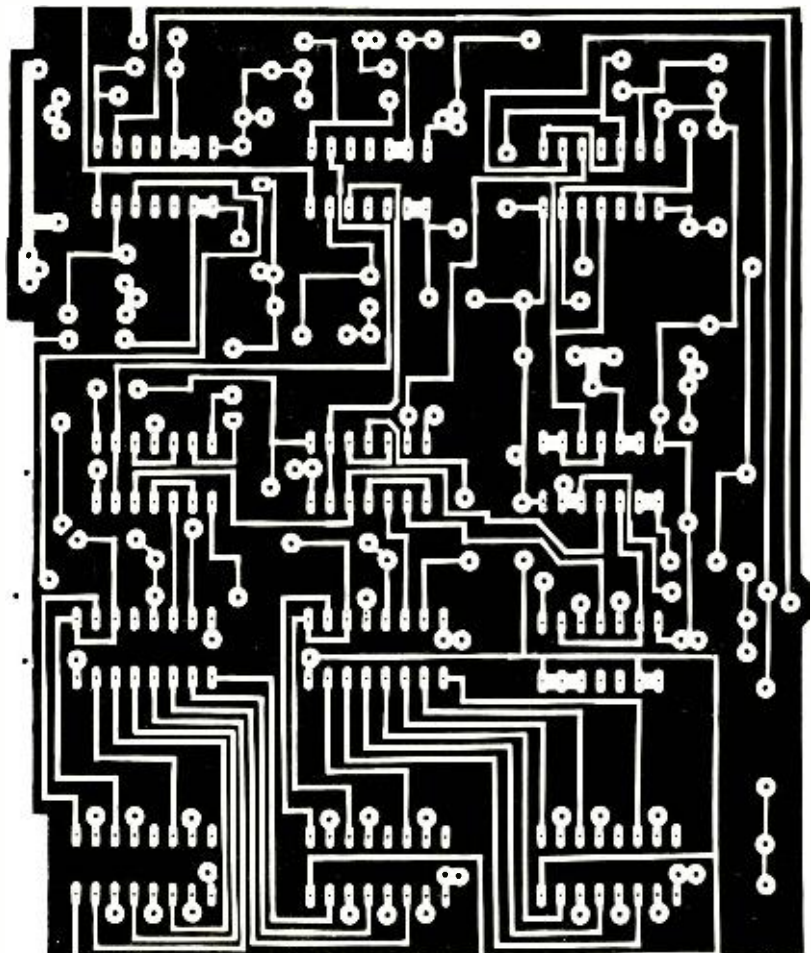

Fig. 2. Pcb board etching and drilling and component (top) guides.

S1 is closed, the output of IC5A goes high and resets counter IC8. Closing S4 (SAFE BET) when pin 5 of IC1 is high and LED3 and LED4 are dark has no effect on pin 15 (the RESET input) of counter IC8. This functional description applies equally to IC9, S2, and S3, the other contestant's decade counter/decoder and switches, respectively.

As each counter receives clock pulses, it counts upward and the successive decimal outputs go high. The inverting buffers (IC10A through IC12F) connected to the counter outputs change state in turn, so that the counter outputs that are high drive the buffer outputs low. When buffer outputs are low, they sink current for the race track LED's (LED5 through LED22) connected to them. Current limiting for the LED's is performed by R22 and R23. Only one limiting resistor per row is required because only one LED per row is on at any time. When pin 9 of either counter goes high and FINISH LED13 or LED22 glows, the OR gate formed by D2, D3, and R21 causes the ENABLE input (pin 13) of both counters to go high. This freezes the counters and prevents further triggering of either one.

Construction. Printed circuit (guides shown in Fig. 2) perforated board, or Wire Wrap techniques can be employed to duplicate the circuit. The use of IC sockets is recommended. Be sure to observe the polarities of all IC's, diodes, and electrolytic capacitors, and to exercise care when handling the CMOS devices. The author's prototype was housed in a Continental Specialties Corporation Model DMC-1 case. However, any enclosure large enough to house the components and battery power supply can be used. Drill and label the front panel of the enclosure using the photograph of the prototype as a guide. Use LED holders or rubber grommets to retain the LED's in place.

Use. Close power switch S6 and RESET switch S5 in that order. Both START LED's and the four control LED's will glow. Two seconds later, the control LED's will start to blink, signalling that play can begin. The "on" time of the LED's and switch conditioning one-shots have been chosen to be close to the average person's reaction time. Therefore, both contestants will have to watch the blinking LED's and anticipate when they will glow. After a few initial games, you will become adept at play and ready for serious competition when you go "To The Races." ◇

DECEMBER 1977



Model AT15Sa/H Dual Magnet Stereo Cartridge pre-mounted in Universal tone arm headshell

To find out how much better our cartridge sounds, play their demonstration record!

There are some very good test and demonstration records available. Some are designed to show off the capabilities of better-than-average cartridges... and reveal the weaknesses of inferior models. We love them all.

Because the tougher the record, the better our Dual Magnet™ cartridges perform. Bring on the most stringent test record you can find. Or a demanding direct-to-disc recording if you will. Choose the

Audio-Technica cartridge that meets your cost and performance objectives. Then listen.

Find out for yourself that when it comes to a duel between our cartridge and theirs... we're ready. Even when they choose the weapons!

What you'll hear is the best kind of proof that our Dual Magnet design and uncompromising craftsmanship is one of the most attractive values in high fidelity. For their records... and yours!



audio-technica®
INNOVATION □ PRECISION □ INTEGRITY

AUDIO-TECHNICA U.S., INC.
Dept. 127P, 33 Shiawassee Avenue, Fairlawn, Ohio 44313
In Canada: Superior Electronics, Inc.

Ohio Scientific advances the state-of-the-art of small computers.

From our inexpensive 8K BASIC in ROM Challenger IIP to our powerful triple processor Challenger III, Ohio Scientific offers a full range of products that are technologically superior to anything available on the market today.

Challenger IIP

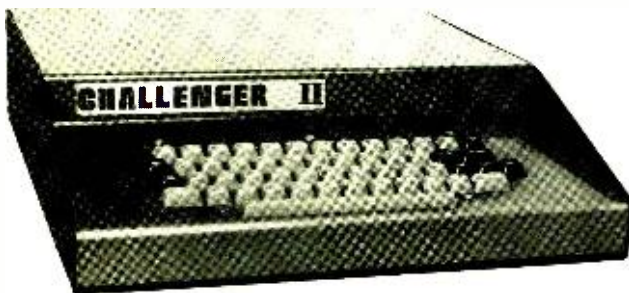

Challenger IIP from Ohio Scientific is our unique personal computer with BASIC in ROM and 4K RAM for programs in BASIC.

Complete with audio cassette interface and a full computer keyboard, Challenger IIP can be connected to a home TV via an RF converter and it's ready to go.

Challenger IIP comes fully assembled and tested for only **\$598.00**.

Challenger II



Challenger II from Ohio Scientific is a disk based computer capable of storing up to 500,000 bytes of information on an Ohio Scientific dual drive floppy disk.

Challenger II comes with 16K of RAM (the disk BASIC is automatically loaded into the computer so there is no need for ROM's) and our powerful Disk Operating System (DOS) which allows the computer to perform big computer functions like random access, sequential and index sequential files in BASIC, and I/O distributors which support multiple terminals and industry standard line printers.

And best of all a 16K Challenger II with serial interface, single drive floppy disk, (250,000 bytes) BASIC and DOS costs only **\$1,964.00** fully assembled.

Challenger III



Challenger III from Ohio Scientific is the revolutionary, new triple processor computer that allows you to run programs written for the 6502A, 6800 and Z-80 processors.

Incredible as this is, a disk based Challenger III costs only about 10% more than conventional single processor microcomputers. A 32K Challenger III with a serial interface and a dual drive floppy disk assembled and tested costs **\$3,481.00**.

OHIO SCIENTIFIC

11679 Hayden • Hiram, Ohio 44234

To order direct call 1-216-569-3241

For more information send for our Free, short form catalog, or send \$1 for our 64 pg. Small Computing Buyers Guide.

Special Focus on Home Computers

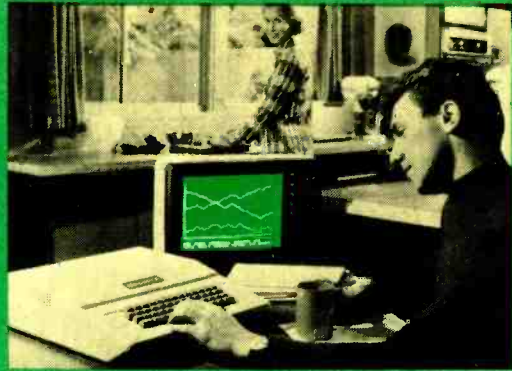

APPLE II Computer System

Basic Guide to Computer Buying

DID YOU know that there are more than 120 companies now manufacturing home computer equipment? And 60 of them actually make computers themselves. Moreover, most provide a bevy of options, while some offer a range of radically different models in their product lines. It's no wonder, then, that buying a home computer system is such a bewildering experience for so many people. So let's establish some sense of order for the buyer to follow in this chaotic, new marketplace.

STEP I

The first step in buying a computer for personal use is to decide whether: (a) you want to build one from a kit; or (b) you want to purchase a wired, checked-out system.

If you choose approach (a), you can save about \$200 to \$300 on machines that sell for about \$900 in wired form. That's a fat savings, but you substitute assembly time and face some possible frustrations and delays if the final product doesn't work properly the first time you use it. You do, though, gain a better idea of how the unit goes together (useful for further modifications and servicing) and have the pleasure of "rolling your own." It's not all that difficult, either. Assembling a microcomputer is easier than building an audio preamplifier.

Whatever your decision, you will have eliminated some confusion since some manufacturers offer *only* wired models, and others offer *only* kits. Many makers offer both versions, of course. Interestingly, there are slightly more wired models available today than there are kit models; but this does not necessarily reflect the number of units sold.

STEP II

The next decisions you face are:

"What kind of home computing do I want to do now and in the near future?" and "Will I want a basic system that can be expanded indefinitely, or one which is pretty complete and ready to plug in and use as soon as I get it?" Your answers to these questions will help you evaluate the many types of systems available.

If, for example, you want to experiment with and learn about computers and their inner workings, with little concern for large-scale data-processing, you can get a *tutorial system* for as little as \$100. Examples are National Semiconductor's SC/MP, RCA's COSMAC 1802 (as used in PE's "Elf" computer), MOS Technology's KIM-1, Paia's 8700, IMSAI's 8048, and E&L's MMD-1. Such systems usually have calculator-type keyboards for input of programs written in the computer's own "machine code," in either hexadecimal (base-16) or octal (base-8) numbers. Some systems have batteries of switches instead. Readout is most often on seven-segment LED's.

Despite their similarities, such systems differ widely in their capabilities. The "Elf" has graphics capability, IMSAI's 8048 has on-board relays to control household devices, and the E&L MMD-1 has a "breadboard" area for experimenting with computer circuits. Some systems even provide for future expansion and the use of high-level programming languages such as limited BASIC; examples include KIM-1 and SC/MP.

These all-on-one-board computers can easily be confused with the "single-board computers" sold for engineering development use, such as the Motorola "Exorcisor" and Intel "SBC." These are less complete, lacking keyboards and readouts.

Chances are, that you'll learn more

about computers with the tutorial type than types discussed later, though tutorial systems are less convenient to use and expanding them into full-blown computers can eliminate their price advantages. Since they usually come without enclosures, they're not easily blended into your living room decor, either; but they do give you a great start in hobby computing with only a small investment.

Programming in machine-language, as you must with most tutorial computers, teaches you a great deal about how the computer works; but it's a slow, demanding process. If you prefer to use a high-level language such as BASIC for writing and running useful and/or entertaining programs, you'll probably want a computer in the next major category: *mainframes*.

These may be likened to separate stereo components—a main power amplifier (the mainframe itself) a separate preamplifier with controls (the terminal) and so on. Most of the full-blown home computers sold today are of this type. It offers the greatest equipment-selection flexibility: BASIC language, internal memory expansion, provisions for plugging in a video terminal, printer, video display module, floppy disk, etc. This is where the home computer industry first started, with the introduction of the MITS "Altair." Here one also finds a myriad of different brands, including Imsai, Heath, Cromemco, The Digital Group, Southwest Technical Corp. and Polymorphic, among many others.

Mainframes are usually built around a *motherboard*, with slots to hold perhaps a dozen or more additional circuit boards. Most commonly, these boards will hold additional memory, allowing the use of longer programs and the handling of more data, or extra "I/O" (Input/Out-

put) ports for connection of such peripherals as printers and terminals. But you'll also find boards to display the computer's output alphanumerically or graphically on a video screen, to control external devices, to communicate with other computers by telephone, to accept vocal input or give "spoken" output, to play music, to measure frequencies or temperature, to tell time, and to read or write PROM's (memories which don't "forget" their programs when the computer is turned off).

Some mainframes have *front panels* chock full of lights and switches, while others are essentially devoid of them except for "power" and "reset." The switches allow one to program the computer directly—a laborious process, but better than nothing if you don't have a separate terminal. They're an aid in troubleshooting, though. With switchless front-panel machines you must have an external terminal. Otherwise the computer cannot be used. Usually, this host of front-panel switches raises the price of the mainframe. A few manufacturers, however, charge more for "turnkey" models without front-panel operation.

The next type is the all-in-one computer, such as Processor Technology's "Sol," Apple Computer's "Apple II," Radio Shack's "TRS-80," CompuColor's "8001," Ohio's "Challenger," and Commodore's "PET." The PET is a true all-in-one, coming with a built-in 9-inch black-and-white video monitor, keyboard and audio tape cassette machine for program storage. CompuColor's \$2750 computer terminal features a 19" color video display, full video terminal, 8-track "Floppy Tape" cartridge and a keyboard in a separate housing. The other machines mentioned have built-in keyboards but require separate TV monitors. Therefore, some of these models may be compared to the hi-fi industry's stereo FM/AM receivers, while others could be likened to integrated amplifiers or control amplifiers.

What you gain with a computer of this type is neatness and physical simplicity. Naturally, you trade off some choice of video monitor or keyboard and may wind up with less internal space for the addition of more memory or other module boards. Also, except for "Sol" and "Challenger," the computers in this group are not available as kits.

STEP III

Program support is vital. Without programs, you can't run a computer. And writing your own programs, even if you already know how, can be time consuming. Most computer manufacturers offer

a number of programs for their computers. Moreover, other sources make available such "software."

Programs written for other computers can be adapted for yours if both computers are built around the same microprocessor unit (MPU). So program availability is partially a function of your MPU's popularity. The 8080 is the most popular MPU, used by about 21 manufacturers, at last count. This is followed by the 6502 and Z-80, which have garnered about 12 companies each. (The Z-80 can also use most 8080 software, but not vice versa.) The 6800 follows with 7 companies, while the 1802 has 5 computer makers using it. The SC/MP is used by two companies. Others, such as the LSI-11, are only supported by one company in the home computer field.

But numbers alone don't tell the whole story. It makes a difference which companies support each chip, as well as how many companies do. Models with Intel's 8080 are offered by MITS, Processor Technology, Heath, IMSAI, Polymorphic, Parasitic, HAL, CompuColor, and Vector Graphic, to name just a few. The Z-80 (from Zilog, a group of designers who broke off from Intel) has Radio Shack, Cromemco, and Technical Design Labs, among others. Motorola 6800 users include Southwest Technical Products Corp (SWTPC), MITS and M&R. The MOS Technology 6502 and its closely-related 6503 are incorporated into computers from Commodore (MOS Technology's parent company), Ohio Scientific, Microcomputer Associates, and Apple, with more joining them. RCA and Netronics are among the companies using RCA's 1802 in kits.

The LSI-11, used only by Heath, is made by Digital Equipment Corp., the leader in the commercial minicomputer industry. It employs the same programs as DEC's PDP-11, which means there is a great deal of very useful software already available for it. The SC/MP, too, is supported by a major manufacturer—National Semiconductor Corp.—which makes the chip and also provides great support for it.

Mainframe producers do not always supply wholly satisfactory documentation, but such information can be expanded by seeking out other sources such as the chip manufacturer and a variety of available texts.

There are some MPU's not noted because there aren't enough end-users to make computers based on them wise choices for most hobbyists. It's helpful to have plenty of users like yourself who can get together at a computer club and

exchange operating, modifying, and servicing ideas, as well as trading of programs and discussions about the latest hardware and software. However, there are many new models that will eventually have many users.

At this time, there are more 8080-based computers in use among hobbyists than any other type; probably more than half of the total. (A Homebrew Computer Club 1976 survey of 100 members found 53 using the 8080, for example.) As a consequence, the 8080 has hung on for some time now as the MPU employed by many computer manufacturers. Other types, however, are indeed making inroads. The 6800-based machines appear to be an easy second in numbers already in the field. However, don't sell the other MPU's short. As the market expands, more software will become available for them.

Aside from program support, the choice of MPU makes surprisingly little practical difference to the average hobbyist. Choosing a computer for its MPU is like shopping for a car on the basis of its engine—usually, you first find the car you're interested in and then, perhaps, give some consideration to the engine. But since some readers are intent on weighing the various MPU's, let's briefly explore them:

The computing "power" of an MPU chip is a function of the number of its internal registers, its speed, and the size of its instruction set. More registers and more instructions mean you can shorten your programs by doing directly, in one step, operations which might take several steps otherwise.

Speed is not very important in most home computing applications. The difference between an average-speed MPU and an extremely fast one will rarely be obvious unless you're either running very long, involved programs or using the computer to control a device whose status changes rapidly.

Some MPU's require as many as three different supply voltages; others require only one. The number of power supplies needed will influence the cost of the computer and the time required to build it from a kit.

STEP IV

Another factor that may or may not be important to you is the computer's *bus structure*. This is the system of leads that carry signals and power to various parts of the computer. The first powerful hobbyist computer, the Altair 8800, uses a 100-pin bus with its 8080 MPU. Manufacturers of add-on equipment who moved into the field naturally made

module boards that mated with what was then the only hobby-computer bus. Computer mainframe makers who subsequently entered the hobbyist market with 8080-based machines also used the "Altair bus," calling it the "S-100" bus. Even more module boards were made for it. Thus, today, there is a wider range of module boards (for memory expansion, vocal interfaces, etc.) that can plug into this bus than into any other.

Bus pinouts have to match, of course, so the 100-pin plug-ins cannot be used on a computer with a different bus structure, such as SWTP's 6800 model, Radio Shack's new entry, Heath's recently introduced computers, or others that utilize different bus systems. Many of these companies have their own lines of module boards and peripherals to match their mainframes. Aside from the 100-pin bus, only SWTP's 6800 computer has drawn the attention of add-on manufacturers thus far. Other buses will probably attract multi-manufacturer support in time.

STEP V

The keypads or switches of tutorial or front-panel computers are useful for machine-language programs. But if you want to use a high-level language such as BASIC (which is much easier to learn), you'll need both a means of loading the program that lets the computer understand BASIC and a typewriter-style keyboard to address that program once it's in.

The program loaded will stay in the computer unless the computer is turned off or there is a blackout. More and more hobbyists, however, are paying an extra buck to have BASIC in ROM so that it will not be eradicated in the event power is shut down. This is sometimes called "firmware" as opposed to "software," which is what tape would be called.

There are different levels of BASIC, each usurping some of your computer's memory (which costs about \$40 or so per kilobyte). The more memory it requires, the greater the instruction and data-handling power it provides. Tops is 12k, followed by 8k, 4k, and 2k (called "Tiny BASIC"). To this you should add at least 2k more memory for your own programming use.

Most mainframe manufacturers have a form of BASIC available. Some are better than others. Also, the language differs slightly from one manufacturer to the next. As a result, if you run someone else's program based on another brand's BASIC on your computer, you'll have to do some editing. This sounds

easy, but it could be very frustrating as you search for the correct command. For example, on one form of BASIC, the word "CLEAR" is used to wipe out whatever programs are in memory. In another BASIC version, the word is "NEW." This is another reason why many computer hobbyists band together in choosing a particular model. It makes it easier to trade software.

STEP VI

There is a *potpourri* of other factors to throw into your computer buying evaluations. For example, you will probably run out of memory in time—no one ever seems to have enough memory. So look ahead if you've gone past the tutorial-type computers, to the day you will require more memory. Check how much can be added inside the computer (usually by plugging more memory boards into the motherboard) and, if that's limited, whether more memory can be added externally.

Given some practical computer operating experience, you'll surely want some means of *mass storage* for storing programs outside the computer. This protects you from having your programs wiped out by a blackout or a blown fuse, and allows you to write and store more programs than the computer could possibly hold at once.

Here you have a choice of a paper tape reader/performer, an audio cassette interface, or a floppy disk. There are many different cassette storage methods, each, of course, incompatible with the other. For example, there is the "Kansas City Standard" that's not really a standard but used by many hobbyists. Then there's the "Tarbell" type, which is much faster than the KC method. And a few manufacturers have their own special audio tape cassette systems for recording data. Here, too, it's best to check your friends or local computer stores to see which one is best to use in your area for program exchange purposes. Floppy disks are the most useful, but also the most expensive. Even if you own one you might also want a cassette or paper tape system for program interchange. Most hobbyists don't move up to "floppies" till their systems are quite far along.

For high-level languages, you also need a keyboard (separate or on a terminal), and either CRT or printer output. CRT terminals are quieter, faster, and don't use up paper. (But printers give you a permanent record.) Check CRT's for number of lines of text on screen—the more the merrier. Cursor control and page mode help you edit, too. For both

printers and CRT's, check the number of characters per line (again, more is better). If you need both capital and lower-case letters, get a terminal whose "character set" includes 96, not just 64 different ASCII characters. (Don't confuse this with the number of characters per line.)

STEP VII

If you have an opportunity to view computer equipment you're considering buying, there are a few other things to look for. For example, check the keyboard to see if you like the way it performs; listen to the noise level the microcomputer produces (some fans can be very noisy); check a video monitor for reading ease (both size and resolution). If it's a kit, check the assembly instructions to see if they're clearly written and satisfactorily illustrated.

We won't belabor cost here, because that's a judgement *you'll* have to make. It's your pocketbook. But do weigh in all the factors so that you get the most value for your money. There's no set weighting factor for each consideration simply because every person probably places more value on one factor than another—whether it's appearance, the ready availability of program tapes, service, what most of the local computer hobbyists own or plan to buy, and so on.

STEP VIII

Lastly, the manufacturer's reputation should be considered. Has the company been in business for many years? This is a new field so many will not have been, but a company that has been around for awhile evokes a feeling of confidence. Is there a local service center for warranty or out-of-warranty work? It's always nice to be able to talk to someone eyeball-to-eyeball if necessary. Besides, who wants to pack and ship a heavy, bulky product across the country if it can be avoided? Can someone at the factory be reached by telephone in the event of a problem? And if so, are they courteous and helpful? Is the company's general image a good one, as judged from its advertising and promotional literature, and from talking to computer store personnel and computer hobbyists? Balance your judgements with care, though. Some companies don't offer especially good communications with customers, but make up for it in very good product value.

One final word—get a copy of our latest annual, the 1978 ELECTRONIC EXPERIMENTER'S HANDBOOK. It includes a complete home computer product directory for mainframes, peripherals and module boards. ◇

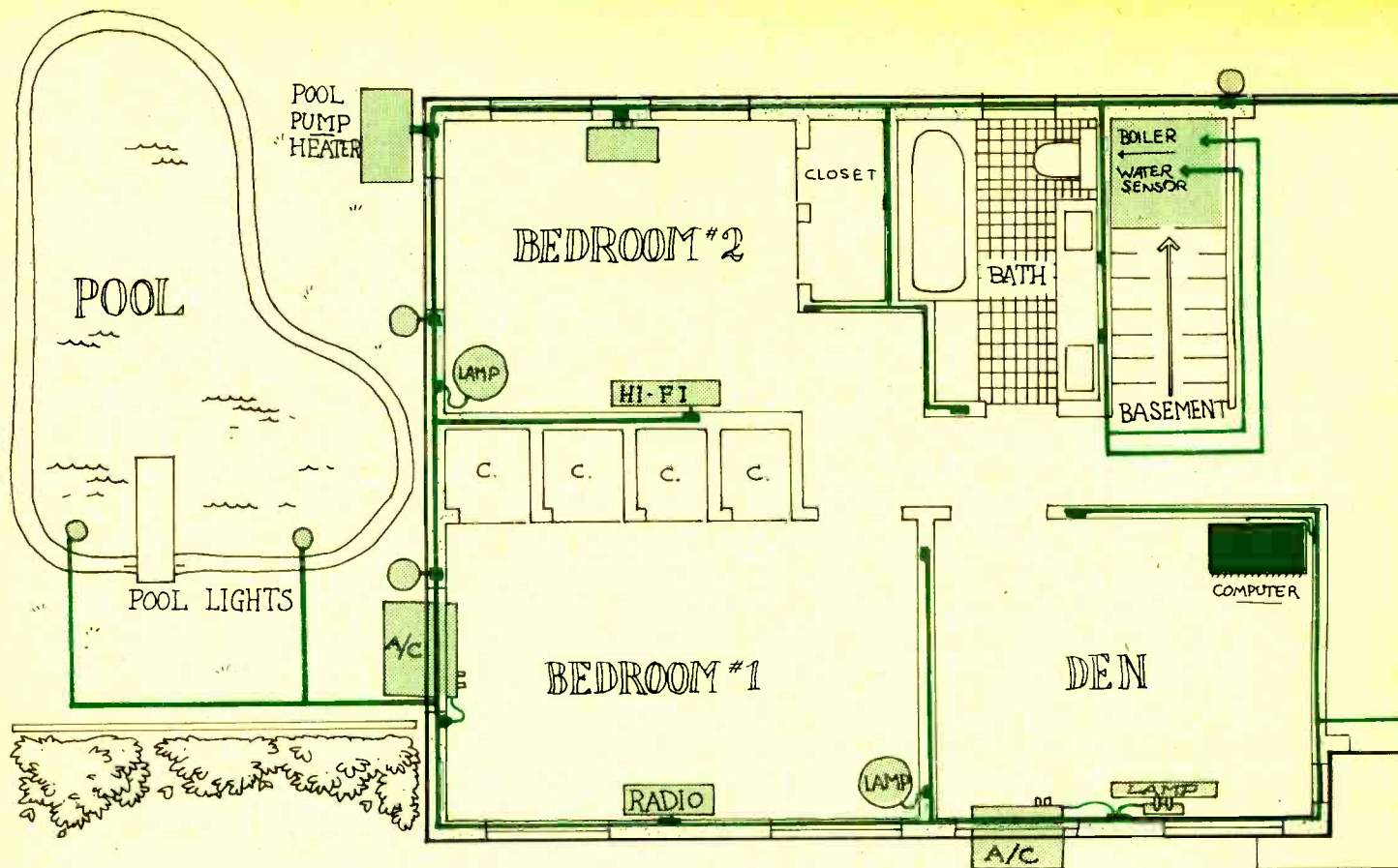

Using Existing House Wiring

BY DAN SOKOL, GARY MUHONEN, AND JOEL MILLER

SOME HOBBYISTS with their own computers at home, use them to play sophisticated games. Others use them for "number crunching." Still others use them simply to learn more about working with microcomputers. Where many computer owners fail to make use of their machines is in the control of electrical appliances in their homes. With the recent introduction of several "controller" boards, in which the computer can activate a power switch, such as a relay or SCR, under program control, the computer's role in the home will undoubtedly change. However, there still remains the frustrating task of wiring the output lines of the computer to the controlled appliances in other rooms.

The Intelligent Remote Controller described here makes room-to-room control wiring a relatively simple matter. With a controller board plugged into any Altair 8800/S-100 bus system, a special ac adapter is connected to the controller board and plugged into the ac line. Commands given by the computer program are sent via the controller to the ac

adapter, which impresses the digital waveform on the ac line at the wall receptacle. Hence, instead of running cable all through your house, you simply take advantage of the already existing house wiring to route signals to various remote appliances.

Special dual-channel remotes, which can be connected to any wall outlet in the premises for both power and reception of the digital control signals, are used for the actual power control. Each remote has two conventional, separately controlled, ac sockets that can accommodate any electrical appliance rated at 500 watts or less. Of course, the output circuits can be modified to handle higher-power appliances.

The remotes (up to 64 with this system) constantly monitor the ac line for commands intended for them. When a command for a particular remote is detected, it controls one or both of the appliances plugged into it, turning on or off the power. The remote then "reports" back to the controller on the status of the selected device.

In this first article, we cover the controller circuit (Fig. 1). There are two major sections in this device—the controller itself and a self-calibration circuit that is used for setting up the remotes.

The power supply for the controller board is shown in Fig. 2. It is typical of most computer bus boards.

About the Circuit. The controller occupies three I/O ports. These ports are assigned by board jumpers, with the input and output sharing the same address and the status port being the input port minus one.

In this bidirectional system, the user can "poll" each remote to determine its status. Two ports are used for both writing data to and receiving data from the remotes. Since decoding circuitry is built into each remote, up to 64 remotes can be controlled by the system.

The filter/amplifier/limiter circuit that is shown in Fig. 3 accepts an input from the ac adapter, passes only that portion of the signal above 20 kHz, and conditions it for use by the following data-

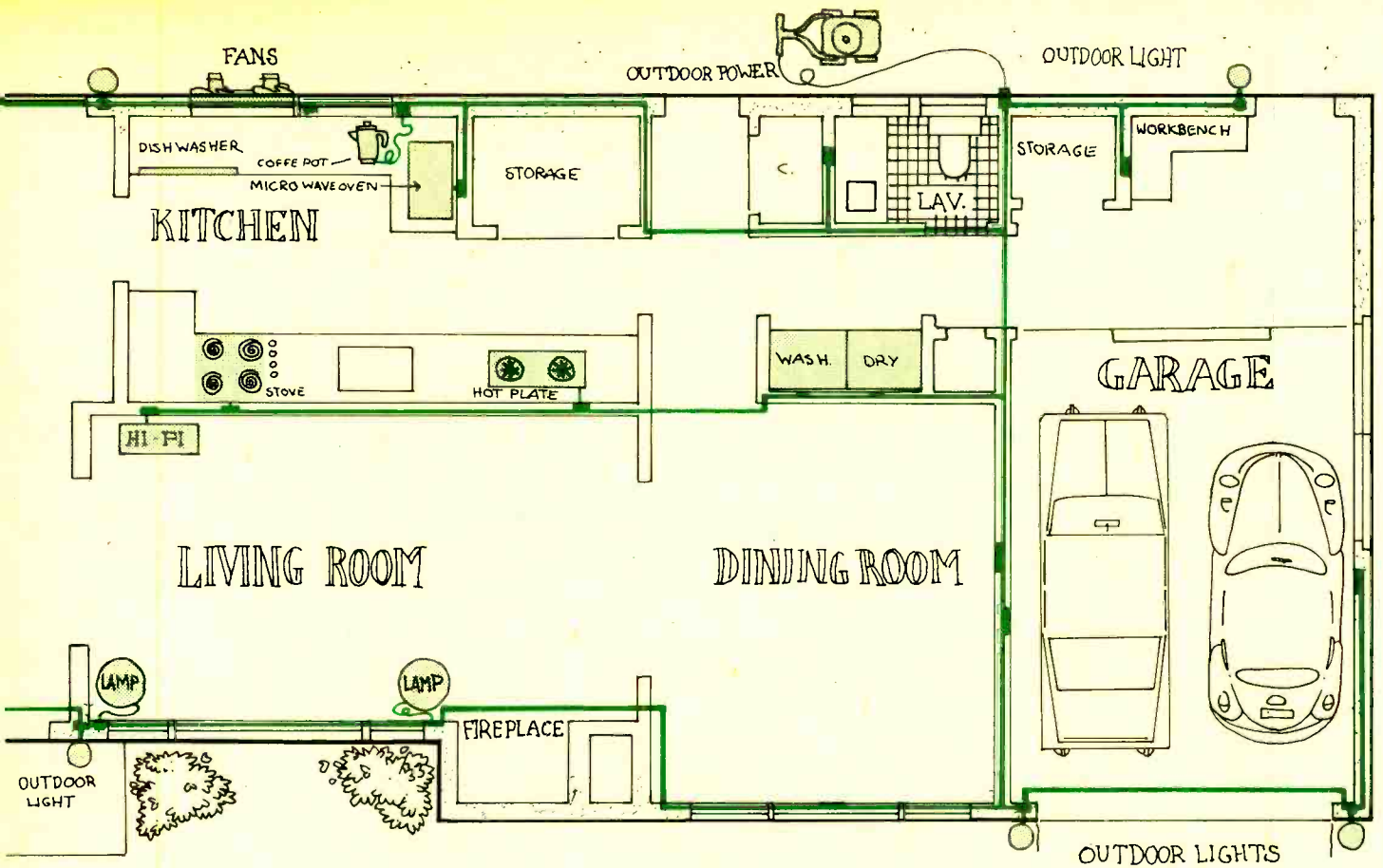

for Computer Remote Control

PART I

recovery PLL (phase-locked loop). Although the amplifier's gain is set at 5, its output is diode-clipped at 0.7 v_{cc} to prevent the PLL from being overdriven and eliminate false triggering. Transistor Q4 acts as a switch that shuts down the amplifier during calibration and during the transmission of data.

The data-recovery and clock-generator circuit consisting of IC4, IC6, and IC8 recovers the transmitted data and generates the transmit frequency. When data is present, the locked output from pin 8 of the PLL outputs the data, which is sent to the UART receiver.

To generate the transmit frequency, the output of the free-running vco in the PLL is buffered by IC6 and used as the transmit frequency by AND'ing it with the UART data before the data is sent to the ac line. In addition, this frequency is divided by 16 by IC8 to generate the clock for the UART and the reference clock for the self-calibration circuit.

During the receive cycle, UART IC18 is clocked by the frequency of the vco so that the vco in the receiver locks onto

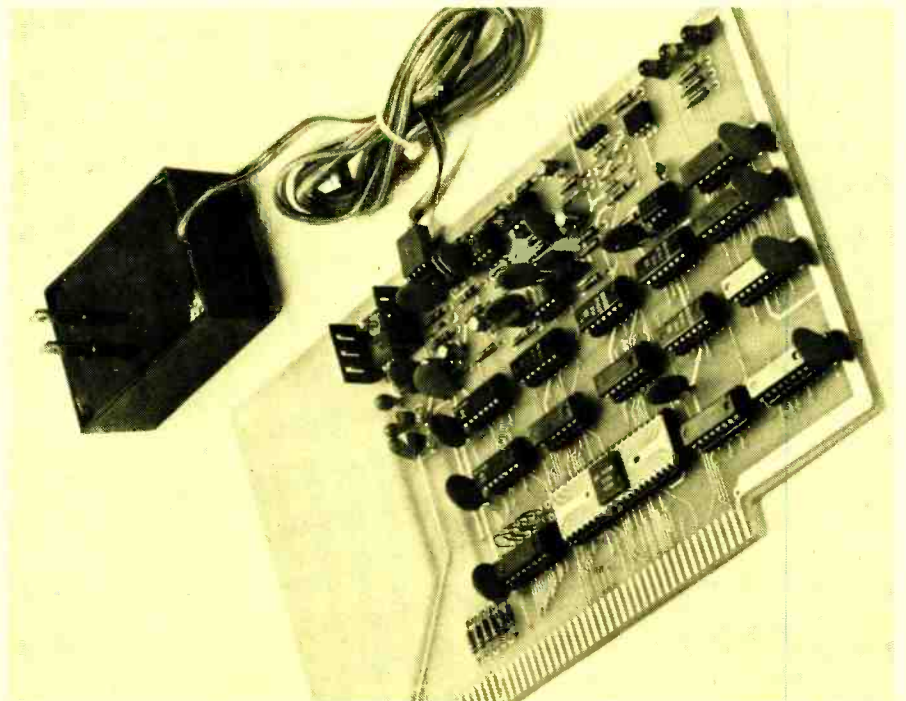

Photo of prototype controller board with adapter plug into ac line.

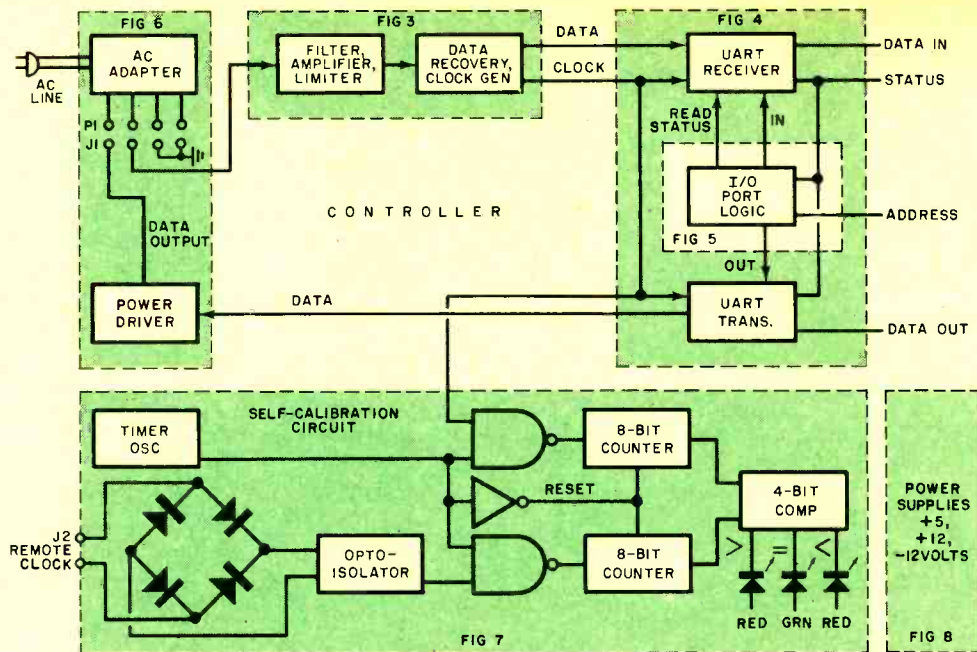

Fig. 1. Overall logic of controller that also includes self-calibration circuit for remote oscillator alignment. Sections of the controller are referred to by figure numbers in which complete schematics are given.

PARTS LIST

C1 through C5, C10 through C14, C17, C18, C19, C25, C26—0.1- μ F disc capacitor
 C6—0.1- μ F disc capacitor
 C7—0.0056- μ F disc capacitor
 C8—0.39- μ F disc capacitor
 C9—0.01- μ F capacitor
 C15, C16—0.001- μ F disc capacitor
 C20, C21—15- μ F, 15-V tantalum capacitor
 C22, C23—10- μ F, 25-V tantalum capacitor
 C24—1- μ F, 35-V tantalum capacitor
 C27—1- μ F capacitor
 D1 through D7—1N4148 diode
 *IC1, IC2—NE535V op amp
 IC3—MCT-2 optoisolator
 IC4—567 phase-locked loop
 IC5—555 timer
 IC6, IC13—74LS04 hex inverter
 IC7, IC12—74LS32 quad 2-input OR gate
 IC8, IC9, IC10, IC15, IC16—74LS93 4-bit counter

IC11—74LS85 4-bit magnitude comparator
 IC14—74LS132 quad 2-input NAND Schmitt trigger
 IC17—8131 6-bit comparator
 IC18—TR1802 UART
 IC19, IC20—74367 tri-state hex buffer
 J1, J2—4-pin right-angle jack (Molex)
 LED1, LED3—Discrete red LED
 LED2—Discrete green light-emitting diode.
 Q1, Q2, Q4—2N2907 transistor
 Q3, Q5—2N2222 transistor
 The following resistors are 1/4-W, 10% tolerance:
 R1 through R7, R9, R19—2200 ohms
 R8, R12, R13, R18, R29—1000 ohms
 R10—390 ohms
 R11—10 ohms
 R14, R15, R22 through R25, R34—3300 ohms
 R16—3900 ohms
 R17—15,000 ohms

R20, R21—10,000 ohms
 R26, R30, R31, R32—100 ohms
 R27—4700 ohms
 R28—100,000 ohms
 R33—27,000 ohms
 RV1, RV2—V33MA1A voltage regulator (GE)
 VR1—7805 5-volt regulator IC
 VR2—79L12 12-volt regulator IC
 VR3—78L12 12-volt regulator IC
 Misc.—Printed circuit board; sockets for IC's; heat sink and mounting hardware for VR1; interface adapter No. ACD-1; wire; etc.
 Note: The following is available from Mountain Hardware, Inc., P.O. Box 1133, Ben Lomond, CA 95005 (Tel.: 408-336-2495): complete controller kit, including ac interface module for \$149.
 *IC's are identified by letter "U" in parts placement guide in Fig. 8.

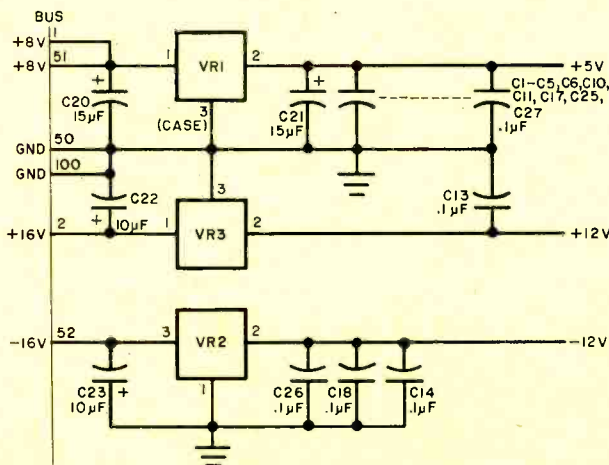

Fig. 2. Schematic of controller power supply.

the frequency of the vco in the transmitter and provides a stable source of the same frequency to the UART. This eliminates the need for expensive crystal oscillators and divider circuits.

The heart of the controller is the UART, shown schematically in Fig. 4. This circuit receives, transmits, and formats data that is sent between the computer and controller. The controller and each remote have their own UART's. Since the UART outputs are tri-state, both the status and the data information can be AND'ed to the same bus.

When power is first applied, the UART is reset by the POC (power-on clear) signal on bus connector 99 after passing

through inverter *IC13*. The UART can be programmed to deal with 5-, 6-, 7-, or 8-bit words, can be set for odd or even or no parity, or the number of stop bits can be set to 1, 1½, or 2. In this circuit, the UART is set for eight data bits, odd parity, and two stop bits.

The transmitter portion of the UART removes the parallel data from the bus and transmits it serially to the power driver circuit. When transmitting a signal, TEOC (transmit end of character) from *IC18*, pin 24's signal is inverted and used to disable amplifier *Q5* in Fig. 3 to stabilize the vco.

The receiver portion of the UART accepts serial data from the PLL, converts it into parallel data, and checks for possible errors. The parallel output of the UART receiver is passed to the bus via tri-state buffers *IC19* and *IC20*.

The receiver section constantly checks its serial input line for a start bit, defined as a mark-to-space transition. When it receives this signal, it waits for a period of time equal to a half-bit period. Then it checks to see if the space is still there to determine if it is a valid start bit. If the start bit is not valid, the UART resumes searching. If the bit is valid, the next 10 bits are clocked into an internal shift register. The start and parity bits are removed before transferring the 8-bit data word to the output holding register. Finally, the UART sets a status flag when readout data is available and when an error is detected.

The three error flags are: receive pari-

Fig. 4. UART connection between controller and computer.

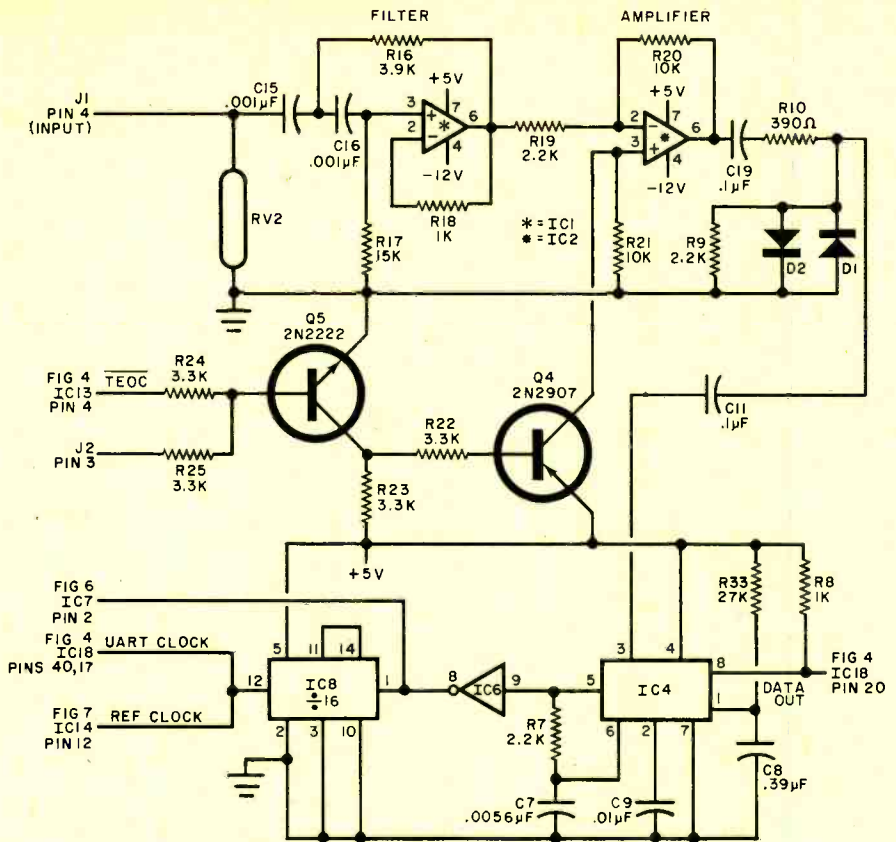
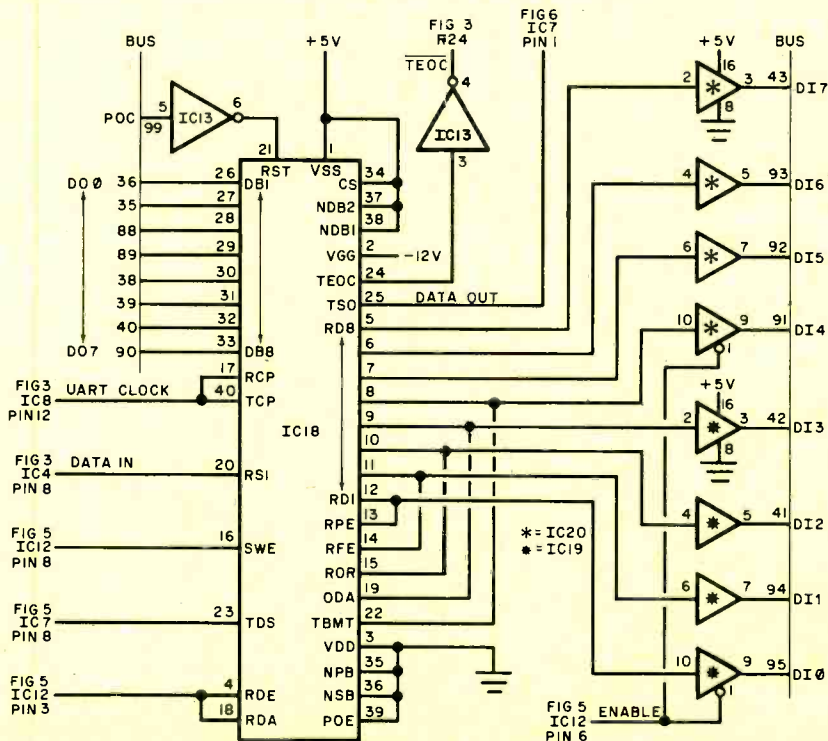

Fig. 3. Filter, amplifier, limiter, and data and clock recovery.

ty error, receive framing error, and receive overrun error. A receive parity error bit of 1 indicates that the data word in the holding register was received with a parity error. If the receive framing error bit is a 1, the word in the register did not have the correct number of bits. If the receive overrun error is a 1, the new word

has overwritten the word previously stored in the register before the old word was read out, indicating that this word has been lost.

Two other status bits are available: output data available (ODA) and transmit buffer empty (TBE). When ODA is a 1, data is available at the receiver's holding register. When TBE is a 0, the transmitter is busy.

The I/O port decoder shown in Fig. 5 determines if the computer is communicating with the controller and prepares the controller for transmitting or receiving data. The output of this circuit causes the controller to place data on or read data from the computer bus.

The circuit acknowledges three commands internal to the controller: read status, read the UART receiver's holding register into register A of the computer, and transfer register A data into the UART buffer and begin the transmit cycle. These internal commands are related to system software commands IN and OUT (the assembly language mnemonics for communicating between the computer and controller). Integrated circuit *IC17* and its associated logic determine the I/O port selection, while the remaining integrated circuits in Fig. 5 decode the command from the computer controller.

The power driver, shown schematically in Fig. 6, provides sufficient drive for

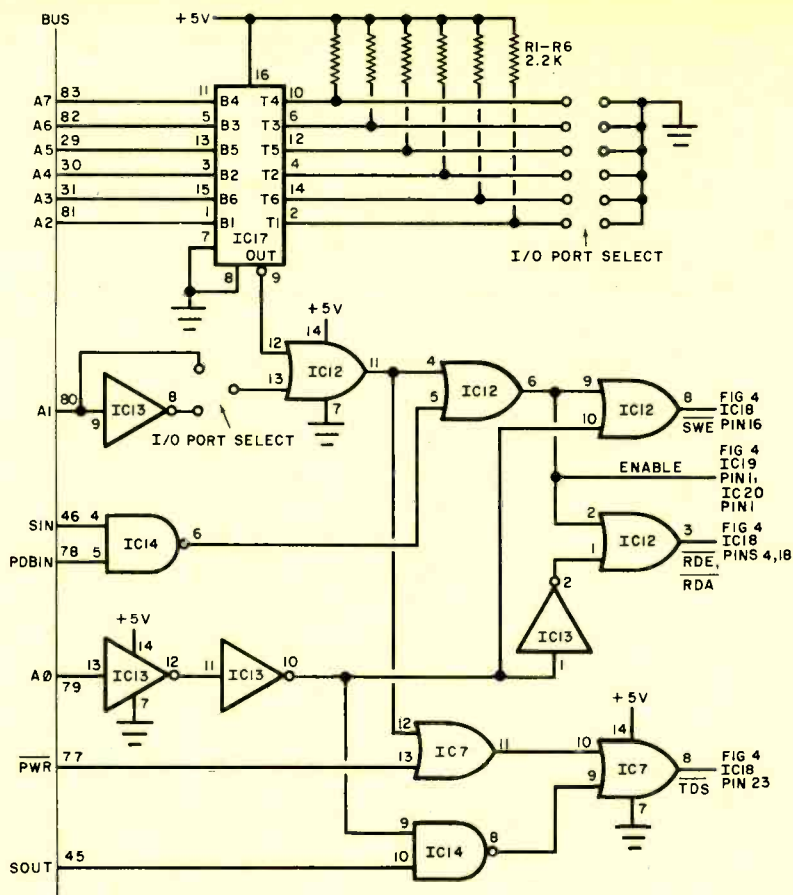

Fig. 5. The I/O port selection is made by choosing the jumper arrangement for the selected port.

the signal to ensure adequate reception at the remote receiver. The driver AND's the transmit frequency with the UART transmitter's serial output (TSO). The circuit then converts the TTL-level input signal into ± 15 -volt levels. The resulting signal is entered into the ac line via the ac interface adapter, which consists of a package that contains three capacitors and a tuned transformer that is resonant at 50 kHz. The adapter is connected to the controller via a four-conductor cable to connector J1.

For the system to function properly, the free-running vco frequencies must be within 4% of each other. If they are not, receiver overrun errors result in incorrect data. The self-calibration circuit shown in Fig. 7 is used to adjust the remote vco. The vco in the controller is not adjustable; it is used as the "reference" for the system. The self-calibration circuit visually indicates whether the remote vco is running faster, slower, or at the same rate as the controller's vco. This circuit also eliminates the need for a relatively expensive frequency counter to check both oscillator frequencies.

The UART clock on the controller board is used as the reference frequency, and the UART clock from the remote

is connected to the controller via J2. The remote is coupled through optical isolator IC3 to keep any line voltage from ap-

pearing on the controller board.

The signal from IC3 is shaped and gated by IC14 and then passed to counter IC15. Free-running oscillator IC5 provides control for IC14 and generates the reset pulse for the counters. This oscillator is set for a 1% duty cycle and provides a "window" to enable the reference clock (and its equivalent from the remote) in two eight-bit counters (IC9, IC10, IC15, and IC16). The counters are arranged as two eight-bit counter chains, and the long period of 99% of the IC5 output is the window that allows the counter to operate, while the short 1% period pulse resets both chains. The four most significant bits from each counter are compared in four-bit comparator IC11.

The outputs of the comparator are inverted and buffered by portions of IC6 and are used to drive three LED's. On the "less than" or "greater than" outputs, red-colored LED1 and LED3 glow. When the output is "equals," green-colored LED2 glows.

During calibration (described in Part II), a cable is connected between the controller and remote. It disables the analog sections and provides a signal path between the two boards. The analog section must be disabled to remove jitter from the vco's.

As the vco control potentiometer on the remote vco is adjusted, the period of time that the green LED glows becomes longer and longer, indicating that the two vco's are running at the same frequen-

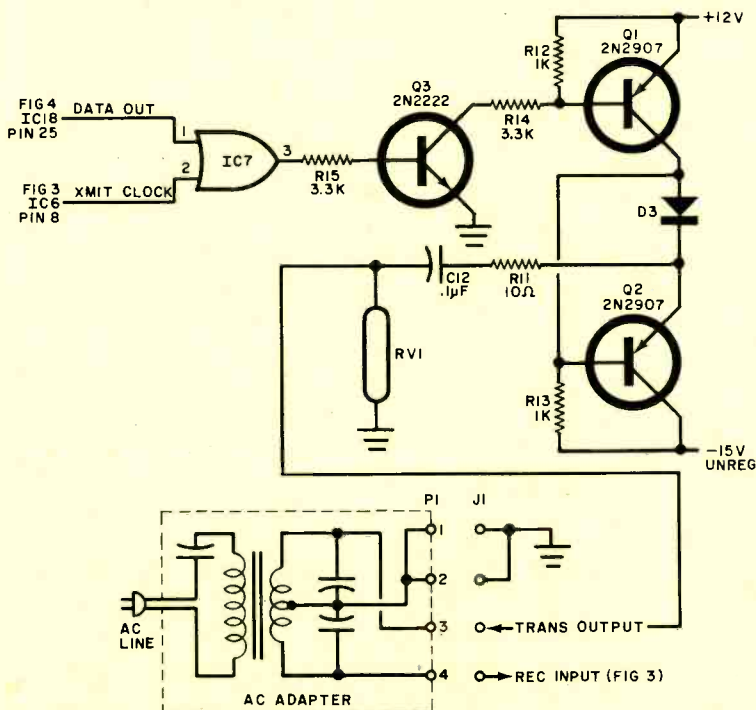

Fig. 6. Power driver accepts UART data and clock and delivers high-level signal to ac adapter.

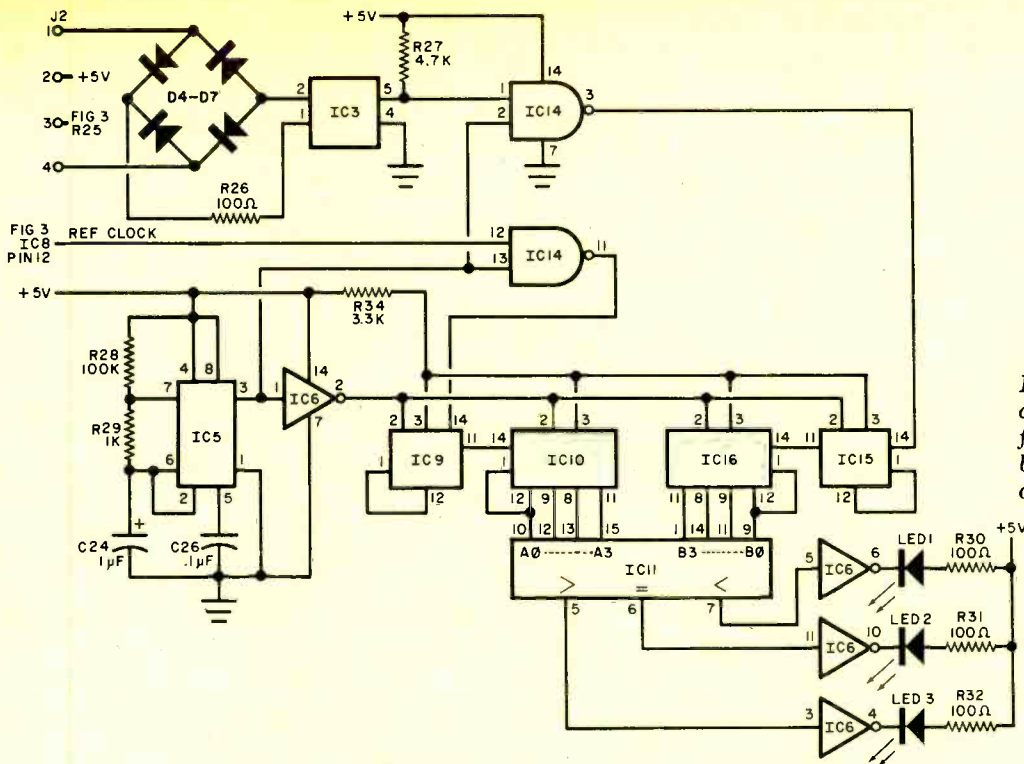
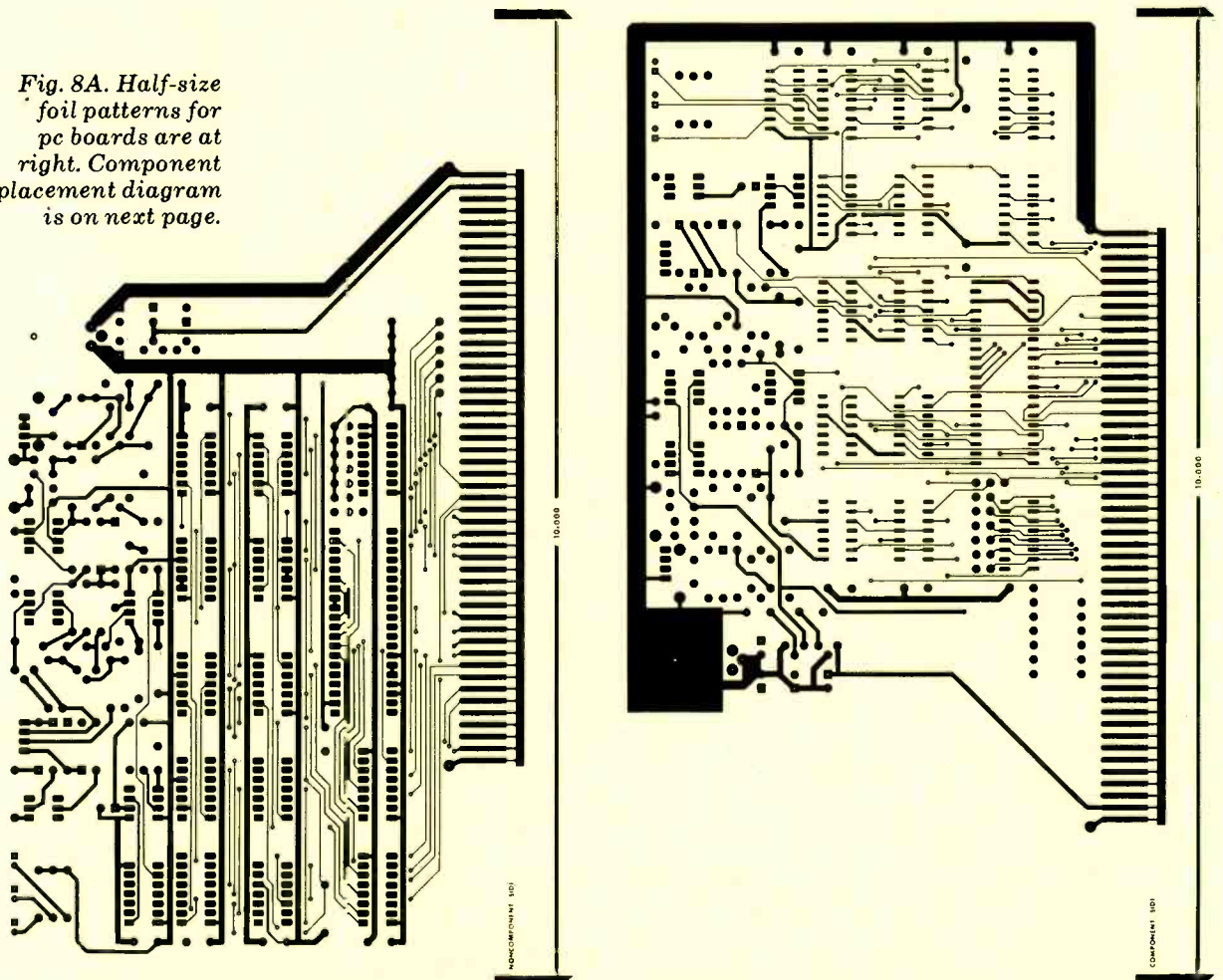

Fig. 7. Self-calibration circuit eliminates need for a frequency counter by comparing local and remote clocks.

Fig. 8A. Half-size foil patterns for pc boards are at right. Component placement diagram is on next page.



cy. The two LED's indicate in which direction the remote vco differs (less or greater than) from the controller vco.

Construction. The only practical way
DECEMBER 1977

of assembling the controller part of the system is on a double-sided printed circuit board. The etching-and-drilling and component-placement guides for the board are shown in Fig. 8. Sockets are

recommended for all IC's. However, the transistors, voltage regulators VR2 and VR3, and optoisolator IC3 can be mounted directly on the board. Main 5-volt regulator VR1 is installed with the

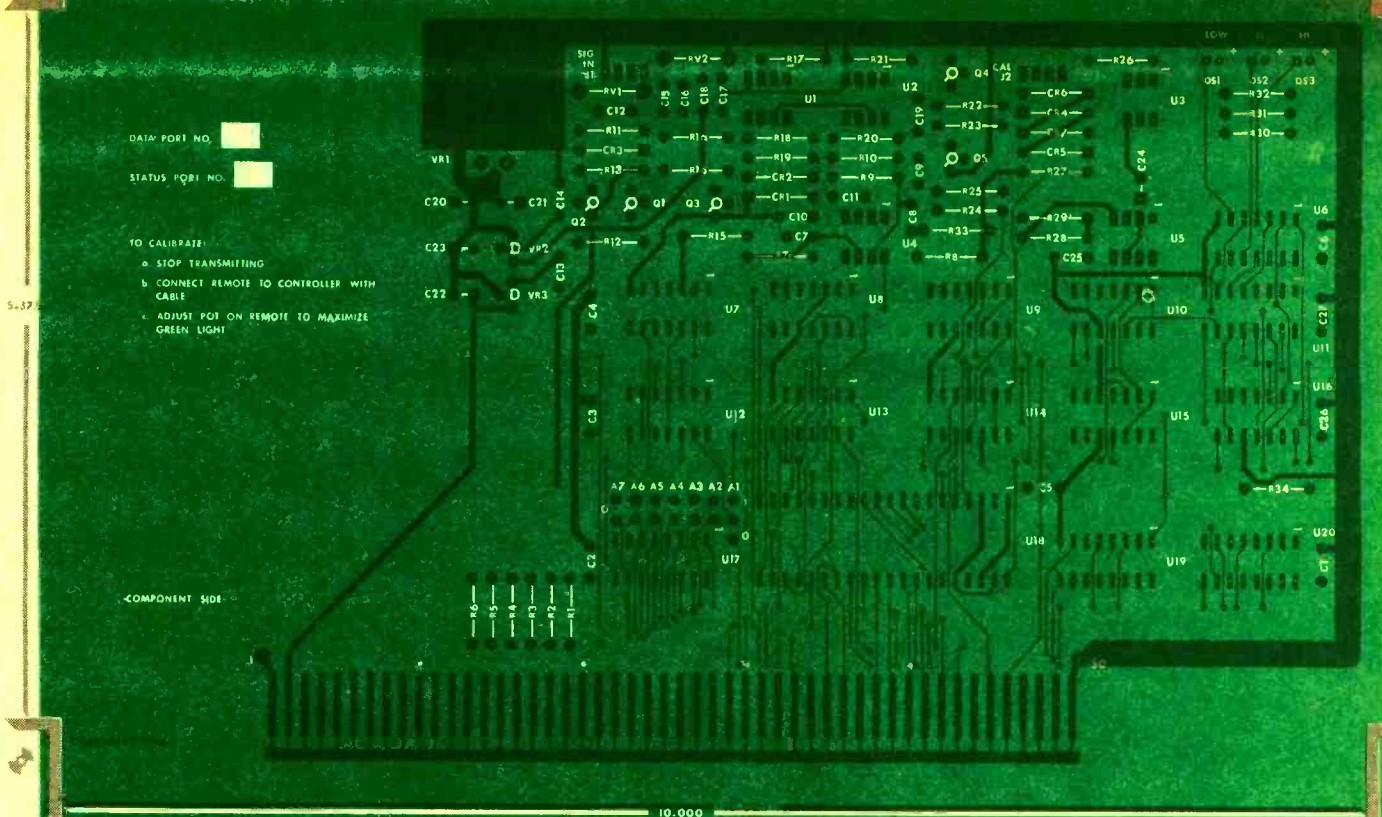

Fig. 8B. Component layout. Note that integrated circuits are designated by letter "U."

usual heat-sink and mounting hardware. As you are installing the components on the board, pay careful attention to the polarization of diodes and capacitors. Install the IC's last, double-checking the

pin-1 identifiers on each to be certain that they are installed properly in their respective sockets. **Coming Up.** Next Month, in Part II of

this article, we will cover the remote receivers to be used around the house. We will also detail the calibration procedure and present some sample software to use with the system. ◇

How To Interface Microprocessors

BY RALPH TENNY

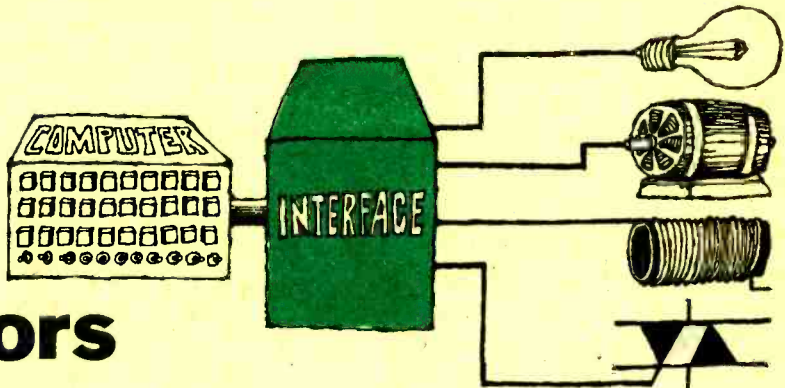

A MICROPROCESSOR is a relatively complex device. Therefore, interfacing one with peripheral equipment may sometimes present a problem. Just as in any electronic interface, the solution lies in understanding how each side of the interface works and then selecting components and techniques to connect the two smoothly. The microprocessor communicates with the outside world through three groups of signals as shown in Fig. 1. The address bus usually has between 12 and 16 lines. The data bus has 8, and there can be 1 to 12 control lines.

The internal operation of a processor is based on time—from an accurate oscillator called a clock. Some processors also require two clock signals ($\phi 1$ and $\phi 2$, where ϕ means phase) slightly displaced in time. They usually have different time durations, but do not overlap. Typical machine cycles of operation are shown in Fig. 2 with the input shown in Fig. 2A and the output in Fig. 2B. Note that each machine cycle is divided into a number of time intervals. In each case, the ADDRESS data is sent out during the middle of interval I1 and holds steady until the middle of I4.

For the input or read cycle, the DATA INPUT strobe is high during I2 and drops during I3. For the output or write cycle, the WRITE strobe is low for most of I3. Each of the I1 through I4 time intervals is about 0.5 microsecond, which means that a read or write cycle will occur every 2 μ s or 500,000 times/s. During the read cycle, the processor is *asking* for data and during the write cycle, the processor is *sending* data. If there is to be communication between the processor and any other equipment, then some circuit must be "listening" for the data being sent or some circuit must

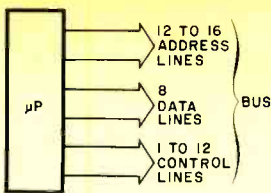
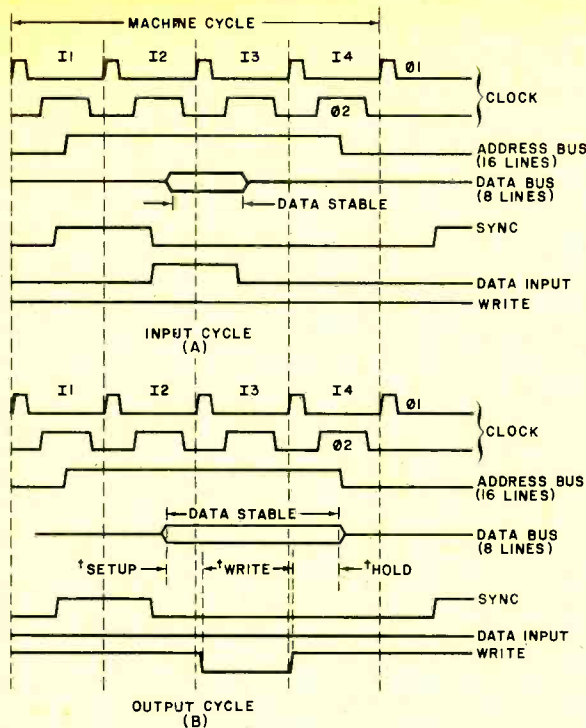

Fig. 1. Address, data, and control line bus allows microprocessor to communicate with outside world.

Fig. 2. Correct timing is secret of computer operation. Above are input cycle (A) and output cycle (B).



be able to furnish the data being requested. The processor may not know when its output is not received; but if the data it is requesting is not available, it may stop its operation. This is because part of the data input may include instructions for further operations.

To avoid chaos, one and only one device can send data to the processor during the input cycle. This device is selected by a unique address code that permits only the addressed device to "listen" to the data bus. A control signal (sometimes called a "handshake") tells the addressed device what to do with the data appearing on the data bus. If the three signals—data, address, and control—are to work properly, they must be coordinated in time and this is done by sending the common clock signal through the bus.

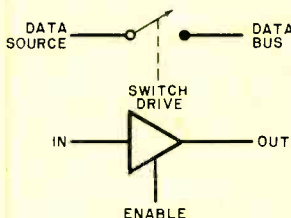

Fig. 3. Three-state buffer is like open switch when enabled.

In summary, successful data transfer between a processor and its associated elements requires three conditions: a unique address, control signals to enable the device being addressed, and means to disconnect data sources from the data bus when they are not specifically requested. Most processors will di-

rectly address 2^{16} (65536) different locations since they have 16 address lines.

The most common connect/disconnect system is the three-state buffer whose basic concept and logic diagram are shown in Fig. 3. Such a three-state buffer simulates an electronic switch that is closed only when the enable input is driven by the control signal. When it is not enabled, the output of the buffer is isolated from the internal circuits.

Timing is very critical for data transfer. Note the area marked DATA STABLE in Fig. 2A. The exact timing for data handling varies with different processors but the principle is the same: data must be available and stable for some minimum time and must remain stable for a short time after the three-state enable signal decays. This condition is usually met by using the enable (or DATA INPUT) signal to drive the three-state lines.

The processor output cycle is shown in Fig. 2B. The major difference between the input and output cycles is that, during the output cycle, the WRITE line is low for most of I3 and the DATA INPUT line remains low. Note that the output data from the processor (t_{write}) is available for only about $0.6 \mu s$ or less. This means that the IC's used must be able to "remember" the data that appears for such a short time.

Memories. IC memories—from simple flip-flops to RAM's—acquire data in one of two ways. Latches and flip-flops (for example the 74279 latch and the 7474 flip-flop) store their input data on either the positive- or negative-going pulses. In

contrast, latches like the 7475, 7477, and 74100 store whatever data is at their D-inputs whenever their enable inputs go high. This is a somewhat subtle distinction and the user must be familiar with the various devices and their performance characteristics. In further contrast, changing data on the D-input of a 7474 will cause no output change until its clock input is driven high. The 7475, 7477, and 74100 outputs follow their D-input as long as their enable inputs are high. Finally, the 74279 latch requires alternate negative-going pulses on the S and R inputs to change the output.

Thus, the 7474 and 74279 devices can be considered to be strobed, or clocked memories, while the 7475's are gated-entry devices. Similar distinctions can be made with CMOS devices, and a careful study of the data sheets will be required to understand each device's operation.

Buffering plays an important part in interfacing a processor with any other device. One common output specification for address and data bus drives for many processors is one TTL load and 130 pF of capacitance. Therefore, if the processor is called upon to handle a number of external devices, some form of buffering must be used to prevent overload of the lines.

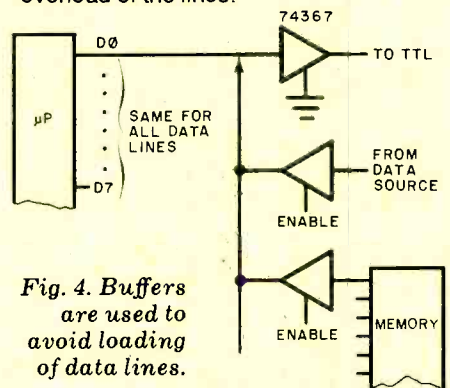
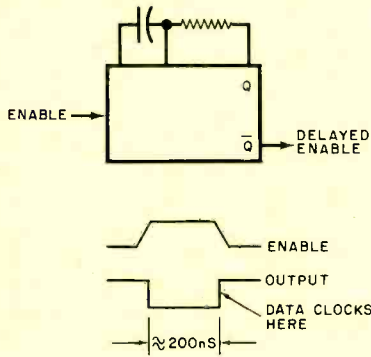

Fig. 4. Buffers are used to avoid loading of data lines.

For the address lines, a device similar to the 74365 or 74367 is recommended, while the data lines are buffered as shown in Fig. 4. If a number of TTL devices is to be driven, then the outgoing lines will also need buffering. Note that the memory lines are also buffered because of the TTL buffer load on the data line. Some medium-size systems use low-power Schottky TTL which has one fourth the loading of a standard TTL, but will drive five standard TTL loads.

Timing. In discussing timing in interfacing, we will refer to Fig. 2B and use a "worst-case" analysis. That is, we will decide which device specification is the

Fig. 5. Enable signal (below) can be delayed by one-shot set for any time delay.



most likely to produce a failure and then be sure the selected part will work.

We will use a D flip-flop such as the 7474 (TTL) or 4013 (CMOS) to "remember" the data. Data set-up time (time the data has to be stable on the D-input before the rising edge of the clock pulse) for the 7474 is a minimum of 20 ns going from logic 0 to logic 1. For the CD4013, data set-up time is 20 ns typically and 50 ns maximum. Data hold time (time the data has to remain stable after the clock pulse edge) for the 7474 is a minimum of 5 ns going from logic 0 to logic 1. Propagation delay (time it takes data to pass through the flip-flop after the clock enters) from the clock pulse edge going from 0 to 1 for the 7474 is 10 ns (min.), 14 ns (typ.), and 25 ns (max.). Going from 1 to 0, it is 10 ns (min.), 20 ns (typ.), and 40 ns (max.). For the CD4013, propagation delay is 150 ns (typ.) and 300 ns (max.).

In a typical processor, the data set-up time when the WRITE line goes down (t_{set-up}) is 140 ns minimum. Data hold time after the trailing edge of the WRITE pulse (t_{hold}) is also 140 ns minimum. The WRITE pulse (t_{write}) is 500 ns min.

Since the maximum set-up time for either flip-flop is 50 ns, either edge of the WRITE pulse could be used to store data. Note the worst-case values: the

Fig. 7. With simultaneous access and enable signals, one bit of data can be passed to data bus via the buffer.

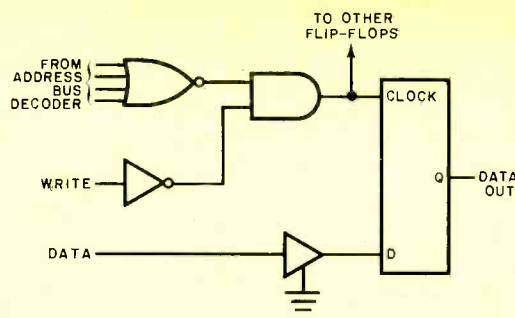
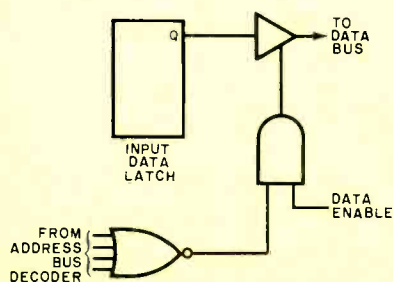

Fig. 6. Circuit above shows how one bit of data can be abstracted from data bus when data, address and handshake signals appear at the same time.

minimum time for the processor and the maximum time for the flip-flops. Input timing for the same processor is almost handled automatically if the input strobe enables the three-state devices.

Since some processors have very tight timing on the data output bus, a delayed enable may be needed. The one-shot, shown in Fig. 5 will trigger on the leading edge of the enable signal; and, if the D flip-flop triggers on the rising edge of the one-shot output, it will now have the proper delay (set by the RC network).

A circuit that captures a data bit from the processor data bus is shown in Fig. 6. A NOR gate receives the correct decoded address signals, while the data is buffered by a permanently enabled buff-

er. The WRITE strobe is inverted. Although only one bit is recorded by this circuit, seven more can be clocked by the AND gate to capture the full 8-bit word when the address is entered.

The inverse function, inserting data onto the data bus is shown in Fig. 7. One bit stored in the flip-flop is sent to the processor (via the data bus) when the correct address is received.

Another important facet of input interfacing is the reset of the input data. Once a computer has "read" an input, it has no way to tell when that point is next sampled if the data then present is new data or the same as previously sampled. Therefore, the processor must either reset the data latch after the data has been read out, or must continuously sample the input line until the data changes state. Then the computer can interpret the data changes as valid.

Sample Interface. The most common man-machine interface element is a basic switch. Three ways to use a switch and a flip-flop to input data to a processor are shown in Fig. 8. In each case, a 7474 or 4013 will work; and the three examples show how different system responses can be obtained by setting the flip-flop output to logic 1 by various means. In each case, the immediate response to the switch closure is the same, but the effect on the processor system is different. An example of each type debouncing is shown in Fig. 9.

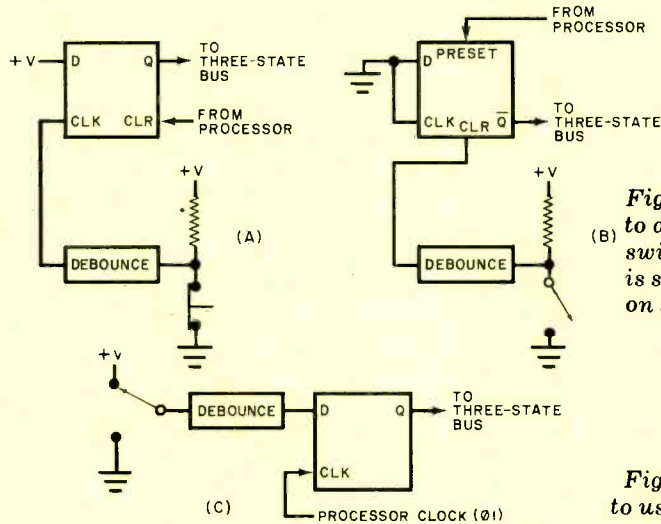
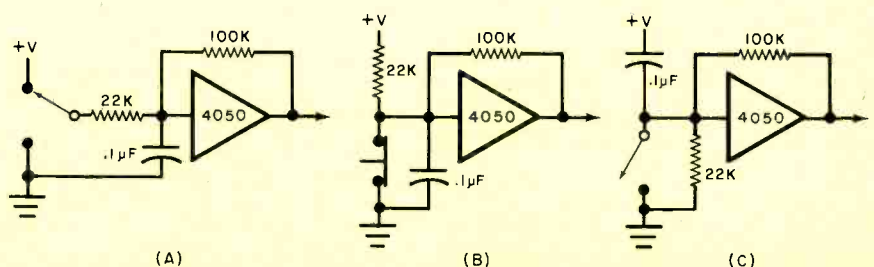

Fig. 8. Three ways, left, to debounce mechanical switch. In all, response is same, but effect on system is different.

Fig. 9. Below are 3 ways to use CMOS to debounce a mechanical switch.



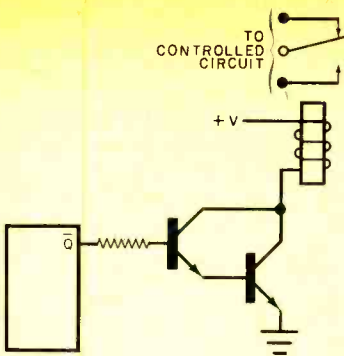

Fig. 10. Output bit can be used to turn on a power transistor and control relay.

In Fig. 8A, the switch drives the clock input high, which causes the Q output to go high. The processor can reset Q to a logic 0 through the clear input and the flip-flop is then ready to respond to another input. Figure 8B shows the clear input being driven, with the output taken from the not-Q and the flip-flop reset accomplished by the preset input. Note that the clear function overrides all other flip-flop inputs so that it will not reset until the switch opens. In Fig. 8C, the flip-flop samples the switch position using the processor clock. The Q output will then track the switch position. If the processor should reset the flip-flop, the Q output would still reflect the switch position after the next clock pulse. Note that the processor clock synchronizes the data entry to the system so that an input can never change while the processor is "reading" the data line.

Control Circuits. If a processor is to perform some useful work, it may have to control large amounts of power. Since its output may be the relatively low current of a flip-flop, some means must be found of controlling higher power. One method is to insert a relay as shown in Fig. 10. The use of Darlington transistors can be extended so that very high-power relays can be controlled. A power semiconductor such as an SCR or triac can be used instead of the relay. The circuit shown in Fig. 11 applies power to the load only at power-line zero crossings to eliminate r-f interference and line transients.

In Fig. 11, when Q1 is turned on by the reed relay, there is no gate drive for Q2. When Q1 is off, the gate drive for Q2 is through R1. Note also that R1 should be capable of handling the full line power while passing adequate current to trigger Q2.

In general, dc loads can be handled in the same way as ac loads except that suitable power transistors are used in-

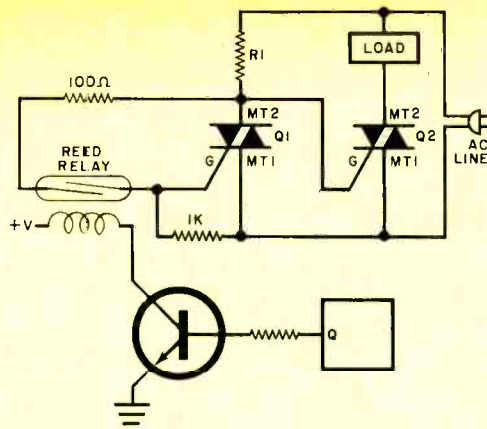

Fig. 11. Using output bit to turn on a triac eliminates RFI during switching operation.

stead of triacs. As long as the dc operating voltages are derived from transformer-powered supplies, the major precautions to be observed are proper voltage insulation, and adequate heatsinking for the power semiconductors.

Motor Controls. In computer control of motor speed, there are two basic methods which can be used: open loop or closed loop. A simple example of the former merely involves setting a supply voltage for the motor and using the resulting motor speed. Depending on how the mechanical load varies, this method can allow motor speed to vary 10 percent or more.

Closed-loop control involves the continuous sampling of motor speed and setting a voltage (or other signal) to obtain the desired speed. Such control usually involves current sampling; and, if the motor or mechanism it is driving becomes jammed, closed-loop control attempts to drive the motor faster. As a result, either the motor, the power supply, or both, can be damaged. The solution

to this problem lies beyond the scope of this article, however.

Sensing motor speed can be done in one of a number of ways. The simplest is accomplished by the circuit shown in Fig. 12A. A series of pulses from the motor drives a counter that is coupled to the processor through three-state buffers. The processor periodically reads the counter, resets it, and compares it with the count required by the program.

The motor rotation pulses can be generated by either of the two systems shown. In Fig. 12B, a sliver of shiny aluminum tape on a dark shaft allows light to bounce onto a photocell. The cell drives a suitable circuit that shapes the pulses for use by the counter. The slotted-disc approach shown in Fig. 12C also uses a light source and a photocell. Both of these methods are linear with changes in rpm, and the choice of which one to use depends on the amount of resolution required. If the motor speed tends to vary very quickly, the rpm must be sampled very often, so a large number of pulses per revolution is required to make accurate measurements. If the motor shaft operates at high speed, and the load has high inertia, one pulse per revolution may be sufficient. Another speed measuring technique involves the use of a tachometer, which is often a part of a motor and delivers a dc voltage linearly proportional to rpm. An analog-to-digital (A/D) converter must be used to convert the tachometer output into a signal suitable for the processor. The converter must also be furnished with address decoding and three-state bus drive. The advantage of the added complexity is that very close control can be maintained over motor speed. The basic logic approach is shown in Fig. 13A.

Another type of closed-loop control is shown in Fig. 13B. A small dc motor is

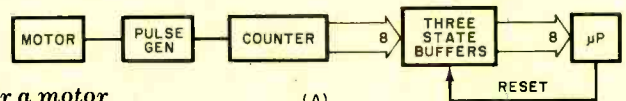
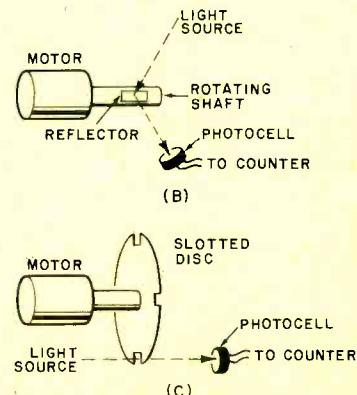

Fig. 12. Circuit for a motor control is shown at (A). Both (B) and (C) show ways to generate pulses that represent motor speed.



used to drive a potentiometer that sets the reference voltage level. If the motor has a large gear-reduction train and if the potentiometer is a multi-turn device, the reference voltage can be set very accurately. Note that, in this scheme, the processor is connected only to the control signals and not the actual power system.

A modern method of producing the necessary accurate reference voltage is shown in Fig. 13C. A D/A converter having an 8-bit resolution (1 part in 256 or 0.4 %) can do the required job. The data latches with address select are necessary to hold the D/A output between changes.

A final type of motor, extensively used with computers, is the stepping motor. It operates by having (typically) two to four drive coils and a rotor with an odd number of poles. When power is applied to a drive coil, the rotor locks in one position. If the alternate drive coil is energized, the first coil is turned off and the rotor increments once and locks. Thus, alternating pulses to the drive coils produce discrete increment rotation. Typically, a rotor may be advanced by 5° or 7.5° per step, which, when combined with a suitable gear train, can produce very fine re-

Fig. 13. Tachometer circuit (A) provides close speed control. In (B), small motor, controlled by computer, adjusts voltage to maintain speed of larger motor. Use of D/A converter (C) provides motor speed accuracy.

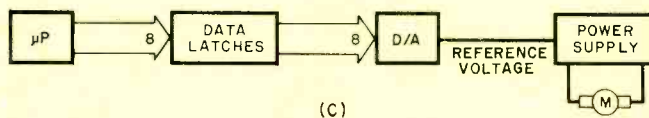
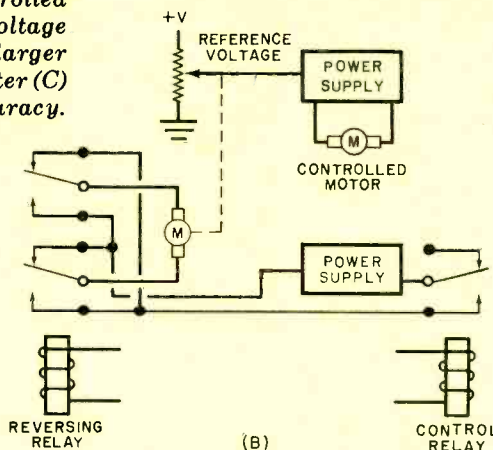
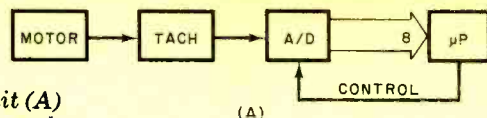

solution of mechanical position. Variation in the pulse rate produces excellent control of motor speed.

Other types of sensors that can be

used with computers include various forms of limit and proximity detectors, item counters (for conveyor belts), and fire and intrusion detectors. ◇

COMPUTER STORES:

A New Retailing Phenomenon

BY SHERMAN WANTZ



Independent shops like N.Y.'s Computer Mart sell many brands.

YESTERDAY, home computers were a science-fiction fantasy. Tomorrow, you'll probably find them under a heading of their own in the "Yellow Pages." And today there are already more than 900 home computer dealers in this country.

Not all computer dealers are alike, though. They range from part-time operations by computer hobbyists, through small departments in big electronics stores, to full-time specialist computer dealers. One way or another, if you live near a city with 50,000 people or more,

you're likely to find a retail computer outlet of some kind nearby.

Finding it may be a problem, though (unless you're in California, which has about 25% of the nation's computer dealers). Most of the specialist stores have limited advertising budgets. And

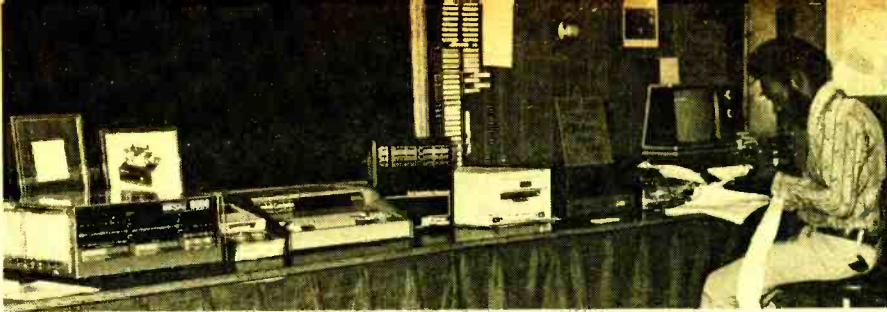

Equipment is displayed in open in MicroComputer System's Florida store.

most "Yellow Pages" listings so far lump the home computer stores with the ones serving businesses, under such headings as "Computing Devices" or "Data Processing Equipment."

Certain key words in the company name will help you identify the home computer stores when you run across them: "Byte," "Computer," "Micro," "Digital" and "Data." Often, too, the names are deliberately un-stuffy, such as "Bits 'n' Bytes," "Kentucky Fried Computers," or "Digital Deli." But not all hobby computer dealers are so readily identified by name alone. Many electronics stores, such as Allied Electronics, Team Electronics and Radio Shack are entering this field.

What You'll Find. Like car dealers and furniture showrooms, computer stores are usually set up to encourage browsing. Most people have never touched a home computer yet and contact is addictive. So you'll seldom find counters separating you from the merchandise. Computers, video terminals, tape readers, keyboards and other equipment are likely to be displayed openly on tables. More often than not, some equipment will be connected and in operation. Ask a salesman if you can try your hand at any of the equipment that's running, or if he can demonstrate what one can do with a computer.

Independent computer stores give you the chance to compare and evaluate many different makes of computer equipment and systems. But not all computer stores are independent. MITS, for example, the company that makes the popular Altair line of microcomputers, has exclusive franchise agreements with dealers who sell no competitive products. Similarly, Heathkit computers are sold exclusively by Heath Electronic Centers and by mail from Heath's main office; Radio Shack stores will handle only the Radio Shack computer line (though Tandy Computer Stores, and probably others, will handle both Radio Shack and competing hardware).

However, computers aren't all you'll find at computer stores. You'll probably see a variety of terminals, for example,

from the old standby Teletype to faster and fancier (or more limited, but cheaper) types of printer, plus several models of CRT terminals. You'll find a variety of peripheral and support types of computer equipment, too.

Along the walls of the store you'll certainly see shelves containing books, magazines, newsletters, promotional material, and probably assorted components, hand tools and test gear. If you're unfamiliar with computers, ask a salesman to suggest which magazines and books to buy, and which brochures to take home and study. These publications will supply answers to some of your initial questions (including the ones you may feel a bit shy about asking). More importantly, they'll also suggest a number of new questions you'll want to ask on your next visit.

Some of the most important merchandise the computer store has to offer is the least impressive looking: software. It is what computer people call the programs without which the hardware wouldn't work. The availability of programs is one of the main factors to consider when buying a computer system. A computer store can help you find out what software is available for your present or prospective system. Even more important, they can help you make the small but vital changes to the programs that may be needed to make it run on your particular system. What's more they can let you try out programs on the store's equipment to see if that software will suit your needs at home.

Your best introduction to computers is to play a game with one. Almost all stores have programs on hand for playing games, from simple Tic-Tac-Toe, through Blackjack, to a sophisticated game called "Startrek," patterned after the popular TV series.

For now, the heaviest emphasis is being placed on the microcomputer's entertainment value; but the availability of more advanced programs and equipment is changing that. Today's hobby computers are being used not only for playing games, but for controlling electro-mechanical devices and business and educational purposes.

Digital Cracker-Barrel. Like the old country store with its potbellied stove and cracker-barrel, the computer store is serving as a meeting and discussion center. Often, you can learn almost as much from talking with the customers as you can from the salesmen. While computer stores and Startrek attract their share of kids, you'll find a number of computer professionals and serious hobbyists there too. They may be programmers who work for one of the growing number of computer service companies; electronic technicians and engineers; students who've already taken computer courses in high school or college; amateur radio enthusiasts; or businessmen anxious to learn how a microcomputer can relieve them of tedious, routine chores.

Your presence at the computer store creates a bond between you and the other customers. You'll find it easy to strike up a conversation with one or more of those who are inspecting or operating equipment. They are as anxious to discuss computers as you are. Often, they'll be more knowledgeable about particular aspects of computer hardware or software than the store's own employees. People who already own computer models that you're considering for yourself can prove particularly helpful.

Look for a bulletin board on which the local computer club might announce the time and place of its next meeting. If you don't see such an announcement, ask one of the store's employees about the existence of a club. He should know. If you can find a club, you'll find a lot of the talk at your first few meetings rather hard to follow. But you'll also meet a lot of other hobbyists who'll be glad to explain things to you.

Special Store Services. Because

Demonstrating a microcomputer system in one of Byte Shops' chain of computer stores.



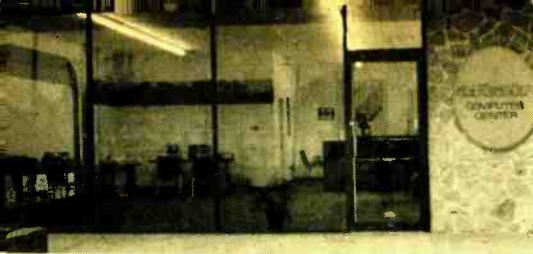

Altair carries mainly MITS gear.

computers are so complex, and so new to most people, computer customers need a lot of special services. And most computer stores provide them.

If you're handy enough to build some of your equipment from kits (and save up to 40 percent in the process), most stores will help you interpret unclear instructions and check out your work when you've finished. If you're unsure about your ability to build a particular kit, the store will often let you look over its construction manual, first, to get an idea of its degree of difficulty.

If you don't want to build a kit, but want an item that's not available in assembled form, many stores have technicians who'll build it for you—for a fee.

Computer stores usually have service facilities where you can take a malfunctioning computer (or the appropriate boards, if you can narrow down the problem) for testing and service. Bring a copy of your program, too; often, computer problems turn out to be in software, not in hardware.

Some technicians don't mind letting

you watch and learn as they troubleshoot your system. But remember that you pay for most repairs at an hourly rate. Talking to the technician slows him down, and costs you money.

Stores will generally replace any defective parts in kits they've sold you (but not kits you've bought elsewhere). Servicing completed kits is usually done for the same flat fee or hourly rate as the manufacturer would charge, and saves you shipping time and charges.

Many stores provide consulting services, custom-designed hardware and software, and information on how to modify your system for better performance. More and more stores, in fact, are devoting a lot of attention to providing such services for small businesses (which gives them lots of experience for handling your problems, but may mean the technician or salesman you want to see is out if you just drop by unannounced). For the hobbyist, many stores give low-cost classes in computer and programming fundamentals.

For established customers, many stores will accept phone orders, often shipping out their orders overnight. Many also accept major credit cards.

When it's time to upgrade your system, the store where you bought your computer will usually have add-on module boards and peripherals, or be able to suggest equipment modifications, that will handle your requirements. If your old

equipment simply can't be made to handle your new needs, many stores have bulletin boards where you can post your old equipment for sale. A few stores even take trade-ins.

If the store nearest you does not yet offer all of these services, don't be disappointed. The field is growing rapidly, and most stores, still small, must work hard to keep up.

Still, this is the calm before the storm, the lull before the home computer hobby really takes off. Someday you may have to take a numbered card and stand in line waiting for a salesman to take our order—as soon as he can free himself from the constantly jangling phone.

Beat the crowds, and begin now to visit the computer stores near you. Compare the lines of equipment each handles. Find out which stores give you the greatest bargains in quality merchandise and the most personal attention. Don't hesitate to ask about the availability of the services mentioned here. (But don't expect to find all of them in any one store, either.) Once you've found a store whose technical experts give you confidence, that's where you should go for help in setting up your own computer system.

And after you have your computer up and running, remember to keep in close touch with your computer store. In this fast-moving hobby, that's where much of the action is. ◇

QUICK HEX-DECIMAL CONVERSIONS

BY RAYMOND J. BELL

CONVERSION from hexadecimal to decimal or vice versa is sometimes required in microcomputers. The table presented here offers a rapid and efficient solution to this problem. It is suitable for integers between 0 and 65,535 (0₁₆ to FFFF₁₆). It can also be easily expanded.

Here's an example of how to use the table. Say the hexadecimal number, A7BD₁₆, is to be converted to decimal. Starting with the right-most digit, D, look at the table's fourth-place digit and read down to D in that column. The decimal equivalent is 13. Repeat for the next digit in the third column. Here, the original number, B, corresponds to 176. Continuing with the next two digits, we read 1792 and 40960, respectively. Add these numbers, and the total is 42941, which is the decimal equivalent of A7BD₁₆.

The table can also be used in reverse to convert decimal numbers to hex. To convert 800₁₀ to hex, for example, look in the table for the highest entry which does not exceed the number, which is 768. This corresponds to a 3 in the third hex digit. (The fourth digit is 0, so it can be ignored.) Next, 768 is subtracted from 800, yielding a remainder of 32. The

highest table entry that does not exceed 32 is 32, which corresponds to a 2 in the second hex digit. Subtracting 32 from 32, the remainder is zero, which means the conversion is complete. (Note: to maintain proper relationship of the hex digits, we put 0 in the first hex

digit, giving 320₁₆ as the hex equivalent of 800₁₆, not 32₁₆, which is 50₁₀.)

The table can be expanded by multiplying the digits of 0 to 15 by the appropriate power of sixteen. To construct the fifth column of the table, multiply 16⁵ (65,536) by 0, 1, 2 to 15. ◇

HEX-DECIMAL NUMBER TABLE

1st Place		2nd Place		3rd Place		4th Place	
Hex.	Dec.	Hex.	Dec.	Hex.	Dec.	Hex.	Dec.
0	0	0	0	0	0	0	0
1	1	1	16	1	256	1	4096
2	2	2	32	2	512	2	8192
3	3	3	48	3	768	3	12288
4	4	4	64	4	1024	4	16384
5	5	5	80	5	1280	5	20480
6	6	6	96	6	1536	6	24576
7	7	7	112	7	1792	7	28672
8	8	8	128	8	2048	8	32768
9	9	9	144	9	2304	9	36864
A	A	A	160	A	2560	A	40960
B	B	B	176	B	2816	B	45056
C	C	C	192	C	3072	C	49152
D	D	D	208	D	3328	D	53248
E	E	E	224	E	3584	E	57344
F	F	F	240	F	3840	F	61440



Sol-20. First it was THE SMALL COMPUTER. Now, it's THE SMALL COMPUTER SYSTEM.

A year ago, we introduced the Sol-20. It wasn't the first small computer. It was the first complete small computer with everything needed to get it up and on the air as it came from the factory. The keyboard, interfaces, extra memory, factory backup, and service notes were all there.

The results are in: Sol-20 is now the number one small computer in the world. Sols aren't the cheapest, just the most valuable.

We originally designed the Sol-20 as the heart of a complete computer system. So now to solve the problems of science, engineering, education, business management and control and manufacturing, we offer fixed price Sol systems in either kit or fully tested and assembled form. We offer language flexibility. Extended BASIC, ASSEMBLER, PILOT BASIC and FORTRAN

IV. We offer Helios II/PTDOS, an extraordinarily capable disk operating system. And remember, though we call these small or personal computer systems, they have more power per dollar than anything ever offered. They provide performance fully comparable and often superior to mini-computer systems costing tens of thousands of dollars more.

What you get. What it costs.

Typical systems include Sol System I priced at \$1649 in kit form, \$2129 fully assembled and tested. Included are a Sol-20/8 with SOLOS personality module storing essential system software, an 8192 word memory, a 12" TV/video monitor, a cassette recorder with BASIC tape and all necessary cables.

Sol System II has the same equipment with a larger capacity 16,384 word

memory. It sells for \$1883 in kit form; \$2283 fully assembled.

For even more demanding tasks, Sol System III features Sol-20/16 with SOLOS, 32,768 words of memory, the video monitor and the dual drive Helios II Disk Memory System with the PTDOS disk operating system and Extended DISK BASIC Diskette. Prices, \$4750 in kit form, \$5450 fully assembled and tested.

More information.

For the most recent literature and a demonstration, see your dealer listed below. Or if more convenient, contact us directly. Please address Processor Technology Corporation, 7100 Johnson Industrial Drive, Pleasanton, CA 94566. Phone (415) 829-2600.

Processor 

AZ: Tempe (602)894-1129; Phoenix (602)942-7300; Tucson (602)327-4579 CA: Berkeley (415)845-6366; Costa Mesa (714)646-0221; Fresno (209)266-9566; Hayward (415)537-2983; Lawndale (213)371-2421; Orange (714)633-1222; Pasadena (213)684-3311; Sacramento (916)443-4944; San Francisco (415)431-0640; (415)421-8686; San Jose (408)377-4685; (408)226-8383; San Rafael (415)457-9311; Santa Clara (408)249-4221; Sunnyvale (408)735-7480; Tarzana (213)343-3919; Van Nuys (213)786-7411; Walnut Creek (415)933-6252; Westminster (714)894-9131 CO: Boulder (303)449-6233; Englewood (303)761-6232 FL: Fort Lauderdale (305)561-2983; Miami (305)264-2983; Tampa (813)879-4301 GA: Atlanta (404)455-0647 IL: Champaign (217)359-5883; Evanston (312)328-6800; Lombard (312)620-5808 IN: Bloomington (812)334-3607; Indianapolis (317)842-2983; (317)251-3139 IA: Davenport (319)386-3330 KY: Louisville (502)456-5242 MI: Ann Arbor (313)995-7616; Royal Oak (313)576-0900; Troy (313)362-0022 MN: Minneapolis (612)927-5601 NJ: Hoboken (201)420-1644; Iselin (201)283-0600 NY: Middle Island (516)732-4446; New York City (212)686-7923; White Plains (914)949-3282 NC: Raleigh (919)781-0003 OH: Columbus (614)486-7761; Dayton (513)296-1248 OR: Beaverton (503)644-2686; Eugene (503)484-1040; Portland (503)223-3496 RI: Warwick (401)738-4477 SC: Columbia (803)771-7824 TN: Kingsport (615)245-8081 TX: Arlington (817)469-1502; Houston (713)526-3456; (713)772-5257; Lubbock (806)797-1468; Richardson (214)231-1096 VA: McLean (703)821-8333; Reston (703)471-9330; Virginia Beach (804)340-1977 WA: Bellevue (206)746-0651; Seattle (206)524-4101 WI: Milwaukee (414)259-9140 WASHINGTON D.C.: (203)362-2127 CANADA: Ottawa (613)236-7767; Toronto (416)484-9708; (416)482-8080; (416)598-0262; Vancouver (604)736-7474; (604)438-3282.

CIRCLE NO. 73 ON FREE INFORMATION CARD

www.americanradiohistory.com

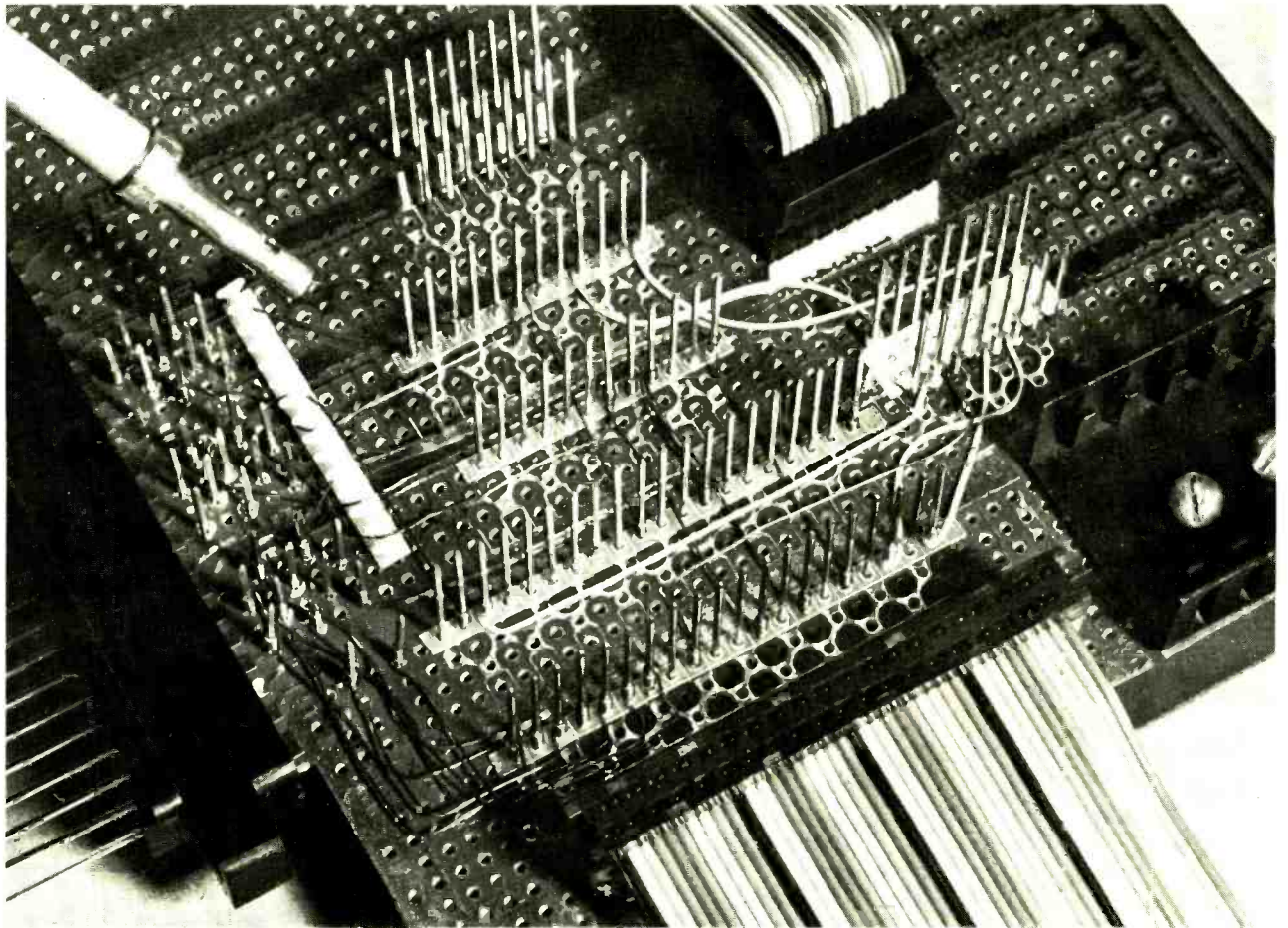

WIRE-WRAPPING TECHNIQUES FOR COMPUTER HOBBYISTS

Modern techniques save assembly time for more complex electronic projects

BY ADOLPH MANGIERI

TRADITIONALLY, electronics hobbyists and experimenters have relied on point-to-point wiring and printed circuits in assembling their projects. This was fine when projects were relatively simple and had few IC component counts. With the coming of home computers, however, traditional wiring methods left much to be desired.

Now, an A/D converter, an I/O port, or a complete microcomputer can be assembled without preparing artwork or etching a complex double-sided pc board. In addition, the circuit can be enlarged or revised with ease. Best of all, a soldering iron is never required. Particularly advantageous for computer projects where wiring flexibility is a must,

Wire Wrapping can be used with almost any type of electronic construction.

Propelled by the growing numbers of microcomputer enthusiasts, hobbyist Wire Wrapping has come into its own,

spanning a broad range of inexpensive tools and accessories. Owners of Altair 8800 and IMSAI 8080 microcomputers, for example, can obtain commercial Wire Wrap plug boards that are compatible with their bus systems. In addition, you can choose between or combine conventional tip-loaded wrapping, bare-wire bus strapping, and speedy insulated-wire bus strapping with a new multi-mode tool from Vector Electronic.

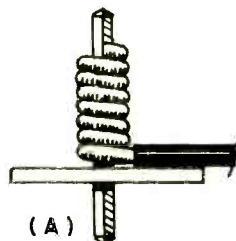

Standard Wrap

The Connection. A Wire Wrap connection consists of a minimum of six closely wound turns of wire applied under tension to a post with a special square cross section. The standard Wire Wrap connection is shown in drawing A.

POPULAR ELECTRONICS

The modified wrap shown in drawing B includes an additional half-turn or so of insulated wire. This wrap can be used when extreme mechanical vibrations might otherwise cause wire breakage. (The modified wrap also precludes short circuits to a ground plane.)

As shown in drawing C, the tip of the Wire Wrap tool includes a centrally located hole that accommodates the wrap post. An off-center hole, or "wire tunnel," accepts the end of the wire. As the tool is rotated, wire coming from the wire tunnel negotiates a sharp 90° bend that results in drag and tension on the wire. Under tension, the wire becomes firmly imbedded against the sharp edges of the post to form a gas-tight contact.

Bus strapping, shown in drawing D, permits rapid interconnection of many posts with a single unbroken length of wire, avoiding repeated insertion of the wire end into the tunnel. Conventionally, continuous bus strapping requires the use of bare wire, which imposes some wiring limitations.



Modified Wrap

Wire Wrapping tools for conventional wrapping are available from Vector Electronic (12460 Gladstone Ave., Sylmar, CA 91342) and OK Machine and Tool Corp., (3455 Conner St., Bronx, NY 10475). Both companies also offer electrically powered automatic tools that greatly reduce operator fatigue and vastly speed up the wiring.

Slit-N-Wrap Tool. A new and rather unique tool, the Vector Electronic Model P180 "Slit-N-Wrap" tool, is a spool-fed insulated-wire bus strapping device that eliminates the need to cut wire and strip away insulation. This high-speed wrapping tool permits a bus to be strapped to the ground plane without the usual danger of causing short circuits.

A 100' (30.5-m) spool of No. 28 polyurethane-nylon insulated wire fastens to the top of the Slit-N-Wrap tool handle. The wire is then fed down through a hole in the body of the tool and exits through the wire tunnel. As the tool is rotated clockwise, a sharp slitting edge at the

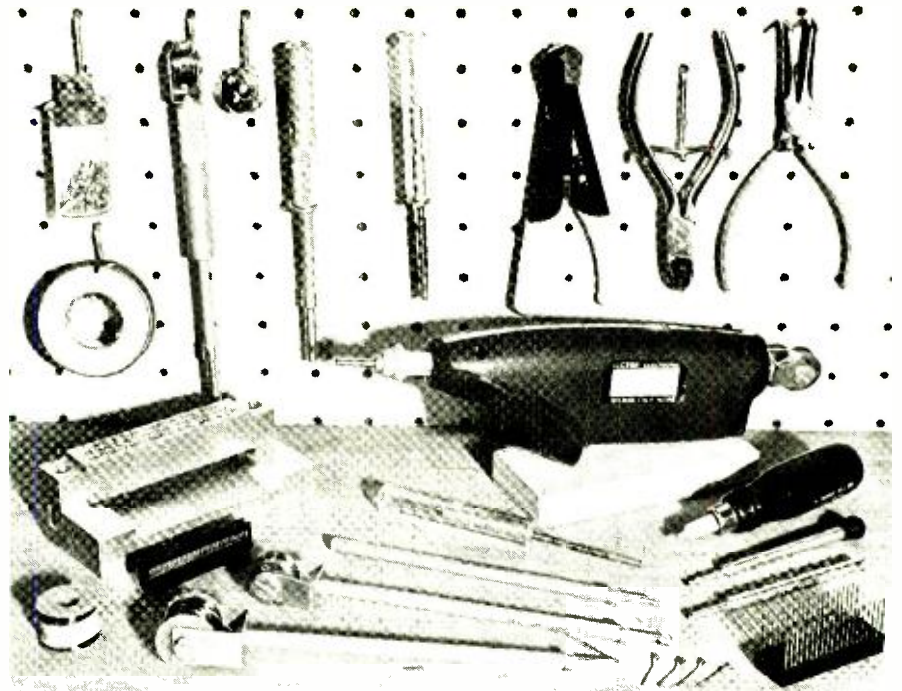

Typical Wire Wrap tools, including power wrapper.

tool's tip splits the insulation on the wire lengthwise. As wiring proceeds, the tension on the wire and pressure at the contact points force the insulation aside to allow the wire to become firmly imbedded against the post. The tool provides at least 10,000 perfect wraps before replacement of the slitting tip becomes necessary. The tool itself is designed to be used on standard 0.025" (0.64-mm) square Wire Wrap posts.

You can "pencil wire" the solder-through insulated wire used with the Slit-N-Wrap tool around any size lug or terminal and solder directly through the insulation, which vaporizes when soldering heat is applied. The Slit-N-Wrap tool

ditional wrapping of bare and Kynar-insulated wire, the Vector Dual-Way Wrap-N-Strap tools operate in either direction. These are highly efficient tools, with slim handles that can be twirled rapidly between the fingers. The tip of the tool is cross-slotted and recessed to permit insertion of the wire ends without having to upend the tool.

The Model P160 Wrap-N-Strap tool wraps No. 26 through No. 30 wire onto 0.025" square wrap posts. The tool can be used for bus strapping by passing bare wire down through its hollow handle. Similar, but with the wire spool and bracket located atop the handle, the Vector Model P160-2A-1 wrap tool is

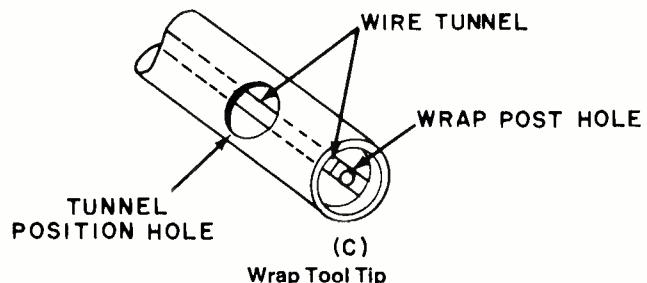

Wrap Tool Tip

also conventionally wraps or straps No. 26 through No. 30 bare and Kynar-insulated wire.

The Slit-N-Wrap tool comes with two spools and the Model P138 chisel knife and wire-forming tool. Replacement spools of wire are available in different colored insulation.

Wrap-N-Strap Tools. For conven-

more convenient for strapping. With the spool-fed wire retracted, this tool is also used for tip-loaded wrapping of bare and insulated wire.

For unwrapping No. 26 through No. 30 wire, the Model P160-1A Dual-Way unwrap tool has a self-adjusting sleeve that contains the unravelled wire for easy removal from the wrap post. The Model P160-9 Wrap-N-Unwrap tool is

double-ended. It can wrap and unwrap wire but it cannot be used for strapping. Tools for wrapping No. 22 through No. 26 wire onto large 0.045" (1.14-mm) square posts and 0.031" x 0.062" (0.79 x 1.57 mm) posts include the Model P160-6 Wrap-N-Strap tool, the Model P160-6-1 Spool Wrap-N-Strap tool with top-mounted wire spool, and Model P160-7 unwrap tool. These dual-way tools have larger grips for greater torque to wrap heavier wire.



(D)

Bus Strapping

Another good wrap/unwrap tool for standard 0.025" Wire Wrap posts is the Model WSU-30 from OK Machine and Tool Corp. Built into the side of this tool is a hardened-steel cutter that neatly and quickly removes Kynar insulation from the wrap wire.

With the extensive Wire Wrapped microcomputer system, powered wrapping, strapping, and unwrapping is advantageous. These tasks are performed almost instantaneously by The Vector Model P160-4R and the OK Model BW 630 cordless power wrapping tools. Both tools wrap in the clockwise direction. The Vector tool has a chuck that accepts the Models P160-2A wrap, P160-9 double-ended, and P180 Slit-N-Wrap tools. It can also be used for strapping when the Model P160-5 spool strapping adapter is used. The OK Model BW 630 power tool comes with wrapping bit and sleeve.

For powered unwrapping, the Model P160-4L cordless power tool from Vector rotates in the counterclockwise direction and accepts the bits of the Models P160-1A and P160-7 unwrap tools. Vector's Model P160-4T power tool kit consists of the Model P160-4R power driver and the Model P180 Slit-N-Wrap tool already installed.

Accessories. A variety of accessories and hardware that ease the task of the Wire Wrap user are available. Vector, for example, has a number of circuit boards, circuit card connectors, and wrap posts. Both Vector and OK offer a variety of dual-in-line (DIP) Wire Wrap sockets for IC's, numeric LED displays, and DIP switches.

The Vector No. 8800V universal microcomputer/processor plugboard is

bus-compatible with the Altair 8800 and IMSAI 8080 microcomputers. The P-pattern, double-clad etched and drilled board provides separate ground and wiring planes that assure effective noise suppression. The board measures 10" x 5.3" (25.4 x 13.5 cm) and has 100 edge contacts, arranged 50 contacts to a side. This board accommodates two 40-pin, eight 24-pin, or 36 16- or 14-pin DIP IC's. It also has two finned heat sinks to accommodate voltage regula-

gripping No. T112 bus link can be slipped onto the post before wrapping the wire; its tab is then soldered to the ground plane.

The Vector No. 3677-6 padboard has interdigitated power and ground bus arrays of oval pads that accept all DIP sockets for either Wire Wrapping or soldered wiring.

Wrap-post board pins can be pushed into P-pattern board holes with inexpensive pin-insertion tools. For soldered installations of discrete components, the rugged and versatile Vector No. T49 Klipwrap post can be used, inserted with a No. P156 insertion tool. It has a stepped fork at one end, allowing temporary snap-in connections. The No. T44 Miniwrap pin, installed with a No. A13 insertion tool, has a small solder slot at one end and can be used for terminating diodes, transistors, etc. Soldered to a foil trace or crimped to insulated board, the No. K32 J pin has many uses.

Perhaps the most useful of the double-ended wrap posts is the Vector No. T46-3 pin, inserted with a No. P133B tool; it accommodates three or four wraps at each end. The No. T46-5 is a similar but slightly shorter wrap post. Fitted into edge contact pads of the No. 8800V board, the single-ended No. T46-4 pin affords two wrapping levels. Where one wrap level will suffice, the short single-ended No. T51 pin can be used to pass a circuit trace from one to the other side of a circuit board.

The No. R32 gold-plated socket pin from Vector can be used to assemble transistor and DIP IC sockets. When installing these or any of the other Vector wrap pins, the No. MB45-20-062 P-pat-

terns. Mating sockets for this board include the Vector No. R681 solder-tail socket with Altair coding and the No. R681-1 wrap-post connector. The Vector No. 4350 logic and interface board that measures 9" x 7" (22.9 x 17.8 cm) can accommodate a medium-sized microcomputer on one or two boards; it provides 80 edge contacts, arranged 40 per side.

A single-clad, etched board that measures 8" x 4.5" (20.3 x 11.4 cm) can be used to assemble a microcomputer trainer with limited memory. For Wire Wrapping, the Vector No. 3677-7 ground-plane board has a continuous grid with copper etched back from the holes to form a relieved ground plane that clears the wrap posts. Power buses can be assembled topside on this board with Vector's No. T107 punched copper bus strips. To ground a wrap post, a self-

Vector 8800V Wire Wrap Board for 8080 microcomputers.

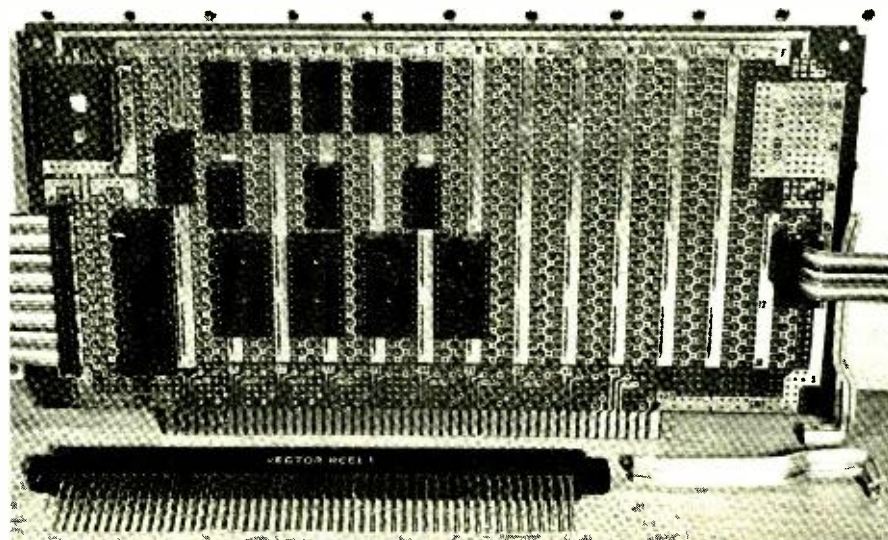



Your computer system needn't cost a fortune.

Some computer kits include little more than a mother board and a front panel, and you pay extra for everything else you need to make an operating computer.

SWTPC doesn't do it that way, so you can get your Southwest Technical 6800 Computer up and running at a bargain cost compared with most other systems. It comes complete at \$395 with features that cost you extra with many other systems.

The Extras You Get

These extras include 4K of random-access memory, a mini-operating system in read-only memory, and a serial control interface. They give you 1) a considerable amount of working memory for your programs, 2) capability through the mini-operating system to simply turn on power and enter programs without having to first load in a bootstrap loader, and 3) an interface for connecting a terminal and beginning to talk with your computer immediately.

Low-Cost Add-Ons

Now that you have a working computer, you'll probably want to add at least two features soon, more memory and interfaces for needed accessory equipment. Memory for our 6800 is another bargain. You can get 4K memory boards for just \$100 and 8K boards for only \$250.

Our interfaces cost little compared with many other systems.

For just \$35 you can add either a serial or parallel interface board. (And you won't have to buy several interfaces on a costly board to get just the one you want.)

Peripheral Bargains

Your computer is no good without at least a terminal for entering data and viewing computer output, and you will probably want a good method of storing programs and data.

We offer you a line of high-quality peripherals at low prices. (You can prove this by just comparing prices.)

Buy our CT-64 Video Terminal for only \$325 and our CT-VM Monitor with matching cover for \$175. Our MF-68 Dual Minifloppy costs just \$995, complete with Disk BASIC and a disk operating system. For cassette storage our AC-30 Cassette Interface gives simple control for one or two cassette recorders.

You can get inexpensive hard copy with our PR-40 Alphanumeric Line Printer.

We back up the 6800 system with low-cost software, including 4K and 8K BASIC.

Compare the value you get with our computer and peripherals before you buy. We think you'll find that SWTPC gives you more for your money in every way.



Southwest Technical Products Corp.

219 W. Rhapsody, San Antonio, Texas 78216

London: Southwest Technical Products Co., Ltd.

Tokyo: Southwest Technical Products Corp./Japan

CIRCLE NO. 59 ON FREE INFORMATION CARD

Enclosed is:

- _____ \$995 for the Dual Minifloppy
- _____ \$325 for the CT-64 Terminal
- _____ \$175 for the CT-VM Monitor
- _____ \$395 for the 4K 6800 Computer

- _____ \$250 for the PR-40 Line Printer
- _____ \$79.50 for AC-30 Cassette Interface
- _____ Or BAC # _____ Exp. Date _____
- _____ Or MC # _____ Exp. Date _____

Name _____ Address _____
 City _____ State _____ Zip _____

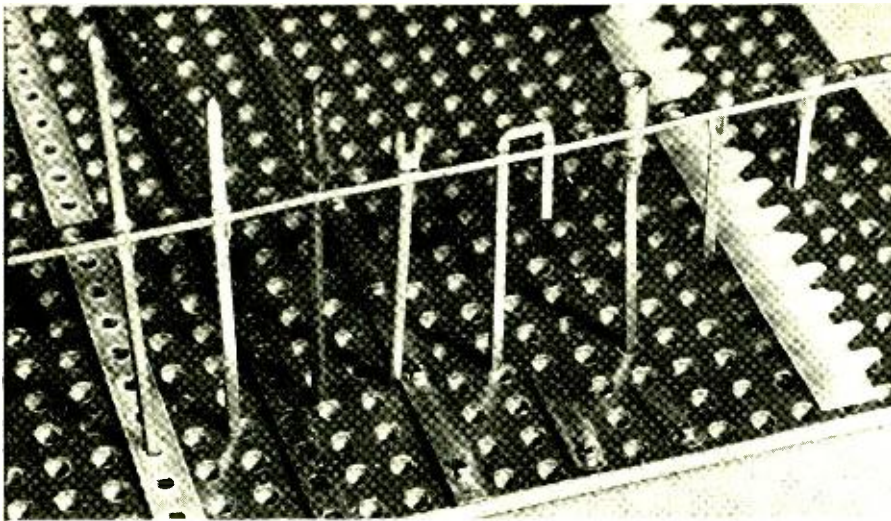

Assortment of terminal-pin hardware for Wire Wrapping.

tern perforated alignment block should be used to assure perpendicular alignment of the posts.

A handy item to have around when Wire Wrapping a project is the Model WD-30-B wire dispenser from OK. It holds a 100' spool of wire that feeds out through a hole in the side of the case to any length required. Built into the dispenser are a wire cutter and an insulation stripper.

Working With Wire Wrap. Rapid bus strapping with the Slit-N-Wrap tool requires very little practice. First, pull out 1" (2.54 cm) of wire, position the tool on the post, and hold the free end of the wire. Rotate the tool clockwise only and wrap seven or eight closely wound turns. You can keep track of the number of turns by counting the number of times the tunnel position marker passes a given point. Lift the tool off the post and form a loose strain relief loop by circling the post with the wrap tool. Form the wire down beside the post and hold it against the board with the plastic end of the No. P183 knife and forming tool.

With the wire tunnel marker up and the wire and tool in a nearly straight line, pull the tool to the next post and wrap as above. At the last post, add an extra turn and omit the strain relief loop. Either snip or break the wire by swinging the tool back and forth. Then use the chisel knife to cut off the excess wire at the first wrap post. To avoid snarling the wire, arrange your work so that you can complete the entire run without setting down the wrap tool.

Tip-loaded wrapping of Slit-N-Wrap wire with the Model P180 tool comes in handy at times. (You should use a heat sink when soldering a pencil-wired

Slit-N-Wrap connection.) The pencil-wired strain relief loop can be omitted, using simpler methods of strain relief, which preclude bending of wrap posts when installing a direct taut connection. As you wrap the first turn, observe the preceding wrap post for evidence of strain or pulling. If pulling is evident, reverse the direction of tool rotation part way once or twice as you slowly form the initial turn.

Another useful method is to position the wire tunnel marker to the far side of the post before anchoring and prior to wrapping the wire. Also, it is very useful to direct the wire tunnel marker and, hence, the direction of the wire as you prefer before lifting the strapping tool from the post. Wire coming off the posts at higher levels creates a "Sawtooth" effect than can interfere with other wiring. One way to avoid this problem is to pencil wire a spiralling turn down the post before removing the tool from the post and, similarly, to reach a higher wrap level on another post.

Conventional tip-loaded wrapping of bare and Kynar-insulated wire proceeds rapidly with the easy-to-load wrap tools. To wrap efficiently, roll the handle of the tool fully as far as you can between your thumb and fingers. When using insulated wire, strip away 1" of the insulation, taking care to avoid wire nicks. (A special Wire Wrap insulation stripper here will obviate nicks.) Then run the wire insulation right up to or around the post to preclude short circuits. You can easily form the modified wrap with the insulated turn by inserting a bit of the insulated portion of the wire into the wire tunnel. Where it can be used, bare-wire strapping and wrapping saves time. Spool-fed strapping avoids wire snarls

and more readily permits pencil wiring of connections around any size terminal or lug. Do not forget: Pencil-wired connections *must* be soldered.

You will discover that wire size plays a part in Wire Wrapping. Commonly used No. 30 bare and insulated wire is readily available in economical bulk spools and in assorted lengths of precut and pre-stripped wire with a variety of insulation colors. The use of prestripped wire affords convenience, but the resulting slack wire can impair high-frequency circuit performance.

Easily wrapped and routed No. 30 wire has little or no tendency to place wrap posts under strain with the taut connection. However, the wire kinks or bends easily if you miss the wire tunnel when tip-loading the wrap tool.

Excellent for power and ground bus-ing, No. 26 wire is much less easily formed and routed on the crowded Wire Wrapped board. The wire has a pronounced tendency to place posts under strain and requires strain relief with taut connections. As a compromise, No. 28 wire is easily tip-loaded and routed and easily strain relieved when required.

Powered wrapping with cordless power tools is ideal for large assembly projects. You will quickly develop proper timing of the motor to achieve efficient wrapping techniques. Very forceful in action, the power tool pulls the wire around the wrap post a half turn or so if you loosely anchor the wire. You can use this to your advantage to make the modified wrap connection.

At first, you may tend to under-wrap connections, leaving a flying end, when using a power tool. You can compensate for this by lifting the power tool partway to examine the wrap and then lowering the tool to complete the job.

With the heavier wire sizes, powered wrapping places even more strain and tension on wrap posts when installing a taut connection. One remedy is to leave some slack wire and pin the wire to the board before wrapping. Alternatively, you can manually advance the rotor one turn before starting the power tool.

In Conclusion. As you become familiar with the Wire Wrap approach to circuit assembly, you will discover that this scheme is much more efficient than the traditional approaches used in project wiring. With a little practice, you will soon master the proper tool-handling techniques to use to produce perfect Wire Wrapped joints every time. It may not be long before you retire your soldering iron for good. ◇

Kit No.1 the electronic erector set



Our \$499 Christmas Special for the gifted businessman, hobbyist or home engineer.

No more nuts and bolts. Today, it's bits and bytes. Or, bytes and bits, as the case may be. That is the bits and pieces of the microcomputer—the electronic erector set. The modern “toy” that stimulates while simulating and intrigues while interfacing.

Business, home or hobby room—there's a computer in your future. With the New Year just around the calendar, Christmas is a good time to start with this handsome gift of equipment; our powerful and popular 8080A microcomputer (pictured above). The funny numbers won't confuse you. The \$499 also includes a 426 page instruction course that tells you what it all means. This course was prepared by Bell and Howell Schools and is the industry standard for basic computer in-

struction. To start all you need is a screwdriver.

To obtain this Christmas Special, or for more facts and figures on the Electronic Erector Set, visit the BYTE SHOP in your neighborhood. Pick up a *free* informational Computer Starter Kit. It tells a lot more about what we mean. Also included are a “get started” flow chart, the computer course syllabus, an official “byte me” button and, if you'll register your birthdate, we'll prepare your very own computer-made biorhythm chart (that's so you'll know the best day to start developing your computer, among other things). But hurry. Christmas isn't next February.

BYTE SHOP
the affordable computer store

Stores now open in: **Arizona**, Phoenix, Phoenix-west, Tucson; **California**, Berkeley, Burbank, Fairfield, Fresno, Hayward, Lawndale, Long Beach, Marina Del Rey, Mountain View, Newport Beach, Palo Alto, Pasadena, Placentia, Sacramento, San Diego, San Fernando Valley, San Francisco, San Jose, San Mateo, San Rafael, Santa Barbara, Santa Clara, Stockton, Thousand Oaks, Ventura, Walnut Creek, Westminster; **Colorado**, Arapahoe County, Boulder, Denver; **Florida**, Cocoa Beach, Ft. Lauderdale, Miami; **Georgia**, Atlanta; **Illinois**, La Grange; **Indiana**, Indianapolis-No.; **Kansas**, Mission; **Montana**, Billings; **Nevada**, Reno; **New York**, Levittown; **North Carolina**, Greensboro, Raleigh; **Ohio**, Columbus, Rocky River; **Oregon**, Beaverton, Portland; **Pennsylvania**, Bryn Mawr; **South Carolina**, Columbia; **Utah**, Salt Lake City; **Washington**, Bellevue; **Canada**, Vancouver, B.C.; **Winnipeg**, Man. Or write to Byte Incorporated, 1261 Birchwood Dr., Sunnyvale, California 94086. Or phone (408) 734-9000

CIRCLE NO. 71 ON FREE INFORMATION CARD

MODEL RAILROAD SOUND SYNTHESIZER

BY HAROLD WRIGHT

ADD CONTROLLABLE "CHUFF-CHUFF",
STEAM, WHISTLE, AND BELL SOUNDS TO
YOUR MODEL RAILROAD LAYOUT AT LOW COST

The train comes roaring down the grade, steam "chuff-chuffing" furiously. As it nears a grade crossing, the wail of the steam whistle is heard and the crossing bars drop. The train lumbers through the crossing and starts laboring on an upgrade as it approaches the station, its bell clanging. There is a full head of steam on, and as the train comes to a halt, a safety valve lets go with a thunderous blast of steam.

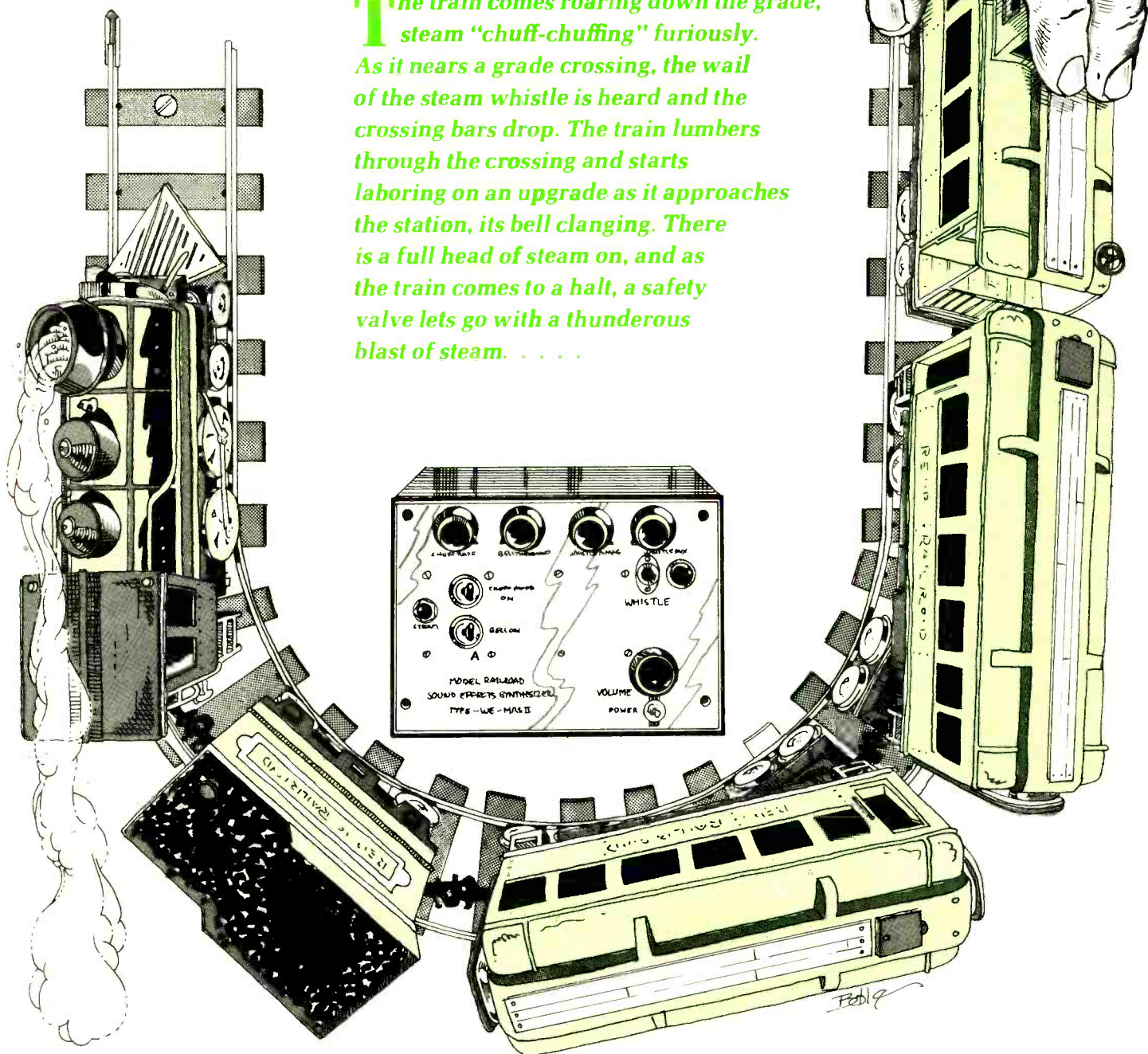

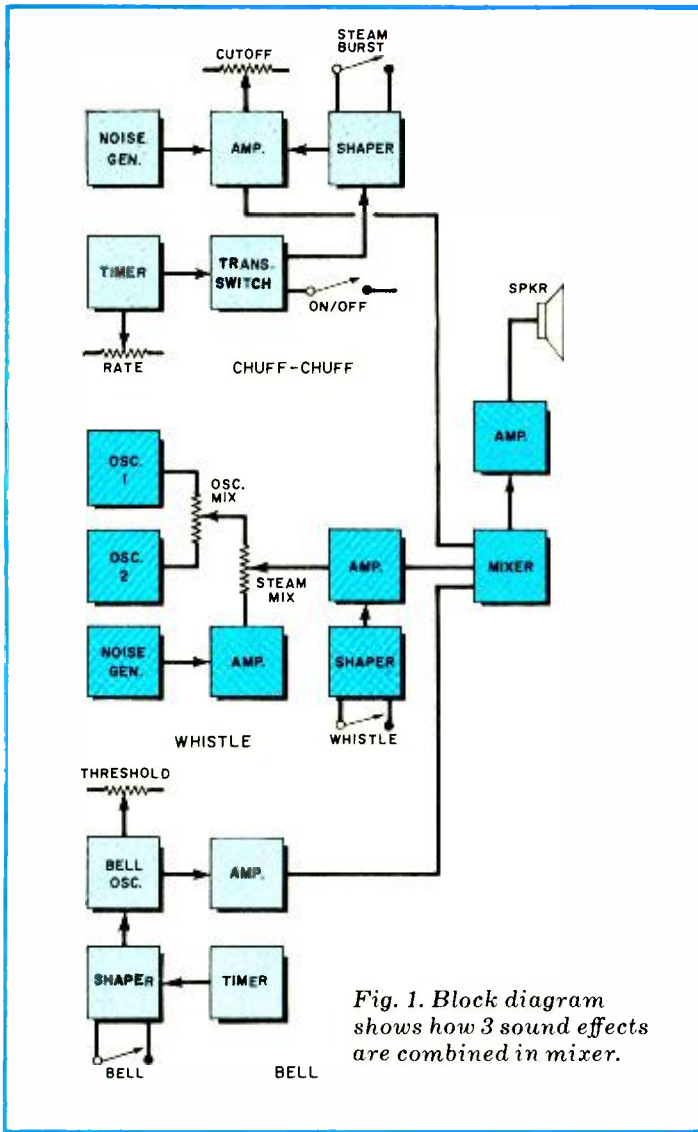

All of the sound effects described on the preceding page can be obtained in your model train layout if you build this sound synthesizer. Using relatively simple circuits and readily available components, the system can be assembled easily in a few hours. The loudness of the sounds obtained is determined by the audio amplifier that you use in conjunction with the synthesizer.

Since most modern railroad layouts are already equipped with electrically operated switches, signal lights, and speed controls, the addition of the sound synthesizer will have the effect of turning your system from a silent movie into one with sound. The synthesized sounds are quite realistic and are of a wide variety. They can range from those of a distant, rapidly approaching train, with the volume increasing as the train approaches and slows down for the station, to the noise of wheels slipping on an engine trying to start with too large a load.

A block diagram of the complete synthesizer is shown in Fig. 1. It consists of four more-or-less independent circuits: a "chuff-chuff" generator for the steam sound, a whistle generator, a bell circuit, and a three-channel signal mixer.

Chuff-Chuff. As shown in Fig. 2, transistor *Q1* is operated in the avalanche mode and generates a steady white noise (hiss) signal across *R2*. This signal is applied to amplifier *Q3*, which is adjusted to a point just below cutoff by *R10*.

Timer *IC1* produces pulses at a rate

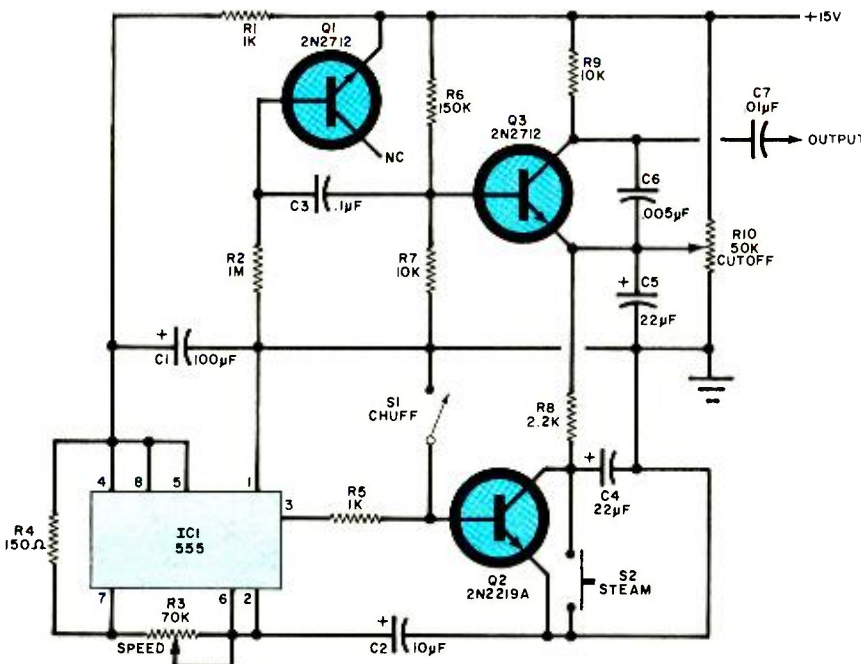

*Fig. 2. Steam sound comes from white-noise generator *Q1*.*

PARTS LIST CHUFF-CHUFF

- C1—100- μ F, 25-V electrolytic capacitor
- C2—10- μ F, 25-V electrolytic capacitor
- C3—0.1- μ F capacitor
- C4, C5—22- μ F, 25-V electrolytic capacitor
- C6—0.005- μ F capacitor
- C7—0.01- μ F capacitor
- IC1—555 timer
- Q1, Q3—2N2712 transistor
- Q2—2N2219 transistor
- The following resistors are 1/2-W carbon composition unless otherwise noted:
- R1, R5—1000 ohms
- R2—1 megohm
- R3—70,000-ohm panel-mount potentiometer
- R4—150 ohms
- R6—150,000 ohms
- R7, R9—10,000 ohms
- R8—2200 ohms
- R10—50,000-ohm board-mount potentiometer
- S1—Spst switch
- S2—Spst NO pushbutton switch

determined by $C2$ and the setting of $R3$. Thus, $R3$ is the chuff-chuff speed control and, with the values shown, can be set to provide sounds from those of a slow starting engine to very fast bursts of steam. Make sure that $R4$ is not less than 150 ohms or the speed setting will be unstable.

The pulses from $IC1$ are applied to $Q2$, which functions as an electronic switch. When $Q2$ conducts, $R8$ is shunted across the lower portion of $R10$, thus bringing $Q3$ above cutoff. Transistor $Q3$ then amplifies for one chuff. Capacitor $C6$ rolls off some of the high frequencies to produce a softer steam sound. Capacitors $C4$ and $C5$ shape the starting and stopping of the individual chuffs. The +15-volt supply is decoupled by $R1/C1$ to keep any pulses from getting into the remainder of the circuit.

Whistle. In this circuit, shown in Fig. 3, transistor $Q1$ is a fixed tuned twin-T os-

illator. The circuit for $Q2$ is almost identical except for tuning control $R11$. The second oscillator can be tuned from a zero-beat with the first oscillator to a frequency that simulates the two-tone effect similar to that heard from a diesel engine. Points between can be selected for a variety of sounds, including a steam whistle.

Because the outputs of the two oscillators are fed to potentiometer $R12$, a further range of possible tones exists. The power supply to the oscillators is decoupled by $R13$ and $C12$.

Transistor $Q3$ is connected as an avalanche-mode white-noise source, whose output (across $R14$) is amplified by $Q4$. The output of $Q4$ is fed to potentiometer $R19$ along with the output of the two tone oscillators. The final mix of tone and steam is fed to amplifier $Q5$.

When whistle pushbutton $S1$ is open, resistors $R22$ and $R25$ keep the emitter of $Q5$ at a higher potential than the base,

so that the transistor is cut off. When $S1$ is closed, $R24$ is grounded, shunting it across $R25$. This causes $C19$ to reach a lower charge level since it is now being discharged by $R24$. Thus the start of each whistle is made less abrupt to simulate a real steam whistle. When $S1$ is released, the recharging of $C18$ removes the terminal thump.

Bell. In the circuit in Fig. 4, transistor $Q1$ operates as a twin-T oscillator with potentiometer $R7$ set so that the circuit is just below the point of oscillation. If this control is set too low, the bell sound will be dull and have too short a decay time. Transistor $Q2$ is an emitter follower isolator between the bell oscillator and the mixer stage. Timer $IC1$ generates pulses to produce repetitive ringing with the rate (about one per second) determined by $R15$ and $C9$. The value of $R15$ can be reduced to increase the ringing rate of the bell.

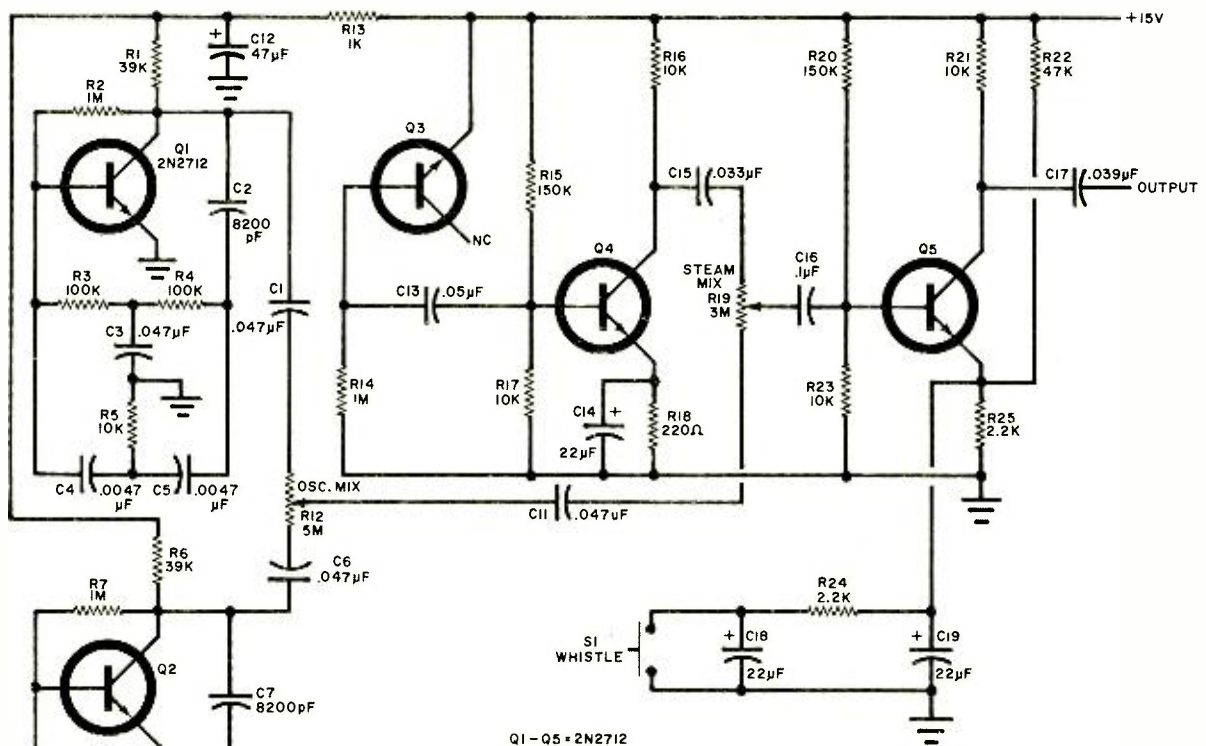

PARTS LIST WHISTLE

- | | |
|--|--|
| C1, C3, C6, C11—0.047- μ F capacitor | R1, R6—39,000 ohms |
| C2, C7—8200-pF capacitor | R2, R7, R14—1 megohm |
| C4, C5—0.0047- μ F capacitor | R3, R4, R8, R9—100,000 ohms |
| C8, C9, C10—0.005- μ F capacitor | R5, R16, R17, R21, R23—10,000 ohms |
| C12—47- μ F, 25-V electrolytic capacitor | R10—3900 ohms |
| C13—0.05- μ F capacitor | R11—5000-ohm panel-mount potentiometer |
| C14, C18, C19—22- μ F, 25-V electrolytic capacitor | R12—5-megohm panel-mount potentiometer |
| C15—0.033- μ F capacitor | R13—1000 ohms |
| C16—0.1- μ F capacitor | R15, R20—150,000 ohms |
| C17—0.039- μ F capacitor | R18—220 ohms |
| Q1 through Q5—2N2712 transistor | R19—3-megohm board-mount potentiometer |
| The following resistors are 1/2-W carbon composition unless otherwise noted: | R22—47,000 ohms |
| | R24, R25—2200 ohms |
| | S1—Spst NO pushbutton switch |

Fig. 3. Oscillator $Q1$ and $Q2$ take white noise from $Q3$ to create steam plus whistle.

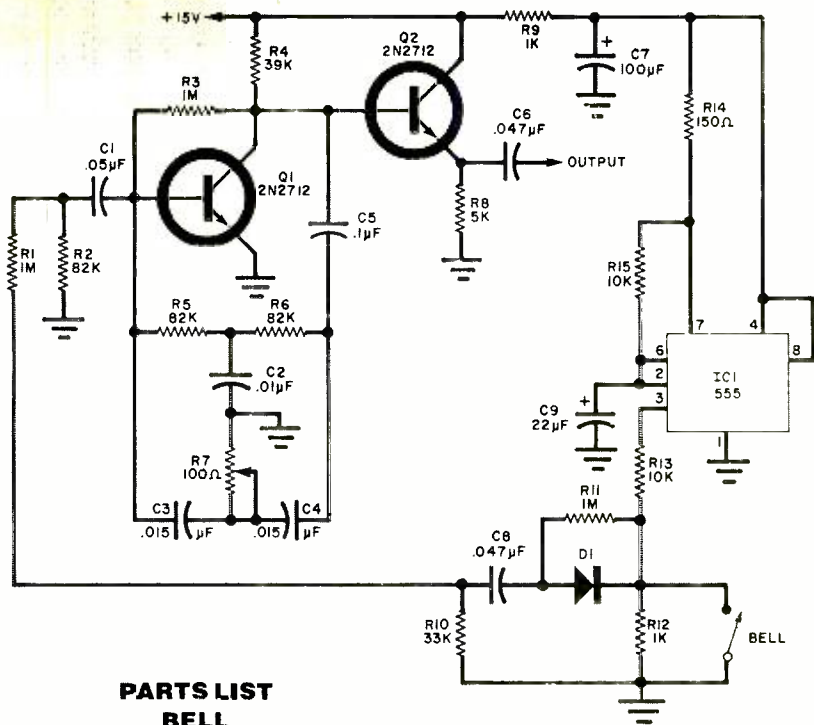

**PARTS LIST
BELL**

- C1—0.05- μ F capacitor
- C2—0.01- μ F capacitor
- C3,C4—0.015- μ F capacitor
- C5—0.1- μ F capacitor
- C6,C8—0.047- μ F capacitor
- C7—100- μ F, 25-V electrolytic capacitor
- C9—22- μ F, 25-V electrolytic capacitor
- D1—Silicon diode rectifier
- IC1—555 timer
- Q1,Q2—2N2712 transistor
- The following resistors are 1/2-W carbon composition unless otherwise noted:
- R1,R3,R11—1 megohm
- R2,R5,R6—82,000 ohms
- R4—39,000 ohms
- R7—100-ohm panel-mount potentiometer
- R8—5000 ohms
- R9,R12—1000 ohms
- R10—33,000 ohms
- R13,R15—10,000 ohms
- R14—150 ohms
- S1—Spst switch

Fig. 4. Bell circuit uses twin-T oscillator Q1 and switch.

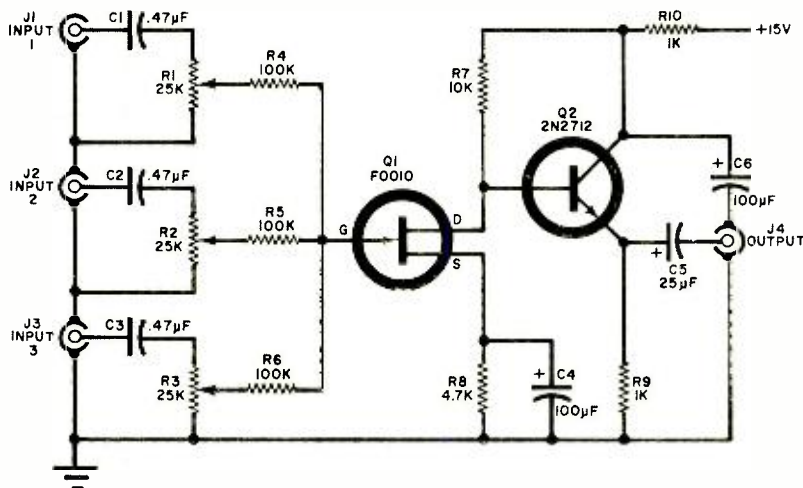

**PARTS LIST
MIXER**

- C1,C2,C3—0.47- μ F capacitor
- C4,C6—100- μ F, 25-V electrolytic capacitor
- C5—25- μ F, 25-V electrolytic capacitor
- J1 through J4—Phono connectors
- Q1—HEPF0010 FET
- Q2—2N2712 transistor
- The following resistors are 1/2-W carbon composition unless otherwise noted:
- R1,R2,R3—25,000-ohm board-mount potentiometer
- R4,R5,R6—100,000 ohms
- R7—10,000 ohms
- R8—4700 ohms
- R9,R10—1000 ohms
- Misc.—Board, wire, solder, etc. for all four circuits.

Fig. 5. Sound effects are combined in Q1 and drive amplifier through Q2.

The output of IC1 (pin 3) is applied to the voltage divider made up of R13 and R12 to reduce the signal level. The pulses are then rectified by D1 and differentiated by C8 and R10 to produce sharp spikes that trigger the twin-T oscillator, Q1.

Mixer. The outputs of the three sound-effect circuits are combined in the circuit shown in Fig. 5. Each input is coupled to its own level potentiometer (R1, R2, or R3) and they are combined at the gate of FET Q1. The output of Q1 is coupled to the external audio amplifier through emitter follower Q2 and capacitor C6.

Construction. The easiest approach to construction of the synthesizer is to build each circuit on its own small board. You can use perforated board and point-to-point wiring or make a small pc board. The arrangement is not critical. Each board can be built and tested using a 15-volt supply and an earphone (or a small amplifier/speaker combination). Be sure that transients generated by the timer IC's are not coupled into any of the circuits. If necessary, more +15-volt line decoupling is recommended. Sockets can be used for the transistors and IC's.

In the prototype, short lengths of shielded audio cable were used to couple the output of the three sound-effect circuits to the mixer inputs. Another length of shielded audio cable connected the mixer output to the audio system being used.

The boards can be installed in any type of chassis, with all controls on the front panel, clearly identified.

Use. Connect the mixer output to a good-quality audio amplifier and speaker combination. In the bell circuit, set the threshold potentiometer (R7) for the best sound when bell switch S1 is operated. There should be no clicks or pops. Do not try to control circuits by turning the power on and off.

The chuff-chuff has three front-panel controls with R3 being the rate control, S2 providing steam bursts, and S1 for on-off. It is best to group these three controls together so that they can be operated with the fingers of one hand. The whistle circuit has one switch (S1); the three internal potentiometers in this circuit should be preset.

If your train system is already equipped with electronic speed controls, you might consider ganging the chuff-rate potentiometer with the train speed control potentiometer for smoother operation of the complete system. ◇



Solid State

By Lou Garner

ONE CIRCUIT/MANY GIFTS

WHETHER you celebrate Christmas, Chanukah, the Saturnalia, or the winter solstice, chances are you're now selecting gifts for your friends, relatives, and loved ones. Of all gifts, perhaps the nicest are those hand-crafted or assembled by the giver. They have that extra personal touch which is so much more meaningful than manufactured items purchased for a fistful of dollars at retail outlets.

itself that determines the nature of the final project, but the way in which it is modified and packaged for its intended application. A change here, a small modification there, a different case or cabinet, and you have a completely new gift. There are a number of designs which can be used, literally, in dozens of interesting gift projects by making relatively minor changes in the circuit or its housing.

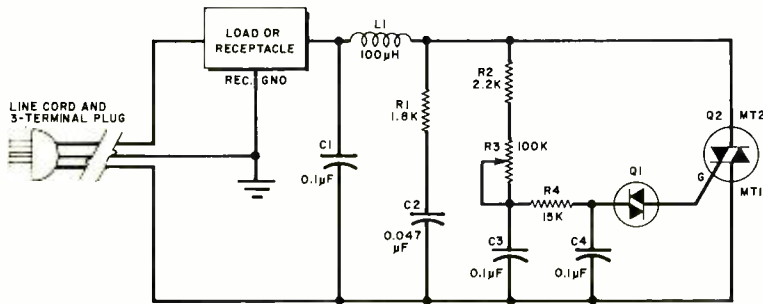

Fig. 1. This basic ac phase-control circuit can be used for a variety of useful and interesting gifts for friends and family during the holidays.

When choosing any gift, first make sure it is something the recipient can appreciate and use—a signal generator might make a dandy gift for a fellow hobbyist or technician, for example, but probably would be of little value to the average housewife, no matter how much care went into its assembly. Second, try to avoid the commonplace or routine—another AM transistor radio for a teen-ager who already has seven might be welcome, but may not be received enthusiastically. Third, make sure the item is safe and that accidental misuse can cause neither damage nor injury.

A good example is the ac power control circuit illustrated in Fig. 1. Starting with this basic design, use an incandescent lamp socket in series with one side of the ac line. The switch may be ganged with control potentiometer *R3*, if preferred. The modified circuit can be used in assembling a variety of variable-intensity lamps, including both table and floor models in traditional as well as modern designs, all of which make excellent gifts for the home or office. Or you could use the circuit in designing and building a modernistic desk lamp for the business executive, student, teacher or office worker. On the other hand, if assembling complete lamps will require more time than you can spare or will tax your financial resources (lampshades are expensive), you could replace the lamp socket

As an electronics hobbyist, you're fortunate in that you can easily assemble gifts to fit virtually everyone's needs and interests, from those of the housewife to the photographer, from the sports enthusiast and outdoorsperson to the student, and from the woodworker to the musician. The gifts may be assembled either from commercially available kits or from "scratch" using published circuit designs, depending on one's individual skills and budget limitations. If you're planning on a number of gifts and assembly from scratch, choose relatively simple proven designs using standard commercial components which, preferably, can be completed in one or two evenings or on a weekend. Elaborate projects, such as home computer systems and laboratory oscilloscopes may make welcome gifts, but you might have to start your project as early as June to complete it for the holiday season.

Fig. 2. General-purpose audio amplifier circuit.

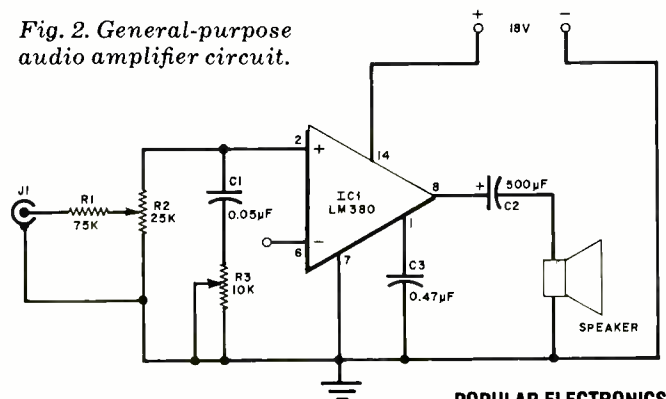

Add a dash of imagination to a blend of knowledge and skill and you'll find that you can use a single basic circuit for a variety of exciting and useful gifts. Quite often, it is not the circuit

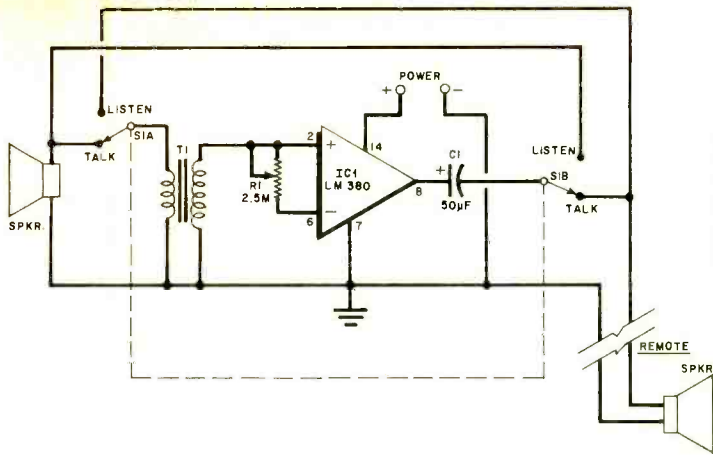

Fig. 3. An intercom based on the circuit originally shown in Fig. 1 makes a good gift for internal communications in most anybody's office or home, or around the workshop.

with a conventional line socket receptacle and assemble the circuit in a small wooden case as an "add-on" lamp dimmer for any existing incandescent lamp—another fine gift!

Perhaps you'd rather not throw a little light on the subject and are looking for something different. No problem! Using the same circuit, add a fuse holder in series with the switch in the power line, and use a line receptacle as the output element. Assemble the circuit in an insulated white enameled case with a white line cord and plug. Then add a dial for the control, install a pointer knob, and you have a variable-speed control for older kitchen appliances, such as blenders and mixers, and a lovely gift for your favorite cook. You could use the same design, but assemble it in a heavy duty gray *Minibox* and add a neon pilot lamp across the ac line as well as mounting holes or brackets. Then the unit becomes a variable-

speed control for small power tools such as drills, sanders and jig saws . . . a terrific gift for woodworkers, repairmen, craftsmen and most other do-it-yourselfers. Assemble the same circuit in a blank sloping-front meter case and you have a versatile lamp control for your friendly neighborhood amateur photographer. He (or she) can use it with an enlarger, printer, or low-power floodlamps.

The suggestions outlined thus far are but a small sampling of the many gifts that can be assembled using one basic circuit. In addition, the same design could be used for a fan speed control (where the fan employs a series-wound universal motor) or as a sewing machine speed control to replace an old-fashioned power rheostat. Other possibilities include a heater control for fish tanks, small hot plates, hair dryers, chemical baths and soldering irons or pots. If, by chance, your

ok® wire wrapping center ok®

NEW HOBBY WRAP MODEL BW 630



Battery
wire
wrapping
tool

\$34.95
ONLY
COMPLETE WITH BIT
AND SLEEVE

STRIP/WRAP/UNWRAP MODEL WSU-30



\$5.95*

RIBBON CABLE ASSEMBLY

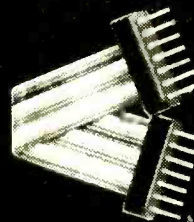

DIP SOCKETS

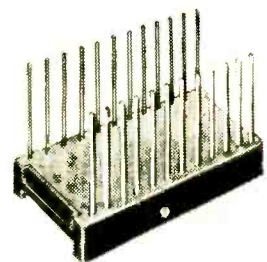

DIP IC INSERTION TOOL WITH PIN STRAIGHTENER

MODEL
INS-1416



\$3.49*

WIRE DISPENSER MODEL WD-30-B



\$3.45*

PRE-CUT PRE-STRIPPED WIRE

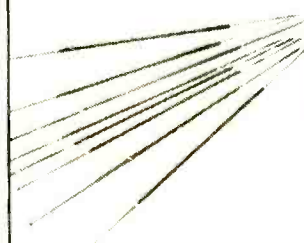

WIRE WRAPPING KIT

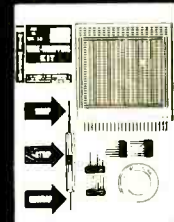

\$15.45*

*MINIMUM ORDER \$25.00. SHIPPING CHARGE \$1.00. N.Y. CITY AND STATE RESIDENTS ADD TAX

OK MACHINE AND TOOL CORPORATION

3455 CONNER STREET, BRONX, NEW YORK, N.Y. 10475 U.S.A.
PHONE (212) 994-6600 TELEX NO. 125091

VECTOR PACKAGING MATERIALS SAVE TIME & MONEY

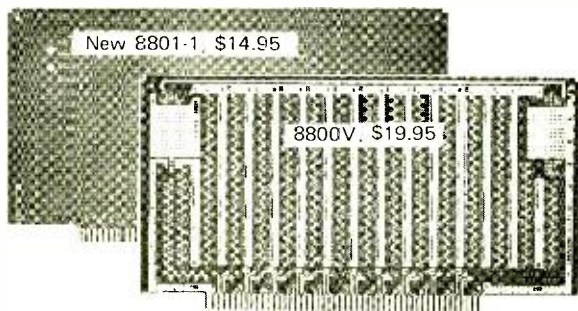

\$100 CARDS—100 PLUG CONTACTS—Convenient universal tinnecc pads and bus lines. For interface, memory expansion, breadboarding. Mount almost anything anywhere on card.



\$100 CONNECTORS for WIRE WRAPPING or SOLDERING

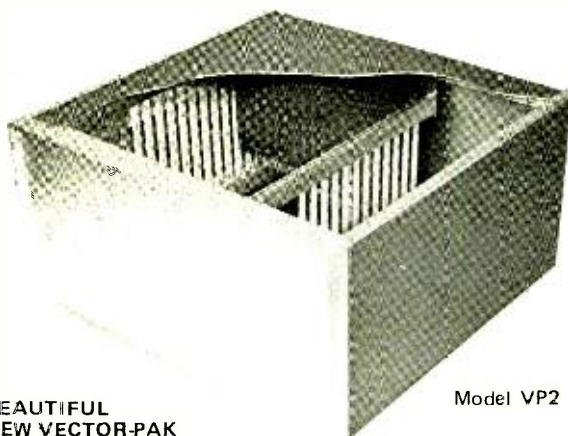

Model VP2

BEAUTIFUL NEW VECTOR-PAK

CASES for micro-computer circuitry, assembled. Constructed of aluminum, finished in vinyl. Slide out covers for easy access. Includes card guides, heavy chassis plate, perforated bottom cover for cooler operation. Card guides perpendicular to front panel, Model VP1, \$128.30. Card guides parallel to front panel, Model VP2, \$134.30.

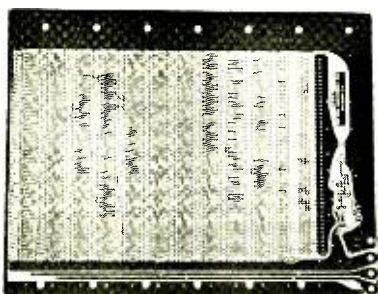

Model
8803

\$100 MOTHERBOARD, \$29.50. 11 positions ready for connectors. Glass epoxy, etched circuitry for passive or active termination, 12 tantalum capacitors and instructions.

PLUS revolutionary Slit-N-Wrap wiring tools, Micro-Vector-board, printed circuit kits, I.C. sockets, extenders.

Send for new catalog.



VECTOR ELECTRONIC COMPANY, Inc.
12460 Gladstone Avenue, Sylmar, CA 91342
phone (213) 365-9661, twx 910-496-1539

540777

intended recipient is another electronics hobbyist, you can simply give him (or her) a kit of the necessary components and hardware, a copy of the circuit diagram, and a list of suggested applications, permitting him (or her) to have the fun of selecting and assembling a favorite project.

Referring to the schematic diagram, the circuit is a conventional phase-control design featuring two active semiconductor devices, a diac bi-directional diode, $Q1$, and a triac thyristor, $Q2$. In operation, $Q2$ acts as a high-impedance device, blocking current flow through the external load until switched to a conducting state during each half cycle by a control voltage applied to its gate electrode through $Q1$. The point during each half cycle at which $Q2$ is fired is determined by the relative phase relationship between the line and gate control voltages. This, in turn, is established by phase-shifting network $R2-R3-C3$. Adjusting $R3$'s value changes the phase relationship between the control and line voltages, firing $Q2$ earlier or later during each half cycle. This permits a greater or lesser average current flow, effectively controlling the power delivered to the load. Snubber network $R1-C2$ is included to reduce transient voltage peaks when the circuit is used with inductive loads such as motors and solenoids, while $L1$ and $C1$ form a simple r-f filter to reduce hash and noise levels.

With neither layout nor lead dress overly critical, the power control circuit can be assembled using any standard construction technique, including perf board, pc board, or point-to-point wiring on a metal chassis. A small heat sink should be provided for $Q2$ if the circuit is to be used for controlling heavy loads, such as heaters and photographic flood lamps, but should not be needed for lighter duty applications. The snubber circuit, $R1-C2$, can be omitted if the circuit is used with resistive loads only; even the r-f filter, $L1-C1$, may be omitted for some applications. Except for linear potentiometer $R3$, all resistors are half-watt types, while the capacitors are 200-V plastic film or tubular paper types. The specified component values are for use with the RCA D3202U diac and T2500B triac, but only nominal value changes, if any, should be required for the use of other equivalent devices. Assembled in a standard TO-220 plastic package, the T2500B is a 6-A, 200-V silicon triac with a 60-A surge-current rating.

Though extremely versatile, the ac power control is by no means the only design adaptable to a wide variety of gift projects. Another example, a general-purpose, medium-power audio amplifier, is shown in Fig. 2. With a suitable IC, this circuit is capable of delivering up to several watts of output at relatively low distortion levels to 4-, 8-, or 16-ohm loads and, while accepting input signals as high as ± 0.5 V, can offer a bandwidth of up to 100 kHz. It can be powered by either battery or well-filtered ac line-operated dc sources from 12 to 22 volts.

You can use the basic audio amplifier for assembling such worthwhile gifts as the following:

- **Portable Phonograph**—a fine gift for a youngster or teenager. Using a battery power pack, assemble the amplifier in an inexpensive attache case, adding a battery powered turntable and high-output crystal cartridge pickup. Install a spst toggle, slide or rotary switch in series with one of the phono motor leads. A second spst switch, ganged to either the *volume* ($R2$) or *tone* ($R3$) control, should be wired in series with the amplifier's positive dc lead. For operating convenience, a 12-volt dc source can be used as a power pack. In this case, the loudspeaker should have a 4-ohm voice coil. Use as large a PM loudspeaker as will fit conveniently within the available space for good sound reproduction.

- **Signal Tracer**—a nice gift for a technician or fellow hobby-

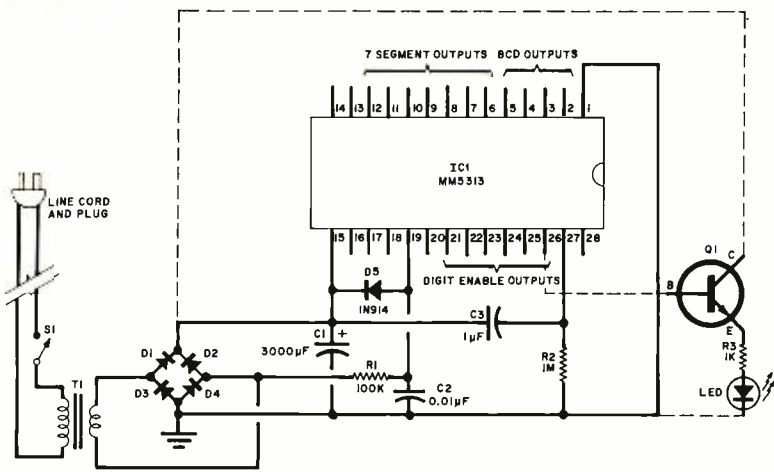

Fig. 4. Using an MM5313 clock chip, individual light emitting diodes can be driven by the BCD and 7-segment outputs to provide a multiple flasher that can be used for decorative lighting outdoors or indoors during the holidays.

ist. Assemble the amplifier in a portable test instrument case with integral power supply. An input jack (J1) is mounted on the front of the case and a separate spst toggle, slide or rotary power switch, wired in series with either the positive supply lead or the transformer's primary winding if an ac power pack is used. The tone-control circuit R3-C1, is optional. If desired, a pilot lamp may be added for an extra professional touch. Simply wire a standard LED across the amplifier's dc power input terminals in series with a resistor of appropriate value for the LED's rated current and the dc source voltage. Furnish shielded test cables with plugs to match J1 and both dc blocking (series capacitor) audio and r-f detector probes.

●Auto Radio Remote Speaker—an interesting gift for campers, picnickers and outdoorspersons. Assemble the am-

plifier in a portable case or loudspeaker cabinet complete with battery power supply. Mount the input jack (J1) on the rear of the cabinet. Add a spst rotary power switch ganged to either the volume or tone controls. Install an output jack in parallel with the car radio's loudspeaker and provide a shielded cable terminated with plugs to match the two jacks.

●Music Instrument Amplifier—a terrific gift for the budding musician. It can be used for practice without rattling the windows. Assemble the amplifier system, controls, jack and power supply (or batteries) in a portable case or wall speaker cabinet, adding a separate power switch and pilot lamp as described in a previous paragraph. Provide an instrument microphone and length of shielded cable with a suitable plug to match the input jack.

(Continued on page 88)

Hirsch-Houck Laboratories called the \$389 Speakerlab 7 "smooth and flat," "highly accurate," and "a very fine speaker system" We call it the best \$279 kit on the market.

When Popular Electronics and Hirsch-Houck Labs assembled and evaluated a set of Speakerlab 7's, the report (which appeared in the September issue of this very magazine) was full of phrases like "good reverberant frequency response", "equally suited to all types of music" and "within ± 3 dB from 35 to 6000Hz, rising at higher frequencies."

As a \$279 kit, the 7's are just one example of how you get more by saving assembly costs with Speakerlab kits. Horn drivers, butyl-surround woofers with hi-temp voice coils, real L-pads and thick-wall walnut veneer enclosures are suddenly affordable if you're willing to spend a few hours with a tube of glue and a staple gun.

Can you handle a speaker kit?

The test report observed that "the instruction manual was clearly written and illustrated" and that "even if you happen to be the unhandiest person around and cannot complete a kit, Speakerlab will finish it for you at no charge (except shipping)." All true.

Send for our free 44-page catalog manual today and hear what Hirsch-Houck Labs heard.

.....

I'm interested in the speaker kit Hirsch-Houck said such nice things about and its eight relatives. Send me your free 44-page catalog/manual. _____ And a reprint of the September '77 Popular Electronics review.

Name _____
 Street _____
 City _____ State _____
 Zip _____

PE-F



Speakerlab
 Dept. PE-F, 5500 35th N.E. Seattle, WA 98105

computer depot inc.®

(Credit Cards Accepted)

3515 W. 70th Street, Minneapolis, MN 55435
(612) 927-5601

- Pana Vise #300 Base with 366 Jaws \$21.95
- B&K #1474 30 MHZ Scope Dual Trace \$765.00
List \$865.00
- E&L Digi-Designer Kit—Design Your Own Circuits. \$77.75
- Speech Lab Kit—Talk To Your S100 Computer . \$249.00
- Wahl Rechargeable Cordless Soldering Iron \$24.95
- Bug Book #1 & 2 Guide to Digital Electronics . . . \$17.00
- Cromemco Bytesaver Kit—Burns & Reads 2708 Eprom \$145.00
- 2708 Eprom Full Spec Prime from Ti & Fairchild . \$16.95
- OK Machine & Tool Hobby Wire Wrap Tool. . . . \$34.95
- E&L SK10 Breadboard Socket—The Best for Less . \$15.00
- Motorola DII 6800 Evaluation Kit \$235.00
- National SCMP Kit & Keyboard. \$190.00
- AP Product 16 Pin IC Test Clip \$4.75
- Free TTL Catalog & More

Remember — We Pay The Shipping Charges

Name _____
Address _____
Part No. _____ Qty. _____ Amt. Enclosed _____

CIRCLE NO 8 ON FREE INFORMATION CARD

●Power Megaphone—a fun gift for the sports enthusiast or amateur coach. Plan on using an external battery power pack to reduce weight, connected to the amplifier system proper through a length of line cord. Assemble the amplifier in a small *Minibox* mounted on the back of a trumpet loudspeaker. Omit the tone-control circuit (*R3-C1*) and substitute a 50-100- μ F electrolytic capacitor for *C2* to emphasize voice frequencies. Omit *J1* and connect in its place a high-output crystal or dynamic microphone, cushioning it in a rubber mounting to minimize mechanical feedback. Add a pistol-grip handle and install a spst pushbutton power switch, wired in series with the positive dc supply lead.

●Intercom—a fine gift for the home, office or shop, this project requires additional modifications in the basic circuit, as shown in Fig. 3. The tone-control circuit has been omitted and the gain control (*R1*) circuit modified. A *Talk-Listen* switching system, *S1A/S1B*, has been added, together with an impedance matching input transformer, *T1*. The output coupling capacitor's size (*C1*) has been reduced to emphasize voice frequencies. As in the other projects, the dc source may be either batteries or a line-operated power supply. A separate spst toggle, slide or rotary power switch must be added, connected either in series with one of the battery leads or in series with the power transformer's primary winding, depending upon what type of power source is used. The use of a pilot lamp is optional. The "Master" (amplifier/speaker/power supply) and "Remote" (loudspeaker) units can be assembled in wooden, plastic or metal cases, as preferred, to suit the installation. Ordinary line cord or twisted pair intercom cable can be used for interconnecting the two units.

Although neither the parts placement nor wiring arrangement should be overly critical, good audio wiring practice should be followed when assembling any of the amplifier projects, with signal carrying leads kept short and direct and reasonable spacing provided between the input and output circuits. Regardless of the actual construction techniques employed—perf board, pc board, or chassis style—an adequate heat sink should be provided for *IC1*.

The lead connections identified in Figs. 2 and 3 are for a *National Semiconductor* type LM380, but other multiwatt audio amplifier IC's may be used in the various projects, provided correct lead connections are chosen and component values are adjusted for optimum performance. With the LM380, pins 3-4-5 and 10-11-12 should be soldered directly to the heat sink and circuit ground. If oscillation occurs under some loading conditions, a series network made up of a 2.7-ohm, 1/2-W, resistor and a 0.1- μ F low-voltage ceramic capacitor should be connected between pin 8 and circuit ground. Referring to Fig. 2, *R1* is a half-watt resistor, *R2* and *R3* are audio-taper potentiometers, *C1* and *C3* are low-voltage ceramics, and *C2* is a 20-V electrolytic capacitor. In Fig. 3, *R1* is an audio-taper potentiometer, *C1* a 20-V electrolytic, and *T1* is a small step-up audio transformer with (approximately) a 25:1 ratio between the secondary and primary windings. Generally, 4-ohm loudspeakers are preferred with dc supplies up to 14 volts, while 8-ohm types offer better performance with amplifier sources from 16 to 22 volts. From an operational viewpoint, the loudspeaker sizes are not critical, but smaller units (2½" to 4") are better for the compact projects, such as the intercom and signal tracer, while the more efficient larger speakers (5" to 10") are preferred for the phonograph, instrument amplifier and remote speaker projects. As a general rule, too, the larger the loudspeaker, the better the low frequencies.

Reader's Circuit. Working with "hobby grade" digital clock

MAKE GREAT CONNECTIONS!



IC SOCKETS
3 Level Wire Wrap Gold

Pin	1-9	10-24	25-100
14pin	.38	.37	.36
16pin	.42	.41	.40
18pin	.45	.44	.43
24pin	.50	.49	.48
40pin	.69	.68	.67

Low Profile D.I.P., Solder roll. (TIN)

IC INTERCONNECT ASSEMBLIES
26 Ga. Ribbon Cable

Pin	6"	12"	18"	24"	36"	48"
14 pin	1.51	1.62	1.72	1.83	2.05	2.26
16 pin	1.64	1.76	1.87	1.99	2.21	2.44
24 pin	2.49	2.69	2.88	3.08	3.48	3.87

DOUBLE END

14 pin	2.76	2.87	2.97	3.08	3.30	3.51
16 pin	3.01	3.13	3.24	3.36	3.58	3.81
24 pin	4.55	4.75	4.94	5.14	5.54	5.93

DUAL IN-LINE PLUGS Use for mounting diodes, resistors, jumpers, etc.

Pin	1-24	25-49	1-24	25-99
8 pin	.46	.39	.10	.09
14 pin	.66	.40	.10	.09
16 pin	.76	.47	.10	.09
24 pin	.79	.72	1.5	1.18
40 pin	\$1.23	\$1.08	.25	.22

25 AMP STUD MOUNT DIODES

D2131 200V, 25Amp \$.85
D2135 400V, 25Amp \$1.00
D2138 600V, 25Amp \$1.55

200V, 30A BRIDGE
Rectangular molded with heat disc insert for high ratings.
BRR-2230M \$2.00

SOLID STATE RELAYS
Ideal for interfacing micro computer to the rest of the world. Rated 250V with dc control from 5V to 30V.

#601-10036 1 Amp. . . \$5.88
#601-10037 5 Amp. . . \$6.88

Miniature Plastic enclosed relay with low voltage dc coil. Operates from only 3 volts. Add a 20 Ohm, ½ watt resistor for 5 volts.

SPDT gold plated contacts rated at 2 Amps.
#RY-0312 \$1.49

NPN Silicon planar transistor
Ideal for high level linear and medium speed switching circuits. 25V, 500 mA, 360 mW. Good for schools and training because of full characterization.

2N3414 SPECIAL . . . \$1.00
Characterization sheets 40c

200V, 1.5A diode with gold leads. Good substitute for 1N4003. #SI-2. . . 12/ \$1.00

6.3VCT, 1.2A Transformer
Just right for that 5V logic supply and filament source. Identical to TRIAD F41X which sells for \$4.12. These are brand new industrial surplus. 2-3/8" mounting cntrs.

#FTX-6312C \$2.49

Fast recovery power diode for hi-freq power supplies. 200V, 1A #MR-812. . . 4/\$1.50

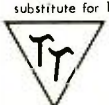

TRI-TEK, INC.
7808 NORTH 27th Ave
PHOENIX, ARIZONA 85021
MASTER CHARGE/BAC (602) 995-9352

Minimum Order. USA, \$10
Foreign. \$15 in US Funds.
Surface Shipping Prepaid.
Add 50c insurance

SEND FOR FREE CATALOG

CIRCLE NO 64 ON FREE INFORMATION CARD

IC's and kits, reader Henry R. Bungay III, Professor of Chemical and Environmental Engineering at the *Rensselaer Polytechnic Institute* (Troy, NY 12181), found that these inexpensive devices could be used effectively as multiple LED flashers, with a single device capable of flashing from a dozen to as many as eighteen LED's in a pseudorandom pattern. Professor Bungay's technique is relatively simple and straightforward, as follows.

Using multiplexed clock IC's, the value of the timing capacitor in the multiplex oscillator circuit is increased to slow the scan speed to a visible rate. Then, individual LED's are substituted for the seven-segment readout elements, with the values of the output-current limiting resistors increased as required to compensate for the longer duty cycle. The resulting multiple flasher can be used for such applications as indoor decorative lighting (*ideal for the Holiday Season!*), as a conversation piece for a recreation or family room, as a stimulating display for advertising, or as a random pattern generator for games.

One of several possible circuit arrangements is illustrated in Fig. 4. Here, spst power switch *S1*, stepdown transformer *T1*, and full-wave bridge rectifier *D1-D4* constitute a conventional power supply, furnishing the 11-to-19-volt dc required for device operation. Capacitor *C1*, a 20-V electrolytic, serves as a simple ripple filter. All resistors are standard half-watt types; *C2* is a low-voltage ceramic capacitor, with a high-value metallized plastic film or tubular paper type used for timing capacitor *C3*. Diode *D5*, typically, is a type 1N914. The pin connections shown in the diagram are for the MM5313 clock chip (*IC1*) but, of course, other clock IC's can be used.

(Continued on page 151)

projection television lenses



Convert color TV to GIANT SCREEN with Model P-1.85 Plastic Lens

- Focal length 12" • f1.85
- Diameter 6.5" • Length 6.5"
- Complete with mounting ring and instructions

\$140 each

Model G-2.5 Glass Lens

- Focal length 12" • f2.5
- Diameter 5" • Length 4 3/8"
- Complete with mounting ring and instructions

\$165 each

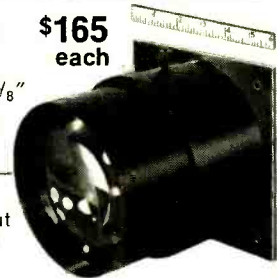

ALSO AVAILABLE

- Newly developed Fresnel 2 element lens in molded hood; designed for easy mounting. Also available in separate elements.
- Newly developed High Efficiency Projection Screens in sizes 30" x 40" and 40" x 51".
- Projection kit complete with TV set. **ALL AT LOW, LOW PRICES.**

Write or call Bill Spellman

MIAMI FLOCK EQUIPMENT CO., INC.

Optical Division

304 N. E. 79th Street, Miami, Florida 33138 • (305) 759-3124

CIRCLE NO. 31 ON FREE INFORMATION CARD

Last chance to save.

Special Bonus Offer!

Special Bonus Offer expires 12/31/77.

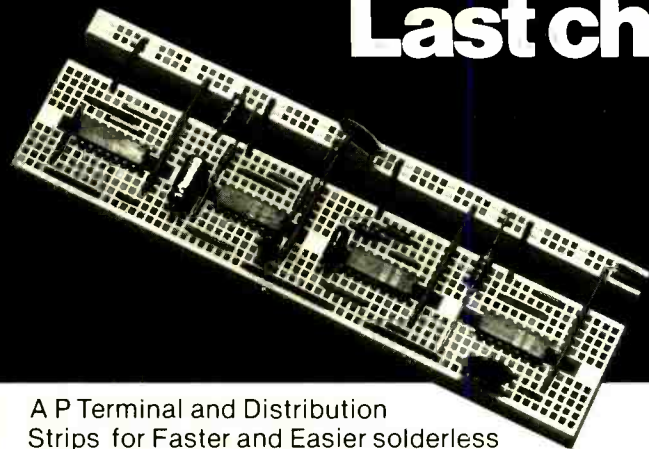

A P Terminal and Distribution Strips for Faster and Easier solderless circuit building and testing. No special patch cords are required, and any solid wire up to No. 20 AWG can be used for connection. Strips accept all components with leads up to .032" diameter, and hardware and mounting templates are provided with every strip. Terminals are non-corrosive nickel/silver.

For the name of the distributor nearest you call Toll-Free 800-321-9668.

Send for our complete A P catalog The Faster and Easier Book.

Faster and Easier is what we're all about.



A P PRODUCTS INCORPORATED

Box 110 • 72 Corwin Drive, Painesville, Ohio 44077 • 216/354-2101 TWX: 810-425-2250

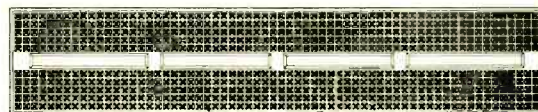

Buy this Model 264L **TERMINAL STRIP**, with 128 five-tie-point terminals, #923261 for only **\$12.50**.



And get this Model 212R **DISTRIBUTION STRIP**, with 24 four-tie-point terminals, #923277 **FREE** of added cost.

Free offer also applies to other sizes.

Look for the Special Bonus Offer Display at your A P distributor.

**THE BOOK YOU'VE
WAITED FOR
IS HERE!**

HEXADECIMAL
MEMORY
ROMs
MNEMONICS
ADDRESSING MODE
INDEX REGISTER
OPERATIONS
PROMs
PROGRAM COUNTER
EPROMs



UNDERSTANDING MICRO COMPUTERS AND SMALL COMPUTER SYSTEMS

Here, at last, is a profusely illustrated, easy-reading, "must" book explaining fundamental concepts behind operation of almost all microcomputers... in simple English... giving you that extra knowledge to read and understand computer magazines and manufacturer's literature... and feel "at home" around computers. Things like:

- How a CPU is organized; how it follows sequences of orders to solve problems
- Illustrates basic instructions from almost every microcomputer
- Discusses common memory addressing modes — illustrates typical uses
- What to know to tell a computer what to do when using machine language programming
- Use of flow charts; program worksheets; hand assembly of source codes into object codes; memory maps; purpose of Editor, Assembler, Monitor.

only \$9.95. Order your copy today!

- How a computer communicates
- Commonly used I/O devices and operational concepts
- Practical aspects of selecting a small computer system
- Plus, hundreds of other practical facts and information! If you're curious about small computers, you must own this 300 page no-nonsense easy-reading text. Includes easy-to-use glossary of key microcomputer-oriented words.

UNDERSTANDING MICROCOMPUTERS. The name says it all! Only \$9.95 ppd. Order your copy today!

**SCELBI COMPUTER
CONSULTING INC.**
P.O. Box 133 — PP STN, Dept. PE
Millford, CT 06460

Price shown for North American customers. Master Charge, Postal and Bank Money Orders preferred. Personal checks delay shipping up to 4 weeks. Pricing, specifications, availability subject to change without notice. SCELBI Books are available in many fine Computer Stores.

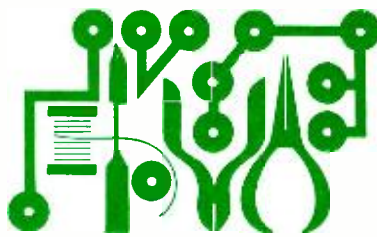

Experimenter's Corner

By Forrest M. Mims

READ/WRITE MEMORIES (RAM's), PART 1

LAST MONTH, we built a read-only memory (ROM) with some diodes and a BCD-to-decimal decoder. Now, we're going to experiment with the 7489 IC, a factory-produced read/write memory that can store sixteen 4-bit words.

As you know, ROM's store information without the need for electrical power and are called *non-volatile* memories. Most RAM's, on the other hand, are *volatile* memories; turn off the power and they forget whatever information is stored in them. You've probably seen read/write memories labeled RAM's and R/WM's. RAM, random access memory, is a fancy way of saying that any bit or word stored in the memory can be addressed as fast as any other. This contrasts with a *serial* memory like magnetic tape where a time-consuming search may be required to find a particular bit or word.

Since both ROM's and RAM's are random access memories, R/WM is a better label for the read/write memory than RAM. But "RAM" is pronounceable and R/WM isn't, so most people use RAM.

The 7489 RAM. The storage capacity of the 7489 is a far cry from that of the 4k (4,096 8-bit bytes) RAM's used by hobby computer enthusiasts, but the 7489 does have some interesting applications. It will help you understand some basic microprocessor terminology and operations.

Fig. 1. The 7489 RAM pin outline.

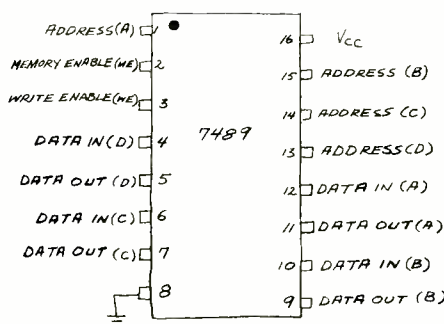

Figure 1 shows the pin diagram for the 7489. Here's a table that organizes the pins according to function:

Function	Pins			
	D	C	B	A
Address lines	13	14	15	1
Data in	4	6	10	12
Data out	5	7	9	11

The 7489 also has a couple of *enable* inputs. The Memory Enable (ME) input, pin 2, is connected to ground (logic 0) during read and write operations. The Write Enable (WE) input, pin 3, must be at logic 0 when data is written into the RAM. Data can be read from the RAM when WE is at logic 1.

The 7489 has 16 storage slots designated by the addresses 0000-1111. Thanks to a built-in address decoder, writing a word into a memory slot is a simple matter of applying the appropriate BCD number to the address lines, placing both ME and WE at logic 0, and presenting the bits to be stored at the data input lines.

Reading a word from the RAM is even simpler. First, the word's storage slot address bits are applied to the address lines. Then ME is placed at logic 0 and WE at logic 1. The *complement* of the word in the selected address will then appear at the output.

Complementing a word means changing its 0's to 1's and its 1's to 0's. Thus, the complement of 1010 is 0101. This means you have to complement a word you want to store before writing it into the memory if you want it to appear in uncomplemented form at the output. In other words, if you want to retrieve 1100, store 0011 instead.

There are two points to keep in mind in using a 7489. First, it is a *volatile* memory, so you must keep power applied as long as you want to save the data stored in it. It's also a *non-destructive* memory. That is, the selected word is not lost when it's read out; it stays in the memory until replaced by a new word.

RAM Demonstration Circuit. You can learn a lot about RAM's by plugging the 7489 into a solderless breadboard along with some LED's to indicate the output data and jumper wires to select addresses and apply input data. Use the arrangement shown in Fig. 2. Take a few minutes to label each jumper with a marked square of masking tape. This will save lots of time later. Connect jumpers you want to be at logic 0 to ground and those at logic 1 to +5 volts. Try loading each storage slot with its binary address for practice.

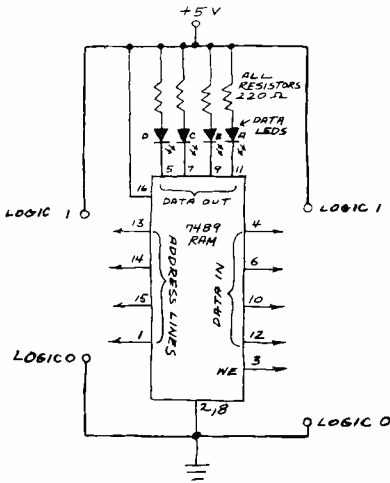

Fig. 2. A RAM demonstration circuit.

In this circuit a glowing LED indicates logic 0 and a dark LED, logic 1. You can automatically invert words stored in the memory by mentally assuming that a glowing LED signifies a logic 1. This means you don't have to load the complement of a word you want to save.

Automated RAM Demonstrator. A much better way to learn about RAM's as well as some microprocessor basics is to connect a binary counter to the address inputs of the 7489. Figure 3 is a block diagram that shows how everything goes together.

Here's how the circuit works using microprocessor terminology. Clock pulses enter the counter, and the 4-bit BCD count is applied to the address inputs of the RAM. The counter acts like a *pointer* as it sequentially selects first one address, then the next, and so forth.

In the READ mode (WE = 1; ME = 0), the data output LED's flash each word in succession as the pointer cycles through the memory. In the WRITE mode (WE and ME = 0), the LED's are extinguished, and the data on the input lines is written into the RAM. This means, of course, that the input data has to be

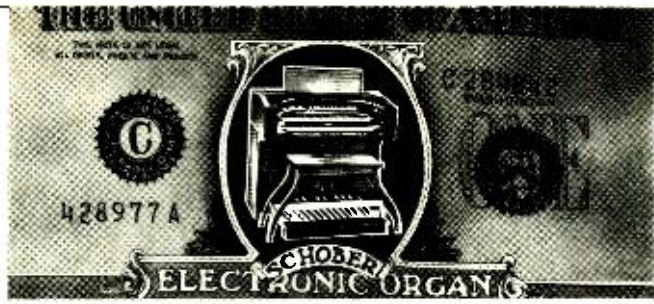

You can build a better organ than you can buy!

A magnificent Schober Electronic Organ

What a marvelous way to put your special talents to work! With our Schober Electronic Organ Kits and your skill, you can build yourself some very special satisfaction, and a lifetime of great music!

Schober Organs are literally far superior to comparably-priced "ready-made" units. You could actually pay twice as much and get no better organ...and miss the fun of assembling it yourself. A PC board at a time, component by component, you'll assemble your own "king of instruments." And when you're done, you'll wish there was more to do. And there is! For then, Schober will help you learn to play, even if you've never played a note before!

Schober Organ Kits range from \$650 to \$2850, and you can purchase in sections to spread costs out...or have two-year time payments. Combine the incomparable quality of Schober components with your talent...and produce a far better organ than you can buy!

Thousands of others have, ever since 1955.

You can have all the details, without cost or obligation. Just send the coupon for the fascinating Schober color catalog (or enclose \$1 for a record that lets you hear as well as see Schober quality.) Why not clip it right now, before you forget?

The Schober Organ Corp., Dept. PE-74
43 West 61st Street, New York, N.Y. 10023

- Please send me Schober Organ Catalog.
- Enclosed please find \$1.00 for 12-inch L.P. record of Schober Organ music

NAME _____
ADDRESS _____
CITY _____ STATE _____ ZIP _____

CIRCLE NO. 55 ON FREE INFORMATION CARD

The leading magazine in the personal computer field

BYTE is the magazine for the creative home computer experimenter. BYTE tells you everything you want to know about personal computers, including how to construct and program your own system.

Home computers are now practical and affordable. Low cost peripherals have resulted in more hardware and software, more applications than you could imagine. BYTE brings it all to you. Every issue filled with stimulating, timely articles by professionals, computer scientists and serious amateurs.

Fill in the coupon today. Read your first copy of BYTE; if it's everything you expected, honor our invoice. If it isn't, just write "CANCEL" across the invoice and mail back. You won't be billed, and the copy is yours.

Allow 6 to 8 weeks for processing.

© Byte Publications, Inc. 1977

BYTE Subscription Dept. 07F
P.O. Box 361 Arlington, Mass. 02174 U.S.A.

Please enter my subscription for:

- One year U.S.-\$12 (12 issues) Two years U.S.-\$22 Three years U.S.-\$32
- Canada or Mexico-\$17.50 Europe (Air Delivered)-\$25
- Surface delivery to all other countries except Europe, Canada or Mexico-\$25 (Air delivery available on request) Please remit in U.S. funds.
- Check enclosed (Bonus: one extra issue) Bill me Bill Bank Americard
- Bill Master Charge

Card Number _____ Expiration date _____
Signature _____ Name (please print) _____
Address _____
City _____ State/Country _____ Code _____



BYTE
The Small Systems Journal

Should your career in electronics go beyond TV repair?

**CREI prepares you at home
for broader and more advanced
opportunities in electronics—
plus offers you special arrangements
for engineering degrees**

There is no doubt television repair can be an interesting and profitable career field. TV repair, however, is only one of the many career areas in the fast growing field of electronics.

As an indication of how career areas compare, the consumer area of electronics (of which TV is a part) makes up less than one-fourth of all electronic equipment manufactured today. Nearly twice as much equipment is manufactured for the communications and industrial fields. Still another area larger than consumer electronics is the government area. That is the uses of electronics in such areas as research and development, the space program, and others.

Just as television is only one part of the consumer field, these other fields of electronics are made up of many career areas. For example, there are computer electronics, microwave and satellite communications, cable television, even the broadcast systems that bring programs to home television sets.

As you may realize, career opportunities in these other areas of electronics are mostly for advanced technical personnel. To qualify for these higher level positions, you need college-level training in electronics. Of course, while it takes extra preparation to qualify for these career areas, the rewards are greater both in the interesting nature of the work and in higher pay. Furthermore, there is a growing demand for personnel in these areas.

Unlike most other home study schools, CREI programs are devoted exclusively to preparing you for careers in advanced electronics. All of CREI programs are college level. And CREI gives you both theory and practical experience in advanced electronics.

Unique Design Lab

A unique feature of CREI training is its Electronic Design Laboratory Program, which trains you to actually design circuits. It also helps you understand the theories of advanced electronics and gives you extensive practical experience in such areas as tests and measurements, breadboarding, prototype construction, circuit operation and behavior, characteristics of electronic components and how to apply integrated circuits.

Career Training at Home

Only CREI offers this unique Lab Program. It is a complete college lab and, we believe, better than you will find in most colleges. The "Lab" is one of the factors that makes CREI training interesting and effective. And the professional equipment in this program becomes yours to keep and use throughout your professional career after you complete the training.

Engineering Degree

CREI offers you special arrangements for earning credit for engineering degrees at certain colleges and universities as part of your home study training program. An important advantage in these arrangements is that you can continue your full time job while "going to college" with CREI. This also means you can apply your CREI training in your work and get practical experience to qualify for career advancement.

Wide Choice of Programs

CREI gives you a choice of specialization in 14 areas of electronics. You can select exactly the area of electronics best for your career field. You can specialize in such areas as computer electronics, communications engineering, microwave, CATV, television (broadcast) engineering and many other areas of modern electronics.

FREE Book

In the brief space here, there isn't room to give you all of the facts about CREI college-level, home study programs in electronics. So we invite you to send for our free catalog (if you are qualified to take a CREI program). The catalog has over 80, fully illustrated pages describing your opportunities in advanced electronics and the details of CREI home study programs.

Qualifications

You may be eligible to take a CREI college-level program in electronics if you are a high school graduate (or the true equivalent) and have previous training or experience in electronics. Program arrangements are available depending upon whether you have extensive or minimum experience in electronics.

Send for this **FREE** Book describing your opportunities and CREI college-level programs in electronics

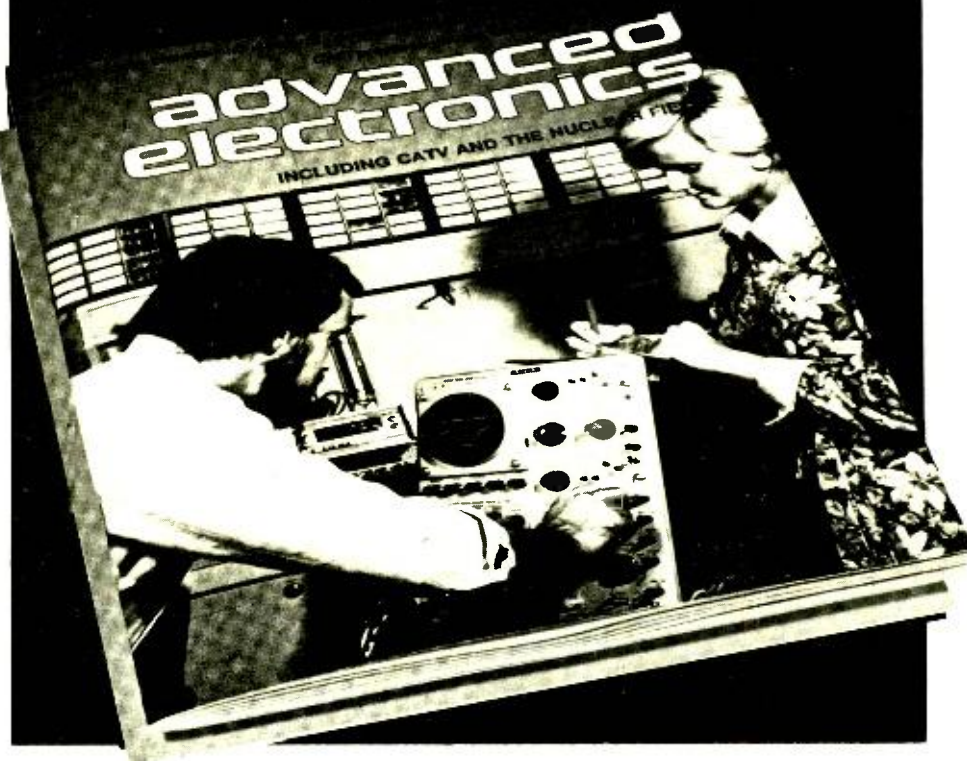

Mail card or write describing qualifications to

CREI **CAPITOL
RADIO
ENGINEERING
INSTITUTE**

McGraw-Hill Continuing Education Center
3939 Wisconsin Avenue Northwest
Washington, D.C. 20016

Accredited Member National Home Study Council

GI Bill

CREI programs are approved for training of veterans and servicemen under the G.I. Bill.



The Best Way To Show You What You'll Get Out Of An Empire Phono Cartridge Is To Show You What Goes Into One.

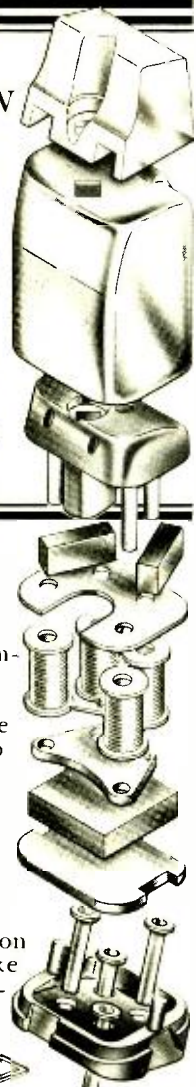

At Empire we make a complete line of phono cartridges. Each one has slightly different performance characteristics which allow you to choose the cartridge most compatible to your turntable.

There are, however, certain advantages, provided by Empire's unique design, that apply to all our cartridges.

One is less wear on your records. Unlike other magnetic cartridges, Empire's moving iron design allows the diamond stylus to float free of its magnets and coils, imposing much less weight on your record's surface and insuring longer recording.

Another advantage is the better channel separation you get with Empire cartridges. We use a small, hollow iron armature which allows for a tighter fit in its positioning among the poles. So, even the most minute movement is accurately reproduced to give you the space and depth of the original recording.

Finally, Empire uses 4 coils, 4 poles, and 3 magnets (more than any other cartridge) for better balance and hum rejection.

The end result is great listening. Audition one for yourself or write for our free brochure, "How To Get The Most Out Of Your Records". After you compare our performance specifications we think you'll agree that, for the money, you can't do better than Empire.

Empire Scientific Corp.
Garden City, New York 11530



changed between clock pulses or the pointer will load all the storage slots in the RAM with the same word.

The complete circuit for the automated demonstrator is shown in Fig. 4. It

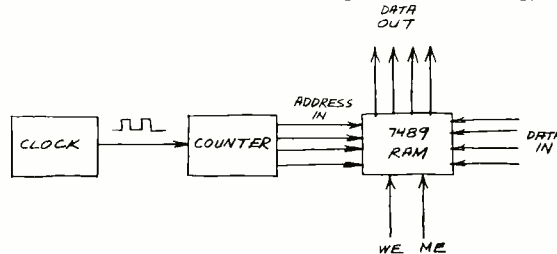

Fig. 3. Block diagram of automated RAM demonstrator.

makes a great fully programmable light flasher so you'll want to build it just to watch it flash.

The role of the clock is filled by a 555 timer, and a 7490 decade counter serves as the address pointer. The 7490 is a BCD counter so it recycles to 0000 after 1001 (decimal 9). This means it can address only ten of the 7489's storage slots. To address all 16 memory slots, you can use a full 4-bit counter (0000-1111) such as a 7493, 74161, or 74191. I've specified the 7490 because its operation has been covered previously here. It's also very inexpensive and readily available.

Notice the various switches and LED's in the circuit. Closing S1 allows clock pulses to reach the counter. The CLOCK LED provides a handy visual indication that the clock is running and, below about 20 Hz, a rough idea of its rate.

The pointer LED indicates when the counter has recycled back to 0000. It's on when the count is 0000 through 0111 and off when the count is 1000 and 1001. This means the counter is pointing to address 0000 in the RAM the moment the pointer LED flashes on after being off for two pulses.

Toggle switches S2 through S5 let

formed by the data input switches into the address slot selected by the pointer.

Of course, you don't have to use switches if you build the circuit on a solderless breadboard. Just remove and reinsert jumpers labeled with masking tape to simulate the on-off action of switches. Real switches, however, make the circuit much easier to use, particularly if you mount them on a small panel and identify them with labels.

Programming the automated RAM demonstrator is a straightforward procedure of loading words into the RAM one at a time until ten address slots are filled. Switch S1 is turned off to disable the clock while a word is being loaded and turned on for one clock pulse to advance the pointer to the next address. It's easy when you slow the clock rate to about a pulse per second (by setting R1 for maximum resistance) and keep an eye on the clock LED.

To Be Continued. Next month we'll discuss programming procedures in more detail. We'll also expand the demonstrator by adding an automatic pseudo-random data loader, and cover some ways to address all sixteen data storage slots in the 7489. ♦

Fig. 4. Automated Ram demonstrator.

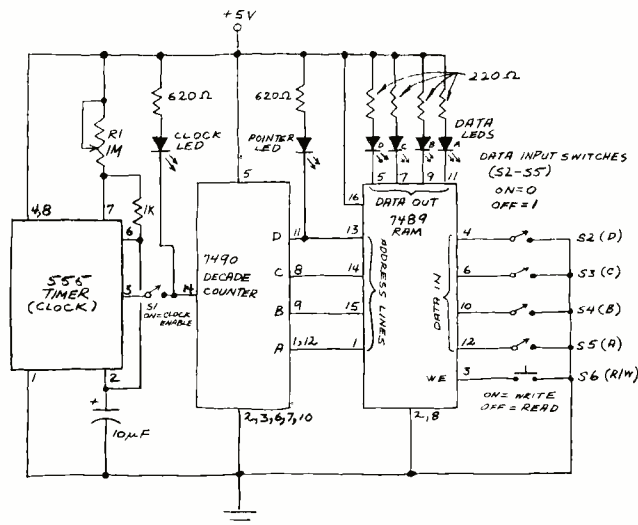

What's Happening...

in Helsinki,
Nairobi, Tel Aviv,
Capetown, Moscow, Saigon
or a thousand other places?

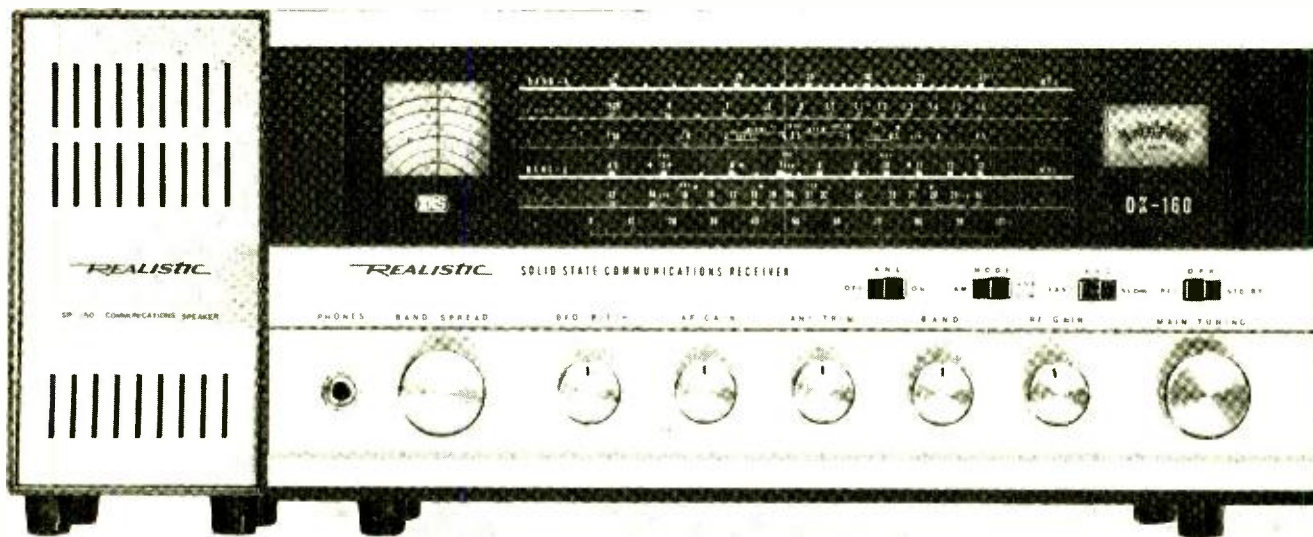

Find out with the Realistic® DX-160

A pro-feature receiver for **HAM/SWL** CB/SSB/AM listening.

The modern world really is a "global village" when you own the versatile DX-160. Five bands covering 130 kHz to 30 MHz let you monitor transmissions from all over the world. Listen in on all 120 CB channels, AM and single-sideband. Hear world news as it develops by tuning in local programs in faraway cities. Receive code as well as voice transmissions. You'll be amazed at the DX-power you can get even on the standard AM broadcast band! Eleven controls and switches really let you "pull out" those distant stations. Main tuning control plus precision bandspread tuning calibrated for the Amateur bands. Switchable noise limiter. Multiple controls for CW and SSB reception. A built-in receive/standby switch lets you use the DX-160 with a Ham transmitter. High-performance FET's in all critical stages. With matching speaker, headphone jack, AC and DC power cords. The DX-160 — what a way to travel! Only **169.95***

Ham Radio Starter Set
Bought Separately **23²⁴**
Special Price **21⁰⁰**

Prepares you to join the action as a Ham operator. Learn theory and code technique with instruction cassette tape, programmed textbook, practice oscillator, and high-speed brass hand key.



FREE! New '78 Catalog

Come in for your copy and see what's really new in electronics. 164 pages — 100 in full color. 2000 exclusive items.

SOLD ONLY WHERE YOU SEE THIS SIGN:

Radio Shack®

A TANDY COMPANY • FORT WORTH, TX 76102 • 6000 LOCATIONS IN 9 COUNTRIES

*Price may vary at individual store and dealers. Price and product may vary in Canada.



Product Test Reports

SPARKOMATIC MODEL CB 2040 CB AM MOBILE TRANSCEIVER

Touch tabs provide quick electronic setting of channels.

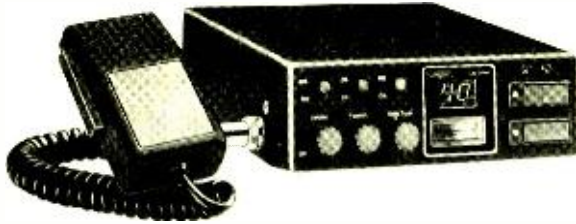

THE 40-channel Model CB 2040 AM transceiver from Sparkomatic has an angled panel for better viewing in mobile installations. It also has two touch tabs ("up" channel and "down" channel) for electronically setting up the channels, which replace the commonly used rotary channel selector switch. The transceiver is designed to operate from a nominal 13.8-volt dc, negative- or positive-ground, electrical source.

The Model CB 2040 employs digital frequency synthesis, using a phase-locked loop (PLL) as all 40-channel transceivers do. Features include: large numeric LED display for channel identification; r-f and audio gain controls; squelch control; individually switched automatic noise limiter (anl) and noise blanker; PA operation; external-speaker jacks; illuminated S/r-f meter; TRANSMIT and RECEIVE LED indicators; electronic voltage regulation; line filter; and reverse-polarity protection.

The transceiver measures 7.5"D × 6.6"W × 2.4"H (19 × 17 × 6 cm) and weighs 3.5 lb (1.6 kg). Supplied with detachable 500-ohm microphone and mobile-mounting hardware, the transceiver is priced at \$159.95.

Technical Details. The receiver employs double conversion to i-f's of 10,695 and 455 kHz. The first conversion is made by heterodyning the CB signal with the voltage-controlled oscillator (vco) in the PLL system, which operates at a frequency 10,695 kHz higher than the signal frequency. The second conversion is made with a 10,240-kHz crystal oscillator signal. The standard 10-kHz reference signal is obtained from

this oscillator and dividers. The vco signal is also mixed down, using a 36,380-kHz crystal signal and then divided according to the channel selected to provide the 10-kHz comparison signal.

Except for the FET-type first mixer, bipolar transistors are used throughout the transceiver. The gain of the receiver is controlled by varying the emitter bias of the r-f input stage. Bandpass coupling is used between the input and output of the two mixers.

Selectivity is obtained with a 455-kHz ceramic filter. The filter is followed by two i-f stages, the detector, and the agc and anl systems. An audio amplifier and a driver stage precede the audio power output stage that uses a transformer-coupled class-B push-pull design.

The noise blanker employs two r-f noise amplifiers, a detector, and a pulse amplifier. The pulse amplifier gates the output of the second mixer through a balanced dual-diode scheme.

The transmitter carrier is generated by difference-mixing the output of the vco with a 10,695-kHz crystal signal. An r-f amplifier is then used for amplification, while a three-section band-pass filter attenuates unwanted spurious responses. Next come a predriver, driver, and the power amplifier stage. The output circuit for the power amplifier has a four-section low-pass filter that matches to 50-ohm loads and minimizes spurious output signals, especially the signals that can cause TVI. The reduction of TVI is further improved by use of a trap.

The receiver antenna input is taken from the power amplifier end of the antenna filter. Hence, input signals above 28 MHz are highly attenuated, improving

the image and other unwanted-signal rejection at the upper frequencies.

An IC microphone preamplifier feeds the audio driver of the receiver's audio section, which then modulates the collectors of the transmitter driver and power-amplifier stages. Automatic modulation control is provided by a feedback compression-type system.

Laboratory Measurements. We measured a receiver sensitivity of 0.5 μ V for 10 dB (S + N)/N at 1000 Hz and 30% modulation, bettering manufacturer's claim of 0.7 μ V and 1 μ V. The squelch threshold range was 0.3 to 10,000 μ V. The agc held the audio output to within 10 dB with a 20-dB input signal change at 1 to 10 μ V and to 15 dB with an 80-dB input change at 1 to 10,000 μ V. The meter registered S1 with a 0.5- μ V input signal and S9 with a 100- μ V signal.

Adjacent-channel rejection and desensitization was nominally 55 dB, as against a -50-dB specification. I-f rejection was -60 dB, while image rejection was -80 dB (versus -55 dB spec) and other unwanted-signal rejection was down a minimum of -50 dB. Overall 6-dB a-f response was 375-1700 Hz and the maximum sine-wave output (both on receive and for PA) at start of clipping was 3 watts at 2.2% THD with 1000 Hz into 8 ohms.

Operating the transceiver from the standard 13.8-volt dc power source, we measured a transmitter output of 3.5 watts. With microphone input levels 16 to 25 dB greater than required for 50% modulation, the modulating level held to just short of 100% using a 1000-Hz test tone. Adjacent-channel splatter under this condition (or with a 2500-Hz test signal) was 50 to 55 dB down. Splatter with voice signals was 55 dB down.

The 6-dB down audio response was 400 to 1700 Hz (+1 dB at 700 Hz). Maximum attainable modulation was only 50% at frequencies beyond 2000 Hz. The transmitter frequency on any channel was within \pm 10 Hz of -160 Hz.

User comment. The transceiver is all black with gray control knobs and channel selector touch tabs. Its panel is angled back slightly, but not really enough to make a significant improvement in viewing. On the other hand, white lettering on the black background does make identification of the controls much easier than is usually the case in mobile transceivers.

Rotary controls are used for adjusting the volume, r-f gain, and squelch, while

miniature toggle switches are used for switching in and out the anl and noise blanker and selecting between CB and PA operation. An edgewise meter sits behind a window that also frames the LED numeric channel display. (The numerals extinguish in the PA mode.)

The touch tabs are located on the right side of the panel. The upper tab is used for cycling through the channels in the upward direction, the lower tab for cycling in the downward direction. In addition, an arrow on each tab indicates the cycling direction. Channels can be manually stepped in either direction or automatically scanned, depending on whether the tabs are touched and released or held depressed. It takes about a second before the automatic scan function begins, after which it scans at a fairly fast rate. Channels cannot be changed while the transmitter is keyed. When the transceiver is first turned on, it automatically goes to Channel 9.

The mode LED indications glow nicely under all lighting conditions. A green LED is used on receive, while a red LED comes on in the transmit mode. The transmit LED also blinks in step with the modulation.

Plenty of audio gain is available from this transceiver. In fact, just by cracking

open the volume control, a good output level is obtained. However, the setting of the volume control is a bit touchy with a sudden change in volume occurring at the most used level.

As usual, the r-f gain control is handy for minimizing overloading by strong signals. With this transceiver, the most notable condition when overloading can occur is in cases where a very strong signal appears about 20 channels above the desired channel. For example, if you are listening to a 1- μ V signal, a 300- μ V signal on a higher channel frequency can also appear as a 1- μ V signal on the tuned channel. This condition is fairly common in PLL-controlled receivers.

As noted above, the audio response on both receive and transmit drops off beyond 1700 Hz. In fact, on transmit, it drops off fairly fast beyond 1000 Hz. We would like to see a higher upper-frequency response for crisper quality.

The transmitter's amc system operates very well. It held down overmodulation and splatter while maintaining full modulation at speaking distances ranging from 1" to 8" (2.5 to 20.3 cm) from the microphone.

Tests with two different impulse-noise generators, an electric razor, and ignition noise in a vehicle proved that the anl

was quite effective. It was interesting to note that, in many cases, even with weak signals, ignition noise virtually disappeared whenever a signal appeared. This made use of the anl seldom necessary, except to drop the residual noise while searching for a signal.

We found no usefulness in switching in the noise blanker, since it had little apparent effect on the noise. In our experience, noise blankers have never been very effective in handling noise problems with AM reception. In cases where an anl and a noise blanker are switched in simultaneously, it is primarily the automatic noise limiting that is the effective noise-reducing element.

This transceiver has no clarifier or Delta tune mechanism, which we have in the past emphasized as being an unnecessary gimmick for AM. It is even more useless with interstation operation in the new 40-channel phase-locked-loop transceivers, since they generally hold the frequency tolerance within better than 200 Hz.

All in all, we find this Sparkomatic transceiver to be very good. It should provide the CB'er with convenience and long service.

CIRCLE NO. 104 ON FREE INFORMATION CARD

SABTRONICS MODEL 2000 DIGITAL MULTIMETER KIT

Low-price, 3½-digit multimeter kit features high-quality components.



THE Sabtronics Model 2000 is perhaps the lowest priced digital multimeter on the market to offer a full 3½ digits of display and five functions. Priced at only \$69.95, this instrument can be used to measure ac and dc voltage and current and resistance. It is available only in kit form.

To keep costs down, the basic Model 2000 comes without test leads and has provisions for only battery operation—using standard carbon-zinc or high-energy alkaline cells. Available as separate options are a test-cable kit (\$3.50),

an ac power supply/battery charger (\$10.90), and a sub-C nickel-cadmium battery pack (\$12.95).

The DMMM measure 8"W × 6.6"D × 3"H (20.3 × 16.5 × 7.6 cm).

Technical Details. The Model 2000 DMM features a full 3½-decade red LED display, automatic zeroing and polarity indication on all ranges, and battery operation for portability. (Ac operation is possible with an optional battery eliminator that doubles as a charger when nickel-cadmium cells are installed.) A to-

tal of 28 ranges is provided, and all function/range selection is performed with pushbutton switches.

Five dc-voltage ranges are provided: 100 mV, 1000 mV (1 volt), 10 volts, 100 volts, and 1000 volts. With the instrument's overrange capability, the display can indicate up to 199.9 mV, 1999 mV, 19.99 volts, 199.9 volts, and 1000 volts. Resolution is rated at 100 μ V, 1 mV, 10 mV, 100 mV, and 1 volt, respectively. The rated accuracy is 0.1% \pm digit on the 100- and 1000-mV ranges, 0.1% \pm 2 digits on the 10-volt range, 0.2% \pm 2 digits on the 100-volt range, and 0.5% \pm 2 digits on the 1000-volt range. Input protection to 1000 volts dc or 1400 volts ac is provided on all ranges. Input resistance is rated at 10 megohms on all ranges, while response time is specified at 500 ms typical.

The ac-voltage ranges are the same as in the dc mode (100 mV, 1000 mV, 10 volts, 100 volts, and 1000 volts). The overrange, resolution, and input protection are also the same. The respective accuracies (at 60 Hz) and frequency responses on the ranges are 0.3% \pm 2 digits, 40 Hz to 50 kHz; 0.3% \pm 1 digit, 40

THE MOST DIVERSIFIED SCIENTIFIC. OWN IT FOR ONLY \$48.88



Commodore Rechargeable 9-MEMORY SR9190R

**A Powerful Preprogrammed
Multifunction Calculator.
Over 117 directly accessible
keyboard functions.**

For Every Engineer
Physicist
Chemist
Geologist
Demographer
Ecologist

Mathematician
Statistician
Quality Control Analyst
Time and Motion Expert
Advanced Student
and so many others!

Credit Card Orders Call Toll Free
800-323-2272
Illinois Residents Call
312-595-0461

Never before has integrated architecture been inscribed with so much power. The operating capacity of Commodore's incredible SR9190R, combined with its speed, accuracy, and diversification, is simply unequalled by any other calculator.

There is so much performance power under its hood that you just have to work with the remarkable SR9190R to appreciate it. That's why we want you to put the SR9190R through its paces for 10 days... **AT OUR EXPENSE.** It's one thing to talk about power, and another thing to have it at your fingertips.

Work with **9-USER MEMORIES** with direct memory multiply and add keys. **3 LEVELS OF PARENTHESES** add to the unit's storage banks. Handle **LINEAR REGRESSION** with direct entry **PLOTTING and CURVE FITTING KEYS.** The SR9190R lets you change entries without destroying the data base. (Try that with any other unit.) Tackle **PERMUTATION, COMBINATION, and FACTORIAL** exercises. Accuracy limits are so extensive that, unlike other machines, the SR9190R is not hindered by the overflow which occurs when the factorial is greater than 10^{99} . **LOG of the GAMMA FUNCTION, STANDARD DEVIATION** divided by 1 and divided by N-1 are also performed with single stroke ease.

COMPLEX NUMBERS, difficult on some calculators, unobtainable on most, are directly accessible from the SR9190R's keyboard.

Compute **HOURS · MINUTES · SECONDS** in digital clock format and obtain time mode results with optimum hyphenated clarity. This feature, alone, puts the 9190 light years ahead. It's great for time study and motion analysis.

Add to this brainpower **A 14-CHARACTER LED DISPLAY** with 10-digit mantissa, 2-digit exponent, and 2-sign symbols, **NUMERICAL INTEGRATION, POISSON and BINOMIAL PROBABILITY, GAUSSIAN DISTRIBUTION, POLAR ↔ RECTANGULAR CONVERSIONS IN ALL QUADRANTS, DEGREE ↔ RADIAN** computation, **ELEVEN METRIC CONVERSIONS, PERCENT CHANGE**, all

HYPERBOLIC and TRANSCENDENTAL FUNCTIONS and more. All are right on the keyboard.

The rechargeable SR9190R comes complete with AC/DC adapter-recharger. It is compact, too: 5 1/4" L x 3" W x 1 1/2" thin, and backed by an **UNCONDITIONAL ONE YEAR MANUFACTURER'S GUARANTEE.**

WE APOLOGIZE

The Commodore SR9190R is unquestionably the most complete and powerful preprogrammed scientific calculator available anywhere. If this article does not do justice to the machine, we've got to apologize to some of the most brilliant and enthusiastic engineers we know -- the team who developed this incredible scientific -- and ran us through its features. They felt that if they could put one in your hand, nothing else would need be said. So, Please, **WORK WITH THE SR9190R FOR 10 DAYS AT OUR EXPENSE.**

If, after 10 days, you are not convinced that it is the complete scientific for you, you can return it for a prompt refund.

ORDER DIRECT

Please send me SR9190R calculator(s) at \$48.88 ea. (Item 9190) Add \$2.50 per calculator for postage and insurance.) If not fully satisfied I can return within 10 days for refund.

Check or M.O. enclosed (Ill. Residents add 5% sales tax).

Please charge my credit card:
 American Express | Bank Americard | Carte
 Diners Club | Master Charge | Blanche

Credit Card No. _____

Master Charge Bank No. _____ Exp. Date _____

Name _____

Address _____

City _____

State _____ Zip _____

Signature _____

PEMA-335 OCM: 1977

Contemporary Marketing Inc.

Call Toll Free: 800-323-2272
Illinois Call: 312-595-0461

790 Maple Lane, Bensenville, Ill. 60105

Hz to 50 kHz; 0.3% ±2 digits, 40 Hz to 20 kHz; 1.0% ±1 digit, 40 to 2000 Hz; and 1.0% ± digits, 40 to 500 Hz. Impedance on all ranges is specified at 10 megohms shunted by 25 pF, while maximum response time is stated at 5 seconds to five digits of reading.

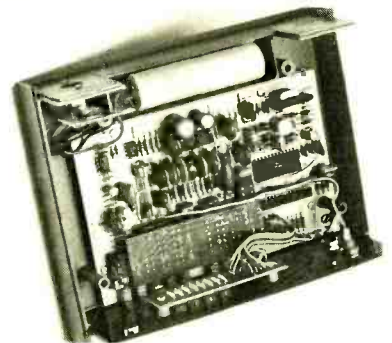

Photo shows neat insides of meter.

The ac and dc current ranges are the same: 10 μA, 100 μA, 1 mA, 10mA, 100 mA, and 1000 mA (1 ampere) full-scale. With overrange, the instrument can display currents to 19.99 μA, 199.9 μA, 1.999 mA, 19.99mA, 199.9 mA, and 1999 mA. The respective resolution on both ac and dc is 10 nA, 100 nA, 1 μA, 10 μA, 100 μA, and 1 mA. Dc accuracy on the three lower ranges is 0.1% ±2 digits and on the other ranges 0.1% ±1 digit. The ac accuracy is 1.0% ±5 digits on the 10-μA range, 0.1% ±2 digits on the 100-μA and 1-mA ranges, 0.1% ±1 digit on the 10-mA range, and 0.8% ±2 digits on the 100-mA and 1000-mA ranges. The ac frequency range is 40 Hz to 500 kHz on the 10- and 100-μA ranges, 40 Hz to 20 kHz on the other ranges. The ac and dc input impedance is 1 ohm on the 100- and 1000-mA ranges, 100 ohms on the 1- and 10-mA ranges, and 10,000 ohms on the 10- and 100-μA ranges. All input ranges in both modes are fuse protected to 2 amperes.

The resistance ranges go to 100 ohms, 1000 ohms, 10 kilohms, 100 kilohms, 1 megohm, and 10 megohms full-scale. With overrange, the display indicates up to 199.9 ohms, 1999 ohms, 19.99 kilohms, 199.9 kilohms 1.999 megohms, and 19.99 megohms, respectively. Resolution on the successive ranges is 0.1, 1, 10, 100, 1000, and 10,000 ohms. Accuracy is rated at 0.1% ±1 digit for the four lowest ranges, 0.2% ±2 digits for the 1-megohm range, and 0.5% ±5 digits for the 10-megohm range. Measuring current is rated at 1 mA for the 100- and 1000-ohm ranges, 10 μA for the 10- and 100-kilohm ranges, and 100 nA for the 1- and 10-megohm ranges. The voltage at the test probes is 100 mV on the 100-ohm, 10-

Stanton joins the New York Jazz Museum in preserving a musical heritage:



The message in the letter was clear: "Many of our recordings are rare or long out-of-print. The music that is preserved in our Archives must be made available to the Museum's visitors in order to enhance their appreciation of our exhibits. However, these recordings must be properly preserved during playback and that is why I am writing to you."



© 1977 STANTON MAGNETICS

So, along with its Archives of over 25,000 items, including photographs, books, pamphlets, magazines, films, musical instruments, art, memorabilia and over 4,000 record albums and 78 rpm recordings — the New York Jazz Museum now has Stanton equipment to help it fully serve its function. The Calibrated Stanton 681 Triple E cartridge is, of course, a prominent component of that system.

So, their sure-to-improve sound is certain to have favorable impact on their growing audience.

Stanton's 681 Triple E cartridge offers improved tracking at all frequencies, and achieves perfectly flat frequency response to beyond 20 kc.

Each 681 Series cartridge is guaranteed to meet its specifications within exacting limits, and each one boasts the most meaningful warranty. An individually calibrated test result is packed with each unit.

For further information write to:
Stanton Magnetics
Terminal Drive
Plainview, N. Y. 11803



kilohm, and 1-megohm ranges and 1 volt on all other ranges. The input is protected by a 2-ampere fuse to 250 volts dc and rms ac.

Power for the DMM can be any 4-to-6.5-volt dc, 120-mA source. The instrument is designed to provide 25 hours of operating time on four C-size alkaline cells, up to 15 hours on four C-size nickel-cadmium cells.

General Details. This is a well-thought-out kit, from packaging to final assembly and calibration. All components are packaged in compartmented polybags for easy viewing and identification. Both the main and display printed circuit boards are silk-screened with component locations and orientations to simplify assembly and help reduce installation errors. The only components that mount off the boards are the input test jacks and the battery supply. (If the optional ac power supply/battery charger is used, its circuitry goes on a small board that mounts to a rear panel of the instrument's case.)

Assembling the DMM is a very simple procedure, thanks mainly to a fine assembly manual and the planning that virtually eliminates point-to-point wiring. To this end, Sabtronics even supplies an auxiliary pc board that goes on top of the nine-bank function/range switching array to interconnect the appropriate lugs and eliminate all possibility of wiring errors here. (This auxiliary board can be installed only one way.)

As we assembled the kit, we noted that, even though the kit price is very low, there was no skimping on the quality of the components used. All resistors, for example, had tolerances of either 5% or 1%, even in places where 10% or even 20% tolerances could have been used. The other components were of commercial-grade quality.

Working at a leisurely pace, it took us less than five hours to assemble, check out, and calibrate the DMM. We noted only one small area where assembly could have been a bit difficult—a battery of resistors with 1% tolerances and color-coding that's not easy to read. Fortunately, Sabtronics has anticipated this problem and supplies an easy-to-interpret slip of paper that explains the coding in full detail. Otherwise, the entire assembly procedure was so simple and straight-forward that we feel even a neophyte could handle the job easily.

After assembling the DMM, we performed the "without-instruments" calibration procedure detailed in the assembly manual. This procedure makes use

of the voltage and resistance calibration standards assembled into the meter. When this was done, we used a voltage standard and high-tolerance resistors to determine the accuracy of the calibration. In all cases, the calibration accuracy was almost as good as we later obtained with the "instrument-calibration" procedure. It certainly displayed all the accuracy needed for hobbyist/experimenter/servicing applications.

The assembled instrument has a clean, modernistic look about it. It has no rotary controls, just a battery of nine color-coded switches. The POWER switch is red, the FUNCTION switches are gray, and the RANGE switches are off-white. To the right of the switches are a red $V\Omega A$ and a black COM input test jacks. Located above the bank of push-button switches are the $3\frac{1}{2}$ decades of LED display. (This is actually a full 4-digit display with only the *a* and *b* segments used to display a numeral 1 and the *g* segment used to display a — sign when dc voltages and currents are being measured.)

Built into the proprietary blue plastic case that houses the instrument are a pair of rails that serve as "feet" for the DMM. They also double as a retaining system for the wire bail that can be pulled down and locked into place to allow the instrument to tilt upward for more convenient viewing in lower-than-eye-level locations.

Operation of the DMM is very simple. After plugging in the test leads one simply presses in the POWER, desired FUNCTION, and desired RANGE switches. (There are four RANGE switches, three of which select a given range directly while the fourth is for selecting the next higher decade range for a given activated range.) Then all one does is touch the probes to the appropriate points in the circuit under test and reads out the value of the display.

User Comment. In our opinion, the Sabtronics Model 2000 DMM gives the buyer top value for his investment. It is a basic digital multimeter that is designed to deliver a level of performance available heretofore only in more expensive instruments. Though it comes without test leads, batteries, and ac power supply/battery charger (all available optionally), it gives a full complement of most-wanted functions, ranges, and features—all at a price directly competitive with analog instruments that do not provide anywhere near the same measuring accuracy.

CIRCLE NO 105 ON FREE INFORMATION CARD

BREADBOARDING & TEST EQUIPMENT
THE COMPLETE, LOGICAL, STEP-BY-STEP, FULL-COLOR SOURCE
CSC

IF THIS BIG CATALOG ISN'T HERE... YOU'D BETTER SEND FOR YOUR FREE COPY NOW!

Look again. If CSC's big, full color BREADBOARDING and TEST EQUIPMENT catalog isn't on the facing page, then, somebody else got to it first! You've got to see it now. There are so many new ideas in it, your library must not be without a copy! How about ordering an extra copy for a friend?

Rush this coupon today, or call if you're in a hurry!
We'll return-mail your copy!

CSC
Continental Specialties Corporation
70 Fulton Terrace, P.O. Box 1942
New Haven, CT 06509
Telephone 203/624-3103

Name _____
Address _____
City _____
State _____ Zip _____

CIRCLE NO 10 ON FREE INFORMATION CARD
POPULAR ELECTRONICS

BREADBOARDING & TEST EQUIPMENT

THE COMPLETE, LOGICAL,
STEP-BY-STEP SOLDERLESS
SOURCE . . .



CONTINENTAL SPECIALTIES CORPORATION

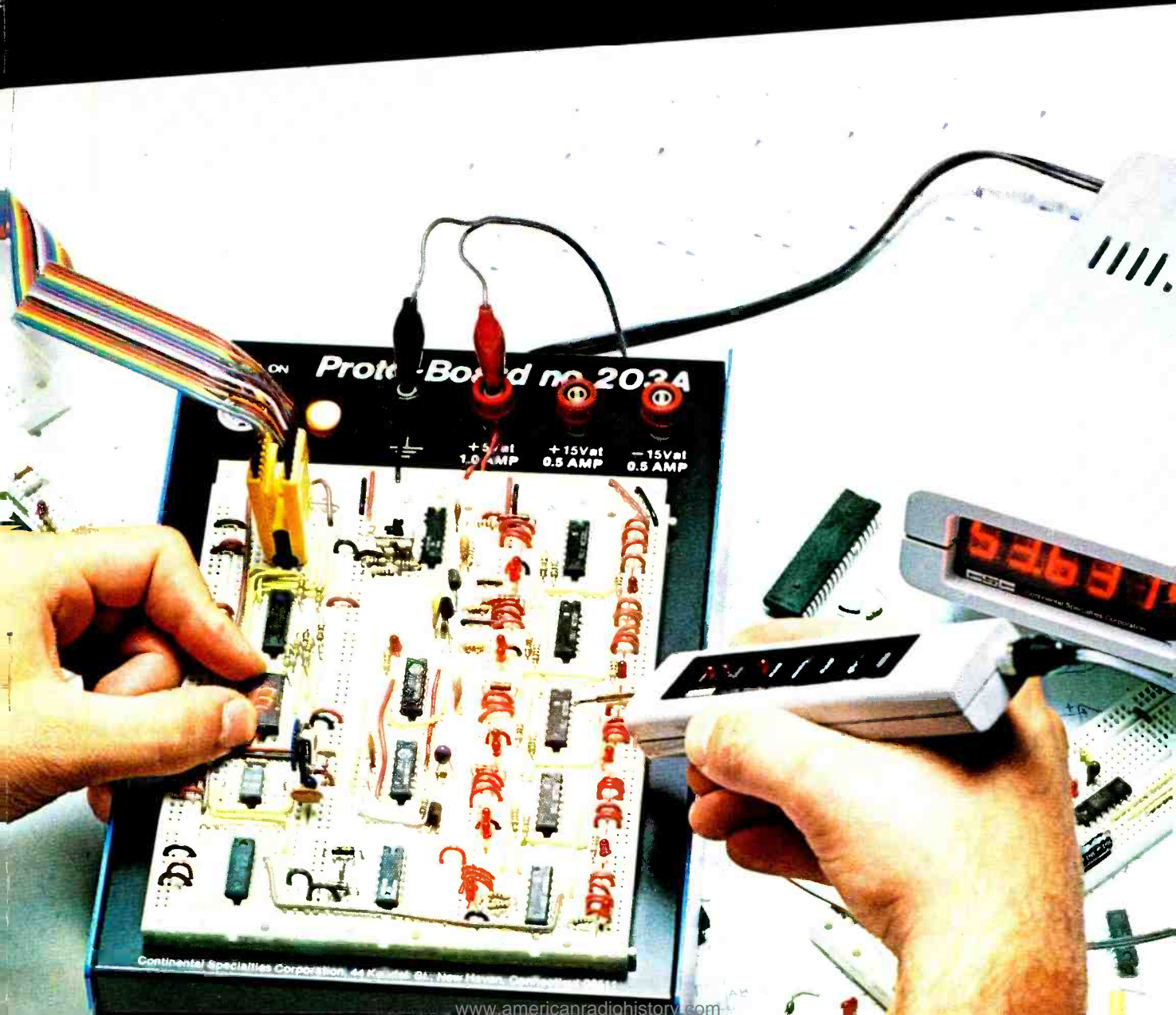

Continental Specialties Corporation, 41 K... New Haven, Connecticut 06510

Create circuits as fast
as you can think.
Start with The Basics . . .

QUICK TEST SOCKETS*

Imagine! Non-stop wiring, testing, modifying and building . . . all without patch cords or solder! Fast, reliable proven CSC Quick Test Sockets let you work out new ideas and reactivate old ones, without a worry over harming discrete or IC components . . . or your fingers.

EASY MOUNTING. Molded-in mounting holes in the housing permit top mounting to any flat surface with 4-40 flat head screws or 6-32F self-tapping screws for behind-the-panel mounting.

ACCEPTS ALL STANDARD COMPONENTS. ICs, diodes, resistors, capacitors, transistors, etc. All plug into the DIP compatible .1" grid without messy, troublesome solder.

HOOK UP. Connect power and ground leads to your bus strip. Plug in your ICs and discretes. Then interconnect with a #22 solid wire. Connect a signal source to bus strip or directly to input point of your circuit. Each socket has **5 tie points per terminal**. Each bus strip has **2 separate rows of interconnecting terminals**. Turn on the power and signal source. Hook-up a scope probe, counter, etc. Then, if you have to add additional wire, need another IC or component — just plug them in.

INTERCONNECTIONS. Each terminal has 5 connected solderless tie points formed from a prestressed, spring loaded non-corrosive alloy to insure secure mechanical and low resistance electrical connections. All sockets are 1.32" wide. All bus strips are .36" wide. All sockets and bus strips are .33" thick. And, all are perfect for high temp jobs up to 100°C.

EASY. That's the hallmark of CSC Quick Test Sockets. **INEXPENSIVE.** It goes without saying. **STANDARD FOR THE INDUSTRY.** Need we say more?

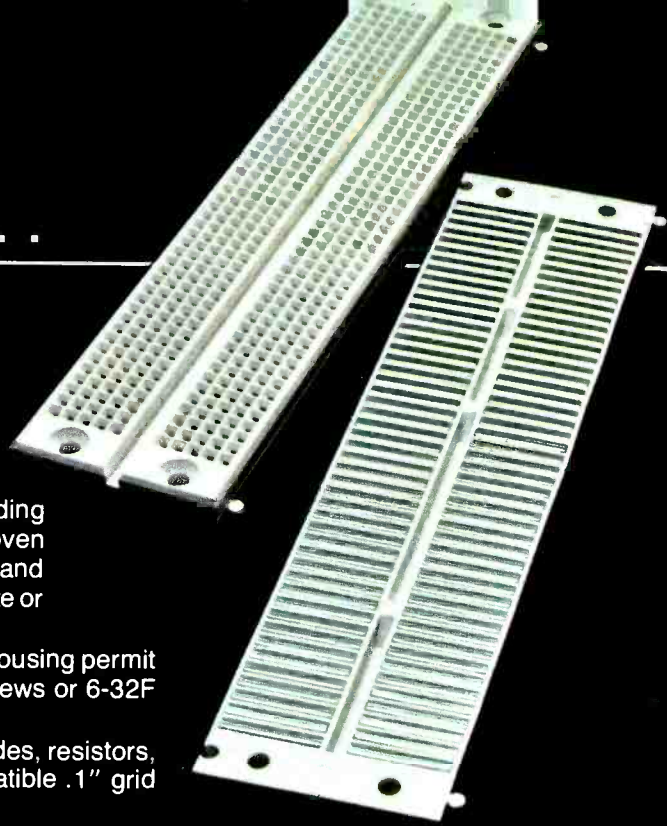

Exclusive SNAP/LOCK design bread-boarding system allows you to expand or contract your work by snapping together as many Quick Test sockets or bus strips as you need, when you need them.

ORDER YOUR QT SOCKETS AND BUS STRIPS TODAY! CONTACT YOUR LOCAL DISTRIBUTOR OR USE THE HANDY ORDER FORM ON THE BACK PAGE!

	Length	Hole-to-hole	Terminals	Unit Price \$
QT-59S	6.5"	6.2"	118	12.50
QT-59B	6.5"	6.2"	20	2.50
QT-47S	5.3"	5.0"	94	10.00
QT-47B	5.3"	5.0"	16	2.25
QT-35S	4.1"	3.8"	70	8.50
QT-35B	4.1"	3.8"	12	2.00
QT-18S	2.4"	2.1"	36	4.75
QT-12S	1.8"	1.5"	24	3.75
QT-8S	1.4"	1.1"	16	3.25
QT-7S	1.3"	1.0"	14	3.00

U.S. Patent Design No. 235,554

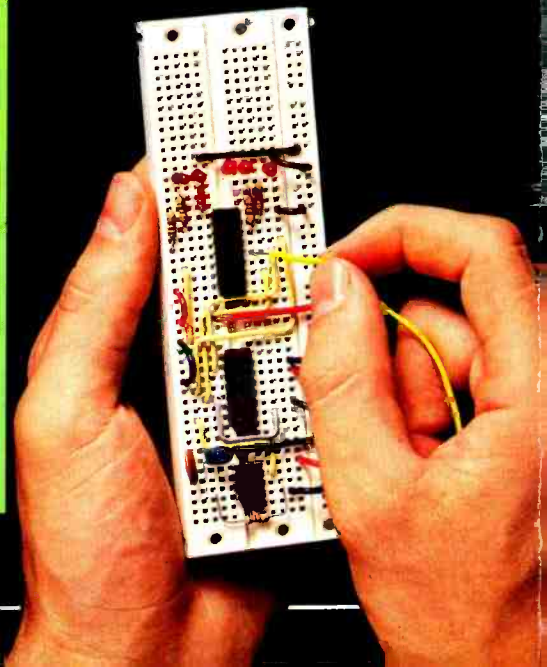

EXPERIMENTORTM SOCKETS

Introducing the Domino Theory of Breadboarding. Snap them together vertically or horizontally with a choice of .6" or .3" centers. When your breadboard becomes overcrowded, just snap on another . . . vertically or horizontally . . . and keep on trucking. Just like dominoes, you keep going and going in any direction, until your idea is completed.

EXPERIMENTOR 300*. 550 individual solderless tie-points with .3" center for smaller D Ps. The ideal mate for peripheral microprocessor ICs . . . without soldering. Each 6" x

You can interface in any direction, horizontally or vertically, just like dominoes. Keep on trucking.

2" x 3/8" board has 47 horizontal dual rows of five interconnected terminals. Plus, a 40 point bus strip along each edge. Best of all, simple interlocking rails let you keep on building as your ideas pour out. **Order your EXPERIMENTOR 300 today. Only \$9.95.**

EXPERIMENTOR 600*. Just like the EXPERIMENTOR 300, with one small difference. You can get into microprocessors with the ease of a .6" center to snap-in LSI chips . . . plan, design, implement your own programs. Now you can actually build your own minicomputer . . . and keep adding as you go. Need more space? Just connect another EXPERIMENTOR 600 and interface. **Hurry! Order your EXPERIMENTOR today! Only \$10.95.**

EXPERIMENTOR 350*. Two rows of 46 five-point terminals, plus two 20-point bus strips. .3" centers. 3/8" x 3 1/2" x 2". A must! **Order today! Only \$5.50.**

EXPERIMENTOR 650*. Two rows of 46 five-point terminals, plus two 20-point bus strips on .6" centers. 3/8" x 3 1/2" x 2 1/4". You shouldn't be without one . . . or two. **Only \$6.25.**

EXPERIMENTOR QUAD BUS STRIP* Flexible with four 40-point bus strips. 3/8" x 6" x 3/4". Essential and economical. **Order yours now! Only \$4.00.**

ORDER YOUR EXPERIMENTORS TODAY! CONTACT YOUR LOCAL DISTRIBUTOR OR USE THE HANDY ORDER FORM ON BACK PAGE!

Model	Length	Width	Center Channel	5 Tie Point Terminals	Bus Strips	Price
EXP300	6.0"	2.1"	.3"	94(470)	2(80)	\$ 9.95
EXP350	3.6"	2.1"	.3"	46(230)	2(40)	\$ 5.50
EXP600	6.0"	2.4"	.6"	94(470)	2(80)	\$10.95
EXP650	3.6"	2.4"	.6"	46(230)	2(40)	\$ 6.25
EXP4B	6.0"	1.0"	n/a	n/a	4(160)	\$ 4.00



Vinyl insulated backing permits mounting anywhere without shorting. Molded-in mounting holes permit mounting to any flat surface with 4-40 flat head screws or 6-32F self tapping screws for behind-the-panel mounting.

*U.S. Patent Number 235,554

Expand your thinking!
Intensify your creativity!
Full-service PROTO-BOARD Breadboards . . .
from kits to built-in power supplies.

PROTO-BOARD[®] BREADBOARDS

Here are six simple, complete total breadboards . . . everything from easy-to-assemble kits to powerhouse regulated power supplies. We've combined the best of the QT Sockets and Bus Strips into easy-to-use, table top, expanded breadboards. Forget soldering. All you need is solid #22 AWG wire for interconnections. Aluminum baseplates on larger models are perfect, solid, ground plane work surfaces. Rubber feet won't scratch. 5-way binding posts for simple tie-ins. And, every Proto-Board is compatible with digital or linear ICs in TO5s, DIP packs and discrete components. So, if you're into kits, we've got two low cost models for you. Or, if you want to start building immediately, look into one of CSC's ready-made ProtoBoard breadboards. And just look at those prices! Very reasonable, considering all you get.

PROTO-BOARD 203

- The breadboard with built-in 1% regulated 5VDC, 1 amp supply 2,250 solderless tie points .24 14-pin DIP capacity which also accepts larger and small IC's up to 40-pin.

So you want ZIP with your ZAP! Have we got a power breadboard tester for you! Just plug in the PB-203 and let your powerful ideas run their course. You've got 2 extra floating 5-way binding posts for external signals. Self-contained power switch, indicator lamp and power fuse . . . plus 24 14-pin DIP capacity. The mighty built-in, regulated power supply is short-proof with 5VDC, 1 amp. It puts out $5V \pm .25V$, with 10 millivolts ripple and noise at .5 amp. And, the load regulation is better than 1%. Now that's power! That's capacity! That's flexibility! That's something else! THAT'S THE PB-203! And, it's all yours, in one power-packed package for only \$80.00. Size? Short and light. 9.75" long x 6.6" wide x 3.25" high (248 x 168 x 83mm) and it weighs a mere 5.5 lbs. (2.26kg). Plug-in. Turn-on. Order your PB-203 NOW! \$80.00

PROTO-BOARD 203A

- Just like the PB-203 . . . and then some! • 1% regulated 5VDC supply
- Regulated separate +15VDC and -15VDC .5A supplies, each with internally, independently adjustable output voltage (7-18V)
- Ripple and noise of + and -15V supplies, 10mV at 0.25A

You say you haven't had enough? You say you want more power? You say you want more flexibility! Tell you what we're gonna do! We're going to offer you the dynamic PB-203A. It's the big brother of PB-203. All the specs are the same, but just look at the separate regulated supplies of +15VDC and -15VDC, 0.5A, each with its own internal, independent adjustable output voltage! If you really want to turn on . . . order your PB-203A . . . NOW! \$129.95

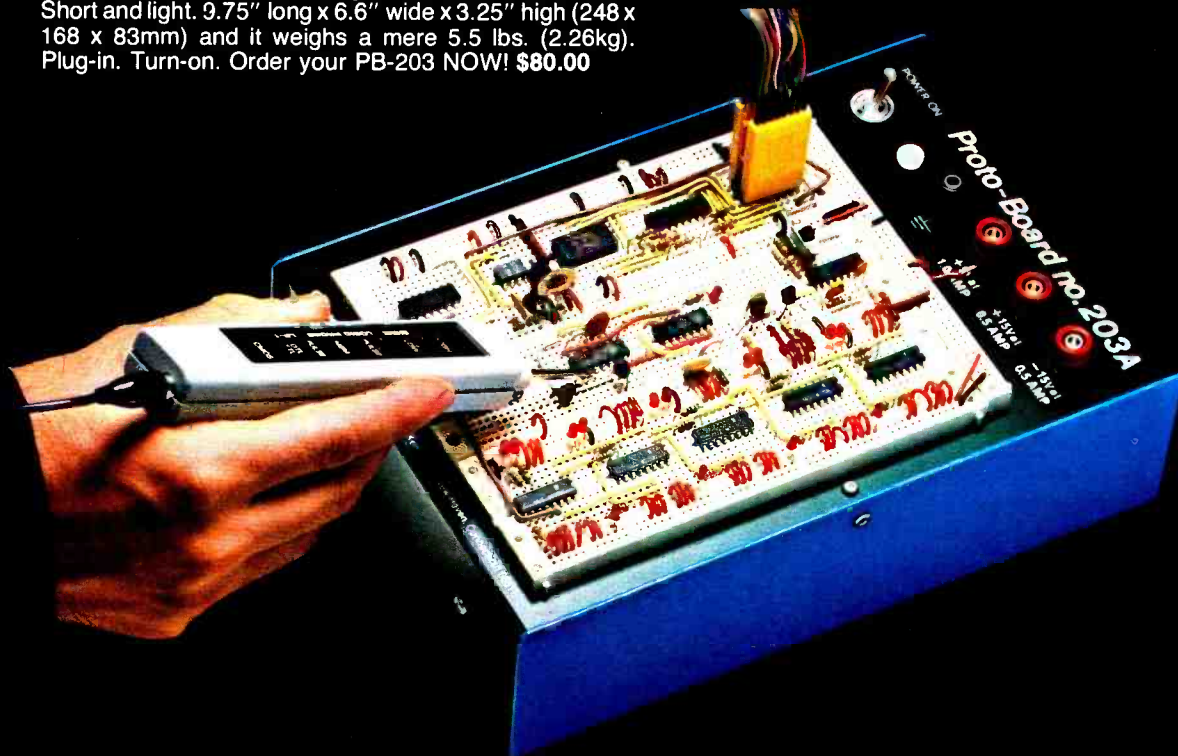

ORDER YOUR PROTO-BOARD BREADBOARDS TODAY! CHECK WITH YOUR
LOCAL DISTRIBUTOR OR USE THE HANDY ORDER FORM ON THE BACK PAGE!



PROTO-BOARD 6

The lowest priced solderless breadboarding kit made today. Completely packaged. Assembles in minutes. Start designing in seconds. Flexible 6 14-pin DIP capacity (also accepts larger and smaller IC's up to 40 pin). 630 tie points, less than 2.5¢ each. And for only \$15.95.



**PROTO-BOARD 100
Mini-Kit**

Assembles in seconds. Ten 14-pin IC capacity and mini-price. 760 tie points. Under 2.7¢ each (also accepts larger and smaller IC's up to 40 pin). Just \$19.95.

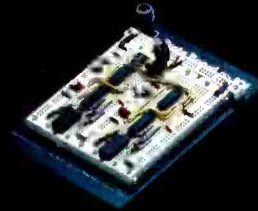

PROTO-BOARD 101

For the "tight fisted" experimenter. Ten 14-pin DIP's (also accepts larger and smaller IC's up to 40 pin). 940 tie points, under 3.2¢ each. 8 distribution buses; 2 horizontal, 6 vertical, 30 contacts each. Only \$29.95.

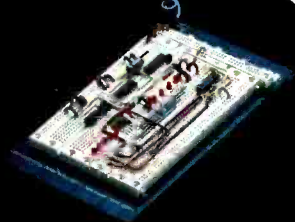

PROTO-BOARD 102

For champagne experimenters on beer budgets. 1,240 solderless tie points, under 3.2¢ each. Twelve 14-pin DIPs (which also accepts larger and smaller IC's up to 40-pin). Only you know how little you spent. \$39.95

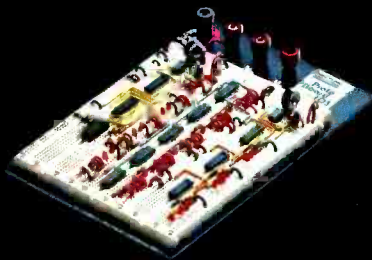

PROTO-BOARD 103

For you tight-fisted designers. Modest price. 2,250 solderless tie points (under 2.7¢ each). 10 distribution buses (2 horizontal w. 40 contacts ea.; 8 vertical with 50 each. Also accepts larger and smaller IC's up to 40 pin). \$59.95

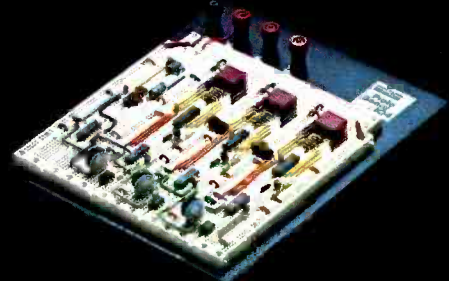

PROTO-BOARD 104

Here's a lollapalooza! 3,060 tie points. Four 5-way binding posts, one grounded. 32 14-pin DIPS (also accepts larger and smaller IC's up to 40 pin). 14 distribution buses. Everything you need. Affordable too. \$79.95

U.S. Patent Design No. 241,252

Model Number	L x W x H (Inches)	Tie Points	IC Capacity (14-Pin DIPs)	No. of Sockets	Type	No. 5-Way Binding Posts	Wght. (Oz.)	Price	Other Features
PB-6	6.0x4.5x1.4	630	6	2 1	QT-47B QT-47S	4	7.0	\$15.95	Kit. Assembles in minutes.
PB-100	6.0x4.5x1.4	760	10	2 1	QT-35S QT-35B	2	7.5	\$19.95	Kit with larger capacity
PB-101	6.0x4.5x1.4	940	10	2 4	QT-35S QT-35B	1	9.0	\$29.95	8 distribution buses. Larger capacity.
PB-102	7.0x4.5x1.4	1240	12	2 3 1	QT-47S QT-47B QT-35B	1	10.0	\$39.95	Large capacity, modest price.
PB-103	9.0x6.0x1.4	2250	24	3 4 1	QT-59S QT-59B QT-47B	4	1.3	\$59.95	Greater capacity.
PB-104	9.8x8.0x1.4	3060	32	4 7	QT-59S QT-59B	4	1.8	\$79.95	Largest capacity.
PB-203**	9.8x6.6x3.3	2250	24	3 4 1	QT-59S QT-59B QT-47B	4	5.0 lbs.	\$80.00	Built-in 1% regulated, short proof 5V, 1 amp low-ripple power supply.
PB-203A**	9.8x6.6x3.3	2250	24	3 4 1	QT-59S QT-59B QT-47B	4	5.5 lbs.	\$129.95	Same as PB-203. Plus separate ½ amp +15V and -15V internally adjustable (10-16V) regulated power supply

** 117VAC 50/60Hz model, and 220VAC 50/60Hz model available at 10% higher cost.

Deep-thinking, expanded logic.
There's no stopping you now.
Build and test virtually anything.

DESIGN MATE^{T.M.} TEST INSTRUMENTS



DESIGN MATE 1
CSC's basic CIRCUIT DESIGNER. Build/test any electronic circuit going! Forget solder forever! Solid #22-30 AWG wire interconnects any discrete component... resistors, transistors, linear/digital ICs in T05 DIP packs (from 8-40 pins), etc. Pop any component in-to socket or bus strip;

DM-1's variable regulated power supply gives 5-15V DC up to 600ma (9 watts). Even monitor the DM-1's internal power supply or external circuits via self-contained 0-15V voltmeter. Lots of laboratory-quality testing for very little money. **\$69.95** (220V @ 50/60Hz operation available at 10% additional cost)



DESIGN MATE 3
Stop squinting at unreadable component markings. Forget color codes. DM-3, the low cost R/C BRIDGE. Solid state null detector with 2 operating controls. Zero-in on exact component value... instantly, better than 5%.

Completely wired, tested, calibrated. Includes easy instructions, lots of applications, operational theory. Anyone can afford it. So, stop squinting. Order your DM-3 today! **\$74.95** (220 @ 50/60Hz operation available at 10% additional cost)

A matched set of high quality, laboratory-grade test instruments at prices anyone can easily afford. The professional. The hobbyist. The curious. All need these independently interfaced problem solvers for their speed, ease, accuracy and modest cost. Completely assembled, with detailed instructions and special application notes.

U.S. Patent Design No. 235,554



DESIGN MATE 2
A proven, low cost 3-waveform FUNCTION GENERATOR made with a short-proof output amplifier, variable signal amplitudes and constant output impedance. Wired, tested, calibrated and ready to go, DM-2 checks anything. Basic audio amplifiers. Op-amp. Lab designs. Complex industrial projects. Get it together with DM-1 and DM-2... a team of low cost workhorses for your lab. **\$74.95** (220 @ 50/60Hz operation available at 10% additional cost)

DM-2's variable regulated power supply gives 5-15V DC up to 600ma (9 watts). Even monitor the DM-2's internal power supply or external circuits via self-contained 0-15V voltmeter. Lots of laboratory-quality testing for very little money. **\$69.95** (220V @ 50/60Hz operation available at 10% additional cost)



DESIGN MATE 4
What can you expect from a \$129.95 PULSE GENERATOR? Plenty! Symmetrical / Asymmetrical pulses from 5Hz to 5MHz. 100mV-10V Positive output with less than 30ns rise/fall time. Independent pulse width/spacing. 100ns to 1 second in 7 overlapping ranges. Independent CMOS, TTL

outputs. 10:1 duty cycle range. Continuous/manual one-shot operation. External triggering to 10MHz. Synchronous output gating. TTL compatible sync output. You get your \$129.95 worth... and then some! So, if your lab needs a quality benchtop pulse generator, but is short on bucks, order DM-4 today. **\$129.95.** (220 @ 50/60Hz operation available at 10% additional cost)

SPECIFICATIONS

DM-1 Circuit Designer

Power Supply: Output; 5-15V at 600ma.
Ripple and Noise: less than 20 mv at full load. **Load and Line Regulation:** better than 1%. **Meter:** 0-15V DC — 5%.
Connectors: 1 QT-59S, 2 QT-59B, 2 power supply 5-way binding posts. **Weight:** 3 lbs.
Power Requirements: 117V AC @ 60Hz 12 watts.

DM-2 Function Generator

Frequency Range: 1Hz to 100 kHz in Five Ranges: 1-10Hz, 10-100Hz, 100-1000Hz, 1-10kHz, 10-100kHz. **Dial Accuracy:** Calibrated at 10Hz, 100Hz, 1kHz and 10kHz, frequency accurate to 5% of dial setting. **Wave Forms:** Sine wave less than 2% THD over frequency range; Triangle wave linearity, better than 1% over range; Square wave rise and fall times less than 0.5 micro seconds with 600 ohms — 20 pf termination. **Output Amplitude:** (all wave forms) variable — 0.1V to 10V peak to peak into open circuit. **Output Impedance:** 600 ohms — constant over amplitude and frequency range. **Weight:** 2 lbs. **Power Requirements:** 117V AC @ 60Hz 5 watts.

DM-3 R/C BRIDGE

Resistance Range: 10 ohms to 10 megohms — 6 Ranges: 10-100 ohms, 100-1000 ohms, 1K-10K ohms, 100K to 1 megohm, 1 megohm to 10 megohms. **Capacitance Range:** 10 pFd to 1 mFd — 5 Ranges: 10-100 pFd, 100-1000 pFd, .001 to .01mFd, .01mFd, .1 mFd, .1 to 1.0 mFd. **Null Detector:** 2 high intensity red LEDs with high/low markings. **Accuracy:** Better than 5% of null Dial and range switch setting. **Weight:** 2 lbs (.91kg). **Power Requirements:** 117V AC @ 60Hz 3 watts.

DM-4 PULSE GENERATOR

Frequency Range: 0.5Hz to 5MHz; **Pulse Wide and Spacing Controls:** 100 ns to 1 sec. in 7 overlapping decade ranges. A single-turn vernier control provides continuous adjustment between ranges. **Duty Cycle:** 10% to 1 Range — adjustable over entire pulse width/spacing range. 100 ns "ON" 1 sec "OFF" to 1 sec "ON" and 100 ns "OFF". **Operating Modes:** RUN: -0.5Hz to 5MHz as per width/spacing and amplitude control settings. TRIG: DC to approx. 10MHz; **Input Requirements:** Sinewaves 2 V P-P; pulses 1 V peak, > 40 ns pulse width; maximum input ± 10V (input impedance: Approx. 10 KΩ DC coupled.) **GATE:** Synchronous gating. Leading edge of gate signal turns generator "ON". Last pulse is completed even if gate ends during pulse. **Input requirements:** Same as "TRIG" Mode. **ONE-SHOT:** Pushbutton for single pulse. Output pulse occurs each time pushbutton is pressed. **OUTPUTS:** VAR OUT - Amplitude, 0.1-10 V positive. Rise/fall time, Less than 30 ns. Impedance, 400 Ω max. TTL OUT: Fan-out, 40 TTL Loads. Sync, 160 milliamps-0.8 V max. Rise/fall time Less than 20 ns. SYNC OUT: Pulse width, Approx. 40 ns. Other sync pulse spec's same as TTL out. Pulse lead time, Sync pulse leads outputs by approx. 20 ns. **POWER:** 117 VAC ± 10%, 50/60Hz, 5 watts. **Size:** (WxLxH): 7.5 x 6.75 x 3.25". **Weight:** 2 lbs (0.91kg).

ORDER TODAY!

USE HANDY ORDER FORM ON LAST PAGE!

LOGIC MONITORS

With the speed of light, you can check all digital ICs and get accurate, foolproof, clearly marked readouts.

LOGIC MONITOR 1

The logical answer to inexpensive, effective testing. Self-powered. Self-contained. Pocket-size. Never needs adjustment or calibration. Tests DTL, TTL, CMOS and HTL. Your digital designs spring to life. You can even watch signals working effortlessly through counters, shift registers, timers, adders, flip-flops, decoders, entire systems. Forget probe grounds, pin counting or sync polarity. Just clip LOGIC MONITOR 1 to any DIP IC, up to 16 pins. Precision plastic guides and unique flexible web* guarantee positive connections between non-corrosive nickel/silver contacts and IC leads. Versatile. Fast. Accurate. Indispensable. That's LOGIC MONITOR 1. And, the price is right. Only \$74.95

SPECIFICATIONS

Input Threshold: $2.0 \pm .2V$. **Input Impedance:** 100,000 ohms $\pm 5\%$ all inputs. **Input Voltage Range:** 4V min. to 15V max. across any two or more inputs. **Maximum Current Drain:** 200 ma @ 10V. **Temperature Range:** 0°C to 50°C. **Weight:** 3 oz. (85 grams). **Maximum Dimensions:** (LxWxD) 4 x 2 x 1.5"

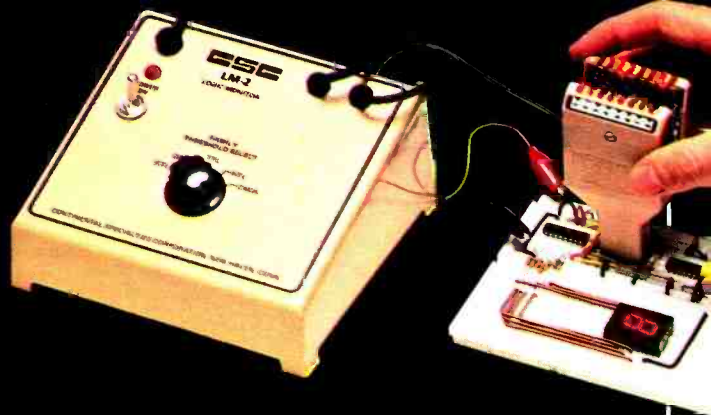

LOGIC MONITOR 2

Second generation IC tester, with fully isolated power supply to eliminate test circuit loading. 2-units-in 1: Connector/Display that clips over dual in-line packages up to 16 pins. Plus, a modular precision reference Power Supply with its own logic family selector switch. Simply switch to a proper logic family. Then connect black clip lead to NEG or GND. When clip module is slipped over IC, LED instantly, automatically displays logic states of the IC. Can't load down test circuit. Comparators provide constant LED current drive for uniform, bright display. Displays gate rising and falling inputs, while passing pulses from circuit to circuit. See flip-flops change state. Encoders/decoders accepting, recording information. Lots more. All 16 display channels work simultaneously. Order your LM-2 today. Get a lot of logic for a fraction of the price of an oscilloscope. \$129.95 (220V 50/60Hz operation available at 10% additional cost)

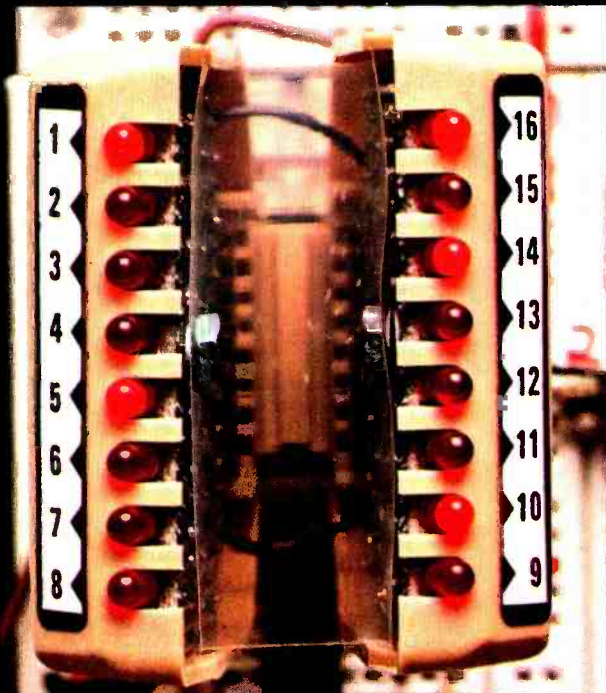

Logic levels appear instantly on 16 large (.125" dia.) clearly marked, high intensity LEDs. Logic "1" (high voltage) turns LED on. Logic "0" (low voltage or open circuit) LED off. Power seeking gate network automatically locates supply leads; feeds them to LM-1.

U.S. Patent No. 3,314,007

LOGIC THRESHOLDS

CMOS: 70% of test unit $V_{cc} \pm 100mV$

HTL: $7.5V \pm 100mV$ **TTL:** $2.4V \pm 100mV$

DTL: $1.6V \pm 100mV$ **RTL:** $1.2V \pm 100mV$

Maximum Visible Input Freq: 30kHz @ 50% duty cycle

Size: (LxWxH) 5.6x6.0x3.0

Weight: 20 oz.

Input Power: 117VAC 50/60 Hz 10W

Heavy thinkers need heavy test equipment they can afford.

LOGIC PROBES & DIGITAL PULSER

LOGIC PROBES

Simpler breadboard testing. That's why CSC Logic Probes were created. These hand-held design/test tools give instant overview of circuit conditions. Just clip power leads to circuit's power supply, set logic family switch to TTL/DTL or CMOS/HTL. Touch probe tip to the test node. Trace logic levels and pulses through digital circuits. Even stretch and latch for easy pulse detection. Best of all, you get instant recognition of high, low or invalid levels, open circuits, and nodes.

Simple dual level detector LEDs tell it quickly, correctly. HI (Logic "1"). LO (Logic "0"). Blinking pulse detector too, e.g. HI and LO LEDs blink on or off, "tracking" "1" and "0" states at square wave frequencies up to 1.5MHz. Pulse LED blinks on for 1/3 second during pulse transition.

There are three models to choose from, depending on your budget, your project, and the speed of your logic circuits.

ORDER YOUR LOGIC PROBES TODAY! SEE YOUR LOCAL DISTRIBUTOR OR USE THE HANDY ORDER FORM ON THE LAST PAGE!

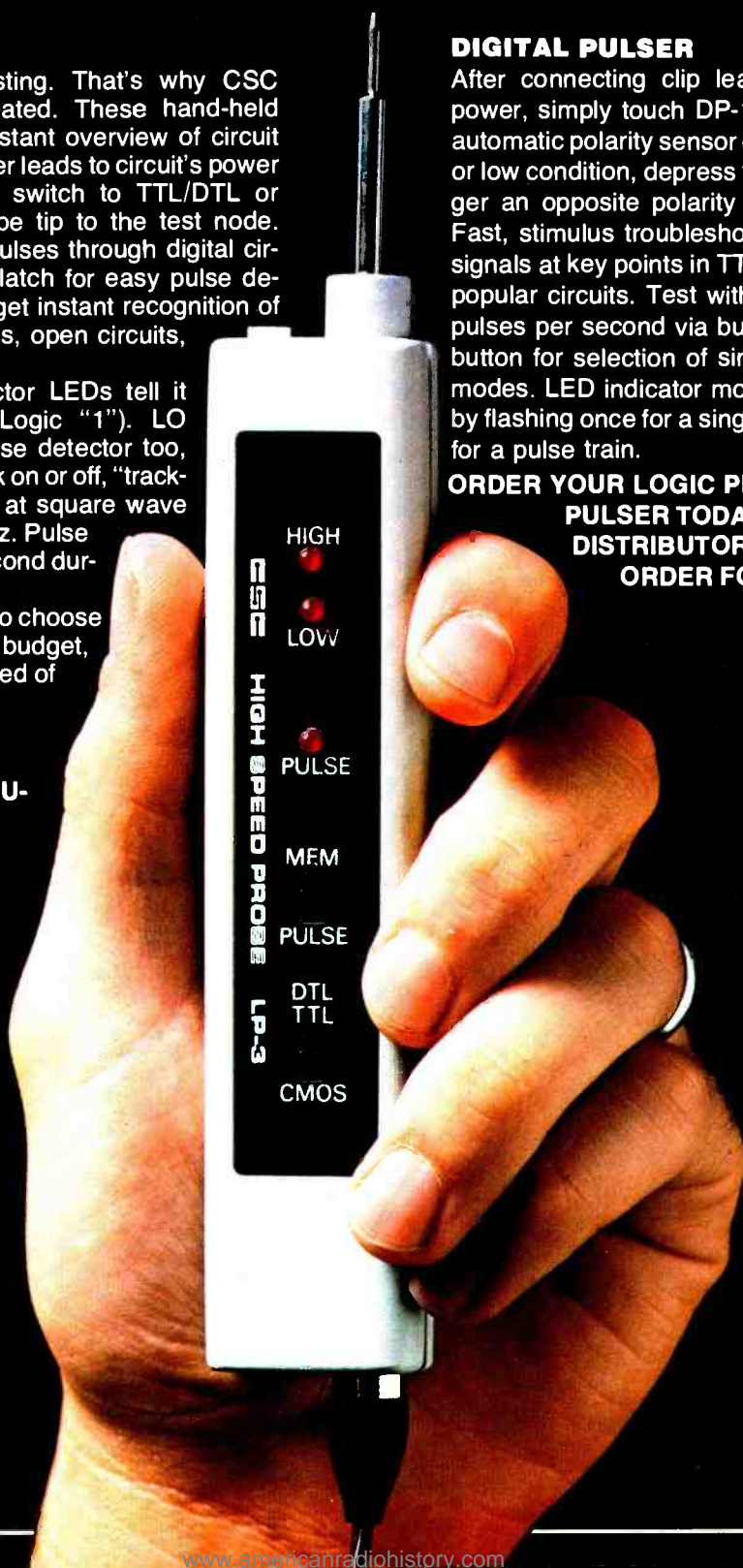

DIGITAL PULSER

After connecting clip leads to POS and NEG power, simply touch DP-1 to a circuit node, and automatic polarity sensor detects the circuit's high or low condition, depress the pushbutton and trigger an opposite polarity pulse into your circuit. Fast, stimulus troubleshooting includes injecting signals at key points in TTL, DTL, CMOS or other popular circuits. Test with a single pulse or 100 pulses per second via built-in dual control pushbutton for selection of single shot or continuous modes. LED indicator monitors operating modes by flashing once for a single pulse or continuously for a pulse train.

ORDER YOUR LOGIC PROBES AND DIGITAL PULSER TODAY! SEE YOUR LOCAL DISTRIBUTOR OR USE THE HANDY ORDER FORM ON BACK PAGE!



LP-1 Hand-held, instant reading of logic levels for TTL, DTL, HTL, or CMOS. **\$44.95**

LP-2 The economy version of LP-1. Safer than voltmeter. More accurate than scope **\$24.95**

LP-3 High speed logic probe captures pulses as short as 10ns. **\$69.95**

DP-1 Completely automatic, pencil-size lab/field pulse generator. Pulse any family of digital circuits. **\$74.95**

ACCESSORIES



LDA-1 1.5" Long Tip - Standard. **\$1.00.**
LDA-2 2.5" Long Tip - Optional. **\$1.00.**



LDA-3 3" Long E-Z Hook and Adapter for use in place of tip - Optional. **\$4.25.**

LDA-4 3" Long Ground Clip with E-Z Hook - Optional. **\$2.75.**

LDA-5 3" Long Ground Alligator Clip with LP-3 only - Standard. Optional. **\$1.95.**



LDA-6 Test Prod Tip Adapter (Converts tip to E-Z Hook) - Optional. **\$2.50.**
LDA-7 Standard Banana Plug (Converts tip for insertion into Banana Plug) - Optional. **\$1.60.**

(Not Shown)

LDA-8 36" Power/Ground Leads with Alligator Clips - Standard. **\$2.00.**

LDA-9 36" Power/Ground Leads with E-Z Hooks - Optional. **\$3.95.**

Input Impedance

LP-1
100,000 Ω

LP-2
300,000 Ω

LP-3
500,000 Ω

DP-1
Output Tri State

Minimum Detectable Pulse

50ns

300ns

10ns

Autopolarity Pulse Sensing

Max. Input Signal (Freq.)

10 MHz

1.5 MHz

50MHz

Sink and Source 100 ma

Pulse Detector (LED)

High Speed Train or Single Event

High Speed Train or Single Event

High Speed Train or Single Event

Pulse Train: 100pps

Pulse Memory

Pulse or Level Transition Detected and Stored

None

Pulse or Level Transition Detected and Stored

LED Indicator flashes in Single Pulse. Stays lit on Pulse Train

Count. Calculate. Create.
And accessorize accurately.

MAX-100 FREQUENCY COUNTER

MAX-100. Portable, high precision, lab-quality frequency counter. **MAXimum performance.** Continuous readings from 20Hz to guaranteed 100MHz. Full 8-digit precise readout from crystal controlled timebase with 3ppm accuracy. **MAXimum sensitivity and protection.** Built-in high sensitivity pre-amp gives readings as tight as 30mV . . . with diode protected input to 200V peaks. **MAXimum visibility.** Bold, bright 8-digit 0.6" display. built-in Flip-up stand. **MAXimum operating ease.** Plug-in. Turn-on. 1Hz readings eliminate range switching and MHz/KHz checks. **MAXimum versatility.** Standard clip-lead cable (supplied), Mini-Whip antenna*, or low-loss in-line tap* with UHF connectors available. Checks AM, FM, CB, Ham

R/C computer clocks, digital circuits. Monitors audio, RF generators. **MAXimum self-monitoring.** Input signals over 100MHz (overflow) automatically flash most significant digit, preventing accidental errors. **MAXimum battery life.** Up to 8 hours of normal intermittent use, cued by flashing display weak-power indicator. **MAXimum flexibility.** Compact (1.75" x 7.75" x 5.63"). Portable from 4 power sources. Internal alkaline or rechargeable NiCad AA batteries. 110 or 220VAC with charger/eliminators*. 12V auto cigarette lighter charger/eliminator. External 7.2-10V power supply (batteries not included). **MAXimum value.** You get all this, and more in the industry's best frequency counter value. **MAX-100. Only \$134.95**



*Optional

**ORDER YOUR MAX-100 TODAY!
SEE YOUR LOCAL DISTRIBUTOR
OR USE THE HANDY ORDER FORM ON THE BACK PAGE!**

ACCESSORIES

**Model 100-CA1/
Model 100-CA2
Charger / Elim-
inators** for 6
Rechargeable Ni-
Cad AA cells
\$9.95 each

Model 100-MWA Mini-Whip Antenna. For direct-coupling to RF equipment. Displays frequencies of nearby portable transmitters. **\$3.95**

Model 100-CLA Mobile Charger/Eliminator
\$3.95

(Not Shown)

Model 100-LLC Low Loss Tap Off connects to equipment or RF line under test. 3W rating. **\$14.95**

Model 100-CC Carrying Case. Soft simulated leather. **\$9.95**

**Model 100-IPC Input Cable with
Clip Leads.** (Included. Additional
units available.) **\$5.95**

PROTO-CLIPTM I.C. TEST CLIPS & DESIGN MATETM CASES

Clip-on. Fool-proof. Short-proof. Power-on. DIP-in. Circuit testing that's right-on . . . for less!

Take your choice from four (4) low cost micro-trouble-shooters. Narrow, deep throat brings IC leads up from crowded pc boards for fast signal tracing, testing, signal injection, even wiring unused circuits into existing boards. Your hands are free to scratch an itch or dig into electronic problems. High impact plastic construction means no more springs or pivots to pop out at critical moments. Molded flexible web* insures positive operation every time, for thousands of uses. Non-corroding nickel/ silver contacts give simultaneous, low-resistance connections to all IC leads. Pick a size. Pick a need. Pick a price. Place an order. Now!



Unique gripping teeth for slip-proof, hands-off probe connections.

Clips

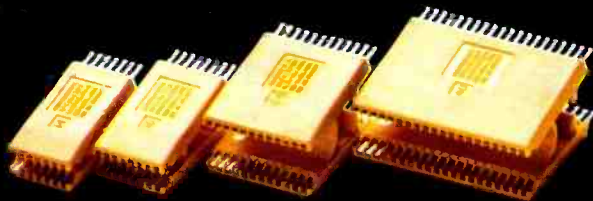

PC-14 (14-pin) \$4.50 PC-16 (16-pin) \$4.75 PC-24 (24-pin) \$8.50 PC-40 (40-pin) \$13.75

*U.S. Patent Design No. 3,914,007

Proto-Clip I.C. Test Clips with pre-wired cables

Model No.	Cable length inches	Price \$ Single Clip	Price \$ Dual Clip
PC-14-	18	\$7.75	\$14.75
PC-14-	24	8.00	15.00
PC-14-	36	8.50	15.50
PC-16-	18	8.50	16.00
PC-16-	24	8.75	16.25
PC-16-	36	9.25	16.75
PC-24-	18	\$ 2.25	\$25.25
PC-24-	24	2.50	25.50
PC-24-	36	3.00	26.00
PC-40-	18	21.00	42.00
PC-40-	24	21.25	42.25
PC-40-	36	21.75	42.75

Cases

DMC-1. Hi-impact insulated plastic. 1-piece. Slope front panel. Metal bottom. Mounting screws. Same size as popular Design Mate Units \$6.95

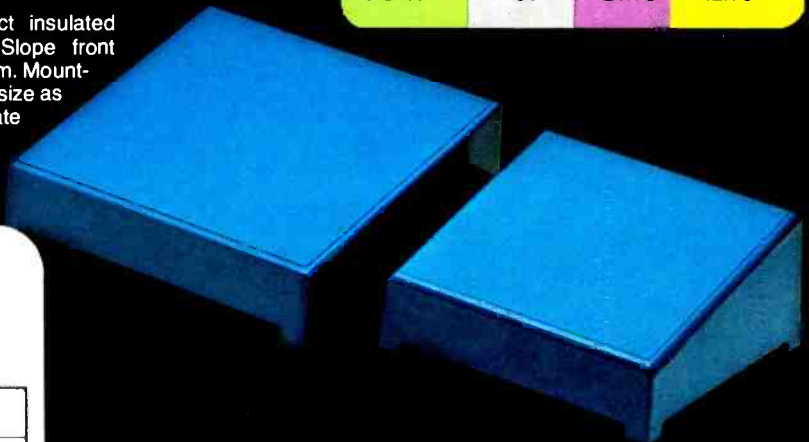

DIMENSIONS

MODEL	A	B	C	D	Weight
DMC-1	3.25"	6.75"	7.5"	1.5"	12 oz.
DMC-2	3.0"	5.63"	6.0"	1.5"	10 oz.

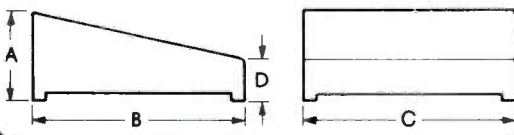

DMC-2. Same features as DMC-1, but slightly more compact \$5.95



Products also available at selected local computer stores.

Alaska
Anchorage - Yukon Radio

Alabama
Muscle Shoals - Jones' Electronics

Arkansas
Little Rock - Carlson-Bates

Arizona
Glendale - Tri-Tek
Phoenix - Electronic Parts
Tempe - Circuit Specialists, Jensen Tools & Alloys

Tucson - Ancona

California - Northern
Berkeley - Electronics Etc. All Lashers Electronics
Cupertino - Interlink Systems
Fremont - Engelman Audio Visual, Inc.
Fresno - Dunlap Electronics
Hayward - Dunlap Electronics
Modesto - Dunlap Electronics, Lombard's Lafayette
Monterey - Zack Electronics
Mountain View - Hattek Electronics
Palo Alto - U.S. Electronics, Zack Electronics
Robnet Park - Dunlap Electronics
Sacramento - Dunlap Electronics, Lombard's Lafayette, Zack Stores
San Carlos - James Electronics
San Francisco - Haver Electronics, Lombard's Lafayette, Zack Electronics
San Jose - Quement Electronics
San Rafael - Electronics Plus
Santa Clara - Anchor Electronics, Olson
Stockton - Dunlap Electronics
Vallejo - Zackit

California - Southern
Brea - Century Electronics
Buena Park - Ford Electronics, S.J. Electronics
Burbank - Electronics City
Canoga Park - Sandy's Elect. Supply Inc.
Cerritos - Olson
Costa Mesa - Map Vac Electronics
Culver City - Ancona
Fullerton - Or Vac Electronics
Harbor City - Buff Electronics
Hollywood - Pacific Radio Exchange, Yale Radio Electronic Co. Inc.
Inglewood - Basic Systems
Lakeside - Dynaserv Corporation
Los Angeles - Dynaserv Company, International Television Corporation
Oxnard - Dow Radio Inc.
Pasadena - Dow Radio Inc.
Redondo Beach - Electronics Warehouse Inc.
Hawk Electronics Inc.
Riverside - Electronics Warehouse
San Diego - Basic Systems Corp., Olson
Shaw's & Wright
Santa Ana - Ancona

Santa Barbara - Basic Systems Inc.
Lombard's Lafayette
Thousand Oaks - Sandy's Electronic Supply Inc.
Westminster - J.K. Electronics
Whittier - Obawo Electronics

Colorado
Denver - G.W. Electronic Sales Co., Gateway Electronics, Fastel's Electronics Supply

Connecticut
Greenwich - Wise Electronics
Hartford - Harty Electronics
New Haven - Harty of New Haven
New London - Jabour Electronics
Stratford - Harty Electronics

Delaware
Wilmington - Wholesale Electronics

District of Columbia
Collins Brothers Electronics

Florida
Coral Gables - Olson
Melbourne - Dynatek Products Inc.
Miami - ESI Electronics Dist., Electronic Equipment Co. Inc.
North Miami Beach - Electronics Company
Orlando - Hammond Electronics
Pensacola - Grace Electronics
Tampa - J & H Electronics Co., Olson

Georgia
Atlanta - Ancona
Decatur - Olson

Hawaii
Honolulu - Precision Radio Ltd

Illinois
Champaign - Klaus Radio Inc.
Chicago - Elect. Dist. Inc., Heathkit Electronic Corp., Howard Elect. Sales Inc., Joseph Elect. Olson, R. W. Electronics Inc.
Des Plaines - Elect. Dist. Inc.
Downers Grove - Heathkit Electronic Corp.
Harvey - George Electronics Inc.
Naples - Joseph Electronics, Wico Inc.
Rockford - J & M Electronics Inc.
Villa Park - Elect. Dist. Inc.
Waukegan - Elect. Dist. Inc.

Indiana
Anderson - Graham Electronics
E. Chicago - Acro Electronics
Evansville - Hatch & Son Inc.
Fort Wayne - Graham Electronics
Hammond - Elect. Dist. Inc.
Indianapolis - Graham Electronics, Meunier Electronics, Ra-Di-Co.
Lafayette - Graham Electronics
Muncie - Graham Electronics
South Bend - Radio Distributing
Terre Haute - Midwest Supply Electronics, Inc.

Iowa
Cedar Rapids - Iowa Radio Supply Co.

Kansas
Topeka - Acme Radio Supply
Wichita - Radio Supply Co. Inc.

Kentucky
Lexington - Radio Electronic Equipment
Louisville - Peerless Elect Equip

Louisiana
Baton Rouge - Davis Wholesale Elect. Sup. Co., Meagard Electronics Inc.
Lafayette - Raleigh's
Lake Charles - Lake Charles Elect. Sup. Inc.
New Orleans - Wm B. Allen Supply Co., Southern Radio Supply Co.
Shreveport - Industrial Electronic Supply

Maryland
Beltville - Treko Sales Inc.
Towson - Baynesville Electronics

Massachusetts
Medford - Tufts Radio Electronics
Needham - You Do It Electronics
N. Wiltabam - Industrial Components
Worcester - R.M. Electronics Inc.

Michigan
Adrian - Sward Enterprises
Ann Arbor - Wedemeyer Elect. Supply
Detroit - Radio Supply & Engr. Co., R.S. Electronics
Flint - Shand Elect. Inc., Taylor Electronic Supply
Grand Rapids - R.S. Electronics, Statz-Friedman
Kalamazoo - R.S. Electronics
Livonia - Wedemeyer Elect. Supply Co.
Livonia - R.S. Electronics
Madison Heights - Olson
(Marquette - NWR Elect Corp)
Saginaw - Shand Elect. Taylor Electronic Supply

Minnesota
St. Louis Park - Edronics Company

Mississippi
Jackson - Ellington Electronic Supply Inc.

Missouri
Columbia - Missouri Cable Company, Inc.
Kansas City - Bursten-Appelbee Company, Walters Radio Supply Inc.
Rolla - Show me Electronics, Inc.
St. Louis - Gateway Elect. Corp., Van Sickle Radio & Elect.

Nebraska
Lincoln - Scott Elect. Sup. Corp.
Omaha - Scott Elect. Sup. Corp.

Nevada
Reno - Elect. Dist. Co. of Nevada

New Jersey
Edison - Bob K. Company, William Elect. Supply
Fair Lawn - Heathkit Electronic Center
Greenbrook - Greenbrook Elect.
Hazlet - Interstate Electronics
Northfield - Rainbow Electronics
Roselle - Garden State Ind. Elect. Inc.
Springfield - Route Elect.

Towaco - Route Electronics 46 Inc.
Trenton - Jackson Distributors Inc.
Vineland - Audio Visual Sales & Service Co.

New Mexico
Albuquerque - Electronic Parts Company
Hobbs - Electronic Module

New York
Bohemia - Car-Lac Electr. Ind.
Bronx - Boy Electronics
Buffalo - Summit Distributors
Corning - Corning Elect. Inc.
Farmingdale - Fordham Radio, Harrison
Radio Corp., Kelvin Electronics
Flushing - M & K Electronic Dist.
Hauppauge - Nationwide Electronics
Levittown - Edie Electronics
Nanuet - Route Electronics 39 Inc.
New York - Advance Electronics, Atlas Electronics, B&B Electronics Corp., Joe Berger Electronics Inc., Dale Electronics, Harvey Radio Company, Metro Electronics Corp., Midtown Electronics, S&S Parts Accessories
North White Plains - Heathkit Electronic Center
Port Chester - Wise Components, Inc.
Richmond Hill - Anchor Electronic Distributors Corp.
Rochester - Rochester Radio Supply, Summit Electronics
Troy - Trojan Electronic Supply Co.
Westbury - Heathkit Electronic Center
Woodside - Orbital Electronics
Yonkers - Forbes Electronics

North Carolina
Greensboro - Hammond Electronics
Raleigh - Southeastern Radio Supply Co.
Ohio
Akron - The Sun Radio
Cincinnati - Hughes - Peters, Inc., United Radio Inc.
Cleveland - Olson, Pioneer
Columbus - Hughes-Peters, Inc.
Dayton - Pioneer
Salon - Repro
Toledo - Lifetime Electronics, RS Electronics
Youngstown - Olson

Oklahoma
Norman - H & B Electronics
Oklahoma City - High Technology, Trice Wholesale Elect.
Tulsa - Component Specialties, Oil Capital Electronics, Radio Inc.

Oregon
Portland - Ancona, Dunn Electronics, Ia-Mac Products Co., Portland Radio Supply Co.

Pennsylvania
Allentown - A. A. Peters, Inc.
Drexel Hill - Kass Electronic Dist. Inc.
Harrisburg - Cumberland Electronics, Pytronic Industries, Inc.
Philadelphia - Herbach & Rodeman
Pittsburg - Olson

Partisville - Mayer Electronic Supply Co.
Reading - Boyer Electronics

Rhode Island
Cranston - Jabour Elect. City
Newport - J & S Electronic Dist.
Pawtucket - Jabour Electronic City

South Carolina
Greenville - Hammond Electronics

Tennessee
Columbia - Randolph & Williams, Inc.
Cookeville - C&S Communications & Elect.
Kingsport - Radio Electric Supply Co.
Memphis - Bluff City Electronics
Austin - Electotex, Wholesale Electronic Supply

Texas
Austin - Electotex, Wholesale Electronic Supply
Beaumont - Electotex
Corpus Christi - Douglas's Electronic
Electotex, Wicks Radio Supply
Dallas - Component Specialties, K.A. Electronic Sales, Wico Corporation
El Paso - International Electronics
Fort Worth - Electronic Module, Electotex
Garland - K.A. Electronics
Houston - Ancona, City Elect. Supply, Component Specialties, Electotex, 2300
Richmond Ave., Electotex, 4435 Airline
Drive, Electotex, 8540 Winkler Drive
Irving - Electotex
Lubbock - Trice Wholesale Elect.
Lufkin - Electotex
Richardson - Martin Wholesale Incorporated
San Antonio - Electotex, Sherman Elect. Supply
Texas City - Electronics Supply
Odessa - Electronic Module

Utah
Ogden - Carter Supply Company
Provo - Central Utah Elect. Supply

Alexandria - Certified Elect. Inc.
Annadale - Arcade Elect. Inc.
Norfolk - Avc Electronics Corporation
Radio Paris Distributing Co.

Washington
Longview - Progress Electronics
Seattle - Almac-Strom Elect., American
Mercantile Co. Inc., Robert E. Priebe
Company, Radar Electric Company

West Virginia
Charleston - Radio Shack Associate Store
Morgantown - Electro Distributing Co.

Wisconsin
Kaukaunoi - Chester Electronic Supply
Madison - Taylor Electronic Company
Milwaukee - Amateur Elect. Supply, Marsh
Elect. Inc., Parts Mart Corp.
Oshkosh - Elect. Industries Inc.
Waterloo - General Precision Elect.
West Allis - Olson

Metric-to-English Slide Rule available at your local distributor.

. . . OR ORDER DIRECT

SIMPLY CUT ON DOTTED LINE AND MAIL

CONTINENTAL SPECIALTIES CORPORATION



**44 Kendall Street P.O. Box 1942
New Haven, Ct., 06509**

Name _____

Address _____

City _____ State _____ Zip _____

This is your shipping label. Please type or print clearly.

5 easy ways to order . . . *24 hour service!

- Include payment (\$5.00 min.) Send check or money order only.
- Charge (\$10.00 min.) Please fill in credit information. Do not send your credit card.
- C.O.D. Available in U.S.A. only. You pay postage and fees.
- Company Purchase Order (rated firms only) Please enclose your purchase order. All orders F.O.B. New Haven, CT or San Francisco, CA. Terms, Net 15.
- In a hurry? . . . Telephone! 9 AM to 5 PM local time at our East-Coast and West-Coast offices. Sorry — no collect calls. We do take credit card orders on the phone.

**Call: on the East Coast — 203-624-3103
on the West Coast — 415-421-8872**

Use Your Credit!

- MASTERCHARGE BANKAMERICARD
 AMERICAN EXPRESS

Bank No.
Master Charge: 4 numbers above your name

CREDIT CARD NO.

EXPIRATION DATE

SIGNATURE

Please give your phone no. in case we have to call you.

Tel. No.

FOR OFFICE USE ONLY —

No. _____

Qty.	Model No.	Price Ea.	Total
1	Metric to English Slide Rule		FREE
			TOTAL
			CONN. OR CALIF. SALES TAX
			POSTAGE & HANDLING
			(see chart)
			TOTAL AMOUNT ENCLOSED

POSTAGE & HANDLING CHART

Orders —	Add
up to \$10.00	\$1.50
\$10.01-25.00	2.00
\$25.01-50.00	2.50
\$50.01 & over	3.00

Foreign Orders: Please add 15% of TOTAL ORDER to cover postage and handling. Credit cards, international money orders or checks drawn on U.S. banks only.

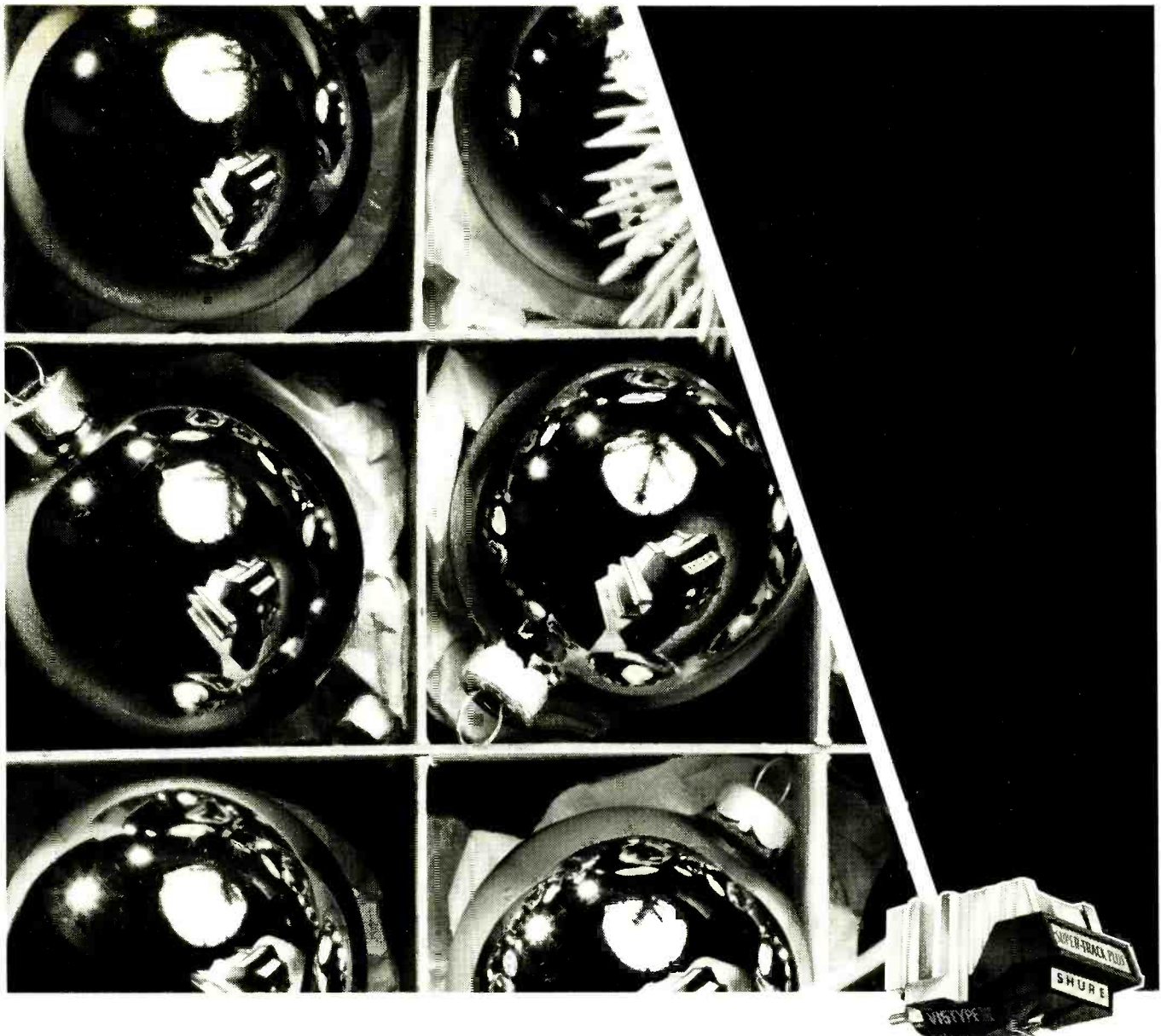

A cartridge in a pear tree.

A gift of the Shure V-15 Type III stereo phono cartridge will earn you the eternal endearment of the discriminating audiophile who receives it. What makes the V-15 such a predictable Yuletide success, of course, is its ability to extract the real sound of pipers piping, drummers drumming, rings ringing, et cetera, et cetera. In test reports that express more superlatives than a Christmas dinner, the performance of the V-15 Type III has been described as "...a virtually flat frequency response... Its sound is as neutral and uncolored as can be

desired." All of which means that if you're the giver, you can make a hi-fi enthusiast deliriously happy. (If you'd like to receive it yourself, keep your fingers crossed!)

Shure Brothers Inc.
222 Hartrey Ave.,
Evanston, IL 60204
In Canada:

A. C. Simmonds & Sons Limited

TECHNICORNER

MODEL V-15 TYPE III

Tracking Force Range: 1/4 to 1 1/4 grams

Frequency Response: 10 to 25,000 Hz

Output: 3.5 mV per channel at 1 KHz, 5 cm/sec peak recorded velocity

Typical Tracking (in cm/sec peak recorded velocity at 1 gram in a Shure-SME Tone Arm):

400 Hz 26 cm/sec

1,000 Hz 38 cm/sec

5,000 Hz 35 cm/sec

10,000 Hz 26 cm/sec

Channel Separation (Minimum): 25 dB at

1 KHz; 15 dB at 10 KHz

Stylus: Model VN35E Bi-radial Elliptical, 5 x

18 microns (.0002 x .0007 inches)

Also available: Model V-15 III G with the

VN3-G Spherical stylus, 15 microns (.0006

inches)

Model VN78E Bi-radial Elliptical stylus, 13 x

63 microns (.0005 x .0025 inches) for mono

78 rpm.



Manufacturers of high fidelity components, microphones, sound systems and related circuitry.

Put Professional Knowledge and a
COLLEGE DEGREE
 in your Electronics Career through
HOME STUDY



Earn Your DEGREE

by correspondence, while continuing your present job. No commuting to class. Study at your own pace. Learn from complete and explicit lesson materials, with additional assistance from our home-study instructors. Advance as fast as you wish, but take all the time you need to master each topic. Profit from, and enjoy, the advantages of directed but self-paced home study.

The Grantham electronics degree program begins with basics, leads first to the A.S.E.T. degree, and then to the B.S.E.E. degree. Our *free* bulletin gives complete details of the program itself, the degrees awarded, the requirements for each degree, and how to enroll. Write for *Bulletin E78*.

Grantham College of Engineering
 2000 Stoner Avenue
 P. O. Box 25992
 Los Angeles, CA 90025

Worldwide Career Training thru Home Study
 CIRCLE NO 21 ON FREE INFORMATION CARD

Try this exciting new hobby! Build your own electronic concert organ. It's easy. No technical knowledge required. Just follow the clearly pictured instructions of the famous **Wersi do-it-yourself system**. Choose from seven different models. Send \$2.00 (refundable) with coupon for colorful 104 page catalog.

WERSI



Wersi Electronics, Inc.
 Dept. 42, Box 5318
 1720 Hempstead Road
 Lancaster, PA 17601

Enclosed is \$2.00 for my copy of your 104 page catalog.

Name _____
 Address _____
 City _____ State _____ Zip _____

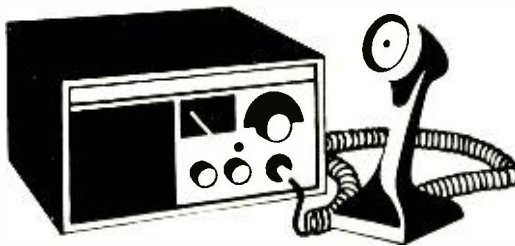

CB Scene

By Gary Garcia, KQI4178

RULES ENFORCEMENT GAME PLAN

EFFECTIVE enforcement of the Citizens Band Radio Service rules and regulations is a vexing duty of the Federal Communications Commission. Unruliness sometimes abounds on the CB frequencies, most noticeably in urban areas where the CB population is most concentrated. Except for an infrequent "strike" (the process of identifying, inspecting, and citing illegal operators by a team of FCC engineers), evidence of CB rules enforcement is practically nonexistent.

The FCC has not yielded to the rule-breakers among us, however. In fact, a recent study by the FCC of the effectiveness of various enforcement techniques suggests that the Commission is determined to increase the level of compliance with the rules of the Citizens Band Radio Service as a means of improving CB communications quality.

Violations. Transgressions impair CB communications quality—the ability of an authorized CB user to establish communications within an acceptable waiting period and complete the communication without undue difficulty. Most harmful are unnecessary, illegal transmissions, says the FCC. Indeed, transmissions of music, sound effects, unmodulated carriers, and obscenities are a major component of the "electromagnetic obstacle course" present in some areas on the 11-meter band.

Interestingly, the FCC study included CB operator behavior on different days of the week. It was learned that the magnitude of violations differed very little from day to day, though statistical results indicated that greatest rules compliance was observed on Fridays and least on Saturdays.

Infractions deemed to be of most importance and equally so by the FCC are:

1. Out-of-band communications.
2. Excessive r-f output power.
3. Communication beyond 150 miles.
4. Failure to identify by callsign.
5. Violation of local or federal law.
6. Profane or indecent language.

Enforcement Techniques. What measures are necessary to promote compliance with the CB rules and regulations? The *conventional* enforcement technique is the so-called "strike," conducted by two pairs of FCC engineers in a particular area.

A somewhat similar method of enforcement is the *criminal sanction* technique. Again, teams of two FCC engineers investigate and identify serious violators. Thereafter, however, this evidence of illegal operation is referred to U.S. Attorneys for initiation of criminal prosecution. The conventional and criminal sanction techniques are the most cost-effective methods investigated during the course of this recent FCC study.

An *educational* technique is employed by the FCC, too. This method consists of a week-long visit to a community by a single FCC engineer. During this period, the engineer conducts an intensive CB Education Program. Slide/sound programs are presented at meetings of CB groups, followed by discussion and question-and-answer sessions. Members of the media in the community visited are contacted to provide publicity for the programs to be conducted during the week; and TV and radio appearances are made by the engineer. "On-the-air" question-and-answer sessions are held on a previously selected CB channel, and even CB dealers are contacted and visited by the engineer. The educational technique is often augmented by the conventional technique to produce the *educational and criminal sanction technique*. This method proved to be more effective than the educational technique alone, but did not produce the results observed after application of the conventional or criminal sanction techniques due to the shortened investigative period. Moreover, although this program has been well received by the CB community, it has not resulted in a significant improvement in rules compliance. Further, rules breakers were not unaware of existing rules and regulations. Violation notices, by the way, carry fines of \$50 to \$100 for each violation

as follows:

- Excessive power: \$100
- Skip communications: \$75
- Overheight antenna: \$75
- Failure to use callsign: \$50

Additional Studies. The study of cost-effectiveness of the various compliance techniques previously mentioned is only one phase of a three-phase program. Additional studies are planned on the relationship between rule compliance and communications quality, and between communications quality and general public benefit derived from use of the Citizens Band Radio Service.

If the level of rules compliance by CB users does not reach an acceptable level, we can be sure that the FCC will eventually take action. Judging from previous actions, we can't guess what new decisions will likely be made. The FCC is simply too erratic. On one hand, rulings were made with the amateur radio fraternity in mind rather than the general public. So, it's no surprise that there are some serious violations of CB rules by people whose numbers loom large simply because they're a small percentage of more than 20-million CB'ers. Alternatively, the FCC has backed off on

some earlier rules—simplifying callsign identification, eliminating Form 452 which had to be displayed in a mobile, etc. Will the FCC be pressured by its inherent policing weakness to further dilute the rules? A User Rule Compliance Task Group in PURAC determined that the following technical factors could foster rule compliance, aside from educational and self-policing efforts:

1. ATIS (automatic transmitter identifier systems.)
2. Time-out timers to limit conversations to five minutes.
3. Linear amplifier sensors to inhibit delivery of power to linear amplifiers.
4. Antenna fuses so that CB antennas can handle only maximum power ratings.
5. Channel 9 deterrent that would use a two-frequency simplex system.

We can see many holes in the foregoing proposals, aside from added cost to the end user. For example, an emergency communication might require more than five minutes talk time. Further, intra-stations (base/mobiles that hold the same station license) are not limited to five minutes talk time. Another example: The use of ATIS. The time to make mandatory installation of this automatic iden-

tifier system was *before* there were so many millions of CB rigs in use. This old-hat proposal was turned down by the FCC earlier when it was possible for it to be used effectively.

We agree that it's unfortunate that FCC rules are being broken, and that these uncourteous actions are a detriment to legal CB communicators. But let's not condemn all CB'ers. Nor should one assume that CB users are the type of people who don't comply with the law. Here are some figures to ponder in this respect: The percentage of time that FCC field operations expend on violation enforcement for CB is 21.7%, resulting in 10,173 violation notices in the last three fiscal years. In contrast, here are the percentages of time spent in some other communication areas, with the number of violation notices during a three-year period in parentheses: Marine, 7.5% (19,054); Broadcast, 7.0% (5,823); Amateur, 2.9% (4,154). Furthermore, about 3/4 of the time spent on CB was for TVI purposes. Given the much greater number of CB'ers as compared to other services, these statistics demonstrate that the Citizens Band Radio Service is not alone in the need for more effective rules enforcement. ◇

IN ELECTRONICS  HAS THE LINE...

DIP/IC INSERTION TOOL WITH PIN STRAIGHTENER



MODEL INS-1416

\$3.49* EACH



STRAIGHTEN PINS

RELEASE

PICK-UP

INSERT

* MINIMUM ORDER \$25.00, SHIPPING CHARGE \$1.00, N.Y. CITY AND STATE RESIDENTS ADD TAX

OK MACHINE AND TOOL CORPORATION

3455 CONNER STREET, BRONX, NEW YORK, N.Y. 10475 U.S.A.

PHONE (212) 994-6600 TELEX NO. 125091

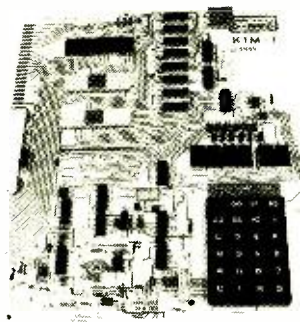

Everything's fully assembled, tested & warranted

MONEY BACK GUARANTEE

Return undamaged within 10 days of receipt and get a complete refund

Our \$279 KIMPAC includes:

- **KIM-1** — Computer with 1K-RAM, 2K-ROM, audio cassette interface, 15 bidirectional I/O lines, 24-key keyboard, and six-digit LED display
 - **Enclosed Power Supply** (5V at 1.2A, 12V at 0.1A) with power line and switch
 - **Software System** (Executive) stored in 2048-ROM Bytes. Dozens of sample programs and listings
 - **Documentation** — KIM-1 user manual, System Schematic, wall size 6500 Hardware Manual, Programming Manual, & Reference Card
- Over 10,000 KIM-1s are educating hobbyists & professionals in programming & applying computers. Isn't it about time you became part of the computer revolution? The KIM can be used for everything from educational games to heat & air conditioning control. Even storage applications like home accounting & inventory control are possible by adding a home cassette recorder to the included interface. Your KIM is easily expandable. NCE offers a backplane that lets you use S100 boards, memory peripherals, & enclosures.

Free Bonus — THE FIRST BOOK OF KIM. Dozens of games & utility programs are included.

This book supplements what has been called the best programming & hardware manuals in the business. Order now & be using your computer the day you get it. Full 90 day warranty.

Please send KIMPAC with all items mentioned. Enclosed is \$279 + \$3.79 for shipping & handling. Mich. residents please add tax (\$1.12).

Name _____

Address _____

City, State, Zip _____

Send check, money order, or Bank card number

Signature _____

(no order will be processed without it)

NCE/CompuMart

1250 N. Main St. Dept. PE127
P.O. Box 8610 Ann Arbor, MI 48104
(313) 994-4445

CIRCLE NO. 38 ON FREE INFORMATION CARD



Computer Bits

By Leslie Solomon

POTPOURRI FROM HERE AND THERE

HERE ARE a number of interesting hardware and software items to titillate the computer hobbyist. Some were brought to our attention through the mail; others were spotted at the Personal Computing show in Atlantic City.

16K for SWTP Computers. Gimix Inc. (1337 W. 37th Pl., Chicago, IL 60609; Tel: 312-376-0440) has introduced a 16k static RAM board for the SS-50 (SWTPC) bus. Using TMS4044 4k-by-1 bit fully static RAM's, each 4k block is switch addressable at any 4k boundary, while memory write protect and memory disable are controllable in 4k switch-selectable blocks. Special features include each 4k block software programmable to any address at 4k boundaries, and software control of write protect and memory disable. This allows multi-tasking with just one 16k board and a little software overhead; it also permits memory beyond 65k.

New Logic Analyzer. In February 1977, POPULAR ELECTRONICS intro-

duced the first logic analyzer kit for the computer hobbyist. This electronic tool has since become a very popular instrument for debugging hardware and software. However, before the instrument can be used, several independent test leads must be connected to the microprocessor system—not an unusual requirement, but a chore nonetheless. Now, the designers of the original logic analyzer have developed a refined version that eliminates these steps, at least for Altair S-100 bus mainframes. It's called the Model 150 Bus Grabber (\$359 in kit form, \$449 assembled, and available from Paratronics, Inc., 800 Charcot Ave., San Jose, CA 95131; Tel: 408-262-2252).

Paratronics has crammed a complete logic analyzer on a single multilayered pc board that can be directly plugged into this popular bus. Working in conjunction with a hand-held "pod" that contains all the switching, the Bus Grabber monitors 64 signals—56 through the board edge connector, and 8 (user defined) through an 8-lead probe assem-

Paratronics' Bus Grabber is analyzer on a pc board.

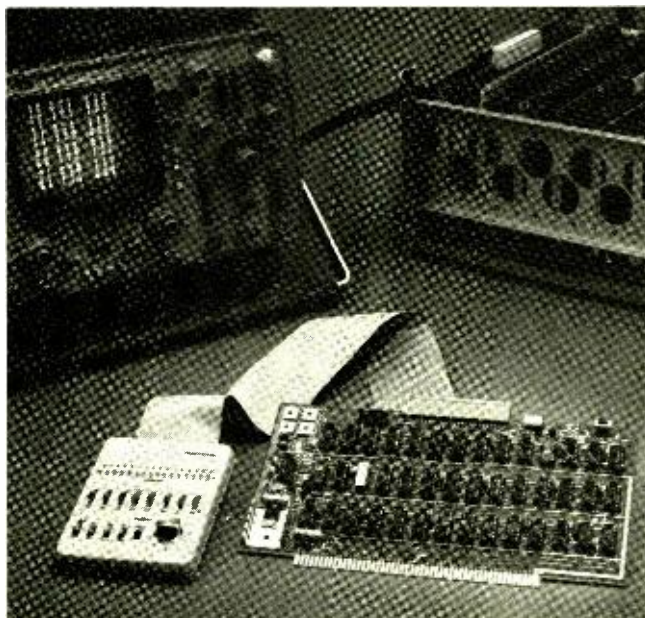

bly. Three connectors couple the board to the scope vertical, horizontal, and intensity inputs.

The display is data domain (1's and 0's truth table); size is 1 byte by 16 words deep; and display can be either octal or hex. Display modes are single or repetitive. Data collection is in either positive or negative time and memory size is 16 bits by 16 words. The trigger word can be 24 bits wide (16 bus address lines and 8 input data lines). The same flexible trigger is also featured, as is the scope trigger for "glitch" analysis. Data is collected at greater than 8 megabytes per second.

The hand-held pod makes operation very simple. Triggering, display formatting, and operational modes of the Model 150 are controlled from this pod, which is ribbon-cable connected to the main board. An 8-position switch on the pod enables looking at the external inputs, MPU control signals, MPU interrupts, MPU status, MPU data bus in, MPU data bus out, and the upper and lower address bytes. With this selection, and a simple program, it is easy to take a look at just about every important signal.

The Bus Grabber takes 700 mA from the -8-volt bus, and 50 mA from the +16-volt bus.

Telephone Interface. If you would like to interface your Altair S-100 bus computer to the Touch-Tone® telephone system, MK Enterprises (8911

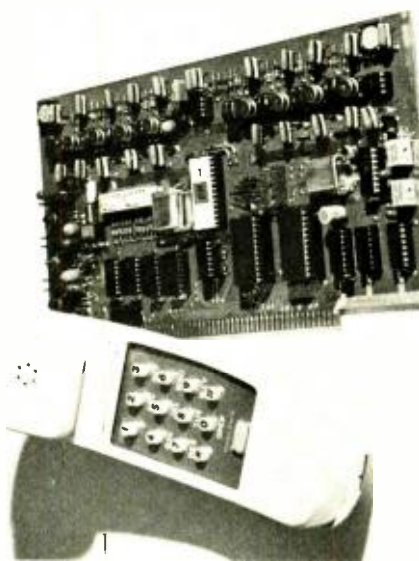

MK Enterprises' MK-II DTMF transceiver board with phone.

Norwick Rd., Richmond, VA 23229; Tel: 804-285-2292) has just the device for the job. Its MK-II dual-tone, multi-frequency (DTMF) transceiver board con-

verts the DTMF (Bell Standard) into binary, and binary into DTMF, making this a fully operational transceiver. The board comes fully assembled and tested with application information and a manual for \$425.

On incoming calls, vectored interrupts allow for ring detection as well as detecting the presence of DTMF signals. This permits phoning into the computer and executing programs by punching the correct tone pad sequence on the remote phone. On outgoing calls, the dialed digits are loaded into a FIFO (first in

first out) buffer at processor speed, then unloading the data into a DTMF tone generator at a rate compatible with the Bell System's equipment. A 4-bit output port allows supervision of trunk interface equipment (DAA devices). Single tones can be generated instead of dual tones (under software control).

Applications of the MK-II include monitoring and tabulation of outgoing phone calls, home security "dialers," and PABX systems. Remote operation of ac appliances is also possible by 60-Hz modulation with DTMF signalling.

Computer Mainframe System

First in the TEI family . . . The MCS-112 and 122 Mainframe Systems.

"The Base on Which to Build"

The cabinet
A heavy duty precision formed cabinet of fine craftsmanship. Completely machined and ready for assembly. The exterior is finished in TEI blue. Vented for most efficient thermal characteristics. Furnished with all necessary hardware.

The motherboard
An S-100 Bus system high quality mother board with 100 pin edge connectors. Compatible with IMSAI, MITS, CROMEMCO, TDL and other S-100 bus configured circuit boards. Plus connectors for reset switch, voltage terminals and screw type to power supply leads. All card guides are provided. 19 slots for MCS-112 model and 22 slots for MCS-122 model.

Edge connectors
High quality edge connectors, factory mounted and wave soldered to eliminate this nuisance for you. Completely checked out for shorts or open traces. All edge connectors furnished, 19 for the MCS-112 and 22 for the MCS-122. No additional expense when you expand your system.

The power supply
One of a kind using a constant voltage transformer (CVT) with a very high immunity to input line noise - greater than 100 db rejection. Line regulation better than - 1% from an input of 95 to 140 volt AC at full load to 85 to 140 volt AC at three quarter load. Designed to meet UL-47B specifications (EDP SPEC). Individual fusing on all input and output voltage lines. See specifications below for power ratings.

The cooling system
A 115 CFM muffin fan with a commercial grade washable filter will provide clean airflow over all circuitry.

The wiring
All wiring is color coded and ALL is exact to length with connecting lugs factory machine applied. Soldering is held to an absolute minimum.

The front panel
The front panel is clean except for an indicating AC switch and a reset switch. However, the chassis and motherboard are designed so that you may remove the front panel and insert an IMSAI or equivalent front panel. Soon to be available will be our "VIRTUAL OPERATING CONSOLE" especially designed to complement our Mainframe Systems.

Specifications

	MCS-112	MCS-122
Dimensions	17 1/4" W x 19" D x 7 1/4" H	17 1/4" W x 19 1/2" D x 7 1/4" H
Power - 8 volt DC	17 amps	30 amps
Power - 16 volt DC	9 amps	4 amps

NOW . . . TEI puts it all together for you. Mainframe systems (6, 12 and 22-slot). Floppy and mini-floppy disc drive systems (single, double and triple with dual density). A Z-80 CPU with addressable "jump to" and autostart capability (also variable speed control). 8K and 16K RAM. 16 Channel A/D and D/A converter. 3 serial + 3 parallel multiple I/O and other supporting boards and our newest item the PROCESSOR TERMINAL - A CRT, keyboard, mini-floppy disc and 12-slot mainframe with a Z-80 CPU - all housed in one quality aluminum case. All of these fine products at prices you will like. **Watch for them all.**

Contact your local TEI dealer or if you are not near one of our dealers, write or call CMC MARKETING CORP direct for more information (DEALER INQUIRIES INVITED)

PLEASE SEND ME

- MCS-112 Kit @ 395.00 MCS-112 Assembled @ 445.00
 MCS-122 Kit @ 495.00 MCS-122 Assembled @ 575.00

Texas residents add 5% Sales Tax

I Enclose Check or Money Order

CMC MARKETING CORP

5601 Brimley, # 515 Houston, TX 77036 Telephone (713) 783-8880

TEI INC.

CIRCLE NO 74 ON FREE INFORMATION CARD

Get A GNOME



For Christmas

Every day more people discover that PAIA's GNOME, the original micro-synthesizer, is the most versatile, cost effective special effects device on the market today.

The Gnome has two envelope generators (one with repeat for cyclic effects), VCA, VCF and VCO. Use along with it's built in ribbon controller or modify to interface to guitar, electronic piano, polytonic keyboards, etc.

Best of all, the Gnome is only \$48.95 in easy to assemble kit form. Is it any wonder why we've sold thousands?

Send the GNOME MICRO-SYNTHESIZER Kit (\$48.95 plus \$2.00 postage)

Send FREE CATALOG



name: _____

address: _____

city: _____ state: _____ zip: _____

BAC/VISA MC card no. _____

cut out & mail to: (405) 843-9626

PAIA DEPT. 12-P
1020 W. WILSHIRE, OKLAHOMA CITY, OK 73116

CIRCLE NO. 44 ON FREE INFORMATION CARD

BUGS TAKE BIG BITE OFF PRICE.

\$16.50. (Save \$2.50)

Rony, Larsen and Titus'
8080 Microprocessor home study course.

When the Bugs bite it saves you bucks. Learn the complete operation of the 8080 Microprocessor for just \$16.50 (A special offer good only until March 1, 1978.) Bugbooks V & VI consist of 900 pages of clearly written text that take you from basic digital electronics to interfacing and programming.

Even better, the Bugs will foot the full \$16.50 if you buy one of our new MMD-1 microprocessors within 90 days. Your dealer will deduct that from your purchase price.

So get your Bug Books now. Enclose \$16.50 for both books

NAME _____

ADDRESS _____

CITY _____

STATE _____ ZIP _____



E&I INSTRUMENTS, INC.
61 First Street, Derby, Conn. 06418
(203) 735-8774 Telex No 96 3536

Enclose check, money order or numbers from BankAmericard or Master Charge. We will ship post paid anywhere in continental U.S.

CIRCLE NO. 76 ON FREE INFORMATION CARD

KIM Doings. If you are a KIM user, or are about to get a KIM, you should also get a copy of the "First Book of KIM" (\$9 from ORB, P.O. Box 311, Argonne, IL 60439). The book is divided into six useful sections, and starts with a viewpoint of the absolute beginner, discussing KIM programming from ground zero. It covers RAM, ROM, hex numbering, program loading and running, and how the KIM works on a step-by-step basis with simple exercises as a learning aid.

The second portion covers 27 games (with full listings) that include some of the better-known BASIC games such as blackjack, lunar lander, and table tennis. A "music box" program that uses the audio output connector of KIM is also included in this portion.

The third section covers 13 utility programs that include Hypertape (allows loading a full 1k in 21 seconds), a directory program, a memory test, a move-data-anywhere program, a KIM phase-locked-loop test, a bubble-sort program, and three useful tape programs: Superdupe, allowing duplication of a tape quickly; Tape Verify, for verification of a just-recorded tape; and Vutape, which lets you see the contents of a KIM format tape as it goes by.

The Expansion section discusses the number of ways that the KIM can be expanded from both hardware and software viewpoints. The Interface section illustrates some low-cost hardware additions.

The last section, called Pot-Pourri, covers guidelines for writing KIM programs, some useful notes on the KIM display, a KIM alphabet for displaying alphanumeric characters, a random-number program, a listing of the many KIM articles and some 6502 software sources. Altogether, a good book for KIM persons.

65K Board. Every computer hobbyist probably needs more memory. There is also no doubt that most hobbyists have been buying peripherals for Altair S100 bus systems. This, of course, brings up the problem of slot space.

The approach used by Extensys Corp. (592 Weddell Dr., S-3, Sunnyvale, CA 94086; Tel: 408-734-1525) to solve both the extra memory and slot space problem is to create a single board that can hold up to 65,536 bytes and has hardware provisions for bank switching to 1 million bytes or more.

The basic RM64-16 Dynamic Memory Board sells for \$595 and comes with 16k of RAM, but it is socketed for all 65k. Also available are the RM-32 for \$895 (32k), the RM-48 for \$1195 (48k), and



Brand New

It's the newest, most exciting magazine in the hobby electronics market. And it covers all the fields you want to read about . . .

Personal Computers, Amateur Radio, Stereo, experimental electronics, CB & Scanners, Short Wave Listening, Radio Control and much more.

We'll show you how to build a robot that'll work for you. We'll show you how to start your car in the cold mornings from inside the comfort of your home. We'll bring you dozens of construction projects in every issue. We'll even show you new ways to program your own computer.

All this and more in modern electronics, the new magazine in electronics that looks really new.

Subscribe today. Special savings for new charter subscribers with the coupon below.

modern electronics

14 VANDERVENTER AVENUE
PORT WASHINGTON, NEW YORK 11050

Regular Sub. Price ~~\$12.00~~

Charter Sub. Price **\$8.95**

Check One: Check Money Order

Master Charge Bank Americard

My account number is:

--	--	--	--	--	--	--	--	--	--	--	--	--	--	--	--	--	--	--	--

Name _____

Address _____

City _____ State _____ Zip _____

the RM-64 for \$1495 (64). If you just want to increase the basic 16k board, then a 16k upgrade kit is available for \$375. Other boards include the MM16 Memory Manager at \$295.

Power requirements are +12 volts at 300 mA, +5 volts at 750 mA, and -5 volts at 1 mA. The memory board has a cycle time of 500 ns and a 400-ns access time.

If you are wondering how you can have 64k of RAM and a few k of ROM with a single 8-bit processor, the new board uses "bank switching" and a special provision that allows for memory overlap. A "Read" may occur from both RAM and ROM, but the bus drivers are inhibited on the RAM board to prevent bus conflict. This allows ROM "Reads" to have precedence over RAM "Reads." From a hardware perspective, it means adding one small lead to the present computer bus. There is also "Write" protection in 16k blocks and board select logic that allows for more than one 64k byte board per system.

TI Programmer. Probably the most widespread digital device used today is the calculator. Available in a variety of types, from the simple "four banger" to complex programmable models, they all have one thing in common—they operate with decimal input and deliver decimal readout.

There is a new guy on the block, designed specifically for computer hardware and software types: the Texas Instruments "TI Programmer" (\$49). The main feature of this unique calculator is that it can perform arithmetic functions in either decimal, octal, or hex with the capability of converting from one base to another at the operation of a single key.

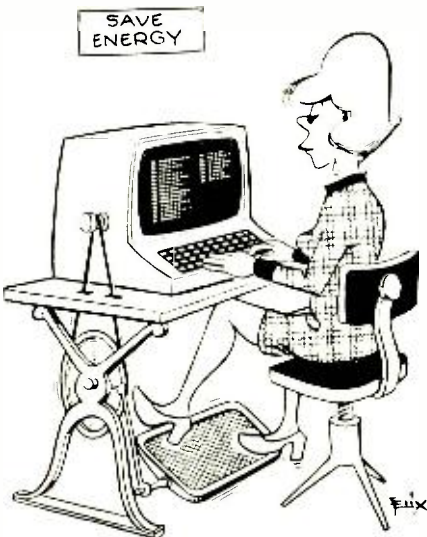

Other features include: signed floating point arithmetic for conventional computations (decimal), a 1's complement key for octal and hex, 15 sets of parentheses at each of the four processing levels, independent memory with summation to memory capability, and ability to perform logic operations such as OR, AND, XOR in octal and hex. A constant mode allows operations with a constant number for all arithmetic and logical operations. A battery saver and automatic turn-off are provided for longer battery life.

Each of the 15 keys used in entering numerical data (to FFFF in hex) is also identified by its binary code printed under each key.

If you do any programming where you have to convert from octal to hex, or vice versa, or you must know the decimal equivalent of an octal/hex number, you really have to take a look at this new low-cost pocket calculator. It is a real time saver. One of our software buddies insists that he can work out quite a bit of his programs with this calculator, enabling him to work away from his computer.

SWTP Firmware. Since the introduction of the SWTPC (Southwest Technical Products Co.) 6800 Computer System, Motorola's MIKBUG has been supplied as the mini-operating system. Although this monitor has proven to be an excellent one, the staff at SWTPC has accumulated a list of additions and modifications to MIKBUG, thereby creating their version called SWTBUG (or Swatbug). Sixteen major subroutines have been positioned with the same entry points as MIKBUG so that most programs which are MIKBUG compatible will also run with the Swatbug, without modification.

The new monitor supports an ACIA MP-S Serial Interface at I/O port-1, as well as a PIA MP-C Control Interface at I/O port 0 or 1. This allows users who have a MP-C Control Interface to use Swatbug without an additional MP-S Serial Interface option. It also permits users who have an MP-S Serial Interface to operate their control terminal from 110 to 9600 baud on the MP-S; an optional MP-C handles the "Kansas City" A -30 Cassette Interface at 300 baud.

The new monitor also generates MP-C Control Interface signals for reader-on, reader-off, punch-on and punch-off. This eliminates terminal control character decoding as used with MIKBUG. The MIKBUG INEEE and OUT-EEE subroutines reside at the same addresses in Swatbug.

Grab your bus...

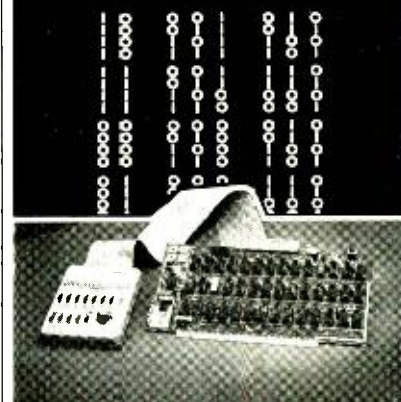

...with our Model 150 S-100 bus Logic Analyzer.

- PLUGS INTO ANY S-100 SLOT
- MONITORS ADDRESS, DATA, STATUS, INTERRUPTS AND CONTROL SIGNALS
- CAN ANALYZE EXTERNAL EQUIPMENT
- OPERATES WITH ANY OSCILLOSCOPE

How does this grab you?

The Model 150 plugs into one slot of an S-100 computer and "grabs" fifty-six major signals. **Fifty-six.** That's more troubleshooting and training visibility than any other logic analyzer can offer you. Need to look at signals external to the bus? No problem. The Model 150 even incorporates a fully-independent 8-channel analyzer identical to the popular Model 100A. (See *Popular Electronics*, Feb. 1977.)

A remote-control plug-in pod provides fingertip control over all triggering, data collection and display functions. So plug the Model 150 into your computer — you may never unplug it again.

Complete kit and manual \$369.00*
 Assembled unit and manual \$449.00*
 Data probes for external analyzer . \$10.95 ppd
 Separate 100-page owner's manual . \$7.95 ppd

*Add \$5.00 for AIR shipping in U.S. \$15.00 foreign.
 Calif. residents please add appropriate sales tax

PT PARATRONICS, INC.
 890 CHARTER AVENUE • SAN JOSE • CALIFORNIA • 95131
 TEL (408) 263-2252

If possible, please use business address in place of home address on reader service card.



Get This Heathkit Catalog



New GD-1110 Pinball Game

The incredible Bally Fireball® pinball game you've been hearing about now in low-cost easy-to-build kit form. One to four players can play this exciting game that's so challenging its impossible to grow tired of. Solid-state electronics and computer technology replace much of the failure-prone electromechanical devices found in other games. The GD-1110 is not a toy but a sophisticated pinball game that will give you years of fun and action. Only \$599.95

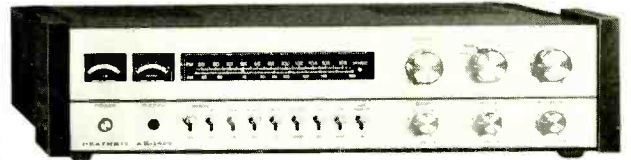

New AR-1429 Stereo Hi-Fi Receiver

This year give symphonies, cool jazz, and the driving beat of rock with this stereo performer from Heath. 35 watts, minimum RMS, per channel into 8 ohms with less than 0.1% total harmonic distortion from 20-20,000 Hz. The AR-1429 is perfect for the budget conscious stereo buff who requires a high quality system. It has all the features of a high-priced receiver and the performance too. Phono hum and noise are -65 dB. FM sensitivity is 1.8 μV. Provision for optional Dolby® FM module. Only \$319.95

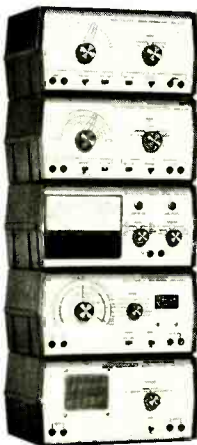

New 5280 Series Test Instruments

Here are five new starter instruments intended for (but not limited to) the beginner. You'll be surprised at the features and performance these new instruments have. There's the IG-5280 RF Oscillator with 320 kHz to 220 MHz frequency range, the IM-5284 high performance multimeter that reads volts, ohms and DC current, the IT-5283 Signal Tracer for RF, AF and logic tracing, the IB-5281 RCL Bridge for design and experimentation and the IG-5282 Audio Oscillator with a 10 Hz to 100 kHz frequency range. And to power the 5280 series, you can build the IPA-5280-1 power supply. Only \$37.95 each



New GD-1186 Digital Electronic Scale

Unique and functional truly describe the new Digi-Scale electronic "weighing machine". Big, bright LED's show your weight with more precision than normal scales and there are no springs or weights to compromise performance. The digital readout may be mounted on the wall or just about anywhere. Only \$99.95

New CS-1048 Cruise Control

You'll appreciate the CS-1048 every time you take a long trip in your car. Just preset your cruise speed and the CS-1048 does the rest electronically. Maintains your car's speed, can help improve mileage too. Only \$79.95

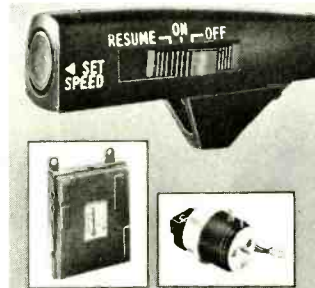

New TO-1860 Heath/Thomas Organ

Microprocessor-based organ has nine preassembled and tested circuit boards for really easy assembly! Color-coded keys and coordinated music make learning to play a breeze. Single-finger chords, automatic rhythms and 17 different instrument voices add real versatility. Only \$1749.95



Read more about these and nearly 400 other unique and exciting kit products—all in the big, new 104-page Heathkit Catalog.

of Top-Value Electronics!



New GC-1107 Digital Alarm Clock

A perfect kit for the first time kitbuilder. This super-accurate timepiece has an attractive blue four-digit display that dims automatically according to ambient light. It also has the features you need in a clock; 24-hour "smart" alarm, snooze switch, alarm-on indicator and power failure indicator. Only \$27.95

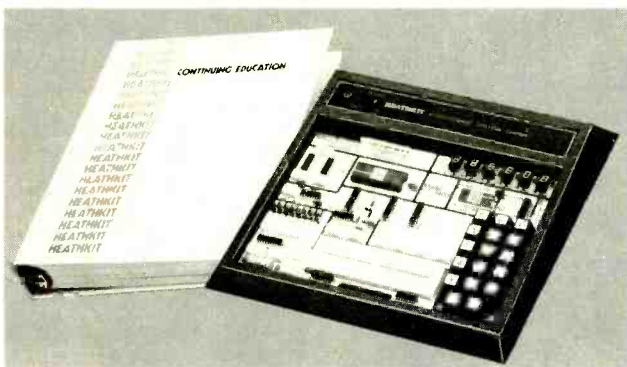

New Microprocessor Self-Instruction Course

Our EE-3401 Microprocessor Course (\$89.95) is your key to learning about microprocessors. Features Heath's famous individualized learning techniques to provide you with a thorough background in microprocessor operation, interfacing and programming. Accompanying software and hardware experiments provide "hands-on" experience with the companion ET-3400 6800 Microprocessor-based trainer (\$189.95).



New Heathkit Personal Computers

For the ultimate gift, there's a Heath Computer System. Destined to be the industry leaders, Heathkit computer products are the total system designs that excell in home, hobby, business and educational applications. Powerful software gets them up and running fast. Superior software, documentation and service support keep them that way.

- 1 H8 8080 8-Bit Digital Computer Kit
- 2 H11 LSI-11 16-Bit Digital Computer Kit
- 3 H9 Video Terminal Kit
- 4 H10 Paper Tape Reader/Punch Kit
- 5 LA36 DEC Writer II (Assembled)

Prices are mail-order net F.O.B. Benton Harbor, Michigan. Prices and specifications subject to change without notice.

FREE!

HEATHKIT CATALOG

Send today for the world's largest selection of top-value electronic kits!

Nearly 400 fantastic kits you can build. Electronic kits for everyone. Stereo hi-fi, television, amateur radio, auto accessories and much, much more.



Heath Company, Dept. 010-360

DECEMBER 1977

HEATH Schlumberger	Heath Company, Dept. 010-360 Benton Harbor, Michigan 49022
Please send me my FREE Heathkit Catalog. I am not on your mailing list.	
Name _____	
Address _____	
City _____	State _____
Zip _____	
GX-339	

CIRCLE NO. 5 ON FREE INFORMATION CARD

PROFESSIONAL DISCOUNTS

Texas Instruments electronic calculator

TI-1750 LCD	\$19.35	SR-40	\$23.25
TI-2550 III	23.25	SR-52 II	47.05
Little Prof.	12.55	TI-57 NEW	63.00
Dataman NEW	19.95	TI-58 NEW	95.79
TI-5100	38.75	TI-59 NEW	219.95
TI-5015 NEW	63.00	PC-100A	147.00
TI-5050M	77.55	MBA	66.95
TI-5040PD	95.00	Money Mgr	16.96
TI-305P	16.98	Bus Analyst	27.40
Dataclip	28.09	All Libraries Available	



HEWLETT PACKARD

We are franchised H-P dealer All accessories at discount

HP-10 NEW	\$139.00	HP-27	\$140.00
HP-19C NEW	275.00	HP-29C NEW	156.00
HP-21	64.00	HP-80	235.00
HP-22	100.00	HP-67	360.00
HP-25	100.00	HP-91	260.00
HP-25C	128.00	HP-92 NEW	500.00
		HP-97	599.00

Also SCM Olivetti National Semiconductor Casio Canon Corvus APF Sharp Craig Sanyo Record-A-Call and more All at great prices!

FAIRCHILD

Programmable Video Game (2000 games possible) Cartridges 17.95
Also Fairchild Watches

WE WILL BEAT OR MEET ANY COMPETITOR'S PRICE IF HE HAS MERCHANDISE ON HAND. All units shipped in original factory cartons with accessories according to manufacturers' specifications. In Calif call (213) 370-5795 or CALL (800) 421-0367 (other than CA). Above prices are for cash only. Credit card prices differ. BankAmericard/Visa & Master Charge accepted. Send money order. Pers. ck (2 wks to clear). In CA add 6% sales tax. Add \$3.50 min. shipping charges. WE SHIP AIR on request. Subject to availability. Send mail orders to DEPT WRITE OR CALL FOR FREE CATALOG PE-L

WILSHIRE - 2 STORES - HAWTHORNE CALL

16611 Hawthorne Blvd., Lawndale, Ca 90260
(213) 370-5795 (800) 421-0367

CIRCLE NO. 61 ON FREE INFORMATION CARD

SAVE!

MONEY • TIME • FREIGHT

QUALITY STEREO EQUIPMENT AT LOWEST PRICES.

YOUR REQUEST FOR QUOTATION RETURNED SAME DAY. FACTORY SEALED CARTONS—GUARANTEED AND INSURED.

SAVE ON NAME BRANDS LIKE:

PIONEER	SANSUI
KENWOOD	DYNACO
SHURE	SONY
MARANTZ	KOSS

AND MORE THAN 50 OTHERS
BUY THE MODERN WAY
BY MAIL - FROM

illinois audio

12 East Delaware
Chicago, Illinois 60611
312-664-0020

CIRCLE NO. 24 ON FREE INFORMATION CARD

COMPUTER BITS

(continued from page 121)

Swatbug also makes it possible for the user to set single-level breakpoints within user programming for debugging purposes. Furthermore, the monitor generates a "home" and "erase" command for the SWTP CT-1024. It also erases each CT-1024 line before writing a new one and vectors all software interrupt instruction to a location pointed to by a user-defined address located in scratchpad RAM. Moreover, Swatbug boots in the new SWRPC MF-68 Mini-floppy Disk by typing in a single character (D).

Other Swatbug commands include cassette or paper tape dumps and appends the now-famous "S9" to the end of the tape, and outputs all of the record/punch (on/off control commands as well).

All SWTPC 6800 Computer Systems with MIKBUG can use the SWTBUG by replacing the socketed MIKBUG with the new chip and making one minor change on the board. The SWTBUG sells for \$19.95 pp.

Video Monitors. If you are thinking about modifying a TV receiver for use as a monitor for your computing system, you should be aware that VAMP, Inc. (P.O. Box 29315, Hollywood, CA 90029) is making available its ADV-1 at \$23.95. This is a universal conversion kit for either transformer-powered receivers or "hot" chassis types. According to VAMP, the kit can be used with any TV receiver. When installed, it provides the necessary isolation to ensure safety and protect the video source. It is said to produce up to 80 characters per line. The kit bypasses the tuner and i-f strip, and a bypass switch is provided for normal TV viewing.

VAMP also offers its RFVM-1 at \$8.95 for installation in the video source. It can be tuned from channel 2 to channel 6.

COSMAC Elf News. A Canadian electronics supplier, Tektron Equipment Corp. (Caistor Centre, Ontario, Canada LOR 1E0) has started a newsletter directed to some 300 1802-MPU-based computer owners in the area. They're trying to form a microprocessor club which will be heavily oriented toward the 1802 MPU's. Domestically, an Elf Users Group is being formed for all 1802 fans by Netronics Inc. (333 Litchfield Rd., New Milford, CT 06776). An exchange of hardware and software ideas is planned for the groups. ◇

Use a Broadcast Quality Pre-Amplifier to Upgrade and/or Improve your Hi-Fi System.

Convert your system from ceramic to magnetic cartridge with Pickering's preamplifier. If you have an economy compact or magnetic system, you'll appreciate this easy, low cost method for getting so much more out of it. Use it to help get real hi fi from the component you own.

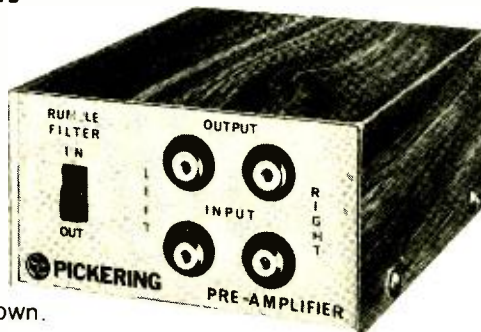

SPECIFICATIONS FOR THE PP-1 PREAMPLIFIER

Input Impedance:	47,000 ohms	Signal to Noise Ratio:	60 dB Min.
Gain @ 1 kHz:	38 dB	Crosstalk:	Better than 60 dB
Frequency Response RIAA:	30-15000 Hz: ±2 dB	Rumble Filter:	Attenuates rumble frequencies a minimum of 15 dB

AUDIOPHILE NET
\$29⁹⁵

STEREO CONVERSION KIT (PP1/V15 AT-2) consists of the Pre-Amplifier and Pickering's V-15 AT-2 cartridge (which is listed at \$24.95). Total Value \$54.90 for only \$39.95.

 PICKERING

"for those who can hear the difference"

For further information write Pickering & Co., Inc. Dept. PE, 101 Sunnyside Blvd., Plainview, N.Y. 11803



Electronics Library

ADVANCED AND EXTRA CLASS AMATEUR LICENSE Q&A MANUAL

by Marvin Tepper

Based on the FCC syllabus-type study guides, this book covers the material appearing on the Advanced and Extra Class theory exams. Within the chapters dealing with each exam, the questions are arranged in such categories as Rules and Regulations, Radio Phenomena, Operating Procedures, Emission Characteristics, Electrical Principles, Practical Circuits, Circuit Components, Antennas and Transmission Lines, and Radio Communication Practices. Other chapters deal with general information and Morse code requirements. Three appendices include practice examinations and answers, excerpts from the Communications Act of 1934 and Part 97 of the FCC Rules and Regulations, and Docket No. 20282 (Proposed Restructuring of the Amateur Radio Service). Published by the Hayden Book Co., Inc., 50 Essex Street, Rochelle Park, NJ 07662. 160 pages. \$5.95 soft cover.

99 WAYS TO IMPROVE YOUR CB RADIO (SECOND EDITION)

by Len Buckwalter

Helpful hints for the CB'er are presented in this book. Section One covers antennas—installation, maintenance, reconditioning, adjustment, and antenna gain. Section Two covers interference suppression, and the following two sections discuss general maintenance and station accessories. Operational techniques and aids are presented in Section Five. The final section contains additional information on activities and programs of interest to the CB'er.

Published by Howard W. Sams & Co., 4300 W. 62nd St., Indianapolis, IN 46206. 128 pages. \$3.95, soft cover.

GETTING INVOLVED WITH YOUR OWN COMPUTER

by Leslie Solomon and Stanley Veit

Here is a solid, well-rounded introduction to home computer fundamentals for the neophyte. There are clear, concise explanations of computer anatomy, kit-building basics, and computer peripherals and I/O devices. Most of the major home computer systems are described in sufficient depth to help the beginner narrow down his search for a system. There is a chapter covering sources of more

(Continued on page 153)

FREE

McIntosh CATALOG and FM DIRECTORY

Get all the newest and latest information on the new McIntosh Solid State equipment in the McIntosh catalog. In addition you will receive an FM station directory that covers all of North America.



MX 113

FM/FM STEREO - AM TUNER AND PREAMPLIFIER

SEND TODAY!

McIntosh Laboratory, Inc.
East Side Station P.O. Box 96
Binghamton, N.Y. 13904
Dept. PE

NAME _____
ADDRESS _____
CITY _____ STATE _____ ZIP _____

If you are in a hurry for your catalog please send the coupon to McIntosh.
For non rush service send the *Reader Service Card* to the magazine.

CIRCLE NO. 30 ON FREE INFORMATION CARD

HOBBYISTS! ENGINEERS! TECHNICIANS! STUDENTS!

Write and run machine language programs at home, display video graphics on your TV set and design microprocessor circuits — the very first night — even if you've never used a computer before!

RCA COSMAC microprocessor/mini-computer



A THOUGHTFUL GIFT FOR ANYONE WHO MUST STAY UP TO DATE IN COMPUTERS AND ELECTRONICS!

ELF II \$99⁹⁵

SPECIFICATIONS

ELF II features an RCA COSMAC COS MOS 8-bit microprocessor addressable to 64k bytes with DMA, interrupt, 16 registers, ALU, 256 byte RAM, full hex keyboard, two digit hex output display, 5 slot plug-in expansion bus, stable crystal clock for timing purposes and a double-sided plated-through PC board plus RCA 1861 video IC to display any segment of memory on a video monitor or TV screen.

USE ELF II FOR ...

GAMES
Play interactive keyboard games, games with analog inputs, games utilizing your TV set for a video display!

GRAPHICS
Create pictures, designs, alpha-numerics and fabulous animated effects on your TV screen for hour after hour of family fun!

CIRCUIT DESIGN
Design circuits using a microprocessor. Use ELF II as a counter, alarm system, lock, controller, thermostat, timer, telephone dialer, etc. The possibilities are infinite!

Coming Soon!
Exclusive Netronics Plug-In Program Debugger and monitor allows visual display of any program on a clock pulse by clock pulse basis to help you learn programming f-a-s-t! • 4k memory • Cassette I/O • D to A, A to D • Controller plug-ins.

SEND TODAY

NETRONICS R&D LTD., Dept. PE-12, 333 Litchfield Road, New Milford, CT 06776 Phone (203) 354-9375

Yes! I want to run programs at home and have enclosed: \$99.95 plus \$3 p&h for RCA COSMAC ELF II kit. **Featured in POPULAR ELECTRONICS.** Includes all components plus everything you need to write and run machine language programs plus the new Pixie chip that lets you display video graphics on your TV screen. Designed to give engineers practice in computer programming and microprocessor circuit design. ELF II is also perfect for college and college-bound students (who must understand computers for any engineering, scientific or business career). Easy instructions get you started right away, even if you've never used a computer before!

As your need for computing power grows, five card expansion bus (less connectors) allows memory expansion, program debugger/monitor, cassette I/O, A to D and D to A converters, PROM, ASCII keyboard inputs, controllers, etc. (soon to be available as kits). Manual includes instructions for assembly, testing, programming, video graphics and games plus how you can get ELF II User's Club bulletins. Kit can be assembled in a single evening and you'll still have time to run programs, including games, video graphics, controllers, etc., before going to bed! \$4.95 for 1.5 amp 6.3 VAC power supply, required for ELF II kit. \$5.00 for RCA 1802 User's Manual.

I want mine wired and tested with the power transformer and RCA 1802 User's Manual for \$149.95 plus \$3 p&h. Conn. res. add sales tax.

NAME _____
ADDRESS _____
CITY _____
STATE _____ ZIP _____

Send info on other kits!
Dealer Inquiries Invited

BACK ISSUES AVAILABLE...



If you've missed any of the previously published issues of Popular Electronics Magazine a wide selection is still available. Copies may be ordered for issues published during the past 36 months. In the event a particular issue ordered is out of print your payment will be returned promptly.

Place your order by mailing \$1.75 for each copy (\$2.25 outside U.S.A.) to Popular Electronics, Consumer Service Division, 595 Broadway, New York, N.Y. 10012. Prices include postage and handling charges.

Please be sure to enclose payment and identify the specific issues you wish to receive.

Operation Assist

If you need information on outdated or rare equipment—a schematic, parts list, etc.—another reader might be able to assist. Simply send a postcard to Operation Assist: POPULAR ELECTRONICS, 1 Park Ave., New York, NY 10016. For those who can help readers, please respond directly to them. They'll appreciate it! (Only those items regarding equipment not available from normal sources are published.)

Knight Kit Star Roamer. Schematic and alignment data. Zenen Martin, 4022 Bell Ave., Bronx, NY 10466.

CRT Tube. Need source of one CP1. Curtis A. Cook, 6507 Washington, Des Moines, IA 50322.

Scott Model LK-48-B stereo amplifier and Bell & Howell Model "C" Design-138 movie projector. Schematics and/or instruction manuals. D. Buechner, 302 Roanoke, Warrenton, MO 63383.

Eico Model 425 oscilloscope. Need owner's manual and schematic. Dave Siever, 10915-141-St., Edmonton, Alberta, Canada T5M 1T3.

John Meck Industries Model RC-5B5 Trail Blazer AM receiver. Schematic and power requirements. Ron McCay, 1200 N. Park Ln. #4, Altus, OK 73521.

Heath Model HW32 20-band transceiver. Manual and schematic. Dom Sagolla, 141 N. Eagle Rd., Havertown, PA 19083.

National Model MC-33. Schematic and service manual. William H. Bragg, 1424 College, Des Moines, IA, 50314.

C.M. Laboratories Model 911 power amplifier. Schematic needed. Kenneth G. Larson, 4070 Rupley Place, Riverside, CA 92505.

Power Mate Corp. Model BP-34D power supply. Schematic needed. D.I. Johnson, Box 171, Sherborn, MA 01770.

Precision Series EV-20 VTVM. Operation manual and/or schematic. A.J. Melito, 3021 Garland St., Erie, PA 16506.

National Model NC-2-40D. Schematic needed. K.P. Mitchell, Route 1, McLeansboro, IL 62859.

Zenith Model L600 trans-oceanic radio. Schematic and maintenance information. John Hay, Route 2, Box 55, Exchange, WV 26619.

Howard Model 518 shortwave radio. Need schematic. Tom Knight, 1309 Hobbs Dr., Alpena, MI 49707.

Hallicrafters Model S-38C receiver. Schematics and service manual. W.H. Barkemeter, 1945 C.G. OL-F, Box 153, APO, NY 09053.

Toshiba Model SA-20Y stereo receiver. Schematic needed. Edward Wirth, Jr., 3123 West Galena St., Milwaukee, WI 53208.

Knight Model KN 2590 citizens band radio. Need any available information and/or operation manual. Leonard Pezderic, RR 2, Box 109, Mason, WI 54856.

U.S. Navy Model RAK-7 WWII vhf receiver. Need manual. J.G. Rowland, 64 Ridge Ave., Rark Ridge, NJ 07656.

JWD Model 100 PA amplifier. Need schematic. R.D. Cornell, Box 202, Glennville, GA 30427.

Metz Model 1512M AM/FM/SW receiver. Any available information. P. Boychuck, 205 S. Olds Blvd., Fairless Hills, PA.

U.S. Army Signal Corps BC-794B. 1304-CHC, 9092-PHILA-44 radio receiver. Need operation manual and schematic, also type and source of crystal used. T. Remington, 19851 E. Comstock Rd., Linden, CA 95236.

U.S. Air Force Model ARC-33 (RT-173 or DY-63) uht transceiver. Schematics and/or operation manual. David McFalls, 626 Seminole Dr., Kernah, TX 77565.

OS-34 USM 32 oscilloscope. Wiring diagram or manual needed. S. Bostwick, 2015 Virginia Ave., McLean, VA 22101.

Nova-Tech Model RDF-404 Pilot II direction finder. Need (Continued on page 146)



Includes Functional Tilt Stand!

NEW EICO 270 3 1/2 DIGIT DMM KIT ONLY \$79.95

Introductory Offer—FREE AC ADAPTOR

The first and only lab accuracy portable DMM Kit featuring MOS/LSI IC economy and reliability. Measures DC/AC Volts, Kilohms, DC/AC milliamps in 21 ranges. Polarity indicators and overload protection are provided, and 0.5 inch LED displays give easiest-to-read digital readout to 9999. The 270 features a basic 0.5% DC accuracy, 10 Megohm input impedance, low voltage drop in all current ranges and automatically-flashing overrange indicator. **Assembled \$109.95**

FREE '78 EICO CATALOG

Check reader service card or send 75¢ for first class mail. See your local EICO Dealer or call (516) 681-9300, 9:00 a.m.-5:00 p.m. EST. Major credit cards accepted.

EICO—108 New South Rd. Hicksville, N.Y. 11802



DAVIS ELECTRONICS

NEW! Mini Counter

60 MHz
600 MHz
(with optional prescaler)

General Purpose Low Cost Counter Without the Sacrifice of Basic Performance

"Check the features we have that some other low cost counters don't have."



- All Metal Cabinet
- Crystal Time Base
- Completely Auto Decimal Point
- 8 Digit 4" LED Display
- 115V or 12V Operation
- Selectable Gate Times (1 sec & .1 sec)
- Input Cable Included
- Push Button Controls
- State of the Art LSI Circuitry
- 12V Input Jack
- Gate Light
- Sensitivity < 10 MV

7208 60 MHz Kit \$119.95 Assembled 169.95

7208A 600 MHz Kit .. \$149.95 Assembled 199.95

ORDER NOW
Call Toll Free
1-800-828-7422



DAVIS ELECTRONICS 636 Sheridan Dr., Tonawanda, NY 14150 716/874-5848

CIRCLE NO. 75 ON FREE INFORMATION CARD

Bearcat 210 Scanner

\$289.



The Bearcat 210 super synthesized receiver scans and searches over 16,000 different frequencies without expensive crystals. The Bearcat 210 covers 32-50, 146-174 & 416-512 Mhz., and has AC/DC operation. Save over \$60.00 now by ordering on our 24 hour toll-free credit card order line 800-521-4414. In Michigan and outside the U.S. call 313-994-4441. Add \$5.00 for shipping in the U.S. or \$9.00 for air UPS to the west coast. Charge cards or money orders only. Foreign orders invited.

COMMUNICATIONS ELECTRONICS
P.O. BOX 1002 DEPT. 603
ANN ARBOR, MICHIGAN 48106



IN A CONFLICT OVER

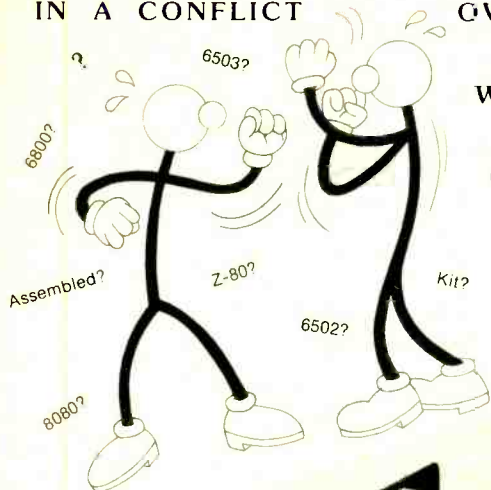

WHICH
COMPUTER
TO
BUY?

MS MINI SAYS

"HAVE WE GOT A DEAL FOR YOU!"



"Compared to our MINI 12 (TM) most of today's personal computers are slow, expensive and not nearly so easy to buy!"

Since MINI 12 is software compatible with the DEC PDP-8 it can offer you the largest range of software available on any personal computer today.

MINI 12's advanced operating system includes... file handling text editor, symbolic assembler, loaders, ODT (octal debugging technique) batch processor and system utilities.



Software supplied (depending on Hardware configuration purchased) is:

Extended Basic - using the most sophisticated compiler available for a small computer.

FORTRAN - the most popular and powerful scientific language.

FOCAL - the popular, easy to use (and learn) conversational language.

ALGOL - with an extremely efficient one pass compiler that supports the full ALGOL - 60 syntax.

Standard features are:

8K words of memory easily expandable to 32K, programmable real time clock.

24 line digital I/O interface, serial interface, buffered external bus, full front panel, binary loader and monitor bootstrap in ROM... AND IT'S FULLY

ASSEMBLED...TESTED...AND READY TO PLUG IN WHEN YOU GET IT!

STEP 2

When your MINI 12 is ready to be shipped you send us \$200 or pay postman COD.

STEP 3

The balance of \$500 is paid in 4 equal monthly installments of \$125 each.

You can use your BAC, VISA, Master Charge or American Express too!

WHAT COULD BE SIMPLER?

And your wife will be happy too! In fact she might just buy it herself (for you of course) for Christmas

I WANT IT!

BUT HOW'M I GO'NA PAY FOR IT?

TLF offers 3 purchase plans:

- 1) CASH with order - and receive a BONUS CERTIFICATE worth \$100 on selected MINI 12 accessories.
- 2) Send \$350 with order and pay balance of \$545 when ready to ship or COD to postman.
- 3) NO INTEREST EASY PAYMENT PLAN

HERE'S HOW IT WORKS:

STEP 1

Fill in coupon

and mail TODAY

with your check for

\$195 to

Make all cheques payable to TLF Corporation.

TLF
P.O. Box 2298
Littleton
Colorado 80161

DEC, PDP and FOCAL are Registered Trademarks of Digital Equipment Corporation, Maynard, MA

© TLF 1977

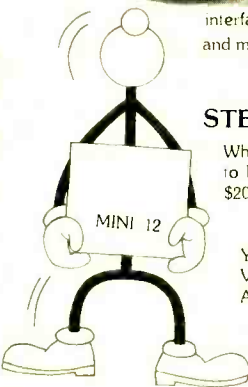

Please enter my order for MINI 12 Computers @ \$895 each as per the plan checked below:

- 1 Enclosed is \$895 - I want the Bonus certificate. Send more information please.
- 2 Enclosed is \$350 - I will pay \$545 when you're ready to ship or COD when delivered.
- 3 Enclosed is \$195 - I will pay \$200 when you're ready to ship and 4 monthly payments of \$125 ea.

Check Money Order BAC/VISA Master Charge American Express

Card # _____ Interbank # _____ Exp Date _____

Signature _____

Name _____ Phone _____

Address _____

City _____ State _____ Zip _____

TLF Corporation P.O. Box 2298 Littleton Colorado 80161
Telephone 303 922 6241 Telex 454541

INDEX

VOLUMES 11 AND 12 JANUARY TO DECEMBER 1977

AUDIO

	Mo./Pg.
Audio Amplifiers, Classes of (Feldman).....	Mar. 74
Audio Analyzer, 1/2-Octave Real Time, Part 1 (Jones & Marsh).....	Sept. 47
Audio Analyzer, 1/2-Octave Real Time, Part 2 (Jones & Marsh).....	Oct. 66
Audio Comander, Build An (Roberts).....	Nov. 43
Basics of Buying Hi-Fi Components, The.....	Sept. 57
Cassette Tape, Selecting the Best for your Recording Needs (Stark).....	Nov. 47
Creative Recording with 4-Channel Tape Recorders (Feldman).....	June 73
Dynamic Crosstalk (Hirsch).....	Nov. 32
Dynamic Noise Reduction Systems and Expanders (Gordon).....	Sept. 60
Eicaset has Arrived, The (Hirsch).....	Oct. 32
FM Tuner Selectivity Ratings and Measurement (Hirsch).....	April 28
Handy Circuit for Checking Phono Preamps and FM Tuners (Freeman).....	Jan. 71
Hi-Fi/TV Audio-Minder, Build the (Kobylarz).....	Apr. 41
How FM Tuners Work! (Hirsch).....	Dec. 48
How Headphones are Tested (Hirsch).....	May 26
IC Multiplex Decoder Improves Stereo FM Performance (Meyer).....	Sept. 67
Infrared Systems for Wireless Stereo (Makosinski).....	Oct. 70
Is There a Digital FM Tuner? (Hirsch).....	Aug. 29
Low-Distortion Low Cost Audio Generator, Build a (Lang).....	Jan. 59
Match Hi-Fi Components, How to.....	May 66
Matching Tapes to Recorders (Feldman).....	Sept. 63
Measuring and Interpreting Turntable Rumble (Hirsch).....	Mar. 24
Multi-Way Speaker Systems, Pros and Cons of (Hirsch).....	Sept. 22
Noise Filtering for Hi-Fi (Hirsch).....	July 32
Pink Noise Generator for Audio Testing, Build a (Bohn).....	July 66
Portable and Mobile Tape Recorders, Choosing (Horstman).....	Aug. 43
Quiz of Audio Basics (Balin).....	Sept. 71
Speaker System Measurements - Is Phase Response Important? (Hirsch).....	June 24
Tape Recorder Headroom Explained (Hirsch).....	Feb. 23
Tape Recorder Hygiene (Stark).....	July 56
What Next in High Fidelity (Hirsch).....	Dec. 23

COMMUNICATIONS

40-MHZ Frequency Counter Project, A (Green).....	June 64
CB Frequency-Generation Methods, Pros and Cons of (Scherer).....	Mar. 46
CB Rules Changes for 1977.....	Mar. 45
Digital Frequency Readout for Shortwave Receivers (Mattis).....	Feb. 49
DX Radio from Outer Space, How to (Hauser).....	Apr. 37
End That "Utility Futility" (Helms).....	July 53
English-Language Shortwave Broadcasts (Wood) Mar. & Apr. 1977.....	Mar. 103
May-Aug. 1977.....	May 101
Sept. & Oct. 1977.....	Sept. 114
Nov. 1977-Feb. 1978.....	Nov. 94
Foreign DX on the Broadcast Band, Chasing (Helms).....	June 78
How External Speakers Can Improve Mobile CB Performance (Davis).....	Mar. 54
Legal In-Flight Airline Receiver, Build a (Lewart).....	May 61
Morse Code Automatic Readout on a TV Screen (Steber).....	May 64
New Band for "Kiddie-Talkies" (Sands).....	Aug. 46
NOAA Weather Radio Operating Locations.....	Feb. 92
Performance Capabilities of 40-Channel CB Transceivers (Scherer).....	June 47
Piracy on the Airwaves (Helms).....	Nov. 56
"Read" Dit's and Dah's with the Morse-A-Letter (Reyer & Steber).....	Jan. 37
Silencer, Build a (Miles).....	Mar. 57
SWR-Facts and Fallacies (Frye).....	Jan. 75
SWR Meter for Low-Power Communications Equipment, High Sensitivity (Vancura).....	Oct. 59

	Mo./Pg.
Will Sunspots Affect CB Communications? (Leinwoll).....	Mar. 51

COMPUTERS

Computer Buying, Basic Guide to.....	Dec. 57
Computers Detect and Correct Transmission Errors, How (May).....	June 70
Computer Remote Control, Part 1, Using Existing House Wiring for (Sokol, Muhonen, Miller).....	Dec. 60
Computer Stores: A New Retailing Phenomenon (Wantz).....	Dec. 70
Cosmac "Elf" Microcomputer, Part III (Weisbecker).....	Mar. 63
Cosmac "Elf", Part IV (Weisbecker).....	July 41
D/A and A/D Converters, the How's and Why's of (Pascoe).....	Apr. 53
Debounce Low-Cost Keyboards, How to Fully (Tenny).....	Jan. 51
Digital Logic Analyzer, Low-Cost (Muething, Spector, Wong).....	Feb. 40
Electronic "Bell" for a TVT-II (Deutsch).....	July 46
First West Coast Computer Faire (Munnecke).....	Sept. 74
HEX-to-ASCII Converter for Your TVT-6 (Lancaster).....	Oct. 49
Hobbyist Computer Club Directory.....	Apr. 97
Hobbyist Computer Club Directory (Additions).....	July 91
Introducing Speechlab-The First Hobbyist Vocal Interface for a Computer (Enea & Reykjalinn).....	May 43
Microprocessors, How to Interface (Tenny).....	Dec. 66
Pixie Animation Program (Deveaux).....	July 42
Teletypewriter Fundamentals for Hams, Swi'lers & Computer Hobbyists (Kahaner).....	Oct. 43
TVT-6: Part I, A Low-Cost Direct Video Display, Build the (Lancaster).....	July 47
TVT-6: Part II, Build the (Lancaster).....	Aug. 49
Wire-Wrapping Techniques for Computer Hobbyists (Mangieri).....	Dec. 74

CONSTRUCTION

10-Hz to 1-MHz Eput Meter, Build A (Hollabaugh).....	Mar. 68
Out of Tune Correction.....	June 6
40-MHZ Frequency Counter Project, A (Green).....	June 64
Accurate Milliammeters on a Budget (Corbin).....	June 67
Audio Analyzer, 1/2-Octave Real Time, Part 1 (Jones & Marsh).....	Sept. 47
Audio Analyzer, 1/2-Octave Real Time, Part 2 (Jones & Marsh).....	Oct. 66
Audio Comander, Build an (Roberts).....	Nov. 43
"Cabonga", Part 1, Build (Barbarelo).....	Aug. 39
"Cabonga", Part 2, Build (Barbarelo).....	Sept. 76
Out of Tune Correction.....	Nov. 12
Computer Remote Control, Part 1, Using Existing House Wiring for (Sokol, Muhonen, Miller).....	Dec. 60
Conference Talk Timer (Schopp).....	Feb. 62
Out of Tune Correction.....	Apr. 6
Cosmac "Elf" Microcomputer, Part III (Weisbecker).....	Mar. 63
Cosmac "Elf", Part IV (Weisbecker).....	July 41
Debounce Low-Cost Keyboards, How to Fully (Tenny).....	Jan. 51
Digital Bicycle-Speedometer, Build a (Randig).....	Mar. 39
Out of Tune Correction.....	July 7
Digital Camera Shutter Timer, Build a (Hedin).....	Aug. 59
Out of Tune Correction.....	Nov. 12
Out of Tune Correction.....	Dec. 6
Digital Capacitance Meter (Fox).....	Apr. 50
Out of Tune Correction.....	Sept. 6
Digital Frequency Readout for Shortwave Receivers (Mattis).....	Feb. 49
Digital IC Tester, Build a (Stitt).....	June 53
Diode Tester, One-Touch (Markegard).....	July 75
Electronic "Bell" for a TVT-II (Deutsch).....	July 46
Electronic Races, To the (Barbarelo).....	Dec. 52
Field Disturbance Sensor for Security, Build a (Powell).....	Nov. 60

	Mo./Pg.
Fluorescent Utility Lamp, Build a (Dunçan).....	Oct. 53
Foil Car Thieves with "Digistart" (Fortuna).....	Apr. 48
Out of Tune Correction.....	July 7
"Four Banger" for Stopwatch Functions, How to Convert a (Stanford).....	Aug. 56
Out of Tune Correction.....	Oct. 14
Out of Tune Correction.....	Dec. 6
Handy Circuit for Checking Phono Preamps and FM Tuners (Freeman).....	Jan. 71
HEX-to-ASCII Converter for Your TVT-6 (Lancaster).....	Oct. 49
Hi-Fi/TV Audio-Minder, Build the (Kobylarz).....	Apr. 41
HP-25 as a Digital Clock & Timer, The (Peters).....	Aug. 57
IC Multiplex Decoder Improves Stereo FM Performance (Meyer).....	Sept. 67
Introducing Speechlab-The First Hobbyist Vocal Interface for a Computer (Enea & Reykjalinn).....	May 43
LED Target Game, Build the (Russell).....	June 50
Legal In-Flight Airline Receiver, Build a (Lewart).....	May 61
"Light Genie", Build the (Graden).....	Apr. 57
Low-Distortion Low-Cost Audio Generator, Build a.....	Jan. 59
Making Digital Electronic Clocks Immune to AC Flicker (Fraser).....	Nov. 58
Model Railroad Sound Synthesizer (Wright).....	Dec. 80
More on Using Calculators as Stoplocks (Stanford).....	Aug. 56
Morse Code Automatic Readout on a TV Screen (Steber).....	May 64
Multiplayer LED Racing Game (Prudhomme).....	Mar. 77
Out of Tune Correction.....	June 6
Out of Tune Correction.....	July 7
Photoelectric Sensor Detects (and Counts) Entrances and Exits (Markegard).....	Jan. 48
Pink Noise Generator for Audio Testing, Build a (Bohn).....	July 66
Portable 60-HZ "Clock" Oscillator (Smith).....	July 70
Quiz-Game Electronics (Robbins).....	Feb. 64
"Read Dit's and Dah's with the Morse-A-Letter (Reyer & Steber).....	Jan. 37
"RFI-Free" Solid-State Thermostat, An (Meijer).....	Jan. 73
Shut-Off Timer for Battery-Powered Appliances (Sandler).....	Aug. 48
Silencer, Build a (Miles).....	Mar. 57
Six CMOS Circuits for Experimenters (Lancaster).....	Apr. 46
Solar Controller, Build a (Cogswell).....	July 69
Solar Energy, Power Your Projects with (Green).....	Dec. 41
State-of-the-Art Battery Charge Monitor, Build a (Prudhomme).....	June 88
SWR Meter for Low-Power Communications Equipment, High Sensitivity (Vancura).....	Oct. 59
Transformerless DC-to-DC Voltage Doubler, Build a (Buchanan).....	Sept. 55
TVT-6: Part I, A Low-Cost Direct Video Display, Build the (Lancaster).....	July 47
TVT-6: Part II, Build the (Lancaster).....	Aug. 49
V-4 VCO for Electronic Music, Build the (Barbarelo).....	Mar. 42
Voltage Regulation to a Color Photo Enlarger, Add (Schneider).....	Nov. 63

DEPARTMENTS AND COLUMNS

Amateur Radio (Brier).....	Feb. 87
Speech Processors.....	Apr. 88
One-Wavelength Loop Antennas.....	Apr. 99
Art's TV Shop.....	Sept. 103
The Abnormal Temperature Caper.....	Oct. 94
CB Scene (Berger).....	Dec. 116
Better Emergency Services are Near.....	Nov. 90
Trends in CB.....	Jan. 97
CB Scene (Garcia).....	Feb. 85
Rules Enforcement Game Plan.....	Apr. 89
CB's Busiest Year.....	May 98
PURAC—A Voice for CB'ers.....	June 100
Uncle Charlie Talks to CB'ers.....	July 88
Uncle Charlie is Snowed-In.....	Aug. 90
CB-Related TVI—And What To Do About It.....	Nov. 90
The Anatomy of CBRS.....	Jan. 99
CB Development News and Views.....	Mar. 107
CB Scene (Salm).....	May 96
The Forgotten CB Service.....	July 89
Computer Bits (Chamberlin).....	Sept. 110
Text Editing.....	Nov. 88
Memory Testing.....	Feb. 89
Debugging Aids.....	Apr. 95
Assemblers.....	June 109
Update on Microprocessor Developments.....	Aug. 88
High-Level Languages.....	Dec. 118
Computer Bits (Gray).....	
Computer Stores.....	
Monitors, or Control Programs.....	
Computer Bits (Solomon).....	
Some New Hardware and Software.....	
Remote Control.....	
Potpouri from Here and There.....	

	Mo./Pg
More Good News for the Computer Group	Oct 97
DX Listening (Hauser)	
The Soviet Pulsar	Mar. 102
Misc. Items	May 100
Publications	Sept. 112
Shortwave Programs	Nov. 93
Editorial (Salsberg)	
Whither TV Servicing?	Jan 4
Hanging Fire	Feb 4
Ma Bell Stalls	Mar 4
Electronic Aids Security	Apr 4
The CB Crossover Point	May 4
TV for Radio Amateurs	June 4
Solar Energy News Notes	July 4
Elitism Finely Drawn	Aug 4
TV Electronic Games Grow Up	Sept 4
The Future of Home Computers	Oct 4
Sniffing Out Smokeys	Nov 4
Electronics 1978	Dec 4
English-Language Shortwave Broadcasts (Wood)	
March and April	Mar. 103
May thru August	May 101
September and October	Sept 114
November 1977 thru February 1978	Nov. 94
Experimenter's Corner (Mims)	
The LM339 Quad Comparator	Jan. 94
Flip-Flops and Decade Counters (Part I)	Feb. 75
Flip-Flops and Decade Counters (Part II)	Mar. 96
Active Filters	Apr. 75
Using LED's as Light Detectors	May 86
The Photoresistor	June 90
The 556 Timer	July 82
The Four-Layer Diode	Aug. 82
Laser Diodes	Sept. 94
IC Voltage Regulators	Oct. 88
Programmable Read-Only Memories	Nov. 77
Read/Write Memories, Part 1	Dec. 90
Inside Basic Electronics (Prensky)	
The Semiconductor Diode	Apr. 101
Out of Tune Corrections for 1976 Articles	
"A Digital Clock for Vehicles" (Green) (Oct.)	Jan. 8
"Digital Electronic Westminster Clock" (Roehl) (Nov.)	June 6
"A/D Temperature Converter" (Pruddhomme) (Dec.)	June 6
Solid State (Garner)	
The Great Guessing Game	Jan. 85
Timers and Counters	Feb. 66
Tachometer-Speed Switches	Mar. 86
Better than MOS	Apr. 66
VMOS—MOSFET's with Muscle	May 76
IC's for Test Instruments	July 77
A Circuit Medley	Aug. 71
IC Audio Preamplifiers	Sept. 85
Hurray for Arrays	Oct. 80
Back to the (Circuit) Mines	Nov. 67
One Circuit/Many Gifts	Dec. 84
Stereo Scene (Hodges)	
Speakers and Such	Jan. 22
Halloween at the Waldorf	Feb. 17
The House that Hi-Fi Built	Mar. 20
Through the Microphone	Apr. 22
The Decontamination Squad	May 18
Expansively Speaking	June 20
Instruments I have Miked	July 22
Tape Topics	Aug. 14
Records and the Vertical Angle	Sept. 14
The Big June Trial Balloon	Oct. 22
New Tests for Loudspeakers	Nov. 22
The Mysterious West	Dec. 20

FEATURES AND TUTORIALS

All Clock Chips are not Alike (Robbins)	Jan. 70
Audio Amplifiers, Classes of (Feldman)	Mar. 74
Average, Peak, and RMS Values (French)	July 68
Batteries, Rechargeable for Consumer Products	Oct. 52
Battle the Divebomber (Graeme)	June 40
Biorhythm Forecast (Lutus)	June 43
Blackjack (Platteler)	June 42
Buying Hi-Fi Components, The Basics of	Sept. 57
Calculators for Fun and Games, How to Program	June 39
Cassette Tape, Selecting the Best for Your Recording Needs (Stark)	Nov. 47
CB Frequency-Generation Methods, Pros and Cons of (Scherer)	Mar. 46
CB Rules Changes for 1977	Mar. 45
Chemicals for Electronics Servicing (Mangieri)	Jan. 44
Choose a Heat Sink, How to (Zwaska)	June 89
Clipper Circuit Quiz (Balin)	Nov. 92
Computers Detect and Correct Transmission Errors, How (May)	June 70
Computer Stores: A New Retailing Phenomenon (Wantz)	Dec. 70
Cosmac "El" Microcomputer, Part III (Weisbecker)	Mar. 63
Cosmac "El", Part IV (Weisbecker)	July 41
Creative Recording with 4-Channel Tape Recorders (Feldman)	June 73
Current "Foldback" Protects Power Supply and Load (May)	Feb. 59

DECEMBER 1977

	Mo./Pg
Custom Design Plastic Cases for Projects, How to (Huff)	Sept. 81
D/A and A/D Converters, the How's and Why's of (Pascoe)	Apr. 53
Design TTL Digital Systems, How to (Huffman)	Oct. 56
Dress Up Your Projects, How to (DeVoe)	Nov. 53
DX Radio from Outer Space, How to (Hauser)	Apr. 37
Dynamic Crosstalk (Hirsch)	Nov. 32
Dynamic Noise Reduction Systems and Expanders (Gordon)	Sept. 60
Eicaset has Arrived, The (Hirsch)	Oct. 32
End that "Utility Futility" (Helms)	July 53
External Speakers Can Improve Mobile CB Performance, How (Davis)	Mar. 54
First West Coast Computer Faire (Munnecke)	Sept. 74
FM Tuner Selectivity Ratings and Measurement (Hirsch)	Apr. 28
Football (Graeme)	June 40
Foreign DX on the Broadcast Band, Chasing (Helms)	June 78
Gyrotor Theory, An Introduction to (Morrison)	July 58
Handle MOS Devices Without Destroying Them, How to (Solomon)	Aug. 67
Hobbyist Computer Club Directory	Apr. 97
Hobbyist Computer Club Directory (Additions)	July 91
How FM Tuners Work! (Hirsch)	Dec. 48
How Headphones are Tested (Hirsch)	May 26
Infrared Systems for Wireless Stereo (Makosinski)	Oct. 70
Is There a Digital FM Tuner? (Hirsch)	Aug. 29
LED Circuit Quiz (Balin)	Jan. 96
Match Hi-Fi Components, How to	May 66
Matching Tapes to Recorders (Feldman)	Sept. 63
Measuring and Interpreting Turntable Rumble (Hirsch)	Mar. 24
Microprocessors, How to interface (Tenny)	Dec. 66
Model Railroad Sound Synthesizer (Wright)	Dec. 80
Multimeters for Electronics, Part I (Hallmark)	Feb. 31
Multimeters for Electronics, Part II (Hallmark)	Jan. 61
Multi-Way Speaker Systems, Pros and Cons of (Hirsch)	Sept. 22
New Band for "Kiddie-Talkies" (Sands)	Aug. 46
New, Practical Op Amp Circuits (Prensky)	Feb. 47
NOAA Weather Radio Operating Locations	Feb. 92
"No-Camera" Printed Circuit Board Methods, New (Mangieri)	May 55
Noise Filtering for Hi-Fi (Hirsch)	July 32
Operational Amplifier Quiz (Parker)	Mar. 111
Performance Capabilities of 40-Channel CB Transceivers (Scherer)	June 47
Piracy on the Airwaves (Helms)	Nov. 56
Pixie Animation Program (Deveaux)	July 42
Portable and Mobile Tape Recorders, Choosing (Horstman)	Aug. 43
Power Nomograph, A (McWilliams)	Oct. 69
Quick Hex-Decimal Conversions (Bell)	Dec. 72
Quiz of Audio Basics (Balin)	Sept. 71
RC Circuit Quiz (Balin)	July 26
Out of Tune Correction	Sept. 6
Soldering Techniques, Basic and New (Frye)	June 106
Space Flight (Lutus)	June 43
Speaker System Measurements—Is Phase Response Important? (Hirsch)	June 24
Switching Regulators Reduce Power Supply Cost (Raudenbush)	Apr. 60
Tape Recorder Headroom Explained (Hirsch)	Feb. 23
Tape Recorder Hygiene (Stark)	July 56
Teletypewriter Fundamentals for Hams, Swl'ers & Computer Hobbyists (Kahaner)	Oct. 43
Test Your ESP (Lutus)	June 43
TTL Logic Quiz (Balin)	Aug. 58
What Next in High Fidelity (Hirsch)	Dec. 23
Will Sunspots Affect CB Communication (Leinwolt)	Mar. 51
Wire-Wrapping Techniques for Computer Hobbyists (Mangieri)	Dec. 74
"Zap" New Life into Dead NiCd Batteries (Myers)	July 60

PRODUCT TEST REPORTS

Acoustic Research Model AR-16 Speaker System	Feb. 26
Akai Model GX-270D-SS Four Channel Tape Recorder	Sept. 32
Aries System 300 Electronic Music Synthesizer	Sept. 98
Ballantine Model 1010A Oscilloscope	Mar. 101
B&K Precision Model 1471B Oscilloscope	May 94
Burwen Model DNF 1201A Noise Reducer	Nov. 39
Cobra Model 29 XLR Mobile 40-Channel CB Transceiver	July 85
Continental Specialties Model Max-100 Frequency Counter	Oct. 93
Drake Model SSR-1 AM/SSB Communication Receiver	Jan. 83
Dual Model 1245 Automatic Turntable	Nov. 37

	Mo./Pg
Empire Model 698 Record Player	Mar. 26
Fluke Model 8020A Digital Multimeter	Aug. 85
Garrard Model DD75 Direct-Drive Record Player	Apr. 32
General Electric Model 3-5825 AM/SSB CB Transceiver	Sept. 97
Heathkit Model IM-2202 Digital Multimeter	Feb. 78
Heath Model AR-1515 AM/Stereo FM Receiver	Aug. 30
H.H. Scott Model R376 Stereo Receiver	Oct. 35
Hy-Gain Model 2716 Mobile AM CB Transceiver	Oct. 91
JVC Model JR-S300 AM/Stereo FM Receiver	Jan. 31
Kenwood Model 600 Integrated Stereo Amplifier	Jan. 29
Kenwood Model TS-820 Transceiver	May 90
Koss Model K/145 Stereo Headphones	July 36
Kraco Model KCB-2330 Mobile AM CB Transceiver	Jan. 82
Kris Model XL-50 40-Channel CB Mobile Transceiver	June 94
Lafayette Model LR-3030 AM/Stereo FM Receiver	June 34
Mitsubishi Model DA-P10 Preamplifier and Model DA-A15 Basic Power Amplifier	Nov. 33
Mura Model PRX-100 "PRM" CB Microphone	May 93
North Star Model MDS-A Micro Disk System	Nov. 86
OK Model WSU-30 Wire-Wrap Tool	Mar. 100
Ortofon Model MC20 Phono Cartridge and Model MCA-76 Preamplifier	Aug. 35
Phase Linear Model 5000 FM Tuner	Dec. 32
Pioneer Model CT-F8282 Cassette Deck	Feb. 24
Pioneer Model RT-707 Bidirectional Tape Deck	Dec. 30
President "Washington" AM/SSB CB Base Station	Aug. 84
Realistic Model STA-2000 Stereo Receiver	July 33
Realistic Model TRC-449 Mobile AM/SSB CB Transceiver	Nov. 85
Rotel Model RX-7707 AM/Stereo FM Receiver	Apr. 29
Sabtronics Model 2000 Digital Multimeter Kit	Dec. 99
Sansui Model TU-9900 AM/Stereo FM Tuner	Jan. 26
Sennheiser Model HDI 434 Infrared Headphones	May 32
Sharp Model CB-800A Mobile CB Transceiver	Feb. 79
Sherwood Model S-7910 Stereo Receiver	Mar. 29
Shure Model 516EQ Microphone	Oct. 39
Shure Model EL-26 Communication Microphone	April 85
Sony Model 565 Eicaset Tape Deck	Oct. 34
Sparkomatic Model CB 2040 CB AM Mobile Transceiver	Dec. 98
Speakerlab Model S7 Speaker System Kit	Sept. 36
Stanton Model 881S Phono Cartridge	Dec. 34
Teac Model PC-10 Cassette Recorder	May 36
Technics Model SB-6000A Linear Phase Speaker System	June 30
Telco Channel Guard Model XL-1000 TVI Filter	Apr. 84
Tennelec Model MPC-1 Memoryscan Monitor Receiver	Apr. 79
Thorens Model TD-126C Record Player	Aug. 33
Vector "Slit-N-Wrap" Wiring Tool	June 98
Wahl Models 7700 and 7800 Cordless Soldering Irons	July 86
Yaesu Model FRG-7 Communication Receiver	June 95

TEST EQUIPMENT AND TV SERVICING

10-Hz to 1-MHz Eput Meter, Build a (Hollabaugh)	Mar. 68
40-MHz Frequency Counter Project, A (Green)	June 64
Accurate Milliammeters on a Budget (Corbin)	June 67
Audio Analyzer, 1/2-Octave Real Time, Part I (Jones & Marsh)	Sept. 47
Audio Analyzer, 1/2-Octave Real Time, Part II (Jones & Marsh)	Oct. 66
Chemicals for Electronics Servicing (Mangieri)	Jan. 44
Digital Capacitance Meter (Fox)	Apr. 50
Out of Tune Correction	Sept. 6
Digital IC Tester, Build A (Stitt)	June 53
Digital Logic Analyzer Low-Cost (Muething, Spector, Wong)	Feb. 40
Diode Tester, One-Touch (Markgard)	July 75
Handy Circuit for Checking Phono Preamps and FM Tuners (Freeman)	Jan. 71
Low-Distortion Low-Cost Audio Generator, Build a (Lang)	Jan. 59
Multimeters for Electronics, Part I (Hallmark)	Jan. 61
Multimeters for Electronics, Part II (Hallmark)	Feb. 31
Oscilloscopes, Guide to (Hallmark)	June 59
Pink Noise Generator for Audio Testing, Build a (Bohn)	July 66
SWR-Facts and Fallacies (Frye)	Jan. 75
SWR Meter for Low-Power Communications Equipment High Sensitivity (Vancura)	Oct. 59

131

DIGI-KEY CORPORATION

Quality Electronic Components

TOLL FREE

-800-346-5144

MINNESOTA RESIDENTS 218-681-6674

DON'T FORGET OUR DISCOUNTS WHEN COMPARING PRICES

I.C.'s • RESISTORS • TRANSISTORS • CAPACITORS • DIODES • I.C. SOCKETS & PINS • SWITCHES CLOCK MODULES • OPTOELECTRONICS • BREADBOARDING & TESTING DEVICES • DRAFTING SUPPLIES DATA BOOKS • HEAT SINKS • WIRE • TOOLS ... AND MORE ... WRITE FOR FREE CATALOG ...

INTEGRATED CIRCUITS

Table listing various integrated circuits with part numbers, descriptions, and prices.

8080A CHIP SET

ONE EACH 8080A, 8212, 8224 AND 8228 PLUS SIXTEEN 2102-1's - ALL FOR \$49.95

MICROPROCESSORS

Best Values Yet! 8080A 8 BIT CPU 2 USE CYCLE \$12.95 8212 8 BIT I/O PORT \$ 3.95

WIRE WRAPPING WIRE IN BULK

Red or Black 30 Gyr. Kyme.

5% CARBON FILM RESISTORS

1/4 & 1/2 WATT SIZE 5% tolerance 1/4" - 100 pieces/box, 1.7" - 1000 pieces/box, 1.2" - 100 pieces/box

PRESSET SAMPLER

AN ASSORTMENT OF METALLIZED POLYESTER CAPACITORS 300 CAPS 18 VALUES \$26.00

METALLIZED POLYESTER CAPACITORS

Table listing capacitor values and prices.

ELECTROLYTIC CAPACITORS

Table listing electrolytic capacitor values and prices.

Bishop Graphics logo and contact information.

JMJ DIGITAL DISPLAY BEZEL advertisement with image and price \$4.95.

LED DIGITS AND LAMPS advertisement with image and prices.

5% CARBON FILM RESISTORS advertisement with image and prices.

DIAMOND logo and 'See Our Catalog For More Diamond Tool' text.

CLOCK MODULES advertisement with image and prices.

ok logo and 'STRIPS - WRAPS - UNWRAPS' text.

SILICON TRANSISTORS advertisement with table of part numbers and prices.

MA1002 0.5" High Digits advertisement with image and price \$12.95.

MA1010 0.84" High Digits advertisement with image and price \$12.95.

MA1003 12.495 advertisement with image and price \$12.495.

Table listing silicon diodes and hardware with prices.

MA1002 0.5" High Digits advertisement with image and price \$10.50.

MA1002C 2 LED 24 Hour Clock Module advertisement with price \$13.95.

MA1010 0.84" High Digits advertisement with image and price \$16.45.

MA1010C 84 LED 24 Hour Clock Module advertisement with price \$13.00.

MA1010C 84 LED 24 Hour Clock Module advertisement with price \$16.45.

DOUBLE DIGIT DISCOUNTS SAVE YOU EVEN MORE!

HANDLING CHARGES \$ 0.00-\$4.99... Add \$2.00 \$ 5.00-\$24.99... Add \$3.00 \$ 25.00-\$49.99... Add \$5.00 \$ 50.00-\$99.99... Add \$7.50 \$ 100.00 & Up... No Charge

VOLUME DISCOUNT & HANDLING CHARGE VOLUME DISCOUNT \$ 0.00-\$24.99... NET \$ 25.00-\$99.99... Less 10% \$ 100.00-\$499.99... Less 15% \$ 500.00-\$999.99... Less 20% \$ 1000.00 & Up... Less 25%

SILICON DIODES advertisement with table of part numbers and prices.

I.C. SOCKETS

Table listing I.C. socket types and prices.

MOLEX I.C. SOCKET PINS

Table listing Molex I.C. socket pin types and prices.

SLIDE SWITCHES 50 VOLT DISCS

Table listing slide switches and voltage discs with prices.

STRANDED HOOK UP WIRE

Table listing stranded hook up wire types and prices.

DIGI-KEY CORPORATION logo and contact information.

FREE CATALOG DATA BOOKS advertisement with list of books and prices.

ANNOUNCING NEW LOW PRICES AT RADIO SHACK, THE "PARTS PLACE"

Top quality devices, fully functional, carefully inspected. Guaranteed to meet all specifications, both electrically and mechanically. All are made by well known American manufacturers, and all have to pass

manufacturer's quality control procedures. These are not rejects, not fallouts, not seconds. In fact, there are none better on the market! Count on Radio Shack for the finest quality parts.



TTL Digital ICs

First Quality Devices Made by National Semiconductor and Motorola

Type	Cat No.	Last Year	NOW ONLY
7400	276-1801	\$.49	35¢
7402	276-1811	\$.49	39¢
7404	276-1802	\$.59	35¢
7406	276-1821	\$.69	49¢
7410	276-1807	\$.49	39¢
7413	276-1815	\$ 1.19	79¢
7420	276-1809	\$.49	39¢
7427	276-1823	\$.69	49¢
7432	276-1824	\$.69	49¢
7431	276-1804	\$ 1.59	99¢
7437	276-1805	\$.99	99¢
7448	276-1816	\$ 1.99	99¢
7451	276-1825	\$.49	39¢
7473	276-1803	\$.79	49¢
7474	276-1818	\$.79	49¢
7475	276-1806	\$ 1.19	79¢
7476	276-1813	\$.79	59¢
7485	276-1826	\$ 1.59	1.19
7486	276-1827	\$.69	49¢
7490	276-1808	\$ 1.19	79¢
7492	276-1819	\$ 1.59	89¢
74123	276-1817	\$ 1.69	99¢
74145	276-1828	\$ 1.49	1.19
74150	276-1829	\$ 1.79	1.39
74154	276-1834	\$ 1.79	1.29
74192	276-1831	\$ 1.69	1.19
74193	276-1820	\$ 1.69	1.19
74194	276-1832	\$ 1.69	1.19
74196	276-1833	\$ 1.69	1.29

74C and 4000 Series CMOS ICs

74C00	276-2301	\$.69	49¢
74C02	276-2302	\$.69	49¢
74C04	276-2303	\$.69	49¢
74C08	276-2305	\$.69	49¢
74C11	276-2310	\$ 1.29	89¢
74C16	276-2312	\$ 1.59	89¢
74C90	276-2315	\$ 2.49	1.49
74C192	276-2321	\$ 2.49	1.69
74C193	276-2322	\$ 2.49	1.69
4001	276-2401	\$.69	49¢
4011	276-2411	\$.69	49¢
4013	276-2413	\$.79	89¢
4017	276-2417	\$ 2.49	1.49
4020	276-2420	\$ 2.49	1.49
4027	276-2427	\$ 1.29	89¢
4049	276-2449	\$.99	69¢
4050	276-2450	\$.99	69¢
4511	276-2437	\$ 2.49	1.69
4518	276-2496	\$ 2.49	1.49

Linear ICs

First Quality Devices by National Semiconductor and Motorola



Type	Cat No.	Last Year	NOW ONLY
3014H	276-017	\$.69	49¢
324N	276-1711	\$ 1.49	1.49
3339N	276-1712	\$ 1.99	1.49
386CN	276-1731	\$ 1.99	99¢
555CN	276-1723	\$ 1.49	79¢
556CN	276-1728	\$ 2.79	1.39
566CN	276-1724	\$ 2.99	1.69
567CN	276-1721	\$ 2.99	1.99
723CN	276-1740	\$.99	69¢
741CN	276-007	\$.69	49¢
741H	276-010	\$.69	49¢
3900N	276-1713	\$ 1.39	99¢
3909N	276-1705	\$ 1.29	99¢
3914N	276-1706	\$ 2.19	1.99
4558CN	276-038	\$.99	79¢
75491	276-1701	\$ 1.49	99¢
75492	276-1702	\$ 1.49	99¢
7805	276-1770	\$ 1.59	1.29
7812	276-1771	\$ 1.59	1.29
7815	276-1772	\$ 1.59	1.29

Experimenter's PC Board

Simplifies IC Projects

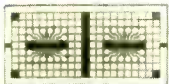

Ideal for two-circuit projects. Fire-retardant copper-clad board is only 2 1/2 x 5 1/16". Really simplifies integrated circuit projects by extending leads for easy soldering. 276-151 2.99

Microcomputer Chip

8080A Microprocessor. With a 16-bit address bus capable of addressing up to 65k bytes of memory and up to 256 I/O ports. "TRI-State" data bus gives it DMA and multiprocessing capability. All buses TTL compatible. Up to 244 variable length instructions, with 6 general purpose registers plus an accumulator. 40-pin DIP. 100% Prime. 276-2510 17.95

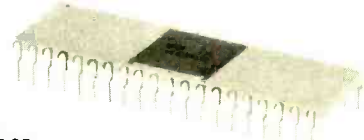

RS2102 Static RAM. 1024-word by one bit random access read/write memory. Under 750 nS access. Single +5V power supply. 276-2501 2.49 each or 8/14.95

1795

LEDs/Optoelectronics

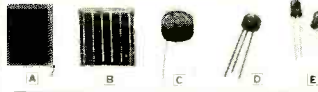

Item	Cat No.	Reg.	Now Only
Solar Cell	276-115		1.59
Silicon Solar Cell	276-128		1.99
Photocell	276-116		99¢
FPT 100	276-130		79¢
Lg Red LED	276-041	2/69c	2/49c
Lg Gr LED	276-047	2/69c	2/49c
Med Red LED	276-026	2/69c	2/49c
Med Gr LED	276-040	2/69c	2/49c
Sm Red LED	276-042	2/69c	2/49c

Digital Displays



Digits	Size	Drive	Cat No.	Last Year	NOW ONLY
4	0.5"	Anod.	276-1201	\$9.95	6.95
4	0.5"	Cath.	276-1202	\$9.95	6.95



Digits	Size	Drive	Cat No.	Last Year	NOW ONLY
1	0.6"	Anod.	276-056	\$3.99	2.99
1	0.6"	Cath.	276-066	\$3.99	2.99
1	0.3"	Anod.	276-053	\$2.99	1.99
1	0.3"	Cath.	276-062	\$2.99	1.99
1	0.3"	Anod.	276-1210	4/86.97	4/6.99
1	0.3"	Cath.	276-1211	4/86.97	4/6.99

Project Accessories

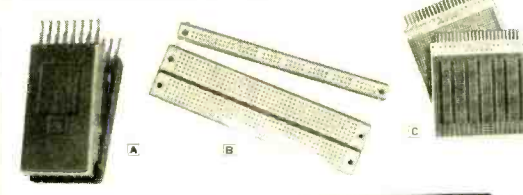

IC Troubleshooting Test Clip. Test up to 14 pins with probes or chips. Reg. 4.99

276-1950 Sale 2.99

IC Troubleshooting Test Clip. Test up to 16 pins with probes or chips. Reg. 4.99

276-1951 Sale 3.49

Experimenter Socket. 2x47 rows of 5 connected tie points. 276-172 9.95

Bus Strip. 2x40 connected tie points. Chips to socket above. 276-173 1.99

Standard Edge-Card Board. 22-pin. 1295 mounting holes. 276-152 2.99

2-Voltage Source Edge-Card Board. 1368 mounting holes. 276-154 2.99

3-Voltage Source Edge-Card Board. 1368 mounting holes. 276-153 2.99

22-Pin Edge-Card Board Connector. 44-terminals. 276-1551 2.99

100-Pin Edge-Card Board Connector. For standard S-100 hobby computer bus. 276-1554 4.99 each or 5/19.95

DIP Header. 16-pin spacing. 276-1980 1.29

Right Angle IC Socket. Mount LED's vertically. 16-pin spacing. 273-050 2.29

276-1985 1.49

Metal Cabinet. 3 1/2 x 2 1/2 x 4 2.59

270-251 2.59

Metal Cabinet. 4 x 2 1/2 x 6 3.49

270-252 3.49

Metal Cabinet. 6 1/2 x 2 1/2 x 7 1/2 4.49

270-253 4.49

Selected Diodes

Type	Cat No.	Last Year	Now Only
1N4001	276-1101		2/39c
1N4003	276-1102	2/59c	2/49c
1N4004	276-1103	2/69c	2/59c
1N4005	276-1104	2/79c	2/69c
1N4735	276-561		2/89c
1N4739	276-562		2/89c
1N4742	276-563		2/89c
1N4744	276-564		2/89c
Trigger Diode	276-1050	\$.49	39c
1N5401	276-1141		2/69c
1N5402	276-1142	2/89c	2/79c
1N5403	276-1143	2/99c	2/89c
1N5404	276-1144	2/5.19	2/99c
PTC205	276-1114		3/1.39c

SCR's and Triacs

Device	Rating	Cat No.	Last Year	Now Only
LASCER	200V 1.6A	276-1095	\$ 1.59	99¢
SCR	200V 6A	276-1067	\$ 1.39	89¢
SCR	400V 6A	276-1020	\$ 1.49	99¢
Triac	200V 6A	276-1001	\$ 1.39	89¢
Triac	400V 6A	276-1000	\$ 1.49	99¢
BR	50PIV 1.4A	276-1151		79c
BR	100PIV 1.4A	276-1152		99c
BR	100V 4A	276-1171		1.49
BR	200V 4A	276-1172		1.69
BR	400V 4A	276-1173		1.89
BR	50PIV 6A	276-1180		1.99

Digital Car Clock Module



Just add switches and install! Type MA1003, with MOS/LSI clock circuit chip, green fluorescent display with four 0.3" digits. Has 2.09 MHz crystal, blinking colon activity indicator. Six-pin edge-connector. For any 12VDC source. 277-1003 24.95

Low-Profile DIP Sockets

8-Pin.	276-1995	Reg. 2 for \$.69	2/59c
14-Pin.	276-1999	Reg. 2 for \$ 1.19	2/89c
16-Pin.	276-1998	Reg. 2 for \$ 1.19	2/89c
28-Pin.	276-1997	Reg. \$ 1.19 Each	89c
40-Pin.	276-1996	Reg. \$ 1.39 Each	99c



8-Rocker DIP Switch

Incorporates 8 on-off switches. For easy change of preset logic states. Fits any 16-DIP socket. 275-1301 1.99



WHY WAIT FOR MAIL DELIVERY?
IN STOCK NOW AT OUR STORE NEAR YOU!

Radio Shack®

Prices May Vary at Individual Stores and Dealers

A TANDY COMPANY • FORT WORTH, TEXAS 76102
OVER 6000 LOCATIONS IN NINE COUNTRIES

S.D. SALES COMPANY

NOW-THE ULTIMATE RAM BOARD

32K FOR \$475.00

**MEMORY CAPACITY
MEMORY ADDRESSING
MEMORY WRITE
PROTECTION**

8K, 16K, 24K, 32K using Mostek MK4115 with 8K boundaries and protection. Utilizes DIP switches. PC board comes with sockets for 32K operation. Orders now being accepted allow 6 to 8 weeks for delivery.

Available the 1st quarter of 1978: 16K, 32K, 48K, 64K using Mostek 4116 with 16K boundaries and protection.

Buy an S100 compatible 8K Ram Board and upgrade the same board to a maximum of 32 K in steps of 8K at your option by merely purchasing more ram chips from S.D. Sales! At a guaranteed price - Look at the features we have built into the board.

PRICES START AT \$151. FOR 8K RAM KIT
Add \$108.00 for each additional 8K Ram

Board fully assembled and tested for \$50. extra.

8K FOR \$151.00

INTERFACE CAPABILITY
Control, data and address inputs utilizes low power Schottky devices.

POWER REQUIREMENTS
+8VDC 400MA DC
+18VDC 400MA DC
-18VDC 30MA DC

on board regulation is provided. On board (invisible) refresh is provided with no wait states or cycle stealing required.

MEMORY ACCESS TIME
IS 375ns
Memory Cycle Time is 500ns.

8K LOW POWER RAM - \$159.95

Fully assembled and tested. Not a kit. Inmsai - Altair - S100 Bus compatible, uses low power static 21L02-500ns fully buffered on board regulated, quality plated through PC board, including solder mask. 8 pos. dip switches for address select.

4K LOW POWER RAM KIT

Fully Buffered - on board regulated - reduced power consumption utilizing low power 21L02 - 1 500ns RAMS - Sockets provided for all IC's. Quality plated through PC board. *Add \$10. for 250ns RAM operation

The Whole Works-\$79.95

MUSICAL HORN

One tune supplied with each kit. Additional tunes - \$6.95 each. Special tunes available. Standard tunes now available:
Dixie - Eyes of Texas - On Wisconsin - Yankee Doodle Dandy - Notre Dame - Pink Panther - Aggie War Song - Anchors Away - Never on Sunday - Yellow Rose of Texas - Deep in the Heart of Texas - Boomer Sooner - Bridge over River Kwai

CAR & BOAT KIT HOME KIT

Special Design Case \$3.50 **\$34.95** **\$26.90**

Jumbo LED Car Clock Kit

FEATURES:

- A. Bowmar Jumbo .5 inch LED array.
- B. MOSTEK - 50250 - Super clock chip
- C. On board precision crystal time base.
- D. 12 or 24 hour Real Time format.
- E. Perfect for cars, boats, vans, etc.
- F. PC board and all parts (less case) inc.

Alarm option - \$1.50
AC XFMR - \$1.50

\$16.95



Bowmar 4 Digit LED Readout Array

4 JUMBO .50" DIGITS ON ONE STICK!
WITH COLONS & AM/PM INDICATOR
\$3.95

Full 1/2" Litronix Jumbo Dual Digit LED Displays

DL 722 - C.C. DL 728 - C.C.
DL 721 - C.A. DL 727 - C.A.
99c \$1.29

Z-80 CPU BOARD KIT - Complete Kit \$139.

CHECK THE ADVANCED FEATURES OF OUR Z-80 CPU BOARD: Expanded set of 158 instructions, 8080A software capability, operation from a single 5VDC power supply; always stops on an M1 state, true sync generated on card (a real plus feature!), dynamic refresh and NM1 available, either 2MHZ or 4MHZ operation, quality double sided plated through PC board; parts plus sockets priced for all IC's. *Add \$10. extra for Z-80A chip which allows 4MHZ operation. Z-80 chip with Manual - \$39.95



DIGITAL LED READOUT THERMOMETER - \$29.95

Features: Litronix dual 1/2" displays. Uses Silicoax LD131 single chip CMOS A/D converter. Kit includes all necessary parts (except case); AC line cord and power supply included. O 1499 F



6 DIGIT ALARM CLOCK KIT

Features: Litronix dual 1/2" displays, Mostek 50250 super clock chip, single I.C. segment driver, SCR digit drivers. Greatly simplified construction. More reliable and easier to build. Kit includes all necessary parts (except case). Xlmm optional. Eliminate the hassle - avoid the 5314! Do not confuse the Non - Alarm kits sold by our competition!
AC XFMR - \$1.50 Case \$3.50 **\$12.95/kit**

5 Digit Countdown Utility-Darkroom Timer Kit - \$44.95

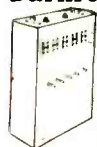

Features: Large LED displays, crystal controlled Mostek 50397 counter display driver, set timer at 0.1 second precision from 0.1 second to 59 minute 59.9 second, 5A-115V relay included to control photographic enlarger, sun lamp, appliances, TV, or other equipment, operates on 115V AC, displays can be turned off for total darkness applications, simple push button operation, use in kitchen, school, office or laboratory. All necessary parts included. Special design case \$3.75

6 Digit General Purpose or Computer Timer Kit - \$29.95

Features: Large LED displays, Mostek 50397 counter display/driver, counts up to 59 minutes, 59.99 seconds with crystal controlled 1/100 second accuracy, operates on 115V AC or 12V DC supply. Use it to time telephone calls, athletic events, practice time, school and laboratory demonstrations, experiments, chess games, etc. Time computer functions in real time such as run times on programs, sup routines and other computer controlled events. Requires two output channels for start/stop and clear controls. All necessary parts included. Special design case \$3.75

RAM'S-CPU'S-PROM'S

21L02 500NS	8/11.50
21L02 250NS	8/15.95
2114 - 4K	14.95
1101A - 256	8/\$4.00
1103 - 1K	.99
MK 4115 - 8K	19.45
74S 200 - 256	3.95

Z-80 includes manual.	29.95
Z-80A includes manual	34.95
8080A CPU 8 BIT	11.95
8008 CPU 8 BIT	6.95

1702A - 1K - 1.5us	3.95 or 10/35.
2708 8K Intel 450ns	14.95
5204 4K	7.95
82S129 - 1K	2.50
2708S - 8K signetics 650ns	9.95

ITT DUAL SENSE AMPLIFIER 75234 and 75235 49c each

SPRAGUE DUAL DIFFERENTIAL AMP TD101 49c each

Low Cost Cassette Interface Kit

\$14.95

Features: K.C. standrad 2400/1200 Hz, 300 Baud, TTL, I/O compatible, phase lock loop, 22 pin connector. Feeds serial data via microprocessors I/O ports and from cassette tape recorder. \$14.95



DISC CAP ASSORTMENT *
PC leads. At least 10 different values. Includes .001, .01, .05 + other standard values 60/\$1.00

39 MFD 16V Mallory Electrolytic 15/\$1.00

* 1000 MFD FILTER CAPS Rated 35 WVDC. Upright style with PC leads. Many popular values. 4/\$1.

JOY STICKS! 4-100K POTS \$3.95 each

RESISTOR * ASSORTMENT PC leads A good MIX of values. SPECIAL! 200/\$2.00

FLAT PACK * 5400 SERIES 20 asst. devices for \$1.00

P.C. LEAD DIODES * 1N4148/1N914 100/\$2.00

POWER RESISTOR 15 OHM 25W by CLAROSTAT 75c Each

ITT PART NO. SAJ 110 Ideal for electronic music circuits 7 stage freq.dividers. 49c each

Microprocessor Chips

8212 I/O port	3.50
8214 - P.I.C	12.95
8216 - Non Invert Bus	4.95
8224 - Clock Gen.	4.95
8226 - Invert Bus	3.95
P10 for Z-80	14.95
CTC for Z-80	14.95
8228 Sys. Controller	8.20
8251 Prog. comm. interface	10.95
8255 Prog. perp. interface	13.50
8820 Dual Line Recr.	1.75
8830 Dual Line Dr	1.75
2513 Char. Gen.	7.50
8838 Quad Bus. Recvr.	2.00
74LS138N - 1/8 decoder	.99
8T97 Hex Tri-State Buffer	1.25
1488/1489 RS232	1.50
TR1602B Uart	3.95

Counter Chips

MK50397 6 Digit elapsed timer	8.95
MK50250 Alarm clock	4.99
MK50380 Alarm chip	2.95
MK50396 6 digit up/down counter	12.95
MK5002 4 digit counter	8.95
MK5021 - Cal. chip sq. root	2.50



S. D. SALES CO. An Empire Ind. Co.

P. O. BOX 28810 - D DALLAS, TEXAS 75228

Call in your Visa or Mastercharge in on our Toll Free Watts Line: 1-800-527-3460

Texas Residents call Collect: 214/271-0022 Dealer Inquiries Invited!

60 DAY MONEY BACK GUARANTEE!

NO COD'S. TEXAS RESIDENTS ADD 5% SALES TAX. ADD 5% OF ORDER FOR POSTAGE & HANDLING. ORDERS UNDER \$10 ADD 75c HANDLING. FOREIGN ORDERS - US FUNDS ONLY!

Choose \$1. Free Merchandise From * Asterisk Items on each \$15. Order!

COMPU/TIME CT 100

COMPU/TIME offers
A Real Darn Clever
Enhancement to users of
IMSAI/ALTAIR Microprocessors

\$100 BUS COMPATIBLE

TIME & CALENDAR

COMPU/TIME CT100	\$199	Kit	\$245	Assembled
COMPU only C101	\$149	Kit	\$189	Assembled
TIME only T102	\$165	Kit	\$205	Assembled
COMPU/TIME PC Board only			\$ 80	

TU-1

You will want to know about the TU-1 Video to Television Interface Kit.
No need to buy a separate Video Monitor if you already own a TV set. Just connect the TU-1 between your system video output and the TV set antenna terminals—that's all there is to it— to convert your TV set to a Video Monitor, and at a much lower cost!

PRICE \$8.95

FCS 8000A — 3½ Digit — 8" Display
NEW! 25 Pin version with color & 4 digit indicator
• Connects almost one for one with 3817, 3817A or D. (3817 available at \$5.00 each)
• Typical segment current: 10mA (except color: 15mA)
• B & c and 10 mm. a & d which are 16 mA
• Forward voltage drop: 1.5 volts
• MAXIMUM FORWARD CURRENT — 25 mA.



SPECIAL \$4.95 EA.

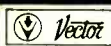

SLIT-N-WRAP WIRE WRAP TOOL

- Slits and opens insulation exposing bare wire
 - No pre-cutting or pre-stripping.
 - Comes complete with two - 100 ft spools #28 AWG wire!
- Model P180 \$24.50**

Vector Plugboards 8800V

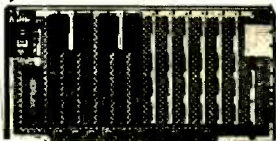

Universal Microcomputer Processor plugboard, use with S-100 bus complete with heat sink & hardware 5.3 x 10 x 1/16"

\$19.95

CHANNEL F

FRANCHISE VIDEO ENTERTAINMENT SYSTEM



\$159.95

- Freeze Action • Speed Option
- Automatic time and scorekeeping
- Battery-free AC operation
- Dual controls with 8-way action
- Built-in Pro Hockey and Tennis games
- Easy hook-up on any B/W or Color TV
- Factory warranty

Channel F — additional cartridges — \$17.95 ea.

0811 — Tic-Tac-Toe/Shooting Gallery
0815 — Spacewar (2 players)
0812 — Desert Fox/Shooting Gallery
0813 — Blackjack (1 or 2 players)
0814 — Spitfire (1 or 2 players)
0818 — Magic Numbers (computer logic)
0819 — Drag strip (1 or 2 players)
0820 — Maze (2 players)
0822 — Baseball (2 players)

EDGE CONNECTORS



NO. PINS	DUAL	PIN	TYPE	PRICE
20	DUAL	10 PIN	GOLD	\$.50
30	DUAL	15 PIN	GOLD	.75
44	DUAL	22 PIN	GOLD	1.95
44	DUAL	22 PIN	GOLD	2.50
80	DUAL	40 PIN	GOLD	4.95
86	DUAL	43 PIN	GOLD (8800)	5.00
100	DUAL	50 PIN	GOLD (IMSAI/ALTAIR)	4.25
100	DUAL	50 PIN	GOLD (IMSAI/ALTAIR)	4.95
100	DUAL	50 PIN	GOLD (NO EARS-IMSAI)	3.50
100	DUAL	50 PIN	TIN (.1" SPACING)	3.25

ALTAIR/IMSAI CARD GUIDES .25¢ EACH

JADE

Computer Products



5351 WEST 144th STREET
LAWDALE, CALIFORNIA 90260
(213) 679-3313

RETAIL STORE HOURS M-F 9-7 SAT. 9-5

Discounts available at OEM quantities. Add \$1.25 for shipping. California residents add 6% sales tax.

CATALOG FREE WITH \$10.00 ORDER

7400N TTL

SN7400N	16	SN7459A	25	SN74154N	1.00
SN7401N	16	SN7460N	22	SN74155N	.99
SN7402N	21	SN7461N	45	SN74156N	.99
SN7403N	16	SN7472N	39	SN74157N	.99
SN7404N	18	SN7473N	37	SN74158N	1.25
SN7405N	24	SN7474N	32	SN74159N	.99
SN7406N	20	SN7475N	50	SN74160N	.99
SN7407N	25	SN7476N	32	SN74161N	1.10
SN7408N	25	SN7479N	5.00	SN74162N	1.10
SN7409N	25	SN7480N	50	SN74163N	1.25
SN7410N	18	SN7482N	96	SN74164N	1.25
SN7411N	35	SN7483N	70	SN74165N	5.50
SN7412N	33	SN7485N	89	SN74166N	2.10
SN7413N	45	SN7486N	39	SN74167N	8.95
SN7414N	70	SN7488N	3.50	SN74173N	1.50
SN7415N	35	SN7489N	2.49	SN74174N	1.25
SN7417N	35	SN7490N	45	SN74175N	.99
SN7420N	21	SN7491N	75	SN74176N	.90
SN7421N	33	SN7492N	49	SN74177N	.90
SN7422N	49	SN7493N	49	SN74180N	.99
SN7423N	37	SN7494N	79	SN74181N	2.49
SN7424N	29	SN7495N	79	SN74182N	.95
SN7426N	29	SN7496N	89	SN74184N	1.95
SN7427N	37	SN7497N	4.00	SN74185N	2.20
SN7429N	42	SN74100N	1.00	SN74186N	15.00
SN7430N	26	SN74101N	.39	SN74187N	6.00
SN7432N	31	SN74121N	.39	SN74188N	3.95
SN7437N	27	SN74122N	.39	SN74190N	1.19
SN7438N	27	SN74123N	.50	SN74191N	1.25
SN7439N	25	SN74125N	.60	SN74192N	.99
SN7440N	15	SN74126N	.60	SN74193N	1.25
SN7441N	89	SN74132N	1.09	SN74194N	1.25
SN7442N	59	SN74136N	.95	SN74195N	.75
SN7443N	75	SN74141N	1.15	SN74196N	1.25
SN7444N	75	SN74142N	4.00	SN74197N	.75
SN7445N	75	SN74143N	4.50	SN74198N	1.75
SN7446N	81	SN74144N	4.50	SN74199N	1.75
SN7447N	69	SN74145N	1.15	SN74200N	5.59
SN7448N	79	SN74147N	2.35	SN74279N	.99
SN7450N	26	SN74148N	2.00	SN74281N	1.19
SN7451N	27	SN74150N	1.00	SN74284N	6.00
SN7452N	27	SN74151N	.79	SN74285N	6.00
SN7454N	20	SN74153N	.89	SN74367N	.75

MANY OTHERS AVAILABLE ON REQUEST
20% Discount for 100 Combined 7400's

CMOS

CD4000	25	CD4030	65	74C04N	.75
CD4001	25	CD4033	1.85	74C05N	.65
CD4002	25	CD4040	2.40	74C06N	.65
CD4006	25	CD4042	1.90	74C07N	1.50
CD4009	59	CD4044	1.50	74C23N	1.50
CD4010	59	CD4046	2.51	74C73	1.15
CD4011	25	CD4047	2.75	74C80N	3.00
CD4012	25	CD4049	.79	74C93N	2.00
CD4013	47	CD4050	.79	74C107N	1.25
CD4016	56	CD4051	2.95	74C151	2.90
CD4017	135	CD4053	3.25	74C154	4.00
CD4019	149	CD4066	3.95	74C157	2.15
CD4020	149	CD4066	1.75	74C160	3.25
CD4022	125	CD4069	.45	74C161	3.25
CD4023	25	CD4071	.45	74C163	3.00
CD4024	150	CD4081	.45	74C164	3.25
CD4025	25	CD4111	2.50	74C173	2.60
CD4026	3.95	CD4518	2.50	74C193	2.75
CD4027	69	MC14566	3.00	74C195	2.75
CD4028	1.65	74C00N	.39	MC4044	4.50
CD4029	2.90	74C02N	.55	MC14016	.55

LINEAR

LM330P	80	LM1414N	1.65	LM1551N	1.65
LM301M	35	LM1418N	1.75	LM1458C	.65
LM301CN	35	LM1458C	1.75	LM1469N	.95
LM302H	.75	LM1370N	1.15	LM1556V	1.85
LM303H	1.00	LM1373N	3.25	LM1559N	1.85
LM305H	.95	LM1377H	4.00	LM2111N	.95
LM307CN	35	LM3080N	.39	LM2901N	2.95
LM308H	1.00	LM3090N	1.05	LM3065N	.69
LM308CN	1.00	LM3811N	1.79	LM3900N	55
LM309H	1.10	LM3523N	1.79	LM3905N	.60
LM309CN	.90	NE510A	6.00	LM3909N	1.25
LM310CN	1.15	NE510A	6.00	LM5556N	1.85
LM311H	90	NE531H	3.00	MC2559N	1.00
LM311H	90	NE536T	6.00	LM7552V	90
LM318N	40	NE567N	6.00	LM7555N	90
LM319N	1.30	NE567N	1.50	80388	.49
LM320K-1	1.35	NE555V	.79	LM75450	4.95
LM320K-2	1.35	NE560B	5.00	75451CN	.39
LM320K-12	1.35	NE561B	5.00	75452CN	.39
LM320K-15	1.35	NE567H	1.95	75453CN	.39
LM320T-5	1.75	NE565H	1.25	75454CN	.39
LM320T-5.2	1.75	NE565N	1.75	75457CN	.79
LM320T-8	1.75	NE566CN	1.25	75492CN	.89
LM320T-12	1.75	NE567H	1.95	75494CN	.89
LM320T-15	1.75	NE567H	1.50	RCA LINEAR	
LM320T-18	1.75	LM703CN	.45	CA3013	2.15
LM320T-24	1.75	LM709H	.29	CA3023	2.56
LM323K-5	9.95	LM709H	.29	CA3035	1.48
LM324N	1.80	LM710N	.79	CA3039	1.35
LM329M	1.70	LM711N	.39	CA3046	2.40
LM340K-5	1.95	LM723H	.55	CA3059	3.25
LM340K-6	1.95	LM723H	.55	CA3060	3.25
LM340K-8	1.95	LM733N	1.00	CA3080	.80
LM340K-12	1.95	LM739N	1.00	CA3091	2.00
LM340K-15	1.95	LM741CN	.35	CA3082	2.00
LM340K-18	1.95	LM741CN	.35	CA3083	1.60
LM340K-24	1.95	LM741-14N	.39	CA3086	1.85
LM340T-5	1.75	LM747H	.79	CA3089	3.75
LM340T-6	1.75	LM747H	.79	CA3091	10.20
LM340T-8	1.75	LM748H	.39	CA3102	2.95
LM340T-12	1.75	LM748H	.39	CA3123	2.15
LM340T-15	1.75	LM1303N	.90	CA3130	1.39
LM340T-18	1.75	LM1304N	1.19	CA3140	1.25
LM340T-24	1.75	LM1305N	1.40	CA3600	.75
LM350N	1.00	LM1307N	.85	RC4194	5.95
LM351CN	.65	LM1310N	2.95	RC4195	3.25

74LS00	29	74LS139	1.95
74LS02	29	74LS151	1.55
74LS04	35	74LS153	1.89
74LS05	35	74LS157	1.55
74LS06	35	74LS162	2.25
74LS08	29	74LS163	2.25
74LS10	29	74LS164	1.95
74LS13	69	74LS174	1.95
74LS14	75	74LS186	1.69
74LS20	29	74LS192	2.85
74LS26	39	74LS193	2.85
74LS27	39	74LS194	2.85
74LS29	39	74LS196	1.89
74LS30	29	74LS197	2.85
74LS32	39	74LS198	1.89
74LS34	39	74LS199	1.89
74LS35	29	74LS257	1.75
74LS35	29	74LS260	.55
74LS35	29	74LS279	.95
74LS73	49	74LS318	1.89

CLOCK CHIPS

MMS309	6 Digit. BCD Outputs. Reset P.N.	\$9.95
MMS311	8 Digit. BCD Outputs. 12 or 24 Hour	4.95
MMS312	4 Digit. BCD Outputs. 1 PPS Output	4.95
MMS314	8 Digit. 12 or 24 Hour or 80 Hz	4.95
MMS316	4 Digit. Alarm. 1 PPS Output	6.95
MMS318	Video Clock Chip. For Use With MMS841	9.95
CT7001	6 Digit. Calendar. Alarm. 12 or 24 Hour	5.95

THE PROM SETTER

WRITE AND READ

EPROM

- Plugs Directly into your ALTAIR/IMSAI Computer
- Includes Main Module Board and External EPROM Socket Unit
- The EPROM Socket Unit is connected to the Computer through a 25 Pin Connector
- Programming is accomplished by the Computer
- Just Read in the Program to be Written on the EPROM into your Processor and let the Computer do the rest.
- Use Socket Unit to Read EPROM's Contents into your Computer
- Software included
- No External Power Supplies. Your Computer does it all.
- Programs and Reads Both 1702A and 2708 EPROMS
- Doubles as an Eight Bit Parallel I/O
- Manual included. Delivery Less than 90 days.

INTRODUCTORY OFFER

THE PROM SETTER

Kit \$210 ASSEMBLED \$375

PROM SETTER I

above unit with 2716 adapter

Kit \$260 Assembled \$425

WIRE WRAP CENTER

HOBBY-WRAP TOOL-BW-630



- Battery Operated (Size C)
- Weighs ONLY 11 Ounces
- Wraps 30 AWG Wire onto Standard DIP Sockets (.025 inch)
- Complete with built-in bit and Sleeve

\$34.95

batteries not included

WIRE-WRAP KIT — WK-2-W

- Tool for 30 AWG Wire
- Roll of 50 Ft. White or Blue 30 AWG Wire
- 50 pcs. each 1", 2", 3" & 4" lengths — pre-stripped wire.

\$11.95

WIRE WRAP TOOL WSU-30

WRAP • STRIP • UNWRAP • \$

MICROCOMPUTER

MICROPROCESSOR'S F-8 19.95 Z-80 25.00 Z-80A 35.00 CDP1802CD 24.95 AM2901 22.95 6502 12.95 6800 19.95 8008-1 8.75 8080A 15.95 TMS-9900TL 89.95 6800 SUPPORT 6810P 4.95 6820P 8.00 6828P 11.25 6834P 16.95 6850P 9.95 6852P 11.95 6860P 14.95 6862P 17.95 6880P 2.70 Z80 SUPPORT DEVICES 3881 12.95 3882 12.95 F-8 SUPPORT DEVICES 3851 14.95 3853 14.95 DYNAMIC RAMS 1103 1.50 2104 4.50 2107A 3.75 2107B 4.50 2107B-4 4.00 TMS4050 4.50 TMS4060 4.50 4096 4.50 4116 42.00 MM5270 5.00 MM5280 6.00 MCM6605 6.00 CHARACTER GENERATORS 2513 UP 6.75 2513 DOWN 6.75 2513 UP (5v) 9.95 2513 DOWN(5v) 10.95 MCM6571 10.80 MCM6571A 10.80 MCM6572 10.80 MCM6574 14.75 MCM6575 14.75	PROM'S 1702A 5.00 2704 15.00 2708 20.00 2716 38.00 3601 4.50 5203AQ 4.00 5204AQ 6.00 6834 16.95 6834-1 14.95 82523B 4.00 825129B 4.25 8223B 2.70 8080A SUPPORT DEVICES 8212 3.95 8214 9.95 8216 4.50 8224 4.95 8228 8.75 8238 8.00 8251 12.00 8253 28.00 8255 12.00 8257 25.00 8259 25.00 <table border="1" style="width: 100%; border-collapse: collapse;"> <tr> <th>STATIC RAMS</th> <th>1-24</th> <th>25-99</th> <th>100</th> </tr> <tr> <td>21L02 (450)</td> <td>1.50</td> <td>1.40</td> <td>1.25</td> </tr> <tr> <td>21L02 (250)</td> <td>1.95</td> <td>1.80</td> <td>1.50</td> </tr> <tr> <td>21L11</td> <td>4.25</td> <td>4.10</td> <td>3.95</td> </tr> <tr> <td>1101A</td> <td>1.49</td> <td>1.29</td> <td>1.10</td> </tr> <tr> <td>2101-1</td> <td>2.95</td> <td>2.75</td> <td>2.60</td> </tr> <tr> <td>2102</td> <td>1.25</td> <td>1.15</td> <td>1.00</td> </tr> <tr> <td>2102-1</td> <td>1.50</td> <td>1.30</td> <td>1.15</td> </tr> <tr> <td>2111-1</td> <td>4.00</td> <td>3.50</td> <td>3.25</td> </tr> <tr> <td>2112-1</td> <td>3.00</td> <td>2.80</td> <td>2.69</td> </tr> <tr> <td>2114</td> <td>17.95</td> <td>16.95</td> <td>16.50</td> </tr> <tr> <td>31L01</td> <td>2.50</td> <td>2.35</td> <td>2.00</td> </tr> <tr> <td>3107</td> <td>3.95</td> <td>3.70</td> <td>3.25</td> </tr> <tr> <td>4200A</td> <td>12.95</td> <td>12.50</td> <td>11.95</td> </tr> <tr> <td>4804/2114</td> <td>17.95</td> <td>16.95</td> <td>16.50</td> </tr> <tr> <td>5101C-E</td> <td>11.95</td> <td>11.25</td> <td>10.25</td> </tr> <tr> <td>74C89</td> <td>3.25</td> <td>3.05</td> <td>2.85</td> </tr> <tr> <td>74S201</td> <td>4.50</td> <td>4.30</td> <td>4.25</td> </tr> <tr> <td>7489</td> <td>2.25</td> <td>2.10</td> <td>1.90</td> </tr> <tr> <td>8599</td> <td>1.88</td> <td>1.75</td> <td>1.60</td> </tr> <tr> <td>9102BPC</td> <td>1.65</td> <td>1.45</td> <td>1.30</td> </tr> </table> KEYBOARD CHIPS AY5-2376 13.95 AY5-3600 13.95 UART'S AY5-1013A 5.50 AY5-1014A 8.95 TR-1602A 5.50 TMS-6011 6.95 IM-6402 10.80 IM-6403 10.80 FLOPPY DISC CONTROLLER 1771B 55.95 1771B-01 59.95 SHIFT REGISTERS STATIC 2518B 3.95 2533V 2.00 TMS3002 1.00 TMS3112 3.95 MM5058 2.00	STATIC RAMS	1-24	25-99	100	21L02 (450)	1.50	1.40	1.25	21L02 (250)	1.95	1.80	1.50	21L11	4.25	4.10	3.95	1101A	1.49	1.29	1.10	2101-1	2.95	2.75	2.60	2102	1.25	1.15	1.00	2102-1	1.50	1.30	1.15	2111-1	4.00	3.50	3.25	2112-1	3.00	2.80	2.69	2114	17.95	16.95	16.50	31L01	2.50	2.35	2.00	3107	3.95	3.70	3.25	4200A	12.95	12.50	11.95	4804/2114	17.95	16.95	16.50	5101C-E	11.95	11.25	10.25	74C89	3.25	3.05	2.85	74S201	4.50	4.30	4.25	7489	2.25	2.10	1.90	8599	1.88	1.75	1.60	9102BPC	1.65	1.45	1.30
STATIC RAMS	1-24	25-99	100																																																																																		
21L02 (450)	1.50	1.40	1.25																																																																																		
21L02 (250)	1.95	1.80	1.50																																																																																		
21L11	4.25	4.10	3.95																																																																																		
1101A	1.49	1.29	1.10																																																																																		
2101-1	2.95	2.75	2.60																																																																																		
2102	1.25	1.15	1.00																																																																																		
2102-1	1.50	1.30	1.15																																																																																		
2111-1	4.00	3.50	3.25																																																																																		
2112-1	3.00	2.80	2.69																																																																																		
2114	17.95	16.95	16.50																																																																																		
31L01	2.50	2.35	2.00																																																																																		
3107	3.95	3.70	3.25																																																																																		
4200A	12.95	12.50	11.95																																																																																		
4804/2114	17.95	16.95	16.50																																																																																		
5101C-E	11.95	11.25	10.25																																																																																		
74C89	3.25	3.05	2.85																																																																																		
74S201	4.50	4.30	4.25																																																																																		
7489	2.25	2.10	1.90																																																																																		
8599	1.88	1.75	1.60																																																																																		
9102BPC	1.65	1.45	1.30																																																																																		

MISC. OTHER COMPONENTS	
NH0025CN 1.70	P-340BA 5.00
NH0026CN 2.50	P-4201 4.95
N8T20 3.50	MM-5320 7.50
N8T26 2.45	MM-5369 1.90
74367 .90	DM-8130 2.90
DM8098 .90	DM8131 2.75
1488 1.95	DM-8831 2.50
1489 1.95	DM-8833 2.50
D-3207A 2.00	DM-8835 2.50
C-3404 3.95	SN74LS367 .90
	SN74LS368 .90

TV
Game Chip
 TMS1955NL
Now Only
\$10.95

PerSci DISK AND CONTROLLER

Use the PerSci Disk and Controller now with the Info 2000 Adapter for the S-100 Bus.

INFO 2000 "SPECIAL"
 (includes Model 277 Dual Drive, Model 1070 Controller, Case with power supply and fan, and cable) \$2,150

Model 277 Dual Diskette Drive \$1,130

Model 1070 Controller \$740

Slimline case with power supply and fan \$280

Adapter for the S-100 Bus (Kit) \$120

JADE PARALLEL/SERIAL INTERFACE KIT
\$124.95 KIT

JADE VIDEO INTERFACE KIT
\$89.95 KIT

8K STATIC RAM BOARD

ASSEMBLED & TESTED

250ns.	\$199.95
350ns.	\$189.95
450ns.	\$169.95

- * WILL WORK WITH NO FRONT PANEL
- * FULL DOCUMENTATION
- * FULLY BUFFERED
- * S100 DESIGN
- * ADEQUATELY BYPASSED
- * LOW POWER SCHOTTKY SUPPORT IC'S

KIT

250ns.	\$169.95
350ns.	\$139.95
450ns.	\$129.95

IMSAI/ALTAIR **S-100** COMPATIBLE

JADE Z80 KIT

—with PROVISIONS for
ONBOARD 2708 and POWER ON JUMP

\$135.00 EA.	(2MHZ)
\$149.95 EA.	(4MHZ)

BARE BOARD \$35.00

IMSAI/ALTAIR **S-100** COMPATIBLE

JADE 8080A KIT

— WITH EIGHT LEVEL VECTOR INTERRUPT

\$110.00 KIT
BARE BOARD \$35.00

JADE



Computer Products
 5351 WEST 144th STREET
 LAWDALE, CALIFORNIA 90260
 (213) 679-3313

RETAIL STORE HOURS M-F 9-7 SAT. 9-5
 Discounts available at OEM quantities. Add \$1.25 for shipping. California residents add 6% sales tax.
CATALOG FREE WITH \$10.00 ORDER

EXAR IC'S

COMMUNICATION CIRCUITS	
XR-2208CP	Four-Quadrant Operational Multiplier \$5.20
PHASE-LOCKED LOOPS	
XR-210	FSK Modulator/Demodulator \$5.20
XR-215	General Purpose Phase-Locked Loop \$6.56
XR-2211CP	FSK Demodulator/Tone Decoder \$6.88
FUNCTION GENERATORS	
XR-205	Waveform Generator \$8.40
XR-2206CP	Monolithic Function Generator \$5.12
XR-2207CP	Current-Controlled Oscillator \$3.84
TONE DECODERS	
XR-567CP	Tone Decoder \$1.68
XR-2567CP	Dual Tone Decoder \$5.18
VOLTAGE REGULATORS	
XR-1468CN	Dual ± 15 Volt Tracking Regulator \$3.84
XR-4194CN	Adjustable Dual Tracking Voltage Regulator \$4.56
XR-4195CP	Dual ± 15 Volt Tracking Voltage Regulator \$3.38
OPERATIONAL AMPLIFIERS	
XR3403CP	Quad Operational Amplifier \$3.33
XR-4202P	Programmable Quad Operational Amplifier \$3.60
XR-4212CP	Quad Operational Amplifier \$2.05
XR-4558CP	Dual Operational Amplifier \$0.86
XR-4739CP	Dual Low-Noise Operational Amplifier \$1.15
TIMING CIRCUITS	
XR-320P	Timing Circuit \$1.52
XR-555CP	Timing Circuit \$1.07
XR-5556CP	Dual 555 Timing Circuit \$1.82
XR-2240CP	Programmable Timing Circuit \$3.44
XR-2556CP	Dual 555 Timing Circuit \$3.20
INTERFACE CIRCUITS	
XR-2200CP	Hammer Driver \$1.17
XR-2201CP/2202CP/2203CP/2204CP	High Voltage, High Current Darlingtion Transistor Arrays \$2.25 ea
XR-2271CP	Flourescent Display Drivers \$1.15
OTHER CIRCUITS	
XR-1310P	FM Stereo Demodulator \$3.20
XR-2264CP	Proportional Servo IC \$4.24
XR-4151CP	Voltage-To-Frequency Converter \$7.50

AMD

ADVANCED MICRO DEVICES, INC.

COMPUTER INTERFACE CIRCUITS					
MM5902CN	1-8	10 UP	MM5903CN	1-8	10 UP
MM5903CN	1-8	10 UP	MM5904CN	1-8	10 UP
MM5905CN	1-8	10 UP	MM5906CN	1-8	10 UP
MM5907CN	1-8	10 UP	MM5908CN	1-8	10 UP
MM5909CN	1-8	10 UP	MM5910CN	1-8	10 UP
MM5911CN	1-8	10 UP	MM5912CN	1-8	10 UP
MM5913CN	1-8	10 UP	MM5914CN	1-8	10 UP
MM5915CN	1-8	10 UP	MM5916CN	1-8	10 UP
MM5917CN	1-8	10 UP	MM5918CN	1-8	10 UP
MM5919CN	1-8	10 UP	MM5920CN	1-8	10 UP
MM5921CN	1-8	10 UP	MM5922CN	1-8	10 UP
MM5923CN	1-8	10 UP	MM5924CN	1-8	10 UP
MM5925CN	1-8	10 UP	MM5926CN	1-8	10 UP
MM5927CN	1-8	10 UP	MM5928CN	1-8	10 UP
MM5929CN	1-8	10 UP	MM5930CN	1-8	10 UP
MM5931CN	1-8	10 UP	MM5932CN	1-8	10 UP
MM5933CN	1-8	10 UP	MM5934CN	1-8	10 UP
MM5935CN	1-8	10 UP	MM5936CN	1-8	10 UP
MM5937CN	1-8	10 UP	MM5938CN	1-8	10 UP
MM5939CN	1-8	10 UP	MM5940CN	1-8	10 UP
MM5941CN	1-8	10 UP	MM5942CN	1-8	10 UP
MM5943CN	1-8	10 UP	MM5944CN	1-8	10 UP
MM5945CN	1-8	10 UP	MM5946CN	1-8	10 UP
MM5947CN	1-8	10 UP	MM5948CN	1-8	10 UP
MM5949CN	1-8	10 UP	MM5950CN	1-8	10 UP
MM5951CN	1-8	10 UP	MM5952CN	1-8	10 UP
MM5953CN	1-8	10 UP	MM5954CN	1-8	10 UP
MM5955CN	1-8	10 UP	MM5956CN	1-8	10 UP
MM5957CN	1-8	10 UP	MM5958CN	1-8	10 UP
MM5959CN	1-8	10 UP	MM5960CN	1-8	10 UP
MM5961CN	1-8	10 UP	MM5962CN	1-8	10 UP
MM5963CN	1-8	10 UP	MM5964CN	1-8	10 UP
MM5965CN	1-8	10 UP	MM5966CN	1-8	10 UP
MM5967CN	1-8	10 UP	MM5968CN	1-8	10 UP
MM5969CN	1-8	10 UP	MM5970CN	1-8	10 UP
MM5971CN	1-8	10 UP	MM5972CN	1-8	10 UP
MM5973CN	1-8	10 UP	MM5974CN	1-8	10 UP
MM5975CN	1-8	10 UP	MM5976CN	1-8	10 UP
MM5977CN	1-8	10 UP	MM5978CN	1-8	10 UP
MM5979CN	1-8	10 UP	MM5980CN	1-8	10 UP
MM5981CN	1-8	10 UP	MM5982CN	1-8	10 UP
MM5983CN	1-8	10 UP	MM5984CN	1-8	10 UP
MM5985CN	1-8	10 UP	MM5986CN	1-8	10 UP
MM5987CN	1-8	10 UP	MM5988CN	1-8	10 UP
MM5989CN	1-8	10 UP	MM5990CN	1-8	10 UP
MM5991CN	1-8	10 UP	MM5992CN	1-8	10 UP
MM5993CN	1-8	10 UP	MM5994CN	1-8	10 UP
MM5995CN	1-8	10 UP	MM5996CN	1-8	10 UP
MM5997CN	1-8	10 UP	MM5998CN	1-8	10 UP
MM5999CN	1-8	10 UP	MM6000CN	1-8	10 UP

ZENER DIODES

ZENER VOLTAGE	PRICE	ZENER VOLTAGE	PRICE
1.8	10 UP	4.7	10 UP
2.0	10 UP	5.1	10 UP
2.4	10 UP	5.6	10 UP
2.7	10 UP	6.2	10 UP
3.0	10 UP	6.8	10 UP
3.3	10 UP	7.5	10 UP
3.6	10 UP	8.2	10 UP
4.0	10 UP	9.1	10 UP
4.3	10 UP	10.0	10 UP
4.7	10 UP	11.0	10 UP
5.1	10 UP	12.0	10 UP
5.6	10 UP	13.0	10 UP
6.2	10 UP	14.0	10 UP
6.8	10 UP	15.0	10 UP
7.5	10 UP	16.0	10 UP
8.2	10 UP	17.0	10 UP
9.1	10 UP	18.0	10 UP
10.0	10 UP	19.0	10 UP
11.0	10 UP	20.0	10 UP
12.0	10 UP	21.0	10 UP
13.0	10 UP	22.0	10 UP
14.0	10 UP	23.0	10 UP
15.0	10 UP	24.0	10 UP
16.0	10 UP	25.0	10 UP
17.0	10 UP	26.0	10 UP
18.0	10 UP	27.0	10 UP
19.0	10 UP	28.0	10 UP
20.0	10 UP	29.0	10 UP
21.0	10 UP	30.0	10 UP
22.0	10 UP	31.0	10 UP
23.0	10 UP	32.0	10 UP
24.0	10 UP	33.0	10 UP
25.0	10 UP	34.0	10 UP
26.0	10 UP	35.0	10 UP
27.0	10 UP	36.0	10 UP
28.0	10 UP	37.0	10 UP
29.0	10 UP	38.0	10 UP
30.0	10 UP	39.0	10 UP
31.0	10 UP	40.0	10 UP
32.0	10 UP	41.0	10 UP
33.0	10 UP	42.0	10 UP
34.0	10 UP	43.0	10 UP
35.0	10 UP	44.0	10 UP
36.0	10 UP	45.0	10 UP
37.0	10 UP	46.0	10 UP
38.0	10 UP	47.0	10 UP
39.0	10 UP	48.0	10 UP
40.0	10 UP	49.0	10 UP
41.0	10 UP	50.0	10 UP
42.0	10 UP	51.0	10 UP
43.0	10 UP	52.0	10 UP
44.0	10 UP	53.0	10 UP
45.0	10 UP	54.0	10 UP
46.0	10 UP	55.0	10 UP
47.0	10 UP	56.0	10 UP
48.0	10 UP	57.0	10 UP
49.0	10 UP	58.0	10 UP
50.0	10 UP	59.0	10 UP
51.0	10 UP	60.0	10 UP
52.0	10 UP	61.0	10 UP
53.0	10 UP	62.0	10 UP
54.0	10 UP	63.0	10 UP
55.0	10 UP	64.0	10 UP
56.0	10 UP	65.0	10 UP
57.0	10 UP	66.0	10 UP
58.0	10 UP	67.0	10 UP
59.0	10 UP	68.0	10 UP
60.0	10 UP	69.0	10 UP
61.0	10 UP	70.0	10 UP
62.0	10 UP	71.0	10 UP
63.0	10 UP	72.0	10 UP
64.0	10 UP	73.0	10 UP
65.0	10 UP	74.0	10 UP
66.0	10 UP	75.0	10 UP
67.0	10 UP	76.0	10 UP
68.0	10 UP	77.0	10 UP
69.0	10 UP	78.0	10 UP
70.0	10 UP	79.0	10 UP
71.0	10 UP	80.0	10 UP
72.0	10 UP	81.0	10 UP
73.0	10 UP	82.0	10 UP
74.0	10 UP	83.0	10 UP
75.0	10 UP	84.0	10 UP
76.0	10 UP	85.0	10 UP
77.0	10 UP	86.0	10 UP
78.0	10 UP	87.0	10 UP
79.0	10 UP	88.0	10 UP
80.0	10 UP	89.0	10 UP
81.0	10 UP	90.0	10 UP
82.0	10 UP	91.0	10 UP
83.0	10 UP	92.0	10 UP
84.0	10 UP	93.0	10 UP
85.0	10 UP	94.0	10 UP
86.0	10 UP	95.0	10 UP
87.0	10 UP	96.0	10 UP
88.0	10 UP	97.0	10 UP
89.0	10 UP	98.0	10 UP
90.0	10 UP	99.0	10 UP
91.0	10 UP	100.0	10 UP

NON-LINEAR SYSTEMS, INC.

PORTABLE 15 MHz OSCILLOSCOPE

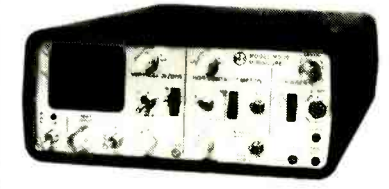

The MS-15 miniscope is only 2.7" x 6.4" x 7.5", and weighs only 3 lbs. Vertical bandwidth is 15 MHz. The graticuled rectangular viewing area is four divisions high by five divisions wide. Division spacing is 0.25 inches. Internal and external triggering, automatic and line synchronization modes, and a horizontal input are provided. There are 12 vertical gain settings from 0.01 V to 50 V per division, and twenty one time base settings from 0.1 μ s to 0.5 s per division. An optional 10 to 1 probe and a carrying case are also available. Power is provided by batteries or the 115 V, 60 Hz line.

MS-15	MINISCOPE	\$289.00
41-140	CARRYING CASE	30.00
41-141	10 TO 1 PROBE	24.50

ANCRONA

ALWAYS FIRST QUALITY COMPONENTS

PARATRONICS Logic Analyzer Kit



• Analyzes any type of digital system
• Checks data rates in excess of 8 million words per second
• Trouble shoot TTL, CMOS, DTL, RTL, Schottky and MOS families
• Displays 16 logic states up to 8 digits wide
• See ones and zeros displayed on your CRT, actual hexa-decimal format
• Tests circuits under actual operating conditions
• Easy to assemble - comes with step-by-step construction manual which includes 90 pages of logic analyzer operation

MODEL 100A	\$229.00/Kit
	\$295.00/Assembled

TRIGGER EXPANDER KIT - Model 10
Adds 16 additional Bits - Connects directly to Model 100A. (Optional baseplate permits mounting to 100A for integrated unit)
(Baseplate - \$12.00)

Model 10 - \$229.00/Kit - \$295.00/Assembled

AVAILABLE THROUGH MAIL ORDER ONLY

SPECIALS FOR NOVEMBER

.125 Dia RED LED XC209-H 11 for Si 00
MONSANTO - 7 SEGMENT DISPLAYS
MAN 71A 1.50 MAN 73A 1.50

7400 N SERIES TTL

1-9	10 UP	1-9	10 UP	1-9	10 UP
SN 7400N	\$1.16	SN 7474N	\$3.25	SN 74160N	\$1.20
SN 7402N	.28	SN 7483N	.69	SN 74161N	.99
SN 7404N	.18	SN 7486N	.38	SN 74162N	1.80
SN 7407N	.29	SN 7489N	2.40	SN 74163N	.98
SN 7408N	.25	SN 7490N	.44	SN 74164N	1.10
SN 7410N	.18	SN 7493N	.49	SN 74165N	1.10
SN 7411N	.27	SN 7495N	.78	SN 74166N	1.10
SN 7413N	.45	SN 74100N	.00	SN 74170N	2.00
SN 7414N	.70	SN 74104N	.50	SN 74171N	1.50
SN 7416N	.35	SN 74105N	.90	SN 74172N	1.20
SN 7417N	.35	SN 74107N	.58	SN 74173N	.90
SN 7420N	.21	SN 74109N	.36	SN 74177N	.90
SN 7425N	.29	SN 74121N	.39	SN 74178N	1.30
SN 7427N	.26	SN 74123N	.49	SN 74180N	.98
SN 7432N	.31	SN 74125N	.59	SN 74181N	2.40
SN 7437N	.27	SN 74126N	.59	SN 74182N	.94
SN 7438N	.27	SN 74128N	.58	SN 74184N	.90
SN 7442N	.58	SN 74132N	1.08	SN 74192N	.89
SN 7445N	.74	SN 74143N	4.50	SN 74193N	.89
SN 7446N	.80	SN 74145N	1.15	SN 74194N	1.20
SN 7450N	.22	SN 74148N	.70	SN 74195N	.75
SN 7451N	.22	SN 74150N	1.00	SN 74196N	1.25
SN 7453N	.22	SN 74152N	1.10	SN 74198N	1.70
SN 7454N	.20	SN 74153N	.88	SN 74199N	1

★ EZ-HOOK ★

EZ Hooks have been designed and field tested through the industry to save time and money in commercial electronic production and servicing. The spring-loaded hook attaches firmly, yet so gently it will not damage component — frees hands while testing. Durably constructed and fully insulated to a single contact point assuring true readings. Meets exacting laboratory and space age computer technology requirements. AVAILABLE IN 10 RETMA COLORS: Red, black, blue, green, orange, yellow, white, violet, brown or gray.

MICRO HOOK 

XM Micro Hook (1.75" long < 1 gram) for difficult IC Testing. Permits hookups to delicate wires where weight and leverage may damage component. \$.85 ea. Specify color. ORDER P/N XM

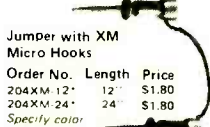
Jumper with XM Micro Hooks 

Order No.	Length	Price
204XM-12"	12"	\$1.80
204XM-24"	24"	\$1.80

Specify color.

XMS MICRO HOOK SET (includes 1 ea. red, black, blue, green, orange, yellow, white, brown, violet and gray Micro Hook). At this low price you can afford more than one set.

COMPLETE SET (10) MICRO HOOKS \$8.45

MINI HOOK 

X100W Mini Hook (2.25" long) combines rugged construction, miniature size and Finger-zip Hysto Action for all the best test connections. Hook is large enough for component leads, yet small enough to get into tight places. \$.80 ea. Specify color. ORDER P/N X100W

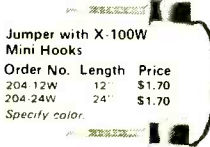
Jumper with X-100W Mini Hooks 

Order No.	Length	Price
204-12W	12"	\$1.70
204-24W	24"	\$1.70

Specify color.

Jumper X-100W Mini Hook to Stacking Banana Plug 

Order No.	Length	Price
201W	32"	\$1.45

Specify color.

Jumper with X-100W Mini Hook 

Order No.	Length	Price
201XM	32"	\$1.50

EXTRA LONG MINI HOOK 

XL-1 Mini Hook (5.0" long) combines all the proven features of the X-100W with an extra long body. It will make safe, short-free test connections in card racks and through deep wiring nest up to 4". ORDER P/N XL-1. Specify color. \$1.30

JUMPER, XL-1 MINI HOOK TO STACKING BANANA PLUG 

Order No.	Length	Price
201XL-1	32"	\$2.05

Specify color.

RCA COSMAC MICROPROCESSOR Integrated Circuits

COP18020C	COSMAC CPU	\$19.95
COP18210C	1024 x 1 Static CMOS Ram	14.75
COP18220C	756 x 4 Static CMOS Ram	15.50
COP18240C	32 x 8 Static CMOS Ram	\$7.75
COP18520C	Byte I/O Port	8.25
COP18560C	Bus Separator/Buffer (Memory)	5.50
COP18570C	Bus Separator/Buffer (I/O)	5.50

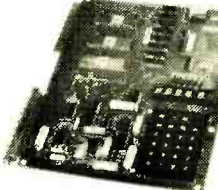
KIM-1 MICROCOMPUTOR 

KIM-1—Computer Module from MOS Technology. 1K RAM, 2K ROM (with timing system executive). Complete audio cassette interface, 15 bidirectional I/O lines, a 24 key keyboard and a six digit LED display.

Documentation—KIM-1 Users Manual \$500 Hardware Manual, and \$500 Programming Manual.

Fully Assembled Only \$245.00

Fully Tested

QUITE PORTABLE VERY AFFORDABLE AND UNBELIEVABLY VERSATILE the PET computer may very well be a lifetime investment



PET MODEL 2001

PET MODEL 2001

\$595.00 with 4K RAM
\$795.00 with 8K RAM

SPECIFICATIONS
DIMENSIONS: LWD 18-1/2" x 16-1/2" x 14" WEIGHT 44 lbs

MEMORY
RAM (user) 4K (8K OPT) exp to 32K ROM (resident operating system) 14K BK-BASIC interpreter 4K Operating system 1K Diagnostic routine 1K Machine language monitor

VIDEO DISPLAY UNIT
9" low high-resolution CRT • 1000 char display 40 col by 25 lines • 8x8 dot matrix for characters and continuous graphics • Auto scrolling from bottom of screen • Winking cursor with full motion control • Reverse field on all characters • 64 standard ASCII char, 64 graphic char

KEYBOARD
9-1/2" wide x 3" deep, 73 keys • All 64 ASCII characters available without shift • Calculator style numeric key pad • All 64 graphic and reverse field characters accessible from keyboard (with shift) Control: Control Clear and erase • Editing: Character insertion and deletion

CASSETTE STORAGE
Fast recording/retrieval scheme assuring reliable data recovery • Modified field for higher reliability of recording and record retention • High noise immunity, error detection and correction • Uses standard audio cassette tapes • Tape files named

OPERATING SYSTEM
Supports multiple languages • Machine language accessibility • File management in operating system • Cursor control, reverse field and graphics under simple BASIC control • Cassette file management from BASIC • True random number generation or pseudo random sequence

INPUT/OUTPUT
All other I/O supported through IEEE-488 instrument interface which allows for multiple intelligent peripherals • All I/O automatically managed by resident system software • Simple character I/O with GET command • Easy strip-line-wire capability • Flexible I/O structure allows for BASIC expansion with intelligent peripherals

BASIC INTERPRETER
Expanded BK BASIC • Upward expansion from current popular BASIC language • Strings, integers and multidim arrays • High-resolution 110 significant digit • Direct memory access through PEEK and POKE commands

ALLOW 60 TO 90 DAYS DELIVERY

CAPACITORS

50V CERAMIC DISC \$1.00 Per Package

50pf	9/pk	300pf	7/pk	0047mf	9/pk
150pf	9/pk	330pf	7/pk	005mf	9/pk
25pf	9/pk	390pf	7/pk	01mf	9/pk
27pf	9/pk	470pf	7/pk	015mf	8/pk
47pf	8/pk	560pf	7/pk	02mf	8/pk
68pf	8/pk	680pf	7/pk	022mf	8/pk
100pf	8/pk	001mf	9/pk	03mf	8/pk
150pf	8/pk	0015mf	9/pk	039mf	7/pk
220pf	8/pk	0022mf	9/pk	047mf	7/pk
270pf	7/pk	003mf	9/pk	1mf	6/pk

PLESSEY POLYESTER MINI BOX

MF	V	S	MF	V	S	MF	V	S
001	1000	14	012	630	14	15	100	20
002	1000	14	015	400	15	18	100	21
0015	1000	14	018	400	15	22	100	23
0018	1000	14	022	400	15	27	100	26
0022	1000	14	027	400	15	33	100	30
0027	1000	14	033	250	15	39	100	33
0033	1000	14	039	250	15	47	100	36
0039	630	14	047	250	15	56	100	44
0047	630	14	056	250	15	68	100	47
0056	630	14	068	250	15	82	100	54
0068	630	14	082	250	17	100	100	60
0082	630	14	1	100	17			
01	630	14	12	100	18			

MATSUO DIPPED TANTALUM

MF	V	S	MF	V	S	MF	V	S
1	35	33	2	20	33	10	30	35
15	35	33	2	35	40	15	20	45
22	35	33	3	35	42	15	30	45
33	35	33	4	35	45	22	16	45
47	35	33	6	16	40	33	20	132
68	35	33	8	35	45	10	30	153
10	35	33	10	16	47	68	16	162
15	35	40	10	25	45			

1% MICA 500V

51 PF	29	220 PF	41	1500 PF	60
62 PF	29	240 PF	41	2000 PF	90
75 PF	29	300 PF	50	2200 PF	94
82 PF	29	390 PF	50	4700 PF	1.80
100 PF	30	470 PF	50	5100 PF	1.80
120 PF	32	620 PF	52	10000 PF	3.60
150 PF	35	820 PF	53		
180 PF	41	1000 PF	60		

ALUMINUM ELECTROLYTIC (RADIAL LEAD)

MF	V	S	MF	V	S	MF	V	S
10	12	10	16	15	10	33	35	30
15	12	10	22	10	35	30	330	50
15	16	10	22	16	33	25	24	50
1	25	14	10	15	22	33	30	220
1	35	10	22	10	33	20	23	470
1	35	10	22	16	33	20	23	470
5	10	13	22	10	15	47	16	18
5	10	13	22	16	16	47	25	24
5	10	13	22	25	16	35	270	50
5	10	13	22	33	25	270	50	1000
5	10	13	22	47	25	270	50	1000
5	10	13	22	68	25	270	50	1000
5	10	13	22	100	25	270	50	1000
5	10	13	22	150	25	270	50	1000
5	10	13	22	220	25	270	50	1000
5	10	13	22	330	25	270	50	1000
5	10	13	22	470	25	270	50	1000
5	10	13	22	680	25	270	50	1000

Intersil 3 1/2 DIGIT PANEL METER

LCD or LED KITS

BUILD A WORKING DPM IN 1/2 HOUR WITH THESE COMPLETE EVALUATION KITS



Test these new parts for yourself with Intersil's low cost prototype kits, complete with A/D converter and LCD display (for the 7106) or LED display (for the 7107). Kits provide all materials, including PC board, for a functioning panel meter

ICL7106EV (LCD) \$29.95 **ICL7107 (LED) \$24.95**

RESISTOR KITS 5% CARBON FILM RESISTORS

Only in Multiples of 100 pcs per value (ohms)

1/4W... \$1.69 per 100
1/2W... \$1.79 per 100

10	100	1.0K	10K	100K	1.0M
11	110	1.1K	11K	110K	1.1M
12	120	1.2K	12K	120K	1.2M
13	130	1.3K	13K	130K	1.3M
15	150	1.5K	15K	150K	1.5M
16	160	1.6K	16K	160K	1.6M
18	180	1.8K	18K	180K	1.8M
20	200	2.0K	20K	200K	2.0M
22	220	2.2K	22K	220K	2.2M
24	240	2.4K	24K	240K	2.4M
27	270	2.7K	27K	270K	2.7M
30	300	3.0K	30K	300K	3.0M
33	330	3.3K	33K	330K	3.3M
36	360	3.6K	36K	360K	3.6M
39	390	3.9K	39K	390K	3.9M
43	430	4.3K	43K	430K	4.3M
47	470	4.7K	47K	470K	4.7M
51	510	5.1K	51K	510K	5.1M
56	560	5.6K	56K	560K	5.6M
62	620	6.2K	62K	620K	6.2M
68	680	6.8K	68K	680K	6.8M
75	750	7.5K	75K	750K	7.5M
82	820	8.2K	82K	820K	8.2M
91	910	9.1K	91K	910K	9.1M

RESISTOR ASSORTMENTS

Each assortment contains 5 pcs each of 10 different values. Values included are shown with 10 Ohm tolerance

1/4W, 5% (50 pcs total) \$1.75 / 1/2W, 5% (50 pcs total) \$1.85

Ass 1: 10 12 15 18 22 27 33 39 47 56 ohm
Ass 2: 68 82 100 120 150 180 220 270 330 390 ohm
Ass 3: 470 560 680 820 ohm 1K 1.2K 1.5K 18K 2.2K 2.7K
Ass 4: 3.3K 3.9K 4.7K 5.6K 6.8K 8.2K 10K 12K 15K 18K
Ass 5: 22K 27K 33K 39K 47K 56K 68K 82K 100K 120K
Ass 6: 150K 180K 220K 270K 330K 390K 470K 560K 680K

Ass 7: 1M 1.2M 1.5M 1.8M 2.2M 2.7M 3.3M 3.9M 4.7M 5.6M
(\$W Assortment No 7 doesn't include 5.6M)

Ass 8R: (A) seven assortments above
1/4W 5% 350 pcs total \$10.95 1/2W 5% 350 pcs total \$11.55

SanKen HYBRID AUDIO POWER AMPLIFIERS

• Multi-purpose linear amplifiers for commercial and industrial applications.
• Less than 0.5% harmonic distortion at full power level.
• 1/2 dB response from 20 to 100,000 Hz.
• Single or split (dual) power supply.
• Rugged, compact and lightweight packages
• Built-in current limiting for SI-1050G and efficient heat radiating construction.

TYPICAL CONNECTIONS
SI-1050G WITH SPLIT SUPPLY

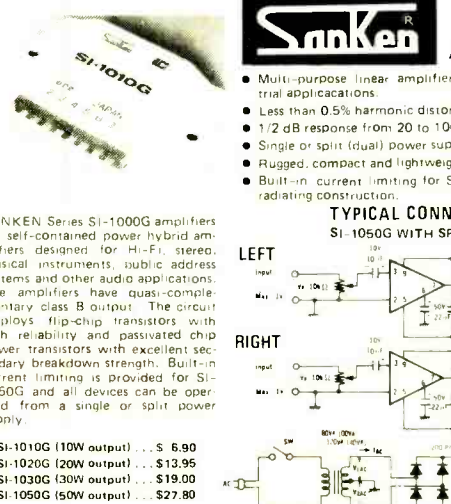

SANKEN Series SI-1000G amplifiers are self-contained power hybrid amplifiers designed for Hi-Fi, stereo, musical instruments, public address systems and other audio applications. The amplifiers have quasi-complementary class B output. The circuit employs flip-chip transistors with high reliability and passivated chip power transistors with excellent secondary breakdown strength. Built-in current limiting is provided for SI-1050G and all devices can be operated from a single or split power supply.

SI-1010G (10W output)	...	\$ 6.90
SI-1020G (20W output)	...	\$13.95
SI-1030G (30W output)	...	\$19.00
SI-1050G (50W output)	...	\$27.80

Data Sheet with Application Notes — \$0.50

SOCKET FOR SANKEN AUDIO AMPLIFIERS

FOR 10 & 20W A.S.I.B. \$95
FOR 30 & 50W A.S.I.LO \$95

DIP SOCKETS

Profile	8 Pin	14 Pin	16 Pin	20 Pin	25 Pin	28 Pin	36 Pin	40 Pin
LOW PROFILE SOLDER TIN	1-24	25-49	50 UP					
STANDARD SOLDER GOLD	8 Pin	16	15	14				
	14 Pin	19	18	17				
	16 Pin	21	20	19				
	40 Pin	62	61	60				
WIREWAP GOLD (Level No. 3)	8 Pin	30	27	24				
	14 Pin	35	32	29				
	16 Pin	38	35	32				
	40 Pin	1.75	1.59	1.45				
	14 Pin	39	38	37				
	16 Pin	43	42	41				

ANCRONA

Send Check or Money Order to P.O. Box 2208, Culver City, Calif. 90230. Calif. residents add 6% sales tax. Minimum Order \$10.00 ADD \$1.00 to cover postage and handling. Master Charge and Bankam-card welcomed (include your card number and exp. date).

TELEPHONE ORDERS: Call (213) 641-4064

VISIT ONE OF OUR STORES TODAY

CALIFORNIA ANCRONA 11080 Jefferson Blvd Culver City, CA 90230 (213) 390-3595	CALIFORNIA ANCRONA 1300 E Edinger Ave Santa Ana, CA 92705 (714) 547-8424	CANADA, B.C. ANCRONA 5666 Fraser St Vancouver, B.C. V5W 2V4 (604) 324-0707
OREGON ANCRONA 1125 N E 82nd Ave Portland, OR 97220 (503) 254-5541	GEORGIA ANCRONA 3330 Piedmont Rd. NE Atlanta, GA 30305 (404) 261-7100	ARIZONA ANCRONA 4518 E Broadway Tucson, AZ 85711 (602) 881-2348
TEXAS ANCRONA 264		

MORE THAN 20,000 DIFFERENT COMPONENTS

7400 TTL				
7400	.18	7442	1.08	74107 .49
7401	.21	7448	1.15	74121 .55
7402	.21	7450	.26	74122 .49
7404	.21	7451	.27	74123 1.05
7405	.24	7453	.27	74125 .60
7407	.45	7454	.41	74126 .81
7408	.25	7460	.22	74132 3.00
7409	.25	7473	.39	74141 1.15
7410	.20	7473	.45	74150 1.10
7411	.30	7474	.45	74151 1.25
7413	.85	7475	.80	74153 1.35
7416	.43	7482	1.75	74154 1.54
7417	.43	7483	1.15	74157 1.30
7420	.21	7485	1.12	74161 1.45
7422	1.50	7486	.45	74164 1.65
7425	.43	7489	.49	74165 1.65
7427	.37	7490	2.69	74166 1.70
7428	.35	7491	1.20	74174 1.95
7430	.26	7492	.82	74175 1.95
7432	.31	7493	.82	74180 1.05
7437	.47	7494	.91	74181 3.55
7438	.40	7495	.91	74191 1.50
7440	.21	7498	.64	74195 1.00
7441	1.10	74100	1.25	74197 1.00

743L SERIES TTL				
74L00	.33	74LS04	.45	74LS113 .98
74L10	.33	74LS10	.39	74LS138 1.38
74L30	.33	74LS20	.39	74LS174 2.50
74L42	1.50	74LS51	.39	74LS386 5.50
74L86	.69	74LS74	.65	74LS153 2.25
74LS00	.39	74LS112	.65	74S387 1.95

74H00 TTL				
74H00	.33	74H11	.33	74H53 .39
74H01	.33	74H20	.33	74H55 .39
74H04	.33	74H21	.33	74H73 .59
74H05	.35	74H30	.33	74H74 .59
74H10	.33	74H40	.33	74H76 .65

MOTOROLA				
MC663P	2.50	MC1460	3.95	
MC666P	1.60	MC1469R	2.50	
MC670P	1.60	MC1488	4.60	
MC679P	2.50	MC1496	1.65	
MC725P	1.50	MC1510G	8.00	
MC789P	1.50	MC1514L	4.50	
MC790P	1.50	MC1595L	6.25	
MC817P	1.30	MC1723CG	3.60	
MC836P	1.35	MC1741CG	1.20	
MC844	1.25	MC1810P	1.25	
MC853P	2.25	MC3004L	2.25	
MC876P	2.25	MC3077P	2.25	
MC1004L	1.25	MC3021L	2.25	
MC1010L	1.25	MC3060L	2.65	
MC1305	1.95	MC3062L	3.00	
MC1352P	1.55	MC4024P	2.20	
MC1357	1.70	MC4044P	4.80	
MC1371	1.85	MC14507CP	1.25	
MC1439	2.65	MC14511CP	2.76	
MC1458P	.50	MC14512CP	1.70	

CMOS				
4001AE	.29	4023AE	.29	
4002AE	.29	4024AE	1.50	
4007AE	.29	4025AE	.35	
4010AE	.58	4028AE	1.60	
4011AE	.29	4029AE	2.90	
4012AE	.29	4030AE	.65	
4015AE	1.25	4037AE	4.50	
4016AE	.65	4040AE	2.40	
4018AE	1.10	4044AE	1.50	
4019AE	.65	4049AE	.75	
4020AE	1.75	4050AE	.75	
4021AE	1.50			

RECTIFIERS				
1N4001	.60	2N2160	.65	MU4892.50
1N4002	7.0	2N2647	.55	MU4894.50
1N4003	.80	2N4851	.75	2N6027 .55
1N4004	.90	2N4852	.75	2N6028 .70
1N4005	1.00	2N4870	.50	D5E37 .35
1N4006	1.10	2N4871	.50	MU10 .35
1N4007	1.20	11.00	MU4891 .50	MU20 .40

LINEAR				
75450BP	.49	LM301H	.35	LM741CH .46
75451BP	.39	LM307H	.35	LM747 .90
75452BP	.39	LM309K	1.25	LM748H .80
75453BP	.39	LM311H	.90	LM1458N .45
75454BP	.39	LM318N	1.50	N5556V 1.50
75491BP	.79	LM339N	1.85	NE5556V 1.00
75492BP	.85	LM351AN	.65	NE5556V .60
CA3005	1.80	LM370N	1.25	NE5556 .150
CA3006	3.50	LM380N	1.45	UA702 .80
CA3018	1.80	LM566	2.25	UA703CH .45
CA3018A	1.60	LM711CH	.80	UA709CH .30
CA3026	1.50	LM723H	.75	UA749CH .45
CA3046	.35	LM741CN	.45	

NEW FROM NEW-TONE
Dry Transfer Patterns for PC Boards, Includes IC pads, donuts, angles, and 3-and 4-connector pads. Over 225 patterns on a 2" x 7 1/4" sheet..... \$1.49

PC BOARDS - MIL GRADE
Glass-epoxy. 2 oz. copper.
 6" x 3" \$.50 • 6" x 6" \$.90 • 6" x 8" \$1.20

5400 SERIES VOLT.REG				
5400	1.00	5475	1.50	LM340K-5 1.95
5404	1.25	5486	1.90	LM340K-6 1.95
5410	1.00	5493	2.00	LM340K-8 1.95
5426	1.25	54100	1.80	LM340K-15 1.95
5473	1.50	54LS04	1.00	LM340K-18 1.95
				LM340K-24 1.95
				LM340T0-5 1.75
				LM340T0-6 1.75
				LM340T0-8 1.75
				LM340T0-12 1.75
				LM340T0-15 1.75
				LM340T0-18 1.75
				LM340T0-24 1.75

RESISTORS
 1/4 Watt ± 5% Packed 5 of any one value \$.25
 1/2 Watt ± 5% Packed 5 of any one value \$.30
 STANDARD RESISTANCE VALUES

MINIMUM ORDER \$5.00
 All orders add \$1.00 Postage and Handling.
 Canada \$1.50.
 N.J. Residents add 5% sales tax

ELECTROLYTIC CAPACITORS					
2.2MF50	Axial Leads	.15	30MF25	Axial Leads	.18
3.3MF10	Axial Leads	.15	47MF25	Radial Leads	.19
3.3MF10	No Polarity	.15	47MF50	Radial Leads	.24
10MF25	Axial Leads	.15	100MF16	Radial Leads	.19
10MF50	Axial Leads	.16	100MF25	Axial Leads	.24
10MF150	Axial Leads	.20	500MF50	Axial Leads	.60
25MF35	Axial Leads	.18	1000MF35	Axial Leads	.65

MICROPROCESSOR					
C1702A	9.95	2708	34.95	8008	19.95
2101	5.75	C5101-3	4.50	8080A	19.95
2102	1.75	MM5013	3.25	8224	10.45

Contact us for all your microprocessor needs.

HARDWARE - SOCKETS
 Nylon Screws, Nuts and Rivets - 50 piece assortment \$1.99
 MK 20 TO-3 Mounting Kit \$5 for \$9.99
 NT-505 Mica and bushing. Specify TO-3, TO-66 or TO-220
 IC Sockets: 14-Pin DIL \$.25 each, 16-Pin DIL \$.27 each, IC Socket \$.32 each, Wire Wrap \$.32 each

JAPANESE TRANSISTORS									
2SA473	.75	2SC373	.70	2SC776	3.00	2SC1306	4.75	2SD180	2.75
2SA484	3.00	2SC374	.70	2SC777	4.00	2SC1307	5.75	2SD187	.80
2SA489	.80	2SC375	.65	2SC778	4.00	2SC1308	4.75	2SD188	.95
2SA495	1.85	2SC380	.70	2SC781	3.00	2SC1317	.80	2SD201	1.95
2SA496	1.15	2SC381	.70	2SC784	1.00	2SC1318	.70	2SD213	3.75
2SA497	1.00	2SC382	.70	2SC785	1.00	2SC1327	.70	2SD218	4.75
2SA562	.70	2SC387	.70	2SC788	2.15	2SC1342	.50	2SD223	4.50
2SA564	.50	2SC394	.70	2SC789	1.00	2SC1347	.80	2SD234	1.00
2SA606	4.25	2SC403	.65	2SC790	1.75	2SC1359	.85	2SD235	1.00
2SA628	.85	2SC454	.65	2SC793	2.50	2SC1377	5.50	2SD257	2.00
2SA634	1.25	2SC458	.70	2SC798	3.10	2SC1382	1.00	2SD261	.80
2SA636	1.25	2SC460	.70	2SC799	3.50	2SC1383	.75	2SD287	4.00
2SA643	.85	2SC478	.80	2SC815	.75	2SC1384	.85	2SD288	1.00
2SA673	.85	2SC481	1.85	2SC821	4.00	2SC1447	1.25	2SD291	.85
2SA678	.75	2SC482	1.75	2SC828	.75	2SC1448	1.25	2SD300	2.50
2SA679	3.75	2SC484	3.75	2SC829	.75	2SC1449	1.30	2SD313	1.10
2SA680	3.75	2SC485	3.25	2SC830	1.60	2SC1475	1.50	2SD314	1.10
2SA682	.85	2SC493	2.75	2SC838	.70	2SC1507	1.25	2SD315	.75
2SA683	90	2SC494	3.50	2SC839	.85	2SC1569	1.25	2SD318	.95
2SA684	95	2SC495	1.10	2SC853	1.00	2SC1675	1.75	2SD325	1.25
2SA689	1.30	2SC496	1.15	2SC866	5.85	2SC1678	5.50	2SD330	1.50
2SA699A	1.45	2SC497	1.60	2SC871	.70	2SC1679	4.75	2SD331	.90
2SA706	.55	2SC502	1.50	2SC900	2SC1728	2.15	2SD350	3.25	
2SA733	.85	2SC509	1.25	2SC922	.55	2SC1730	.60	2SD360	1.50
2SA777	90	2SC515	.80	2SC929	2SC1756	1.25	2SCF8	3.50	
2SB22	.65	2SC517	4.25	2SC930	2SC1760	2.15	2SCF6	1.25	
2SB54	.70	2SC535	.75	2SC938	2SC1816	4.50	2SF8	3.00	
2SB56	.70	2SC536	.65	2SC945	2SC1908	.70	HEPS3001	3.25	
2SB77	.70	2SC537	.70	2SC1000	2SC1909	4.75	JSP7001	.75	
2SB175	.55	2SC608	4.90	2SC1013	1.50	2SC1957	1.50	MRF8004	3.00
2SB186	.60	2SC609	4.90	2SC1014	1.50	2SC1964	4.75	MFS8000	1.25
2SB187	.60	2SC610	3.80	2SC1017	1.50	2SC1973	1.50	MFS9001	1.25
2SB324	1.00	2SC619	.70	2SC1018	1.50	2SC1974	1.90	MFSU02	.50
2SB337	1.75	2SC620	.80	2SC1034	3.50	2SC1975	4.90	MFSU31	4.00
2SB387	1.60	2SC627	1.75	2SC1060	.75	2SC2020	2.50	SD1074	19.95
2SB370	.65	2SC634A	.65	2SC1061	1.65	2SC2027	6.00	SD1076	28.95
2SB405	.85	2SC644	.70	2SC1079	3.75	2SC2028	1.10	SK3047	3.75
2SB407	1.65	2SC674	.60	2SC1080	3.75	2SC2029	4.75	SK3048	3.25
2SB415	.85	2SC708	3.00	2SC1096	1.20	2SC2034	3.00	SK3049	4.75
2SB435	.75	2SC710	.70	2SC1098	1.15	2SC2074	3.00	SK3054	1.25
2SB461	1.25	2SC711	.70	2SC1115	2.50	2SC2075	5.50	SK319	1.75
2SB463	1.85	2SC712	.70	2SC1116	4.00	2SC2091	1.10	SK330A	1.00
2SB474	1.50	2SC715	.70	2SC1124	1.25	2SC2092	4.75	SK33A	1.20
2SB481	2.10	2SC730	.65	2SC1166	.70	2SC2166	4.75	SK41	1.75
2SB492	1.25	2SC814	3.00	2SC1170	4.00	2SD45	2.00	SK322Y	2.75
2SB495	.95	2SC732	.70	2SC1172	4.00	2SD68	1.90	SK340	2.75
2SB507	.90	2SC733	.70	2SC1172B	4.25	2SD72	1.00	SK345	2.75
2SB511	.70	2SC734	.70	2SC1173	.95	2SD77	1.00	SK349	2.75
2SC116	3.00	2SC735	.70	2SC1209	.75	2SD81	3.25	4004	3.00
2SC183	1.00	2SC738	.70	2SC1211	.75	2SD88	1.50	4005	3.00
2SC184	1.00	2SC756	3.00	2SC1213	1.00	2SD92	1.50	4008	1.25
2SC281	.65	2SC763	.70	2SC1226A	1.25	2SD118	3.25	40081	1.50
2SC371	.70	2SC774	1.75	2SC1237	4.50	2SD130	1.25	40082	3.00
2SC372	.70	2SC775	2.75	2SC1239	4.00	2SD170	2.00		

IC's ON THE MOVE
 BBD BUCKET BRIGADE DEVICE
 MM3001 19.50 MN3002 11.70 MM3003 39.45
 HALL IC: DN834 1.25 DN837 1.50
 DN835 1.35 DN838 (

Watch for our supermarket bargains each month!

POLY PAKS® IS THE WORLD'S LARGEST ELECTRONIC SUPERMARKET DISCOUNT

DEC. 77 POP ELECTRONICS SPECIALS

"GEL-SEL" POWER PAK

Rechargeable! Perfect for back-up power for computers, alarms, and more. Sealed, spill-proof, leak-proof. Better than Ni-CADS, recharges to 100% capacity. Compact, only 4" x 3" x 2", stack 'em in series or parallel. Lead or lead/antimony gel (sorry, no choosing).
6 V
1000 MILS
 No. 12E4088 **\$4.95**

100 KHz* MARKER CRYSTALS

Build your own marker generator at 100, 200, 300 KHz etc. Calibrate receivers, ham rigs and more. Accuracy: 0.001%, size 1/2" x 1/4" x 1/8". Instructions for building marker generator. 100 KHz after trimming. Wt. 1 oz.
 Order by Cat. No. 12E3896 **\$2.95**
 104.067 KHz 105.000 KHz
 104.092 KHz 114.000 KHz

POLY PAKS "CHIPS" AWAY IC PRICES!

Order Cat. No. 12E4048 and Type No.

Type	Sale	
ICM7205	Stopwatch	\$14.95
A13-8500-1	Six V Games	9.95
MM5330	4 1/2 Digit VOM	4.95
8038C	Volt Control Osc	4.95
KR2376	Encoder ROM BCD	6.95
95H900C	350 MHz Prescaler	8.88
MC14410	Touch Tone Encoder	9.95
MK2002P	Char. Gen. (2513 equal)	3.95
72074/7208	Frequency Counter, pair	29.95
ICM7107	3 1/2 Digit DPM	12.50
MM5316	Alarm Clock	2.95
80B0A	Microprocessor	14.95
1702A	Erasable PROM	4.95
9K EPROM	8K EPROM	22.88
2102-1	1K RAM	1.39

RCA "POCKET" VOM

Model WV-509A Features 1000 ohms per volt. 100% precision movements diode protected against burnout. Measures DC volts 0-15-150-1000, AC volts 0-15-150-1000, DC current 0-150mA, resistance X1000. Sensitivity 1000 ohms/volt AC-DC. Leaky positive cell, not included. Size 2 1/2" x 1 3/4" x 1 1/2". Wt. 5 ozs. x 3/4". Cat. No. 12E3921 **\$8.88**

CONDENSER MIKE "TIE PIN" TYPE

It's a little giant in sound quality. Metal encased with built-in FET circuit, omnidirectional. Frequency 20-12,000Hz. Less tie pin or label clip. 600 ohm impedance. 1.5VDC. No. 12E3178 **4.95**

7/16" x 7/8" long

AM-FM-MPX TUNER AMP

4D Matrix for 2 & 4 speaker systems. Wall/Console. Contemporary design black and chrome front panel.

The Philharmonic
 SPECIFICATIONS: AMP: Power out 5W x 2 RMS, both channels into 8 ohms. 10-20000 Hz. THD 0.9%. Freq. resp. 15-20,000 ± 2db. S/N ratio 55db. FM: Sens 2.7 uV for 20 db S/N. Requires 110VAC 60 Hz. Size 1 1/2" x 1 3/4" x 3 3/4". Wt. 1 lbs.

12E4007 **\$69.95**

LAB-N-HOBBY TEST EQUIPMENT FACTORY OVERSTOCK TRANSISTOR CHECKER

DYNAMIC Tests NPN, PNP, Poppers and unknown sem's. Simple to use. Both in-or-out of circuit. Automatically identifies polarity. Tests leakage, matches similar transistors. Use with VOM to test noise, dynamic leakage and more. Built-in check test socket. Requires 1 1/2" V.D. cell. With instructions. 2 1/2" x 2 x 5". Wt. 16 ozs. Cat. No. 12E3933 **\$14.95**

STEREO TO QUAD ADAPTOR

Derives quad sound from stereo. Works with all models. 12E3910 also, makes, hooks up in seconds. Gives the feel of a "live" performance. No power necessary. Inputs 2 RCA jacks. Outputs 4 RCA jacks. Size: 3 1/4" x 2 1/2" x 2". Wt. 14 ozs.

12E3934 **\$12.95**

WESTINGHOUSE "SKINNY-TRIMS"

6 for \$250

OHMS	10	20	50	100	200	500	1000
Wattage	20	40	100	200	400	1000	2000

12E3863 25 Turn upright, type 64
 12E3864 25 Turn flat, type 64
 12E3866 Single turn flat, type 63

"CB" POWER SUPPLY

16.88 (4 AMPS)
 19.95 (3 AMPS)

Ideal for CB's, Ham rigs, tape decks & more! Modern cabinet, 5 x 4 1/2 x 2 1/2" with on/off switch, LED lamp, built-in circuit breaker. Size: 5 1/2" x 4 1/2" x 2 1/2". Wt. 5 lbs. Cat. No. 12E3452

SANTA'S BARGAINS

1-AMP REGULATED POWER SUPPLY

New! Easy to assemble! Uses LM440K positive voltage regulator. Reverse leads for a negative supply. Buy 2! for a 2-amp power supply! With transformer, regulator, PCB board & all components. Complete kit, nothing else to buy. Wt. 4 lbs.

Your choice **\$8.88**

Cat. No. Volts 2 for
 12E3854 5 \$15.95
 12E3857 12
 12E3858 15

WYS

BUY 100 25% OFF
 BUY 10 15% OFF

We know we have the lowest prices!

Type	Sale	& Type No.	
SN7460	.20	SN7461	.20
SN7401	.14	SN7462	.14
SN7402	.14	SN7463	.14
SN7403	.14	SN7464	.14
SN7404	.17	SN7465	.14
SN7405	.18	SN7470	.28
SN7406	.17	SN7471	.69
SN7407	.24	SN7472	.31
SN7410	.14	SN7473	.31
SN7411	.19	SN7474	.31
SN7412	.14	SN7475	.31
SN7414	.61	SN7476	.31
SN7416	.24	SN7477	.79
SN7417	.24	SN7478	.31
SN7420	.14	SN7479	.31
SN7423	.26	SN7480	.33
SN7427	.26	SN7482	.33
SN7430	.14	SN7483	.69
SN7432	.24	SN7485	.88
SN7437	.24	SN7486	.88
SN7438	.24	SN7488	2.95
SN7439	.14	SN7490	.69
SN7441	.79	SN7491	.63
SN7442	.69	SN7492	.63
SN7443	.61	SN7493	.45
SN7444	.61	SN7494	.69
SN7445	.69	SN7495	.69
SN7447	.69	SN7496	.69
SN7449	.14	SN7497	.77
SN7451	.14	SN7498	.69
SN7453	.14	SN7499	.69
SN7454	.14	SN7500	.69
SN7455	.14	SN7501	.69

BARREL KITS EXCLUSIVE

TEST 'EM YOURSELF - SAVE!

GUARANTEED 50% YIELD ON UNTESTED.....

Buy 10 BARREL KITS AND CHOOSE THE 11TH KIT FREE

BARREL KIT #203 CALCULATOR KEYBOARDS 10 for \$1.98	BARREL KIT #253 LINE CORDS 8 for \$1.98	BARREL KIT #35 120V LAMPS 30 for \$1.98	BARREL KIT #244 1702A ROMS 3 for \$1.98	BARREL KIT #201 6V INDICATORS w/leads 15 for \$1.98	BARREL KIT #210 GLOWIN' PANELS 3 for \$1.98	BARREL KIT #276 1-WATT ZENERS 100 for \$1.98	BARREL KIT #188 400 PARTS \$1.98
BARREL KIT #225 SOUND TRIGGERS 3 for \$1.98	BARREL KIT #221B IC SOCKETS 8 for \$1.98	BARREL KIT #205 MINI BLOCK CAPACITORS 50 for \$1.98	BARREL KIT #201 6V INDICATORS w/leads 15 for \$1.98	BARREL KIT #210 GLOWIN' PANELS 3 for \$1.98	BARREL KIT #276 1-WATT ZENERS 100 for \$1.98	BARREL KIT #188 400 PARTS \$1.98	BARREL KIT #127 AXIAL ELECTROS 40 for \$1.98
BARREL KIT #184 1/4-WATT METAL FILM 150 for \$1.98	BARREL KIT #182 JUMBO RED LEADS 15 for \$1.98	BARREL KIT #163 MINI TRIM POTS 30 for \$1.98	BARREL KIT #160 HOBBY VOLTAGE REGULATORS 10 for \$1.98	BARREL KIT #138 MINI-DIP IC'S 100 for \$1.98	BARREL KIT #128 MINI-DIP IC'S 100 for \$1.98	BARREL KIT #128 MINI-DIP IC'S 100 for \$1.98	BARREL KIT #127 AXIAL ELECTROS 40 for \$1.98
BARREL KIT #126 UPRIGHT ELECTROS 40 for \$1.98	BARREL KIT #115 MOLEX SOCKETS 150 for \$1.98	BARREL KIT #109 TERMINAL STRIPS 100 for \$1.98	BARREL KIT #104 SLIDING VOLUME CONTROLS 10 for \$1.98	BARREL KIT #101 RESISTOR SPECIAL 200 for \$1.98	BARREL KIT #99 PHOTO ELECTRIC CELLS 200 for \$1.98	BARREL KIT #81 POLYSTYRENE CAPS 100 for \$1.98	BARREL KIT #83 HALF WATTERS 200 for \$1.98
BARREL KIT #87 NAT. IC BONANZA! 100 for \$1.98	BARREL KIT #86 HOBBY LEADS 40 for \$1.98	BARREL KIT #83 LM-340T VOLTAGE REGULATORS 15 for \$1.98	BARREL KIT #71 CAPACITOR SPECIAL 100 pcs. \$1.98	BARREL KIT #68 2 WATTERS 100 for \$1.98	BARREL KIT #61 POLYSTYRENE CAPS 100 for \$1.98	BARREL KIT #58 SLIDE SWITCHES 30 for \$1.98	BARREL KIT #53 HOBBY NPN POWER TRANSISTORS 15 for \$1.98
BARREL KIT #39 HOBBY NPN POWER TRANSISTORS 15 for \$1.98	BARREL KIT #31 METALLIC RESISTORS 100 for \$1.98	BARREL KIT #30 PREFORMED RESISTORS 200 for \$1.98	BARREL KIT #27 PREFORMED DISCS 150 for \$1.98	BARREL KIT #26 PLASTIC TRANSISTORS 100 for \$1.98	BARREL KIT #20 LONG LEAD DISCS 100 for \$1.98	BARREL KIT #19 DIPPED MYLARS 60 for \$1.98	BARREL KIT #14 PRECISION RESISTORS 200 for \$1.98
BARREL KIT #27 VOLUME CONTROL 30 for \$1.98	BARREL KIT #23 SWITCHING DIODES 100 for \$1.98	BARREL KIT #21 SN7400 DIP IC'S 75 for \$1.98	BARREL KIT #19 DIPPED MYLARS 60 for \$1.98	BARREL KIT #18 DIPPED MYLARS 60 for \$1.98	BARREL KIT #17 DIPPED MYLARS 60 for \$1.98	BARREL KIT #16 DIPPED MYLARS 60 for \$1.98	BARREL KIT #15 DIPPED MYLARS 60 for \$1.98

ELECTRONICS MARKET PLACE

CRYSTALS

THESE FREQUENCIES ONLY

Part #	Frequency	Case Style	Price
CY1A	1 000 MHz	HC33 U	\$5.95
CY2A	2 000 MHz	HC33 U	\$5.95
CY2.01	2 010 MHz	HC33.U	\$1.95
CY3A	4 000 MHz	HC18 U	\$4.95
CY7A	5 000 MHz	HC18 U	\$4.95
CY12A	10 000 MHz	HC18 U	\$4.95
CY14A	14.31818 MHz	HC18.U	\$4.95
CY15A	18 000 MHz	HC18 U	\$4.95
CY22A	20.000 MHz	HC18 U	\$4.95
CY30B	32 000 MHz	HC18 U	\$4.95

BREAD BOARD JUMPER WIRE KIT

Each kit contains 350 wires cut to 14 different lengths from 0.1 to 5.0. Each wire is snipped and the leads are bent 90° for easy insertion. Wire lengths is classified by color coding. All wire is solid tinned 22 gauge with PVC insulation. The wires come packed in a convenient plastic box.



JK1 ... \$10.00 / kit

CONNECTORS

PRINTED CIRCUIT EDGE-CARD
156 Spacing-Tin-Double Read-Out

Biturcated Contacts — Fits 054 to 070 P.C. Cards

15/30	PINS (Solder Eyelet)	\$1.95
18/36	PINS (Solder Eyelet)	\$2.49
22/44	PINS (Solder Eyelet)	\$2.95
50/100	PINS (Wire Wrap)	\$6.95
50/100A (1.100 Spacing)	PINS (Wire Wrap)	\$6.95

25 PIN-D SUBMINATURE

DB25P	PLUG	\$3.25
DB25S	SOCKET	\$4.95

HEAT SINKS

205-CB	Beryllium Copper w-black finish for TO-5	\$.25
291-36H	Aluminum for TO-220 Transistors & Regulators	\$.25
680-75A	Black Anodized Aluminum for TO-3	\$1.60
Dude 4	Black Anodized Aluminum — predrilled mounting holes for TO-3 — 4 1/4" x 1 1/4" x 2"	\$1.75

DIP SWITCHES

SPST Slide Action

#206-4 (8 pin dip)	4 switch unit	\$1.75 ea.
#206-7 (14 pin dip)	7 switch unit	\$1.95 ea.
#206-8 (16 pin dip)	8 switch unit	\$2.25 ea.

Etching Kits

(cannot be shipped via air)

32 X A-1	P.C. Etch Materials Kit enough for 5 circuit boards	\$29.95 ea.
27 X A-1	Etched Circuit Kit	\$ 9.95 ea.
3662	Complete kit — only add water	\$ 6.95 ea.
22/44	6.5 x 4.5 x 1.16 Epoxy glass P-Pattern-14 P.C. Tabs-spaced 156 Making connector for plugboard — 22 pin double readder	\$ 2.95 ea.
8800V	Universal Microcomputer/Processor plugboard—Epoxy Glass — complete with heatsink and mounting hardware 5.313 x 10 x 1.16 copper clad	\$19.95 ea.

1/16 VECTOR BOARD

Part No	P-Pattern	W	L	Price
0.1 Hole Spacing 1.0 to 10 up				
PHENOLIC	64P44 062XXP	4.50	6.50	1.72 1.54
	169P44 062XXP	4.50	17.00	3.69 3.32
EPoxy	64P44 062WE	4.50	6.50	2.07 1.86
GLASS	64P44 062WE	4.50	17.00	2.56 2.31
	169P44 062WE	4.50	17.00	5.04 4.53
	169P44 062WEC	8.50	17.00	9.23 8.26
EPoxy GLASS COPPER CLAD	169P44 062WEC1	4.50	17.00	6.80 6.12

SLIT-N-WRAP WIRE WRAP TOOL

- Slits and opens insulation exposing bare wire
 - No pre-cutting or pre-stripping.
 - Comes complete with two — 100 ft spoons #28 AWG wire
- Model P180 \$24.50**

HEXADECIMAL ENCODER 19-KEY PAD

• 1 - 0
• ABCDEF
• Shift Key
• 2 Optional Keys

\$10.95 each

63 KEY KEYBOARD

This keyboard features 63 unencoded SPST keys unattached to any kind of P.C.B. A very solid molded plastic 13 x 4 base suits most applications.

HB6165	Encoder Chip (encodes 16 Keys)	\$7.95 ea.
AT-5-237E	Encoder Chip (encodes 88 Keys)	\$14.95 ea.

TOOLS

A97MS	Diagonal Cutter - 4" semi-flush cut	\$7.95 ea.
A11DMS	Chain Nose Pliers - 4 1/2" long	7.50 ea.
T-6	Wire Stripper - #16 to #26 gauge	3.75 ea.
55B	Wire Stripper - #10 to #20 gauge	2.50 ea.
CS-8	Cutter-Crimper Tool - 8 1/4" long	7.95 ea.
Nibbling Tool	Cuts, Trims or Notches Metal up to #18 gauge	6.95 ea.
Nibbling Tool	Replacement Punch	3.75 ea.

PERMACEL® P-29 PLUS

Electrical Tape - All Weather - 1/4" wide x 1/2" thick - Black vinyl

1-9 Rolls \$7.99 each 10-up Rolls \$6.95/10 roll package

MICROPROCESSOR COMPONENTS

8080A	CPU	\$16.00	CDP1802	CPU	\$19.95
8212	8 Bit Input/Output	4.95	MC68000	8 Bit MPU	24.95
8214	Priority Interrupt Control	15.95	MC68020	Periph Interface Adapter	15.00
8216	Bi-Directional Bus Driver	6.95	MC6801A	128 x 8 Static RAM	6.00
8224	Clock Generator/Driver	9.95	MC6830L8	1024 x 8 Bit ROM	15.00
8228	System Controller Bus Driver	10.95	280	CPU	29.95

SPECIAL REQUESTED ITEMS

8080-2	Super 8008	16.00	1101	256 x 1	Static	\$ 1.49	
2650	8 Bit MPU	26.50	210	256 x 4	Static	5.95	
P8065	CPU	29.95	702	1024 x 1	Dynamic	1.75	
			2107	5280	256 x 1	Dynamic	4.95
			2107	256 x 4	Static	6.95	
			189	16 x 4	Static	7.99	
			8101	256 x 4	Static	5.95	
			8111	768 x 4	Static	1.99	
			8599	1024 x 1	Static	2.25	
			21102/291102	1024 x 1	Static	2.25	
			9200	768 x 1	Static	6.95	
			93421	1024 x 1	Dynamic	4.99	
			MM5309	2K x 1	Dynamic	2 for 100	
			UP0414(2104)4K		Dynamic 16 Pin	5.99	
			3203	1048	Famous	\$ 9.95	
			3203	1048	Famous	15.99	
			82523	12 x 8	Drams D	5.00	
			825123	12 x 8	Tristate	5.00	
			45267	1024	Static	9.95	
			3601	256 x 4	Static	8.95	
			2708		Epotrom	19.95	
			2716	16K	Epotrom	34.95	
			6301-1	1024	Tri State Bipolar	3.99	
			6330-1	256	Open Collector Bipolar	2.95	

PARATRONICS

Featured on February's Front Cover of Popular Electronics

Logic Analyzer Kit Model 100A

\$229.00/kit

- Analyzes any type of digital system
- Checks data rates in excess of 8 million words per second
- Trouble shoot TTL, CMOS, DTL, RTL, Schottky and MOS families
- Displays 16 logic states up to 8 digits wide
- See ones and zeros displayed on your CRT, octal or hexadecimal format
- Tests circuits under actual operating conditions
- Easy to assemble — comes with step-by-step construction manual which includes 80 pages on logic analyzer operation.

Model 100A Model 10

PARATRONICS TRIGGER EXPANDER - Model 10
Provides digital delay and qualification of input clock and 24-bit trigger word. — Connects direct to Model 100A for Integrated Unit. Baseplate — \$6.95

BK PRECISION

3 1/2-Digit Portable DMM

- Overload Protected
- 3 High LED Display
- Battery or AC Operation
- Auto Zeroing
- Fine 1/20 0.1 ohm resolution
- Overrange reading
- 10 meg input impedance
- DC Accuracy 1% typical
- Ranges: DC Voltage - 0-1000V AC Voltage 0-1000V
- Freq. Response 30-100 KHz
- DC AC Current 0-100mA
- Resistance 0-10 meg ohm
- Size 6 1/2 x 4 1/2 x 2

Model 2800 \$99.95

Accessories: AC Adapter BC-28 8.00 Rechargeable Batteries BP-26 20.00 Carrying Case LC-28 8.00

ESE

100 MHz 8-Digit Counter

- 20 Hz - 100 MHz Range
- 6 LED Display
- Crystal-controlled timebase
- Fully Automatic, lighter adapter and external
- Portable — completely self-contained
- MAX-100 power supply
- Size — 1 7/8" x 7.38" x 5.63"

MAX-100 \$134.95

Accessories FOR MAX 100: Mobile Charger/Eliminator use power from car battery \$3.95 Charger/Eliminator Model 100 — CLA \$3.95 use 110 V AC Model 100 — CAI \$9.95

CONTINENTAL SPECIALTIES

PROTO BOARD 6 \$15.95 (6 long X 4 wide)

Other CS Proto Boards

PB100 - 4 1/2 x 6	\$ 19.95
PB101 - 5 8 x 4 1/2	29.95
PB102 - 7" x 4 1/2	39.95
PB103 - 9" x 6	59.95
PB104 - 9 1/2 x 8	79.95
PB203 - 9 7/8 x 6 1/2 x 2 1/4	80.00
PB203A - 9 7/8 x 6 1/2 x 2 1/4	129.95 (includes power supply)

PRD TO CLIPS

14 PIN	\$4.50
16 PIN	4.75
24 PIN	8.50
40 PIN	13.75

DESIGN MATES

DM1 - Circuit Designer	\$69.95
DM2 - Function Generator	\$74.95
DM3 - RC Bridge	\$74.95

LOGIC MONITOR for DTL, HTL, TTL or CMOS Devices **\$84.95**

QT PROTO STRIPS

QT type	notes	price
QT-595	590	12.50
QT-598	bus strip	2.50
QT-475	470	10.00
QT-478	bus strip	2.25
QT-355	350	8.50
QT-358	bus strip	2.00
QT-185	180	4.75
QT-125	120	3.75
QT-85	80	3.25
QT-75	70	3.00
Experimenter 300		\$ 9.95
Experimenter 600		\$10.95

\$5.00 Minimum Order — U.S. Funds Only. Spec Sheets - 25c — Send 35c Stamp for 1978 Catalog Dealer Information Available

James ELECTRONICS

1021-A HOWARD AVE., SAN CARLOS, CA. 94070
PHONE ORDERS WELCOME — (415) 592-8097
All Advertised Prices Good Thru December

1978 CATALOG NOW AVAILABLE

Timeband Digital Alarm Clocks

- 24 hour alarm
- Doze Button
- 100% Sleep Stale
- Large Red LED Display
- 8 Digit
- AM/PM Indicator
- Seconds display at touch of button
- Power failure indicator
- One year factory warranty

C-500 Ivory Case **\$16.95**
C-500B Ebony Case **\$19.95**

C-8211 Woodgrain Case

Timeband LAMP CLOCK

- 24 hour alarm
- Doze button
- Alarm on indicator
- 8" high Red LED Display
- AM/PM Indicator
- High intensity lamp
- Lamp shuts off when collapsed

Model C-590 (Ivory) \$29.95

AM/FM 8-Track Stereo Receiver

With BSR Changer

- PLL System
- BSR Record Changer
- Slide Controls
- Automatic AFC Control
- 4 Speaker Output
- Walnut finish vinyl covered wood veneer with smoke dust cover
- Size: 20" w x 9 1/2" h x 15 1/2" D

Model 8365 \$149.95

DIGITAL STOPWATCH

- Bright 6 Digit LED Display
- Times to 99 minutes 59.99 seconds
- Crystal Controlled Time Base
- Three Stopwatches in One
- Times Single Event — Split & Tally
- Size 4 1/2 x 2 1/2 x 9/16 (1 1/4 ounces)
- Uses 3 Penlite Cells

Kit — **\$39.95**
Assembled — **\$49.95**
Heavy Duty Carry Case \$5.95

Stop Watch Chip Only (7205) **\$19.95**

3 1/2 DIGIT DPM KIT

Model KB500 DPM Kit \$49.00
Model 3110-5C-5V Power Kit \$17.50

- New Bipolar Unit
- Auto Zeroing
- 5" LED
- Auto Polarity
- Low Power
- Single IC Unit

JE700 CLOCK

The JE700 is a low cost digital clock but it's a very high quality unit. The unit has a simulated walnut case with dimensions of 6" x 2 1/2" x 1 1/4". It utilizes a MAN72 high brightness readout and the MM5313 clock chip.

12 or 24 Hour
KIT ONLY \$16.95

JOYSTICK

These joysticks feature four 100K potentiometers that vary resistance proportional to the angle of the stick. Study metal construction with plastic components only at the movable joint. Perfect for electronic games and instrumentation.

100K	\$5.95
5K	\$4.95

INSTRUMENT/CLOCK CASE

Injection molded unit. Complete with red bezel. 4 1/2" x 4" x 1-9/16"

\$3.95 ea.

JE803 PROBE

The Logic Probe is a unit which is for the most part indispensable in trouble shooting logic timers. TTL, DTL, RTL, CMOS. It derives the power it needs to operate directly off of the circuit under test, drawing a scant 10 mA max. It uses a MAN73 readout to indicate any of the following states by these symbols: "1", "L", "D", "X", "PL", "SE", "P". The Probe can detect high frequency pulses to 45 MHz. It can't be used at MOS levels or circuit damage will result.

\$9.95 Per Kit
printed circuit board

T⁺L 5V 1A Supply

This is a standard TTL power supply using the well known LM309K regulator. It provides a solid 1 AMP of current at 5 volts. We try to make things easy for you by providing everything you need in one package, including the hardware for only **\$9.95 Per Kit**

7400N TTL

Table listing various TTL chips such as SN7400N, SN7401N, SN7402N, etc., with their respective quantities and prices.

BUGBOOK

Continuing Education Series



THE 555 TIMER APPLICATIONS SOURCEBOOK WITH EXPERIMENTS... INSTRUCTOR'S MANUAL... OP AMP MANUAL... CMOS - DESIGNERS PRIMER... COMPLETE MANUAL FOR DIGITAL CLOCKS...

BUGBOOKS I and II

BUGBOOK I and II by Peter R. Roy, David G. Larson, WB4Y7. Sold as a set these two books outline over 90 experiments...

BUGBOOK III

BUGBOOK III by Peter R. Roy, David G. Larson, WB4Y7, Jonathan A. Titus. Here in the book 'BUG III' are all the experiments...

BUGBOOK IV and V

BUGBOOK IV and V by David G. Larson, Peter R. Roy, Jonathan A. Titus. Experiments in digital electronics...

CMOS - DESIGNERS PRIMER AND HANDBOOK

CMOS - DESIGNERS PRIMER AND HANDBOOK by Peter R. Roy, David G. Larson, Jonathan A. Titus. Starts at basic structure of CMOS devices...

Table for DISCRETE LEDS listing various colors and sizes (125, 150, 185, 200, 250 dia) with prices.

DISPLAY LEDS

Table for DISPLAY LEDS listing various types (MAN 1, MAN 2, etc.), polarities, and prices.

RCA LINEAR

Table listing RCA linear components like CA3013, CA3023, etc., with prices.

XR-2206K Kit \$19.95

Table listing XR-2206K kit components like XR-2206P, XR-2206C, etc., with prices.

HOBBY-WRAP TOOL-BW-630

Battery Operated (Size C) Weighs ONLY 11 Ounces Wraps 30 AWG Wire onto Standard DIP Sockets (.025 inch) Complete with built-in bit and sleeve

\$34.95



WIRE-WRAP KIT - WK-2-W

WRAP • STRIP • UNWRAP • Tool for 30 AWG Wire • Roll of 50 Ft. White or Blue 30 AWG Wire • 50 pcs. each 1, 2, 3 & 4 lengths • Pre-stripped wire

\$11.95

WIRE WRAP TOOL DSU-30

WRAP • STRIP • UNWRAP - \$5.95 WIRE WRAP KIT - 30 AWG 25ft min \$1.25 50ft \$1.95 100ft \$2.95 1000ft \$15.00 SPECIFY COLOR - White - Yellow - Red - Green - Blue - Black

WIRE DISPENSER - WD-30

50 ft. roll 30 AWG KYNAR wire wrap wire \$3.45 ea. Cuts wire to desired length Strips 1" of insulation Specify - Blue-Yellow-White-Red

REPLACEMENT DISPENSER SPOOLS FOR WD 30

Specify blue, yellow, white or red \$1.98/spool

O/P/C INSERTION TOOL WITH PIN STRAITENER

Inserts both 14 and 16 pin packages. Pin Straightener built into handle. Model INS-1416 \$3.49/ea

HP 5082-7400 SERIES - MULTI-DIGIT

1/8" ht. Common Cathode Red 2 Digit \$ 79 69 3-5 volts or 5 millisecond 3 Digit 89 79 7 segment Monolithic 4 Digit 99 89 Dip Package 5 Digit 1 19 99

TV GAME CHIP SET - \$9.95

Includes AY-3-8500-1 Chip and 2 010 mhz crystal (2 010 crystal - \$1.95 ea AY-3-8500-1 Chip - \$8.95 ea.)

ZENERS - DIODES - RECTIFIERS

Table listing Zener diodes and rectifiers with various voltages and prices.

SCR AND FW BRIDGE RECTIFIERS

Table listing SCR and FW bridge rectifiers with prices.

TRANSISTORS

Table listing various transistors like 2N2904, 2N3904, etc., with prices.

CAPACITOR

Table listing various capacitors like 100V ceramic disc capacitors with prices.

CORNER

Table listing various corner components like 50V electrolytic capacitors with prices.

20% Discount for 100 Combined 7400's

CMOS

Table listing CMOS chips like CD4000, CD4001, CD4002, etc., with prices.

LINEAR

Table listing linear chips like LM309H, LM309CN, LM309D, etc., with prices.

74LS00 TTL

Table listing 74LS00 TTL chips like 74LS00, 74LS01, 74LS02, etc., with prices.

IC SOLDERABLE - LOW PROFILE (TIN) SOCKETS

Table listing IC solderable sockets with prices.

SOLDERTAIL STANDARD (TIN)

Table listing soldertail standard sockets with prices.

SOLDERTAIL STANDARD (GOLD)

Table listing soldertail standard gold sockets with prices.

WIRE WRAP SOCKETS (GOLD) LEVEL #3

Table listing wire wrap sockets with prices.

50 PCS. RESISTOR ASSORTMENTS \$1.75 PER ASS'T.

Table listing 50 PCS resistor assortments with prices.

ASST. 8R includes Resistor Assortments 1-7 (350 PCS) \$9.95 ea.

\$5.00 Minimum Order - U.S. Funds Only Spec Sheets - 25c - Send \$5 Stamp for 1978 Catalog California Residents - Add 6% Sales Tax Dealer Information Available

James JELECTRONICS logo and address: 1021-A HOWARD AVE. SAN CARLOS, CA. 94070 PHONE ORDERS WELCOME - (415) 592-8097

PLANNING TO MOVE?

Let us know 8 weeks in advance so that you won't miss a single issue of **POPULAR ELECTRONICS**.

Attach old label where indicated and print new address in space provided. Also include your mailing label whenever you write concerning your subscription. It helps us serve you promptly.

Write to: PO. Box 2774, Boulder, CO 80322 giving the following information.

- Change address only Extend my subscription

ENTER NEW SUBSCRIPTION

- 1 year \$12.00 Payment enclosed
 Allow 30-60 days for delivery. (1 extra BONUS issue)
 Bill me later

← AFFIX OLD LABEL →
 If you have no label handy, print OLD address here.

Name _____ please print
 Address _____
 City _____ Zip _____
 State _____

NEW ADDRESS HERE 0213

Name _____ please print
 Address _____ Apt. _____
 City _____
 State _____ Zip _____

Additional postage on foreign orders: add \$3 a year for Canada, \$5 a year for all other countries outside the U.S. and its possessions. Cash only on foreign orders, payable in U.S. currency.

OPERATION ASSIST

(Continued from page 128)

schematic and/or instruction manual. Bruce Crain, 307 Meadow Ln., Sewickley, PA 15143.

Movic Stereo One tape recorder. Schematic and service manual. John R. Carp, 19606 S. Albert Ave., Carritos, CA 90701.

Superior Instruments Model TW-11 tube checker. Schematic and tube chart. Howard E. Sykes, 2909 W. Paris St., Tampa, FL 33614.

E.H. Scott Model SLRF shortwave radio, Serial No. 512. Circa 1930's. Need any available information. Al Stiles, 240 E. 35th St. (16th Fr.), New York, NY 10016.

Magnavox Model 15C237 stereophonic record player, Chassis No. AP 8001 40. Need schematic and component information. Clinton Reed, 5911, Deering Ave., Parma Heights, OH 44130.

MDS (possibly Montgomery Data Systems) Automatic Wake-up Alarm, Assembly No. 200410A. Operation and external interfacing information needed. Also address of company if available. Edward A. Wald, 1353 Unruh Ave., Philadelphia, PA 19111.

Telrate Systems Model 72TVK2012, Serial No. 345(1183). Any available information. Thomas Serra, 31 Cleveland St., Hyde Park, MA 02136.

Sinclair Model X-20 Class-D hi-fi amplifier. Schematics and/or available information. J.M. Rice, Star Rte, Box 337, Buckingham, VA 23921.

Knight Model R55A receiver. Schematic and/or operation manual. Neil Van Oost Jr., RD #1, Box 301P, Waretown, NJ 08758.

Philco Model 47-1227 78 rpm, AM/FM. Need source of tubes, 5A2A and 7X7. Dick Eachus, P.O. Box B, West Point, CA 95255.

Fada Model FC 0212 stereo, Chassis No. R-285. Need

ADVANCED COMPUTER PRODUCTS

MOTOROLA COMPATIBLE MODULES

MI K6800 D2 KIT \$235.00

9601 16 Pin Mother Bt \$175.00
 9607 16 Pin Trd Capr 72.00
 9615 16 Pin Board 36.00
 9615 8K EPROM Module (1702A) 350.00
 9615P 1K EPROM Kit Module 275.00
 9620 16 Pin Parallel I/O 375.00
 9625 8K Static RAM Module 35.00
 9627K 8K Static RAM Kit 275.00
 9650 8 Pin Duplex Async Serial I/O 395.00
 Connectors \$6.50 12/98.95

All assembly & tested kit kits

AMI EVK 99 \$133.00

EVK 99 Kit \$133.00
 EVK 99 EX expanded 449.95
 Universal Kluge Board 95.00
 16K Rote-RAM Board 75.00
 5 Slot Motherboard 35.00
 E-Header Board 45.00
 Video Board 95.00
 Connectors \$6.50 12/98.95

PLUS MICRO-LEVEL TV MONITORS (PRIME)

Model M1002 101 17" display \$219.95
 Model M2000 15.5" display \$199.95

Add \$10.00 for shipping

THE FIRST TO OFFER PRIME PRODUCTS TO THE HOBBYIST AT FAIR PRICES NOW LOWERS PRICES EVEN FURTHER!

- ### 1. Proven Quality
- Factory tested products only, no re-test or fallbacks. Guaranteed money back. We stand behind our products.
- ### 2. Same Day Shipment
- All orders will be shipped same day as received.
- | | | | | | |
|-----------------------------|---------|---------|--------------------------|---------|--|
| RAM'S (cont.) | | | CLOCK CHIPS | | |
| 4096 16 pin | 1.95 | MM5315 | | \$4.50 | |
| 21078 E | 4.95 | MM5316 | | 1.95 | |
| MM5317 | 3.95 | MM5317A | | 4.95 | |
| MM5322 | 2.95 | MM5317B | | 4.95 | |
| 21078 | 1.80 | MM5317C | | 4.95 | |
| 1101C | 2.95 | MM5317D | | 4.95 | |
| 1101 | 1.95 | MM5317E | | 4.95 | |
| 1101D | 1.95 | MM5317F | | 4.95 | |
| 5000's | 2.95 | MM5317G | | 4.95 | |
| FLOPPY DISK | | | A TO D CONVERTERS | | |
| AMI 372 | 50.00 | | FD-302 | \$13.95 | |
| MO57114 Processor | 99.95 | | FD-302-2 | 11.95 | |
| Alphanumeric processor | | | FD-302-3 | 11.95 | |
| CHARACTER GENERATORS | | | FD-302-4 | 11.95 | |
| RO33513 Upper | \$18.95 | | FD-302-5 | 11.95 | |
| RO33513 Lower | 18.95 | | FD-302-6 | 11.95 | |
| HD1016 | 9.95 | | FD-302-7 | 11.95 | |
| KEYBOARD ENCODERS | | | FD-302-8 | 11.95 | |
| AY5226 | \$14.95 | | FD-302-9 | 11.95 | |
| AY5286 | 19.95 | | FD-302-10 | 11.95 | |
| UARTS/USRTS | | | FD-302-11 | 11.95 | |
| AY51013A DUAL | 6.95 | | FD-302-12 | 11.95 | |
| AY51013A | 5.50 | | FD-302-13 | 11.95 | |
| AY51013B | 6.95 | | FD-302-14 | 11.95 | |
| AY51013C | 6.95 | | FD-302-15 | 11.95 | |
| AY51013D | 6.95 | | FD-302-16 | 11.95 | |
| AY51013E | 6.95 | | FD-302-17 | 11.95 | |
| AY51013F | 6.95 | | FD-302-18 | 11.95 | |
| AY51013G | 6.95 | | FD-302-19 | 11.95 | |
| AY51013H | 6.95 | | FD-302-20 | 11.95 | |
| AY51013I | 6.95 | | FD-302-21 | 11.95 | |
| AY51013J | 6.95 | | FD-302-22 | 11.95 | |
| AY51013K | 6.95 | | FD-302-23 | 11.95 | |
| AY51013L | 6.95 | | FD-302-24 | 11.95 | |
| AY51013M | 6.95 | | FD-302-25 | 11.95 | |
| AY51013N | 6.95 | | FD-302-26 | 11.95 | |
| AY51013O | 6.95 | | FD-302-27 | 11.95 | |
| AY51013P | 6.95 | | FD-302-28 | 11.95 | |
| AY51013Q | 6.95 | | FD-302-29 | 11.95 | |
| AY51013R | 6.95 | | FD-302-30 | 11.95 | |
| AY51013S | 6.95 | | FD-302-31 | 11.95 | |
| AY51013T | 6.95 | | FD-302-32 | 11.95 | |
| AY51013U | 6.95 | | FD-302-33 | 11.95 | |
| AY51013V | 6.95 | | FD-302-34 | 11.95 | |
| AY51013W | 6.95 | | FD-302-35 | 11.95 | |
| AY51013X | 6.95 | | FD-302-36 | 11.95 | |
| AY51013Y | 6.95 | | FD-302-37 | 11.95 | |
| AY51013Z | 6.95 | | FD-302-38 | 11.95 | |
| AY51014 | 6.95 | | FD-302-39 | 11.95 | |
| AY51014A | 6.95 | | FD-302-40 | 11.95 | |
| AY51014B | 6.95 | | FD-302-41 | 11.95 | |
| AY51014C | 6.95 | | FD-302-42 | 11.95 | |
| AY51014D | 6.95 | | FD-302-43 | 11.95 | |
| AY51014E | 6.95 | | FD-302-44 | 11.95 | |
| AY51014F | 6.95 | | FD-302-45 | 11.95 | |
| AY51014G | 6.95 | | FD-302-46 | 11.95 | |
| AY51014H | 6.95 | | FD-302-47 | 11.95 | |
| AY51014I | 6.95 | | FD-302-48 | 11.95 | |
| AY51014J | 6.95 | | FD-302-49 | 11.95 | |
| AY51014K | 6.95 | | FD-302-50 | 11.95 | |
| AY51014L | 6.95 | | FD-302-51 | 11.95 | |
| AY51014M | 6.95 | | FD-302-52 | 11.95 | |
| AY51014N | 6.95 | | FD-302-53 | 11.95 | |
| AY51014O | 6.95 | | FD-302-54 | 11.95 | |
| AY51014P | 6.95 | | FD-302-55 | 11.95 | |
| AY51014Q | 6.95 | | FD-302-56 | 11.95 | |
| AY51014R | 6.95 | | FD-302-57 | 11.95 | |
| AY51014S | 6.95 | | FD-302-58 | 11.95 | |
| AY51014T | 6.95 | | FD-302-59 | 11.95 | |
| AY51014U | 6.95 | | FD-302-60 | 11.95 | |
| AY51014V | 6.95 | | FD-302-61 | 11.95 | |
| AY51014W | 6.95 | | FD-302-62 | 11.95 | |
| AY51014X | 6.95 | | FD-302-63 | 11.95 | |
| AY51014Y | 6.95 | | FD-302-64 | 11.95 | |
| AY51014Z | 6.95 | | FD-302-65 | 11.95 | |
| AY51015 | 6.95 | | FD-302-66 | 11.95 | |
| AY51015A | 6.95 | | FD-302-67 | 11.95 | |
| AY51015B | 6.95 | | FD-302-68 | 11.95 | |
| AY51015C | 6.95 | | FD-302-69 | 11.95 | |
| AY51015D | 6.95 | | FD-302-70 | 11.95 | |
| AY51015E | 6.95 | | FD-302-71 | 11.95 | |
| AY51015F | 6.95 | | FD-302-72 | 11.95 | |
| AY51015G | 6.95 | | FD-302-73 | 11.95 | |
| AY51015H | 6.95 | | FD-302-74 | 11.95 | |
| AY51015I | 6.95 | | FD-302-75 | 11.95 | |
| AY51015J | 6.95 | | FD-302-76 | 11.95 | |
| AY51015K | 6.95 | | FD-302-77 | 11.95 | |
| AY51015L | 6.95 | | FD-302-78 | 11.95 | |
| AY51015M | 6.95 | | FD-302-79 | 11.95 | |
| AY51015N | 6.95 | | FD-302-80 | 11.95 | |
| AY51015O | 6.95 | | FD-302-81 | 11.95 | |
| AY51015P | 6.95 | | FD-302-82 | 11.95 | |
| AY51015Q | 6.95 | | FD-302-83 | 11.95 | |
| AY51015R | 6.95 | | FD-302-84 | 11.95 | |
| AY51015S | 6.95 | | FD-302-85 | 11.95 | |
| AY51015T | 6.95 | | FD-302-86 | 11.95 | |
| AY51015U | 6.95 | | FD-302-87 | 11.95 | |
| AY51015V | 6.95 | | FD-302-88 | 11.95 | |
| AY51015W | 6.95 | | FD-302-89 | 11.95 | |
| AY51015X | 6.95 | | FD-302-90 | 11.95 | |
| AY51015Y | 6.95 | | FD-302-91 | 11.95 | |
| AY51015Z | 6.95 | | FD-302-92 | 11.95 | |
| AY51016 | 6.95 | | FD-302-93 | 11.95 | |
| AY51016A | 6.95 | | FD-302-94 | 11.95 | |
| AY51016B | 6.95 | | FD-302-95 | 11.95 | |
| AY51016C | 6.95 | | FD-302-96 | 11.95 | |
| AY51016D | 6.95 | | FD-302-97 | 11.95 | |
| AY51016E | 6.95 | | FD-302-98 | 11.95 | |
| AY51016F | 6.95 | | FD-302-99 | 11.95 | |
| AY51016G | 6.95 | | FD-302-100 | 11.95 | |

Knight Model R55A receiver. Schematic and/or operation manual. Neil Van Oost Jr., RD #1, Box 301P, Waretown, NJ 08758.

Fada Model FC 0212 stereo, Chassis No. R-285. Need

MICROPROCESSORS	SUPPORT DEVICES (cont.)	PROMS
286	8278 Buffer	2708
287	8279 Buffer	2709
386	8278 Buffer	2710
387	8279 Buffer	2711
486	8278 Buffer	2712
586	8279 Buffer	2713
686	8278 Buffer	2714
8086	8279 Buffer	2715
8088	8278 Buffer	2716
80801	8279 Buffer	2717
2801	8278 Buffer	2718
2802	8279 Buffer	2719
2803	8278 Buffer	2720
2804	8279 Buffer	2721
2805	8278 Buffer	2722
2806	8279 Buffer	2723
2807	8278 Buffer	2724
2808	8279 Buffer	2725
2809	8278 Buffer	2726
2810	8279 Buffer	2727
2811	8278 Buffer	2728
2812	8279 Buffer	2729
2813	8278 Buffer	2730
2814	8279 Buffer	2731
2815	8278 Buffer	2732
2816	8279 Buffer	2733
2817	8278 Buffer	2734
2818	8279 Buffer	2735
2819	8278 Buffer	2736
2820	8279 Buffer	2737
2821	8278 Buffer	2738
2822	8279 Buffer	2739
2823	8278 Buffer	2740

KEYBOARD ENCODERS	UARTS/USRTS	IC CHIPS
AY5226	AY51013A	MM5315
AY5286	AY51013B	MM5316
AY5226	AY51013C	MM5317
AY5286	AY51013D	MM5317A
AY5226	AY51013E	MM5317B
AY5286	AY51013F	MM5317C
AY5226	AY51013G	MM5317D
AY5286	AY51013H	MM5317E
AY5226	AY51013I	MM5317F
AY5286	AY51013J	MM5317G
AY5226	AY51013K	MM5317H
AY5286	AY51013L	MM5317I
AY5226	AY51013M	MM5317J
AY5286	AY51013N	MM5317K
AY5226	AY51013O	MM5317L
AY5286	AY51013P	MM5317M
AY5226	AY51013Q	MM5317N
AY5286	AY51013R	MM5317O
AY5226	AY51013S	MM5317P
AY5286	AY51013T	MM5317Q
AY5226	AY51013U	MM5317R
AY5286	AY51013V	MM5317S
AY5226	AY51013W	MM5317T
AY5286	AY51013X	MM5317U
AY5226	AY51013Y	MM5317V
AY5286	AY51013Z	MM5317W
AY5226	AY51014	MM5317X
AY5286</		

schematic. Sean A. Devitt, 2237 Wharton Rd., Glenside, PA 19038.

Atwater Kent Model 30 receiving set, Serial No. 518473. Parts source, service data and instruction manual. Edward N. Ham, 1727 26th Avenue N. St. Petersburg, FL 33713.

JBL Model SG-520 preamplifier and Model SE-400S power amplifier. Need service manuals. Jacob Landy, 11 Gardenia Ln., Hicksville, NY 11801.

Mercury Electronics Model 300 tube tester. Operating manual, schematics, parts list, and tube-socket charts. Also source of Model AD-300 adapter. **Superior Instruments** Model 82 or 82A tube tester. Any available information. Vernon Lawver, RR1, Box 85A, Rockton, IL 61072.

Tele-tone Model TV-208. Schematic, parts list, and/or manual. Barry Wilen, 7439 Prince George Rd., Baltimore, MD 21208.

Halicrafters Model SX-71 communication receiver. Instruction manual. Also need tube. VR150 or OD3. Jeff Cherry, 603 S. Cedar, Brea, CA 92621.

C.R. Doty Model PAS ultra linear 70 amplifier and transistorized preamp. Operation and service manuals. Russ Buchheit, Lake Walton, Rd., Wappingers Falls, NY 12590.

Hammarlund Model HQ-215 receiver. Need service information. Karl A. Williamson, D&W Electronics, Box 251, Fenton, MO 63026.

Jackson Model CRO-2 oscilloscope. Operating instructions and schematic. Howard Adams, 209 W. Shadywood Dr., Midwest City, OK 73110.

Atwater Kent Model 185A radio. Schematic and parts list. J.H. Taylor, Box 51, RD #2, Glen Mills, PA 19342.

United Cinephone Model FL-893 test oscilloscope made for U.S. Army Signal Corps. Any available information. N. Marshall, 2122 Buckingham, Lincoln Park, MI 48146.

Gonset Model G-66B receiver and Model G-77 transmitter. Need schematic, and operating and service manuals. James A. Hansatte, 802 Moondale Dr., Glenshaw, PA 15116.

Intercontinental Instruments Model PG-1 and PG-32 pulse generators. Service manual and/or schematic. Daniel Hoyt, Hall High School, West Hartford, CT 06117.

Scott Model 99-C amplifier. Operation and maintenance manuals. John Collins, 1211 W. Old Cold Spring Ln., Baltimore, MD 21209.

Zenith Model 3000-1 transoceanic FM-AM multiband receiver. Schematic and/or service manual. Douglas J. Picirillo, 452 Riverside Dr., Apt. 22, New York, NY 10027.

Browning Labs Model ON-5 oscilloscope. Circa 1958. Need wave forms and voltage-to-resistance readings. Lorne Hosking, 4722 Cape May Ave., San Diego, CA 92107.

Wurlitzer Model 2910 juke box. Service manual needed. James Chadek, 2609 River Hills Rd., Two Rivers, WI 54241.

U.S. Army Signal Corps. R-19H/TRC-1 radio receiver, Serial No. 4733. Any available information. Joe L. Hill, 1100 Jones Dr., Bowling Green, KY 42101.

Halicrafters Model SX 100 receiver. Schematic and/or operation manual. D. Kearney, Box 193, Sta. A, Goose Bay Airport, Labrador, Canada AOP 150.

Atwater Kent Model 545-S and **Philco** Model 40-140 and 40-190 radios. Need schematics. Milton Obuch, 1308 N. 4th St., Sayre, OK 73662.

Packard Bell Model RPT-1 stereo and receiver and Model 8TU-1 tuner. Schematic and manuals needed. Dale Shulz, 9536 Schagel St., Longmont, CO 80501.

Rider radio manuals. Need volumes 23,21,20 and 17 plus indexes. Also old 4-pin radio tubes for Radiola collection. Ken Westfall, 323 1/2 Newport Ave., Long Beach, CA 90803.

Stephens midrange loudspeaker. Need data and replacement PM unit. Sam Zumbro, RR #2, Box 672-A, Redlands, CA 92373.

Friden Model SP5 flexowriter. Any available information. Steve A. Parra, 409 Oregon Ave., Alamogordo, NM 88310.

J.H. Bunnell antique telegrapher's key and sounder, mounted on single base. Any information or history on unit or company. Philip G. Martin, 1010 Chicago St., Hammond, IN 46327.

Philco Model 7100 color bar and dot generator. Schematic and calibration information. **B&K** Model 400 cathode rejuvenator.

(Continued on page 149)

the 4th Annual HOLIDAY SPECIAL



Four 8Kx8 ECONORAM II kits---now only \$475.00!

You read it right---32K of memory for \$475. But price isn't the only reason to go Godbout; look at our features. We're fully buffered (with tri-state outputs), fast (under 450 ns), low power (guaranteed under 1 1/2 A), fully static for no timing hassles, S-100 compatible, the ability to handle DMA devices, sockets for all ICs...this is a board you can depend on.

COMING ATTRACTIONS:

We'll be happy to supply your Heath H8 with 12K of memory for \$235, which is what Heath charges for their 8K board. Watch this space...

1.8432 MHz Xtal; HC6 w/ wire leads \$5.95

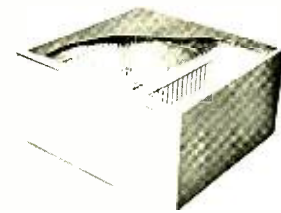

New from VECTOR..

VP2 ASSEMBLED MICROCOMPUTER CASE...an adjustable packaging system for S-100 buss microcomputers. Card guides and hardware for 12 cards, with provision for 21 cards total on .75" centers. Instantly accessible interiors with slip out covers; sturdy chassis plate for power supply. And...it's really beautiful...\$134.30



Another Special: "Grandson of a Cheap Clock"

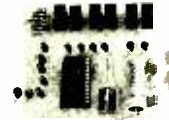

Assembled stereo 2b amp uses LM880 ICs. Volume, tone and balance controls. Ideal for 12V battery use, music minamp, & more. Only \$10.

Reduced to \$10.95! This is our popular 6 digit, 0.4" readout clock at a special price. Includes transformer, PC board, time set switches, & all parts. Less case only.

GODBOUT

BILL GODBOUT ELECTRONICS
BOX 2355, OAKLAND AIRPORT, CA 94614

TERMS: Prices good through end of magazine cover date. Cal res add tax. BankAmericard®/VISA®/Mastercharge® orders (\$15 min) call (415) 562 0636, 24 hrs. Allow up to 5' shipping (more for power supplies); excess refunded. COD orders OK with street address.

CIRCLE NO 20 ON FREE INFORMATION CARD

EDMUND SCIENTIFIC



ENVIRONMENTS

• Strange, beautiful records that can help you think. Scientifically designed to help you study, read, meditate, romance or eliminate unwanted noise these long-playing 33 1/3 rpm records provide a unique tranquil experience. Each provides one-hour of naturally occurring sounds that range from soothing surf to thunderstorm.

\$7.25 Ea. Ppd.

- A) Seashore/Aviary — surf on one side, melodic birds on other. No. 72,156
- B) Thunderstorm/Rain in Forest — beautifully realistic rainfall. No. 72,157

SEND FOR
FREE
CATALOG



EDMUND SCIENTIFIC CO., Dept. AV24
Edscorp Bldg., Barrington, N.J. 08007

GIANT 164 Pg. Catalog packed with unusual bargains.

Name _____
Address _____
City _____ State _____ Zip _____

SENSITIVE TR METAL DETECTOR



Fully transistorized transmitter/receiver (TR) detector with sensitivity rivaling models twice the price. Built of rugged aluminum with a waterproof search coil. Detects a penny at 5" Wt. 2 lb. 6 oz.
No. 80,262 \$39.95 Ppd.

GIANT MAGNET, LITTLE PRICE!

Tie a line to our over-150 lb.-lift ceramic magnet and haul up treasure from the sea. 4 ceramic magnets, in series, between steel plates. A 1-lb. "giant"!
No. 42,318
(1x1 1/4x4 3/8")



\$11.95 Ppd.

Complete and Mail Coupon Today

EDMUND SCIENTIFIC CO., Dept. AV23
Edscorp Bldg., Barrington, N.J. 08007

Enclosed please find check/M O

Charge My Amer Exp BAC MC

Interbank # _____ Acct # _____

Seashore Record(s) (No. 72,156) @ \$7.25

Thunderstorm Record(s) (No. 72,157) @ \$7.25

Metal Detector(s) (No. 80,262) @ \$39.95

Magnet(s) (No. 42,318) @ \$11.95

Total _____ (incl. \$1.00 hdlg. chg.) (N.J. residents add 5%)

Signature _____
Address _____
City _____ State _____ Zip _____

CIRCLE NO 16 ON FREE INFORMATION CARD

OPERATION ASSIST

(Continued from page 147)

nator and tester. Schematic and operation information. **DeVry** Model 1S14 VTVOM. Schematic and calibration information. Dan Nelson, 541 SE 1st, Toledo, OR 97391.

Hallicrafters Model 505 television. Need source of 7JP4 picture tube. Hollis Shull, 15 S. California, Morris, MN 56267.

Navy Model OCP-4 sonar portable testing equipment. Need schematic and operation manual. Ira C. Davey, 566 Norton Pkwy, New Haven, CT 06511.

RCA Model AR77 communications receiver. Schematics and operation manual. Manny Galindo, 4 Stanton Rd., Newburgh, NY 12550.

Hamm-arlund Model HQ 150 receiver. Operation manual and schematic. Bob Sqwallsh, 414 Brunswick Rd., Fayetteville, NC 28303.

Hallicrafters Model S-38C SW receiver. Owner's manual. Irving M. Prais, 2679 Puesta del Sol, Santa Barbara, CA 93105.

General Radio Navy Surplus Model LP, type CAG-60006 radio. Need source of rectifier power unit, type CAF-60080 and schematic. Brad Sausser, Star Route, Coeur D-Alene, ID 83814.

National Radio Model NC 109. Operating instructions, alignment data and schematic. John A. Bradstreet, 404 Western Ave., Augusta, ME 04330.

Morse Electro Products Model TR-7100CC stereo unit. Operation manual. **General Electric** Model RP-1816BN-A and RP-1817BG-A record players. Wiring diagram and/or operation manual. Scott Dunsford, 209 Patterson St., Newmarket, Ontario, CAN. L3Y 3L5.

National Model SW3 shortwave receiver. Series 10-20 coils needed. M. Edeheit, 245-21 77 Crescent, Bellrose, NY 11426.

Gonset Model G-76 radio. Schematic or any available information. Dietmar May, 1590 Potomac Heights Dr., Oxon Hill, MD 20021.

Marlux Model MAX-409A 7-inch reel-to-reel tape recorder. Schematics or any available information. Don Gillard, Box 86530, North Vancouver, British Columbia, CAN.

Superior Instruments Model 82A Tube Tester. Data chart and operation manual. Wesley Garcia, 709 Locust St. #5, Pasadena, CA 91101.

Hammarlund Radio H.C. 100. Copy of tube location. George Dundas, Jr. Box 62, Metlakatla, AK 99926.

Grundig Model 3066 Multi-band receiver. Need power transformer 9078-041. L. A. Petragalla, 515 N. Federal Hwy., Deerfield Beach, FL 33441.

Fried-Eisemann Model # FE-15, No. 393E. Schematic and component information. Garry Hahn, 1788 Augusta Ct., Lexington, KY 40505.

Crosley Corp. radio receiver and transmitter BC 654-A. Schematic and service manual. Joe Wilson, 6800 Hwy. 17 East, Conniston, Ontario, P0M 1M0, CAN.

RadioBar Corp. of America, Philco 5-tube chassis — 3 band type. Schematic, tube numbers and layout. Phil Nielson, 8323 Rothesay Place, Stockton, CA 95209.

Browning Labs, Inc., Oscilloscope, Model OL-15A. Schematic or service manual. Neil Streitberger, 1460 Kensington Dr., Fullerton, CA 92631.

Bell Model 2425 AM-FM stereo receiver, serial # 120639. Need transformer #32B119. Kevin Hayden, Lot 16, 1946 Wyoming Ave., Exeter, PA 18643.

GE Model 635 portable AM radio. Service manual and schematics. Mike Tickal, Box 477, Mason City, IA 50401.

Hallicrafter Model S-38D receiver. Schematics or other information. John McNamee, 924 24, Santa Monica, CA 90403.

Harvey-Wells Model T90 Band Master transmitter. Schematic. John Tranthan, Rt. 4, Box 199, Ashville, NC 28806.

Precision Apparatus series 914 tube tester. **RCA** #156-B tube tester. Schematic, manual, tube charts. W.R. Gulliford, 714-7th Ave., Seattle, WA 98104.

Jackson oscilloscope Model CRO-2. Any information needed. Curt Palme, 990 Wavertree Rd., No. Vancouver, B.C. CAN V7R 1S5.

ABOUT YOUR SUBSCRIPTION

Your subscription to POPULAR ELECTRONICS is maintained on one of the world's most modern, efficient computer systems, and if you're like 99% of our subscribers, you'll never have any reason to complain about your subscription service.

We have found that when complaints do arise, the majority of them occur because people have written their names or addresses differently at different times. For example, if your subscription were listed under "William Jones, Cedar Lane, Middletown, Arizona," and you were to renew it as "Bill Jones, Cedar Lane, Middletown, Arizona," our computer would think that two separate subscriptions were involved, and it would start sending you two copies of POPULAR ELECTRONICS each month. Other examples of combinations of names that would confuse the computer would include: John Henry Smith and Henry Smith, and Mrs. Joseph Jones and Mary Jones. Minor differences in addresses can also lead to difficulties. For example, to the computer, 100 Second St. is not the same as 100 2nd St.

So, please, when you write us about your subscription, be sure to enclose the mailing label from the cover of the magazine—or else copy your name and address exactly as they appear on the mailing label. This will greatly reduce any chance of error, and we will be able to service your request much more quickly.



Seeking Original Japanese Replacement Parts for CB and Stereo Repair Use?

Original Japanese Transistors, FET, IC, Diodes
CHECK OUR LOW PRICES!

TRANSISTORS	2SA 816	7.0	2SC 403	.59	2SC 871	.59	2SC 1448	1.10	2SD 358	1.30	
2SA 49	.59	2SA 818	1.40	2SC 430	1.10	2SC 897	2.65	2SC 1449	1.00	2SD 360	1.20
2SA 70	1.10	2SA 839	2.15	2SC 454	.59	2SC 898	4.40	2SC 1451	1.60	2SD 382	1.40
2SA 101	.59	2SA 841	.59	2SC 458	.59	2SC 902	.59	2SC 1475	1.40	2SD 388	3.40
2SA 102	.59	2SA 847	.59	2SC 460	.59	2SC 929	.59	2SC 1478S	7.0	2SD 424	8.50
2SA 234	.59	2SA 850	7.0	2SC 461	.59	2SC 930	.59	2SC 1509	1.10	2SD 427	2.80
2SA 342	.90	2SA 872A	.59	2SC 481	1.60	2SC 943	1.20	2SC 1584	8.50	2SD 525	1.60
2SA 353	.70	2SA 908	11.00	2SC 482	1.50	2SC 945	.59	2SC 1586	6.60	2SD 526	1.60
2SA 377	2.00	2SB 54	.59	2SC 485	1.60	2SC 959	1.50	2SC 1624	1.30	2SD 555A	6.10
2SA 440	.90	2SB 55	1.10	2SC 486	1.60	2SC 971	1.00	2SC 1626	1.10	2SD 610	1.90
2SA 483	3.00	2SB 75	.59	2SC 493	3.90	2SC 983	1.00	2SC 1628	1.30		
2SA 484	2.50	2SB 77	.59	2SC 495	1.00	2SC 984	.90	2SC 1647	5.9		
2SA 485	2.00	2SB 186	.59	2SC 497	1.60	2SC 1000BL	.59	2SC 1669	1.60	2SK 19	1.60
2SA 489	1.60	2SB 187	.59	2SC 509	.90	2SC 1014	1.20	2SC 1674	5.9	2SK 30	.90
2SA 495	.70	2SB 202	1.60	2SC 517	3.95	2SC 1017	1.40	2SC 1675	5.9	2SK 33	1.10
2SA 496	1.10	2SB 220	.70	2SC 535	.70	2SC 1018	1.20	2SC 1678	2.25	2SK 40	.70
2SA 497	1.60	2SB 303	.59	2SC 536	.59	2SC 1030C	2.80	2SC 1682	4.45	2SK 49	1.30
2SA 509	.70	2SB 324	.70	2SC 537	.59	2SC 1047	.70	2SC 1684	5.9	2SK 55	1.30
2SA 525	2.10	2SB 337	1.60	2SC 538A	.70	2SC 1060	2.25	2SC 1708	5.9	2SK 68	1.30
2SA 537	2.25	2SB 367	1.50	2SC 562	2.15	2SC 1061	1.40	2SC 1728	2.00	2SK 88	1.30
2SA 539	.70	2SB 368B	2.15	2SC 563	1.10	2SC 1080	4.40	2SC 1760	2.00	2SK 22	2.55
2SA 561	.59	2SB 379	1.10	2SC 620	.59	2SC 1096	1.00	2SC 1775	4.5	2SK 35	2.25
2SA 562	.59	2SB 400	.59	2SC 632A	.70	2SC 1111	3.40	2SC 1816	4.25	3SK 39	2.25
2SA 564A	.59	2SB 405	.70	2SC 644	.59	2SC 1115	3.40	2SC 1885	7.0	3SK 40	2.25
2SA 565	1.10	2SB 407	1.40	2SC 645	.70	2SC 1116	4.40	2SC 1908	5.9	3SK 41	2.50
2SA 566	3.40	2SB 415	.70	2SC 650	1.30	2SC 1116A	4.90	2SC 1909	4.40	3SK 45	2.50
2SA 606	1.90	2SB 434	1.20	2SC 668	.59	2SC 1124	1.30	2SC 1951	1.10	MK 10	2.00
2SA 624	1.10	2SB 440	.70	2SC 680	2.60	2SC 1182	1.10	2SC 1957	1.20		
2SA 627	3.60	2SB 463	1.50	2SC 684	1.40	2SC 1186	.59	2SC 1965	4.40	AN 214Q	3.40
2SA 628	.59	2SB 471	1.60	2SC 693B	.59	2SC 1173	.90	2SC 1973	1.10	AN 315	3.70
2SA 634	.90	2SB 472	2.80	2SC 696	1.95	2SC 1175	.90	2SC 1975	4.40	AN 511	3.40
2SA 640	.59	2SB 474	1.20	2SC 708A	1.90	2SC 1177	14.00	2SC 2028	.90	BA 521	3.70
2SA 643	.70	2SB 492	1.00	2SC 710	.59	2SC 1189	1.40	2SC 2029	3.90	HA 1151	3.70
2SA 659	.59	2SB 507	1.60	2SC 711	.59	2SC 1211D	.70	2SC 2091	3.60	LA 4400	3.70
2SA 663	4.90	2SB 509	1.90	2SC 712	.59	2SC 1213	.70	2SC 2092	3.90	TA 7045M	3.00
2SA 666	.70	2SB 514	1.40	2SC 717	.59	2SC 1222	.45	2SC 2098	3.90	SN 7400	.19
2SA 670	.70	2SB 526C	1.30	2SC 730	4.40	2SC 1226	1.00	2SD 28	2.80	SN 7490	.80
2SA 673	.70	2SB 527	1.90	2SC 732	.59	2SC 1237	4.25	2SD 75	1.10	TA 7055P	3.00
2SA 678	.70	2SB 528D	1.60	2SC 733	.59	2SC 1239	3.50	2SD 90	1.60	TA 7060P	1.60
2SA 683	.70	2SB 536	1.60	2SC 734	.59	2SC 1279	.70	2SD 91	1.60	TA 7061AP	1.90
2SA 684	.70	2SB 539	4.90	2SC 735	.59	2SC 1306	4.40	2SD 92	1.50	TA 7062	1.90
2SA 695	.70	2SB 541	4.40	2SC 736	.59	2SC 1307	4.90	2SD 118	3.00	TA 7205P	3.90
2SA 697	.70	2SB 554	10.00	2SC 756	2.80	2SC 1312	.59	2SD 130	1.20	TA 7310P	3.95
2SA 706	1.60	2SB 561B	.70	2SC 763	.59	2SC 1313G	.59	2SD 142	2.00	JPC 592H2	1.60
2SA 715	1.40	2SB 564	.90	2SC 773	.70	2SC 1317	.59	2SD 143	2.80	PL 02A	8.90
2SA 719	.70	2SB 595	1.80	2SC 774	1.60	2SC 1318	.59	2SD 178	1.40		
2SA 720	.70	2SB 600A	7.00	2SC 775	1.95	2SC 1327	.59	2SD 180	2.50		
2SA 721	.70	2SC 183	.59	2SC 776	2.65	2SC 1330	1.50	2SD 187	.59	IS 84	1.00
2SA 725	.59	2SC 184	.59	2SC 778	3.90	2SC 1342	.59	2SD 188	3.00	IS 188	.45
2SA 726	.59	2SC 281	.59	2SC 781	2.65	2SC 1344	.59	2SD 205	1.40	IS 332	.45
2SA 733	.59	2SC 284	1.40	2SC 783R	3.60	2SC 1345D	.59	2SD 217	4.40	IS 953	.45
2SA 740	2.65	2SC 367	.90	2SC 784	.59	2SC 1359	1.40	2SD 223	1.90	IS 1007	.45
2SA 744	3.70	2SC 369	.70	2SC 785	.70	2SC 1360	1.00	2SD 224	1.90	IS 1209	.45
2SA 745R	4.40	2SC 371	.59	2SC 788	1.90	2SC 1362	.59	2SD 227	.59	IS 1211	.45
2SA 747	5.80	2SC 372	.59	2SC 793	2.90	2SC 1364	1.40	2SD 234	1.00	IS 1555	.32
2SA 750	.59	2SC 373	.59	2SC 799	3.60	2SC 1377	4.90	2SD 235	1.00	IS 1588	.32
2SA 756	3.40	2SC 374	.59	2SC 815	.59	2SC 1383	.59	2SD 287	3.70	IS 1885	.45
2SA 758	5.80	2SC 380	.59	2SC 828	.59	2SC 1400	.59	2SD 313	1.10	IS 2076	.45
2SA 774	.59	2SC 381	.59	2SC 829	.59	2SC 1402	3.70	2SD 315	1.20	IS 2093	.45
2SA 777	1.10	2SC 382	.59	2SC 838	.59	2SC 1403	3.70	2SD 325	1.10	IS 2473	.45
2SA 798	.70	2SC 387	.59	2SC 839	.59	2SC 1419	1.10	2SD 356D	1.16	IN 34	.25
2SA 814	1.90	2SC 394	.59	2SC 870	.59	2SC 1444	2.80	2SD 357D	1.00	IN 60	.25

PRICES MAY CHANGE WITHOUT NOTICE COD ORDERS WELCOMED

IMMEDIATE DELIVERY WITHIN 48 HOURS
ON ALL TRANSISTORS IN STOCK
Minimum order \$5.00 Ohio residents add 4% sales tax.
Add \$1.00 postage and handling. Quantity discount prices.
ASK FOR OUR COMPLETE PRICE LIST
MANUFACTURER INQUIRIES WELCOMED
All Parts Guaranteed Against Factory Defects

FUI-SVEA ENTERPRISE
 Dept. Popular Electronics
 P.O. Box 40325
 Cincinnati, OH 45240
 (513)874-0220
 874-0223

ELECTRONIC DOOR CHIME KIT

WITH TI TMS 1000 MICROPROCESSOR CHIP
PROGRAMMED TO PLAY
24 DIFFERENT TUNES

INTERNATIONAL FLAVOR — PLAYS NATIONAL ANTHOMS OF U.S., BRITAIN FRANCE AND WEST GERMANY PLUS OTHER FOLK TUNES. CLASSICAL AND TRADITIONAL MELODIES.

- * SUPPLIED WITH ALL PARTS INCLUDING PC BOARD, SPEAKER, CASE AND COMPLETE INSTRUCTION MANUAL WITH FULL CIRCUIT DETAILS.
- * USES 29V TRANSISTOR BATTERIES (NOT SUPPLIED).
- * LOW POWER CONSUMPTION.
- * INTERNAL SELECTION OF TUNE, VOLUME, TEMPO AND TIMING FUNCTIONS.
- * PROGRAMMED MATHEMATICALLY TO PLAY IN PERFECT PITCH PERMANENTLY.

\$39.50

SHIPPING \$1.00

2708 FULL SPEED EROM \$14.95	2102 500NS 1K RAM \$1.29
5314 6 DIGIT CLOCK CHIP \$2.95	LD110, LD111 \$24.75 3 1/2 DIGIT A/D CONVERTER SET
82S23 256 BIT PROM \$2.95	74S200 256 BIT RAM TRI-STATE \$3.25
2513 CHARACTER GEN 64 x 8 x 5 ASCII \$8.95	1702A 2K ERAS PROM \$4.75

ALL IC'S 10% OFF ON \$25.00 15% OFF ON \$50.00

Satisfaction guaranteed. Shipment will be made postage prepaid within 3 days from receipt of order. Payment may be made with personal check, charge card (include number and exp. date), or money order. Phone Orders — Bot A and M/C card or C.O.D.

FREE CATALOG AVAILABLE ON REQUEST

Add \$1.00 to cover shipping and handling if order is less than \$10.00. California residents add sales tax. Include shipping expense for orders shipped out of U.S. and Canada approx. 10% of order.

INTERNATIONAL ELECTRONICS UNLIMITED
VILLAGE SQUARE, P.O. BOX 449, CARMEL VALLEY, CA 93924 USA
TELEPHONE 408 659-3171

CIRCLE NO. 26 ON FREE INFORMATION CARD

J.B. Saunders Co.

3050 VALMONT ROAD, M/S 1271 BOULDER, COLORADO 80301

- Minimum order \$5.00
- Please add \$1.00 postage and handling.
- Colorado residents add 3% tax
- No COD's, please.
- Foreign Orders send U.S. Funds ONLY.

Mini-Switch Brand new by C & K, high quality SPDT toggle switch. Rated 5 amps @ 125 VAC. On-Off-On type. MST-111 \$1.10	Reed Relay Ultra-sensitive SPDT reed relay. May be driven directly by TTL. —Unlimited number of uses!!! RRY-510 \$1.50	RO170 Diode The famous Motorola universal replacement diode for TV's, radios etc. 1000 PIV @ 2.5A HEP-170 \$ 20 100 for only \$14.50
Opto-Isolator Popular 4N27 type NPN phototransistor & PN infrared light emitting diode by Motorola. 1500 volt isolation, 3 Ma collector output current. Excellent frequency response to 300KHz. Brand new units in 6-pin plastic DIP package, w/ full specs and data. Use in audio circuits or any other circuit where isolation is wanted. Unbeatable price! POI-427 \$1.00 (10 for \$9)	Photoflash Capacitor Brand new by Rubycon, this is one of the finest capacitors made!!! 600uf @ 360 VDC. Designed to withstand thousands and thousands of cycles with unparalleled reliability. Use with our JBS strobe tube & transformer set (listed in our catalog) to make a very high quality strobe light!!!! PFC-360 \$1.95	
V.O.X. Solid state Voice Operated Switch. Complete w/ all parts and completely assembled. SCR output. W/ schematic. VOX 900 \$1.50	Transformer Mini-transformer for use in clocks, etc. Outputs: BV @ 500Ma & 12V @ 180Ma. With specs. CMX-812 \$1.50	Snap Switch Mini SPDT snap switch by Cherry. Rated 5 amps, 125 ~250 volts AC. Fantastic price!!!! MSW-523 \$.65
100K Trimmer New by IRC, PC mount 100K trimmer pot. Measures only 1/8" high by 1/2" in diameter. PCT-104 \$.50	Rubber Feet Molded, adhesive-back rubber feet in peel-off strips from 3M Corporation. Round (RRF-120) - 12/75" \$.50 Square (SRF-120) - 12/55"	Wire Wrap Not just ordinary wire-wrap, but Meltable-Insulation wire-wrap. MWW-030 100 feet \$2.50 500 feet \$8.50 1000 feet \$14.50
Numeric Bezel Black molded bezel to add that professional touch to digital displays, etc. Measures 2 1/4" horizontally by 7/8" vertically. Super price!!! NBZ-001 \$.75	Micro-Switch Miniature SPDT momentary action pushbutton switch. Rated 5A @ 125VAC. Mounts in 1/4" hole. MSP-111 \$.95	

FREE CATALOG !!!

Probably the best bargain in this ad!!! —The NEW J.B. Saunders catalog of unique electronic parts is now available **ABSOLUTELY FREE**. Order your copy now and save on items such as pneumatic switches, electric motors, LED's, fascinating kits, IC's, resistors, caps, diodes, and many other unique components we aren't even going to mention at this time!!!

CIRCLE NO. 77 ON FREE INFORMATION CARD

MINI-KITS

FM WIRELESS MIKE KIT
FM 1 \$2.95
Transmit up to 300 to any FM radio. Sensitive microphone. Requires dynamic (not ceramic) mike. Runs on 3 D batteries.

TONE DECODER KIT
Complete tone decoder on a single PC board. Features 400 to 500 Hz adjustable frequency range, voltage regulation, 567 IC (useful for touch-tone decoding, tone burst detection, FSK cannot, signaling, and many other uses. Use 7 for 12 button touch-tone decoding. Runs on 5 to 12 volts.
Complete Kit, TD-1 \$4.95

LED BLINKY KIT
A great attention getter which alternately flashes a jumbo LED. Use for name badges, buttons, or warning type panel lights.
Complete Kit, BL-1 \$2.95

SUPER-SNOOP AMPLIFIER
A super-sensitive amplifier which will pick up a pin drop at 15 feet! Great for monitoring baby's room or as a general purpose test amplifier. Full 2 watts of output, runs on 6 to 12 volts, uses any type of mike. Requires 8-45 ohm speaker.
Complete Kit, BN-9 \$4.95

MUSIC LIGHTS KIT
See music come alive. 3 different lights flicker with music or voice. One light for lows, one for the mid range and one for the highs. Each channel individually adjustable and drives up to 300 watts. Great for parties, band music, night clubs and more.
Complete Kit, ML-1 \$7.95

SIREN KIT
Produces upward and downward wail characteristic of police sirens. 200mhz sine wave circuit, runs on 3-6 volts uses 8-45 ohm speaker.
Complete Kit, SM-3 \$2.95

CODE OSCILLATOR KIT
Powerful 1 watt audio oscillator of approx. 1 khz, good for many uses. Great for warming alarm, battery checker, voltage indicator and code generator.
Complete Kit, CPO-1 \$2.50

POWER SUPPLY KIT
Complete triple regulated power supply provides variable 0-15 volts @ 200ma and 0-5 volts @ 1 amp. 50ma load regulation, good filtering and small size. Kit less transformers. Requires 6-8V at 1 amp and 18 to 30VDC.
Complete Kit, PS-3LT \$6.95

DECADE COUNTER PARTS KIT
Includes: 7490A 33 MHz counter, 7475 latch, 7447 LED driver, LED resistor, current limit resistors, hook up details and instructions on how to build an easy low cost frequency counter.
Kit of Parts, DCU-1 \$3.50

Frequency Counter

\$79.95 KIT

You've requested it, and now it's here! The CT-50 Frequency Counter Kit has more features than counters selling for twice the price. Measuring frequency is now as easy as pushing a button, the CT-50 will automatically place the decimal point in all modes, giving you quick, reliable readings. Want to use the CT-50 mobile? No problem, it runs equally as well on 12 VDC as it does on 110 VAC. Want super accuracy? The CT-50 uses the popular TV color burst freq. of 3.579545 MHz for time base. Tap off a color TV with our adapter and get ultra accuracy — .001 ppm! The CT-50 offers professional quality at the unheard of price of \$79.95. Order yours today!

CT-50, 60MHz Counter Kit \$79.95
CT-50WT, 60 MHz counter, wired and tested \$159.95
CT-600, 600 MHz prescaler option for CT-50, add \$29.95



UTILIZES NEW MOS-LSI CIRCUITRY

SPECIFICATIONS

Sensitivity: less than 25mV
Frequency range: 5Hz to 60MHz, typically 65MHz
Gate time: 1 second, 1/10 second, with automatic decimal point positioning on both direct and prescale
Display: 8 digit red LED, 4" height
Accuracy: 10 ppm, .001 ppm with TV time base!
Input: BNC, 1 meg ohm direct, 50 ohm with prescale option
Power: 110 VAC 5 watts or 12 VDC @ 1 Amp
Size: Approx. 6" x 4" x 2", high quality aluminum case
Color burst adapter for .001 ppm accuracy available in 6 weeks. CB-1, Kit \$14.95

VIDEO TERMINAL KIT \$149.95

A compact 5 x 10 inch PC card that requires only an ASCII keyboard and a TV set to become a complete interactive terminal for connection to your microprocessor asynchronous interface. Its many features are single 5-volt supply, crystal controlled sync and baud rates (up to 9600 baud), 2 pages of 32 characters by 16 lines, read to and from memory, computer and keyboard-operated cursor and page control, parity error display and control, power-on initialization, full 64-character ASCII display, block-type see-thru cursor, Keyboard/computer control backspaces, forward spaces, line feeds, rev line feeds, home, returns cursor. Also clears page clears to end of line, selects page 1 or 2, reads from to memory. The card requires 5 volts at approx. 900 ma and outputs standard 75 ohm composite video.

TH3216 Kit \$149.95
TH3216, Assembled and Tested \$239.95
VD-1, Video to RF Modulator Kit \$ 6.95

SIX DIGIT 12/24 HR CLOCK KIT

Want a clock that looks good enough for your living room? Forget the competitor's kludges and try one of ours! Features: jump-6, 4 digits, Polaroid lens filter, extruded aluminum case available in 5 colors, quality PC boards and super instructions. All parts are included, no extras to buy. Fully guaranteed. One to two hour assembly time. Colors: silver, gold, black, blue and bronze (specify).

Clock Kit, DC-5 \$22.95
Alarm Clock, DC-8, 12 hr. only \$24.95
12/24 Hour, 10 min. ID timer \$25.95
Mobile Version, DC-7 \$25.95
Assembled and tested clocks available, add \$10.00 to kit price.

741 MINI DIP, house marked 10/\$2.00

600 mhz Prescaler

Fully assembled and tested. Extend the range of your counter to 10 times higher in frequency. Works with any counter. High sensitivity input with built-in on-chip pre-amp.

PS-1B — 10 \$59.95

CAR CLOCK KIT \$27.95

12/24-Hour, 12-Volt, AC or DC. AUTO DIMMER \$2.60
Automatically adjusts display brightness according to ambient light level. For DC-11 Car Clock.

- High Accuracy (1 minute/month)
- 6 Jumbo 4-LED readouts
- Easy, no-polarity hookup
- Display blanks with ignition
- Case, mounting bracket included
- Super instructions

Complete Kit, DC-11 \$27.95

LINEAR	REGS	TRANSISTORS
555 50	309K 99	NPN 2N3904 type 10/\$1.00
556 75	340K-12 99	PNP 2N3906 type 10/\$1.00
566 1.49	7805 99	NPN Power Tab 40W 3/\$1.00
567 1.49	7812 99	PNP Power Tab 40W 3/\$1.00
324 1.49	7815 99	FET MRF-102 type 3/\$2.00
1458 49	78M0 1.50	UJT 2N2646 type 3/\$2.00
380 1.49	723 49	2N3055 NPN Power 75

ramsey electronics

BOX 4072A ROCHESTER, NY 14610 (716) 271-6487

Individual LED's are driven directly by the BCD and 7-segment outputs, pins 2 to 12, through 1000-ohm, 1/2-W, current-limiting resistors. Another LED can be driven by the pulse output available at pin 20 (through a 1000-ohm resistor, of course). Low-frequency pulse signals are also available at the digit enable outputs, pins 21 to 26, and can be used to flash LED's through appropriate npn driver transistors (Q1), as shown by the dotted line connections. A separate driver transistor, current-limiting resistor (R3) and LED is required for each output. However, the transistors can be low-cost "bargain package" types, for they are used only as switches.

The multiple LED flasher can be assembled using any preferred construction technique, although Professor Bungay suggests perf board construction with Molex LED sockets to minimize possible heat damage from soldering, to simplify circuit changes and modification, and to permit experimentation with different color LED's. He suggests, further, that some hobbyists might wish to cluster a number of clock IC's, flashing from 50 to 100 or more LED's. The only real limits on the possible combinations and applications are one's imagination and financial resources.

Device/Product News. Imaginative experimenters will welcome a new long-delay bucket-brigade device (BBD) recently introduced by *Panasonic's Electronic Components Division* (One Panasonic Way, Secaucus, NJ 07094) and the *Matsushita Electric Corporation of Japan*. The new one-chip IC, type MN-3005, is a 4,096-stage unit that can delay an audio signal electronically for up to 205 milliseconds. Accepting input signals up to 1.3-V rms, the device has a S/N ratio of 75 dB and offers essentially 0-dB insertion loss. Supplied in a special 8-lead DIP, the MN-3005 can be used to create improved reverberation and echo effects in electronic musical instruments such as organs, music synthesizers and guitar amplifiers, and also may be used for variable or fixed analog signal delays, analog shift registers, and time compression or voice scrambling in communication systems.

Creative hobbyists should be able to have a ball dreaming up applications for the MCA-7 reflective object sensor manufactured by *Monsanto* and available through *Schweber Electronics* and other franchised industrial electronics distributors. Netting for a little under four dollars each in unit quantities, the device comprises a gallium-arsenide infrared LED and silicon photodarlington in a single package, arranged so that both are perpendicular to the face of the device. The latter permits the photodarlington to respond to light reflected by nearby objects or surfaces.

Teledyne Semiconductor (1300 Terra Bella Ave., Mountain View, CA 94043) has introduced a new low-cost voltage/frequency/voltage (V/F/V) converter which combines bipolar and CMOS technology on a single chip. Designated type 9400, the new IC is available in 14-pin plastic or ceramic DIP's. Interfacing with all logic families, the device operates from 10 Hz to 100 kHz in V/F applications, with 0.01% typical linearity to 10 kHz, supplying both pulse and square-wave outputs. In the F/V mode, the 9400 operates from dc to 100 kHz, with 0.1% typical linearity over the full range. It can be used with either single or dual power supplies, requiring only 1.6 mA. Typical applications include 13-bit A/D converters, digital panel meters, microprocessor data acquisition, analog data transmission, temperature or speed sensing and control, digital scales, and analog frequency meters. ◇

SMOKE & GAS ALARM

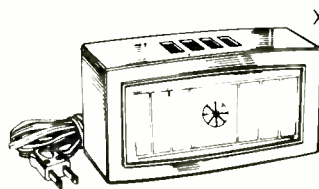

XM-646

REG. 19.99 **12.99**

- Protects Your Family From Fire & Smoke
- Loud Horn Warning

VHF-AM PORTABLE 3-CHANNEL RECEIVER



RA-422

Was ~~5.99~~
1.99

in 677 Cat.

- Hear (Hi-VHF 150-175 mHz) Police, Weather, Fire, More!
 - Hurry! Quantities Limited
 - Just Install Crystals Needed
 - 9V Battery Included
- XM-677. Crystals . . . Ea. 99¢

PUSHBUTTON AM AUTO RADIO

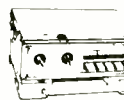

10.99

AU-580

- Mounts In or Under Dash
- Has Volume, Tone and Manual Tuning Controls

CB MONITOR CONVERTER CHANNELS 1 THRU 23

4.99

CB-417



- Converts AM Auto Radio to CB Monitor
- For Traffic & Road Condition Reports

8-TRACK TAPE 40-MINUTE BLANK

Reg. 79¢



TA-907

49¢

- Designed for Music Reproduction
- Erased Never Used

BATTERY NI-CAD RECHARGEABLE "AA" PEN-LITE CELL

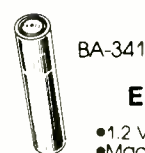

BA-341

EACH

\$1

- 1.2 Volt
- Made By 3 Famous Manufacturers

CASSETTES

Pkg. of 3 TA-879



REG. 1.49

79¢

- 60-Minute Blank

NICKEL CADMIUM BATTERY PACKS

LOW AS

2.75

- Standard Penlight Size
 - Rechargeable Over & Over
- 2-"AA" Batt. Pack. 2.4 Volts BA-359 Ea. 2.00
3-"AA" Batt. Pack. 3.6 Volts BA-327 Ea. 3.00
4-"AA" Batt. Pack. 4.8 Volts BA-361 Ea. 4.00

Olson® electronics
260 S. FORGE ST.
DEPT. I-6 AKRON, OHIO 44327

NAME _____
ADDRESS _____
CITY _____ STATE _____ ZIP _____

QTY	STK #	DESCRIPTION	PRICE EA	TOTAL

TTL PLASTIC DUAL-IN-LINE I.C.			CMOS			CMOS			CMOS			TEXAS INSTRUMENTS I.C. SOCKETS (Low Profile Solder Tail)		
Part No.	QTY	Price	Part No.	QTY	Price	Part No.	QTY	Price	Part No.	QTY	Price	Description	Unit Price	
SN7400N	12	SN7453N	14	SN74132N	69	SN74186N	750	CD40008E	13	CD4052BE	1.15	74C14/40014PC	75	
SN7401N	14	SN7454N	14	SN74136N	59	SN745188AN	1.85	CD4001BE	16	CD4053BE	89	74C85/40085PC	1.20	
SN7402N	14	SN7460N	14	SN74141N	88	SN74190N	1.04	CD4002BE	16	CD4055BE	1.29	80C97/40097PC	65	
SN7403N	14	SN7470N	26	SN74142N	3.70	SN74191N	1.04	CD4006BE	99	CD4060BE	99	80C98/40098PC	65	
SN7404N	17	SN7472N	25	SN74143N	3.98	SN74192N	84	CD4008BE	80	CD4068BE	.24	74C161/40161PC	1.50	
SN7405N	17	SN7473N	29	SN74144N	3.98	SN74193N	.84	CD4009BE	37	CD4069BE	.24	74C162/40162PC	1.50	
SN7406N	25	SN7474N	28	SN74145N	.69	SN74194N	.89	CD4010BE	37	CD4070BE	.24	74C163/40163PC	1.50	
SN7407N	25	SN7475N	46	SN74147N	1.58	SN74195N	.54	CD4011BE	16	CD4071BE	.24	74C174/40174PC	1.40	
SN7408N	17	SN7476N	30	SN74148N	1.19	SN74196N	.87	CD4012BE	16	CD4072BE	.29	74C175/40175PC	1.40	
SN7409N	17	SN7480N	35	SN74150N	.94	SN74197N	.73	CD4013BE	29	CD4073BE	.29	74C192/40192PC	1.50	
SN7410N	14	SN7481AN	95	SN74151N	.61	SN74198N	1.64	CD4014BE	74	CD4075BE	.29	74C193/40193PC	1.50	
SN7411N	20	SN7482N	55	SN74152N	3.45	SN74199N	1.64	CD4015BE	74	CD4076BE	.28	74C194/40194PC	1.40	
SN7412N	21	SN7483AN	65	SN74153N	.61	SN74221N	1.14	CD4016BE	29	CD4078BE	.24	74C195/40195PC	1.40	
SN7413N	39	SN7484AN	1.50	SN74154N	.95	SN74246N	1.95	CD4017BE	79	CD4081BE	.24			
SN7414N	62	SN7485N	84	SN74155N	.70	SN74247N	1.70	CD4018BE	79	CD4082BE	.29	SG3501AT	3.60	
SN7416N	24	SN7486N	30	SN74156N	.64	SN74248N	1.75	CD4019BE	38	CD4085BE	.75	SG3524J	7.25	
SN7417N	29	SN7489N	1.85	SN74157N	.59	SN74249N	1.75	CD4020BE	84	CD4086BE	.75	SG4501T	1.80	
SN7420N	14	SN7490AN	43	SN74159N	2.50	SN74251N	1.05	CD4021BE	89	CD4502BE	1.15	RC4194TK	3.95	
SN7421N	20	SN7491AN	59	SN74160N	.85	SN74259N	1.35	CD4022BE	89	CD4507BE	.39	RC4195TK	2.35	
SN7422N	20	SN7492AN	44	SN74161N	.85	SN74265N	.85	CD4023BE	16	CD4510BE	1.05	78H05KC	3.15	
SN7423N	25	SN7493AN	44	SN74162N	.85	SN74273N	1.35	CD4024BE	67	CD4511BE	1.25	78H05KC	6.35	
SN7425N	25	SN7494AN	69	SN74163N	.85	SN74276N	.75	CD4025BE	16	CD4512BE	.69	7800 Series	.99	
SN7426N	22	SN7495AN	67	SN74164N	.98	SN74278N	1.99	CD4026BE	1.39	CD4514BE	2.50	TO 220 / LM340T	1.39	
SN7427N	25	SN7496AN	65	SN74165N	.97	SN74279N	.57	CD4027BE	38	CD4515BE	2.50	7800 Series	1.39	
SN7428N	28	SN7497N	2.50	SN74166N	1.09	SN74283N	1.39	CD4028BE	74	CD4516BE	.84	7800 Series	1.49	
SN7430N	14	SN74100N	97	SN74167N	2.75	SN74284N	4.50	CD4029BE	.78	CD4518BE	.84	7800 Series	1.49	
SN7432N	23	SN74104AN	42	SN74170N	1.69	SN74285N	4.50	CD4030BE	37	CD4519BE	.79	78L00 AWC Series	.29	
SN7433N	30	SN74105N	42	SN74172N	8.75	SN74290N	8.5	CD4031BE	160	CD4520BE	.79	TO 92	2.6	
SN7437N	21	SN74107N	28	SN74173N	1.24	SN74293N	.83	CD4032BE	1.60	CD4522BE	1.98	7900 Series	1.25	
SN7438N	21	SN74109N	47	SN74174N	.94	SN74298N	1.64	CD4033BE	2.95	CD4526BE	1.90	TO 220 / LM320T	1.50	
SN7440N	14	SN74110N	52	SN74175N	.84	SN74351N	1.92	CD4034BE	98	CD4527BE	1.50	7900 Series	1.35	
SN7442N	37	SN74111N	69	SN74176N	.77	SN74365N	.65	CD4035BE	98	CD4528BE	1.20	TO 5 / LM320H	1.75	
SN7443N	68	SN74116N	1.50	SN74177N	.76	SN74366N	.65	CD4040BE	67	CD4529BE	1.20	TO 3 / LM320K	1.20	
SN7444AN	85	SN74120N	1.40	SN74178N	1.19	SN74367N	.65	CD4041BE	97	CD4531BE	1.25	7900 Series	1.20	
SN7445AN	65	SN74121N	34	SN74179N	1.49	SN74368N	.65	CD4042BE	45	CD4539BE	1.20	78MGT2C	1.20	
SN7446AN	70	SN74122N	38	SN74180N	.67	SN74376N	.75	CD4043BE	45	CD4555BE	.75	79MGT2C	1.20	
SN7447AN	59	SN74123N	48	SN74181N	1.94	SN74390N	1.40	CD4044BE	45	CD4556BE	.75	79MGT2C	1.20	
SN7448AN	69	SN74125N	40	SN74182N	.59	SN74393N	1.40	CD4045BE	2.45	CD4558BE	2.25		1.45	
SN7450N	14	SN74126N	40	SN74184N	1.75	SN74426N	.45	CD4046BE	2.45	CD4582BE	.95	78GU1 TO 220	1.25	
SN7451N	14	SN74128N	59	SN74185AN	1.74	SN74490N	1.90	CD4047BE	2.45	CD4585BE	1.80	79GU1 TO 220	1.80	
								CC4051BE	89			78GK TO 3	1.80	
												79GK TO 3	2.10	



Our new comprehensive 1978 Catalogue, listing complete descriptions, illustrations and special monolithic pricing on over 10,000 items, is now available on request.

Active Electronic Sales Corp.

P.O. BOX 1035

FRAMINGHAM, MASSACHUSETTS 01701

Telephone Orders & Enquiries (617) 879-0077

New Catalogue available on request

NOW IN CANADA

6551 Ferrier st.

44 Fasken Dr. Unit 25

MINIMUM ORDER \$10.00 * ADD \$2.00 TO COVER

2 Locations

Montreal, Quebec

Rexdale, Ontario

POSTAGE & HANDLING * Canadian customers add 30% for duty and handling. All federal and provincial taxes extra

CIRCLE NO. 2 ON FREE INFORMATION CARD

UNIVERSAL 4K x 8 MEMORY BOARD KIT

32 2102 1 fully buffered, 16 address lines, on board decoupling for any 4 of 64 pages, standard 44 pin buss

EXPANDABLE F8 CPU BOARD KIT

featuring Fairbug PSU 1K-ohm static ram, RS 232 interface, documentation, 64 BYTE register

4K BASIC FOR FAIRBUG F8

on paper tape \$25.00

C/MOS (DIODE CLAMPED)

74C100	22	4012	22	4023	22	4046	2.75
74C193	1.50	4013	40	4024	75	4049	4.00
4001	22	4015	95	4025	22	4050	4.00
4002	22	4016	40	4026	40	4055	1.50
4006	1.20	4017	1.05	4028	88	4066	8.00
4007	22	4018	100	4029	1.10	4071	2.77
4009	42	4019	25	4030	22	4076	1.05
4010	42	4020	1.05	4035	1.10		
4011	22	4022	95	4042	.78		

WSU-30 Hand wire wrap tool used to wrap, unwrap & strip #30 wire \$5.30

#24, EIGHT CONDUCTOR SPECTRA FLAT CABLE	DIP SOCKETS	#30 WIRE WRAP WIRE SINGLE STRAND
10A/1.50	8 PIN - 22 24 PIN - 40	100'/71.40
100/13.50	14 PIN - 25 28 PIN - 50	
	16 PIN - 28 40 PIN - 60	
	18 PIN - 30	

2/08 8K EPROM	\$15.75
2E72 256 BIT SHIF. REG	\$ 1.95
2E13 CHARACTER GEN	\$ 6.75
2E18 HEX 32 BIT SR	\$ 2.50
2I07 11024 BIT RAM	\$ 1.19
2/08	\$ 3.50
MK4008P	\$ 1.95
5E70 4K BYT NARIC RAM	\$ 4.75
1101A 256 BIT RAM	\$ 7.75
MMS203 UV PROM	\$ 6.95
1702A UV PROM	\$ 4.95
5704 4K PROM	\$10.95
82523	\$ 1.95
AY 51013 UART	\$ 6.95

LIGHT ACTIVATED SCR's TO 18 200V 1A \$ 1.10

2A 4148 INDI 1A 15 \$1.50

2A 81 OPTICAL LIMIT SWITCH \$1.50

LED READOUTS

FND 359 C.C. 4"	\$ 50	DL 704 3" C.C.	\$ 95
FND 70 C.C. 4"	\$ 55	MAN 7 3" C.A.	\$ 95
FND 503 C.C. 5"	\$ 85	NS 333 8-pin array	\$ 75
FND 510 C.C. 5"	\$ 85	DL 743 C.A. 6"	\$ 1.95

PRINTED CIRCUIT BOARD

4" x 6" 1/2" SINGLE SIDED EPOXY BOARD 1/16" thick copper foil 60 ea \$52.60

7 WATT LD-65 LASER DIODE IR \$8.95

2N 3820 P FET \$ 45
2N 5457 N FET \$ 45
2N2646 \$ 45
ER 900 TRIGGER DIODES 4 \$ 100
2N 6928 RHOD. DIODE \$ 65

MINIATURE MULTI-TURN TRIM POT'S 100, 500, 1K, 2K, 5K, 10K, 25K, 50K, 100K, 200K, 500K 1Meg. \$75 each. \$ 2.00

CCD 202-100 x 100 charge coupled device image sensor \$145.00

VERIPAX PC BOARD

This board is a 16" single side (paper epoxy) board, 4" x 6" DRILLED and ETCHED which will hold up to 21 single 14 pin IC's or 8, 16 or LSI DIP IC's with sockets for power supply connector. \$5.00

5V 5691 YELLOW-GREEN \$ 90
BI-POLAR LED \$ 50
FB 100 P-10 T-R \$ 90
RED, YELLOW, GREEN OR AMBER LARGE LED'S \$ 6.50
11.5 (MCT-2) \$ 75
MOLEX PINS \$100.51
1000/58.00

10 WATT ZENERS 3.9, 4.7, 5.6, 6.8, 8.2, 12, 18, 22, 100, 150 or 200V ea. \$.60
1 WATT ZENERS 4.7, 5.6, 10, 12, 15, 18 or 22V ea. \$.25
MC6860 MODEM CHIP \$9.95

Silicon Power Rectifiers

PRV	1A	3A	12A	50A	125A
100	06	14	30	81	370
200	07	20	35	115	425
400	09	25	50	140	650
600	11	30	70	180	850
800	15	35	90	230	1050
1000	20	45	110	275	1250

SILICON SOLAR CELLS

2 1/2" diameter 4V at 500 ma. \$4.00

309K	\$ 95	340K 5, 12, 15	\$ 85
723	\$ 50	or 24V.	\$ 85
LM 376	\$ 60	340T 5, 6, 8, 12	
320K 5 or 15V	\$ 1.40	15, 18 or 24V 5.10	
320T 5, 15	\$ 1.15	78 MG	\$ 1.35
or 24V		79 MG	\$ 1.35

RS232 DB 25P male \$2.95
CONNECTORS DB 25S female \$3.50

TRANSISTOR SPECIALS

2N3585 NPN Si TO 66 \$.95
2N3772 NPN Si TO 3 \$ 1.00
2N1546 PNP GE TO 3 \$.75
2N4908 NPN Si TO 3 \$ 1.00
2N6056 PNP Si TO 3 \$ 1.70
2N5086 NPN Si TO 92 \$ 4.10
2N4998 NPN TO 66 \$ 1.00
2N404 PNP GE TO 5 \$ 1.00
2N3919 NPN Si TO 3 RF \$ 1.50
MPS4 13 NPN Si TO 92 \$ 3.10
2N3767 NPN Si TO 66 \$.70
2N2222 NPN Si TO 18 \$ 1.00
2N3055 NPN Si TO 3 \$.60
2N3904 NPN Si TO 92 \$ 1.00
2N3906 NPN Si TO 92 \$ 1.00
2N5296 NPN Si TO 220 \$.50
2N6109 NPN Si TO 220 \$.55
2N3638 NPN Si TO 6 \$ 1.00
2N6517 NPN TO 92 Si \$ 1.00

TTL IC SERIES

7400	.16	7445	.65	74151	.65
7401	.16	7446	70	74153	.65
7402	.16	7447	65	74154	1.00
7403	.16	7448	70	74155	.70
7404	.20	7450	15	74157	.65
7405	.25	7472	32	74157	.85
7406	.25	7473	32	74163	.80
7407	.25	7474	32	74164	.95
7408	.20	7475	45	74165	1.05
7409	.20	7476	30	74173	1.35
7410	.16	7480	45	74175	

ELECTRONICS LIBRARY

(Continued from page 127)

detailed information, such as dealers, computer clubs and major publications. The book also focuses on the basic knowledge needed to implement computer application.

Published by Ridley Enslow Publishers, 60 Crescent Pl., Box 301, Short Hills, NJ 07078. 216 pages. Hard cover. \$8.95.

ADVANCED ELECTRONIC TROUBLESHOOTING

by Derek Cameron

In its 14 chapters, this book is designed to guide the reader through analysis, diagnosis, and repair of a wide range of electronic equipment. Troubleshooting examples include AM and FM receivers, audio equipment, closed-circuit TV and video recorders, monochrome and color TV receivers, specialized radio equipment, electronic organs and digital equipment, electronic instruments, and marine electronic equipment. The text assumes that the reader is familiar with basic troubleshooting procedures rather than on theory. The use of comparatively sophisticated test equipment is emphasized.

Published by Reston Publishing Co., Inc., P.O. Box 547, Reston, VA 22090. Hard cover. 325 pages. \$16.95.

HANDBOOK OF SIMPLIFIED TELEVISION SERVICE

by John D. Lenk

This book concentrates on a basic approach to TV receiver repair. It demonstrates how test equipment can be used to locate TV receiver faults quickly and easily and then how to correct the trouble. The book avoids theoretical discussions, concentrating instead on step-by-step procedures that spell out the precise sequence for diagnosing TV receiver trouble. The text has been arranged to tell the reader what he must know to service monochrome and color TV receivers, how to work with fragmentary service literature, and how features found in commercial TV test equipment relate to solving problems in TV servicing.

Published by Prentice-Hall, Inc., Englewood Cliffs, NJ 07632. Hard cover. 415 pages. \$15.95.

MASTER TRANSISTOR/IC SUBSTITUTION HANDBOOK

Virtually every American and foreign IC and transistor part number is listed and referenced to a replacement part number in this new handbook. More than 80,000 IC's and transistors are listed. Every entry is cross-referenced to the closest available substitutes by leading manufacturers of replacement parts. The book is divided into two parts. The first part contains basing diagrams and a brief description of the manufacturer (Sylvania, RCA, Motorola, International Rectifier, General Electric, and Workman) re-

placement parts are listed in the substitution guide section that makes up part two.

Published by Tab Books, Blue Ridge Summit, PA 17214. 518 pages. \$11.95 hard cover; \$7.95 soft cover.

EVERYTHING YOU'VE ALWAYS WANTED TO KNOW ABOUT RPN

Oriented toward three specific Reverse Polish Notation calculators, much of the material in this book is also applicable to other RPN calculators. In fact, an Appendix titled "Using This Book With Other Calculators" describes how to adapt the solutions to the multitude of

problems presented in the text to calculators other than the Corvus 500. The book is divided into two parts: the basic operation of the Corvus 500 calculator, and a selection of problems and their solutions.

Published by tk enterprises, 16611 Hawthorne Blvd., Lawndale, CA 90260. Soft cover. 116 pages. \$7.50.

MICROCOMPUTER HANDBOOK

by Charles J. Sippl

Written to serve as a guide and reference book for computer users, this handbook will prove useful to anyone who must master the knowledge required to operate low-cost mi-



NEW LSI TECHNOLOGY FREQUENCY COUNTER

TAKE ADVANTAGE OF THIS NEW STATE-OF-THE-ART COUNTER FEATURING THE MANY BENEFITS OF CUSTOM LSI CIRCUITRY. THIS NEW TECHNOLOGY APPROACH TO INSTRUMENTATION YIELDS ENHANCED PERFORMANCE, SMALLER PHYSICAL SIZE, DRASTICALLY REDUCED POWER CONSUMPTION (PORTABLE BATTERY OPERATION IS NOW PRACTICAL), DEPENDABILITY, EASY ASSEMBLY AND REVOLUTIONARY LOWER PRICING!



SIZE:
3" High
6" Wide
5 1/2" Deep

1 3/4 LBS.
COLOR:
BLACK

FEATURES AND SPECIFICATIONS:

DISPLAY: 8 RED LED DIGITS .3" CHARACTER HEIGHT
GATE TIMES: 1 SECOND AND 1/10 SECOND
[AUTO DEC. PT. PLACEMENT]
RESOLUTION: 1 HZ AT 1 SECOND, 10 HZ AT 1/10 SECOND
FREQUENCY RANGE: 10 HZ TO 60 MHZ. [65 MHZ TYPICAL]
SENSITIVITY: 10 MV RMS TO 50 MHZ, 20 MV RMS TO 60 MHZ TYP.
INPUT IMPEDANCE: 1 MEGOHM AND 20 PF.
[DIODE PROTECTED INPUT FOR OVER VOLTAGE PROTECTION.]
ACCURACY: ± 1 PPM [$\pm .0001\%$] AFTER CALIBRATION TYPICAL
STABILITY: WITHIN 1 PPM PER HOUR AFTER WARM UP [.001% XTAL IC PACKAGE COUNT: 8 [ALL SOCKETED]]
INTERNAL POWER SUPPLY: 5.2 V DC AT 800 MA. REGULATED.
INPUT POWER REQUIRED: 8-12 VDC OR 115 VAC AT 50/60 HZ.
POWER CONSUMPTION: 4 WATTS
INPUT CONNECTOR: BNC TYPE

ORDER BY PHONE OR MAIL
COD ORDERS WELCOME

KIT #FC-50C 60 MHZ COUNTER WITH CABINET & P.S. \$119.95

KIT #PSL-650 650 MHZ PRESCALER [NOT SHOWN] 29.95

MODEL #FC-50WT 60 MHZ COUNTER WIRED, TESTED & CAL. 165.95

MODEL #FC-50/600 WT 600 MHZ COUNTER WIRED, TESTED & CAL. 199.95

KIT #FC-50C IS COMPLETE WITH PREDRILLED CHASSIS ALL HARDWARE AND STEP-BY-STEP INSTRUCTIONS. WIRED & TESTED UNITS ARE CALIBRATED AND GUARANTEED. PRESCALERS WILL FIT INSIDE COUNTER CABINET.

TERMS: FOR SHIPPING, HANDLING & INSURANCE
TO US & CANADA ADD 5% ALL OTHERS 10%.
FLORIDA RES. ADD 4% SALES TAX. COD
CHARGE \$1.00.



OPTOELECTRONICS, INC.

BOX 219 • HOLLYWOOD, FLA. 33022 • (305) 921 2056

crocomputers. In addition to coverage of design and engineering topics, the handbook compares and contrasts the microcomputer to standard computers and minicomputers. It also compares the various types and capabilities of microcomputers. Software and programming techniques are also compared. Published by Mason Charter Publishers, 641 Lexington Ave., New York, NY 10022. Hard cover. 480 pages. \$19.95.

have been published on this new device. From this large body of literature, the editors of this book have selected 45 of the best papers for the engineer who wants to learn about or to apply CCD technology. The reprints in this book are arranged into five parts for the reader's convenience: Introduction, Device Physics and Technology, Imaging, Memory, and Analog Signal Processing. Each part is preceded by introductory comments designed to place the papers in perspective and to assist in making use of this important new technology.

CHARGE-COUPLED DEVICES: TECHNOLOGY AND APPLICATIONS

edited by Roger Melen & Dennis Buss

Although charge-coupled devices were announced only in 1970, over 1000 papers

Published by John Wiley & Sons, Inc., 605 Third Ave., New York, NY 10016. 415 pages. \$19.95 clothbound; \$9.95 paperbound.

P.O. Box 4430C Santa Clara, CA 95054 (408) 988-1640

Same day shipment. First line parts only. Factory tested. Guaranteed money back. Quality IC's and other components at factory prices.

INTEGRATED CIRCUITS

740071	74LS538	30	LM370	1.15	CD4211	22	74C14	2.10
74008	17 74LS74N	35	LM377	4.50	CD4212	22	74C20	2.8
74009	17 74LS10N	47	LM379	4.50	CD4213	22	74C28	2.8
74010	17 74LS10N	47	LM380	1.50	CD4214	94	74C48	2.95
74011	17 74LS10N	47	LM391	1.50	CD4215	94	74C74	2.95
74012	17 74LS10N	47	LM392	1.50	CD4216	94	74C175	3.90
74013	17 74LS10N	47	LM393	1.50	CD4217	0.00	74C192	1.15
74014	83 74LS107N	35	LM394	1.50	CD4218	94	74C201	1.80
74015	17 74LS107N	35	LM395	1.50	CD4219	50	74C203	1.80
74016	39 74LS138N	35	LM396	1.50	CD4220	11	74C206	1.80
74017	39 74LS138N	35	LM397	1.50	CD4221	11	74C209	1.80
74018	39 74LS138N	35	LM398	1.50	CD4222	11	74C210	1.80
74019	39 74LS138N	35	LM399	1.50	CD4223	11	74C211	1.80
74020	60 74LS154N	67	LM374N	62	CD4224	83	74C212	1.80
74021	60 74LS154N	67	LM375N	62	CD4225	83	74C213	1.80
74022	17 74LS154N	67	LM376N	62	CD4226	39	74C214	1.80
74023	17 74LS154N	67	LM377N	62	CD4227	39	74C215	1.80
74024	17 74LS154N	67	LM378N	62	CD4228	39	74C216	1.80
74025	17 74LS154N	67	LM379N	62	CD4229	11	74C217	1.80
74026	60 74LS154N	67	LM380N	1.27	CD4230	11	74C218	1.80
74027	60 74LS154N	67	LM381N	1.27	CD4231	11	74C219	1.80
74028	60 74LS154N	67	LM382N	1.27	CD4232	11	74C220	1.80
74029	60 74LS154N	67	LM383N	1.27	CD4233	11	74C221	1.80
74030	60 74LS154N	67	LM384N	1.27	CD4234	11	74C222	1.80
74031	60 74LS154N	67	LM385N	1.27	CD4235	11	74C223	1.80
74032	60 74LS154N	67	LM386N	1.27	CD4236	11	74C224	1.80
74033	60 74LS154N	67	LM387N	1.27	CD4237	11	74C225	1.80
74034	60 74LS154N	67	LM388N	1.27	CD4238	11	74C226	1.80
74035	60 74LS154N	67	LM389N	1.27	CD4239	11	74C227	1.80
74036	60 74LS154N	67	LM390N	1.27	CD4240	11	74C228	1.80
74037	60 74LS154N	67	LM391N	1.27	CD4241	11	74C229	1.80
74038	60 74LS154N	67	LM392N	1.27	CD4242	11	74C230	1.80
74039	60 74LS154N	67	LM393N	1.27	CD4243	11	74C231	1.80
74040	60 74LS154N	67	LM394N	1.27	CD4244	11	74C232	1.80
74041	60 74LS154N	67	LM395N	1.27	CD4245	11	74C233	1.80
74042	60 74LS154N	67	LM396N	1.27	CD4246	11	74C234	1.80
74043	60 74LS154N	67	LM397N	1.27	CD4247	11	74C235	1.80
74044	60 74LS154N	67	LM398N	1.27	CD4248	11	74C236	1.80
74045	60 74LS154N	67	LM399N	1.27	CD4249	11	74C237	1.80
74046	60 74LS154N	67	LM380N	1.27	CD4250	11	74C238	1.80
74047	60 74LS154N	67	LM381N	1.27	CD4251	11	74C239	1.80
74048	60 74LS154N	67	LM382N	1.27	CD4252	11	74C240	1.80
74049	60 74LS154N	67	LM383N	1.27	CD4253	11	74C241	1.80
74050	60 74LS154N	67	LM384N	1.27	CD4254	11	74C242	1.80
74051	60 74LS154N	67	LM385N	1.27	CD4255	11	74C243	1.80
74052	60 74LS154N	67	LM386N	1.27	CD4256	11	74C244	1.80
74053	60 74LS154N	67	LM387N	1.27	CD4257	11	74C245	1.80
74054	60 74LS154N	67	LM388N	1.27	CD4258	11	74C246	1.80
74055	60 74LS154N	67	LM389N	1.27	CD4259	11	74C247	1.80
74056	60 74LS154N	67	LM390N	1.27	CD4260	11	74C248	1.80
74057	60 74LS154N	67	LM391N	1.27	CD4261	11	74C249	1.80
74058	60 74LS154N	67	LM392N	1.27	CD4262	11	74C250	1.80
74059	60 74LS154N	67	LM393N	1.27	CD4263	11	74C251	1.80
74060	60 74LS154N	67	LM394N	1.27	CD4264	11	74C252	1.80
74061	60 74LS154N	67	LM395N	1.27	CD4265	11	74C253	1.80
74062	60 74LS154N	67	LM396N	1.27	CD4266	11	74C254	1.80
74063	60 74LS154N	67	LM397N	1.27	CD4267	11	74C255	1.80
74064	60 74LS154N	67	LM398N	1.27	CD4268	11	74C256	1.80
74065	60 74LS154N	67	LM399N	1.27	CD4269	11	74C257	1.80
74066	60 74LS154N	67	LM380N	1.27	CD4270	11	74C258	1.80
74067	60 74LS154N	67	LM381N	1.27	CD4271	11	74C259	1.80
74068	60 74LS154N	67	LM382N	1.27	CD4272	11	74C260	1.80
74069	60 74LS154N	67	LM383N	1.27	CD4273	11	74C261	1.80
74070	60 74LS154N	67	LM384N	1.27	CD4274	11	74C262	1.80
74071	60 74LS154N	67	LM385N	1.27	CD4275	11	74C263	1.80
74072	60 74LS154N	67	LM386N	1.27	CD4276	11	74C264	1.80
74073	60 74LS154N	67	LM387N	1.27	CD4277	11	74C265	1.80
74074	60 74LS154N	67	LM388N	1.27	CD4278	11	74C266	1.80
74075	60 74LS154N	67	LM389N	1.27	CD4279	11	74C267	1.80
74076	60 74LS154N	67	LM390N	1.27	CD4280	11	74C268	1.80
74077	60 74LS154N	67	LM391N	1.27	CD4281	11	74C269	1.80
74078	60 74LS154N	67	LM392N	1.27	CD4282	11	74C270	1.80
74079	60 74LS154N	67	LM393N	1.27	CD4283	11	74C271	1.80
74080	60 74LS154N	67	LM394N	1.27	CD4284	11	74C272	1.80
74081	60 74LS154N	67	LM395N	1.27	CD4285	11	74C273	1.80
74082	60 74LS154N	67	LM396N	1.27	CD4286	11	74C274	1.80
74083	60 74LS154N	67	LM397N	1.27	CD4287	11	74C275	1.80
74084	60 74LS154N	67	LM398N	1.27	CD4288	11	74C276	1.80
74085	60 74LS154N	67	LM399N	1.27	CD4289	11	74C277	1.80
74086	60 74LS154N	67	LM380N	1.27	CD4290	11	74C278	1.80
74087	60 74LS154N	67	LM381N	1.27	CD4291	11	74C279	1.80
74088	60 74LS154N	67	LM382N	1.27	CD4292	11	74C280	1.80
74089	60 74LS154N	67	LM383N	1.27	CD4293	11	74C281	1.80
74090	60 74LS154N	67	LM384N	1.27	CD4294	11	74C282	1.80
74091	60 74LS154N	67	LM385N	1.27	CD4295	11	74C283	1.80
74092	60 74LS154N	67	LM386N	1.27	CD4296	11	74C284	1.80
74093	60 74LS154N	67	LM387N	1.27	CD4297	11	74C285	1.80
74094	60 74LS154N	67	LM388N	1.27	CD4298	11	74C286	1.80
74095	60 74LS154N	67	LM389N	1.27	CD4299	11	74C287	1.80
74096	60 74LS154N	67	LM390N	1.27	CD4300	11	74C288	1.80
74097	60 74LS154N	67	LM391N	1.27	CD4301	11	74C289	1.80
74098	60 74LS154N	67	LM392N	1.27	CD4302	11	74C290	1.80
74099	60 74LS154N	67	LM393N	1.27	CD4303	11	74C291	1.80
74100	60 74LS154N	67	LM394N	1.27	CD4304	11	74C292	1.80
74101	60 74LS154N	67	LM395N	1.27	CD4305	11	74C293	1.80
74102	60 74LS154N	67	LM396N	1.27	CD4306	11	74C294	1.80
74103	60 74LS154N	67	LM397N	1.27	CD4307	11	74C295	1.80
74104	60 74LS154N	67	LM398N	1.27	CD4308	11	74C296	1.80
74105	60 74LS154N	67	LM399N	1.27	CD4309	11	74C297	1.80
74106	60 74LS154N	67	LM380N	1.27	CD4310	11	74C298	1.80
74107	60 74LS154N	67	LM381N	1.27	CD4311	11	74C299	1.80
74108	60 74LS154N	67	LM382N	1.27	CD4312	11	74C300	1.80
74109	60 74LS154N	67	LM383N	1.27	CD4313	11	74C301	1.80
74110	60 74LS154N	67	LM384N	1.27	CD4314	11	74C302	1.80
74111	60 74LS154N	67	LM385N	1.27	CD4315	11	74C303	1.80
74112	60 74LS154N	67	LM386N	1.27	CD4316	11	74C304	1.80
74113	60 74LS154N	67	LM387N	1.27	CD4317	11	74C305	1.80
74114	60 74LS154N	67	LM388N	1.27	CD4318	11	74C306	1.80
74115	60 74LS154N	67	LM389N	1.27	CD4319	11	74C307	1.80
74116	60 74LS154N	67	LM390N	1.27	CD4320	11	74C308	1.80
74117	60 74LS154N	67	LM391N	1.27	CD4321	11	74C309	1.80
74118	60 74LS154N	67	LM392N	1.27	CD4322	11	74C310	1.80
74119	60 74LS154N	67	LM39					

Electronics Classified

REGULAR CLASSIFIED: COMMERCIAL RATE: For firms or individuals offering commercial products or services, \$2.25 per word. Minimum order \$33.75. **EXPAND-AD CLASSIFIED RATE:** \$3.35 per word. Minimum order \$50.25. Frequency discount: 5% for 6 months; 10% for 12 months paid in advance. **READER RATE:** For individuals with a personal item to buy or sell, \$1.35 per word. No minimum! **DISPLAY CLASSIFIED:** 1" by 1 column (2-1/4" wide), \$260.00. 2" by 1 column, \$520.00. 3" by 1 column, \$780.00. Advertiser to supply film positives. For frequency rates, please inquire.

GENERAL INFORMATION: Payment must accompany copy except when ads are placed by accredited advertising agencies. First word in all ads set in caps. All copy subject to publisher's approval. All advertisers using Post Office Boxes in their addresses **MUST** supply publisher with permanent address and telephone number before ad can be run. Advertisements will not be published which advertise or promote the use of devices for the surreptitious interception of communications. Ads are not acknowledged. They will appear in first issue to go to press after closing date. Closing Date, 1st of the 2nd month preceding cover date (for example, March issue closes January 1st. Send order and remittance to **POPULAR ELECTRONICS**, One Park Avenue, New York, New York 10016, Attention: Hal Cymes

FOR SALE

FREE! Bargain Catalog—I.C.'s, LED's, readouts, fiber optics, calculators parts & kits, semiconductors, parts. Poly Paks, Box 942PE, Lynnfield, Mass. 01940

GOVERNMENT and industrial surplus receivers, transmitters, snooperscopes, electronic parts. Picture Catalog 25 cents Meshna Nahant, Mass. 01908.

LOWEST Prices Electronic Parts. Confidential Catalog Free. KNAPP, 3174 8th Ave. S.W., Largo, Fla. 33540

ELECTRONIC PARTS, semiconductors, kits, **FREE FLYER** Large catalog \$1.00 deposit. BIGELOW ELECTRONICS, Bluffton, Ohio 45817.

RADIO—T.V. Tubes—36 cents each. Send for free catalog. Cornell, 4213 University, San Diego, Calif. 92105.

AMATEUR SCIENTISTS, Electronics Experimenters, Science Fair Students... Construction plans—Complete, including drawings, schematics, parts list with prices and sources... Robot Man — Psychedelic shows — Lasers — Emotion/Lie Detector — Touch Tone Dial — Quadraphonic Adapter — Transistorized Ignition — Burglar Alarm — Sound Meter... over 60 items. Send 50 cents coin (no stamps) for complete catalog. Technical Writers Group, Box 5994, University Station, Raleigh, N.C. 27607.

METERS—Surplus, new, used, panel or portable. Send for list, Hanchett, Box 5577, Riverside, CA 92507.

MECHANICAL, **ELECTRONIC** devices catalog 10 cents. Greatest Values — Lowest Prices Fertik's, 5249 "D", Philadelphia, Pa. 19120

SOUND SYNTHESIZER KITS—Surf \$12.95. Wind \$12.95. Wind Chimes \$17.95. Musical Accessories, many more. Catalog free PAIA Electronics, Box J14359, Oklahoma City, OK 73114

BUGGED??? New locator finds them fast. Write, Clifton, 11500-L N.W. 7th Avenue, Miami, Florida 33168

YOU WILL SAVE BIG MONEY! Surplus, Clearouts, Bankruptcy, Inventory, Deals, Catalog \$1 (redeemable). ET- COA Electronics, Box 741, Montreal, H3C 2V2 U.S. Inquiries.

HEAR POLICE / FIRE Dispatchers! Catalog shows exclusive directories of "confidential" channels, scanners. Send postage stamp Communications, Box 56-PE, Com-mack, N.Y. 11725.

UNSCRAMBLERS: Fits any scanner or monitor, easily adjusts to all scrambled frequencies. Only 4" square \$29.95, fully guaranteed. Dealer inquiries welcomed PDQ Electronics, Box 841, North Little Rock, Arkansas 72115.

RECONDITIONED Test Equipment \$0.50 for catalog. Walter's Test Equipment, 2697 Nickel, San Pablo, CA 94806.

POLICE/Fire scanners, large stock scanner crystals, antennas. Also CBs. Harvey Park Radio, Box 19224, Denver, CO 80219.

TELETYPE EQUIPMENT for sale for beginners and experienced computer enthusiast Teletype machines, parts, supplies. Catalogue \$1.00 to: ATLANTIC SALES, 3730 Nautilus Ave., Brooklyn, NY 11224. Tel: (212) 372-0349.

WHOLESALE C.B., Scanners, Antennas, Catalog 25 cents. Crystals: Special cut, \$4.95. Monitor \$3.95. Send make, model, frequency. G. Enterprises, Box 461P, Clearfield, UT 84015.

BUILD YOUR OWN SPEAKERS AND SAVE UP TO 50%

Send for our free fact-packed 44 page catalog manual and learn how to assemble your own multi-element stereo speakers from scratch or from kits. Our catalog includes chapters on design construction & covers enclosures, mixers, woofers, tweeters and horns. Write us today.

SPEAKERLAB
Dept PE-A 5500 35th N E
Seattle Washington 98105



YES, YOU CAN BUILD AN ELECTRONIC ORGAN

That has a PIPE ORGAN SOUND

With **DEVTRONIX** easy to build assemblies
Own the ultimate in organ design & sound
at 1/3 the cost of commercial organs.

BROCHURE AND DEMO RECORD \$1.00

Dept. C
5872 Amapala Dr.
San Jose, CA 95129

Devtronix
ORGANS, INC.

BUILD AND SAVE. TELEPHONES, TELEVISION, DETECTIVE, BROADCAST Electronics. We sell construction plans with an Engineering Service. Speakerphones, Answering Machines, Carphones, Phonevision, Dialers, Color TV Converters, VTR, Games, \$25 TV Camera, Electron Microscope, Special Effects Generator, Time Base Corrector, Chroma Key, Engineering Courses in Telephone, Integrated Circuits, Detective Electronics, PLUS MUCH MORE. NEW Super Hobby Catalog PLUS year's subscription to Electronic News Letter, \$1.00. Don Britton Enterprises, 6200 Wilshire Blvd., Los Angeles, Calif. 90048.

NAME BRAND Digital/Analog Test Equipment. Discount prices. Free catalog. Salen Electronics, Box 82, Skokie, Ill. Illinois 60076.

SURPLUS COMPONENTS. Communication and test equipment. Illustrated catalog 25 cents. E. French, P.O. Box 249, Aurora, Illinois 60505

CB RADIOS, monitors, crystals, CD ignitions. Southland, Box 3591-B, Baytown, Texas 77520.

TELEPHONES UNLIMITED, Equipment, Supplies, All types, Regular, Keyed, Modular. Catalog 50 cents. Box 1147E, San Diego, California 92112.

CARBON FILM RESISTORS 1/4W, 1/2W - 1.7 cents each. FREE sample / specifications. Other components COMPONENTS CENTER, Box 134P, New York, N.Y. 10038.

PROFESSIONAL UNSCRAMBLERS — several models that fit any scanner. Free information. Capri Electronics, 8753T Windom, St. Louis, MO 63114.

UNSCRAMBLE CODED MESSAGES from Police, Fire and Medical Channels. Same day service. Satisfaction guaranteed. Don Nobles Electronics, Inc., Rt. 7, Box 265B, Hot Springs, Arkansas 71901. (501) 623-6027.

ANYTHING ELECTRONIC — we've got it. Catalog \$1.00. Razoo, Box 1224, Cupertino, Calif.

BUILD YOUR OWN TV CAMERA!
— Ideal for home & business —

THE ECONOMIC ANSWER TO HOME MONITORING OF BUSINESSES, ENTRANCES, DRIVEWAYS, BUSINESS AND INDUSTRIAL SURVEILLANCE, TV, AMATEUR TV PLUS HUNDREDS OF OTHER APPLICATIONS.

MODEL #T-1-A, SERIES B KIT FORM \$19.95
ASSEMBLED \$75. SOLID-STATE, WORKS ON ANY TV SET. OPTIONAL SOUND KIT \$28.95.

PHONE or WRITE for catalog, Dial 402-967-3771

1301 BROADWAY ATV Research DAKOTA CITY, NE 68731

SEEKING ORIGINAL JAPANESE TRANSISTORS FOR CB AND STEREO REPAIR? Request complete list. Compare 1 to 9 prices. 2SC710, 59 cents, 2SC517, \$3.95, 2SC799, \$3.60, 2SC1306, \$4.40, 2SC1678, \$2.25, TA7205P, \$3.90; BA521, \$3.70. BA511, \$3.40. Fuji-Svea Enterprises, Dept. P, Box 40325, Cincinnati, OH 45240

USED TEST EQUIPMENT — Tektronix, HP, GR. Write: PTI, Box 8699, White Bear Lake, MN 55110. Phone: (612) 429-2975.

WEATHER MAP RECORDERS: Copy Satellite Photographs, National-Local Weather Maps. Learn How! \$1.00. Atlantic Sales, 3730 Nautilus Ave., Brooklyn, N.Y. 11224. Tel: (212) 372-0349.

AUDIO EXPERIMENTERS, Serious Music Synthesizer Stuff: literature, kits, components, circuits and more. Send SASE for FREE INFO. CFR Associates, POB F, Newton, NH 03858.

FREE CATALOG. Solar Cells, Nicads, Kits, Calculators, Digital Watch Modules, Ultrasonics, Strobes, LEDS, Transistors, IC's, Unique Components. Chaney's, Box 27038, Denver, Colorado 80227.

MICRO MINI MIKE™
WIRELESS MICROPHONE

World's smallest! solid state, self-contained. Picks up and transmits most sounds without wires up to 300 ft. through FM Radio. Use as mike, amp., alarm & alert sys., hot line, baby sitter, etc. Money back guarantee. B.A. M/C cds, COD ok. \$18.95 plus \$1.00 post & hdg. Calif. res. add tax. Mail orders Qty. Disc. Avail. **AMC SALES, INC.**
Dept. 23, Box 928, Downey, Calif. 90241

SIZE 2 1/4" x 3/4" x 1 1/2"

MAKE YOUR PLANS COME TRUE by using electronic kit of Touch Switch, Patrol Car Siren, Sound Switch, Singing Bird. Each Kit \$5.00 ppd. QMC, P.O. Box 4816, Irvine, California 92716.

SPEAKERS — Save 60%. Factory assembled or kits. Free catalog. Quality Acoustics, 15428 Center, Harvey, Illinois 60426.

B&K TEST EQUIPMENT. Dinosaur discounts. Free shipping. Free catalog. Spacatron, 948 Prospect, Elmhurst, IL 60126.

HYPNOTIC DISK! Projects spiral image! Induces sleep/relaxation! Instructions included. \$2.00 ppd. Boone Products, PE12, 930 S. Bonnie Brae No. 313, Los Angeles, CA 90006

EXPERIMENTERS — STOP BUYING SPECIAL TRANSFORMERS — New Concept — Universal transformer alterable in minutes — Any number of windings at any voltage (Max 50VA) — Imagine winding 5V at 5A plus two 12V at 1A and 15V at .4A today then changing tomorrow! Only \$16.50 — 30 day refund — other models available. ETS, 398 Sound Beach Avenue, Old Greenwich, CT 06870.

BEING BUGGED — NEW DETECTOR finds bugs fast. Save money. Send \$5.00 for plans and schematic. L. Parker, 1674 Milverton, Troy, Mich. 48084.

TRANSISTORS FOR CB REPAIR, IC's and diodes. TV audio repairs. 2SC799 — \$3.00, 2SC1306 — \$2.95, 2SC1307 — \$3.85, TA7205 — \$3.50, more. Free catalog and transistor. B&D Enterprises, Box 32, Mt. Jewett, PA 16740.

BREAKERLESS ELECTRONIC ignition: Auburn Spark-plugs, Synthetic Lubricants, Wheel Stabilizers. Information 26 cents. Anderson Engineering, Epsom, N.H. 03234.

CRYSTAL CONTROLLED DIGITAL CROSSHATCH/DOT GENERATOR. Kit \$31.95, built \$41.95. Free Catalog. PHOTOLUMINE CORP., 118 East 28 Street, New York, NY 10016.

MAKE PROFESSIONAL QUALITY PC boards with silk-screen techniques. Complete information, \$4.95 postpaid. TerraTronic Research, Box 513DP, Quincy, Ill. 62301

LOGIC PROBE — Test CMOS and TTL. Compact size. A must for hobbyists. Construction plans \$1.50. Engineering Services, Box 1615, Fitchburg, Mass. 01420.

GOLDMINE OF PARTS, POWERFUL POWER SUPPLY, documentation, in complete CARTRIVISION electronic assembly. Perfect for MICROPROCESSOR and all electronic applications. \$24.95 total. Master Charge, BankAmericard. Free Brochure. MADISON ELECTRONICS, INCORPORATED, 369 Madison, Alabama 35758. SATISFACTION GUARANTEED.

CHRISTMAS PRESENT for the Home Mechanic — Digital Dwell Tachometer with Points Resistance Indication — Faster, Easier to use, more accurate than old analog meters — 4, 6, 8 Cyl., 0-6000 RPM, 0-90° Dwell, 4 digits — Send \$69.95 plus \$1.25 for postage and handling to: Palmer Electronics, 10704 Blossom Lane, Silver Spring, MD 20903. Maryland residents add 5% sales tax.

17-DIGIT ELECTRONIC TIMEPIECE KIT. Simultaneous date, time, alarm, and timer readout, \$109.00. **PINK NOISE GENERATOR KIT**, \$9.95. West Side Electronics, Box 636-P2, Chatsworth, California 91311.

GRAB BAG! Fantastic variety unused-mint components. ICs, transistors: \$10/10 pounds! FIFTEEN Western Electric relays, 2' rack: \$9.75. Postpaid. Satisfaction Guaranteed! Computron, Box 18160-G, Cleveland, Ohio 44118.

ELECTRONIC Voltage Regulators for Cars. Most imports. \$14.95 ppd. State year, make, model. Solid State Co., Box 108, Clarkson, Mississauga, ONT., Canada. L5J 3X9. U.S. Inquiries Welcomed.

MUSIC — CMOS Envelope Generator — Attack - Fallback - Sustain - Decay: Versatile - Highest quality - Inexpensive. Plans \$2.50. POE, 18578 Haskins, Chagrin Falls, Ohio 44022.

BARGAIN PRICES Radio-TV parts. Free Wholesale Catalog. K-D Sales, Box 3549, Akron, Ohio 44310.

NEW PERIODIC TABLE OF ELEMENTS. Atomic physics breakthrough now reveals precise atomic models of each element. Striking wall chart. \$3.00. Circlon, 29500 Greenriver Gorge, Enumclaw, WA 98022.

ACOUSTIC COUPLER-MODEM Never used. Latest technology. \$195. (714) 272-4381.

UNBELIEVABLE GOLDMINE of Electronic Schematics. 201 dynamite projects. \$9.99. Send for free project list. Space-tech, Box 182, Gillette, N.J. 07933.

CITIZENS BAND EQUIPMENT. Discount prices. Free List. CRS Communications, 1552 Central Park Ave., Yonkers, N.Y. 10710.

PLANS AND KITS

AMAZING ELECTRONIC PRODUCTS

LASERS SUPER POWERED, RIFLE, PISTOL, POCKET — SEE IN DARK, PYRO, TECHNICAL, DE-BUGGING, UNCRAMBLERS, GIANT TESLA, STUNWAND, TV DISRUPTER, ENERGY PRODUCING, SCIENTIFIC DETECTION, ELECTRIFYING CHEMICAL, ULTRASONIC, CB, AERO, AUTO AND MECH DEVICES, HUNDREDS MORE... ALL NEW PLUS INFO UNLTD PARTS SERVICE

INFORMATION unlimited

Box 826 Lord Jeffrey PZ • Amherst, N.H. 03031

CATALOG \$1

FREE KIT Catalog contains Test and Experimenter's Equipment. Dage Scientific Instruments, Box 1054P, Livermore, CA 94550.



TIGER SST SIMPLI-KIT

FOR THE DO-IT-YOURSELFER NOW! a high quality CD Electronic Ignition System in kit form.

Contains all components and solder to build complete Solid State Electronic CD Ignition System for your car. Assembly requires less than 3 hours.

- Increases MPG 15%
- Eliminates 4 of 5 tune-ups
- Increases horsepower 15%
- Instant starting, any weather
- Plugs and Points last 50,000 miles
- Dual system switch

Fits only 12 volt neg. ground. Only **\$21.95** postpaid

Tri-Star Corporation

P. O. Box 1727 Grand Junction, Colorado 81501

MIXERS—Preamps—Speakers, Top Quality Kits—Plans—Parts. Send 25 cents for catalog. Audio Design & Engineering Co., P.O. Box 154, Lee, Mass. 01238. (413) 243-1333.

THE "KING OF KITS". Artisan Organ Kits feature all new modular construction, with logic-controlled stops and RAM Preset Memory System. Write for brochure to: AOK Manufacturing, Inc., P.O. Box 445, Kenmore, WA 98028.

FREQUENCY COUNTER: 300 MHz, miniportable/mobile, 7 digit 4" LED display, dual timing, memory. Construction plans: \$3.00. Kits available. PANAXIS, Box 5516-AL, Walnut Creek, CA 94596.

ROBOT Plans That Work! \$5.00. American Robots, Dept. E, P.O. Box 1304, Tulsa, OK 74101.

QUALITY KITS for amazing devices. Send 25 cents for catalog. Ideatronics, 263 Lawrence Ave., Highland Park, N.J. 08904.

BUILD INEXPENSIVE AMPLIFIERS, Equalizers, Guitar Effects, Mixers, etc. Details 25 cents. Chastronics, Box 8615, Universal City, CA 91508.

DIGITAL IC's, TTL, CMOS, plans, kits, and parts. Free bargain flyer. T. Wong, 103 E. Bway, Dept. 4A, New York, NY 10002.

HIGH FIDELITY

DIAMOND NEEDLES and Stereo Cartridges at Discount prices for Shure, Pickering, Stanton, Empire, Grado and ADC. Send for free catalog. LYLE CARTRIDGES, Dept. P, Box 69, Kensington Station, Brooklyn, New York 11218. For Fast Service call Toll Free 800-221-0906.

BURGLAR ALARMS

Burglar. Smoke Fire Alarm Catalog

• Billions of dollars lost annually due to lack of protective warning alarms.

FREE CATALOG Shows you how to protect your home, business and person. Wholesale prices. Do-it-yourself. Free engineering service.



Burdex Security Co.

Box 82802 PE 127 Lincoln, Ne. 68501

CB's BECOME BURGLAR ALARMS with Modex Alarm Circuit. Plans \$1.99. Modex, Box 887, Middletown, Conn. 06457.

DON'T PURCHASE alarm equipment before getting our free value packed catalog. SASCO, 5619-C St. John, Kansas City, MO 64123. (816) 483-4612.

AUTO ALARM SYSTEMS. Secure-It represents the finest in automatic alarms. Available in either audible or silent paging systems. Write or call for free catalog. Armout Security Inc., 1030 N. Grove St., Anaheim, Calif. 92806. (714) 630-3042.

WANTED

GOLD. Silver, Platinum, Mercury wanted. Highest prices paid by refinery. Ores assayed. Free circular. Mercury Terminal, Norwood, MA 02062.

TUBES

RADIO & T.V. Tubes—36 cents each. Send for free Catalog. Cornell, 4213 University, San Diego, Calif. 92105.

TUBES receiving, factory boxed, low prices, free price list. Translertec, Inc., 1365 39th Street, Brooklyn, N.Y. 11218A, Telephone: 212-633-2800.

TUBES: "Oldies". Latest, Supplies, components, schematics. Catalog Free (stamp appreciated). Steinmetz, 7519-PE Maplewood, Hammond, Ind. 46324.

TUBES, free low priced list. Specializing obsolete types. TJ, Inc., Box 43, Bradley Beach, N.J. 07720.

MUSICAL INSTRUMENTS

UP TO 60% DISCOUNT. Name brand instruments catalog. Freeport Music, 114 G. Mahan St., W. Babylon, N.Y. 11704.

TAPE AND RECORDERS

8-TRACK and CASSETTE BELTS — money back guarantee. Long wearing. Free Catalog — \$3 minimum order. PRB Corp., Box 176, Whitewater, Wisconsin 53190.

RECORDS—TAPES! Discounts to 73%, all labels, no purchase obligations; newsletter, discount dividend certificates; 100% guarantees. Free details. Discount Music Club, 650 Main St., Dept 5-1177, New Rochelle, New York, N.Y. 10801.

GOVERNMENT SURPLUS

MANUALS for Govt Surplus radios, test sets, scopes. List 50 cents (coin). Books, 7218 Roanne Drive, Washington, D.C. 20021.

GOVERNMENT SURPLUS Buy in your Area. How, where. Send \$2.00. Surplus, 30177-PE Headquarters Building, Washington, D.C. 20014.

JEEPS—\$59.30! CARS—\$33.50! 200,000 ITEMS—GOVERNMENT SURPLUS—Most COMPREHENSIVE DIRECTORY AVAILABLE tells how, where to buy—YOUR AREA—\$2.00—MONEYBACK GUARANTEE—Government Information Services, Department GE-4, Box 99249, San Francisco, California 94109. (433 California.)

GOVT SURPLUS — buy direct from gov't. Complete info plus application form \$2.00. Info-Capsule A-1, P.O. Box 151, Shelocta, PA 15774.

PERSONALS

MAKE FRIENDS WORLDWIDE through international correspondence. Illustrated brochure free. Hermes-Verlag, Box 110660-Z, D-1000 Berlin 11, Germany.

INVENTIONS WANTED

INVENTORS

RECOGNITION... FINANCIAL REWARD... OR CREDIT FOR "INVENTING IT FIRST" MAY BE YOURS!

If you have an idea for a new product, or a way to make an old product better, contact us, "the idea people." We'll develop your idea, introduce it to industry, negotiate for cash sale or royalty licensing. Write now without cost or obligation for free information. Fees are charged only for contracted services. So send for your FREE "Inventor's Kit." It has important Marketing Information, a special "Invention Record Form" and a Directory of 1001 Corporations Seeking New Products.

RAYMOND LEE ORGANIZATION
230 Park Avenue North, New York, NY 10017

At no cost or obligation, please rush my FREE "Inventor's Kit No. A-112"

Name _____

Address _____

City _____ State _____ Zip _____

Phone No _____ Area code _____

FREE PAMPHLET: "Tips on Marketing Your Invention", from an experienced fee-based invention service company. Write: United States Inventors Service Company, Dept. T, 1435 G Street NW, Washington DC 20005.

INSTRUCTION

LEARN ELECTRONIC ORGAN SERVICING at home all makes including transistor. Experimental kit—trouble-shooting. Accredited NHSC. Free Booklet. NILES BRYANT SCHOOL, 3631 Stockton, Dept. A, Sacramento, Calif. 95820.

SCORE high on F.C.C. Exams. Over 300 questions and answers. Covers 3rd, 2nd, 1st and even Radar. Third and Second Test. \$14.50. First Class Test, \$15.00. All tests, \$26.50. R.E.I., Inc., Box 806, Sarasota, Fla 33577.

UNIVERSITY DEGREES BY MAIL! Bachelors, Masters, Ph.D's. Free revealing details. Counseling, Box 317-PE12, Tustin, California 92680.

LEARN WHILE ASLEEP! HYPNOTIZE! Astonishing details, strange catalog free! Autosuggestion, Box 24-ZD, Olympia, Washington 98507.

SELF-STUDY CB RADIO REPAIR COURSE. THERE'S MONEY TO BE MADE REPAIRING CB RADIOS. This easy-to-learn course can prepare you for a career in electronics enabling you to earn as much as \$16.00 an hour in your spare time. For more information write: **CB RADIO REPAIR COURSE**, Dept. PE127, 531 N. Ann Arbor, Oklahoma City, Okla. 73127.

GRANTHAM'S FCC LICENSE STUDY GUIDE — 377 pages, 1465 questions with answers/discussions — covering third, second, first radiotelephone examinations. \$13.45 post-paid. GSE, P.O. Box 25992, Los Angeles, California 90025.

INTENSIVE 5 week course for Broadcast Engineers. FCC First Class license. Student rooms at the school. Radio Engineering Inc., 61 N. Pineapple Ave., Sarasota, FL 33577 and 2402 Tidewater Trail, Fredericksburg, VA 22401.

1977 TESTS-ANSWERS for FCC First Class License. Plus "Self-Study Ability Test." Proven! **\$9.95. Moneyback Guarantee. "FREE" BROCHURE.** Command, Box 26348-P, San Francisco 94126.

RADIO BROADCASTING. Become DJ, engineer, owner. Start your own station — receive free tapes, records. Learn Details Free. "Broadcasting", Box 5516-AL, Walnut Creek, CA 94596

NEW FCC License Exams and instructional material by author of published FCC License workbooks. Covers Second-First Classes and Radar. Hundreds of questions and answers with full solutions. Free counselling service. **\$19.95.** Victor Veley, P.O. Box 14, La Verne, Calif. 91750.

BUSINESS OPPORTUNITIES

I MADE \$40,000.00 Year by Mailorder! Helped others make money! Free Proof. Torrey, Box 318-NN, Ypsilanti, Michigan 48197.

FREE CATALOGS. Repair air conditioning, refrigeration. Tools, supplies, full instructions. Doolin, 2016 Canton, Dallas, Texas 75201.

MAILORDER MILLIONAIRE helps beginners make \$500 weekly. Free report reveals secret plan! Executive (1K12), 333 North Michigan, Chicago 60601.

HIGHLY PROFITABLE ONE-MAN ELECTRONIC FACTORY

Investment unnecessary, knowledge not required, sales handled by professionals. Postcard brings facts about this unusual opportunity. Write today! Barta-DL, Box 248, Walnut Creek, CA 94597.

GET RICH with Secret Law that smashes debts and brings you \$500 to \$5 Million cash. Free report! Credit 4K12, 333 North Michigan, Chicago 60601.

NEW LUXURY Car Without Cost. Free Details! Codex-ZZ, Box 3073, Toledo, Ohio 43614.

\$500 PER DAY POSSIBLE. New C.B. related business. Send 25 cents. P.A. Schubert Company, P.O. Box 187, Howell, Mich. 48843.

\$500.00 WEEKLY! IMMEDIATE Home income stuffing envelopes. **FREE** Supplies! Guaranteed! Send 25 cents, Stamp. ALCO, B19110-PED, Las Vegas, NV 89119.

FREE REPORT: Big Money in Mail! Transworld-9K, Box 6226 Toledo, Ohio 43614.

GET RICH!!! Secret law erases debts. Free report exposes millionaire \$\$ secrets. Blueprints. No. EE12 453 W. 256, NYC 10471.

MECHANICALLY INCLINED Individuals desiring ownership of Small Electronics Manufacturing Business — without investment. Write Marks, 92-K12 Brighton 11th, Brooklyn, New York 11235.

GUARANTEED SECRETS of solid mail order success! Fantastic details! Free! Wayne, Box 644ZD, Ottawa, KS 66067.

\$500/1000 Stuffing envelopes. Free supplies. Send stamped addressee envelope. Fars Enterprises, Box 2128 PE, Union, N.J. 07083.

\$500.00 WEEKLY guaranteed, start your home envelope stuffing business, no experience, complete details, send stamped envelope. Fortunesworth Opportunities, Box 4451, Union City, N.J. 07087.

EARN IMMEDIATELY STUFFING ENVELOPES. \$300.00 Thousand Possible. Free supplies. Send Stamped envelope. Salomon Industries — PE3, 6059 W. 55th St., Chicago, IL 60638.

RUBBER STAMPS

RUBBER STAMPS, BUSINESS CARDS. Many new products. Catalog, Jackson's, Dept. K, Brownsville Rd., Mt. Vernon, Ill. 62864.

EMPLOYMENT OPPORTUNITIES

ELECTRONICS/AVIONICS EMPLOYMENT OPPORTUNITIES. Report on jobs now open. Details FREE. Aviation Employment Information Service, Box 240E, Northport, New York 11768.

REAL ESTATE

BIG, NEW, FREE, SPRING CATALOG! Over 2,500 top values coast to coast! UNITED FARM AGENCY, 612-EP, West 47th, Kansas City, MO 64112.

DO-IT-YOURSELF

MODULAR TELEPHONES now available. Sets and components, compatible with Western Electric concept. Catalog 50 cents. Box 1147W, San Diego, California 92112.

TAPE-SLIDE SYNCHRONIZER lap-dissolve, multiprojector audiovisual plans \$8.50. Free Catalog. Millers, 1896 Maywood, South Euclid, OH 44121.

HOME ENTERTAINMENT FILMS

XMAS SHOP BY MAIL! Save Dollars! Apollo XV. Ride of the Rover. \$5.95 S8 B&W; Std 8 Color, \$14.95 Tunney/Gibbons & Tunney/Heeny on one reel, only \$5.95 Std 8 or S8. Celebrate Dempsey/Tunney 50th Anniversary — both fights, one reel, S8 or Std 8, \$6.95 ea PPD. — our lowest prices of the year. Want Super 8 Sound? Order from Columbia catalog, \$0.85. Universal 8 catalog, \$0.75. Sportlite forms \$0.35. **SAVE 10% ACROSS THE BOARD!** SPORTLITE. Elect-12, 20 N. Wacker Drive, Chicago, IL 60606.

HYPNOTISM

SLEEP learning. Hypnotic method, 92% effective. Details free. ASR Foundation, Box 23429EG, Fort Lauderdale, Florida 33307.

FREE Hypnotism. Self-Hypnosis. Sleep Learning Catalog! Drawer H400, Ruidoso, New Mexico 88345.

AMAZING self-hypnosis record releases fantastic mental power. Instant results! Free trial. Write: Forum (AA12), 333 North Michigan, Chicago 60601.

BOOKS AND MAGAZINES

FREE book prophet Elijah coming before Christ. Wonderful bible evidence. Megiddo Mission, Dept. 64, 481 Thurston Rd., Rochester, N.Y. 14619.

POPULAR ELECTRONICS INDEXES For 1976 now available. Prepared in cooperation with the Editors of "P/E," this index contains hundreds of references to product tests, construction projects, circuit tips and theory and is an essential companion to your magazine collection. 1976 Edition, \$1.50 per copy. All editions from 1972 onward still available at the same price. Add \$2.25 per order for postage and handling, \$.50 per copy, foreign orders. INDEX, Box 2228, Falls Church, Va. 22042.

TECHNICAL MANUALS — Ameco, Arrl, Cowan, Gilfer, Rider, RCA Radio Callbook, Sams, Tab. T.I., Postage 35 cents bk, ppd. Five, Madison Electronics, 1508 McKinney, Houston, Texas 77002.

TRS-80 USERS GROUP — Join — Monthly newsletter. \$17.00 first year. Marsh, 621 13th S., Onalaska, WI 54650.

ROBOTICS NEWSLETTER. \$8 year. Issued monthly. International Institute for Robotics, Dept. PE, Box 615, Pelahatchie, MS 39145.

CLASSIFIED ADVERTISING ORDER FORM

1	2	3
4	5	6
7	8	9
10	11	12
13	14	15
16	17	18
19	20	21
22	23	24
25	26	27
28	29	30
31	32	33
34	35	36

Please refer to heading on first page of this section for complete data concerning terms, frequency discounts, closing dates, etc. **WORD COUNT.** 15 WORD MINIMUM. Include name and address. Name of city (Des Moines) or of state (New York) counts as one word each. Zip Code not counted. Count each abbreviation, initial, single figure or group of figures or letters as a word. Symbols such as 35mm, COD, PO, AC, etc., count as one word. Hyphenated words count as two words. Telephone numbers count as one word.

Words

\$2.25 (Commercial Rate)
\$3.35 (Expand-Ad Rate)
\$1.35 (Reader Rate)

Payment of \$ _____ enclosed for _____ insertions.

AmEx BAC

MC Others

CHARGE for _____ insertions.
 You will be billed monthly.

Account # _____ Expiration Date _____

Master Charge Interbank # (4 digits above name) _____

SIGNATURE MUST BE PROVIDED BELOW

PRINT NAME _____

ADDRESS _____

CITY _____ STATE _____ ZIP _____

SIGNATURE _____ PE-1277

1978 Electronic Experimenter's Handbook



This latest edition includes a Hobbyist and Microcomputer Section! It also features a host of exciting construction projects with complete construction plans, parts lists and printed-circuit board patterns. PLUS — A complete Home Computer Buying Directory with product specifications, latest prices, and photos. Only \$1.95!

Order your copy from **ELECTRONIC EXPERIMENTER'S HANDBOOK**, Consumer Service Division, 595 Broadway, New York, N.Y. 10012. Enclose \$2.50* (\$1.95 plus 55c postage and handling). Outside U.S.A. \$3.

*Residents of CA, CO, FL, IL, MI, MO, NY STATE, DC and TX add applicable sales tax (Postage and handling charges non-taxable).

COLLECTIONS & HOBBIES

STAMPS — SAVINGS! QUALITY! Free price list. Fast. Professional. Arizona Stamp, 4668C Speedway, Tucson, AZ 85712.

MISCELLANEOUS

MPG INCREASED! Bypass Pollution Devices easily. REVERSIBLY!! Free details—Posco GEE12, 453 W. 256, NYC 10471.

Why you should buy a digital multimeter from the leader in digital multimeters.

If you're shopping for your first multimeter, or moving up to digital from analog, there are a few things you should know.

First, look at more than price. You'll find, for instance, that the new Fluke 8020A DMM offers features you won't find on other DMMs at *any* price. And it's only \$169.*

Second, quality pays. Fluke is recognized as the leading maker of multimeters (among other things) with a 30-year heritage of quality, excellence and value that pays off for you in the 8020A.

Third, don't under-buy. You may think that a precision 3½-digit digital multimeter is too much instrument for you right now. But considering our rapidly changing technology, you're going to need digital *yesterday*.

If you're just beginning, go digital.

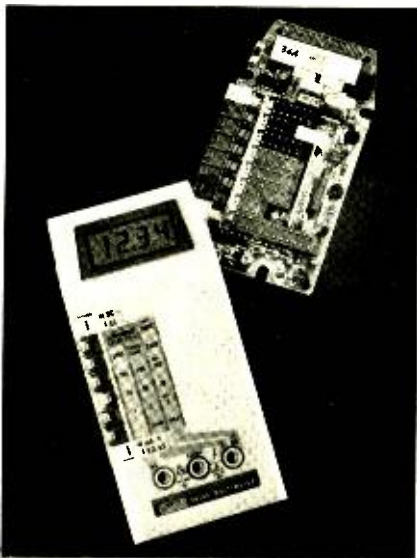

Why not analog? Because the 8020A has 0.25% dc accuracy, and that's *ten*

times better than most analog meters.

Also, the 8020A's digital performance means things like 26 ranges and seven functions. And the tougher your home projects get, the more you need the 8020A's full-range versatility and accuracy. The 8020A has it; analog meters don't.

If you're a pro.

You already know Fluke. And you probably own a benchtop-model multimeter.

Now consider the 8020A: smaller in size, but just as big in capability. Like 2000-count resolution and high-low power ohms. Autozero and autopolarity. And the 8020A has 3-way protection against overvoltage, overcurrent and transients to 6000V!

Nanosiemens?

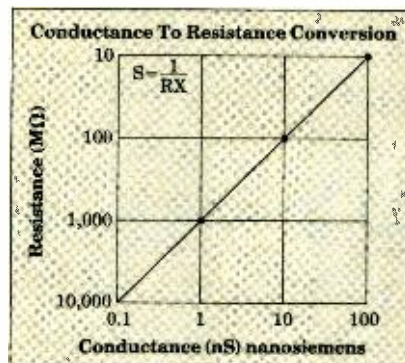

Beginner or pro, you'll find the meter you now have can't measure nanosiemens. So what? With the 8020A *conductance* function, you can measure the equivalent of 10,000 megohms in nanosiemens. Like capacitor, circuit board and insulation leakage. And, you can check transistor gain with a simple, homemade adapter. Only with the 8020A, a 13-oz. heavyweight that goes where you go, with confidence.

What price to pay.



\$169.*

Of course, you can pay more. Or less. In fact, you could pay almost as much for equally compact but more simplistic meters, and get far less versatility. And, the 8020A gives you the 'plus' of custom CMOS LSI chip design, and a minimum number of parts (47 in all). All parts and service available at more than 100 Fluke service centers, worldwide. Guaranteed, for a full year.

Rugged. Reliable. Inexpensive to own and to operate; a simple 9V battery assures continuous use for up to 200 hours.

Where to buy.

Call (800) 426-0361 toll free. Give us your chargecard number and we'll ship one to you the same day. Or, we'll tell you the location of the closest Fluke office or distributor for a personal hands-on feel for the best DMM value going.

*U.S. price only

Fluke 8020A DMM for Home Electronics Experts: \$169



Select what you want in a record cleaner.

Convenience in use and storage.

You shouldn't need a separate shelf, elaborate motions or an act of Congress to clean your records. A comfortable, hand-held instrument that works best on a rotating turntable is ideal.

Effectiveness against micro-dust.

Tiny, invisible dust particles hide in delicate record grooves and can be ground into the vinyl. Only a slanted (directional) fiber using special ultra-small fiber tips can scoop up, rather than rearrange, this micro-dust contamination.

Effectiveness against chemical contamination.

Fingerprints and vapor-borne oils will deposit into channels of a record groove. Such contamination hides from adhesive rollers and all dry cleaning systems. Only a special fluid plus micro-fibers can safely remove such audible, impacted deposits.

Total removal of contamination/fluid.

Capillary action—the lifting of fluid by small fiber surface tension—is totally effective. You want to get contamination off the record, along with any fluid traces.

Lasting construction.

You want quality. A record cleaner can last a lifetime. A plastic wonder can crack into oblivion—or you can purchase the hand-rubbed elegance of milled walnut befitting the rest of your audio system.

Ultimate economy.

The value of a truly fine record cleaner is justified by the cost of replacing your record collection. Fifteen dollars is a small investment in long-term protection.

All of the above.

**DISCWASHER, the Superior
Record Cleaner.**

See the finer audio dealers for a demonstration.



discwasher, inc. 1407 N. Providence Rd., Columbia, MO 65201

Now... a Hide-away CB that doesn't sacrifice audio quality. From Johnson CB.

Johnson's new remote-mounting Hide-away CB includes a full-size 2-way radio communications speaker. Others don't.

With other hide-aways you get a miniature speaker in the microphone, which delivers miniature sound. Or, you get no speaker at all. You have to hook up your CB through your car radio speaker. Either way, there's a compromise with communication audio clarity.

But the Johnson Hide-away CB is engineered and built as a system. Our voice-tailored audio circuitry is designed to drop off signals outside voice frequencies and it is matched to our communication speaker characteristics.

The CB chassis mounts out of sight in the trunk or under the seat. It has our exclusive TANL for full-time suppression of electrical noise. Plus a built-in AGC to prevent audio overload from strong, nearby stations. The result is a superb sounding CB.

The compact speaker/readout module which mounts in the passenger compartment, gives full, rich sound and some other unique advantages. We put our large LED channel display on the module, instead of the microphone to make it easier and safer to read.

And only Johnson gives you a choice between a conventional microphone, or a beautiful radiotelephone-type handset that gives you all the advantages of the conventional mike plus private listening with the flip of a switch. Both give you volume, squelch and electronic channel changing — all within a finger's reach. And our built-in amplified speech compressor circuitry delivers maximum "talk power" automatically.

So whether your transmitting or receiving, Johnson is the best-sounding hide-away you can buy. And the most reliable, too — made in America and backed by Johnson's one-year warranty with nation-wide service.



Compare Johnson's big speaker with competitive speaker in the mike.



JOHNSON CB

JOHNSON AMERICAN INC. 1401 6TH AVE S
CLEAR LAKE IA 50428
A SUBSIDIARY OF E. F. JOHNSON COMPANY



JOHNSON AMERICAN CB. INGENIOUS!

CIRCLE NO. 33 ON FREE INFORMATION CARD

www.americanradiohistory.com