

CHEMICALS FOR ELECTRONICS SERVICING

Popular Electronics

WORLD'S LARGEST-SELLING ELECTRONICS MAGAZINE

JANUARY 1977/\$1.25

Build The "MORSE-A-LETTER"

ANYONE CAN "READ" MORSE CODE
WITH THIS AUTOMATIC READOUT DEVICE



Test Meters For Electronics

A Low-Distortion, Low-Cost Audio Generator Project

How To Interface Computer Terminal Keyboards

SWR- Facts and Fallacies

Build A Direction-Sensing Photoelectric Switch/Counter

TEST REPORTS: Sansui AM/FM Stereo Receiver, Kenwood Integrated Amplifier, Kraco Receiver, Drake SWL Receiver

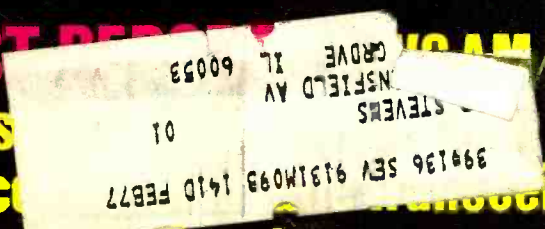



THE COBRA 32XLR. A TECHNOLOGICAL PUNCHTHROUGH.

Cobra has a reputation for punching through loud and clear. The new Cobra 32XLR, of course, continues the reputation. And creates another—for innovative design, superb engineering and technical superiority.

Start with the illuminated 4-in-1 meter. It tells you exactly how much power you're pushing out and pulling in. As well as monitoring your modulation in precise percentages. And measuring your punch with an SWR check. In short, the 32 XLR lets you keep an eye on your ears.

ScanAlert, Cobra's unique scanning system, continually monitors Channel 9 when you're on another channel. If an emergency comes up, the ScanAlert light goes on. And the incoming message automatically locks the receiver on the active channel.



The 32XLR's Digital Channel Selector is the very latest. With large LED numerals—for a read-out that registers clearly and quickly. Plus switchable "pulse block" noise blanking that rejects short-pulse noise not normally blocked by other systems. Which makes it the most effective in the business. Finally, add automatic noise limiting, Dynamike Plus (with built-in power mike) and Delta Tuning.

The new Cobra 32XLR. It has virtually everything. And it has everything to do just one thing. Punch through loud and clear.



Punches through loud and clear.

Cobra Communications Products
DYNASCAN CORPORATION
6460 W. Cortland St., Chicago, Illinois 60635

FREE

THE NEW HEATHKIT CATALOG

the world's largest selection of fun-to-build, money-saving electronic kits!

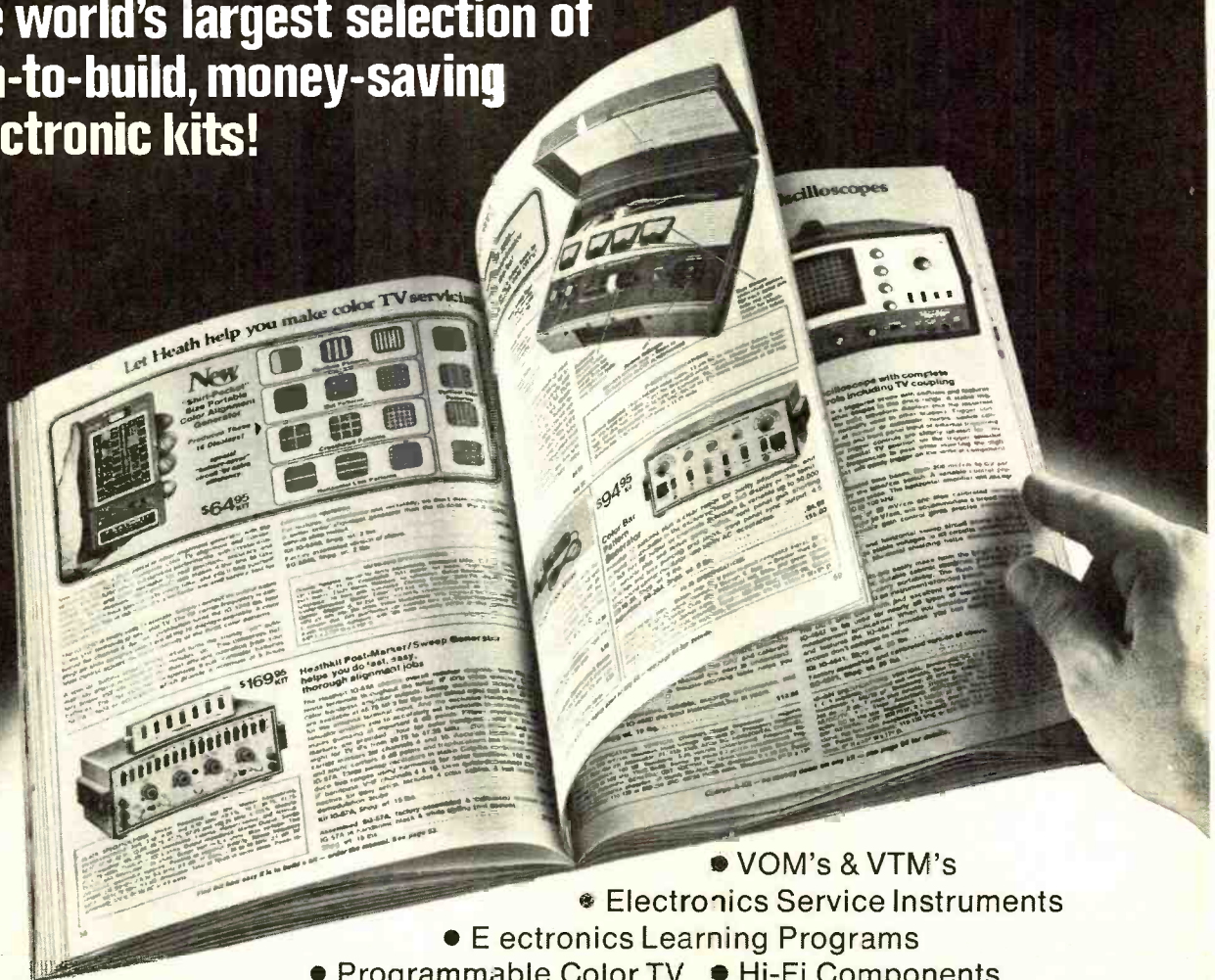

- VOM's & VTM's
- Electronics Service Instruments
- Electronics Learning Programs
- Programmable Color TV • Hi-Fi Components
- Amateur Radio • Radio Control Modeling Equipment
- Digital Clocks & Weather Accessories • Marine, Auto & Aircraft Accessories

Read about the nearly 400 electronic kits you can build and service yourself. The famous Heath assembly manuals guide you every step of the way, and our quality design assures top performance from every kit you build.

Send for your copy today!

Heath Co., Dept. 10-25
Benton Harbor, Michigan 49022

JANUARY 1977

HEATH	Schlumberger
	Heath Company, Dept. 10-25 Benton Harbor, Michigan 49022
Please send me my FREE Heathkit Catalog. I am not on your mailing list.	
Name _____	
Address _____	
City _____ State _____ Zip _____	
CL-602B	

CIRCLE NO. 5 ON FREE INFORMATION CARD

THE SOLDERING IRON VS. THE PROTO-BOARD.[®]

(IT'S NO CONTEST.)



The Soldering Iron

If you're still designing and testing breadboard circuits the conventional way, you're doing a lot of extra work, and getting a lot of grief in return. You've got to think as much about manual labor as you do about the circuit. Maybe even more.

Every time you add a component, there are 2 or more connections to make... over a dozen with most IC's, while watching out for overheating components and cold solder joints. And that's only half the problem.

The other half is when you want to change components or connections. Even with good desoldering equipment, you can still have a hassle on your hands. (Ever try to desolder a temperature-sensitive 14-pin DIP on a component-filled board?)

Solder. Desolder. Resolder.
Desolder: Now there's a better way...

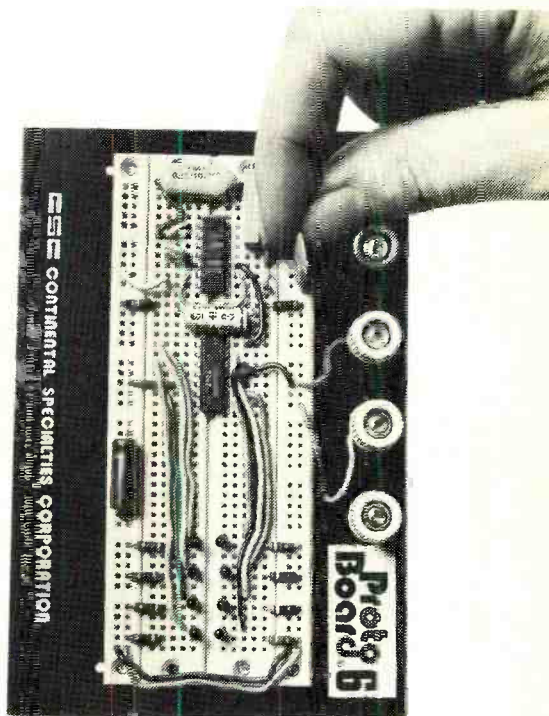

The Proto-Board

With the CSC Proto-Board breadboarding system, connecting components is as simple as pushing a lead into a hole. Rugged 5-point contacts insure low-resistance connections, and where jumpers are needed, components are interconnected with standard #22 AWG solid wire.

That's all there is to it.

You can choose Proto-Boards with anywhere from 530 to 3060 solderless tie-points. Proto-Boards with or without regulated power supplies. Even assemble your own, with the same solderless QT sockets and Bus Strips,* for smaller (or larger) capacity. However you do it, you'll save time... money... aggravation... on every circuit.

CONTINENTAL SPECIALTIES CORPORATION



For more information, see your CSC dealer or distributor... or contact us for our catalog and distributor list.

Continental Specialties Corp., 44 Kendall Street, Box 1942, New Haven, CT 06509 • 203-624-3103 TWX: 710-465-1227
West Coast Office: Box 7809, San Francisco, CA, 94119 • 415-421-8372 TWX: 910-372-7992
Canada: Len Finkler Ltd., 25 Toro Rd., Downsview, Ontario • 416-630-9103

An Extraordinary Offer to introduce you to the benefits of Membership in

ELECTRONICS BOOK CLUB

take any **3** of these unique electronics books (value to \$61.70) for only **99¢** each

with a Trial Membership in the Book Club that guarantees to save you 25% to 75% on a wide selection of electronics books

All 2- and 3-book sets count as only one of your 3 Selections.



May we send you your choice of these 3 practical, time-and-money-saving books as part of an unusual offer of a Trial Membership in Electronics Book Club?

Here are quality hardbound volumes, each especially designed to help you increase your know-how, earning power, and enjoyment of electronics. Whatever your interest in electronics, you'll find Electronics Book Club offers practical, quality books that you can put to immediate use and benefit.

This extraordinary offer is intended to prove to you, through your own experience, that these very real advantages can be yours...that it is possible to keep up with the literature published in your areas of interest, and to save substantially while so doing. As part of your Trial Membership, you need purchase as few as four books during the coming 12 months. You would probably buy at least this many anyway...without the substantial savings offered through Club Membership.

To start your Membership on these attractive terms, simply fill out and mail the coupon today. You will receive the 3 books of your choice for 10-day inspection. **YOU NEED SEND NO MONEY!** If you are not delighted, return the books within 10 days and your Trial Membership will be cancelled without cost or obligation.

ELECTRONICS BOOK CLUB, P.O. Box 10, Blue Ridge Summit, Pa. 17214

Facts About Club Membership

- The 3 introductory books of your choice carry publishers' retail prices of up to \$61.70. They are yours for only 99¢ each (plus postage and handling) with your Trial Membership.
- You will receive the Club News, describing the current Selection, Alternates and other offerings, every 4 weeks (13 times a year).
- If you want the Selection, do nothing; it will be sent to you automatically. If you do not wish to receive the Selection, or if you want to order one of the many Alternates offered, you simply give instructions on the reply form (and in the envelope) provided, and return it to us by the date specified. This date allows you at least 10 days in which to return the form. If, because of late mail delivery, you do not have 10 days to make a decision and so receive an unwanted Selection, you may return it at Club expense.
- Personal Service for your account—no computers used!
- To complete your Trial Membership, you need buy only four additional monthly selections or alternates during the next 12 months. You may cancel your Membership any time after you purchase these four books.
- All books—including the introductory Offer—are fully returnable after 10 days if you're not completely satisfied.
- All books are offered at low Member prices, plus a small postage and handling charge. Prepaid orders shipped postpaid.
- Continuing Bonus: If you continue after this Trial Membership, you will earn a Dividend Certificate for every book you purchase. Three Certificates, plus payment of the nominal sum of \$1.99, will entitle you to a valuable Book Dividend of your choice which you may choose from a list provided Members.

ELECTRONICS BOOK CLUB

P.O. Box 10
Blue Ridge Summit, Pa. 17214

Please open my Trial Membership in ELECTRONICS BOOK CLUB and send me the 3 books circled below. I understand the cost of the books I have selected is only 99¢ each, plus a small shipping charge. If not delighted, I may return the books within 10 days and owe nothing, and have my Trial Membership cancelled. I agree to purchase at least four additional books during the next 12 months, after which I may cancel my membership at any time.

101	487/729/780	628/691	563/636	582
	627/672	655	728	735
	785	800	835	870
			901	919

Name _____ Phone _____

Address _____

City _____

State _____ Zip _____

(This offer valid for new Members only. Foreign and Canada add 10%) PE-17



Letters

OBTAINING LOGS

Michael Covington's method of obtaining common logarithms with a calculator equipped with only the \ln function (Letters,

September 1976) is difficult to remember and gives only a two-place accuracy. A method that will produce an exact conversion for base-10 logs is to first obtain the natural log of the number and then divide by $\ln 10$. The accuracy here is down to the tenth place. Interestingly, this method can be used to find the log of a number to any base. Just find the natural log of the number and divide by the natural log of the desired base. For example, $(\ln 3.2)/(\ln 6.5)$ will give the log of 3.2 to the base 6.5—*Craig A. Pearce, Berwyn, IL*

KEEP 'EM HAPPY

I have been a reader of POPULAR ELECTRONICS for three years and am happy to re-

new my subscription. I particularly liked the August 1976 Editorial ["Planting Electronics Hobby Seeds"] I am one of the 8.2% of your readers who are under 18 years old and I can assure you that PE has been my best source of information on electronics over the years. Thanks to a few nice people, I have learned FORTRAN and BASIC computer languages and have used the Altair 8800 with 8K BASIC and IBM 360 with FORTRAN IV.—*Scott Crane, Victoria, TX*

MORE EM BOOKS

I teach electronic music at Bucks County Community College and have enjoyed the EM articles published in POPULAR ELECTRONICS. John McVeigh mentioned some excellent books on this subject in the September 1976 Hobby Scene. I would like to add two more titles to his list: Craig Anderton's "Electronic Projects for Musicians," which is slanted toward beginners and deals with sound modification instead of sound-generating devices and National Semiconductor's "The Audio Handbook," which has a wealth of information on preamps, electronic effects, IC power amps, etc. I use Mr. Anderton's book as a textbook in my classes.—*David Karr, Levittown, PA*

DETECTING COLOR-TV X-RAY

With regard to the September 1976 Editorial, if the test kit for color-TV X-ray emission is non-screen film, at least 25 to 50 millirads of X-ray would be required to visibly darken the film. This is a comparatively large amount of radiation. Secondly, if the detector is capable of detecting X-ray emissions from the TV receiver, it would probably do a poor job of evaluating the total leakage. In a Bureau of Radiological Health article issued in 1969, a radiation measuring device with the trade name "Ray-alert" was reviewed. I believe that the remarks addressed to this unit would be very relevant to the color-TV radiation detector kit described in the Editorial.—*Clark Hickman, Public Health Physicist, Division of Environmental Health, Santa Ana, CA*

LIKE REFERENCE TABLES

In "Designing Optimum-Q and Small Inductors" (September 1976), the author states that intermediate inductance or number of turns can be found using the formula $L = KT$. However, the formula should be $L = KT^2$ to agree with the table listed. The article provided me with some much needed information. Keep the reference tables coming.—*Rodney L. Egleston, Alderson, WV*

The September issue's two charts on "Designing Optimum-Q and Small Inductors" made this issue worth the entire subscription renewal price.—*George E. S. Thompson, Oakland, CA*

SENSOR PIN NUMBERS

In my "Improved Gas and Fume Detector" (August 1976), the pin-number diagrams for the sensor and the semiconductors were

POPULAR ELECTRONICS

SPECIAL OFFER!

Buy 23-channel CB now. Get new 40-channel later at 1/2 price!

UPON FCC TYPE ACCEPTANCE

"Don't be without CB while waitin' for the FCC"
NO MODIFICATION FEES—NO MODIFICATION DELAYS—OWN AND KEEP TWO UNITS



handic[®]

handic USA, Inc. 14560 NW 60th Ave. Miami Lakes, FL 33014

THE ORANGE EQUIPMENT KNOWN FOR PROFESSIONAL QUALITY THE WORLD OVER

CIRCLE NO. 28 ON FREE INFORMATION CARD



wire wrapping center...

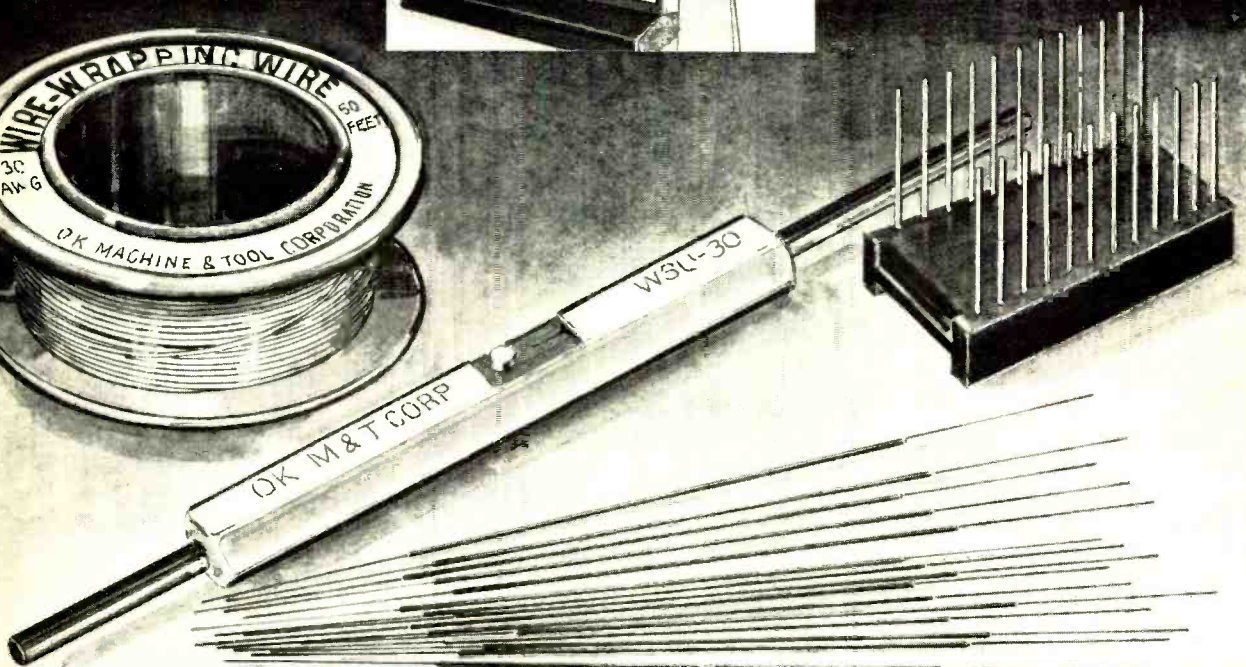
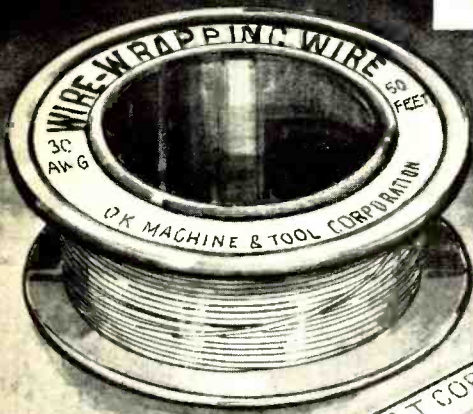

for quality electronic parts and tools.

OK MACHINE & TOOL CORPORATION

3455 Conner St., Bronx, N.Y. 10475 / (212) 994-6600 / Telex 125091

omitted. The numbering of the pins is as follows:

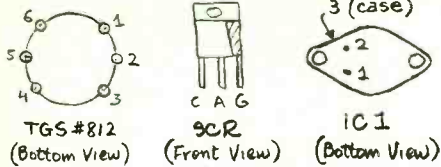

—C.R. Lewart, Holmdel, NJ.

MAIL FOR THE "ELF"

I'm building the "Cosmac 'Elf'" featured in the August 1976 issue and would like to cor-

respond with others who are doing the same or have already built their microcomputers.—E.M. Robertson, Jr., 1534 Hermitage Ct., Durham, NC 27707.

We have included Mr. Robertson's entire address so that interested readers can correspond directly with him.

I have just completed building the "Cosmac 'Elf'" and am very happy with it. Some things I would like to see in upcoming issues are a 1K memory or a means of expanding the memory broken down into 1K blocks and a program that could be used with the Elf on the "HIT" recording system. Thanks for interesting projects like the Elf. If you keep up

bringing us projects like this, I will have to extend my subscription, which is good only until 1980.—Stanley W. Pozerski, Jr., Lowell, MA.

I would very much like to complete assembling my Elf microcomputer, but I do not understand where the remaining 11 connections go after the circuits in Fig. 4 and Fig. 5 in the construction article are interconnected.—David W. Getchell, Madison, CT.

As you surmised, there are 11 connections left over after the two circuits are interconnected. The left-over connections go nowhere; just leave them as shown in Fig. 4.

JFET'S SELF-LIMIT

"Universal Interface Between Low-Power Logic and Load Drivers" (June 1976) presented some unique interfacing techniques. However, what I do not understand is what prevents the JFET's junction between the source and gate from becoming heavily forward biased as it clearly will in D, E, and F with the logic swing shown and implied. Would not the current flow be rather heavy under these conditions?—William D. Kraengel, Jr.

The advantage inherent in JFET's is their self-limiting of current. The I_{DSS} is intended to be the normal and maximum current in these applications.—Vern Gregory

KIT SUPPLIER RESPONDS

I was less than pleasantly surprised to find a letter in the October 1976 Letters column complaining about articles containing "ultra-unique" devices that are not widely available. The complaint about using state-of-the-art components to do previously impossible tasks does not warrant comment. What upsets me very much is the implication that I marked up the price of the MN3001. Thanks to an untimely price increase, unknown to me at the time, the one-to-nine-piece price was almost 25% less than it should have been. The only distributor I know of selling MN3001's in less than thousand-piece quantities is Solid State Inc. in NJ. Price is \$19.50.—John H. Roberts, Phoenix Systems, Westport, CT.

Out of Tune

In "A Digital Clock for Vehicles" (October 1976), the hookup from the main to the display board is in error. Connections A and 2 should be moved one pad each to the right, connection 1 two pads to the right, and connection C one pad to the right (see Fig. 2 component layout diagram).

tenna-loc[®]

THE ANTI-THEFT CB ANTENNA LOCK

PROTECT YOUR ANTENNA

tenna-loc it!

tenna-loc is the first, really positive protection designed to keep your antenna intact and in place — year round! Yes, you may remove it for car wash or long term storage... but there's no need to every time you park! It works like a charm in all kinds of weather and keeps on working for years. **tenna-loc** features a turn-proof locking stud integrated into a specially notched U-bolt with a 5-tumbler, corrosion proof key lock. We also give you a heavy-duty mounting bracket

and an electro-polished, stainless steel replacement cup, where needed, for easy, quick installation. At \$11.95 (approx), it's a steal! Get one today.

- Choice of models, to fit most trunk mount antennas.
- Installs quickly, easily: keeps your antenna secure.
- Chrome plated, 5-tumbler, corrosion proof key lock.
- Exclusive, turn-proof, U-bolt with lock-in stud.
- Made in U.S.A.; patent pending.

See Your Dealer!



A product of:
VERNITION CORPORATION
CONSUMER PRODUCTS DIVISION
Lake Success Park, Community Drive, Great Neck, N.Y. 11021 (516) 487-0140

MAGAZINES AT DISCOUNT!

You SAVE UP TO 50%

Here's your chance for a real bargain bonanza on your favorite magazines. Select as many as four of these titles at the low introductory rates shown below—up to 50% off. Use the attached card to order or write to: MAGAZINES AT DISCOUNT, A Division of Ziff-Davis Publishing Co., P.O. Box 2703, Boulder, Colorado 80321.



- APARTMENT LIFE (21)** You pay only \$4.97
Reg. Rate: 9 Issues for \$7.46
- CAR & DRIVER (02)** You pay only \$3.99
Reg. Rate: 12 Issues for \$7.98
- CYCLE (03)** You pay only \$3.99
Reg. Rate: 12 Issues for \$7.98
- FAMILY HANDYMAN (51)** You pay only \$6.98
Reg. Rate: 9 Issues for \$8.55
- FLYING (04)** You pay only \$6.99
Reg. Rate: 12 Issues for \$11.98
- GOLF (63)** You pay only \$3.97
Reg. Rate: 12 Issues for \$7.94
- MECHANIX ILLUSTRATED (28)** You pay only \$5.96
Reg. Rate: 18 Issues for \$8.47
- PLAYBOY (34)** You pay only \$12.00
Newsstand Rate: 12 Issues for \$19.00
- POPULAR ELECTRONICS (06)** You pay only \$6.99
Reg. Rate: 12 Issues for \$9.98
- POPULAR PHOTOGRAPHY (07)** You pay only \$4.99
Reg. Rate: 12 Issues for \$9.98
- POPULAR SCIENCE (35)** You pay only \$4.50
Newsstand Rate: 12 Issues for \$9.00
- PSYCHOLOGY TODAY (08)** You pay only \$7.00
Reg. Rate: 12 Issues for \$12.00
- SPORTS ILLUSTRATED (38)**
You pay only \$9.75 for 25 Issues
Newsstand Rate: 25 Issues for \$25.00
Basic annual rate: 52 Issues for \$9.00
- STEREO REVIEW (11)** You pay only \$3.99
Reg. Rate: 12 Issues for \$7.98
- TIME (40)** You pay only \$12.50
Newsstand Rate: 25 Issues for \$25.00
- TV GUIDE (41)** You pay only \$7.39
Lowest Available Rate: 32 Issues

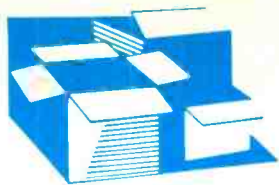

New Products

Additional information on new products covered in this section is available from the manufacturers. Either circle the item's code number on the Reader Service Card inside the back cover or write to the manufacturer at the address given.

RADIO SHACK

MIKE-CONTROLLED CB MOBILE

The Realistic TRC-61 "One-Hander" mobile CB AM transceiver from Radio Shack has all controls built into the microphone. This includes the on-off/volume control, squelch, and rotary 23-channel selector. The remote section can be mounted where desired. All crystals are supplied for 23-channel operation of this 4-watt r-f unit. The One-Hander



has a built-in noise-blanker and automatic noise limiter. Sensitivity is given as $0.5 \mu\text{V}$ for 10 dB (S+N)/N, selectivity as $-6 \text{ dB} \pm 3 \text{ kHz}$, adjacent channel rejection as -60 dB . A three-position switch on the transceiver selects a built-in speaker, external speaker, or uses the microphone as a speaker. The remote section measures $7''\text{D} \times 5\frac{1}{4}''\text{W} \times 1\frac{1}{2}''\text{H}$ ($17.8 \times 13.3 \times 3.8 \text{ cm}$). \$149.95.

CIRCLE NO. 87 ON FREE INFORMATION CARD

YAMAHA POWER AMPLIFIER

The B-2 power amplifier is the second-generation amplifier using the Yamaha FET's in a patented cascode bootstrap circuit, said to achieve a 115-dB S/N. The front panel is like the \$250 UC-1 control panel used on the B-1, except that it is permanently attached and has connections for two sets of speakers instead of five. The dual peak-reading meters



have a range from -50 to $+5 \text{ dB}$, and are said to indicate peaks within 2 dB for a single 10-kHz sine wave. The B-2 is rated at 100 watts per channel, 20 to 20,000 Hz at 0.08% THD, into 8 ohms (140 W into 4 ohms). The frequency response, at 1 W output, 8 ohms, dc setting, is dc to 100 kHz, $+0/-1 \text{ dB}$. Measures $17\frac{1}{8}''\text{W} \times 14\frac{5}{8}''\text{D} \times 6''\text{H}$ ($43.5 \times 37.1 \times 15.2 \text{ cm}$). \$850.

CIRCLE NO. 88 ON FREE INFORMATION CARD

AVANTI TVI FILTERS

Avanti offers three filters for CB'ers with TV interference problems. The AV-800 low-pass filter is for transceivers radiating harmonics of the same frequency as one or more of the local TV channels. The AV-811 filter on the TV lead-in is designed for problems at the TV receiver due to front-end overloading. The AV-820 AC Line Filter is prescribed if the CB signal is being transmitted through ac power lines.

CIRCLE NO. 89 ON FREE INFORMATION CARD

B&K 30-MHz DUAL-TRACE SCOPE

A dual-trace triggered scope with signal delay, designed for applications where very high-speed waveforms must be viewed with clarity and accuracy, has been introduced by B&K-Precision as the Model 1474. An internal 160-ns signal delay line permits the user to view information appearing during the very short rise and fall times of high-frequency waveforms. Minimum visible delay is 12 ns. The 1474 is suitable for such applications as microprocessor system development, troubleshooting of minicomputers and peripheral equipment, and most other digital applications. Rise time is specified as 11.7 ns or less. Waveforms are displayed on an $8 \times 10 \text{ cm}$ CRT viewing area. A ten-position vertical attenuator covers 5 mV to 5 V/cm at an accuracy of $\pm 30\%$. The unit is said to have a



smooth response to well beyond 30 MHz and can trigger on signals up to 50 MHz. Other features include 20 calibrated sweep positions from $0.2 \mu\text{s/cm}$ to 0.5 s/cm (X5 magnification increases sweep speed to 40 ns/cm). The unit, \$820, is fully regulated and designed to maintain accuracy over a 105-130-volt ac range. It measures $9.8''\text{H} \times 14.5''\text{W} \times 17.8''\text{D}$ ($20 \times 25 \times 36 \text{ cm}$). Net weight is 19.6 lb (8.8 kg).

CIRCLE NO. 91 ON FREE INFORMATION CARD

YAESU "DIGITAL" HAM TRANSCEIVER

The Yaesu FT-310D solid-state transceiver with digital readout covers amateur bands from 160 through 10 meters, plus WWV/JJY reception for time signals. Frequency readout to six places is provided by a red LED display. It's rated at 200 watts PEP power input, 200 watts CW, 50 watts AM and FSK (accepts keyboard shifts of 170 or 850 Hz). Receiver sensitivity is $0.25 \mu\text{V}$ at S/N 10 dB. Features switchable selectivity. Audio re-



sponse is 300 to 2700 Hz at -6 dB . Distortion products are less than -31 dB . Frequency drift during any 30-minute period is said to be less than 100 Hz. The unit may be powered by a 13.5-V dc source, negative ground, drawing 21 A in transmit, 0.9 A receive. A matching ac supply with self-contained speaker is available. Measures $11''\text{W} \times 7\frac{1}{16}''\text{D} \times 4\frac{15}{16}''\text{H}$ ($28 \times 19.5 \times 12.5 \text{ cm}$).

CIRCLE NO. 92 ON FREE INFORMATION CARD

AUTO CASSETTE/RADIO

The Superscope CA-15 is an in-dash stereo cassette-tape player that features automatic reverse, manual direction select switch, fast



forward and rewind, manual eject, and slide controls for volume, tone and stereo balance. There are also indicator lights for each direction of tape travel.

CIRCLE NO. 93 ON FREE INFORMATION CARD

TRIPLETT FET VOM

Triplet's model 64 battery-powered FET voltohmmeter has 29 ranges, including six for low-power ohms. These six have an open-cir-



Experience the excitement of owning the finest *personal* computer – IMSAI 8080

Waiting for you – all the incredible performance and power of the IMSAI 8080. And at a price you would normally pay for a home music system: \$599 in kit; \$931 assembled.

WORLD OF USES

The IMSAI 8080 is a superbly engineered, quality computer. It is versatile, expandable and powerful, putting literally hundreds of

applications and uses at your fingertips. Imagine sitting at your desk and enjoying interaction with your IMSAI 8080! Press the on switch and you're ready for game playing, research, education, business applications, or for laboratory instrument control. It has all the power you need, and more, to make your application ideas come alive.

GROWS WITH YOU

The IMSAI 8080 is designed for many years of pleasure. With its open-chassis engineering you can expand your system by adding peripherals and interfaces. The 22-slots and 28 amp power supply mean that you can plug-in today's, plus *tomorrow's* modules.

Right now you can add a module for displaying color graphics and characters on TV; a ready-to-use keyboard; small and large printers, and a single interface that lets you attach multiple devices including a cassette tape recorder. Expect the latest, exciting equipment from IMSAI. We are committed to leadership in this expanding technology.

EASY TO PROGRAM

With our BASIC language you can operate the IMSAI 8080 quickly and easily. Technically knowledgeable? Use our assembly language to develop sophisticated and unique software.



If you're thinking personal computer,
treat yourself to the very best –
IMSAI 8080

Send for free four-color brochure
or \$1 for catalog. Call or write for
name of nearest dealer.

IMSAI

IMSAI Manufacturing Corporation
14860 Wicks Blvd.
San Leandro, CA 94577
(415) 483-2093
TWX 910-366 7237

CIRCLE NO. 30 ON FREE INFORMATION CARD

NEWS RELEASE 1976

OFFICIAL TESTING LAB RATES ALLISON #1... the BEST of ALL Ignition Systems!

NEW ALLISON 'OPTO XR-700'
with the Exclusive... "Built-In" SOLID-STATE VOLTAGE REGULATOR

The ALLISON "Opto" was Officially Rated #1 by a Foreign Government Testing Laboratory as the BEST "Fuel Saving" Ignition of ALL the Ignition Systems Tested, including Systems with C.D. "add-ons!"

Allison replaced the mechanical Breaker-Points and Condenser with a "Highly Accurate" Optical Control. A Beam of Light, passing through a specially designed "ROTOR" precisely triggers a Heavy-Duty "POWER MODULE" that BOTH "Charges and Fires" the Ignition Coil, with the "FASTEST" High Voltage RISE TIME, producing the MAXIMUM "HIGHEST ENERGY" SPARK available.

Since there is NO Mechanical Friction, there are NO Parts to ever WEAR or need replacing, and ONCE properly Timed, it should NEVER need any Maintenance! DWELL never needs adjustment, it is PRE-SET to supply the OPTIMUM Performance at BOTH High and Low Speeds. The RPM Capability of the "XR-700" is Factory Tested to 15,000 RPM.

The "High-Energy" SPARK INTENSITY and DURATION... permits the Positive FIRING of Spark-Plugs, even under the MOST ADVERSE conditions, results in more COMPLETE COMBUSTION and Eliminates "Engine Misfire", hence fewer exhaust Emissions, IMPROVED Fuel Mileage, a HIGHER Performance Level... and helps keep Plugs FROM FOULING, which greatly extends the Spark-Plug LIFE!

Only the Highest Grade (U.S. Made) Solid-State Components are used... UNAFFECTED by Moisture or Vibration! The Allison "XR-700" was engineered to OUTLAST the LIFE OF YOUR CAR!

"EASY-TO-FOLLOW" INSTALLATION.
(Not Necessary to Dismantle your Distributor.)

"CB" USERS: The XR-700 completely ELIMINATES the Major Cause of Primary (Ignition Noise) Interference.

Factory-Backed 10-Year Warranty.
FREE Unit Repair or Replacement on ANY Defects.

ORDER WITH CONFIDENCE...
Remember, even if you PAY Three Times as much, you cannot get a better Ignition System than the "XR-700"!

SAVE! ORDER FACTORY DIRECT.
Send Check or M.O., Car Make, Year, No. Cyl. (4, 5, or 8-Cyl.)

You may use your MASTER CHARGE or BANKAMERICARD. Send us (1) Your Number, (2) Interbank No., (3) Exp. Date.

MC or BA Card Holders, ORDER BY TOLL FREE PHONE:
(800) 423-6525, Ext. 2. (When in Continental U.S.A.)

Before Buying ANY other Type Ignition System, **Send Postcard for FREE BROCHURE.**

If you have already installed a "Capacitive-Discharge" Ignition, **Convert Your "C-D" Unit to BREAKERLESS!** INCREASE ITS EFFICIENCY with "XR-CD"... Only \$34.95

America's Oldest and Largest Manufacturer of Opto-Electronic Ignition Systems.

ALLISON AUTOMOTIVE CO. Our BEST Salesmen...are the USERS of our ALLISON Systems!

1267 -E8, East EDNA PL., COVINA, CAL. 91722

CIRCLE NO. 7 ON FREE INFORMATION CARD

cuit voltage of 90 mV, for fast in-circuit resistance and continuity measurements without biasing or destroying sensitive diodes, IC's or transistors. The 64 is said to have internal circuitry that prevents explosive arcs in high-energy circuits up to the 2-A/1000-V fuse capacity. The ranges include eight each for dc and ac volts, six for low-power ohms, one megohm, junction test forward and reverse conduction. The meter also features a single range-selector switch and modular construction. One test-probe set is used for all measurements. \$130.00.

CIRCLE NO. 94 ON FREE INFORMATION CARD

SAE POWER AMPLIFIER

The SAE 2000 medium-power stereo amplifier is rated at 100 watts per channel, and at 0.05% THD and IM, from 20 Hz to 20 kHz, +0.25 dB, at 250 mW to rated power. The dual-differential inputs, full complementary drivers and output stages are said to provide very low transient and steady-state distortion. The power display uses 15 LED's per channel to indicate the average power (peak responding) of the amplifier over a range of 20 mW to full rated power plus indicating any amplifier overloads. The display indicates power in 3-dB increments. \$450.00.

CIRCLE NO. 95 ON FREE INFORMATION CARD

M&R COMPUTER KIT

Although called a "kit," the Astral 2000 microcomputer from M&R Enterprises is actually over 70% assembled. The power supply, 6800-based processor board and 8K RAM board are assembled and tested. All boards



plug directly into the backplane. Both RS-232 and 20-mA current loop are provided, along with a 2k monitor in ROM, cycle-stealing DMA, and a built-in software-controlled, real-time, six-digit clock display. Options include a video terminal board, 8k EPROM board, I/O tape interface, and 8k BASIC. The minimum Astral 2000 consists of power supply, cabinet, front-panel components, backplane, processor board and 8K RAM board, at \$995 partially assembled, \$1250 fully assembled.

CIRCLE NO. 96 ON FREE INFORMATION CARD

RCA MOBILE CB TRANSCEIVER

The RCA 14T301 Co-Pilot is a 23-channel mobile CB transceiver with a frequency-synthesized phase-locked loop circuits and maximum allowable r-f power output. Features include a switchable automatic noise limiter, illuminated double-function S/r-f/SWR meter, delta tuning, noise-blanker switch, LO/DX

POPULAR ELECTRONICS

FREE McIntosh CATALOG and FM DIRECTORY

Get all the newest and latest information on the new McIntosh Solid State equipment in the McIntosh catalog. In addition you will receive an FM station directory that covers all of North America.



MX 113

FM/FM STEREO - AM TUNER AND PREAMPLIFIER

SEND TODAY!

McIntosh Laboratory, Inc.
East Side Station P.O. Box 96
Binghamton, N.Y. 13904
Dept. PE

NAME _____
ADDRESS _____
CITY _____ STATE _____ ZIP _____

If you are in a hurry for your catalog please send the coupon to McIntosh.
For non rush service send the Reader Service Card to the magazine.

CIRCLE NO. 36 ON FREE INFORMATION CARD



**THESE LITTLE BEAUTIES DELIVER
INCREDIBLE INTERFERENCE REJECTION
ON 40 CHANNELS. AUTOMATICALLY.**

You're looking at the only dual cascaded, crystal lattice filter system available in any CB radio.

These little beauties are the ultimate answer to one of the toughest demands of the experienced CB operator: freedom from adjacent channel interference. Which explains why we've engineered them into our most advanced new 40-channel CB radios.

Dual crystal filtering produces a nearly ideal steep-skirt, flattop selectivity curve. It can deliver a clear message from a weak signal on Channel 18 even while powerful signals "drill in" on 19.

Dual crystal filtering: It's just one of Johnson's exclusive state-of-the-art features. Automatic speech compression, automatic RF gain control, I.F. noise blanking and tapered automatic noise limiting (TANL) are all built-in.

And that's the beauty of it. The ultimate in professional two-way radio performance is *automatic* with Johnson.

Sale or lease of this equipment not permitted until
F.C.C. Type Acceptance has been obtained



JOHNSON

E. F. JOHNSON COMPANY, WASECA, MINN. 56093

In Canada: A. C. Simmonds & Sons, Ltd.

CIRCLE NO. 33 ON FREE INFORMATION CARD

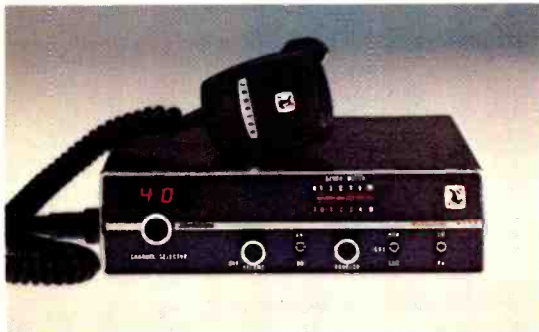

**THE AUTOMATIC CB.
JOHNSON.**

The Best Way To Show You What You'll Get Out Of An Empire Phono Cartridge Is To Show You What Goes Into One.

At Empire we make a complete line of phono cartridges. Each one has slightly different performance characteristics which allow you to choose the cartridge most compatible to your turntable.

There are, however, certain advantages, provided by Empire's unique design, that apply to all our cartridges.

One is less wear on your records. Unlike other magnetic cartridges, Empire's moving iron design allows the diamond stylus to float free of its magnets and coils, imposing much less weight on your record's surface and insuring longer record life.

Another advantage is the better channel separation you get with Empire cartridges. We use a small, hollow iron armature which allows for a tighter fit in its positioning among the poles. So, even the most minute movement is accurately reproduced to give you the space and depth of the original recording.

Finally, Empire uses 4 coils, 4 poles, and 3 magnets (more than any other cartridge) for better balance and hum rejection.

The end result is great listening. Audition one for yourself or write for our free brochure, "How To Get The Most Out Of Your Records". After you compare our performance specifications we think you'll agree that, for the money, you can't do better than Empire.

Empire Scientific Corp.
Garden City, New York 11530

EMPIRE
Already your system sounds better.

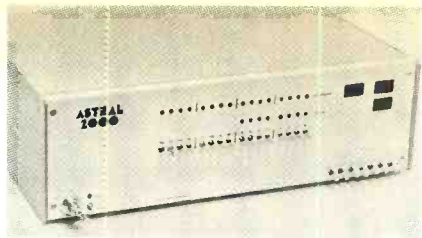

switch, a built-in ALC circuit to compensate for variations in voice level, public address mode and an external speaker jack. \$189.95.

CIRCLE NO. 97 ON FREE INFORMATION CARD

WELLER-XCELITE TOOL SET

A 12-piece starter tool set, Model 250K, for electronic technicians and kit builders, from Weller-Xcelite, comes in a compact plastic carrying case with storage tray. The set includes a Weller 25-watt iron with two 750°F tips; soldering-aid tool and 10 oz of rosin-core solder; Xcelite 4" long-nose pliers; diagonal cutters and wire strippers, all plastic grips; 1/4" nut-driver; and both slotted and Phillips-head screwdrivers with chrome vanadium steel blades and plastic handles. \$35.95.

CIRCLE NO. 98 ON FREE INFORMATION CARD

GARRARD AUTOMATIC TURNTABLE

Garrard's GT55 is a belt-driven turntable with single- and multiple-play modes. It features a tonearm of lightweight magnesium alloy, with a mass of 14 grams. Called the "True Tangent Tonearm," it has an articulated head that maintains the 90-degree relationship from rim to center, and is said to eliminate



tracking error. Belt-driven by a 1000-rpm dc servomotor, the GT55 also features an electronic variable-speed control with an illuminated stroboscope, variable-rate cueing damped by the main cam, and magnetic anti-skating control. \$249.95.

CIRCLE NO. 99 ON FREE INFORMATION CARD

CB HATCHBACK MOUNT ANTENNA

The Antenna Specialists M-431 CB antenna has a hatchback mount that lets the user adjust the antenna to vertical on hatchback and fastback cars. The antenna also doubles as a trunk-groove mount. It has a base-loaded coil, stainless-steel shock spring, and a 17-7PH stainless-steel whip. Complete with 17 feet of 58/U coax and attached PL-259 connector, the M-431 is \$26.95.

CIRCLE NO. 100 ON FREE INFORMATION CARD

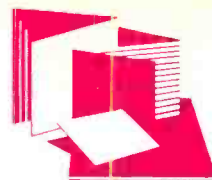

New Literature

SEMICONDUCTOR REPLACEMENTS

The 1976 Replacement Guide and Catalog, Bulletin No. ECG2129, that cross-references more than 119,000 industry parts numbers to its ECG semiconductor line is available from GTE Sylvania. The 240-page publication contains 5000 more part numbers than previous editions. Among new devices in the Sylvania line are high-voltage divider networks, high-power bridge and half-wave rectifiers, additional digital and linear IC's, and transistors. Designed as a quick reference for maintenance and repair technicians, the 1976 guide includes a section of outline drawings, circuit diagrams, and technical descriptions of the listed transistors, diodes, rectifiers, SCR's, modules, IC's, gate-controlled switches, and special-purpose devices. Listings in the Replacement Directory are alphanumeric. Price is \$2.95. Address: GTE Sylvania Advertising Services Center, 70 Empire Dr., West Seneca, N.Y. 14224.

MOBILE CB ANTENNA BROCHURE

The importance of the antenna to good CB communications performance is outlined in a new full-color, 4-page brochure available from Avanti. Using cutaway photos with call-out descriptions of each component, the booklet explains the importance of each feature to satisfactory CB performance. Although pinpointing the Racer 27 base-loaded mobile antenna, the publication also illustrates and describes other mobile antennas in the company's line. Address: Avanti Research & Development, Inc. 340 Stewart Ave., Addison, IL 60101.

HARD-TO-FIND TOOLS

A 128-page catalog of unusual and hard-to-find tools is available from Jensen Tools and Alloys. It describes over 2800 tools of interest to engineers, electronics technicians, and instrument mechanics working on fine assemblies. Major categories include micro-tools, power tools, test equipment, soldering equipment, engineering supplies, and a 30-page section featuring the company's tool kits and tool cases. Also included is technical data on tool selection, metric and temperature conversion charts, glossaries of tool terms, equivalency tables, safety tips, and specific information on plastics and the solderability, tensile strength, and melting point of various metals. Address: Jensen Tools and Alloys, 4117 No. 44th St., Phoenix, AZ 85018.

All SBE 23-channel CB units have a 40-channel future.

With all the talk about 40-channel CB units tomorrow, why should you buy SBE 23-channel units today?

Simple. We just give you the chance to buy today with tomorrow in mind. Which is what the SBE FUTURE-40 CB UPDATE PROGRAM is all about. Here's how it works: We're including a special Future-40 Certificate with all SBE 23-channel units. It entitles the SBE buyer to update his 23-channel unit to 40 channels



A Future-40 CB Update Program Certificate comes packed in each of the following SBE units: Coronado II (SBE-10CB), Cortez (SBE-21CB), Formula "D" (SBE-26CB), Catalina III (SBE-29CB), Touch/Com (SBE-32CB), Brute (SBE-34CB), Trinidad (SBE-11CB), Trinidad II (SBE-30CB), Sidebender II (SBE-12CB), Sidebender IV (SBE-27CB), Console II (SBE-16CB), Console IV (SBE-28CB)

within 1977.

You send in the certificate, we'll set up the update of your unit to a full 40 channels. All, for a reasonable charge, depending on the model involved.

Simple as that.

All in all, the SBE Future-40 CB Update Program is aimed to hit those people who'd like to buy now, but are a bit confused about what's around the corner.

And thinking ahead, about what's around the corner, that's what SBE is all about.



Better Communications through Creative Technology

For information write: SBE, Inc., 220 Airport Blvd., Watsonville, CA 95076

INTERNATIONAL OFFICES: E. S. Gould Marketing Co. Ltd., Montreal, Canada/Linear Systems S.A. Geneva 1, Switzerland

CIRCLE NO. 49 ON FREE INFORMATION CARD

www.americanradiohistory.com

NRI offers you five TV/Audio Servicing Courses

NRI can train you at home to service TV equipment and audio systems. You can choose from 5 courses, starting with a 48-lesson basic course, up to a Master Color TV/Audio Course, complete with designed-for-learning 25" diagonal solid state color TV and a 4-speaker SQ™

Quadrasonic Audio System. NRI gives you both TV and Audio servicing for hundreds of dollars less than the two courses as offered by another home study school.

All courses are available with low down payment and convenient monthly payments. All courses provide professional tools and "Power-On" equipment along with NRI kits engineered for training. With the Master Course, for instance, you build your own 5" wide-band triggered sweep solid state oscilloscope, digital color TV pattern generator, CMOS digital frequency counter, and NRI electronics Discovery Lab.



*Trademark of CBS Inc.

NRI's complete computer electronics course gives you real digital training.

Digital electronics is the career area of the future . . . and the best way to learn is with NRI's Complete Computer Electronics Course. NRI's programmable digital computer goes far beyond any "logic trainer" in preparing you to become a computer or digital technician. With the IC's in its new Memory Kit, you get the only home training in machine language programming . . . experience essential to trouble shooting digital computers. And the NRI programmable computer is just one of ten kits you receive, including a TVOM and NRI's exclusive electronics lab. It's the quickest and best way to learn digital logic and computer operation.

You pay less for NRI training and you get more for your money.

NRI employs no salesmen, pays no commissions. We pass the savings on to you in reduced tuitions and extras in the way of professional equipment, testing instruments, etc. You can pay more, but you can't get better training.

More than one million students have enrolled with NRI in 62 years.

Mail the insert card and discover for yourself why NRI is the recognized leader in home training. No



salesman will call. Do it today and get started on that new career.

APPROVED UNDER GI BILL
if taken for career purposes Check box on card for details.



NRI SCHOOLS
McGraw-Hill Continuing Education Center
3939 Wisconsin Avenue,
Washington, D.C. 20016

Learn to service Communications /CB equipment at home...with NRI'S COMPLETE COMMUNICATIONS COURSE

Learn design, installation and maintenance of commercial, amateur, or CB communications equipment.

The field of communications is bursting out all over. In Citizens Band alone, class D licenses grew from 1 to over 2.6 million in 1975, and the FCC projects about 15 million CB'ers in the U.S. by 1979. That means a lot of service and maintenance jobs . . . and NRI can train you at home to fill one of those openings. NRI's Complete Communications Course covers all types of two-way radio equipment (including CB), AM and FM



Transmission and Reception, Television Broadcasting, Microwave Systems, Radar Principles, Marine Electronics, Mobile Communications, and Aircraft Electronics. The course will also qualify you for a First Class Radio Telephone Commercial FCC License or you get your tuition back.

Learn on your own 400-channel digitally-synthesized VHF transceiver.

You will learn to service all types of communication equipment, with the one unit that is designed mechanically and electronically to train you for CB, Commercial and Amateur communications: a digitally-synthesized 400-channel VHF transceiver and AC power supply. This 2-meter unit gives you "Power-On" training. Then we help you get your FCC Amateur License with



special instruction so you can go on the air.

The complete course includes 48 lessons, 9 special reference texts, and 10 training kits. Included are: your own electronics Discovery Lab, Antenna Applications Lab, CMOS Frequency Counter, and an Optical Transmission System. You'll learn at home, progressing at your own speed, to your FCC license and into the communications field of your choice.

NEW CB SPECIALIST COURSE NOW OFFERED



NRI now offers a special course in CB Servicing. You get 37 lessons, 8 reference texts, your own CB Transceiver, AC power supply and multi-meter . . . for hands-on training. Also included are 14 coaching units to make it easy to get your commercial radio telephone FCC license--enabling you to test, install, and service communications equipment.



Stereo Scene

By Ralph Hodges

SPEAKERS AND SUCH

NOTICE that the latest installment of the great omnidirectional vs. directional loudspeaker controversy has pretty much died down, with its combatants a bit out of breath but certainly unbowed, and (I suspect) hardly anyone's opinion changed one iota. If you missed the action, it concerned the view (held by one side) that omnidirectional speakers provide nothing but an "undifferentiated wodge of sound" where the stereo should be, opposed by the counterview that omnidirectional speakers are the *only* means to a truly satisfactory stereo image.

It turned out to be quite a tussle this time (everyone had obviously been nursing his grievances since the last go-round), with missiles of vituperative prose being lobbed across the Atlantic from England on an almost fortnightly basis, their arrival provoking vigorous volleys of return fire. In my view, the American effort was hampered to an extent by a dearth of really top-quality directional speakers. Most U.S. "hi-fi" speakers are designed for maximum possible dispersion of sound, if not actually for multidirectional propagation. Hence it was hard to find a suitable standard-bearer for the directional-speaker cause with which to make comparison. I confess I had trouble getting good stereo from either speaker type until I made some headway in stabilizing tonearm/cartridge performance, after

which both seemed to do very well. This, I was curtly informed, was because the exaggerated stereo of multi-tracked U.S. recordings to an extent worked against the omnis' faults and glossed them over. Never did get that point resolved to my satisfaction.

The Dust Settles. With the passing of the "great debate," events seem to have sowed to a much more moderate pace in speaker-design circles around the country. Now that many of the serious audiophiles have settled down with their electrostatics, big folded horns, or other preferences of the moment and are fixed up for the next couple of years, the focus of activity has turned once again to the first-time buyer. And the first-time buyer seems, as always, to be most interested in simple, unadorned boxes in the medium- to low-price range, perhaps bearing a brand name he recognizes from some previous contact or report. He wants nothing too complicated or razzle-dazzle, just a solid middle-of-the-road performer.

For example: in a recent conversation with George Sioles, president of Design Acoustics, I learned that this company's latest product, the D-1 speaker system, is turning in a puzzling performance in the marketplace. On the face of it, it should be a winner; the price is right, the sound is all it should be from advance reports, and it does not come surround-

ed by a blizzard of technical verbiage likely to panic the timid. There's just one thing, however—its cabinet is brushed aluminum.

The cabinet was supposed to be a good idea. It is comparatively inexpensive, good looking in a sleek, modern sort of way, and even after being braced and damped for rigidity and inertness it is substantially thinner than a wood-panel design, conserving internal volume while shrinking external dimensions. When on display it appears to attract a lot of attention, and ultimately the D-1 seems to sell briskly enough—but in the slightly larger and more expensive walnut-cabinet version, not the aluminum. The innate conservatism of the buyer in this price range seems to persist as usual.

The Heil Woofer Again. For years now, the innovative ESS/Heil *woofer* has poised for introduction during the winter months, and every time it has faded back into the Sacramento labs for more development work. This time it may make it, judging from the increased pitch of promotional activity at ESS.

Not long ago I saw what are supposed to be the final prototypes at a semi-private showing. The design retains its "squeeze-box" configuration, with squared-off Lexan diaphragms working into wedge-shaped chambers open at the thicker end. The floor of the wedge forms the stationary plate against which the diaphragm above squeezes its charge of air. Five or more wedge assemblies (not large) are mounted on a baffle board, arranged so that each diaphragm has the bottom of another wedge—to serve as a stator for its upward excursions—just above it. Vertical drive shafts to propel the diaphragms penetrate the row of wedges from top to bottom and terminate in a large voice coil that is driven by a comparatively conventional permanent-magnet motor. It is not at the moment clear to me whether there will be voice coils at both top and bottom, operating in a push-pull fashion, or whether a single coil, presumably at the base of the affair, will be the final arrangement. The prototypes appeared to have just a single coil.

The Heil device remains a dipole radiator, subject to front-to-back acoustical cancellations at lower frequencies. This didn't seem to bother it much in the demonstration I heard. Indeed, ESS has designed electronics to complement the speaker, and these may be sold as an integral part of the final package. One of the factors that prompted this is that the



The B.I.C. Formula 7's control panel. The prominent chart facilitates interpretation of the sound-level indicators.



The first complete small computer under \$1,000

Twenty-five years ago a computer so powerful cost you a cool million.

Today, for less than 0.1% of the cost, you can have your own personal computer with even greater power—one that fits in a package no larger than a typewriter.

It's the Sol-20 Terminal Computer. There's nothing like it anywhere.

A powerful computer at your disposal is quite simply, fantastic!

Use your computer to run your ham station. Do your taxes and books with it. Control your inventory. Curb your energy bill by letting your computer regulate energy usage. Use it to study science and engineering. Use it to help you invent.

And after hours, take your computer home to play (and create) sophisticated games. Computers may indeed be the ultimate hobby because you never outgrow them. Uses for computer intelligence are literally unlimited.

You can find a basic computer kit for about \$600. Though by the time you purchase the other components needed to make it run—keyboard, additional memory, software and I/O interfaces—you're up around \$1,500. Phew!

Now, the good news. The new Sol-20 in kit form gives you an entire working system for \$995.

Those of you who are already into personal computers will recognize what an

incredible advance this is in computer packaging. This is the only small computer that offers all of the following as *standard* features:

8080 microprocessor—1024 character video display circuitry—control PROM memory—1024 words of static low-power RAM—1024 words of preprogrammed interface capable of controlling two recorders at 1200 baud—both parallel and serial standardized interface connectors—a complete power supply including fan—a beautiful case with solid walnut sides—software which includes a preprogrammed PROM personality module and a cassette with BASIC-5 language plus two sophisticated computer video games—the ability to work with all S-100 bus, including Altair, Imsai and Processor Technology products.

Full expansion capability

Tailor the Sol-20 system to your applications with our complete line of peripheral products. These include the video monitor, audio cassette and digital tape systems, dual floppy disc system, memories, and interfaces.

Write for our new 22 page catalog. Get all the details.

Processor Technology, Box M, 6200 Hollis St., Emeryville, CA 94608. (415) 652-8080.



in the black.



They say that you can't judge a book by its cover; that's true, but what a cover. What was, and is, the most beautiful look in the professional field is now the most daring look in general audio. BUT looks are not the whole story, in fact, not even the best part. Inside—that's where you find true SAE quality and performance. Here are just a few highlights of this SAE system:

MARK VIII FM DIGITAL TUNER—A 5-gang tuning cap., Dual MOSFET front-end, Linear-Phase IF filters with 7-stage limiter and PLL MPX. IHF Sen.—1.6uV, Stereo Sen. (—50dB)—30uV, mono THD—less than 0.15%, stereo THD—less than 0.2%:

MARK IXB PRE-AMPLIFIER EQUALIZER—Low noise phono circuits, 7-band equalizer with precision wound toroid inductors. THD and IM—less than 0.02%, Phono S/N (10mV ref.)—75dB, Aux. S/N—95dB.

2200 STEREO POWER AMPLIFIER—Fully complementary circuitry, LED Power Display, Relay Protection, **100 WATTS RMS/CHANNEL** (both channels driven) from 20Hz to 20kHz at less than 0.05% Total Harmonic Distortion.

This system combines beauty, performance, quality and because its SAE a FREE 5 YEAR Service Contract. Compare and you'll find this is another great value by the people who make "Components for the Connoisseur."

SAE

Scientific Audio Electronics, Inc.
P.O. Box 60271, Terminal Annex
Los Angeles, Ca. 90060

Please send more information on the MkVIII, MkIXB, and 2200.

NAME _____

ADDRESS _____

CITY _____

STATE _____ ZIP _____

woofer's impedance curve begins to go mountain-climbing near the bottom of its useful output range. Rather than suffer the reduced output that would be inevitable with a conventional amplifier seeing such a load, ESS has developed a "current-feedback" power amplifier that is said to include the speaker in its feed-



The Design Acoustics D-1 in brushed aluminum.

back loop. And apparently there are other reasons besides this that are responsible for ESS's strongly recommending—nay, almost insisting on—the use of their own electronics with this particular speaker.

Blinkenlights. Elsewhere in the speaker scramble, B.I.C. has an idea it is convinced will revolutionize our listening habits. It is a set of indicator lights—the inevitable LEDs—intended to monitor the performance of speaker and amplifier, and they come as an integral part of two new B.I.C. speaker systems.

One light display is concerned with detecting overdrive conditions, and as such it must be precalibrated by the user. The procedure is simple. Using a test record supplied by B.I.C. (containing a rapidly pulsed sinewave at about 1 kHz), you raise the volume until the sound begins to turn sour, indicating the onset of amplifier clipping. At this point you adjust the threshold control of the indicator light until it almost turns on. On the other hand, if the light should come on before distortion occurs, it presumably means that the amplifier's available output exceeds the power-handling capability of the loudspeaker (the light is preset to respond to maximum allowable input at the factory). In this case you don't move the calibration control from its full-up position; you simply keep in mind that whenever the light comes on (except for brief flickers) your speakers are on the point of disintegrating. The

test signal involves only mid-frequencies, so it is not clear what effect excessive input to the woofer or tweeter has on the indicator system. However, to avert the worst, the speaker incorporates pre-set circuit breakers, separate for the woofer and the higher-frequency drivers, with indicator lights to tell you which one has tripped.

The second set of lights, provided only on the larger Formula 7, shows acoustic-output levels referred to designated measuring distances on the loudspeaker's axis. This should be good for compiling an impressive list of facts and figures, but it is not likely to be utilitarian in the strictest sense.

The Other Transducer. Worldwide, the audiophile community is continuing to get lathered up over the moving-coil cartridges that are rising up out of Japan and elsewhere. In response, the specialist market is beginning to teem with transformers and active-gain boxes that will let these low-impedance devices drive a standard phono preamplifier to a reasonable output, and it is not unusual to find suitable high-gain preamplifiers ("head amps," they are usually called) already built into the newer deluxe preamplifiers.

As for the cartridges themselves, I've gotten together a partial list of distributors for these little wonders. I can't in all cases be entirely specific about models and prices; some of the manufacturers bring out new models at the slightest provocation. (On my last trip to Japan, the stores had some that hadn't even been heard of here yet.) And I can't be sure of long-term availability, as some of these devices have an uncertain status in relation to existing U.S. patents. But here goes:

The Denon cartridges, manufactured by Nippon Columbia, include two moving-coil designs that have attracted a vast following. One has a spherical stylus, the other a bi-radial CD-4 stylus. Preferences between these two vary. I have successfully driven a conventional phono amplifier with their outputs directly, but I can't guarantee they will work to satisfaction with every preamp. A major U.S. source for Denon is American Audioport, 317 Professional Building, 909 University, Columbia, MO 65201. At this writing the spherical-stylus model costs \$175, the CD-4 \$200. (There are reports that Denon will be entering the U.S. market as its own entity sometime soon.)

Fidelity Research, a popular brand for some time, has relatively frequent model updates, and I fear anything I said now

would be out of date when it reached print. However, the FR cartridges are generally admired for their top end, (among other characteristics), which exhibits a rising response on most samples measured. They usually require a gain box or step-up transformer. The source is Fidelity Research of America, P.O. Box 5242, Ventura, CA 93003.

Nakamichi introduced its moving-coil cartridge, the MC 1000, in mid-1976. The first published test reports (from England) have been excellent. The MC 1000 has a Shibata stylus, although it is not unconditionally recommended for CD-4. It requires some help in driving preamps, and Nakamichi offers a transformer for \$100. Nakamichi Research is at 220 Westbury Avenue, Carle Place, NY 11514.

Superex has undertaken the distribution of the Satin pickups from Japan, the only moving-coil cartridges with user-replacable styli. There are models with Shibata, elliptical, and spherical tips at prices of \$190, \$170, and \$140. Outputs are said to be compatible with direct preamp connection. The Superex address is 151 Ludlow Street, Yonkers, NY 10705.

Supex was perhaps the first Japanese moving-coil to reach these shores and

receive acclaim. Several improved models have followed, and are held in high esteem. Some assistance is generally needed for preamp interface. The latest Supex models (between Japan and here I have become confused about what they are) are available from Sumiko, Inc., P.O. Box 5046, Berkeley, CA 94705. At last report, prices were well over \$100 and may be passing \$200 by now.

Ultimo has been trying to break into the U.S. market for some time, and may succeed at any moment. They offer one of the two moving-coil (CD-4/stereo) types with beryllium cantilevers (the other being Nakamichi), together with a more conventional stereo model. Both have unusually high outputs and can almost always plug directly into a preamp. However, availability is uncertain, as are prices.

And, lest we forget, Ortofon, which has been quietly marketing moving-coils to the U.S. for years, is still with us. Their latest, the MC-20 (\$120), has a modified Shibata stylus; the SL-20Q (\$150), for stereo and CD-4, has a bi-radial stylus; and the acclaimed SL-20E (\$100) retains its elliptical stylus. These cartridges require either a gain box, which Ortofon now makes for \$170

(MCA-76), or a transformer. Ortofon can be reached through Harman International, 55 Ames Court, Plainview, NY 11803.

For those cartridges that need them, some people apparently prefer to use transformers, rather than gain boxes. A number of the foregoing manufacturers offer transformers; and there is even an independent supplier, Verion (1 Riverdale Ave., Bronx, NY 10463), that builds what is said to be a very good one. Gain boxes come from companies like Mark Levinson and (more and more) as existing facilities in new preamplifiers.

Now that you've been suitably scandalized by the prices charged for these things, and will perhaps soon become aware of their interface complexities, rather high weight, generally unimpressive compliances, and other crotchets (old-timers will remember their distressing affinity for small metallic objects and ferrous turntable platters—characteristics they still possess), you're justified in asking the question "Why?"

I look forward to answering that question as soon as the reasons for their vaunted sonic superiority (which I'm convinced I hear) are adequately explained to me. Until then, I suggest you find one and listen to it. ◇

Build your own TTL-5 Power Supply



The fast, easy way to build a TTL-5 Power Supply that provides the rigid power requirements of the TTL (Transistor-Transistor Logic) and C-MOS digital circuits. Comes complete with all necessary parts for assembly and illustrated, step-by-step instruction booklet. See the TTL-5 Power Supply, Motor Speed Control, Digital Clock, DC Regulated Power Supply and Burglar Alarm kits at Calectro dealers everywhere.

- Ⓢ 5 V lamp output
- Ⓢ Excellent voltage regulation and transient suppression
- Ⓢ Internal short circuit, thermal shutdown and safe operating area protection
- Ⓢ Low output impedance and ripple rejection

GC ELECTRONICS
DIVISION OF HYDROMETALS, INC. 
ROCKFORD, ILLINOIS 61101 U.S.A.

*Calectro Kits - Ready to Assemble
Fun - Practical - Educational*

Audio Reports



ABOUT THIS MONTH'S REPORTS

"Super" FM tuners are usually priced from \$1000 up. So it is interesting to find that Sansui's new Model TU-9900 tuner, at a modest \$450, matches the performance of more expensive models, at least in the most important respects.

Kenwood's Model 600 integrated stereo amplifier uses separate power supplies for each channel. Measuring the conservatively rated amplifier's distortion can tax the capabilities of the finest laboratory test equipment.

The \$400 JVC JR-S300 receiver features a built-in graphic equalizer. It combines exceptional control capabilities with a clean, moderate-power amplifier and competent tuner.

—Julian D. Hirsch

SANSUI MODEL TU-9900 AM/STEREO FM TUNER

Super-quality FM at moderate price.

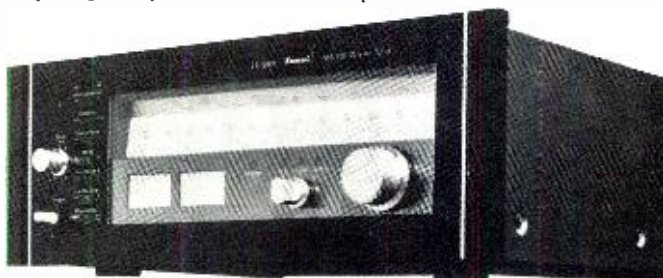

The Model TU-9900 is Sansui's finest stereo FM tuner. It is an ideal mate for the highest quality amplifiers and speaker systems. Interestingly, the TU-9900's nationally advertised value of approximately \$450 belies its performance capabilities.

Esthetically impressive, the large, heavy tuner is finished in black and is designed to complement other recent separate components from Sansui. It measures 18 $\frac{1}{8}$ "W × 12 $\frac{1}{4}$ "D × 6 $\frac{5}{16}$ "H (46 × 31.1 × 16 cm) and weighs just slightly more than 21 lb (about 9.5 kg).

General Description. The upper half of the large front panel is occupied by a dial cutout behind which are the FM and AM scales. Below the cutout are a large tuning knob; the mode selector switch with positions for AM, FM AUTO, and FM MONO, each of which has its own colored lights; and a red STEREO pilot light. Two illuminated meters are provided for

indicating relative signal strength and FM center-channel tuning.

To the left of the cut-out area are seven pushbutton switches. The top switch, labelled ANTENNA ATTENUATOR, introduces a nominal 20-dB attenuation to prevent overload from very strong local signals when it is pushed in. Below this are BAND WIDTH, NOISE CANCELLER (blends stereo channels at high frequencies to reduce hiss on weak signals), MUTING, CALIBRATION LEVEL, LOW PASS FILTER and METER SELECTOR switches. The last switch allows the signal-strength meter to indicate FM multipath distortion when pressed in. To the left of the switches are the VOLUME control and a lever-type POWER switch.

The tuner offers a choice of two FM i-f bandwidths. WIDE is for normal use, while NARROW is for situations where the greatest possible selectivity is needed. In the NARROW mode, the stereo channel separation, capture ratio, and distortion are somewhat degraded (but still meet all essential requirements for high-fidelity reception). In WIDE, the tuner

achieves state-of-the-art performance, but at some sacrifice of adjacent- and alternate-channel selectivity.

The CALIBRATION LEVEL button replaces the normal audio outputs with a tone whose level corresponds to -10 dB, relative to 100% modulation. It can be used to set up the level controls of a tape recorder so that program peaks will not exceed a safe recording level. The LOW PASS FILTER removes the 19- and 38-kHz components of a stereo signal from the tuner outputs, with minimal effect on the audio frequency response. (These ultrasonic signals could create beats with the bias oscillator on some tape recorders, or could affect the operation of a Dolby noise reducing accessory.) With the filter out of the circuit, there is an appreciable amount of 19-kHz pilot carrier in the audio outputs (though not enough to affect normal listening), but the response is perfectly flat up to 15,000 Hz and beyond.

On the rear apron are binding post terminals for a 300-ohm FM antenna and a wire-type AM antenna, a coaxial connector for a 75-ohm FM antenna, and a hinged and pivoted AM ferrite rod antenna. In addition to the normal audio outputs, there is a second pair of outputs designated DOLBY FM whose level is not affected by the VOLUME control, and whose deemphasis characteristic is the 25 μ s required by a Dolby decoder instead of the normal 75 μ s. There is also an FM DETECTOR output, without deemphasis, for use with a future 4-channel FM decoder. Vertical and horizontal outputs are provided for connection of an oscilloscope multipath indicator. The single accessory ac outlet is unswitched.

Laboratory Measurements. The setting of the BAND WIDTH switch has a profound effect on many of the tuner's performance parameters. It was necessary, therefore, to check all related aspects of the tuner's operation separately in the WIDE and NARROW settings of the BAND WIDTH switch.

With the switch set to the WIDE position the IHF sensitivity was 10 dBf (1.8 μ V) in mono and 21 dBf (6 μ V) in stereo, the latter determined by the stereo switching threshold. The 50-dB quieting sensitivity was 15 dBf (3 μ V) at 0.35% THD in mono and 35 dBf (30 μ V) at 0.3% THD in stereo. The S/N at 65 dBf (1000 μ V) was 74 dB in mono and 71.5 dB in stereo, while distortion measured an incredible 0.021% and 0.052% respectively. (These figures, like some of the others we obtained, are better than

the "everything" turntable

Dust cover, Realistic-by-Shure magnetic cartridge included in a low discount price. No extras to buy.

"Everything" starts with a cartridge — because that's where your signal begins. The Realistic® LAB-300 includes a superb, elliptical-stylus model, performance-matched to the tone arm. It's our top-of-the-line magnetic cartridge, a \$44.95-value in itself.

A superb belt-drive manual. Eliminating the complexity of a changer cuts cost and noise, and lets Realistic concentrate on getting maximum music and life from your 33 $\frac{1}{3}$ and 45 RPM discs. The S-shape tone arm tracks accurately down to $\frac{3}{4}$ gram. Wow and flutter: less than 0.1%. Rumble: better than -60 dB (DIN B).

With automatic arm return. Touch the arm only to start the record. At disc's end, an independent mechanism engages the arm and shuts off the motor. Damped cueing, direct-reading tracking force adjustment and variable anti-skate control.

A look of luxury. Solid and uncluttered. Handsome walnut grained vinyl veneer base. Steel-hinged self-supporting dust cover. Precision aluminum, stainless steel and chrome tone arm assembly.

Available near you. With over 4800 Radio Shack locations in the USA and Canada alone, you can always find Realistic sales, service and factory parts. So come in and find out what an "everything" turntable sounds like — today. Just 159.95*.



SOLD ONLY WHERE YOU SEE THIS SIGN:

Radio Shack®

A TANDY COMPANY • FORT WORTH, TEXAS 76107

*Prices may vary at individual stores and dealers.



Realistic LAB-100
Semi-automatic, belt-driven.
Cartridge, dust cover, simulated
walnut grain finish base. 99.95*



Realistic/Miracord-46
Fully automatic. Umbrella-
spindle, cartridge, walnut
veneer base. 199.95*



Realistic/Miracord-42
Fully automatic. Umbrella-
spindle, cartridge, simulated
walnut grain finish. 149.95*



Realistic LAB-50
Fully automatic, belt-drive.
Cartridge, walnut grained vinyl
veneer base. 99.95*

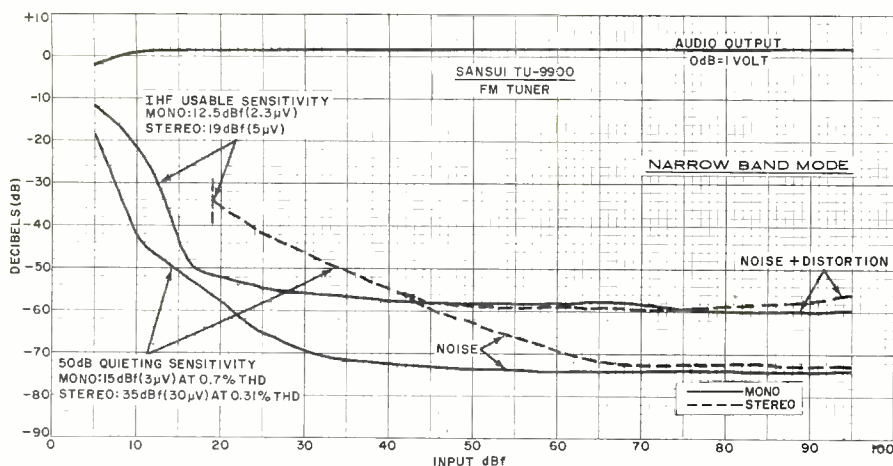

Sensitivity, noise and distortion in narrow-band mode.

the guaranteed performance of the Sound·Technology signal generator we used, but they leave no doubt that the tuner has stretched the capabilities of our test equipment to its limits.) The stereo distortion, using L-R modulation, was 0.32% at 100 Hz, 0.032% at 1000 Hz, and 0.075% at 6000 Hz.

The capture ratio at 65 dBf input was just under 1 dB, a point at which measurement becomes very difficult. AM rejection was an excellent 71 dB. Image rejection was unmeasurable, exceeding the 100-dB range of our test equipment. The selectivity measured 53.5 dB at 400-kHz spacing (alternate channel) and 5.7 dB at 200-kHz spacing (adjacent channel). The muting threshold was 22 dBf (7 μ V), approximately the same as the stereo switching threshold. Hum level was -70 dB.

With the LOW PASS filter switched out, the frequency response was flat within +0.2 and -0.6 dB from 30 to 15,000 Hz. Switching in the filter dropped the response at 12,000 Hz by 0.4 dB and at 15,000 Hz by 2.5 dB, typical of most tuners in which the filter is always in the circuit.

Stereo channel separation was al-

most as unbelievable as the distortion figures, exceeding 60 dB from 60 to 600 Hz and reducing smoothly to 45 dB at 5000 Hz, 40 dB at 10,000 Hz, and 34 dB at 15,000 Hz. The 19-kHz pilot carrier leakage into the audio outputs was relatively large, -36 dB, but switching in the filter reduced it to an almost unmeasurable -85 dB.

With the BAND WIDTH switch set to NARROW the S/N, IHF stereo sensitivity, muting threshold, pilot-carrier leakage, hum, and frequency response were the same as in the WIDE mode. The mono IHF sensitivity was slightly poorer, measuring 12.5 dBf (2.3 μ V). The 50 dB quieting sensitivity was the same as in WIDE, but with a slightly higher mono distortion of 0.7%.

The THD was 0.13% in mono and 0.11% in stereo, which would be considered excellent for any tuner, although it was considerably higher than in our WIDE mode measurement. The stereo L-R distortion was also somewhat higher, measuring 0.36% at 100 Hz, 0.044% at 1000 Hz, and 0.63% at 6000 Hz.

The capture ratio was noticeably degraded in the NARROW mode, measuring 2.7 dB. However, the principal reason

for using the NARROW mode is to improve selectivity, which it did admirably. The alternate-channel selectivity was unmeasurable (greater than 100 dB) and the adjacent-channel selectivity of 17 dB was one of the best we have ever measured on a tuner. The stereo channel separation was reduced, though not in a way that could affect listening quality. It measured an almost constant 27 dB from 30 to 3000 Hz and 26 dB beyond 3000 Hz.

The DOLBY FM output was a constant 0.42 volt at 100% modulation, with a 25- μ s deemphasis. Pressing in the CALIBRATION LEVEL button replaced the tuner's audio signal with a tone that was exactly 10 dB below 100% modulation. The ANTENNA ATTENUATOR reduced the sensitivity by 22.7 dB. The MUTING operated positively, yet silently, with no transient thumps or noises. Calibrated at 0.25-MHz intervals, the dial proved to be extremely accurate, with no discernible error. The tuning mechanism was one of the smoothest we have used, with a flywheel action that made it possible to cover the entire FM band with a single spin of the knob.

The only test we made on the AM section was of its frequency response, which was even more restricted than most AM tuners we have measured. The frequency response was down 6 dB at 60 and 2200 hertz.

User Comment. Clearly, the Sansui Model TU-9900 tuner is a very superior performer. It is unfortunate that few FM stations transmit programs with sufficient fidelity to make this tuner sound any different from many competitive tuners. (Most good tuners tend to sound pretty much alike on most stations.) On the other hand, it is a safe assumption that any untoward sounds heard via this tuner originate from the FM station or in a subsequent part of the sound system in which it is used.

The calibrating signal is a genuine convenience to anyone who tapes programs off the air. Normally, it is used to set the recorder's meters to -10 dB, which allows a couple of decibels reserve for an occasional over-modulated peak without risking distortion from tape saturation. If your recorder has, say, 5 dB of "headroom" above 0 dB, the tone can be set to give a -5-dB reading. In any case, you are no longer at the mercy of the FM station program levels at the time you are setting up your recorder for a future taping. The only feature of the tuner that did not perform superbly was the multipath meter indication. Checking

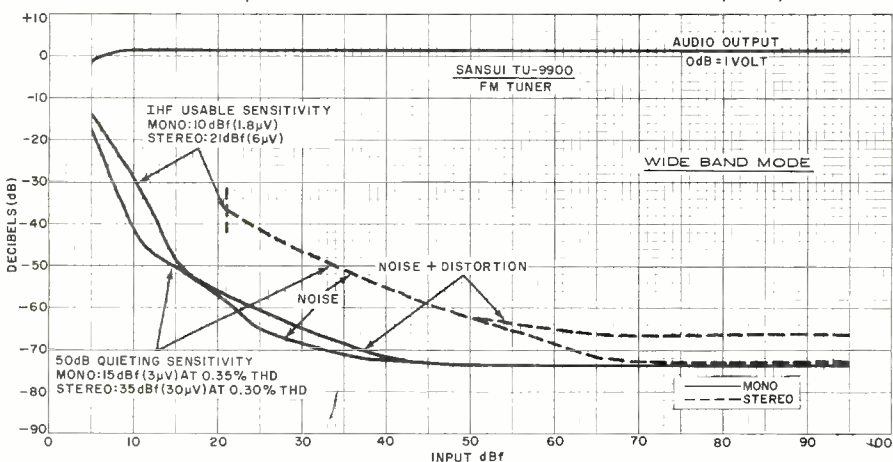

Sensitivity, noise and distortion in wide-band mode.

it against an oscilloscope display, we found that the meter was of little value in revealing moderate amounts of multipath distortion, although very high distortion levels did cause some deflection of its pointer.

In sum, this separate tuner excels in

virtually every area of FM performance and is capable of capturing all the fidelity that FM broadcasters can produce. Sure, the TU-9900 doesn't offer some special features (digital readout, oscilloscope, variable muting, etc.) that some higher-priced units do. But considering

raw performance and the special features it does provide, this tuner is worthy of serious consideration by anyone who wishes to listen to superlative FM, assuming that is the quality being broadcast. And considering the TU-9900's moderate price, it's a top-value unit.

CIRCLE NO 101 ON FREE INFORMATION CARD

KENWOOD MODEL 600 INTEGRATED STEREO AMPLIFIER

Features compactness, dual power supplies and flexible preamp.



The performance caliber of Kenwood's new top-of-the-line Model 600 stereo control

amplifier is clearly reflected in its 130-watt/channel power rating into 8 ohms from 20 to 20,000 Hz at less than 0.08% distortion. It is surprisingly compact for such a powerful amplifier, measuring only 17 5/16"W × 15 1/4"D × 6"H (44 × 38.7 × 15.2 cm), but its 47-lb (21.4-kg) weight is a clue to the quality of design and construction of this handsome and versatile amplifier.

In addition to providing a moderately high power level, the amplifier is also equipped with just about every control facility one could desire. The controls themselves are large and easy to manipulate, including large-size toggle and pushbutton switches. All inputs and outputs (except the headphone output) are conveniently grouped on the amplifier's rear apron. Priced at \$749.95.

General Description. The amplifier's pale gold, satin-finished front panel is dominated by a large VOLUME control at its center. A concentric ring around this control provides for BALANCE adjustment. The VOLUME control is a stepped attenuator that varies the volume in almost imperceptible 1-dB steps from maximum to about -33 dB and in progressively larger steps to greater than -64 dB before completely silencing the outputs. The BALANCE control is lightly detented at its center position. A small yellow lamp is located just above the

VOLUME knob. It comes on whenever power is turned on.

Three knobs at the upper left of the panel control the speaker system outputs for three pairs of speakers and one combination of two pairs and OFF and the BASS and TREBLE controls. The tone controls are continuous rotary potentiometers, although they are detented at 2-dB intervals over a ±10-dB range. They are separate for the two channels, but a slip clutch arrangement permits both channels to be adjusted simultaneously or individually, as desired.

Below the tone controls are TURN-OVER switches that bypass the tone controls in their center positions and offer a choice of 150- and 400-Hz bass and 3000- and 6000-Hz treble turnover frequencies in their alternate positions. A third lever switch allows the user to introduce a fixed midrange PRESENCE boost that is centered at either 800 or 3000 Hz. Two pushbutton switches are provided for engaging and disengaging the LOW and HIGH FILTER circuits. When engaged, they provide 12-dB/octave slopes and turnover frequencies of 40 and 8000 Hz.

At the upper right of the panel are the INPUT SELECTOR and a lever switch for selecting either the TUNER or AUX 1 high-level inputs or transfer control to the INPUT SELECTOR switch, which has positions for PHONO 1, PHONO 2, and AUX 2. A three-position lever-type ATTENUATOR switch allows the gain to be reduced by 15 or 30 dB, adapting it to the input levels and speaker efficiency so that the VOLUME control can be operated in the

portion of its range that gives the smoothest control and a suitable loudness compensation, assuming the latter feature is used.

A TAPE DUBBING switch is provided for interconnecting two tape decks so that a program can be copied from either deck onto the other. The MONITOR switch connects the amplifier to the playback output of either deck or to the selected source signal, giving the capability of dubbing tapes while listening to another program.

At the lower right of the panel are small knob controls for LOUDNESS compensation (OFF plus four degrees of low-frequency boost as the VOLUME setting is reduced); MODE (L, R, STEREO, REV stereo, and L+R); and a PHONO 2 GAIN control that can be used to reduce the gain of the PHONO 2 input by up to 6 dB relative to the PHONO 1 input level for matching the levels from two different phono cartridges. Next to these controls is a switch that allows selection of 30,000, 50,000, or 100,000 ohms input impedance for the PHONO 1 input. The PHONO 2 input impedance is fixed at 50,000 ohms.

In addition to having all the signal input and output jacks, the rear apron also has separate preamplifier output and power amplifier input jacks. These two latter sets of jacks are normally joined together by a switch adjacent to them. Each of the tape recorder jacks is duplicated by a DIN socket.

Insulated binding posts are provided for speaker system hookups to the amplifier. There are two switched and one unswitched accessory ac outlets on the rear apron.

The amplifier has entirely separate power supplies for the two channels. Its power amplifiers are direct coupled from their inputs to the speaker outputs. A fast-acting relay provides a 4-second turn-on delay before connecting the speaker systems to the outputs and protects the speakers against damage in the event of a catastrophic failure in the amplifier. The output transistors are also electronically protected against overload damage.

Kenwood claims that the combination

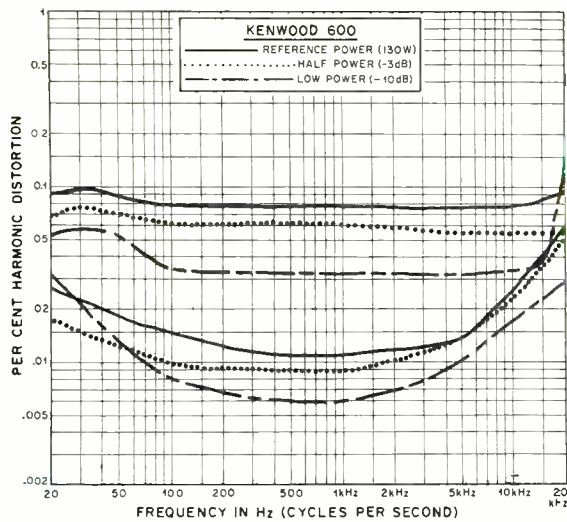

1-kHz total harmonic and 60/7000-Hz IM distortion.

of dc amplifiers and separate power supplies gives the Model 600 exceptionally low dynamic crosstalk distortion. According to the company, a very-low-frequency transient signal in one channel can cause a "sag" of power supply voltage in amplifiers that use a single power supply, introducing an intermodulation (IM) distortion component in the opposite channel.

Other special design features of the amplifier include an all-FET preamplifier with precision components in its phono equalization circuits; a dual VOLUME control attenuator that acts both ahead of and following the preamp to reduce noise to a minimum; and the greatest possible use of printed boards to minimize point-to-point wiring and possible interaction between channels.

Laboratory Measurements. Following the standard preconditioning period at one-third power, the amplifier delivered 153 watts/channel at 1000 Hz into 8-ohm loads at the clipping point, exceeding its rating. The power into 4- and 16-ohm loads was 216 and 95 watts/channel, respectively. At 1000 Hz, the THD was below our measurement limit of 0.003% from 0.1 to 30 watts output. It reached 0.014% at the rated 130-watt output and was 0.023% at 150

watts, just before the onset of clipping. The IM distortion measured between 0.01% and 0.02% between 1 and 90 watts, reaching 0.058% at 180 watts. It rose slightly at very low power levels, to 0.18% at an output of about 13 mW.

Across the full frequency range of the amplifier, the distortion was less than 0.015% from 100 to 6000 Hz at the rated output power. It increased to 0.028% at 20 Hz and to 0.06% at 20,000 Hz. It was lower at reduced power levels, which means that the distortion could be expected to fall between 0.006% and 0.01% at most frequencies and output powers.

The amplifier could be driven to a reference 10-watt output by 46 mV at its high-level inputs (0-dB ATTENUATOR setting). The 15- and 30-dB settings of the ATTENUATOR switch reduced the sensitivity to 0.25 and 1.45 volts, respectively. The noise level, referred to 10 watts, was -75 to -76 dB through the high-level inputs on all ATTENUATOR control settings.

The phono sensitivity measured 0.72, 4.2, and 23 mV, depending on the setting of the ATTENUATOR control. These figures were doubled through the PHONO 2 input when the PHONO 2 GAIN control was set for minimum gain. The noise level, which is dependent on the input

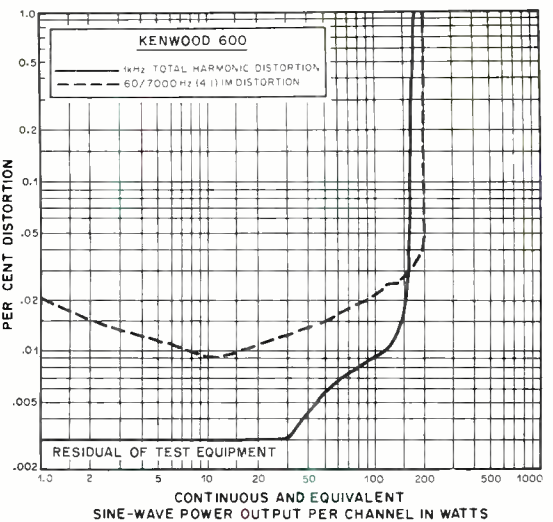

Harmonic distortion at three power levels.

source impedance as well as the settings of the ATTENUATOR and VOLUME controls, was difficult to define in a universally applicable manner. Our normal procedure is to terminate the phono input with a 2200-ohm resistor, set the gain for a 10-watt output with a 10-mV input at 1000 Hz, and read the wideband (unweighted) noise at the amplifier's output. Depending on the various control settings, the S/N referred to 10 watts was between -66 and -70 dB. Shorting the phono inputs reduced the noise substantially. Kenwood's -76-dB rating is based on an "A" weighting curve; considering the difference in test conditions, it is probably consistent with our findings.

We were impressed with the high phono overload input of about 230 mV. (It was 440 mV through the PHONO 2 input with a -6-dB gain setting.)

The responses of the filters were down 3 dB at 28 and 5500 Hz, with the slopes at 12 dB/octave. The loudness compensation boosted only the low frequencies at reduced VOLUME control settings. The four positions of the LOUDNESS switch, in combination with the other gain-setting controls of the amplifier, gives an almost infinite variety of response curves.

The RIAA phono equalization was within ± 0.6 dB from 50 to 15,000 Hz and ± 1 dB from 20 to 20,000 Hz. The phono cartridge's inductance had a negligible effect on the equalization, changing it by less than 0.5 dB at any frequency.

Tone controls provided a wide range of response curves. When the 150- or 6000-Hz turnover frequencies were selected, it was possible to have about ± 9 dB of response variation at the extremes of the frequency range, with less than 1 dB change between 250 and 3000 Hz.

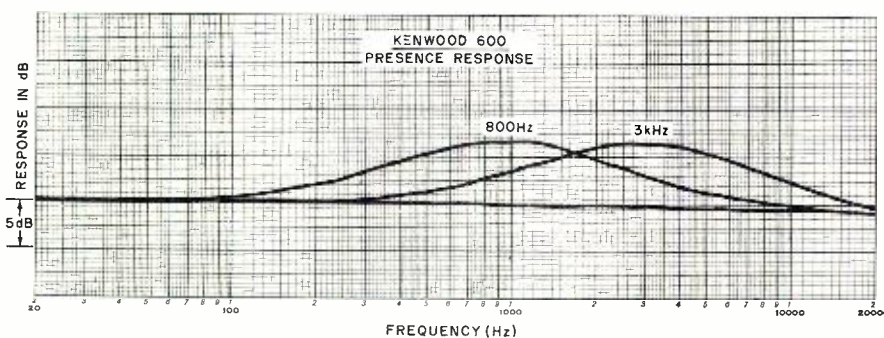

Response effects produced by Presence switch.

The PRESENCE switch introduced a broad rise of 6.5 dB, maximized at about 1000 or 3000 Hz and affecting a total of about four octaves.

The square-wave rise time was about 3 μ s through the entire amplifier and about 1.5 μ s through the power amplifier section alone. We could not measure the slew rate because the amplifier's protective relay tripped whenever we tried. A 2- μ F capacitor across the 8-ohm load resulted in a 50% amplitude ringing on a 1000-Hz square wave at about 50,000 Hz.

Although we did not attempt to duplicate Kenwood's test setup for evaluating dynamic crosstalk, we made one test that appeared to verify its absence. One channel was driven to a 1-watt output at 1000 Hz while the other was delivering

130 watts at 10 Hz. A spectrum analysis around the 1000-Hz output of the first channel revealed absolutely no sign of modulation sidebands at ± 10 Hz or its harmonics, down to a measurement floor of -90 dB (0.003%).

User Comment. The Model 600 is directly competitive with several other fine integrated amplifiers that have roughly similar power ratings and control features. Without attempting to make any comparisons (which would be meaningless when one is dealing with the near perfection of this type of equipment), we can say that the Model 600 does everything claimed for it and is rated with great conservatism.

It is interesting to note that this integrated amplifier is considerably smaller

than some basic power amplifiers with the same or slightly higher, ratings. Yet it includes a fine, fully flexible preamplifier section. Not only is there no sign of skimping in its design or construction, but the Model 600 appears to have sufficient safeguards to withstand almost any abuse to which it might be subjected. It is a "brute" in performance, if not in appearance.

Kenwood's attention to detail and smooth control operation makes it a delight to handle and for listening. It even has filters that really work, removing unwanted noise without damaging the sonic balance, and that rarest of features—a loudness compensation circuit that does not muddy the sound. It should appeal to the audiophile who wishes to use a separate tuner.

CIRCLE NO 102 ON FREE INFORMATION CARD

JVC MODEL JR-S300 AM/STEREO FM RECEIVER

Features excellent built-in graphic equalizer.

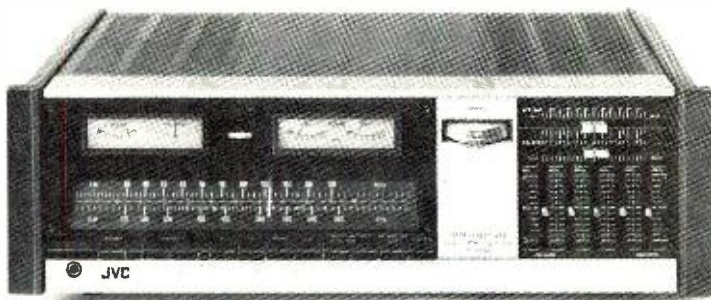

In the middle of JVC's receiver line is the Model JR-S300, a medium-power receiver

rated at 50 watts/channel into 8 ohms between 20 and 20,000 Hz with less than 0.3% total harmonic distortion (THD).

Perhaps the most striking aspect of the JR-S300 is the total absence of any conventional control knobs. Every control is either a pushbutton or a slide potentiometer (the tuning "knob" is a horizontal wheel, a portion of which protrudes from the panel).

The receiver makes extensive use of integrated circuits in its tuner section. After the discrete-component "front end," which has a FET r-f amplifier, there are an isolation stage, dual ceramic filter, and single IC that provides the i-f gain, limiting and FM-detection functions. Another IC is the multiplex demodulator. (It is not stated whether it is a PLL type, but its performance suggests that it is.)

The entire AM tuner's active circuitry is on a single IC chip. The balance of the circuits employ discrete components, and the power amplifiers are direct-coupled all the way out to the speaker terminals. A relay in the output circuit provides a turn-on time delay and protects the speakers from damage if a transistor or other component fails.

The Model JR-S300 measures 19 11/16" W \times 13 3/16" D \times 6 5/16" H (50 \times 33.5 \times 16 cm) and weighs about 23 lb (10.4 kg.). Price is \$400.

General Description. The receiver is finished in black, with accents of aluminum, and the meter scales are lighted in blue. The dial occupies the lower portion of a large cutout on the left side of the panel. Above it are two pairs of meters. The left pair are tuning meters that indicate relative signal strength and FM center-channel tuning. To their right are audio "power output" meters for the two channels, calibrated to indicate from 0.25 to 50 watts, based on the use of 8-ohm loads. Between the groups of meters is an FM STEREO indicator.

The tuning wheel is on an aluminum panel to the right of the dial, and the slider controls form a group at the right side of the panel. Across the top of the control section are the horizontal VOLUME and BALANCE controls (the latter is detented at its center point). Below them are the five SEA ("Sound Effect Amplifier," in JVC's terminology) sliders, which take the place of tone controls and offer the greater flexibility of a graphic equalizer. They operate at center frequencies of 40, 250, 1000, 5000, and 15,000 Hz, and provide a nominal control range of

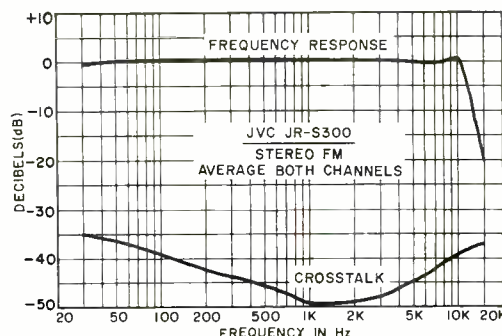

Frequency response and crosstalk averaged for both channels in stereo FM of JVC receiver.

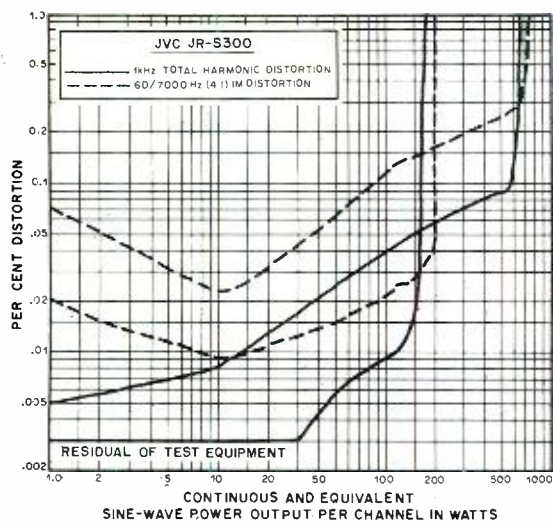

1-kHz total harmonic and 60/7000-Hz IM distortion.

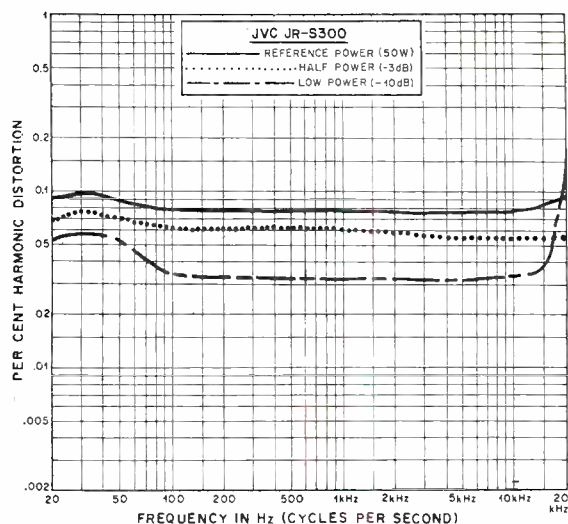

Harmonic distortion at three power levels.

as much as ± 12 dB at their respective center frequencies.

A row of pushbutton switches along the lower edge of the dial area completes the front-panel lineup. From left to right, they control POWER; two sets of SPEAKERS that can be activated individually or simultaneously; input selection for AM, FM, PHONO, and AUX; TAPE MONITOR functions for two tape decks; a combined FM MUTE OFF/MONO switch; and LOUDNESS compensation. Programs can be dubbed from TAPE 1 to TAPE 2 (but not the other way around), and the TAPE 1 circuit is also designated for use with an external noise-reduction unit (Dolby or JVC's own ANRS system). When so used, the TAPE 2 circuits are still available for a tape recorder. For proper reception of Dolby-encoded FM programs with an external adapter, it is also necessary to use an external network to convert the 75- μ s FM de-emphasis to a 25- μ s characteristic. The side panels of the receiver are ribbed to resemble metal heat sinks, but they are actually plastic and their only nonprotective function is to serve as handles for lifting the receiver. In addition to the signal connectors, the rear apron has a DIN socket for TAPE 2, an FM DET OUT jack

for use with a future FM discrete 4-channel decoder, and separate preamplifier outputs and main amplifier inputs that are joined by removable jumper links. There are FM antenna terminals for 75- and 300-ohm antennas, a wire that capacitively couples the line cord to the antenna terminals to serve as an antenna in strong-signal areas, a hinged AM ferrite-rod antenna and a terminal for a long-wire AM antenna. Speaker terminals are insulated pushbutton spring clips. Two accessory ac outlets are incorporated, one of which is switched.

Laboratory Measurements. In almost every respect, the FM tuner section of the JVC JR-S300 surpassed its published ratings. The major exception was the IHF sensitivity, rated at 1.9 μ V. Our test sample measured 2.8 μ V (14 dBf). The stereo sensitivity was set by the switching threshold of 25 dBf (10 μ V). However, the tuner's limiting curve was steep, which resulted in a 50-dB quieting sensitivity in mono of 14.8 dBf (3.0 μ V) with 3.2% THD. In stereo, it was considerably less sensitive, measuring 40 dBf (55 μ V) with 0.37% THD.

The FM distortion at 65 dBf (1000 μ V) was low, measuring 0.41% in mono and

0.2% in stereo. Respective S/N measurements at that level were 68 and 66 dB. The stereo THD, with 100% L-R modulation, was 0.89% at 100 Hz, 0.63% at 1000 Hz, and 0.1% at 6 kHz.

The FM capture ratio at 45 dBf (100 μ V) was 1.6 dB, and AM rejection was 60 dB at that level. Image rejection at 98 MHz was 60-dB. The alternate-channel selectivity (400-kHz spacing) was 66 dB, and the 200-kHz selectivity (adjacent channel) measured 6.4 dB. Muting and stereo thresholds were both 22 dBf (7 μ V). FM frequency response was flat within ± 1 dB from 30 to 10,000 Hz, but the pilot-carrier filter cut off at too low a frequency, dropping the response to -5.5 dB at 12,000 Hz and to -19.3 dB at 15,000 Hz. However, the 19-kHz pilot-carrier leakage was a very low -75 dB referred to 100% modulation. The stereo channel separation was excellent, better than 35 dB from 30 to 15,000 Hz and exceeding 45 dB between 500 and 5000 Hz. Tuner output hum was -72 dB. The AM frequency response, down 6 dB at 35 and 3000 Hz, was typical of the AM sections of most receivers.

The audio amplifier outputs clipped at a power of 60.5 watts into 8-ohm loads at 1000 Hz. Into 4 ohms, the clipping power was 78.3 watts, and into 16 ohms it was 40 watts. The THD at 1000 Hz was a very low 0.005% at 0.1 watt. It rose slowly to 0.04% at 10 watts, 0.089% at the rated 50 watts, and 0.14% at 60 watts. The IM was 0.07% at 0.1 watt, fell to 0.022% at 1 watt, and rose smoothly to 0.24% at 50 watts and 0.52% at 75 watts.

Distortion was virtually independent of frequency, with the 50-watt THD remaining between 0.08% and 0.1% from 20 to 20,000 Hz. At half power and one-tenth

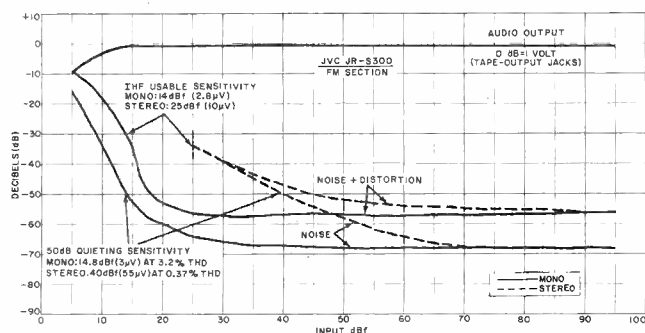

Noise and sensitivity curves for FM section.

power the characteristic was similar, but the distortion was about 0.06% and 0.02% at the respective power levels.

The high-level (AUX) input sensitivity for a 10-watt reference output was 77 mV with a very low -79-dB noise level. Phono sensitivity was 1.2 mV, with a -75-dB noise level and a very high overload input of 200 mV.

The loudness compensation boosted both low and high frequencies as the volume control setting was reduced. Although the receiver has no low- and high-cut filters as such, JVC suggests using the 40-Hz and 15-kHz SEA controls for that purpose. However, these filters removed an undesirable amount of the program content, and we would not consider them suitable for this purpose. Also, the SEA filters are able to attenuate the response by only about 12 dB, leveling off at that point and then returning to the normal response level above and below their minimum response points. This is in contrast to a normal filter, whose attenuation continues to increase, at least within the audio band.

As an equalizer, or "tone control," the SEA system performed very well. In fact, it is superior to any conventional tone control we have used, including those that offer a choice of turnover frequencies. If your ears are good enough to tell you when you have achieved the desired response, there is a very good chance that it can be realized with this highly versatile control system. Although it lacks the ultimate control capability of an octave-band equalizer, it is much easier to use.

The RIAA phono equalization was accurate to within ± 0.5 dB from 20 to 20,000 Hz and was affected by less than 1 dB when measured through the inductance of a phono cartridge. Calibration of the power meters was only approximate. One channel read from 5% to 25% high, and the other was typically about 35% high. However, the meters are adequate to give one a rough idea of operating power level.

User Comment. The Model JR-S300 offers a combination of more-than-competent, if not exceptional, FM performance. (We suspect that the loss of high-frequency response mentioned earlier was doubtlessly caused by a defective component rather than a design fault) with a very clean low-distortion low-noise amplifier that is capable of driving all but the very low efficiency speaker systems likely to be used in the home.

We're very impressed with the bene-

fits of the excellent SEA tone-control system. It's one of the very few that can really improve the overall sound without introducing greater aberrations than those it corrects.

The receiver has its peculiarities, though, and people will doubtlessly react to them in different ways. For example, some may find it hard to see the advantages of linear slider controls used for volume and balance. (In the case of the SEA controls, of course, everyone will agree that the "graphic" configuration makes good sense; others may feel it exudes a "professional-appearance" touch). The horizontal tuning wheel, while perfectly functional, requires some getting used to. We found it helpful to rest the hand on top of the receiver when adjusting either tuning or volume with a thumb or finger to achieve the necessary smoothness of control (which would have been more easily obtained with conventional knob-operated controls).

At first, the combining of the muting and stereo/mono switching functions into a single pushbutton switch seemed strange, but after some thought it proved to be logical. The muting and stereo thresholds are identical, so that any signal too weak to overcome the muting system will be receivable only in mono anyway. Thus, simultaneously un-muting and going into the mono mode causes no real inconvenience. Incidentally, the muting action was positive and free of transients.

On overall balance, the JR-S300 is a lot of receiver for the money. Its generally good performance and distinctive styling will appeal to many people looking for all-in-one package stereo electronics at a moderate price.

CIRCLE NO 103 ON FREE INFORMATION CARD

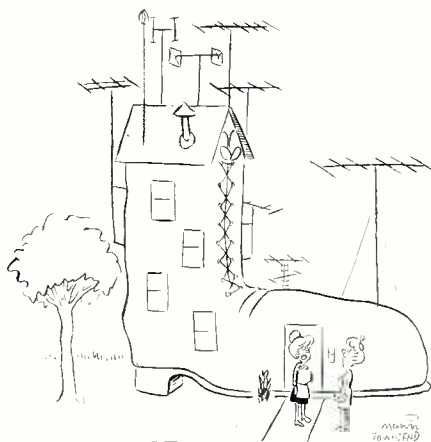

"First Junior got interested in amateur radio; then Henry took up CB; George got an FM stereo; Fred got color TV; then—"

Learn the naked truth about your phono cartridge.

If you're the kind of music lover who wants to get the very most from your stereo system, you can't afford to be without the Micro-Acoustics Transient and Tracking Ability Demonstration Test Record. Because it does what no test record ever did before.

Until now, test records concentrated on tracking ability—how well a stylus keeps contact with record grooves on louder, harder-to-follow passages, at low stylus pressures.

But cartridges need good transient ability, as well. To accurately reproduce the sudden start-and-stop bursts of sound at all frequencies that differentiate one instrument from another... and localize instruments in space.

Micro-Acoustics' new TT 2002 test record is the only record specifically designed to test both abilities. On side 1 of this easy-to-use disc is a series of electronic and musical tests incorporating technology we've developed as the world's leading manufacturer of recording stylus. Side 2 is a dramatic demonstration of quality music, played by the top names in the business.

One small catch: Our record has humbled many a proud stereo cartridge, and may well make you unhappy with what you're using. Unhappy enough to listen to our 2002-e direct-coupled cartridge—which isn't intimidated by any record. Even ours.



Micro-Acoustics Corp.
8 Westchester Plaza, Elmsford,
N.Y. 10523

- Enclosed is \$3.50. Send me the record. I'm curious and unafraid.
 I'm just curious. Send free literature.

Name _____

Address _____

City _____

State _____ Zip _____

ma
Micro-Acoustics PE



By John McVeigh

COIL FORMULA

Q. When I read the letter from David Gardner in the May issue, I knew for sure what your answer would be. Tell Dave to get a Lightning Calculator from the ARRL. It will tell him everything he needs to know about winding coils for r-f circuits.—Oscar A. Hoyt III

A. Thanks for the tip, Oscar. I've used a Lightning Calculator myself and have found it to be most useful. The L/C/F Calculator (Type A) will, at the flick of a wrist, tell you the number of turns you will need for a particular coil, and will determine the resonant frequency of an LC network. It is available for \$2.00 post-paid from the American Radio Relay League, 225 Main Street, Newington, CT 06111. Also of interest to experimenters is the new ARRL Electronics Data Book. It covers (among other things) filter design, transformer design (emphasizing toroids), antennas and feed systems, and construction and testing data. The Data Book is available for \$4.00 from the same source.

SIMPLE TTL CLOCK

Q. I need a simple circuit that generates TTL-compatible clock pulses. Any ideas?—Jean-Baptiste Duval, Levis, Quebec

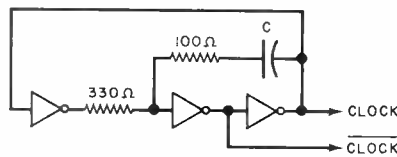

A. The circuit shown uses one half of a hex inverter—say, a 7404—and three passive components. A two-phase clock output is provided. The frequency of the clock is dependent on the value of C. For example, when a 200-pF capacitor is used, the output frequency is 5 Megahertz. When C is increased to 1600 pF, the output frequency drops to 1 Megahertz. A 100-kHz output can be obtained when 0.018 μ F is used, or 10 kHz with 0.18 μ F. Use of a close tolerance, high-quality capacitor is recommended to minimize frequency drift. Be sure to make V_{CC} and ground connections to the proper pins of your inverter IC.

MOBILE PROTECTION

Q. How can I protect my mobile transceiver from overvoltages?—Steve Hackett, Bangor, ME

A. The circuit shown uses the “crowbar” technique. That is, if the voltage applied

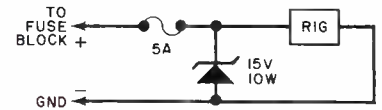

to the rig reaches 15 volts, the zener diode starts conducting heavily and will blow the 5-Ampere (fast blow) fuse. The circuit will “crowbar” and remove power from the transceiver before it is damaged by the overvoltage. If you have a positive-ground electrical system, reverse the zener diode. The fuse can be inserted on either side of the dc supply.

MULTIPATH

Q. What is “multipath” and how does it affect FM reception? What can be done to prevent it?—Tom McLaughlin, Redford, MI

A. Multipath is the constructive and destructive combination of two or more out-of-phase versions of an FM signal at the receiver. It occurs when a building or similar structure reflects a portion of the signal. When the reflected signal arrives at the receiving antenna, it slightly lags the phase of the signal travelling directly from the transmitting site to the receiving antenna. Reflections by several structures compound the problem. Multipath can be dealt with in several ways. First, the reflected signals should be attenuated as much as possible by the use of a high-gain directional antenna. The antenna should be oriented for minimum fading. Proper receiver tuning also helps. The use of a zero-center tuning meter is recommended. Some sophisticated tuners and receivers now come with a “multipath oscilloscope” which allows precise tuning for minimum distortion. Finally, it's important that the tuner's capture ratio be as low as possible. Reflections can be almost as strong as the direct signal, and it definitely helps to have a tuner that can reject signals whose strength is just below that of the desired one.

Have a problem or question on circuitry, components, parts availability, etc? Send it to the Hobby Scene Editor, POPULAR ELECTRONICS, One Park Ave., New York, NY 10016. Though all letters can't be answered individually, those with wide interest will be published.

EAR-SAVER

Q. Is there a device I can build to limit static crashes at the audio output of my communications receiver? Whenever I listen with my headphones on, I am plagued by atmospheric and power switch noise bursts.—Don R. Smith, K6CHS, Hemet, CA

A. The circuit shown will give some relief to your ears. It's actually a biased diode clipper which prevents the audio signal

from exceeding a threshold in either the positive or negative direction. Adjust the 5,000-ohm potentiometer for the desired clipping level. When no clipping is desired, open switch S1. Note, however, that this circuit can do nothing to prevent preceding stages such as the i-f amplifiers from being overloaded by noise spikes. The best solution is the use of an r-f noise blanker installed before the high-selectivity stages of the receiver.

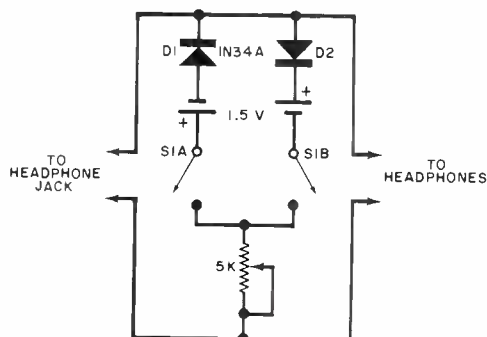

NEWS HIGHLIGHTS

New Novice Callsigns

As of October 1, 1976 the FCC stopped issuing distinctive callsigns to Novice Class Amateur radio stations. Under the old system, callsigns were prefixed by the letters "WN" to facilitate their identification as Novice stations. This, however, led to difficulties in the processing of Amateur applications. Now, all Amateur Novices with license expiration dates of October 1 or later will be issued new Novice licenses. The new licenses will be identical to the old, except they will be printed with the callsign the Novice licensee would have received under the old system upon obtaining higher class operating privileges. The new call assignment must be used by the Novice licensee as his callsign.

Computerized Devices at WESCON

"Dynavit," a bicycle exerciser based on a Rockwell PPS-4/2 microcomputer, was introduced at WESCON last year. The exerciser monitors fitness level, calorie loss and heartbeat. Weight, age and sex are punched in with a keyboard and used by the computer to calculate loading on the machine's pedals. After a few minutes, pulse beat is combined with this data to calculate a "health factor." Calorie loss and pulse beat are also displayed, and a flashing red light warns if pulse rate is more than normal.

TVI Inquiry Center

An inquiry center to deal with television interference problems caused by Citizens Band radios has been set up by the United States CB Radio Association. A television interference instructional kit prepared by the R.L. Drake Company and J.W. Miller Company details how to handle the interference problem, and can be obtained free of charge by writing to TVI, P.O. Box 21, Hartford, CN 06101.

Computer Records Dance

A University of Pennsylvania engineer has designed a computer editing system which enables choreographers to notate their dance scores quickly and accurately. New ballets can be recorded by several methods of notation, the most common being Labanotation, but it is rarely done due to the extremely complicated symbols used. The editing system employs a graphic display terminal connected to a keyboard with Labanotation symbols instead of letters on its keys. After a page of notation is completed, it is stored in the computer's memory and can be retrieved easily for quick reference. This new technique is expected to revolutionize the art of dance, where choreography was most often only recorded in the memories of the dancers and their audiences.

Interconnect Plan Opposed

AT&T has asked a federal court panel to reject the Federal Communications Commission's registration program for terminal interconnection, based on the Commission's alleged

lack of consideration to the cost involved in implementing such a program and the economic effect it would have on operating telephone companies. A spokesman for AT&T claimed that the FCC's refusal to consider the economic impact of the program so undermined it, legally, that the court must reject the program and send it back to the FCC for further consideration. Thus, the registration program introduced by the FCC, bypassing the telephone companies who heretofore charged for a modem on a monthly basis, has not yet been implemented.

QSL Card for Hawaii

As part of Hawaii's Bicentennial celebration, the standard time and frequency broadcast station of the Commerce Department's National Bureau of Standards (NBS) in Hawaii has issued a QSL card for shortwave listeners and ham operators who tune in to the station. The card depicts an open, double-hulled sailing canoe and honors the bicentennial voyage of a Polynesian canoe that sailed from Hawaii to Tahiti recently without the use of modern navigational equipment.

1977 Computer Conference

A major program on personal computing is being planned as part of the 1977 Computer Conference to be held June 13-16 in Dallas, Texas. Included will be a personal computing fair; exhibits of computer products; paper, panel and workshop presentations; and a computing club congress where representatives of clubs can gather to discuss ideas and problems. For further information on the 1977 NCC, write to AFIPS Headquarters, 210 Summit Avenue, Montvale, New Jersey 07645.

23-Channel Retrofit OK'd

The Federal Communications Commission has decided that manufacturers of Citizens Band transceivers can retrofit their 23-channel models to 40-channel capacity. Add-on devices are strictly prohibited. However, CB manufacturers can obtain equipment authorizations for units capable of operating on the new frequencies and then use a type-accepted 23-channel unit in the manufacture of certified equipment covering the full 40 channels.

REACT Convention

Representing 21 states and Canada, 208 delegates attended the first REACT International Convention, held at Trinity College, Deerfield, Illinois, last August. Highlighted was the potential growth of REACT through regular exchanges of information at the state and local levels. Discussion included the expansion of Class D Citizens Radio channels, National Emergency Air Radio, the monitoring of channel 9, and disaster preparedness. REACT received recognition and approval from the government agencies attending the convention, and a new era of cooperation and mutual assistance is expected between REACT and the American Radio Relay League. Due to the success of the meeting, it was decided that an International Convention should be held annually.

SWTPC NEWS

More Memory-Same Price 4K Now Standard In 6800

San Antonio—The SwTPC 6800 computer system, always a best buy is now an even greater bargain. Price reductions by the manufacturers of MOS memory circuits have made it possible to now offer the standard \$395.00 6800 computer kit with 4K of memory instead of 2K as previously. Memory circuits are 21L02 types which make possible powering up to 24K of memory in the stock chassis with the standard power supply.

The Southwest Technical 6800 at \$395.00 includes everything needed to work with your terminal. You get 4K of static MOS memory and a serial interface as part of the basic package. These are not extra cost options (?) as in many computer systems on the market.

8K MEMORY CARDS ANNOUNCED —

For those 6800 systems needing the maximum possible amount of memory, Southwest Technical Products announces 8K memory cards. These memory expansion cards have 8K Bytes of low power MOS memory per board. These kits feature the new 4K static RAMS that are now becoming available. These new RAMS make it possible to put 8K of memory on a board without crowding the parts, or using small hard to solder connecting lines. These new memory boards feature DIP switch address selection and a write protect switch on each board.

The low power consumption of this new memory board makes it possible to use up to 48K of memory in the standard 6800 chassis with the stock power supply. Priced at \$250.00 these memory cards cost no more than less dense memories from other sources.

PRICES CUT ON 4K MEMORIES

Southwest Technical Products has reduced the price of its standard 4K memory card by 20%. These cards use low power 21L02 static memories. The new price for the MP-M memory kit is \$100.00 for a full 4K kit.

This kit contains 4K of memory with full buffering and dual on-board voltage regulators. Six of these memory cards may be used in a standard 6800 chassis to provide 24K of memory for the system. Memory now becomes even more of a bargain—24K for only \$600.00.

Who Needs It?

We continue to get reports from customers who are amazed at the ease of assembly of the 6800 computer. One reports that he purchased test equipment before ordering a computer at the advice of friends who owned brand "X" machines. His total use of the test equipment was zero (0) when he installed

each board in the 6800 and they all proceeded to work perfectly the first time. He later found in comparing notes with other 6800 owners that his was not a unique experience.

People who have built most of the various types of computers on the market generally agree that our instructions are the best and most complete. So don't worry about purchasing the least expensive computer system, there are still good honest values being offered in the world of personal computing.

SUPER SOFTWARE

"Lack of Software" can no longer be used as an excuse by those who have the poor taste to purchase computers using older, less elegant processors than the MC-6800. Southwest Technical Products has not only editor-assembler and game programs available for the 6800, but also both 4K and 8K BASIC.

The ability to run ANSI standard BASIC programs on the 6800 make the enormous number of BASIC programs out there all usable on the SwTPC 6800. That's right, you can run anyones BASIC programs on the 6800 provided they are written in standard BASIC (as most are). 4K Basic at \$4.95 and 8K BASIC at \$9.95 are inexpensive enough for anyone to own. They do not cost hundreds of dollars as in some systems, or only become available when combined with purchase of huge amounts of memory as in others.

Loading even a relatively long program such as 8K BASIC into your SwTPC 6800 is not a long procedure when the AC-30 cassette interface is used. This super reliable and inexpensive (\$79.95 complete with cabinet and power supply) cassette interface uses the "Kansas City" standard format and will load 8K BASIC in approximately five minutes.



SOUTHWEST TECHNICAL PRODUCTS CORPORATION
219 W. Rhapsody
San Antonio, Texas 78216

CIRCLE NO. 55 ON FREE INFORMATION CARD



**“READ”
DIT’S
AND
DAH’S
WITH**

THE MORSE-A-LETTER

Automatically decodes Morse transmissions and displays them alphanumerically, for amateur radio, shortwave, and code training purposes.

NOW YOU can read a message in Morse even if you don't know the code. The “Morse-A-Letter” project presented here automatically converts dahs and dits to alphanumeric characters. With this converter, SWL's can eavesdrop on code exchanges, and prospective and seasoned radio amateurs can have a valuable audio-visual Morse code training and operating aid.

What's more, the Morse-A-Letter features a sophisticated electronic design that ensures accurate and reliable performance. It accepts input signals from a receiver's headphone jack (or from across the speaker leads) and decodes them. The text characters—letters, numerals, and punctuation marks—are then shown sequentially on a LED matrix alphanumeric display. Standard TTL and linear IC's are employed, as well as two ROM's, a MOS character generator, and discrete components. Other features include a built-in monitor loudspeaker, a highly selective active filter, an agc circuit, ASCII output, and simplified, one-control operation. Total project cost is about \$120.

Morse Code Theory. Before examining the Morse-A-Letter circuit, let's review the basics of Morse code. Interna-

tional Morse code is a method of encoding Roman letters, Arabic numerals, and punctuation marks so that messages comprising them can be transmitted by radio or wire. Each character is uniquely represented as a group of elements taking the form of audio tones or silences (spaces) of prescribed length.

The tone elements are called dits and dahs, and the spaces consist of element spaces, character spaces, and word spaces. The dits and dahs within a character are separated by element spaces. (For example, the letter *s* is represented by the sequence: dit, element space, dit, element space, dit.) Whole characters and words are separated by character and word spaces, respectively. The normalized, ideal element lengths are shown in Fig. 1. For English text, the common method for determining the rate of transmission is expressed by the formula: code speed (in words per minute) equals dits per minute divided by 25.

Those familiar with Baudot or ASCII codes will consider Morse rather primitive. Each element is of variable length, and there is no provision for parity checking or error correction. Nevertheless, Morse is widely used by commercial press and ship-to-shore stations, the

military, and amateur radio operators. This is partly due to the simplicity of the equipment required. Virtually any transmitter with provision for keying the r-f carrier on and off can be used for CW (continuous wave, or Morse code) work.

Other factors favoring Morse include its inherent efficiency. Just as much information is contained in the spaces as in the dits and dahs. Therefore, the amount of energy required to transmit a message is reduced by about 50 percent. Additional efficiency results from characters of variable length, from one to eleven elements. The most common letters in English text are assigned the shortest code.

The factors which make Morse efficient also make it difficult to decode. Atmospheric or man-made noise can occur, particularly during spaces (when no signal is present). This can introduce spurious elements. The fact that characters are not uniform in length means that character length is difficult to predict. However, the things that affect decoding most are the physical and psychological factors that influence manual sending quality. Fatigue, inattentiveness, and forgetfulness on the part of the sender cause randomness, unpredictability, and inaccuracy in element length.

The foregoing makes it clear that a Morse decoder must function with a high degree of accuracy for it to be effective. The Morse-A-Letter has been designed to meet this need by utilizing narrow filters for noise rejection, agc for fading compensation, and circuitry that allows for sending-speed variations.

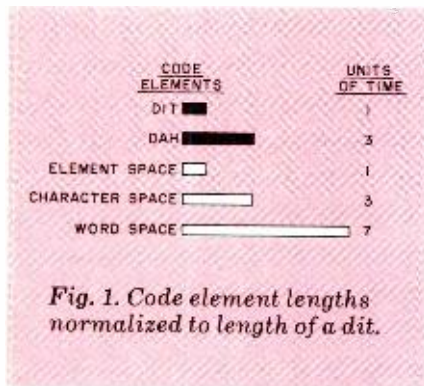

System Analysis. A block diagram of the Morse-A-Letter is shown in Fig. 2, with the complete schematic in Fig. 3. A selector switch at the system's input allows selection of either the internal 1100-Hz oscillator for code practice or an external audio signal from a radio receiver. The signal applied to the input is conditioned by an agc stage whose gain is determined by a voltage fed back from a succeeding stage. The output of the agc circuit feeds a two-stage narrow bandpass filter whose response is centered at 1100 Hz. An op amp and a speaker are connected to the filter output for monitoring purposes.

The filter output also drives a full-wave rectifier which demodulates the audio tones so that only low voltages or high voltages are generated. The demodulated signal is applied to two stages simultaneously. It is smoothed and filtered into the control signal of the agc loop, and is also "squared up" by a two-stage Schmitt trigger. At the output of the Schmitt trigger, a logic one corresponds to a key down condition, and a logic zero to a key up condition. Clean, constant-level Morse signals are thus available for processing by the decoding circuitry.

The processed Morse is then applied to two counters, called the key-up and key-down counters. One counter, but not both, will count, depending on whether the key is up or down. These key-condition counters operate at a rate dependent on the frequency of an internal, adjustable clock which must match the input code speed. However, the clock rate can be off by as much as $\pm 50\%$ and still provide solid copy.

Each time the key-up counter detects

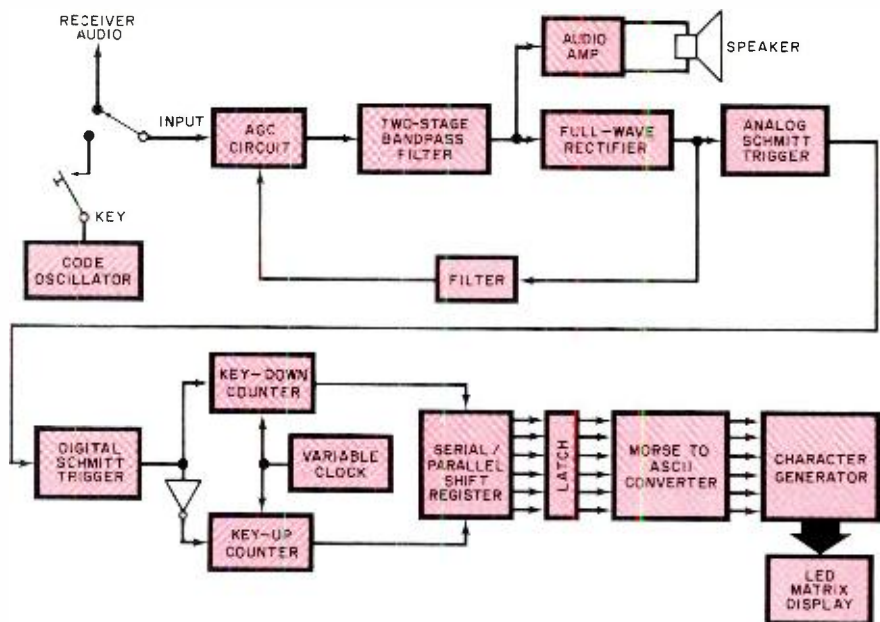

Fig. 2. Block diagram of the Morse-A-Letter shows how incoming code is converted to visual display.

PARTS LIST

C1—1- μ F, 15-volt tantalum capacitor
 C2 through C7, C18—0.1- μ F, $\pm 10\%$ Mylar capacitor
 C8—150- μ F, 15-volt upright electrolytic capacitor
 C9—6.8- μ F, 15-volt tantalum capacitor
 C10—0.01- μ F Mylar capacitor
 C11, C12, C13, C15, C17—0.1- μ F disc ceramic capacitor
 C14—0.15- μ F Mylar capacitor
 C16—470-pF silver mica capacitor
 C19, C20—2.2- μ F, 15-volt tantalum capacitor
 D1, D2—1N914 diode
 D3, D4, D5, D7, D8—1N270 diode
 D6—4.7-volt, 1-watt zener diode (1N4732A or equivalent)
 DIS1—MAN-2.5 \times 7 LED matrix display
 IC1, IC2—747A dual operational amplifier IC
 IC3—741 operational amplifier IC (8-pin mini-DIP)
 IC4, IC7, IC21—555 timer IC
 IC5—7413 dual NAND Schmitt trigger IC
 IC6, IC8, IC20—74161 synchronous four-bit counter IC
 IC9—74121 monostable multivibrator IC
 IC10, IC11—7495 four-bit right-shift/left-shift register IC
 IC12, IC14—7475 quadruple bistable latch IC
 IC13—7404 hex inverter IC
 IC15, IC16—8223 256-bit bipolar programmable Read-Only Memory IC
 IC17—2513 MOS character generator IC
 IC18—7407 hex buffer/driver IC
 IC19—74145 decoder/driver IC
 LED1, LED2—20-mA miniature LED
 Q1—2N3823 n-channel JFET
 Q2, Q3—2N2222 npn switching transistor
 The following fixed resistors are $\frac{1}{4}$ -watt, 10% tolerance unless otherwise specified.
 R1—4700 ohms
 R2, R18, R19—10,000 ohms
 R3, R12—200 ohms, 5% tolerance

R4, R5, R13, R14, R24—2200 ohms, 5% tolerance
 R6, R15—180 ohms, 5% tolerance
 R7, R16—100,000 ohms
 R8, R10—39,000 ohms
 R9, R22, R35 through R40—1000 ohms
 R11, R34—470 ohms
 R17, R20—1500 ohms
 R23—68,000 ohms
 R25—47 ohms
 R26, R32—47,000 ohms
 R28, R30—27,000 ohms
 R29, R31, R42 through R46—330 ohms
 R33, R41—5600 ohms
 R21—5000-ohm printed circuit trimmer potentiometer
 R27—100,000-ohm printed circuit trimmer potentiometer
 R47—100,000-ohm linear taper potentiometer
 S1—Spdt toggle switch
 Misc.—Printed circuit board, 22-pin edge connectors (2, optional), suitable enclosure, plastic bezel, IC sockets or Molex Soldercons, small 8-ohm dynamic speaker, suitable jacks, standoff spacers, rubber grommets, brackets, machine hardware, hookup wire, shielded cable, etc.

Note—The following items are available from Select Circuits, 1411 Lonsdale Road, Columbus, OH 43227: Complete kit of parts including etched and drilled G-10 glass epoxy printed circuit board, power supply components and all parts except chassis and enclosure (MAL-1 PCK), \$109.95; Etched and drilled G-10 printed circuit board (MAL-1), \$17.95; Preprogrammed Letter ROM (LET-15), \$6.00; Preprogrammed Numeral ROM (NUM-16) \$6.00. Prices of ROM's include shipping charges if ordered with pc board MAL-1. If ordered separately, add \$0.50 each for shipping charges. MAL-1 and MAL-1 PCK prices include shipping charges within the continental U.S. Ohio residents add 4% sales tax.

an element space (a condition which occurs whenever the key-up counter detects less than 15 clock pulses), it serially transfers a logic 0 or 1 to the next stage, an eight-bit serial/parallel shift register. This shift register is always initialized to the binary word 00000001 so that the beginning of each Morse character will be uniquely decodable. The transfer of a logic 0 or 1 to the shift register is determined by the condition of the key-down counter. This counter differentiates between dits and dahs. If the key-down counter counts more than 15 clock pulses, the tone element is a dah. Otherwise, it is a dit. This simple detection scheme has been found to be very efficient and reliable in actual use.

This procedure continues until the key-up counter detects a space longer than an element space. At this point, it is known that a complete character has been sent, and the unique binary code present in the serial/parallel shift register is parallel-transferred to a latch for storage and ASCII encoding. The key-condition counters and shift register are then re-initialized and ready for the next Morse character.

Read-only memories (ROM's) are used to convert the binary code in the latch into ASCII. One ROM encodes letters, and another handles numerals and special characters. Conventional character-generating techniques are then employed for the display of the appropriate alphanumeric symbol.

A power supply circuit for the project is shown in Fig. 4. Current demand on the +5-volt supply is about 600 mA; while the -5-volt demand is only about 10 mA. Each 12-volt supply provides about 40 mA.

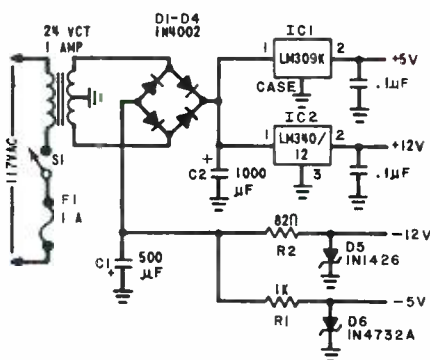

Fig. 4. Schematic of power supply.

POWER SUPPLY PARTS LIST

- C1—500- μ F, 35-volt electrolytic capacitor
 - C2—1000- μ F, 35-volt electrolytic capacitor
 - C3, C4—0.1- μ F disc ceramic capacitor
 - D1 through D4—1N4002 rectifier diode
 - D5—12-volt, 1-watt zener diode (1N1426 or equivalent)
 - D6—4.7-volt, 1-watt zener diode (1N4732A or equivalent)
 - F1—1-ampere fuse
 - IC1—LM309K 5-volt regulator IC
 - IC2—LM340/12 12-volt regulator IC
 - R1—1000-ohm, 10%, 1/4-watt resistor
 - R2—82-ohm, 10%, 1-watt resistor
 - S1—Spst switch
 - T1—24-volt center tapped, 1-ampere transformer.
- Misc.—Terminal strips, silicone grease, line cord and strain relief, fuseholder, hookup wire, solder, machine hardware, etc.

Construction. The Morse-A-Letter is most easily constructed on a printed-circuit board. The etching and drilling and parts placement guides for a board are shown in Fig. 5. Be sure to use a small-tipped, low-wattage soldering iron and Molex Soldercons or IC sockets. Start by inserting the smallest components first, gradually working up to the larger

items. For example, install all the jumpers, then the 1/4-watt resistors, followed by the diodes, etc. Naturally, you should follow good soldering practices.

Note that DIS1, S1, S2, LED1, LED2, the monitor speaker, jacks and sockets, and the power supply are not mounted on the pc board. Rather, provisions are made for using 22-pin edge connectors for interfacing. (See Table 1 for connector terminal number assignments.) Off-board components should be mounted in a convenient manner on a suitable project enclosure.

The ROM's (IC15 and IC16) must be properly programmed. The truth tables are given in Tables 2 and 3. In POPULAR ELECTRONICS, July 1975, there's an article entitled "How to Program Read-Only Memories" that describes the required procedure. However, some parts sources will program the 8223's if you include the truth tables with your order. The kit supplier (see Parts List) also offers pre-programmed ROM's.

Install the IC's in their sockets, taking the usual precautions when handling MOS devices such as IC17. Apply power to the project.

Internal Adjustments. Two potentiometer adjustments must be made. The first determines the pitch of the code practice oscillator. Plug a telegraph key into the key jack and put S1 in the osc position. Depress the key and adjust R27 for the loudest output from the speaker. An aural adjustment is adequate. The pitch of the oscillator output will be approximately 1100 Hz (the center frequency of the active filter).

The second adjustment sets the threshold of analog Schmitt trigger

Fig. 5. Component placement guide is at right. Etching and drilling guide for pc board opposite.

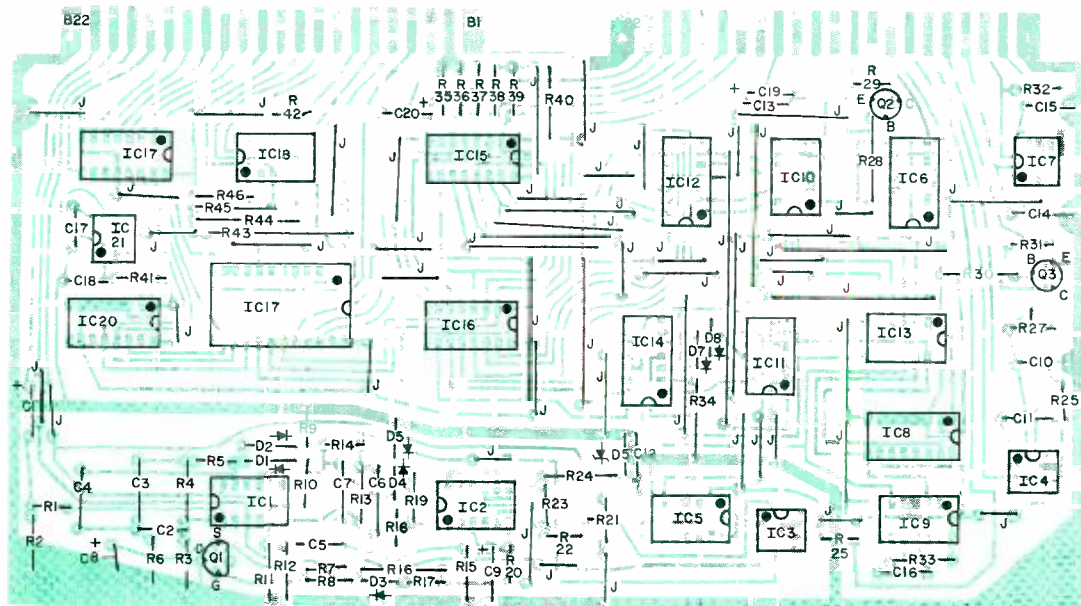

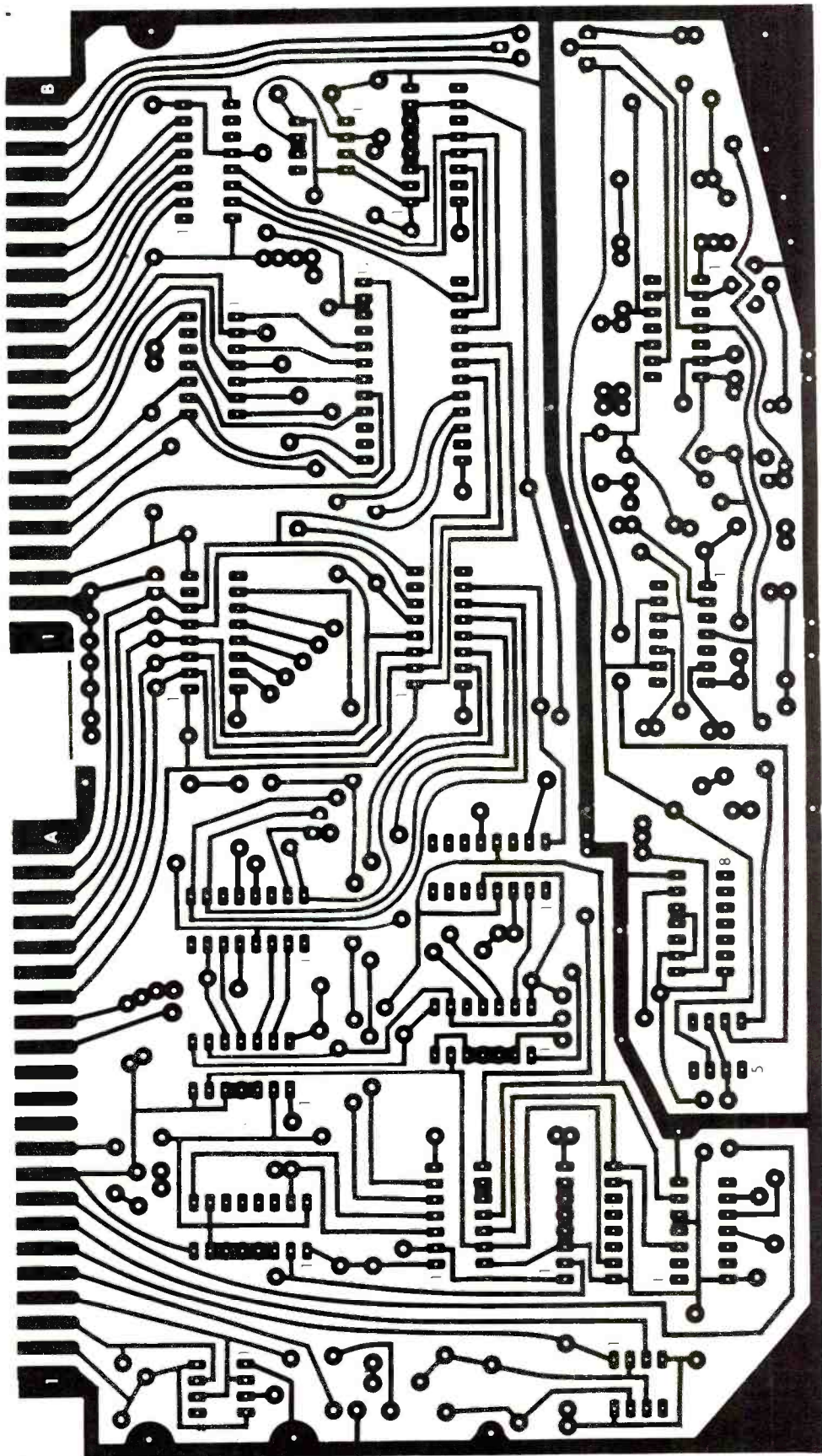

IC2B. Connect the audio output of a shortwave receiver equipped with a BFO to the audio input jack of the Morse-A-Letter. You can take the audio signal from across the speaker leads or from the headphone jack. Use shielded cable for the interconnection.

The best way to make the adjustment is with a dc-coupled oscilloscope. Connect the receiver to the Morse-A-Letter audio input, and put *S1* in the RCVR mode. Carefully tune in a signal so that its pitch is in the center of the filter passband. When it is properly tuned in, the CODE LED (*LED1*) will glow. The signal will also be heard through the small monitor speaker. Note that the Morse-A-Letter's input stage is very sensitive and, therefore, does *not* require a large audio signal. Back down on the audio gain if you have trouble getting a signal properly tuned in. Connect a probe from the oscilloscope's vertical amplifier to pin 7 of *IC2*. The signal at this point should follow the code, with zero voltage when the key is up (spaces) and about four volts when the key is down (tone elements). The waveform will appear rounded or low-pass filtered.

Decide where you would like *IC2B*'s threshold to be, based on your observations of the waveform and its response to QRM (interference from other stations), QRN (interference from static), etc. Then place the scope probe on pin 6 of *IC2* and adjust *R21* so that the voltage at this point is the same magnitude as the chosen signal threshold. You'll observe that this voltage will not remain at exactly the same level, but will shift a small amount as the Schmitt trigger follows the code.

If a scope is not available, you can still make an approximate adjustment. Tune in a suitable signal as described earlier. Measure the key-up and key-down voltages at pin 7 of *IC2* with a high-impedance (20,000 ohm/volt or more) voltmeter. The key-up voltage should be zero and the key-down voltage about four volts. Then measure the voltage at pin 6 of *IC2*. Adjust *R21* so that this voltage is about 40% of the key-down voltage at pin 7. This technique should produce satisfactory results. There is nothing "magical" about the 40% figure. Experiment with the setting of *R21*.

If the Morse-A-Letter is to be used solely as a code practice device, the adjustment of *R21* should be made by either of the methods described, using the internal code practice oscillator as the signal source. Of course, the oscillator output frequency must first be set at the center of the active filter's passband.

CIRCUIT DETAILS

As shown in Fig. 3, a selective bandpass filter comprises *IC1A* and *IC1B* and the associated components. It provides a bandwidth of about 100 Hz and a degree of threshold limiting due to *D1* and *D2*. The filter forms the forward portion of the agc loop which automatically provides variable gain for operation during periods of signal fading. The agc loop is completed by full-wave detection of the audio output of *IC1B* by *IC2A*, *D4*, *D5* and the associated resistors. The resulting dc voltage controls the bias of *Q1*, a FET acting as a variable resistor. Capacitor *C8*, diode *D3*, and resistors *R16* and *R17* provide independent attack and decay times for the agc circuit.

Op amp *IC2B* is an analog Schmitt trigger which squares up the output of *IC2A*. The trigger's threshold is fixed after initial adjustment of *R21* because the agc loop maintains almost constant signal levels at this point even under extreme variations in input levels. The output level of *IC2B* is made TTL-compatible by zener diode *D6*. Op amp *IC3* is the remaining analog stage. It is a voltage follower that passes the band-pass filter output to a small speaker, providing adequate volume for monitoring purposes. A 555 free-running timer, *IC4*, is used as a code practice oscillator. Its output is fed to the band-pass filter when switch *S1* is in the Osc position.

The input to the "digital" section of the Morse-A-Letter (*IC5*) is a 7413 Schmitt trigger IC. It provides additional noise immunity and sharp rise and fall times for the succeeding stages. The output of *IC5* is used to enable or disable *IC6* and *IC8*, the 4-bit binary key-up and key-down counters, respectively. Both counters are wired to count to 15 and then latch up.

Assume that the key has been up for a few seconds. Key-down counter *IC6* is being held clear by the input signal. Key-up counter *IC8* has counted to 15 and latched. Thus, pin 15 (the carry output) of the key-up counter is at logic one, putting shift register *IC10IC11* in the parallel mode. (These two four-bit shift registers are wired together to act as one eight-bit register.)

Now assume the key is depressed. The word 00000001 is parallel-loaded into *IC10IC11* and *IC8* is cleared, putting the shift register in the serial mode. If SPEED control *R47*—which governs the clock rate of *IC7*—is set properly, *IC6* will count less than 15 clock pulses when a dit is sent, or latch at 15 when a dah is sent. Next, assume the key is released. The data at pin 15 of *IC6* is serially entered into the shift register and key-up counter *IC8* is allowed to count the length of the space. If it is short (meaning the character has not been

completed), pin 15 of *IC8* will remain low and the shift register will remain in the serial mode. The stages will now process the next dit or dah.

This procedure will continue until the character is completed. The data in the shift register will then be equivalent to the Morse sent, with a dit a logic 0 and a dah a logic 1. Note, however, that a leading logic 1 has been inserted to identify the start of the character in the register. This is important because Morse is a variable length code. For example, the letter A (dit dah) will appear as 0000101 while a U (dit dit dah) will appear as 00001001. The leading (left-most) logic 1 is needed to eliminate the ambiguity that would otherwise exist.

A long space occurs at the end of a character which allows *IC8* to count to 15 and latch. This causes *IC9*, a one shot, to generate a new character pulse which will load the data from shift register *IC10IC11* into latches *IC12* and *IC14*. The data is held there and used to drive the display circuitry until the next character is completed.

If a letter is being decoded, only the first five bits are really needed. If a numeral or punctuation mark is received, six or seven bits are required. However, any punctuation mark or numeral is uniquely described by the five low-order bits in the register. If the sixth or seventh bit is a 1, the character is a numeral or punctuation mark. If the sixth and seventh bits are 0's, the character is a letter. So these bits are OR'ed together by *D7*, *D8*, and *R34* before being entered into the latches. The resulting signal selects either the letter ROM (*IC15*) or the numeral/punctuation ROM (*IC16*) to decode the remaining five bits.

The output of the ROM's is standard six-bit ASCII. This ASCII is used to drive *IC17*, a 2513 character generator, and is also available for use with a TV typewriter. (A "new character" pulse output is provided for CRT display.) Decoders and drivers *IC18-20* activate a MAN-2 LED matrix (*DIS1*) that provides alphanumeric display of the transmitted Morse characters. Integrated circuit *IC21* provides clock pulses for the decoder and driver stages. Two discrete LEDs are also used for monitoring purposes.

The CODE LED1 is driven by the Schmitt trigger output. This LED glows when the Morse signal is properly tuned in and is reaching the Schmitt trigger. The DAH LED2 is driven by the data signal at pin 15 of key-down counter *IC6*. This LED glows when the transmitted tone element is longer than 15 clock pulses. A simple means of determining when SPEED (clock rate) control *R47* is properly set is thereby provided.

**TABLE 1
CONNECTOR TERMINAL
ASSIGNMENTS**

- A1—Ground
- A2—+5 Volts
- A3—To speed pot R47
- A4—To speed pot R47
- A5—To "CODE" LED
- A6—To key
- A7—Oscillator output
(to RCVR/OSC select switch)
- A8—To speaker
- A9—Ground
- A10—To "DAH" LED
- A11—No connection
- A12—No connection
- A13—No connection
- A14—New character pulse
- A15—+5 Volts
- A16—ASCII output bit 1
- A17—ASCII output bit 2
- A18—ASCII output bit 3
- A19—ASCII output bit 4
- A20—ASCII output bit 5
- A21—ASCII output bit 6
- A22—Ground

- B1—No connection
- B2—+5 Volts
- B3—Ground
- B4—-5 Volts
- B5—-12 Volts
- B6—To MAN 2 (DIS1) pin 14
- B7—To MAN 2 (DIS1) pin 13
- B8—To MAN 2 (DIS1) pin 8
- B9—To MAN 2 (DIS1) pin 1
- B10—To MAN 2 (DIS1) pin 5
- B11—+5 Volts
- B12—To MAN 2 (DIS1) pin 2
- B13—To MAN 2 (DIS1) pin 12
- B14—To MAN 2 (DIS1) pin 3
- B15—To MAN 2 (DIS1) pin 4
- B16—To MAN 2 (DIS1) pin 11
- B17—To MAN 2 (DIS1) pin 10
- B18—To MAN 2 (DIS1) pin 9
- B19—+12 Volts
- B20—-12 Volts
- B21—Audio input from receiver
- B22—Ground

**TABLE 2
TRUTH TABLE FOR IC15**

Character	Input					Output					
	A ₀	A ₁	A ₂	A ₃	A ₄	B ₀	B ₁	B ₂	B ₃	B ₄	B ₅
A	0	0	1	0	1	1	0	0	0	0	0
B	1	1	0	0	0	0	1	0	0	0	0
C	1	1	0	1	0	1	1	0	0	0	0
D	0	1	1	0	0	0	0	1	0	0	0
E	0	0	0	1	0	1	0	1	0	0	0
F	1	0	0	1	0	0	1	1	0	0	0
G	0	1	1	1	0	1	1	1	0	0	0
H	1	0	0	0	0	0	0	0	1	0	0
I	0	0	1	0	0	1	0	0	1	0	0
J	1	0	1	1	1	0	1	0	1	0	0
K	0	1	1	0	1	1	1	0	1	0	0
L	1	0	1	0	0	0	0	1	1	0	0
M	0	0	1	1	1	1	0	1	1	0	0
N	0	0	1	1	0	0	1	1	1	0	0
O	0	1	1	1	1	1	1	1	1	0	0
P	1	0	1	1	0	0	0	0	0	1	0
Q	1	1	1	0	1	1	0	0	0	1	0
R	0	1	0	1	0	0	1	0	0	1	0
S	0	1	0	0	0	1	1	0	0	1	0
T	0	0	0	0	1	0	0	1	0	1	0
U	0	1	0	0	1	1	0	1	0	1	0
V	1	0	0	0	1	0	1	1	0	1	0
W	0	1	0	1	1	1	1	1	0	1	0
X	1	1	0	0	1	0	0	0	1	1	0
Y	1	1	0	1	1	1	0	0	1	1	0
Z	1	1	1	0	0	0	1	0	1	1	0

Operation. The Morse-A-Letter is very easy to operate. The only adjustment that you must make is the setting of the SPEED control (R47), and only a rough setting is required. Remember that the Morse-A-Letter input is quite sensitive, so you should set the receiver's audio gain a little lower than usual. If this is done, the primary source of audio output will be the project's internal speaker, and you will quickly learn how to tune the signal in to the center of the filter passband.

Once the signal is properly tuned in, the CODE LED will blink in step with the Morse. Adjust the SPEED control so that the DAH LED glows only when dahs are sent, not when dits are. The MAN-2 display will now read out the incoming characters. Note that "illegal" Morse characters will be displayed as @. For code practice sessions, place S1 in the osc position and adjust the SPEED control for the approximate sending speed. You may wish to calibrate the SPEED control. If so, the following formula will help you determine the required calibration points: Speed (wpm) = 0.15 f. That is, the code speed in words per minute equals fifteen hundredths of the clock frequency, which is determined by the setting of SPEED control R47.

Some users might feel that the center frequency of the passband (and thus the pitch of the practice oscillator) is too high. Or it may not coincide with the center frequency of the crystal filter in a given receiver. If a change of the center frequency is contemplated, the values of R4-6 and R13-15 should be modified. Here are alternate values for two frequencies:

Resistors	800 Hz	1000 Hz
R4, R5, R13, R14	3300 ohms	2700 ohms
R6, R15	270 ohms	220 ohms

As mentioned earlier, the passband of the filter is about 100-Hz wide. A narrow filter is very desirable when used with a stable receiver that's equipped with a smooth, slow-moving tuning dial assembly. But if the receiver has a tendency to drift or the tuning dial is compressed or has some play in it, a narrow filter should not be used. Instead, the use of wide-tolerance, randomly selected, or even deliberately mismatched components for C2, C4, C5, C7, R4-6 and R13-15 is recommended to broaden the filter's passband.

As a final note, you are cautioned not to relay to a third party any information garnered from press transmissions or the like. Except for ham or broadcast transmissions, it's illegal to do so. ◇

**TABLE 3
TRUTH TABLE FOR IC16**

Character	Input					Output					
	A ₀	A ₁	A ₂	A ₃	A ₄	B ₀	B ₁	B ₂	B ₃	B ₄	B ₅
0	1	1	1	1	1	0	0	0	0	1	1
1	0	1	1	1	1	1	0	0	0	0	1
2	0	0	1	1	1	0	1	0	0	0	1
3	0	0	0	1	1	1	1	0	0	0	1
4	0	0	0	0	1	0	0	1	0	1	1
5	0	0	0	0	0	1	0	1	0	1	1
6	1	0	0	0	0	0	1	1	0	1	1
7	1	1	0	0	0	1	1	1	0	1	1
8	1	1	1	0	0	0	0	0	1	1	1
9	1	1	1	1	0	1	0	0	1	1	1
.	1	0	1	0	1	0	1	1	1	0	1
?	1	0	0	1	1	0	0	1	1	0	1
/	0	1	1	0	0	1	1	1	1	1	1
-	1	0	0	1	0	1	1	1	1	0	1

Chemicals for Electronics Servicing

BY A. A. MANGIERI

What you will need for:

cleaning

degreasing

lubricating

insulating

heat-sinking

protection

conduction

soldering

cementing

component debugging

shielding

paint removing

ELECTRONICS servicing requires the use of a number of specially formulated chemicals. If you do a lot of servicing work, you will need cleaners, lubricants, insulating chemicals, adhesives, etc. On the other hand, if your

needs are minimal, you might be able to get by with only a few general-purpose chemicals. Bear in mind that best results are obtained by using the types and kinds of chemicals specially formulated for given jobs.

It is well to have some chemicals in both liquid and aerosol-spray form. Special packaging of many chemicals in dispenser vials, syringes, squeeze tubes and bottles, and pen oilers offer convenience in portability and application.

Keeping It Clean. Fundamental to all electronics servicing is to have on hand a wide variety of cleaners and degreasers. A service technician is often called upon to clean TV tuners, volume and tone control potentiometers, switch and relay contacts, and chassis and cases. It is quite common to restore an erratic TV tuner simply by cleaning away gummy residues and oxides from switch contacts.

Aerosol-spray and liquid cleaners include degreasing cleaners that leave no residue, and the polishing cleaners that leave behind a light protective lubrication. Most aerosol cleaners come with an extension tube that allows the user to pinpoint a confined blast of the cleaner and to get into otherwise inaccessible locations in a chassis.

To clean a tuner, you start by blowing out loose dust, using *WEP Air Blast* (Workman Electronic Products) or a similar compressed-air product. If the tuner's switch contacts are not visibly worn or oxidized, you can use a degreasing cleaner, such as *GC Nuvi-Tran* and *Tuner Bath* (GC Electronics) and *WEP Ultra Wissh* and *Miracle Bath*, etc. These nonresidue cleaners are specially formulated not to detune critical circuits or induce drift. If the tuner's contacts seem worn or oxidized, a lubricating and polishing cleaner with silicone, such as *WEP Super Wissh* or *GC Spra-Lube*, is called for. Foaming cleaners, such as *GC Magic Vista* and *WEP Lubrite*, lift off dirt and lubricate and polish the switch contacts. Lubricating cleaners usually do not induce drift or instability. If this should occur, you can use a degreasing cleaner on neutralizing and trim capacitors.

All parts of a TV tuner should be cleaned, including the fine-tuning mechanism, shafts and bearings, and grounding wipers. Lubricate the mechanical portions where required. For big cleaning jobs, you should use a nonflammable liquid cleaner like *GC Chloro-Kleen*.

De-Ox-Id is an effective cleaner in an oil base that loosens oxides and leaves a light lubricant on switch contacts. This cleaner should be applied sparingly on switch and relay contacts, after first removing dust and grime with *GC Replay-Kleen*. You can usually restore scratchy volume and tone controls by injecting a

drop or two of *De-Ox-Id* inside them and on the shaft bushings. Touch up rough relay contacts with the burnisher supplied in the *GC Contact Burnishing Kit*, which also includes a cleaning solvent. Faulty toggle switches used in light-duty applications are usually dirty, rather than worn. Try working in some *De-Ox-Id* along the solder lugs or other opening to clear up the problem.

Oxide build-up on audio and video tape heads impairs frequency response. Use a cleaner that is especially formulated for tape heads and does not harm tape, plastics, or paint. You may prefer to brush clean tape heads with *GC Magnetic Head Cleaner*. Record discs should also be cleaned periodically. You can use cleaner/lubricators like *Disc-washer*, *Sound Guard*, *Rek-O-Magic Reco Kleen* or others with built-in anti-static chemical.

Smooth Running. Lubricants for electronics servicing are highly refined oils and greases that provide high lubrication, rust inhibition, and stable viscosity over a wide temperature range. Additives minimize oxidation, foaming, and gumming.

Always apply lubricants sparingly since any excess may drip or creep from the point of application onto nearby rubber parts and insulation, causing damage. Most lubricants are convenience packaged in unbreakable pocket pen oilers and vials, plastic squeeze bottles, and aerosol-spray cans. Greases are packaged in bottles, syringes, and squeeze tubes.

Dispensing high-quality instrument oil, the *Reach-All* pen oiler with steel extension tube permits application of one drop at a time or less. Also dispensing high-quality general-purpose oil, the *Zoomer-Spout Oiler* has a 7" (17.8-cm) flexible extension spout that reaches into normally inaccessible places with ease. *WEP's Lub-A-Kit* is a pocket-size lubrication kit that includes vials of instrument oil and liquid graphite, as well as dry graphite that is dispensed in puffs from a squeeze tube.

Although general-purpose oils do a creditable or superior job in most applications, special-purpose oils are available for special applications. The *GC No. 9400 Electronic Oils* kit, for example, includes radio-TV, phono, tape-recorder, penetrating, and driplless oils, plus liquid graphite. Driplless oil should be used wherever messy oil creeping must be avoided, such as on cabinet hinges, topside tape deck drives, etc. Liquid graphite can be used to lubricate

locks, slides, hinges, pushbutton switch mechanisms (mechanical portions only) with a thin film of lubricant that does not foul easily with grit.

Lubricants in aerosol spray cans allow large areas to be sprayed for lubrication and rust prevention. For spraying smaller areas, the spray extension tube that comes with the aerosols can be used. The *WEP Spray Oil* dispenses general-purpose oil with a silicone additive. Silicone spray oils like the *GC Sili-Spra* provide a light lubrication and long-lasting protection. *Sili-Spra* can be applied in a light, medium, or heavy coating by adjusting its three-way spray valve. An unusually slippery silicone lubricant, *WEP Slic-Spra* lubricates and protects as well as eliminates sticking. It also protects rubber and leather and waterproofs fabrics.

You will need several grades and types of grease for record-changer mechanisms, switch and relay contacts, and other mechanical devices that require no-flow lubrication. Light greases for switch contacts and controls, such as *GC Lube-Rex* and *Contact Dope*, lubricate and protect self-wiping contacts. You can also use *Lube-Rex* on gears, bearings, and slides.

Greases in squeeze tubes, like *Lubriplate* and *Phonolube*, are easy to apply as needed and tuck away unobtrusively in a tool caddy. *WEP Precision Grease* comes in a syringe, which precludes messy over-lubrication. This grease is free of zinc and metal oxides, which would impair high-frequency operation.

Insulating Chemicals. Problems with insulation are likely to occur in the high-voltage section of a TV receiver. Arcing and corona discharge result when the insulation on the flyback transformer or horizontal output transformer peels, cracks, or melts off. If the flyback transformer is still operative, repairs can be made with any of several chemicals.

When repairing a flyback transformer, the first thing to do is check out the horizontal output tube and circuit to correct the fault that caused the problem. Then, clean the high-voltage cage and components inside it with a nonresidue cleaner. You may be able to remove portions of the cage or the entire cage by unsoldering two wires. Spray or brush onto the flyback transformer's windings several coats of *GC Red-X*, *GC HV Corona Dope*, *WEP Corona Dope* or similar product. If thick pieces of insulation have peeled off the windings, make repairs with *GC High-Voltage Putty*. Then check for corona discharge in a darkened room; apply *High-Voltage Putty* and/or corona dope as required. (CAUTION: Readers not familiar with TV receiver circuits and safe working practices around high voltages should not open the high-voltage cage or attempt such repairs.)

A fast-drying coil dope, *GC Polystyrene Q-Dope*, insulates and protects r-f, uhf, and vhf coils without affecting Q. Insulate and protect motor windings and transformers with *GC Red GLPT Insulating Varnish*. *GC Liquidope*, a versatile general-purpose transparent coil



Chemicals galore assist you in servicing today's electronics. They include lubricants, contact cleaners, component coolers, etc.



Pc board chemicals include silicone grease heat-sink compounds, conductive paints, silicone resin lacquer board coating and solvent.

coating, shrinks on drying and tightens loose coil windings. You can use it in TV receiver high-voltage cages as a corona dope and in many other applications. *GC Liquid-Tape* is a black viscous high-voltage coating that is strong and pliable and will not chip, crack, or peel. It can be used to coat fraying motor-lead wires, as a sealant to exclude moisture, as a paint-on insulator, etc.

Insulating and Dipping Varnish from GC has an exceptionally high dielectric strength (2000 volts/mil), penetrates well and insulates and moisture proofs field coils, power and output transformers, filter chokes, linearity chokes, width coils, etc. Among the aerosol-spray insulating coatings are *GC Insul-Volt* and *Koloid K-29*, which are general-purpose coatings for electrical windings. Al-

though the various insulating coatings have a common job to perform, their differences in drying rates, penetrating quality, temperature range, toughness, flexibility, etc., will influence your choice for a particular application.

Chemicals for PC Work. An indispensable chemical for servicing solid-state circuits, silicone-grease heat-sinking compound insures efficient heat transfer from transistor cases to heat sinks. It is applied between the case of the transistor and the heat sink and does not melt or run or freeze over a wide temperature range. *GC Z5 Transistor Silicone Compound*, a transparent grease, and *WEP Silicone Lube* are free of metals and oxides. They can also be used as anti-corona compounds and

protective lubricants. *GC Z9 Silicone Super Heat Sink Compound* contains metal oxides that effectively increase the thermal conductivity of the grease.

Liquid solder fluxes that can safely be used on printed circuit boards are *GC Print Kote* and *Liquid Solder Fluxes*. These solutions contain rosin as the active agent. In a pinch, you can make a better than passable solder wick by dipping small-size tinned wire braid into these solutions. The potent noncorrosive *Soldering Paste* from GC effectively tins soldering iron tips. If you must use this paste on an electrical connection, thoroughly clean the connection to remove all traces of the flux.

Resin lacquer coatings that are often applied to printed circuit boards to protect the foil traces from oxidizing foul solder wicks and impede desoldering. The coatings can be removed with *Print-Kote Solvent* and replaced with *Silicone Resin Lacquer*, both from GC.

Conductive paint permits a foil trace on a pc board to be touched up, without having to go to the bother of soldering. It can also be used to paint a conductive shield or draw a ring around the input terminals of a sensitive component. *GC Copper Print* consists of copper particles suspended in a fast-drying binder. This paint requires very thorough mixing before and during use to keep the copper particles in suspension.

Silver Print paint, also by GC, is costlier but much easier to use than is *Copper Print*. *Silver Print* consists of finely divided silver particles in a somewhat more fluid binder. More like an ink than a paint, *Silver Print* mixes easily and stays in suspension during use. *Silver Print* can be applied with the finest of brushes and even ruling pens and compasses used by draftsmen. To develop a feel for conductive paints, paint a few lines of varying widths, lengths, and weights and measure the resistance, which may vary between a few milliohms to tens of ohms for thin films.

Cements and Adhesives. You will need at least one of three classes of cements and adhesives to repair loud-speaker cones, control knobs, and equipment cases and cabinets. The super-strength epoxy and cyanoacrylate cements are invaluable but cannot be used on porous materials. The plastic-base cements with solvent agents are inexpensive but cure slowly when bonding nonporous materials and most have low initial bonding strength. In the last group are the contact cements that bond almost all materials with good initial



Servicing adhesives include plastic base cements, rubber base contact cements, and the super-strength epoxy and cyanoacrylate adhesives.

bonding strength but are not well suited for small-area, high-stress bonds.

The latest of the super-strength "miracle" adhesives, the cyanoacrylates (such as *GC PermaBond* and *WEP Quick Bond*), are thin-film adhesives that bond nonporous materials almost instantly. These cements flow readily into hairline cracks but will not fill in larger voids or tolerate dirty or ill-fitting surfaces. You can obtain maximum bonding strength with the aid of a highly effective surface cleaner and activator supplied in the *Workman No. 33-102 Bond-Solv Kit*. In addition to *Quick Bond* adhesive, the kit includes *Bond-Fix* solvent for cleaning and activating the surfaces; *Bond-Solv*, a true solvent for releasing cured bonds and cleaning up; and the unique *Pro-Bond Industrial Syringe* with flexible needle that applies the adhesive without waste. With the *Workman* kit, you can bond plastics, metals, rubber, vinyl, nylon, Teflon, polyethylene, and even some silicone materials.

Cyanoacrylate cement must never be spread on the surfaces to be joined because it dries too rapidly. Apply a drop in a puddle on only one surface and firmly press the parts together to spread the adhesive. Although developing high strength in seconds, allowing the bond to cure overnight will insure maximum strength.

Epoxy cement, also a super-strength adhesive, cures by chemical action between epoxy resin and a hardener mixed in equal proportions before use. Standard epoxy cements cure overnight. You may, however, find it more convenient to use the "five-minute" epoxies, such as *GC's Quik-Stik* and *WEP's Double Barrel Epoxy*, the latter dispensed from a double syringe to assure mixture of the proper proportions of resin and hardener. Epoxy cement readily fills in gaps and voids between the surfaces to be joined and cures without serious shrinkage or loss of bonding strength. Cleaning up of cured excess epoxy is difficult. Therefore, it is always good policy to clean away any excess promptly, before the cement has had time to cure. Although it is preferably used on nonporous materials, epoxy cement can be used on dense woods like maple, ash, etc.

Less expensive plastic-based cements are well suited for many repairs. The fast-drying *GC Radio-TV Service Cement* is ideal for cementing speaker cones and grille cloth, but it dries slowly on nonporous materials. A general-purpose cement for plastics, *GC Plastic Cement* bonds acetates, butyrates, phe-

nolics, and vinyls. Special-purpose plastic cements include *Bakelite Cement*, which bonds such thermoplastics as the ureas and phenolics, *Acrylic Cement*, which bonds such thermoplastics as *Lucite* and *Plexiglass*, and *Vinylite Cement*, which welds or bonds vinylite. All three are available from *GC*, as is *Magnetic Cement*, which bonds broken loopsticks, yoke cores, and other ferromagnetic materials.

Contact cements are rubber based. They must be applied to both surfaces that are to be joined and allowed to dry until tacky before pressing the two surfaces together. You can use contact cements on grille cloths, paper, rubber, wood, plastics, and metals. A high-grade general-purpose contact cement available under the name *Plybond* from *GC* surpasses ordinary contact cements. Special-purpose contact cements include *GC Rubber To Metal Cement* and *Ne-O-Prene Cement*. An aerosol spray cement, such as *WEP Stik-E-Wipe*, makes cementing a tube-replacement chart or schematic diagram to a cabinet a no-mess snap of a job.

Miscellaneous Chemicals. You can spend a lot of time tracking down an intermittent transistor, capacitor, resistor, or other component. But you can also save a lot of time by using a circuit cooler, such as *GC Zero-Mist Circuit Cooler* or *WEP Super Freeze-It*, which are aerosol spray refrigerants that almost instantly cool the suspected component to below freezing. In use, when the heat-related intermittent component is cooled and circuit operation returns to normal, you have located the fault.

You can replace peeling or flaking picture tube coating with *GC No. 49-12 aerosol Television Tube Coat* or *No. 49-2 brush-on Tube Coat*. The conductive coating often flakes off where it contacts a grounding spring or wiper. Incidentally, this chemical can also be sprayed or painted on the inside surfaces of a plastic case to form an electrostatic shield. As a last resort, you can use *Tube Coat* to repair breaks or worn spots of the carbon element in a volume or tone control.

You can safely remove enamel from the thin wire used in r-f coils and chokes by applying *Strip-X*, which removes enamel, *Formvar*, *Formex*, and other such coatings. Other useful chemicals include *WEP Lubricant & Moisture Displacer*, which clears electrical short circuits due to moisture, and *GC Liquid Non-Slip*, which eliminates slippage of dial cables and belts. ◇

Without our software, we're just another flasher.



Let's face it. No microcomputer is worth a dime if you can't make it work. Even E&L's Mini-Microdesigner would be just a "light flasher" if it weren't for our software system.

But the fact is that our tutorial software is the best in the business. Not just a pathetic rehash of chip manufacturers' specifications. But a clearly written, step-by-step instruction that teaches you all about the microcomputer. How to program it. How to interface it. How to expand it.

The teaching material is written by Rony/Larsen/Titus (authors of the famous Bugbooks). It's called *Bugbook V*. And it teaches through experiments designed specifically to get you up to speed on our Mini-Microcomputer (MMD-1). And you don't need any prior knowledge of digital electronics!

The best news? E&L's MMD-1 costs only \$380 in kit form, including all software and teaching material. Send your check or Money Order today (or complete BankAmericard/Master Charge information). We'll pay shipping charges anywhere in continental U.S.

CIRCUIT DESIGN, INC.

Division of E & L Instruments, P.O. Box 24,
Shelton, Conn. 06484

I believe you, I am ready to order at \$380.00 for the MMD-1 Kit. Enclosed find my Check/Money Order or charge information for BankAmericard or Master Charge (Make sure you sign the order blank)

Name: _____

Address: _____

City: _____ State: _____ Zip Code: _____

Signature: _____

Circuit Design will prepay shipping charges anywhere in the US. Contact the factory for additional charges elsewhere.

PS: If you want an assembled and tested unit order the MMD-1/A at \$540.00.

PHOTOELECTRIC SENSOR

DETECTS (AND COUNTS) ENTRANCES & EXITS

In/out detection system counts events (up and down) and can be used to control lights, appliances, etc.

BY DAVID MARKEGARD

MOST photoelectric entry detectors are unidirectional. They can detect when an individual enters a given area but not when he leaves. A more practical system, from both a security and a convenience point of view, would be able to detect motion in both directions. A store owner would then know whether or not all customers who entered his premises had left by the close of the day. In the home, such a system could be used to automatically turn on and off lights as you enter and leave a room.

The in/out detection system described here is a relatively simple and inexpensive approach that takes advantage of readily-available TTL IC's. It not only turns on the room lighting (or any other electrical device) when the first person enters the monitored area, it also keeps tabs on the number of people entering and leaving the area. The system turns off the electrical device only after the last person has passed the sensor while exiting the area.

The basic circuit is designed to count up and down a maximum of nine events. However, it can easily be modified to count 99, 999, etc., events simply by adding extra IC's and diodes. Additionally, the system can accommodate two or more sets of sensors should you have more than one doorway to monitor.

About the Circuit. In the circuit shown in Fig. 1, the UP and DOWN sections of the system operate in an identical manner, the only difference being in the direction of the count. Since operation is identical, we will discuss the sequence of events in only the UP section.

When an external light beam shines

on *LDR1*, the resistance of this light-dependent resistor is a low 100 ohms (approximately). Consequently, the input to pin 13 of *IC1* is low, making the output of this inverter stage, at pin 12, high. Now, when the beam to *LDR1* is broken, the light-dependent resistor's characteristic resistance rapidly increases to several megohms, placing a relatively high positive voltage at the pin-13 input of *IC1* to generate a low output at pin 12. The steep edge of the rapidly falling voltage at pin 12 is differentiated by *C1*, *R2*, and *R3* to produce a sharp negative pulse whose width remains constant regardless of how long the light path to *LDR1* is broken.

Resistor *R2* also serves as a "pull-up" for the input of *IC2*, a timer integrated circuit that is connected as a one-shot multivibrator. When triggered, *IC2* generates a positive-going pulse at its pin-3 output. This pulse is then inverted by another inverter stage in *IC1*, after which it is passed to the "count-up" input (pin 5) of up/down counter *IC4*, registering a one-count increase. With each successive breaking of the beam to *LDR1*, the system registers another up-count (to a maximum 9 count, after which the system automatically resets to 0).

The same inverted signal that is applied to the pin-5 input of *IC4* is also applied to the reset input (pin 4) of *IC3*, another timer integrated circuit connected as a one-shot multivibrator. This inhibits the output of *IC3* and prevents any possibility of generating a false down-count in the system. Bear in mind that *LDR1* and *LDR2* in the finished project are mounted physically close to each other so that a common light beam can

be used for both. This means that when an opaque body passes between the beam and *LDR1*, a discrete interval later it passes between *LDR2* and the beam. Hence, if *IC3* were not inhibited, the system would count up and almost immediately count down as the beam to first one and then the other LDR is broken. The system must, therefore, respond to the count generated by the first LDR to be activated—in this case, *LDR1*—for true bidirectional performance.

The four outputs from *IC4* are coupled through isolating diodes *D1* through *D4* and current-limiting resistor *R10* to the base of transistor *Q1*. The transistor is held in cutoff whenever all the outputs of *IC4* are low and conducts whenever any one or more outputs are high. When *Q1* is conducting, relay *K1* is energized and operates whatever external device is connected to its contacts.

As noted earlier, the basic system is configured for a maximum count of 9 in either direction. If you wish to increase the count range, you can add one or more 74192 up/down counter IC's to the basic circuit as shown in Fig. 2. Each added 74192 IC will then provide a one-decade increase in range. For example, two 74192's increase the maximum count to 99, three 74192's to 999, etc. When up/down counters are added, the "carry" and "borrow" pins (pins 12 and 13) of each preceding counter become the inputs to the next counter in line. Note also that all "clear" inputs (pin 14) of the counters must connect to CLEAR switch *S1*.

An adequate light source for the system can be obtained by using a low-voltage power transformer with an appropriate

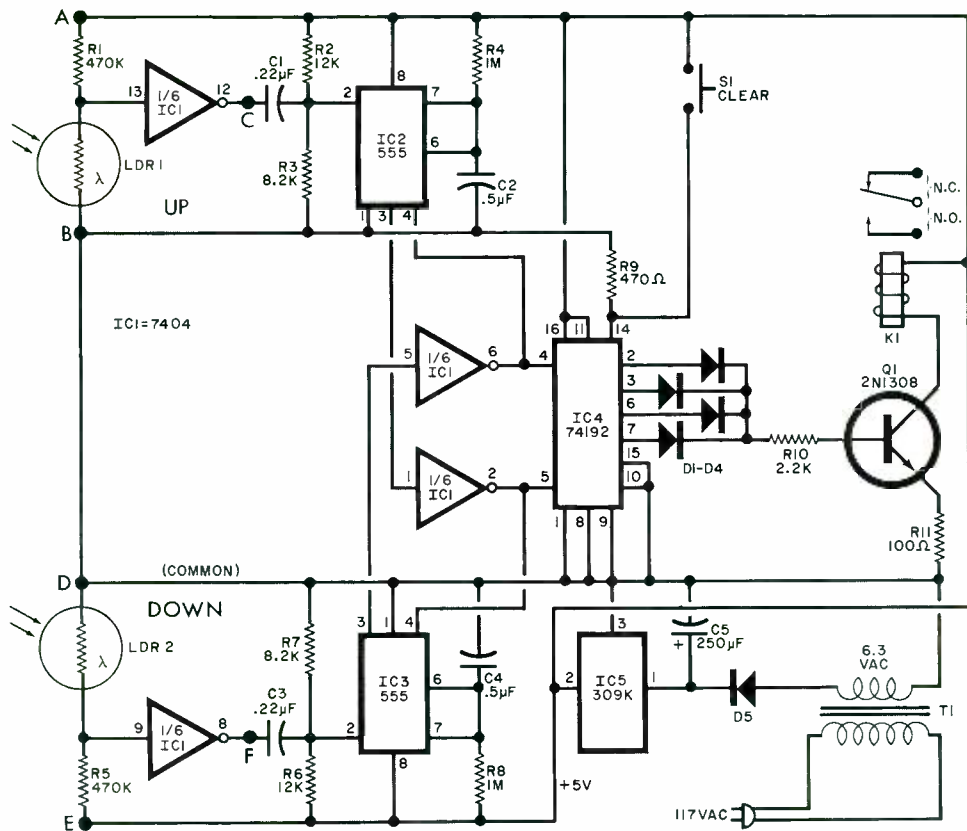

Fig. 1. Any sudden change in light on LDR1 causes an output pulse which is counted to drive relay K1. Two one-shots are cross-coupled so that only the first one activated is counted.

PARTS LIST

C1, C3—0.22- μ F capacitor
 C2, C4—0.5- μ F capacitor
 C5—250- μ F, 25-volt electrolytic capacitor
 D1 through D5—1N4001 rectifier diode
 IC1—7404 hex inverter IC
 IC2, IC3—555 timer IC
 IC4—74192 up/down counter IC
 IC5—309 5-volt regulator IC
 K1—3-volt, 25-mA relay (Calectro No. D1-965 or similar)
 LDR1, LDR2—Light-dependent resistor with

1-megohm maximum, 100-ohm minimum resistance (Radio Shack No. 276-116 or similar)
 Q1—2N1308 or similar transistor
 The following resistors are 2-watt, 10%:
 R1, R5—470,000 ohms
 R2, R6—12,000 ohms
 R3, R7—8200 ohms
 R4, R8—1 megohm
 R9—470 ohms
 R10—2200 ohms

R11—100 ohms
 S1—Spst momentary-action pushbutton switch
 T1—12-volt, 300-mA power transformer
 Misc.—IC and transistor sockets (optional); heat sink for IC5; perforated board; suitable box to house circuit; line cord; hookup wire; chassis-mounting ac receptacle; sheet of insulating plastic; materials for making light source (see text); rubber grommet; machine hardware; solder; etc.

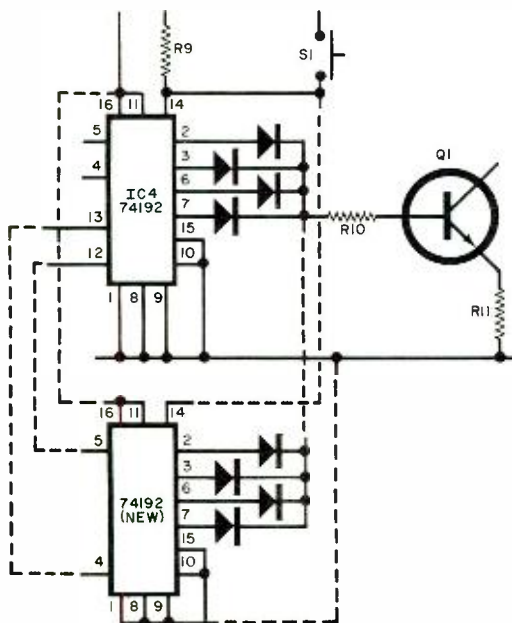

Fig. 2. Count can be increased by adding another up/down counter.

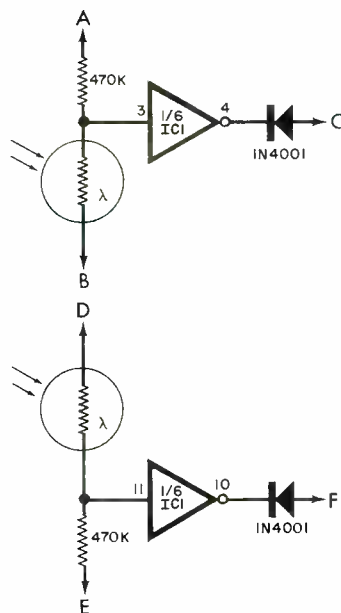

Fig. 3. Second pair of counting inputs can cover another entry.

ate panel lamp connected across its secondary winding. By wiring a 100-ohm potentiometer in series with one of the transformer's secondary leads and the lamp, you can vary the intensity of the beam to suit conditions. The lamp can be set into an ordinary flashlight reflector to focus the light into a narrow beam.

If it is necessary to cover a second doorway, the system will accommodate an extra pair of UP/DOWN counting inputs, connected as described in Fig. 3. This will use up the remaining two inverters in the 7404 hex inverter used for IC1. In the event that more than two doorways must be covered, extra UP/DOWN counting inputs can be used, provided that you add as many inverter pairs as there are LDR pairs.

Construction. There is nothing critical about circuit layout or lead routing. The entire circuit can be assembled on a 5" x 4" (12.7 x 11.4 cm) piece of perforated board, as shown in Fig. 4. It is

Hi-fi Harmony

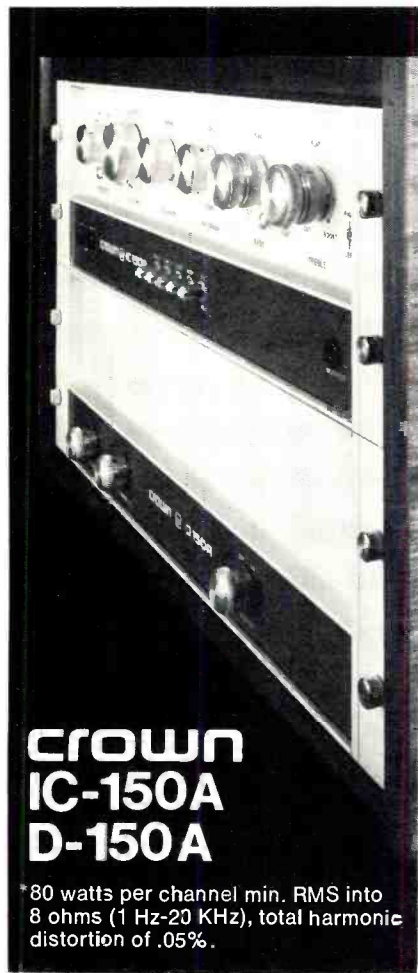

Crown IC-150A D-150A

*80 watts per channel min. RMS into 8 ohms (1 Hz-20 KHz), total harmonic distortion of .05%.

In any great vocal group, each singer could make it on his own. Together, they're beautiful.

That's how we designed the Crown IC-150A pre-amp and the Crown D-150A power amp.

The IC-150A provides precise control with minimum distortion. The D-150A provides reliable power* to drive almost any stereo speakers. Each one could be a superb addition to your system.

But together we think they're incomparably beautiful, whether you think of beauty as powerful, clean sound; or honest, uncluttered appearance; or simple, accurate control.

If the receiver or integrated amp in your current system seems somehow limited, please consider seriously the Crown IC-150A/D-150A combination. You'll be pleased at a new quality of sound, and surprised at a real bargain.

Write us today for the name of a dealer near you. It could be the start of a harmonious relationship.

*When listening
becomes an art,*



Box 1000, Elkhart, IN 46514

CIRCLE NO. 17 ON FREE INFORMATION CARD

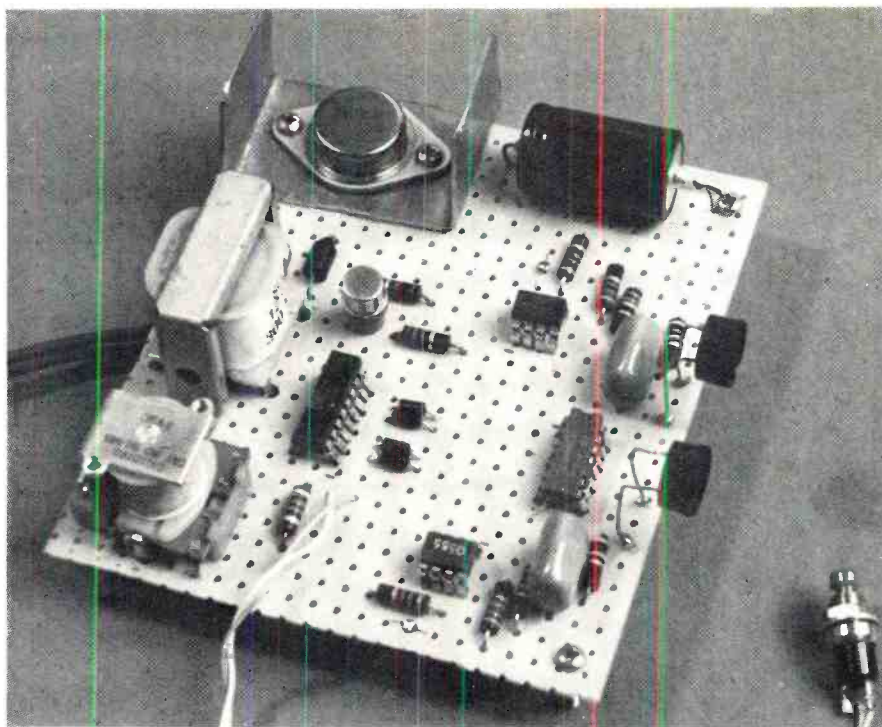

Fig. 4. The prototype of the photoelectric sensor was assembled entirely on perforated board. LDR's are on right side of board. CLEAR switch is connected by twisted leads.

advisable to use sockets for the IC's and transistor. Note also the need for a heat sink with IC5.

Light-dependent resistors *LDR1* and *LDR2* should be mounted about 1" (2.54 cm) apart so that a single light beam will suffice for both. If you are using extra UP/DOWN counting inputs, mount their LDR's on a small piece of perforated board. Cut holes in a small box to allow light-beam access to the LDR pair, mount the LDR board inside the box, and interconnect this assembly with the main board via twisted cable.

The box that houses the main circuit board should be large enough to accommodate the main circuit board, a chassis-mounting ac receptacle, and CLEAR pushbutton switch *S1*. Drill holes in the box as required to mount all components in place and to provide light-beam access to *LDR1* and *LDR2*. Mount *S1* and the receptacle in their respective holes. You can use ordinary hookup wire to interconnect *S1* with the circuit board, but it is advisable that you use a length of regular line cord to interconnect the relay contacts and the receptacle. Slip the free end of the line cord through a rubber-grommet-lined hole in the case and solder it to the appropriate points in the circuit. A sheet of insulating plastic should be placed between the box and the bottom of the board before the latter is finally bolted down. This will obviate the possibility of the live ac on

the primary side of *T1* from shorting out against the metal box.

Testing the Circuit. Plug the system's line cord into a convenient ac receptacle and direct a beam of light onto *LDR1* and *LDR2*. The relay should immediately energize. Depressing the CLEAR button (*S1*) should cause the relay to immediately deenergize. Now, block the light beam by passing your hand in front of first *LDR1* and then *LDR2*. The relay should again energize. With the relay still energized, passing your hand in front of first *LDR2* and then *LDR1* should cause *K1* to drop out.

Pass your hand several times from *LDR1* to *LDR2*. The relay should immediately energize on the first pass and remain energized with each successive pass. Now pass your hand an equal number of times from *LDR2* to *LDR1*. The relay should remain energized for all but the last pass. On the last pass, the relay should deenergize. This procedure checks the up and down counting operation of the circuit.

The relay specified for *K1* in the Parts List can safely handle up to 3 amperes of current. If you wish to operate a device that requires a greater amount of current, you will have to substitute a low-voltage, low-current relay whose contacts can handle the current drain. Alternatively, you can use the specified relay to drive a higher-current relay. ◇

HOW TO FULLY DEBOUNCE LOW-COST KEYBOARDS



Inexpensive approach to properly interfacing calculator keyboards to microcomputers

BY RALPH TENNY

KEYBOARDS for home-brew calculators or even minicomputers are available from many sources (such as those advertising in this magazine). Unfortunately, most of these keyboards lack two important features—contact debouncing and key encoding. Without debouncing, each key closure can produce multiple signals, while encoding makes it possible to determine just which key has been operated.

There are many different types of debouncing circuits, but most of them are applicable to just one contact. Debouncing a full keyboard can be very expensive. Also, when debouncing a keyboard, encoding is very complex since each key closure must result in a unique code output.

A simple, low-cost way to overcome these problems is shown in the circuit in

Fig. 1. It produces a binary-coded output, fully debounced, from any low-cost 16-key board. The keys are labelled in hexadecimal so that the board can communicate with a microprocessor.

Four 8-input NAND gates (*IC1* through *IC4*) encode all the keys except 0. All of these gates are held high by resistors *R4* through *R19*. When a key is depressed (except 0), that input is brought to ground and its associated NAND gate output goes high. For example, if key D is depressed, the outputs of *IC1*, *IC3*, and *IC4* go high to produce 1101, the hex code for D.

Because it is necessary to know when any key, including 0 is depressed, OR gates *IC6A* and *IC6B* detect the presence of any key closure. When a 0 comes on, *IC5A* passes the signal to gate *IC6B*.

Although we can now detect all key closures and encode them on the 1-2-4-8 lines, contact bounce remains a problem. The waveforms in Fig. 2 show what happens when a key is depressed and bounces one time. The output of *IC6B* is waveform M, which drives the *R1-C1* combination to produce waveform N. When the key stops bouncing, *C1* can be charged up enough to cause *Q1* to fire. Resistor *R1* is low enough so that *Q1* latches in and stays on. As a result, point P is held low, and the two sections of *IC5* produce high or low Data Ready signals. The latter is indicated by a rule over the words in Fig. 1.

When *Q1* latches in, it provides some protection against multiple-key closures. If a second key is depressed after *Q1* fires, the output code will be correct but no Data Ready strobe will be produced.

Fast, Fool-proof TV Alignment

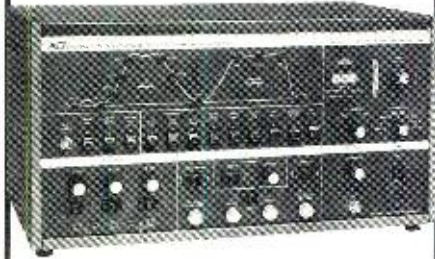

B&K-PRECISION SWEEP/MARKER GENERATOR

Model 415, \$485

With the B&K-PRECISION Model 415 you can complete a TV alignment in about the time you would spend hooking up the instruments for conventional alignment procedures. It's ideal for testing adjacent channel interference in CATV installations, too.

Everything you need is built into the Model 415—sweep and marker generators, a marker adder and three bias supplies. The 10 crystal-controlled IF markers can be shown either vertically or horizontally on your scope, and they light up on the front panel IF response and chroma bandpass diagrams as you use them.

Proper set alignment is assured and is almost automatic when you follow the Model 415's programmed alignment procedures.

Contact your local B&K-PRECISION distributor for a demonstration, or write for detailed information on how the Model 415 can save you time and increase your profits.

B&K PRECISION
PRODUCTS OF DYNASCAN
6460 West Cortland Avenue
Chicago, Illinois 60635 • 312/889-9087
In Canada: Atlas Electronics, Toronto

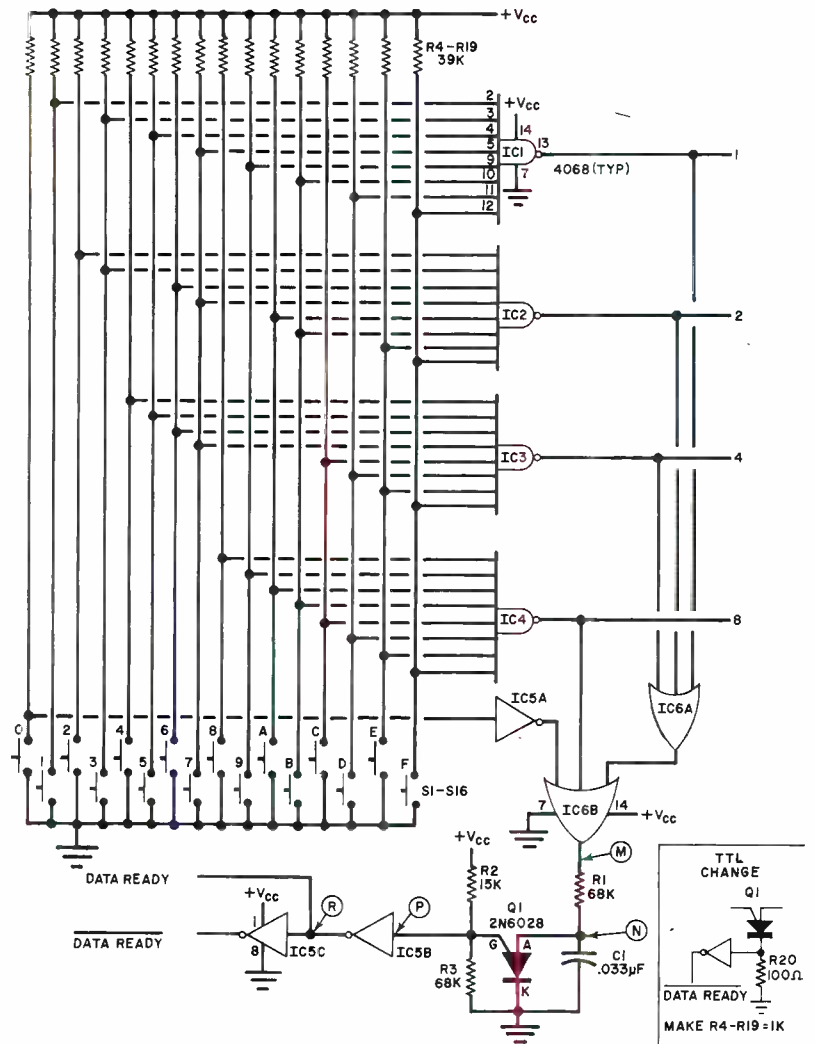

Fig. 1. The circuit produces a 1-2-4-8 binary code and provides a debounced data-ready strobe.

PARTS LIST

C1—0.033- μ F, 15-V capacitor
IC1-IC4—CD4068 8-input NAND gate (for TTL, use 7430)
IC5—CD4049 inverting hex buffer (for TTL, use 7404)
IC6—CD4075 triple 3-input OR gate (for TTL, use 7432)

Q1—2N6028 programmable unijunction transistor
R1, R3—68,000-ohm, 1/4-watt resistor
R2—15,000-ohm, 1/4-watt resistor
R4-R19—39,000-ohm, 1/4-watt resistor
R20—100-ohm, 1/4-watt resistor (TTL only)
S1-S16—Normally open switch/keyboard

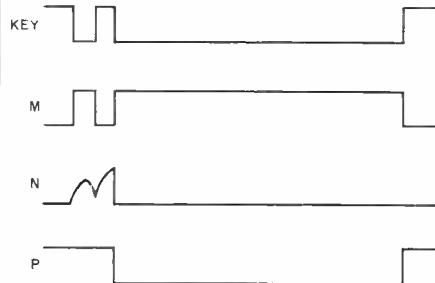

Fig. 2. Waveforms show how bouncing key can produce a clean single output.

The UJT will reset only after all the keys are released, and the output of IC6B returns to zero. If a second key is closed within a few milliseconds (while the first key is still bouncing), an erroneous output can be produced.

The keyboard can be battery powered if the CMOS devices are used. If you are going to drive TTL logic with this adaptor, change the IC's to their TTL counterparts (see Parts List), change the values of R4 through R19 to 1000 ohms, and add a 100-ohm resistor in the cathode of Q1. The Data Ready signal is then available as shown in Fig. 1. \diamond

**THE VOICE OF EXPERIENCE
COMES TO CB.**

MOTOROLA®

1930

Motorola® puts sound on wheels with the introduction of the first commercial car radio.

1942

Motorola engineers create the hand-held Walkie-Talkie—the first miniaturized AM transceiver small enough to be cradled in a hand.

1950

Motorola is clearly the leader in professional communications as police, fire departments, taxis, and industry put the tool of 2-way radio to work.

1971

Motorola puts the first FM receiver on wheels on the moon.

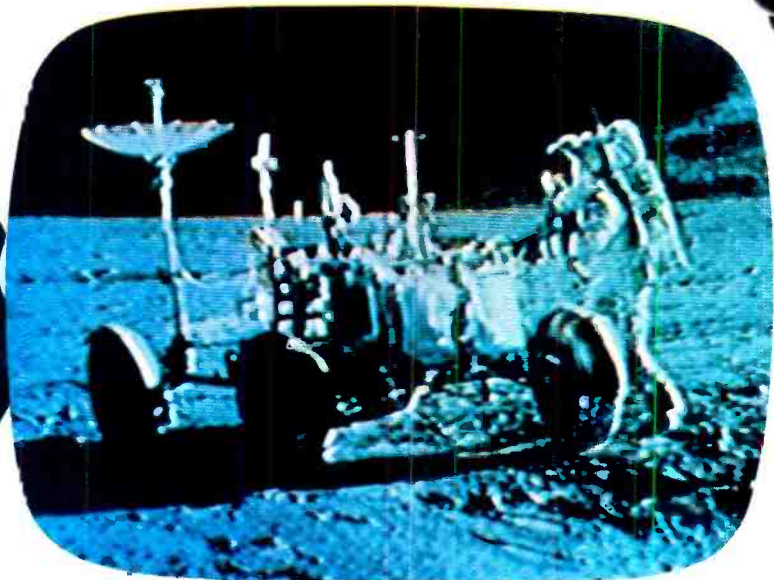

1977

Motorola introduces the 40-channel CB radio that only 40 years of experience could produce.



The Motorola Series 4000 CB radio: a look under the hood.

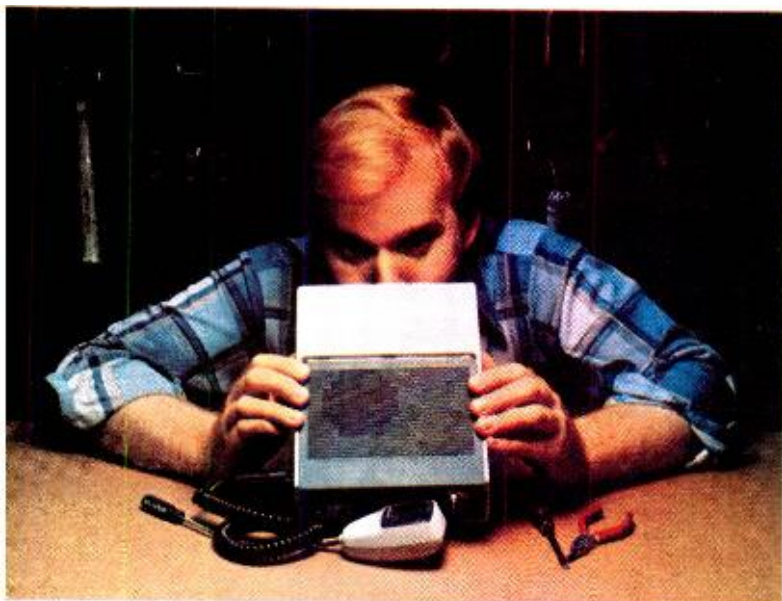

Don't be deceived by the simple, uncluttered styling of the Motorola CB radio.

Tucked under that hood are many built-in, fully automatic circuits that result in truly superior talk/listen performance—instead of unnecessary dials and switches.

Our microphone **1**, for instance. A built-in pre-amp makes it a power mic. But you don't need batteries. And it doesn't cost an extra 50 bucks.

What you do get is full legal modulation, at a very low level of distortion. Which means people *will* hear you, sounding like you, not some relative of Donald Duck's.

Built-in audio compression and a high level splatter filter **2** improve audio fidelity, maximize "talk" power—while making sure all your signal stays on channel.

And a highly effective TV interference filter **3** will help keep peace in the neighborhood should you operate as a base station (see Accessories, pg. 6).

On the listening side, the Motorola CB boasts a professional-quality 3½-inch top-fire speaker **4**. Top-fire directs the sound up at you (or rebounds it to you). Bottom-fire sends it down into the sound-absorbing carpet.

Automatic Gain Control **5** (built-in, naturally) protects you from being "blasted" or blocked by a signal that's too strong, too close. Yet it boosts weak, distant signals.

Automatic Noise Limiting **6** on a Motorola CB is truly automatic—limiting only when necessary and only the noise, not the signal.

Every Motorola CB utilizes a sophisticated digital phase lock loop synthesizer **7** for on-frequency transmissions without the need for features like delta tuning.

Selected models offer an L.E.D. channel readout display **8** that can be read at a glance.

Two models (the 4005 & 4020) give you the additional advantage of an Extender[®] **9**, a super-sensitive noise blanker that "extends" your range in weak signal/high noise areas.

All Motorola CB models are completely solid state. All offer an external speaker jack **10**, squelch control **11**, PA switch **12**, and S/Rf meter **13**.

All provide burn-out protection for your radio in the event the radio is operated with a damaged antenna. Your radio is protected, too, if the set is accidentally wired back-

wards during installation.

But for all the state-of-the-art technology that goes into our radio, it's really performance that counts.

We believe the Motorola CB will outperform any of its competitors. Put one under your dash and you'll believe, too.

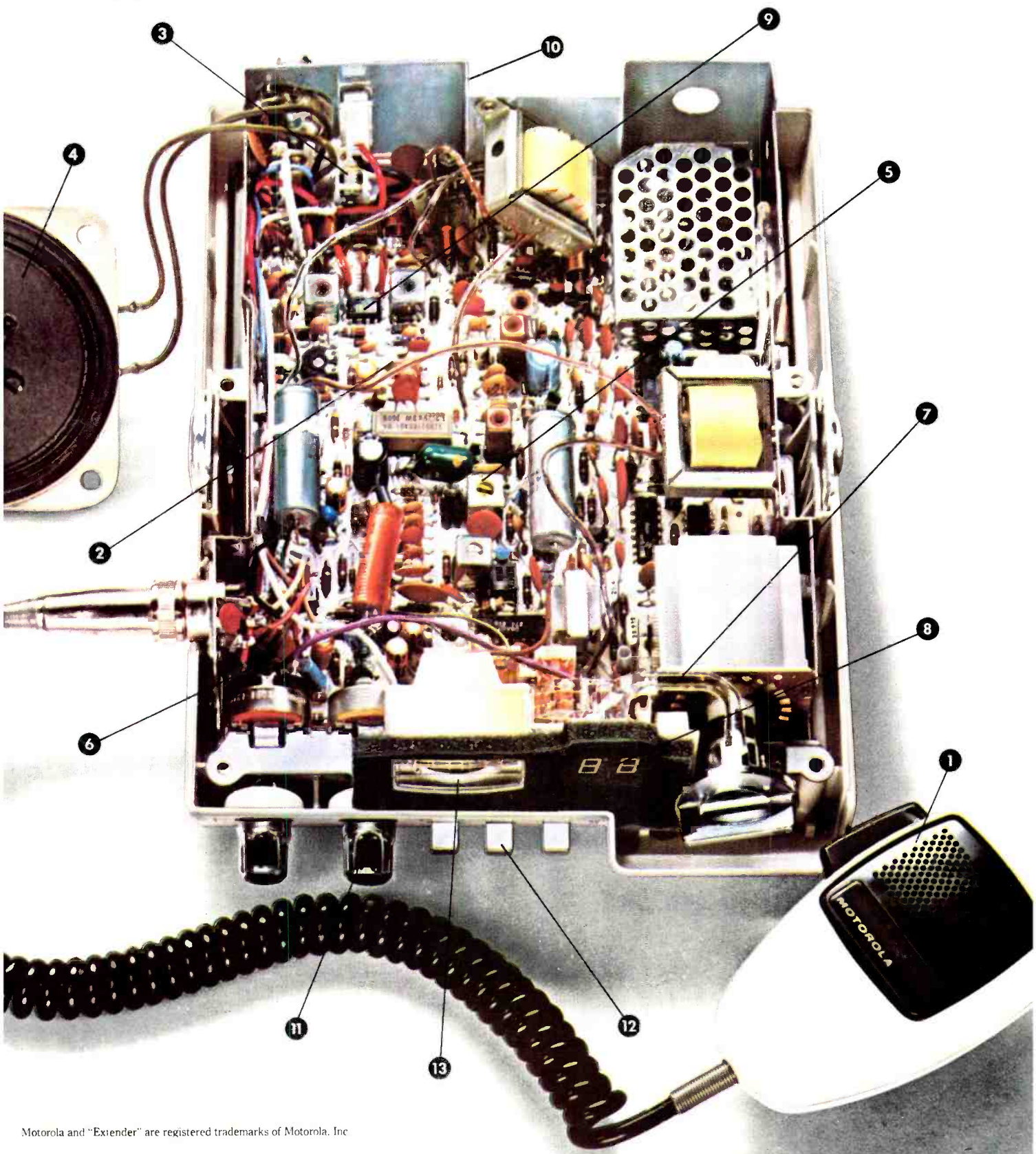

Motorola and "Extender" are registered trademarks of Motorola, Inc

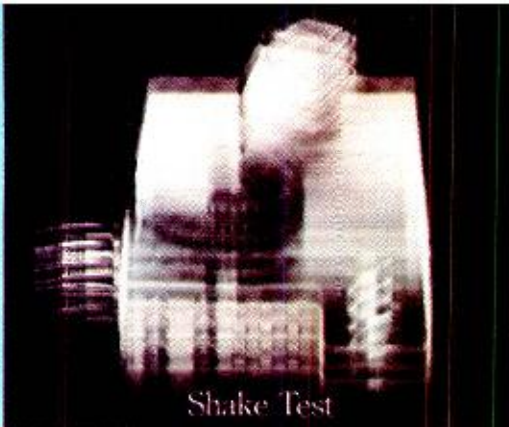

A Motorola CB isn't just tested. It survives.

Each Motorola CB is 100% tested and inspected at each step in the manufacturing process.

We even station Motorola inspectors at suppliers' plants to inspect parts before they're shipped.

This kind of attention to quality control has made Motorola 2-way radios the standard of dependability in professional communications.

So we make sure our CB radios will live up to their reputation by making them live through the same tests our professional radios survive.

Motorola Service.

Should a Motorola CB ever require service, there's a national network of highly qualified technicians ready to handle your problem.

Motorola service center personnel are experienced and knowledgeable (many handle our Automotive Sound Products as well).

What's more, Motorola CB radios are made in America and all parts are stocked here in America.

Motorola Accessories.

Motorola CB antennas combine truly superior efficiency with heavy-duty construction for the best possible performance from your radio (whether it's a Motorola or not).

Each comes pre-tuned, packaged with all the necessary cable, hardware, and mounting instructions. You just mount, plug in, and enjoy.

A base station converter turns any Motorola Series 4000 CB into a home or office unit. A stand-up mic is also available. A Motorola external speaker gives your CB a Public Address capability. A variety of Motorola accessories is also available at most dealers that handle Motorola CB radios.

Motorola CB

From the voice of experience in 2-way radio.

Sale or lease of Motorola 40-channel CB radios is subject to FCC type acceptance. To find the dealer nearest you, write: Customer Relations Manager, Motorola, Inc., Automotive Products Division, 333 Northwest Ave., Northlake, Illinois 60164.



Build a Low-Distortion Low-Cost Audio Generator

Generates sine waves with less than
0.02% distortion, or acts as a gyrator.

BY DAVID R. LANG

MOST function generators use operational amplifiers to generate the basic square and triangle waveforms. The sine waveform is not generated directly; instead, a passive or active shaping network is generally used to "soften up" the triangle wave to produce an approximation of the sine wave, which means that the distortion level leaves much to be desired.

The least expensive way to generate precision sine waves, at only 0.02% distortion, is to use a "gyrator." Using the gyrator, only a single potentiometer is required to cover a 15:1 frequency range. A pair of switch-selectable capacitors can then be used to establish the desired frequency range.

In addition to serving as a precision low-distortion oscillator, the gyrator circuit can also be used as a high-quality variable inductance and as a narrow-band audio pass/reject filter. The schematic is shown on the following page.

About the Circuit. As shown in the schematic diagram, the generator's circuit is arranged as a gyrator, one side of which is referenced to the common or ground point of the split power supply. Operation of the circuit is best understood by observing that *IC3* has a gain of $1/(R4C1\omega)$ and that *IC3* is followed by a current generator made up of *Q1* and *Q2*, which has a transfer function of $1/Rk$. Integrated circuit *IC1* is used as a voltage follower whose gain is unity and input impedance is very high. Integrated circuit *IC2* is operated as a unity-gain in-

verter, where *R1* and *R2* have similar resistance values.

An input voltage, *E1*, to *IC1* generates a current specified by the formula $I1 = 1/(R4RkC1\omega)$, which can be written as $E1/L = I1$, since dimensionally $L = R^2C$. The statement $1/Rk$ is simply the ratio of the input voltage (from *IC3*) to the total collector current changes referenced to the common point of the power supply. Ignoring the input resistance to the transistors and assuming $\alpha = 1.00$, $Rk = [R7(R6+R5)]/2R5$ and $L = R4RkC1$.

When the circuit is operated as an oscillator, *C2* performs as a low-pass parallel-resonant LC network that is driven by *IC5* through *R11*, where the feedback level is determined by the setting of *R9*. Switch *S1* is used to disconnect *IC5* from the inductance to disable the oscillator when only an inductance or an LC network is desired. The inductance is linear as long as the peak-to-peak voltage at the junction of the collectors of *Q1* and *Q2* does not exceed about 6 volts for the 18-volt supply illustrated.

With *S2* open, *IC5* serves as a comparator that clips the sine wave to produce a square-wave output from the system. Potentiometer *R3* is used to adjust the square wave's duty cycle.

Construction. The circuit can be assembled on perforated board with sockets for the IC's and transistors or on a printed circuit board of your own design. Be sure to note that the pin designation numbers for the IC's in the schematic diagram are for an eight-pin DIP device.

You can use any other package style of 741 op amp, but be sure to observe proper pin designations.

For best temperature stability, all fixed resistors should be of metal-film or wire-wound construction, and polystyrene, mica, or Mylar capacitors should be used for *C1*, *C2*, and any other range-determining capacitors. For *Q1* and *Q2*, any reasonable low-leakage, high-gain silicon transistors can be used.

Complementary sine-wave outputs are available from *IC1* and *IC2*, since the 741 op amp is not designed to deliver substantial output power, a buffer should be used if a load impedance of less than 1000 ohms is anticipated.

Range capacitors *C1* and *C2* should be mounted on a multi-position two-deck rotary switch (*S4*), along with any other range capacitors you might decide to use. RANGE switch *S4*, POWER switch *S3*, FEEDBACK control *R9*, FREQUENCY control *R4B*, L/OSC switch *S1*, SINE/SQUARE switch *S2*, and output binding posts *BP1* through *BP4* should all mount on the front panel of the box in which the circuit is to be housed. Mount a piece of heavy white paper or stiff cardboard behind the hex nut that holds *R4B* in place; it will become a scale for the FREQUENCY control. Slip over the shaft of this control a knob with a pointer. Then label all controls and switch positions according to function and/or range.

Setting It Up. For best results, a frequency counter should be used to set trimmer potentiometer *R4A* to provide

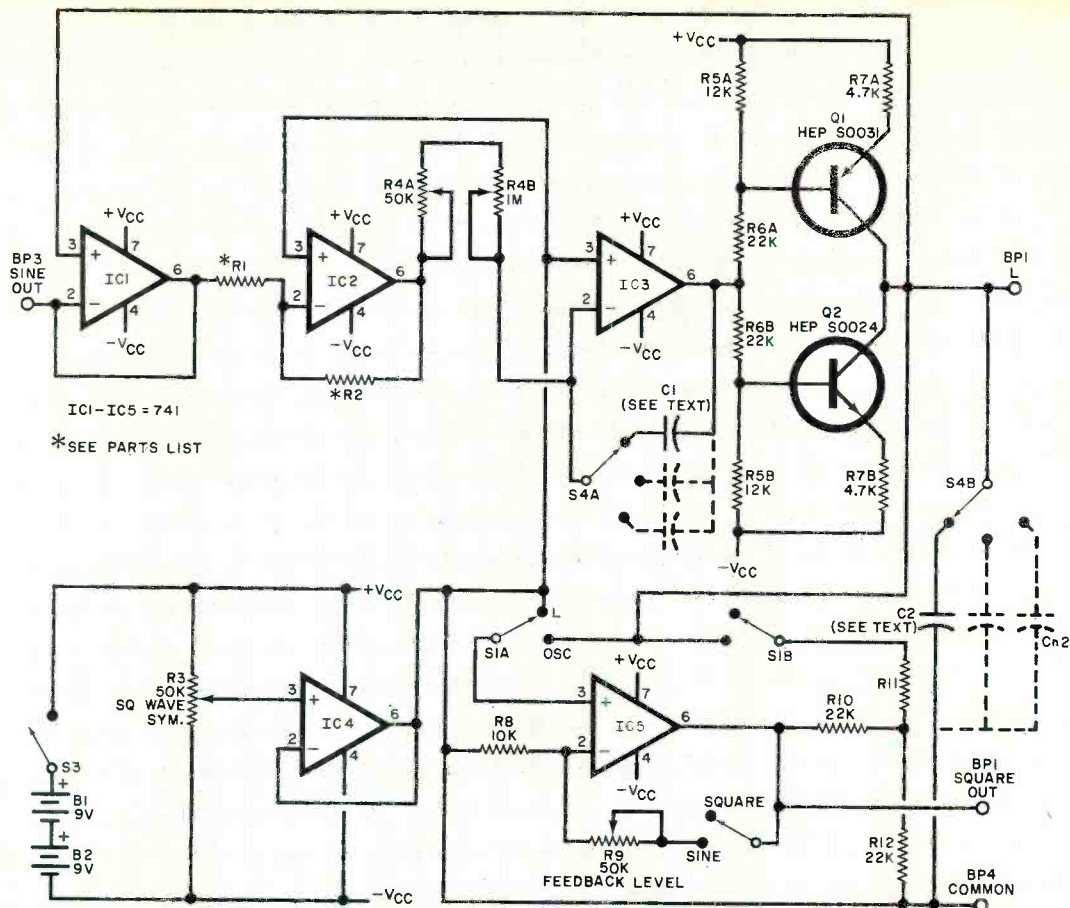

Sine-wave generator also serves as a-f filter or simulates inductor from 1 to 1000 H.

PARTS LIST

B1, B2—9-volt battery
 BP1 through BP4—Four-way binding post
 C1, C2—0.15- μ F Mylar capacitor (for 13-to-130-Hz range); 0.015- μ F capacitor (for 130-to-1300-Hz range); 0.0015- μ F capacitor (for 1300-to-13,000-Hz range)
 IC1 through IC5—741 operational amplifier
 Q1—HEP S0031 (Motorola) or similar pnp silicon transistor
 Q2—HEP S0024 (Motorola) or similar npn silicon transistor
 R1, R2—6800-to-8200-ohm, 1% tolerance film resistor (value not critical)

R3, R4A—50,000-ohm trimmer potentiometer
 R5A, R5B—12,000-ohm, 1% tolerance film resistor
 R6A, R6B—22,000-ohm, 1% tolerance film resistor
 R7A, R7B—4700-ohm, 1% tolerance film resistor
 R8—10,000-ohm, 5% tolerance resistor
 R9—50,000-ohm potentiometer
 R10, R12—22,000-ohm, 5% tolerance resistor
 R11—470,000-to-600,000-ohm film resistor

(Stability more important than absolute value)
 S1—Dpdt switch
 S2, S3—Spst switch
 S4—Two-pole, three-position nonshorting rotary switch.
 Misc.—Battery connectors (2); suitable case; perforated board (or pc board); IC sockets (5); transistor sockets (2); control knobs (two round one pointer type); heavy white paper or cardboard; dry-transfer lettering kit; machine hardware; hookup wire; solder; etc.

an exact 10:1 frequency spread over $R4B$'s range, which corresponds to an inductance range of 100:1 ($R4A = R4B/99$). Starting at the highest frequency, where the scale is compressed, use the frequency counter to establish convenient frequency intervals on the FREQUENCY control's dial. A different color ink can be used to label the inductance values in accordance with the relationship $L = 1/\omega^2 C$. With the component values specified, the inductance range is from 1 to 1000 H.

When $R4B$ is a 1-megohm potentiometer, the values of 0.0015, 0.015, and 0.15 μ F for the $C1$ and $C2$ components provide ranges of 1300 to 13,000 Hz,

130 to 1300 Hz, and 13 to 130 Hz, respectively. If these sets of capacitors are accurately related by powers of 10, switching between ranges should yield frequencies within a few percentage points of the expected values. The frequencies at the scale endpoints can be changed for all ranges simultaneously by trimming the value of $R2$.

FEEDBACK control $R9$ should be set to just beyond the point where oscillation begins, at the lowest-frequency setting. The oscillations will rapidly increase in amplitude until $IC5$ goes into clipping, establishing an operating point. The value of resistor $R11$ must be large to suppress harmonic distortion by minimizing

the parallel resistive shunt across $L/C2$, thereby increasing its Q . When the circuit is operating properly, the dc potential at $BP1$ is within a few millivolts of COMMON binding post $BP4$, and the current demand on the power supply will be approximately 8 mA.

The least distortion occurs when the FEEDBACK control is adjusted to the point where it just barely sustains oscillation. If $R9$ were a fixed value to enable operation on all ranges and at all frequencies, the maximum distortion would be about 0.1%. Stray capacitance limits the oscillations to about 40,000 Hz if $R4A$ is unchanged from its low-frequency value. \diamond

MULTIMETERS FOR ELECTRONICS

PART 1

BY CLAYTON J. HALLMARK

Focus on traditional VOM's and analog-type electronic multimeters.

THE MULTIMETER, the workhorse of electronics servicing and experimenting, is usually the first instrument you reach for and the last you put away. What makes this instrument so popular is its versatility in performing tests and making measurements of a number of different electrical parameters. Needless to say, there is a wide variety of multimeters on the market, ranging from the traditional VOM to sophisticated digital instruments. Selecting a multimeter, therefore, requires a basic understanding of what each instrument can and cannot do. Even more important, you must understand how to use the instruments to obtain the maximum benefit from them.

Examined here will be problems common to all electronic measurements, including some of the lesser known, but very important pitfalls to be avoided. We will also discuss the problems often encountered in making measurements in modern state-of-the-art circuits.

In this first part, we focus on the traditional VOM and analog-type electronic multimeters.

Technical Details. Multimeters can be classified into two general categories. In one category we have passive VOM's. All other types of multimeters—VTVM's, TMM's, and DMM's—are classified as electronic or active types. The big difference between the two

categories is that passive instruments must extract current from the circuit under test to deflect the meter movement, while electronic instruments have their own power supplies to drive the display.

In extracting current from a circuit, a VOM can upset circuit conditions. This "loading" effect on the circuit can cause inaccurate measurements. How much the conditions are upset depends on the resistance between the meter's test leads. The circuit shown in Fig. 1 demonstrates the effects of meter loading. Without the meter connected across R_2 , total circuit resistance is 200,000 ohms, divided equally between the two resistors. The actual voltage drop across each resistor is 30 volts without the meter connected to the circuit. When it is connected as shown, the meter's 100,000-ohm resistance is in parallel with the 100,000-ohm value of R_2 , which yields a net resistance of 50,000 ohms for the parallel combination and a total circuit resistance of 150,000 ohms. Because of the meter's loading on the

circuit, the measured voltage across R_2 will be 20 volts, a 33.3% inaccuracy.

With all conditions remaining the same in the Fig. 1 circuit, using a meter with an 11-megohm input resistance, the parallel resistance of R_2 and R_m would for all practical purposes be 100,000 ohms. Hence, the voltage dropped across R_2 , with minimal meter loading, would register roughly 30 volts.

The resistance of a VOM depends on the full-scale voltage. Hence, the meter's sensitivity is specified in ohms/volt. To determine resistance, the meter's sensitivity is multiplied by the full-scale voltage. This means that the resistance of a 1000 ohms/volt meter on the 100-volt range is 100,000 ohms, while for a standard 20,000 ohms/volt meter on the 100-volt range, the resistance would be 2 megohms. For a high-resistance circuit like that in Fig. 1, a 20,000 ohms/volt meter would be acceptable, but a 1000 ohms/volt meter would be unacceptable. (The ohms/volt rating is generally specified for the dc function only. The sensitivity on the ac function is typically only 20% to 50% of the dc sensitivity, or 5000 ohms/volt versus 20,000 ohms/volt.)

Loading can occur in low-voltage as well as high-resistance circuits. The resistance of a 20,000 ohms/volt meter is only 10,000 ohms on the 0.5-volt range. For service measurements, the meter's resistance should exceed 10 times the

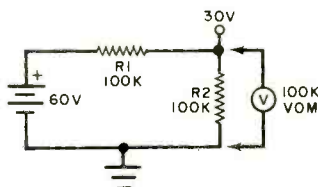

Fig. 1. The VOM here loads down the circuit, causing 33.3% inaccuracy.

source impedance of the voltage to be measured to avoid excessive errors. This means that a 20,000 ohms/volt meter would be unsuitable for measuring 0.4 volt if the source impedance is more than 1000 ohms, but a 100,000 ohms/volt meter could measure a 0.4-volt potential across impedances up to 5000 ohms. Circuits with both low voltages and high impedances place critical demands on the meter.

For very accurate measurements, the resistance of the meter should exceed 25 times the source impedance. The loading error will then be maintained at less than 2%, which would be in the range of the meter's accuracy.

The inherent accuracy of meters is commonly expressed as a percentage of the full-scale reading. A reading on the 250-volt range of a 3% meter could be off by as much as 7.5 volts (250 volts \times 0.03 = 7.5 volts). A 200-volt reading could indicate anywhere between 192.5 and 207.5 volts.

On the ac ranges, the accuracy might vary with frequency and range. For example, the rated accuracy of a good VOM might apply up to 100,000 Hz on all ranges up to 50 volts but only to 20,000 Hz on the 250-volt range.

Fig. 2. Reading of 10 volts may indicate 9.7 to 10.3, 8.5 to 11.5, or 2.5 to 17.5 volts depending on the range setting.

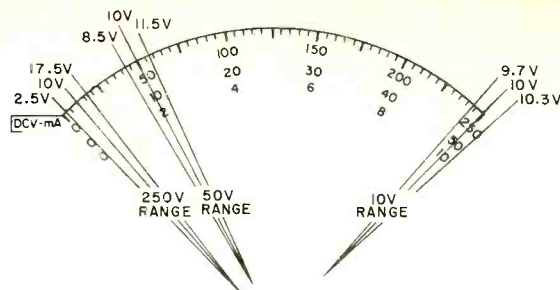

In taking a voltage or current measurement, always start out on a higher range than necessary to protect the meter from possibly damaging overloads. For best accuracy, however, take your final reading on the lowest usable range so that the meter's pointer indicates in the upper portion of the scale where it is most accurate. As Fig. 2 demonstrates, a reading of 10 volts on a 3% meter can be between 9.7 and 10.3 volts on the 10-volt range, between 8.5 and 11.5 volts on the 50-volt range, and between 2.5 and 17.5 volts on the 250-volt range. In the last case, the inaccuracy is so great that the reading would be meaningless.

Worst-case accuracy occurs when the voltage to be measured just exceeds full-scale on one range so that the next higher range must be used. For a 3%

meter with ranges of 3, 12, 60 volts, etc., the worst-case accuracy is $\pm 15\%$, obtained when measuring just over 12 volts on the 60-volt range. Using a 3% meter with 1.5-, 5-, 15-volt, etc., ranges provides an improvement in the worst-case accuracy of $\pm 9\%$. Needless to say, the scaling sequence can have an important effect on accuracy.

An Old Favorite. The VOM, or volt-ohm-milliammeter, was probably the first instrument most of us learned to use and the first one we bought. In many cases, we still reach for it when we must measure a voltage, current, or resistance. The VOM is extremely versatile, capable of measuring just about any ac or dc parameter that can be related to Ohm's law. And it is rugged and



Sencore's FF27 "Big Henry" is a field-effect multimeter with P-P and RMS ac scales.

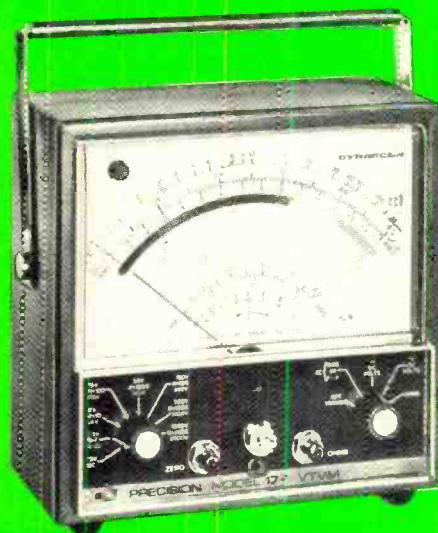

B&K Precision's Model 177 vacuum-tube voltmeter has a large 7" mirrored meter and a special 0.5-V dc scale.



High-voltage multiplier probe made by B&K Precision.

also battery powered. Add to this its operating ease and low cost, and it is no wonder that the VOM has retained its high popularity.

A typical VOM has 0.25- and 1.0-volt full-scale ranges in both the ac and dc functions; dc current ranges as low as 50 μ A to as high as 500 mA full-scale; and resistance ranges of up to 30 megohms. The decibel ranges cover from -20 to +50 dB, with 0 dB specified as 1 mW into 600 ohms.

Most VOM's are rated at 20,000 ohms/volt and will range between \$25 and \$125. There are still some VOM's around with a 1000-ohm/volt sensitivity, but these are of very limited usefulness for electronics measurements. Sensitive VOM's with ratings of 100,000 ohms or even 1 megohm/volt are also available for between \$65 and \$250.

The accuracy of the typical VOM is within 2% of full-scale on the dc ranges, 3% on the ac ranges, and 2% to 3% of scale length on the resistance ranges.

All VOM's come with separate red and black test leads. The black lead is inserted into the common, or reference, jack on the meter (marked COM, NEG, or -). The red lead goes into the "hot" jack (marked ν , Ω , MA, or +). For the very

highest and lowest voltage ranges and current ranges, the red lead is inserted into an extra positive jack that is appropriately labelled.

Most VOM's are similar in the way they operate. A polarity-reversing switch, usually labelled +DC/-DC provides a convenient means of transposing test lead polarity on dc and resistance measurements. For normal operation, this switch is set to the +DC position. Then, using the black test lead as the reference, positive-polarity signals produce an up-scale deflection. Conversely, negative signals are accommodated without transposing test probes simply by switching to -DC.

The uppermost scale on a typical VOM unit is for resistance and is usually color coded in black. If the RANGE switch is set to any position other than $R \times 1$, the reading obtained must be multiplied by the resistance multiplier indicated by the switch setting. For resistance, the scale is inverse and nonlinear. The most accurate measurements are obtained when the pointer is in the lower one-third to one-half of the scale, where the calibrations have the widest separation. All other VOM scales are most accurate at their high ends.

Second from the top is often the dc scale, which is usually coded black. This scale has several sets of numbers at the major calibration marks, with each set applying to one or more settings of the RANGE switch. For the Simpson Model 160, for example, the numbers from 0 to 50 apply to range/function settings of 50 μ A, 50 volts, 500 volts, and 500 mA. (On the 500-volt and 500-mA ranges, the indication provided by the meter's pointer must be multiplied by 10.)

There are usually two ac scales, both marked in red. The same scale numbers used for the dc scale are used for the upper red ac scale, while the bottom red scale, used for low ac voltage measurements, has its own numbers. Below this is the decibel (dB) scale.

Using the VOM is very simple. You just insert the test leads into their appropriate jacks, switch to the proper range and function, connect the leads to the circuit under test, and observe the position of the pointer on the scales. Note that for voltage measurements, the test probes are connected in parallel with the circuit or element under test. For current measurements, the circuit must be broken to allow the meter to be connected in series with it.

Tripplett's Model 603 solid-state VOM has switchable isolation resistor in probe for dc and low-power-ohms function.

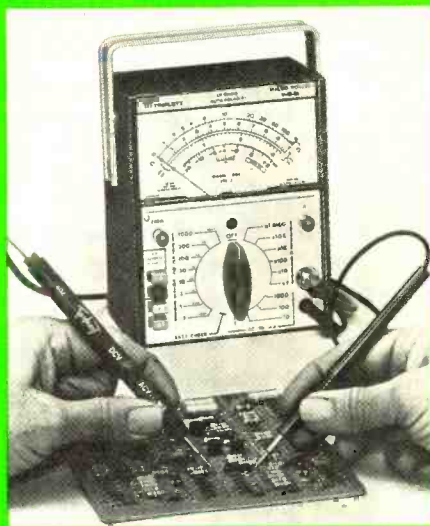

Hickok's pushbutton-operated Model 370 has automatic polarity indicator and anti-parallax mirror-backed scale with automatic polarity indicator and FET input.

The Leader Model LEM-75, a transistor multimeter, has a temperature scale that is used with an accessory probe.



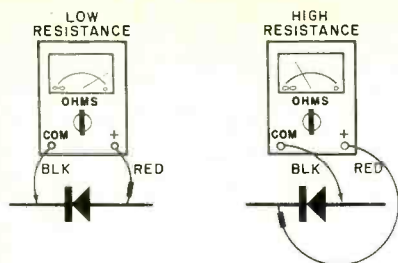

Fig. 3. In checking a diode, resistance in one direction should be 100 times more than in the other direction.

Ohmmeter Use. Resistance measurements are only a little less simple to perform than voltage measurements with a VOM. Always bear in mind that the ohmmeter must *never* be connected to a powered circuit or it will be damaged. Make sure all power is shut off and that all electrolytic capacitors, if any, are discharged.

Since the ohmmeter incorporates a battery to supply current to the measurement circuit, it is necessary to correct for battery and other circuit changes. You do this by setting the selector switch to the desired range, shorting together the test probes, and operating the ZERO ADJUST control until the meter pointer is resting exactly at 0 on the scale. If the meter cannot be zeroed, the battery must be replaced. Repeat this procedure whenever you change ranges.

The ohmmeter can also be used to check the condition of diodes out-of-circuit, as shown in Fig. 3. You simply measure the diode's resistance in one direction, reverse the test leads (or flip the polarity-reversing switch) to measure its resistance in the other direction, and compare your readings. For a good diode, the readings should differ by 100 or more times. If the resistance is zero in both directions, the diode is shorted; if it is infinity in both directions, the diode is open.

Though it is not usually recommended as a safe procedure, transistor junctions can also be tested with an ohmmeter—if certain precautions are exercised. Always bear in mind that some ohmmeters and some ranges on all ohmmeters can damage low-voltage semiconductors and electrolytic capacitors. In testing semiconductors, use the $R \times 100$ range of the ohmmeter. Avoid using the highest and lowest ranges because they can supply excessive voltage and excessive current, respectively, to the device under test.

The resistance of nonlinear components, such as diodes, will measure different values on different ranges. For

example, a diode could measure 80 ohms on the $R \times 1$ range and 300 ohms on the $R \times 100$ range. This is normal and is the result of the diode characteristic.

In-circuit resistance measurements can be misleading as well as damaging, as follows. Assume that in the Fig. 4 circuit you took a measurement across R_B with the positive test probe touching ground. Since R_E is also connected to ground, the voltage applied by the ohmmeter would forward bias the emitter-base junction of the transistor. In effect, R_E would be in parallel with R_B . One way around this problem would be to disconnect one end of R_B from the circuit for the test. Another way would be to use an ohmmeter with a low-power-ohms circuit. Such an instrument applies a voltage that is too low to bias on or damage a junction. The Simpson low-power-ohms probe adds this feature to any VOM with a 250-mV (50- μ A) jack and a 12-ohm center-scale meter. An open-circuit voltage of only 30 mV or less is applied to the circuit under test.

Ac Problems. Another problem with VOM's concerns ac measurements. In a VOM, the ac voltage is rectified to provide a pulsating dc voltage that can be measured by a dc-only meter movement. Unfortunately, the VOM responds to, or measures, the average value of the ac voltage rather than the rms value in which we are more interested. Since the ratio of the rms value to the average value of a sine wave (its form factor) is known to be a constant 1.11 (Fig. 5), meter manufacturers skirt the problem by calibrating their meter scales to give the rms value of a sine wave. This means, for example, that if 100 volts is applied, the meter's pointer actually registers 53.7 volts but is registering 70.7 volts on the doctored scale. For waveforms other than the sine wave, only an approximate rms value is obtained.

Electronic Multimeters. The next step up from the VOM in sophistication, price, and performance is the electronic multimeter. Instruments in this category represent a marriage of a solid-state amplifier in the TMM or a vacuum-tube amplifier in the VTVM to a basic electrical metering circuit.

Using built-in amplification results in a sensitive instrument that is capable of measuring ac and dc voltages and resistance over a much wider range than is possible with a VOM. It also results in a much higher input resistance, typically a constant 10 megohms, and a much higher frequency limit. This makes the

electronic multimeter useful in high-impedance, low-voltage circuits and r-f circuits in which a VOM would be highly inaccurate. (In circuits within the frequency and impedance limits of the VOM, however, the passive multimeter's accuracy is similar to that of most electronic multimeters.)

The electronic multimeter category includes service-type VTVM's that cost between about \$65 and \$120 and TMM's that range in price from about \$65 to \$240. (This category also includes the digital multimeter, or DMM, which we will discuss in Part 2.)

A typical modern VTVM with an extra-long meter scale that provides maximum readability and accuracy is the Triplett Model 850. This VTVM can measure dc voltages and ac rms voltages up to 1500 volts in ranges that are similar to those of a sensitive VOM. In addition, it measures resistances to 1000 megohms and peak-to-peak voltages. VTVM's do not measure current.

As is the case with other electronic multimeters, the Triplett VTVM employs an isolation probe that is connected to the input via a coaxial cable. A coaxial cable is required because the high input impedance makes the instrument susceptible to stray-field effects, especially on the low-voltage ranges. The isolation probe has a 1-megohm resistor that is placed in series with the input on the dc voltage ranges by operating a slide switch. This resistor minimizes the effective input capacitance of the coaxial cable and permits dc measurements in oscillator and r-f tuned circuits without disturbing circuit conditions. Other probes can be used to extend the frequency range of the VTVM to 250 MHz and the voltage range to 30,000 volts such as B&K Precision's shown here.

The solid-state revolution created some new measurement problems. Fortunately, it also provided the solution by making possible the versatile transistor multimeter, or TMM. This instrument has

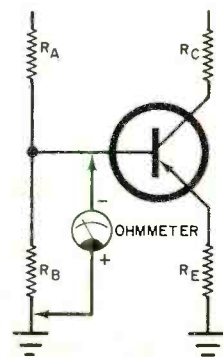

Fig. 4. This setup may cause wrong reading for base resistor.

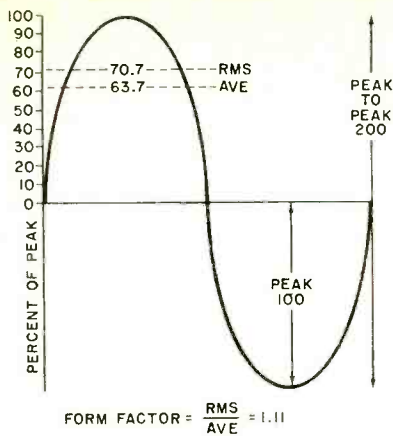

Fig. 5. The various ac values that can be measured by a meter.

the sensitivity of a VTVM, plus the advantages of solid-state design: instantaneous operation with no warmup; no heat generation and, hence, less aging and better accuracy in the long run; and cordless operation. Also, the TMM measures current. FET's ensure high input impedance.

An example of the TMM is Leader's versatile Model LEM-75. It offers a stable accuracy of 3% to 4% for almost any electronics application. The instrument features dc and ac rms voltage ranges of from 0.3 to 1000 volts full-scale; dc and ac current ranges from 30 μ A to 300 mA full-scale; and resistance ranges from 0.5 ohm to 500 megohms full-scale. There is even a temperature scale, for use with an optional thermistor probe. The minimum sensitivities of 10 mV and 1 μ A on both ac and dc make it possible to check the tiny bias and signal levels in the most advanced solid-state circuits.

On most TMM's and VTVM's, a ZERO control is used to set the meter pointer to 0 on the scale with the input probes shorted together and the power turned on before measurements are made. It is advisable to check for zero indication whenever you change either range or function or both. Before making a resistance measurement, it is also necessary to adjust the OHMS control to set the meter's pointer at infinity, with the probes not touching each other.

The scales on VTVM's and TMM's are similar to those on VOM's with two notable exceptions. First, the electronic multimeter usually has a zero-center scale that is useful for aligning discriminator and other balanced circuits. Secondly, the resistance scale increases in the same direction as the other scales, not inversely as on VOM's.

Some disadvantages of electronic

multimeters, with respect to VOM's, are warm-up time and drift, higher battery drain, slightly more complicated operation, stray pickup, and grounding requirements. For many, however, the much lower loading effect of the electronic multimeter makes it a favored instrument.

Electronic multimeters are fitted with a ground lead that must be connected to the ground or lowest-potential point of the circuit under test. The ground lead must not be connected to a point at a potential in excess of that recommended by the manufacturer, which is typically 400 volts ac or 600 volts dc.

The ground lead is often internally connected to the power line ground. Accordingly, you must not touch the ground lead to a test point at power-line potential or the line fuse will blow. When making measurements on a line-powered circuit, check the circuit ground to determine if it is isolated from circuit ground. If it is not, orient the circuit ground so that it is at the same potential as line ground.

The Circuits. Electronic multimeters can be classified according to whether the amplifier or the rectifier comes first.

Fig. 6. Arrangement at (A) gives a sensitive, average-responding meter. (B), used in service-type DVM's, gives a peak-responding meter.

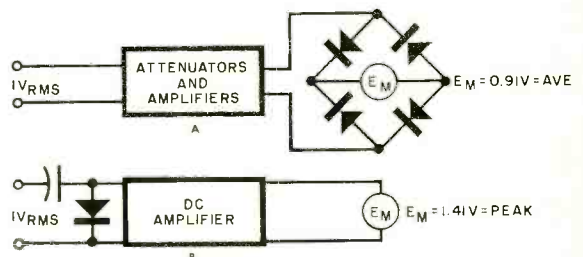

The amplifier-rectifier arrangement shown in Fig. 6A is used in very sensitive laboratory instruments that can measure potentials on the order of microvolts. As with the VOM, these are average-responding meters, calibrated to indicate rms values of sine waves. Since average-responding meters can give useful rms indications for waveforms with 10% or greater distortion, they are widely used as substitutes for expensive instruments that are true rms responding.

In the rectifier-amplifier, or peak-responding, circuit shown in Fig. 6B, a storage capacitor charges up through a diode to the peak value of the input voltage. The capacitor voltage is amplified by a dc amplifier to drive a meter movement. The high input impedance of the amplifier means that only a very small current is drawn from the circuit under test to keep the capacitor charged. The

input impedance has been pretty much standardized at 10 megohms—11 megohms with the probe resistor.

Without the diode and storage capacitor, the peak-responding meter serves as a dc voltmeter and, by adding shunts and an internal dc source, as a milliammeter and ohmmeter. Most VTVM's and TMM's use this principle.

One big advantage of the peak-responding meter is that the diode and capacitor can be placed in the probe so that the measured ac signal has to travel no farther than the probe. This reduces the loading caused by the capacitance of the test leads and input circuit.

With an r-f probe, available as an accessory item, the electronic multimeter can measure voltages at frequencies in the hundreds of megahertz range with tolerable loading. The input impedance decreases to between 50,000 and 100,000 ohms at 100 MHz. The error becomes especially serious for the higher voltages at high frequencies.

If the waveform measured by a peak-responding instrument is not symmetrical, a different reading will be obtained if the leads are reversed, thereby charging the capacitor to the alternate peak value. This turnover effect is eliminated in

some instruments by using a voltage doubler circuit that rectifies both alternations of the input signal voltage and gives a peak-to-peak response. The rms scales of these meters are accurate for sine waves, while the peak-to-peak scales are accurate for nonsinusoidal and complex waveforms. This permits accurate measurement of TV sweep and video waveforms, which are often specified in peak-to-peak voltages.

The zero-center scale on electronic multimeters is useful in solid-state servicing when it is not known whether the voltage being measured is positive or negative with respect to ground. Also, VTVM's and TMM's normally use a 1.5-volt cell in the ohmmeter section, which is relatively safe for semiconductor measurements.

Coming up. The major focus in Part 2 will be on digital multimeters. \diamond

The better the training the better you'll

Send for
FREE
illustrated
career
guide

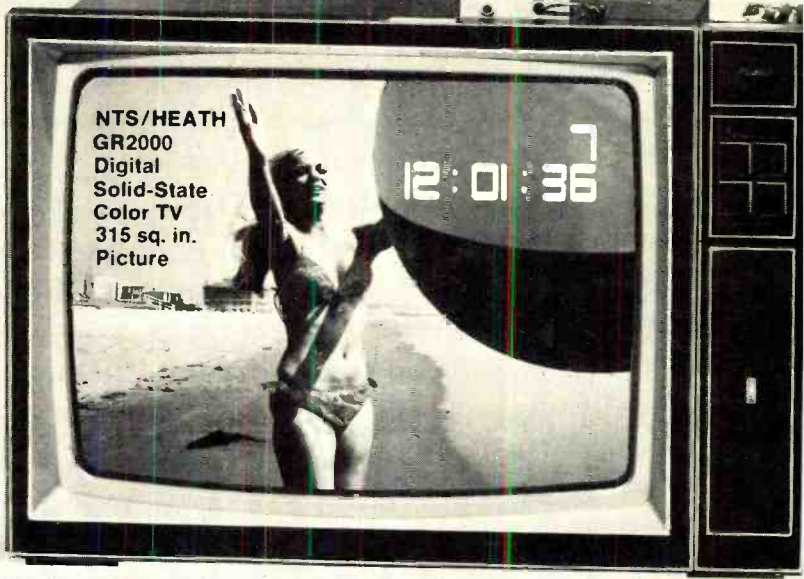
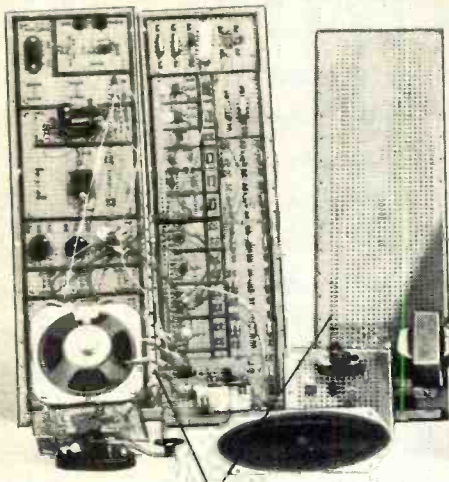
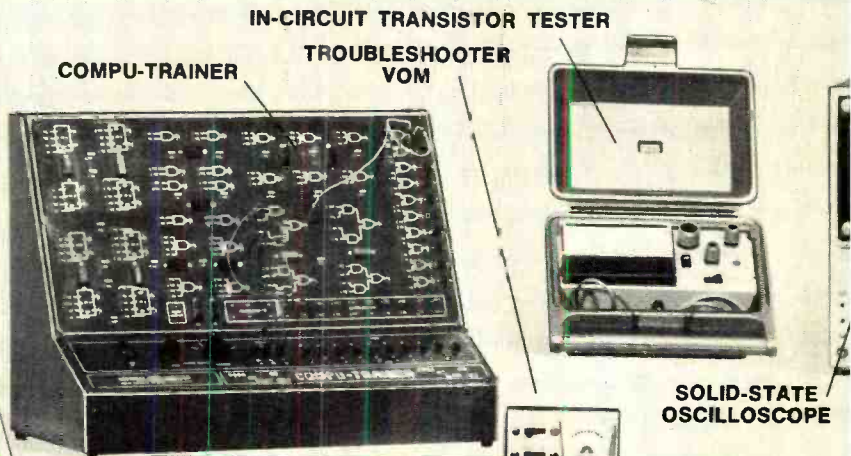
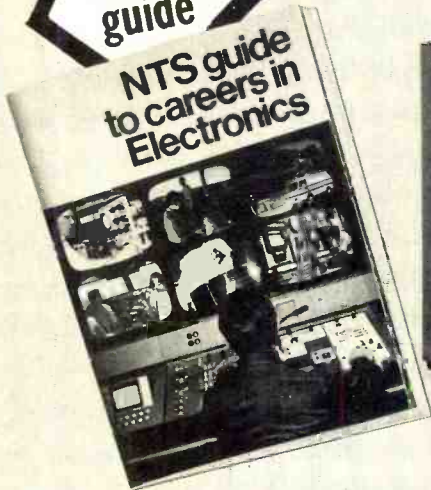

ELECTRO-LAB

(Simulated TV Reception)

As an NTS student you'll acquire the know-how that comes with first-hand training on NTS professional equipment. **Equipment you'll build and keep.** Our courses include equipment like the **NTS/Heath Digital GR-2000 Solid State color TV** with first-ever features like silent varactor diode tuning; digital channel selection, (with optional digital clock), and big 315 sq. in. ultra-rectangular screen.

Also pictured above are other units — 5" solid state oscilloscope, vector monitor scope, solid-state stereo AM-FM receiver with twin speakers, digital multimeter, and more. It's the kind of better equipment that gets you better equipped for the electronics industry.

This electronic gear is not only designed for training; it's field-type — like you'll meet on the job, or when you're making service calls. And with NTS easy-to-read, profusely illustrated lessons you learn the theory behind these tools of the trade.

Choose from 12 NTS courses covering a wide range of fields in electronics, each complete with equipment, lessons, and manuals to make your training more practical and interesting.

Compare our training; compare our lower tuition. We employ no salesmen, pay no commissions. You receive all home-study information by mail only. All Kits, lessons, and experiments are described in full color. Most liberal refund policy and cancella-

POPULAR ELECTRONICS

and the equipment be equipped.

COMPARE OUR
KITS AND LESSONS.
COMPARE OUR
TUITION.

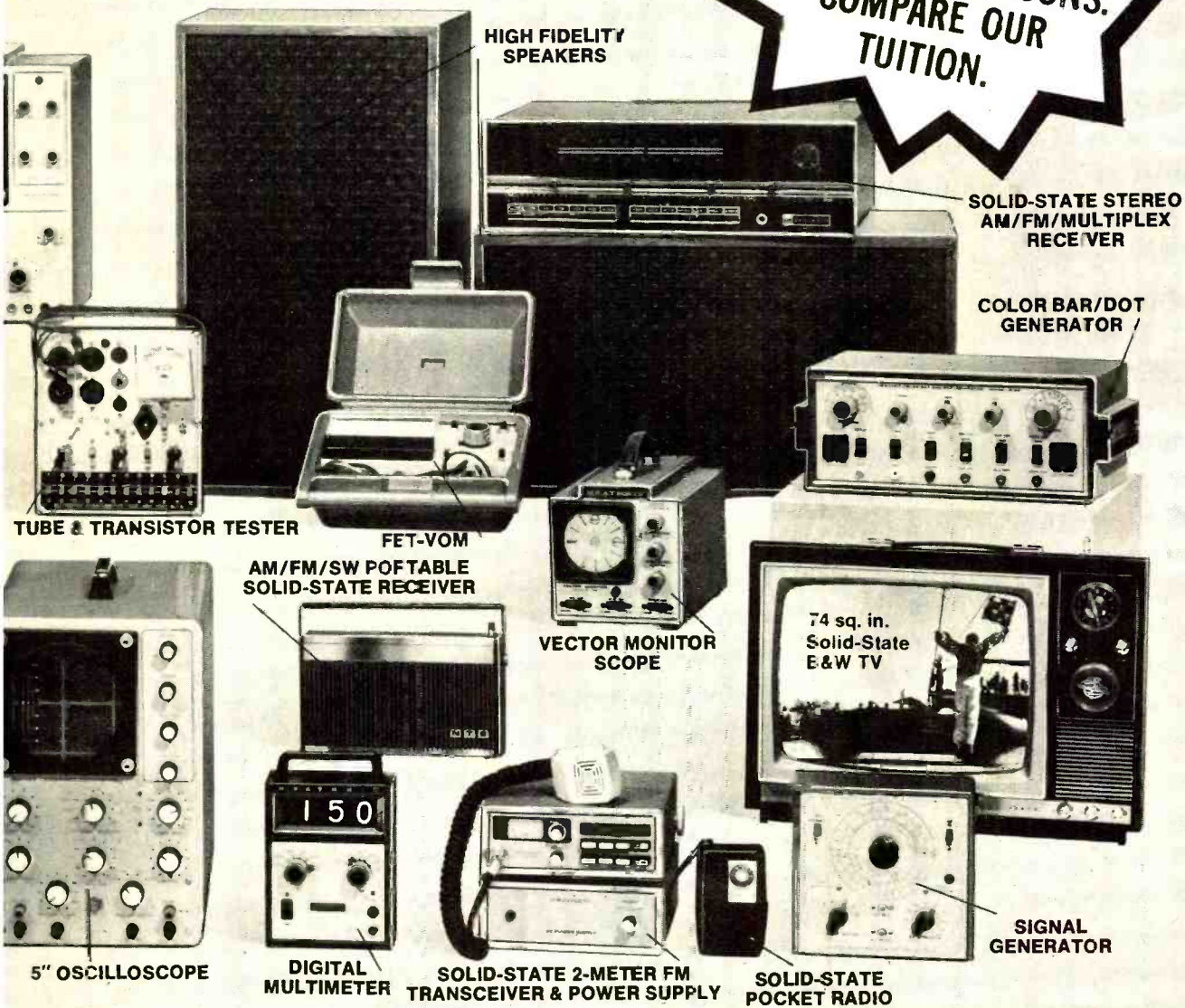

tion privileges spelled out. Make your own comparisons, your own decision. Mail card today, or clip coupon if card is missing.

NO OBLIGATION. NO SALESMAN WILL CALL

APPROVED FOR VETERAN TRAINING
Get facts on new 2-year extension

NATIONAL TECHNICAL SCHOOLS

TECHNICAL-TRADE TRAINING SINCE 1905
Resident and Home-Study Schools
4000 So. Figueroa St., Los Angeles, Calif. 90037

NATIONAL TECHNICAL SCHOOLS Dept. 205-017
4000 South Figueroa St., Los Angeles, Calif. 90037
Please send FREE Color Catalog and Sample Lesson.
NO OBLIGATION. NO SALESMAN WILL CALL.

Color TV Servicing Electronics Technology
 B & W TV and Radio Servicing Computer Electronics
 Electronic Communications Basic Electronics
 FCC License Course Audio Electronics Servicing

NAME _____ AGE _____
 ADDRESS _____ APT # _____
 CITY _____ STATE _____

Please fill in Zip Code for fast service _____
 Check if interested in G.I. Bill information.
 Check if interested ONLY in classroom training in Los Angeles.

FREE EICO CATALOG

358 Ways To Save On Instruments, Citizens Band, Burglar Alarms, Automotive & Hobby Electronics!

The more you know about electronics, the more you'll appreciate EICO. We have a wide range of products for you to choose from, each designed to provide you with the most pleasure and quality performance for your money. The fact that more than 3 million EICO products are in use attests to their quality and performance.

"Build-it-Yourself" and save up to 50% with our famous electronic kits.

For latest EICO Catalog and name of nearest EICO Distributor, check reader service card or send 50¢ for fast first class mail service.

**EICO—283 Malta Street,
Brooklyn, N.Y. 11207**

*Leadership in creative electronics
since 1945.*



ALL CLOCK CHIPS ARE NOT ALIKE

BY MICHAEL S. ROBBINS

NOT ALL digital clock chips are alike. But you would expect that those with the same part number from one manufacturer would all function in the same circuit. This is not the case with the popular line of PMOS clock IC's from *National Semiconductor*.

National introduced its MM5300 series of clock circuits in 1972 and has since expanded it to include six different numbers, all employing the same basic silicon chip. Each variation employs a different metalization pattern to bring out the required functions. The table details how the clock chips differ and lists the functions of each.

Looking over the table, everything looks simple enough, but watch out. You may find that replacing the chips in a three- or four-year-old clock with a chip that has a late 1975 or 1976 code date causes your clock to display only one

digit! National has made the new chips smaller, which affects how they operate. The new IC's will work in all of your favorite clock circuits if you change the values of the multiplex resistor. In many circuits employing the old chip, the resistor value was 100,000 ohms. If you change that to 220,000 or 330,000 ohms, the new chips will work as well as the older ones did. Also, if the multiplex rate is too slow with the new resistor, use a smaller-value capacitor with it. Cut the capacitance in half when using a 220,000-ohm resistor and by two-thirds when using a 330,000-ohm resistor.

This change should be made in all projects that have appeared in *POPULAR ELECTRONICS* and other magazines in the past, including the author's "A Digital Stopclock for Short & Long Event Timing," in the January 1976 issue of *POPULAR ELECTRONICS*. ◇

	MM5309	MM5311	MM5312	MM5313	MM5314	MM5315
4 OR 6 DIGITS	•	•		•	•	•
4 DIGITS ONLY			•			
1 pps OUTPUT			•	•		
12-HOUR FORMAT, LEADING-ZERO BLANKING	•	•	•	•	•	•
24-HOUR FORMAT	•	•	•	•	•	•
HOLD-COUNT CONTROL		•		•	•	•
RESET TO 00:00 OR 12:00:00	•					•
50- OR 60-Hz INPUT	•	•	•	•	•	•
BCD OUTPUT	•	•	•	•		•
7-SEGMENT OUTPUT	•	•	•	•	•	•
24-PIN PACKAGE			•		•	
28-PIN PACKAGE	•	•		•		•
OUTPUT-ENABLE CONTROL	•	•			•	

HANDY CIRCUIT for CHECKING PHONO PREAMPS and FM TUNERS

Low-Cost pre-emphasis network simplifies frequency response tests.

THIS circuit, (Fig. 1) makes it easy to perform frequency response tests on phono preamplifiers and FM tuners. Previously, such tests were very difficult because of built-in de-emphasis characteristics. Depending on the tolerance of the parts used, the circuit can be assembled for about \$25, and will adhere fairly closely to the RIAA and FM pre-emphasis characteristics.

Pre-emphasis is a system of noise reduction often used in communications

equipment. Since most noise that creeps into high-fidelity circuits is high frequency in nature, the signal highs are boosted in strength before transmission or recording. Along the way (before "playback"), this noise joins up with the signal. However, if the overall level of the highs is reduced in the receiver (or preamp), the flat frequency response at the signal source will be obtained, along with an improved S/N ratio. This occurs because the high-frequency noise is dramatically attenuated.

FM and Disc Characteristics. The combination of pre-emphasis and de-emphasis appears in FM and recorded disc media. The pre-emphasis characteristics are easily synthesized using passive RC networks. These are preceded and followed by op amps giving gain or isolation.

Placing switch *S1* in the FM position will feed the input signal for jack *J1* to the noninverting input of amplifier *A1*, an op amp. (To reduce parts count, 747 op amps, which are two 741's in one pack-

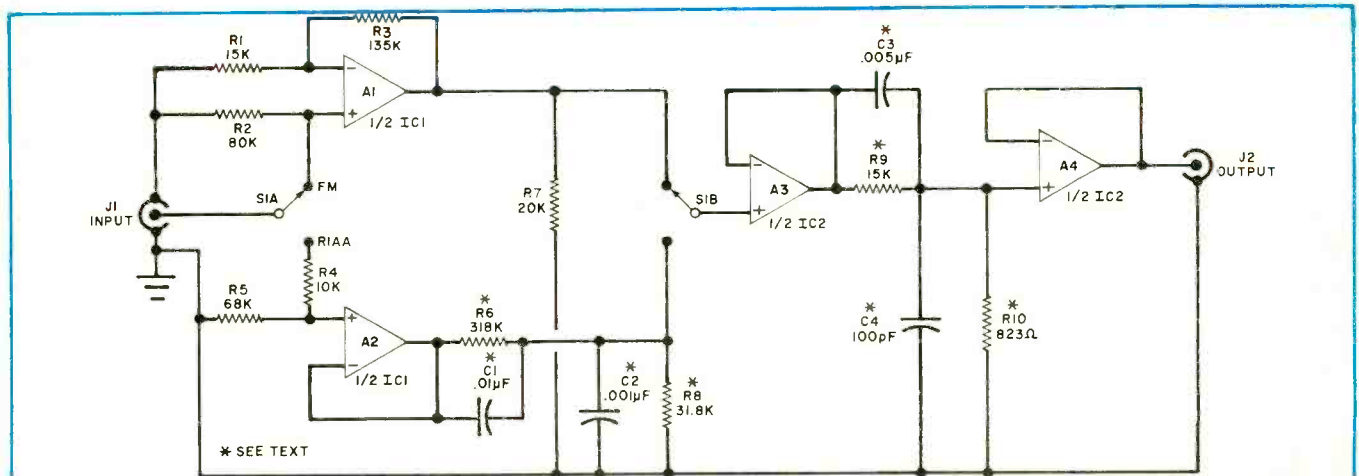

Fig. 1. Passive RC networks provide desired time constants. Op amps yield isolation and/or gain.

PARTS LIST

- C1—0.01- μ F capacitor* (polystyrene, mica, ceramic, or Mylar)
- C2—0.001- μ F capacitor* (polystyrene, mica, ceramic, or Mylar)
- C3—0.005- μ F capacitor* (polystyrene, mica, ceramic, or Mylar)
- C4—100-pF capacitor* (polystyrene, mica, ceramic, or Mylar)

- IC1, IC2—747 dual op amps
- J1, J2—RCA phono jacks
- Following resistors are 1/2-watt.
- R1—15,000-ohm resistor*
- R2—80,000-ohm resistor*
- R3—135,000-ohm resistor*
- R4—10,000-ohm 5% resistor
- R5—68,000-ohm 5% resistor

- R6—318,000-ohm resistor*
- R7—20,000-ohm 5% resistor
- R8—31,800-ohm resistor*
- R9—15,000-ohm resistor*
- R10—823-ohm resistor*
- S1—Dpdt switch
- * See Text

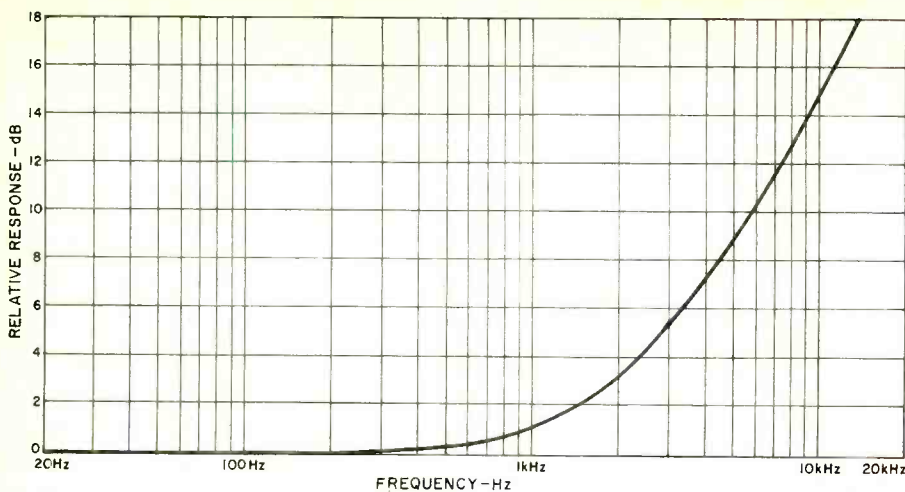

Fig. 2. FM 75-microsecond pre-emphasis curve. High frequencies are boosted in strength to improve S/N.

age, will be used.) This stage provides 20 dB of gain. Its output drives A3, a voltage follower used as a buffer. Resistor R9 and capacitor C3 provide the desired 75- μ s pre-emphasis time constant ($T=RC$). Very high frequencies are rolled off by the R10-C4 combination. Another voltage follower, A4, adds unity gain and isolation between the RC network and the output. The circuit's frequency response will be a good approximation of the 75- μ s pre-emphasis curve shown in Fig. 2.

When S1 is in the RIAA position, the input signal is applied to A2, an op amp buffer. This, in turn, drives the RC network consisting of R6, R8, C1 and C2.

The RIAA time constants of 3180 and 318 μ s are provided by this network. The signal is then routed through A3 and the 75- μ s RC network. Voltage follower A4 isolates the sensitive RC combination from the output. The prototype's RIAA pre-emphasis curve of amplitude versus frequency is shown in Fig. 3.

Construction. For the most part, construction of the pre-emphasis network is not critical. Either pc or perforated board can be used. One area is critical however—parts tolerance of the asterisked components in Fig. 1. To provide the desired time constants, these values should be as close to the published val-

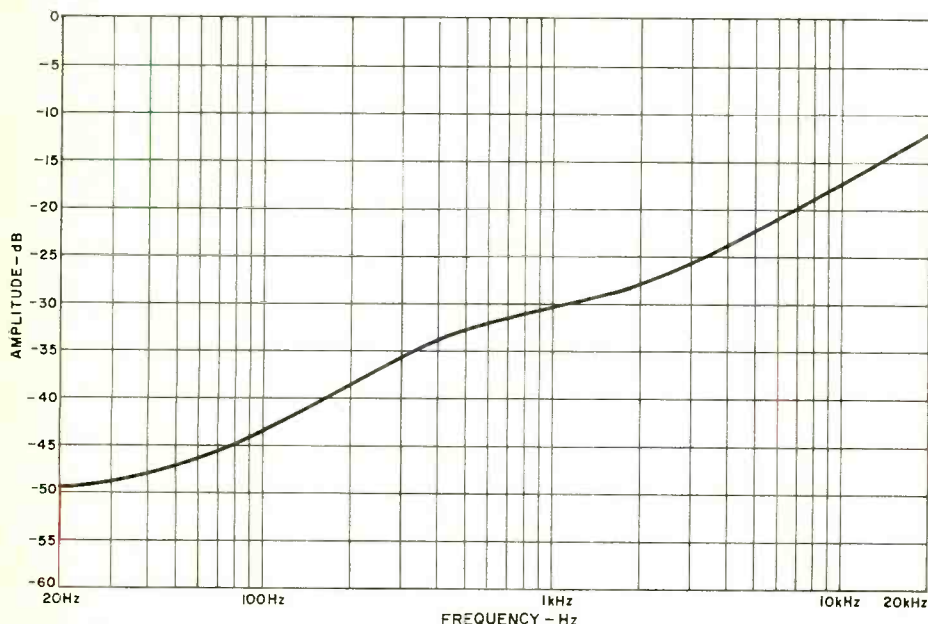

Fig. 3. RIAA pre-emphasis response. The circuit produces a close approximation of the standard RIAA curve.

ues as possible. This does *not* mean that you'll have to spend lots of money for precision parts—assuming you're lucky enough to find a source. However, there's a much easier way. Buy lower-tolerance parts (say 5% resistors and caps) and use small trimmer (or padder) pots and capacitors. For example, several surplus dealers are offering high-quality rectangular pc trimmer pots for less than \$1 each. If they are available in the correct ranges, you can use them alone for the resistive components, after adjusting them with a quality digital or analog multimeter. Also, a regulated bipolar 15-V dc supply is required for best results.

Using the Pre-emphasis Network. To test a phono preamp, connect a frequency-sweep function generator to the input of the pre-emphasis network. Then, connect the output of the pre-emphasis network to the phono input using a short patchcord. Monitor the preamp output on an oscilloscope. Connect the output to the vertical amplifier and the main sweep sawtooth output of the function generator to the horizontal amplifier. When the generator sweep range and the preamp circuitry are properly adjusted, you'll get a pictorial image of the preamp's "flat" response on the CRT.

For FM measurements, you can use one of two techniques. If you have an FM generator, connect the swept function generator's output to the modulation input of the FM generator through the FM pre-emphasis network. Then attach the FM output to the antenna terminals of the tuner, observing the output on the scope (using the vertical and horizontal amps as above).

If you don't have an FM generator, connect the function generator (through the pre-emphasis network) to the FM detector output—at the input of the tuner's de-emphasis network. You should then observe a flat response (up to 15 kHz) at the tuner output.

Signal Levels. The pre-emphasis network will provide 30 dB of attenuation at 1000 Hz in the RIAA mode and 5 dB in the FM mode. This allows the use of a high (line) level driving signal without additional padding. If 0-dB attenuation is desired, you can simply crank up the function generator output. Alternatively, you can use an op amp preamplifier at the INPUT jack with switchable gain—selecting the feedback resistor to provide 5 or 30 dB of gain for FM and RIAA, respectively. \diamond

AN "RFI-FREE" SOLID-STATE THERMOSTAT

Noise-free thyristor circuit is triggered by thin-film temperature sensor.

AN ELECTRONIC circuit including a triac and/or an SCR (connected to a suitable sensor) is often considered a desirable substitute for a bi-metallic thermostat. However, the radio frequency interference (RFI) generated by such a circuit has impeded any large-scale movement toward its use. Presented here is a thyristor thermostat which generates no RFI, uses inexpensive components, and is mechanically stable.

The circuit, which employs one of the new Moxie™ thin-film thermal sensors, has other interesting features:

- Uses true zero firing of the thyristor.
- Provides symmetrical line loading (an even number of half cycles).
- Is adaptable to any size triac and load.
- Has essentially no deadband (hysteresis).

Circuit Operation. As the power line's phase angle increases from 0°, the voltage at point A in Fig 1 becomes progressively more positive with respect to point B. Diodes D1 and D2 are both forward biased, and the voltage across R1 (the thermal sensor) continues to rise as the phase angle approaches 90°. The value of R2 is chosen so that, at some point before 90°, sufficient voltage develops across R1 to turn it on, and its impedance drops from a high to a low value. The lower the Moxie's temperature, the higher the voltage across it must be to turn it on. Thus, the value of R2 is determined

by the minimum control temperature required.

When R1 turns on, the cathode of D1 becomes highly positive with respect to point A. The value of the voltage developed on the cathode of D1

depends on the required "firing" voltage of R1. This in turn depends only on sensor temperature.

If a sufficiently positive voltage develops on the cathode of D1 (referred to point A) and voltage divider

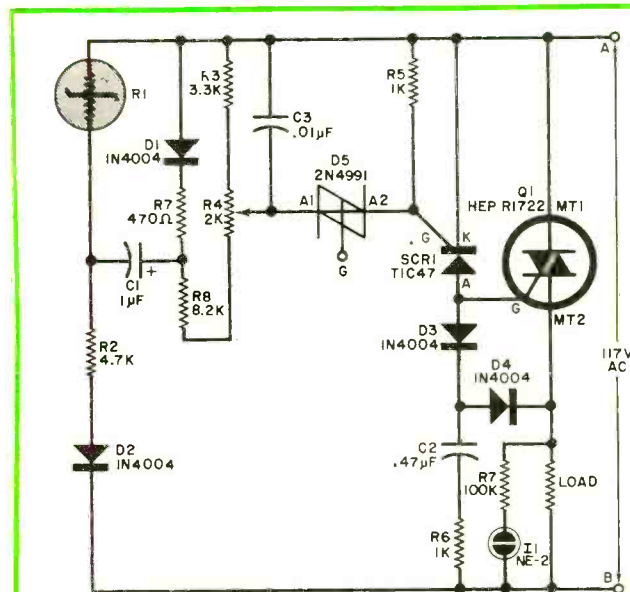

Fig. 1. Sensor R1 triggers thyristor firing circuit when heat is needed

PARTS LIST

C1—1- μ F, 200-WVDC electrolytic capacitor
 C2—0.47- μ F, 200-WVDC Mylar film capacitor
 C3—0.01- μ F, 25 WVDC disc capacitor
 D1 to D4—1N4004 rectifier
 D5—2N4991, ECG6404 (Sylvania) silicon bilateral switch
 I1—NE-2 neon indicator
 Q1—HEP R1723 triac (see text)
 R1—TS3-57S Moxie™ thermal sensor
 R2—4700-ohm, 2-watt resistor
 R3—3300-ohm, 1/4-watt resistor
 R4—20,000-ohm, 1-watt, linear taper, 10% tolerance potentiometer

R5—1000-ohm, 1/4-watt resistor
 R6—1000-ohm, 2-watt resistor
 R7—100,000-ohm, 1/4-watt resistor
 R8—8200-ohm, 1/4-watt resistor
 SCR1—TIC47, ECG5404

Misc.—Printed circuit or perforated board, solder, hookup wire, suitable enclosure, thermal paste, machine hardware, etc.

Note—The Moxie thermal sensor is available for \$1.09 from Elcom Sales, Box 9112, Rochester, NY 14625, and from Multi-State Devices Ltd., 1330 Trans Canada Highway S., Dorval, P. Q., Canada. H9P 1H8.

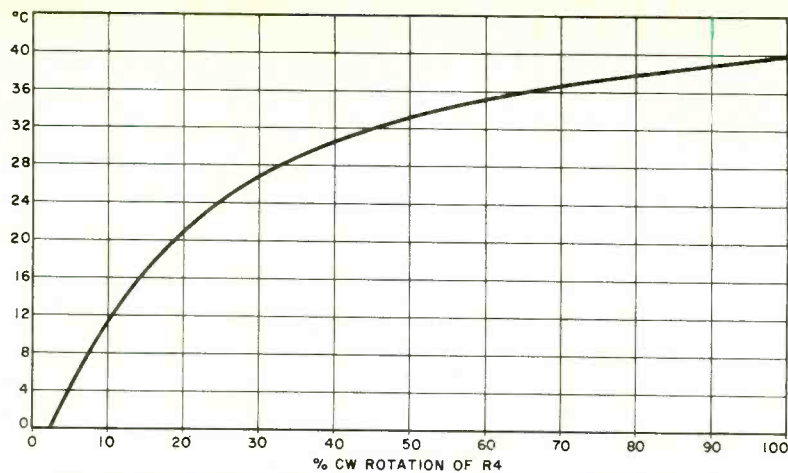

Fig. 2. Curve shows how thermostat setting is affected by *R4*.

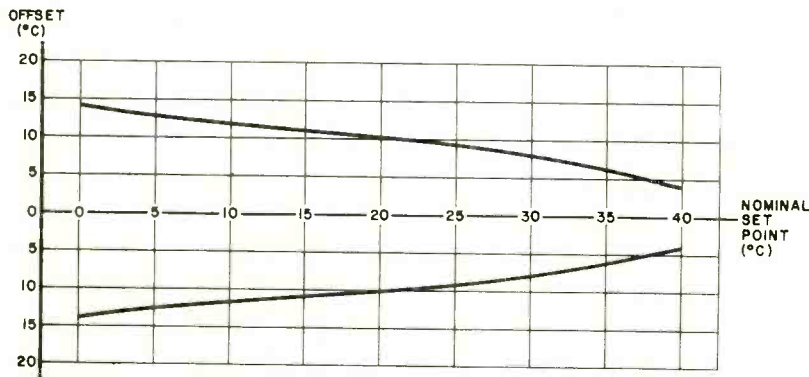

Fig. 3. Worst-case recalibration curve for a nontypical *D5*.

R4 is set properly, then the diac *D5* (also called a silicon bilateral switch, or SBS) will turn on and latch. Capacitor *C1* is sufficiently large to hold *D5* in its on state from the firing point of *TDR1* (less than 90°) to at least 180°. Of course, if *TDR1* fires at a sufficiently low voltage (sensor hot), then there will not be enough voltage to fire diode *D5*.

But if *D5* does fire, it will do so prior to 90° and remain in this state through 180°. Therefore, *SCR1* has positive gate current at 180°. Prior to this phase angle, *SCR1* remains off since its anode is negative with respect to its cathode. As soon as the phase angle passes 180°, *SCR1* conducts current into the gate of the triac *Q1*. The current through *SCR1* is limited to the minimum turn-on current of *Q1*, as it serves as a shunt around *SCR1*.

So, the triac is on from 180° to 360°, when the current through it falls below its holding point. The slaving circuit consisting of *D3*, *D4*, *C2*, and *R6* serves to store the peak voltage across the load on *C2*. This stored voltage provides the triac with gate current between 270° and 450°, insuring zero-cross firing at 360°.

In this way, the load will be ener-

gized for at least two half cycles when heat is required. If still more heat is needed, two more half cycles will follow to keep the load energized.

Construction. Since the circuit is fairly simple, either pc or perforated-board techniques can be used. In any event, the circuit should be mounted in a suitable enclosure, observing the safety practices that are necessary when dealing with line-powered equipment. Thermal sensor *TDR1* should be mounted so that it samples the average temperature of the room, not that of any heat-generating com-

ponent in the circuit. For example, it could be mounted in one corner of the enclosure away from triac *Q1*, with numerous holes drilled around it for unimpeded air flow. Alternatively, it could be mounted in a small metal box a short distance away from the rest of the circuit, with short interconnecting leads between the two. Thermal paste could then be used to keep sensor and enclosure at the same temperature.

Calibration and Use. Potentiometer *R4* acts as the thermostat's sensitivity control. Figure 2 shows how the thermostat's set point varies as *R4* is rotated. This curve is valid when all components are at their "typical" values. Of course, solid-state and thin-film devices are subject to some variations. Figure 3 shows the worst-case recalibration required with a "nontypical" *D5*. Worst-case variations of the thermal sensor will affect the calibration curve as well, and the resulting recalibration is shown in Fig. 4. All thermostats can be calibrated to within 2° C of Fig. 2 by trimming *R3* and *R8*.

You will most probably want to make a calibrated dial for adjusting *R4* to the desired room temperature. This is best done empirically. Thermally couple a good-quality thermometer to *R1* and adjust *R4* until the neon indicator *I1* flickers or glows. At that point current is flowing through the heating element (LOAD), and the temperature of the sensor can be read off the thermometer. For temperatures higher than the room temperature, *R1* can be gently heated.

One final note—the triac specified for *Q1* (HEP R1722) is rated at 10 amperes forward current. If your heating element draws more current, simply use a higher-power triac. Of course, adequate heat-sinking is necessary for any thyristor. ♦

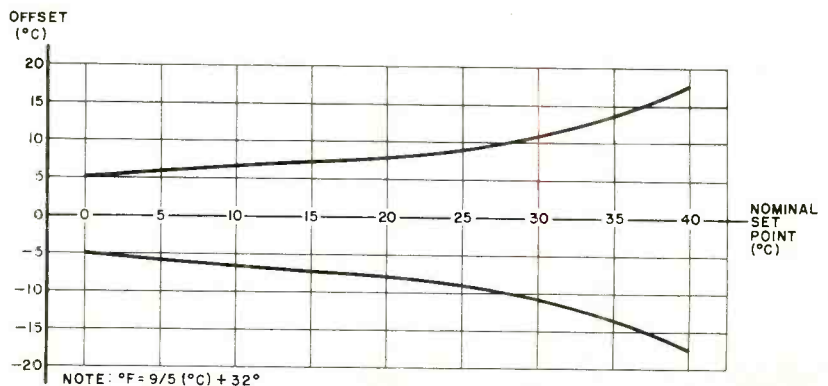

Fig. 4. Variations in *R1* can be corrected using these curves.



SWR—FACTS AND FALLACIES

By John T. Frye, W9EGV

"MAC," Barney said, pulling a little notebook from his shirt pocket, "lay down your solder gun for a minute and bend an ear to these comments about SWR I've heard on the CB and ham bands recently. So help me, I'm quoting these gems verbatim! Just listen:

"You've a strong carrier but low modulation—get your SWR down and the signal will be fine. . . . You can't get out unless your SWR is below 2:1. . . . If you have a high SWR, reflected power will go back into the tank circuit and burn out your final tubes or transistors. . . . This 75-meter mobile whip is a lot better than my old one because its SWR is lower. . . . A high SWR makes your feedline radiate and causes TVI. . . . Subtract your reflected power from your transmitter output power and what's left is all that's going into your antenna. . . . Reflected power is not power at all because the voltage and current are 90 degrees out of phase. . . . My signal should be much better now because I put a new balun in the middle of the antenna and it lowered the SWR here. . . . I can't put up an antenna for 80 meters because the lot is only 80' deep. . . . I'd like to work down around 3.5 MHz, but this antenna is cut for 3.75 MHz and the SWR is 'way too high down there for me to get out. . . . SWR readings don't mean anything unless you take them right at the antenna or a multiple of a half wavelength away from it."

"Each one of those statements," Barney said to his employer, "displays ignorance of the true nature of SWR and its effects, but an amazing number of hams and CB operators believe at least some of them. More misconceptions about SWR are floating around than any other aspect of station operation. I get mad when I hear a guy smugly mouthing that drivel into a microphone because I know many listeners without a technical background will accept those fallacies as gospel and spread the same garbage."

"Ah, would that I were young enough

again to become that indignant about ignorance," Mac said with a sigh as he leaned back against the wall and lighted his pipe. "But I can see you're about to lecture me on SWR, so get on with it. Let's see you shatter those clay pigeons you've tossed up."

Theory Is Not Simple. "Delighted," Barney replied, "but it's only fair to admit many uttering those foolish things are only repeating what they've read. Their chief sin is gullibility, as they believe anything they read without regard for who wrote it. Ignorant, careless writers are the chief culprits. A writer should know his subject matter before he undertakes to instruct. Antenna and transmission line theory is not simple, and anyone who pretends otherwise is not being honest. Most of the half-baked articles I've read containing implicit or explicit errors about SWR usually carry titles like 'SWR Made Easy,' or 'All You Need to Know about SWR.' Other irresponsible writers, too lazy to dig out the facts for themselves, quote from these articles and so perpetuate the fallacies.

"Actually the truth about SWR is not

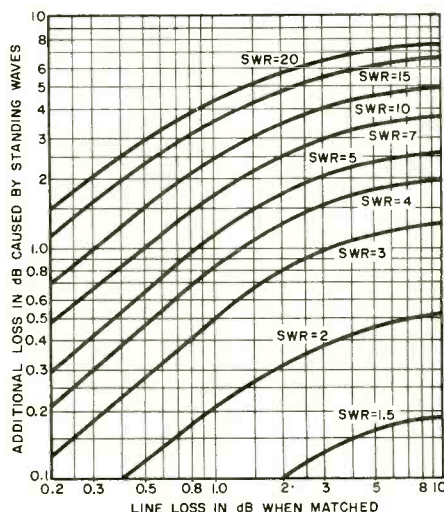

Increase in line loss due to standing waves (ARRL Antenna Book).

difficult to find. *The Radio Amateur's Handbook* and *The ARRL Antenna Book* have presented it in time-tested edition after edition. So have such writers as George Grammer, retired technical editor of *QST*, and Dr. Yardley Beers, senior scientist of the Quantum Electronics Division of the National Bureau of Standards. But the most recent, lucid, and complete discussion of the subject is contained in an on-going nine-part series in *QST* called 'Another Look at Reflections' by M. Walter Maxwell, W2DU. He's the engineer in charge of the antenna laboratory and test range at RCA's Space Center in Princeton, NJ. More than 30 earth-orbiting spacecraft, including Echo I and all Tiros-ESSA weather satellites, carry antennas designed by Mr. Maxwell. If you think I get hot under the collar about published SWR fallacies, you should read his reaction! As of now, parts of the series appeared in the *QST* issues of April, June, August, and October, 1973, April and December, 1974, and August, 1976. Each part runs about 5,000 words and a 61-item bibliography is included."

"You're not going to cover all that, I hope!"

"No, but I want you to have reliable sources to check any statement that you question. All conclusions in the cited works are supported by quoted authority, sound logic, mathematical proofs, and laboratory experiments using top-notch equipment. There's no disagreement among these authors.

"But before we start pigeon-busting, I must define three terms: *source power* is the power a transmitter delivers to the input of the transmission line; *incident power* is power flowing up the transmission line towards the antenna; and *reflected power* is unabsorbed power appearing at the junction of the antenna and a mismatched line, power that flows in a separate wave back down the line towards the transmitter.

Reflected Power. "Reflected power isn't 'imaginary,' 'wattless,' or 'lost.' It's just as real as incident power, but the current direction reversal at the antenna mismatch causes a 180° phase shift between current and voltage in the reflected wave. This is in contrast to current and voltage in the incident wave, which, seeing only the resistive impedance of the line, are in phase with a 0° phase angle. For power in the reflected wave to be reduced to wattless, reactive volt-amperes, their phase difference would have to be 90°. Furthermore, if reflected power were wattless, it couldn't deflect a

If you can't go to college for your career in electronics —read this!

CREI brings college-level training to you with eight educational advantages, including special arrangements for engineering degrees

The best way to qualify for top positions and top pay in electronics is obviously with college-level training. The person with such training usually steps more quickly into an engineering level position and is paid considerably more than the average technician who has been on the job several years.

A regular college engineering program, however, means several years of full-time resident training—and it often means waiting several years before you can even start your career. This, of course, is difficult if you must work full time to support yourself and your family.

If your career in electronics is limited without college-level training, take a look at the advantages a CREI home study program can offer you.

1. Convenient Training

CREI brings the college to you. Through the convenience of home study, you receive exactly the same level of training you will find in any college or university offering programs in electronic engineering technology. With CREI, however, you can “go to college” whenever you have spare time at home or on the job.

2. Specialized Programs

With CREI, you enjoy the advantage of *specialized* training. That is, your program will include only those courses directly applicable to your career in electronics. We omit such courses as English, social studies and other subjects, which are usually required in resident schools. Therefore, with CREI, you move ahead faster to the more interesting and useful part of your training.

3. Practical Engineering

CREI programs give you a *practical engineering* knowledge of electronics. That is, each part of your training is planned for your “use on the job.” By using your training, you reinforce the learning process. And by demonstrating your increased knowledge to your employer, you may qualify for faster career advancement.

4. Engineering Degrees

CREI offers you a number of special arrangements for earning engineering degrees at recognized colleges and universities. You can earn college credit while you are taking your CREI program or apply later, whatever is best for your career plans.

Career Training at Home

5. Unique Laboratory

Only CREI offers you the unique Electronic Design Laboratory Program. This complete college laboratory makes learning advanced electronics easier and it gives you extensive practical experience in many areas of engineering, including design of electronic circuits. No other school offers this unique program. It is a better "Lab" than we have found in many colleges. And the professional equipment included in the program becomes yours to keep and use throughout your professional career.

6. Wide Program Choice

CREI gives you a choice of specialization in 14 areas of electronics. You can select exactly the area of electronics best for your career field. You can specialize in such areas as computer electronics, communications engineering, microwave, CATV, television (broadcast) engineering and many other areas of modern electronics.

7. Prepared by Experts

Experts in industry and technical organizations of government develop CREI programs. Each part of your training is developed by a recognized expert in that area of electronics. That means you get the most up-to-date and practical instruction for your career.

8. Industry Recognition

That CREI training is recognized by industry and government is evident from the fact CREI provides training to advanced technical personnel in over 1,700 technical organizations. Many subsidize the training of their employees with CREI. If there is any question about the advantages of CREI training for you, ask your employer or any engineer to evaluate the outline of a CREI program for you.

Other Advantages

Of course, there are many other advantages to CREI training. For example, throughout your training, CREI's staff gives you personal instruction for each step of your program. And in many industrial areas, both in the U. S. and abroad, CREI Field Service Representatives provide a number of important personal services for your training and your career.

FREE Book

There isn't room here to give you all of the facts about career opportunities in advanced electronics and how CREI prepares you for them. So we invite you to send for our free catalog (if you are qualified). This fully illustrated, 80 page catalog describes in detail the programs, equipment and services of CREI.

Qualifications

You may be eligible to take a CREI college-level program in electronics if you are a high school graduate (or the true equivalent) and have previous training or experience in electronics. Program arrangements are available depending upon whether you have extensive or minimum experience in electronics.

Send for this **FREE Book** describing your opportunities and CREI college-level programs in electronics

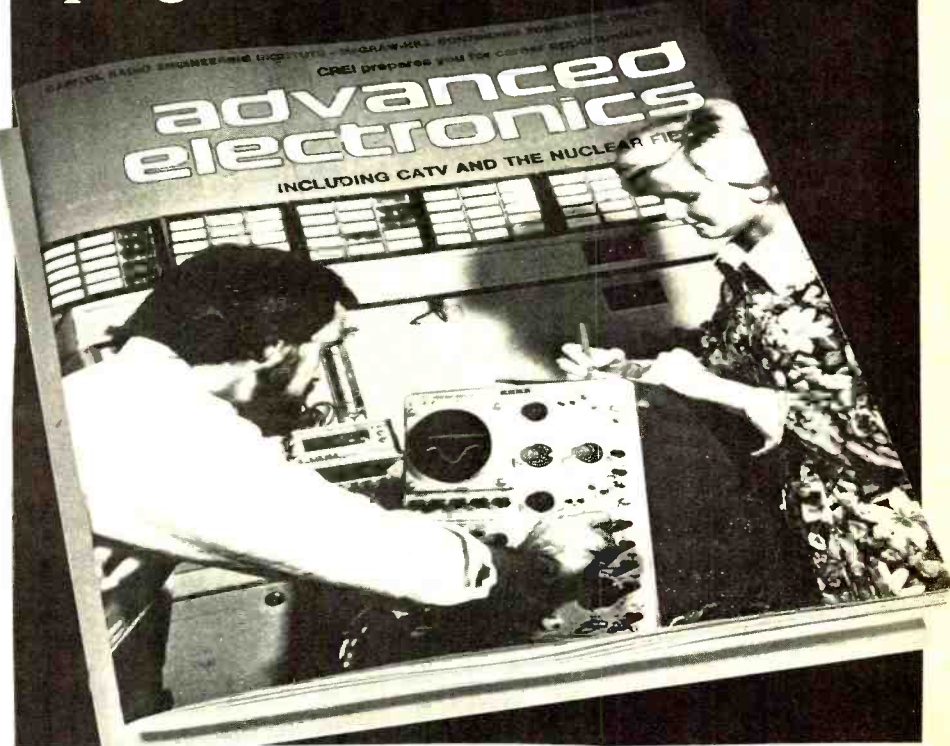

Mail card or write describing qualifications to

CREI **CAPITOL
RADIO
ENGINEERING
INSTITUTE**

McGraw-Hill Continuing Education Center
3939 Wisconsin Avenue Northwest
Washington, D.C. 20016

Accredited Member National Home Study Council

GI Bill

CREI programs are approved for training of veterans and servicemen under the G.I. Bill.

meter connected to the output of a directional coupler—as it certainly does.

“Neither is reflected power mysteriously ‘lost,’ breaking the law of the conservation of energy. When the downgoing reflected wave encounters a conjugate match at the transmitter end of the line, it is again totally reflected and its voltage and current go through another 180° phase shift which brings them into step with the 0° phase angle of the incident waves continuously travelling up the line. The reflected power thus adds to the source power; and the fortified incident power combination is sufficient, with a lossless line, to override the mismatch at the top and deliver the full source power to the antenna. You might say the reflected power is salvaged and recycled!”

“What’s a ‘conjugate match?’” Mac asked.

“It’s a condition of system resonance that establishes a unilateral match between the transmitter and the line. Such a match creates a “one-way mirror” at the bottom of the line. The transmitter sees only the resistive component of the line-input impedance, as it would if there were no reflected power. At the same time, the down-coming wave sees a perfectly reflecting mirror that again reverses its direction. The proper adjustment of the transmitter’s output circuit will provide a conjugate match if the pi-network has sufficient range to cancel the reactive component of the line’s input impedance produced by standing waves on the line. If not, an antenna tuner or “transmatch” can supplement the limited impedance matching range of the transmitter output circuit.”

“Don’t standing waves on the line waste power?”

“Yes, but not nearly so much as many believe. Remember a perfectly flat line suffers some signal-attenuating losses. The amount of attenuation depends on the type and length of the transmission line and on the operational frequency, as shown in the table giving loss per 100 feet in dB for popular transmission lines at selected frequencies. The 28-MHz figures can be applied to the CB 27-MHz band. When there are standing waves on the line caused by a mismatched load, there’s an additional loss of reflected power during its round trip down to the transmitter and back again because the line attenuates the reflected wave to the same degree it attenuates the incident wave. The higher the line attenuation, the less reflected power reaches the source where it is turned around and added to the incident power. This simply

means less reflected power is recycled and eventually radiated.

“Both the line attenuation and the SWR must be high, however, for this additional loss to be serious, as is shown in the diagram. For example, 100 feet of RG-8/U perfectly matched to an antenna resonant at 3.75 MHz would have a 0.32-dB loss. At either 3.5 or 4.0 MHz the SWR of such an antenna would rise to about 5:1, but the extra loss because of this high SWR at 4 MHz would only be 0.46 dB. Even a 1-dB drop in signal strength is barely noticeable, so the extra loss due to SWR would be insignificant; but use the chart and the graph to see how SWR-induced losses climb as you go up in frequency or use a higher-loss cable, such as RG58/A-AU.

“A lower SWR doesn’t *always* mean a stronger radiated signal. If reactive cur-

lossy coil. The good coil will thus produce an SWR of about 3:1, while the worst coil will give an SWR of about 1.3:1. Power wasted in heating the lossy coil will far exceed the small loss caused by the higher SWR on the short length of RG8/U feeding the antenna.”

“Don’t you believe in baluns?” Mac asked.

“Certainly, but not for lowering SWR! A good balun eliminates current flowing on the outside of the coax, the result of directly feeding a balanced antenna with an unbalanced line. This current can cause feedline radiation and TVI, as can ‘antenna current’ induced onto a feedline that is brought away from the antenna at an acute angle. Keep in mind that voltages and currents produced by standing waves are confined to the inside of the coax, and cannot radiate.

TRANSMISSION LINE CHARACTERISTICS

Type of line	Zo ohms	Velocity %	Attenuation in dB per 100 ft			
			3.5 MHz	14 MHz	28 MHz	144 MHz
RG58/A-AU	53	66	0.68	1.5	2.2	5.7
RG58 Foam	50	79	0.52	1.1	1.7	4.1
RG8/A-AU	52	66	0.30	0.66	0.98	2.5
RG8 Foam	50	80	0.27	0.62	0.90	2.2
RG59/A-AU	73	66	0.64	1.3	1.8	4.2
RG59 Foam	75	79	0.48	1.0	1.4	3.4
#12 Open wire line, ignoring radiation		97	0.03	0.07	0.10	0.25

rents saturate the core of an underrated balun when operating far from the antenna’s resonant frequency, the SWR might read lower. But power heating the saturated core is subtracted from the radiated signal. A similar effect can be caused by a high-resistance connection in the antenna-feedline system. Be suspicious if a thin-wire 80-meter antenna fed with 50-ohm coax doesn’t display an SWR of around 5:1 when tuning more than a few hundred kHz from the resonant frequency.

“A vertical antenna with lots of radials has a combined ground-and-radiation resistance that is considerably lower than the surge impedance of a 50-ohm line, as evidenced by a fairly high SWR. Reducing the number of radials increases the ground resistance in series with the radiation resistance, thus lowering the SWR, but power now heating the ground is subtracted from the radiated signal. A center-loaded whip for 80 meters has a radiation resistance of about one ohm and an average “ground” resistance of 7 ohms. The resistance of a high-Q loading coil is around 8 ohms, but this may go as high as 31 ohms for a

“Antenna current flowing on the outside of the coax makes it impossible to measure the true SWR. So does leakage between the forward and reflected circuits of a directional coupler, or use of an instrument not accurately matched to the impedance of the line. If these conditions exist, alone or in concert, SWR readings may change significantly when adding or subtracting a few feet of transmission line; but this *does not* mean the SWR is changing with line length. With a reliable instrument and no current on the outside of the coax, the SWR reading will be virtually the same anywhere in the line except for a gradual small decrease as you move away from the antenna, which is caused by attenuation of the reflected wave as it moves down the line.”

“Aren’t there any valid reasons for keeping the SWR down?”

“Of course there are, but they’re chiefly concerned with the effect of SWR on line input impedance and not on lost power or TVI. For example, solid-state CB transceivers have very limited antenna matching ranges; so you can’t obtain a conjugate match with their unaided

output circuits if the SWR is much greater than 2:1. With a high SWR on the line, the transceiver's final amplifier may be grossly over- or under-loaded when working into a complex line input impedance whose value is dependent on line length. This can easily blow the transistors, but note the damage is not done 'by reflected power backing up into the rig.'

"How about voltage breakdown on the line with high SWR?"

"The flat-line rms voltage equals the square root of line impedance times power. This would be $\sqrt{50 \times 100}$ or 70.7 volts for 100 watts into a 50-ohm line. With standing waves, the voltage maximum becomes the flat-line voltage times the square root of the SWR. With a 5:1 SWR this would be $\sqrt{5} \times 70.7$ or 158 volts. At 4.0 MHz, RG8/U will handle 700 watts CW continuously within ratings even when an SWR of 5:1 exists on the line. With the duty cycle of SSB, you'll be well below the maximum ratings at 2000 watts PEP. But this kind of power is not recommended for the closer-spaced RG58/U or RG59/U."

"As I get it," Mac interrupted, ticking the points off on his fingers, "you're saying many operators restrict their activities unnecessarily because of unwarranted fear of misunderstood SWR. An antenna doesn't have to be resonant to radiate all the power delivered to it, and with a conjugate match, a high SWR will not prevent all real power available at the feed point from being absorbed by the radiator. With the aid of a transmatch you can work the full width of the 3.5-4.0-MHz band without any significant loss of power from resulting SWR on an RG8/U line. Much higher values of SWR on an open wire line will cause no appreciable loss of radiated power. Mismatch-produced SWR does not cause TVI. You don't have to measure SWR at a multiple of a half wavelength from the antenna if you have a quality instrument. Reflected power is not irretrievably "lost". Lower SWR doesn't necessarily mean a more efficient antenna or a stronger signal, and reflected power doesn't flow backwards into a pin-network-coupled transmitter."

"You're a good listener," Barney said, clapping his hands, "and I hope you'll spread the gospel. It would be nice if the truth could just be stated once and that would be the end of misunderstanding, but that's not the way it is. Fallacies, like dandelions, keep sprouting up, going to seed, and blowing in the wind. They must be sprayed repeatedly with the truth to keep them from taking root and multiplying." ◇

LOVE at first BYTE

If you have
your own computer, or if you're
into computers at all, have we got
a magazine for you!

BYTE A magazine for and about the state of the art of personal computing. Written by pros and hobbyists who know the ropes. Edited by Carl Helmers, who knows what personal computer users need to know. Written so everyone from the neophyte to the mastermind can understand and enjoy it. Month-after-informative-month, a continuous flow of pioneering articles, practical applications, source listings and detailed articles like...

- Machine Readable Printed Programs
- Voice Outputs • Golf Handicapping • Games
- Programmed Music • Computer Languages
- Small Business Applications • Bio-Rhythms
- Home Automation • Weather Forecasting
- Text Editing and Systems Programming
- Plus, many, many more...

Rush this coupon today! Charge on BankAmericard or Master Charge. If you can't wait, call directly: (603) 924-7217. Ask for Subscription Department.

Subscribe to BYTE right now. Only \$12 for one full year's subscription of 12 big issues. Two years for \$22... save \$2.00! A three-year subscription is only \$30. Save \$6.00! When you get your first issue read it from cover-to-cover. If it's what you expected, honor our invoice. If not, write "CANCEL" across invoice and send it back. You won't be bothered again. Subscribe today.



BYTE Peterborough, NH 03458

Please enter my subscription to BYTE...

- \$12 One Year \$22 Two Years
 \$30 Three Years

Bill me.

Enclosed is my check for \$_____

Bill BankAmericard

Bill Master Charge

Credit Card # _____

Credit Card Expiration Date _____

Name _____
(Please Print)

Address _____

City _____

State _____ Zip _____

PE1/77

CIRCLE NO. 14 ON FREE INFORMATION CARD

SAVE!

MONEY • TIME • FREIGHT

♪ QUALITY STEREO EQUIPMENT AT LOWEST PRICES.

♪ YOUR REQUEST FOR QUOTATION RETURNED SAME DAY.

♪ FACTORY SEALED CARTONS—GUARANTEED AND INSURED.

♪ SAVE ON NAME BRANDS LIKE:

A.D.C.	KLH
A.R.	SHURE
DYNACO	KOSS
SONY	FISHER

PIONEER
AND MORE THAN 50 OTHERS
BUY THE MODERN WAY
BY MAIL—FROM

illinois audio

Department 2175
12 East Delaware
Chicago, Illinois 60611
312-664-0020

CIRCLE NO. 32 ON FREE INFORMATION CARD

FREE catalog

over 2000



unique tools,
handy kits,
precision
instruments,
technical
supplies.

Our 23rd year of service to the World's finest craftsmen and technicians.

A carefully selected and tested assortment of unique, hard-to-find tools, clever gadgets, precision instruments, bargain kits. One-stop shopping for the technician, craftsman, hobbyist, lab specialist, production supervisor. Many tools and measuring instruments available nowhere else. One of the most unusual and complete tool catalogs anywhere. Get your copy of the NC FLASHER today.

National Camera
2000 West Union Ave., Dept. GGA
Englewood, Colorado 80110
(303) 789-1893

CIRCLE NO. 38 ON FREE INFORMATION CARD



Product Test Reports

KRACO MODEL KCB-2330 MOBILE AM CB TRANSCEIVER

23-channel mobile provides clean/crisp transmit signal.



THE Kraco Model KCB-2330 is a full 23-channel AM CB transceiver designed for mobile use. It employs crystal frequency synthesis and can be powered from 11.5-to-14.5-volt dc sources with either negative- or positive-grounding systems. Built in are a dual line filter and reverse-polarity protection. Voltage regulation is provided for the critical circuits in the transceiver.

A full-time automatic noise limiter (anl) with a switchable noise blanker and an r-f gain control back up the usual features. These features include a channel selector, fine tuning (Delta tune), squelch and audio gain controls, transmit and receive indicators, S/r-f meter, PA operation, external-speaker jacks, detachable dynamic microphone, and automatic modulation control (amc).

The transceiver measures 8½"W × 7"D × 2¼"H (21.6 × 17.8 × 5.7 cm). Supplied with mobile mounting hardware, it retails for \$219.95.

The Receiver. The dual-conversion receiver provided a measured sensitivity of 0.4 μV (rated 0.7 μV) for 10 dB (S + N)/N at 30% modulation, using a 1000-Hz test tone. The first i-f is at 11.275 MHz, obtained by heterodyning the incoming CB signal with the summed mixture of one of six crystals in the 23.290-to-23.540-MHz range and one of four crystals in the 14.950-to-14.990-MHz range. The 455-kHz second i-f is obtained with an 11.730-MHz crystal signal.

The second i-f strip consists of two active stages preceded by a ceramic filter

to provide selectivity. This setup yielded an adjacent-channel rejection and desensitization of nominally 60 dB, while allowing an overall bandpass—including the response of the audio section—of 500 to 2700 Hz at the 6-dB points.

The r-f front-end circuits and band-pass coupling between the mixers held the primary image rejection to at least 70 dB. However, a spurious signal around 26 MHz, which appeared to be a secondary image, was only 35 dB down. Otherwise, the unwanted-signal rejection, including that of the i-f, was 60 dB minimum.

The diode detector also provides the agc, which held the audio output variation to within 6 dB with an r-f input change of 20 dB at 1 to 10 μV and to within 10 dB with an input change of 80 dB at 1 to 10,000 μV . A 30- μV signal was required to produce an S9 reading on the meter. The amplified squelch arrangement had a threshold sensitivity range of 0.5 to 1000 μV . The anl is a series-gate circuit that operates full-time.

The audio section employs an IC that includes a class-B output amplifier, which also functions in the usual manner as the transmitter modulator. A maximum sine-wave audio output for both receive and PA operation of 3 watts was measured at 4% THD with a 1000-Hz signal into an 8-ohm load.

The noise blanker picks the noise pulses off the first mixer's output and detects them with a voltage-doubling diode scheme. Coupling is to a transistor across the second mixer's output circuit,

momentarily shorting out this circuit to disable the signal path during each pulse. The anl itself is quite effective, but the additional insertion of the noise blanker significantly enhances the impulse-noise attenuation, making for good reception of weak signals under noisy conditions.

Current drain for the receiver is nominally 200 mA.

The Transmitter. The transmitter's frequency is obtained by combining the synthesizer's output (in the 38.240-Hz range) with an 11.275-MHz crystal signal and using the difference frequency at a transmitter mixer. The mixer employs the usual output filtering for minimizing spurious responses.

An emitter-follower stage is then coupled to a buffer, following which are the driver and power-amplifier stages. The latter employs a dual-section output circuit for harmonic attenuation and 50-ohm antenna matching. The carrier output measured up to 4 watts during operation from a 13.8-volt dc source.

The driver and power amplifier are conventionally collector modulated, and an excellent amc system is employed, providing a high degree of compression for maintaining full modulation under varying voice level conditions. This system involves a rectified audio feedback setup that varies the collector-to-emitter resistance of a transistor connected across the speech-input circuit. It then acts as an automatic microphone-gain control.

Using a 1000-Hz test tone with a 40-dB level increase above that required for 50% modulation (40 dB of compression), the modulated waveform held to a sine wave at 100% modulation with only 5% THD and adjacent-channel splatter down 55 dB. Under dynamic (voice) conditions, modulation still remained at 100%, indicating good time constants, with splatter averaging 55 to 60 dB down. The overall response was 550 to 4500 Hz, referred to 1000 Hz, with a 2.5-dB peak at 1700 Hz.

The microphone appears to be a noise-cancelling design inasmuch as it was quite directional. One must speak directly into the front of the mike to obtain maximum signal level. The output dropped considerably when we spoke into it more than slightly off-axis.

The r-f tolerance of the transmitter was within 0.0022% on any channel. Current drain on transmit measured 0.85 to 1.5 amperes, depending on modulation.

User Comment. The transceiver is in a metal case with a wood-grain finish. A chromed bezel surrounds three black panels. Except for the channel selector, the chrome-finished control knobs are small and spaced closely together. The ANL/NB and PA/CB switches are push-button types. The meter is fairly large and round faced, but its illumination is rather low in level, which might make it difficult to read under bright ambient lighting conditions.

The microphone connector is located on the bottom of the transceiver's case, about halfway back toward the left rear. The 3" (7.6-cm) speaker produces good quality sound, even though it faces the bottom of the case.

The range of the RF GAIN control circuit is somewhat limited. The same is true of the VOLUME control when operating on PA.

With no antenna, or during the absence of a signal, the receiver is ex-

ceptionally quiet, so quiet, in fact, that it gives the impression that the rig has gone dead. Nevertheless, we determined that the receiver has somewhat better than average sensitivity for a given S/N ratio than the average transceiver and is plenty lively even when weak signals are present. We might also add that the exceptionally fine performance of the amc system ensures a well-rounded and clean transmit signal with plenty of pep.

CIRCLE NO. 104 ON FREE INFORMATION CARD

DRAKE MODEL SSR-1 AM/SSB COMMUNICATION RECEIVER

Latest SWL receiver fills performance-price void.



THE R.L. Drake Company's Model SSR-1 is a moderately priced general-coverage AM/SSB communication receiver that is especially suited to the needs of the SWL and good enough for a beginning radio amateur. The 0.5-to-30-MHz receiver employs triple conversion in a superheterodyne design and has a drift-cancelling local oscillator system that is not normally found in inexpensive consumer receivers.

The compact receiver measures 13"W x 11"D x 5½"H (33 x 28 x 14 cm) and weighs 14 lb (6.4 kg). It retails for \$350.

General Description. An understanding of the operation of the receiver can be obtained from the block diagram. Front-end selectivity is provided by a single tuned circuit that is controlled by a front-panel PRE-SELECTOR control and a four-position BAND switch whose positions are labelled 0.5-1.5, 1.5-5, 5-12, and 12-30 in MHz.

A single r-f stage is followed by a 30-MHz low-pass filter and the first mixer. (All mixers in the receiver are diode types.) The signal is heterodyned against an HF oscillator that covers 45.5 to 75.5 MHz and is tuned by a MHz knob on the control panel. The associated

MHz dial is calibrated from 0 to 30 in 1-MHz intervals.

The first i-f is a 1-MHz-wide bandpass amplifier that covers a range of from 44.5 to 45.5 MHz. The second conversion oscillator signal is obtained in an unconventional manner. A 10-MHz crystal oscillator signal is frequency divided by an IC that also contains the active circuitry for the crystal oscillator. It generates a "comb" of signals at integral megahertz frequencies. A bandpass filter passes the comb components from 3 to 30 MHz to a mixer, where the frequen-

cies are combined with the output of the HF oscillator, and the mixer output is passed through a 42.5-MHz bandpass amplifier. The output of this amplifier combined with the 44.5-to-45.5-MHz first i-f signal to produce a second i-f in the 2-to-3-MHz range.

Although the HF oscillator is subject to drift and other instabilities, it can be seen that an increase in its frequency will simultaneously increase the frequency of the first i-f component and the second conversion oscillator frequency so that the frequency of the signal in the 2-to-3-MHz second i-f is unchanged. The main tuning control, labelled KHZ, tunes the second i-f amplifier and a third conversion oscillator that covers a range of 2.455 to 3.455 MHz to produce a third i-f signal at 455-kHz. The dial that corresponds to the KHZ knob is calibrated from 0 to 1000 kHz in 10-kHz increments.

The selectivity of the receiver is provided by the third i-f amplifier, with two stages of ceramic filtering whose bandwidth can be changed by the setting of the MODE switch (labelled AM, USB, LSB). For AM reception, a conventional

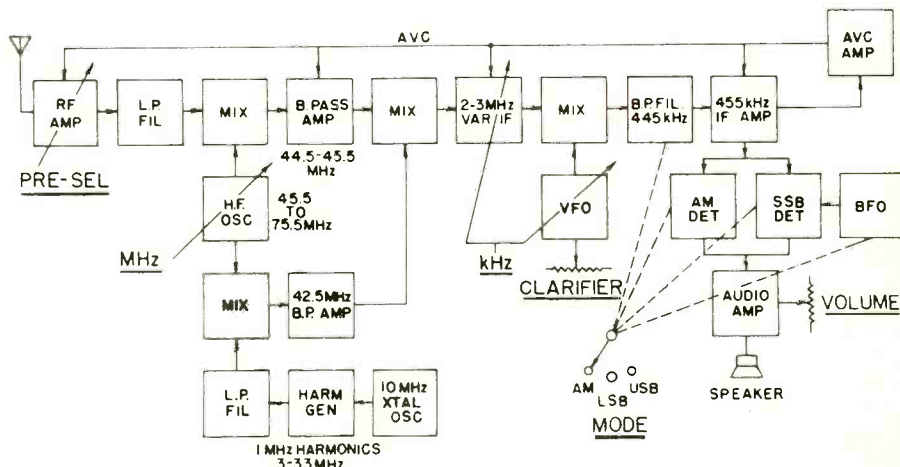

Block diagram of SSR-1 Receiver

full-wave diode detector is used, while for SSB and CW a four-diode balanced modulator is used as a product detector, with a separate bfo for the final detection. The MODE switch changes the frequency of the bfo for upper- or lower-sideband (USB or LSB) selection. The outputs of the two detectors are also switched, by diodes, in accordance with the mode setting. The frequency of the third conversion oscillator can be varied over a range of ± 2 to ± 5 kHz by a CLARIFIER control to simplify tuning of SSB signals. The entire audio amplifier section is a single integrated circuit.

A telescoping whip antenna screws into the receiver through a hole in the top of the cabinet. There are also terminals on the rear apron for a 75-ohm unbalanced external antenna. The built-in ac power supply can be operated from 117- or 240-volt, 50-to-60-Hz ac lines, as well as on internal D cells or an external 12-volt dc source. Even with the cells installed in the receiver, the ac power takes over when line power is available and the receiver is plugged into it, thus avoiding unnecessary battery drain. The signal meter and dial scale are illuminated when the receiver is operated on line power. However, during battery operation, a button on the front panel must be pressed to light them.

Also on the front panel are the audio VOLUME control/power switch, headphone jack, and front-facing built-in loudspeaker. Jacks on the rear apron provide access to an internal muting circuit for silencing the receiver during transmit in ham radio applications and to bring out a constant-level audio signal for connection to a tape deck. A slide switch changes the power supply from 117- to 240-volt operation, while a second switch inserts a 20-dB attenuator in the antenna circuit to prevent overloading by very strong signals.

The receiver's sensitivity is rated at $0.3 \mu\text{V}$ for SSB and $1 \mu\text{V}$ for AM between 2 and 30 MHz for a 10-dB (S+N)/N. From 0.5 to 2 MHz, the sensitivity is about 10 dB lower. The dial calibration accuracy is 5 kHz over the full tuning range, and the -6-dB bandwidth is 3 kHz for SSB and CW and 5.5 kHz for AM. Image and i-f rejection are rated at 50 dB. (The i-f rejection reduces to 40 dB above 20 MHz.) The audio output is 2 watts at 5% THD, and the internal loudspeaker is silenced when headphones or an external speaker are plugged into the front-panel jack. The entire receiver, exclusive of pilot lamps, is rated to draw less than 100 mA of quiescent current at 12 volts.

Laboratory Measurements. The AM sensitivity for a 10-dB (S+N)/N was $2.8 \mu\text{V}$ at 1 MHz, $2.4 \mu\text{V}$ at 3 MHz, and between 1.6 and $1.85 \mu\text{V}$ from 4 to 30 MHz. The SSB sensitivity could not be measured accurately because the agc could not be disabled; the signal output never rose more than 8 dB above the background noise level in the absence of a signal. Rough checks suggested that the SSB sensitivity was 0.6 to $0.7 \mu\text{V}$ over most of the frequency range. Tuning across a single band, 3 to 4 MHz, the sensitivity varied slightly, from $2.4 \mu\text{V}$ at the low end to $1.9 \mu\text{V}$ at the high end of AM.

The agc action was very good. The audio output level varied less than 2 dB from $0.5 \mu\text{V}$ input to the strongest signal we could apply. Selectivity could not be measured, again because the agc could not be defeated. The signal meter, which is uncalibrated and has three major divisions, reached the first division at $0.3 \mu\text{V}$, the second at $0.75 \mu\text{V}$, and the third at $11 \mu\text{V}$.

The i-f rejection at the first i-f (45 MHz) was 57 dB. The second i-f rejection (2.5 MHz) was 61 dB. And the third i-f rejection (455 kHz) was in excess of 100 dB. Image rejection, against a 52.5-MHz signal when the receiver was tuned to 3.5 MHz, was 93 dB. The dial calibration was accurate to within the 5-kHz rating; the typical error was less than 3 kHz. The clarifier range was typically about ± 3 kHz.

User Comment. The sensitivity of the receiver is more than adequate for most SWL and amateur radio work, and the triple-conversion design makes the receiver effectively immune to most sources of image interference. The receiver's stability was excellent, and we could never detect any drift, even from a cold start.

The dial calibration is certainly good enough for any SWL application and acceptable for amateur operation, except near the edge of a band. The CLARIFIER control makes tuning in SSB signals an easy matter. Even without it, the kHz tuning dial is fairly smooth and free from backlash to serve as a clarifier. The skirt selectivity of the i-f filter is obviously no match for that of the multi-pole crystal filters used in good amateur equipment because we could hear interference from strong signals just off frequency that was undetectable on a good amateur communications receiver.

The agc time constant is rather short, producing an annoying "pumping" effect on SSB signals. It could benefit from a

selectable long time constant and perhaps from a disabling switch.

The manual that came with the receiver points out the existence of strong spurious "marker" signals at integral megahertz intervals from the first oscillator synthesizer comb filter. These are useful as a check on dial accuracy, but they also prevent the reception of any signals within a couple of kilohertz of the integral megahertz points. There are also occasional low-level "birdies" when adjusting the MHz tuning control, but the tuning point is not critical and a slight readjustment eliminates the spurious response.

Although the receiver operated well with the built-in telescoping antenna, it should be used with an external all-band dipole or equivalent antenna for best results.

We judge this receiver to be a fine choice for the fairly serious SWL with limited funds. Although a noise blanker, slot filter and other such amenities are absent, the solid-state SSR-1 fills a total void in its class that was formerly held by Drake's no-longer-made SW-4A \$300 tubed model.

CIRCLE NO. 105 ON FREE INFORMATION CARD

COMING UP IN
THE FEBRUARY

Popular Electronics®

Build a Low-Cost
Logic Analyzer

How to Add Digital Frequency
Readout to a
Shortwave Receiver

Multimeters for Electronics
Part 2—Digital Meters

Test Reports:
Pioneer CTF8282
Stereo Cassette Deck
Acoustic Research AR-16
Speaker System

Hy-Gain Model 9 CB
Mobile AM Transceiver

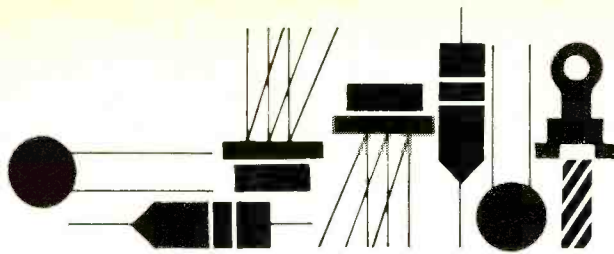

Solid State

By Lou Garner

THE GREAT GUESSING GAME

REGULAR readers of this column know that each January I like to challenge the semiconductor industry to a guessing game, predicting what new products will be introduced during the coming year, price trends, and possible technological breakthroughs. In many ways, it's a tough game. If I guess right, there are many who will say, in hindsight, "why that was obvious!" If I'm wrong, just as many will say, "even I could have done better." So goes it in every game. But it's still a lot of fun.

About my predictions. I use a variety of techniques. Some are straightforward extrapolations of present trends; if, for example, preliminary research work is being done in a certain technical area, we can predict with fair success that a commercial product based on that research will be introduced within a reasonable period. If a product with mass appeal, such as a digital calculator or watch, is introduced, we can anticipate expanding sales which, in turn, will lead to reduced prices. Other predictions are based on existing needs which, I feel, can be filled . . . a sort of "wouldn't it be nice if somebody made. . ." type of prediction. Still others are outright guesses based, if you will, on an intuitive "gut feeling" (oddly enough, these are often the most successful).

Virtually all of the predictions I've made within the last two decades have been fulfilled, although not always within the predicted time frame. In January, 1975, for example, I predicted two new products for that year which didn't materialize . . . a digital MPG (miles-per-gallon) meter for automotive applications and low-cost electronic games based on calculator technology. Yet both products were introduced during 1976, just a few months late. The digital MPG meter was announced by the Heath Company (Benton Harbor, MI 49022) as their Model CI-1078, while the calculator based games were introduced by Texas Instruments, as described in last month's column ("Calculator Squares" and "Check Out," both priced at under twenty dollars).

Let's see, now, how well I did with the predictions made in last January's column. In case you've forgotten, I predicted:

- *The introduction of additional special-purpose calculators utilizing nonvolatile memories.* Unless I missed a new product announcement somewhere, I score a big fat "zero" on this prediction. But it seemed like a good idea. Maybe next year!
- *Digital electronic watches retailing for less than \$25.* Oh, boy, did I hit this one on the button! In fact, TI almost beat me to the punch, announcing their new "under twenty dollar" digital LED watches within days after my column was published. Several other manufacturers, including Fairchild and National Semiconductor, met TI's challenge during the year, with a plethora of digital watches offered during the holiday sales for less than \$25 each.
- *More so than in previous years, 1976 should be the year of*

the programmable calculator, with an expansion in the variety of types offered, a general drop in prices, and the possible use of nonvolatile memories to retain programs. Right on! Programmable types are now available from virtually all calculator manufacturers, with some models retailing for under fifty dollars each. Both Hewlett-Packard and Texas Instruments cut the prices of their magnetic card programmable calculators during the year and, *as predicted*, a programmable model featuring a nonvolatile memory was announced last summer . . . HP's Model HP-25C. Featuring a CMOS "Continuous Memory," the HP-25C Scientific Programmable Calculator will retain an entered program or memory data for weeks, even when switched OFF. Priced at \$200, the HP-25C also offers a choice of fixed decimal, scientific or engineering notation as well as a RPN logic system with 4-memory stack, 8 addressable memories, 72 pre-programmed functions and operations, and full editing, branching and conditional test capabilities.

- *The introduction of pocket calculators featuring internal access connectors or jacks.* Although this concept hasn't caught on in a big way as yet, TI offers two pocket calculators (SR-52 card programmable and SR-56 key programmable) which have access connectors permitting their use with an optional external thermal printer, the PC-100. In operation, the PC-100 may be used to produce a "hard copy" (printed form) of data, intermediate results, calculation steps, or final answers. If desired, the unit will even produce a complete print-out of the calculator's program for permanent reference or checking purposes.

- *The development of higher density memory chips.* Check! Several semiconductor manufacturers are now offering memory chips with expanded capabilities and, as reported in *Circuits Manufacturing* last August, Siemens of Germany is now using a unique "lift-off" production process to produce higher-density IC's.

- *The use of microprocessor IC's in automotive applications, at least on an experimental basis.* Another winner! General Motors has scooped the auto industry by introducing a microprocessor-based electronic spark-timing system in their 1977 Oldsmobile Toronados. Dubbed MISAR (for Microprocessed Sensing and Automatic Regulation), the new system receives input data from several engine sensors on vacuum, coolant temperature, engine speed and crankshaft position. Using this data, the microcomputer calculates the best spark-firing position, then signals the ignition system's distributor to fire the spark at precisely the proper instant. According to a GM spokesman, the MISAR system should improve the auto's responsiveness and smoothness of ride, while increasing mileage by approximately 10%.

- *A substantial drop in the prices of microprocessor and*

Herb Laney's a tough-minded optimist. How about you?

Herb takes his future seriously. Without worrying about it. He knows his CIE training is giving him valuable skills in electronics. Skills a lot of people will be glad to pay for. And that's good reason for all the optimism in the world. How about you?

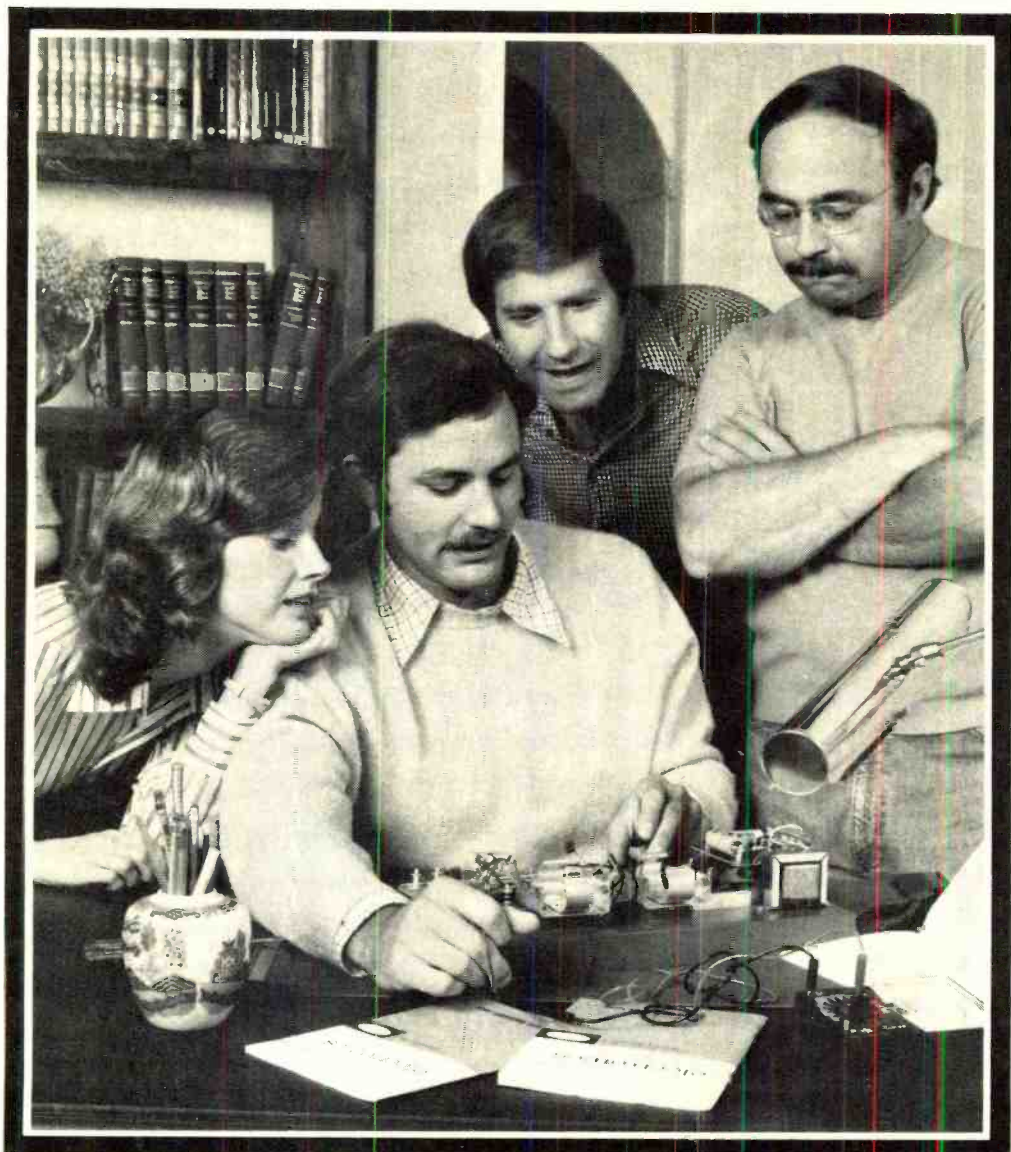

Learning new skills isn't something you just breeze through. Especially in electronics. You've got to really *want* success if you're going to build your skills properly.

Herb knew that right from the start. But he also knew what rewards he could earn if he took some time and did it right. He knew that, in today's world, people who really *know* electronics find a lot of other people... even whole industries... looking for their help.

How about you? How much do you want that thrilling feeling of success... of being in demand? Enough to work for it?

Why it pays to build skills and know-how.

One of the things that got Herb interested in electronics is that electronics seems to be something just about *everybody* needs. Almost everywhere you look these days — in a business office... a manufacturing plant... a department store... a doctor's office... a college... even your own home you'll find all kinds of electronic devices.

That spelled "opportunity" to Herb. Plus he liked the idea of having a set of skills that might lead to jobs in places as different as a TV station... a hospital... an airport... a petroleum refinery.

But what Herb liked *most* about electronics is that it's just plain *interesting*. Even though it takes time and effort to learn, the subject is so fascinating it *almost* doesn't seem like "studying" at all!

How CIE keeps you interested.

CIE's unique study methods do a lot to *keep* you interested. Since electronics starts with ideas... with principles... CIE's Auto-programmed® Lessons help you get

the idea — at your own most comfortable pace. They break the subject into bite-size chunks so you explore each principle, step by step, until you understand it thoroughly and completely. *Then* you start to use it.

How CIE helps you turn ideas into reality.

Depending on the program you choose, CIE helps you apply the principles you learn in a number of different ways.

If you're a beginner, you'll likely start with CIE's Experimental Electronics Laboratory. With this fascinating workbench lab, you actually perform over 200 experiments to help you grasp the basics! Plus you use a 3-in-1 precision Multimeter to learn testing, checking, and analyzing.

In some programs, you build your own 5MHz triggered-sweep, solid-state oscilloscope — and learn how to "read" waveform patterns... how to "lock them in" for closer study... how to understand and interpret what they tell you.

To help you develop practical, skill-building knowledge you then receive a Zenith 19" diagonal



solid-state color TV featuring nine removable modules. You learn how to trace signal flow... how to detect and locate malfunctions... how to restore perfect operating standards.

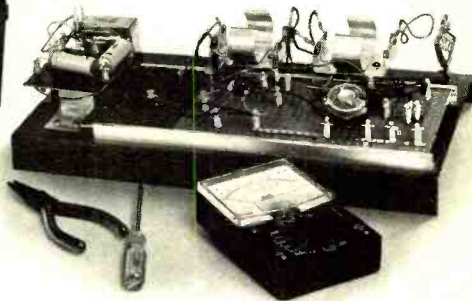

What to do first.

Get all the facts. Send for CIE's FREE school catalog and career information package TODAY. Check *all* the CIE programs — and see which one's right for you. Do it now.

Why it's important to get your FCC License.

More than half of CIE's courses prepare you for the FCC License exam. In fact, based on continuing surveys, better than 4 out of 5 CIE graduates who take the exam get their License!

That's important. For some jobs in electronics, you *must* have your FCC License. For others, employers often consider it a mark in your favor. It's *government-certified proof* of specific knowledge and skills!

Free catalog!

Mail the card. If it's gone, cut out and mail the coupon. If you prefer to write, mention the name of this magazine. We'll send you a copy of CIE's FREE school catalog — plus a complete package of independent home study information! For your convenience, we'll try to have a representative call to help you with course selection. Mail the card or coupon... or write: CIE, 1776 East 17th Street, Cleveland, Ohio 44114.



CIE Cleveland Institute of Electronics, Inc.

1776 East 17th Street, Cleveland, Ohio 44114
Accredited Member National Home Study Council

YES... I want to succeed in electronics. Send me my FREE CIE school catalog — including details about all electronics courses — plus my FREE package of home study information! PE-25

NAME _____
ADDRESS _____ (please print) APT. _____
CITY _____
STATE _____ ZIP _____
AGE _____ PHONE (area code) _____

Check box for G.I. Bill information: Veteran Active Duty

Mail today!

YOU CAN BE SURE

MORE TIMES IN MORE CIRCUITS WITH SENCORE DIGITAL MULTIMETERS

SENCORE

A NEW BREED OF DVM'S BACKED BY 25 YEARS OF ALL AMERICAN CRAFTSMANSHIP, WITH SIX EXCLUSIVE FEATURES, SO YOU CAN BE MORE SURE, MORE OFTEN AND ALL WITH HI & LO POWER OHMS FOR MEASURING ACCURATELY IN SOLID STATE CIRCUITS.

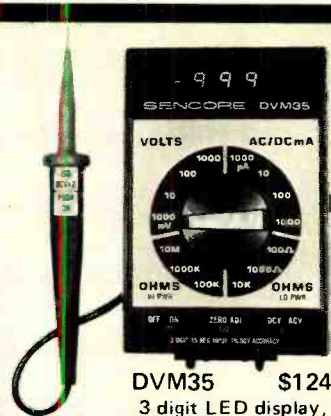

DVM35 \$124
3 digit LED display,
1% DCV accuracy,
battery or AC operated



I ONE THIRD LESS CIRCUIT LOADING to make you sure that you are affecting the circuit being tested as little as possible for more accurate measurements. Sencore digitals are 15 megohm, others are 10 megohm.



E 2000 DCV range to make you sure that you can measure TV boost volts, scope voltages, medical equipment, etc. Other digitals stop at 1000 volts. High voltage probe extends measuring capabilities to 50 KV.



E PROTECTED INSIDE AND OUT so you can be sure that your meter is working and not in the repair shop. Drop it from 10 feet, apply 1000 volts overload and even apply volts on ohms accidentally and Sencore digitals keep right on working.

memory IC's. On target again! Costing hundreds of dollars each when first introduced, μ P prices have dropped steadily over the years, with the really big break coming, as predicted, in 1976. Today, a Fairchild type 3850 CPU (Central Processing Unit) costs less than fifteen dollars each in unit quantities, with the companion 3851 program storage memory IC priced similarly.

● The introduction of a moderately priced thermoelectric module for the experimenter and hobbyist market. Oops! Bombed out on this prediction! Despite tremendous hobbyist interest, there is not, as yet, a really large market for thermoelectric devices, and without a mass market, manufacturers cannot achieve the production economies needed to make substantial price cuts. Guess we'll have to wait another year or two on this one.

Things to Come. As the two-faced god Janus, who could observe both the past and future, I must now turn to 1977. Taking my slightly cracked crystal ball in hand and peering into its misty depths, I foresee:

● A drop in the price of simple pocket calculators to the "five-dollar" range. Frankly, I can see no reason why a simple four-banger calculator can't be manufactured at a price competitive with pocket-sized AM receivers. Both products require about the same number of similarly priced components, and both require comparable labor for assembly.

● Similarly, basic digital electronic watches, probably 3-function LED types, retailing in the ten-dollar range. This may require another manufacturing breakthrough similar to the one made by TI in breaking the twenty dollar price barrier, but I think it can be done.

● Basic microcomputer kits for less than fifty dollars each in small quantities, greatly expanding their appeal to hobbyists and experimenters. Currently, the lowest priced kit with which I am familiar nets for about a hundred dollars. However, I'm confident that continued reductions in μ P and memory prices as the automotive and other mass markets develop will make a \$50 kit a practical reality. Of course, this is without power supply or input/output peripherals.

● Commercial digital multimeters selling in the fifty dollar, or less, price bracket. During mid-1976, Siliconix, Inc. (2201 Laurelwood Road, Santa Clara, CA 95054) introduced a new low-cost 3-digit monolithic digital voltmeter chip which should make possible such an instrument. Identified as the LD130, the Siliconix IC is a self-contained analog-to-BCD converter capable of driving standard CMOS or TTL display decoder/drivers. With an input impedance greater than 1000 megohms, the device offers a typical accuracy of $\pm 0.5\% \pm 1$ count, with built-in temperature compensation, automatic polarity and range changing, internal oscillator and analog stages, and a total power requirement of only 25 mW. Supplied in an 18-pin DIP, the LD130 can be operated with either a split or single-ended dc power supply.

● A marked increase in the availability and use of analog (linear) devices. Although the major emphasis in recent years has been on digital devices and their applications, some rather interesting developments have been taking place in the design and manufacture of linear or analog circuits. More important, the real world operates on an analog rather than digital basis, except at the micro or atomic level. Temperatures rise and fall gradually, not in discrete steps. Velocities, whether of natural phenomena, such as the wind, or of man-made vehi-

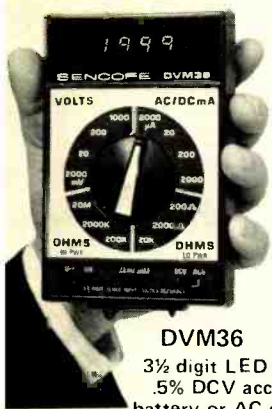

DVM36 \$148
3½ digit LED display,
.5% DCV accuracy,
battery or AC operated



DVM32 \$198
3½ digit LED display,
.5% DCV accuracy,
battery or AC operated
with automatic battery saver



DVM33 \$348
3½ digit LED display,
.1% DCV accuracy,
AC operated, auto-ranging,
auto-zero, king size pushbuttons



4 BATTERY SAVING FEATURES WHEN INSTRUMENT IS NOT IN USE so you can be sure that your meter will be ready the next time you need it. Push the button on the probe on the DVM35 and DVM36 and only then do you start drawing current from your battery. An automatic patented circuit does the same job for you automatically when you apply voltage to the DVM32. The DVM38 is AC operated.

TEN DAY FREE TRIAL

5 10 DAY FREE TRIAL to be sure that Sencore digitals are all that we say they are. Simply march into your Sencore distributor and ask for a free trial or pay cash with a promise of a 10 day money back guarantee, if not 100% satisfied. Or, write Sencore, and we will see that our distributor contacts you.



6 100% MADE RIGHT LIFETIME GUARANTEE so you can be sure your meter was made right. If at any time you discover that a Sencore DVM was not made right, Sencore will make it right, parts and labor free of charge, for the lifetime of the product.

Plus other "make sure" features such as - direct reading with no parallax error - no effect from magnetic fields such as motors & RF fields - lab accuracy with high resolution - auto-polarity auto-zeroing and auto-ranging on the DVM38 . . . and you can see why you can be sure more times, in more circuits, than with any other multimeter on the market today - and for less money than old fashioned analog meters.

SENCORE 3200 SENCORE DRIVE
SIOUX FALLS, S.D. 57107

CIRCLE NO. 53 ON FREE INFORMATION CARD

cles, change gradually, not in sudden steps. Even growth itself is a gradual, rather than stepped, process.

● *A breakthrough in solar-cell technology, leading to price reductions of up to fifty percent in the dollar/watt cost ratio of solar powered electrical systems.* Considerable research effort has been expended in this field and a technical/economic breakthrough is long overdue. For the immediate future, I envision a price drop to about \$10/watt . . . and, within a few years, to below \$5/watt. As the cost of solar powered electrical systems approaches a figure of \$1/watt, such systems will become competitive with general utility power for commercial and residential use.

● *The development of fast response liquid crystal displays, paving the way for the eventual development of practical flat-screen TV receivers.* In many respects, LCD's are perfect display devices, for they are thin, flat, light-weight, relatively easy to manufacture, operate on comparatively low voltages, and require minuscule amounts of power, while providing a quite acceptable image contrast ratio. Unfortunately, most currently available types have one serious limitation—a relatively long response time which makes it difficult to present moving images without excessive smearing and blurring. Eliminate this handicap and the LCD's potential applications will expand tremendously.

● *Increasing sophistication and complexity in solid-state video and calculator-based games.* Riding a popularity crest, video games have several limitations. No matter how fascinating the presentation, only limited skill is required to manipulate a knob or lever control. As the initial novelty wears off, I feel that users will demand—and get—games which require the simultaneous operation of two or more controls, which have

more play variation options, and which add a random element of "chance." Possible variations include the addition of foot pedal controls to be operated simultaneously with the hand control as well as controls with multiple operating planes. Naturally, such games will require new and more complex IC's.

● *Solid-state/fiber-optic control and/or communication projects and kits for experimenters and hobbyists.* With a LED at one end as a transmitter, a photosensor at the other as a receiver, a fiber optic "light conduit" offers a number of advantages over copper wire for transmitting communications data

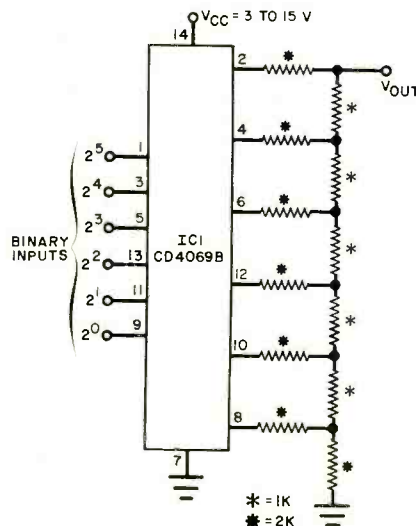

Fig. 1. Digital/analog converter uses COSMOS inverter.

or control information. Among these are freedom from hum and noise pickup, minimal phase shift, little or no distortion, and superb high-frequency response. Though a number of firms are developing commercial applications in this area, little or nothing has been offered to the experimenter/hobbyist. I feel that such projects and/or kits will be offered during 1977 with, perhaps, the first project a simple application, such as an intercom with a fiber-optic link between the master and remote station.

Readers' Circuits. Reviewing Robert Schuman's digital-to-analog (D/A) converter circuit in the June column, reader Keith Lawler (21 W. 264 Coronet, Lombard, IL 60148) suggests that his approach, illustrated in Fig. 1, may offer advantages over the earlier design in many experimenter applications. As in Robert's D/A converter, Keith has used a hex inverter (IC1) as a buffer and a weighted resistor network to combine the buffer's outputs and develop an analog signal. Keith's improvements consist of using a COS/MOS rather than a TTL inverter and an R-2R ladder network rather than a series of resistors with doubled and redoubled values. According to Keith, the COS/MOS device delivers more consist-

ent "1" and "0" outputs than does the TTL unit, while the R-2R ladder network is easier to assemble, requiring only two resistance values and a lower total parts count.

Referring to the schematic diagram, IC1 is an RCA type CD4069B, while the resistors are standard 1/4- or 1/2-watt types; for optimum results, precision (low-tolerance) resistors should be used in the ladder network. While neither parts placement nor the wiring arrangement are critical, customary care should be exercised when installing IC1 to avoid damage, remembering that this is a MOS device. The dc source is not critical and may range from 3 to 15 volts, furnished either by batteries or a well regulated and filtered line-operated power supply.

Ted Reiter (1442 Brook Drive, Titusville, FL 32780) suggests that the ubiquitous 555 timer can be used effectively as a CMOS-logic-to-TTL interface device. Given in Fig. 2, his circuits illustrate the use of the 555 as a CMOS/TTL buffer, Fig. 2A, and as an inverter, Fig. 2B. Neither design requires external resistors nor capacitors, and both can be operated on standard 5-volt dc power sources. In addition to serving as a CMOS/TTL interface, the 555 can be used as an interface driver between CMOS logic and relays, etc.

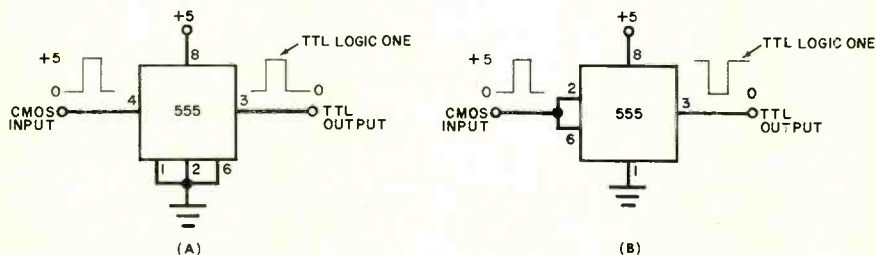

Fig. 2. Suggested CMOS-to-TTL interfaces using the 555. In a buffer circuit (A); and in an inverter circuit (B).

Get More from Your Car with a Mark 10 System.

The best-selling CDI system of its kind in the world—now at discount prices!

Would you like more power? Better mileage? And could you stand to eliminate 3 out of 4 of those expensive tune-ups? Well, that's what the MARK 10 capacitive discharge electronic ignition system is all about. Very simply, it boosts the spark to your engine—promoting better combustion, and minimizing combustion contaminants. Spark plug life is extended, all-weather starts are insured, and you can feel an increase in acceleration and overall engine performance—no matter what kind of car you drive. Learn more about a MARK 10 CDI system for your car (and take advantage of year-end discount prices), when you write today for a catalog and price list.



DELTA PRODUCTS, INC.

P.O. Box 1147, Dept. PE
Grand Junction, CO 81501
(303) 242-9000

I want to know more about Mark Ten CDI's. Send me complete no-nonsense information on how they can improve the performance of my car.

Name

Address

City State Zip

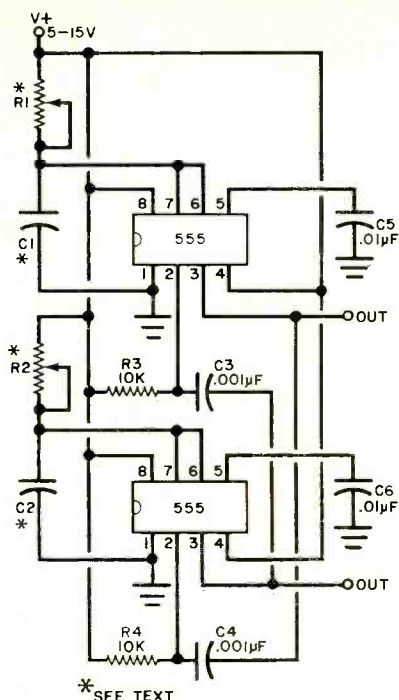

Fig. 3. A 555 complementary multivibrator.

Another interesting technique for using the 555 timer (or its dual version, the 556) is illustrated in Fig. 3. Submitted by Evan Williams (6995 Anglers Lane, RR1 Brentwood Bay, British Columbia VOS 1A0), the circuit features a pair of 555's interconnected to form a symmetrical multivibrator with a moderate output current capability. Evan developed the circuit for use as a low-power inverter, driving the primary of a small transformer through a series current limiting resistor (needed only if the transformer primary has a low dc resistance). For higher power inverter applications, Evan recommends that the circuit be used to drive power transistors connected to a center-tapped output transformer. In addition to its use as an inverter, Evan indicates that the design can serve in such applications as a two-phase clock for logic circuits, as a lamp flasher, and as a "coin flipper." He also suggests that a number of 555's can be interconnected in similar fashion to form a free-running ring oscillator which could be used in such projects as animated displays, games, or even for an electronic "roulette wheel."

Referring to Fig. 3, each 555 is connected for operation as a monostable multivibrator (or one shot), but is triggered by the negative edge of a signal from the other, coupled through differentiation networks C3-R3 and C4-R4. Each, then, is either "ON" or "OFF" alternately, with the duty cycle and operating rate (frequency) determined by timing networks R1-C1 and R2-C2. When one is serving as an output current sink, the other acts as a current source, thus providing true complementary operation and high overall efficiency.

When duplicating the circuit, neither layout nor lead dress should be critical as long as good wiring practice is followed, and the circuit can be assembled on a suitable pc or perf board using point-to-point wiring, as preferred. Resistors R3 and R4 are 1/4- or 1/2-watt types, while capacitors C3, C4, C5 and C6 may be either small ceramics, paper tubulars, or plastic film types. The values of R1-C1 and R2-C2 are determined by the desired frequency of operation, but each RC time constant must be greater than that of the input differentiator network (R3-C3 or R4-C4). If potentiometers are used for R1 and R2 (typically, 10k to 50k), connect a 1,000-ohm resistor in se-

ries with each to prevent reducing either resistance to zero. The supply voltage is not critical and the circuit should operate on sources of from 5 to 15 volts.

Device/Product News. On the West Coast, both the Fairchild Camera and Instrument Corp. (Digital Products Division, 464 Ellis St., Mountain View, CA 94042) and the National Semiconductor Corp. (2900 Semiconductor Drive, Santa Clara, CA 95051) have announced new products of potential interest to hobbyists and experimenters. If you're high on digital, you'll want to check into the newest additions to Fairchild's Isoplanar family of CMOS IC's, including the 4528 dual retriggerable, resettable monostable multivibrator, the 4511 BCD-to-7-segment latch/decoder/driver, the 4006 18-stage shift register, the 4041 quad true/complement buffer, the 4043 quad NOR R/S latch, 3-state, the 4044 quad NAND R/S latch, 3-state, the 4510 BCD up/down counter, and the 4516 binary up/down counter. All of the devices are designed to meet or exceed the new industry standard "B" Series CMOS specifications. On the other hand, if you're also (or more) interested in analog circuits, then you'll want to investigate National's new zinc and plastic package designs for their LX1700 series of pressure transducers as well as their new inexpensive AF100 series of active filters. Suitable for pressure measurements from ± 5 psi to 0-300 psi, the LX1700 devices are assembled in packages featuring key-locked cables and 5-pin connectors. Available in either 16-pin plastic DIP's or 12-pin TO-8 metal cans, the AF100 devices comprise three interconnected and one uncommitted op amps in a single package. Designed for use at frequencies up to 10 kHz, the devices can be programmed with external resistors to form virtually any filter network needed. ◇

1702A MANUAL EPROM PROGRAMMER

Features hex keypad, two digit hex address and two digit hex data display. Controls include load, clear, go! (step), key/copy, data in/data out, and counter up/down. Profile card includes high voltage pulse regulator, timing, 8 bit address and 8 bit data drivers/receivers. Two 6 1/2" x 9" stacked cards with spacers. Allows programming in 20 minutes - copying in 5 minutes. Requires +5, -9, and +80 volts.

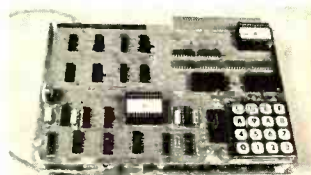

ASSEMBLED \$299.95
KIT \$189.95

NOW

The best of two worlds... use our 1702 EPROM programmer as a manual data/address entry programmer... or connect it to your processor.

IMSAI/ALTAIR computer interface (requires 3 output ports, +1 input port) and software \$49.95

Briefcase unit with power supplies and interface connectors (assembled and tested only) \$599.95

ANNOUNCING

Our NEW 16K Byte Pseudo-Static, IMSAI/ALTAIR compatible RAM. Single card slot. Uses less power than equivalent low power RAM. All memory chips socketed. Uses all prime, factory fresh ICs. High quality, two-sided, through-hole plated circuit board. Crystal controlled, totally invisible refresh system requires NO software management. Just plug it in and use like STATIC memory.

Complete kit \$349.95
Assembled, tested, and burned in \$549.95

ASSOCIATED ELECTRONICS

12444 Lambert Circle • Garden Grove, CA 92641
(714) 539-0735

CIRCLE NO. 11 ON FREE INFORMATION CARD

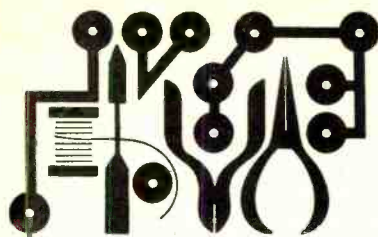

Experimenter's Corner

By Forrest M. Mims

THE LM339 QUAD COMPARATOR

Multiple integrated circuits are a real boon to the electronics experimenter. They reduce a project's parts count, and are less expensive than the equivalent number of single-function IC's. Furthermore, they make the assembly of projects requiring several IC's of the same type much easier.

A particularly useful multiple circuit IC is the LM339 quad comparator. This versatile chip contains four independent voltage comparators which can be operated from a single-ended power supply. The pin diagram for this IC (Fig. 1) shows how each of the comparators is connected.

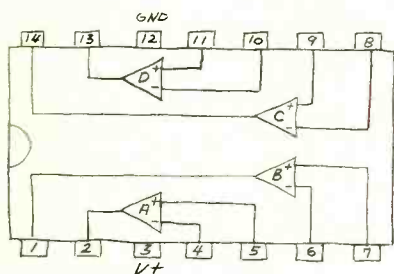

Fig. 1. Pin diagram of the LM339.

Before examining some practical applications for the LM339, let's briefly review comparator operation. As its name implies, a comparator literally compares two voltages. In a typical application, one voltage is supplied by a fixed reference and the other by a variable input signal. Whenever the signal voltage exceeds the reference voltage, the comparator switches on.

You can understand how a comparator works by thinking of it as an op amp without a feedback resistor, and therefore, having the highest possible gain. If you have used an op amp in this mode, you know that a relatively small input signal will cause the output to swing fully

on. Actually, a comparator is merely a modified op amp, and you can often operate an op amp as a comparator.

VCO Circuits. National Semiconduc-

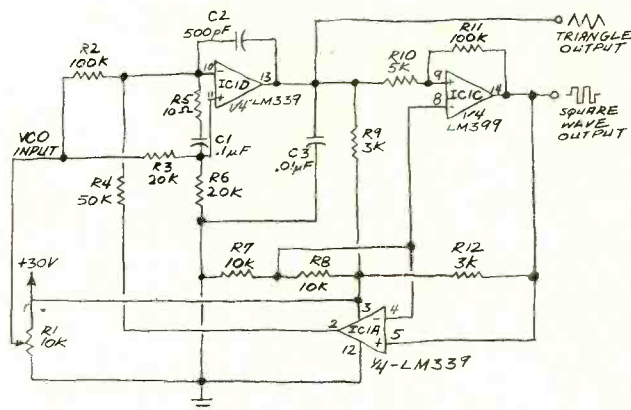

Fig. 2. Voltage-controlled oscillator using the LM339.

tor has published a number of circuit applications for the LM339 in application note AN-74 (R.T. Smathers, et al., "LM139/LM239/LM339: A Quad of Independently Functioning Comparators," January 1973). One of the most interesting circuits is the voltage controlled oscillator (VCO) shown in slightly modified form in Fig. 2.

A VCO is an oscillator whose frequency is governed by an input voltage. Two

important applications for VCO's are phase locked loops and analog telemetry systems. In the latter role, the variable voltage from a sensor is used to control the frequency of a transmitted tone. Changes in the tone frequency can be analyzed with a decoder circuit to determine variations in the sensor voltage.

The VCO of Fig. 2 provides both square and triangle wave outputs. The input control voltage is provided by potentiometer R1 which is connected as a voltage divider. But you can use any variable voltage source by removing R1 from the circuit and applying the control voltage between the input of the VCO and pin 12 (ground) of the LM339.

Figure 3 is a graph I plotted for the circuit of Fig. 2. The graph shows the VCO frequency versus the input voltage. Note that the relationship between the two variables is nearly linear. The graph also illustrates the wide dynamic range of the

circuit. With an input of 1 volt, the output frequency was 3447 Hz and the square waves at pin 1 were 150 μ s wide. With an input of 20 volts, the frequency was 50,869 Hz and the square waves at pin 1 only about 10 μ s wide.

With the values specified, the VCO will accept a minimum control voltage of about 40 millivolts, resulting in an output frequency of 8 Hz. You can increase C1 to 1 μ F for even lower frequencies.

Fig. 3. Control voltage vs operating frequency of LM339 vco.

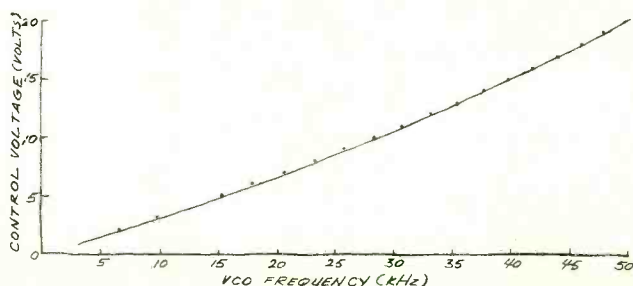

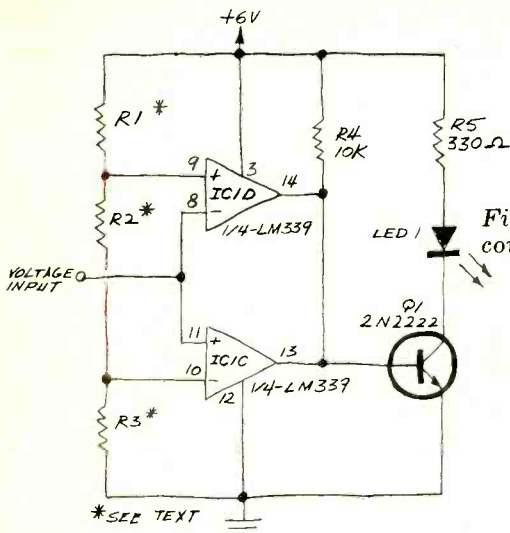

Fig. 4. LM339 Limit comparator.

Though all the results given here were made when a 30-volt power supply was used, the circuit will operate at much lower voltages.

Limit Comparators. Another interesting circuit is the limit comparator shown in Fig. 4. The circuit uses two of the comparators in the LM339, and its operation is straightforward. When both comparators are off, Q1 is turned on by the base bias from R4. In turn, Q1 activates LED1. If either comparator turns on, Q1's base is shorted to ground, and the LED turns off.

This circuit has a variety of voltage sensing and indicator applications. The voltages at pins 9 and 10 of the LM339 determine if either comparator will be turned on. They are established by the resistance ratios in the voltage divider R1 R2 R3.

Resistors R1 and R3 determine the voltage levels at which the LED switches

on and off. Because R2 is connected between pins 9 and 10, reducing its resistance causes the switching voltages of the two comparators to approach one another. Increasing R2's resistance causes the switching voltages of the comparators to diverge. Accordingly, the resistance of R2 can be changed to adjust the input voltage range over which the LED stays on.

By using potentiometers for R1, R2, and R3, I was able to adjust the circuit so that the LED turns on when very small input voltages are applied. For example, when R1 is about 500 ohms, R2 is about 1200 ohms, and R3 is about 1 megohm, the LED will begin to turn on when the input signal is only 4 millivolts! The LED will reach maximum brightness at 6 mV and turn off at 8 mV. When R1 and R3 are both about 15,000 ohms and R2 is 25,000 ohms, the LED will turn on at an input signal of 1.5 volts and turn off when the input reaches 4.2 volts.

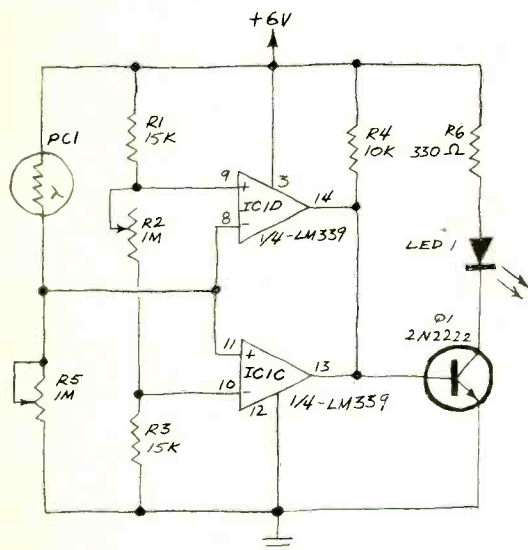

Fig. 5. Limit comparator operated as a programmable light meter

Be sure to experiment with the values of R1, R2 and R3. Also, you might want to try replacing Q1 with a PNP transistor (2N2907, 2N3906, etc.) to reverse the operation of the LED. A PNP transistor will cause the LED to be normally on and to turn off when a desired voltage appears at the input. If you try this substitution, reverse the emitter-collector connections for Q1 shown in Fig. 4.

I mentioned earlier that the limit comparator of Fig. 4 has a variety of voltage sensing and indicator applications. Fig 5 shows one such application, a programmable light meter. The light sensor is a standard cadmium sulfide (CdS) photocell with a high dark resistance and a low light resistance.

Potentiometers R2 and R5 can be adjusted to cause the LED to glow only at a desired light level, or to glow when the light either exceeds or falls below a preset level. Incidentally, note that photocell PC1 and R5 of Fig. 5 are simply added to the circuit of Fig. 4. Since these two components form a voltage divider, you might want to try experimenting with their location in the circuit to reduce the component count. For example, try substituting PC1 for R1 and R5 for R3. ◇

PROFESSIONAL DISCOUNTS

Texas Instruments
electronic calculator

TI-30	\$22.95	SR-51-II	\$59.95
1600	21.95	SR-56	79.95
1650	26.95	SR-52	199.95
2550-II	29.95	PC-100	199.95
SR-40	34.95	TI-5050M	99.95
Bus Anst.	42.50	5040-PD	119.95
5100	54.95	Laborates	26.00
Little Prof. (2 min)			\$16.95



HEWLETT PACKARD

(No credit cards)		HP-77	\$154.00
HP-21	\$ 71.00	HP-25C	175.00
HP-22	109.95	HP-67	395.00
HP-25	127.60	HP-97	664.95

NOVUS NATIONAL SEMICONDUCTOR

Math 4510 (2 min)	\$17.88	Statistician PR 6035	\$39.95
Scientist 4520	29.95	NS 852	24.95
Scientist PR 4525	54.95	NS 4615	39.95
Financier 6020	26.45	NS 4640	54.95
Statistician 6030	26.45	NS 4650	44.95
Financier PR 6025	39.95	NS 4660	59.95

In California call (213) 370-5795 or
ORDERS ONLY CALL (800) 421-0367 (other than CA.)
Send money order, Pers. ck (2 wks. to clear); in
CA., add 6% sales tax. Add \$2.50 min. shipping
charges US only \$4.00 for SR-52, PC-100, HP-67, 97.

Canada min. shipping charge \$6.50.
WE SHIP UPS AIR.

 **enterprises**
BETTER BUSINESS PRODUCTS

16611 HAWTHORNE BLVD., LAWNSDALE, CA 90260
(213) 370-5795

CIRCLE NO. 56 ON FREE INFORMATION CARD

LED CIRCUIT QUIZ

BY ROBERT P. BALIN

The seven-segment LED digital read-out has become a popular and important addition to many electronic devices. But getting them to light up may not always be a simple matter.

For example, in the circuit shown

here, as each of the switches (A-J) is closed, providing the segments with the proper voltage, a different digit is displayed. To test your ability at circuit tracing, see if you can determine what the numbers will be.

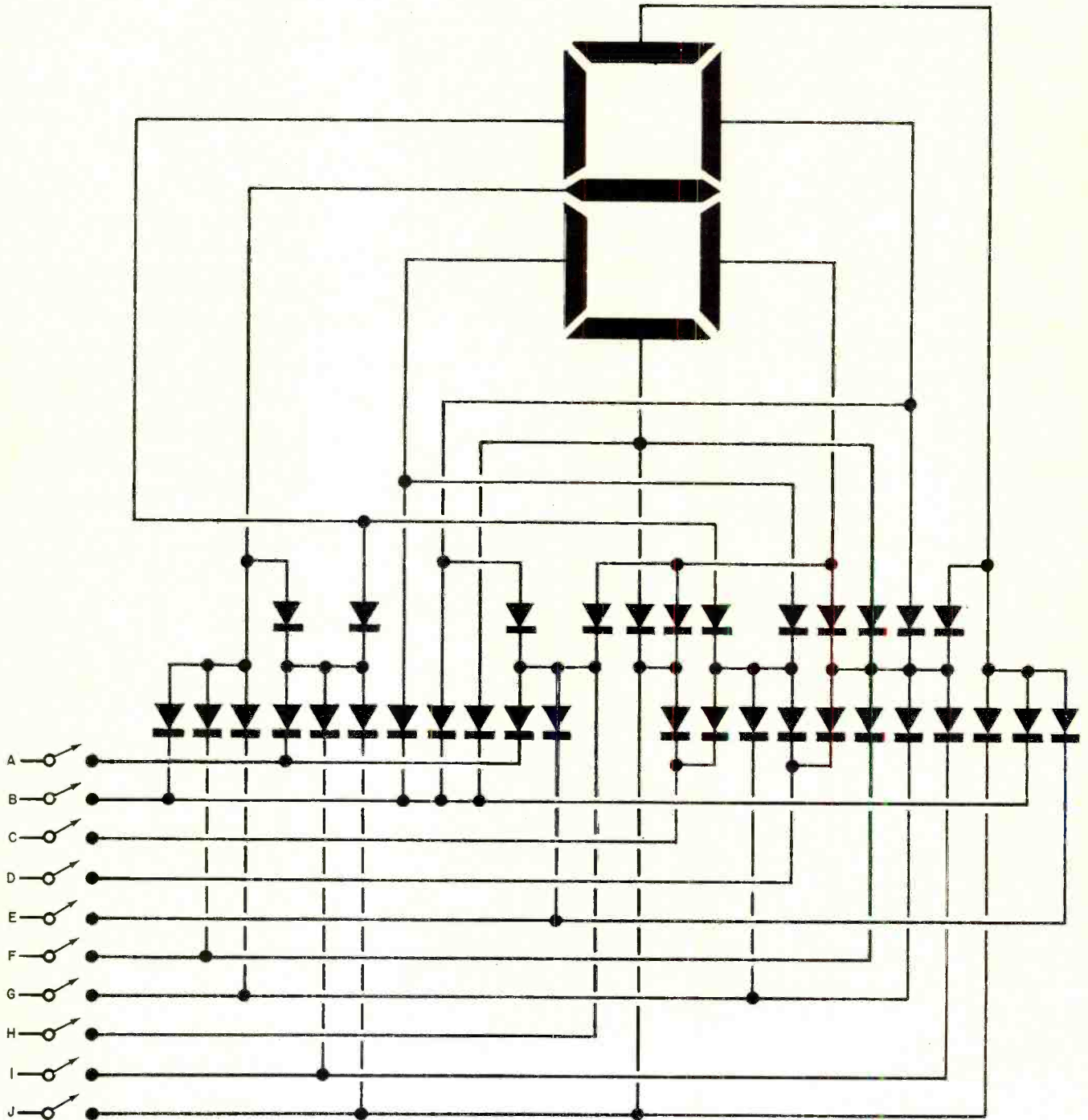

- | | |
|-----|-----|
| J-5 | E-7 |
| I-9 | D-0 |
| H-1 | C-6 |
| G-8 | B-2 |
| F-3 | A-4 |

Answers

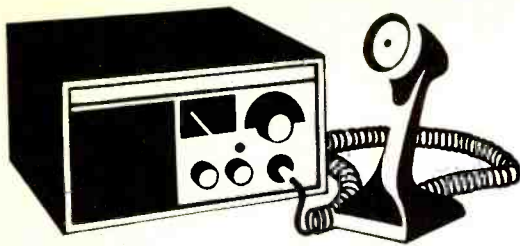

CB Scene

By Ray Newhall, KW16010

CB'S BUSIEST YEAR

IT HAS BEEN the biggest year ever for CB, with well over 7½ million new sets sold during 1976, and new license applications pouring into the FCC offices at Gettysburg, PA at more than ½ million each month. We have seen many technical advances in CB equipment and many new FCC Rules to govern its use in the past year or so. The most significant changes involved the liberalization of operating rules and procedures, increasing the number of channels available from 23 to 40, and affirmation by the FCC that CB is here to stay.

The new 40-channel rules, which go into effect on January first, do not obsolete the older 23-channel rigs in any way. In fact, there will never be better buys in CB gear than you can get right now.

The 40-channel rigs, when they become available, promise to be at least 20% more costly than older 23-channel units. Moreover, technical emission requirements are stiffer, a step taken to reduce interference to other types of electronic equipment as well as to adjacent channels. In addition to requiring greater attenuation of spurious harmonics from the transmitter, a receiver certification must be obtained for the first time to minimize signal radiation from local oscillators.

The radiation standard of 5 µV has been stretched to 8 µV in actual FCC tests. Moreover, the limit for production-model sampling is an unofficial 15 µV. This leniency may be decried by some people, but it's difficult to lower the boom in one fell stroke without seriously impairing production or increasing prices, as witness auto pollution devices.

For those owners of older CB transceivers with individual channel crystals, the FCC does not permit changing crystals to receive or transmit on any of the new 17 channels. Twenty-three-channel (or less) units can still be manufactured, you should know. However, manufacture must cease by August 1, 1977 if they do not meet the new standards. Furthermore, sales of old type-accepted

units that are not certified for new standards must stop after January 1, 1978, although persons owning such rigs are permitted to continue to use them.

Present owners of 23-channel rigs shouldn't bite their wrists because they do not own 40-channel ones. As observed at other times, there won't be many people to talk to for a while. Channel 9 is still the emergency channel, and it'll be about three years before land-mobile communicators, which share four of the new CB channels (channel 24 at 27.235, channel 25 at 27.245, channel 26 at 27.265 and channel 27 at 27.275) must stop operation. With up to 30 watts input power permitted to these Industrial, Land Transportation and Public Safety Radio Services licensees, some of the new channels will be exposed to the possibility of interference that users never expected.

Looking Back. The two 1976 articles in this column that stirred the strongest reader response were those about (1) "Avoiding CB Ripoffs" (June) and (2) "Is Class E Dead" (August). Here are some of these reader comments, and other points which have come to our attention.

CLASS D CB FREQUENCIES

(Effective Jan. 1, 1977)

MHz	Channel	MHz	Channel
26.965	1	27.215	21
26.975	2	27.225	22
26.985	3	27.255	23
27.005	4	27.235	24
27.015	5	27.245	25
27.025	6	27.265	26
27.035	7	27.275	27
27.055	8	27.285	28
27.065	9	27.295	29
27.075	10	27.305	30
27.085	11	27.315	31
27.105	12	27.325	32
27.115	13	27.335	33
27.125	14	27.345	34
27.135	15	27.355	35
27.155	16	27.365	36
27.165	17	27.375	37
27.175	18	27.385	38
27.185	19	27.395	39
27.205	20	27.405	40



Want a career in electronics? Like to attend a university with a world-wide reputation in engineering education? Northrop University offers a small-class environment where learning really happens. The faculty, many have wide industry experience, are always there to help. The facilities are top-notch and graduate placement continues to be outstanding. Many EE students belong to the student chapter of the Institute of Electrical and Electronic Engineers, a national professional society. These students know . . . opportunities in electronics, begin at Northrop U.

For information, complete and mail the coupon below. There's no obligation, of course.

NORTHROP UNIVERSITY

1123 W. Arbor Vitae Street
Inglewood, California 90306

An independent, accredited, coeducational senior institution offering undergraduate and graduate programs in engineering, math, science, technology, computer science and management.

Northrop University 1123
1123 W. Arbor Vitae St., Inglewood, CA 90306

Please send me more information, I am interested in:

- Undergraduate Graduate
 Colleges of: Engineering, Technology, Science & Humanities
 College of Business & Management
 Institute of Technology (A & P)
 School of Law (Graduate)

H.S. Grad. Date _____ 19 _____

Name _____ Age _____

Address _____

City _____

State _____ Zip _____

(1) Many of the responses to the CB theft article were from CBers who wanted to relate how their own rigs were ripped-off.

We received several responses from readers who were inquiring about the best way that they could register the serial numbers of their rigs in order to increase the chances of recovery in case of theft. In our article, we recommended against such registration programs because such lists, if published, might provide excellent shopping lists for would-be thieves. However, one company came up with a plan which showed promise. They planned to list subscriber's serial numbers in their computer in such a manner that they could quickly recover the name and address of the registered owner upon request of bonafide law enforcement agencies who could make use of a confidential toll-free number.

This plan has stirred the interest of several law enforcement agencies. It should be especially useful now that all new rigs must include a permanently-affixed, unique serial number. Unfortunately, we have not been able to contact that particular company recently to confirm the fact that they are still in business at the original address.

We received many announcements from commercial interests plugging anti-theft products, but one of the more interesting devices brought to our attention was sent in by an electronics experimenter, Dave Medlin of Northfield, MN, who sent us a simple circuit diagram for an SCR trigger device which will sound an alarm when the ground circuit from the rig is broken (see diagram). It only draws about 1/2 mA of idle current and should not discharge a vehicle's battery even over an extended period of time; or it could be rigged to include an independent battery.

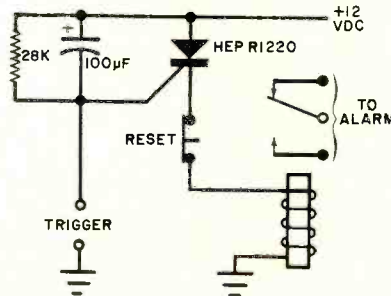

(2) The "Class E" article, which described a proposed class of CB radio in the high VHF frequencies and utilizing frequency modulation, drew a deluge of angry letters from Hams who are under-

standably concerned that they may lose a part of their frequency allocations to CB for the second time. But not all the letters, not even all of those from Hams, disagreed with the Class E proposal. It has now become evident that a new band must eventually be established to provide our citizens with high-quality personal communications. Whether or not the "Class E" band is the way to go is another question.

Keep Letters Coming. This type of feedback from our readers is very important because it lets us know who is reading our column and what they'd like to see covered.

We know that many CBers are reading our column and subscribing to POPULAR ELECTRONICS by the tremendous response we have had to the offer to send a Form 555-B to anyone who will send us a self-addressed, stamped envelope (more than 500 received). We'll continue to supply these forms and will also keep a supply of license applications (Form 505) on hand as well, even though they will be packed with all new sets sold after January 1, 1977. Please send requests to REST MARINE, Box 170, Old Greenwich, CT 06870. ◇

Circuits happen Faster and Easier with Super-Strip.™

As little as
\$17



Now, whenever you'd like to give a circuit a try, you can build it up nearly as fast as you can dream it up with Super-Strips™, the faster, easier and less expensive solderless breadboards from A P Products. When you build your circuit on a Super-Strip, everything stays as good as new. Once you're through, you can use everything again and again. Instantly. Put a Super-Strip to work for you. Eight distribution lines handle signal and power, and 128 five-tie-point terminals can handle 9 ICs and then some. It's a whole lot easier than printing a circuit and a whole lot handier than haywire.

Part Number	Model Number	Terminal Type	Price Each
923252	SS-2	nickel-silver	\$17.00
923748	SS-1	gold-plated	\$18.90

Order from your A P distributor today. Our distributor list is growing daily. For the name of the distributor nearest you call Toll-Free 800-321-9668.



Send for our complete A P catalog, the Faster and Easier Book.

A P PRODUCTS INCORPORATED

Box 110-H Painesville, OH 44077 (216) 354-2101 TWX: 810-425-2250



Computer Bits

TEXT EDITING

By Hal Chamberlin

TEXT EDITING is a fundamental function that almost every hobby computer will be called upon to perform. Even an operation as simple as typing a command into a monitor program and then backspacing to correct an error is a form of text editing. Preparing programs in assembly language or BASIC is primarily program text editing. In fact, most BASIC language systems have a built-in text editor. A good program editor can greatly increase the speed, accuracy, and fun of writing large programs.

An editor designed for English text would be useful to non-computer-oriented family members as well. For people who hate to write letters, a text-editor program makes it so easy that the relatives will be swamped with mail. Maybe your sister types dissertations and reports for students at a nearby university. A good text-editing program could increase her speed and accuracy to the point of making it a lucrative business. An author is much more productive (at least this one is) when sentences and paragraphs can be rearranged on the spot to make the work "sound right."

Hardware. Every microprocessor in common use by hobbyists is ideal for text editing applications. The amount of memory required is not great; 4k bytes is adequate for a useful system but 8k allows a sophisticated editor program, as well as a full single-spaced page of text, to fit in memory at once.

If the goal is quality editing of English text for reports, then an upper- and lower-case keyboard is needed. A good "feel" is helpful if a touch typist will be using the system. A useful keyboard feature is a shift-lock key that affects only the letters of the alphabet. There are many suitable keyboards on the surplus market. The best ones for text editing are those made by Microswitch and Clare-Pendar.

Since the goal of most text editing is to produce letter-perfect printed pages, some kind of printer is necessary. For informal work a Teletype, either ASCII or

Baudot, is acceptable. For higher quality upper- and lower-case reproduction, about the only present possibilities for the hobbyist are a used Selectric terminal (golf-ball printer) or a manual Selectric typewriter converted to computer operation. In a year or so, used "daisy wheel" printers made by Diablo and others, should be appearing on the surplus market. These are an absolute "dream come true" in a text-editing application. A printer is the biggest obstacle to overcome in setting up a text-editing system.

Having a CRT display on a text-editing system is like having a picture with your TV sound. Usually the text being typed in or edited is shown on the screen exactly as it would appear when printed out. When editing, finding the exact phrase or word to be changed is very rapid and the result of the change is instantly visible. If the change involves an insertion or deletion, the editing software automatically moves words from line to line to maintain an even right margin. Similarly, if a sentence or paragraph is moved elsewhere on the page, the movement appears immediately on the screen.

By far the best kind of video-display interface to use for text editing is one that generates the display from directly addressable computer memory. Here, merely moving bytes around in memory will also move the text around on the screen. If your computer has an "ALTAIR" bus, the VDM-1 from Processor Technology or the PolyMorphic Systems video interface are ideal. In addition they



Video monitor driven by computer displays first lines of this column.

offer both upper- and lower-case characters and a line length of 64 characters, as wide as a typewritten page with one-inch margins. The typical "TV typewriter," although excellent for communicating with the computer, is less suited to editing applications, because most changes to text on the screen require retransmission of the whole page through a serial I/O port. Also, the 32-character line with upper-case only is awkward in most cases.

A mass-storage device, while not required, can greatly increase the usefulness of an editing system. Without mass storage you are limited to editing what can fit in your available memory. For short reports this might not be much of a restriction since one page at a time can be typed in, edited, and printed. With long reports or programs, mass storage allows editing and updating to be done days or weeks later. Because of frequent insertions, deletions, and updates, a floppy disk is better suited to text editing than the low-cost tape cassette approach. However two high-speed program-controlled cassette decks can be successfully used. A sophisticated system with mass storage allows text to be appended from one page onto another as well as provide for maintaining full pages during insertions. In fact, a good editing program also makes a dandy general-purpose information storage and retrieval system.

Software. Once the needed hardware has been assembled, the key to a useful system is the editing software. Unlike most other applications, very little specialized knowledge is required to write an editing system; only a good knowledge of programming techniques. In most cases common sense and experience with manual editing of text will be sufficient to keep system development on the right track.

One of the fundamental decisions to be made is whether a program editor or an English-text editor is desired. The main difference is that programs are line-oriented (each line of text is independent) and English text is sentence- and paragraph-oriented, with little importance attached to actual lines. A strict program editor is easier to write but is of limited use on English text. On the other hand, a good English text editor can handle programs well also.

A related decision is whether text stored in the system is page-oriented or handled as a long scroll. A page is the amount of text that fits on a standard typewritten page; about 50 lines single-

The POLY 88 Microcomputer System is here!



POLY 88 is a complete, solid and trustworthy personal computer. No technological background is required to enjoy this versatile machine.

The POLY 88 is the invaluable tool for the home and office. With it, children can play or even develop their own mathematical and scientific games. Simple or Complex equations and projections can be programmed, stored and altered in the BASIC programming language. The POLY 88 starts at \$595 in kit form.

If you are in need of a quality tool, the POLY 88 is it.

PolyMorphic Systems

737 S. Kellogg, Goleta, CA 93017
(805) 967-2351

CIRCLE NO. 45 ON FREE INFORMATION CARD

spaced or 25 lines double-spaced. A scroll has a variable number of lines according to the particular text being edited. Programs are best handled as a long scroll, since actual printed-page boundaries are of little significance. One scroll might be an entire program of hundreds or thousands of lines. A page-oriented system is better suited to English text, since one could not expect titles and paragraph breaks to come out right if a long scroll were printed simply as 50 lines per page.

When text is stored on a mass storage device, a software-maintained *index* is quite helpful to both the operator and the software in locating the desired page or scroll. Each index entry could give a name, a sequence number, and the location on the storage medium for each page or scroll stored. The name identifies and briefly describes the associated text. The sequence number might be a page number in a particular report. The storage location gives a record number or a track and sector number of the text depending on whether a tape or disk is used. Software could be written so that a user command such as "GET (name)" would search the index for the requested name and read the text into memory for display and editing. Additional commands and associated software would be available for creating new pages, deleting unwanted pages, and renaming or resequencing pages. Some of these index-manipulation commands may not be needed with a program editor.

One very useful feature in an English text-editing system which alone increases typing speed substantially is called *word wrap*. With an ordinary typewriter, the user is constantly listening for the end-of-line bell and worrying about fitting words into the right margin. With word-wrap software the computer automatically moves any words that don't fit within the right margin to the next line while they were being typed in. Thus the user simply types away without having to type carriage returns and need not stop until the end of a paragraph.

Within the software there will be a number of elementary subroutines for handling the display. The most basic are the cursor-movement routines. For example, with the VDM-1 display, a cursor is displayed by setting the eighth bit in a byte to one. When this is done the character is shown as black on a white background. Normally only one character will have this bit on and the cursor is said to be at that character position. There is a switch on the VDM-1 board that causes the cursor to flash if desired. Besides

having the bit set, there are two numbers to be maintained in memory; one is the line number of the cursor and the other is the character number. Four cursor-movement routines are needed: left, right, up, and down. The routines would be fairly simple; cursor left deletes the cursor bit in the character pointed to by the cursor, decrements the cursor character number, and then sets the cursor bit in the character at the new cursor location. Cursor right is the same except that the character number is incremented. Up and down are also the same except that the line number is manipulated. Note that checking will have to be done to prevent the cursor from going off the page. If the keyboard being used has some extra keys, a good use for them is cursor movement.

Even if the editor is page-oriented, a scrolling routine will be needed to allow the user to see all of the page with a 16-line display. Normally there would be a text buffer in memory to hold the entire page being edited. One k-bytes of that buffer would be stored in the display memory and show up on the screen. One approach simply divides the page into 16-line segments and provides a command to display the desired segment. A better approach would constantly adjust the display and text buffers so that the line the cursor is on is in the middle of the screen. Then in all cases the user could see several lines of text before and after the line being edited. Most microprocessors are fast enough so that the text movement associated with display scrolling is essentially instantaneous.

The actual editing of text is done with a fairly small number of commands. Mostly one wants to insert, delete, and move basic elements of text such as characters, words, lines, sentences, and paragraphs as well as simply type over mistakes. The cursor is very important in performing these functions. To perform a typeover, the user positions the cursor at the first character to be changed and starts typing. Actually, simple entering of new text can be considered as typing over blanks. For deleting characters, the cursor is placed at the first unwanted character and a "delete character" key is pressed. For maximum usefulness, the text to the right of the deletion moves left to fill the hole created and the cursor winds up on the next character. Thus multiple characters are deleted by using the "repeat" key with the delete-character key. For insertions, the cursor is placed where the insertion is to be made and an "insert mode" key is pressed.

**CONFUSED BY
ELECTRONIC
IGNITION CLAIMS ?**

**The
PROOF is in
PERFORMANCE!**



Amazing MEGASPARK, the advanced-design Opto-Electronic Breakerless Ignition System, FITS ANY CAR! Replaces points and condenser — gives longer spark plug life. Increases performance, mileage and driving satisfaction while cutting fuel and maintenance costs dramatically. Learn the facts and don't settle for less than the best. Models from \$29.50 to \$64.50

The only unit that gives you all these features:

- LIFETIME WARRANTY
- DIFFERENTIAL AMPLIFIER CIRCUITRY
- FULL INTERNAL VOLTAGE REGULATION
- SUPERFAST DARLINGTON OUTPUT STAGE
- AUTOMATIC OVERCURRENT PROTECTION

Rush name and address for FREE information package including catalog and discount offer. Or call toll-free 24-hours 800-648-4711, Ext. 22.

MEGASPARK™
by **ISI** IGNITION SYSTEMS INC.
2547-S4 Eighth Street
Berkeley, California 94710
(415) 845-3584

Now, as each character is typed, text to the right of the cursor moves right and down to make room for the next piece of inserted text.

For larger elements of text the concept of "designation" is helpful. First there are commands to designate a word, a line, a sentence, and a paragraph. To perform a designation, the cursor is placed anywhere in the element to be designated and the appropriate command given. The software then searches forward and backward, applying rules for the text element to determine which characters are within the element. The rules for a sentence, for example, might be any string of characters starting with a capital and ending with a period. Designation might be shown on the screen by turning the cursor bit on in the designated block. Once a block is designated, it could be either deleted or moved somewhere else.

In a system with mass storage, a useful function is appending text from one page to another. A simple implementation would allow text from another page to be placed at the bottom of the page being edited. The converse operation would split one page into two or more pages. With these functions, text can be easily moved around in a report. Also, documents can be assembled from previously stored paragraphs.

Finally, there is a large number of possibilities for "justifying" edited text for final printout. The simplest is to make sure that the maximum number of words possible are on each line. This will give a standard typewriter appearance with ragged right margin. If a flush-right margin such as in newspapers is desired, a method that is compatible with standard printers is to distribute the blanks at the end of the line between the words. Unfortunately the word spacing may become a little erratic, but many people prefer the "blocked-off" appearance of the text. In both cases the appearance can be improved by hyphenating long words at the end of the line. Automatic hyphenation according to the rules of English is difficult to program. A good compromise is to have the software ask the user how words that need to be broken should be hyphenated. A very impressive demonstration is provided by a justification routine moving words around on the display screen.

A useful editing program need not have all of these features, but one nice property of text-editing applications is that new functions can be easily added when desired up to the limits of available memory. ◇

Operation Assist

If you need information on outdated or rare equipment—a schematic, parts list, etc.—another reader might be able to assist. Simply send a postcard to Operation Assist, POPULAR ELECTRONICS, 1 Park Ave., New York, NY 10016. For those who can help readers, please respond directly to them. They'll appreciate it. (Only those items regarding equipment not available from normal sources are published.)

Nemsclarke (Div. of Vitro Corp.) Model 1432 Phase Lock receiver. **Air Associates** Model CR3-G receiver. Coil data for Air Associates manuals and schematics for both. Rudy Rutener, 20632 Hartland #2, Canoga Park, CA 91303.

RCA Model WO54B 3-inch oscilloscope. Need schematic and alignment instructions. Henry M. Gort, Box 289 Chloride Star Rt., Kingman, AZ 86401.

Signal Corps Model BC-348L receiver built by Belmont. Schematic and/or manual. Darhl Boucher, R.D. 1, Falls Creek, PA 15840.

General Electric GE-93 multi-band radio. Schematic and alignment instructions. **Ballantine** Models 220 ac VTVM and 314 decade amplifier. Schematics and operating instructions. Rad Smith, 3188 Rumsey Drive, Ann Arbor, MI 48105.

Atwater Kent Model 60. Schematic and any info on restoring, source for tubes, and speaker rebuilding. Bruce Boyes, 976 River Hts. Blvd., Logan, UT 84321.

U.S. Govt-National R-651/URR39 receiver model NC183MR. Schematic and/or service manual. Sal Ruggieri, 345 Aldrich Rd., Howell, NJ 07731.

Tube source for 19X8 and 12AL5. W. Clumm Entwood, R.R. 1, Amesville, OH 45711.

Precision Apparatus Model EV-10 VTVM, **Precise** r-f/a-f/TV marker/bar generator Model 630. Schematics and/or manuals. David Houston, 1076 Williston Road, Burlington, VT 05401.

Cariole Model 19545 cassette recorder. Schematic and any other information. Max Hatwig, Alexander, IA 50420.

Phone King Model J36 telephone answering device. Schematic and parts list or maintenance manual. Masha Cornfeld, Apt. 2, 1261 N. Laurel Ave., Los Angeles, Ca 90046.

Audion Model 2515-1 AM/FM/8-track/phonograph. **Matter** SP-200 100-W/ch audio power amp. Schematics, service manuals, or Audion address. G.D.C., Box 824, Huntsville, AL 35804.

Analab Model 1120 oscilloscope main frame with #700 plug-in. Schematic needed. Ken Lesniak, 15 Academy Road, Somers, NJ 08873.

Precision Apparatus Co. Series EV-10A VTVM. Schematic. George F. Oelkers, 609 St. James Rd., Newport Beach, CA 92663.

Bradford Model S52506 portable stereo cassette recorder. Schematic and/or service manual and source for replacement heads and switch contacts. Tim Melton, Box 1738, Cave Creek, AZ 85331.

Western Electric Model RU-17 aircraft radio receiver. Built for BuShips contract 84530 21 April 1941. Maintenance and operating manuals, and source for plugs and jacks used on this equipment. S.E. Stokes, 26006 Crenshaw Blvd. #115-B, Torrance, CA 90505.

Keystone Model 2000-CSR stereo cassette deck. Service manual or schematics. Roy Cantu, 1980 Flora Place, Eureka, CA 95501.

Capehart Deluxe Model 411M AM/FM/SW radio and phonograph manufactured by Capehart Division, Farnsworth TV and Radio Serial 18507F. Company address, schematics, and any manuals available. Scott Stockwell, R.R. 1, Box 102, Riley, KS 66531.

Motorola Model AN/VRC-19 transceiver containing transmitter T-278/U and receiver R-394-U. Any available information. Mel Swanberg, 1037 Scripps, Claremont, CA 91711.

RCA Victor Model 8-V-151 Victrola radio phonograph. **Navy** surplus receiver type CAY-46077-A. Schematics needed. Roger Ream, Rte. 5, Box 62-H, Melbourne, FL 32935.

Electronic Tube Corp. Model K470 oscilloscope. Service manual and/or schematics for scope, power supply, and plug-ins. L. Beecroft, 5913-54th Ave., Red Deer, Alta., Canada T4N 4M7.

Put Professional Knowledge and a COLLEGE DEGREE in your Electronics Career through HOME STUDY

Earn Your DEGREE

by correspondence, while continuing your present job. No commuting to class. Study at your own pace. Learn from complete and explicit lesson materials, with additional assistance from our home study instructors. Advance as fast as you wish, but take all the time you need to master each topic. Profit from, and enjoy, the advantages of independent study.

The Grantham electronics degree program begins with basics, leads first to the A.S.E.T. degree, and then continues through the B.S.E.E. degree level. Our free bulletin gives complete details of the program itself, the degrees awarded, the requirements for each degree, and how to enroll. Write or phone (no collect calls please) and ask for BULLETIN E-77

Grantham School of Engineering
2000 Stoner Ave., Los Angeles, CA 90025

● Telephone (213) 477-1901 ●

Worldwide Career Training thru Home Study

CIRCLE NO. 27 ON FREE INFORMATION CARD



You can build a better organ than you can buy!

A magnificent Schober Electronic Organ

What a marvelous way to put your special talents to work! With our Schober Electronic Organ Kits and your skill, you can build yourself some very special satisfaction, and a lifetime of great music!

Schober Organs are literally far superior to comparably-priced "ready-made" units. You could actually pay twice as much and get no better organ... and miss the fun of assembling it yourself. A PC board at a time, component by component, you'll assemble your own "king of instruments." And when you're done, you'll wish there was more to do. And there is! For then, Schober will help you learn to play, even if you've never played a note before!

Schober Organ Kits range from \$650 to \$2850, and you can purchase in sections to spread costs out... or have two-year time payments.

Just send the coupon for the fascinating Schober color catalog (or enclose \$1 for a record that lets you hear as well as see Schober quality.)

The **Schober Organ Corp.**, Dept. PE-69
43 West 61st Street, New York, N.Y. 10023

Please send me Schober Organ Catalog.
 Enclosed please find \$1.00 for 12-inch L.P. record of Schober Organ music.

NAME _____
ADDRESS _____
CITY _____ STATE _____ ZIP _____

CIRCLE NO. 51 ON FREE INFORMATION CARD

ELECTRONICS MARKET PLACE

NON-DISPLAY CLASSIFIED: COMMERCIAL RATE: For firms or individuals offering commercial products or services, \$2.25 per word (including name and address). Minimum order \$33.75. Payment must accompany copy except when ads are placed by accredited advertising agencies. Frequency discount; 5% for 6 months; 10% for 12 months paid in advance. **READER RATE:** For individuals with a personal item to buy or sell, \$1.35 per word (including name and address.) No minimum! Payment must accompany copy. **DISPLAY CLASSIFIED:** 1" by 1 column (2-1/4" wide), \$260.00. 2" by 1 column, \$520.00. 3" by 1 column, \$780.00. Advertiser to supply film positives. For frequency rates, please inquire.

GENERAL INFORMATION: First word in all ads set in caps at no extra charge. All copy subject to publisher's approval. All advertisers using Post Office Boxes in their addresses **MUST** supply publisher with permanent address and telephone number before ad can be run. Advertisements will not be published which advertise or promote the use of devices for the surreptitious interception of communications. Ads are not acknowledged. They will appear in first issue to go to press after closing date. Closing Date: 1st of the 2nd month preceding cover date (for example, March issue closes January 1st. Send order and remittance to **POPULAR ELECTRONICS**, One Park Avenue, New York, New York 10016, Attention: Hal Cymes.

FOR SALE

FREE! Bargain Catalog—I.C.'s, LED's, readouts, fiber optics, calculators parts & kits, semiconductors, parts. Pcly Paks, Box 942PE, Lynnfield, Mass. 01940.

GOVERNMENT and industrial surplus receivers, transmitters, snooper scopes, electronic parts. Picture catalog 25 cents. Meshna, Nahant, Mass. 01908.

LOWEST Prices Electronic Parts. Confidential Catalog Free. KNAPP, 3174 8th Ave. S.W., Largo, Fla. 33540.

ELECTRONIC PARTS, semiconductors, kits. FREE FLYER. Large catalog \$1.00 deposit. BIGELOW ELECTRONICS, Bliffton, Ohio 45817.

RADIO—T.V. Tubes—36 cents each. Send for free catalog. Cornell, 4213 University, San Diego, Calif. 92105.

AMATEUR SCIENTISTS. Electronics Experimenters. Science Fair Students... Construction plans—Complete, including drawings, schematics, parts list with prices and sources... Robot Man — Psychedelic shows — Lasers — Emotion/Lie Detector — Touch Tone Dial — Quadraphonic Adapter — Transistorized Ignition — Burglar Alarm — Sound Meter... over 60 items. Send 50 cents coin (no stamps) for complete catalog. Technical Writers Group, Bcx 5994, University Station, Raleigh, N.C. 27607.

METERS—Surplus, new, used, panel or portable. Send for list. Hanchett, Box 5577, Riverside, CA 92507.

MECHANICAL. ELECTRONIC devices catalog 10 cents. Greatest Values — Lowest Prices. Fertik's, 5249 "D", Philadelphia, Pa. 19120.

SOUND SYNTHESIZER KITS—Surf \$12.95. Wind \$12.95. Wind Chimes \$17.95. Electronic Songbird \$6.95. Musical Accessories, many more. Catalog free. PAIA Electronics, Box J14359 Oklahoma City, OK 73114.

BUGGED??? New locator finds them fast. Write, Clifton, 11500-L N.W. 7th Avenue, Miami, Florida 33168.

YOU WILL SAVE BIG MONEY! Surplus, Clearouts, Bankruptcy, Inventory, Deals. Catalog \$1 (redeemable). ETCOA Electronics, Box 741, Montreal, H3C 2V2, U.S. Inquiries.

HEAR POLICE/FIRE Dispatchers! Catalog shows exclusive directories of "confidential" channels, scanners. Send postage stamp. Communications, Box 56-PE, Commack, N.Y. 11725.

SURPRISE! Build inexpensively, the most Unusual Test Instruments, Futuristic Gadgets using Numerical Readouts! Catalogue Free! GBS, Box 100A, Green Bank, West Virginia 24944.

UNSCRAMBLERS: Fits any scanner or monitor, easily adjusts to all scrambled frequencies. Only 4" square \$29.95, fully guaranteed. Dealer inquiries welcomed. PDQ Electronics, Box 841, North Little Rock, Arkansas 72115.

RECONDITIONED Test Equipment, \$0.50 for catalog. Walter's Test Equipment, 2697 Nickel, San Pablo, CA 94806.

POLICE, Fire monitors, scanners, crystals, CB Transceivers, New Crystal-less scanners. Discount priced. Box 19224, Denver, CO 80219.

NON SEMI SURPLUS. Monthly picture flyer. Quality Low prices. Send 25 cents. U.S. only. Startronics, Box 683, McMinnville, OR 97128.

TELETYPE EQUIPMENT for sale for beginners and experienced computer enthusiasts. Teletype machines, parts, supplies. Catalogue \$1.00 to: ATLANTIC SALES, 3730 Nautilus Ave., Brooklyn, NY 11224. Tel: (212) 372-0349.

JAPANESE TRANSISTORS, all transistors original factory made. Free catalog. West Pacific Electronics, P.O. Box 3879, Torrance, CA 90510.

SEMICONDUCTOR AND PARTS Catalogue, \$1.00 refundable, from the semiconductor specialists, J & J Electronics, Box 1437P, Winnipeg, Manitoba, Canada. U.S. Inquiries.

ELECTRONIC ignition: Capacitor-Discharge, pointless. Auburn Sparkplugs, Wheel Stabilizers, Information 20 cents. Anderson Engineering, Epsom, N.H. 03234.

CARBON FILM RESISTORS. Brand new as low as 17 cents. Discounts of 20%. Prompt delivery. FREE samples/specifications. COMPONENTS CENTER, Box 134P, N.Y., N.Y. 10038.

WHOLESALE C.B., Scanners, Antennas. Catalog 25 cents. Crystals: Special cut. \$4.95, Monitor \$3.95. Send make, model, frequency. G. Enterprises, Box 461P, Clearfield, UT 84015.

ORGAN KITS KEYBOARDS

THE ULTIMATE IN DESIGN
AND SOUND

Demo Record & Brochure \$1.00



Wurlitzer reproductions

DEVTRONIX ORGAN PRODUCTS, Dept. C
5872 Amapola Dr. • San Jose, CA 95129

CB CRYSTALS over 20,000 standard and specials in stock from 6.0 MHz to 45.0 MHz. Call or write for information package. Dealer inquiries invited. Roberts Electronics Sales, 73563 29 Palms Highway, 29 Palms, California 92277. (714) 367-6235.

REGULATED Power Supplies. New. Fixed and adjustable one thru four outputs, T03 IC's. Single 1A \$14.95, Triple 2A \$27.95. Send \$2.00 for brochure refunded on first order. Mechelect, Inc., Box 911, Plymouth, Mass. 02360.

SURPRISES GALORE! Projects, ham radio, music synthesizers, etc. IC's, pots, hardware, crystals, keyboards, resistors, etc. Send 13 cents stamp for catalogue. UTEP, Box 26231B, Salt Lake City, Utah 84125.

LOW cost digital/analog test equipment. Exceptional values. Free catalog. Salen Electronics, Box 82, Skokie, Illinois 60076.

DON'T LET VOLTAGE TRANSIENTS ZAP YOUR HI-FI. Solid state equipment protector plugs into outlet protects any transistorized equipment. \$6.95. Kopp Electronics, 1650 William St., Buffalo, N.Y. 14206. Free Brochure.

COMPUTER HOBBYISTS. Classified advertising newsletter, \$3.75/year. Free sample. ON LINE, 24695 Santa Cruz Hwy., Los Gatos, CA 95030.

LEARN Design Techniques. Electronics Design Newsletter, Digital, linear construction projects, design theory and procedures. Annual Subscription \$6.00, sample copy \$1.00. Valley West, Box 2119-B, Sunnyvale, CA 94087.

Tips on top CB/Ham operation



Channel 51 magazine includes tips, articles, and step-by-step guidelines to improve your CB/Ham operation. More meaty editorial per page than leading CB/Ham magazines! Learn to build, repair, and professionally operate your own unit. And more! For your Channel 51, send name, address, and \$1.50 now to:

Hufco Box 357, Dept. C51, Provo, Utah 84601 801/375-8566

CB RADIOS, monitors, crystals, CD ignitions. Southland, Box 3591-B, Baytown, Texas 77520.

FERRIC CHLORIDE ETCHANT. 1/2 gallon \$5.50. Gallon \$9.50. Postpaid. CIRCOCLEX, Box 198, Marcy, N.Y. 13403.



DELTA ELECTRONICS CO.
P.O. BOX 2, AMESBURY, MASS. 01913

KEYBOARDS

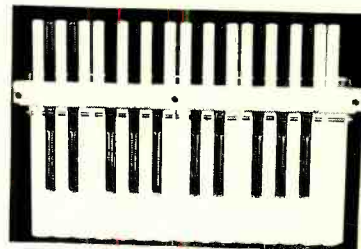

We have a good selection of 1, 2, & 3 Octave keyboards for your organ or synthesizer.

- 1 Octave STOCK NO. P5454 4.95 2/9.00
- 2 Octave STOCK NO. P5280 8.95 2/17.00
- 3 Octave STOCK NO. P5210 17.95 2/35.00

STANCOR AUTO-TRANSFORMER

STANCOR P8640 115/230 V, 500 VA autotransformer. Distributor net \$27.82
DELTA PRICE 11.95 ea. 2/22.00
STOCK NO. P6453 Wt. 10 lbs. with cord.

ISOLATION TRANSFORMER

115/115 isolation trans, 175 watts. 5 lbs.
STOCK NO. P9971 7.95 2/14.00

POWER TRANSFORMER

22 Vct @ 4A. & 9 V @ 4A. 5lbs.
STOCK NO. P6466 8.95 ea. 2/16.00

Send for latest free catalog. Minimum order \$5, phone orders welcome: (617) 388-4705. Include sufficient postage; excess refunded. BankAmericard & Mastercharge welcome, ALL numbers needed for processing. Min. charge \$15.

CIRCLE NO. 18 ON FREE INFORMATION CARD
POPULAR ELECTRONICS

BULLET ELECTRONICS

P.O. BOX 19442P • DALLAS, TEXAS 75219 • 214/823-3240

PS-01 POWER SUPPLY KIT

IMAGINE! A power supply with a well filtered, regulated output in three voltages. The PS-01A has quality IC regulators, semiconductors and components. The transformer is custom designed and well made. Features 10mv load regulation.

YOU GET:

- Drilled and Plated board
- Complete kit of components
- Heatsinks +5V @ 1.5A
- Complete Instructions ±15V @ 200MA

\$14.95

NOTE: +5 and ±12VDC supply is available at same price. Order PS-01/B.

BUILD A COMPLETE CDI IGNITION KIT AT A FRACTION OF THE COST OF OTHER UNITS. A special buy allows us to sell the complete kit at this low price! Up to 40,000 volts from your present ignition without changing the kit. Simple connections.

- INCLUDES: Special toroid transformer
- Drilled and Plated board
- Complete instructions
- All resistors and caps
- All semiconductors

\$9.95

(Does not include heatsink or case.) For 12V negative ground systems.



QUALITY METAL PROJECT CASES

Cases are heavy gauge aluminum with baked white finish and black wrinkle tops.

REGULAR

	A	B	C	
Small:	2 7/8" x 2 1/2" x 1 1/2"			\$1.60
Medium:	4 1/2" x 2 1/2" x 1 7/8"			2.15
	SHADOW FRONT			
Medium:	4 13/16" x 3 3/8" x 2"			3.50
Large:	7" x 4" x 2 3/8"			4.35

3A 200V TRIACS

Guaranteed!

.49



VOLTAGE REGULATORS

UNMARKED — TESTED GOOD

7569 Pos Reg — 50c
7563 Neg Reg — 40c
800 N/A
3 to 30 Volts
10-40

Can be used with external pass transistor for high current. Guaranteed!

ULTRASONIC SENDER-RECEIVER KIT

A special buy on a high quality ultrasonic transducer allows us to offer this kit at a super price — but hurry, quantities are limited! You can build intrusion alarms, motion detectors, remote controls, echo ranging or liquid level measurement equipment. We supply the basic transmitter and receiver electronics including a drilled and plated PCB. The units work at 23KHZ with a range of 20 ft. and can be positioned opposite each other or side-by-side and bounced off a solid surface. The output will sink up to 300ma to drive a relay, alarm circuit, etc.

ORDER US-01

\$19.95

WABLE ALARM Kit A piercing 10 WATTS of dual tone noise that can't be ignored. Perfect for burglar alarms, warning devices, or to call your boss home for supper! Complete with PCB board. Less speaker or switch. Requires 6 to 15 VDC. \$25.00 COMPLETE

SORRY — NO COD'S. Foreign orders add 10% (20% Per Airmail) CHECK OR M.O. ALL PARTS GUARANTEED. Add 2% for Postage. ORDERS UNDER \$10.00 ADD 60c HANDLING. We accept BankAmericard and Master Charge. UTEP, Box 26231B, Salt Lake City, Utah 84125. Phone Orders No COD

STATEMENT OF OWNERSHIP, MANAGEMENT AND CIRCULATION (Required by 39 U.S.C. 3685). 1. Title of Publication: Popular Electronics. 2. Date of filing: October 1, 1976. 3. Frequency of issue: Monthly. A. No. of issues published annually: 12. B. Annual subscription price: \$9.98. 4. Location of known office of publication: One Park Avenue, New York, New York 10016. 5. Location of the Headquarters or General Business Offices of the publishers: One Park Avenue, New York, New York 10016. 6. Names and complete addresses of publisher, editor, and managing editor: Publisher, Edgar W. Hopper, One Park Avenue, New York, New York 10016; Editor, Arthur P. Salsberg, One Park Avenue, New York, New York 10016; Managing Editor: John R. Riggs, One Park Avenue, New York, New York 10016. 7. Owner: Ziff-Davis Publishing Company, One Park Avenue, New York, New York 10016; Ziff Corporation, One Park Avenue, New York, New York 10016. 8. Known bondholders, mortgagees, and other security holders owning or holding 1 percent or more of total amount of bonds, mortgages or other securities: None.

10. Extent and nature of circulation	Average no. copies during preceding 12 months	Actual no. copies of single issue published nearest to filing date
A. Total No. Copies Printed (Net Press Run)	456,093	478,148
B. Paid Circulation		
1. Sales through Dealers and Carriers, Street Vendors and Counter Sales	80,464	82,975
2. Mail Subscriptions	322,418	342,530
C. Total Paid Circulation (Sum of 10B1 and 10B2)	402,882	425,505
D. Free Distribution by Mail, Carrier or Other Means		
Samples, Complimentary, and Other Free Copies	7,695	8,462
E. Total Distribution (Sum of C and D)	410,577	433,967
F. Copies not distributed		
1. Office Use, Left Over, Unaccounted, Spoiled After Printing	2,767	2,663
2. Returns from News Agents	42,749	41,518
G. Total (Sum of E, F1 and 2—should equal net press run shown in A)	456,093	478,148

11. I certify that the statements made by me above are correct and complete.
WILLIAM L. PHILLIPS, Assistant Treasurer

12. For Completion by Publishers Mailing at the Regular Rates: (Section 132.121, Postal Service Manual)
39 U. S. C. 3626 provides in pertinent part: "No person who would have been entitled to mail matter under former section 4359 of this title shall mail such matter at the rates provided under this subsection unless he files annually with the Postal Service a written request for permission to mail matter at such rates."
In accordance with the provisions of this statute, I hereby request permission to mail the publication named in Item 1 at the phased postage rates presently authorized by 39 U. S. C. 3626.
WILLIAM L. PHILLIPS, Assistant Treasurer

SURPLUS 'SMART' TERMINALS, components, serious music synthesizer kits, plans, parts, and more. Send SASE for FREE INFO Package. CFR Associates, POBF, Newton, N.H. 03858.



TANK! JUST ONE OF THE 16 GAMES YOU CAN PLAY WITH OUR NEW INCREDIBLE HAND HELD ELECTRONIC GAME. SPECIAL INTRODUCTORY PRICE ONLY: \$8.95 SATISFACTION GUARANTEED INTERFAB, 27963 CABOT RD, LAGUNA NIGUEL, CA 92677

FOR SALE. Sam's Photofacts 700 through 1570. make offer. Gerald Orf, Route 2, Wentzville, MO 63385.
FANTASTIC — Solderless breadboard kit with all parts for fascinating experiments with Flasher / Oscillator / Siren chip \$12.95 less battery. Catalog 50 cents (refundable). Satisfaction Guaranteed. Ego, Box 1331-pc, Thousand Oaks, California 91360.

BLINK 'N' BOOPER
IS HERE!!
The Memory Concentration Timing Game.
Send \$1.00 (refundable with order) for illustrative information packet, includes technical description circuit functions, component line-up, and game dynamics.
visulex P.O. Box 4204P Mountain View, CA 94040

TOROID CORES. Iron powder and ferrite. Free catalog. Palomar Engineers, P.O. Box 455, Escondido, CA 92025.

PCB NEGATIVES. finished circuit boards, from your art work. Complete info and sample board \$1.00. Equinox, Box 622, Bellevue, WA 98009.

POWER your electronic gear with household trash. Simple setup. No combustion. \$3.00. D. Gedney, Box 352, Skip-pack, PA 19474.

FIREPLACE BUILDING made easy by following step by step instructions. Send \$1.00 to: Eubanks Fireplaces, Route Five, Box 227, Thomaston, Georgia 30286.

TELEPHONES AND PARTS. Free catalog. Write: Surplus Saving Center, P.O. Box 117, Waymart, PA 18472.

BUILD AND SAVE. TELEPHONES, TELEVISION, DETECTIVE, BROADCAST Electronics. We sell construction plans with an Engineering Service. Speakerphones, Answering Machines, Carphones, Phonevision, Dialers. Color TV Converters, VTR, Games, S25 TV Camera, Electron Microscope, Special Effects Generator, Time Base Corrector, Chroma Key, Engineering Courses in Telephone, Integrated Circuits, Detective Electronics. PLUS MUCH MORE. NEW Super Hobby Catalog \$1.00 year's subscription to Electronic News Letter, \$1.00. Don Britton Enterprises, 6200 Wilshire Blvd., Los Angeles, Calif. 90048.

The easy \$25 counter kit!



An easy-to-build 50MHz (6-Digit) Frequency Counter for a measly \$25! Standard easy-to-find parts. 100! Uses 7segment LED readouts—no scarce Nixie tubes! No tricky crystal oscillators! Kit includes classy cabinet with front panel. PC boards, hardware, instructions, and diagrams. A proven design! An unbeatable offer! Write or call today! (please add \$2 for postage and handling)
HUFCO Box 357, Dept. 58, Provo, UT 84601 (801) 375-8566 **Hufco**

FLYING helmets, headsets with boom microphones, adapted to CB's. Avcom, 10139 Apache Road, Richmond, VA 23235.

TTL 7400N			
SN7400N	.15	SN7440N	.15
SN7401N	.15	SN7442N	.38
SN7402N	.15	SN7443N	.85
SN7403N	.15	SN7444N	.85
SN7405N	.18	SN7445N	.74
SN7405N	.18	SN7446AN	.74
SN7405N	.18	SN7447AN	.78
SN7406N	.34	SN7448N	.74
SN7407N	.34	SN7450N	.15
SN7408N	.18	SN7451N	.15
SN7409N	.18	SN7453N	.15
SN7410N	.15	SN7454N	.15
SN7411N	.21	SN7456N	.15
SN7412N	.28	SN7470N	.28
SN7413N	.41	SN7472N	.27
SN7414N	.29	SN7473N	.31
SN7416N	.76	SN7474N	.31
SN7417N	.31	SN7475N	.48
SN7420N	.15	SN7476N	.34
SN7421N	.21	SN7480N	.39
SN7422N	.21	SN7481AN	.99
SN7423N	.27	SN7482N	.59
SN7425N	.27	SN7483AN	.69
SN7426N	.24	SN7484AN	1.65
SN7427N	.27	SN7485N	.88
SN7428N	.35	SN7486N	.32
SN7430N	.15	SN7489N	1.95
SN7432N	.24	SN7490AN	.45
SN7433N	.35	SN7491AN	.64
SN7437N	.23	SN7492AN	.46
SN7438N	.23	SN7493AN	.46
SN74154N	.99	SN74155N	.78
SN74155N	.69	SN74156N	.69
SN74157N	.69	SN74157N	2.85
SN74157N	.69	SN74100N	.99
SN74159N	2.50	SN74104AN	.43
SN74160N	.89	SN74105N	.43
SN74161N	.89	SN74107N	.29
SN74162N	.89	SN74109N	.49
SN74221N	.89	SN74110N	.54
SN74164AN	1.10	SN74111N	.74
SN74247N	.99	SN74116N	1.75
SN74248N	1.75	SN74120N	1.40
SN74249N	1.75	SN74121N	.36
SN74251N	1.40	SN74122N	.42
SN74252N	1.80	SN74123N	1.29
SN74253N	2.59	SN74125N	.45
SN74279N	.99	SN74126N	.45
SN74283N	1.45	SN74128N	.65
SN74284N	4.50	SN74132N	.84
SN74285N	4.50	SN74136N	.64
SN74290N	.85	SN74141N	.93
SN74293N	.85	SN74142N	3.70
SN74298N	1.98	SN74143N	3.98
SN74351N	1.92	SN74144AN	3.98
SN74365N	.65	SN74145N	.89
SN74366N	.65	SN74147N	1.68
SN74367N	.65	SN74148N	1.25
SN74368N	.65	SN74150N	.99
SN74390N	1.40	SN74151N	.63
SN74393N	1.40	SN74153N	.63
SN74490N	1.90		
SN74154N	.99	SN74154N	.99
SN74155N	.78	SN74155N	.78
SN74156N	.69	SN74156N	.69
SN74157N	.69	SN74157N	.69
SN74157N	2.85	SN74157N	2.85
SN74159N	2.50	SN74159N	2.50
SN74160N	.89	SN74160N	.89
SN74161N	.89	SN74161N	.89
SN74162N	.89	SN74162N	.89
SN74163N	.89	SN74163N	.89
SN74221N	.89	SN74221N	.89
SN74164AN	1.10	SN74164AN	1.10
SN74247N	.99	SN74247N	.99
SN74248N	1.75	SN74248N	1.75
SN74249N	1.75	SN74249N	1.75
SN74251N	1.40	SN74251N	1.40
SN74252N	1.80	SN74252N	1.80
SN74253N	2.59	SN74253N	2.59
SN74279N	.99	SN74279N	.99
SN74283N	1.45	SN74283N	1.45
SN74284N	4.50	SN74284N	4.50
SN74285N	4.50	SN74285N	4.50
SN74290N	.85	SN74290N	.85
SN74293N	.85	SN74293N	.85
SN74298N	1.98	SN74298N	1.98
SN74351N	1.92	SN74351N	1.92
SN74365N	.65	SN74365N	.65
SN74366N	.65	SN74366N	.65
SN74367N	.65	SN74367N	.65
SN74368N	.65	SN74368N	.65
SN74390N	1.40	SN74390N	1.40
SN74393N	1.40	SN74393N	1.40
SN74490N	1.90	SN74490N	1.90
SN74154N	.99	SN74154N	.99
SN74155N	.78	SN74155N	.78
SN74156N	.69	SN74156N	.69
SN74157N	.69	SN74157N	.69
SN74157N	2.85	SN74157N	2.85
SN74159N	2.50	SN74159N	2.50
SN74160N	.89	SN74160N	.89
SN74161N	.89	SN74161N	.89
SN74162N	.89	SN74162N	.89
SN74163N	.89	SN74163N	.89
SN74221N	.89	SN74221N	.89
SN74164AN	1.10	SN74164AN	1.10
SN74247N	.99	SN74247N	.99
SN74248N	1.75	SN74248N	1.75
SN74249N	1.75	SN74249N	1.75
SN74251N	1.40	SN74251N	1.40
SN74252N	1.80	SN74252N	1.80
SN74253N	2.59	SN74253N	2.59
SN74279N	.99	SN74279N	.99
SN74283N	1.45	SN74283N	1.45
SN74284N	4.50	SN74284N	4.50
SN74285N	4.50	SN74285N	4.50
SN74290N	.85	SN74290N	.85
SN74293N	.85	SN74293N	.85
SN74298N	1.98	SN74298N	1.98
SN74351N	1.92	SN74351N	1.92
SN74365N	.65	SN74365N	.65
SN74366N	.65	SN74366N	.65
SN74367N	.65	SN74367N	.65
SN74368N	.65	SN74368N	.65
SN74390N	1.40	SN74390N	1.40
SN74393N	1.40	SN74393N	1.40
SN74490N	1.90	SN74490N	1.90
SN74154N	.99	SN74154N	.99
SN74155N	.78	SN74155N	.78
SN74156N	.69	SN74156N	.69
SN74157N	.69	SN74157N	.69
SN74157N	2.85	SN74157N	2.85
SN74159N	2.50	SN74159N	2.50
SN74160N	.89	SN74160N	.89
SN74161N	.89	SN74161N	.89
SN74162N	.89	SN74162N	.89
SN74163N	.89	SN74163N	.89
SN74221N	.89	SN74221N	.89
SN74164AN	1.10	SN74164AN	1.10
SN74247N	.99	SN74247N	.99
SN74248N	1.75	SN74248N	1.75
SN74249N	1.75	SN74249N	1.75
SN74251N	1.40	SN74251N	1.40
SN74252N	1.80	SN74252N	1.80
SN74253N	2.59	SN74253N	2.59
SN74279N	.99	SN74279N	.99
SN74283N	1.45	SN74283N	1.45
SN74284N	4.50	SN74284N	4.50
SN74285N	4.50	SN74285N	4.50
SN74290N	.85	SN74290N	.85
SN74293N	.85	SN74293N	.85
SN74298N	1.98	SN74298N	1.98
SN74351N	1.92	SN74351N	1.92
SN74365N	.65	SN74365N	.65
SN74366N	.65	SN74366N	.65
SN74367N	.65	SN74367N	.65
SN74368N	.65	SN74368N	.65
SN74390N	1.40	SN74390N	1.40
SN74393N	1.40	SN74393N	1.40
SN74490N	1.90	SN74490N	1.90
SN74154N	.99	SN74154N	.99
SN74155N	.78	SN74155N	.78
SN74156N	.69	SN74156N	.69
SN74157N	.69	SN74157N	.69
SN74157N	2.85	SN74157N	2.85
SN74159N	2.50	SN74159N	2.50
SN74160N	.89	SN74160N	.89
SN74161N	.89	SN74161N	.89
SN74162N	.89	SN74162N	.89
SN74163N	.89	SN74163N	.89
SN74221N	.89	SN74221N	.89
SN74164AN	1.10	SN74164AN	1.10
SN74247N	.99	SN74247N	.99
SN74248N	1.75	SN74248N	1.75
SN74249N	1.75	SN74249N	1.75
SN74251N	1.40	SN74251N	1.40
SN74252N	1.80	SN74252N	1.80
SN74253N	2.59	SN74253N	2.59
SN74279N	.99	SN74279N	.99
SN74283N	1.45	SN74283N	1.45
SN74284N	4.50	SN74284N	4.50
SN74285N	4.50	SN74285N	4.50
SN74290N	.85	SN74290N	.85
SN74293N	.85	SN74293N	.85
SN74298N	1.98	SN74298N	1.98
SN74351N	1.92	SN74351N	1.92
SN74365N	.65	SN74365N	.65
SN74366N	.65	SN74366N	.65
SN74367N	.65	SN74367N	.65
SN74368N	.65	SN74368N	.65
SN74390N	1.40	SN74390N	1.40
SN74393N	1.40	SN74393N	1.40
SN74490N	1.90	SN74490N	1.90
SN74154N	.99	SN74154N	.99
SN74155N	.78	SN74155N	.78
SN74156N	.69	SN74156N	.69
SN74157N	.69	SN74157N	.69
SN74157N	2.85	SN74157N	2.85
SN74159N	2.50	SN74159N	2.50
SN74160N	.89	SN74160N	.89
SN74161N	.89	SN74161N	.89
SN74162N	.89	SN74162N	.89
SN74163N	.89	SN74163N	.89
SN74221N	.89	SN74221N	.89
SN74164AN	1.10	SN74164AN	1.10
SN74247N	.99	SN74247N	.99
SN74248N	1.75	SN74248N	1.75
SN74249N	1.75	SN74249N	1.75
SN74251N	1.40	SN74251N	1.40
SN74252N	1.80	SN74252N	1.80
SN74253N	2.59	SN74253N	2.59
SN74279N	.99	SN74279N	.99
SN74283N	1.45	SN74283N	1.45
SN74284N	4.50	SN74284N	4.50
SN74285N	4.50	SN74285N	4.50
SN74290N	.85	SN74290N	.85
SN74293N	.85	SN74293N	.85
SN74298N	1.98	SN74298N	

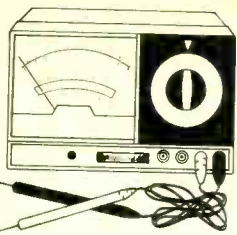

MultiMeter
\$14.95
 *6 DC Volt ranges
 *3 DC current
 *5 AC ranges
 *2 ohms ranges
 * -20 to +22 dB
 *Includes 34" test leads
 *20K Ω /V DC
 *10K Ω /V AC
 *50 uA meter
 *Ohms adjust
 *5/8 x 3/4 x 1 5/8"



ECONORAM BASIC RAM

\$99.95 in kit form; \$129.95 assembled. A no compromise 4K by 8 memory board; Altair, IMSAI, compatible --- uses 5-100 buss. \$88 (kit form only). This 4K by 8 memory is designed for compatibility with the JOLT microcomputer system, but will work with any system employing a bi-directional bus. Same size as JOLT memory card with current drain under 1.3 Amps. If you don't need the on-board regulation or address and data buffers of our "Bigger Brother" 4K board, then this is the way to go. Like Econoram, sockets are included for all ICs.

REQUIRES 1 AA CELL (not incl) -- ADD \$1 PSTGE/HANDL.

Low Profile Solder Tail Socket SPECIAL

GODBOUT

BILL GODBOUT ELECTRONICS
 BOX 2355, OAKLAND AIRPORT, CA 94614
 TERMS add 50¢ to orders under \$10. No COD. Call res and tax. Mastercharge/BankAmericard call (415) 562-0636, 24 hours. SEND FOR OUR FLYER!

- 8 pin.....10/\$1.60
- 14 pin.....10/\$1.95
- 16 pin.....10/\$2.15
- 18 pin.....8/\$1.50
- 20 pin.....8/\$2.50
- 22 pin.....8/\$2.80
- 24 pin.....3/\$1.10
- 36 pin.....3/\$1.65
- 40 pin.....3/\$1.85

IC CHIP SET
 1-8080A
 1-8212
 1-18 Mhz Xtal
 1-8224
\$36.95

We now stock VECTOR-PAK ENCLOSURES!
 Perfect for computer hobbyists, others. Write us for complete order info & prices.

CIRCLE NO. 26 ON FREE INFORMATION CARD

Send for your information packet today - which also includes circuit functions, component line-up, and accessories. Information Packet \$1.00 (refundable with order).

visulex P.O. Box 4204P Mountain View, CA 94040

HIGH LEVEL Scientific, Accounting Instructions for 8080 with Plug-in Compatible Board. Available for most development systems. MRD, 612 Stonestreet Ave., Rockville, MD 20850

NEW ADJUSTABLE THREE OUTPUT REGULATED POWER SUPPLY, plus 900 parts worth \$400.00 list, contained in a solid state CARTRIVISION television recorder electronic unit. Schematics, parts cross reference furnished. Uses: HEATHKIT television transistor substitutions, power CB radios and MICROPROCESSORS, built electronic projects. \$17.95 plus \$3.50 S&H. USA. Free brochure. Master Charge, BankAmericard. Satisfaction Guaranteed. MADISON ELECTRONICS COMPANY, INCORPORATED, Box 369, D55, Madison, Alabama 35758.

BUILD YOUR OWN SPEAKERS AND SAVE UP TO 50%

You can assemble your own high quality, multi-element stereo speakers in a few hours and save up to half the cost of comparable speakers. Send for our free 32-page catalogue of speaker kits, raw speakers and accessories.

SPEAKERLAB
 Dept. PE-9, 5500-35th N.E. Seattle, Washington 98105

FREE CATALOG. Calculators, Digital Thermometers, Ultrasonics, Kits, Strobes, Ni-cads, LEDs, Transistors, IC's, Unique Components. Chaney's, Box 27038, Denver, CO 80227.

For faster service

USE ZIP CODE

on all mail

ANYONE CAN SOLDER WITH — KESTER SOLDER

DO-IT-YOURSELFERS!

Let Kester solder aid you in your home repairs or hobbies. A radio, TV, model train, jewelry, plumbing, etc. Save money — repair it yourself. Send self-addressed stamped envelope to Kester for a FREE Copy of "Soldering Simplified".

KESTER SOLDER / 4201 Wrightwood Ave. Chicago, Ill. 60639

BIG-BRIGHT - .5" LED ALARM CLOCK
6 DIGIT AC or DC or ELAPSED TIMER KIT

\$19.95 Complete

- PC Board Drilled & Silk Screened (Includes Xtal Time Base Circuitry)
- 5375 Nat. Clock Chip & Fairchild Displays
- Includes EVERY part required for clock and all options except Cabinet and Crystal Time Base components. If desired, see below.
- Brightness Control
- Freeze feat. on every mode
- Field Tested over 1 Yr.
- 24 Hr. Alarm w/snooze
- 0-60 Min. Elapsed Timer
- 12 Hr., 60 Hz oper.

Most Important — Complete Instructions, schematics Pictorials, layouts — everything for trouble free assembly

OPTION — XTAL Time Base Components - \$2.95 when purchased w/clock

Clock Kit Accessories

Wooden Case - Walnut gr. incl. Filter \$4.00 each
 Dimension - 6 5/16" W x 2 9/16" H x 3 7/16" D (3/4" Material)

Plexiglass Case (Ch. - Bl., White, Blue, & Smoke) incl. Filter \$3.00 each
 Dimension - 5 13/16" W x 2 1/4" H x 5 3/8" D (1/2" Material)

Individual Filters - Red, Smoke, Blue, Amber and Green \$.60 each

60 Hz. Crystal Time Base
For: Cars, Boats Campers, Field Use

\$4.95 COMPLETE

KIT INCLUDES: P.C. Board Drilled & Silk Screened
 Crystal, MOS 17 Stage Divider IC, all necessary components, Inst. Sheets & Specs.

Blinky/Flasher/Timing Kit
\$2.50 each 5 for \$10.00

Kit includes:
 P.C. Board, 555 Timer, all components and a connector for a 9V Battery

SPECIALS

8080A Microprocessor	\$19.95 ea.
21L02-1 Low Power 500NS RAM	\$1.95 ea.
.6" Display Common Anode or Cathode	\$1.95 ea.
.5" Fairchild Display Com. Anode or Cathode	79¢ ea.
(Same as FTK 0001 & FTK 0002)	
.8" 3 1/2 Digit Display Module	\$5.40
(Same as FTK 0010)	

The LS LINE of TTL
 Low Power, High Speed Schottky, Factory Prime

74LS00 — 29	74LS27 — 33	74LS155 — 1.10
74LS02 — 29	74LS30 — 33	74LS157 — 1.10
74LS04 — 32	74LS32 — 35	74LS160 — 1.50
74LS08 — 29	74LS37 — 35	74LS162 — 1.50
74LS10 — 29	74LS38 — 35	74LS163 — 1.50
74LS11 — 33	74LS74 — 50	74LS175 — 1.50
74LS20 — 33	74LS90 — 90	74LS258 — 1.25
74LS21 — 33	74LS132 — 90	74LS367 — 90
74LS22 — 33	74LS138 — 90	74LS368 — 90
	74LS139 — 90	

National MA1001A Digital Alarm Clock Module
 including Power Supply
\$9.95 complete

- 4 Digit 0.5" Display
- 12 Hr. 50/60 Hz. oper.
- Brightness Cont. Cop.
- Alarm & Snooze Timers

HOBB-Y-TRONIX, INC.
 Box 511, Edison, N.J. 08817

Orders must include Check - No COD's. Add \$1.00 handling for orders under \$25.00. N.J. residents - add 5% tax. Outside Continental U.S.A., please add postage.

6 Digit LED Clock Kit - 12/24 hr.

\$9.95 ea. QTY. 12 OR MORE

\$10.95 ea. QTY. 6-11

\$11.95 ea. QTY. 1-5

- KIT INCLUDES**
- INSTRUCTIONS
 - QUALITY COMPONENTS
 - 50 or 60 Hz OPERATION
 - 12 or 24 HR OPERATION

6-LED Readouts(FND-359 Red, com. cathode)
 1-MM5314 Clock Chip (24 pin)
 13-Transistors
 3-Switches
 6-Capacitors
 5-Diodes
 9-Resistors
 24-Molex pins for IC socket

LARGE .4" DIGITS!
 ORDER KIT #850-4
AN INCREDIBLE VALUE!

"Kit #850-4 will furnish a complete set of clock components as listed. The only additional items required are a 7-12 VAC transformer, a circuit board and a cabinet, if desired."

Printed Circuit Board for kit # 850-4 (etched & drilled fiberglass)\$2.95
 Mini-Brite Red LED's (for color in clock display) pkg. of 5 1.00
 Molded Plug Transformer 115/10 VAC (with cord) 2.50
 NOTE: Entire Clock may be assembled on one PC Board or Board may be cut to remote display.
 Kit # 850-4 will fit Plexiglas Cabinet II.



PLEXIGLAS CABINETS

Great for Clocks or any LED Digital project. Clear-Red Chassis serves as Bezel to increase contrast of digital displays.

Black, White or Clear Cover

CABINET I
3"H,6 1/4"W,5 1/2"D

CABINET II
2 1/2"H,5"W,4"D

ANY SIZE/COLOR

\$6.50 ea. **2/12.**

RED OR GREY PLEXIGLAS FOR DIGITAL BEZELS

3"x6"x1/8"

95¢ ea. **4/3**

MOBILE LED CLOCK

12 OR 24-HOUR OPERATION

12 VOLT AC or DC POWERED FOR FIXED OR MOBILE OPERATION.

SIX LARGE .4" DIGITS!

KIT OR ASSEMBLED

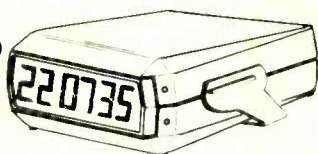

MODEL 2001

ACCURATE TIME WITH ADJUSTABLE XTAL TIME BASE

Approx. Size:

1 3/4" H x 4" W x 4 1/2" D

BATTERY BACK-UP FOR POWER FAILURE OR TRANSPORTING FROM HOUSE TO CAR. ETC.

- 6 JUMBO .4" RED LED'S BEHIND RED FILTER LENS WITH CHROME RIM.
- SET TIME FROM FRONT VIA HIDDEN SWITCHES • 12/24-Hr. TIME FORMAT
- STYLISH CHARCOAL GRAY CASE OF MOLDED HIGH TEMP. PLASTIC
- BRIDGE POWER INPUT CIRCUITRY - TWO WIRE NO POLARITY HOOK-UP
- OPTIONAL CONNECTION TO BLANK DISPLAY (Use When Key Off in Car. Etc.)
- TOP QUALITY PC BOARDS & COMPONENTS - EXCELLENT INSTRUCTIONS

KIT # 2001 COMPLETE KIT **29.95** EA. 3 OR MORE **\$27.95** EA.

115 VAC Power Pack #AC-1 **\$2.50** EA.

ASSEMBLED UNITS WIRED & TESTED ORDER #2001 WT (LESS 9V BATTERY) **\$39.95** EA. 3 OR MORE **\$37.95** EA. Assembled Units May Be Mixed With Kits for Qty. Price

JUMBO RED LED'S 12/\$1.00 50/\$3.95

6 Digit-LED Clock-Calendar-Alarm Kit

This is a complete, top of the line, Kit for the person that wants the best. Some of the many features and options are: 12/24 time, 28-30-31 day calendar, alternates time (8 sec) and date (2 sec) or can display time only and date on demand, 24 hr alarm - 10 minute snooze, alarm set indicator, 50/60 HZ. line operation or use with Xtal time base (#TB-1), built in OSC for battery back-up / AC failure, Aux. timer, CHOICE OF DIGITS.

60 HZ.

XTAL TIME BASE KIT

Will enable Digital Clock or Clock-Cal. Kits to operate from 12VDC. Uses MM5369 and 3.58MHZ. XTAL. Req. 5-15VDC/2.5 MA. 1"x2" PC Board. Easy 3 wire hookup Accuracy: +- 2 PPM

#TB-1 [adjustable] Complete kit \$4.95 ea Wired & Cal. \$9.95 ea

PRINTED CIRCUIT BOARDS for CT-7001 Kits sold separately with assembly info. PC Boards are drilled Fiberglass, solder plated and screened with component layout. Specify for #7001B or #7001C (Set of 2) \$7.95

JUMBO DIGIT CLOCK KIT

A complete Kit (less Cabinet) featuring: six .5" digits, MM5314 IC, 12/24 Hr. time, 50/60 HZ., Plug-Transformer, Line Cord, Switches, and all Parts.

[Ideal Fit in Cabinet II]

\$19.95 ea. **2/38.**

JUMBO DIGIT CONVERSION KIT

Convert small digit LED clock to large .5" displays. Kit includes 6-.5" LED's, Multiplex PC Board & easy hook-up info.

Kit #JD-1CC For common Cathode
 Kit #JD-1CA For common Anode

\$9.95 ea. **2/19.**

SCHOTTKY TTL		DTL		PRESCALE		EXAR		OP AMPS			
74S00	\$.35	930	\$.09	11C90DC	\$15.95	XR 2566	\$ 1.75	3/1.00			
74S01	.40	932	.09	96H90	9.95	XR 2567	1.95	301 TO-5			
74S04	.55	937	.09			TRANSISTORS		709 DIP			
74S05	.80	LED DRIVERS				2N2222A	TO-18 \$51.00	709 TO-5			
74S09	.55	7447	\$.96	DIODES		2N3415	TO-92 \$51.00	741 DIP			
74S10	.40	7448	.96	IN-4002	1A, 100 PIV	12/81.00	2N3704	TO-92 \$51.00	741 M-DIP		
74S15	.55	75491	.66	IN-4005	1A, 600 PIV	11/81.00	2N4249	TO-92 \$51.00	741 TO-5		
74S20	.50	75492	.66	IN-4007	1A, 1000 PIV	10/81.00	2N4400	TO-92 \$51.00	747 DIP		
74S22	.45	VOLTAGE REGULATORS		RECTIFIER	2.5A, 1000 PIV	4/81.00	2N4437	TO-92 \$51.00	748 DIP		
74S40	.45	LM 309H TO-5	\$.95	IN-914	SIL SIGNAL	20/81.00	2N5089	TO-92 \$51.00			
74S50	.45	LM 309K TO-3	1.25	IN-4148	SIL SIGNAL	20/81.00	2N5457 N	J-FET .95	DISCRETE LED'S		
74S51	.55	REGULATORS		DYAC	28V.	4/81.00			JUMBO RED		
74S60	.85	7805 TAB	.95	PLUG TRANSFORMERS						12/1.00	
74S64	.55	7812 TAB	1.25	12 VAC at 150 MA	\$ 2.50					50/13.95	
74S73	1.25	7815 TAB	1.25	12 VAC at 500 MA	3.50					100/17.50	
74S74	.85	7815 TO-3	1.25	LINEAR							
74S75	1.75	7815 TO-5	.75	555 TIMER	2/81.00						
74S78	1.50	7824 TO-3	1.25	566 DUAL TIMER	.95						
74S96	.95	723 DIP	.75	565 PLL	.95						
74S107	.95	723 TO-5	.75	566 FUNCTION GEN.	1.75						
74S112	.95	74S133	.75	567 TONE DECODER	1.75						
74S113	1.40	DIGITAL CLOCK IC'S		IC SOCKETS							
74S114	.95	MM 5312	\$ 4.95	PINS	1-24 .25 100						
74S121	.95	MM 5314	3.95	6	\$.25 \$.22 20						
74S133	.75	MM 5375 AB	3.95	14	.28 .22 20						
74S134	.75	CT-7001	7.95	16	.28 .22 23						
74S138	1.75	CT-7002	13.95	18	.31 .28 26						
74S139	1.50	50380	3.95	24	.50 .45 40						
74S151	1.95	MM 5369	2.50	28	.60 .55 50						
74S152	1.95			40	.75 .70 66						
74S156	1.95	XTAL		MEMORY							
74S157	1.80	21L02	1K RAM								
74S158	2.50										
74S174	2.50										
74S175	2.50										
74S181	2.95										
74S182	1.95										
74S251	2.75	3.579545 MHZ.	\$ 1.95								

BUY 100 OR MORE IC'S [Any Mix] TAKE 10% DISCOUNT.

OPTOELECTRONICS, inc.

BOX 219 • HOLLYWOOD, FLA. 33022 • (305) 921-2056



WE PAY ALL SHIPPING IN CONTINENTAL USA — OTHERS ADD 5% [10% FOR AIRMAIL]

Fairchild Super Digit FND-359

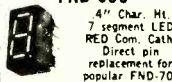

4" Char. HL 7 segment LED RED Com. Cath. Direct pin replacement for popular FND-70.

95¢ ea. **10/\$8.50**

100/\$79.00

SET OF 6 FND-359 WITH MULTIPLEX PC BOARD \$6.95

25 AMP BRIDGE

\$1.95 ea.

3/\$5.00

100 PIV

PC TRIM POTS

25K 6/1.00

4.7K 6/1.00

SPECTROL 10K/10 TURN

95¢

4/\$3.00

TELEPHONE FORMAT KEYBOARD BY Chomerics

2-1/4"x3" 5/32" thick

\$4.95

6/28.

SEE THE WORKS Clock Kit Clear Plexiglas Stand

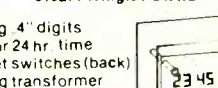

• 6 Big 4" digits
 • 12 or 24 hr time
 • 3 set switches (back)
 • Plug transformer
 • all parts included
 Plexiglas is Pre-cut & drilled
 Size: 6"H, 4 1/2"W, 3"D

A SUPER LOOKING CLOCK!

Kit #850-4CP **\$23.50** ea. **2/45.**

7-SEG LED COMMON CATHODE

COLOR HT. DEC PT. P.R.E.A.

FND-359 RED .4" RHDP \$.95

FND-503 RED .5" RHDP \$1.35

DL-750 RED .6" LHDP \$2.95

XAN-654 GREEN .6" NDP \$2.95

XAN-664 RED .6" NDP \$2.95

COMMON ANODE

DL-747 RED .6" LHDP \$2.95

XAN-72 RED .3" LHDP \$1.25

XAN-81 YELLOW .3" RHDP \$1.75

XAN-351 GREEN .3" RHDP \$1.50

XAN-361 RED .3" RHDP \$1.50

XAN-362 RED .3" LHDP \$1.50

XAN-662 RED .6" NDP \$2.50

XAN-692 RED .6" NDP \$2.50

Form Inexpensive Sockets 100 for \$1.25

Reel of 1000 - \$8.50



Same day shipment. First line parts only. Factory tested. Guaranteed money back. Quality IC's and other components at factory prices.

INTEGRATED CIRCUITS

74007TL	SN74LS74H	59	LM3490BN	89	CD4042	1.50	INTERFACE		
SN7400N	SN74LS75N	75	MC1458V	59	CD4043	2.00	8096	75	
SN7402N	SN74LS90N	1.10	NE540L	3.90	CD4044	2.00	8096	75	
SN7404N	SN74LS92N	1.10	NE540L	3.90	CD4045	2.00	8097	75	
SN7410N	SN74LS96N	1.89	NE555V	43	CD4050	4.00	8098	75	
SN7414N	SN74LS107N	1.05	NE555A	1.00	CD4061	1.20	8109	1.25	
SN7420N	SN74LS125N	2.20	NE567V	1.25	CD4062	1.20	8119	1.25	
SN7430N	SN74LS152N	2.20	NE567V	1.25	CD4069	4.00	8120	6.95	
SN7400N	LINEAR		NE567V	1.25	CD4071	4.00	8123	3.10	
SN7447N	CA3082	1.90	SN75451CN	39	CD4072	4.00	8124	3.50	
SN7450N	CA3089	2.75	SN75452CN	39	CD4073	4.00	8125	3.20	
SN7473N	LM3084A	3.35	SN75491CN	50	CD4075	4.00	8126	3.20	
SN7474N	LM3014H	3.35	SN75492CN	55	CD4078	4.00	8127	2.45	
SN7475N	LM3070	3.35	SN75494CN	89	CD4081	4.00	8128	2.45	
SN7489N	LM3071	3.35	A to D CONVERTER	CD4082	4.5	2101	4.50		
SN7490N	LM309K	95	8700CN	16.00	CD4510	2.00	2102	2.20	
SN7492N	LM320K-5	1.35	CMOS		CD4511	2.20	2107A	8.00	
SN7493N	LM320K-12	1.35	CD40001 Fair	42	CD4515	4.00	2111-1	7.00	
SN74107N	LM320K-15	1.35	CD4002	25	CD4520	2.50	2112-2	7.90	
SN74121N	LM320T-5	1.60	CD4006	1.80	CD4527	4.75	2113-2	7.90	
SN74125N	LM320T-8	1.80	CD4007	25	CD4528	1.50	2119	10.00	
SN74150N	LM320T-12	1.60	CD4008	2.30	CD4533	4.50	MM5508	3.50	
SN74151N	LM320T-15	1.60	CD4010	25	CD4585	2.45	MM5509	2.20	
SN74154N	LM324N	1.10	CD4011	25	CD4012	3.00	MM5522	3.50	
SN74157N	LM339N	55	CD4012	25	74C00	2.00	MM5530	9.75	
SN74174N	LM340K-5	1.60	CD4013	25	74C04	33			
SN74175N	LM340K-12	1.60	CD4014	2.00	74C10	2.10	MM5329	4.00	
SN74193N	LM340T-8	1.70	CD4015	2.00	74C14	2.10	MM5311	3.60	
SN74285N	LM340T-12	1.70	CD4016	50	74C20	2.50	MM5312	4.50	
SN74298N	LM340T-15	1.70	CD4017	3.85	74C23	2.85	MM5313	3.60	
74LS00 TTL	LM380N	1.00	CD4020	1.35	74C24	75	MM5314	3.90	
SN74LS00N	LM380N	1.00	CD4021	2.00	74C106	2.10	MM5315	4.00	
SN74LS02N	LM709H	2.8	CD4022	1.20	74C112	2.40	MM5316	6.35	
SN74LS04N	LM723N	44	CD4024	1.20	74C119	2.40	MM5317	6.55	
SN74LS08N	LM733N	89	CD4025	37	74C121	2.75	MM5369	3.00	
SN74LS10N	LM741CH	35	CD4027	3.85	74C122	2.75	MM5371	5.50	
SN74LS12N	LM741N	25	CD4027	55	74C123	2.75	MM5841	10.80	
SN74LS20N	LM1303N	82	CD4029	1.70	74C124	2.75	MM5841	10.80	
SN74LS24N	LM2902	1.50	CD4030	55	74C125	10.50	CT7001	5.80	
SN74LS38N	LM3900N	55	CD4040	2.25	74C927	12.00			



Olson electronics

Parts and Accessories

SPECIALIZING IN ELECTRONICS FOR 35 YEARS

master charge
BANKAMERICARD
welcome here

Voice Activated Switch

Activates lights, tape recorders, etc. Comes with 5" leads. 3 x 1/4". Operates on 4.5 VDC. Shpg. wt. 1/2 lb.

Reg. 1.98 **1.59**

XM-566

LOCKMOUNT

Locks CB or player in place. Slides in & out. 6 x 3/4 x 7". 6 or 12 VDC. 2 lbs.

Reg. 2.50 **1.79**

AU-344

Color TV Tuner Cleaner

Cleans and lubricates control & contact points. 6 oz can. 1/2 lb.

Reg. 1.49 **53c**

TL-459

BLACK LIGHT BULB

Screw into any ordinary socket. Light up posters, decorations, etc. Shpg. wt. 1/2 lb.

Reg. 4.99 **1.49c**

XM-291

RV 12 V Alarm/Clock Kits

Beautiful stainless finish, crystal accuracy. Excellent for wall mount on campers, boats.

RVC-4 clock kit \$31.95
Fully assembled 36.95
RVC-6A alarm clock kit \$49.95
Fully assembled 54.95

8K Ram board Kit

Plug compatible with Altair 8800 and Imtai 8080

Low power 50K RAMS

All parts included with full instructions. \$250.00

EPROM and I/O Board kits also available.

60 Hz Crystal Time Base Kit \$5.95

Converts digital clocks from AC line frequency to crystal time base. Outstanding accuracy. Kit includes: PC board, MM5369, crystal, resistors, capacitors and trimmer.

Digital Temperature Meter Kit

Indoor, outdoor - 30° + 125°. 50" LED readout available. Dec. Full Instructions \$39.95

MODEM \$79.50

Used Vadic modems in excellent condition, 103 type, 0 to 300 Baud. 202 type also available, 0 to 1200 Baud. \$175.00

Mile Per Gallon Circuit

Digital Flow Sensor \$29.50
Speed Transducer 8.00
(Specify car make and year)

CMOS Rate Multipliers 19.95
2-50 in. Displays 2.50
(orange or red)

Includes circuit description. PC Board not included.

Not a Cheap Clock \$17.45

Includes everything except case.

2-PC boards. 6-1/2 LED Displays. 534 clock chip transformer, all components and full instructions.

Frequency Counter Kit

Covers audio, ultrasonic and low amateur band to 5 MHz typical Dual channel high sensitivity ±25 millivolts. Crystal controlled clock. Can be scaled for higher frequency. 6-50" digits. Full instructions. Less power supply \$40.00

COSMAC 'ELF'

RCA CMOS microcomputer

CDP1802 325.50
CDP1802 9.00
CDP1852 10.25

Complete kit of additional parts minus power supply and board \$40.00

TERMS: \$5.00 min. order U.S. funds
Calif. residents add 6% tax.

FREE: Send for your copy of our 1976 QUEST CATALOG. Include 13c stamp.

CIRCLE NO. 46 ON FREE INFORMATION CARD

CLASSIFIED ADVERTISING ORDER FORM

Please refer to heading on first page of this section for complete data concerning terms, frequency discounts, closing dates, etc.

1	2	3	4	5
6	7	8	9	10
11	12	13	14	15
16	17	18	19	20
21	22	23	24	25
26	27	28	29	30

WORD COUNT: 15 WORD MINIMUM. Include name and address. Name of city (Des Moines) or of state (New York) counts as one word each. Zip Code numbers not counted. (Publisher reserves right to omit Zip Code if space does not permit.) Count each abbreviation, initial, single figure or group of figures or letters as a word. Symbols such as 35mm, COD, P.O., AC, etc., count as one word. Hyphenated words count as two words. Tele- phone numbers count as one word.

_____ Words \$2.25 (Commercial Rate) \$1.35 (Reader Rate)

Payment of \$ _____ enclosed for _____ insertion(s).

PRINT NAME _____

ADDRESS _____

CITY _____ STATE _____ ZIP _____

SIGNATURE _____ PE-177

PARTS & COMPONENTS	REG.	SALE
1/4 RPM Timing Motor, 117 V. AC	MO-277	49 .30
1 RPM Timing Motor, 117 V. AC	MO-289	49 .30
8 RPM Reversible Motor, 117 V. AC	MO-393	2.50 .99
Tubular Capacitor Kit, 100 Pcs.	CC-229	2.00 1.29
Ceramic Capacitor Kit, 100 Pcs.	CC-211	1.49 1.19
100 Ceramic Capacitors, values clearly marked	CC-210	1.29 .80
50 Assd. Electrolytic Capacitors, Axial/Radial	CC-407	5.00 2.00
100 Assd. Carbon Resistors 1/4-1/2 Watt Sizes	RR-077	1.79 1.00
5 Assd. SCR's, 15 V. and Up, 100 MA to 1.6 AMP	TR-298	1.79 1.00
500 MW Zener Diodes, 4-36-3.9-1.12 & 15 Volts	DI-052	1.00 .50
3 Unijunction Transistors, 40 V. 375 MW. 4 ON/S	TR-441	1.29 .50
L.E.D. Pkg. of 5 Red, 2 Volt, 5 MA	PL-233	1.19 .60
Ultra Mini L.E.D. Pkg. of 5 Red, 2 V. 5 MA	PL-289	1.29 .70
T1 Calculator Key Board, 20 Keys	MM-523	5.00 1.60
3 1/2 Digit Liquid Crystal Display	XM-371	10.00 3.00
Oscillator Amp. Transistor Kit, 6 Transistors	TR-507	2.00 1.50
Photo Transistor, 5 Pieces - Epoxy Type	DI-502	1.00 .60
6 Amp. Full Wave Bridge Rectifier 50 PIV	DI-057	1.20 .80
6 Amp. Full Wave Bridge Rectifier 400 PIV	DI-058	1.90 1.00
PNP Transistor Assortment Pkg. of 10	TR-445	1.00 .60
NPN Transistor Assortment Pkg. of 10	TR-446	1.00 .60
7-Segment L.E.D. Display 3 In. Green	XM-341	2.89 1.00
7-Segment L.E.D. Display 3 In. Red	XM-370	2.00 1.00
7-Segment L.E.D. Display 3 In. Yellow	XM-342	2.49 1.00
Micro Type Switch Kit, 7 Assorted	SW-340	1.89 1.49
Knob Kit, 25 Pcs. Assorted	KW-030	1.00 .69
Hobby Motor Kit, 3-6 V. DC, Pkg. 5	MO-333	.59 .49
TOOLS - SPECIAL AND PRACTICAL		
Wire Wrap Tool, 30 Ga Wire on .025 Post	TL-845	2.60 2.00
IC Insertion/Extraction Tool	TL-846	1.25 1.00
IC Plug-in Test Adapter	TE-356	2.60 2.00
12 Volt DC Soldering Iron, Pencil Tip	TL-793	4.00 3.00
Oymo Label Maker, Uses 1/4 In. Tape	TL-752	1.89 .90
Double Face Foam Tape 3/4 x 52 In.	TA-903	1.00 .80

FREE CATALOG

OLSON ELECTRONICS, 250 S. FORGE ST., DEPT IT, AKRON, OHIO 44327

NAME _____

ADDRESS _____

CITY _____ STATE _____

ZIP _____

Free PA Catalog Send Olson Catalog

Ship The Following:

How Many	Stock Number	Description	Price	Total

ENCLOSE POSTAGE AND SALES TAX

CIRCLE NO. 60 ON FREE INFORMATION CARD
POPULAR ELECTRONICS

S.D. SALES CO

P.O. BOX 28810 - D
DALLAS, TEXAS 75228

Z-80 CPU CARD KIT FOR IMSAI/ALTAIR

\$149.^{KIT}

From the same people who brought you the \$89.95 4K RAM kit. We were not the first to introduce an IMSAI/ALTAIR compatible Z-80 card, but we do feel that ours has the best design and quality at the lowest price.

The advanced features of the Z-80 such as an expanded set of 158 instructions, 8080A software compatibility, and operation from a single 5VDC supply, are all well known. What makes our card different is the extra care we took in the hardware design. The CPU card will always stop on an M1 state. We also generate TRUE SYNC on card, to insure that the rest of your system functions properly. Dynamic memory refresh and NMI are brought out for your use. Believe it or not, not all of our competitors have gone to the extra trouble of doing this.

As always, this kit includes all parts, all sockets, and complete instructions for ease of assembly. Because of our past experience with our 4K kit we suggest that you order early. All orders will be shipped on a strict first come basis. Dealers inquiries welcome on this item.

Kit shipped with 2 MHZ crystals for existing 500NS memory. Easily modified for faster RAM chips when the prices come down.
Z-80 Manual - \$7.50 Separately.

Kit includes Zilog Manual and all parts.

JUMBO
LED
CAR
CLOCK

\$16.95 KIT

You requested it! Our first DC operated clock kit. Professionally engineered from scratch to be a DC operated clock. Not a makeshift kluge as sold by others. Features: Bowmar 4 digit .5 inch LED array, Mostek 50252 super clock chip, on board precision time base, 12 or 24 hour real time format, perfect for cars, boats, vans, etc. Kit contains PC Board and all other parts needed (except case). 50,000 satisfied clock kit customers cannot be wrong!

FOR ALARM OPTION ADD \$1.50
FOR XFMR FOR AC OPERATION ADD \$1.50

60 HZ CRYSTAL TIME BASE FOR DIGITAL CLOCKS S.D. SALES EXCLUSIVE!

KIT FEATURES:

- A. 60HZ output with accuracy comparable to a digital watch.
- B. Directly interfaces with all MOS Clock Chips.
- C. Super low power consumption. (1.5 ma typ.)
- D. Uses latest MOS 17 stage divider IC.
- E. Eliminates forever the problem of AC line glitches.
- F. Perfect for cars, boats, campers, or even for portable clocks at ham field days.
- G. Small Size, can be used in existing enclosures.

\$5.95 or
2/\$10.

KIT INCLUDES CRYSTAL, DIVIDER IC, PC BOARD
PLUS ALL OTHER NECESSARY PARTS & SPECS

50HZ CRYSTAL TIME BASE KIT - \$6.95

All the features of our 60HZ kit but has 50HZ output. For use with clock chips like the 50252 that require 50HZ to give 24 hour time format.

THIS MONTH'S SPECIALS!

- 300.00 KHZ CRYSTAL - \$1.50
- 8080A - CPU CHIP by AMD - \$19.95
- 82S129 - 256 x 4 PROM - \$2.50
- N.S. 8865 OCTAL DARLINGTON DRIVERS
3 for \$1.00
- Z-80 - CPU by ZILOG - \$69.95
- MM5204 - 4K EPROM - \$7.95

Prices in effect this month ONLY!

SPECIAL

SPECIAL

4K LOW POWER RAM BOARD KIT THE WHOLE WORKS - \$89.95

Imsai and Altair 8080 plug in compatible. Uses low power static 21L02-1 500ns. RAM's, which are included. Fully buffered, drastically reduced power consumption, on board regulated, all sockets and parts included. Premium quality plated thru PC Board.

SIGNETICS ANALOG MANUAL - \$5.95

Just out! From the acknowledged leader in linear technology. Theory, applications, and specs. on op amps, timers, phase locked loops, etc. 637 pages.

A MUST For Any Technical Library!

STICK IT!
in your clock
in your DVM, etc.!

Huge Special Purchase
Not Factory Seconds
As sold by others!

\$3.95

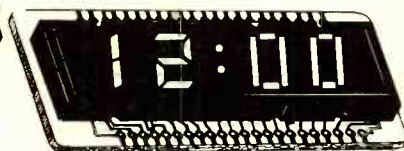

4 JUMBO .50"
DIGITS ON
ONE STICK!
(with colons and
AM/PM Indicator)

BUY 3 for \$10.

BOWMAR 4 DIGIT LED READOUT ARRAY

The Bowmar Opto-Stick. The best readout bargain we have ever offered. Has four common cathode jumbo digits with all segments and cathodes brought out. Increased versatility since any of the digits may be used independently to fit your applications. Perfect for any clock chip, especially direct drive units like 50380 or 7010. Also use in freq. counters, DVM's, etc. For 12 or 24 hour format.

UP YOUR COMPUTER! 21L02-1 1K LOW POWER 500 NS STATIC RAM TIME IS OF THE ESSENCE!

And so is power. Not only are our RAM'S faster than a speeding bullet but they are now very low power. We are pleased to offer prime new 21L02-1 low power and super fast RAM's. Allows you to STRETCH your power supply farther and at the same time keep the wait light off.

8 for \$12.95

HOUSE NO. TTL

7400 - 8/\$1.00	7420 - 8/\$1.00	74141 - 3/\$1.00
7404 - 8/\$1.00	7437 - 5/\$1.00	74153 - 3/\$1.00
7408 - 8/\$1.00		7438 - 5/\$1.00

Please specify that you are ordering House No. TTL

WESTERN DIGITAL UART

No. TR1602B. 40 pin DIP
This is a very powerful and popular part.
NEW-\$6.95 with data
LIMITED QUANTITY

RESISTOR ASSORTMENT

¼ W 5% and 10%
PC leads. A good mix
of values. 200/\$2.

FAIRCHILD BIG LED READOUTS

A big .50 inch easy to read character. Now available in either common anode or common cathode. Take your pick. Super low current drain, only 5MA per segment typical.

FND 510 Common Anode
FND 503 Common Cathode
PRICE SLASHED! 59c each

TERMS:

Money Back Guarantee. No COD. Texas Residents add 5% tax. Add 5% of order for postage and handling. Orders under \$10. add 75c. Foreign orders: US Funds ONLY!

SLIDE SWITCH ASSORTMENT

Our best seller. Includes miniature and standard sizes, single and multi-position units. All new, first quality, name brand. Try one package and you'll reorder more. SPECIAL 12/\$1.

MOTOROLA POWER DARLINGTON Back in Stock!

Like MJ3001. NPN 80V. 10A. HFE 6000 TYP. TO-3 case. We include a free 723C volt reg. with schematic for power supply. SPECIAL-\$1.99

CALL YOUR BANK
AMERICARD OR MASTER
CHARGE ORDER IN ON
OUR CONTINENTAL
UNITED STATES TOLL
FREE WATTS:

1-800-527-3460

Texas Residents Call Collect
214/271-0022

S.D. SALES CO.
P.O. BOX 28810 D
Dallas, Texas 75228

PLANNING TO MOVE?

Let us know 8 weeks in advance so that you won't miss a single issue of **POPULAR ELECTRONICS**.

Attach old label where indicated and print new address in space provided. Also include your mailing label whenever you write concerning your subscription. It helps us serve you promptly.

Write to: P.O. Box 2772, Boulder, CO 80323, giving the following information:

Change address only Extend my subscription

ENTER NEW SUBSCRIPTION

1 year \$.98 Payment enclosed

Allow 30-60 days for delivery. (1 extra BONUS issue)

Bill me later

AFFIX OLD LABEL

If you have no label handy, print OLD address here.

Name _____ please print

Address _____

City _____

State _____ Zip _____

NEW ADDRESS HERE 0202

Name _____ please print

Address _____

City _____

State _____ Zip _____

Additional postage per year. For Canada add \$3. For countries outside U.S. and Canada, add \$5—cash in U.S. currency only.

PLANS AND KITS

AMAZING ELECTRONIC PRODUCTS

LASERS SUPER POWERED, RIFLE, PISTOL, POCKET - SEE IN DARK - PYRO-TECHNICAL DE-BUGGING UNCRAMBLERS GIANT TESLA STUNWAND - TV DISRUPTER - ENERGY PRODUCING, SCIENTIFIC DETECTION, ELECTRIFYING, CHEMICAL, ULTRASONIC, CB, AERO, AUTO AND MECH DEVICES, HUNDREDS MORE ALL NEW PLUS INFO UNLTD PARTS SERVICE

UNIONIFIED unlimited

CATALOG #1 Box 626 Lord Jeffery PZ, Amherst, N.H. 03031

FREE KIT Catalog contains Test and Experimenter's Equipment. Dage Scientific Instruments, Box 1054P, Livermore, CA 94550.

TIGER SST SIMPLI-KIT

FOR THE DO-IT-YOURSELFER

NOW! a high quality CD Electronic Ignition System in kit form.

Contains all components and solder to build complete Solid-State Electronic CD Ignition System for your car. Assembly requires less than 3 hours.

- Increases MPG 15%
- Increases horsepower 15%
- Plugs and Points last 50,000 miles
- Eliminates 4 of 5 tune-ups
- Instant starting, any weather
- Dual system switch

Fits only 12 volt neg. ground. Only \$21.95 postpaid

Tri-Star Corporation
P.O. Box 1727 Grand Junction, Colorado 81501

FIVE OCTAVE Touch Sensitive Electronic PIANO KIT. Components \$229 airmail. U.S.A., Canada. Cief Products, 31, Mountfield Road, Bramhall, Cheshire, England SK7 1LY.

TAPE-SLIDE Synchronizer, lap-dissolve, multiprojector, audiovisual plans, \$8.50, Sampler, \$1.00. Millers, 1896 Maywood, S. Euclid, OH 44121.

BUILD YOUR OWN state of the art systems, enclosures, and devices. Complete plans. Send one dollar (redeemable) for complete info. Slater Design, P.O. Box 14466, Long Beach, CA 90814.

NEGATIVE ION GENERATOR. Detailed construction plans and schematics. \$7.50. Golden Enterprises, Box 1282PE, Glendale, Arizona 85311.

The "KING OF KITS". Artisan Organ Kits feature all new modular construction, with logic-controlled stops and RAM Preset Memory System. Write for brochure to AOK Manufacturing, Inc., P.O. Box 445, Kenmore, WA 98028.

ETCH IT YOURSELF PRINTED CIRCUIT KIT, Photo-Positive Method — All the supplies for four P.C. Boards. Direct from magazine article in less than 2 hours. Only \$19.95 S.A.S.E. for details. Excel Circuits, 4412 Fernlee, Royal Oak, Michigan 48073.

HIGH FIDELITY

DIAMOND NEEDLES and Stereo Cartridges at Discount prices for Shure, Pickering, Stanton, Empire, Grado and ADC. Send for free catalog. LYLE CARTRIDGES, Dept. P, Box 69, Kensington Station, Brooklyn, New York 11218.

SAVE 50% build your own speaker system write: McGee Radio Electronics, 1901 McGee Street, Kansas City, Missouri 64108.

HOME ENTERTAINMENT FILMS

OUT THEY GO... JANUARY CLEARANCE SALE! Apollo 15 — The Ride of the Rover, 200' Super 8, B&W, \$5.95 (save \$3.00 + shipping). Tunney-Gibbons; Tunney-Heeny, B&W, Standard or Super 8, \$5.95 each (save \$3.00 + shipping). Sugar Ray Robinson-Basilio/Turpin, 200' B&W Columbia Standard 8, a ring classic at \$4.95 + 75 cents shipping. INDY "500", Speedway classics, 1967 (A.J. Foyt) & 1968 (Bobby Unser), 200' Standard 8 (can be shown on dual 8 projector) Eastman Color. \$8.95 ea PPD — less than lab cost. '69 NBA Highlights (Bill Russell's last year), 200' Super 8 B&W, \$6.95 ea PPD (save \$2.00 + shipping). New Columbia 54-page Glossy Catalog, \$1.00 refundable with purchase. Castle 24-pg order form, \$0.50; new Sportlite flyer, \$0.35; Castle 4-pg order form, \$0.25. (Coins or stamps, pls). SPORTLITE, Elect-1, 20 N. Wacker, Chicago, IL 60606.

10% OFF WITH \$25 ORDER
15% OFF WITH \$100 ORDER

THESE DISCOUNTS APPLY TO TOTAL OF ORDER — SPECIALS INCLUDED

POCKET CALCULATOR KIT

5 function plus constant — addressable memory with individual recall — 8 digit display plus overflow — batteries never — uses standard size rechargeable batteries — all necessary parts in ready-to-assemble form — instructions included



Calc. Kit. Kit only \$9.95
Batteries (alkaline, disp.) 2.00
Adapter 3.95

FREE CATALOG AVAILABLE ON REQUEST INCLUDES RESISTORS +1%, +5%, TANTALUM CAPACITORS, POWER SUPPLY KITS, CLOCK KITS, TOOLS, RESISTOR & CAPACITOR KITS & MISCELLANEOUS DEVICES

TTL	7400	.13	7451	.17	74153	.89
7401	.16	7453	.17	74154	1.20	
7402	.15	7454	.17	74155	.97	
7403	.15	7460		74156	.97	
7404	.16	7464	.35	74157	.99	
7405	.19	7465	.35	74158	1.79	
7406	.20	7470	.30	74160	1.23	
7407	.28	7472	.30	74161	.97	
7408	.18	7473	.35	74162	1.39	
7409	.19	7474	.28	74163	1.09	
7410	.16	7475	.49	74164	.99	
7411	.25	7476	.30	74165	.99	
7413	.43	7483	.68	74166	1.25	
7414	.65	7485	.68	74170	2.10	
7416	.35	7486	.40	74173	1.49	
7417	.35	7489	2.25	74174	1.23	
7420	.16	7490	.43	74175	.97	
7422	.30	7491	.75	74176	.89	
7423	.29	7492	.48	74177	.84	
7425	.27	7493	.48	74180	.90	
7426	.26	7494	.78	74181	2.45	
7427	.29	7495	.79	74182	.79	
7430	.20	7496	.79	74184	1.90	
7432	.23	74100	.98	74185	2.20	
7437	.25	74105	.44	74187	5.75	
7438	.25	74107	.37	74189	1.15	
7440	.15	74121	.38	74191	1.25	
7441	.89	74122	.38	74192	.95	
7442	.59	74123	.65	74193	.85	
7443	.73	74125	.54	74194	1.25	
7444	.73	74126	.58	74195	.74	
7445	.73	74132	.89	74196	1.25	
7446	.81	74141	1.04	74197	.73	
7447	.79	74145	1.04	74198	1.73	
7448	.79	74150	.97	74199	1.69	
7450	.17	74151	.79	74200	5.45	

IC SOCKETS

Solder Tail - low profile

8 pin	.17	24 pin	.42
14 pin	.20	28 pin	.59
16 pin	.22	40 pin	.69
18 pin	.29		

WIRE WRAP - gold plate

18 pin	.49
--------	-----

LINEAR

101	.24	324	1.52	360	3.39
102	.33	339	1.58	362	3.39
104	.80	140K	1.69	565	1.18
105	.71	372	2.43	567	1.95
107	.26	373	2.42	709	.26
108	.84	376	6.48	710	.35
109K	1.07	380	1.30	711	.26
110	1.07	381	1.25	712	.32
111	.95	382	1.75	748	.35
119	1.13	383	1.75	747	.71
1201	1.39	392	2.95	748	.35
120K	1.39	340	2.95	75491	.71
322	1.70	364	1.19	75492	.80

OPTO ISOLATORS

MC2D	Opto isolator diode	1.09
MC2T	Opto isolator transistor	.70

SHIFT REGISTERS

MM5013	1024 bit accum. dyn.	1.75
MM5016	500/312 bit dyn.	1.59
515-4025	Quad 25 bit	.99
2504	1024 bit multiplexed dyn	3.95

Data included with order on request. Add \$.30 ea. if item is priced below \$1.00

CENTRAL PROCESSING UNIT

8008	\$19.95	CALCULATOR CHIP	TTL	LINEAR	LED				
8080	\$19.95	MM5738	\$1.75	7410	.12	301 mDIP	.22	MV10B	.10
				7437	.20	307 DIP	.22	MV50	.20
				7474	.22	365 DIP	.97	5020 RED	.12
				74121	.29	741 mDIP	.22	D110A	1.69
				9602	.49	739 DIP	.89	MANS	.98

2102 RAM

1024 bit fully decoded static RAM
DTL/TTL compatible — 16 pin DIP \$ 1.49

1702A UV ERASABLE PROM

— 2048 bit static PROM 256x8
elect programmable & erasable TTL/DTL comp. \$6.95

TANTALUM CAPACITOR KIT

60 solid dipped tantalum capacitors — 30% tolerance capacitors in a durable styrene union box — with color code charts

1 ufd	33V	10 ufd	30V	1 ufd	33V	2.2 ufd	35V
4.7 ufd	16V	6.8 ufd	6V	10 ufd	25V	15 ufd	20V
10 ufd	16V	10 ufd	10V	47 ufd	6V	56 ufd	6V

\$10.95

TANTALUM CAPACITORS

Solid dipped +20%

.1 mfd	35V	\$.25	10 mfd	16V	\$.40
.33 mfd	35V	.25	10 mfd	25V	.45
1 mfd	35V	.25	15 mfd	10V	.40
2.2 mfd	20V	.25	15 mfd	20V	.45
2.2 mfd	35V	.30	22 mfd	16V	.45
3.3 mfd	35V	.30	33 mfd	10V	.40
4.7 mfd	16V	.30	47 mfd	6V	.40
6.8 mfd	6V	.30	56 mfd	6V	.45
6.8 mfd	50V	.40	150 mfd	15V	.50

Electronic Games

A great gift idea or for your own family entertainment center. We have available in kit form **Electronic Roulette** and **Electronic Craps**. Both kits contain P.C. boards, LED's, all necessary components, transformer, case and instructions for easy assembly. Included with each kit is a 55 page booklet explaining the entire game.

Electronic Roulette

Dimensions 6 1/2" x 6 1/2" x 1 1/2" \$23.95

Electronic Craps

Dimensions 6 1/2" x 3 1/2" x 1 1/2" \$14.95

CMOS

4000A	.26	4018A	1.39	4066A	.89
4001A	.25	4020A	1.72	4068A	.44
4002A	.25	4021A	1.18	4069A	.44
4006A	1.35	4022A	.94	4071A	.26
4007A	.26	4023A	.25	4072A	.35
4008A	1.52	4024A	.89	4073A	.39
4009A	.57	4025A	.25	4075A	.39
4010A	.54	4027A	.59	4078A	.39
4011A	.29	4028A	.98	4082A	.35
4012A	.25	4030A	.44	4518A	1.56
4013A	.45	4035A	1.27	4528A	1.56
4014A	1.27	4040A	1.39	4585A	2.10
4015A	1.27	4042A	1.47		
4016A	.48	4049A	.59		
4017A	1.01	4050A	.59		

74C00	.19	74C74	1.04	74C162	2.49
74C02	.26	74C76	1.34	74C163	2.66
74C04	.44	74C107	1.13	74C164	2.66
74C08	.68	74C151	2.62	74C173	2.22
74C10	.35	74C154	1.76	80C95	1.15
74C20	.35	74C157	1.76	80C95	1.15
74C42	1.61	74C160	2.48	80C97	.96
74C73	1.04	74C161	2.49		

FREE CATALOG AVAILABLE ON REQUEST

Satisfaction guaranteed. Shipment will be made postage prepaid within 3 days from receipt of order. Payment may be made with personal check, charge card (include number and exp. date), or money order. Phone Orders — BofA and M/C card or C.O.D.

Add \$1.00 to cover shipping and handling if order is less than \$10.00. California residents add sales tax. Include shipping expense for orders shipped out of U.S. and Canada approx. 10% of order.

INTERNATIONAL ELECTRONICS UNLIMITED
P.O. BOX 3036-R MONTEREY, CA. 93940 USA
PHONE (408) 659-3171

DIGI-KEY CORPORATION
Quality Electronic Components
Double-Digit Discounts
Save You Even More

2102-1	8080A	LM3909
\$1.99	\$24.95	69¢

NATIONAL SEMICONDUCTOR CLOCK MODULES

MA1010A 12 Hour (AM-PM) Version . . . \$13.00
MA1010C 24 Hour Version \$13.00



MA1002A 12 Hour (AM-PM) Version \$10.50
MA1002C 24 Hour Version \$10.50

0.5" High LED Digits



Special transformer and 6 switches, when ordered with module add \$3.45.

0.84" High LED Digits



Special transformer and 6 switches when ordered with module add \$3.45

Hobby-Wrap-30 \$5.95

Strips, Wraps and Unwraps 30 ga. wire on standard wire wrapping pins

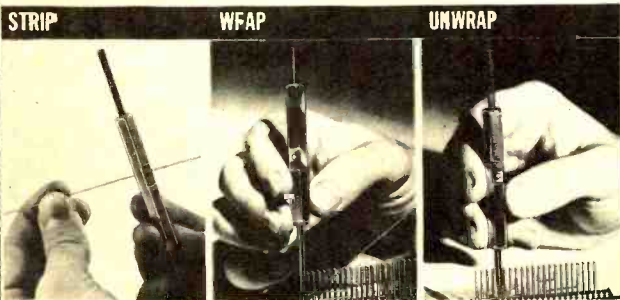

STRIP **WFAP** **UNWRAP**

MA1002 & MA1010 Series Electronic Clock Modules

The MA1002 & MA1010 Series Electronic Clock Modules are assembled and pretested modules which combine a monolithic MOS-LSI integrated clock circuit, 4-digit LED display, power supply and other associated discrete components on a single printed circuit board to form a complete electronic clock module. The user need add only a transformer and switches to construct a digital clock for application in clock-radios, alarm or instrument panel clocks. Time-keeping may be from 50 or 60 Hz inputs and 12 or 24 hour display formats may be chosen. Direct LED drive eliminates RF interference. Time setting is made easy through use of "Fast" and "Slow" scanning controls.

The MA1002A and MA1010A have a 12 hour display with an AM and PM indicator. The MA1002C and MA1010C have a 24 hour display.

Features include alarm "on" and "PM" indicators, "sleep" and "snore" timers and variable brightness control capability. The modules are extremely compact, the MA1002 measuring 1.375" by 3.05", the MA1010 measuring 1.75" by 3.75". This small size is achieved by bonding the I.C. to the back of the circuit board.

It is highly recommended that the transformer be obtained with the clock module as it is a special dual secondary type not otherwise readily available.

ACE201-K \$24.95

1,032 SOLDERLESS PLUG-IN TIE POINTS
CAPACITY: UP TO 12 14-PIN DIP'S

TWO 5-way bonding posts
Size: 4-9/16" x 7-1/2" x 1-1/2"
Kit form

WIRE WRAPPING WIRE
Red or Black Kynar insulated pre-cut and stripped 30 ga. wire. 1" of insulation is removed from each end.

Insulation Length	No. in Pkg.	Price per Pkg.
1.0"	100	\$2.50
2.0"	100	\$2.60
2.5"	100	\$2.65
3.0"	100	\$2.70
3.5"	100	\$2.75
4.0"	100	\$2.80
4.5"	100	\$2.90
5.0"	100	\$3.00
6.0"	50	\$1.60
7.0"	50	\$1.70
8.0"	50	\$1.80
9.0"	50	\$1.90
10.0"	50	\$2.00
15.0"	50	\$2.50

SLIDE SWITCHES

Single Pole Single Throw	Double Pole Double Throw
.15 1.20/10 10.00/C	.23 2.00/10 19.00/C

BATTERY HOLDERS

1-AA .26c	2-AA .42c
1-C .35c	1-D .42c
1-D .35c	1-D .42c

BISHOP GRAPHICS Printed Circuit Drifting Aids are now available from Digi-Key

RADIAL ELECTROLYTICS

47/50V .08 .65/10	22/50V .12 1.00/10	330/25V .23 1.86/10
1/50V .08 .65/10	100/6.3V .09 .75/10	470/10V .21 1.71/10
2/2/50V .08 .65/10	100/10V .10 .77/10	470/16V .23 1.81/10
3.3/50V .08 .65/10	100/16V .11 .85/10	470/25V .29 2.35/10
4.7/35V .08 .65/10	100/25V .13 1.10/10	1000/10V .24 1.96/10
4.7/50V .08 .65/10	100/50V .21 1.71/10	1000/16V .29 2.35/10
10/16V .08 .65/10	220/10V .13 1.06/10	1000/25V .42 3.33/10
10/25V .08 .65/10	220/16V .15 1.16/10	2200/10V .42 3.33/10
10/50V .10 .75/10	220/25V .21 1.71/10	2200/16V .54 4.30/10
22/16V .08 .67/10	220/50V .29 2.35/10	2200/25V .58 4.67/10
22/25V .09 .70/10	330/10V .15 1.16/10	3300/16V .89 7.14/10
	330/16V .21 1.66/10	

INTEGRATED CIRCUITS - TTL, CMOS, LINEAR & MOS

7400 21	7476 .32	74181 2.15	4012 23	4520 .114
7401 21	7480 .70	74182 .79	4013 40	4527 1.68
7402 21	7482 .70	74184 2.19	4014 96	4528 .88
7403 21	7483 .70	74185 2.19	4015 96	4589 1.23
7404 21	7485 .89	74188 3.50	4016 40	2102(-) 1.99
7405 21	7486 .28	74189 3.50	4017 105	8080A 24.95
7406 25	7489 2.19	74190 1.23	4018 105	CA3046 .75
7407 25	7493 .44	74191 1.23	4019 40	LM211N 1.25
7408 21	7491 .70	74192 .88	4020 1.14	LM309K 1.80
7409 21	7492 .44	74193 .88	4021 1.14	LM324A 1.28
7410 21	7493 .44	74194 .88	4022 96	LM340T-5 1.25
7411 21	7494 .70	74195 .88	4023 23	LM340T-18 1.25
7412 21	7495 .70	74196 .88	4024 84	LM340T-8 1.25
7413 25	7496 .70	74197 .88	4025 23	LM340T-12 1.25
7414 89	74100 1.28	74198 1.49	4026 168	LM340T-15 1.25
7416 25	74107 .30	74199 1.49	4027 40	LM340T-18 1.25
7417 25	74109 .33	74201 .89	4028 89	LM340T-24 1.25
7420 21	74121 .35	74209 1.55	4029 1.14	LM3900N .88
7421 25	74122 .44	74365 .67	4030 23	LM3909N .69
7422 35	74123 .61	74366 .67	4033 51	MC1456V 1.00
7423 35	74125 .40	74367 .67	4034 350	MC1458V .53
7426 25	74126 .40	74368 .67	4035 1.14	MC3302P 1.15
7427 33	74132 .70	8093 .40	4040 1.14	NE561T 3.24
7428 28	74141 .88	8094 .40	4041 79	NE540L 2.04
7430 21	74145 .70	8095 .67	4042 79	NE555V .48
7432 25	74147 1.63	8096 .67	4043 70	NE560B 3.83
7433 30	74148 1.30	8097 .67	4044 70	NE560V 3.83
7437 25	74150 1.16	8098 .67	4046 1.86	NE561B .88
7438 25	74151 .70	75150 1.16	4049 40	NE562B 3.83
7440 21	74153 .65	75450 .88	4050 40	NE565A 1.25
7442 53	74154 1.03	75451 .61	4051 26	NE566V 1.28
7443 63	74155 .70	75452 .61	4052 26	NE567V 1.36
7445 70	74156 .70	75453 .61	4053 26	uA709CV 4.44
7446 70	74157 .70	4060 58	4071 23	uA711CA 53
7447 70	74160 .88	75491 .81	4066 79	uA712CA 53
7448 70	74161 .88	75492 .84	4071 23	uA723CA .75
7450 21	74162 .88	75493 1.09	4072 23	uA733CA .75
7451 21	74163 .88	75494 1.19	4073 23	uA741CA .75
7453 21	74164 .88	82525 2.19	4075 23	uA747CA .75
7454 21	74165 1.15	4000 23	4081 23	uA748CV 1.25
7459 21	74166 1.26	4001 23	4082 23	uA7805CU .49
7460 21	74170 2.64	4002 23	4083 23	uA7805CU .49
7470 30	74173 1.42	4006 1.23	4510 1.14	uA7808CU 1.25
7472 30	74174 .98	4007 1.23	4511 1.05	uA7812CU 1.25
7473 30	74175 .98	4008 1.23	4514 2.80	uA7815CU 1.25
7474 30	74176 .98	4009 1.23	4515 2.80	uA7818CU 1.25
7475 49	74177 .98	4010 44	4516 1.23	uA7824CU 1.25
	74180 70	4011 23	4518 1.14	

WIRE WRAPPING WIRE IN BULK
Red or Black 30 ga. Kynar

100' \$2.00	500' \$8.50	1000' \$15.00
-------------	-------------	---------------

ENTIRE ROCKWELL CALCULATOR LINE ON DISCOUNT IN OUR LATEST CATALOG

MOLEX PINS
Make your own IC sockets on PC board

85/C	8.20/M	38.20/5M	275.00/50M
------	--------	----------	------------

SILICON DIODES

1N4001	64/10	5.50/C	\$49/M
1N4002	66/10	5.60/C	\$51/M
1N4003	68/10	5.80/C	\$53/M
1N4004	70/10	5.95/C	\$54/M
1N4005	82/10	7.05/C	\$63/M
1N4006	90/10	7.75/C	\$69/M
1N4007	99/10	8.60/C	\$77/M
1N4148	40/10	3.50/C	\$29/M

DOUBLE DIGIT DISCOUNTS
Save You Even More!

RESISTOR ASSORTMENTS

5 ohm all 10% 1/4 w. val. 10 thru 5.6 meg (350 pcs)	\$12.00
5 ohm all 10% 1/4 w. val. 2.2 thru 22 meg (425 pcs)	\$12.00

1/2 WATT ZENER DIODES

1N5226B 3.3v 15 S11/C	1N5236B 7.5v 15 S11/C
1N5227B 3.6v 15 S11/C	1N5237B 8.2v 15 S11/C
1N5228B 3.9v 15 S11/C	1N5238B 8.7v 15 S11/C
1N5229B 4.3v 15 S11/C	1N5239B 9.1v 15 S11/C
1N5230B 4.7v 15 S11/C	1N5240B 10v 15 S11/C
1N5231B 5.1v 15 S11/C	1N5241B 11v 15 S11/C
1N5232B 5.6v 15 S11/C	1N5242B 12v 15 S11/C
1N5233B 6.2v 15 S11/C	1N5243B 13v 15 S11/C
1N5234B 6.8v 15 S11/C	1N5244B 14v 15 S11/C
1N5235B 7.5v 15 S11/C	1N5245B 15v 15 S11/C

PERF BOARD
0.1" spacing between holes

4 1/4" x 6"	\$1.71
4 1/4" x 17"	\$4.25

TERMINALS
for above perf board

1-D	\$1.50/C
-----	----------

LED LAMPS

NSL5053 T-1 1/4	18 \$15/C
NSL5056 T-1 1/4	18 \$15/C

LED DISPLAYS

FND352 CC 375'	\$1.75
FND500 CC 500'	\$1.75
FND 507 CA 500'	\$1.75
FND800 CC 800'	\$3.50
FND807 CA 800'	\$3.50

DATA BOOK

TTL DATA BOOK

DATA BOOKS

TTL IC's 595 p.	\$4.00
Linear IC's 957 p.	\$5.00
CMOS IC's 256 p.	\$3.00
Transistors 288 p.	\$3.00
Memory IC's 592 p.	\$3.00
Interface IC's 464 p.	\$4.00
Volt. Regs. 128 p.	\$3.00
Linear Appl. 1 432 p.	\$4.00
Linear Appl. 2 246 p.	\$3.00
Audio 196 p.	\$3.00

AXIAL ELECTROLYTICS

47/10V .11 90/10	33/25V .14 1.15/10	330/16V .29 2.35/10
1/30V .11 90/10	33/50V .19 1.52/10	330/25V .32 2.54/10
3.3/35V .12 95/10	47/16V .14 1.15/10	470/16V .32 2.55/10
3.3/50V .12 100/10	47/25V .17 1.30/10	470/25V .37 3.00/10
4.7/25V .11 90/10	47/50V .21 1.71/10	1000/10V .23 2.65/10
4.7/35V .12 95/10	100/10V .14 1.13/10	1000/16V .39 3.15/10
4.7/50V .12 100/10	100/16V .17 1.30/10	1000/25V .56 4.45/10
10/25V .12 100/10	100/25V .20 1.55/10	2200/10V .50 3.98/10
10/50V .14 1.15/10	100/50V .29 2.36/10	2200/16V .62 4.95/10
22/16V .12 100/10	220/10V .18 1.42/10	2200/25V .79 6.36/10
22/25V .13 1.05/10	220/16V .20 1.55/10	3300/16V .95 7.63/10
22/50V .17 1.32/10	220/50V .29 2.35/10	4700/16V/10V 8.70/10
33/16V .12 100/10	330/10V .14 1.16/10	10000/10V 1.15 9.19/10

WIRE-WRAPPING TOOL \$5.95
Wraps, Unwraps & Strips 30 ga. Wire

1/4 & 1/2 WATT 5% CARBON FILM RESISTORS
5c each in multiples of 5 per value
\$1.70/100 & \$12.00/1000 of same value
1 ohm thru 1.0 megohm

DOUBLE-DIGIT DISCOUNT SCHEDULE

Hardware	Discount	Hardware	Discount
2-56 1/4 Screw	99/C 7.20/M	Merchandise	NET
2-56 1/2 Screw	99/C 7.65/M	\$ 0.00-\$24.99	5%
4-40 1/4 Screw	55/C 3.60/M	\$25.00-\$99.99	10%
4-40 1/2 Screw	60/C 4.05/M	\$100.00 & Up	25%
6-32 1/4 Screw	65/C 4.15/M		
6-32 1/2 Screw	75/C 4.85/M		
8-32 3/8 Screw	90/C 5.85/M		
8-32 5/8 Screw	99/C 7.00/M		
2-56 Hex Nut	55/C 3.60/M		
4-40 Hex Nut	55/C 3.75/M		
6-32 Hex Nut	60/C 4.00/M		
6-32 Hex Nut	60/C 4.15/M		
No. 2 Lockwasher	85/C 5.75/M		
No. 4 Lockwasher	45/C 3.00/M		
No. 6 Lockwasher	45/C 3.00/M		
No. 8 Lockwasher	45/C 3.00/M		

Then Add the Standard Charge Below

STANDARD SHIPPING/HANDLING CHARGE

If your merchandise total after discount is between

\$ 0.00 - 4.99	+ add \$2.00	\$100.00 - 999.99	+ add \$9.25
\$ 5.00 - 24.99	+ add \$2.75	\$1000.00 & up	+ add \$25.00
\$25.00 - 99.99	+ add \$3.50		

Includes shipping and insurance to USA & Canada

DIGI-KEY CORPORATION

Box 677, Thief River Falls, MN 56701 218-681-6674

CB SPECIALS-R.F. DRIVERS-R.F. POWER OUTPUTS-FETS

25C481	1.85	25C767	15.75	25C866	5.85	25C1449-1	1.60	40081	1.50
25C482	1.75	25C773	85	25C013	1.50	25C475	1.50	40082	3.00
25C495	1.10	25C774	1.75	25C1014	1.50	25C1678	5.50	25C608	4.85
25C502	3.75	25C775	2.75	25C1017	1.50	25C1679	4.75	SK3046	2.15
25C517	4.75	25C776	3.00	25C1018	1.50	25C1728	2.15	SK3047	3.75
25C614	3.80	25C777	4.75	25C1173	1.25	25C1760	2.15	SJ2095	3.50
25C615	3.90	25C778	3.25	25C1226A	1.25	25C1816	5.50	SK3048	3.25
25C616	4.15	25C797	2.50	25C1237	4.50	25C1908	7.00	SK3054	1.25
25C617	4.25	25C798	3.10	25C1239	3.50	25C1957	1.50		
25C699	4.75	25C781	3.00	25C1243	1.50	25F8	3.00	25K19	1.75
25C710	.70	25C789	1.00	25C1306	4.75	HEP S 3001	3.25	25K30	1.00
25C711	.70	25C796	3.15	25C1306-14	9.00	25D235	1.00	25K33	1.20
25C735	.70	25C799	4.25	25C1307	5.75	MRF8004	3.00		
25C756	3.00	25C802	3.75	25C1307-16	6.00	4004	3.00	SK40	2.75
25C765	9.50	25C803	4.00	25C1377	5.50	4005	3.00	SK45	2.75
25C766	10.15	25C839	.85	25C1449	1.30	40080	1.25	SK49	2.75

JAPANESE TRANSISTORS

2SA52	.60	2SB187	.60	2SC458	.70	2SC815	.75	2SC1569	1.25
2SA316	.75	2SB235	1.75	2SC460	.70	2SC828	.75	2SC1756	1.25
2SA473	.75	2SB303	.65	2SC478	.80	2SC829	.75		
2SA483	1.95	2SB324	1.00	2SC491	2.50	2SC830	1.60	2SD30	.95
2SA489	.80	2SB337	2.10	2SC497	1.60	2SC839	.85	2SD45	2.00
2SA490	.70	2SB367	1.60	2SC515	.80	2SC945	.65	2SD45	.75
2SA505	.70	2SB370	.65	2SC535	.75	2SC1010	.80	2SD68	.90
2SA564	.50	2SB405	.85	2SC536	.65	2SC1012	.80	2SD72	1.00
2SA628	.65	2SB407	1.65	2SC537	.70	2SC1051	2.50	2SD88	1.50
2SA643	.85	2SB415	.85	2SC563	2.50	2SC1061	1.65	2SD151	2.25
2SA647	2.75	2SB461	1.25	2SC605	1.00	2SC1079	3.75	2SD17C	2.00
2SA673	.85	2SB463	1.65	2SC620	.80	2SC1096	1.20	2SD180	2.75
2SA679	3.75	2SB471	1.75	2SC627	1.75	2SC1098	1.15	2SD201	1.95
2SA682	.85	2SB474	1.50	2SC642	3.50	2SC1115	2.75	2SD218	4.75
2SA699	1.30	2SB476	1.25	2SC643	3.75	2SC1166	7.00	2SD300	2.50
2SA699A	1.75	2SB481	2.10	2SC644	.70	2SC1170	4.00	2SD313	1.10
2SA705	.55	2SB492	1.25	2SC681	2.50	2SC1172B	4.25	2SD315	.75
2SA815	.85	2SB495	.95	2SC684	2.10	2SC1209	.55	2SD318	.95
2SA816	.85	2SB507	.90	2SC687	2.50	2SC1213	.75	2SD341	.95
		2SB511	.70	2SC696	2.35	2SC1226	1.25	2SD350	3.25
2SB22	.65			2SC712	.70	2SC1243	1.50	2SD352	.80
2SB54	.70	2SC206	1.00	2SC713	.70	2SC1293	.85	2SD380	5.70
2SB56	.70	2SC240	1.10	2SC732	.70	2SC1308	4.75	2SD389	.90
2SB77	.70	2SC261	.65	2SC733	.70	2SC1347	.80	2SD390	.75
2SB128	2.25	2SC291	.65	2SC739	.70	2SC1383	.75	2SD437	5.50
2SB135	.95	2SC320	2.00	2SC715	1.75	2SC1409	1.25		
2SB152	4.50	2SC352	.75	2SC762	1.90	2SC1410	1.25	C106B1	.50
2SB173	.55	2SC353	.75	2SC783	1.00	2SC1447	1.25		
2SB175	.55	2SC371	.70	2SC784	.70	2SC1448	1.25	MPS-U31	4.00
2SB178	1.00	2SC372	.70	2SC785	1.00	2SC1507	1.25	MPS-8C001.25	
2SB186	.60	2SC394	.70	2SC793	2.50	2SC1509	1.25		

POWER-TRANSISTORS HIGH-VOLT. TV. TYPE

BU204	1300V	3.90	BU207	1300V	5.40	2SC1172B	1100V	4.25
BU205	1500V	4.70	BU208	1500V	6.25	2SC308	1100V	4.95
BU206	1700V	5.90	2SC1170	1100V	4.00	2SC1325	1100V	4.95

CIRCLE NO. 39 ON FREE INFORMATION CARD

OEM SPECIALS

1N270	.10	2N960	.55	2N2219A	.30	2N2913	.75	2N3740	1.00	2N4401	.20
1N914	.10	2N962	.40	2N2221	.25	2N2914	1.20	2N3771	1.75	2N4402	.20
		2N967	.50	2N2221A	.30	2N2916A	3.65	2N3732	1.90	2N4403	.20
2N173	1.75	2N1136	1.35	2N2222	.25	2N3019	.50	2N3773	3.00	2N4409	.20
2N178	.90	2N1142	2.25	2N2222A	.30	2N3053	.30	2N3819	.32	2N4410	.25
2N327A	1.15	2N1302	.25	2N2270	.40	2N3054	.70	2N3823	.70	2N4416	.75
2N334	1.20	2N1305	.30	2N2322	1.00	2N3055	.75	2N3856	.20	2N4441	.85
2N336	.90	2N1377	.75	2N2323	1.00	2N3227	1.00	2N3866	.85	2N4442	.90
2N338A	1.05	2N1420	.20	2N2324	1.35	2N3247	3.40	2N3903	.20	2N4443	1.20
2N398B	.90	2N1483	.95	2N2325	2.00	2N3250	.50	2N3904	.20	2N4452	.55
2N404	.30	2N1540	.90	2N2326	2.85	2N3375	6.50	2N3905	.20	2N5061	.30
2N443	1.75	2N1543	2.70	2N2327	3.80	2N3393	.20	2N3906	.25	2N5064	.50
2N456	1.10	2N1544	.80	2N2328	4.20	2N3394	.17	2N3925	3.75	2N5130	.20
2N501A	3.00	2N1549	1.25	2N2329	4.75	2N3414	.17	2N3954	3.50	2N5133	.15
2N508A	.45	2N1551	2.50	2N2368	.25	2N3415	.18	2N3954A	3.75	2N5138	.15
2N555	.45	2N1552	3.25	2N2369	.25	2N3416	.19	2N3955	2.45	2N5198	3.75
2N652A	.85	2N1554	1.25	2N2484	.32	2N3417	.20	2N3957	1.25	2N5294	.50
2N677C	6.00	2N557	.15	2N2712	.18	2N3442	1.85	2N3958	1.20	2N5296	.50
2N706	.25	2N1560	2.80	2N2894	.40	2N3553	1.50	2N4037	.60	2N5306	.20
2N706B	.40	2N1605	.35	2N2903	3.30	2N3563	.20	2N4093	.85	2N5354	.20
2N711	.50	2N1613	.30	2N2904	.25	2N3565	.20	2N4124	.20	2N5369	.20
2N711B	.60	2N1711	.30	2N2904A	.30	2N3638	.20	2N4126	.20	2N5400	.40
2N718	.25	2N1907	4.10	2N2905	.25	2N3642	.20	2N4141	.20	2N5401	.50
2N718A	.30	2N2060	1.85	2N2905A	.30	2N3643	.15	2N4142	.20	2N5457	.35
2N720A	.50	2N2102	.40	2N2906	.25	2N3645	.15	2N4143	.20	C103Y	.25
2N918	.35	2N2128	.25	2N2906A	.30	2N3646	.14	2N4220A	45	C103D	.40
2N930	.25	2N218A	.30	2N2907	.25	2N3730	1.50	2N4234	95	C106B1	.50
2N956	.30	2N2219	.25	2N2907A	.30	2N3731	2.75	2N4400	.20	C106D1	.75

SILICON UNIJUNCTIONS

2N2646	50	2N2160	.65
2N2647	60	2N4870	50
2N6027	55	2N4871	50
2N6028	70	2N4891	50
D5E37	25	2N4892	50
		2N4893	50
		2N4894	50
		MU10	.40

INTEGRATED CIRCUITS

UA703C	.40
709C OP. AMP.	.25
741C OP. AMP.	.25
7400	.15
TA 7061P	3.50
TA 7205P	10.00
UPC 1001h2	6.00
NE 555	1.25

RECTIFIERS

IN4001	.60	5.00
IN4002	.70	6.00
IN4003	.80	7.00
IN4004	.90	8.00
IN4005	1.00	9.00
IN4006	1.10	10.00
IN4007	1.20	11.00



New-Tone Electronics
P.O. Box 1738 A
Bloomfield, N.J. 07003
Phone: (201) 748-6171, 2, 3

ALL PARTS GUARANTEED AND TESTED ON PREMISES.

N.J. residents add 5% sales tax. Minimum order \$5.00. All orders add \$1.00 postage. Dealers write or phone for discount prices.

PRINTED CIRCUIT BOARD

4 1/2" x 6 1/2" SINGLE SIDED EPOXY BOARD 1/16" thick, unetched
\$.50 ea.
VECTOR BOARD 1" SPACING
4.5" x 6" SHEET \$1.25

7 WATT LD-65 LASER DIODE IR \$8.95

2N 3820 P FET	\$.45
2N 5457 N FET	\$.45
TIS 43 UJT	\$.35
ER 900 TRIGGER DIODES	4/\$1.00
2N 6028 PROG. UJT	\$.65

VERIPAX PC BOARD

This board is a 1/16" single sided paper epoxy board, 4 1/2" x 6 1/2" DRILLED and ETCHED which will hold up to 21 single 14 pin IC's or 8, 16, or LSI DIP IC's with busses for power supply connector. \$4.00

MV 5691 YELLOW-GREEN BIPOLAR LED	\$.125
FP 10 PHOTO TRANS.	\$.50
RED, YELLOW, GREEN OR AMBER LARGE LED's	ea. \$.20
14 PIN DIP SOCKETS	\$.25
16 PIN DIP SOCKETS	\$.25
MOLEX PINS	100/\$1.00
8 PIN MINI DIP SOCKETS	\$.25
10 WATT ZENERS 3.9, 4.7, 5.6, 8.2, 12, 15, 18, 22, 100, 150 or 200V	ea. \$.60
1 WATT ZENERS 4.7, 5.6, 10, 12, 15, 18 OR 22V	ea. \$.25

Silicon Power Rectifiers

PRV 1A	3A	12A	50A	125A
100	.06	.14	.30	.80
200	.07	.20	.35	1.15
400	.09	.25	.50	1.40
600	.11	.30	.70	1.80
800	.15	.35	.90	2.30
1000	.20	.45	1.10	2.75

SILICON SOLAR CELLS

2 1/2" diameter
4V at 500 ma. . . \$5.00 ea., 6/\$27.50

REGULATED MODULAR POWER SUPPLIES

+ 15 VDC AT 100ma	\$27.95
115VAC INPUT	\$24.95
5VDC AT 1A, 115VAC INPJT	\$24.95
12 VDC AT 3 AMP	\$24.95
IN 4148 (IN914)	15/\$1.00

TANTALUM CAPACITORS

22UF 35V 5/81.00	4UF 35V 4/81.00
47UF 35V 5/81.00	6.3UF 35V 3/81.00
68UF 35V 5/81.00	22UF 35V \$.40
1UF 35V 5/81.00	33UF 35V \$.40
2.2UF 20V 5/81.00	30UF 6V 5/81.00
3.3UF 35V 4/81.00	100UF 35V \$.50
	190UF 15V \$.50

M7001 ALARM CLOCK CHIP \$6.00

MM1402-1.75	MM5057-2.25
MM1403-1.75	MM5058-2.75
MM1404-1.75	MM5060-2.75
MM5013-2.50	MM5061-2.50
MM5016-2.50	MM5555-4.75
MM5017-2.70	MM5556-4.75
MM5052-2.25	MM5210-1.95
MM5056-2.25	MM5260-1.75

NATIONAL MOS DEVICES

7400-14	7442-.52	74125-.40
7401-14	7445-.70	74126-.40
7402-14	7446-.70	74151-.70
7403-14	744	

THE KING OF ALTAJ

25.50



6-DIGIT ALARM CLOCK

THE KING FEATURES:

- 1) 6 digit, 12 hr. 60 cycle or 24 hr. 50 cycle alarm clock.
- 2) Time sharing capability for display of additional information.
- 3) Single 12v. supply and a minimum of interface components.
- 4) AM PM and automatic power fail ure indications.
- 5) 10 minute snooze.
- 6) Intensity control of LEDs.

Kit No. 70250-1R (Red readouts)
Kit No. 70250-1G (Green readouts)
Kit No. 70250-1Y (Yellow readouts)
Kit No. 70250-2R (DL727 readouts) .5 in. \$29.50

All kits include components, PC Boards, Transformer, case, and construction manual.

THE KING'S HAREM

FATIMA 4-DIGIT TEMP. KIT

\$24.95

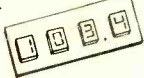

Features 4 digit temperature display, Fahrenheit or Centigrade; complete C Mos application; uses 7002 4 digit counter.

Kit includes all components, PC Board and instructions for interfacing with THE KING 6 digit alarm clock. Addition Number 2

DELILA APPLIANCE STARTER \$9.95

(Example) Set your alarm for 7 a.m., set timer for 15 min. At exactly 7 a.m., the appliance will start; at 7:15 your clock alarm will wake you.

Kit includes all components, PC Board and instructions for interfacing with THE KING 6 digit alarm clock. Addition Number 2

TANYA 60 HZ CRYSTAL TIME BASE

\$5.95

ADDITIONAL FEATURES:

- 1) Low Power Consumption
- 2) Directly interfaces with King MOS Clock Chip.
- 3) 60 Hz output with crystal time base accuracy.
- 4) Ideal for Cars, Boats, & Campers

Kit includes all components, PC Board and instructions for interfacing with THE KING 6 Digit Alarm Clock. Addition Number 3.



FND70
RED, .25 in. Char.
15mA per segment.
Common Cathode.
\$1.27



DL727
One of our best readouts
5 in. High, 20mA per
segment. Common anode.
\$3.75



FND800 CATHODE
5 in. High. The Best
on the market. Ideal
for large readout
application. \$4.95



**BURROUGHS
12 DIGIT**
75 in. high orange
digit. 160V dc.
Free socket. \$2.50



FND503
New 5 in. display
by Fairchild
Common Cathode.
\$1.60
\$37.50



TI

Fully multiplexed common cathode.
Goldplated. Ideal for mini 6-line
clock. \$1.30



LEDS
Mini red 12
Jumbo red 15
Jumbo green 20
Jumbo yellow 25



DL33
If you like an
array of displays,
we have it. Com-
mon cathode. \$1.95

TTL BOARDS

MEMOREX computer boards with TTL's Diodes and Transistors, etc.
5 Boards containing 150-250 IC's \$4.50

GE TRANSISTOR ASSORTMENT
T09B caser Darling, SCRs,
PNP, PNP, ect.
50 for \$1.50
100 for \$2.50
300 for \$6.00

LSI INTEGRATION

MM5316	4-6 digit alarm clock 40 pin dip w/sep.	\$ 4.25
7002	4 digit counter/latch decoder, 7 segment and BCD outputs, 28 pin dip w/sep.	\$12.50
7006	4 digit counter/latch decoder, 7 segment output only, 24 pin dip w/sep.	\$ 9.50
7007	4 digit counter/latch decoder with BCD output only, 16 pin dip w/sep.	\$ 7.00
70250	4,8 digit alarm clock, 28 pin dip w/sep.	\$ 4.25
PC Board for 70250		
70380	4 digit non multiplexed radio alarm clock featuring direct drive display output 40 pin dip w/sep.	\$4.50
PC Board for 70380		\$ 3.75
80036	8 bit parallel CPU	\$19.50
2102	1K static RAM for 8008	\$ 2.25
MM5203	2K UV erasable PROM.	\$12.25
75491	segment driver	\$ 0.35
75492	digit driver	\$ 0.45
7020	6 function calculator chip with direct segment drive, 8 digit.	\$ 2.25

TTL

7400	2'	7448	94	74151	80
7102	21	7453	21	74153	93
7404	21	7413	44	74154	100
7406	29	7474	42	74161	104
7408	21	7475	70	74163	124
7410	21	7476	44	74164	154
7413	54	7483	90	74165	154
7420	2'	7489	250	74174	134
7427	29	7493	80	74181	230
7430	21	7490	74	74182	230
7437	44	7493	80	74192	130
7438	36	7486	80	74193	130
7440	21	7495	80	74195	84
7439	36	7486	80		
7442	74	74121	43		
7447	84	74123	80		

CMOS

4000	24	4018	149	4037	4 50
4001	24	4019	59	4040	1 50
4002	24	4020	159	4041	89
4006	149	4021	149	4042	79
4007	24	4022	119	4043	80
4008	115	4023	24	4044	59
4009	59	4024	99	4047	59
4010	55	4025	24	4049	59
4011	24	4027	59	4050	59
4012	24	4028	99	4068	99
4013	59	4029	139	74C12	29
4014	149	4030	49	74C04	29
4015	119	4034	325	74C07	129
4016	59	4035	139		
4017	129				

4 & 6 DIGIT PC BOARDS

PC Board for 4 digit display FND 800 or 807	\$2.75
PC Board for 6 digit display FND 800 or 807	\$3.50
PC Board for 4 digit display MM series or DL707	\$1.75
PC Board for 6 digit display MM series or DL707	\$2.25
PC Board for 4 digit display FND503	\$2.00
PC Board for 6 digit display FND503	\$2.50
PC Board for 4 digit display DL747	\$3.00
PC Board for 6 digit display DL747	\$3.50
PC Board for 4 digit display DL727	\$2.25
PC Board for 6 digit display DL727	\$2.75
PC Board for 4 digit display FND70	\$1.75



MSI

Wise move



4-DIGIT DECADE COUNTER KIT

\$19.95 KIT 012

One chip 4 digit decade counter kit, with both 7 segment and BCD output.

- 1) Chip features internal oscillator for scanning speed.
- 2) Overflow and count extend out puts.
- 3) Transfer, reset, count, blanking and true complement control inputs.
- 4) PC Boards can be cascaded to 8 1/2 16 etc. digit displays.
- 5) Kit Includes counter chip, drive circuit for 4 cathode type displays and PC Board. (Far read out board see FND70 FND503)

KIT 016 FREQ. COUNTER

Features FET input front end with trigger circuit for measuring complex waveforms. Measures from 0.1Hz to 10MHz when used with Kit 015 or 019. Measures from 0.1Hz to 35MHz when used with Kit 013 and 014.

\$24.50



KIT 030 POWER SUPPLY

1.999V output, 25V max. Output current: 1 amp max. Load regulation: 50mV. Output voltage: 5V. Line regulation: 0.1%. Requires 8 20V transformer. \$4.55 (Contains all parts except transformer)



TIME BASES

1 Mhz crystal chain time base divider. Outputs: 1Mhz 100Khz 10Khz 1Khz 100Hz 10Hz 0.1Hz. Accuracy better than .005% with proper adjustment

Kit 013 complete CMOS with PC board \$15.75
Buffer Circuit for TTL Interfacing

Kit 014 Same as Kit 013, but with TTL \$13.75

Kit 015 50KHz or 60KHz chain time base using line frequency as reference. Accuracy 0.1 0.05%. Outputs 10Hz 1Hz 0.1Hz. Complete with CMOS shaping circuit and PC Board \$9.75

Kit 019 Same as Kit 015, but with TTL and 60Hz only. \$7.75

Kit 018 60KHz chain time base using line frequency for Kit 020 RPM counter.

*Outputs: 6 sec., 100th of RPM
6 sec., 10th of RPM
60 sec. full revolution \$9.75

MODULAR SCIENTIFIC INSTRUMENTATION

Now you can build some of the most advanced digital electronic instruments with our new series of lowest cost modular scientific kits. These kits will expand the range of your electronic applications enormously and all at a surprisingly low cost.

The heart of the system is our 4 digit Decade Counter (Kit 012) which features a full 4 digit LED readout (you choose the size best suited to your application). Combine this with a 5 volt regulated power supply (Kit 030) and you have the basis of a wide range of sophisticated electronic instruments, including:

- A Digital Voltmeter (DVM) - Kit 012 + Kit 030 + Kit 017
- Frequency Counter - Kit 012 + Kit 030 + Kit 016 + Time Base RPM Counter - Kit 012 + Kit 030 + Kit 020 + Kit 018

MSI CLUB

Send for your membership card to the Modular Scientific Instrumentation Club and receive a big 15% off on future purchases of MSI kits. Send \$3.00 with your name and address. We will promptly send your very own registered membership card. Don't miss out on the savings. Write now.

Memberships valid for one year from date of registration.

LSI INTEGRATION

MM5316	4-6 digit alarm clock 40 pin dip w/sep.	\$ 4.25
7002	4 digit counter/latch decoder, 7 segment and BCD outputs, 28 pin dip w/sep.	\$12.50
7006	4 digit counter/latch decoder, 7 segment output only, 24 pin dip w/sep.	\$ 9.50
7007	4 digit counter/latch decoder with BCD output only, 16 pin dip w/sep.	\$ 7.00
70250	4,8 digit alarm clock, 28 pin dip w/sep.	\$ 4.25
PC Board for 70250		
70380	4 digit non multiplexed radio alarm clock featuring direct drive display output 40 pin dip w/sep.	\$4.50
PC Board for 70380		\$ 3.75
80036	8 bit parallel CPU	\$19.50
2102	1K static RAM for 8008	\$ 2.25
MM5203	2K UV erasable PROM.	\$12.25
75491	segment driver	\$ 0.35
75492	digit driver	\$ 0.45
7020	6 function calculator chip with direct segment drive, 8 digit.	\$ 2.25

TTL

7400	2'	7448	94	74151	80
7102	21	7453	21	74153	93
7404	21	7413	44	74154	100
7406	29	7474	42	74161	104
7408	21	7475	70	74163	124
7410	21	7476	44	74164	154
7413	54	7483	90	74165	154
7420	2'	7489	250	74174	134
7427	29	7493	80	74181	230
7430	21	7490	74	74182	230
7437	44	7493	80	74192	130
7438	36	7486	80	74193	130
7440	21	7495	80	74195	84
7439	36	7486	80		
7442	74	74121	43		
7447	84	74123	80		

CMOS

4000	24	4018	149	4037	4 50
4001	24	4019	59	4040	1 50
4002	24	4020	159	4041	89
4006	149	4021	149	4042	79
4007	24	4022	119	4043	80
4008	115	4023	24	4044	59
4009	59	4024	99	4047	59
4010	55	4025	24	4049	59
4011	24	4027	59	4050	59
4012	24	4028	99	4068	99
4013	59	4029	139	74C12	29
4014	149	4030	49	74C04	29
4015	119	4034	325	74C07	129
4016	59	4035	139		
4017	129				

4 & 6 DIGIT PC BOARDS

PC Board for 4 digit display FND 800 or 807	\$2.75
PC Board for 6 digit display FND 800 or 807	\$3.50
PC Board for 4 digit display MM series or DL707	\$1.75
PC Board for 6 digit display MM series or DL707	\$2.25
PC Board for 4 digit display FND503	\$2.00
PC Board for 6 digit display FND503	\$2.50
PC Board for 4 digit display DL747	\$3.00
PC Board for 6 digit display DL747	\$3.50
PC Board for 4 digit display DL727	\$2.25
PC Board for 6 digit display DL727	\$2.75
PC Board for 4 digit display FND70	\$1.75



\$26.95



Ideal for Car, Boat, Camper, Etc. with Built-in Backup Power Supply.

'THE TRAVELER' 4-DIGIT AUTOMOBILE CLOCK

FEATURES:

- 1) 5" Inch Displays
- 2) AC/DC Operated
- 3) Automatic Charge and Recharging of Backup Power Supply
- 4) Able to Keep Time While Changing from House to Car or Car to Boat Using Built-in Backup Power Supply
- 5) Protected From Noise and Voltage Spikes in Car and Boat
- 6) Direct Drive Outputs
- 7) Non-Multiplexed Output Circuitry

KIT INCLUDES:
COMPONENTS, PC BOARD,
TRANSFORMER, AND
CONSTRUCTION MANUAL

LIGHTS

MUSIC 66 WATT COLOR ORGAN

Completely self contained unit with 70 volt power cord included

\$2.00

\$85 SAVE! 4-DIGIT ALARM CLOCK

KIT NO. 1 \$13.95 (with PC Board)

FEATURES:

- Does three display outputs. Current control regulation on chip. Low power brightness control on chip. RFI interference stop circuitry. Sleep Radio feature. 24 hr. snooze alarm. Independent time setting. Non multiplexed output circuitry. 12V AC CT 112 amp transformer for Kit No. 1

\$2.00

'KIT NO. 2

Complete kit with components, PC Board, Transformer, wood grain case and filter for display window. Includes 25 pin readouts. \$21.50

'KIT NO. 3

Complete kit with components, PC Board, Transformer, wood grain case, and filter for display window. Includes 5 inch readouts. \$22.50

* Components for Kit No. 2 or Kit No. 3 sleep radio feature, add \$95

Add 10% for Shipping

555 Timer Mini dip	0.65
8038 Functional generator	4.25
RCA 30K3 FM IF, Aud Preamp.	1.20
565 Phase Lock Loop	1.95
567V Eric Decoder	0.55
LM723 Pos. Volt. Reg.	1.10
LM309 Sv. 1 amp Reg	1.10
LM380 2w. Audio Amp, 8 pin dip	1.00
LM741 Operational Amp	0.25
RCA200V 115W TDS NPN	1.25
GE D40C1 NPN Darl	0.25
2N4425SCR 400V/8A T0220	0.65
2N2222 NPN Gen Amp	0.10
2N3904 NPN Driver	0.20
2N3906 PNP Compl. 2N3904	0.15
2N4400 NPN Low level noise	0.20
2N5401 PNP Noise driver	0.25

CRYSTALS

THESE FREQUENCIES ONLY

Part#	Frequency	Case/Style	Price
CV1A	1.000 MHz	HC33/U	\$5.95
CV2A	2.000 MHz	HC33/U	\$5.95
CV3A	4.000 MHz	HC18/U	\$4.95
CV7A	5.000 MHz	HC18/U	\$4.95
CV12A	10.000 MHz	HC18/U	\$4.95
CV14A	14.31818 MHz	HC18/U	\$4.95
CV19A	18.000 MHz	HC18/U	\$4.95
CV22A	20.000 MHz	HC18/U	\$4.95
CV30B	32.000 MHz	HC18/U	\$4.95

XR-2260BK Kit \$27.95

XR-2206KA Kit \$17.95

WAVEFORM GENERATORS		TIMERS	
XR 205	\$8.40	XR-555CP	\$ 9
XR 2206CP	4.49	XR-556CP	1.85
XR 2207CP	3.95	XR-555CP	3.20
STEREO DECODERS		PHASE LOCKED LOOPS	
XR-1310CP	\$3.20	XR-210	5.20
XR-1310CP	3.20	XR-1488	5.80
XR-1800P	3.20	XR-1489	4.80
XR-2567	2.99	XR-2208	5.20

EXAR

MISCELLANEOUS

XR-4136	\$5.70	99	
XR-1466	3.85	XR-210	5.20
XR-1488	5.80	XR-215	6.60
XR-1489	4.80	XR-567CT	1.35
XR-2208	5.20	XR-567CT	1.70

CONNECTORS

PRINTED CIRCUIT EDGE-CARD

156 Spacing-Tin-Double Read-Out
Bifurcated Contacts — Fits .054 to .070 P.C. Cards

15/30	PINS (Solder Eyelet)	\$1.95
18/36	PINS (Solder Eyelet)	\$2.49
22/44	PINS (Solder Eyelet)	\$2.95

25 PIN-D SUBMINATURE

DB25Plug	\$3.25
DB25Socket	\$4.95

3 1/2 DIGIT DVM KIT



This 0-2 VDC .05 per cent digit voltmeter features the Motorola 3 1/2 digit DVM chip set. It has a 4" LED display and operates from a single +5V power supply. The unit is provided complete with an injection molded black plastic case complete with Bezel. An optional power supply is available which fits into the same case as the 0-2V DVM allowing 117VAC operation.

A. 0-2V DVM with Case	\$49.95
B. 5V Power Supply	\$14.95

VECTOR WIRING PENCIL

Vector Wiring Pencil P173 consists of a hand held featherweight (under one ounce) tool which is used to guide and wrap insulated wire. Fed off a self-contained replaceable bobbin onto component leads or terminals installed on pre-punched P. Pattern Vectorboard. Connections between the wrapped wire and component leads, pads or terminals are made by soldering. Complete with 250 FT of red wire. \$9.95

REPLACEMENT WIRE — BOBBINS FOR WIRING PENCIL

W36-3-A-Pkg	3	250 ft 36 AWG GREEN	\$2.40
W36-3-B-Pkg	3	250 ft 36 AWG RED	\$2.40
W36-3-C-Pkg	3	250 ft 36 AWG CLEAR	\$2.40
W36-3-D-Pkg	3	250 ft 36 AWG BLUE	\$2.40

1/16 VECTOR BOARD

Part No.	0.1" Hole Spacing	P-Pattern	W	L	Price
PHENOLIC	64K4-02KXXP	2.50	6.50	1.72	1.51
	16P4-1 02KXXP	4.50	17.00	3.08	3.32
EPOXY	61P4-1 062	4.50	6.50	2.07	1.86
GLASS	61P4-1 062	4.50	6.50	2.36	2.31
	16P4-1 062	6.50	17.00	3.04	3.53
	16P4-1 062	6.50	17.00	9.23	8.26
EPOXY GLASS	16P4-1 062C	4.50	17.00	6.80	6.12

HEAT SINKS

205-CB	Beryllium Copper Heat Sink with Black Finish for TO-5	\$ 25
291-36H	Aluminum Heat Sink for TO-220 Transistors & Regulators	\$ 25
680-75A	Black Anodized Aluminum Heat Sink for TO-3	\$1.60

HEXADECIMAL ENCODER 19-KEY PAD

- 1 - 0
- ABCDEF
- Return Key
- Optional Key (Period)
- — Key

\$10.95 each

63 KEY KEYBOARD

This keyboard features 63 unenclosed SPST keys, unattached to any kind of P.C.B. A very solid molded plastic 13" x 4" base suits most applications.

\$19.95

HO0165 16 LINE TO FOUR BIT PARALLEL KEYBOARD ENCODER \$7.95



JOYSTICK

These joysticks feature four potentiometers, that vary resistance proportionally to the angle of the stick. Sturdy metal construction with plastics components only at the movable joint. Perfect for electronic games and instrumentation.

*5K Pots \$6.95
*100K Pots \$7.95

MICROPROCESSOR COMPONENTS

8080 SUPPORT DEVICES

8080A	8212	8 BIT INPUT/OUTPUT PORT FOR 8080	\$ 4.95	8080	
\$29.95	8216	NON INTERRUPT BI-DIRECTIONAL BUS DRIVER	6.95	\$24.95	
	8224	CLOCK GENERATOR AND DRIVER FOR 8080	12.95		
	8228	SYSTEM CONTROLLER AND BUS DRIVER FOR 8080	12.95		

CPU'S		RAM'S		
8008	8 BIT CPU	1101	256 x 1 Static	\$ 2.25
8080	Super 8008	1103	1024 x 1 Dynamic	1.00
8080A	Super 8008	2101	256 x 4 Static	5.95
		2102	1024 x 1 Static	1.75
		2107	4096 x 1 Dynamic	9.95
		2111	256 x 4 Static	29.95
		7010	1024 x 1 Static	6.95
		7489	16 x 4 Static	2.49
		8101	256 x 4 Static	6.95
		8111	256 x 4 Static	6.95
		8599	16 x 4 Static	3.29
		9102	1024 x 1 Static	2.49
		9100	256 x 1 Static	2.49
		9342	256 x 1 Static	2.95
		M55262	2K x 1 Dynamic	9.95

ROM'S		PROMS		
2513	Char Gen	5203	2048	\$12.95
251E	Char Gen	82523	32 x 8	5.00
745387	1024-Bit Programmable	825123	32 x 8	5.00
		745287	1024	7.95
		3601	256 x 4	3.95

BIPOLAR PROM SPECIAL

6330-1	256 Bit (32 x 8) Open Collector	2.95	6306-1	2048 Bit (512 x 4) Three State	9.95
6331-1	256 Bit (32 x 8) Three State	2.95	6340-1	2048 Bit (512 x 8) Open Collector	19.95
6330-1	1024 Bit (256 x 4) Open Collector	3.49	6341-1	2048 Bit (512 x 8) Three State	19.95
6331-1	1024 Bit (256 x 4) Three State	2.49	6352-1	4096 Bit (1024 x 4) Open Collector	19.95
6305-1	2048 Bit (512 x 4) Open Collector	8.95	6353-1	4096 Bit (1024 x 4) Three State	19.95

Continental Specialties

Proto Board 100
New & low cost 100 pin IC capacity breadboard with all the features of 100 pin sockets and the ease of the Proto Board design. Complete with the unit, hot melt and solder. Includes 2 1/2" 35S-500000. **\$19.95**

The Mini-Breadboard Budget Kit
Proto Board 131 Compact. Measures 10 1/2" x 4" x 1 1/2". 50 pin DIP capacity. **\$29.95**

Proto Board 102 Compact 112 pin DIP capacity. **\$39.95**

Proto Board 103 230 contacts on 20 pins. 14 1/2" x 4" x 1 1/2". 20 pin DIP capacity. **\$59.95**

Proto Board 6
The PB-6 fits the pins and bulk pack IC components in parallel. It contains an interconnection bus for 25 contacts on 16 pins. It is a must for breadboard prototyping. **\$14.95**

LOGIC MONITOR
Simultaneously displays static and dynamic logic states of DTL, TTL, PTL or CMOS DIP ICs. **\$84.95**

SPECIAL!

DT-595	DT-18S	DT Photo Strips
DT-598	DT-12S	DT-595
DT-475	DT-8S	DT-358
DT-478	DT-7S	DT-356
DT-355		DT-358
DT-355		DT-12S
DT-358		DT-8S
DT-358		DT-7S
DT-358		DT-7S

Grab Bag Specials

CAPACITORS — 100 ea. Ceramic Disc	\$2.00/lot	RESISTORS — 40 ea. wire-wound	\$5.50/lot
CAPACITORS — 80 ea. Mylar	4.00/lot	RESISTORS — 40 ea. wire-wound	5.50/lot
CAPACITORS — 50 ea. Electrolytics	4.00/lot	RESISTORS — 10 ea. 1000 25K	5.00/lot
CAPACITORS — 40 ea. Dipped Tantalum	3.00/lot	SWITCHES — 12 ea. Micro Switches	3.00/lot
DELAY LINE — 10 ea.	2.00/lot	SWITCHES — 25 Miniature Slide	3.00/lot
DIODES — 100 ea. Germanium	2.00/lot	SWITCHES — 12 each Pocker	3.00/lot
DIODES — 100 ea. Rectifiers Silicon	2.00/lot	SWITCHES — 20 ea. Reed-Coil & Magnetics	5.00/lot
DIODES — 100 ea. Silicon	4.00/lot	THERMISTORS — 20 ea.	3.00/lot
IC'S — 100 ea. Unmarked or House #	5.00/lot	TRIMMERS — 40 ea. Miniature	4.00/lot
LED'S — 100 ea. Ass't. Sizes & Colors	4.00/lot	TRANSISTORS — 100 ea. Plastic & Power	3.00/lot
LAMPS NEON — 40 ea. NE2 Type	4.00/lot	TUBING, SHRINK — 30 pcs. 6"	4.00/lot
POTENTIOMETERS — 10 pcs. P.C. Mount. Ass't.	4.00/lot		
RESISTORS — 40 ea. Values & Wattages	3.00/lot		

PRINTED CIRCUIT BOARDS — Min. 50 ea. Various Components \$2.00 each

DIGITAL QUARTZ CAR CLOCK

Complete kit from mounting bracket of the injection molded case down to the three conductor power cord and all components including MM5314 clock chip. Features quartz accuracy of .01%, six digit, 35" high LED display, and P.C. Boards. Works on any 12 volt system — motorcycles, boats, vans, motorhomes, autos, and trucks.

Kit: \$29.95 Assembled: \$39.95

CASE ONLY (includes hardware, mounting bracket and bezel) \$5.95

DIGITAL CLOCK KIT — 3 1/2 INCH DIGITS

This clock features: big 3 1/2" high digits for viewing in off hrs, auditoriums etc. Each digit is formed by 31 bright 0.2 LED'S. The clock operates from 117 VAC has built in 24 hr. operation. The 6 digit version is 2 3/4" x 1 1/2" and the 4 digit is 1 1/2" x 2 3/4" x 1 1/2". Kits come complete with all components, case and transformer.

4 DIGIT KIT \$49.95 4 DIGIT ASSEMBLED \$59.95
6 DIGIT KIT \$69.95 6 DIGIT ASSEMBLED \$79.95

\$5.00 Minimum Order — U.S. Funds Only Spec Sheets - 25¢ — Send 24¢ Stamp for 1977 Catalog
California Residents — Add 6% Sales Tax Dealer Discount Available — Request Pricing

James JELECTRONICS

1021-A HOWARD AVE., SAN CARLOS, CA. 94070
PHONE ORDERS WELCOME — (415) 592-8097
All Adverised Prices Good Thru January

PONG SINGLE GAME \$55.00

PONG SUPER PONG 4 GAMES IN ONE \$79.95

(Pong, Super Pong, Catch, Handball)

• Incremental speak on volleys increases excitement.
• Game appears in color or in black & white, depending on television set.
• Digital scoring, flashes on the screen between each point.
• Hooks up simply to any model television set. The screen actually becomes the playing field.
• Battery operated by 4 size "C" flashlight batteries (included with the Unit, AC Adaptor (Eliminates Batteries)

\$9.95

DIGITAL WATCHES

Ladies Watch	EXELAR Mens Watch
• 6 Function	• 6 Function
• Bracelet Styling	• Quartz Crystal
• 1 Year Guarantee	• Black Leather Band
• Model 500	• Manufacturer Guarantee
• Specify Gold or Chrome	• Specify Gold or Chrome

\$69.95 **\$29.95**

5 FUNCTION ELECTRONIC CALCULATOR RADCIN MODEL 8P

\$8.95

FEATURES:

- 8 Digit Display
- 5 Functions consists of addition, subtraction, multiplication, division, percentage with constant on all functions, with full floating decimal point.
- Power source is 1 piece 9V DC Battery UD GP, lock for AC adapter.
- Black super fine grained finish plastic cabinet.

DIGITAL STOPWATCH

- Bright 6 Digit LED Display
- Times 59 minutes 59.99 seconds
- Crystal Controlled Time Base
- Three Stopwatches in One
- Times Single Event — Split 8 Taylor
- Size 4 1/2" x 2 1/4" x 3/8" (4 1/2" diameter)
- Uses 3 Penic Cells

Kit — \$39.95
Assembled — \$49.95
Heavy Duty Carry Case \$5.95

DIGITAL ALARM CLOCK

This 4 digit Novus Alarm Clock is a very reliable and smartly styled unit. It provides such features as an alarm settable to any minute of the day, a 7 minutes snooze alarm, a power failure indicator, and even an A.M., P.M. indicator.

\$19.95

NOT A KIT

JE700 CLOCK

The JE700 is a low cost digital clock. But is a very high quality unit. The unit features a simplified walnut case with dimensions of 5" x 2 1/2" x 1". It utilizes a MAN5114 brightness readout and the MM5314 clock chip.

12 or 24 Hour

115 VAC

\$17.95

This large digit clock (6" hours & minutes, 3 seconds) features the MM5314 clock chip. It operates from 117 VAC, and will operate in either a 12 or 24 hour mode. The clock is complete with a walnut grain case, and has fast set, slow set, and hold time set features.

KIT - ALL COMPONENTS & CASE \$34.95 WIRE & ASSEMBLED \$39.95

JE803 PROBE

The Logic Probe is a unit which is for the most part indispensable in trouble shooting logic families TTL, DTL, RTL, CMOS. It reveals the power it needs to operate correctly off of the circuit under test, drawing a scant 10 mA max. It uses a MAN3 readout to indicate any of the following states: these symbols (H) = (LOW) = (PULSE) = The Probe can detect high frequency pulses to 45 MHz. It can't be used as MOS levels or circuit damage will result.

\$9.95 Per Kit printed circuit board

T⁺L 5V 1A Supply

This is a standard TTL power supply using the well known LM209K regulator IC to provide a solid 1 AMP of current at 5 volts. We try to make things easy for you by providing everything you need on one package, including the hardware for only

\$9.95 Per Kit

± 5 VOLT POWER SUPPLY

Completely Assembled

- +5 Volts @ 6 Amps Regulate Output
- -5 Volts @ 6 Amps Regulate Input
- 6.3Volts @ 5 Amps Unregulated Output
- Length 8 1/2" x Width 6 1/2" x Height 4"

\$39.95

Limited Supply

7400N TTL

SN7400N	16	SN7450A	25	SN74154N	1.00
SN7401N	16	SN7450B	22	SN74155N	99
SN7402N	21	SN7470N	45	SN74156N	99
SN7403N	16	SN7472N	39	SN74157N	99
SN7404N	18	SN7473N	37	SN74158N	1.25
SN7405N	22	SN7474N	32	SN74159N	99
SN7406N	20	SN7475N	50	SN74161N	99
SN7407N	29	SN7476N	32	SN74163N	99
SN7408N	25	SN7479N	5.00	SN74164N	1.10
SN7409N	25	SN7480N	50	SN74165N	1.10
SN7410N	18	SN7482N	99	SN74166N	1.25
SN7411N	30	SN7483N	70	SN74167N	5.00
SN7412N	33	SN7485N	89	SN74170N	2.10
SN7413N	45	SN7486N	39	SN74172N	8.00
SN7414N	70	SN7487N	3.50	SN74173N	1.50
SN7415N	35	SN7489N	2.49	SN74175N	99
SN7417N	25	SN7490N	45	SN74175N	99
SN7420N	21	SN7491N	75	SN74176N	90
SN7421N	33	SN7492N	49	SN74177N	90
SN7422N	49	SN7493N	49	SN74178N	99
SN7423N	37	SN7494N	79	SN74181N	2.49
SN7425N	29	SN7495N	79	SN74182N	95
SN7426N	29	SN7496N	89	SN74184N	1.50
SN7427N	37	SN7497N	4.00	SN74185N	2.25
SN7428N	32	SN7498N	1.00	SN74186N	1.25
SN7430N	26	SN74107N	39	SN74187N	6.00
SN7432N	31	SN74121N	39	SN74188N	3.95
SN7437N	27	SN74122N	39	SN74190N	1.19
SN7438N	27	SN74123N	50	SN74191N	1.25
SN7439N	25	SN74124N	60	SN74192N	99
SN7440N	15	SN74126N	60	SN74193N	89
SN7441N	89	SN74128N	1.09	SN74194N	1.25
SN7442N	27	SN74136N	95	SN74195N	75
SN7443N	75	SN74141N	1.15	SN74196N	1.25
SN7444N	75	SN74142N	80	SN74197N	75
SN7445N	75	SN74143N	4.50	SN74198N	1.75
SN7446N	81	SN74144N	4.50	SN74199N	1.75
SN7447N	68	SN74145N	1.15	SN74200N	5.99
SN7448N	79	SN74147N	2.35	SN74203N	90
SN7449N	26	SN74148N	2.00	SN74205N	1.79
SN7451N	27	SN74150N	1.00	SN74206N	6.00
SN7452N	27	SN74151N	79	SN74208N	6.00
SN7454N	27	SN74153N	89	SN74209N	.75

MANY OTHERS AVAILABLE ON REQUEST
20% Discount for 100 Combined 7400's

CD4000	25	74C04N	75
CD4001	25	74C04N	65
CD4002	25	CD4003	1.85
CD4006	2.50	CD4040	2.45
CD4009	59	CD4042	1.50
CD4010	59	CD4046	2.51
CD4011	25	CD4047	2.75
CD4012	47	CD4049	79
CD4013	47	CD4050	79
CD4016	56	CD4051	2.95
CD4017	1.35	CD4053	2.95
CD4019	55	CD4060	3.25
CD4020	1.49	CD4061	3.25
CD4022	1.25	CD4069	4.51
CD4023	25	CD4071	45
CD4024	1.50	CD4081	45
CD4025	25	CD4081	2.50
CD4027	69	CD4181	2.25
CD4028	1.65	CD4566	3.00
CD4029	2.90	74C00N	39
CD4030	65	74C02N	55

LINEAR

LM300H	80	LM1310N	2.95
LM301H	35	LM1351N	1.65
LM303CN	75	LM1414N	1.75
LM304H	1.00	LM1485C	6.50
LM305H	95	LM1496N	65
LM307CN	35	LM1556V	1.85
LM309H	1.00	LM2011N	1.95
LM309CN	1.00	LM2011N	2.95
LM309N	1.00	LM3095N	59
LM309H	1.00	LM3900N	65
LM309CN	99	LM3905N	60
LM310CN	1.15	NE501K	8.00
LM311H	90	NE502N	1.85
LM311CN	90	NE531H	1.00
LM318CN	1.50	NE532N	1.00
LM319N	1.30	NE540L	6.00
LM320K-5	1.35	NE555V	9.95
LM320K-12	1.35	NE555V	9.95
LM320K-15	1.35	NE560H	5.00
LM320T-5	1.75	NE561H	5.00
LM320T-12	1.75	NE562B	5.00
LM320T-15	1.75	NE565N	1.75
LM320T-17	1.75	NE566CN	1.25
LM320T-17	1.75	NE567H	1.56
LM320T-18	1.75	NE573N	1.50
LM323K-5	1.95	74C03N	45
LM324N	1.80	LM709N	49
LM339N	1.70	LM710N	79
LM340K-5	1.95	LM713N	45
LM340K-6	1.95	LM723H	55
LM340K-12	1.95	LM723H	55
LM340K-15	1.95	LM733N	1.00
LM340K-18	1.95	LM733N	1.00
LM340K-24	1.95	LM741CN	39
LM340T-5	1.75	LM747H	79
LM340T-6	1.75	LM747H	79
LM340T-12	1.75	LM748H	39
LM340T-15	1.75	LM748H	39
LM340T-18	1.75	LM748H	39
LM340T-24	1.75	LM748H	39
LM350N	50	LM1305N	1.40
LM351CN	65	LM1307N	85

CLOCK CHIPS

MM5309	5 Digit, BCD Outputs, Reset Pin	49.95
MM5311	6 Digit, BCD Outputs, 12 or 24 Hour	59.95
MM5312	1 Digit, BCD Outputs, 1 PPS Output	4.95
MM5314	8 Digit, 12 or 24 Hour, 50 or 60 Hz	6.95
MM5316	1 Digit, Alarm, 1 PPS Output	6.95
MM5318	Video Clock Chip, For Use With MM541	9.95
CT7001	6 Digit, Calendar, Alarm, 12 or 24 Hour	5.95

DATA HANDBOOKS
7400 Pin-out & Description of 4000 Series ICs \$2.95
CMOS Pin-out & Description of 4000 Series ICs \$2.95
Linear Pin-out & Functional Description \$2.95
ALL THREE HANDBOOKS \$6.95

FAIRCHILD TECHNOLOGY KITS FAIRCHILD



- Complete Specifications on back of each kit
- Packaged for WALL DISPLAY APPEARANCE
- Dealer's Inquires Invited — Price List Available

DIGITS	
FTK0001	0-9 High Common Cathode Digit \$1.00
FTK0003	5-9 High Common Cathode Digit 1.00
FTK0002	35-7 High Common Cathode Digit .75
FTK0004	0-9 High Common Cathode Digit 2.00
FTK0005	0-9 High Common Anode Digit 2.00
PHOTO ARRAYS	
FTK0040	9-Element Tape Reader Array 15.00
FTK0041	12 Element Card Reader Array 24.00
FTK0042	Reflective Opto Coupler 4.00
COUPLERS	
FTK0050	3 General Purpose Opto Couplers 1.00
FTK0051	Darlington Opto Coupler 1.00
MOS CLOCK CIRCUITS	
FTK0400	Digital Clock Calendar Circuit 7.00
FTK0401	Digital Clock Calendar with BCD Outputs (FCM7002) 7.00
FTK0402	Direct Drive Digital Clock Circuit with AC Output (FCM387A) 5.00
FTK0403	Direct Drive Digital Clock Circuit with DC Output (FCM387D) 5.00
FTK0405	Direct Drive Digital Clock/Calendar Circuit (FCM7015) 6.00
PHOTO TRANSISTORS	
FTK0030	5 Flat Lens Photo Transistors 1.00
FTK0031	5 Round Lens Photo Transistors 1.00
FTK0032	3 Flat Lens Photo Collimators 1.00
FTK0033	3 Round Lens Photo Collimators 1.00
KITS	
FTK106	Automobile Clock Kit 40.00

DISCRETE LEDS

Part No.	Color	HT	Part No.	Color	HT
XC209	Red	10.51	XC111	Red	10.51
XC209	Green	4.51	XC111	Green	4.51
XC209	Orange	4.51	XC111	Yellow	4.51
			XC111	Orange	4.51

125' dia. 90' dia.
200' dia. 185' dia. 200' dia. .085' dia.

DISPLAY LEDS

TYPE	POLARITY	HT	TYPE	POLARITY	HT
MAN 1	Common Anode	270 2.95	MAN 3620	Common Anode-orange	300 1.75
MAN 2	Common Anode	300 4.95	MAN 3640	Common Anode-orange	300 1.75
MAN 3	Common Cathode	125 1.39	MAN 4710	Common Anode-Red	400 1.95
MAN 4	Common Cathode	187 1.95	DL701	Common Anode-red	300 99
MAN 7	Common Anode	300 1.25	DL704	Common Cathode	300 99
MAN 7C	Common Anode-green	300 1.95	DL707	Common Anode	300 99
MAN 7Y	Common Anode-yellow	300 1.95	DL 728	Common Cathode	500 95
MAN 52	Common Anode-green	300 1.75	DL 747	Common Anode	600 2.25
MAN 64	Common Anode-red	400 1.75	DL 750	Common Cathode	600 2.49
MAN 72	Common Anode	300 2.25	DL 388	Common Cathode	500 1.10
MAN 74	Common Cathode	300 1.50	FN707	Common Cathode	250 75
MAN 82	Common Anode-yellow	300 1.75	FN503	Common Cathode	500 1.00
MAN 84	Common Cathode-yellow	300 1.75	FN507	Common Anode	500 1.00

IC SOLDERTAIL — LOW PROFILE (TIN) SOCKETS

1-24	25-49	50-100	1-24	25-49	50-100
8 pin	\$1.17	16	24 pin	\$3.37	37
16 pin	20	19	28 pin	45	44
16 pin	22	21	36 pin	60	59
18 pin	23	28	40 pin	63	62
22 pin	37	36			

SOLDERTAIL STANDARD (TIN)

14 pin	\$2.27	25	28 pin	\$1.99	30
16 pin	30	27	36 pin	1.59	1.26
18 pin	35	29	40 pin	1.59	1.45
24 pin	49	45	42		

SOLDERTAIL STANDARD (GOLD)

8 pin	\$3.00	27	24 pin	\$1.70	63
14 pin	35	32	28 pin	1.10	1.00
16 pin	38	35	36 pin	1.75	1.40
18 pin	52	47	43	1.75	1.59

WIRE WRAP SOCKETS (GOLD) LEVEL #3

10 pin	\$4.15	41	37	51	95
14 pin	39	38	37	40	1.25
16 pin	43	42	41	41	1.59
18 pin	75	68	62	40	1.75

WIRE WRAP TOOL Part Number WSU 30 \$5.95 ea.



WIRE WRAP WIRE

30 AWG — 25 ft. min. — \$2.10 50 ft. — \$2.75 100 ft. — \$3.50 1000 ft. — \$24.00
SPECIFY COLOR — White - Yellow - Red - Green - Blue - Black

50 PCS. RESISTOR ASSORTMENTS \$1.75 PER ASST.

ASST. 1	5 ea.	10 OHM	12 OHM	15 OHM	18 OHM	22 OHM	27 OHM	33 OHM	39 OHM	47 OHM	56 OHM	1/4 WATT 5% — 50 PCS.
ASST. 2	5 ea.	180 OHM	220 OHM	270 OHM	330 OHM	390 OHM	470 OHM	560 OHM	680 OHM	820 OHM	1K	1/4 WATT 5% — 50 PCS.
ASST. 3	5 ea.	1.2K	1.5K	1.8K	2.2K	2.7K	3.3K	3.9K	4.7K	5.6K	6.8K	1/4 WATT 5% — 50 PCS.
ASST. 4	5 ea.	8.2K	10K	12K	15K	18K	22K	27K	33K	39K	47K	1/4 WATT 5% — 50 PCS.
ASST. 5	5 ea.	22K	27K	33K	39K	47K	56K	68K	82K	100K	120K	1/4 WATT 5% — 50 PCS.
ASST. 6	5 ea.	150K	180K	220K	270K	330K	390K	470K	560K	680K	820K	1/4 WATT 5% — 50 PCS.
ASST. 7	5 ea.	1M	1.2M	1.5M	1.8M	2.2M	2.7M	3.3M	3.9M	4.7M	5.6M	1/4 WATT 5% — 50 PCS.

ASST. 8R Includes Resistor Assortments of 1-7 (350 PCS.) \$10.95 ea.

\$5.00 Minimum Order — U.S. Funds Only
California Residents — Add 6% Sales Tax
Spec Sheets — 25¢ — Send 24¢ Stamp for 1977 Catalog
Dealer Discount Available — Request Pricing

James ELECTRONICS

1021-A HOWARD AVE., SAN CARLOS, CA. 94070
PHONE ORDERS WELCOME — (415) 592-8097
All Advertised Prices Good Thru January

MINIATURE TOGGLE

DPDT	ON	OFF	ON	OFF	ON	OFF	ON	OFF	ON	OFF	ON	OFF	ON	OFF
223	2.95	2.55	1.87	1.70										
223	2.95	2.15	1.58	1.43										
123	2.35	1.95	1.43	1.30										
123	2.05	1.65	1.21	1.10										

PUSH BUTTON

PB-123 \$1.75
PB-126 \$1.75

THUMBWHEEL SWITCHES

Ordering: Order desired type or switch and add necessary accessories for your particular application.

Part No.	Description	Price
SP 12	5 Pin Front Mount	\$2.50
SR 12	12 Pin	3.00
SR 21	10 Pin Front BCD only	2.50
SR 21	10 Pin Front BCD only	3.00

DIP SWITCH

These switches feature seven SPST side switches in a molded dip. They are ideally suited for microprocessor applications.

\$1.95

CLIPLITE!! 4/\$1.00

NEW LED MOUNTING SYSTEM

- CLIPLITE mounts from the front of the panel in a .250 hole on 3/16" centers. Panel thickness from 1/16" to 1/8".
- CLIPLITE equalizes and increases the brightness of commonly used wide beam LEDs.
- CLIPLITE is to be used with XC556 LEDs.
- Specify colors—red, green, amber, or yellow when ordering.

ZENERS — DIODES — RECTIFIERS

TYPE	VOLTS	W	PRICE	TYPE	VOLTS	W	PRICE
1N75A	3.3	400m	4/10	1N4006	60	1/2	100
1N75B	4.7	400m	4/10	1N4006	100	1/2	100
1N75C	6.2	400m	4/10	1N4006	150		

TREASURE FINDERS

TREASURE may lie beneath your feet! Discover gold, silver, coins, rings, artifacts and more with world-famous, deeper-detecting White's metal detectors. From \$79.50. Dealers world-wide. Free literature! White's Electronics, Dept. PD7-C, 1011 Pleasant Valley Rd., Sweet Home, OR 97386.

REAL ESTATE

BIG...NEW...FREE...SPRING 1977 CATALOG! Over 2,600 top values coast to coast! UNITED FARM AGENCY, 612-EP, West 47th, Kansas City, MO 64112.

MAGNETS

MAGNETS. All types. Specials-20 disc or 10 bar, or 2 stick or 8 assorted magnets. \$1.00. Magnets, Box 192-H Randallstown, Maryland 21133.

TUBES

RADIO & T.V. Tubes—36 cents each. Send for free Catalog. Cornell, 4213 University, San Diego, Calif. 92105. TUBES receiving, factory boxed, low prices, free price list. Transletronic, Inc., 1365 39th Street, Brooklyn, N.Y. 11218A, Telephone: 212-633-2800. TUBES: "Oldies". Latest. Supplies, components, schematics. Catalog Free (stamp appreciated). Steinmetz, 7519-PE Maplewood, Hammond, Ind. 46324.

HYPNOTISM

SLEEP learning. Hypnotic method. 92% effective. Details free. ASR Foundation, Box 23429EG, Fort Lauderdale, Florida 33307. FREE Hypnotism. Self-Hypnosis. Sleep Learning Catalog! Drawer H4C0, Ruidoso, New Mexico 88345. AMAZING self-hypnosis record releases fantastic mental power. Instant results! Free trial. Write: Forum (AA1), 333 North Michigan, Chicago 60601.

ARIES brought you the first calculator kit, and the first digital clock kit... and now brings you three of the most innovative electronic kits ever made. The System 300 Electronic Music Synthesizer kit is the most advanced in the world today, regardless of price. The AR-781 is a space-age beauty for any decor. And the wholly solid state AR-830 does the work of a \$400.00 tape memory unit.



WARNING... if you're interested in a music synthesizer, don't make a move until you see our catalog first. It's more like a handbook than a catalog, with hundreds of in-depth photographs and descriptions to explain electronic music principles, and to show equipment to do the job. ARIES now offers a complete complement of modules, keyboards, and cases, matched to the most rigorous professional standards. Starter systems priced as low as \$395.00.

A clear, ruby-red cylinder shows off all six digits of this modern calendar clock. Easy-to-read numbers show the hours, minutes, and seconds, as well as the month and day every ten seconds.



Red LED 7-segment numerals are 0.33" high, in a sturdy cylinder 2-1/2" in diameter and 4-3/4" long, with finished hardwood ends. Time and calendar are controlled by 60 Hz line frequency, with a 12-month movement. Separate time and calendar adjustments. Includes all the components, PC boards, housing, and instructions. Shipping weight 2 lbs. AR-781 Clock Kit\$34.50

Add finger-touch operation to your old-fashioned dial telephone with an ARIES AR-830 Automatic Digital Telephone Dialer. This has the same layout and convenience as Ma Bell, plus other features she doesn't offer yet. For instance... AR-830 always remembers the last number you dialed, in case the line was busy and you want to try again later. Not only that, but the Dialer's memory can store as many as ten of your favorite numbers for one-touch dialing. AR-830 uses standard dialing and muting contacts; consult local tariffs before connecting. Sh. wt. 2 lbs. AR-830 Dialer Kit\$69.50



ARIES INC.
BOX 808
Peabody, Mass., 01960
(617) 744-2400

CIRCLE NO. 10 ON FREE INFORMATION CARD

RECORDS

RECORD RATERS WANTED! Anyone qualifies. We ship you nationally released LP's to rate. We pay postage and handling. You pay nothing for LP's. All you pay is small membership fee. Applicants accepted "first come basis." Write: E.A.R.S., Inc., Dept PE, Box 10245, 5521 W. Center Street, Milwaukee, Wisconsin 53210.

PERSONALS

MAKE FRIENDS WORLDWIDE through international correspondence. Illustrated brochure free. Hermes-Verlag, Box 110660/Z, D-1000 Berlin 11, Germany.

WANTED

GOLD, Silver, Platinum, Mercury wanted. Highest prices paid by refinery. Ores assayed. Free circular. Mercury Terminal, Norwood, MA 02062.

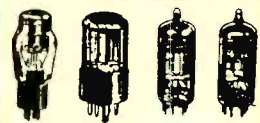

70% OFF LIST!

1AD2	1.59	6AU8	2.15
1B3GT	1.58	6AV6	1.11
1K3	1.58	6AW8A	1.79
1S2A	2.27	6AX4GTB	1.52
1U4	1.58	6AY3B	1.52
1V2	.96	6AZ8	2.30
1X2B	1.56	6BA6	1.34
2AH2	1.59	6BA11	1.95
2AV2	1.26	6BE6	1.47
2D21	1.95	6BH11	1.77
2GK5	1.58	6BJ6	1.65
3A3C	1.61	6BK4C6	2.98
3A5	2.50	6BK7B	2.07
3AT2B	1.56	6BL8	1.10
3BS2	1.70	6BM8	1.10
3CU3A	1.95	6BN6	1.97
3CY3	1.76	6BN8	1.56
3D13	1.70	6BN11	2.46
3GK5	1.55	6BQ5	1.56
3HA5	1.53	6BQ7A	2.09
3HQ5	2.27	6BR8A	2.12
3JC6A	2.06	6BX6	1.49
3V4	1.83	6BZ6	1.26
4AU6	1.58	6C4	1.58
4BL8	.92	6CA4	1.60
4BZ6	1.41	6CA7	2.04
4CB6	1.10	6CB6A	1.32
4DT6	1.56	6CG3	1.58
4EH7	1.46	6CD6GA	2.83
4EJ7	1.46	6CG7	1.22
4HS8	1.50	6CG8A	1.73
4JC6A	2.04	6CJ3	1.50
4JD6	1.88	6CL3	1.61
4KE8	2.48	6CL6	2.07
4LJ8	1.80	6CL8	1.95
5A04	4.50	6CM7	1.71
5EW6	1.63	6CU5	1.65
5GH8A	1.88	6CW4	3.30
5GJ7	1.11	6CW5	1.02
5GS7	1.17	6DJ8	2.25
5GX7	1.68	6DL4	2.39
5HZ6	1.20	6DQ6	2.15
5JK6	1.47	6DT6A	1.32
5JL6	1.47	6DW4	1.50
5KE8	2.48	6DX8	1.01
5LJ8	1.76	6EA8	1.58
5U4GB	1.23	6EB8	2.40
5Y3GT	1.32	6EH7	1.53
5Y4GT	1.14	6EJ7	1.43
6A8	4.69	6EM7	2.25
6AB4	1.53	6EU7	1.61
6AC7	2.36	6EW6	1.43
6AC10	1.73	6EW7	2.38
6AD10	3.68	6F6GT	3.49
6AF4	2.21	6FG6	1.19
6AF9	2.13	6FG7	2.28
6AH6	2.94	6FM7	1.85
6AJ8	1.74	6GE5	2.16
6AL3	.92	6GF7A	2.12
6AL5	1.31	6GH8A	1.26
6AN8A	1.82	6GJ7	1.11
6AQ5	1.35	6GK5	1.86
6AQ8	.98	6GK6	1.41
6AR5	.81	6GM6	1.68
6AS8	2.48	6GM8	3.30
6AU4GT	1.97	6GS7	1.38
6AU5GT	2.41	6GU7	1.67
6AU6A	1.31	6GW8	.98

**EDLIE
BARGAIN
BONANZA
OF
HIGHEST QUALITY
TUBES**

BUY BRAND NEW MANUFACTURER'S BOXED TUBES (Raytheon, Dumont, IEC Mullard, etc.) AT 70% OFF LIST! HERE IS A BIGGER & BETTER LIST THAN WE EVER OFFERED BEFORE...AND REMEMBER... 70% OFF LIST!

**ALL TUBES
BRAND NEW
MANU. BOXED
70% OFF**

MINIMUM ORDER \$7.50

MONEY BACK GUARANTEE

Terms: Minimum order \$7.50. In-clude postage. Either full payment with order or 20% deposit, balance C.O.D.

6GX6	1.38	6JH8	2.51
6HG6	2.71	6JM6A	2.16
6HA5	1.53	6JN6	2.03
6HB7	1.55	6JR6	3.54
6HE5	1.91	6JSGC	2.95
6HF5	3.78	6JT6	2.40
6HF8	2.16	6JT8	1.91
6HQ5	2.03	6JU6	2.84
6HS5	2.94	6JV8	1.77
6HS6	1.46	6JW8	1.80
6HS8	1.91	6JW8	1.35
6HV5	3.54	6K6GT	1.64
6HZ6	1.28	6K7GT	2.24
6J5	1.89	6K8	4.69
6J7	2.31	6KA8	1.95
6J10	2.45	6KD6	3.38
6JB6	2.42	6KE8	2.45
6JC6A	1.79	6KM6	3.38
6JD6	1.85	6KT8	2.18
6JE6C	3.35	6KV6A	2.67
6JG6A	2.67	6KZ8	1.64
6JH6	1.43	6L6	4.86

**WRITE FOR
FREE VALUE PACKED
CATALOG**

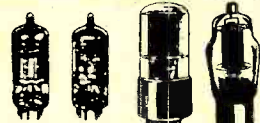

70% OFF LIST!

6L7	2.84	12BH7A	1.58
6LB6	3.23	12BY7	1.43
6LE8	2.27	12DQ6B	2.10
6LF6	3.20	12FX5	1.34
6LF8	2.34	12GN7	2.22
6LJ8	1.76	12HL7	1.95
6LM8	1.95	12JB6A	2.55
6LN8	1.05	12MD8	1.77
6LT8	1.64	12SL7	2.31
6LU8	1.92	13GF7A	2.09
6LX8	1.05	13210	2.55
6M11	2.76	14BL11	3.11
6MB8	1.52	15BD11A	2.25
6MD8	2.34	15CW5	.87
6SA7	2.04	15KY8A	2.91
6SG7	2.30	16A8	1.23
6SJ7	2.19	16LU8A	2.97
6SK7	2.03	17AY3A	1.52
6SL7GT	2.30	17BE3	1.52
6SN7GT	1.52	17BF11	2.39
6S07	2.01	17BR3	1.23
6T8A	1.92	17BS3	1.52
6T10	2.25	17CK3	1.31
6U8A	1.56	17CU5	1.26
6U10	1.62	17DW4	1.41
6V6	3.57	17IN6	2.16
6X4	1.46	17JQ6	1.85
6X5GT	1.47	17JZ8	1.43
6X9	1.82	19CG3	1.58
7F8	6.00	20AQ3	1.17
7V7	3.00	21GY5	2.01
8A8	.93	21HB5	1.92
8AC9	1.88	21J56	4.30
8AR11	2.46	21JZ6	2.10
8B10	1.80	21LR8	1.89
8BA11	2.25	21LU8	1.86
8BM11	2.30	22JF6	2.66
8BQ11	1.98	22JF6	2.73
8BU11	2.30	22KM6	3.08
8C7	1.12	23Z9	1.91
8JW8	1.86	24JE6C	3.20
8L78	1.61	25CG3	1.38
9A08	2.31	29KQ6	3.53
9G8	1.67	30AE3	1.17
9JW8	1.26	31JS6C	2.89
10CW5	1.02	31LQ6	3.05
10DX8	.98	31LZ6	3.38
10GK6	1.82	33GY7A	2.42
10GN8	1.92	35C5	1.31
10JT8	2.06	35W4	.89
10JY8	1.50	35Z5GT	1.41
10KR8	2.04	36KD6	3.36
11AF9	2.13	38HE7	2.92
11AR11	2.46	38HK7	2.86
11BM8	1.86	40KG6A	3.26
11FY7	1.52	42CE4A	1.59
11KV8	2.20	42KN6	2.75
11MS8	1.53	50B5	1.21
12AB5	1.41	50C5	1.23
12AT6	1.13	50EH5	1.47
12AT7	1.37	50GY7A	3.60
12AU7A	1.23	50LG6T	1.95
12AV6	1.02	80	1.88
12AX7A	1.13	6267	2.10
12AZ7A	1.74	6973	1.85
12B4A	1.77	7025A	1.13
12BA6	1.16	7189A	1.73
12BE6	1.22	7199	2.06

EDLIE ELECTRONICS, INC.

2700-JP HEMPSTEAD TPK., LEVITTOWN, N. Y. 11756

CIRCLE NO. 22 ON FREE INFORMATION CARD

SOCKETS

STANDARD, SOLDER, TIN

14 Pin	1-24	25-49	50-100
16 Pin	0.27	0.25	0.24
18 Pin	0.30	0.27	0.25
18 Pin	0.35	0.32	0.30
24 Pin	0.49	0.45	0.42
28 Pin	0.99	0.90	0.81
36 Pin	1.39	1.26	1.15
40 Pin	1.59	1.45	1.30

STANDARD, SOLDER, GOLD

8 Pin	1-24	25-49	50-100
14 Pin	0.30	0.27	0.24
16 Pin	0.35	0.32	0.29
18 Pin	0.38	0.35	0.32
18 Pin	0.52	0.47	0.43
24 Pin	0.70	0.63	0.57
28 Pin	1.10	1.00	0.90
36 Pin	1.75	1.40	1.26
40 Pin	1.75	1.59	1.45

WIREWRAP, GOLD (Level No.3)

10 Pin	1-24	25-49	50-100
14 Pin	0.45	0.41	0.37
14 Pin	0.39	0.38	0.37
16 Pin	0.43	0.42	0.41
18 Pin	0.75	0.68	0.62
24 Pin	1.05	0.95	0.85
28 Pin	1.40	1.25	1.10
36 Pin	1.59	1.45	1.30
40 Pin	1.75	1.55	1.40

LOW PROFILE, SOLDER, TIN

8 Pin	0.16	0.15	0.14
14 Pin	0.19	0.18	0.17
16 Pin	0.21	0.20	0.19

18 Pin	0.28	0.27	0.26
22 Pin	0.36	0.35	0.34
24 Pin	0.37	0.36	0.35

28 Pin	0.44	0.43	0.42
36 Pin	0.59	0.58	0.57
40 Pin	0.62	0.61	0.60

SAMS BOOKS

TTL COOKBOOK	No.21035	\$9.95
IC OP-AMP COOKBOOK	No.20969	\$12.95
SECOND CLASS RADIOTELEPHONE LICENSE HANDBOOK, 5TH Ed.	No.21111	\$7.50
TRANSISTOR SUBSTITUTION HANDBOOK, 15th Ed.	No.21169	\$4.50
REFERENCE DATA FOR RADIO ENGINEERS, 6th Ed.	No.21218	\$30.00
BASIC ELECTRICITY/ELECTRONICS SERIES, Vol.1: BASIC PRINCIPALS AND APPLICATIONS	No.20167	\$5.50
TV TYPEWRITER COOKBOOK	No.21313	\$9.95

TRANSISTOR SPECIFICATIONS

MANUAL, 7th Ed.	No.21208	\$5.95
FIRST-CLASS RADIOTELEPHONE LICENSE HANDBOOK, 4th Ed.	No.21144	\$7.50
SEMICONDUCTOR REPLACEMENT GUIDE	No.21092	\$3.95
BUILDING & INSTALLING ELECTRONIC INTRUSION ALARMS	No.20929	\$4.50
UNDERSTANDING IC OPERATIONAL AMPLIFIERS	No.20855	\$3.95
HOW TO USE IC LOGIC ELEMENTS, 2nd Ed.	No.21081	\$4.50
UNDERSTANDING CMOS INTEGRATED CIRCUITS	No.21129	\$4.95

SOLID-STATE Digital Auto Clock Build-It-Yourself Kit FROM



COMPLETE KIT - ONLY \$40.00

Our Quality Is Best!

NEW 74C00 SERIES CMOS

74C00N	38	74C74N	90	74C157N	340	74C195N	180
74C002N	40	74C76N	100	74C160N	210	74C221N	210
74C004N	60	74C83N	275	74C161N	210	74C801N	100
74C008N	40	74C85N	275	74C162N	210	74C902N	100
74C10N	50	74C85N	100	74C163N	210	74C903N	100
74C14N	220	74C89N	1400	74C164N	210	74C904N	100
74C20N	50	74C90N	270	74C165N	210	74C906N	100
74C30N	50	74C93N	260	74C173N	180	74C907N	100
74C32N	50	74C95N	180	74C178N	170	74C914N	275
74C42N	210	74C107N	180	74C179N	170	80C95	100
74C48N	330	74C151N	380	74C192N	210	80C97	100
74C73N	120	74C154N	570	74C193N	210		

DISPLAYS - (COMMON ANODE) Data Sheet EP1000 \$25

LARGE 1"		XCITRON 3"	
EP1000 RED	5.50	XAN72	2.00
3 Pins EP1000 GREEN	15.00	XAN52	2.00
5 Pins EP1000 YELLOW	22.50	XAN22	2.00
LITRONIX 3"		LITRONIX 6"	
DL707 RED	2.35	DL747	2.50

.125" dia.		LEDs .160" dia.		LOW PROFILE	
209 RED	\$25	216 RED	\$25	226 RED	\$30
209 YELLOW	35	216 YELLOW	30	226 GREEN	30
209 GREEN	35	216 GREEN	30	226 ORANGE	30
.200" dia.		.200" dia.		.12" dia.	
5053 RED	\$35	5053 YELLOW	\$25	MV50 RED	\$30
5053 GREEN	40	5053 ORANGE	40	OPTO COUPLER MCT-2	1.50

CONTINENTAL SPECIALTIES

PROTO BOARDS & EXPERIMENTERS

Build & test circuits as fast as you think!

PB-6	\$15.95	PB103	\$59.95
PB100	19.95	PB104	79.95
PB101	29.95	EX300	9.95
PB102	39.95	EX600	10.95

PROTO BOARDS

With built-in regulated short-proof power supplies

PB203	5V, 1 amp regulated power supply	\$75.00
PB203A	5V, 1 amp and ±15V, ½ amp regulated power supply	120.00

LOGIC MONITOR 1

Simultaneously displays static and dynamic logic states of DTL, TTL, HTL or CMOS DIP ICs. Pocket size. \$74.95

LOGIC MONITOR 2

Displays static and dynamic states of digital ICs such as CMOS, HTL, TTL, DTL & RTL. Selectable threshold control. \$124.95

LOGIC PROBE LP-1

Compact, circuit powered multifunction logic probe. Multi-family compatibility. DTL/TTL/HTL/CMOS. Traces logic levels and pulses through digital circuitry. \$44.95

PROTO-CLIP

For power-on/hands off signal tracing. Bring IC leads up from PCB surface for fast trouble-shooting.

PC14	14-pin	\$4.50
PC16	16-pin	4.75
PC24	24-pin	8.50
PC40	40-pin	13.75

SOCKETS & BUS STRIPS

Plug-in, wire, test, modify or expand without patch cords or solder. Snap together to form breadboard needed.

PN/Description	Terms	Price
QT59S Socket	118	\$12.50
QT59B Bus	20	2.50
QT47S Socket	94	10.00
QT47B Bus	16	2.25
QT35S Socket	70	8.50
QT35B Bus	12	2.00
QT18S Socket	36	4.75
QT12S Socket	24	3.75
QT7S Socket	16	3.25
QT7S Socket	14	3.00

BREADBOARD JUMPER WIRE KIT

Each kit contains 350 wires cut to 14 different lengths from 0.1" to 5.0". Each wire is stripped and leads are bent 90° for easy insertion. Wire length is classified by color coding. All wire is solid tinned 22 gauge with PVC insulation. The wires come packed in a convenient plastic box. BK-1 \$9.95

MATSUO DIPPED TANTALUM CAPACITORS

PLESSEY POLYESTER (CAPACITOR) MINI BOX

MF V	\$	MF V	\$		
001	1000	14	039	250	15
0012	1000	14	047	250	15
0015	1000	14	056	250	15
0018	1000	14	068	250	15
0022	1000	14	082	250	17
0027	1000	14	1	100	17
0033	1000	14	12	100	18
0039	630	14	15	100	20
0047	630	14	18	100	21
0056	630	14	22	100	23
0068	630	14	27	100	26
0082	630	14	33	100	30
0100	630	14	39	100	33
0120	630	14	47	100	36
0150	450	14	56	100	44
0180	450	14	68	100	47
0220	450	14	82	100	54
0270	450	14	100	100	60
0330	250	15			

PLESSEY SAMPLER

300 METALIZED CAPACITORS 18 DIFFERENT STD. VALUES \$26.00

L-15 PULSE/SWEEP FUNCTION GENERATOR KIT

FEATURES: 1 Hz to 100 KHz in 5 ranges, at constant amplitude - Sine and triangle adjustable to 20vp-p into 100 ohms - Sine distortion is 1% typical - Voltage controlled sweep of sine and triangle waves - TTL square wave has a fully adjustable pulse and drives 600 ohms - Frequencies of lower than 1 Hz and greater than 100 KHz are obtainable - Short pulse. Complete with power supply and metal case. \$55.00

CARBON FILM RESISTORS (5%)

Only in Multiples of 100 pcs per value (ohms)

1/4W ... \$1.69 per 100

1/2W ... \$1.79 per 100

10	100	1.0K	10K	100K	1.0M
11	110	1.1K	11K	110K	1.1M
12	120	1.2K	12K	120K	1.2M
13	130	1.3K	13K	130K	1.3M
15	150	1.5K	15K	150K	1.5M
16	160	1.6K	16K	160K	1.6M
18	180	1.8K	18K	180K	1.8M
20	200	2.0K	20K	200K	2.0M
22	220	2.2K	22K	220K	2.2M
24	240	2.4K	24K	240K	2.4M
27	270	2.7K	27K	270K	2.7M
30	300	3.0K	30K	300K	3.0M
33	330	3.3K	33K	330K	3.3M
36	360	3.6K	36K	360K	3.6M
39	390	3.9K	39K	390K	3.9M
43	430	4.3K	43K	430K	4.3M
47	470	4.7K	47K	470K	4.7M
51	510	5.1K	51K	510K	5.1M
56	560	5.6K	56K	560K	5.6M
62	620	6.2K	62K	620K	6.2M
68	680	6.8K	68K	680K	6.8M
75	750	7.5K	75K	750K	7.5M
82	820	8.2K	82K	820K	8.2M
91	910	9.1K	91K	910K	9.1M

RESISTOR ASSORTMENT

Each assortment contains 5 pcs each of 10 different values. Values included are shown in (Ohms)

1/4W, 5% (50 pcs total) ... \$1.75

1/2W, 5% (50 pcs total) ... \$1.85

Asst. 1: 10, 12, 15, 18, 22, 27, 33, 39, 47, 56 ohm

Asst. 2: 68, 82, 100, 120, 150, 180, 220, 270, 330, 390 ohm

Asst. 3: 470, 560, 680, 820 ohm, 1K, 1.2K, 1.5K, 1.8K, 2.2K, 2.7K

Asst. 4: 3K, 3.9K, 4.7K, 5.6K, 6.8K, 8.2K, 10K, 12K, 15K, 18K

Asst. 5: 22K, 27K, 33K, 39K, 47K, 56K, 68K, 82K, 100K, 120K

Asst. 6: 150K, 180K, 220K, 270K, 330K, 390K, 470K, 560K, 680K, 820K

Asst. 7: 1M, 1.2M, 1.5M, 1.8M, 2.2M, 2.7M, 3.3M, 3.9M, 4.7M, 5.6M

Asst. 8R: (All seven assortments above)

1/4W, 5%, 350 pcs total: \$10.95 - 1/2W, 5%, 350 pcs total: \$11.55

JANUARY SPECIALS

MICROPROCESSOR CIRCUITS

B080A	23.90	1402A	10.00	P2102-1	2.50
AM9080A	31.95	1403A	3.00	P2102A-2	3.20
AM2901DC	34.00	1404A	3.00	P2111	5.80
C1702A	11.00	1405A	3.40	P2111-1	4.80
AM2902PC	3.80	2809PC	8.00	P2112-2	4.80
AM2905PC	10.10	AM9101ADC	8.00	P2405	8.00
AM2906PC	11.20	AM9101APC	6.00	P3101	4.00
AM2907PC	9.75	AM9130ADC	28.40	P3101A	4.10
AM2909PC	25.95	AM9140ADC	28.40	P8212	3.60
AM2911DC	19.95	P8101	4.85	AM2502PC	5.80
AM2918PC	5.40	P8102	4.17	AM2504DC	7.50
AM2920PC	6.25	P8111	4.85	AM2505PC	12.00
AM2921PC	6.25	P1101A	2.20	AM2602PC	1.90
AM685DC	10.00	P210	2.20	28D84PC	4.00

Valid only until January 31, 1977

XR FUNCTION GENERATOR

XR-2206KA SPECIAL \$16.95

Includes monolithic function generator IC, PC board, and assembly instruction manual.

XR-2206KB SPECIAL \$26.95

Same as XR-2206KA and includes external components for PC board.

HIGH SPEED TTL

74H00N	33	74H06N	40	74H73N	80	74H106N	95
74H04N	33	74H101N	33				

SCHOTTKY TTL

74S00	44	74S11	65	74S64	80	74S114	120
74S02	60	74S20	65	74S74	90	74S133	80
74S04	55	74S30	80	74S76	115	74S138	220
74S08	60	74S32	80	74S112	100	74S151	220
74S10	55	74S40	65	74S113	150	74S160	300
						74S257	240

Minimum order \$10.00. Add \$1.00 to cover postage and handling. California Residents add 6% sales tax. Mail Order - Send check or money order to: P.O. Box 2208P Culver City, CA 90230. COD, Master Charge and BankAmericard Welcomed. (Stores do not accept mail or phone orders.)

Phone Order - Call: (213) 641-0664

AMCRONA

CALIFORNIA AMCRONA	CALIFORNIA AMCRONA	ARIZONA AMCRONA	OREGON AMCRONA	GEORGIA AMCRONA	CANADA, B.C. AMCRONA
11080 Jefferson Blvd. Culver City, CA 90230 (213) 390-3595	1300 E. Edinger Ave. Santa Ana, CA 92705 (714) 547-8424	4518 E. Broadway Tucson, AZ 85711 (602) 881-2348	1125 N.E. 82nd Ave. Portland, OR 97220 (503) 254-5541	3330 Piedmont Rd. NE Atlanta, GA 30305 (404) 261-7100	5656 Fraser St. Vancouver, BC V5W 2Z4 (423) 324-0707

INSTRUCTION

F.C.C. EXAM MANUAL

PASS FCC EXAMS! Memorize, study... "Ten Answers" for FCC 1st and 2nd class Radio Telephone licenses. Newly revised multiple-choice questions and diagrams cover all areas tested in FCC exams plus "Self-Study Ability Test" - \$9.95 expanded. Money-back Guarantee!

COMMAND PRODUCTIONS P.O. BOX 26348-P
RADIO ENGINEERING DIVISION SAN FRANCISCO, CALIF. 94126

LEARN WHILE ASLEEP! HYPNOTIZE! Astonishing details, strange catalog free! Autosuggestion. Box 24-ZD, Olympia, Washington \$8507.

SELF-STUDY CB RADIO REPAIR COURSE. THERE'S MONEY TO BE MADE REPAIRING CB RADIOS. This easy-to-learn course can prepare you for a career in electronics enabling you to earn as much as \$16.00 an hour in your spare time. For more information write: CB RADIO REPAIR COURSE, Dept. PE017, 531 N. Ann Arbor, Oklahoma City, Okla. 73127.

ADVANCED MICROCOMPUTER PRODUCTS

BUILD YOUR OWN COMPLETE COMPUTER SYSTEM

★ AMI EVK 99 6800 BASED MICROCOMPUTER

Ask the Home-Brew Computer Club in Santa Clara, California why they choose the EVK 99 Microcomputer. They use them BECAUSE. The reasons are effective: Performance, versatility and cost effectiveness. Photo of expanded EVK 99 Board.

Photo of expanded EVK 99

★ TV GAME KITS

Qty (1) GI AY38001 TV Game Chip **\$29.95**

TV KIT NO. 1 ONLY **\$34.95**
Includes AY38001 TV Game Chip
PC Board for video composite output plus instructions. Add \$5.95 for 2MHz crystal.

TV KIT NO. 2 ONLY **\$49.95**
Includes AY38001 TV Game Chip, PC Board, Switches, pot, speaker, crystal, RFMR, Brine and all parts required for video composite. Works superb with terminal. Includes instructions and data sheets.

- 1. EVK 99** consists of the following only:
Qty: (1) PCB 10x x 12
(1) 6800 8 Bit CPU
(1) 6850 A/D (Analog/Digital Conversion Interface Adapter)
(1) 6820 I/O (Peripheral Interface Adapter)
(2) 6830 ROM Subroutine Program Library (11 8881) 16K ROM
(4) 8810 1 RAM
1. Over-arg Manual & Instructions
To implement fully expanded system additional IC's are required. (See Photo)
- 2. UNIVERSAL KLUGE BOARD \$98.00**
Completely compatible to the EVK system. This board allows the user to add any additional parts he desires. It has 5400 holes, 94 18 pin IC's or others on 2, 4, 6, 9, or 16 pin sockets. 2.50 pin 1, 20 pin flat pack, 1.25 pin MS22 connector.
- 3. 16K BYTE RAM BOARD \$77.95**
16K x 8 or 16 x 16 Organization. Uses 2102's and adapts to slow memory.
- 4. 6 SLOT MOTHER BOARD \$29.95**
Connects most of 75' boards. May be plugged together for expanded applications.
- 5. EXTENDER BOARD \$46.50**
For use with back door and card cage configuration.
New boards are now in development including cassette I/O and others. If you want more information drop us a line.

★ C MARKET PLACE ★

★ LINEAR

LM100 3.50	LM300K 5.2 1.45	LM3831N 1.78	LM1414N 1.75	7524 3.5C
LM100H 2.50	LM300K 1.25 1.45	LM3832N 1.79	LM1458N 65	SC4501T 2.40
LM301 45	LM320T 1.5 1.45	LM555CN 58	LM1859N .35	SC4501N 2.40
LM301CN 45	LM320T 1.5 1.75	LM556CN 1.45	LM2113N 1.30	SC2504 8.95
LM302 1.25	LM320T 1.5 1.75	LM567CN 1.35	LM2901N 1.95	RC4194T 6.95
LM304 1.20	LM320T 1.2 1.75	LM568CN 1.35	LM2902N 1.95	RC4196T 6.95
LM305A 1.85	LM320T 1.5 1.75	LM569CN 1.40	LM2903N 55	RC1458CN 6.95
LM305AH 1.85	LM320T 1.5 1.75	LM590CN 45	LM2904N 1.10	RC1556CN .99
LM305A 95	LM324M 1.05	LM709N 40	LM7524N 1.75	RC4131CN .99
LM307CN 1.50	LM324M 1.30	LM719N 70	LM7525A 1.90	RC4135D 1.90
LM308 35	LM340A 1.95	LM7171N 39	LM7534N 2.20	RC4588CN .99
LM308CN 1.00	LM340A 1.95	LM7171N 39	LM7525A 1.25	RC4581N 6.50
LM309 1.10	LM340A 1.95	LM7232A 55		
LM309CN 1.25	LM340A 1.95	LM7232A 1.25		
LM310CN 1.15	LM340A 1.95	LM7232A 1.00		
LM310A 1.15	LM340A 1.95	LM7232CN 1.45		
LM311A 90	LM340A 1.95	LM7232N 1.29		
LM311CN 49	LM340A 1.95	LM741CN 35		
LM312A 1.95	LM340A 1.95	LM741CN 14 39		
LM318A 1.50	LM340A 1.95	LM741CN 75		
LM318CN 1.50	LM340A 1.95	LM741CN 75		
LM319A 1.30	LM380CN 1.35	LM741CN 39		
LM320A 1.45		LM741CN 39		

★ 7400 TTL

7400N 18	7448N 99	74129N 44	74185N \$2.10
7401N 18	7448N 99	74129N 60	74185N \$1.30
7402N 18	7447N 99	74150N 79	74191N \$1.30
7403N 18	7448N 99	74151N 79	74192N \$1.10
7404N 18	7448N 99	74152N 79	74193N \$1.10
7405N 20	7447N 76	74153N 88	74194N .95
7406N 25	7448N 76	74154N 70	74195N .95
7407N 25	7448N 76	74155N 96	74196N .95
7408N 21	7447N 45	74156N 119	74197N \$1.10
7409N 21	7447N 30	74157N 115	74198N \$1.45
7410N 21	7447N 30	74158N 119	74199N \$1.85
7411N 21	7447N 30	74159N 115	74200N \$1.45
7412N 21	7447N 30	74160N 115	74201N \$1.10
7413N 21	7447N 42	74161N 95	8092N .49
7414N 98	7448N 70	8092A .49	
7415N 35	7447N 95	8092N .95	
7416N 35	7448N 99	8092N .99	
7417N 35	7448N 99	8092N .99	
7418N 35	7448N 99	8092N .99	
7419N 35	7448N 99	8092N .99	
7420N 35	7448N 99	8092N .99	
7421N 35	7448N 99	8092N .99	
7422N 35	7448N 99	8092N .99	
7423N 35	7448N 99	8092N .99	
7424N 35	7448N 99	8092N .99	
7425N 35	7448N 99	8092N .99	
7426N 35	7448N 99	8092N .99	
7427N 35	7448N 99	8092N .99	
7428N 35	7448N 99	8092N .99	
7429N 35	7448N 99	8092N .99	
7430N 35	7448N 99	8092N .99	
7431N 35	7448N 99	8092N .99	
7432N 35	7448N 99	8092N .99	
7433N 35	7448N 99	8092N .99	
7434N 35	7448N 99	8092N .99	
7435N 35	7448N 99	8092N .99	
7436N 35	7448N 99	8092N .99	
7437N 35	7448N 99	8092N .99	
7438N 35	7448N 99	8092N .99	
7439N 35	7448N 99	8092N .99	
7440N 35	7448N 99	8092N .99	
7441N 35	7448N 99	8092N .99	
7442N 35	7448N 99	8092N .99	
7443N 35	7448N 99	8092N .99	
7444N 35	7448N 99	8092N .99	
7445N 35	7448N 99	8092N .99	
7446N 35	7448N 99	8092N .99	
7447N 35	7448N 99	8092N .99	
7448N 35	7448N 99	8092N .99	
7449N 35	7448N 99	8092N .99	
7450N 35	7448N 99	8092N .99	

100 PIECES MIX TAKE 10% DISCOUNT
1000 PIECES MIX TAKE 15% DISCOUNT

ADVANCED MICROCOMPUTER PRODUCTS

P. O. BOX 17329
IRVINE, CALIFORNIA 92713
PHONE (714) 968-3655

LEARN ELECTRONIC ORGAN SERVICING at home all makes including transistor. Experimental kit—trouble-shooting. Accredited NHC. Free Booklet. NILES-BRYANT SCHOOL, 3631 Stockton, Dept. A, Sacramento, Calif. 95820.

EARN ELECTRONICS DEGREE by correspondence. Free information bulletin. Grantham, 2000 Stoner Avenue, Los Angeles, California 90025.

Electronics • Computer Science

Learn the skills of the future through ITI's effective correspondence courses. We offer over 20 individual courses in Accounting, Computer Science, Electronics (including FCC license preparation) and Mathematics. Write today for free information.

Intermountain Technical Institute
P.O. Box 258 Jerome Idaho 83338

DON'T FAIL FCC examinations! First, second, third questions-answers guide gives results. \$8.00. "Guaranteed Exams", Box 5516-AA, Walnut Creek, CA 94596.

FCC LICENSE. Specializing in electronics training. Home study. Free brochure. Genn Tech, 5540 Hollywood Blvd., Los Angeles, Calif. 90028.

★ MICROPROCESSOR PRODUCTS

8080A 980A \$24.95	58800	\$15.95	21L02/91L02	1.90
8080 9800	58820	11.00	2102/9102	1.89
AY2081	29.95	58810-1	3.75	9111/2111
GI 3P400	69.95	58850	18.95	9101/2101
Z80	89.95	52350	12.95	9112/2112
6802	29.95	51883	18.99	9102/2102
AM9302C	\$ 3.95	58834-1	22.99	4108/4804
AM9303C	10.95	58800	15.00	402A
AM9304C	11.95	58800	15.00	4220
AM9305C	10.75	58800	23.95	9113/4PC
AM9306C	24.95	58800	17.00	9114/4PC
AM9307C	18.95	8212	4.75	AM2533
AM9308C	6.75	8224	6.25	AM2411
AM9309C	7.95	8216	4.95	AM1402
AM9310C	6.75	8226	5.95	AM1403
AM9311C	5.50	8228	5.90	AM1404
AM9312C	4.95	9501	18.95	MM500H
AM9313C	14.95	9501	18.95	MM500H
AM9314C	12.00	9505	18.95	MM501H
AM9315C	9.95	9505	18.95	MM501H
AM9316C	9.95	9505	18.95	MM501H
AM9317C	9.95	9505	18.95	MM501H
AM9318C	9.95	9505	18.95	MM501H
AM9319C	9.95	9505	18.95	MM501H
AM9320C	9.95	9505	18.95	MM501H
AM9321C	9.95	9505	18.95	MM501H
AM9322C	9.95	9505	18.95	MM501H
AM9323C	9.95	9505	18.95	MM501H
AM9324C	9.95	9505	18.95	MM501H
AM9325C	9.95	9505	18.95	MM501H
AM9326C	9.95	9505	18.95	MM501H
AM9327C	9.95	9505	18.95	MM501H
AM9328C	9.95	9505	18.95	MM501H
AM9329C	9.95	9505	18.95	MM501H
AM9330C	9.95	9505	18.95	MM501H
AM9331C	9.95	9505	18.95	MM501H
AM9332C	9.95	9505	18.95	MM501H
AM9333C	9.95	9505	18.95	MM501H
AM9334C	9.95	9505	18.95	MM501H
AM9335C	9.95	9505	18.95	MM501H
AM9336C	9.95	9505	18.95	MM501H
AM9337C	9.95	9505	18.95	MM501H
AM9338C	9.95	9505	18.95	MM501H
AM9339C	9.95	9505	18.95	MM501H
AM9340C	9.95	9505	18.95	MM501H
AM9341C	9.95	9505	18.95	MM501H
AM9342C	9.95	9505	18.95	MM501H
AM9343C	9.95	9505	18.95	MM501H
AM9344C	9.95	9505	18.95	MM501H
AM9345C	9.95	9505	18.95	MM501H
AM9346C	9.95	9505	18.95	MM501H
AM9347C	9.95	9505	18.95	MM501H
AM9348C	9.95	9505	18.95	MM501H
AM9349C	9.95	9505	18.95	MM501H
AM9350C	9.95	9505	18.95	MM501H

TV KIT NO. 3 ONLY **\$59.95**
New design utilizes the AY38001 Chip which features Hysteresis, Tennis Practice and Pong. Modular design includes chassis and all necessary components. Add \$5.95 for 2MHz crystal with RF output. Kit comes complete with instructions and data sheets.

RF MODULATOR MODULE
To convert your video composite to RF try
LM101 Channel 3/4 VHF Modulator **\$8.95**

DC Switchable DC Coupled modulator input with positive feedback characteristic. VCC = 6.5 volts. Designed for use with TV Games.

★ NEW PRODUCTS

NEW FROM NEC Microcomputer! FIRST TIME OFFERED

D372 Floppy Disk Controller Chip **\$125.00**
D371 Mag. Tape Cassette Controller Chip **\$99.95**
Application Notes (26 pages) **6.95**
GI AY3550 4 1/2 Digit DVM Chip **29.95**
GI AY3500 Keyboard Encoder **9.95**
Intersil 8030C **4.95**
XR2263 Servo Can **6.95**
RO 32513 Char Gen **9.95**

★ SPECIALS

75452	10/2.50
87768	2/5.00
LM1318	1.00
74166	.99
8097	.60
74161	.60
7414C	10/2.50
MH0026CN	3.95
1488	1.29
1489	1.29

★ CMOS

CD4000	25	CD4026	1.95	CD4075	35
CD4001	25	CD4027	1.95	CD4076	35
CD4002	25	CD4028	1.50	CD4081	35
CD4003	1.75	CD4029	1.99	CD4082	35
CD4004	25	CD4030	60	CD4083	1.35
CD4005	1.95	CD4031	2.49	CD4084	1.10
CD4006	1.48	CD4032	4.95	CD4085	1.15
CD4007	1.48	CD4033	1.79	CD4086	2.19
CD4008	1.95	CD4034	1.45	CD4087	2.19
CD4009	1.48	CD4035	1.45	CD4088	2.19
CD4010	2.8	CD4036	1.45	CD4089	2.19
CD4011	2.8	CD4037	1.45	CD4090	2.19
CD4012	2.8	CD4038	1.45	CD4091	2.19
CD4013	2.8	CD4039	1.45	CD4092	2.19
CD4014	1.9				

LIVE IN THE WORLD OF TOMORROW... TODAY!

And our FREE 164 PAGE CATALOG is packed with exciting and unusual values in electronic, hobby and science items — plus 4,500 finds for fun, study or profit... for every member of the family.

A BETTER LIFE STARTS HERE

KNOW YOUR ALPHA FROM THETA!

For greater relaxation, concentration, monitor your Alpha/Theta brainwaves w/ audible or visible signal on Biosone II. Has 3 feedback modes, outputs to monitor logic signal, filter sel. feedback, broad sensitivity control; other professional feats. of \$200-up units. Easily operated 4-lb. portable has total brainwave monitoring capability! 2 9v tr. batteries.

No. 1668 AV (9½ x 5¾ x 4¼") \$149.95 Ppd.

LOW COST STARTERS' UNIT (PORTABLE)

No. 71,809 AV (4½ x 2¾ x 4¼") \$59.95 Ppd.



SUPER POWER FOR ANY AM RADIO

New antenna assist turns a tiny transistor into a tiger, has pulled in stations up to 1000 miles away! Just set beside radio (no wires, clips, grounding) and fine-tune Select-A-Tenna's dial to same frequency—and that's it! Great for clearing weak signals in radio depressed areas, off-coast islands, crowded frequency stations. Solid state—uses no electricity, batteries, tubes.

Stock No. 72,095AV \$19.95 Ppd.

ULTRA SELECT-A-TENNA

No. 72,147AV (*OVER 1000 MI.) \$24.95 Ppd.



3000 MI. POWER FOR AM RADIOS

REMARKABLY CLEARER RECEPTION!

Get ball games from distant cities, your old home town, up to 3000 miles away (subject to local conditions). Deluxe Ultrasensitive AM Antenna pre-amplifies signal before it goes into your hi-fi AM receiver or tuner inputs. Nulls interference. Great for marginal AM reception areas! Shielded ferrite rod 6¾ lb. directional indoor antenna has 2-stage FET amplifier with frequency & sensitivity controls for precise selection, optimum reception. Easily attached; 110VAC, 60 cycles.

No. 72,263AV (3¾ x 9 1/16 x 11") \$177.50 Ppd.

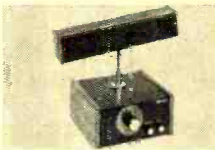

SAVE 50%! 8 X 20 MONOCULAR

Fantastic bargain! Top quality Spy Scope, a \$30 value, now offered at \$14.95! Our special purchase saves you 50% and you get 100% coated optics; 393 ft. field of view. Only 2 oz.—stores in pocket, purse, glove compartment. Fits in your palm—peer into hard-to-see places without letting subject know you're spying. Great for birders and race fans; incl. neck strap, leatherette 3½ x 1½ x 2" case. Beautiful brushed metal finish. Buy two—one for a gift!

Stock No. 1568AV \$14.95 Ppd.



NEW! THE UNIQUE EDMUND 4¼", f/4 NEWTONIAN RICHEST FIELD REFLECTOR TELESCOPE

Clear, bright, spectacular wide angle views of stars, moon, comets—and portable! See heavenly wonders! Sets up in seconds (pre-collimated, ready to use). Pop in the eyepiece, focus, and its 3½° field of view gives you more stars in a single view than any other type 'scope! Bright, crisp, finely resolved images. For sky gazing and earth gazing! Take it anywhere (only 17", 10 lb.), easily use it over your shoulder, (has adjustable carrying strap), in your lap, on a tripod; rotate the spherical base on its own mount for use on a table, car hood. Top quality optical system features 4¼", f/4 parabolic primary mirror (½ wave, 17" F.L.); std. 28mm Kellner eyepiece (15X). No other telescope like it. Bright Scharfianian rec!

No. 2001AV ... \$149.95 Ppd.



SEE MUSIC IN PULSATING COLOR

New 3-Channel Color Organ adds to music listening pleasure, lets you modulate 3 independent strings of colored lamps with intensity of your music to create an audio "light show." They flash, vary in brightness related to music's rhythm,



pitch, volume—pulsating lighting performance to music! Fully assembled & priced half that of others, the Edmund Sound To Light Control is a terrific value. Plug in, turn on!

No. 42,309AV (ASSEMBLED) \$18.50 Ppd.

No. 42,336AV (UNASSEMBLED) \$15.95 Ppd.

LOW COST PORTABLE INFRA-RED EYE

For infra-red crime detection surveillance, security system alignment, I.R. detection, laser checking, nite wildlife study, any work req. I.R. detection & conversion to visible spectrum.



Self-cont. scope incl. I.R. light source (90° nite vision!), 6032 I.R. converter tube, f/3.5 obj. lens, adjust. triplet eyepiece, auto lighter adapter. 1.6X focuses 10' to inf.; 6. 12v DC. Not avail. to CA res. exc. auth. pers./sci., edu.

No. 1683AV (11 x 14¼ x 3") \$299.95 Ppd.

BINOCULAR STYLE: AS ABOVE, BUT 2.5X

No. 1685AV (SUPER BRIGHT I.R. EYE) \$329.95 Ppd.

QUALITY DETECTOR UNDER \$40

New Edmund-developed, fully transistorized BFO unit capable of locating quarter at 18"—powerful 6-trans. oscillator-amplifier circuit. Easily compares to others priced 50% higher! Aluminum pole and housing—not plastic! 6" waterproof search coil (Faraday shielded to elim. outside interference); long 50-hr. battery (9V) life; power-



ful 2" speaker; 1-knob on-off tune control. Perfect balance; lightweight (2 lbs.). Great buy!

Stock No. 80,222AV \$39.95 Ppd.

SUPER-SENSITIVE TRANSMITTER/RECEIVER UNIT

No. 80,251AV (OUR TR EARTH CHALLENGER) \$69.95 Ppd.

MAIL COUPON FOR GIANT FREE CATALOG!

164 PAGES • MORE THAN 4500 UNUSUAL BARGAINS

Completely new 1977 edition. New items, categories, illustrations. Dozens of electrical and electromagnetic parts, accessories. Enormous selection of Astronomical Telescopes. Unique lighting and ecological items. Microscopes, Binoculars, Magnifiers, Magnets, Lenses, Prisms. Hard-to-get-surplus bargains. Ingenious scientific tools. 1000's of components.

EDMUND SCIENTIFIC CO.
300 Edscorp Building, Barrington, N. J. 08007
Please rush Free Giant Catalog "AV"

Name, _____
Address _____
City _____ State _____ Zip _____



COMPLETE & MAIL WITH CHECK OR M.O.

EDMUND SCIENTIFIC CO.

300 Edscorp Building, Barrington, N.J. 08007

How Many Stock No.

Description (609) 547-3488

Price Each

Total

PLEASE SEND GIANT FREE CATALOG "AV"

Charge my American Exp.

BankAmericard Master Chg.

Interbank No.

My Card No. Is

Card Expiration Date

30-DAY MONEY-BACK GUARANTEE.

You must be satisfied or return any purchase in 30 days for full refund.

Name

Address

City

State

Zip

Add Service and Handling Charge \$1.00

I enclose

check money order for TOTAL \$

Signature

SECTION "A-A" THRU
ELLIPTICAL STYLUS

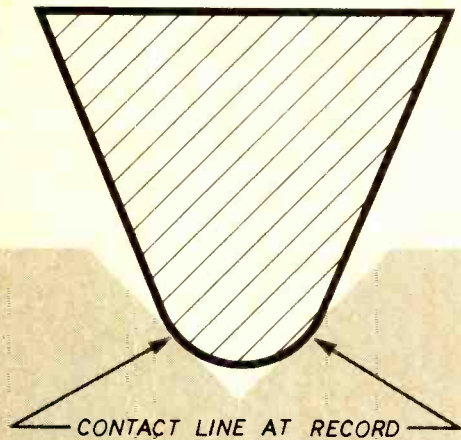

SECTION "B-B" THRU
STEREOHEDRON STYLUS

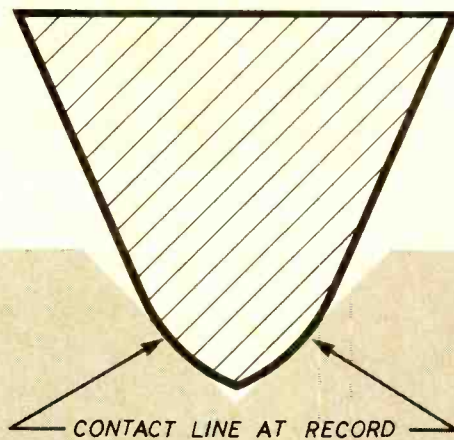

Conventional elliptical styli have a relatively limited bearing radius at the contact area with the groove. The Stereohedron combines the elliptical and Quadrahedron concepts to create a stylus having a larger bearing contact radius at the area in order to reduce stylus wear and prolong record life.

what is a Stereohedron stylus tip?

... it is the unique, new development
in stylus tip design.

It makes possible a wider, more open, finer sound — because it maximizes stereo tracing capabilities with the slightest, lightest touch a record ever had. It adds to the useful life of each record groove because force is spread over a greater contact area. And that means the least record wear — and longest stylus life — achievable in these times (with a stereo cartridge).

**Buy it? Yes you can in the new
Pickering XSV/3000. It's
the source of perfection in
stereo sound.**



TECHNICAL DESCRIPTION

October 29, 1976

The XSV/3000 with STEREOHEDRON™ TIP

The Stereohedron diamond is mounted in a thin-wall tubular alloy cantilever for extremely low effective tip mass and optimum coupling to a tiny, yet powerful rare earth permanent magnet.

An unusual suspension design affords very high compliance and highly linear motion for distortionless reproduction of high amplitude low frequency modulation while supplying the precise amount of damping at all frequencies.

Results:

1. An extraordinarily smooth and flat frequency response with uniformly excellent channel separation across the entire audio band.
2. Near perfect transient response for superb definition.
3. Accurate tracing of complex waveforms for low intermodulation distortion.

Engineering Dept., Pickering & Co., Inc.

For further information write to: Pickering & Co., Inc., Dept. PE
101 Sunnyside Blvd., Plainview, N.Y. 11803



If you take a creative approach to recording, you'll appreciate the special versatility of the new Dual C 919 cassette deck. Four separate slide controls for the line-level and microphone inputs allow you to mix and record signals from disc, tape or FM with live voices and instruments. Output level controls eliminate the need to readjust your amplifier's volume when switching programs, such as to tuner or record player. (These and additional features are shown below.)

The Dual C919 is so versatile, you might think of it as a miniature recording console.

What about performance? The C919 uses the highly reliable Continuous Pole/synchronous motor, tapeheads, electronics and a uni-directional version of the transport system of our new Auto/Reverse deck, which *Audio* magazine reported as "...another outstanding example of the great strides in cassette deck technology in recent years. Wow and flutter

was indeed extremely low, measuring 0.065% (WRMS)...total harmonic distortion...well below the 1.5% claimed...about the fastest and smoothest [wind] we have encountered...we also found that the Dual deck was able to handle [C-120 cassettes] smoothly...A distinct feeling of quality...seems well worth the price."

Thus, whether you have special program-mixing requirements, or simply want superb overall performance, both are available in the C919 cassette deck. Less than \$450.00.

United Audio Products, 120 So. Columbus Ave., Mt. Vernon, N.Y. 10553

Exclusive U.S. Distribution Agency for Dual

Dual

Output level controls.

Memory for locating pre-selected passages on tape.

Headphone level control for precise stereo monitoring.

Bias and equalization for ferric-oxide, chromium-dioxide, and ferrichrome tapes.

Wow and flutter; 0.07%. Frequency response ($\pm 3\text{dB}$): ferric-oxide, 20-16,500 Hz, chromium-dioxide, ferrichrome, 20-17,000 Hz.

Level meters with VU characteristics; meters tilt for optimum viewing angle.

Level controls for microphones and line inputs.

Dolby system with calibrators; can be switched to decode Dolbyized FM broadcasts too.

Dolby is a trademark of Dolby Laboratories, Inc.