

TV VIDEO GAMES FOR CHRISTMAS

Popular Electronics®

WORLD'S LARGEST-SELLING ELECTRONICS MAGAZINE DECEMBER 1976/\$1.25

PE PROJECT FIRSTS!

Universal 4-Channel Matrix Decoder



**DECODES
QS
AND SQ
RECORDINGS**

**AND BROADCASTS - PLUS "SURROUND
SOUND" WITH VARIO-MATRIX SYSTEM**

A Solar Energy Meter

MEASURES SUN'S ENERGY

16-PAGE BONUS!

SPECIAL FOCUS ON DIGITAL ELECTRONICS

- **How to Select a Hobbyist Microcomputer**
- **Build a Digital Auto Gas Gauge**

490664 LNE 10082099 0410 JAN79
 12
 KENNETH J LINES
 1088 22ND AV SE
 MINNEAPOLIS MN 55414

**Logic -
and more**

PLUS:

**How to Determine
CB Radio
Communication Range**

**Annual Index of
1976 Articles
and Columns**

**TEST REPORTS:
Technics SA 5460**

Stereo Receiver

Shure M24H

Stereo Cartridge

**SBE Formula D "Touch-Com"
AM CB Mobile**



**Sencore Portable
Transistor/FET Meter**



THE COBRA 32XLR. A TECHNOLOGICAL PUNCHTHROUGH.

Cobra has a reputation for punching through loud and clear. The new Cobra 32XLR, of course, continues the reputation. And creates another — for innovative design, superb engineering and technical superiority.

Start with the illuminated 4-in-1 meter. It tells you exactly how much power you're pushing out and pulling in. As well as monitoring your modulation in precise percentages. And measuring your punch with an SWR check. In short, the 32 XLR lets you keep an eye on your ears.

ScanAlert, Cobra's unique scanning system, continually monitors Channel 9 when you're on another channel. If an emergency comes up, the ScanAlert light goes on. And the incoming message automatically locks the receiver on the active channel.

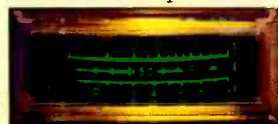

The 32XLR's Digital Channel Selector is the very latest. With large LED numerals — for a read-out that registers clearly and quickly. Plus switchable "pulse block" noise blanking that rejects short-pulse noise not normally blocked by other systems. Which makes it the most effective in the business. Finally, add automatic noise limiting, Dynamike Plus (with built-in power mike) and Delta Tuning.

The new Cobra 32XLR. It has virtually everything. And it has everything to do just one thing. Punch through loud and clear.



Punches through loud and clear.

Cobra Communications Products
DYNASCAN CORPORATION
6460 W. Cortland St., Chicago, Illinois 60635

For information on our complete line write for brochure #CB-2.

CIRCLE NO. 17 ON FREE INFORMATION CARD

www.americanradiohistory.com

The Simple Answer is A Complex Solution.

Combine **D3** with the slanted micro-fibers of the Discwasher brush—and you have the most functional, most convenient record care system in the world. At Discwasher dealers worldwide.



 **Discwasher Group**
Columbia, Missouri

The small wonder



of the micro-world

Measuring just 11" wide x 11" deep x 5" high, and weighing a mere 7 pounds, the Altair™ 680b is a complete, general-purpose computer.

The secret to this revolutionary, small computer is its CPU board. This double-sided board fits along the bottom of the Altair case and plugs directly into the front panel board. It contains the new 6800 microprocessor, 1,024 bytes of RAM memory, a 256 byte PROM monitor, provisions for 768 bytes of additional PROM or ROM, and a single Interface port with a Motorola ACIA serial interface adapter which can be configured either RS-232 or TTY. A five level Baudot interface option is also available.

The Altair 680b can be programmed from front panel switches, or it can be interfaced to a video display terminal, or teletypewriter. Three additional circuit boards can be plugged inside the Altair 680b for further memory and interface expansion. The first of these boards is a 16K static RAM memory board.

Software already developed includes Altair 680 BASIC with all the features of the 8K BASIC previously developed for the Altair 8800. These include Boolean operators, the ability to read or write a byte from any I/O port or memory location, multiple statements per line, and the ability to interrupt program execution and then continue after the examination of variable values. This software takes only 6.8K bytes of memory space and a copy is included free with the purchase of the Altair 680 16K memory board.

Other software includes a resident two pass assembler. The Altair 680b is also compatible with Motorola 6800 software.

The Altair 680b is ideal for hobbyists who want a powerful computer system at an economic price. Altair 680b owners qualify

for membership in the Altair Users Group, and like other Altair owners, they receive a complimentary subscription to **Computer Notes** and complete factory support.

PRICES:

Altair 680b kit with complete, easy-to-understand assembly manual, operator's manual, and programming manual	\$466
Assembled Altair 680b	\$625
Altair 680b Turnkey model kit	395
Expander Card 680MB (required to expand 680)	\$ 24
Altair 680BSM 16K static RAM board kit with 680 BASIC	\$685
Altair 680 BASIC when purchased separately	\$200
Baudot option	\$ 42

MAIL THIS COUPON TODAY

- Enclosed is a check for \$ _____
- BankAmericard # _____ or Master Charge # _____
- Altair 680b Kit Assembled Other (specify) _____
- enclose \$8 for postage and handling
- Please send free information package.

NAME _____

ADDRESS _____

CITY _____ STATE & ZIP _____



2450 Alamo SE/Albuquerque, NM 87106, 505-243-7821

NOTE: Altair is a trademark of MITS, Inc.

Price, specifications subject to change. Please allow up to 60 days for delivery.

Popular Electronics®

WORLD'S LARGEST-SELLING ELECTRONICS MAGAZINE

FEATURE ARTICLES

ROUNDUP OF TV ELECTRONIC GAMES	Kris Carrole	32
HOW TO PREDICT CB RADIO RANGE	Ira S. Gerson	48
<i>Antenna height, ERP, noise, and sensitivity influence communication range.</i>		
UNDERSTANDING ACTIVE FILTERS	Don Lancaster	69
LAMP CIRCUIT QUIZ	Robert P. Balin	99

CONSTRUCTION ARTICLES

BUILD A UNIVERSAL 4-CHANNEL MATRIX DECODER	Robert Colman & Toshiaki Okawa	37
<i>Decodes SQ and QS or provides surround sound or concert hall ambience.</i>		
MEASURE THE SUN'S ENERGY WITH A SOLAR RADIOMETER	Warren Jochem	45

SPECIAL FOCUS ON DIGITAL ELECTRONICS

HOW TO SELECT A HOBBYIST MICROCOMPUTER	Stephen B. Gray	51
DIGIT PROBE	Leslie Solomon	56
BUILD A MINIATURE DIGITAL STOPWATCH	Wayne Kashinsky	57
DIGITAL FUEL GAUGE	Gregory Baxes	59
AN A/D TEMPERATURE CONVERTER	W. J. Prudhomme	62
PROPAGATION DELAY—THE LOGIC GREMLIN	Ralph Tenny	64

COLUMNS

STEREO SCENE	Ralph Hodges	24
<i>Evaluating Four-Channel.</i>		
HOBBY SCENE Q & A	John McVeigh	28
INSIDE BASIC ELECTRONICS	Sol D. Prenskey	86
<i>Capacitors and RC Circuits, Part 2.</i>		
SOLID STATE	Lou Garner	90
<i>'Tis the Season to be Solid.</i>		
CB SCENE	Ray Newhall	94
<i>More on Mobile Antennas.</i>		
COMPUTER BITS	Stephen B. Gray	101
<i>Books on Programming</i>		
EXPERIMENTER'S CORNER	Forrest M. Mims	111
<i>The Neon Glow Lamp.</i>		

PRODUCT TEST REPORTS

TECHNICS MODEL SA-5460 STEREO RECEIVER	74
SHURE MODEL M24H ALL-FORMAT PHONO CARTRIDGE	76
SBE MODEL 32CB FORMULA D TOUCH/COM CB TRANSCEIVER	78
SENCORE MODEL TF70 PORTABLE TRANSISTOR TESTER	79

DEPARTMENTS

EDITORIAL	Art Salsberg	4
<i>Turning the Electronics Corner.</i>		
LETTERS		8
OUT OF TUNE		8
<i>"Build the Ultimate Metronome" (July 1976)</i>		
<i>"Power-Failure Alarm" (June 1976)</i>		
NEW PRODUCTS		12
NEW LITERATURE		22
NEWS HIGHLIGHTS		30
ELECTRONICS LIBRARY		109
OPERATION ASSIST		110
EDITORIAL INDEX TO VOLUMES 9 AND 10 (1976)		114
ADVERTISERS INDEX		135

POPULAR ELECTRONICS, December 1976, Volume 10, Number 6, Published monthly at One Park Avenue, New York, NY 10016. One year subscription rate for U.S., \$9.98; U.S. Possessions and Canada, \$12.98; all other countries, \$14.98 (cash orders only, payable in U.S. currency). Second Class postage paid at New York, NY and at additional mailing offices. Authorized as second class mail by the Post Office Department, Ottawa, Canada, and for payment of postage in cash.

POPULAR ELECTRONICS including ELECTRONICS WORLD, Trade Mark Registered. Indexed in the Reader's Guide to Periodical Literature.

COPYRIGHT © 1976 BY ZIFF-DAVIS PUBLISHING COMPANY. ALL RIGHTS RESERVED.

Ziff-Davis also publishes Boating, Car and Driver, Cycle, Flying, Modern Bride, Popular Photography, Skiing and Stereo Review.

Material in this publication may not be reproduced in any form without permission. Requests for permission should be directed to Jerry Schneider, Rights and Permissions, Ziff-Davis Publishing Co., One Park Ave., New York, NY 10016.

Editorial correspondence: POPULAR ELECTRONICS, 1 Park Ave., New York, NY 10016. Editorial contributions must be accompanied by return postage and will be handled with reasonable care; however, publisher assumes no responsibility for return or safety of manuscripts, art work, or models.

Forms 3579 and all subscription correspondence: POPULAR ELECTRONICS, Circulation Dept., P.O. Box 2774, Boulder, CO 80302. Please allow at least eight weeks for change of address. Include your old address, enclosing, if possible, an address label from a recent issue.

Popular Electronics®

EDGAR W. HOPPER
Publisher

ARTHUR P. SALSBERG
Editorial Director

LESLIE SOLOMON
Technical Editor

JOHN R. RIGGS
Managing Editor

STEPHEN B. GRAY
Senior Editor

ALEXANDER W. BURAWA
Feature Editor

EDWARD I. BUXBAUM
Art Director

JOHN McVEIGH
Associate Editor

ANDRE DUZANT
Technical Illustrator

PATRICIA GIRRIER-BROWN
Production Editor

Contributing Editors
HAL CHAMBERLAIN, LOU GARNER
GLENN HAUSER, JULIAN HIRSCH
RALPH HODGES, ART MARGOLIS
FORREST MIMS, RAY NEWHALL
SOL PRENSKY, WILFRED SCHERER

JOSEPH E. HALLORAN
Advertising Director

JOHN J. CORTON
Advertising Sales

LINDA BLUM
Advertising Service Manager

PEGI McENEANEY
Executive Assistant

STANLEY NEUFELD
Associate Publisher

ZIFF-DAVIS PUBLISHING COMPANY
Popular Electronics
Editorial and Executive Offices
One Park Avenue New York, New York 10016
212-725-3500

Hershel B. Sarbin, President
Furman Hebb, Executive Vice President
John R. Emery, Senior Vice President, Finance and Treasurer

Phillip T. Heffernan, Senior Vice President, Marketing
Edward D. Muhfeld, Senior Vice President, Sports Division
Philip Sine, Senior Vice President

Frank Pomerantz, Vice President, Creative Services
Arthur W. Butzow, Vice President, Production
Lawrence Sporn, Vice President, Circulation

George Morrissey, Vice President
Sydney H. Rogers, Vice President
Sidney Holtz, Vice President

Al Traina, Vice President
Philip Korsant, Vice President

Paul H. Chook, Vice President, Market Planning
Charles B. Seton, Secretary

Edgar W. Hopper, Vice President, Electronics Div.
William Ziff, Chairman

W. Bradford Briggs, Vice Chairman

Midwestern Office

The Patti's Group, 4761 West Touhy Ave.,
Lincolnwood, Illinois 60644, 312 679-1100
GERALD E. WOLFE, THOMAS HOCKNEY

Western Office

9025 Wilshire Boulevard, Beverly Hills, CA 90211
213 273-8050, BRadshaw 2-1161

Western Advertising Manager, BUD DEAN

Japan: James Yagi

Oji Palace Aoyama, 6-25, Minami Aoyama
6 Chome, Minato-Ku, Tokyo 407-1930/6821,
582-2851



The publisher has no knowledge of any proprietary rights which will be violated by the making or using of any items disclosed in this issue.



Editorial

TURNING THE ELECTRONICS CORNER

The year 1976 has been a good one for persons deeply interested in electronics. I think the future might be even better—we are sitting smack in the middle of the electronics revolution that was promised a few decades ago.

As we turn the corner to 1977, we can see more clearly the fruition of many research and development projects of the past. Just think. Electronic digital watches were virtually unknown in 1972. In 1973 they cost a few hundred dollars when, around Christmas, PE introduced a kit for less than \$70. They're expected to sell for less than \$20 in 1977. Similarly, microcomputers were at the \$3000 level in 1974 when PE published plans for a kit that sold for less than \$400.

There are other examples we could mention, but the important thing is that the imaginations of voracious consumers were captured by these enticing electronic products. This led manufacturers to increase their production levels of medium- and large-scale IC's, thereby lowering their costs. As a consequence, product sales increased further, and the cycle of decreasing costs continued—to the benefit of the public.

Integrated circuits are making a host of products "smart." Just watch things happen in '77. For example, TV electronic games will be booming, thanks to inexpensive dedicated microprocessors. It's predicted that this consumer product area will reach annual sales of 12-million units by 1980. New educational and programmable calculators will bow in '77, taking advantage of lower-cost memory chips.

In another area, the use of home TV receivers as video terminals will become more apparent to many people in the new year. For example, the video disc is promised in '77, and Japanese manufacturers are revving up for production of video tape cassette units (with a battle looming between JVC's and Sony's systems). A video jack, promised by some manufacturers, will lower cost of attachments. Hobbyist computer buffs already know that graphic display has come of age right now.

There are also modifications on the audio front that could well change the product mix in the future. These include the new Elcaset system that bridges the gap between present-day cassettes and open-reel tape. Then there are 40-channel CB transceivers.

It is anticipated that all major areas of consumer electronics will exhibit greater growth in the coming year. Of special interest is a market study by Venture Development Corp. of Wellesley, Mass., which predicts that the hobby computer market will show a 150 percent sales increase from 1975 (just under 7500 units) to 1976 (over 18,600 units). The study also indicates that this "promises to be nothing less than the leading edge of a consumer computer revolution."

At this time of year, many people dream about some special "breakthrough." I'm no exception. One of my wishes is for the acknowledgement from outer space of the hydrogen atom's 1420-MHz frequency that earthlings have transmitted to outer space in a search for extraterrestrial life. The odds are almost insurmountable against making such a radio contact, of course. But just think of the excitement it would generate—and the projects we could all build and use. After all, one never knows what's around the electronics corner.

Best Wishes for a Joyous Holiday Season
and a Happy New Year

POPULAR ELECTRONICS



all the best to you

Look at 'em. Aren't they pretty? But, their real beauty is the way they'll turn your CB on! Because with a "Kriket®" external CB speaker, you can hear more clearly than you ever thought possible.

Who else makes a full line . . . to accommodate your every need? Isn't it about time somebody did?

Give one to a friend **you** care about.
Priced from \$14.95 to \$24.95.
Available at CB dealers everywhere!

Kriket Care

afs / **Kriket**® speakers

World Wide Headquarters
Acoustic Fiber Sound Systems, Inc.
7999 Knue Road, Suite 116
Indianapolis, Indiana 46250
(317) 842-0620

Exclusive Canadian Distributor
Persona Communications Ltd.
1149 Pioneer Road
Burlington, Ontario L7M 1N7
(416) 639-9070

All AFS®/KRIKET® speakers are manufactured in the U.S.A. using American materials and craftsmen.

DECEMBER 1976

Copyright 1976 Acoustic Fiber Sound Systems, Inc.

Imagine a microcomputer

Imagine a microcomputer with all the design savvy, ruggedness, and sophistication of the best minicomputers.

Imagine a microcomputer supported by dozens of interface, memory, and processor option boards. One that can be interfaced to an indefinite number of peripheral devices including dual floppy discs, CRT's, line printers, cassette recorders, video displays, paper tape readers, teleprinters, plotters, and custom devices.

Imagine a microcomputer supported by extensive software including Extended BASIC, Disk BASIC, DOS and a complete library of business, developmental, and industrial programs.

Imagine a microcomputer that will do everything a mini will do, only at a fraction of the cost.

You are imagining the Altair™ 8800b. The Altair 8800b is here today, and it may very well be the mainframe of the 70's.

The Altair 8800b is a second generation design of the most popular microcomputer in the field, the Altair 8800. Built around the 8800A microprocessor, the Altair 8800b is an open ended machine that is compatible with all Altair 8800 hardware and software. It can be configured to match most any system need.

MITS' plug-in compatible boards for the Altair 8800b now include: 4K static memory, 4K dynamic memory, 16K static memory, multi-port serial interface, multi-port parallel interface, audio cassette record interface, vectored interrupt, real time clock, PROM board, multiplexer, A/D convertor, extender card, disc controller, and line printer interface.

MITS' peripherals for the Altair 8800b include the Altair Floppy Disc, Altair Line Printer, teletypewriters, and the soon-to-be-announced Altair CRT terminal.

Introductory prices for the Altair 8800b are \$840 for a kit with complete assembly instructions, and \$1100 for an assembled unit. Complete documentation, membership into the Altair Users Club, subscription to "Computer Notes," access to the Altair Software Library, and a copy of Charles J. Sippl's Microcomputer Dictionary are included. BankAmericard or Master Charge accepted for mail order sales. Include \$8 for postage and handling.

Shouldn't you know more about the Altair 8800b? Send for our free Altair Information Package, or contact one of our many retail Altair Computer Centers.

mits 2450 ALAMO S.E. ALBUQUERQUE, NEW MEXICO 87106 (505) 243-7821

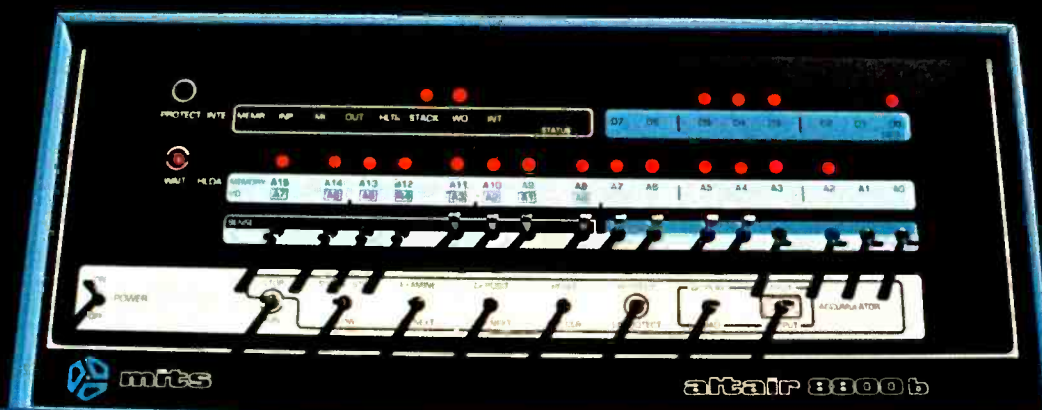

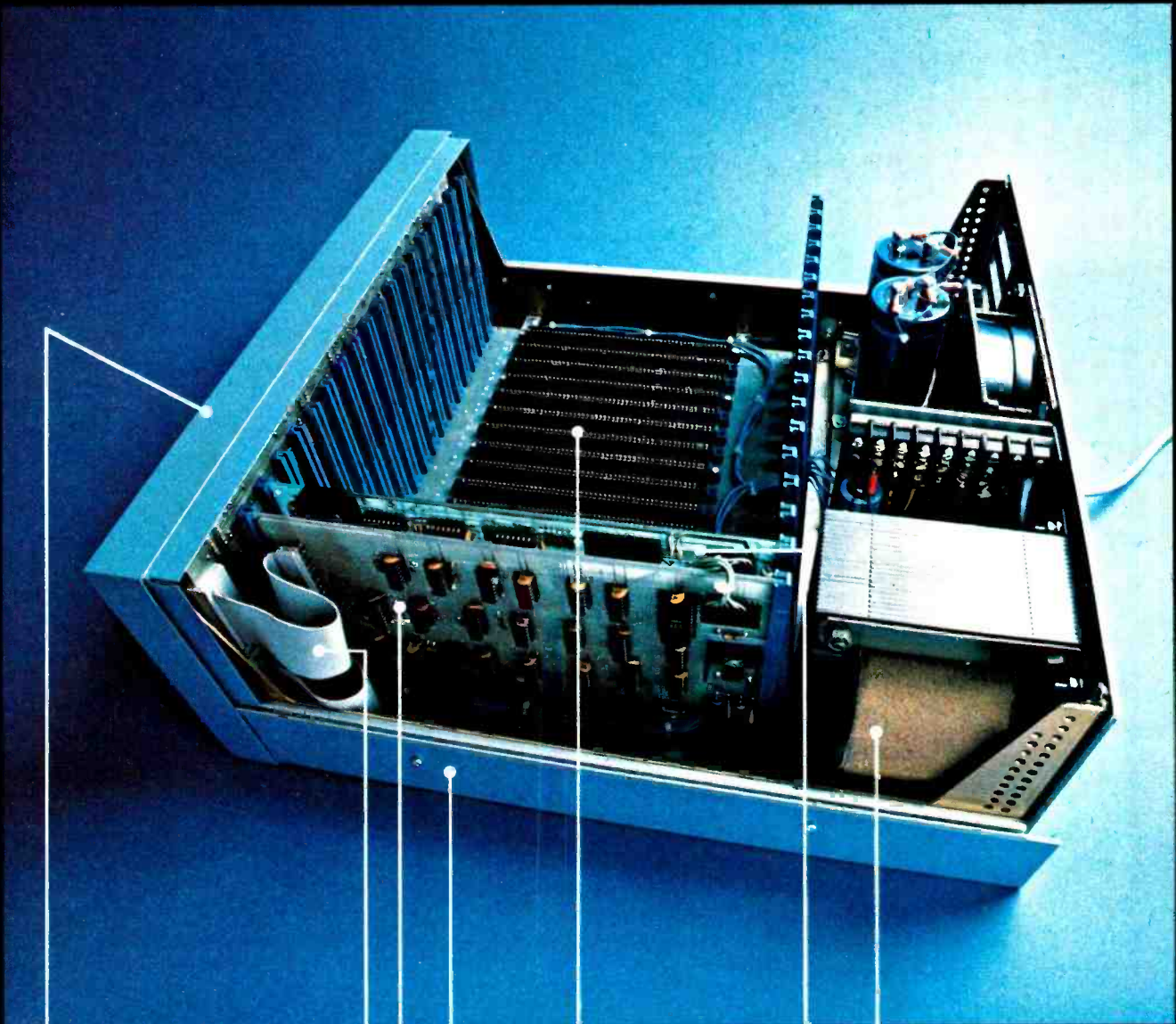

Redesigned front panel. Totally synchronous logic design. Same switch and LED arrangement as original Altair 8800. New back-lit Duralith (laminated plastic and mylar, bonded to aluminum) dress panel with multi-color graphics. New longer, flat toggle switches. Five new functions stored on front panel PROM including: DISPLAY ACCUMULATOR (displays contents of accumulator), LOAD ACCUMULATOR (loads contents of the 8 data switches (A7-A0) into accumulator), OUTPUT ACCUMULATOR (Outputs contents of accumulator to I/O device addressed by the upper 8 address switches), INPUT ACCUMULATOR (inputs to the accumulator from the I/O device), and SLOW (causes program execution at a rate of about 5 cycles per second—for program debugging).

Full 18 slot motherboard.

Rugged, commercial grade Optima cabinet.

New front panel interface board buffers all lines to and from 8800b bus.

Two, 34 conductor ribbon cable assemblies. Connects front panel board to front panel interface board. Eliminates need for complicated front panel/bus wiring.

New, heavy duty power supply: +8 volts at 18 amps, +18 volts at 2 amps, -18 volts at 2 amps. 110 volt or 220 volt operator (50/60 Hz). Primary tapped for either high or low line operation.

New CPU board with 8080A microprocessor and Intel 8224 clock generator and 8216 bus drivers. Clock pulse widths and phasing as well as frequency are crystal controlled. Compatible with all current Altair 8800 software and hardware.

altair 8800-b



2450 Alamo SE/Albuquerque, NM 87106/505-243-7827

Prices, delivery and specifications subject to change.

NOTE: Altair is a trademark of MITS, Inc.

CIRCLE NO. 49 ON FREE INFORMATION CARD

www.americanradiohistory.com

how often could you use an Xcelite® "99"?



it's every
tool you
need 99%
of the time...
an Xcelite original!

it's a screwdriver



...for slotted, Phillips, Frearson, Bristol, clutch head, Scrulox® screws; in inch and metric size Allen hex and Allen hex ballpoint socket types; and Pozidriv® style.

it's a nutdriver

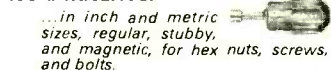

...in inch and metric sizes, regular, stubby, and magnetic, for hex nuts, screws, and bolts.

it's a reamer



it's extendable



...for greater reach and torque.

5 DIFFERENT HANDLE STYLES

...regular and Tee, with and without reversible ratchet; junior, and stubby; all with Xcelite's unique spring device for quick blade insertion and removal. All shockproof, breakproof (UL).

85 INTERCHANGEABLE BLADES

...all the popular types and sizes. All precision-made, genuine Xcelite quality. Fit all five handles.

IN SETS, KITS, OR PIECEMEAL

...roll-up service kits, compact, stand-up, plastic-cased sets; or individually as needed.



in stock at leading
electronic distributors... nationwide

Weller-Xcelite Electronics Division

The Cooper Group



P. O. BOX 728,
APEX, NORTH CAROLINA 27502

CIRCLE NO. 71 ON FREE INFORMATION CARD



Letters

1-MHZ COUNTER IC SOURCE

The 14583 Schmitt trigger IC used in the "Low-Cost 1-MHz Frequency Counter" (August 1976) is a Motorola part. It can be obtained from any large OEM dealer that distributes Motorola parts or for \$1.69 plus 25¢ postage from the following address.—Norman Huffnagle, 7511 Village Green Dr., Orlando, FL 32807.

DIGITAL SPEEDOMETER COMMENTS

In the article "Build a Digital Speedometer For Your Car" (September 1976), the opening states that the speedometer cable turns 1000 revolutions per mile travelled. If the speedometer cable is connected directly to the wheel, this means that the wheel must make 1000 revs per mile. The average radius of a wheel is about 13", which means that its circumference is 81.86". There are 63,360" in a mile (5280 × 12). If we divide 63,360" by 81.68", we obtain 775.7 revs per mile. To have 1000 revs per mile, the diameter of the tire would have to be 20".—Edward J. Picardi, Philadelphia, PA

The speedometer cable is not connected to the wheels. It goes to the transmission through a gearing system. Most cars use 1000 revs per mile, although this may differ from one make to another. We assumed 1000 revs per mile, but we also stated in the paragraph on adjustment that you can make the timing adjustment on a measured mile.

In reading the Speedometer article, I happened upon several design errors. First, IC2 through IC7 are TTL devices that operate only between 0° and 70°C, which means that during the winter months the speedometer will have to be warmed up before it will operate. Secondly, IC10 regulates the supply voltage between 4.70 and 5.30 volts, while the 7400 series IC's require voltage regulation between 4.75 and 5.25 volts.—Kevin J. Byer, Sr., Johnstown, PA

TTL devices do not freeze and will operate below 0°C. The barrier voltage increases somewhat with temperature reduction, but the IC's will operate where a human being can tolerate the temperature. The operating voltage range for TTL devices is from about 4.7 to 5.3 volts. The output of the 309 regulator can range from 4.8 to 5.2 volts, with a typical of 5.05 volts. Once the system is turned on, power dissipation inside the 7400 IC's will heat up the chips; hence, there will not be much of a "warm-up" time. Of course, if you prefer better lower temperature devices, you

can use the 5400 series IC's that operate down to -55°C.

In the Speedometer article, you mention two ways to make the final adjustment. However, I feel that I have a way that is easier and better. I connected a 4-digit tach to my car and then started the engine and got it up to the rpm I wanted for the mph I wanted to go. I then made my final adjustment, using the formulas $\text{rpm} = (\text{mph} \times \text{gr} \times 336) / \text{td}$ and $\text{mph} = (\text{rpm} \times \text{td}) / (\text{gr} \times 336)$, where gr is the gear ratio of the rear end and td is tire diameter.—Richard Perry, Everett, VA

We have not tried this one, but it looks like it should work.

AN ELFIN TYPO

I have been very impressed by your careful editing of the articles on building the COSMAC "Elf" (August and September 1976). I found only one typographical error: In Part 2, Fig. 1 shows a 4058 IC, whereas the text refers to a CD4508 and Fig. 2 shows 4508's, whereas the text refers to 4058's.—George E. Smith, Homell Heights, Onatrio, Canada

The correct number in both cases is CD4508.

HOME BREW CLARIFICATION

The article "Guide to Home Brew Phono Preamp Design" (September 1976) is helpful, but raises two questions. First, at the bottom of the first column on page 63, reference is made to R6, R10, and Rz in Fig. 5, which does not have resistors with these designations. Secondly, in the second column on page 63, it is stated that tone controls can easily be added to the Fig. 7 circuit. Where should the controls go and what component values should be used?—Carl Hartman, Newport Beach, CA

The 240-ohm, 100K, and 2.4K resistors in Fig. 5 refer to R6, R10, and Rz, respectively. The tone controls can be connected to the output (wipers of the volume controls). To prevent impedance problems, unity-gain op amp buffers can be used with passive RC networks. Or, active filters can be used.

"EXPERIMENTER'S CORNER"

I was just rereading parts of the June 1976 POPULAR ELECTRONICS and happened to glance at the Experimenter's Corner. The article on the TTL NAND gate is the most understandable I have read in PE.—U. Vandrei, Ontario, Canada

Out of Tune

In "Build the Ultimate Metronome" (July, p 57), R2 should go to pin 11 of IC2, not pin 10, and R8 should go to pin 11 of IC5, not pin 10.

In "Power-Failure Alarm" (June, p. 55), Q2 is shown as an npn transistor, whereas the 2N2621 is a pnp device. Any general-purpose npn transistor will work.

POPULAR ELECTRONICS

All SBE 23-channel CB units have a 40-channel future.

With all the talk about 40-channel CB units tomorrow, why should you buy SBE 23-channel units today?

Simple. We just give you the chance to buy today with tomorrow in mind.

Which is what the SBE FUTURE-40 CB UPDATE PROGRAM is all about. Here's how it works: We're including a special Future-40 Certificate with all SBE 23-channel units. It entitles the SBE buyer to update his 23-channel unit to 40 channels



A Future-40 CB Update Program Certificate comes packed in each of the following SBE units: Coronado II (SBE-40CB), Cortez (SBE-24CB), Formula "D" (SBE-26CB), Catalina III (SBE-29CB), Touch Cam (SBE-32CB), Brute (SBE-34CB), Trinidad (SBE-14CB), Trinidad II (SBE-30CB), Sidebander II (SBE-42CB), Sidebander IV (SBE-27CB), Console II (SBE-16CB), Console IV (SBE-28CB)

within 1977.

You send in the certificate, we'll set up the update of your unit to a full 40 channels. All, for a reasonable charge, depending on the model involved.

Simple as that.

All in all, the SBE Future-40 CB Update Program is aimed to hit those people who'd like to buy now, but are a bit confused about what's around the corner.

And thinking ahead, about what's around the corner, that's what SBE is all about.



Better Communications through Creative Technology

For information write: SBE, Inc., 220 Airport Blvd., Watsonville, CA 95076

INTERNATIONAL OFFICES: E. S. Gould Marketing Co. Ltd., Montreal, Canada/Linear Systems S.A. Geneva 1, Switzerland

Hewlett-Packard Calculators:

The HP-91 scientific portable printing calculator \$425.00*

The HP-91 is a completely portable scientific calculator with integrated printer. Now you can generate a permanent record of each calculation to document your work, in the office, or at a job site in the field.

- Lightweight briefcase portability. Operates on battery power or AC.
- Full range of scientific and arithmetic functions complete with printed record.
- Built-in, sophisticated, quiet thermal printer.
- Extra large, easy-to-read display.
- Four dozen built-in functions and data manipulation operations.
- Pre-programmed for science, mathematics and statistics.
- 16 addressable memories.

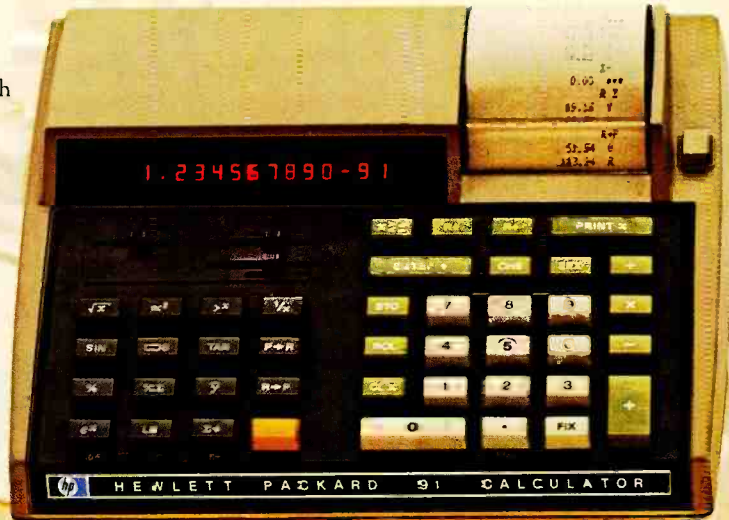

The HP-21 scientific \$80.00*

The HP-21 makes short work of technical calculations. If you seek a calculator that does more than simple arithmetic, this is it.

- 32 built-in functions and operations.
- Performs all standard log and trig functions (in radians or degrees).
- Performs rectangular/polar conversion, register arithmetic and more.
- Addressable memory.
- Two selectable display modes: fixed point and scientific.
- Lowest-priced HP scientific calculator.

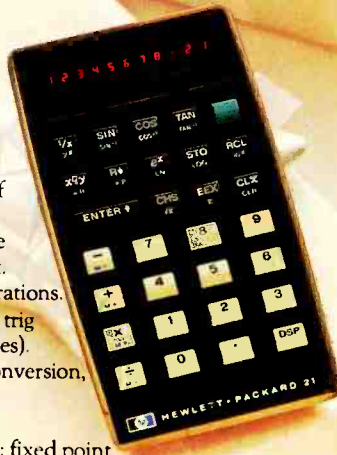

The HP-22 business management \$125.00*

The HP-22 easily handles the kinds of calculations most often faced in business management today. It can breeze through business math calculations and build existing statistical data into reliable forecasts. If you want a business management calculator, here it is.

- Combines financial, mathematical and statistical capabilities.
- Performs complex time-value-of-money including interest rates computations.
- Performs rates of return and discounted cash flows for investment analysis.
- Performs extended percent calculations, accumulated interest, amortization and more.
- 10 addressable memories.
- Full decimal display control.

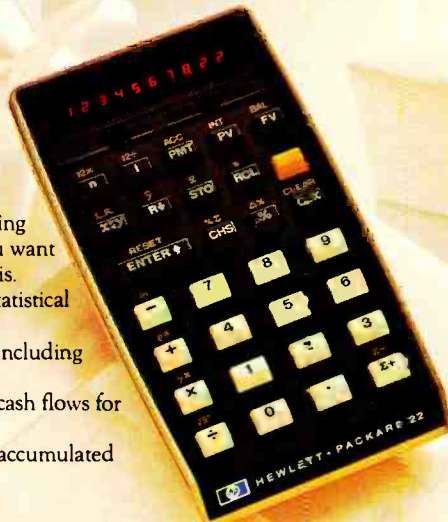

The HP-27 scientific/plus \$175.00*

The HP-27 is for the scientist, engineer or business person responsible for budgets, cost analysis, resource allocations and more.

It features a comprehensive set of statistical and financial functions for planning, forecasting and analysis. For the first time, they've been added to HP's complete set of scientific functions.

- 10 financial functions for investment analysis. NEW—internal rate of return and net present value for uneven cash flows.
- 15 statistical functions for planning and forecasting.
- NEW—normal distribution and correlation coefficients.
- 28 pre-programmed exponential, log and trig functions for scientific and engineering calculations.
- 20 memories with selective clearing options for greater flexibility, 10 of which are addressable memories.



The First Family.

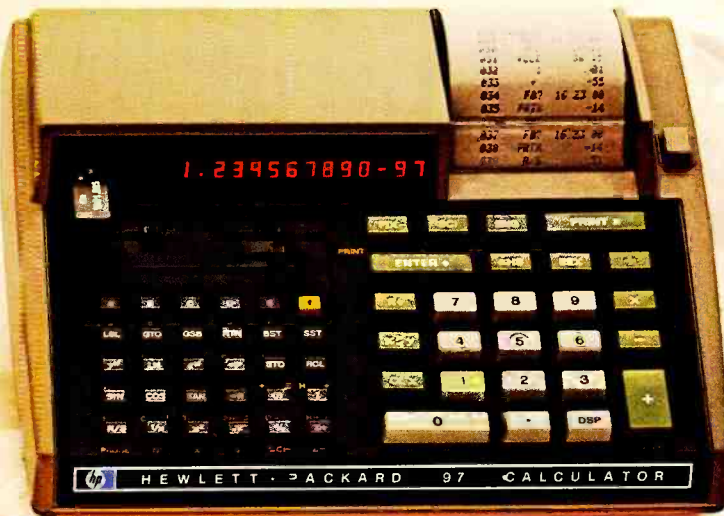

The HP-97 & the HP-67 powerful fully programmable calculators HP-97 \$750.00* HP-67 \$450.00*

The HP-97 and HP-67 are the most powerful fully programmable battery-operated portable scientific calculators you can buy. In fact, both offer about 3.4 times** the programming power of our classic HP-65—the industry standard. Programs written for either the HP-67 or HP-97 can be run on the other without modifications of any kind. The HP-97's thermal printer is also remarkable—and unusually quiet.

- Handles up to 224 steps.
- All prefix functions and operations are merged.
- Directly records programs or contents of all 26 data storage registers onto magnetic cards.
- 10 user-definable keys.
- 3 types of addressing—Label, Relative and Indirect.
- 3 printing modes—Manual, Normal and Trace. (HP-97 only)
- Standard Application Pac with 15 programs of broad appeal included free. Optional Pacs in engineering, finance and other disciplines available at \$35.00 each.

**Complete details on request.

The HP-25C scientific programmable with continuous memory \$200.00*

The HP-25C is our keystroke programmable. It can solve automatically the repetitive problems every scientist and engineer faces. What's more, its Continuous Memory capability lets you retain programs and data even when it's turned off.

- Continuous Memory capability.
- 72 built-in functions and operations.
- Keystroke programmability.
- Branching conditional test and full editing capability.
- 8 addressable memories.
- We also offer the HP-25 (without the Continuous Memory feature) for \$145.00*



The HP-80 financial \$295.00*

The HP-80 performs calculations involving the relationship between time and money: bond prices and yields, conversions, trend line analysis, interest calculations and more. A built-in 200-year calendar figures number of days in bond or loan calculations.

- Financial functions: simple interest, payment per period, number of periods, present and future values, sum-of-the-years-digits depreciation.
- Bond functions: prices and yields, 200-year calendar.
- Statistical functions: mean, standard deviation, trend line.
- Mathematical functions: percentages, x/y, serial or chain calculations.
- Addressable memory.
- Selectable display modes: fixed point and scientific notation.



For more information on any of these Hewlett-Packard calculators and the name of your nearest dealer, simply telephone toll-free 800-648-4511 (in Nev. 323-2404 collect). Or write: Hewlett-Packard, Dept 254 E, 1000 N.E. Circle Blvd., Corvallis, Ore. 97330. CIRCLE NO 36 ON FREE INFORMATION CARD

HEWLETT  PACKARD

Sales and service from 172 offices in 6 countries. Dept. 254 E, 1000 N.E. Circle Blvd., Corvallis, Oregon 97330.



New Products

Additional information on new products covered in this section is available from the manufacturers. Either circle the item's code number on the Reader Service Card inside the back cover or write to the manufacturer at the address given.

HY-GAIN REMOTE-CONTROL MOBILE CB

The Hy-Gain 9 (Model 2679) is a 23-channel AM, PLL-circuit unit with separate transceiver and microphone/control. The microphone in-



corporates digital channel readout, channel selector, and volume and squelch controls. It also acts as a loudspeaker. A coiled cable links the control unit to an underdash connector, from where a cable can be run to the remotely located transceiver. Sensitivity is said to be 0.7 μ V for 10-dB (S+N)/N, adjacent channel rejection at -40 dB, and full legal r-f power output. The transceiver incorporates automatic noise limiter circuitry.

CIRCLE NO. 88 ON FREE INFORMATION CARD

HITACHI RECEIVER

The SR-903 is Hitachi's top AM/FM stereo receiver, rated at 75 watts per channel with less than 0.3% THD. The class-G amplifier



circuit is said to increase efficiency by at least 50%, thus eliminating the need for large heat sinks and reducing the receiver's weight by

almost 40 percent. Frequency response of the FM section is 30 to 15,000 Hz \pm 1 dB, and the FM tuner has a 1.6-microvolt sensitivity, 80-dB selectivity. A protection circuit shuts off the speakers in case of an electrical malfunction and lights an LED. Other features include a 41-clickstop volume control, simultaneous tape-dubbing and monitoring capability, high and low filters, and afc that locks on to the station when the user lets go of the tuning knob. Measures 19 $\frac{1}{4}$ "W x 15 $\frac{3}{4}$ "D x 5 $\frac{5}{8}$ "H (48.9 x 40 x 12.9 cm). \$499.95.

CIRCLE NO. 89 ON FREE INFORMATION CARD

40-PIN IC TEST CLIP

Continental Specialties has released the fourth in its series of IC test clips, the PC-40. Patterned after the earlier models, the PC-40 is compatible with 0.6" center IC's up to 40 pins. This mini-troubleshooter offers a narrow throat for bringing IC leads up from high-density pc boards, thus minimizing accidental shorts while testing live circuits. It can also be used to inject signals and wire unused circuits into other boards. Scope probes and test leads lock onto gripping contact teeth, freeing hands for other work. Noncorrosive nickel/silver contacts provide simultaneous wiping action and low-resistance connections to IC leads. Overall plastic construction eliminates springs and pivots. \$13.75.

CIRCLE NO. 91 ON FREE INFORMATION CARD

AFS STEREO HUMP-MOUNT CONSOLE

The Kar Kriquet KK-1080 is a hump-mount console from Acoustic Fiber Sound Systems that mounts a stereo radio, or an 8-track or cassette system and has storage space for

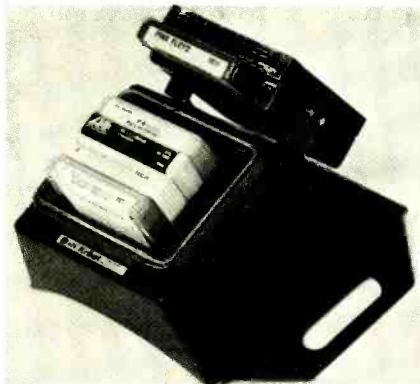

four cartridges or seven cassettes. The console requires no fastening devices, but rests on the driveshaft hump. Polymer "teeth" in the base prevent movement while driving. By unplugging the power, antenna and remote-speaker leads, the entire unit can be taken out and placed in the trunk. Size is 12"D x 8"W x 7"H (30.5 x 19.3 x 17.8 cm). \$9.95.

CIRCLE NO. 92 ON FREE INFORMATION CARD

CB SPEECH PROCESSOR

"Talk Power" is an add-on speech processor from Communications Power, said to provide a substantial increase in average speech talk

power for CB transceivers without spillover and with minimum distortion. This logarithmic speech compressor plugs into existing 4-conductor microphone receptacles, requires no other CB-set connections or alterations. The existing microphone is retained. A solderless internal patch panel permits easy microphone connections. The unit operates from vehicle battery or ac power line. Size is 4 $\frac{7}{8}$ "W x 3 $\frac{1}{4}$ "D x 2 $\frac{5}{8}$ "H (12.4 x 8.2 x 6.7 cm). \$69.95.

CIRCLE NO. 93 ON FREE INFORMATION CARD

PICKERING PHONO CARTRIDGE

"Stereohedron" is the name Pickering gives to the new stylus-tip shape featured in the XSV/3000 stereo cartridge. It is said to in-

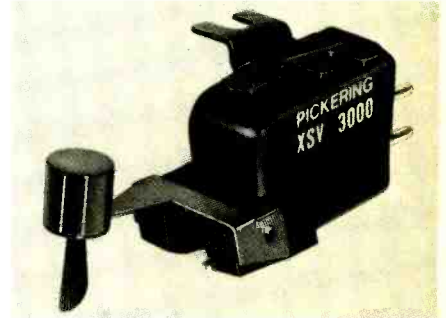

crease the area of contact with the groove wall, and to increase record life because force is spread over this greater contact area. Specifications are: frequency range of 10 to 30,000 Hz; channel separation, 35 dB (reference 1000 Hz), output, 5 mV; resultant tracking force, 1 gram $+\frac{1}{2}$, $-\frac{1}{4}$ (add 1 gram to setting with record-cleaning brush). \$99.95.

CIRCLE NO. 94 ON FREE INFORMATION CARD

PAIA POLYPHONIC KEYBOARD

The latest electronic music kit from PAIA is OZ, a polyphonic pitch source for use as a portable practice keyboard, mini-organ, or trigger/pitch source for a synthesizer. The



unit is battery-powered and has a built-in one-watt audio amplifier and speaker. A five-position range switch transposes the 1 $\frac{1}{2}$ -octave keyboard for over 6 $\frac{1}{2}$ octaves of total range. The switch-selectable step or multiple-pulse trigger allows a simple synthesizer interface, and a mixing input permits playing other instruments through the OZ amplifier. A tone control rolls off the normal square-wave

POPULAR ELECTRONICS

If you thought a rugged, professional yet affordable computer didn't exist,

think IMSAI 8080.

Sure there are other commercial, high-quality computers that can perform like the 8080. But their prices are 5 times as high. There is a rugged, reliable, industrial computer, with high commercial-type performance. The IMSAI 8080. Fully assembled, it's \$931. Unassembled, it's \$599. And ours is available now.

In our case, you can tell a computer by its cabinet. The IMSAI 8080 is made for commercial users. And it looks it. Inside and out! The cabinet is attractive, heavy-gauge aluminum. The heavy-duty lucite front panel has an extra 8 program controlled LED's. It plugs directly into the Mother Board without a wire harness. And rugged commercial grade paddle switches that are backed up by reliable debouncing circuits. But higher aesthetics on the outside is only the beginning. The guts of the IMSAI 8080 is where its true beauty lies.

The 8080 is optionally expandable to a substantial system with 22 card slots in a single printed circuit board. And the durable card cage is made of commercial-grade anodized aluminum.

The IMSAI 8080 power

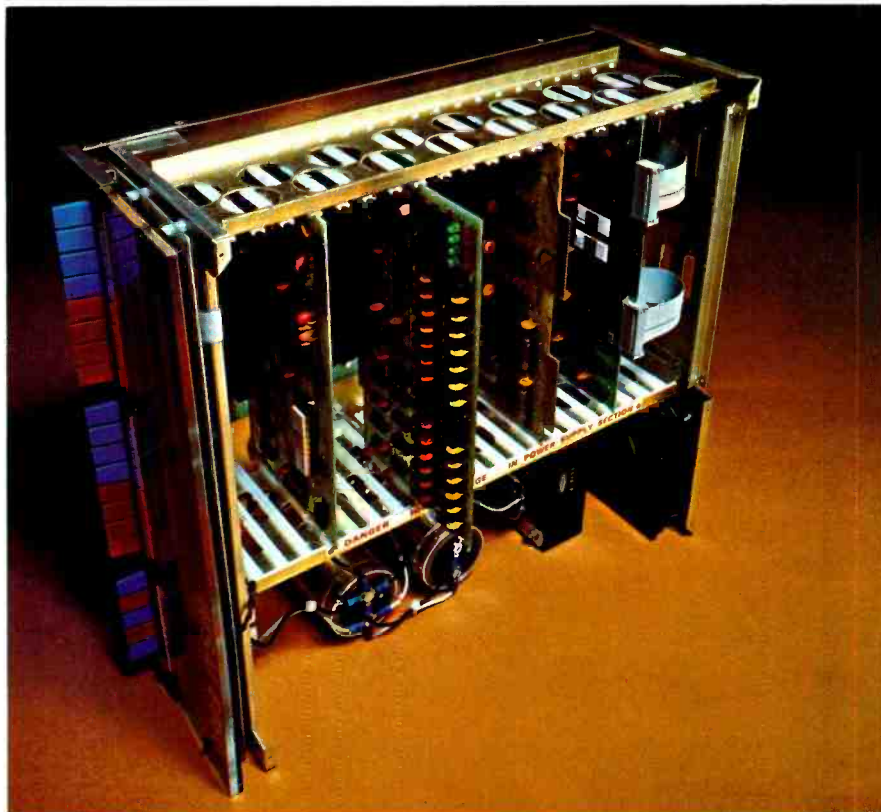

supply produces a true 28 amp current, enough to power a full system.

You can expand to a powerful system with 64K of memory, plus a floppy disk controller, with its own on-board 8080—and a DOS. A floppy disk drive, an audio tape cassette input device, a printer, plus a video terminal and a teleprinter. These peripherals will function with an 8-level priority interrupt system. IMSAI BASIC software is available in 4K, that you can get in PROM. And a new \$139 4K RAM board with software



memory protect. For the ultimate in flexibility, you can design the system for low-cost multiprocessor, shared memory capability.

Find out more about the computer you thought didn't exist. Get a complete illustrated brochure describing the IMSAI 8080, options, peripherals, software, prices and specifications. Send one dollar to cover handling.

Call us for the name of the IMSAI dealer nearest you.

Dealer inquiries invited.

IMSAI

IMS Associates, Inc.
14860 Wicks Boulevard
San Leandro, CA 94577
(415) 483-2093

PE-12

Another Heathkit Color TV breakthrough...

There's never been a Color TV System like this before.

A Bold New Concept In TV

The new GR-2001 TV system is the most sophisticated, best performing color TV kit we've ever designed, but it is also much more. It is the heart of a total home viewing system — a Computer TV!

Complete Programming Capability

With its optional Programmer, this Computer TV system allows you to program your set for an entire evening's viewing. The top bank of 8 keys [1] accesses the static NMOS RAM and turns the on-screen clock display into a computer CRT readout which allows you to see your "program" as you enter it through the bank of 12 keys below the programmer panel. The selected time appears in the first four digits of the clock display, the channel number appears in the last two. First, enter the time at which you want the set to change channels. Next, enter the channel number you want. Then the memory takes over. While you sit back and relax, the Programmer automatically changes to the right channel at the right time. You can program up to 32 channel changes within two 12/24-hour periods!

Those two programming periods add extra versatility. Program the first for your daytime viewing schedule, the second for evening shows. Or, program the first for week nights, the second for weekends. You can even preselect the programs young children can watch — once the programmer is engaged, the manual keyboard is disconnected and can only be reactivated by the remote control or by pressing the correct button on the programming panel.

You can even program the set to return to manual operation at a preselected time, then resume automatic operation at another time. When the last program you want to see is over, the set can be programmed to switch to an empty channel. This will cause the screen to go blank and the on-screen readout to flash on and off indicating that it is time to turn the system off with the front panel pushbutton or optional remote control.

Convenient Remote Control

The optional wireless remote control [2] lets you adjust volume, turn the set on or off, adjust tint, activate the digital readout, scan up or down through the preselected channels, and turn the optional programmer on and off — all at the touch of a button. This wireless remote control has improved circuitry for greater range and reliability and is the best we've ever offered.

Random Access Tuning

The 3 x 4 keyboard [3] lets you instantly choose any of up to 16 preselected stations — up to 24 with the optional eight channel accessory. Switch from VHF to UHF, up or down, in any sequence, and be tuned in instantly without switching through empty channels. Up and down

buttons on the keyboard also let you scan all the preselected stations.

Automatic Antenna Rotor Control

A Heathkit exclusive! With the optional antenna rotor control [4], you can program the GR-2001 to automatically rotate your outdoor antenna system as it changes from one channel to another, for optimum reception on every channel. No special knobs to turn, no buttons to push. You can select up to eight separate antenna headings with up to three stations per heading. It's perfect for areas where stations are in widely separated locations.

Superb Color and Sound

The TV set itself contains dozens of circuit refinements and improvements designed to give you the best picture and performance you've ever seen. The Automatic Gain Control circuit, for example, has been significantly improved to better resist airplane flutter. And since you build it yourself, you can be assured of a set that is free of mass production "glitches" that show up all too often in other sets now on the market. Other improvements are listed below.

Separate Audio IF Stage

The audio circuitry is probably the finest on any commercial set in the world. The sound signal has its own separate IF stage [5] to dramatically reduce the "buzz" caused by the picture carrier modulating the sound. You can hear the difference — especially if you use the output jack to connect the GR-2001 to your stereo system. The built-in wide-range speaker offers excellent fidelity as well. It's one of the first sets ever to give you real hi-fi sound from a TV!

Phase-Locked-Loop Horizontal and Vertical Hold Circuits

New phase-locked-loop horizontal and vertical oscillators [6] "lock-in" on any channel for a picture that's rock-steady and stable. There are no conventional vertical and horizontal hold controls because you never need them! There are no align-

ment problems either, so you get consistently excellent pictures year after year.

Black-Matrix Picture Tube

The GR-2001's 25" (diagonal) ultra-rectangular picture tube [7] assembles one of the brightest, sharpest pictures in the world. The tube is fully shielded to maintain outstanding color purity by eliminating stray magnetic fields.

Easy To Assemble

Though the GR-2001 is one of our more complex kits, the average person shouldn't have any difficulty in assembling it. A step-by-step illustrated manual will lead you through assembly right up to troubleshooting and testing. And if you do happen to need assistance, help is only a phone call away. A complete staff of Technical Consultants will answer all your questions. We won't let you down.

GR-2001 Specifications

Deflection: Magnetic 90°.

Focus: Electrostatic.

Convergence: Magnetic.

Antenna Input Impedance: VHF: 300Ω balanced or 75Ω unbalanced. UHF: 300Ω balanced.

Picture IF Carrier: 45.74 MHz.

Sound IF Carrier: 41.25 MHz.

Color IF Subcarrier: 42.17 MHz.

Sound IF Frequency: 4.5 MHz.

Video IF Bandwidth: 4.08 MHz at 6 dB down.

Hi-Fi Output: Frequency Response: ±1 dB, 50 Hz to 15 kHz.

Output Voltage: Greater than 1.0 V RMS.

Audio Output: 4Ω or 8Ω, 2 Watts.

Power Requirement: 110 to 130 Volts AC, 60 Hz, 200 Watts.

Kit Net Weight: 146 lbs.

GR-2001 TV kit alone (chassis, picture tube and one speaker): 699.95

Send for your FREE copy of our new catalog containing almost 400 fun and practical electronic kits.

Heath Company, Dept. 10-24
Benton Harbor, Michigan 49022

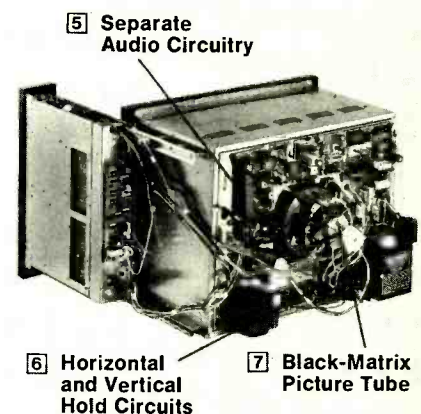
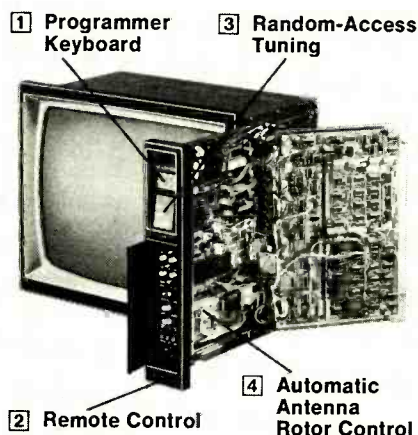

the world's only computerized TV system.



CIRCLE NO. 5 ON FREE INFORMATION CARD

www.americanradiohistory.com

Learn digital computer

NRI is the only school to train you at home on a real digital computer.

Learn computer design, construction, maintenance and programming techniques on your own programmable digital computer.

Qualified technicians are urgently needed for careers in the exciting new field of digital and computer electronics . . . and the best way to learn digital logic and operations is now available to you in NRI's Complete Computer Electronics Course.

This exclusive course trains you at home on your own digital computer! This is no beginner's "logic trainer", but a complete programmable digital computer that contains a memory and is fully automatic. You build it yourself and use it to define and flow-chart a program, code your program, store your program and data in the memory bank. Press the start button and the computer solves your problem and

displays the result instantly.

The NRI digital computer is one of 10 kits you receive in the NRI Complete Computer Electronics Course. You build and use your own TVOM, and experiment with NRI's exclusive Electronics Lab. You perform hundreds of experiments, building hundreds of circuits, learning organization, operation, trouble-shooting and programming.

New NRI Memory Expansion Kit

The Model 832 NRI Digital Computer now comes with a new Memory Expansion Kit. Installed and checked out in 45 minutes, it doubles the size of the computer's memory, significantly increasing the scope and depth of your knowledge of digital computers and programming. With the large-scale IC's you get the only home training in machine language programming . . . experience essential to trouble-shooting digital computers.



electronics at home.

NRI offers you five TV/Audio Servicing Courses

NRI can train you at home to service Color TV equipment and audio systems. You can choose from 5 courses, starting with a 48-lesson basic course, up to a Master Color TV/Audio Course, complete with designed-for-learning 25" diagonal solid state color TV and a 4-speaker SQ™ Quadraphonic Audio System. NRI gives you both TV and Audio servicing for hundreds of dollars less than the two courses as offered by another home study school.

All courses are available with low down payment and convenient monthly payments. All courses



provide professional tools and "Power-On" equipment along with NRI kits engineered for

training. With the Master Course, for instance, you build

your own 5" wide-band triggered sweep solid state oscilloscope, digital color TV pattern generator, CMOS digital frequency counter, and NRI electronics Discovery Lab.



*Trademark of CBS Inc.

NRI's Complete Communications Course includes your own 400-channel VHF transceiver

NRI's Complete Communications Course will train you at home for one of the thousands of service and maintenance jobs opening in CB; AM and FM transmission and reception; TV broadcasting; microwave, teletype, radar, mobile, aircraft, and marine electronics. The complete program includes 48 lessons, 9 special reference texts, and 10 training kits. Included are: your own "designed-for-learning" 400-channel VHF transceiver; electronics Discovery Lab™; CMOS digital frequency counter; and more. You also get your all



important FCC Radio-telephone License, or you get your money back.



CB Specialist Course also available



NRI also offers a 37-lesson course in CB Servicing with your own CB Transceiver, AC power supply, and multimeter. Also included are 8 reference texts and 14 coaching units to make it easy to get your Commercial Radiotelephone FCC License

You pay less for NRI training and you get more for your money.

NRI employs no salesmen, pays no commissions. We pass the savings on to you in reduced tuitions and extras in the way of professional equipment, testing instruments, etc. You can pay more, but you can't get better training.

More than one million students have enrolled with NRI in 62 years.

Mail the insert card and discover for yourself why NRI is the recognized leader in home training. Do it today and get started on that new career. No salesman will call.

If card is missing write:

NRI NRI SCHOOLS
McGraw-Hill Continuing
Education Center
3939 Wisconsin Avenue
Washington, D.C. 20016

output to produce a more flute-like sound. Six LED's indicate range setting and trigger output. The pressure-sensitive pitch-blender uses body capacitance to chromatically transpose single notes or whole chords by up to an octave for vibrato, glissando and trilling effects. Size is 13"D x 11"W x 4"H (33 x 27.9 x 10.2 cm). \$84.95.

CIRCLE NO. 95 ON FREE INFORMATION CARD

OSI MAINFRAME COMPUTER

Ohio Scientific Instruments' completely assembled mainframe computer, the OSI Challenger, is designed to accept a number of op-

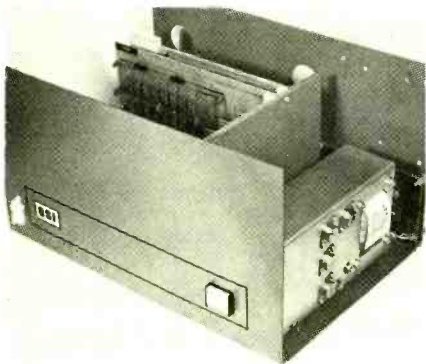

tions. However, the minimum configuration comes with a serial interface, 1024 words of RAM, and a 256-word monitor PROM, all of which make the machine immediately usable.

Housed in a heavy-duty chassis, the computer has a UL-approved power supply with full over-voltage and over-current protection. All major IC's are socketed. The backplane board accepts eight OSI 400 system boards for expansion purposes. Measures 17"W x 10"H x 12"D. \$599.

CIRCLE NO. 96 ON FREE INFORMATION CARD

McCLELLAN FREQUENCY COUNTER

The pocket-sized 302 frequency counter from the Gary McClellan Company has a frequency range of 3 Hz to 20 MHz, better than 30 mV sensitivity at 23 MHz, and $\pm 0.005\%$ accuracy. Three frequency-measurement ranges and a four-digit LED display combine to provide up to seven digits of display. The 302 is powered by a standard NiCd battery pack; the unit comes with a charger. \$120.00. Address: Gary McClellan Co., P.O. Box 2085, 1001 West Imperial Highway, LaHabra, CA 90631.

SONY ELCASET TAPE DECK

The EL-5 is Sony's front-loading tape deck featuring the new Elcaset system that uses a cassette shell larger than the Philips-type cassette, with 1/4-inch tape travelling at 3 3/4 ips. During automatic threading, the tape is pulled out of the cassette for transport. The EL-5 has two ferrite-and-ferrite heads, Dolby noise-reduction system, and a dc servo-con-

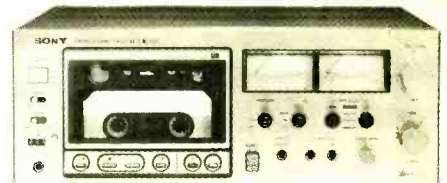

trolled motor. Feather-touch operation is provided by a solenoid-operated logic-controlled system that permits changing from one mode to another without depressing the stop button. Separate EQ and bias switches accommodate three types of tape. Other features include a memory rewind tape counter, line/mic mixing, large VU meters, and MPX filter switch. Under \$700.

CIRCLE NO. 98 ON FREE INFORMATION CARD

EPICURE PREAMPLIFIER

The Epicure Four stereo preamplifier is rated at less than 0.005% THD and -85 dB S/N for the phono section ("C" weighted) and -100



ok wire-wrapping center

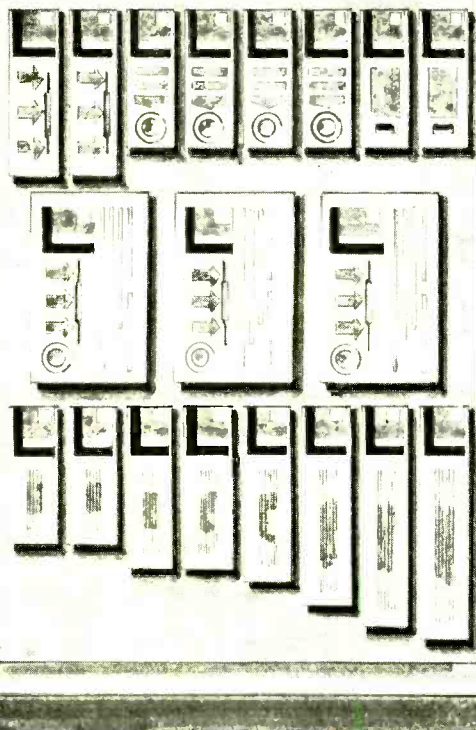

ok

wire wrapping center

your one stop shopping for quality electronic parts and tools.

50ft. wire roll



dip socket

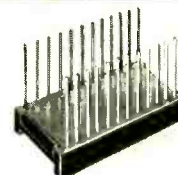

Hobby-wrap tool

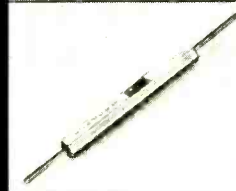

pre-stripped wire

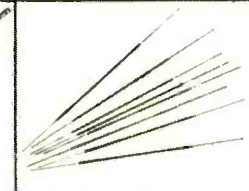

OK MACHINE & TOOL CORPORATION

3455 Conner St., Bronx, N.Y. 10475 / (212) 994-6600 / Telex 125091

Do-it-yourself JBL.



Take the guts of what makes JBL JBL and adapt it to your own ideas of what a loudspeaker system should be.

Mix and match with forty-seven individual JBL components—horns, lenses, dividing networks, transducers, everything.

And when you've found your perfect sound, we'll help you find somewhere to put it: The JBL Enclosure Construction Kit, with complete plans for building your own loudspeaker enclosure from scratch.

See your authorized JBL Loudspeaker Components dealer for the start of a great new team in sound: You and JBL.

Gentlemen

Send me your loudspeaker components catalogue and the name and address of my nearest dealer

Name _____

Address _____

City _____

State _____ Zip _____

Mail to: James B. Lansing Sound, Inc.
8500 Balboa Blvd., Northridge, Ca. 91329

PE-12

The JBL logo, consisting of the letters "JBL" in a bold, white, sans-serif font, centered within a solid black square.

**Can another
portable DMM
measure up to
our popular
280?**



B&K-PRECISION
MODEL 280
\$99.95

**You be
the judge!**

?? 280

- Completely portable—uses ordinary C cells or rechargeables.
- Measures AC/DC voltage, AC/DC current and resistance.
- High accuracy. DC accuracy is $\pm 0.5\%$ on all but the highest range ($\pm 1\%$). Ohms accuracy is 1% on most ranges.
- Full measurement capability, including current measurement to 1 amp.
- 1mV, 1 μ A, 0.1 Ω resolution.
- High/Low-power ohms measurements.
- Large, bright LED display.
- Auto-polarity and decimal point.
- 10-megohm input impedance.
- 0° to +50° C operating range.
- Measures only 6.4 x 4.4 x 2". Under 2 lbs. with batteries.
- Full line of accessories including, AC adapter/battery charger, tilt stand and carrying case.

Compare our features, accuracy and price and you'll see why thousands of buyers have selected the B&K-PRECISION 280.

Now in stock at your local distributor.

B&K PRECISION
PRODUCTS OF DYNASCAN
6460 West Cortland Avenue
Chicago, Illinois 60635 • 312/889-9087
In Canada: Atlas Electronics, Toronto

dB ("A" weighted). Frequency response is said to be 20 to 20,000 Hz ± 0.25 dB, high level. Features two pairs of inputs for phono, two pairs for tape, one pair each for tuner and aux. Outputs are for two tape recorders and two power amps. Controls are slide-type or pushbutton. Other features include selectable inflection tone controls, front panel dubbing and monitoring facilities, six ac power outlets, muting relay with 10-second delay at turn-on, steep-cutoff high and low filters, and three regulated dc power supplies. Rated output is 2.5 Vrms. Measures 18 1/4"W x 9 1/2"D x 5 1/2"H (46.4 x 24.1 x 14 cm). Comes with rack mount or walnut panel ends. \$449.

CIRCLE NO. 99 ON FREE INFORMATION CARD

PIONEER DIRECT-DRIVE TURNTABLE

Pioneer's new high-end turntable, the PL-530, is a dual-motor automatic direct-drive model. The platter is driven by a brush-



less dc servomotor, and the second motor is used for fully automatic lead-in and return. A double-float mounting system is said to be unique and to absorb all external vibrations, including feedback. Wow and flutter is rated at 0.3% Wrms, and S/N at 70 dB (DIN B). Other features include an S-shaped pipe tonearm, viscous-damped cueing device, strobe pattern on platter rim, and speed adjustment of $\pm 2\%$. Measures 18 29/32"W x 15 11/32"D x 6 11/16"H (48 x 39 x 17 cm). \$250.

CIRCLE NO. 100 ON FREE INFORMATION CARD

DYMEK ALL-WAVE OMNI ANTENNA

McKay Dymek's new DA 100 all-wave, omnidirectional antenna is designed to replace traditional outside long-wire antennas for improved reception in the 50-kHz-30-MHz bands. Consisting of a 4-ft collapsible whip attached to a small weatherproof box, the unit contains a broadband untuned preamp. Output impedance is 50 ohms and is compatible with any multi-band communications receiver that will accept an external antenna. The whip-amplifier section is mounted on a pole or pipe, window frame, ledge, or any high place. The control module, which operates from the standard power line, can be placed in any convenient indoor location. The control module measures 9"W x 5"H x 9"D. Power requirements are 110 or 220 V ac (switch selectable), 50-60 Hz. \$125.

CIRCLE NO. 101 ON FREE INFORMATION CARD



New Literature

PHONO CARTRIDGE DATA

A colorful six-page brochure which describes the company's "transversal suspension system" has been issued by AKG Acoustics on five models of its "Phonocartridges." Using cutaway diagrams and line drawings, the brochure discusses the new system and provides specifications on the five models in the new line. Address: AKG Acoustics, 91 McKee Drive, Mahwah, NJ 07430.

ELECTRONIC CIRCUIT-DESIGN AIDS

A 26-page catalog of electronic circuit-design aids from sockets and breadboards to complete educational systems is available from E&L Instruments. The catalog includes more than 180 products for builders of electronic circuitry. Described in the catalog are systems for teaching and experimenting with op amps, IC logic, and microprocessors. Other products covered are solderless breadboarding sockets, tools, component kits, and a selection of practical and instruction manuals. Address: E&L Instruments, Inc., 61 First St., Derby, CN 06418.

IEEE STANDARDS CATALOG

The new 32-page catalog of IEEE Standards lists over 350 standards publications in numerical sequence and also provides a subject index to the standards. Many American National Standards published by the IEEE are also included. Standards developed within the IEEE cover test methods, practices for electrical installations, units, definitions, graphic symbols, and application methods. The catalog lists important new and newly revised publications on graphic symbols, metric practice, and instrument interfaces. Address: IEEE Standards Office, 345 E. 47th St., New York, NY 10017.

DATA CONVERSION COMPONENTS

A 288-page 1976-77 Engineering Product Handbook from Datel Systems contains information on A/D and D/A converters, sample-and-holds, analog multiplexers, operational amplifiers, power supplies, dc-dc converters, digital panel meters, digital panel printers, digital panel instruments, and various data systems. The data conversion components are featured in three different technologies: monolithic, hybrid, and modular. Address: Datel Systems, Inc., 1020 Turnpike St., Canton, MA 02021.

DECEMBER CB SALE HUGE SAVINGS



THE REALISTIC *One-Hander* ^{T.M.}

SAVE 50⁰⁰

REG. 149⁹⁵ NOW ONLY 99⁹⁵*

Everything's in ONE Hand!

- Volume/On-Off
- Variable squelch
- LED channel selector/pilot light
- Speaker/Mike



Rugged handset with pushbutton mike, speaker, channel selector, on-off, volume and squelch

Red LED in handset glows when set is "On" and lights the channel number

Coiled cord on handset extends to 5' — lets you mount rest of transceiver out of sight

SAVE 70⁰⁰
REG. 229⁹⁵
159⁹⁵*



SUPERB TRC-55 BASE/MOBILE

The **One-Hander** is a natural for mobile CB — and Radio Shack invented it. Ride along with all the safety and companionship CB offers — without ever having to fumble around to make adjustments. (The 1½x5¼x7" remote section tucks away under dash, seat or in glovebox for theft protection.) With all crystals for 23-channel coverage. Built-in blander and ANL chop out ignition-type noise. Ceramic filter cuts station interference. Jack for optional-extra speaker. Adjustable mounting bracket and power cable for any 12VDC pos./neg. gnd. vehicle included. Buy during December — save enough to pay for your (Archer®) antenna!

The **TRC-55** base/mobile unit is packed with convenience and performance features. Whether you use it for personal 2-way communications or for business, you'll appreciate the all-pro design. Crystals for all 23 channels. SWR and S/R meters. Delta fine-tuning for bringing in off-frequency stations. Adjustable RF gain and an IF filter optimize both weak and strong signals. Digital timer/alarm clock turns on the rig at any preset time. Add an external speaker and it's a public address system, too. On-the-air and modulation lights. With plug-in mike, mobile mounting bracket, AC and DC power cords.



FREE NEW 1977 CATALOG

- Exciting New 56th Anniversary Edition
- Over 2000 Exclusive Products
- Full Color • 164 Pages

AT OUR 4200 USA STORES AND DEALERS

EVERYTHING IN QUALITY CB SINCE 1960

Radio Shack®

A TANDY COMPANY • FORT WORTH, TEXAS 76107
5000 LOCATIONS IN NINE COUNTRIES

*Retail price may vary at individual stores and dealers.



Stereo Scene

By Ralph Hodges

EVALUATING FOUR-CHANNEL

I HAVE JUST spent the better part of a weekend listening to and evaluating four-channel records. Certainly it's not difficult to derive considerable satisfaction from many of these discs as musical diversions. But when you're called upon to figure out exactly what's going on, spatially and directionally, then diversion turns into work. And when faced with an ambiguity in the sonic positioning of some voice or instrument, it's hard to know whether to blame the recording, the medium, the listening room, or your own ears.

I have a sneaking suspicion that getting the most out of four-channel sound, as the commercial record companies are presenting it to us, will turn out to involve a gradual learning process. I know that, over the years, I've gotten better at ferreting out the producer's intent in the "surround sound" type of recording, and I don't think superior decoders and recording techniques are entirely responsible.

For example, during my first months of quadraphonic listening I could play a surround-sound record three or four times before realizing that the acoustic guitar on band 3 was coming—or was supposed to be coming—from the right rear. With more practice, I began to find that I could make such distinctions almost instantly in many cases. In short, I had apparently developed a sensitivity to certain aural "cues," and perhaps even a certain ability to anticipate the producer's hand on the pan pot. This was certainly a far cry from my first encounters with four-channel, when I often found myself standing in the middle of a room, listening to a discrete "ambiance-type" quadraphonic tape of a symphony orchestra, and wondering which direction was front.

Matrix Anyone? Of course, it is this sort of ambiguity for which early matrix systems have been notorious, even though many discrete recordings have not been entirely free of it either. Indeed,

it is easy to bad-mouth the matrix approach; a little too easy in my opinion. If a simple Dynaquad hookup can do so much to enhance the experience of recorded music, then a still-more-elaborate matrix must be good for something, right?

Well, during this past weekend I finally got around to assembling the equipment, acquiring the records, and doing the listening necessary to make or break the case for matrix in my own mind.

The Equipment. This project was precipitated by the almost simultaneous arrival of several key ingredients: CBS SQ and Sansui QS-encoded versions of Michael Oldfield's recording *Ommadawn*, the only strictly commercial release I know of that is available in these two systems; a freshly checked-out Sansui QSD-1 QS decoder; and a brand-new SQL-200 SQ decoder from CBS Technology Center.

Both of these decoders are logic-assisted in their own proprietary ways. The Sansui is the most elaborate of the Vario-Matrix decoders, functioning in three separate frequency bands in an effort to provide maximum aural separation. The CBS product combines the gain-riding "corner" logic with the recently developed variable-blend technique to enhance front-to-back separation.

With a left-front input, the frequency response of the Sansui measured up almost 2 dB in the mid-bass region, down

about ½ dB in the upper mid-range, and down at least as much above 14 kHz or so. The CBS device was admirably flat at low frequencies but rose almost a dB in the upper mid-range, descending to about -2 dB above about 9 kHz. These measurements were made with the CBS STR 130 test record by comparing a straight-through signal with the response plots obtained when each of the decoders was inserted into the chain. And they were made after the completion of listening to avoid prejudicing subjective reactions.

Ommadawn. This recording, which served as the standard for comparison of the two systems, was a reasonably happy choice in one respect and a poor one in another. Mr. Oldfield's work is nothing if not repetitious, and this permitted the same musical material to be judged at length without constantly backtracking on the record. This was good. What was not so good was that the two records—SQ and QS—were not equivalent in quality. The QS version, apparently cut and pressed in England, tended to be noisy and distinctly "unclean" sounding (for lack of a better term to describe various distortions). The SQ disc, a domestic product, was head and shoulders above this mediocre level (good on you, Columbia, for once!), and the difference had to be allowed for in the comparisons.

Nor was this the only difference. Once I got going, with levels matched and channels frequency-equalized with the appropriate test records, it became clear that I could have easily been dealing with two separate mixes of the original master tape. The SQ disc, on first hearing, exhibited much more evidence of intense rear-channel activity than the QS, which seemed to sneak an instrument behind you only occasionally.

In this respect, the SQ rendition was more impressive and satisfying. But trouble occurred in subsequent playings when I tried to determine precisely what was happening, and where, in the SQ



CBS SQL-200 Decoder.

You're going to spend \$300 for a receiver? And you never heard of PPR?

Stereo Receivers	Sugg. Ret.† Price	Min. RMS Power Per Channel into 8 Ohms	Total Harmonic Distortion at Rated Power (Max.)	FM Sensitivity IHF '58	Stereo -50dB*
SA-5760	\$799.95	165 watts from 20Hz-20kHz	0.08%	1.8μV	35.7dBf
SA-5560	499.95	85 watts from 20Hz-20kHz	0.1	1.8μV	36.2dBf
SA-5460	399.95	65 watts from 20Hz-20kHz	0.1	1.8μV	36.2dBf
SA-5360	299.95	38 watts from 20Hz-20kHz	0.3	1.9μV	37.2dBf
SA-5160	229.95	25 watts from 30Hz-20kHz	0.5	1.9μV	37.2dBf
SA-5060	169.95	12 watts from 40Hz-20kHz	0.9	2.0μV	38.2dBf

†Technics recommended price, but actual retail price will be set by dealers.

*New IHF '75 standard

PPR is price performance relationship. And we feel it's a meaningful way of judging a receiver because it can tell you how much power, technology and performance you're getting for your money.

And when you look at our price performance relationship it's easy to see why your next receiver should be a Technics.

Of course, we want you to listen to our receivers. Especially since all six have the reserve power to float through complex musical passages with a minimum of distortion and clipping. And they all have rugged transformers. Bridged rectifiers. As well as high-capacitance filtering.

Play a record. You'll hear it the way it was recorded. Quietly and with greater dynamic range. Because we use an overload-resistant 3-stage IC in the phono equalizer sections.

Tune in an FM station. Even a weak one. In addition to hearing all the music, you'll also get increased stereo separation. Negligible distortion. And a minimum of noise. Thanks to flat group delay filters and Phase Locked Loop IC's in the tuner sections.

So if you'd like to know a simple way to discover just some of the reasons why a Technics receiver is so good... it's as easy as PPR.

All cabinetry simulated wood.

Technics

by Panasonic

CIRCLE NO. 66 ON FREE INFORMATION CARD



rear channels. Within the thick textures of Oldfield's orchestration it was next to impossible. The sound certainly surrounded one in a flattering wash of aural color; and, in the few spots where instrumentation became simple, the localization was reasonably good. However, as a whole the impression was one of vague zones of sonic identities. Frequently they seemed to shift, but I could never be sure just where.

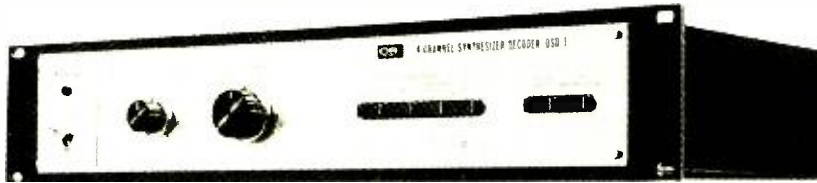

Sansui QSD-1 Synthesizer Decoder.

By contrast, in the QS rendition the localization of sound sources was relatively precise, and most of it frontal. Now and again an instrument would pop up in the rear, and usually it would stay put. What the QS cut lacked was the "spacey" impression of the SQ rendering, which was genuinely dramatic although imprecise and undefinable. (The recording also lacked adequate treble, which was a severe handicap in the comparison.)

Logic, etc. As mentioned before, the records seemed like products of two different mixes, and quite possibly they are. But if we can legitimately make the assumption that both were intended to be faithful to some prior "authoritative" mix, and if we then ask which of the two is the more faithful, I think the edge has to go to QS. It was able to exhibit the stability of localization that, in general, enabled you to confirm where instruments were, and one would expect that to have been a goal of the engineer who created the four-channel mix. On the other hand, every time I tried to focus in on the specifics of SQ's quadraphonic image I became more confused rather than less, despite the enjoyment I derived from the spacious-seeming SQ "wash" of sound.

Both manufacturers are wont to give highly impressive separation figures for their logic-assisted decoders (ranging from 20 dB to infinity), but these don't reflect the changing conditions encountered in music. Ultimately, when all four channels get equally busy, any logic manipulation has to be turned off within the decoder, and the system reverts to the separation figures of the basic matrix (3 dB between adjacent channels). But

what happens as the condition of equal busy-ness is approached? My guess is that the SQ "corner" logic is turned off first, because any attempt to keep its gain-riding action going will result in a loss of signal. The variable-blend should be able to go on working forever, if you're willing to accept the loss of left-right separation it imposes.

The QS Vario-Matrix system would seem to have an advantage in being

able to keep its logic going almost up to the bitter end. Its action involves no signal losses, and the logic circuits can be designed to function speedily and drastically with no obvious distortions of the aural image. As far as I can tell, neither of these systems shines with material like the steady-state drone of *Ommadawn*, but the QS decoder holds on to its localization deeper into the stew of sound than the SQ unit, and the principle of its logic operation is as good an explanation for this as any.

Other Recordings. On the better ambient-type four-channel recordings, I can find virtually no fault with either of the matrix systems. Evidently, one of the fronts on which real progress has been made in recent years is the miking and mixing of credible ambiance and reverberation. Even the highly touted new Columbia recording of *Carmina Burana* with Michael Tilson Thomas and the Cleveland Orchestra, nominally a surround-sound or at least wrap-around-sound production, has its (rather short-lived) moments in which the evocation of large spaces is powerful. On the Vox label, engineers Joanna Nickrenz and Marc Aubort have captured some remarkably rich and spacious sounding reverberation in QS-encoded form. A particular standout is Ravel's orchestral works with the Minnesota Orchestra, although the disc processing does not always do full justice to the inherent merits of the recordings.

Every once in a while, someone arises to deplore the fact that current four-channel schemes have no specific provision for a height dimension; these remarks are often accompanied by a proposal for ceiling speakers, or at least

units that are placed higher up the walls than is customary. Nevertheless, if memory serves, it was James Cunningham, an eminent name in audio for many years, who first suggested that conventional four-channel techniques can produce a feeling of height, and then proceeded to prove it with several demonstrations. He has proved it again on a record produced with his assistance on Dick Schory's Ovation label. The disc serves as a four-channel (QS) demonstration vehicle and sampler for the Ovation catalog. In my opinion, the best moments come in the demo section. It includes an all-too-brief excerpt from a fabulous thunderstorm, a rousing fireworks bombardment, and a few aptly designed synthesizer effects.

The Cunningham/Schory thesis is that a mono signal from all four speakers will produce an apparent sound source somewhere over a centrally located listener's head. The technique seems to work fine. At one point there is an electronic hailstorm of sound that appears to rise up from the front speakers, pass over the listener's head at a point somewhere about ceiling level, and dive back down into the rear speakers. Then there is a brief sea-scape excerpt, where I hear the cries of a gull hovering on a thermal about 15 or 20 feet above the surf. I may be kidding myself in some way, but I swear that's where the bird is to my ears, with very little ambiguity.

I hope this means that four-channel is making some progress. I confess to being a fan of the medium—or its potential, at least—and I certainly don't want to be the *last* on my block with four speakers in his listening room. ◇

COMING UP IN
THE JANUARY

Popular Electronics®

**Morse-to-Alphanumeric
Code Converter Project**

**Build a Low-Distortion
Audio Generator**

Meters for Electronics

Test Reports:

**JVC AM/FM Stereo Receiver
Sansui AM/FM Stereo Tuner
Kenwood Audio Amplifier**

Yamaha headphones take the headache out of holiday shopping.

Every year it's the same old story. You move heaven and earth trying to find a gift that's both personal and practical. After all, you never were one to buy just any new thing and call it a gift. It's got to be right. No matter how long it takes to find it.

So this year, give Yamaha HP-2 Orthodynamic headphones. They're headache-proof. For both the gift-giver and the gift-getter. There are just two criteria. You must like someone. And that someone must like music. Simple as that. Just buy them and wrap 'em.

Holiday cheer for the ear. Yamaha's Orthodynamic design offers the crisp highs of the best electrostatic headphones, and the rich, clean bass of the best dynamic types. So all the music comes through.

What's more, the HP-2's superb tonality, wide frequency response and low distortion are comparable to those of headphones costing much more than our suggested retail price of \$45. (In other words, your gift sounds more like a million dollars than a few dollars.) And there's comfort to match. Yamaha consulted world-famous designer

Mario Bellini to help us make these headphones the most comfortable ever worn. A soft strap distributes the HP-2's featherlight 8 ounces evenly over your head. The ear cups, with supple foam pads, are specially designed to ride lightly on your ears. Instead of flattening them out. And of course, height and angle are completely adjustable.

In short, the HP-2s add the convenience of personal listening to the enjoyment of any stereo system. They're compatible with anything that's got a headphone jack. And make most anything sound better, too.

A gift that sits on the head instead of the shelf. And, unlike some things you might give, Yamaha headphones won't wind up gathering dust in the corner. They'll be enjoyed. And used.

Chances are, they'll spend part of each day on someone's head. And you'll spend part of each day on someone's mind.

(Or, if you give to yourself, you'll experience the best of both worlds this holiday season. And, why not? You don't deserve any headaches either.)

Yamaha HP-2 Orthodynamic headphones.

Only at your Yamaha Audio Specialty Dealer. Where you'll find lots of terrific ways to say "Happy Holidays."





By John McVeigh

WIDEBAND NOISE GENERATOR

Q. I've heard that a "white" noise generator is very useful in checking out shortwave receivers. I'd like to experiment with one, but don't have a circuit. Do you?

—Stu Goldberg, Cambridge, MA

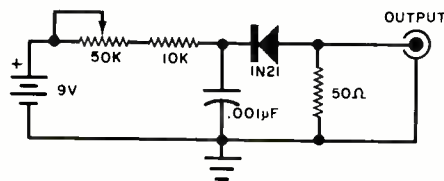

A. The circuit shown will produce wide-band r-f noise. It uses a reverse-biased diode and has a low-impedance output. You can use it to align the receiver for optimum performance.

LINE VOLTAGE MONITOR

Q. I'm not sure, but I think that the line voltage of the commercial power mains in my area varies a great deal. Do you have a simple circuit for monitoring the line? I have used my VOM to do this, but I'd like to leave something in the line continuously.

—Phil Poyner, Corpus Christi, TX

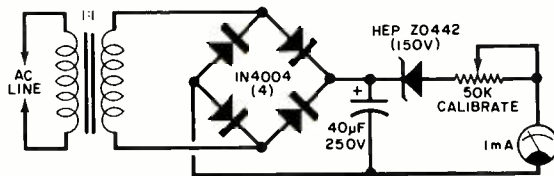

A. This circuit can be left in the line as a continuous monitor. It will give reliable indications over a limited range up to about 125 volts. Use an accurate ac voltmeter to calibrate the unit. An isolation transformer is included for safety reasons. However, the circuit does not draw much current, and a low-wattage transformer can be used.

RADIO SPECTRUM ALLOCATIONS

Q. Do you know where I can find detailed information on radio frequency allocations for the various services? I realize there will be revisions at the outcome of WARC'79, but for now any information would be appreciated.

—Richard Collins

A. A fairly complete listing of radio allocations in tabular form is found in Volume II, Part Two of the FCC's Rules and Regulations. The listing is done by frequency from below 10kHz to above 275 GHz. Allocations are given under the fol-

lowing categories: Worldwide: Region II (the Americas); United States; and Federal Communications Commission. For details on getting a copy, write to the Superintendent of Documents, U.S. Government Printing Office, Washington, DC 20402.

CRYSTALS

Q. I'm looking for miniature, low-frequency crystals for the 50- to 250-kHz frequency range. Do you know where I can find some?

—Sam Schwart, Nova Scotia

A. I would suggest that you contact the

International Crystal Manufacturing Co., Box 32497, Oklahoma City, OK 73132. They have a very broad line of crystals and oscillators for just about any frequency of interest to experimenters and hobbyists. But I don't know how small they can make crystals that oscillate at such low frequencies.

SURGE CURRENT PROTECTION

Q. My solid state power supply went dead when I turned it on. There is nothing wrong with the circuit, and all components checked out okay before I assembled the project. But the rectifier went west. Any ideas?

—John Nagurney, Urbana, IL

A. Apparently the surge current flowing through the rectifier was more than it could handle. When you first turn on the supply, the large filter capacitors are essentially dead shorts until they start charging up. This causes a surge current of many amperes to flow through the diodes. Although you can replace the rectifiers with ones having larger surge current ratings, it's best to either insert some resistance in series with the capacitors or to use a circuit like that shown here. The power supply is turned

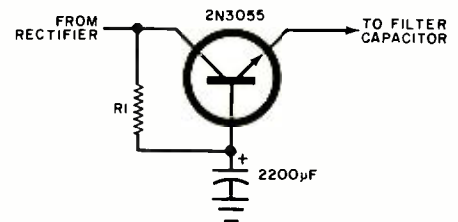

on as slowly as the 2200-µF capacitor charges through R1. The greater the resistance of R1, the longer the turn-on time will be. Experiment with various values until the delay is suitable for your application. This circuit is especially effective in eliminating the "thump" that occurs in audio power amplifiers. The transistor specified has a maximum collector current rating of 15 Amperes and a total device dissipation of 115 watts. A smaller transistor can be used in low-power circuits.

Have a problem or question on circuitry, components, parts availability, etc? Send it to the Hobby Scene Editor, POPULAR ELECTRONICS, One Park Ave., New York, NY 10016. Though all letters can't be answered individually, those with wide interest will be published.

THE LOGICAL CHOICE: Third in a series

SYMMETRICAL AND UNSYMMETRICAL PULSES
0.5Hz-5MHz.

CONTINUOUS, MANUAL ONE-SHOT & EXTERNAL TRIGGER OPERATION
External triggering to 10MHz

INDEPENDENTLY-CONTROLLABLE PULSE WIDTH & SPACING
100 nanosec-1 sec in 7 overlapping ranges 10¹:1 duty cycle range



INDEPENDENT CMOS AND TTL OUTPUTS Fan-out to 40 TTL loads

SYNCHRONOUS OUTPUT GATING

100mV-10V POSITIVE OUTPUT Less than 30 nanosec rise/fall times

CSC'S DESIGN-MATE™ 4: \$124.95. NO OTHER DIGITAL PULSE GENERATOR GIVES YOU SO MUCH, FOR SO LITTLE.

Sounds hard to believe... but even a brief look at Design-Mate 4's specifications proves CSC's engineers have done it again. Whatever your application — whether you're looking for precision, flexibility or just plain economy — this compact source of fast, clean digital pulses offers the performance you need... at a price that discourages procrastination.

Use it as a clock source, delayed pulse generator, synchronous clock, manual system stepper, pulse stretcher, clock burst generator or in dozens of other applications. Use it alone or in tandem with other DM-4's for gated control. The

wide range of controls and multiple outputs give you enormous versatility... plus compatibility with all major logic families, for research, design, development, quality control, production testing, maintenance, troubleshooting... you name it.

Now, read the specs that follow... and check the price again. Or better yet, try DM-4 for yourself at your local CSC distributor. Once you do, we think you'll find it's as hard to do without as it is easy to own.

For more information about CSC's other fine products, and a list of distributors, please call or write.

DM-4 SPECIFICATIONS

Frequency Range:	0.5 Hz to 5 MHz	ONE-SHOT	Pushbutton for single pulse Output pulse occurs each time push-button is pressed
Pulse Width and Spacing Controls:	100 nanosec to 1 sec in 7 overlapping decade ranges A single-turn vernier control provides continuous adjustment between ranges 10 ¹ :1 Range adjustable over entire pulse width/spacing range. 100 nanosec ON 1 sec OFF to 1 sec ON and 100 nanosec OFF	OUTPUTS:	
Duty Cycle:		VAR OUT	Amplitude 0-10V positive Rise/fall time Less than 30 nanosec
Operating Modes:		TTL OUT	Fan-out 40 TTL Loads Sink 160 milliamps - 0.8V max Rise/fall time Less than 20 nanosec
RUN	0.5 Hz to 5 MHz as per width/spacing and amplitude control settings	SYNC OUT	Approx 40 nanosec Other sync pulse specs same as TTL out
TRIG	DC to approx. 10 MHz	Pulse lead time	Sync pulse leads outputs by approx 20 nanosec
Input requirements	Sine waves 2 VP-P; pulses 1 V peak, >40 nanosec wide, maximum input = 10 V (Input Impedance Approx 10KΩDC coupled)	POWER	117 VAC ± 10%, 50/60 Hz, 5 watts (220 VAC, 50/60 Hz also available, at slightly higher cost)
GATE	Synchronous gating Leading edge of gate signal turns generator ON Last pulse is completed, even if gate ends during pulse	SIZE	7.5 x 6.5 x 3.25"
Input requirements	Same as TRIG Mode	WEIGHT	191 x 165 x 83 mm 2 lbs (0.91 Kg)

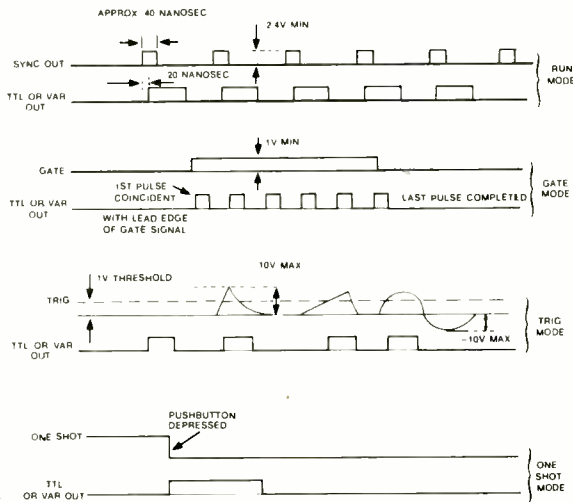

CONTINENTAL SPECIALTIES CORPORATION



EASY DOES IT

44 Kendall Street, Box 1942 New Haven, CT 06509 • 203-624-3103 TWX: 710-465-1227
West Coast office: Box 7809, San Francisco, CA 94119 • 415-421-8872 TWX: 910-372-7992

NEWS HIGHLIGHTS

CB Crossing the Border

The Canadian and Mexican governments have recently been getting tough on incoming motorists with Citizens Band radios. Unless you have a permit to use your radio in either country, your set could be confiscated at the border or sealed against use. To insure against this, send a copy of your FCC license to any office of the Canadian Dept. of Communications, at least six weeks before your trip. Travelers bound for Mexico must write to the Secretaria de Comunicaciones, Mexico City, or contact the nearest Mexican consulate.

Marine Radiotelephone Misuse

A recent nationwide survey made by the Radio Technical Commission for Marine Services has indicated a rapidly growing increase in the misuse of marine radiotelephone. Focusing primarily on vhf/FM, which is used by more than 250,000 boatmen, the Commission observed that there was unnecessary and excessive use of channel 16 (the emergency channel), overly long conversations, omitted call signs, and excessive use of procedural words. Unlike Citizens Band, which is intended for business or personal use, the Marine Band is emergency oriented. The commission praised the well disciplined radio communication used by air traffic controllers, where every word spoken is essential, in comparison to many marine communications where exchanges are long and cumbersome.

CMOS For Garage Openers

With the introduction of a new digital radio control by Chamberlain Manufacturing, in its "Electro-Lift" garage-door openers, the possibility of outside false activation of automatic garage-door openers has been narrowed. New CMOS integrated circuits built into the radio's transmitter and receiver allow homeowners to select their own exclusive codes. The control, called "Code Command," provides up to 64 possible code combinations for added security.

Electronic Organ Tuning Advance

A new digital IC tone-generator system introduced by Schober abolishes any need for organ tuning adjustments. The new circuitry uses digital logic technology to make pitch relationships among the notes of an organ permanently correct. An oscillating circuit generating a signal about 250 times as high as the pitch of the highest organ note acts as a reference source for all the pitches. A single knob on the front of the organ alters the tuning so that pitch can be adjusted to match a recording or the tuning of another instrument. Before the development of this digital IC generator system, only organs with rotating mechanical generators did not require tuning. The new system is contained on a single pc board (7½" x 14"), in contrast to the company's former requirement of 12 pc boards.

"10-Four, Good Buddy!"

"10-Four, Good Buddy!" is a new board game by Parker Brothers. The players act as truckers, driving their tractor trailers down game board highways, using CB radio consoles equipped with hi and lo frequency spinners that determine the number of spaces the trucks can move. The game employs the special "trucker language;" players meet up with "Smokies" and a "Bear in the Air," and can get caught in a "Bear Trap."

Operation "Moonbounce"

Amateur radio operator Allen Katz, West Windsor, New Jersey has become the first person to complete two-way communication with all six major continents via radio signals reflected off the moon. On a frequency band similar to uhf television broadcast, and with a 28-foot-diameter dish antenna in his backyard, Katz achieved his goal. He was awarded a "Worked All Continents" certificate by the National Amateur Radio Union, headquartered with the ARRL.

Electronics for Autos

Tenna Corporation has entered into an agreement with the Lincoln-Mercury Division of Ford Motor Company to supply retractable Citizens Band antennas to be offered as optional equipment on the 1977 Lincoln and Mark V models. The rear-mount, electrically powered antenna features a thin center-loaded coil, which enables the unit to be retracted completely when not in use.

Rockwell International has agreed to supply General Motors with the "Misar" spark timing system, which will be standard on 1977 Oldsmobile Toronado cars. The new system, the first use of a microcomputer in a production automobile, contains two LSI circuits with more than 20,000 transistors and electronic elements.

AM Stereo Progresses

In response to a request by the FCC in the fall of 1975, for a committee to study AM stereo, the National AM Stereophonic Radio Committee was formed. At a recent meeting, the committee evaluated proposals for AM stereo systems, submitted by Communication Associates, Motorola, RCA and Sansui. Transmitter and antenna perimeters for testing AM stereo were examined and a list of test stations meeting criteria set by the committee was developed. After these test stations have been observed, the committee plans to submit its final report to the FCC for Rule Making. The committee also opposed a petition submitted by Kahn Communications, Inc., which is also developing an AM stereo system, asking the FCC to deny their petition, and encouraging Kahn to participate in the committee efforts to ensure a standardized test procedure.

FLUKE PROVES AN INEXPENSIVE, HANDHELD DMM CAN BE BUILT WITHOUT LEAVING EVERYTHING OUT.

Let's face it.

Before now, if you bought an inexpensive, handheld digital multimeter you didn't get much—they just left most everything out.

We knew that was no answer.

So we built the 8030A 3½-digit DMM. It's a small, portable, inexpensive, handheld DMM, but it performs like our benchtop units.

With one basic difference. The 8030A was designed, built and tested to a size and shape proven best for field service and laboratory technicians. There's a built-in hood that can be slipped forward to shade the readout in sunshine. It has rms capability. The best overload protection. Diode test. It weighs 2.2 pounds, and will take a beating without failing. Finally, we guarantee accuracy specifications for one year.

And it only costs \$235*.

True rms.	Fluke
1-year accuracy specs.	Fluke
High voltage protection.	Fluke
Diode test.	Fluke

A full line of accessories offering rf voltage, high current ac, high voltage dc, and temperature measurement probes. Fluke

There's only one place to go for all the performance you need in a handheld DMM.

There are measurement functions in five selectable ranges for dc volts, ac volts (true rms), dc current, ac current (true rms), and resistance. DC voltage measurement is from 100 μ V to 1100V with basic accuracy of $\pm 0.1\%$, ac measurement is from 100 μ V to 750V rms with basic accuracy of $\pm 0.5\%$. DC and ac current is from 100 nanoamps to 1.999 amps with basic dc accuracy of $\pm 0.35\%$ and basic ac accuracy of $\pm 1\%$. Resistance measurement is from 100 milliohms to 2 megohms with a basic accuracy of $\pm 0.4\%$.

We added true rms response for ac measurements. Specified accuracy is still attainable when the measured waveform is distorted.



"Fluke does the impossible again."

There is extensive overload protection. It has been tested with transients up to 6000V peak across the input terminals.

Options include two battery operations: a rechargeable NiCad for 8 hours operation and throw-away alkaline cells. Accessories include probes for measure-

ment of rf voltages, high current ac, high voltage dc and temperature.

80T-150 Temperature Probe	
Sensitivity:	1 mV/°C or 1 mV/°F
Accuracy:	
+15°C to +35°C ambient:	$\pm 2^\circ\text{C}$ (3.6°F) - 25°C to +125°C $\pm 3^\circ\text{C}$ (5.8°F)
-50°C to -25°C and +125°C to +150°C	
0°C to 15°C, 35°C to 50°C ambient:	Add 1°C (1.8°F) to above

You can also get temperature measuring capabilities with the 8030A.

And because the 8030A gives you so much in performance, let us remind you once more of the price.

Only \$235*.

For the first handheld DMM that's small in size, small in price, but huge in performance.

For data out today, dial our toll-free hotline, 800-426-0361.

John Fluke Mfg. Co., Inc., P.O. Box 43210, Mountlake Terrace, WA 98043
Fluke (Nederland) B.V., P.O. Box 5053, Tilburg, The Netherlands.
Phone: (013) 673-973 Telex: 52237

*U.S. price only.

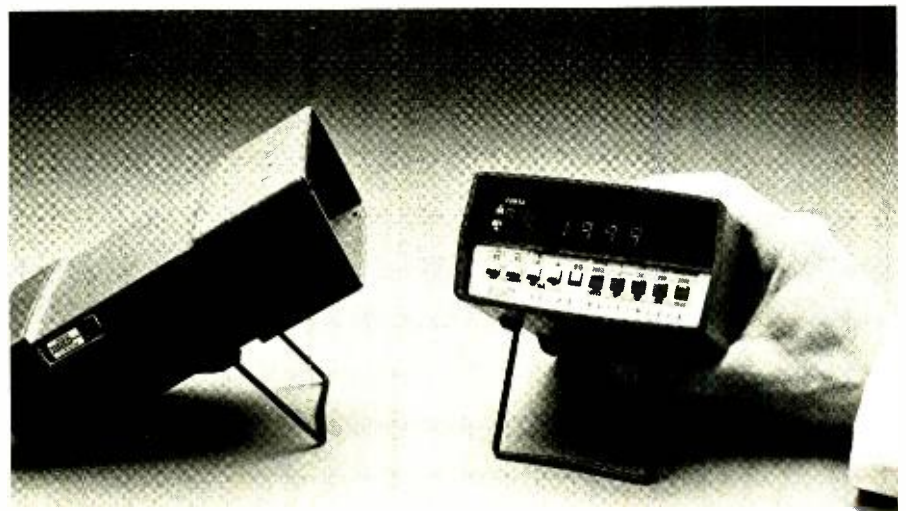

A NEW ADVANCE. 8030A DMM. 

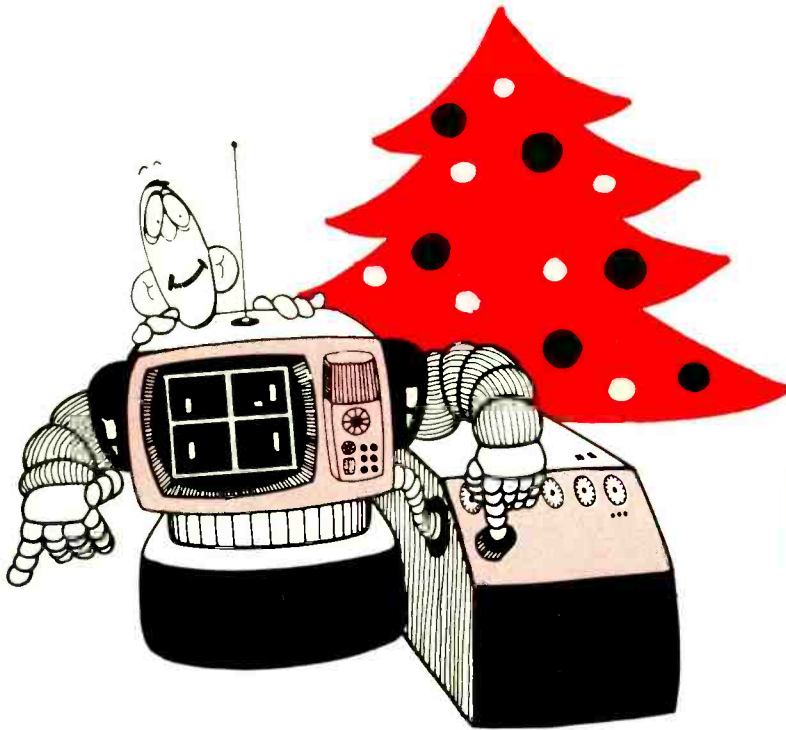

Roundup of TV Electronic Games

Video games are becoming almost as popular as pocket calculators, digital watches, and CB transceivers on the consumer electronics scene. In fact, suppliers don't believe they can produce enough TV games to keep retailers' shelves filled during this Christmas season of 1976.

Connected to the antenna terminals of any TV receiver, these new electronic marvels pit one player against another or against the machine in a variety of games ranging from tennis to tic-tac-toe. Some of the new video games illustrate the on-screen graphics in color.

Magnavox got the video game market rolling about four years ago with the introduction of its Odyssey® game. The original game was basically paddles and a white square that moved about on an empty TV screen. The playing field, a plastic laminate that physically attached to the face of the picture tube, gave the

game boundaries, markers, and areas from which to maneuver your "man" on the screen.

It was not until fairly recently that video games began to catch on as improved versions were introduced to the market. Atari, makers of Pong®, is one company that deserves a lot of credit for popularizing the video game. Pong, a game of table tennis, added some significant improvements: electronically generated on-screen colored courts; sound effects for every hit, miss, and ricochet of the ball; and automatic on-screen digital scoring. Add to this the selling expertise of Sears, and you have a notable contender for the projected \$750-million market by 1980.

There are currently some 35 companies making video games. At this writing, however, only 20 or so have had their games type approved by the FCC and are marketing games.

Tennis Anyone? Tennis (actually, table tennis) is available in all video games in one form or another. The first game of Odyssey gave player control over the ball in both horizontal and vertical positions. Pong® and the newer games give player control in only the vertical position. Competition between the new game makers has not grown out of what moves a player can make but on the games in which he can participate. The new games still include tennis, but now hockey and handball are typically available at the flip of a switch.

The new Odyssey 400 now allows you to play handball and hockey as well as tennis and includes on-screen digital scoring and sound effects. Atari's new Super Pong gives you a choice of the original Pong tennis game, two-man team tennis called Super Pong, Catch, and Solitaire. Catch is unique in that it allows you to control the position of a "hole" in the boundary on your side of the court. Solitaire is similar to a one-man handball game, but the height of the backboard wall is adjustable to make the game easy or difficult. When you play Solitaire, if you get the ball over the wall, you make a point; miss on a return bounce, however, and the machine scores.

Games designed to pit your skill against the machine are made by companies other than Atari and Magnavox. In addition to tennis and hockey, First Dimension has a clever Robot game

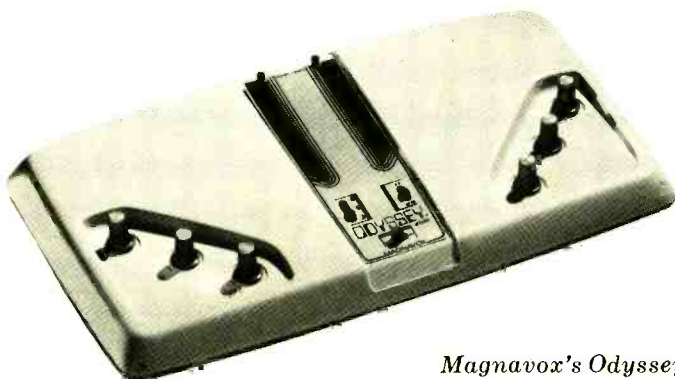

Magnavox's Odyssey



National Semiconductor's Adversary

that has you trying to score by getting the ball into a goal that is usually blocked by a mechanized moving paddle. Coleco's handball game has provisions for only one player to bounce the ball off a wall at the far side of the screen; you can miss, losing a point, but the wall remains stationary, always returning the serve.

Unisonic gives you a choice of six games, two of which are Skeet and Targets. A white block, your target, randomly crosses the screen. You shoot at this target with an electronic gun supplied with the game. Your score of hits is automatically displayed on the TV screen after 15 rounds. Skeet and Targets are slightly different in concept than other games that merely use the TV screen as a graphic display; in these two games, the screen is an active part of the circuitry. A photocell inside the gun senses the presence (or absence if you miss) of light from the screen each time you pull the trigger and updates the score accordingly.

The Unisonic machine's sound effects are different, too. Rather than having the sound come from a speaker built into the game itself, the audio is modulated with the video and sent to the TV receiver. The sound is then reproduced by the TV receiver's speaker.

Universal Research has added a button to give hockey a realistic twist. Ordinarily, the puck can only be deflected by players on the screen as with most

other games. A special "Puck Control" switch on the Universal Research game allows each player to catch and hold the puck, passing off only when desired. This is just one of the many switches now appearing on the more complex games.

In addition to the usual player position controls, many manufacturers are incorporating other controls to add to the skill level requirements of their games. Paddle size, speed, and ball angle can all be changed, either individually or collectively, depending on the switching arrangement provided in a particular video game. Odyssey 300, for example, has one switch with Amateur, Average, and Professional skill positions. In the Amateur position, the paddle is large and the

speed and angle of the ball are mild. In Average, the paddles become smaller and the angle of deflection is increased, but the speed remains the same. In Professional, the paddles again become large, but only to keep up with the large deflection angles (40° versus 20°) and high speed (0.65 versus 1.3 seconds across the screen) of the ball while it is in play.

APF uses three separate switches to allow the player to tailor the game to the way he wishes it to be played. First Dimension allows just the speed of the ball to be changed, but each player is provided with a separate speed control, which is a bit more practical because each player can be separately handicapped. Other switches on some games permit



Atari's Super Pong

two or four players to participate in the game and provide automatic and manual serve selection.

The game selector switch sets up the playing field for the particular game you wish to play. While the graphics are generally set up in the same manner by each manufacturer, there are differences here, too. National Semiconductor's Adversary game, for example, allows you to play tennis on a green court, hockey on blue "ice," and handball on a brown "clay" court when used with a color TV receiver.

IC Technology Base. What has been primarily responsible for bringing

video games down to practical size and price is the LSI integrated circuit technology support the industry has received. For many game manufacturers, the General Instruments dedicated n-channel MOS chip is used. (There are separate chips available for U.S. and European TV standards.) The 28-pin IC contains all the logic required for tennis, hockey, handball, and practice. With slightly more outboard logic, this chip also provides target and skeet game modes that are played with a remote electronic gun. Score update and display for all games are also on-chip generated for these IC's.

Input programming pins on the Gener-

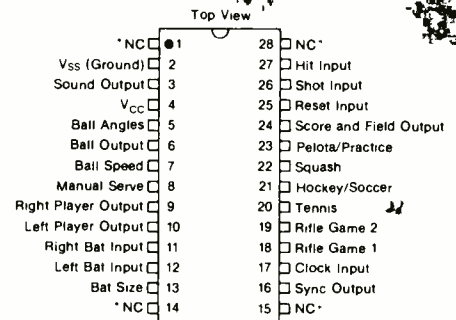

Pin configuration of General Instrument's AY-3-8500 game chip.

al Instruments chip permit direct non-buffered switch connections for game selection, ball speed, paddle size, and four different ball-return angles. Other inputs provide for automatic and manual ball serving after each point is scored and separate resetting.

Separate video outputs from the GI chip allow combining for a monochrome or use with a color generator for a color picture display. An audio output pin on the IC can be used to deliver a signal that can be modulated with the video signal or buffered through a one-transistor circuit to drive a loudspeaker.

The flexibility of the GI chip makes it quite attractive to video games manufacturers. Game complexity, which determines the manufacturing cost, is basically a matter of whether or not a given pin on the IC is used. All that must be added to the primary circuit are a 2-MHz clock generator, r-f modulator for TV Channel 3 or Channel 4, paddle control potentiometers, loudspeaker, and power supply. The power supply is usually a set of six C cells, which may or may not be supplied with the game.

The game Adversary is quite naturally designed around National Semiconductor's MM57100 video game and LM1889 video modulator chips. In addition to providing three selectable skill levels, Adversary allows an opponent to play against another opponent, against himself, or against the machine. A special "time-out" feature stops the play instantly, with no effect on the game. (The usual reset function returns all scores to 0 and initiates a new game.)

Texas Instruments has also gotten into the video-games market, but not with a finished product that bears its name. TI is offering six separate chips that can be combined in different arrays to create a range of video games from simple to complex. The TI chips currently being offered include: game logic with automatic random English, horizontal and vertical sync generator, game logic

HOME VIDEO GAMES

Brand	Model	Price	Games*	Players	Color	Remarks
APF	401	80	1,2,3,4	2,1	no	
Atari	Pong	80	1	2	yes	
	Super Pong	90	1,7,8	2,1	yes	4th game, Super Pong, is ten. dbls. (4 players)
Coleco	Telstar	60	1,2,4	2,1	no	
	Telstar Classic	70	1,2,4	2,1	no	same as above except cabinet and ac operation
Dyn	Paddle Four	70	1,2,3,4	2,1	no	
	Ralley Four	80	1,2,3,4	2,1	no	same as above except cabinet different
Enterprex	Apollo	80	1,2,3,4	2,1	no	
Entex	Tele Pong	60	1,3,4	2,1	no	H-V control on tennis. 4th game, table tennis has V-control only manual scoring
Executive Games	TV	70	1,2	2	no	
	Tennis Hockey/Soccer	90	2	2	no	360° player movement, puck control
First Dimension	76	70	1,2,3,4	2,1	no	
	76C	80	1,2,3,4	2,1	yes	same as 76, with color
	3000 W	100	1,2,9	4,2,1	no	on-screen moving bar for score
Heath	GD-1380	50	1,2,3,4	2,1	no	Video output. Can be used only with Heath kit TV receivers
Kings Point	TG-600	60	1,2,3,4	2,1	no	
Lloyds	Lloyds	100	1-6	2,1	no	
	Monte Verde	100	1-6	2,1	no	same as above except cabinet different
Magnavox	200	70	1,2,3	2	no	H-V player movement. On-screen moving bar score
	300	70	1,2,3	2	no	
	400	100	1,2,3	2	yes	H-V player movement. English control.
Micro-electronics	Riccochet	120	1,2,3,4	2,1	yes	var. color, English
National Semiconductor	Adversary	100	1,2,3	2,1	yes	time-out button
Phoenix	Video Sports	80	1,2,3,4	2,1	no	
Quadronics	Q-376	70	1,2,3,4	2,1	yes	second model, \$80, same but with remote controls
Radio Shack	60-3050	70	1,2,3,4	2,1	no	
Tele-Match	4400	70	1,2,3,4	2,1	no	
	7700	90	1,2,3,4	2,1	no	same as above except cabinet
Unisonic	2000	120	1-6	2,1	no	
Universal Research	Video Action III	120	1,2,9	2,1	yes	

*1-tennis, 2-hockey, 3-handball, 4-practice, 5-targets, 6-skeet, 7-solitaire, 8-catch, 9-robot.

Security is Mallory.

With Mallory Security Products on the job, intruders get the message loud and clear.

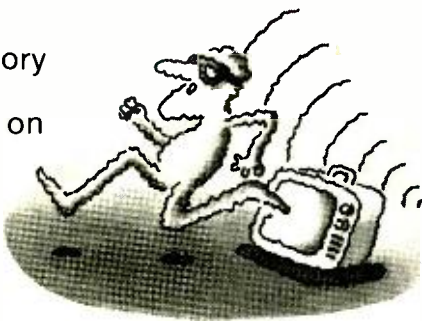

Anyplace, anytime. For the few dollars they cost, here are mighty effective ways to signal forced entry of a building, home, apartment, office, automobile.

Put the Mallory CA3 Intrusion Alarm in your living room, for instance. It'll easily pass for a radio or stereo tuner while transmitting a 20-foot ultrasonic wavelength field. One that will detect the slightest intruder movement and activate an alarm. This compact area-and-



perimeter device comes with solid-state circuitry and big reliability. And a wide variety of indoor and outdoor warning accessories to choose from—bells, horns, sirens, rotating red lights, tape switches, many more.

For automobile security, install the Mallory ABA1 Car Alarm with entry sensing and instant siren alert for doors, hood and trunk. It comes as an easy-to-install kit, complete with switches, wire, keys, warning decals.

From any angle, Mallory Security Products mean protection. See your Mallory distributor. Or send for our Security Products Bulletin No. 9-654.



Mallory CA3 Intrusion Alarm and ABA1 Car Alarm.



MALLORY DISTRIBUTOR PRODUCTS COMPANY

a division of P. R. MALLORY & CO. INC.
Box 1284, Indianapolis, Indiana 46206; Telephone: 317-856-3731

Capacitors • Controls • Security Products • Recording Tapes • Resistors • Semiconductors • SONALERT® • Switches • Fastening Devices

SONALERT® is a registered trademark of P. R. Mallory & Co. Inc.

with manual English, wall and ball generator, character generator, and digital scorekeeping IC's. TI plans to supplement this lineup with other chips in the near future.

In spite of the wide acceptance of dedicated video-game IC's, Fairchild's new game (not available at this time) may set the trend for all video games for the future. Built around the F8 micro-processor and four random-access memory (RAM) chips, the Fairchild game is unique because it can be externally programmed with a special "Videocart" and a keyboard on the player console. Similar to a cassette tape, the Videocart reprograms the system for a new selection of games other than the system's resident tennis and hockey games. You simply consult the jacket of the Videocart for the particular game you would like to play and use the keyboard to punch in the game number. Skill levels and even time limits can be added at the console.

Fairchild intends to market the Videocarts for about \$20 each. The first cartridge contains programming for a tic-tac-toe game, shooting gallery, and a doodle game that allows you to draw in color on your TV receiver's screen. Fairchild expects a total of 17 games to be available by Christmas.

As a point of interest, the use of a computer-based video-game system, which is the idea behind the Fairchild game, opens possibilities for using your TV receiver as a serious tool for learning and storing information. One Videocart might contain a question-and-answer quiz for students, while another might be programmed with a host of cooking recipes. The possibilities of such a system are limited only by the imagination of the user. Greg Reyes, Vice President and General Manager of Fairchild's Consumer Group, sees it as "opening up a flexible capability for future TV-based applications."

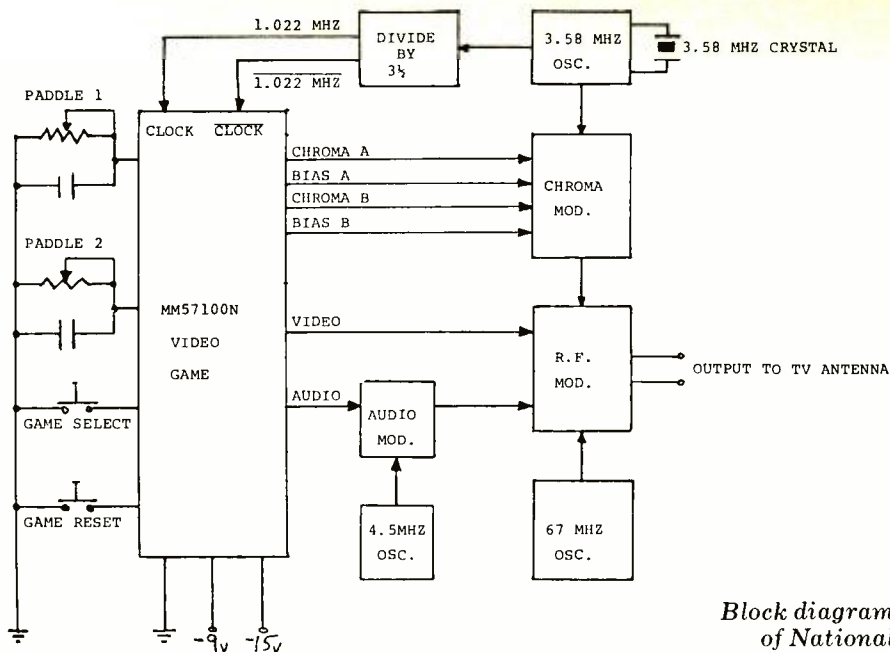

Block diagram of National Semiconductor's Adversary game.

Hooking It Up. Since all video games contain their own modulator for the video (and sometimes the audio) signal, they simply connect to your TV receiver via its vhf antenna input terminals. Each game manufacturer supplies a small r-f switching box that accepts an input from the game console and another from an external standard TV antenna. Once the system is hooked up, you can select either the TV or the GAME position of the switch as desired. A second switch, which is usually buried inside the game console, allows selection of the modulator frequency for either Channel 3 or Channel 4.

Ironically, the simplest section of the video game's circuitry has been the cause of a great deal of trouble for the game manufacturers. Since video games are r-f generating devices, they must meet the requirements of Part 15 of the FCC's Rules and Regulations. There must be a minimum of 60 dB of isolation between the video game and

TV antenna to keep the game signal from exceeding the 15- μ V/m limit of radiation from the antenna set by the FCC. Unless the TV/GAME selector switch can provide the necessary 60-dB minimum isolation, the game will not receive FCC type acceptance.

There is an alternative to the r-f problem that eliminates the need for a modulator—direct video access to the TV receiver with which the game is to be used. Unfortunately, there are not many TV receivers around that provide this access. Magnavox, however, plans to offer a 1977 TV receiver with a built-in video game. The game will feed directly into the video amplifier section of the receiver, bypassing the r-f and i-f sections of the receiver. Once the trend gets started, TV receivers of the future are likely to have video input jacks as standard equipment. Such jacks will not only accommodate video games, but they will also accommodate video tape recorders and video discs. \diamond

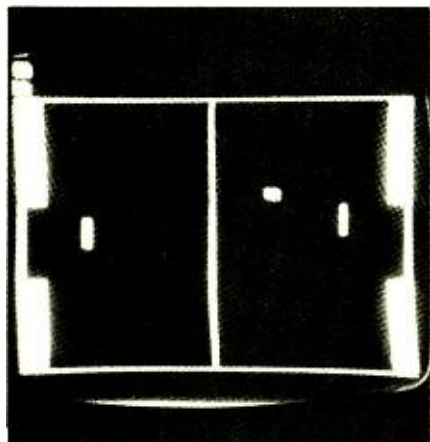

Hockey game on a TV screen. Courtesy First Dimension.

Fairchild's new game (not available at time of writing) is built around the F8 MPU and four RAM's.





*Decodes SQ and QS
or provides surround
sound or concert hall
enhancement to stereo.*

BUILD A

Universal 4-Channel Matrix Decoder

FOUR-CHANNEL sound can produce a new, welcome audio dimension, approaching a live performance ambience. Although it has not yet captured the consumer's fancy in the manner that stereo did (for reasons such as higher cost, multiple quadraphonic systems, and poor separation with earlier systems), it is slowly but surely moving into the marketplace.

With more and more matrix 4-channel FM broadcasts available around the country and lots of matrix-type records that use standard stereo cartridges, quadraphonic sound promises to grow in importance over the years.

The universal decoder presented here features the advanced QS vario-matrix

approach used by Sansui, and will operate with SQ (producing the equivalent of "half logic" SQ) and other matrix-encoded media. Additionally it can synthesize four channels from existing two-channel sources, yielding a choice of simulated quadraphonic sound or "Surround Sound," each with 20-dB separation. A complete kit is available for \$75 plus \$12 for an attractive case. As illustrated in Fig. 1, the circuit employs only four unique IC's and a handful of transistors.

Circuit Operation. Essentially, the QS vario-matrix analyzes where the reproduced sources are coming from, and adjusts the matrix parameters to cancel out the inter-channel leakages that are

normally present in simple matrix decoding. This approach is in contrast with the gain-riding logic that attempts to alter the gain of the four channels to reduce the undesired inter-channel crosstalk.

As shown in Fig. 1, the two-channel audio enters the system via the LT (left) and RT (right) input jacks. After a stage of gain (*Q01-Q02*), the signal splits into two paths.

One pair of signals (marked A and B in Fig. 1) is used to drive the two phase discriminator IC's (HA 1327) that use the phase and level signals between the L_{total} and R_{total} encoded signals to detect the location of the predominant signal. The outputs of these two IC's then become four control signals—right, left,

FOUR-CHANNEL DEFINITIONS

What is QS?

QS is the trademark of Sansui Electric Company of Japan for its 4-channel matrix encoding and decoding system. This is a symmetrical matrix that is totally compatible with any simple matrix decoder (RM, Dynaco, etc.), or vario-matrix decoding.

What is SQ?

SQ is the trademark of CBS Inc. for its 4-channel matrix encoding and decoding system. This is a nonsymmetrical phase matrix that uses phase-shift networks to provide the decode function and logic action to produce the interchannel separation.

What is a Synthesizer?

This is a circuit that accepts conventional

2-channel (stereo) sources from records, tapes, or stereo broadcasts and creates a 4-channel simulation.

What is the Surround Mode?

This mode uses stereo-to-4-channel simulation so that the sound emanates from all four speakers to "surround" the listener as if he were positioned on the conductor's podium, or almost in the middle of the orchestra or group performing.

What is the Hall Mode?

In this mode, the listener is acoustically positioned "up front and center" with the stereo stage presented across the front while the ambience is at the rear with 20 dB separation between front and back.

Does QS or SQ require a special cartridge/stylus?

Only carrier disc demodulation systems (CD-4) require a special cartridge/stylus. The QS or SQ system can use any high-quality stereo cartridge/stylus combination.

What is the difference between vario-matrix and phase matrix?

Vario-matrix achieves high separation between channels by altering the matrix parameter dynamically during decoding. Phase matrix achieves its separation by varying the gain of the channels according to the loudness of the desired signal, and uses logic to decrease the effect of unwanted crosstalk between channels.

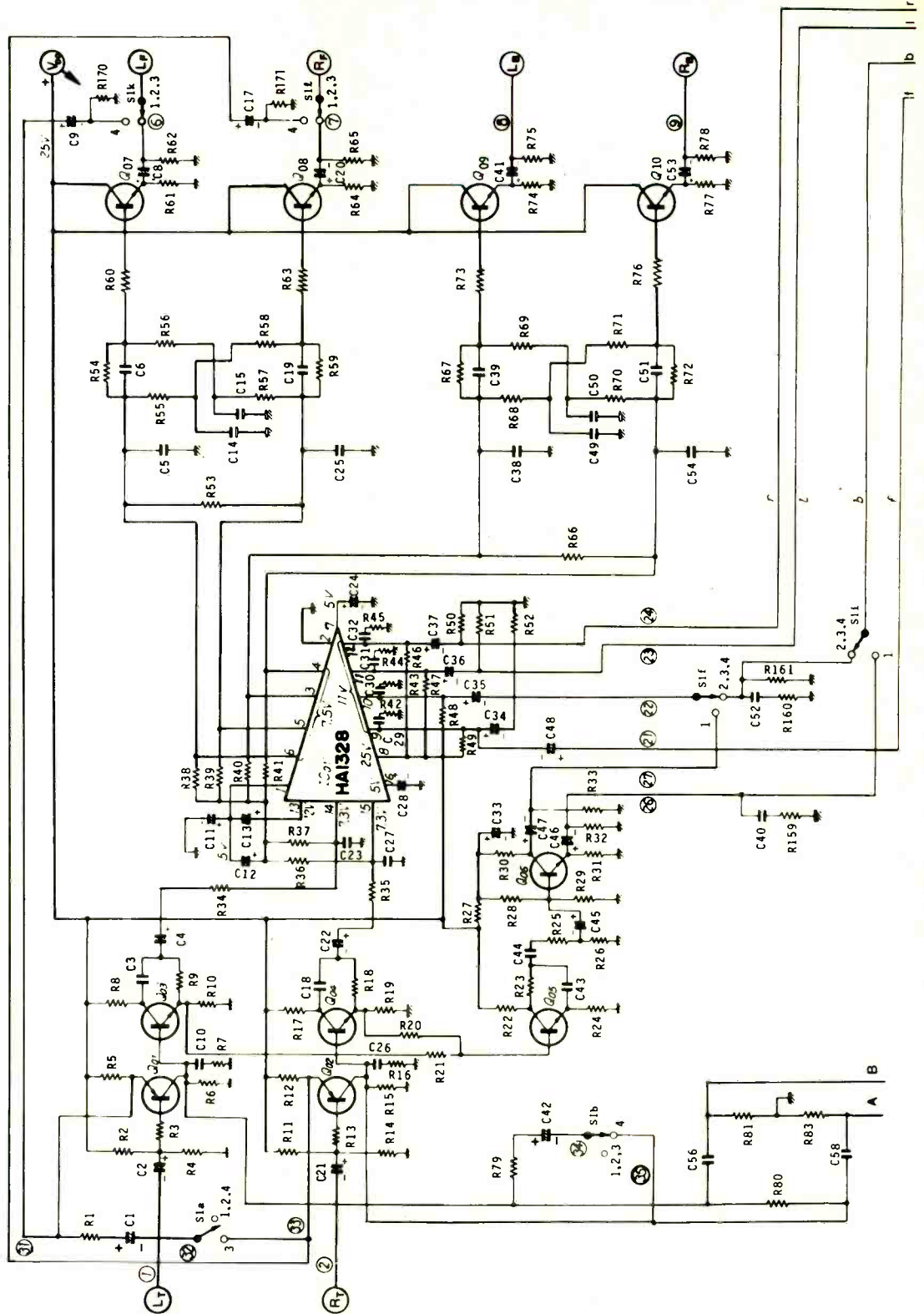
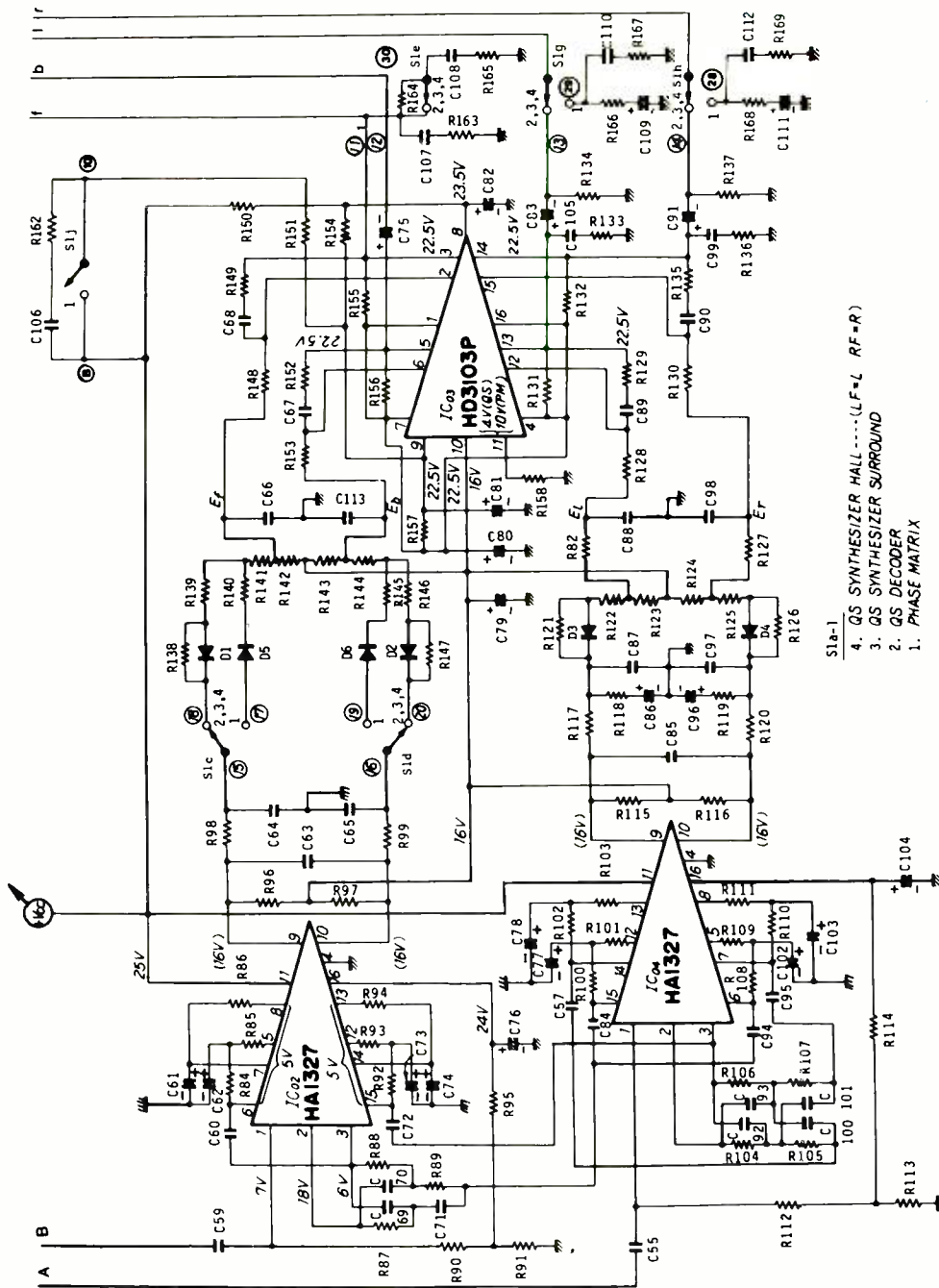

Fig. 1. Schematic of decoder is shown above and on opposite page. Parts List includes power supply shown in Fig. 3.

PARTS LIST

- C1, C34, C35, C36, C37, C42, C46, C47, C81, C82—10- μ F, 25-volt radial electrolytic capacitor
- C2, C21, C45, C48, C75, C83, C91—3.3- μ F, 16-volt radial electrolytic capacitor
- C3, C18, C44—0.01- μ F, 5% capacitor

- C4, C8, C20, C22, C41, C53, C86, C96, C109, C111—1- μ F, 16-volt radial electrolytic capacitor
- C5, C25, C38, C54, C71, C100, C101—470-pF, 5%, styrene capacitor
- C6, C19, C39, C51, C66, C113—0.01- μ F capacitor
- C7, C16—not used



- C9, C17—1- μ F, 16-volts, axial electrolytic capacitor
- C10, C26, C108—0.0068- μ F capacitor
- C11, C12—100- μ F, 10-volt radial electrolytic capacitor
- C13, C24, C28, C33—47- μ F, 25-volt radial electrolytic capacitor
- C14, C15, C49, C50, C88, C98—0.033- μ F capacitor
- C23, C27—100-pF, 5% styrene capacitor
- C29, C30, C31, C32—3300-pF capacitor
- C40, C110, C112—0.012- μ F capacitor
- C43—0.0047- μ F, 5% capacitor
- C52, C107—0.015- μ F capacitor
- C55, C59—330-pF, 5% styrene capacitor
- C56, C57, C58, C84, C94, C95—0.001- μ F, 5% capacitor
- C60, C72—0.0039- μ F, 5% capacitor

- C61, C62, C73, C74, C77, C78, C102, C103, C116—4.7- μ F, 25-volt radial electrolytic capacitor
- C63, C85—0.068- μ F capacitor
- C64, C65, C87, C97, C106—0.056- μ F capacitor
- C67, C68, C89, C90—0.0022- μ F capacitor
- C69, C70—0.033- μ F capacitor
- C76, C79, C80, C104—33- μ F, 25-volt radial electrolytic capacitor
- C92, C93—0.068- μ F, 5% capacitor
- C99, C105—0.018- μ F capacitor
- C114—0.01- μ F, 50-volt, ceramic capacitor
- C115—1000- μ F, 35-volt electrolytic capacitor
- C117—220-pF, ceramic capacitor
- D1 through D6—1N914
- D7 through D10—1N4001

- F1— $\frac{1}{2}$ -ampere slow-blow fuse and holder
 - IC1—HA1328 (Sansui)
 - IC2, IC4—HA1327 (Sansui)
 - IC3—HD3103 (Sansui)
 - IC5—723 voltage regulator
 - J1 through J6—phono jack
 - LED1—red LED
 - Q1, Q2—MPSA55
 - Q3 through Q10—2N3391A
 - Q11—1-ampere npn power transistor
- The following resistors are $\frac{1}{4}$ -watt, 5%, unless otherwise noted:
- R1—5600 ohms
 - R2, R11—47,000 ohms
 - R3, R13, R60, R63, R73, R76, R167, R169—1000 ohms
 - R4, R14, R20, R21, R62, R65, R75, R78, R129, R135, R149, R152—100,000 ohms
 - R5, R6, R8, R10, R12, R15, R17, R19, R27, R166, R168—2200 ohms
 - R7, R16, R176—3300 ohms
 - R9, R18, R31, R38, R39, R40, R41, R55, R57, R68, R70, R157—22,000 ohms
 - R22, R24, R30, R165—1500 ohms
 - R23, R87, R88, R104, R106—6800 ohms
 - R25, R34, R35, R105, R107—68,000 ohms
 - R26—18,000 ohms
 - R28, R66, R85, R93, R96, R97, R101, R103, R109, R111, R115, R116—120,000 ohms
 - R29, R86, R94—390,000 ohms
 - R32, R89, R134, R137—33,000 ohms
 - R33, R175—8200 ohms
 - R36, R37—27,000 ohms
 - R42, R43, R44, R45—47 ohms
 - R46, R47, R48, R49, R131, R132—15,000 ohms
 - R50, R51, R52, R159, R161—1200 ohms
 - R53—150,000 ohms
 - R54, R56, R58, R59, R67, R69, R71, R72, R80, R81, R83—220,000 ohms
 - R61, R64, R74, R77, R150—4700 ohms
 - R79—3900 ohms
 - R82, R91, R100, R102, R108, R110, R113, R127, R141, R144—330,000 ohms
 - R84, R92, R122, R125—270,000 ohms
 - R90, R95, R112, R114—680,000 ohms
 - R98, R99, R117, R118, R119, R120, R164, R170, R171—56,000 ohms
 - R121, R126—1.5 megohms
 - R123, R124, R140, R145—560,000 ohms
 - R128, R130, R148, R153—1 megohm
 - R133, R136—560 ohms
 - R138, R147—2.2 megohms
 - R139, R142, R143, R146—470,000 ohms
 - R151, R154, R177—2700 ohms
 - R155, R156—12,000 ohms
 - R158—10,000 ohms
 - R160, R163—680 ohms
 - R162—120 ohms
 - R172—2000 ohms
 - R173—2.4-ohm, $\frac{1}{2}$ -watt
 - R174—1500-ohm trimmer potentiometer

- S1—12-position, 4-pole rotary switch
 - S2—spst switch, 3-ampere rating
 - T1—30-volt secondary
- Misc.—Suitable enclosure, line cord, shielded cable, hookup wire, hardware, etc.

Note—The following are available from Photolume Corp., 118 E. 28th St., New York, NY 10016: kit of IC1 through IC4 with etched and drilled pc board, #QSP-3 at \$25; complete kit of all parts except case, #QSK-3 at \$75, plus \$2 for shipping (Canadian and foreign, add shipping and insurance for 4 lb); drilled and screened case at \$12. New York state and city residents, include appropriate sales tax.

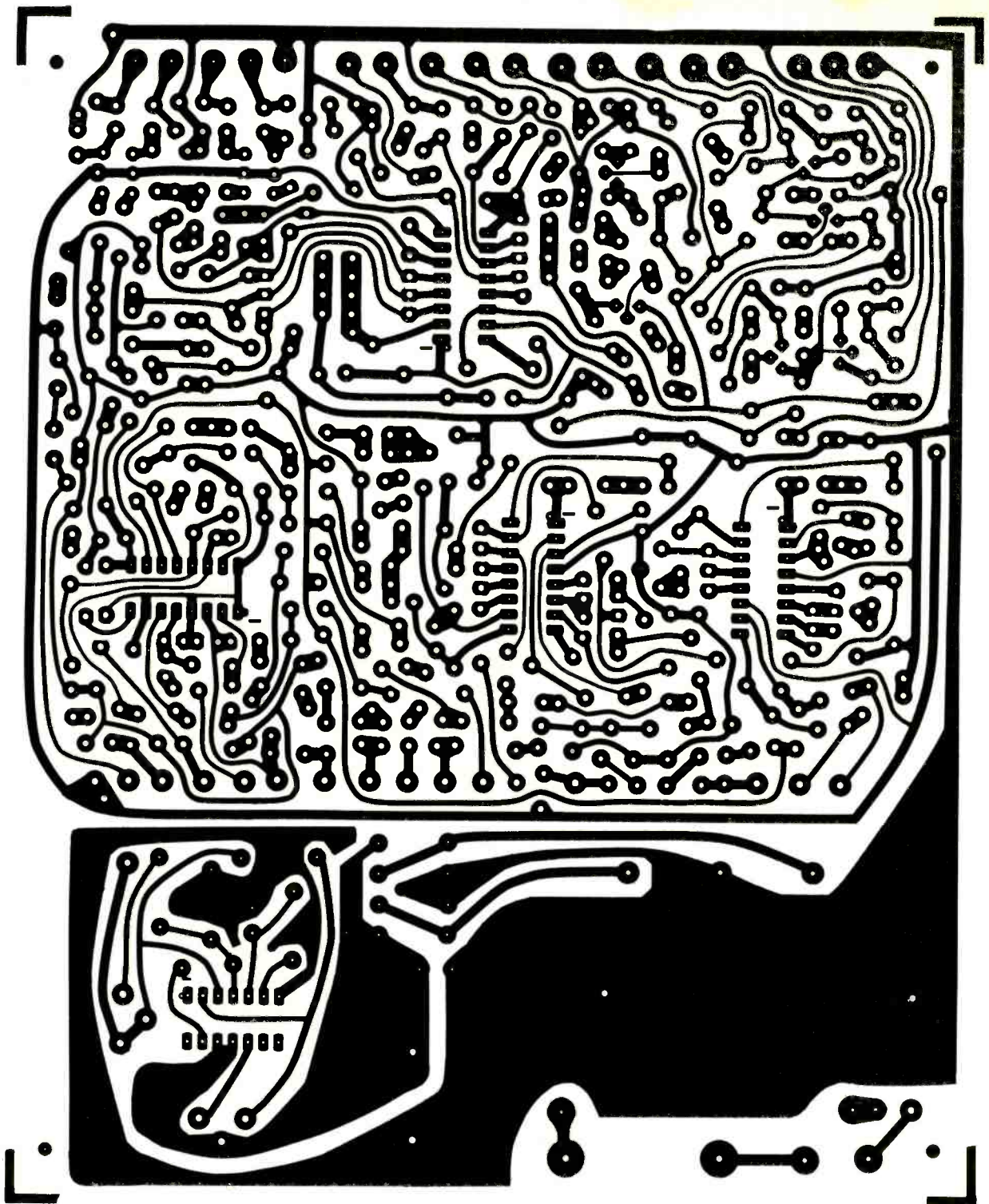

Fig. 2. Actual-size etching and drilling guide above, components placement on opposite page.

back, and front—that are passed to control IC (HD3103). This IC, containing five FET's, generates the dc voltages that are used to vary the parameters of the phase-matrix IC—HA1328.

The second signal path feeds the phase-matrix transistors Q03 and Q04, whose outputs go to the HA1328. In the matrix IC, the incoming audio signals are combined with the control signals from the HD3103 to produce four audio outputs—*L_{front}*, *R_{front}*, *L_{back}*, and

R_{back} with a better than 20-dB inter-channel separation. These signals are then passed through cross-coupled emitter followers (Q07 through Q10) to form the actual output signals.

The technique involving the use of a symmetrical variable encoding/decoding matrix (vario-matrix), and controlling it with signals derived from the phase relationship of the two encoded channels, enhances the separation between any pair of the four decoded channels. The

same vario-matrix can be used to enhance the reproduction of conventional 2-channel stereo signals into an excellent simulation of 4 channels because, in conventional stereo recording, the majority of the left and right signals are in phase with each other. Even when some of these signals are out of phase, the reverse-phase components are minimal compared to those components that are in phase. If the reverse-phase information could be added to the in-phase,

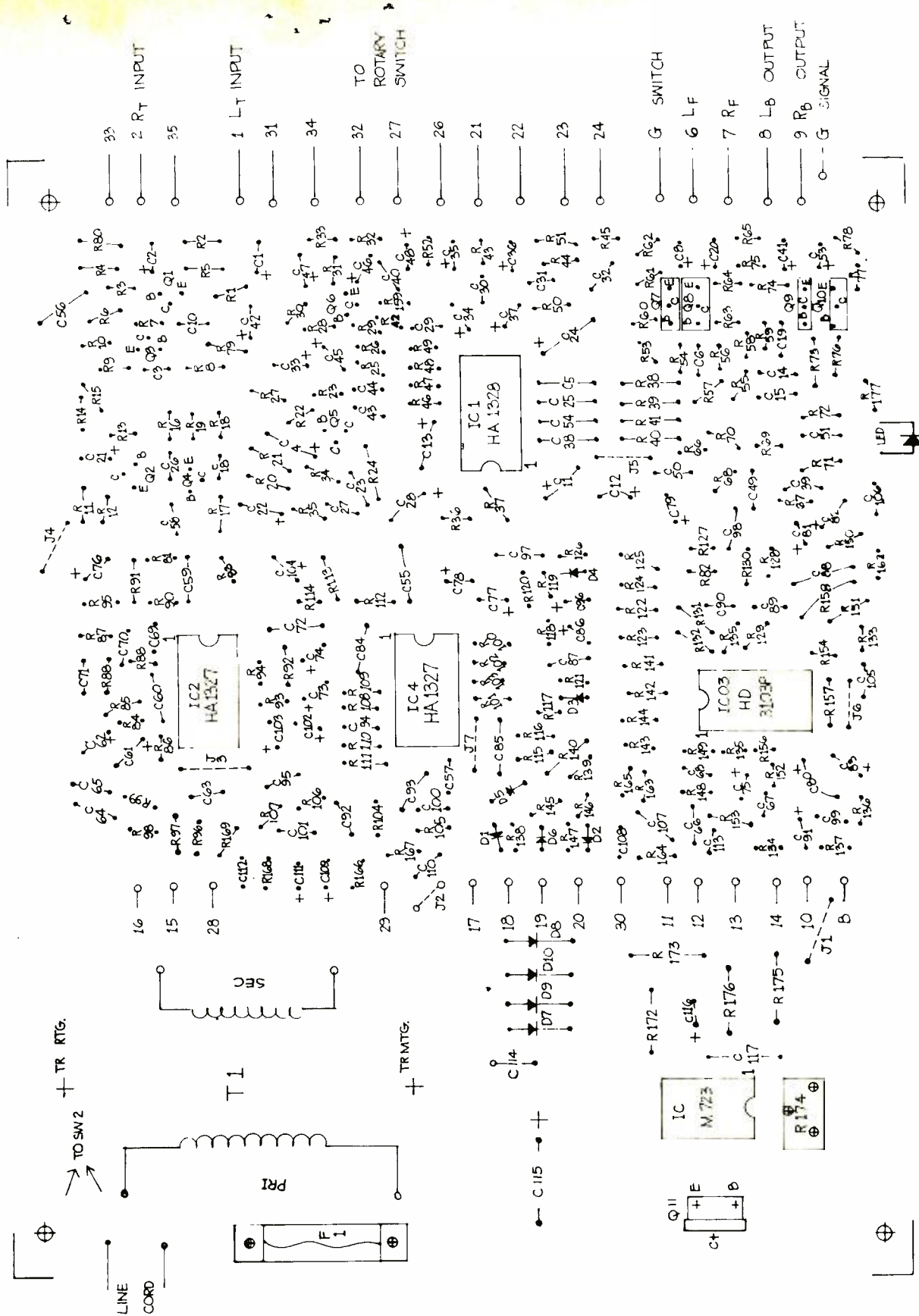

theoretically it would be possible to produce 4-channel separation from a conventional stereo recording.

By the addition of some relatively simple switching, the vario-matrix system can produce two other synthesized listening modes—"Concert Hall," and

"Surround." In the "Concert-Hall" mode, the normal stereo signals are heard from the front two speakers, while the ambience information appears at the rear two speakers. In the "Surround" mode, the stereo signals are caused to appear "around" the listener with very distinct

directional sound coming from all four speakers. The effect is to place the listener on the conductor's podium, or just about in the middle of the group that is playing.

The decoder can also be used for 4-channel reproduction from sources en-

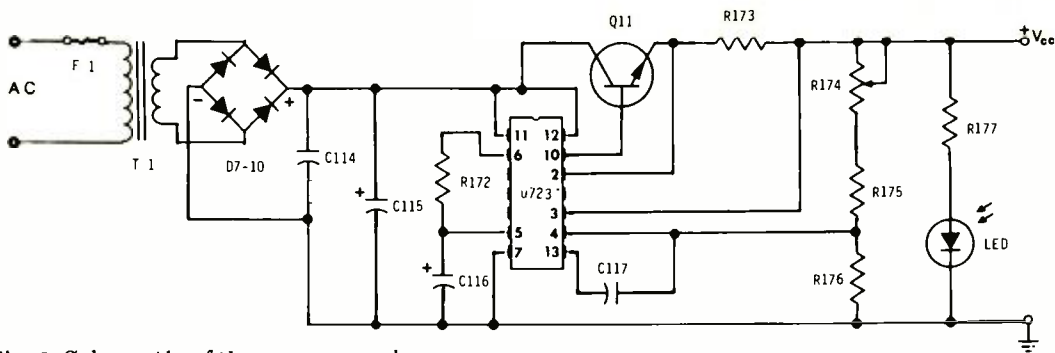

Fig. 3. Schematic of the power supply. Components are given in Parts List for Fig. 1.

coded with the CBS SQ system (a phase-matrix technique). The four outputs (LF', RF', LB' and RB') are equivalent to the outputs from a basic SQ decoder with partial logic. This provides a corner separation of between 3 dB and infinity. Application of the vario-matrix to phase-matrix decoding provides a greater separation between CF (center front and CB (center back) than the basic SQ decoder.

Construction. Although any type of construction can be used, the complexity of the circuit can be greatly reduced by using the single-sided foil pattern shown in Fig. 2, which also shows the component installation. Because of the board density, most of the resistors are mounted vertically. Sockets should be used for the IC's. A low-power soldering iron (25 watts) with small-gauge rosin-core solder is used to mount the components. Check the polarities of semiconductors and electrolytic capacitors. After component installation, look the board over for accidental shorts between the closely spaced copper traces. Note that a well-regulated power supply (Fig. 3) using an IC regulator and series pass transistor (with slip-on heat sink) has been incorporated on the board and the +VCC is connected to the main portion of the board via a small jumper (J1). Do not connect this jumper at this time.

To select the four functions—SQ, QS, Surround, and Hall—a four-position, 12-pole rotary switch is wired as shown in Fig. 4. Note that seven components are mounted on the switch, while all the other connections are made to numbered pads on the board. The switch should be pre-wired with sufficient cable length to reach the board after the switch has been mounted on the front panel. Multi-conductor cable makes for the best appearance. Power-on LED1 is also mounted on the front panel with a sufficient length of insulated pair to connect it to the pc board.

The finished pc board without the IC's installed (except for the power supply regulator), should be tested before installing it in a cabinet. (The prototype used a Ten-Tec MW-8, having dimensions of 4 3/16" high, 6 5/16" deep by 7 13/16" wide.) Drill suitable holes in the front panel for the function selector switch, power on-off switch, and LED1.

The six phono connectors—two for inputs and four for outputs, can be mounted on the rear apron and suitably identified. The power line can exit via a grommetted hole on the rear apron.

The system requires only one adjustment—the power supply voltage level. Using a dc voltmeter connected between the positive output of the supply

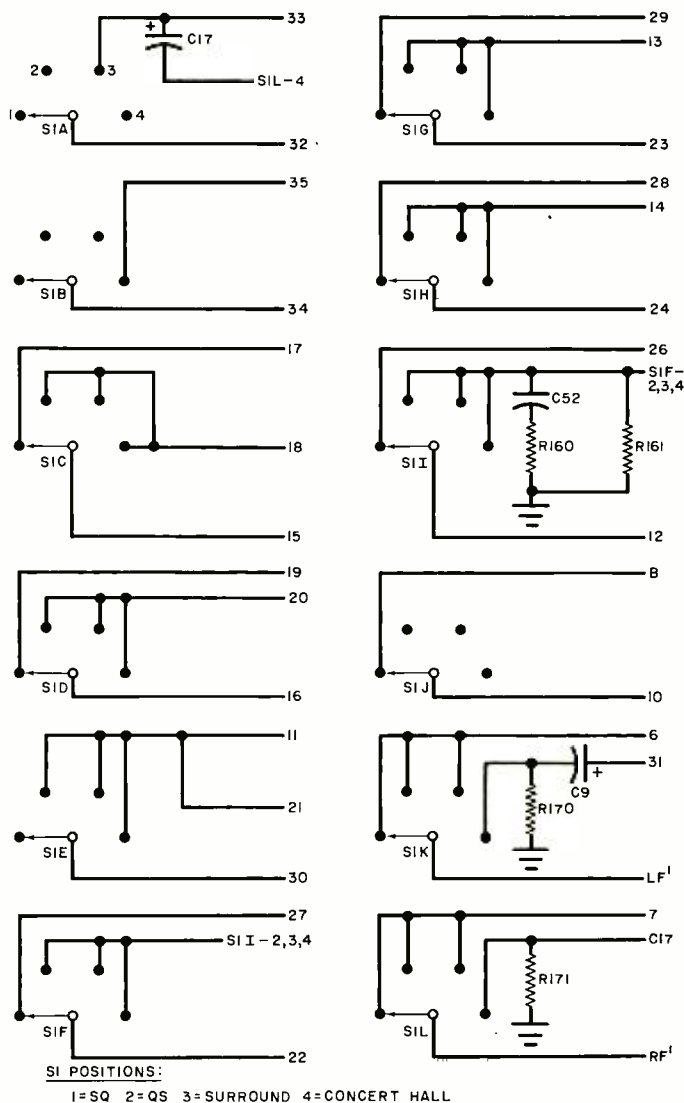

Fig. 4. Some components are mounted on function switch.

(jumper *J1*) and ground, turn on the power and note that *LED1* glows, then adjust trimmer potentiometer *R174* for a meter indication of 25 volts. Once this adjustment has been made, turn off the power and connect jumper *J1* into place.

Install the IC's, identifying each pin 1 by its index cutout and dimple. Take a last look at the board checking for correct component installation, then turn on the power. The front-panel LED should come on. Using the dc voltmeter, check the *V_{CC}* line at each of the points where the voltage is applied, according to the schematic. If the dc voltage at any point is off by more than 15%, there is an incorrect condition that must be cleared up before going further. If the power supply is functioning properly and the voltages at the IC's are incorrect, recheck the wiring and component installation. Install in the cabinet.

If all dc checks are good, connect the decoder into an operating system such as that shown in Fig. 5.

To make a final system check, the use of a QS encoded test record is suggested. One of these, the Ovation Records OVQD 4000, features musical and test-tone sequences to demonstrate that the proper channel locations and separations are being achieved.

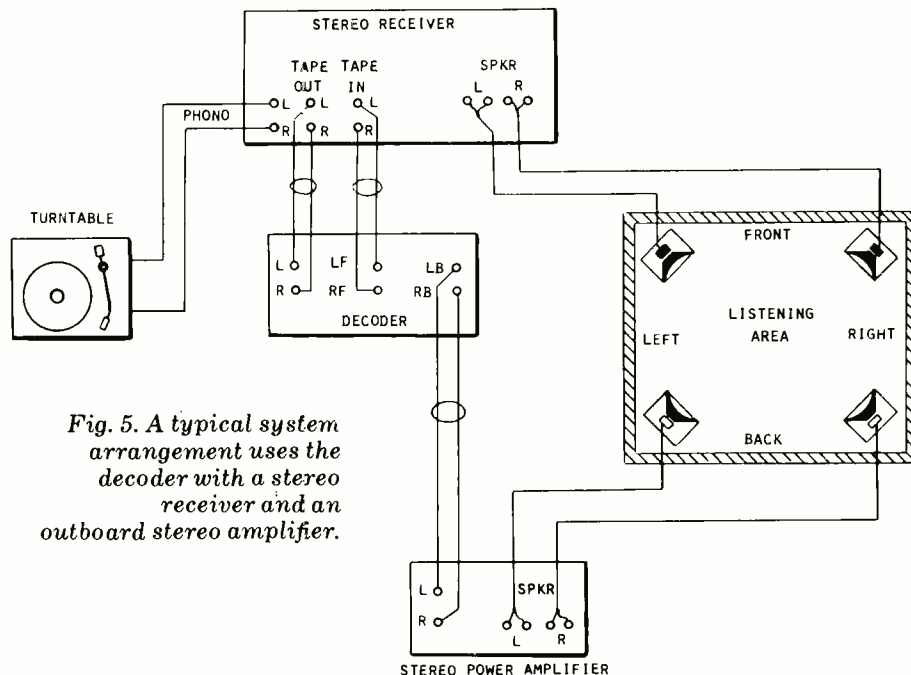

Fig. 5. A typical system arrangement uses the decoder with a stereo receiver and an outboard stereo amplifier.

To test the SYNTHESIZER mode, a stereo record such as Pink Floyd's "Dark Side of the Moon" (SMAS-1163), using the cut "Money," will show the quality of synthesized four-channel music that can be obtained from a stereo disc.

To test the CONCERT HALL mode, any

good classical recording with reasonably good ambience will demonstrate the desired effect.

For SQ testing, either an SQ test record, or a musical selection such as the Bill Chase recording "Chase" (EQ-30472), using the cut "Open Up Wide," can be used. ◇

Get More from Your Car with a Mark 10 System.

The best-selling CDI system of its kind in the world—now at discount prices!

Would you like more power? Better mileage? And could you stand to eliminate 3 out of 4 of those expensive tune-ups? Well, that's what the MARK 10 capacitive discharge electronic ignition system is all about. Very simply, it boosts the spark to your engine—promoting better combustion, and minimizing combustion contaminants. Spark plug life is extended, all-weather starts are insured, and you can feel an increase in acceleration and overall engine performance—no matter what kind of car you drive. Learn more about a MARK 10 CDI system for your car (and take advantage of year-end discount prices), when you write today for a catalog and price list.



DELTA PRODUCTS, INC.
P.O. Box 1147, Dept. PE
Grand Junction, CO 81501
(303) 242-9000

I want to know more about Mark Ten CDI's. Send me complete no-nonsense information on how they can improve the performance of my car.

Name _____
Address _____
City _____ State _____ Zip _____

CIRCLE NO. 21 ON FREE INFORMATION CARD

Three "power mike" gift ideas from Telex.

"Power mikes?" you say, "but two of them look like headsets." And you're right! And if you're a seasoned CBER

ready to move up, take a second look at the aviation-type Telex CB-88 power-mike headset. Your CB listening is private; lets others around you visit, relax or sleep without a blaring speaker. You hear better and transmit better. Weighs less than 3 oz. Uniquely, you can wear it without the headband by attaching it to your eyeglasses (adapter included). Check out the CB-1200, especially right for high-noise environments, and the aviation-inspired Double-Header power mike. Then move up to Telex, the quality standard of the aviation communications industry, now producing the most powerful CB gift ideas around. And if you want to drop a loud-and-clear hint, just tear out this ad and leave it where your gift-giver will find it... or take it to your Telex CB dealer for a gift-idea demonstration.

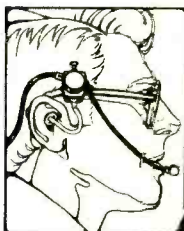

Can be worn without headband. Easy-to-use eyeglass adapter.

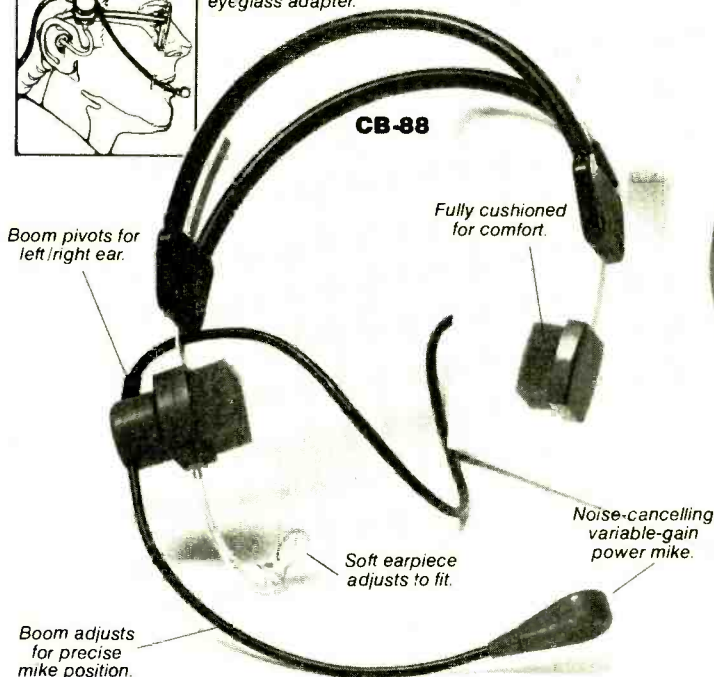

Use as conventional power mike or as superior noise-cancelling, power mike thanks to Double-Header feature.



Style used by pilots around the world, fits every hand.

Built-in variable gain power amplifier.

Front mount ends mike fumbling. Mike comes off bracket in talk position. Rear mount also included.

Long-life coil cord.

The Pilot People

TELEX

COMMUNICATIONS, INC.

9600 Aldrich Ave. So., Minneapolis, MN 55420 U.S.A.
 Europe: 22 rue de la Legion d'Honneur 93200 St. Denis, France
 Canada: Telak Electronics, Ltd., Scarborough, Ontario.

CIRCLE NO. 72 ON FREE INFORMATION CARD

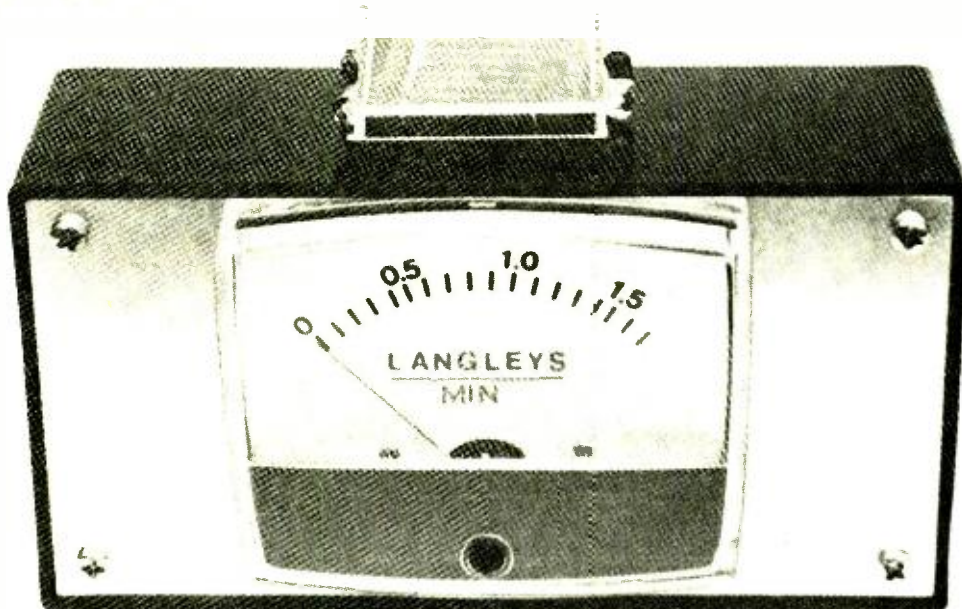

Measure the sun's energy with A SOLAR RADIOMETER

BY WARREN JOCHEM

WITH INTEREST in alternate sources of energy at an all-time high, a definite need exists for simple, reliable instruments to aid the experimenter. This project—a solar radiometer—is one such device. It will enable you to plan and set up solar energy converters with maximum efficiency.

Solar radiometers are by no means new. Many of us have seen Crookes radiometers, which are partially evacuated glass bulbs containing rotating vanes silvered on one side and darkened on the other. When exposed to bright light, temperature imbalance causes the vanes to spin. The brighter the light source, the faster the vanes will move. But such devices are really "conversation pieces." Commercial instruments which measure solar radiation accurately are very expensive. But this project, composed of a silicon solar cell, a milliammeter, and a shunt resistor, will measure the amount of sunlight falling on a given area. It will do so with reasonable accuracy (about 5% if the specified components are used).

Circuit Theory. The solar cell used as a light detector in the radiometer is really a large pn junction (like a diode) with one side exposed to light. Leads are attached to each side of the junction. In the presence of light of the proper

wavelength, a voltage will be generated across the two leads. When a silicon cell is placed in bright sunlight, a high-impedance voltmeter will measure about 0.6 volt across it.

If a resistance (in this case a meter and shunt resistor) is connected to the output leads, a current will flow. Reducing this resistance to a very small value (0.3 ohm in this circuit) means that the solar cell is effectively working into a short circuit. It can be shown that the short-circuit current is directly proportional to the intensity of the light falling on the cell. Also, the short-circuit current is largely independent of temperature. This is important to the accuracy of the meter if it is exposed to a wide range of ambient temperatures. Actually, the current does increase slightly with heating. If the meter is left in the bright sun for a while, its readings might be a bit on the high side.

The radiometer is calibrated in "Langleys per minute," a unit which might be unfamiliar to some readers. This unit was chosen because it is the standard used in most solar research today. Accordingly, you will find comparisons of your experimental data with existing records a very simple process as no conversions are necessary. By definition, one Langley per minute is equivalent to one gram calorie of energy falling on a

surface area of one square centimeter for one minute. In other words, one Langley per minute represents enough energy falling on one square centimeter in one minute to raise the temperature of one gram of water one degree Celsius. This statement is expressed mathematically by the equation:

$$\frac{1 \text{ Langley}}{\text{minute}} = \frac{1 \text{ gram calorie}}{\text{cm}^2 \text{ minute}}$$

For those who do not yet want to go metric, and who are more familiar with BTU's, the equation is:

$$\frac{1 \text{ Langley}}{\text{minute}} = \frac{221 \text{ BTU}}{\text{ft}^2 \text{ hour}}$$

In words, this means that one Langley per minute represents the energy falling on one square foot in one hour required to raise the temperature of 221 pounds of water one degree Fahrenheit.

The peak insolation (incident solar radiation) measured at sea level is about 1.6 Langleys per minute. With this maximum in mind, the circuit has been designed so that the meter reads 1.7 Langleys/minute full scale in 0.1-Langley/minute increments. Over the course of one year at the author's New Jersey location, the peak insolation varies from about 0.7 to 1.2 Langleys/minute. Using the meter at your location, you can estimate how much solar energy is available for conversion.

The radiometer circuit is shown sche-

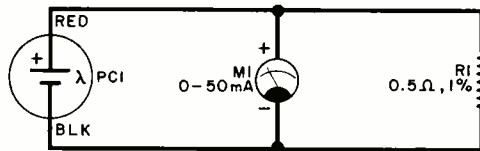

PARTS LIST

M1—0 to 50-mA dc milliammeter (Calectro D1-914)
 PC1—Silicon photovoltaic solar cell (Calectro J4-800 or Herback & Rademan TM 20K 187)
 R1—0.5-ohm, 1% resistor (see text)

Misc.—Suitable enclosure (Calectro H4-722 or equivalent), lug-type terminal strip, hookup wire, 30-gauge enamelled copper magnet wire, airplane cement or dope, general-purpose adhesive, machine hardware, solder, etc.

Fig. 1. The solar cell causes a current to flow through the meter

cell leads to the lugs observing proper polarity. The red lead from the cell is positive and should be connected to the lug holding the wire attached to the + terminal of the meter. Secure the lug connections by soldering them. Reassemble the enclosure by attaching the front panel to the enclosure body, securing it with the hardware provided.

Checkout and Use. The solar radiometer is now complete and ready for testing. Position the project near an incandescent lamp. The meter needle should move upscale. If it deflects downscale, the meter leads are reversed.

Using the radiometer is easier than using a light meter. To measure the peak solar radiation at a particular moment, aim the cell directly at the sun and record the maximum reading. This value represents the energy one square centimeter of a solar panel would receive if it were pointed directly at the sun. But very few solar panels are built to track the sun—most are pointed south and tilted upward at an angle approximately 10° greater than the local latitude. By positioning the radiometer in this manner, you can measure how much solar energy a panel would receive in practice.

To calculate the total energy reaching this type of installation over the course of a day, mount the radiometer on the top surface of the panel. Take meter readings frequently throughout the day.

Plot the radiometer readings (L) versus time (t) on Cartesian graph paper. The L axis should be scaled with 0.1-Langley/minute increments, and the t axis should have 10-minute increments.

matically in Fig. 1. Current from photovoltaic (solar) cell $PC1$ flows through $M1$, a 0 to 50-mA meter, and shunt resistor $R1$. This resistor, consisting of a length of 30-gauge magnet wire wound on the body of a 2-watt, 1-megohm carbon resistor, bypasses some of the current around the meter, thereby expanding the range of light intensity to which the meter will respond. A new meter face calibrated in Langleys per minute is applied over the old one for direct insolation readout. Note that the prototype was calibrated only for the parts specified. Do not substitute any others or the accuracy might be adversely affected. However, you should have no problem finding the parts listed because they were chosen for their availability.

Construction. Begin by carefully removing the cover of meter $M1$. The cover should snap off. Remove the two small Phillips head screws that hold the face plate in place. Cut out the new scale shown in Fig. 2 and cement it over the old scale using a general-purpose adhesive. Then carefully reattach the plate (after the adhesive has set) to the meter body, securing it with the two small screws. Snap the meter cover back on the meter assembly, making sure to position the cover's zero-adjust screw in the thin metal slot on the meter movement. Fashion a 1.75-inch (4.4-cm) diameter mounting hole on the center of an appropriate enclosure's face plate and mount the meter in it.

Remove the solar cell and padding from the small plastic box it comes in and drill two small holes in the black bottom of the box. Position the holes to allow the leads from the solar cell to pass directly through the box when the cell is centered in it. Then center the box—black side down—on top of the enclosure (see photo). Drill two holes on

the top of the enclosure to line up with those in the photocell box. Replace the foam padding and feed the output leads of the solar cell through the small plastic box into the project enclosure. Center the solar cell—blue side up—making sure it is level. Then close the transparent lid of the box. Glue the bottom of the box to the top of the enclosure, making sure that it is centered and that the cell leads pass freely into the case.

Mount a lug-type terminal strip on the left inside wall of the enclosure.

You now need a 0.5-ohm, 1% resistor. If you can find a commercial component, you can use it. If not, you can make one yourself. Prepare a 57-inch (144.8-cm) length of 30-gauge enamel-covered copper magnet wire, scraping the insulation from both ends so the wire can be soldered. Then solder one end to a 2-watt, 1-megohm carbon resistor. (Actu-

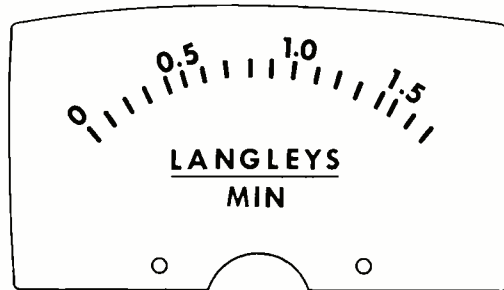

Fig. 2. Cut out this scale for the meter and attach it to the meter faceplate.

ally, any 2-watt, carbon resistor greater than or equal to 100,000 ohms is suitable.) Coil the wire around the body of the resistor and solder the free end to the other side of the resistor. Coat the wire with model airplane dope or glue to hold it in place.

When the dope is dry, attach the resistor leads to two lugs of the terminal strip. Connect short lengths of hookup wire from both sides of the resistor to the meter terminals. Then attach the solar

If these scaling factors are used, one block on the graph paper represents one calorie per square centimeter. To determine the amount of energy per square centimeter that reached the solar panel in the course of the day, you must "integrate" the curve by finding the total area under it. The simplest way to do this is to count the number of boxes and fractions of boxes lying under the curve. This total will be all the energy falling on one square centimeter of the panel for that

day. To find out how much energy was available to the entire panel, multiply the area under the curve (in calories/cm²) by the total area of your solar panel (in cm²).

It should be stressed that the total *available* energy is not the total energy output of the solar energy converter. Solar heating panels are never 100% efficient, but average 70 to 80% for flat-plate water heaters. Any good physics or solar energy book will outline steps to measure actual efficiency. Remember that, 'due to variations in components and measurement techniques, your measurements will be accurate to about ±5% at best. This is fine, however, for "backyard experiments."

Other Uses. There are several other applications for this project. It can be used as a transmittance/reflectance meter to measure the percentage of solar energy transmitted or reflected by a particular material or surface. The radiometer can also be used as a pyranometer to measure radiation from the sky. Simply point the solar cell straight up. Readings taken over the course of the day should now correspond with standard meteorological data.

Relative efficiencies of lamps and other light sources can be determined. You can easily measure the electric power input (or use manufacturer's data), and the radiated output power can be calculated using this relationship:

$$\frac{1 \text{ Langley}}{\text{minute}} = \frac{0.0698 \text{ watt}}{\text{cm}^2}$$

From this data, efficiency (power out/power in) can be obtained.

Another interesting experiment uses the radiometer as an air pollution indicator. Record direct readings of solar energy as the sun is setting. On a pollution-free day, a plot of this data versus time should fall off smoothly as the length of the sun's rays' path through the atmosphere increases. However, if a large cloud of smog is hanging over a city to the west, the readings might dip sharply as the sun goes "behind" the smog cloud. This is only a relative indication, but comparisons over a period of days might point to some sort of pattern. By determining the angle above the horizon at which the readings start to dip and the distance to the city, you should be able to calculate the approximate height of the smog cloud by trigonometry. The technique will also be applicable looking east in the morning.

With a little imagination, you will surely find other applications for this useful project. ◇

DECEMBER 1976

Our Synergistic System

We make one of the finest tone arms in the world (ask the editors of AUDIC magazine) but how well it performs is dependent—at least partly—on the cartridge.

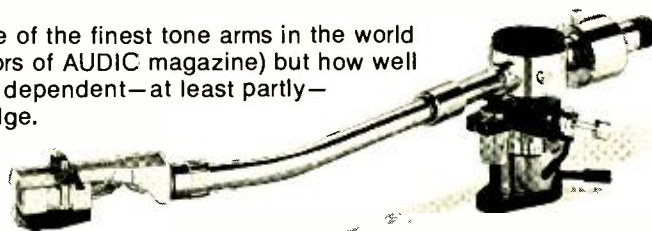

We also make one of the finest phono cartridges in the world (ask almost anyone about the AT20SLa) but how well it can perform is governed at least in part by the tone arm.



But even the finest combination of cartridge/tone arm is influenced by how clean the records may be... and how clean the stylus is. So we have both a superb manual and automatic record cleaner, and a fine stylus cleaner.



And of course the whole system works best only if it is free from such things as acoustic or mechanical feedback (especially with a cartridge having subsonic capabilities like ours), and excessive cable capacity.

We solve these problems neatly and effectively with our AT-605 Audio Insulator and AT-610 Low Capacity cable set.



Finally, we also make one of the finest headphones in the world (ask Len Feldman) our incredible AT-706 that makes all the care that went before audibly worthwhile.

Any one of these components in your system can assure you of the very finest standard of performance— from that component. All of them *together* provide an unparalleled listening experience.

Start anywhere in our system. You'll soon find that as you *add* Audio-Technica products, you *multiply* enjoyment.



 **audio-technica.**
INNOVATION □ PRECISION □ INTEGRITY

AUDIO-TECHNICA U.S., INC., Dept. 126P, 33 Shiawassee Avenue, Fairlawn, Ohio 44313

www.americanradiohistory.com

HOW TO PREDICT CB RADIO RANGE

*Antenna height, ERP, noise, and sensitivity
influence effective communication range.*

BY IRA S. GERSON

OF MAJOR concern to most CB'ers is the effective working range of their communications equipment. Here we explore a method of accurately predicting range for base-to-mobile and mobile-to-base radio links. Since CB communications are limited by FCC regulations to 150 miles, we'll focus our attention on *ground wave* rather than *sky wave* signals.

Radiation from an antenna follows two routes. One component travels parallel to the earth's surface. This is called the ground wave. The other component goes up into the sky, sometimes reflected back by the ionosphere as "skip." Although the range of skip signals can be hundreds or thousands of miles, skip is a transient phenomenon at best. Apart from legal considerations, skip is presently very rare because solar activity is low, and will remain so for at least a few years in the future.

Range Predictions. By limiting our consideration to the ground wave, we can arrive at a good estimate of the consistent range of a two-way radio system. To come up with a meaningful result, three basic quantities must be deter-

mined. They are defined as follows:

●ERP or effective radiated power—a function of the r-f power output of the transmitter, losses in the connectors and transmission line, and antenna gain or loss.

●Propagation loss—a function of the heights of the two antennas, the distance between them, and the terrain loss for a given communications reliability above the median of 50% level.

●Receiver Environmental Loss—a function of ambient noise in the vicinity of the receiver, the receiver antenna gain or loss, losses in connectors and the transmission line, and the receiver's signal plus noise to noise ratio (S+N/N).

A convenient way to relate these three quantities is with the graph shown in Fig. 1. It is called a "Power Level Diagram." To use the diagram, simply find the power level which is equivalent to your base or mobile receiver's sensitivity in dBm or microvolts. Then add a quantity called the "J factor" and the propagation losses (both of these will be thoroughly developed). You can now determine the required ERP for the distance covered, or the distance that can be reached for a given ERP.

The J Factor. This is the difference between the receiver's sensitivity and the signal level required for effective communications. Studies indicate that a signal level greater than the receiver's sensitivity rating is necessary for good results. This signal level, V_a , is principally influenced by the ambient r-f noise in the vicinity of the receiver. (Note that the noise considered in an S+N/N measurement is generated by the receiver itself.) However, receiving antenna, transmission line, and connector losses will also affect the value of V_a .

To determine the J factor, you must either assume a value of ambient noise in the service area of the base or mobile transceiver or measure the noise level with the unit's signal strength meter. If you are going to estimate the noise level, you can use the following generalizations: $1\mu\text{V}$ for rural areas; 3 to $10\mu\text{V}$ in the suburbs; and 10 to $40\mu\text{V}$ for most urban areas.

On the other hand, the transceiver's S meter can be used. Keep the squelch wide open, and note the meter reading on a clear channel. Then check the operations manual of the transceiver, a product test report, or write the manu-

facturer, requesting the actual signal strengths in microvolts that correspond to meter readings from S1 through S9.

Once the value of r-f noise has been determined, refer to the graph of Fig. 2. Note that two curves have been plotted. These correspond to receiver sensitivities of 0.3 μV and 1 μV , which are the approximate lower and upper limits for state-of-the-art transceivers. Find the proper value of noise on the horizontal axis, and then determine the value of V_a . This value is then inserted in the following formula:

J factor (dB) = $20 \log_{10} (V_a/\text{receiver sensitivity})$.

Propagation Losses. These relate the ERP of the transmitting portion of the link to the fraction of the output recoverable at the receiver. Here, propagation losses over plane (flat) earth were calculated based on a base antenna height of 60 feet (18.3 m) above average ground level and a mobile antenna height of ten feet (3.05 m). One very important assumption here is that the intervening terrain is relatively flat with no high hills, deep valleys, and a few man-made obstructions. Also, additional losses of 4 dB are added to achieve a greater margin of reliability.

In many areas, the terrain is hardly ideal or flat. Accordingly, you can expect to have range decreased or increased, depending on whether the mobile is at one point on top of a steep hill or in a valley, or near the base of a tall building.

There are other factors besides contour that can make the terrain non-ideal. One such factor is ground resistivity. Although the plane earth is described as a flat, perfectly conducting surface, real earth acts as a resistance. It has been found that at frequencies near 30 MHz, vertically polarized signals passing over "good" soil (clay, loam, marsh or swamp) are affected by the contour of the surface and soil resistivity if the an-

tenna heights are less than 30 feet (9.13 m) above average ground level.

Mobile antennas fall into this category, and as a result a decrease in propagation loss of as much as 10 dB can occur. In addition to affecting propagation, earth ground can also influence the impedance of a mobile antenna and thus affect the efficiency figure of the antenna system.

Range Predictions. Having determined the J factor, you can now proceed to estimate the range for a given communications link. Referring to the Power Level Diagram in Fig. 1, the "padding" effect of the J factor is readily apparent. In Fig. 2, the influence of the J factor on V_a for given noise levels and receiver sensitivities can also be seen. The J factor and propagation losses have been considered in setting up Fig. 3, which relates ERP to distance. To simplify its use, a family of curves was plotted for the two receiver sensitivities (0.3 and 1 μV for 10 dB S+N/N) and for four levels of r-f noise (0.3, 1, 3, and 10 μV).

Suppose that omnidirectional coverage from a base station with an antenna of 60 feet (18.3 m) is desired. Assume that the ERP is four watts or 36 dBm. (This condition occurs when the transceiver r-f power output is four watts—the legal limit—and when antenna gain exactly compensates for connector and transmission line losses.) Further assume that the service area is suburban with a 3- μV noise level, and that the re-

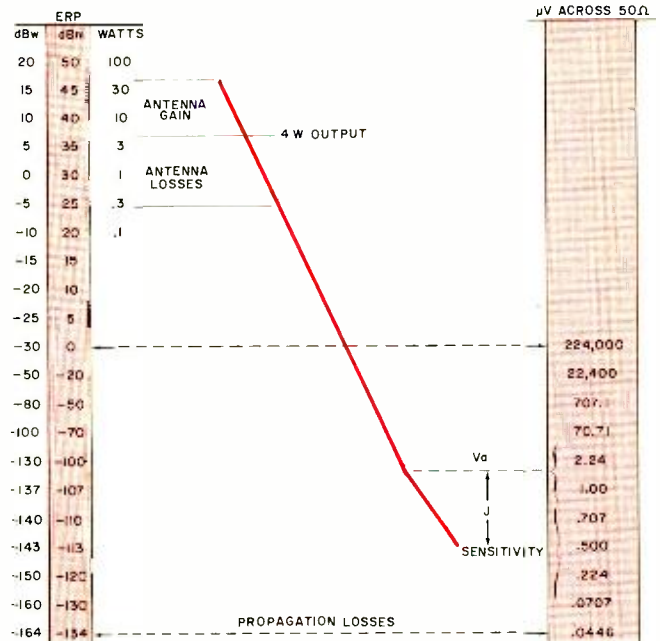

Fig. 2. Plot of V_a versus ambient r-f noise.

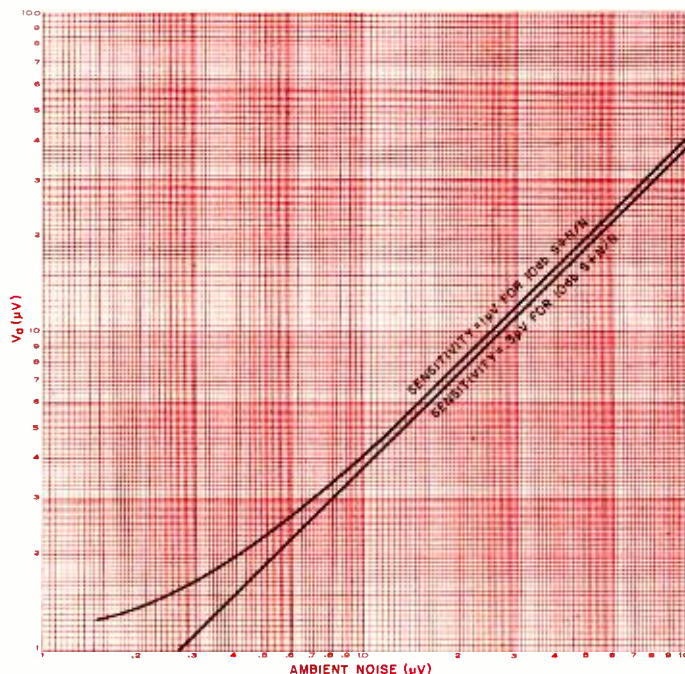

Fig. 1. Power level diagram shows relation between ERP, propagation losses, J factor and sensitivity.

The POLY 88 Microcomputer System

The POLY 88 Microcomputer System brings to the user, in one compact package, the capability of developing programs and hardware as well as enjoying the interaction with computers.



The POLY 88 System uses a video monitor for display, a keyboard for input and cassette tape for storage. The system will also connect to a hard-copy terminal. Poly 88 hardware consists of an 8080 based CPU circuit card with on-board memory and I/O, video display circuit card with keyboard input port and graphics capability, and mini-cards that connect to the CPU board via ribbon cable for cassette or serial interface.

The Firmware Monitor is integral to the POLY 88 System. This 1024 byte program in ROM allows the user to display data on a TV screen, enter data into memory using a keyboard, read and dump data to the cassette interface in Kansas City format, and single step through a program while displaying the contents of each of the 8080's internal registers.

Prices: Basic kit including chassis, CPU and video cards — \$595, \$795 assembled. Cassette option — \$90 kit and \$125 assembled. 8K of RAM — \$300 in kit form or \$385 assembled.

Dealers: This system will sell itself.

All prices and specifications subject to change without notice. Prices are USA only. California residents add 6% sales tax. Prepaid orders shipped postpaid. BankAmericard and Master Charge accepted.

PolyMorphic Systems

737 S. Kellogg Avenue, Goleta, Ca. 93017
(805) 967-2351

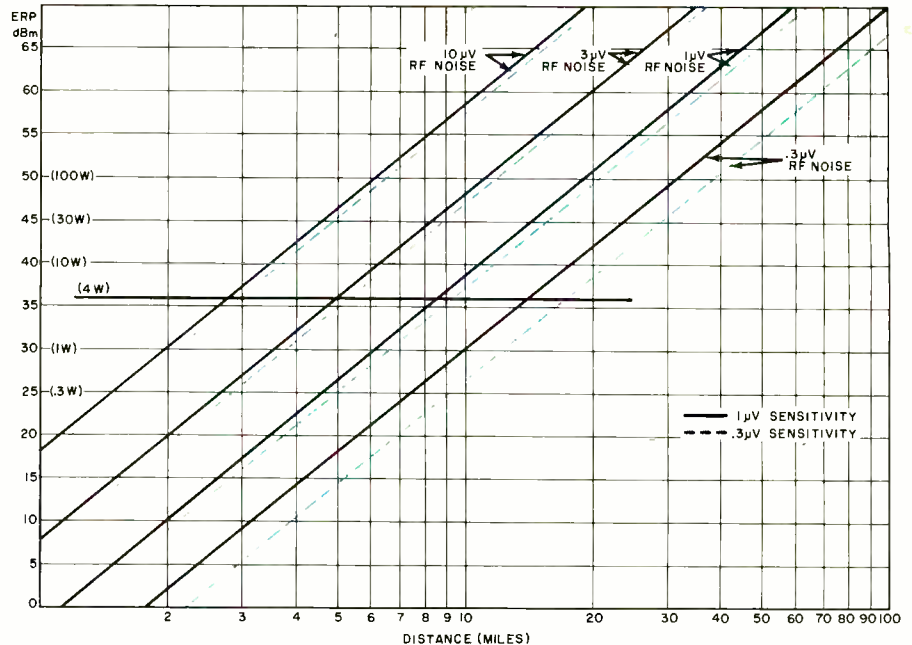

Fig. 3. Effective radiated power versus distance for two sensitivities and various r-f noise levels.

ceiver sensitivity is $1 \mu\text{V}$ for 10 dB S+N/N. Here's how the range is predicted.

Locate the 36-dBm line and proceed across until the $3\text{-}\mu\text{V}$ curve is reached. Then read the corresponding distance. In this case, it is five miles (8 km). Of course, you can work backwards and determine how much ERP is required for 5-mile coverage. Proceed down the 5-mile line until the $3\text{-}\mu\text{V}$ curve is reached, and then read the corresponding ERP value (36 dBm or four watts).

Further Comments. Mobile antennas are less efficient than base antennas, so it is obvious that mobile range will be more limited. It will typically be three miles (1.8 km). From Figs. 2 and 3, it can be concluded that, for ambient r-f noise levels above $1 \mu\text{V}$ (which is usually the case on the Citizens Band), an increase in receiver sensitivity of 333 $\frac{1}{3}$ %, say, from $1 \mu\text{V}$ to $0.3 \mu\text{V}$ for 10 dB S+N/N, reduces the required ERP only 10%. Only in extremely quiet r-f environments (under $0.5 \mu\text{V}$), which probably don't exist on the Citizens Band in even the most rural areas, will there be any significant reduction in ERP required for a given distance.

In other words, a sensitivity of $1 \mu\text{V}$ for 10 dB S+N/N appears to be adequate for most applications. However, whether an S+N/N of 10 dB is sufficient for good intelligibility is altogether another question. If a more sensitive receiver ($0.3 \mu\text{V}$ for 10 dB S+N/N) is used, providing a better ratio, say, 15 dB at $1 \mu\text{V}$, the oper-

ator has a definite advantage in terms of audio quality or intelligibility.

Another area for consideration is the relative merit of a beam over an omnidirectional antenna. Unquestionably, a beam will allow you to reduce interference (and thereby improve intelligibility) from stations in other directions than the desired station. But let's limit this discussion to the relative merit in terms of range. The maximum permissible height for an omni is 60 feet (18.3 m) above ground, natural formation, or man-made structure. For a beam, the maximum allowable height is 20 feet (6.1 m). It can be shown that if the antenna height is halved, you will require 6 dB more power to reach the same distance.

Therefore, if you now have or are planning an omnidirectional antenna with unity gain mounted at 60 feet (18.3 m), and want to weigh the advantages of installing a high-gain beam and rotor system, consider this. You must subtract 6 dB from the beam's gain because of its lower height. In terms of the graph of Fig. 3, start at 36 dBm ERP, add the beam's gain, subtract 6 dB, and proceed across the graph until the appropriate r-f noise curve is reached. Then note the predicted range. If the gain of the beam is 6 dB, the range will be the same for the omni and the beam. If gains of 9 dB or more are not available, or if the beam will not be mounted considerably higher than 30 feet (9.15 m) above average ground level, the omnidirectional antenna at 60 feet (18.3 m) above ground level is the better choice. \diamond

Special Focus on Digital Electronics

Digital techniques play a leading role in electronics today. Switching, coding and logic function methods are not difficult to grasp. And equally important, they make it possible to create many interesting electronics circuit designs. In this special supplement, many of these con-

cepts are illustrated, including projects for a digital auto fuel gauge and a shirt-pocket digital stopwatch. In addition, the first article gives many helpful hints on how the electronics hobbyist should go about choosing a microcomputer from the many available today.

How to Select a Hobbyist Microcomputer

BY STEPHEN B. GRAY
Senior Editor

DECIDING which microcomputer to buy is quite a challenge. Not only are there several dozen on the market, but they're available in a wide range of prices, with a variety of features and peripherals, and with several different MPU's (microprocessor units), such as the 8080, 6800, 6502, F8 and 6100, among others.

One of the easiest ways to narrow down your choice of a microcomputer is to decide which basic type is best for your own use. To do this requires a breakdown of microcomputer types, as in the following paragraphs.

1. Box With. The best-known type of microcomputer looks very much like a minicomputer: a box with a bunch of switches and lights on the front panel. Two hobby computers of this type are the MITS Altair 8800b and the Imsai 8080. This microcomputer type is the most widely used among hobbyists, with the widest choice of peripherals and memory expansion boards.

2. Box Without. The second type of computer is also a box, but with a bare





Type 1:
MITS Altair 8800b



Type 1:
Imsai 8080



Type 2:
Southwest Technical 6800

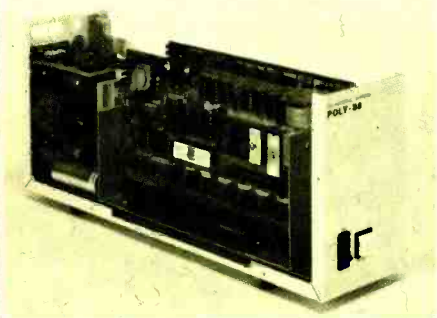

Type 2:
PolyMorphic Poly-88

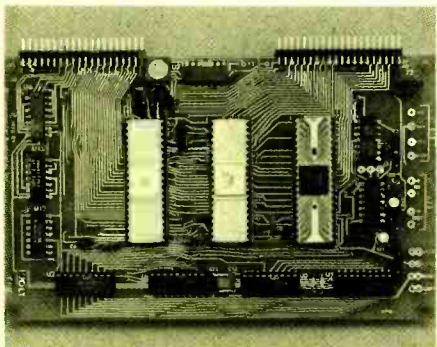

Type 3:
Microcomputer Assoc. JOLT

minimum of switches and lights. An example is Southwest Technical Products' 6800, which has only two switches, for power and reset. Only the power switch has a light.

There are two main differences between Type 1 and Type 2 computers. First, with a Type 1, you can load short programs and operate the computer manually, reading the results on the LED display. Obviously, you can't do this with a Type 2 machine. The second difference is in loaders. When you turn on any microcomputer, you can't put a program into memory until a bootstrap loader is inserted first. This acts as a set of signs to guide the program to the right places in memory. With most of the Type 1 computers, you have to load the bootstrap instructions by hand, using the front-panel switches. With most of the Type 2 computers, which have stored loaders, all you do is press RESET and the loader is inserted automatically.

However, just because a microcomputer has a full set of switches and lights isn't always a sign that the loader must be inserted by hand. The MITS 680b is a good example of a micro with switches, lights, and a bootstrap loader in permanent memory which doesn't "drop out" when the power is turned off.

Note too, that not all micros have the same internal expansion capability. This sometimes accounts for differences in size and, naturally, influences price too.

3. PC Board. The third main type of microcomputer consists of a printed-circuit board without input or output. These were first introduced for use in commercial products, or for engineering evaluation, and many are still sold for such purposes. Several recent ones are being sold mainly to hobbyists. The best-known of Type 3 are the Jolt and SC/MP.

All the computers described up to this point have neither separate input nor output. So unless you enjoy loading programs via front-panel switches (if your microcomputer has them) and reading out the program results from the front-panel lights, you'll need some more hardware. This means a keyboard for putting data into the computer, and a more sophisticated readout for checking that the program is correct and for reading the results. There is already a wide variety of keyboard terminals available, and the most common readout today is a TV screen.

4. All-On-One-Board. For those who want a complete computer with less sophisticated inputs and outputs than

teletypewriter and video monitor, there are many everything-on-one-board microcomputers. This type includes a small keyboard and some form of readout. The readout is sometimes individual LED's, but is usually segmented alphanumeric display. The KIM-1 is the best known of these, although several others are coming up fast. Two units come with a case, the Infinite UC 1800 and the Hamilton/Avnet Pacer. They have built-in power supplies, whereas most of the others don't.

Just about the least expensive Type 4 microcomputer for the hobbyist who wants to learn the basics is the Elf, featured as a construction project in the August and September 1976 issues of POPULAR ELECTRONICS. This hardware and software trainer, with RCA COSMAC MPU, toggle-switch input, hex LED display, 256 bytes of RAM, four input lines, and a latched output line, costs about \$80 to build. Memory is expandable at minimum cost.

Nearly all the computers of this type are on a single pc board; two exceptions are the Mike 3 and Mike 8, from Martin Research. Each is a stack of several boards, separated by spacers, with the keyboard and display on the console board at the top, CPU on a second board, memory on a third, etc. This modular approach permits using different CPU boards, either for the 8080A MPU, Z-80, or 8008.

The keyboard almost always has 16 hex keys for entering programs in machine language plus various control keys. These boards are popular among people who want to learn what computers are all about, at minimum cost. For those who want to go further, more memory can be added, as can be peripherals such as a full keyboard and/or a printer, to start with.

5. All-In-One Box. Another type of computer that doesn't require buying a keyboard or TV set has a built-in keyboard and CRT, such as the various models of the Sphere. Although this type of computer is expensive, it does have everything you'd need for almost any type of programming. However, you are locked into the integrated input/output system much as you are for an FM tuner when it's built into an FM receiver. A printed output can be added on, as it can to almost any hobby computer. The cost of a simple printer has decreased substantially. For example, Southwest Technical offers one in kit form for \$250, and Electronic Products Associates has an assembled printer for \$450.

Among the computers of this type, the Intecolor 8001, with an 8-color CRT, is unique. This adds an extra dimension to graphics and to just about anything you want to put on the screen.

Intelligent Terminals. A step up from most hobby terminals, which can be used only as input/output devices, is the intelligent terminal. With one of these, you can write, edit and store programs for transmission to a larger computer directly, or to a time-sharing computer over a telephone line (using a modem device).

Any hobby computer with a keyboard, RS-232 or 20-mA current-loop interface, and enough memory can be used as an intelligent terminal, of course. All you need are the right programs. The SOL terminal from Processor Technology provides these programs in the form of pre-programmed PROM's, called "Personality Modules," at three levels.

One module allows simple terminal operations. A second-level module makes SOL an editing terminal. The top-level module transforms it into an intelligent terminal as well as a stand-alone computer.

Programming. An important factor in choosing a hobby micro is to decide at which level you want to program. How much memory your computer has will determine its price and also what kind of programming language you can use.

With only a few hundred bytes of memory, you'll usually be restricted to programming in machine language, or to short programs in assembly language. Some people enjoy working in machine language, down at the bit level, using instructions such as 00111010, which is the 8080 code for "load the accumulator with the contents of the specified memory address."

But working with machine language may be boring to all but real "computer freaks." Also, you can easily make mistakes that aren't at all quickly apparent when working with only zeroes and ones. With a little more memory, though, you can program in assembly language. In order to do this, you must load an assembler into your computer's memory. This is a program that translates the assembly-language instructions, such as LDA, into machine language; in this case, 00111010.

In assembly language, you use *mnemonic* names for program instructions; these are easy-to-remember abbreviations, such as LDA for "load accumulator" and MOV for "move the contents of the accumulator to register B." To add

one number to another in 8080 assembly language takes eleven steps, including five mnemonics and three pairs of address codes. Address codes are in pairs because addresses take up two bytes; that is, groups of 8 bits. (An 8080 machine can address 2^{16} memory locations.)

The program for adding two numbers consists of these steps: load the accumulator with the number to be found at, say, memory address 128. Then take what's in the accumulator and move it to register B. Next, load the accumulator with the number to be found at address 129, and add the contents of register B to what's in the accumulator. Take the sum that's now in the accumulator, and store it at address 130. If you've previously stored numbers at addresses 128 and 129, this program will add them together and put the sum in 130. Actually, you can use any memory addresses you want, instead of 128, 129 and 130, as long as you don't select an address that's higher than the maximum address in your system.

If you'd rather write programs with mnemonics such as LDA, MOV and STA, then you need, as previously noted, an assembler program, which is also stored in memory along with your own program. For example, the MITS Altair 8800b assembler takes up 5500 bytes of memory, so if you're going to be writing programs of any real length, you'll need at least 8k bytes of memory.

But suppose you're not really interested in programming for programming's sake, but rather in what the program will do for you. If so, then you might prefer BASIC, a high-level language that will do in a single instruction, LET C = A + B, what requires eleven assembly-language instructions to do. That single BASIC instruction will store the sum of A and B in memory location C, which is determined by the BASIC interpreter all by itself, thus taking care of much housekeeping. Should you want to show the answer on your TV screen, or print it out, simply write PRINT C. Or you can combine both steps by writing a single BASIC instruction, PRINT A+B.

Just about all high-level-language programs written for hobby computers are in BASIC (there are several varieties of BASIC, each with minor differences). You can get several BASIC interpreters for some computers, requiring 4k, 8k or 12k bytes of memory. The 8k and 12k versions offer more features than the 4k BASIC. The 8k BASIC interpreter, which turns LET C = A+B into machine language, takes up 5.7k bytes of memory in

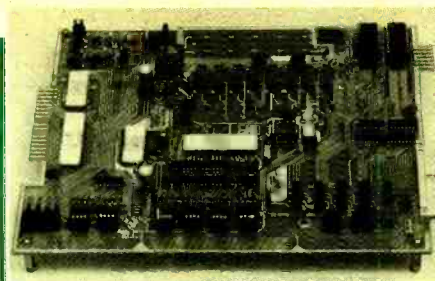

Type 3:
HAL MCEM-8080

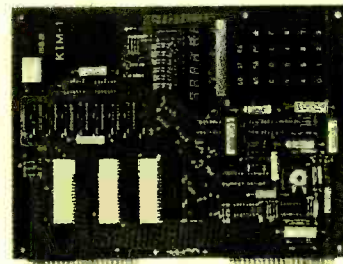

Type 4:
MOS Technology KIM-1

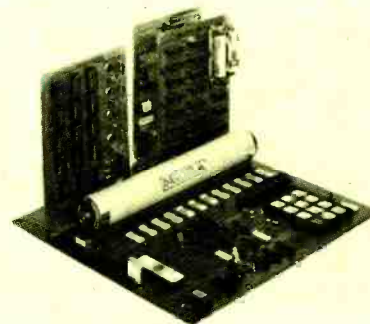

Type 4:
Intersil Intercept Jr.



Type 5:
Sphere 310

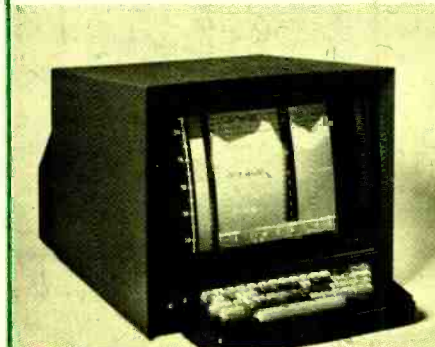

Type 5:
Intelligent Sys. Intecolor 8001

the Altair 8800b, for example. MITS specifies it as requiring 8k bytes of memory so that you'll have 2.3k bytes for your own use in writing programs. Incidentally, although many serious computer hobbyists will be satisfied with 8k or 16k of memory, many hobby computers can be expanded to 65k.

Hobbyist Bus. The MITS Altair 8800 microcomputer was the first to be sold in large volume, and set a bus standard that some other micro manufacturers have followed. This standard is based on the 100-pin bus, to which all the Altair 8800 boards are connected in common. Consequently, many other manufacturers of CPU boards, memory boards, and peripheral boards have tailored their designs so they will plug into the Altair 8800, and also into the busses of several other computers that use the Altair bus structure, including the Imsai 8080, the PolyMorphic Poly-88 and Processor Technology's SOL. As a result, there are more boards for CPU and memory, and for peripherals such as printers, disk drives, graphics devices,

cassette memory, etc., available to owners of computers using this bus.

There are other bus lines, of course. For example, the Southwest Technical 6800 computer utilizes a different bus, with a growing number of boards for it.

Price. Of the five basic types of hobby computers, the cheapest is the pc-board-only, with which you need a power supply, an input, and an output. The complete-computer-on-a-board follows, and usually requires the addition of only a power supply. Next is a box-type computer with which you'll need input and output peripherals. With a box-with-CRT type, which gives you the most equipment at a minimum cost, on a one-shot basis, you already have the peripherals, unless you also want a printed output.

Let's look at what it costs to buy a microcomputer with enough memory for the various levels of programming, taking into consideration several of the best-selling micros. The basic computer, without memory can range from \$212 to \$840 in kit form, \$500 to \$1100 assembled. These wide ranges are due to

some of the computers being full-featured models, others being "bare-bones" types. Not many 1k memory boards are being offered any more; they used to be about \$120 kit, \$160 assembled. Using just a basic 8-bit computer and 1k of memory, you could write programs containing up to about 500 instructions, if you don't mind flipping switches for hours and hours.

Stepping up to assembly language, you'll need two 4k memory boards, each of which run from \$125 to \$167 kit, \$279 to \$325 assembled. If you buy the Altair 8800b and the two 4k boards at the same time, you get a "software package" for \$75, which includes the assembler and several other programs. The Southwest Technical 6800 editor/assembler package is \$14.95.

You'll need some sort of input/output, of course. To connect your computer to your TV set requires an interface that can cost from \$40 to \$148 kit, \$60 to \$180 assembled. For keyboard input, you may be able to use the same interface if it can handle two serial I/O devices. You'll also need a keyboard termi-

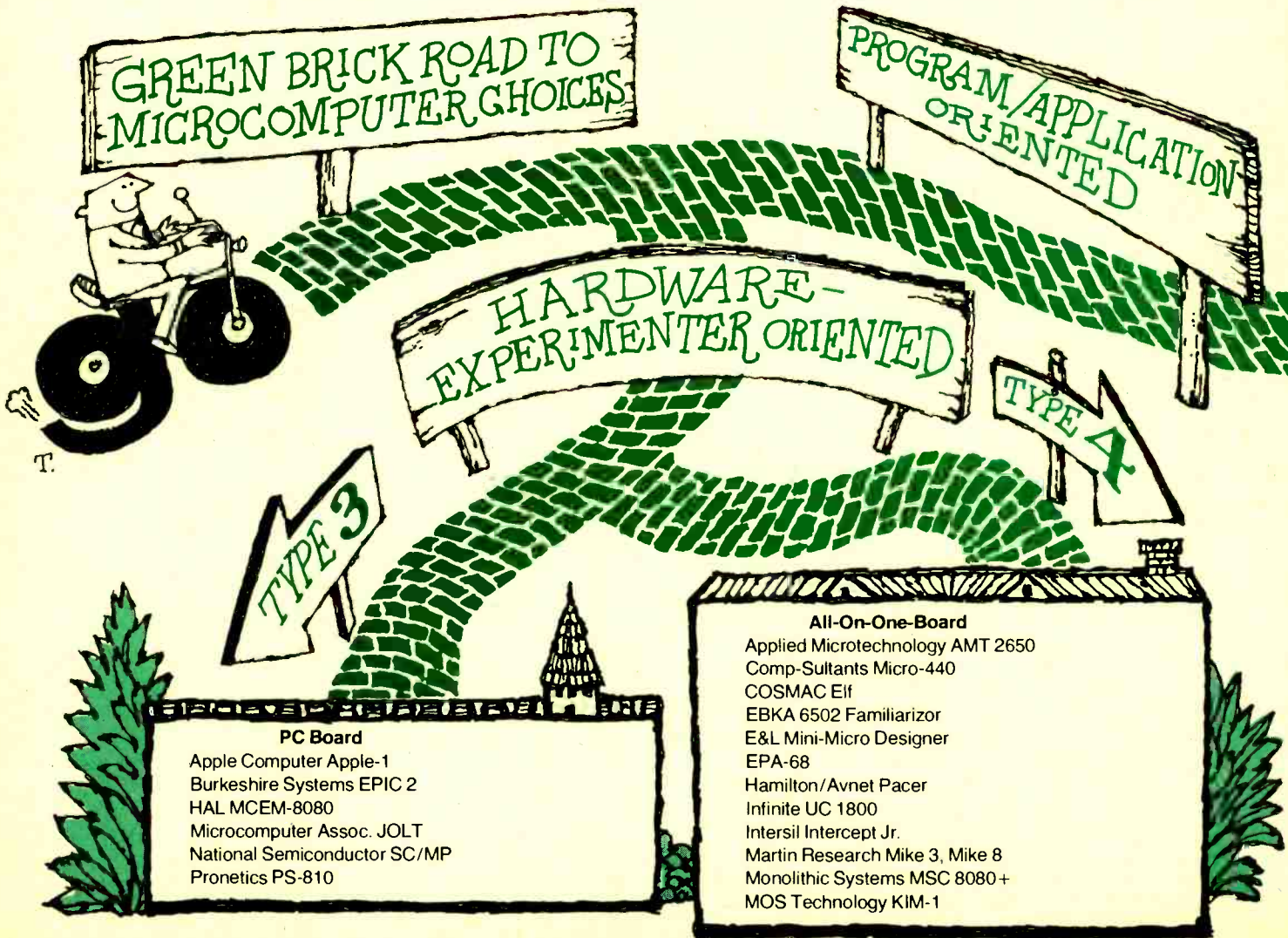

nal, such as a Model 33 Teletype. This, however, is expensive, costing between \$769 and \$1500 new, depending on what features you select. With an ASR33, you can enter a program from either the keyboard or punched paper tape. Or you could get a hobby unit, such as Southwest Technical's CT-1024 terminal. With this, the program is entered via the keyboard. The CT-1024 kit, less cabinet and power supply, is \$175; there are various options available.

Programs can be entered into the computer much faster by using a cassette. To enter the 8k BASIC interpreter into the Altair 8800b takes 12 minutes from paper tape, 4 minutes from cassette. Typical cassette interfaces range from \$35 to \$138 kit, \$65 to \$195 wired. You can buy a 4k BASIC interpreter for \$4 to \$60 depending on manufacturer. The 8k BASIC interpreter ranges in price from \$8 to \$75.

Which to Pick? A major question to answer is: will you be satisfied with programming in assembly language, or do you want to program in BASIC? If you're

sure you'll be happy with assembly language, you have two types of computers to choose from. The least expensive is the all-on-one-board computer, Type 4, such as the KIM-1 or 6502 Familiarizer, where the only extra to buy is a power supply except for a couple that have it built in. The other choice is Type 3, the pc board with no I/O, such as the SC/MP. To use one of these, you'll need a power supply, keyboard, and some sort of output, either a printer or a TV receiver or video monitor.

If you're more interested in programs than in computers, and want BASIC, you have three choices. The Type 1 computers, including the Altair 8800b and Imsai 8080, require interfaces and peripherals for input and output, as do the Type 2 machines, such as Southwest 6800 and Poly-88. You can add these at any time. You'll need no additional hardware if you buy a Type 5 computer, which has both CRT and keyboard.

Summarizing, you must decide what you plan to do with the microcomputer now and in the future, as well as what your bankbook can tolerate.

Are you determined to be an experimenter, more interested in hardware and/or learning the fundamentals of computers? If so, a Type 3 or 4 unit might be your best bet.

If you're more interested in "talking" to your computer and getting results easier and faster, but wish to add peripherals of your own choice at some future time, a Type 1 or 2 could be the way to go.

Should you want an all-in-one type of micro, with peripherals already incorporated, then perhaps a Type 5 should be considered.

There are other factors to weigh, of course, including language availability (do they have assembler or BASIC?), reputation of the computer manufacturer (how good are their computers and how long will they stay in business?), whether or not you plan to join a computer club for sharing ideas and trading information on software, and so on.

More Help. In addition to asking a manufacturer to send information on his microcomputer for performance details (see address listing), there are many

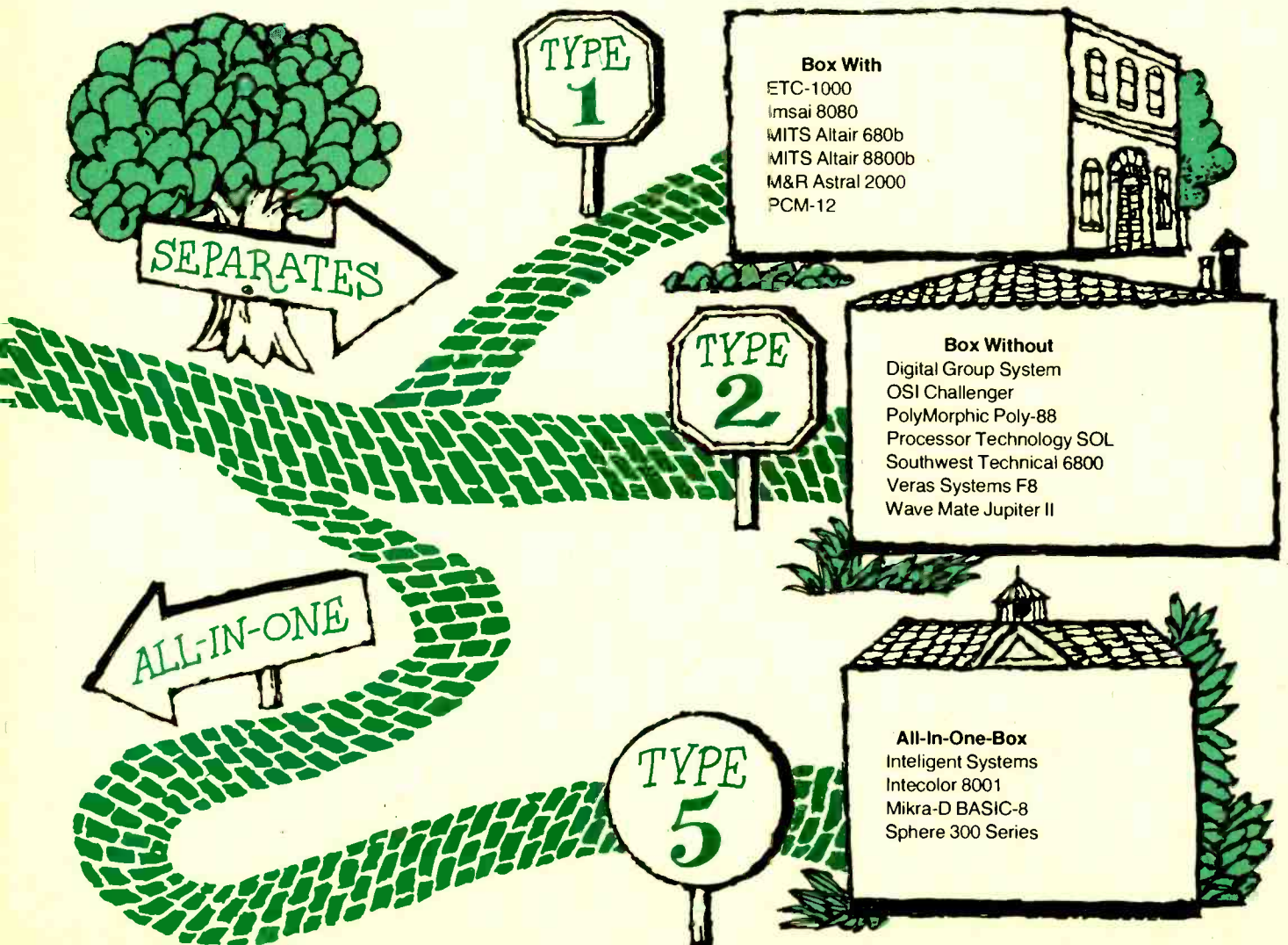

other ways to help you decide which to buy. There are over 90 computer clubs, many with membership in the hundreds, where you can talk with people who are using various hobby computers. Dozens of computer stores around the country will show you how their products work,

and answer your questions in detail. Magazines and club newsletters devoted to the computer hobbyist are also excellent sources of information. And if you get to a hobby-computer convention, such as the ones that were held in New Jersey (Trenton and Atlantic City), you

can check out dozens of computers and peripherals in a single day, as well as listen to talks about hardware, software and applications.

Whatever choice you make, you'll find yourself in a new, exciting field that will add to your knowledge and fun. ◇

DIRECTORY OF MICROCOMPUTER AND PERIPHERAL MANUFACTURERS

Apple Computer Co.

770 Welch Rd., Palo Alto, CA 94304

Applied Microtechnology

100 N. Winchester Blvd., Santa Clara, CA 95050

Burkeshire Systems

P.O. Box 512, Mountain View, CA 94040

Comp-Sultants

P.O. Box 1016, Huntsville, AL 35800

Cromemco

One First St., Los Altos, CA 94022

Digital Group, The

Box 6528, Denver CO 80206

Dutronics

P.O. Box 9160, Stockton, CA 95208

E&L Instruments, Inc.

61 First St., Derby, CN 06417

EBKA Industries, Inc.

6920 Melrose Lane, Oklahoma City, OK 73127

Electronic Control Technology

P.O. Box 6, Union, NJ 07083

Electronics Products Associates, Inc.

1157 Vega St., San Diego, CA 92110

Electronic Tool Co.

4736 El Segundo Blvd., Hawthorne, CA 90250

Gnat Computers

8869 Balboa Ave., Unit C, San Diego, CA 92123

Godbout Electronics

Box 2355, Oakland Airport, CA 94614

Hal Communications Corp.

P.O. Box 365, Urbana, IL 61801

Hamilton/Avnet Electronics

10950 West Washington Blvd., Culver City, CA 90230

IMS Associates, Inc.

14860 Wicks Blvd., San Leandro, CA 94577

Infinite Inc.

P.O. Box 906, Cape Canaveral, FL 32920

Intelligent Systems Corp.

4376 Ridgegate Dr., Duluth, GA 30136

Intersil, Inc.

10900 N. Tantau Ave., Cupertino, CA 95014

Lear Siegler Inc.

714 N. Brookhurst St., Anaheim, CA 92803

M&R Enterprises

P.O. Box 1011, Sunnyvale, CA 94088

Martin Research

3336 Commercial Ave., Northbrook, IL 60062

Microcomputer Associates

2589 Scott Blvd., Santa Clara, CA 95050

Micro Peripherals, Inc.

P.O. Box 22101, Salt Lake City, UT 84122

Mikra-D, Inc.

30 Main St., Ashland, MA 01721

MIT'S

2450 Alamo SE, Albuquerque, NM 87106

Monolithic Systems Corp.

14 Inverness Dr. East, Englewood, CO 80110

Mos Technology, Inc.

950 Rittenhouse Rd., Norristown, PA 19401

National Multiplex Corp.

3474 Rand Ave., So. Plainfield, NJ 07080

National Semiconductor Corp.

2900 Semiconductor Dr., Santa Clara, CA 95051

Ohio Scientific Instruments

11679 Hayden St., Hiram, OH 44234

PCM Company

Box 215, San Ramon, CA 94583

PolyMorphic Systems

737 S. Kellogg, Goleta, CA 93017

Processor Technology

6200 Hollis St., Emeryville, CA 94608

Pronetics Corp.

P.O. Box 28582, Dallas, TX 75228

RCA Solid State Division

Box 3200, Somerville, NJ 08876

Scientific Research Instruments Co.

P.O. Drawer 2096, Ashland, VA 23005

Southwest Technical Products Corp.

Box 32040, San Antonio, TX 78284

Sphere Corp.

P.O. Box 213, Bountiful, UT 84010

Tarbell Electronics

144 Miraleste Dr., #106, Miraleste, CA 90732

Vector Electronics Co., Inc.

12460 Gladstone Ave., Sylmar, CA 91342

Veras Systems

P.O. Box 74, Somerville, MA 02143

Wave Mate

1015 W. 190th St., Gardena, CA 90248

Wintek Corp.

902 N. 9th St., Lafayette, IN 47904

Digit Probe

BY LESLIE SOLOMON
Technical Editor

*Compact, easy-to-use logic probe
fits your finger.*

EVER SEE a logic probe that was so compact that it could fit over the tip of your finger? Although there is such a device (see photo), don't look for it commercially—you have to make it yourself. We call this ultra-compact little gem the "Digit Probe," mainly because in use it's like an extension of your index finger. Used in this manner, the Digit Probe makes it easy to trace pulses around crowded IC assemblies and pc board foil traces that all look alike.

As shown in the schematic diagrams, the circuits for the Digit Probe are basic



The Digit Probe fits on finger.

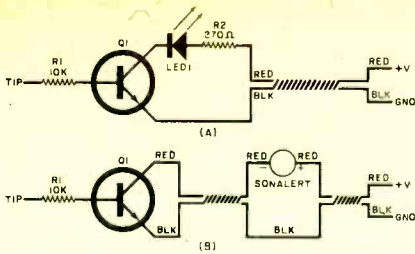

Use either a LED readout or audible signal.

HI/LO indicators. Circuit A provides a visual indication of conditions existing in the circuit under test via light-emitting diode LED1. Circuit B provides an audible indication via the Mallory Sonalert®. Circuit A is convenient for tracing pulses in an operating system, while circuit B is more convenient when you have to look away from the system under test to make equipment adjustments and can't monitor a LED.

All components (except the Sonalert) in both circuits should be kept as small as possible so that the assembled circuit can be mounted on an ordinary plastic guitar/banjo pick. Use a miniature general-purpose npn transistor for Q1 and

1/8-watt resistors for R1 and R2. Any size of color discrete light emitting diode can be used for LED1.

Construction. The Digit Probe circuit mounts directly on the outer surface of the guitar/banjo pick and is held in place with quick-setting clear epoxy cement. Assembly is very easy and non-critical, but you will have to take care to keep the physical layout as compact as possible.

Start construction by trimming both leads of the two resistors to 1/4" (6.4 mm) and bending the lead stubs into hooks. Pre-tin the head of a straight pin with solder and solder the head of the pin to one lead of R1. Solder the other lead of R1 to the base lead of Q1. Solder the cathode lead of LED1 to the collector lead of Q1 and the anode lead to one end of R2. Solder separate 36" (about 1-m) lengths of small-diameter stranded hookup wire to the free end of R2 and the emitter lead of Q1, using red and black insulation, respectively. Terminate the free ends of the hookup wire with miniature alligator clips. Finally, loosely twist together the hookup wires.

If you're planning to make the audible version of the Digit Probe, eliminate R2 and LED1. Wire the circuit as described above, locating the Sonalert about 10" (25.4 cm) from the alligator clip end of the twisted-pair power cable.

Liberalily coat the area of the guitar/banjo pick on which the Digit Probe circuit is to mount with epoxy cement. Press the circuit into the cement, orienting it as shown in the photo. Slip over the projecting straight pin a length of plastic sleeving, leaving about 1/8" to 3/16" (3.2 to 4.8 mm) near the point of the pin exposed. Coat the circuit with more epoxy cement to assure a firm mechanical anchor. Then allow the cement to cure for at least 24 hours before using the probe.

In Use. Slip the Digit Probe over the index finger of the hand you would normally use to hold a probe during tests. Clip the alligator clips on the black and red twisted-pair hookup wire to the - and + supply lines of the circuit under test. Then, using the probe is as simple as pointing your finger. ◇

BY WAYNE KASHINSKY

Build a Miniature Digital Stopwatch

Times from 1/100 s to 59 min, 59.99 s in split or Taylor modes.



THERE have been many sports timer construction articles, but never one for a project as small as this. Although this six-digit LED readout timer can measure time intervals from one 1/100 of a second to 59 minutes, 59.99 seconds, it can be held easily in the palm of

the hand and stored in a shirt or jacket pocket. Timing can be in either the split-cumulative mode (display frozen when START-STOP pushbutton is depressed and total elapsed time with each successive switch operation) or the Taylor-sequential mode (time interval displayed

between successive switch operations).

The single IC used in this timer has a built-in crystal-controlled oscillator, a low-battery indicator (decimal points come on), and internal digit and segment drivers. The output transistors can handle up to 20 mA per segment and do

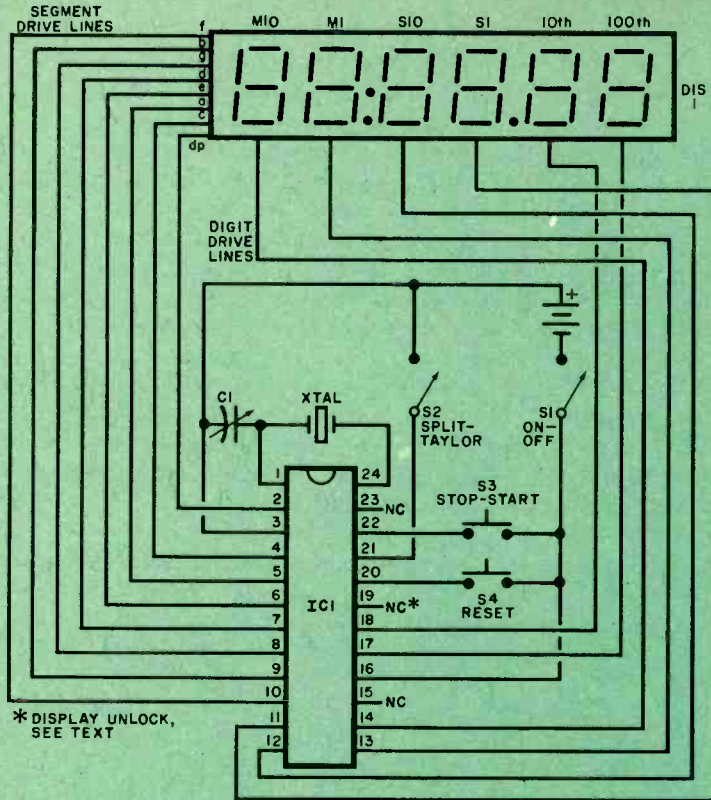

* DISPLAY UNLOCK, SEE TEXT

PARTS LIST

- B1—Three AAA cells in series
- C1—8-40-pF subminiature trimmer capacitor (optional, see text)
- DIS1—Common-cathode six-digit calculator readout stick on 2-in. board
- IC1—7205 timer (Intersil)
- S1, S2—Spdt subminiature slide switch
- S3, S4—Spst miniature pushbutton switch, normally open
- XTAL—3.2768-MHz crystal

Misc.—Plastic case and cover (Pomona 2104 or similar), 24-pin IC socket (optional), Molex pins (optional), press-on type or fine brush and white paint, hook-up wire.

Note—The following are available from AD-AGE, Box 1004, New Brunswick, NJ 08903: kit K1, consisting of IC1 and XTAL, for \$21.95; kit K2, consisting of all parts, including drilled case, except batteries, for \$39.95. Include \$1.50 for shipping. New Jersey residents, add 5% sales tax.

Fig. 1. Complete timing circuit is contained in 7205 IC.

not require external current-limiting resistors. The total average current demand is less than 40 mA so that three AAA cells or 3-N rechargeables can be used as the power source for up to 12 hours. When the battery voltage drops below 2.6, the indicator comes on. Generally, the timer can still be used for about 15 minutes after this occurs. The simplicity of the circuit can be seen in Fig. 1. A complete description of the circuit's operation can be found in the August, 1976, issue of POPULAR ELECTRONICS, p. 73.

Construction. Although any type of construction can be used, to make the sports timer as small as possible, the foil pattern shown in Fig. 2 should be used. Note that components are mounted on both sides of the board as shown in Fig. 3. The IC is mounted on the blank side of the board, preferably using a socket

or Molex pins, or it can be soldered in place, depending on the cells used.

The LED display is a conventional 2-inch calculator 6-to-9-digit stick with flat red lens. In the prototype, an NSN-66A (National Semiconductor) was used, but a brighter readout can be obtained with an NSA-1188. Other types of readouts can be used if the appropriate jumpers are made from the display pads on the board. The NSN-66A can be mounted on the foil side of the board as shown in Figs. 2 and 3. If the bottom surface of the display stick has exposed bare copper leads, cover it with a layer of masking tape to avoid shorting to the pc foil pattern. Mount the display and switches so that the tops of the switch bodies are flush with the upper surface of the display.

All wire connections to the board are made through the blank side of the board using slender flexible insulated

wire. The batteries are wired in series and formed into a small bundle.

For the prototype a small plastic case was used for the timer. It measured 2 3/8" W x 1 1/2" H x 1 1/2" D, with a fitted cover. Drill holes for S3 and S4 on one side of the case with sufficient spacing for the crystal between them. With the switches mounted on the case and connected to the proper points, solder the power leads to the AAA cells. Then fit the cells into the bottom of the case and put the pc board in the case with the display between the two switches. The edges of the pc board (and possibly the display) may have to be trimmed to make a proper fit. Insert the pc board until the upper surface of the display is just slightly below the rim of the case. The operating handles of S1 and S2 should stick above the case rim.

Once the board has been properly positioned, determine the locations of the readouts and S1 and S2 and cut the necessary slots in the cover. Install the cover and identify all the switches with a white dry-transfer lettering kit. Using the same careful techniques, apply a decimal point on the upper surface of the display just to the left of the two digits on the right end. Then apply a colon to the left of the second pair of digits.

If desired, an spst switch can be added between IC1 pin 19 and the negative side of the battery. Operating this switch will permit the display to show the running clock at any time.

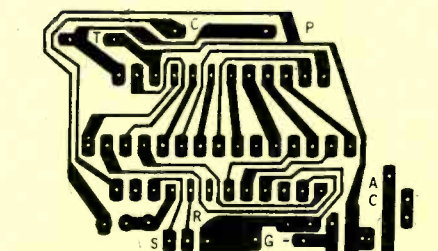
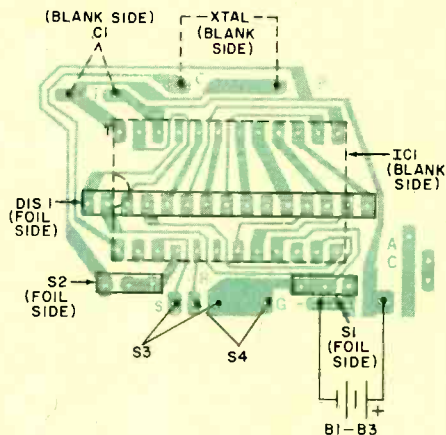

Fig. 2. Etching and drilling and component installation guides.

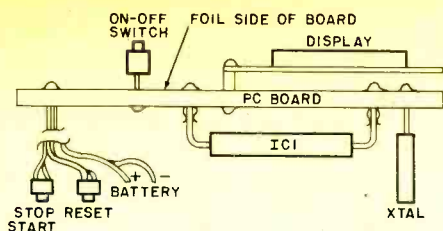

Fig. 3. Top and bottom of board.

Testing. Place S1 (ON-OFF) in the ON position and note that the display is .00. Depressing S3 (START-STOP) should cause the display to start counting in hundredths of a second. The IC has built-in automatic power-on reset and leading zero blanking so that the other digits will not be displayed until they are needed. Depressing S3 again should cause the display to stop and indicate some elapsed time.

Using the Timer. The START-STOP

If only one digit comes on and it is very bright, the internal oscillator is not working. Examine the crystal circuit. If segments are missing, check the two pc boards for solder bridges or broken traces. If a segment and digit-driver line are shorted, that particular segment will not glow.

Once the timer operates correctly, it can be checked by listening to WWV or CHU. Place S2 in the SPLIT position and start the timing on the minute signal. Check the time against the signal every few minutes to determine the timer accuracy. If the displayed time is more than it should be, mount a small trimmer capacitor (8 to 40 pF) on the pc board as indicated in Fig. 2. Adjust the capacitor and continue the timing tests until the desired accuracy is obtained.

pushbutton is used as in a mechanical stopwatch. The RESET button zeros the counter.

In the SPLIT mode, operate the START-STOP button at the beginning of an event; then once more when the desired interval (half or full lap, etc.) is finished. The display will indicate the elapsed time. However, the counter is still operating, so depressing the START-STOP switch again causes the display to indicate the total elapsed time since the start of the event. If desired, operate the RESET pushbutton to stop the counter and return it to zero.

The TAYLOR mode automatically resets the counter to zero with each operation of the START-STOP switch, and the display shows the time interval between depressions. This is a useful function when you want to time each lap in a race without resetting the timer to zero. ◇

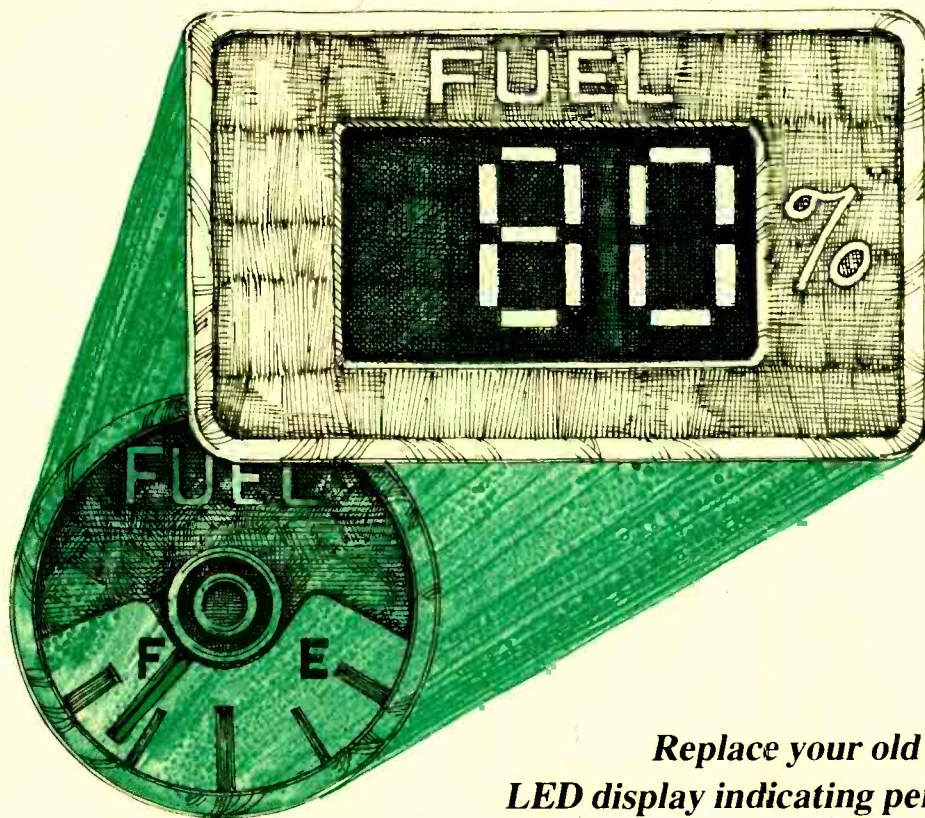

Digital Fuel Gauge

BY GREGORY BAXES

Replace your old analog meter with a bright LED display indicating percentage of fuel remaining.

THE FUEL gauge in most motor vehicles is a simple electrical meter-type movement that constantly monitors a changing current through a sensor located in the fuel tank. It is a simple matter to convert the monitoring system to a digitally generated numeric display and eliminate the uncertainties involved with reading and interpreting meter-type displays. Furthermore, a numeric display is much easier to read at a glance, which

adds up to greater driver safety on the road or highway.

The digital fuel gauge described in this article can be installed in just about any motor vehicle to display the quantity of fuel remaining in the tank in 10's of percent. It uses readily available low-power TTL logic and linear IC's and large, easy-to-read seven-segment LED displays. The entire project can be built for about \$25.

About the Circuit. The block diagram of the basic gas gauge circuit is shown in Fig. 1. Note that although the system is rigged to display three digits (to represent from empty, or 0, to full, or 100%), the units digit is a dummy seven-segment display that is always powered to show a 0; it is not driven by the circuit's logic as are the 10's and 100's digits. Since only 11 increments are actually displayed by the system, only 1½ di-

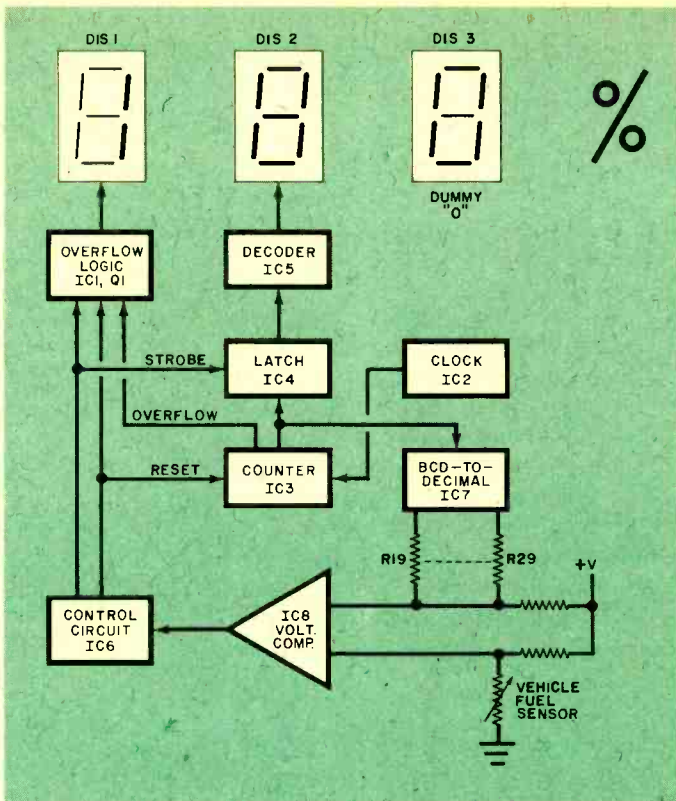

Fig. 1. Block diagram showing how gauge works.

gits are required. Hence, DIS1 is either blanked or displays a 1.

Integrated circuit IC2 serves as the clock generator for the system, operating at about 1 Hz. It drives a conventional decade-counting system consisting of counter IC3, latch IC4, decoder/driver IC5, and display DIS2. Under normal conditions, this counter simply cycles, with the clock pulses, from 0 to 9 and then generates an "overflow" pulse. In this system, however, the BCD outputs from IC3 are also coupled to BCD-to-decimal decoder IC7. The 0-through-9 outputs from IC7 and R19 through R29 generate a voltage that is proportional to the count at any instant. This voltage and a second voltage that is determined by the amount of fuel left in the gas tank are summed in voltage comparator IC8. The output of IC8 is either high or low, depending on the differential between the two input voltages.

The values of weighting resistors R19 through R29 are selected to provide 10% changes in the display count. If, for example, the tank is 50% full, when the IC3 through IC7 circuit "sees" a 5, IC8's output changes state to activate the IC6 control circuit. Dual monostable multivibrator IC6 generates a strobe pulse to cause a 5 to be displayed by DIS2. Shortly after this, IC6 generates a reset pulse to allow the circuit to cycle again. In our example, the display system will indicate 50%.

The only time the system displays 100% is when the gas tank is full. At this time, IC3 counts through 9 and goes to 0, generating an overflow, or "carry," signal. The carry signal passes to the overflow logic and is used to turn on the 1 in DIS1 when the strobe pulse appears.

The reset pulse will return the system back to 0 so that the cycle can repeat. Thus, the display is updated every second or so, depending on the rate of the clock. The display will not flicker, however, because the latch in the used 1½ digits will maintain power to the digits between strobe pulses.

Although, with slightly more logic, the gas gauge could have been designed to provide a full 100-step resolution, an 11-step resolution was selected for practical reasons. A greater than 10% resolution would have resulted in an annoying fluctuation of the numerals displayed by DIS3 as the motion of the vehicle caused the level of the gas in the tank to rise and fall.

The complete schematic diagram of the gas gauge is shown in Fig. 2.

Construction. You can use either a printed circuit board of your own design or perforated board to assemble the gas gauge. In either case, it is recommended that you use sockets for all IC's to obviate the possibility of heat damage to these components during soldering. It

is also suggested that you use two boards—one for the display and a second for the rest of the circuit. Use color-coded hookup wire for the interconnections between the boards.

There are three external connections to be made for the gas gauge: +12 volts to the vehicle's electrical system, vehicle ground, and the "hot" side of the fuel sensor. This is most practically accomplished with the aid of a three-lug screw-type terminal strip mounted on the rear of the case in which the circuit is housed. Additionally, if you prefer, voltage regulator IC9 can also be mounted on the case, provided the case is metal, for heat-sinking purposes.

Note in Fig. 2 that the values of resistors R19 through R29 are not specified. These resistor values must be determined for the specific fuel sensor with which the gas gauge is used. To determine the values of these resistors you must first locate the "hot" lead of the fuel sensor going to the meter on the vehicle's dashboard. Break this lead so that you can measure the sensor's resistance between the lead and ground.

There are two ways to obtain a relatively accurate list of fuel-sensor measurements. First, you can drive your car into a gas station with your car's meter-type fuel gauge still connected and registering empty. (Do not completely empty your tank of gas. If you assume an empty tank when the gauge reads empty, you will have a margin of safety when your tank runs low.) Have the attendant fill your tank to full and keep a record of the amount of fuel required to fill the tank. Divide the number by 10. You now know gallons at each 10% point. Then the next time you go for a refill, disconnect the "hot" sensor lead from the meter and have the attendant fill your tank in the previously noted 10% increments while measuring and logging the sensor's resistance at each 10% point.

The second way is to estimate the 10% marks on your car's meter-type fuel gauge, marking these points on the meter's faceplate with a grease pencil. Fill your tank to full, install a switch in the sensor's "hot" lead, and (with the switch closed) drive around until the meter's pointer registers 90%. Pull over, open the switch, and measure the sensor's resistance. Repeat this procedure until the meter registers empty, keeping a log of your measurements. Again, do not drive your car until the tank is completely empty. Remove the switch from the sensor's hot lead.

The resistance measured for an empty tank is the value of R19 at pin 1 of IC7,

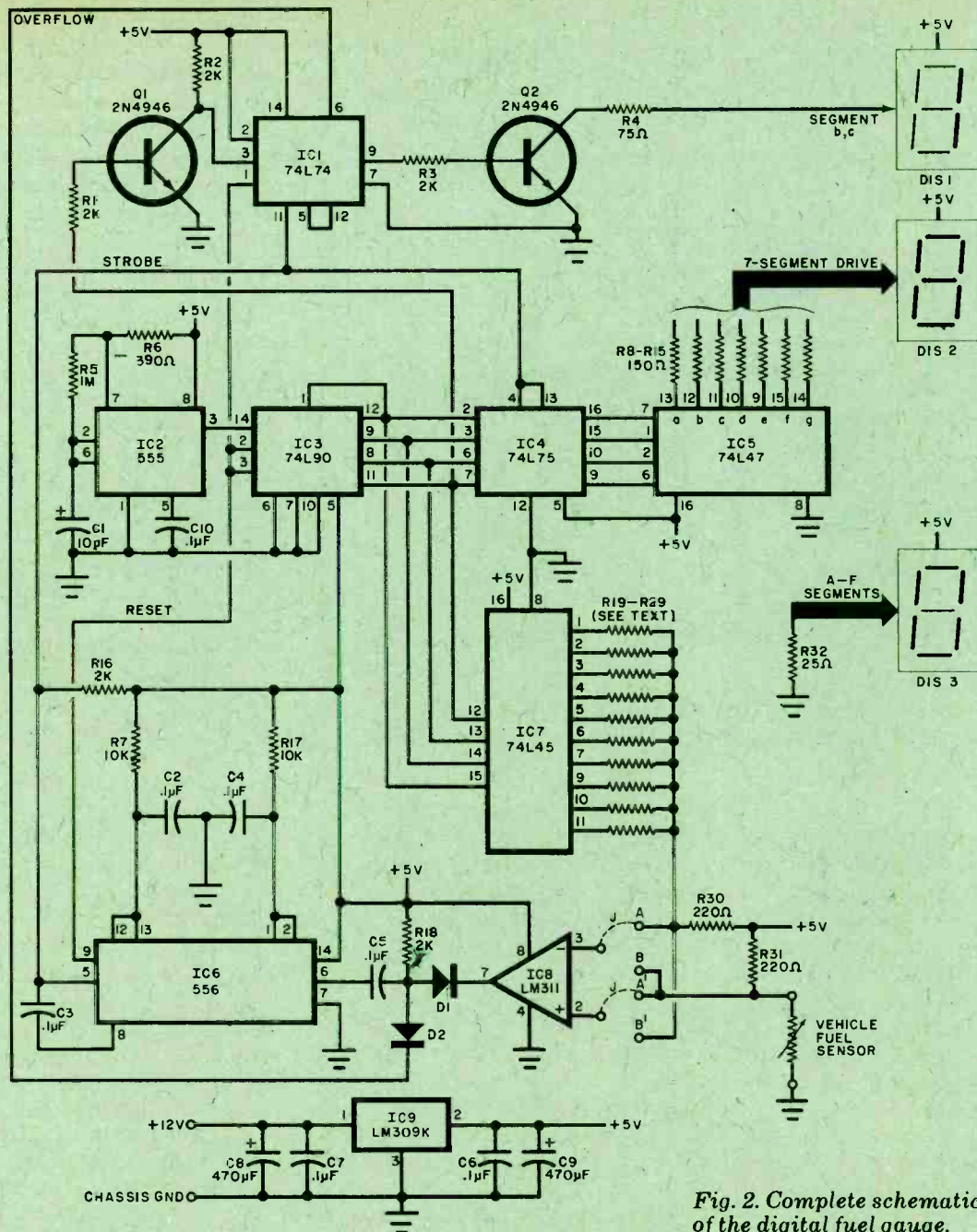

Fig. 2. Complete schematic of the digital fuel gauge.

PARTS LIST

C1—10- μ F, 10-volt electrolytic capacitor
 C2 through C7, C10—0.1- μ F, 10-volt capacitor
 C8, C9—470- μ F, 15-volt electrolytic capacitor
 D1, D2—1N4454 diode
 DIS1, DIS2, DIS3—MAN-52 (Monsanto) or any common-anode seven-segment LED display
 IC1—74L74 dual D flip-flop
 IC2—555 timer

IC3—74L90 decade counter
 IC4—74L75 latch
 IC5—74L47 seven-segment decoder/driver
 IC6—556 dual timer
 IC7—74L45 BCD-to-decimal decoder/driver
 IC8—LM311 voltage comparator
 IC9—LM309K 5-volt regulator
 Q1, Q2—2N4946 transistor
 The following resistors are 1/4 watt, 10%:
 R1, R2, R3, R16, R18—2000 ohms
 R4—75 ohms
 R5—1 megohm

R6—390 ohms
 R7, R17—10,000 ohms
 R8 through R15—150 ohms
 R30, R31—220 ohms
 R19 through R29—Trimmer potentiometer (see text)
 R32—25 ohm, 10%, 1/2-watt resistor
 Misc.—Perforated or pc board; sockets for IC's (optional); chassis box; white dry-transfer lettering kit; red plastic display window; hookup wire; solder; machine hardware, etc.

while the resistance measured for a full tank is the value of $R29$ at pin 11 of $IC7$. All other resistances are the values of $R18$ through $R28$ and fit into the circuit in consecutive order between pin 2 and pin 10 of $IC7$. (Note that pin 8 of $IC7$ goes to

ground; skip this pin when installing the resistors.) You can use miniature pc-type trimmer potentiometers for $R19$ through $R29$.

If your tank's fuel sensor resistance increases as the fuel decreases, con-

nect the inputs of $IC8$ to pins A and A' as shown with a jumper. If the tank sensor's resistance decreases as the fuel level decreases, connect the inputs of $IC8$ to B and B'

Once the digital fuel gauge project is

assembled, mount a red plastic window in front of the displays. Then, using a white dry-transfer lettering kit, label the legends FUEL above and PERCENT below the displays. (If you prefer, you can paint a white % sign on the window.)

Once the project has been assembled, it can be installed in your vehicle on top of the dashboard or in any location where it provides an unobstructed view of the displays. Make the three connections to the vehicle's electrical

system: (1) +12-volt power input line to any point in the system that is powered when the ignition is on and off when the ignition is off; (2) ground to the vehicle's chassis ground; (3) sensor to the "hot" side of the fuel sensor. ◇

An A/D Temperature Converter

BY W. J. PRUDHOMME

Use your frequency counter to measure temperature to 0.1°C resolution.

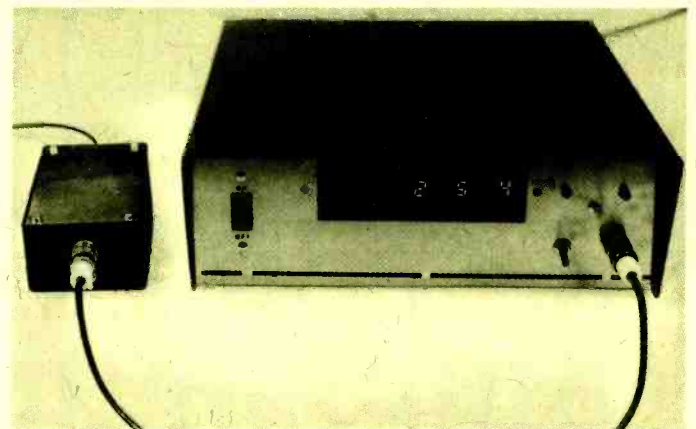

THIS project is a low-cost analog-to-digital converter which allows you to make accurate temperature measurements with a frequency counter. Its range is 0° to 100°C, with a resolution of 0.1°C and an accuracy of 0.5°C.

The circuit uses an inexpensive silicon signal diode as a temperature sensor, a dual operational amplifier IC, a unijunction transistor, and a handful of resistors and capacitors. Parts cost is less than \$10. No warm-up period is required, and the project is easily calibrated. Several sensors can be switched into the circuit to provide temperature readings at various locations.

About the Circuit. The converter's schematic diagram is shown in Fig. 1. When power is applied to the circuit, zener diode *D1* and resistor *R6* set up a reference 1-mA current through temperature sensor *D2*, a 1N914 silicon signal diode. When *D2* conducts, it exhibits a forward voltage drop of approximately 0.7 volt at room temperature (25° C). But this voltage drop is temperature dependent. For each 1° C increase in ambient temperature, the forward voltage drop decreases 2.2 millivolts. Conversely, for

each 1°C decrease, the voltage drop increases 2.2 millivolts. This voltage signal is applied to the noninverting input of *IC1A*, an op amp integrator.

When the voltage across integrating capacitor *C1* reaches a certain value, unijunction transistor *Q1* turns on, discharging *C1*. Potentiometers *R2* and *R5* set the minimum and maximum charge/discharge rates, respectively. Each time *C1* is discharged, an output pulse is generated. This pulse is coupled to the noninverting input of *IC1B*, an op amp buffer whose gain has been selected to produce a pseudo-square-wave output. The output signal, appearing at *J2*, is then coupled to the frequency counter input by a short jumper of coaxial cable.

The conversion ratio of the A/D converter is 10 Hz per degree C when properly calibrated. That is, when the measured temperature is 25.4° C, the counter will indicate a frequency of 254 Hz.

A bipolar (± 9 -volt) power supply is required. A line-powered dc source can be used, but two 9-volt transistor batteries connected in series are also suitable.

Construction. Circuit layout is not critical, so printed circuit or perforated

board can be used. Etching and drilling and component layout guides for a suitable pc board are shown in Fig. 2. Trimmer potentiometers *R2* and *R5* can be fashioned from vertical mounting types. Simply bend the three lugs on each so the controls can be mounted flat against the circuit board. Be sure to observe proper polarity and basing on the IC, and other semiconductors. The use of an IC socket or Molex Soldercons is recommended.

Temperature sensor *D2* should be connected to a length of shielded cable terminated with a phono plug. Be sure to connect the diode so that its cathode is grounded. Otherwise, false readings will be obtained. Also, it is recommended that you dip the diode in clear epoxy cement after it has been soldered. Allow the epoxy to cure for 24 hours before using the sensor. This will give a protective coating around the diode.

Connection to the frequency counter should also be made with a jumper of shielded cable terminated with proper plugs. You may want to use the same jack for *J1* as is on the counter, such as a BNC jack. Alternatively, a phono jack can be used.

Propagation Delay

The Logic Gremlin



Where those “glitches” come from and what to do about them.

LOGIC circuits usually behave very logically. For example, trigger a flip-flop and its outputs change state; or drive an inverter and the signal flips over. What could be simpler?

Unfortunately, “glitches” (undesired signals) sometimes get into a circuit and cause it to misbehave. When you look into the problem, you find that all the digital logic IC’s are good; the clock is fine and healthy; the power supply is clean and well-regulated; and the wired interconnections are all OK. But the circuit still produces erratic results!

If you are blessed with a high-quality oscilloscope, it is possible to spot mysterious glitches wandering around the circuit, appearing like that shown in Fig.

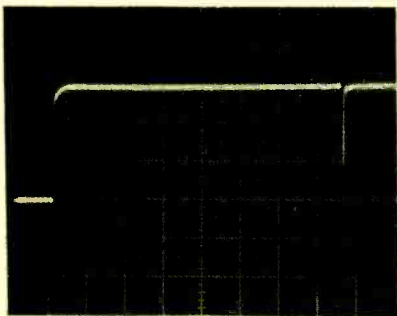

Fig. 1. Retouched photo of glitch.

1. If this signal is applied to a logic circuit, the circuit will trigger on the glitch as well as on the leading edge of the real signal. This produces an erratic result. In this article, we will discuss the sources of such glitches and how to eliminate them, if possible.

Basic Element. Let’s begin by considering the simplest logic element—the basic inverter. Although it seems that the input and output of an inverter occur in step with each other, this is *not* the

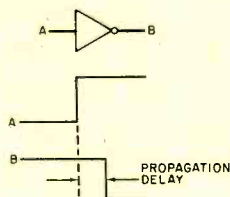

Fig. 2. Inverter output delay.

case. These devices require a finite amount of time to respond to a signal input. This “propagation delay” is shown in Fig. 2. Specification sheets for the logic device give the amount of delay to be expected. Interestingly, propagation delay is not related to waveform rise and fall time and is different for positive-

going and negative-going waveforms. To further complicate matters, many TTL specification sheets list both minimum and maximum delay times, with both specified for a standard resistive and capacitive load. Any extra capacitance in the load will simply produce more delay.

For example, if two TTL devices such as the 7400 quad 2-input NAND gate and the 7404 hex inverter are combined in a circuit that depends on propagation

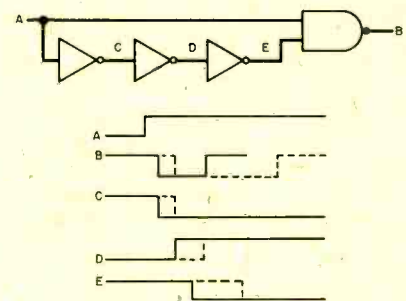

Fig. 3. Making use of the glitch.

delay (sometimes we can make the glitch work for us), we can observe the effect of typical and maximum delay times. The circuit, a propagation delay one-shot, is shown in Fig. 3 with its as-

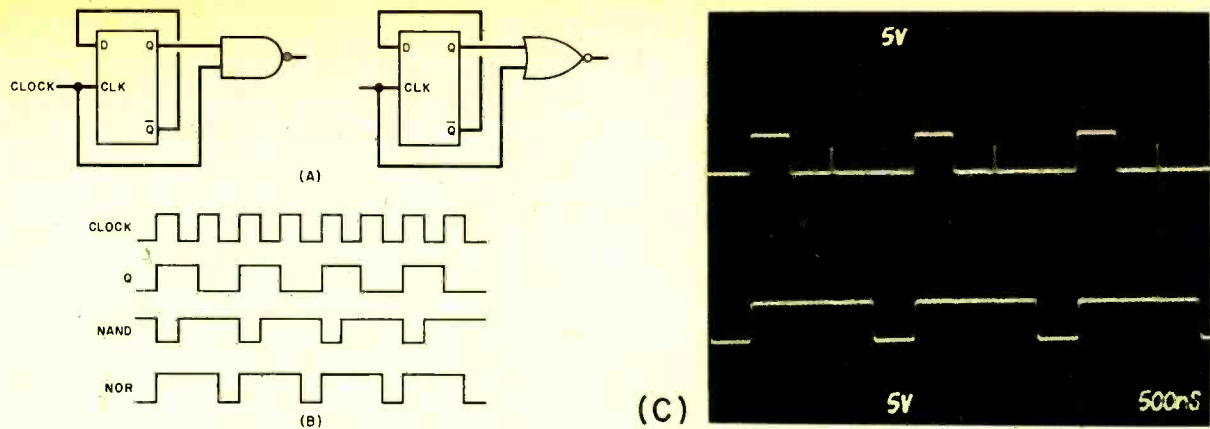

Fig. 4. Circuits in (A) should produce waveforms at (B). But (C) shows a glitch.

sociated waveforms. The positive-going edge (A) causes the output to fall one delay time later (B). At about the same time the output at (C) falls. One more delay later, output (D) rises. Finally three delays after input (A), output (E) drives output (B) high. The solid lines show an ideal situation while the dashed lines show how propagation delay affects the width of the output pulse. Note that the output pulse width depends on the combined propagation delays of the devices used.

The question then is: which delay figures should be used? The answer is: the worst-case figures. That is simple enough, but which is the worst case? The answer to that depends on the application. The designer must decide what effect a slow or fast (responding) device will have on each part of the circuit under consideration.

Predicting Propagation Delays.

Here is one method that can be used to predict whether propagation delays will cause an unwanted glitch. Two divide-by-two circuits are shown in Fig. 4A. In the circuit on the left, a NAND gate is operated by a flip-flop. In the other circuit, the gate is a NOR. Theoretically the output waveforms of the two circuits would be similar and would look like those in Fig. 4B. However, Fig. 4C shows the actual output as viewed on a scope, except that AND and OR gates were used and the top waveform was inverted from that shown in the NAND portion of Fig. 4B. Now, where did that glitch come from?

To answer this question, we will redraw Fig. 4B using a time scale of 50 nanoseconds per division and take propagation delay into account. Fig. 5A is the result. Note that the glitch is produced by the overlap between the clock and the Q output caused by the propagation delay in the flip-flop. In the case illustrated, it was assumed that the flip-flop had

maximum delay and the gates were typical devices—which makes the largest glitch. Fig. 5A does not look exactly like Fig. 4B because the latter was drawn as if the waveform transitions were instantaneous, which they are not. The effects provided by rise and fall times are shown in Fig. 5B.

So far we have considered only simple circuits. Clearly, by choosing the OR gate in Fig. 4A, we avoid the glitches. Now, suppose the design requires a source of timing signals derived from a counter. In the circuit in Fig. 6A, a 74197 counter drives a 74154 decoder to produce the waveforms shown in Fig. 6B. The circuit produces 16 sequential timing pulse outputs, but only five are shown in Fig. 6B. So far, so good. Unfortunately, if you look at the output on a scope, the waveform in Fig. 7A is the result. This is not a pretty picture! What went wrong?

The 74197 is a ripple counter. This means that the input clock toggles the first flip-flop, which in turn toggles the second flip-flop, etc. Eventually, the signal propagates to the output. The spec sheet for this device indicates a max-

imum of 60 ns delay, with a minimum of 10 ns for each stage. Next, in the 74154, the inputs are buffered by an inverter and then inverted again as necessary for the final decoding. The interlocking arrangement of inverters and gates produces differential delays and thus permits the occurrence of glitches—even if the decoder inputs are synchronized. In this case, the solution is to feed a narrow clock pulse to the *enable* inputs of the 74154, then invert the clock to drive the 74197 counter. This "de-glitcher" is shown by the dotted lines in Fig. 6A. If the clock pulse is wider than the counter delay, the output signals become as clean as those shown in Fig. 7B.

Solutions. We can now summarize the points covered and learn a little more about de-glitching:

1. Glitches are caused by unbalanced propagation delays in the signal path. In theory, the glitch of Fig. 5 could be eliminated by adding a delay in the circuit as shown in Fig. 8. This would require that both inverters and flip-flop have "typical" delay specifications.

2. In general, decoding with OR/NOR

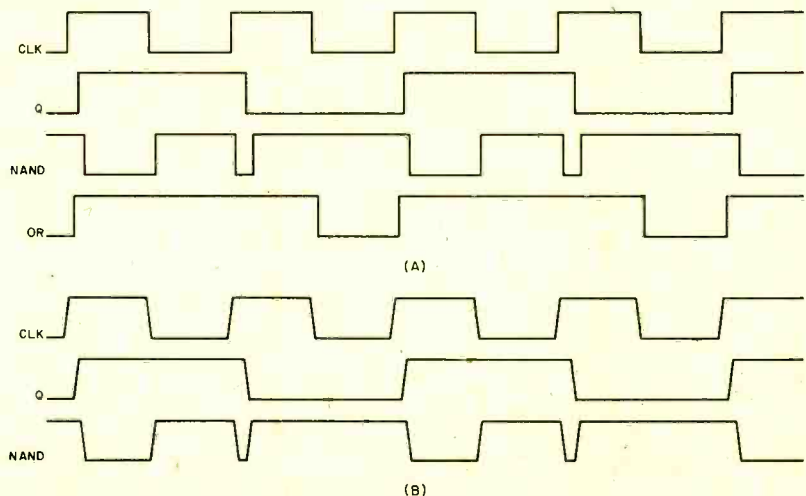

Fig. 5. Expansion of Fig. 4B shows propagation delay.

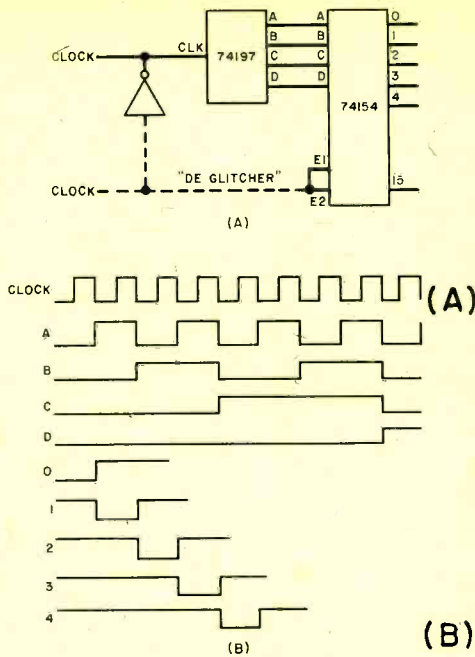

Fig. 6. Dotted circuit in (A) is added to remove glitches.

gates, as in Fig. 4A, eliminates glitches.

3. Some logic devices incorporate enable inputs, which, if properly used, can eliminate glitches.

4. Some functions can be performed differently, such as by using synchronous counters like the 74193/74163 instead of ripple counters like the 7490/74197.

5. Though some logic families such as CMOS have slow rise times and slow operation (which should eliminate glitches), remember that any logic family will respond to glitches produced by that logic family.

6. In many cases, glitches can be eliminated by flip-flop sampling. If you have a glitched output that comes from a "black box" that can't be de-glitched by simple methods, use the circuit shown in Fig. 9A. The black-box output is fed to a D flip-flop that is clocked by the system clock. Propagation delay of the black box causes the glitches to fall between the clock pulses, but the real signal is available at the correct times. Note in the Fig. 9B that the flip-flop output is free of glitches but has been delayed one

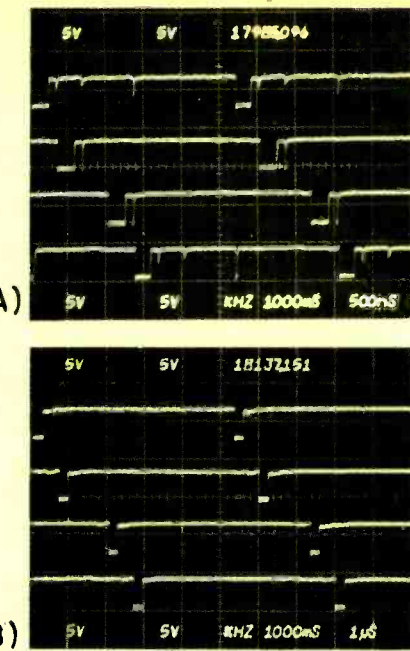

Fig. 7. Enable gating removes glitches in (A) to give (B).

clock period plus the propagation delay of the flip-flop. If there are critical timing path considerations in the circuit, then it may be necessary to make some delay adjustment in one of the other "down-stream" circuits.

7. An RC delay can be used to combat narrow glitches using the technique shown in Fig. 10A. Timing waveforms are shown in Fig. 10C. By proper selection of the RC time constant, the delay across the RC network is longer than the glitch time and the glitch disappears. For extra long glitches, it may even be necessary to use two RC networks separated by a logic gate as shown in Fig. 10B.

The RC de-glitching method is just barely acceptable for TTL logic for two reasons. The first is that since the TTL inputs require 1.6 mA drive, the resistor is limited to about 180 ohms. This requires the use of fairly large-valued capacitors—on the order of 1000 pF. Even so, the 180-ohm resistor reduces the noise immunity of the input it feeds. The second reason is that the large-valued capacitors require large drive currents from the TTL. Since CMOS logic has

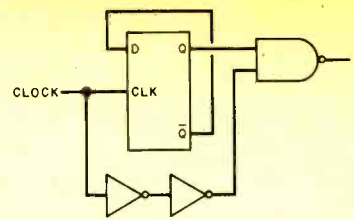

Fig. 8. Modification of Fig. 4.

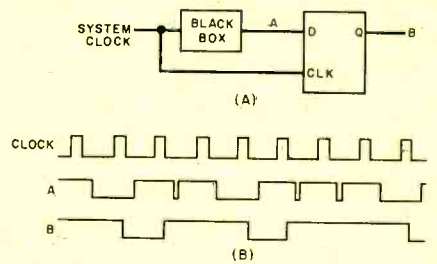

Fig. 9. Flip-flop removes glitches.

very high input impedance, the RC delay is very effective as a CMOS de-glitching method.

8. One particular type of TTL logic that will tolerate large values of RC time constants for de-glitching is the TTL Schmitt trigger. Figure 11 shows circuits and waveforms using the 7414 (hex Schmitt) and 74132 (quad 2-input Schmitt) for this purpose. It is still necessary to limit the resistor value to about 330 ohms using these devices. The CD4093 is a CMOS quad 2-input Schmitt trigger device that is very effective for de-glitching and delay using resistor values up to about 100,000 ohms.

9. A CMOS buffer (CD4010, CD4050) can be used for de-glitching, delay, and even switch debouncing with the circuit shown in Fig. 12. Feedback resistor R_2 determines the hysteresis of the circuit (the Schmitt trigger action) while the time constant of R_1/C sets the amount of delay.

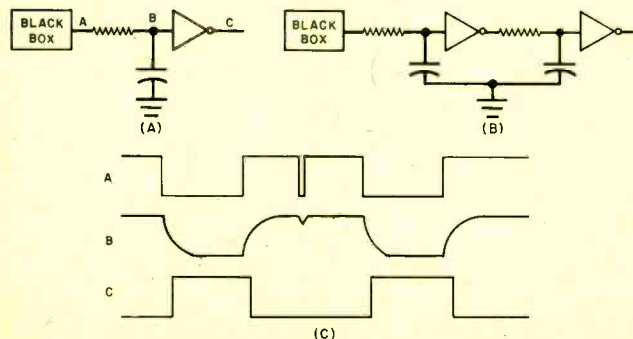

Fig. 10. RC delay can be used to remove narrow glitches.

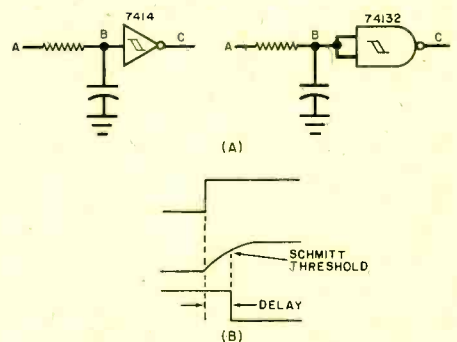

Fig. 11. Schmitt trigger solution.

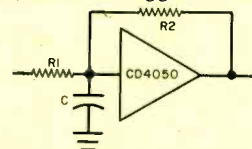
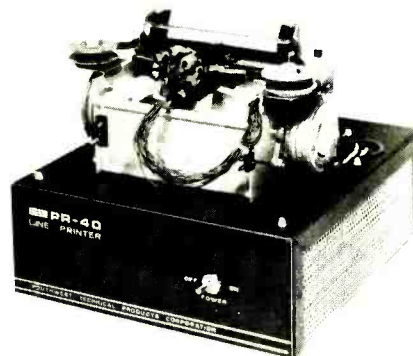

Fig. 12. CMOS de-glitcher.

NEED HARDCOPY?

If you are one of the many computer users who wants hardcopy printouts, but can't afford any of the available machines, your troubles are over. Our PR-40 is a universal printer that gives you clear easy to read hardcopy like the sample on the right with almost any computer. Our printer operates from any eight bit parallel I/O port. The printer has it's own character generator and memory buffer. This means that the computers only job is to feed data when the printer is ready. No special program is needed in the computer to convert the data to a form that the printer can use as each character is printed. The PR-40 is easy to use, easy to interface and easy to afford.

- * SWTPC PR-40 ALPHANUMERIC PRINTER *
- * 40 CHARACTERS / LINE
- * 5 X 7 DOT MATRIX IMPACT PRINT
- * USES STANDARD 3 7/8" CALCULATOR PAPER
- * 75 LINE / MINUTE PRINT RATE
- * AUTOMATIC RIBBON REVERSE
- * 64 CHARACTER ASCII CHARACTER SET
- * 40 CHARACTER LINE MEMORY
- * TTL, SWTPC 6800, MITS COMPATIBLE



PR-40 LINE PRINTER KIT..... \$250.00 PPd

HOW ABOUT PICTURES?

Games are more fun with pictures. Now you can add graphics displays to your game programs and on any type computer. Our GT-6144 operates from any eight bit parallel I/O port. It has it's own self contained memory, so memory space for the display is not robbed from your computer. The 9½ x 13 circuit board contains all you need to produce a graphic display like the one of the starship "Enterprise" shown on the left. Kit is less power supply, or chassis.

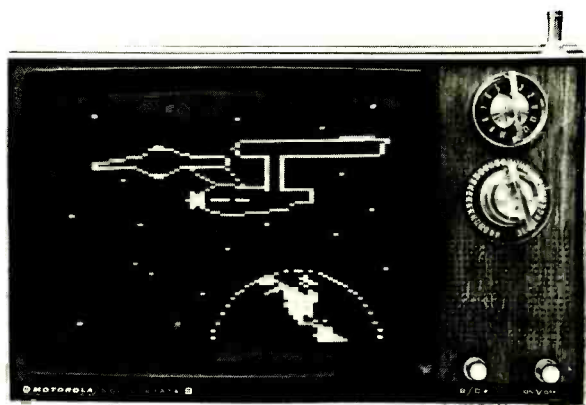

GT-6144 GRAPHICS TERMINAL KIT . \$ 98.50 PPd



I know a bargain when I see it. Send the following:

- | | | | |
|----------------------------------------------------|----------|-------------------------------------------|----------|
| <input type="checkbox"/> 6800 Computer | \$395.00 | <input type="checkbox"/> PR-40 Printer | \$250.00 |
| <input type="checkbox"/> GT-6144 Graphics Terminal | \$ 98.50 | <input type="checkbox"/> Just data (free) | |

NAME _____

ADDRESS _____

CITY _____

STATE _____

ZIP _____

Southwest Technical Products Corp.
Box 32040, San Antonio, Texas 78284

If you can see a difference, imagine what you'll hear.



Magnified, you can see record vinyl wearing away.

With same magnification, record vinyl shows no wear.

You're looking at the solution to one of the oldest problems in audio—how to protect records from wear, while at the same time preserving full fidelity.

It's called Sound Guard,* and it's remarkable.

Independent tests show that discs treated with Sound

distortion as "mint condition" discs played once.

A by-product of dry lubricants developed for aerospace applications, Sound Guard preservative is so smooth it reduces friction, yet so thin (less than 0.000003") it leaves even the most fragile groove modulations unaffected.

Len Feldman in Radio Electronics reports "At last!

The long awaited record-care product has arrived. It preserves frequency response

in a kit complete with a non-aerosol pump sprayer and

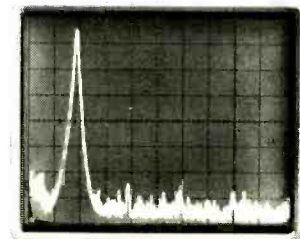

Test record played first time.

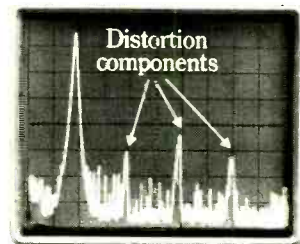

After 100 plays without Sound Guard.

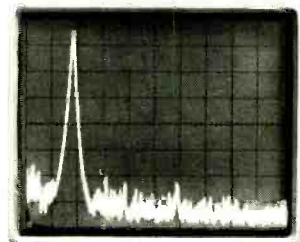

Identical test record after 100 plays with Sound Guard.

Guard preservative played 100 times display the same full amplitude at all frequencies and the same absence of surface noise and harmonic

while reducing distortion and surface noise." It's effective and safe for all discs, from precious old 78's to the newest LP's.

Sound Guard preservative,

velvet buffing pad, is available in audio and record outlets.

Sound Guard™ keeps your good sounds sounding good.



*Sound Guard is Ball Corporation's trademark for its record preservative. Copyright © Ball Corporation, 1976.

CIRCLE NO. 60 ON FREE INFORMATION CARD

Understanding Active Filters

Using op amps makes filter design easy and low-cost.

FREQUENCY-SELECTIVE filters (high-pass, low-pass, or band-pass) can be either passive or active. The former is traditionally an inductor-capacitor circuit which, particularly at audio frequencies, can be cumbersome and expensive and have a response shape that is not as selective as desired. Active filters use conventional resistors and capacitors and operational amplifiers. They are low in cost, easy to tune, not sensitive to field and hum, small and light, and are not influenced by varying load and source impedances. In addition, active filters can be easily cascaded, so that a complex filter response can be broken down into simple factored blocks that do not interact.

Where are active filters used? Electronic music is one obviously important area. Here, active filters serve as modifiers of conventional instruments, to generate new sounds by way of formant synthesis and vcf (voltage controlled filter) techniques, and to

generate the transient responses involved with bell and other percussion voices.

Biofeedback circuits that monitor brainwaves use ultra-low-frequency active filters to separate the alpha, beta, delta, and theta response waves. Active filters are also used in graphic equalizers to permit modifying the audio channel response to suit individual tastes or room acoustics. Microprocessor and computer-related uses of active filters include cassette tape sine-wave generators for data recording and transmission and reception of *modem* (modulator-demodulator) systems that send data over the phone lines.

Laboratory applications are widespread, ranging from ultra-low-frequency seismic and geophysical signal processing, to speech and hearing studies, and Doppler tracking of moving radar targets. Elaborate, general-purpose active filters are also available for many different lab situations where certain fre-

quencies must be emphasized and others rejected or minimized. These same circuits can be converted into high-quality signal sources with external feedback.

The biggest users of active filters are probably engineers at the phone company. They developed most of the math concepts behind active filters and have an incredible variety of uses for them, ranging from multiplexing of phone conversations onto a common carrier to equalization of telephone lines.

Psychedelic lighting systems use active filters to pick up an audio signal, break it down into various frequency channels, and modulate colored lights or lasers on a multicolor dynamic display.

Actually, today you can use active filters for just about any frequency selective task you can dream up, ranging in frequency from a few hundredths of a hertz to several hundred kHz or more. The most common types

of filter you'd be interested in are low-pass, band-pass, high-pass, universal, notch, and voltage-controlled filters. Now, let's take a detailed look at how you can build your own active filters.

Low-Pass. Active filters are normally broken down into building blocks that are simple and easy to tune. For fancier responses, you combine as many simple blocks as you need to get the overall desired result. One popular building block is called a *second-order section*. A second-order low-pass is pretty much flat in response up to a *cutoff frequency*. Above that, the response drops by one fourth each time you double the frequency. We say it has a cutoff slope of -12 dB per octave. A "mirror image" high-pass second-order section will have a complementary slope of $+12$ dB per octave, leveling off near the cutoff frequency and staying uniform for higher frequencies. Each of the second-order sections uses one or more operational amplifiers. For most lower frequency audio work, the 741 op amp is ideal.

Improved 741's, particularly the duals and quads (4558 and 4136 are typical) are now available at low cost. Where you really need high-"Q" values or large signal swings at high frequencies, you can turn to a super 741 such as the LM318, with fifteen times the bandwidth and 150 times the slew rate of a stock 741. Or, if you're into very-low-frequency work, it pays to raise the impedance levels of your circuit as high as possible to get by with smaller valued capacitors. The FET or CMOS op amps are ideal for this, with the 3140 being a top choice for many low-cost applications.

A pair of second-order low-pass active filters, having a 1-kHz frequency are shown in Fig. 1. Each circuit is flat to near 1-kHz and then drops at -12 dB/octave well above 1-kHz. As the frequency increases, the response continues to die out.

The first circuit (Fig. 1A) is called the unity gain Sallen-Key circuit otherwise known as a VCVS or voltage controlled voltage-source filter. Since the op amp is used as a *source follower* (a noninverting amplifier with a gain of

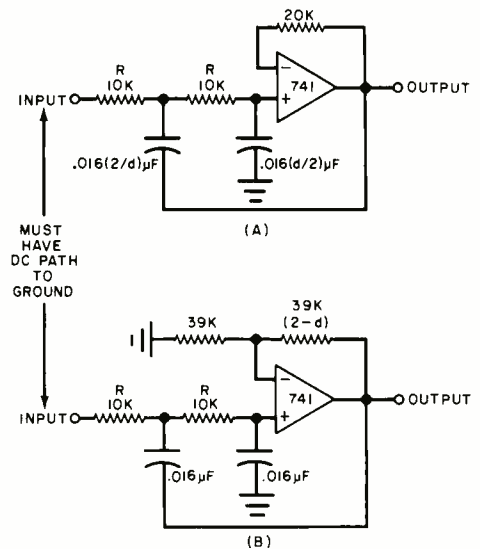

Fig. 1. Unity gain (A) and equal component (B) Sallen-Key low pass filters. See table for values of *d*.

one, a high input impedance, and a low output impedance), an ordinary transistor emitter follower can be used just as well.

How does the circuit work? It looks at the overall mathematical *transfer func-*

RESISTOR AND DAMPING VALUES FOR VARIOUS LOWPASS AND HIGHPASS RESPONSES

	First Section		Second Section		Third Section	
	Resistor R (kilohms)	Damping d	Resistor R (kilohms)	Damping d	Resistor R (kilohms)	Damping d
Best Delay Low-pass						
12 dB/octave	7.87	1.731	—	—	—	—
24 dB/octave	6.98	1.916	6.19	1.241	—	—
36 dB/octave	6.19	1.959	5.90	1.636	5.23	0.977
Flattest Low-pass						
12 dB/octave	10	1.414	—	—	—	—
24 dB/octave	10	1.848	10.0	0.765	—	—
36 dB/octave	10	1.932	10.0	1.414	10.0	0.518
1 dB Peak Low-pass						
12 dB/octave	11.5	1.045	—	—	—	—
-24 dB/octave	19.1	1.275	10.5	0.281	—	—
36 dB/octave	28.8	1.314	13.7	0.455	10.2	0.125
Well-Damped High-pass						
-12 dB/octave	12.7	1.731	—	—	—	—
-24 dB/octave	14.3	1.916	16.2	1.241	—	—
+36 dB/octave	16.2	1.959	16.9	1.636	19.1	0.977
Flattest High-pass						
+12 dB/octave	10.0	1.414	—	—	—	—
-24 dB/octave	10.0	1.848	10.0	0.765	—	—
-36 dB/octave	10.0	1.932	10.0	1.414	10.0	0.518
1 dB Peak High-pass						
-12 dB/octave	8.66	1.045	—	—	—	—
+24 dB/octave	5.23	1.275	9.53	0.281	—	—
+36 dB/octave	3.48	1.314	7.32	0.455	9.76	0.125

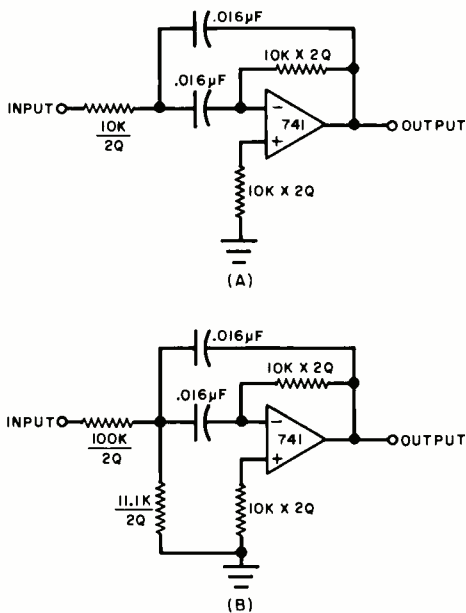

Fig. 2. Multiple-feedback bandpass filter (A) is improved at (B) to have higher input impedance.

tion for an inductor-capacitor-load circuit and synthesizes a similar result. So, while it does not actually replace the inductor, it's a simple matter with some fancy math to show that the circuit does everything that can be done with a passive inductor/capacitor filter and then some.

If the op amp weren't there, and if the first capacitor went to ground, we'd have an old-fashioned two-stage RC filter. This circuit has unity gain at very low frequencies (if not loaded), and a falloff at -12 dB/octave at very high frequencies. The problem is in-between where we'd like to have a sharp passband. Here the RC filter's response is very droopy and ill-defined.

Now, when the "ground" end of the first capacitor is connected to the output of the op amp, just enough energy is fed back from the power supply to simulate the energy storage in an inductor, and thus bolster the response as much as we want at the cutoff frequency. Very nicely, this feedback is localized *only* near the cutoff frequency. Why? Because the capacitor has too high a reactance to feed anything back at very low frequencies; and at very high frequencies, the output signal is too small to be worth feeding back. So, it's only near the cutoff frequency that the feedback has any appreciable effect.

Just how much energy do we want to feed back? This depends entirely on how much bolstering of the response

we need near the cutoff frequency, and thus determines the cutoff response shape. The amount of feedback is called " d ", short for *damping*. The larger the first capacitor is with respect to the second the lower the damping, and the more peaked the response. Values of d range from two down to zero. A damping of 2.00 is what we get with two cascaded but isolated RC sections. A d value of 1.73 will give the best possible transient and pulse response while a d of 1.41 gives the flattest possible amplitude and also a cutoff frequency that's exactly -3 dB down (0.707 voltage) from the fundamental. If we lower d further, we get a hump or peaking near the cutoff frequency. For instance, d values of 1.045, 0.895, and 0.767 correspond to humps of one, two, and three decibels respectively. If d ever hits zero, we get infinite peaking, otherwise known as an output with no input, or an oscillator.

To build the Fig. 1A circuit, we must decide what the damping is going to be, and then calculate the two capacitor values. For a flattest amplitude filter (also called a Butterworth), d will equal 1.41, and the left capacitor will be $0.02 \mu\text{F}$ and the right capacitor will be $0.01 \mu\text{F}$, rounded off to stock values.

How do we change frequency? By changing either the capacitors or the resistors marked "R" or both. The only thing NOT allowed is to change the ratio of the two resistors (from 1:1) or the ratio of the two capacitors (from $4/d^2$). The product of the resistors and capacitors sets the frequency. The ratio of the capacitors sets the damping figure.

If the capacitor values are doubled, the cutoff frequency drops to 500 Hz. If the resistance values are doubled, the cutoff frequency also drops to 500 Hz. Do both and the frequency drops to 250 Hz and so on. The capacitors can be switched in steps and a dual potentiometer used to change resistance for a 10:1 frequency change.

By the way, note that the frequency varies inversely with the potentiometer settings. This will give you a dial that's very cramped at one end and nonlinear. Two ways to beat this problem are to use pots with reverse log tapers or to use pots with standard audio log tapers but put the dial on the pot shaft and the pointer on the panel, instead of vice versa. Selector switches and stepped resistor values provide another route to frequency selection and

usually offer more precise control than ganged pots. Frequency steps can be in a linear or log arrangement.

Polystyrene capacitors are excellent for active filter use, but you have to keep them away from solvents and be careful not to nick them with a soldering iron. More expensive mica and Mylar capacitors can also be used. Under no circumstances should a disc or an electrolytic capacitor be used for filters.

There are one or two details that can cause trouble if you don't watch for them. With this circuit or any other low-pass filter, you have to bias the op amp's inputs in some way. This is usually done through the source, so there has to be a low-resistance dc return path through the source to ground. The source impedance, dc and otherwise, should be well below 10,000-ohms if it's not going to change the response. A second detail is to note that this is a true lowpass filter, so it also passes dc. Any bias, dc level, or offset voltage at the input goes on to the output, and if too large, can saturate the amplifier or limit the dynamic range. This effect can be eliminated by putting a blocking capacitor on the input, but you still have to bias your op amp. The 20,000-ohm resistor connected to the negative input isn't critical, and usually it is picked for minimum op amp offset.

While the Fig 1A circuit is simple and easy to build, we can do better. The capacitor values are hard to calculate and tend to spread widely for low d values, thus damping is hard to adjust. There's also no easy way to switch from high-

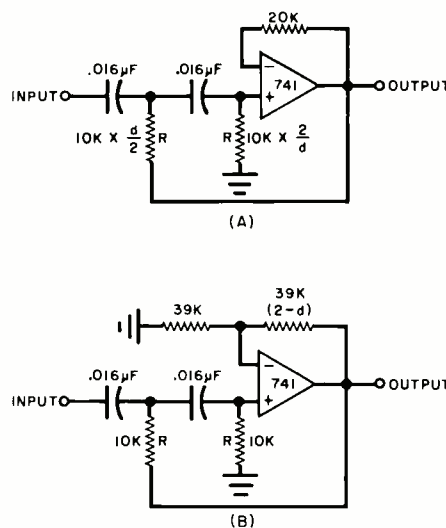

Fig. 3. High-pass filters: unity gain (A) and equal component (B).

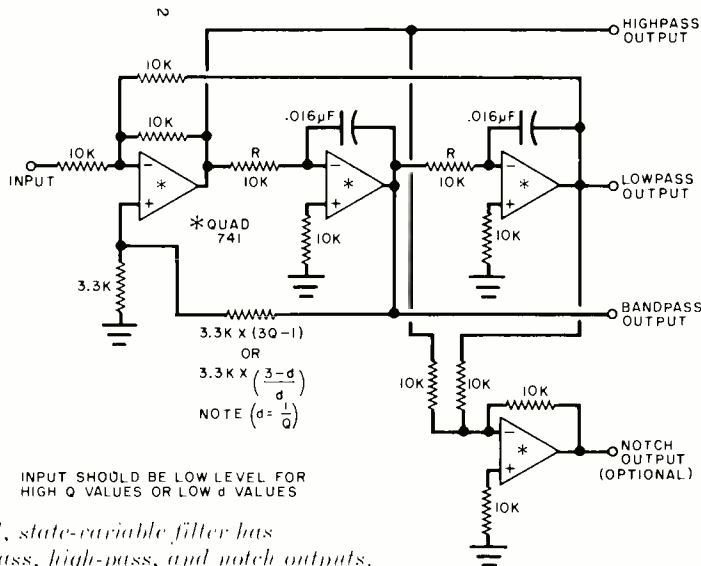

Fig. 4. Universal, state-variable filter has low-pass, band-pass, high-pass, and notch outputs.

pass to low-pass just by rearranging components.

If you go through the Sallen-Key math in detail (a very ugly process), it turns out that there is one magic value of op amp gain that solves all these problems. This is the ultra-simple and practically unknown *equal component value Sallen-Key filter* shown in Fig. 1B. The magic gain value is $3-d$, which means that you trim the damping by trimming the gain. The R resistors and the capacitors are identical values and are changed in pairs to change frequency. As an added feature, it can be changed to a high-pass characteristic with identical response simply by interchanging the resistors and capacitors.

One new detail to watch is that the feedback resistor must be held lower

than the 78,000-ohm value that corresponds to a $d = 0$ oscillator. Fortunately, the d values shown here are normally well away from this danger zone, and the gain is easily set by the ratio of two resistors.

Band-pass. Sallen-Key techniques don't really make good band-pass filters, so we go to the *multiple feedback* filters shown in Fig. 2. Usually, we are involved with such low d values in a bandpass filter that we use its inverse or Q instead. The Q is simply the ratio of the bandwidth to the center frequency. The circuit of Fig. 2A has a gain of $-2Q^2$ at resonance (the minus means a 180-degree phase shift), and a resonance frequency of 1 kHz.

The circuit is tuned by changing the values of the resistors or the capacitors, but, once again, both resistors and both capacitors are kept at fixed ratios.

The op amp gain should be at least $20Q^2$ at the operating frequency, so this particular circuit works best with

lower Q values and lower resonance frequencies. You also tend to get a wide resistor spread with high Q values so this circuit is best used for Q values of 20 or less. At resonance, the gain is very high, so be sure to limit the size of the input signals so the op amp doesn't clip or saturate.

The extra resistor added to Fig. 2B raises the input impedance and drops the gain. However, it still has a respectable gain of $-Q^2/5$ and ten times the input impedance of the earlier filter circuit.

High-pass. The Sallen-Key circuits can be used for high-pass by making them mirror images of the low-pass. These are shown in Fig. 3. Note that the unity gain version (3A) now has resistor ratios set by the damping and 1:1 capacitor ratios, so there is no way to switch the same parts around for identical low-pass and high-pass responses. The equal component value circuit of Fig. 3B doesn't have this problem and we get from high-pass to low-pass with 4pdt switching. Since there is an internal dc bias path, we no longer have to worry about providing a dc return through the source.

High-pass filters are inherently noisier than low-pass ones because they emphasize transients, and pass harmonics of supposedly rejected wave forms. Certain circuits tend to reduce the stability margins of the internal op amp compensation. So, rarely will you get a really "clean" high-pass output from a filter, active or passive. Note also that the op amp sets an upper frequency limit and you have to save enough "daylight" between the desired cutoff frequency and the op amp's cutoff frequency to have a passband left.

Sometimes the capacitor values of a low-frequency active filter (high-pass or

FOR MORE INFORMATION

Here are some good sources of information on active filters:

The Active Filter Cookbook, #21168, Howard W. Sams, Indianapolis, IN 46206, (1975).

"A Practical Method of Designing RC Active Filters," *IRE Transactions*, CT-2, March 1955.

"State Variable Synthesis for Insensitive Integrated Circuit Transfer Functions," *IEEE Journal*, SC-2, September 1967.

The first of these has the most detail on circuits, background math, and tuning techniques (for these and other circuits), along with many response curves, rip-off circuits, and detailed band-pass design information. The second and third references are theoretical "horses mouth" source documents covering the theory behind Sallen-Key and State-Variable filters.

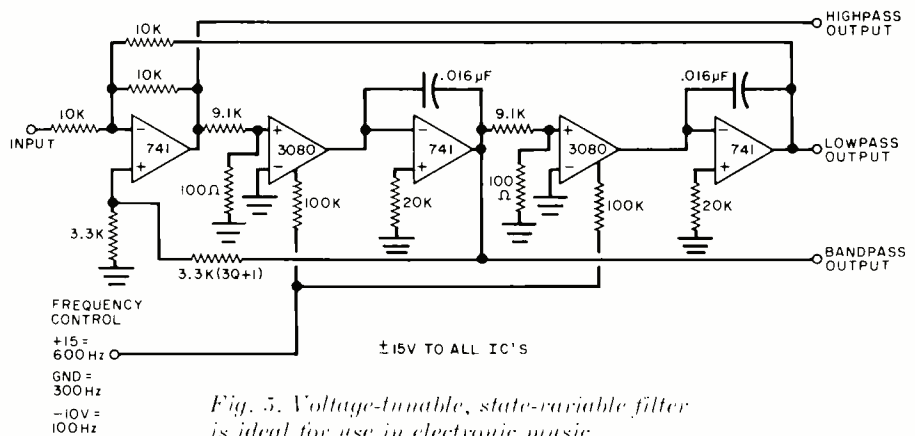

Fig. 5. Voltage-tunable, state-variable filter is ideal for use in electronic music.

otherwise) get too large and too expensive. This can be avoided by raising the impedance of the circuit suitably. For instance, to raise the impedance by a factor of ten *multiply* all resistors by ten and *divide* all capacitors by ten. These higher impedance circuits tend to be more offset-sensitive and should be used only when capacitor size is a serious problem.

Universal Filters. These are also called *state variable filters*, and they take three or four op amps per second-order section, often in a quad package, and use more resistors than the simpler circuits. However, they are vastly better. Universal filters have three, and sometimes more, simultaneous outputs—low-pass, band-pass, high-pass, and an optional notch output. They are easily used with Q values of 500 or more and don't tax the frequency limits of the op amps very heavily at all. They easily realize ultra-low *d* values without stability problems, they are easy to voltage tune, and they are very easy to switch from high-pass to band-pass to low-pass. About their only limitation is that a lot of parts are required in systems with fancy filter responses and multiple channels.

One universal filter is shown in Fig. 4. It is tuned by changing the *R* resistors or the capacitors. Once again, the resistors should be identical and the capacitors identical at all times. The Q or *d* is set with the feedback resistor as shown, while op amp gain at the cutoff frequency should be 3Q or better. Note that Q or *d* is easy to adjust independently. We can also design to different values of circuit gain, but this involves some non-obvious resistor calculations on the first stage. For completely independent gain, damping, and frequency another op amp can be added.

The low-pass, band-pass, and high-pass outputs are progressively phase-shifted by 90 degrees at the cutoff frequency. We can build quadrature art systems by routing the LP and BP outputs to a scope or plotter and inputting interesting audio signals to the filter. Since the circuit gain at resonance is Q, be sure to limit input signals to a suitably small size.

This circuit is really an analog computer that models a rusty pendulum. With an infinite Q resistor (*d* = 0), there is no damping (an oscillator). The Q resistor adds rust, or damping, to the pendulum.

The notch output shown has nothing

to do with the rest of the circuit and can be left off if not desired. This output produces a zero output at resonance and a notch width proportional to the circuit Q. The notch works by summing the low-pass and high-pass outputs which cancel at the resonance frequency. If one of these input resistors is changed, the notch can be moved either side of the resonance frequency. This is a powerful class of filters called *Cauer* or *Elliptical* filters that strongly reject signals immediately outside the passband.

Cascading. Two second-order sections can be connected together to build a fourth, and three to get a sixth, but *the damping and frequency values must be watched if a useful overall response is to be obtained*. For instance, we've seen how a maximally flat second-order section is built with a *d* value of 1.41. But cascade three of these and what was a -3 decibel cutoff frequency is now a very droopy -9 decibels and no longer flat at all.

The Table shows the correct damping and frequency values for high-pass and low-pass filters of second, fourth, and sixth order. The shapes selected are for the best delay, the flattest amplitude, and a slightly peaked response. These are called the *Bessel*, *Butterworth*, and *One Decibel Chebycheff* responses. The cutoff frequency of all values, defined to three decibels below peak response is 1 kHz. The circuits can be tuned to any other frequency by the previous techniques we've looked at, but all cascaded sections must be changed by the same amount. While five-percent resistor and capacitor values are usually more than adequate for these circuits, values correct to one percent are indicated in the Table.

Voltage Control. To voltage control a universal filter, replace the fixed or variable frequency determining *R* resistors with something that looks like an electrically variable resistor. One very good choice is the CA3080 transconductance amplifier, and a voltage controlled universal filter can be built as shown in Fig. 5. This circuit provides a linear voltage versus frequency control; and frequency ranges of 100:1 and even 1000:1 are possible with careful design. One important design detail is to keep the input voltage on the 3080 positive input to 100 millivolts or less peak-to-peak for good linearity. ◇

Does your computer talk to you?

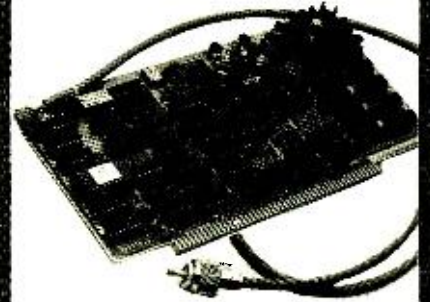

The intelligence of your 8080 system is only as great as its capacity to communicate. Processor Technology's **VDM-1** will function as a highly cogent link to that intelligence. This **ultra-high speed output device** plugs into your Altair or IMSAI to provide fast, versatile human interface. It generates 16 lines of display: 64 characters each, **both upper and lower case**. 1024 bytes of random access memory are on the card. The VDM-1 scrolls upwards or downwards, up to a top speed of **2000 lines per minute!** Any combination of cursors (up to 1024) can be displayed as black-on-white or vice versa—perfect for video games. The VDM-1 will work with any standard video monitor, or your own TV set can be easily modified. The module comes with **free terminal mode software**, for teletype replacement when used with BASIC or assemblers.

Our detailed VDM-1 Owner's Manual is available for \$4, refundable with purchase of the VDM-1. **Kit Price:** (eff. 7/1/76): **\$199** (premium grade, low profile IC sockets included).

Write Us,
about our other
plug-in modules,
compatible with
the 8800 system,

**Processor
Technology**
6200-N Hollis Street
Emeryville, CA 94608



Product Test Reports

ABOUT THIS MONTH'S HI-FI REPORTS

Technics' new line of stereo receivers does not in general represent any radical departure from the company's past offerings. However, judging by the Model SA-5460, receiver performance has been refined still further, to the point where this \$400 receiver is capable of FM and audio performance that should satisfy the needs of the critical listener. Our tests revealed that the receiver's rather impressive specifications are completely realistic.

The long-awaited CD-4 phono cartridge from Shure Brothers has finally made its appearance—the Model M24H. It is more than just a very good CD-4 cartridge, however. It is also a first-rate stereo cartridge whose “trackability” matches that of the company's Model M95ED stereo cartridge and comes close to rivalling the top-of-the-line V-15 Type III in stereo performance. Best of all is the fact that the M24H is moderately priced, costing just a few dollars more than the better stereo cartridges.

—Julian D. Hirsch

TECHNICS MODEL SA-5460 STEREO RECEIVER

Top-notch performance in medium-priced range.

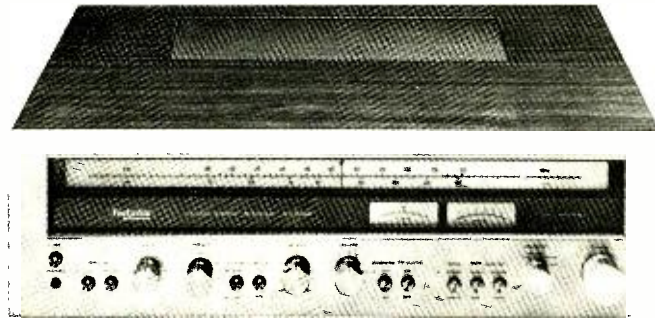

The Model SA-5460 is one of a new line of stereo receivers from Technics by Pan-

asonic. Its differential, completely direct-coupled audio amplifiers are rated at 65 watts/channel into 8-ohm loads with less than 0.1% distortion over a frequency range of 20 to 20,000 Hz. The complementary output transistors are also direct-coupled to the speaker systems driven by the amplifier section.

The phono preamplifier circuit employs integrated circuits, with precision components in the RIAA feedback equalizing network. The FM tuner section has a seven-stage i-f amplifier whose three two-element filters have uniform group delay characteristics. The

i-f section, in conjunction with a phase-locked-loop multiplex demodulator, contributes to the receiver's rated channel separation of 35 to 45 dB across the audio range.

The receiver is furnished with a simulated wood-grain cabinet. It measures about 19¾" W × 16½" D × 5⅞" H (50.2 × 42 × 15 cm) and weighs 31 lb (14 kg). List price is \$399.95.

General Description. The receiver's styling is quite similar to the Technics equipment of last year. The pale gold, satin finished aluminum front panel has a large dial window. The various controls and switches are arranged in a single row across the bottom of the panel. Half the dial area is devoted to the calibrated scales, with the FM calibration

marks linearly spaced at 500-kHz intervals. The lower half of the dial cutout is finished in black, except for the illuminated signal-strength and center-channel tuning meters and a red STEREO indicator light.

At the lower left of the panel are the POWER pushbutton switch and PHONES jack, followed by pushbutton switches for two pairs of speaker systems. The BASS and TREBLE controls are lightly detented at 11 positions and the BALANCE control is center detented. The HIGH and LOW audio filters are pushbutton controlled. The VOLUME control is followed by a row of five pushbutton switches for LOUDNESS compensation, FM MUTING, stereo/mono MODE selection, and TAPE MONITOR functions for two tape decks. (A tape can be directly dubbed from one to the other tape deck.) The SELECTOR switch has positions for AM, FM AUTO, PHONO, and AUX. Finally, the large TUNING knob operates a very smooth fly-wheel tuning mechanism.

On the rear apron of the receiver is a 4 CH MPX OUT jack that provides a detected but unprocessed signal for use with a future discrete 4-channel FM decoder. Insulated binding posts are used for the 300- and 75-ohm FM and long-wire AM antenna input terminals and the speaker output terminals. Covered fuses protect the output transistors. There are two accessory ac outlets on the rear apron, one of which is switched. The ferrite-rod AM antenna is inside the receiver and is not adjustable.

Laboratory Measurements. Following the FTC preconditioning period of operating amplifiers for one hour at one-third the rated output power, the receiver's amplifiers clipped at 87 watts/channel into 8-ohm loads, 110 watts into 4 ohms, and 54 watts into 16 ohms. These tests were made with a 1000-Hz input signal. The THD measured 0.01% between 0.1 and 1 watt. It increased slowly to 0.02% at 20 watts, was 0.03% at 30 watts, and hit 0.1% at 75 watts. The intermodulation (IM) distortion was between 0.03% and 0.05% from 0.1 to 40 watts. It reached 0.1% at 60 watts.

At the rated output of 65 watts, the distortion was less than 0.08% between 20 and 20,000 Hz and was typically about 0.04%. At half and one-tenth power, the distortion was substantially less. At any normal playing level and frequency, the distortion can be expected to be between 0.15% and 0.02%.

An input of 50 mV at the AUX jacks drove the amplifier to a reference 10-watt output, with the noise level 75.5 dB

POPULAR ELECTRONICS

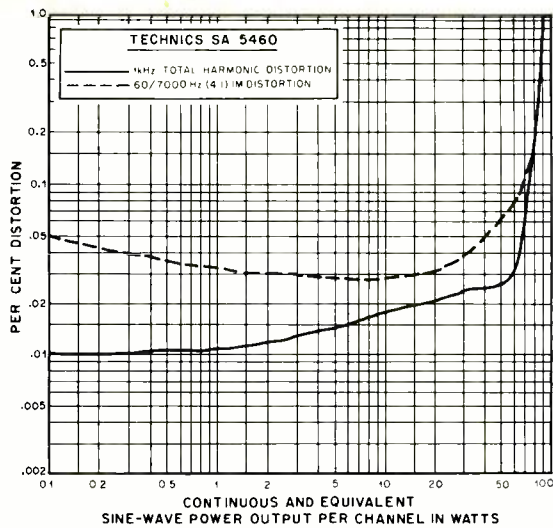

1-kHz total harmonic and 60/7000-Hz IM distortion.

below 10 watts. The phono sensitivity was 0.82 mV, with a 70-dB S/N ratio. The phono circuits overloaded at a very safe 125 mV input signal level.

The Baxandall tone controls had a sliding turnover frequency in the bass range and a treble response hinged at about 2000 Hz. At intermediate settings, the BASS control could give a substantial modification of the response below 200 Hz, with negligible effect at higher frequencies. The loudness compensation became effective only at fairly low settings of the VOLUME control and boosted only the low frequencies. The HIGH and LOW filters had gradual 6-dB/octave slopes, with the -3-dB responses at 100 and 6000 Hz. The RIAA phono equalization was accurate to within ± 0.5 dB from 50 to 20,000 Hz. Unlike the case with most phono preamplifiers, the frequency response was boosted slightly at the high end of the range by the interaction with the cartridge's inductance. However, the effect was small, amounting to only 1 dB at 15,000 Hz and 3 dB at 20,000 Hz.

The FM tuner section lived up to the promise of the receiver's specifications. The IHF sensitivity was 11 dBf (2.0 μ V) in mono, while in stereo it was determined by the stereo switching threshold of 23 dBf (8 μ V). In mono, 50 dB of quieting was achieved at 15 dBf (3.0 μ V), with 0.7% distortion, while in stereo it was 37 dBf (40 μ V), with 0.37% distortion. The S/N at 65 dBf (1000 μ V) was 70 dB in mono and 68 dB in stereo, and the respective distortion measurements were 0.083% and 0.15%, well below the rated 0.15% and 0.25%. With the L-R modulation called for by the IHF standards, the THD was 0.63% at 100 Hz, 0.14% at 1000 Hz, and it was 0.32% at 6000 Hz.

The frequency response of the FM tuner was almost ruler flat from 30 to 10,000 Hz and down a mere 0.8 dB at 15,000 Hz. The channel-separation characteristic was also very flat, measuring 40 dB across most of the audio range and still a very good 33.5 dB at 30 Hz and 35 dB at 15,000 Hz. The capture ratio was an excellent 1.1 dB. AM rejection

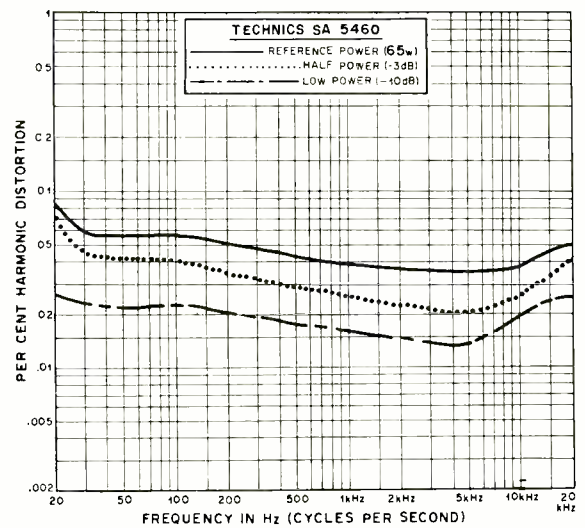

Harmonic distortion at three power levels.

was 74 dB at 65 dBf but reduced to 57 dB at 45 dBf. (It is rated at 55 dB.)

The tuner's image rejection was 54.8 dB, which was close to the rated 53 dB. Alternate-channel selectivity was 5.3 dB. The muting threshold was 22 to 24 dBf (7 to 9 μ V). In spite of the very flat FM frequency response, the 19-kHz pilot carrier was suppressed a very good 70 dB (rated 65 dB). The hum was measured to be 65 dB down.

The AM frequency response was restricted at both ends of the spectrum. The response was down 6 dB at 160 and 3500 Hz.

User Comment. If this receiver had been offered for sale only a couple of years ago, it would have been outstanding at any price. The constant improvement in IC's and other electronic components has contributed in great measure to the creation of this fine receiver, whose relationship with its predecessors must be regarded as evolutionary rather than revolutionary. This is not intended to denigrate the new receiver in any

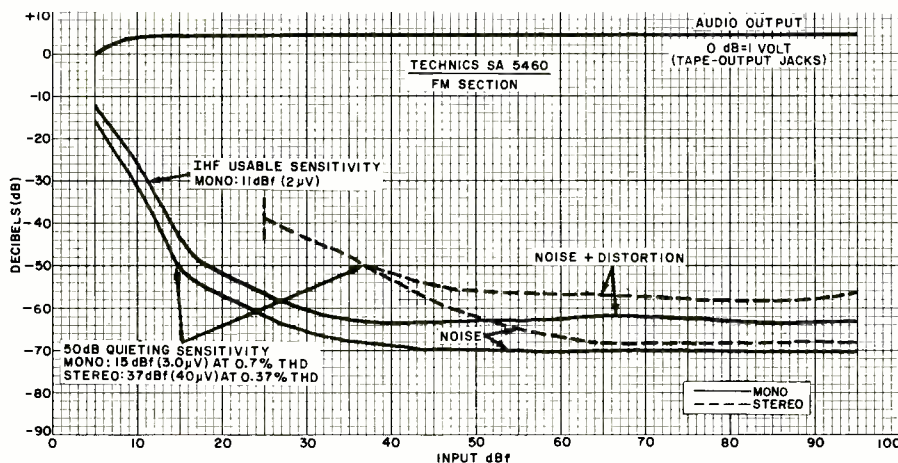

Noise and sensitivity curves for FM section.

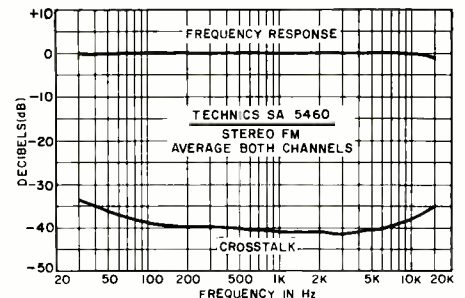

Frequency response and crosstalk averaged for both channels in stereo FM of Technics receiver.

way. It is an excellent product whose handling and freedom from undesirable side effects are only too easy to take for granted.

The receiver's stereo FM performance is so close to ideal that a significant improvement would be difficult to imagine. There are no program sources whose frequency response, flatness, distortion, and channel separation can

come even close to those of the Model SA-5460. Although not quite in the "super-power" category, the Model SA-5460 is actually a very powerful receiver, capable of doing justice to almost any home speaker system in a large listening room. Obviously, the receiver's distortion and other characteristics are consistent with the requirements of a deluxe receiver.

Our positive reaction to this receiver was enhanced by two factors that are often overlooked in receiver design but which we consider to be very important: the FM dial calibration is both legible and accurate, and the muting circuit is positive yet free of the noise bursts that sometimes accompany tuning on and off a station.

CIRCLE NO 102 ON FREE INFORMATION CARD

SHURE MODEL M24H ALL-FORMAT PHONO CARTRIDGE

Plays stereo/matrixed and discrete 4-channel.

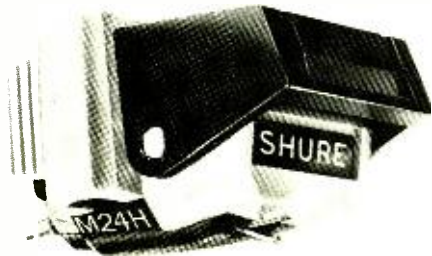

The Model M24H is Shure's first phono cartridge designed to provide high-quality playback of both stereo/matrixed quadraphonic and discrete 4-channel CD-4 records without compromising any format. The new cartridge is not only designed to be compatible with all modern record formats, but it tracks at lower stylus pressure and is reasonably priced.

The Model M24H physically resembles Shure's Model M95ED stereo cartridge, with a hinged stylus guard attached to its removable stylus assembly. Price is \$74.95.

General Description. The extended frequency response of the Model M24H has been achieved in several ways. First, the winding inductance has been reduced (compared to stereo cartridges). Second, the moving mass of the stylus has been reduced to 0.39 mg, which is claimed to be lower than the mass of any other CD-4 cartridge on the market. Finally, a new "hyperbolic" diamond stylus with radii of 0.3 and 0.7 mil was developed, the edges of which are shaped to contact a larger portion of the groove walls on the record than is possible with a conventional elliptical stylus.

The cartridge is designed to track at stylus forces of between 1 and 1.5 grams, with 1.25 being the optimum. The typical frequency response curve published by Shure illustrates an essentially flat response up to about 10,000 Hz. The curve rises to a broad maximum

of about +5 dB in the region between 20,000 and 30,000 Hz before returning to the midrange level at 50,000 Hz. Channel separation is specified at nominally 22 dB at 1000 Hz, while the output is rated at 3 mV at 5 cm/s peak velocity.

Shure's "trackability" data for the cartridge indicates that the Model M24H is essentially equivalent to the company's Model M95ED stereo and not far behind the top-of-the-line Model V-15 Type III stereo cartridges in this important parameter. The company candidly states that the stereo-only listener who has no plans for a discrete 4-channel record-playing capability might as well choose the lower-priced Model M95ED or go to the V-15 Type III cartridge if his budget permits. However, if there is any possibility of future conversion to CD-4, the Model M24H is an ideal choice of cartridges. It combines the best of both worlds at a price that is intermediate between the two top stereo cartridges.

Because of the lower inductance of the coils, the optimum stereo load capacitance of the cartridge is less than that of other Shure cartridges. Shure recommends 100 to 250 pF of capacitance in parallel with a 47,000-ohm resistance, as opposed to the 400 to 500 pF preferable for the Models M95ED and V-15

Type III cartridges. For CD-4 operation, the optimum load for the new cartridge is the 100,000-ohm input resistance that is standard for all CD-4 demodulators, in parallel with 100 pF capacitance.

Laboratory Measurements. We tested the cartridge in the tonearm of a Dual Model 701 record player, using the recommended loads for measurements in the audio and carrier ranges. The cartridge tracked the high-level, low-frequency test records nicely at only 0.9 gram, but there was considerable waveform distortion on the 1000-Hz, 30-cm/s tones of the Fairchild 101 record at 1.25 grams and still some peak clipping at 1.5 grams. The 300-Hz tones of the German High Fidelity Institute record were playable at the 60-micron level. An increase to 1.25 to 1.5 grams did not make a significant improvement. We used 1.25 grams for our subsequent tests and listening evaluation.

The output from the cartridge was 2.7 mV at 3.54 cm/s velocity. The vertical stylus angle measured 24°. IM distortion was extremely low, measuring 0.6% to 1%, at velocities from 6.7 to 18 cm/s, using the Shure TTR-102 test record. The IM rose steeply at high velocities, reaching 5% at 22 cm/s and definitely

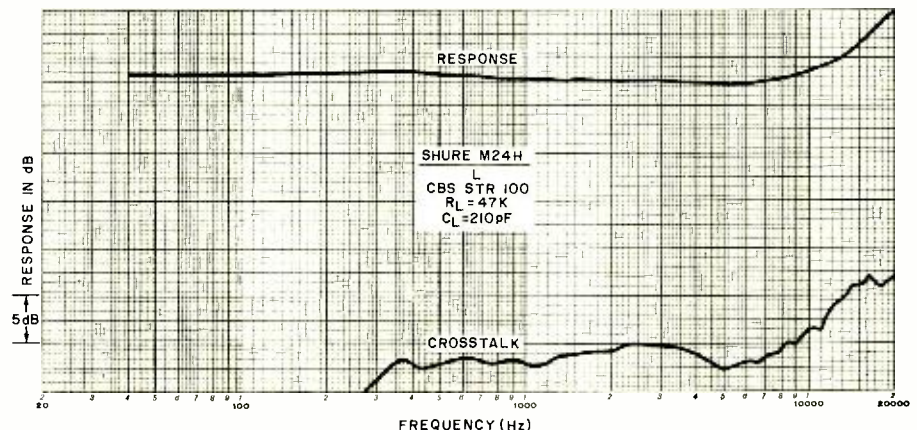

Response and channel separation in audio range.

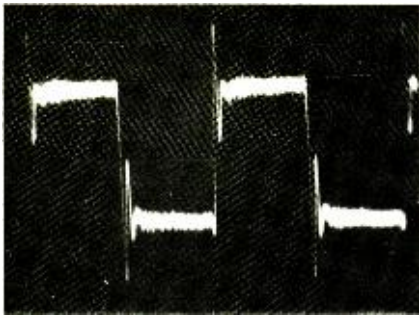

Results of square-wave tests with CBS STR-112 record.

mistracking at the much higher levels.

The repetition rate distortion of the tone bursts on the Shure TTR-103 test record was also exceptionally low, matching the Model M95ED cartridge in this test and surpassing just about every other cartridge we have tested. The distortion measured 0.6% from 15 to 22.5 cm/s and only 0.8% at 30 cm/s. The low-frequency resonance in the Dual tonearm was at about 9 Hz.

Using the CBS STR100 test record, our frequency response measurements in the audio range were flat to within ± 1 dB up to about 10,000 Hz, rising to +7 dB at 20,000 Hz. Channel separation was 20 to 30 dB in the midrange. (The two channels were not identical in this respect.) One channel maintained outstanding separation all the way to 20,000 Hz, where it measured 28 dB, while the other channel was a very good 20 dB at this frequency.

We used the JVC TRS-1005 record to measure the cartridge's response in the carrier-frequency band. It was almost identical to the curve published by Shure, flat up to 10,000 Hz and rising to between +6 and +7 dB in the range between 20,000 and 30,000 Hz. At 50,000 Hz, the output was the same as at 1000 Hz. On one channel, the separation was 15 to 20 dB all the way up to 50,000 Hz,

while on the other channel it was 8 dB at 40,000 Hz and 2 dB at 50,000 Hz.

In stereo, the subjective trackability was judged with the aid of Shure's Audio Obstacle Course—Era III test record. At 1.25 grams, the cartridge played every portion of this record without difficulty, except for a trace of "sandpaper" quality at the highest level of the sibilance section. Very few cartridges, stereo or CD-4, can do as well, let alone match this performance.

We connected the cartridge to a Technics Model SH-400 demodulator for playing CD-4 records. Not surprisingly, the cartridge acquitted itself admirably. Most of the records that have been prone to "shattering" distortion with other cartridges delivered clean, well-separated 4-channel sound with the Shure cartridge. In the few instances where distortion was heard, the same effect has been observed with every other cartridge. It can, therefore, be assumed that the record is at fault.

User Comment. Our tests and use of the Model M24H confirmed Shure's claim that this is a "no compromise" cartridge for playing stereo/matrixed and CD-4 records. We could find no audible fault with the cartridge in our lab and listening tests. While it does have an accentuated response in the uppermost audible octave from 10,000 to 20,000 Hz, this does not give the cartridge an audibly bright sound. Even if the cartridge should sound a trifle crisp, most good amplifier tone controls should be able to correct the response.

As a CD-4 player, this cartridge is as good as any we have used. There are one or two CD-4 cartridges that can match the performance of the Model M24H when operated at 1 gram, but the difference between 1.25 and 1.0 gram is negligible. Not so negligible is the price

FREE EICO CATALOG

358 Ways To Save On Instruments, Citizens Band, Burglar Alarms, Automotive & Hobby Electronics!

The more you know about electronics, the more you'll appreciate EICO. We have a wide range of products for you to choose from, each designed to provide you with the most pleasure and quality performance for your money. The fact that more than 3 million EICO products are in use attests to their quality and performance.

"Build-it-Yourself" and save up to 50% with our famous electronic kits.

For latest EICO Catalog and name of nearest EICO Distributor, check reader service card or send 50¢ for fast first class mail service.

**EICO—283 Malta Street,
Brooklyn, N.Y. 11207**

Leadership in creative electronics since 1945.



CIRCLE NO 25 ON FREE INFORMATION CARD

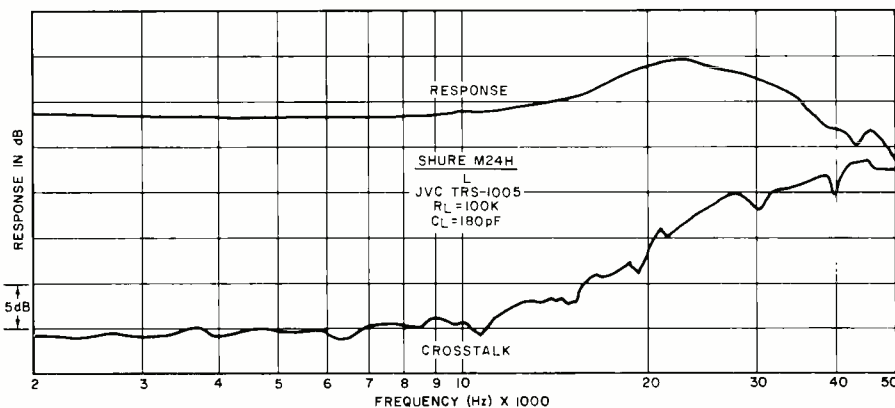

Response and channel separation in carrier-frequency band.

DECEMBER 1976

difference between the Shure and any other cartridge of comparable quality. Based on a list-price basis, the Shure cartridge saves the user \$25 to \$100 on

the purchase of a new CD-4 cartridge, while supplying stereo/matrixed reproduction capability. The Model M24H strikes us as being a fine value as a uni-

versal phono cartridge. It certainly passed all of our tests easily for both 4-channel and stereo use.

CIRCLE NO. 103 ON FREE INFORMATION CARD

SBE MODEL 32CB FORMULA D TOUCH/COM CB TRANSCEIVER

Mike contains LED channel display and squelch, volume, and channel controls.



THE SBE Model 32CB Formula D Touch/Com AM CB mobile transceiver employs the latest in digital frequency synthesis to provide full 23-channel coverage. What sets this transceiver apart from most others on the market is that the SQUELCH, VOLUME, and CHANNEL selector controls and a pair of red LED numeric displays are on the microphone. This puts the most-used controls right at the operator's fingertips and permits the transceiver to be located in an out-of-the-way place.

Electronically and in its performance, the transceiver is similar to the SBE Formula D reviewed in the October 1975 issue of POPULAR ELECTRONICS. It includes a switchable automatic noise limiter (NL), audio TONE control, S/RF meter, DELTA TUNE control, DISTANCE/LOCAL switch, PA operation, and a transmitter-on indicator. Operation can be from any 11.7-to-15.9-volt, negative- or positive-ground, dc power source capable of delivering up to 2.5 amperes of current. The power-supply section features reverse-polarity protection, voltage regulation, and a line filter.

The transceiver measures $9\frac{3}{8}'' \times 6\frac{3}{4}'' \text{D} \times 2\frac{1}{2}'' \text{H}$ ($24 \times 17 \times 6.4$ cm). It retails for \$289.95.

Technical Details. The receiver section employs double conversion to i-f's at 10.695 MHz and 455 kHz. A dual-gate FET is used for the r-f amplifier, which is followed by the first and second mixers, 455-kHz ceramic filter, two bipolar tran-

sistor i-f stages, diode detector, agc, squelch, series-gate anl, two audio stages, and a class-B power-output stage. The last stage is also used for PA operation and for modulating the transmitter.

The digital frequency synthesis system uses a phase-locked loop (PLL) IC. (For detailed information on how the frequency synthesizer works, see October 1975 Product Test Report for the Formula D transceiver.)

The design of the transmitter section is conventional. It uses a dual-gate FET mixer and pre-driver, driver, and r-f power output amplifiers. A double-pi output network provides matching to 50-ohm loads and spurious-response attenuation, augmented by a 54-MHz TVI trap. Automatic modulation control (amc) is designed into the circuit. Antenna transfer is accomplished electronically with a diode switch.

Overall Performance. The performance of the transceiver was quite similar to that of its predecessor, the Formula D. Our measurements indicated a receiver sensitivity of 0.3 to 0.5 μV , depending on the setting of the TONE control, for a 10-dB (S + N)/N with 30% modulation at 1000 Hz. Image and i-f signal rejection were 80 dB, while unwanted spurious-signal responses were a minimum of 60 dB, except for signals near 26 MHz, where the figure was 50 dB. Adjacent-channel rejection was measured at 50 dB.

The agc held the audio output level to

within 7.5 dB with an r-f input variation of 80 dB at 1 to 10,000 μV . At 1 to 10 μV , the output remained within 4 dB. The meter indicated S9 with a nominal input signal level of 30 μV . The squelch threshold range was 0.25 to 10,000 μV .

The maximum sine-wave audio output at the onset of clipping was 3 watts at 7% THD, using a 1000-Hz test signal and taking the measurement with an 8-ohm load. The overall 6-dB response, including that of the i-f passband, was 425 to 3500 Hz. Good sound quality was obtained from the bottom-facing speaker. The effectiveness of the anl system was fine. It permitted readability of a 0.3- μV signal in the presence of 1000- μV and more peaks of most external noise pulses.

The LOCAL/DISTANCE switch dropped the r-f gain by about 30 dB when set to the LOCAL position. However, the good signal-handling capabilities of the transceiver made it seldom necessary to use the LOCAL position in the presence of strong signals.

Operating the transceiver from a 13.8-volt source, the transmitter carrier output measured slightly greater than 4 watts. Increasing the microphone input level by 10 dB over that required for 50% modulation held the r-f envelope to a sine wave at 100% modulation with 4.25% THD while using a 1000-Hz test tone. A 15-dB increase introduced clipping of both positive and negative peaks with overmodulation on the latter. The THD in this case was 12.5% with adjacent-channel splatter down 50 dB. The overall signal level with voice operation allowed full modulation while holding the splatter to an excellent 55 to 60 dB down. The 6-dB audio response was 200 to 6500 Hz.

The frequency tolerance on all channels was essentially the same, holding to within 0.0001%. The current drain was a little higher than usual. On receive, the drain was between 1.0 and 1.75 amperes, while on transmit it was 1.7 to 2.25 amperes. The power supply used during these tests was rated at 13.8 volts.

User Comment. The microphone had
POPULAR ELECTRONICS

the customary push-to-talk switch button on the left side of its case. The VOLUME and SQUELCH controls are thumbwheel types and are located on the right side of the case. These controls have numerals on their edges, requiring the user to rotate the mike to observe the numerals.

Two square buttons located at the top of the mike's housing are for selecting the CB channel desired. The button on the left is marked UP for an upward numerical progression through the channels. The button on the right, labelled DN, is for a downward progression. Every time either button is momentarily depressed and released, the system steps one channel. By holding down

a button, the channels can be continuously advanced up or down automatically until the desired channel is reached. When the transceiver is first turned on, Channel 1 always comes up first. Progression through the channels can be made in either direction at any time.

The seven-segment LED numeric displays used for indicating the channel are located at the lower center of the front of the microphone's case.

Taken as a whole, the Touch/Com transceiver provides convenient and safe handling as well as fine performance and the latest in frequency synthesis. Its very up-to-date design is well suited for any mobile application.

CIRCLE NO. 104 ON FREE INFORMATION CARD

SENCORE MODEL TF40 PORTABLE TRANSISTOR TESTER

Checks in- and out-of-circuit devices without setup information.



SENCORE'S new Model TF40 "Pocket Cricket" is a portable, compact in-circuit and out-of-circuit transistor and FET tester. It employs the same basic test principles used for the company's more expensive ac-only Cricket testers and does not require set-up information to test any device.

The Pocket Cricket provides good/bad gain tests, meter-calibrated leakage, and transistor basing identification. Additionally, an audible test tone sounds if the device under test has good gain. The tester is equally convenient to use in the field on battery power and on the test bench on battery or line power, the latter with an optional power adapter. For fast in-circuit tests, there is also available an optional "Touch Test Probe" No. 39G85.

The transistor tester measures 6"L x 4"W x 1 1/4"D (15.2 x 10.2 x 3.2 cm) and weighs 14 oz (0.39 kg). The Model TF40 tester is priced at \$98; the optional No. PA202 power adapter and No. 39G85 Touch Test Probe, \$9.95 each.

General Description. The tester is designed for rapid checking of transis-

DECEMBER 1976

tors and diodes even by persons with little or no technical knowledge. The control complement, therefore, has been limited to just three function switches and a rotary thumbwheel potentiometer. The device condition display is a 2 1/2" (6.4-cm) wide meter movement whose scale is broken up into BAD and GOOD sections for gain and battery-check indications. It is calibrated from 0 to 2500 μ V for leakage measurements. A built-in loudspeaker emits a tone during the tests when gain is "good."

A large 12-position "permutator" switch occupies the major portion of the instrument's front panel. Arranged along the bottom of the panel are the power ON/OFF and BATT CHECK SWITCH, LEAD ID control pot, and ID/GAIN/LEAK function switch. Exiting through the bottom of the instrument's case is a cable whose three conductors are terminated in color-coded E-Z Hook® connectors. A single 9-volt battery, housed in a compartment at the top-rear of the case, provides the power necessary for testing.

Connections to the device under test are made via the E-Z Hooks. It is not necessary to know the basing or type of device being tested. You simply connect the E-Z Hooks at random to the device's leads. Then, setting the power switch to ON and function switch to GAIN and rotating the permutator switch through its positions will give a good/bad gain indication and simultaneously identify the device as being npn (or n-channel) or pnp (or p-channel). At one or two positions of the permutator switch, the built-in speaker will emit a tone, assuming the device under test is good. Depending on whether the "good" positions of the switch are located in the N or the P la-

The Best
Way To Show
You What
You'll Get
Out Of An
Empire
Phono
Cartridge
Is To
Show You
What Goes
Into One.

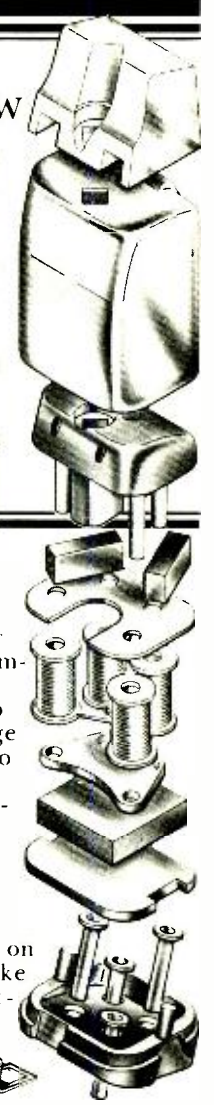

At Empire we make a complete line of phono cartridges. Each one has slightly different performance characteristics which allow you to choose the cartridge most compatible to your turntable.

There are, however, certain advantages, provided by Empire's unique design, that apply to all our cartridges.

One is less wear on your records. Unlike other magnetic cartridges, Empire's moving iron design allows the diamond stylus to float free of its magnets and coils, imposing much less weight on your record's surface and insuring longer record life.

Another advantage is the better channel separation you get with Empire cartridges. We use a small, hollow iron armature which allows for a tighter fit in its positioning among the poles. So, even the most minute movement is accurately reproduced to give you the space and depth of the original recording.

Finally, Empire uses 4 coils, 4 poles, and 3 magnets (more than any other cartridge) for better balance and hum rejection.

The end result is great listening. Audition one for yourself or write for our free brochure, "How To Get The Most Out Of Your Records". After you compare our performance specifications we think you'll agree that, for the money, you can't do better than Empire.

Empire Scientific Corp.
Garden City, New York 11530



Already your system
sounds better.

CIRCLE NO. 30 ON FREE INFORMATION CARD

belled area of the dial ring, the device is either an n type or a p type.

Once the gain/type test is performed, the function switch goes to the LEAK position and the permutator switch is rotated through only the six positions of the identified type. The meter then indicates the six possible leakage conditions for the transistor.

Finally, the permutator switch is set to either of the two "good" positions and the function switch to ID. Then the LEAD ID control is adjusted until the test tone ceases in either position, at which time the transistor is known to be bipolar and

its basing is identified by matching the three-letter color code on the dial ring with the legend on the switch pointer. If the tone does not cease in either position of the permutator switch, the device is a FET, and its basing is also identified in the same manner.

Testing diodes is quite simple. Only the red and yellow E-Z Hooks are used here. The function switch is set to LEAK and the permutator switch first to the top two and then the bottom two positions. A good diode will cause the meter's pointer to deflect far up-scale in either the two upper or two lower, but not both sets of

positions. A good diode will cause the test tone to sound in either the two upper or the two lower positions of the permutator switch. If the diode is open, no tone will be heard; if it is shorted, a tone will be heard in all four positions. For a good diode, the position of the permutator switch and color-code identification of the E-Z Hooks will identify the cathode and anode.

All tests can be performed in- or out-of-circuit. For in-circuit tests, the optional Touch Test Probe is a real time saver. This probe connects to the tester via the E-Z Hooks according to a color-coding scheme. At the test end of the probe are three, also color-coded, sharp test points that contact the transistor's connection pads. The test points are pivotable to permit use of the probe on a wide variety of transistor basing and spacing configurations.

User Comment. The Pocket Cricket is a delight to use. Its proven gain-test circuit that detects a device's ability to amplify and invert a safe-level test signal, combined with a leakage test calibrated in microamperes, provides the degree of test accuracy needed by a service technician or experimenter. Combined with the in-circuit/out-of-circuit test capability and no set-up requirement, it makes testing transistors, diodes, and FET's easy and fast. In fact, we were testing and sorting loose transistors at a rate of one about every 90 seconds or so.

Small size and battery or ac line (with an adapter) power plus a ruggedized case add to the tester's worthiness. Of course, the Pocket Cricket is not the type of analyzer that an engineering technician or electronics engineer would be likely to require for complete parameter tests. Nor does it reliably test high-frequency oscillators. But for what it does, and at its price, this is an impressive instrument. It is made all the better when used with the optional Touch Test Probe and power accessory. The power accessory can serve both as a battery eliminator and recharger, the latter when the standard 9-volt battery is replaced by rechargeable nickel-cadmium cells.

Built into the tester's case is a swing-out tilt stand that raises the Pocket Cricket to a convenient viewing angle on the work bench. Another nice touch is the four rubber feet on the bottom of the instrument case. Made of non-skid plastic material, the feet prevent the instrument from sliding around on a busy electronics workbench.

CIRCLE NO. 105 ON FREE INFORMATION CARD

POPULAR ELECTRONICS

SPECIAL OFFER!

Buy 23-channel CB now. Get new 40-channel later at 1/2 price!

UPON FCC TYPE ACCEPTANCE

"Don't be without CB while waitin' for the FCC"
NO MODIFICATION FEES—NO MODIFICATION DELAYS—OWN AND KEEP TWO UNITS



handic

handic USA, Inc. 14560 NW 60th Ave. Miami Lakes, FL 33014

THE ORANGE EQUIPMENT KNOWN FOR PROFESSIONAL QUALITY THE WORLD OVER

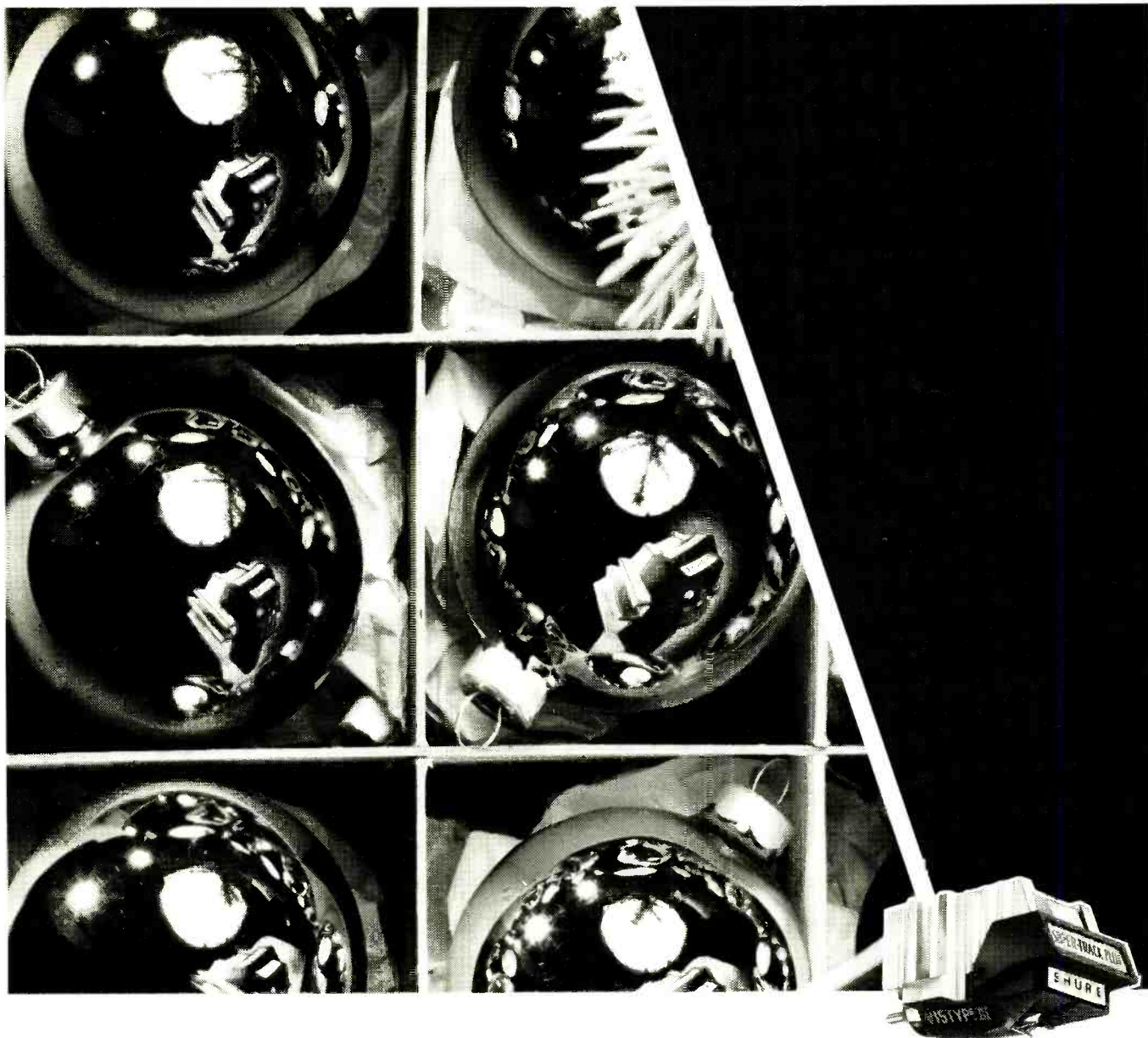

A cartridge in a pear tree.

A gift of the Shure V-15 Type III stereo phono cartridge will earn you the eternal endearment of the discriminating audiophile who receives it. What makes the V-15 such a predictable Yuletide success, of course, is its ability to extract the real sound of pipers piping, drummers drumming, rings ringing, et cetera, et cetera. In test reports that express more superlatives than a Christmas dinner, the performance of the V-15 Type III has been described as "...a virtually flat frequency response... Its sound is as neutral and uncolored as can be

desired." All of which means that if you're the giver, you can make a hi-fi enthusiast deliriously happy. (If you'd like to receive it yourself, keep your fingers crossed!)

Shure Brothers Inc.
222 Hartrey Ave.,
Evanston, IL 60204
In Canada:

A. C. Simmonds & Sons Limited

TECHNICORNER

MODEL V-15 TYPE III

Tracking Force Range: 1/4 to 1 1/4 grams
Frequency Response: 10 to 25,000 Hz
Output: 3.5 mV per channel at 1 kHz; 5 cm/sec peak recorded velocity

Typical Tracking (in cm/sec peak recorded velocity at 1 gram in a Shure-SME Tone Arm):

400 Hz	26 cm/sec
1,000 Hz	38 cm/sec
5,000 Hz	35 cm/sec
10,000 Hz	26 cm/sec

Channel Separation (Minimum): 25 dB at 1 kHz; 15 dB at 10 kHz

Stylus: Model VN35F Biradial Elliptical, 5 x 18 microns (.0002 x .0007 inches)

Also available: Model V-15 III G with the VN3-G Spherical stylus, 15 microns (.0006 inches)

Model VN78E Biradial Elliptical stylus, 13 x 63 microns (.0005 x .0025 inches) for mono 78 rpm.



Manufacturers of high fidelity components, microphones, sound systems and related circuitry.

Should your career in electronics go beyond TV repair?

**CREI prepares you at home
for broader and more advanced
opportunities in electronics—
plus offers you special arrangements
for engineering degrees**

There is no doubt television repair can be an interesting and profitable career field. TV repair, however, is only one of the many career areas in the fast growing field of electronics.

As an indication of how career areas compare, the consumer area of electronics (of which TV is a part) makes up less than one-fourth of all electronic equipment manufactured today. Nearly twice as much equipment is manufactured for the communications and industrial fields. Still another area larger than consumer electronics is the government area. That is the uses of electronics in such areas as research and development, the space program, and others.

Just as television is only one part of the consumer field, these other fields of electronics are made up of many career areas. For example, there are computer electronics, microwave and satellite communications, cable television, even the broadcast systems that bring programs to home television sets.

As you may realize, career opportunities in these other areas of electronics are mostly for advanced technical personnel. To qualify for these higher level positions, you need college-level training in electronics. Of course, while it takes extra preparation to qualify for these career areas, the rewards are greater both in the interesting nature of the work and in higher pay. Furthermore, there is a growing demand for personnel in these areas.

Unlike most other home study schools, CREI programs are devoted exclusively to preparing you for careers in advanced electronics. All of CREI programs are college level. And CREI gives you both theory and practical experience in advanced electronics.

Unique Design Lab

A unique feature of CREI training is its Electronic Design Laboratory Program, which trains you to actually design circuits. It also helps you understand the theories of advanced electronics and gives you extensive practical experience in such areas as tests and measurements, breadboarding, prototype construction, circuit operation and behavior, characteristics of electronic components and how to apply integrated circuits.

Career Training at Home

Only CREI offers this unique Lab Program. It is a complete college lab and, we believe, better than you will find in most colleges. The "Lab" is one of the factors that makes CREI training interesting and effective. And the professional equipment in this program becomes yours to keep and use throughout your professional career after you complete the training.

Engineering Degree

CREI offers you special arrangements for earning credit for engineering degrees at certain colleges and universities as part of your home study training program. An important advantage in these arrangements is that you can continue your full time job while "going to college" with CREI. This also means you can apply your CREI training in your work and get practical experience to qualify for career advancement.

Wide Choice of Programs

CREI gives you a choice of specialization in 14 areas of electronics. You can select exactly the area of electronics best for your career field. You can specialize in such areas as computer electronics, communications engineering, microwave, CATV, television (broadcast) engineering and many other areas of modern electronics.

FREE Book

In the brief space here, there isn't room to give you all of the facts about CREI college-level, home study programs in electronics. So we invite you to send for our free catalog (if you are qualified to take a CREI program). The catalog has over 80, fully illustrated pages describing your opportunities in advanced electronics and the details of CREI home study programs.

Qualifications

You may be eligible to take a CREI college-level program in electronics if you are a high school graduate (or the true equivalent) and have previous training or experience in electronics. Program arrangements are available depending upon whether you have extensive or minimum experience in electronics.

Send for this **FREE** Book describing your opportunities and CREI college-level programs in electronics



Mail card or write describing qualifications to

CREI **CAPITOL
RADIO
ENGINEERING
INSTITUTE**

McGraw-Hill Continuing Education Center
3939 Wisconsin Avenue Northwest
Washington, D.C. 20016

Accredited Member National Home Study Council

GI Bill

CREI programs are approved for training of veterans and servicemen under the G.I. Bill.



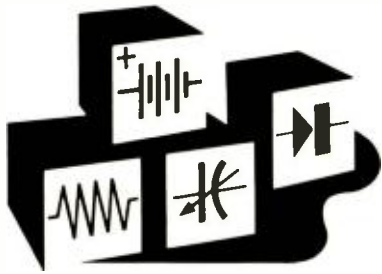

Inside Basic Electronics

CAPACITORS AND RF CIRCUIT, Part 2

By Sol D. Prenskey

AS WE mentioned last month, a capacitor exhibits an opposition to the flow of ac that decreases as the capacitance or frequency of the applied signal (or both) is increased. This *capacitive reactance* is measured in ohms, but is not a true resistance because it does not consume power and dissipate it as heat. But you might find it helpful at this point to consider the capacitor as a "phantom" resistor. The exact amount of reactance that a capacitor exhibits at a given frequency is found by using the equation $X_C = 1/(2\pi fC)$, where X_C is in ohms, f (frequency) in hertz, and C (capacitance) in farads. For example, a 1- μ F capacitor has 159.2 ohms of reac-

tance at 1000 Hz, and 0.1592 ohms at 1 megahertz.

Frequency Response. One of the key terms used in discussing RC combinations is *frequency response*. Referring to Fig. 1, this concept is used to relate the input signal to the output signal. In descriptions of such circuits, we often come across such terms as the *corner* or *cut-off frequency*, or the *break*, *half-power* or *-3-dB point*. They all refer to a

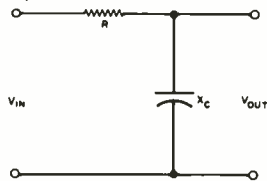

Fig. 1. An RC low-pass filter.

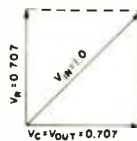

Fig. 2. Voltage vectors.

particular frequency that is a mathematically convenient reference point.

Viewing the circuit from the input, the network looks like a series combination of resistor R and capacitive reactance

X_C . These two behave somewhat like a voltage divider—the voltage drop across each element varies with its relative amount of resistance or reactance. If X_C is much greater than R , most of the input voltage appears across the capacitor. Thus, the output voltage is an appreciable fraction of the input. At higher frequencies, less and less voltage appears across the capacitor, while most of the input is dropped across the resistor, reducing the output voltage. (Assume these voltages are measured with a high-impedance ac voltmeter to avoid loading down the voltage divider, as discussed in a previous column.)

When R is equal to X_C , we find that exactly $1/\sqrt{2}$ or 70.7% of the input voltage appears across the output. And because power is proportional to the square of the voltage, half of the input power is available at the output. This is why the frequency at which X_C equals R is called the half-power point. Also, a 50% drop in power is 3 dB below the original level, so this frequency is also called the half-power point. (Don't confuse this with a half-voltage point, where a 50% decrease in volts is -6 dB.)

You might think that 50% of the voltage appears across the capacitor, and the other 50% appears across the resistor. Such a response is correct if you are talking about a purely resistive voltage divider. But here, reactance is involved, complicating the situation. Without going into a detailed analysis, we'll simply say

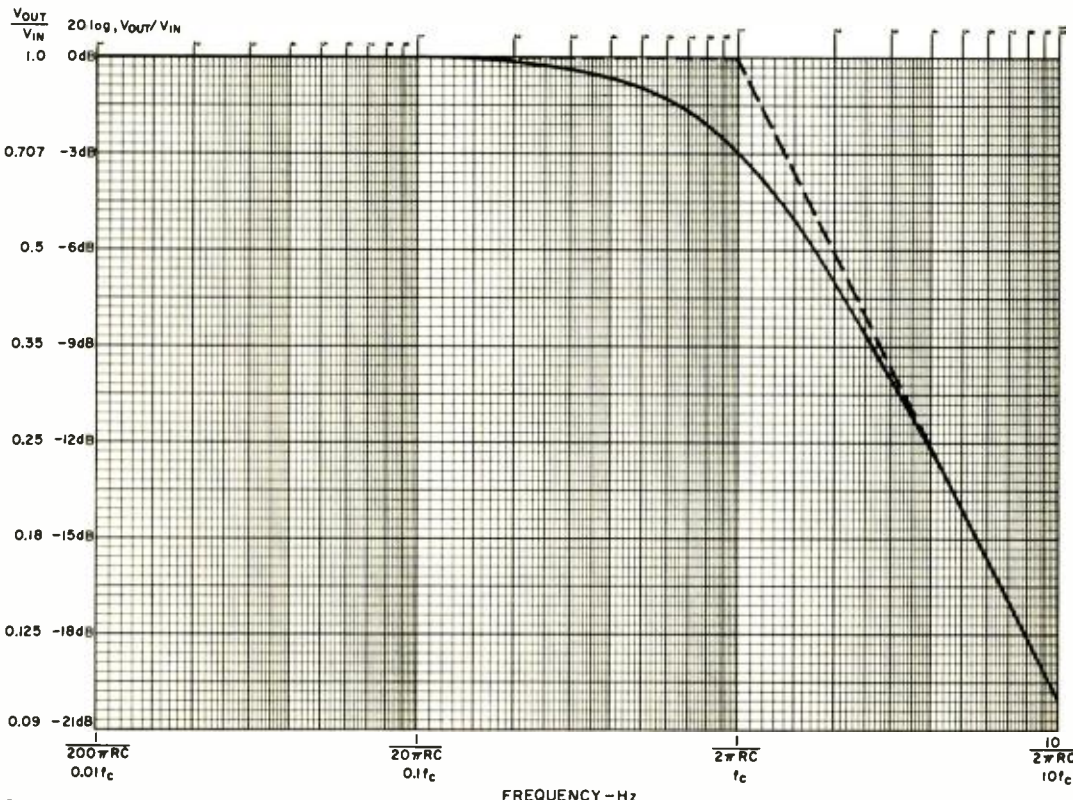

Fig. 3. Universal frequency-response curve for an RC low-pass filter.

The better the training and equipment the better you'll be equipped.

Send for one of these **FREE Illustrated Career Guides**:



Build and keep some of the finest technical equipment made when you train with an NTS Project-Method home study course. And it's usually the same type of equipment you'll meet in the field and use on the job. It will help you acquire first-hand experience and skill — help prepare you better for a variety of exciting technical careers:

ELECTRONICS DIVISION: Courses include professional equipment like 5" solid-state oscilloscope, transistor and tube-tester, vector monitor scope, 74 sq. in. B&W TV, and solid-state stereo AM-FM multiplex receiver, speakers. Color TV courses feature advanced NTS/HEATH DIGITAL GR-2000 Color TV with silent varactor diode tuning; digital read-out channel selection (with optional digital clock), big 315 sq. in. screen.

MECHANICS DIVISION: Learn engine diagnostics, motor overhaul, transmissions, automotive maintenance. Courses include 9 in. solid-state automotive oscilloscope, testers, tools, mechanic's steel tool box, & more.

AIR CONDITIONING, REFRIGERATION/HEATING DIVISION: Learn servicing of commercial, industrial and residential heating and cooling equipment. Courses include hermetic unit analyzer, leak detector, charging testing-purging manifold set, tools and more.

HOME APPLIANCES DIVISION: Courses cover repair and maintenance of washers, dryers, ranges, smaller appliances. Equipment includes NTS Circuit-Trainer and professional multimeter.

LOWER TUITION FOR YOU: We employ no salesmen, pay no commissions. You receive all home-study information by mail only. Make your own decision, your own comparisons. Send card today or write for illustrated catalog in field of your choice, all details.

NO OBLIGATION. NO SALESMAN WILL CALL.

APPROVED FOR VETERAN TRAINING

Get facts on new 2-year extension.

NATIONAL TECHNICAL SCHOOLS

TECHNICAL-TRADE TRAINING SINCE 1905

Resident and Home-Study Schools

4000 So. Figueroa St., Los Angeles, Calif. 90037

NATIONAL TECHNICAL SCHOOLS

4000 South Figueroa St., Los Angeles, Calif. 90037 Dept. 205-126

Please send **FREE** Color Catalog and Sample Lesson.
NO OBLIGATION. NO SALESMAN WILL CALL.

- Electronics Division
- Mechanics Division
- Air Conditioning/Refrigeration/Heating Division
- Home Appliances Division

NAME _____ AGE _____

ADDRESS _____

CITY _____ STATE _____

Please fill in Zip Code for fast service _____

- Check if interested in G.I. Bill information.
- Check if interested **ONLY** in classroom training in Los Angeles.

that, where a resistance and a reactance are found, we must treat the voltage across each of them as *vectors*. As shown in Fig. 2, V_R and V_C are at right angles to each other. Each has a magnitude of 0.707, referenced to an input voltage of 1.0. By simple trigonometry ($c^2 = a^2 + b^2$) V_{IN} equals 1.0, which agrees with our basic supposition. And the *phase angle*—that is, the angle between the V_{IN} vector and the V_C vector—is 45° .

The relationship between cut-off frequency f_C and the values of R and C can be summarized by the simple equation

$f_C = 1/(2\pi RC)$ or $1/2\pi T$, where T is the RC time constant in seconds. This frequency occupies an important point on the RC low-pass filter frequency response curve shown in Fig. 3. In this graph, the vertical axis represents the fraction of the input voltage appearing at the output of Fig. 1. Also given on the vertical axis is the decibel relationship between V_{IN} and V_{OUT} . The horizontal axis is the signal frequency on a logarithmic scale. This is done so that the falling response characteristic quickly approaches a straight line with a constant slope. The slope for the simple

low-pass filter shown in Fig. 1 is -6 dB per octave (from a given frequency f_1 to $2 f_1$) and -20 dB per decade (from f_1 to $10 f_1$).

This frequency response curve can be approximated by two straight lines, as the dashed region indicates. We can therefore generalize the frequency response by saying that, from dc up to f_C , there is no attenuation of the input signal. At this point, the response "breaks" or "corners," then falls at a rate of -6 dB per octave.

Low-Pass Scratch Filter. Now let's look at a practical application of the RC low-pass filter. Many old-time music buffs treasure vintage 78 rpm records, and learn to live with the high surface noise that has developed on them over the years. Most of this noise is composed of high frequencies. So if a low-pass filter is inserted between, say, the preamplifier and the power amp, and if a proper cut-off frequency is chosen, much of the noise can be filtered out without sacrificing too much of the musical content.

A cut-off frequency of 8000 Hz is a fairly good choice. This corresponds to an RC time constant of 20 microseconds. Any reasonable combination of a resistor and capacitor that will give this result is satisfactory. For example, an R of 20,000 ohms and a C of 0.01 microfarads will yield the desired response. By using the universal curve shown in Fig. 3, with $1/(2\pi RC)$ equal to 8000 Hz, you can observe how the high-frequency material will be filtered out.

High-Pass Rumble Filter. So far, we've considered low-pass filters which pass, unhindered, signals below f_C , and increasingly attenuate signals above f_C as the frequencies rise. However, we can make a *high-pass* filter which behaves in exactly the opposite manner by interchanging the positions of R and C as shown in Fig. 4. It has a frequency response that is a mirror image or converse of Fig. 3. Accordingly, all frequencies above the cut-off frequency—still

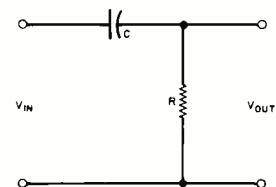

Fig. 4. A simple RC high-pass filter.

tenna-loc[®]

THE ANTI-THEFT CB ANTENNA LOCK

PROTECT YOUR ANTENNA

tenna-loc it!

tenna-loc is the first, really positive protection designed to keep your antenna intact and in place — year round! Yes, you may remove it for car wash or long term storage... but there's no need to every time you park! It works like a charm in all kinds of weather and keeps on working for years. **tenna-loc** features a turn-proof locking stud integrated into a specially notched U-bolt with a 5-tumbler corrosion proof key lock. We also give you a heavy-duty mounting bracket



and an electro-polished, stainless steel replacement cup, where needed, for easy, quick installation. At \$11.95 (approx), it's a steal. Get one today.

- Choice of models, to fit most trunk mount antennas.
- Installs quickly, easily; keeps your antenna secure.
- Chrome plated, 5-tumbler corrosion proof key lock.
- Exclusive, turn-proof, U-bolt with lock-in stud.
- Made in U.S.A.; patent pending.

See Your Dealer!



A product of
VERNITRON CORPORATION
 CONSUMER PRODUCTS DIVISION
 Lake Success Park, Community Drive, Great Neck, N.Y. 11021 (516) 487-0140

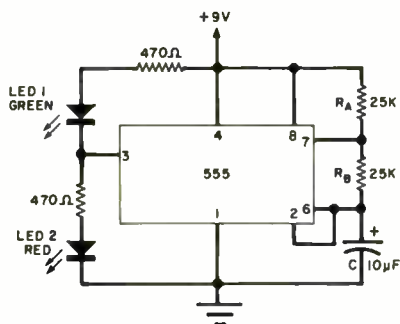

Fig. 5. A 555 RC relaxation oscillator that flashes LED's.

determined by the formula $f_c = 1 / (2\pi RC)$ —are passed unattenuated. Below this frequency, the circuit's response falls off at a rate of -6 dB per octave.

Here's a practical application. Suppose your stereo system is troubled by acoustic feedback or rumble. By inserting a high-pass filter with a suitable f_c between the preamp and power amp, we can prevent these low frequencies from reaching the speaker. The cut-off frequency should be selected so that it will cause no loss in bass response, but do an effective job of attenuating the rumble. A good choice is 16 Hz, corresponding to an RC time constant of 10,000 microseconds. With an R of 20,000 ohms and a C of 0.5 μ F, the desired response will be achieved.

If we wanted to go to a higher f_c , say, one octave up to 32 Hz, we need only modify the RC product so that it is halved. This could be done by using a 10,000-ohm resistor and a 0.5- μ F capacitor, a 20,000-ohm resistor and a 0.25- μ F capacitor, or any other reasonable RC combination.

Timers and Oscillators. Last month, we looked at two RC oscillators. One was a neon-lamp relaxation oscillator and the other used a 741 op amp as a square-wave generator. The RC time constant appears in the general formula for the oscillating frequency of these relaxation oscillators: $f_0 = k / 2 \pi RC$. The value of the constant k depends on whatever parallel resistance paths appear in the circuit, and also on the power supply used.

One very common application for the RC combination is as a controlling element in 555 timer and oscillator circuits. This versatile IC can function as a monostable or astable multivibrator. In the first case, it will generate a single pulse whose width is determined by the RC time constant. In the second, two resistors and a capacitor determine the amount of time the output is high, how

long it is low, the rate of repetition (frequency), and the duty cycle of the output waveform. The circuits will work with any supply between 5 and 15 volts, and the pulse width or frequency is independent of the value of the supply voltage.

The astable multivibrator shown in Fig. 5 will produce square waves with a period T equal to $0.693 (R_A + 2 R_B)C$. The output frequency will be the reciprocal of the period ($f = 1/T$). And the duty cycle, which is the portion of the time the output is high, divided by the entire period, is given by the expression $D = R_B / (R_A + 2R_B)$. For the values shown in

Fig. 5, T is 0.525 seconds, f is 1.9 Hz, and the duty cycle is $33\frac{1}{3}\%$. This can be verified by watching the LED's flash. When the output is low, the IC sinks current for LED1, a green light-emitting diode. When the output is high, there is no voltage drop across LED1, and it is dark; but the IC sources current for the red LED2. Component tolerances will have some effect on the nominal frequency. However, if a tantalum capacitor is used for C, it should be close to 2 Hz. Of course, you can slow down the flash rate by increasing the values of the resistances or capacitance. \diamond

THE BEST EQ KIT VALUE ANYWHERE!

A Quiet* Announcement, Based On The Undistorted* Truth About Equalizers

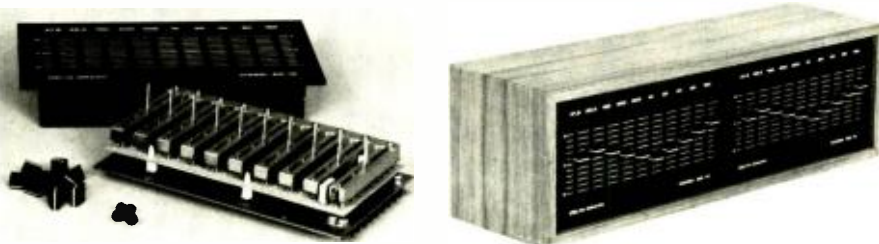

Does the equalizer you're considering offer full ten band control with symmetrical "mirror-image" boost and cut responses centered on ISO preferred octave bands? Does it have permanently-lubricated 60mm metal-cased sliders with metal shafts and center click detents? Do the specs tell you what to expect at all settings...or only at the "flat" setting, where the critical tuned networks are bypassed? Does it employ advanced hum & saturation-free "gyrator" simulated inductors on all low and mid-frequency bands? How about truly differential balanced and unbalanced inputs and outputs for use in any audio system, amateur or pro? And "fit anywhere" packaging designed for 19" rack, in-wall, in-console or optional wood cabinet mounting? What about truly flat response (both amplitude and phase angle) at the center reference setting?

WE BELIEVE IN OUR PRODUCTS. We want you to see them...read our fully-illustrated assembly and applications guide...inspect the quality of the components...at no risk to you! Simply use the coupon below to indicate the item(s) you want, your name and address and enclose a check or money order (no COD or bankcards) for the full amount. Upon receipt of your completed order, we'll rush your kit(s) to you, pre-paid shipping in the U.S.A.

After careful inspection of the kit(s), you may return any or all items in their original unassembled condition for a full immediate refund if you are not totally satisfied... (no questions asked.) And, if you decide to keep and build the kit(s), our normal guarantee on the specs and parts still applies...if your properly assembled kit(s) fail to operate as stated, we will exchange any defective parts free for the first 30 days.

*QUIET 90dB below 1 volt input, 20 to 20K, set flat or fully boosted *UNDISTORTED...Below 0.1%THD & 0.05%IM at any EQ setting...below 0.05%THD and 0.0075%IM set flat.

ORDER BLANK

QUAN.	ITEM	DESCRIPTION	PRICE
()	EQ-10M	Single EQ module kit (mono) less power supply	\$ 56.00
()	EQ-10SP	Two EQ module kits (stereo) plus PS-4 power supply kit	\$130.00
()	EQ-10QP	Four EQ module kits (quad) plus PS-4 power supply kit	\$235.00
()	EQ-10B2P	Eight EQ module kits plus two PS-4 power supply kits	\$460.00
()	PS-4	Power supply kit (open frame) power up to four modules	\$ 20.00
()	EQ-10WC	Walnut veneer (genuine wood) cabinet fits EQ-10SP kit	\$ 20.00

AMOUNT ENCLOSED \$ _____

NAME _____
 ADDRESS _____
 CITY _____ STATE _____
 ZIP _____ COUNTRY _____

Washington State residents add 5% state sales tax. Returns of unassembled kits for refund must be made within 10 days of receipt and returned items must be packed in original condition, using original packing materials. Prices and "trial offer" valid for orders postmarked on or before January 31, 1977. Outside U.S., check reader service card for ordering information.

Delta-Graph Electronics Company P.O. Box 741 Dept. PE Pasco, WA 99301

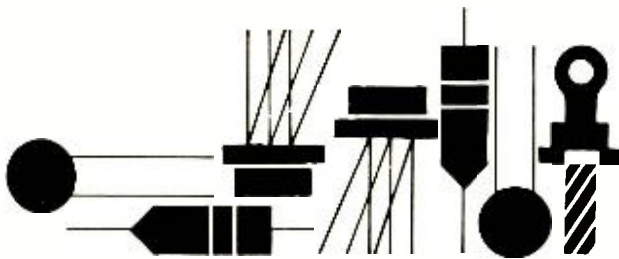

Solid State

By Lou Garner

'TIS THE SEASON TO BE SOLID

THERE was a time—not too long ago—when choosing solid-state gifts for the holidays was a really tough task. Prices were high and selections limited. Today, the job is more of a cinch than a chore . . . so much so, in fact, that unless your shopping list is a short one restricted to such items as diamond rings, fur coats, and caviar, chances are you'll find it next to impossible *not* to include at least one or two solid-state items.

You can spend as much or as little as you'd like because solid-state gifts are available at prices ranging from less than five to as high as several thousand dollars.

For many, AM, FM, and combination AM/FM or multiband radio receivers are excellent gifts, as are portable tape recorders. A screw-in solid-state dimmer for table lamps is a nice, but inexpensive, gift for students, office workers and housewives. If your budget permits, you'll find that virtually everyone will be delighted with a solid-state portable TV set (even *more* than delighted if it's a color model).

You might even consider giving a digital calculator to *every*one on your list, selecting types and models appropriate to each one's age and interests. If you have a limited budget, you'll find simple four-function (often called "four-banger") models for less than ten dollars. On the other hand, if money is the least of your problems, you can spend hundreds of dollars and thrill your friends with magnetic card programmable calculators such as Hewlett-Packard's HP-67 or Texas Instrument's SR-52. Both firms can supply pre-programmed card libraries for their instruments covering virtually every field from finance to engineering. TI also offers an optional thermal printer accessory which delivers permanent copies of calculations, including all program steps. Between these two extremes, you'll find moderately priced specialized instruments suitable for students, scientists, engineers, accountants, salespersons, mathematicians, and retailers. And there are ultra-thin models which may be carried in a purse or shirt pocket, models with non-volatile memories for retaining bank balances, folding models, and metric converters which housewives should find handy as the metric system comes into broader use. There are even special easy-to-use calculators for youngsters, such as TI's "Little Professor" and National Semiconductor's "QuizKid" models.

In one sense, the solid-state equivalent of such teaching aids as flash cards, the educational calculators add new interest and excitement to the learning experience. For family fun, there are calculator board games, such as TI's "Calculator Squares" and "Check Out."

A TV game attachment also makes a fine family gift. Electronic tennis, anyone? These are covered in a separate article in this issue.

Digital electronic watches make excellent gifts and are available at prices to suit virtually every budget. If your wallet

is thin, but you have a special someone who would like a watch, TI offers several models in their TI-501 and TI-502 series which list for less than twenty dollars each. On the other hand, if you're a lavish giver and have a bank account to match, you might consider the ultra-limited-edition Pulsar Time Computer[®] manufactured by Time Computer, Inc. (Lancaster, PA 17604). Priced at a little under four thousand dollars (*each*, that is), this beauty combines a 6-digit, 5-function (with memory) calculator and a 5-function digital LED wristwatch in a single 18-kt gold case with matching 18-kt gold bracelet. It comes complete with a combination pen and key presser tool. A less expensive version is available in stainless steel for economy-minded individuals who must limit their gifts to under six hundred dollars.

CB radio is big—and growing bigger every day. Spiced with colorful language, it is considered as a hobby by many, as a cult by some, and as a necessity by others. If your gift choice is CB equipment, you can select a low-cost hand-held "walkie-talkie" (but not the 100 mw or less type that's being phased out) or spend hundreds for a complete mobile or base station. New twenty-three-channel units are available at bargain-basement prices right now because people foolishly think that they'll be obsoleted by the introduction of 40-channel types next year. (They won't!). Check the POPULAR ELECTRONICS CITIZENS BAND HANDBOOK 1976 for help in making your choice.)

For technically oriented friends who share your hobby interests, you might select such gifts as project kits, special-purpose IC's, circuit etching, breadboard kits, solder irons, or a subscription to your favorite electronics magazine (*plug*). Try to choose items which parallel your friends' special areas of interest—a microprocessor or memory IC for those interested in microcomputers or control circuitry, for example. Perhaps you might choose a set of TI's new video game IC's for those with more general interests. The new TI IC's include the SN 76423 game logic with automatic random English, the SN76425 horizontal and vertical sync generator, the SN76426 character generator, the SN76427 wall and ball generator, the SN76428 game logic with manual English, and the SN76460 0 to W (Win) at 20 Digital Scoring. Supplied in standard 300-mil wide plastic packages, these new IC's may be combined to allow games with multiple balls, multiple walls, multiple players, and obstacles, and are suitable for use in tennis, hockey, racing, battle, pool, and pin ball video games.

If you prefer to choose more general technical gifts, you might check into the latest offerings from the Vector Electronics Co., Inc. (12460 Gladstone Ave., Sylmar, CA 91342). These include two new etched circuit board kits, Models 32X-1 and 32XA-1, and the Model 41X modular breadboard kit. The etched circuit kits feature positive-resist coated circuit

boards as well as bare copper clad boards, together with all the materials needed for fabricating circuits using either the direct-art-then-etch process or the positive photo-resist technique. The more complete 32XA-1 kit includes seven circuit boards and is priced at \$28.00, while the smaller 32X-1 kit includes two boards and costs \$11.50. Vector's new 41X breadboard kit features the firm's patented *slit-N-wrap* wiring tool, and includes ten 16-pin DIP sockets, press-in wrap posts plus an installation tool, bus strips, socket cards, and other hardware, and is priced at a little over sixty-three dollars.

Clocking Your Circuits. Many digital logic and microprocessor circuit designs require a fixed frequency pulse source for timing. The circuits supplying these signals, essentially simple oscillators, generally are called *clocks*, since their primary function is to provide a timing signal. A number of sim-

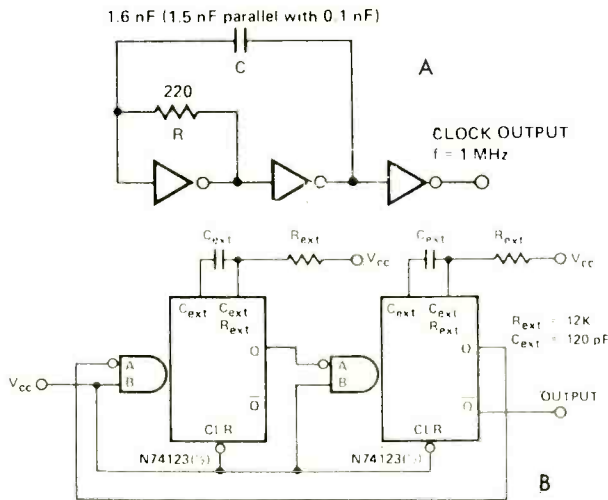

Fig. 1. RC clock circuits.

ple and inexpensive clock generator circuits are illustrated in Figs. 1 through 3. Designed specifically for use with the Signetics 2650 Microprocessor, the circuits are suitable for use with any microprocessor or logic circuit requiring single-phase, TTL-level signals. They may be used, too, as general-purpose signal sources for various other projects, such as signal generators, electronic musical instruments, function generators, or signal injectors if their operating frequencies are changed to meet the needs of the specific application. All of the circuits were abstracted from Application Memo MP52, published by the Signetics Corporation (811 East Arques Ave., Sunnyvale, CA 94086).

A pair of simple RC oscillators is shown in Fig. 1. The first, Fig 1A, uses three standard 7400 inverters. Resistor *R* biases the first inverter into its linear region while capacitor *C* pro-

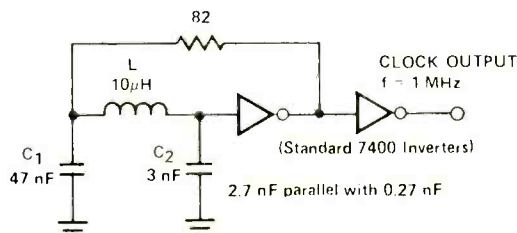

Fig. 2. LC clock circuit.

vides the feedback signal from the second stage needed to start and sustain oscillation. The third inverter serves as a simple buffer/driver. The circuit's oscillation period is approximately $3RC$ or, with the component values specified, about 1 μ s, resulting in an output frequency of 1 MHz. In test mea-

BREAKER BREAKER

... for a 10-5 from the BLACK CAT®

Whether you're rolling in a convoy or copying the mail from your home twenty, you get a four roger every time with Black Cat® CB accessories from Wawasee Electronics. So if you've got your ears up copy the following list of rugged accessories:

- Antenna Whip
- JB 700 Mobile Antennas
- Trunk Lid Antenna Mount
- West Coast Antenna Mount
- 3-Ft. Jumper Cable
- 20-Ft. Jumper Cable
- Co-Phase Harness
- JB 1000 Dummy Load
- JB 1000 SM Oscilloscope / RF Wattmeter / SWR Bridge
- JB 2000 SW Power Meter / SWR Bridge



For a complete listing of all Black Cat® CB accessories and dealers, drop us a line and we'll get right back to you.

WAWASEE ELECTRONICS

"HOME OF BLACK CAT® PRODUCTS"

Wawasee Electronics Co., Inc.

P.O. Box 36 • Syracuse, Indiana 46567

Phone: (219) 457-3191

MHz output signal. In both circuits, overall frequency stability with respect to temperature and source voltage is determined by the crystals' characteristics.

When duplicating the clock generator circuits for specific projects, remember that the series 7400 IC's specified require a well-filtered, reasonably well-regulated 5-volt dc source, and that the power (V_{CC}) and GND connections must be made to the specified pins of each device, as indicated by the appropriate terminal diagrams. All resistors are 1/4- or 1/2-watt types, while the capacitors can be either ceramic, mica, or plastic film units. Neither lead dress nor layout should be overly critical but, of course, good wiring practice should be observed, with signal-carrying leads kept short and direct.

Reader's Circuit. Submitted by a 17-year old reader, David Wang (1490 Waukazoo Drive, Holland, MI 49423), the digital electronic lock circuit illustrated in Fig. 4 features inexpensive 7400 series TTL IC's in conjunction with a pair of type 555 timers. David writes that he assembled his original model for under five dollars by using an inexpensive surplus "4-banger" calculator keyboard for his basic switch array. In operation, the lock is opened (i.e., the external sensitive relay is activated) when a five-number combination is entered within a specified time limit. No number may be entered twice or out of sequence. If any number not in the combination is entered, a "penalty" delay is activated which prevents circuit operation for, during the penalty period, the lock circuit is held in reset and not even the right sequence will activate it. The combination of a limited operational time once the initial key is pressed and an unknown penalty time if a wrong key is pressed makes the lock exceedingly difficult to defeat by "guess" and manipulation.

The basic circuit consists of four interconnected J-K flip-flops, with the Q terminal of the last one providing the circuit's output signal. Operation is initiated when the 555 "enable" timer is switched to a low state by depressing key 1. Thereafter, the flip-flops are clocked in turn by depressing keys 2, 3, 4 and 5 in order. After the preset time delay, the enable timer goes to a high state, triggering the flip-flop chain and providing an output signal. If any of the penalty keys is pressed accidentally, the penalty timer is activated, applying a signal through logic gates to hold the flip-flops in a reset state for a given time.

The initial (operational) time delay is established at about 3 seconds by a 1-megohm resistor in conjunction with the 1- μ F capacitor, *R4* and *C3*, respectively, while the longer "penalty" delay is determined by *R5* and *C4*. Capacitor *C1*, shunted by *R1*, serves to reset the final flip-flop when the circuit is first switched on. In the power supply circuit, *R3* and *C2* form a simple keyboard debounce filter. Series resistor *R2* in the penalty timer circuit serves to stabilize the 555 against false triggering.

With neither parts placement nor wiring arrangement critical, the electronic lock circuit can be assembled on perf board using point-to-point wiring or on a suitable etched circuit board, as preferred. All the resistors are 1/2-watt types, while the capacitors can be either low-voltage ceramics or electrolytics, as appropriate to their values. The flip-flop IC's are type 7473, the logic gates type 7400, and the timers, as indicated previously, type 555. The combination switches are spst momentary-contact pushbutton types (as on a calculator keyboard), while the main power switch is a spst toggle, slide, or rotary type. The lock circuit's output can be used to activate a sensitive relay or as a control signal for other logic circuitry.

Until next year . . . Happy Holidays! \diamond

FOR HOME AND INDUSTRY
7400
 PRODUCTS

WORLD'S MOST PRACTICAL SOLDER HANDLING TOOLS

**SOLDERING +
 DESOLDERING +
 RESOLDERING =**

SOLDER Ability ELEMENTARY TO ELITE

- LONG
- MED
- SHORT

FEATURE FOR FEATURE - A LOT OF TOOL FOR THE MONEY!

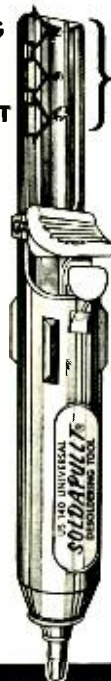

ADJUSTABLE
 VACUUM STROKE

US140

**UNIVERSAL
 SOLDAPULL®**
 DESOLDERING TOOL



Compact tool for convenient tool box storage. Precision molded plastic barrel and low-mass plunger creates rapid vacuum impulse with negligible recoil. Three position plunger adjusts loading span to fit large or small hands. Ample vacuum for most circuit board desoldering requirements.

contact your local **DISTRIBUTOR** inquiries invited

Covered by U.S. and Foreign Patents and Pending Applications

EDSYN 144 PAGE TRAINING MANUAL **FANOVISION**

144 PAGE TRAINING MANUAL **NEW! OVER 1,000** ILLUSTRATIONS

1444 W. BROADWAY, SUITE 100, NEW YORK, N.Y. 10014 (212) 973-5115

CIRCLE NO. 28 ON FREE INFORMATION CARD

1702A MANUAL EPROM PROGRAMMER

Features hex keypad, two digit hex address and two digit hex data display. Controls include load, clear, go! (step), key/copy, data in/data out, and counter up/down. Profile card includes high voltage pulse regulator, timing, 8 bit address and 8 bit data drivers/receivers. Two 6 1/2" x 9" stacked cards with spacers. Allows programming in 20 minutes - copying in 5 minutes. Requires +5, -9, and +80 volts.



ASSEMBLED \$299.95
 KIT \$189.95

NOW

The best of two worlds . . . use our 1702 EPROM programmer as a manual data/address entry programmer . . . or connect it to your processor.

IMSAI/ALTAIR computer interface (requires 3 output ports, +1 input port) and software \$49.95

Briefcase unit with power supplies and interface connectors (assembled and tested only) \$599.95

ANNOUNCING

Our NEW 16K Byte Pseudo-Static, IMSAI/ALTAIR compatible RAM. Single card slot. Uses less power than equivalent low power RAM. All memory chips socketed. Uses all prime, factory fresh ICs. High quality, two-sided, through-hole-plated circuit board. Crystal controlled, totally invisible refresh system requires NO software management. Just plug it in and use like STATIC memory.

Complete kit \$349.95
 Assembled, tested, and burned in \$549.95

ASSOCIATED ELECTRONICS

12444 Lambert Circle • Garden Grove, CA 92641
 (714) 539-0735

CIRCLE NO 11 ON FREE INFORMATION CARD

YOU CAN BE SURE

MORE TIMES IN MORE CIRCUITS WITH SENCORE DIGITAL MULTIMETERS

SENCORE

A NEW BREED OF DVM's BACKED BY 25 YEARS OF ALL AMERICAN CRAFTSMANSHIP, WITH SIX EXCLUSIVE FEATURES, SO YOU CAN BE MORE SURE, MORE OFTEN AND ALL WITH HI & LO POWER OHMS FOR MEASURING ACCURATELY IN SOLID STATE CIRCUITS.



DVM35 \$124
3 digit LED display,
1% DCV accuracy,
battery or AC operated



1 ONE THIRD LESS CIRCUIT LOADING to make you sure that you are affecting the circuit being tested as little as possible for more accurate measurements. Sencore digitals are 15 megohm, others are 10 megohm.



2 2000 DCV range to make you sure that you can measure TV boost volts, scope voltages, medical equipment, etc. Other digitals stop at 1000 volts. High voltage probe extends measuring capabilities to 50 KV.



3 PROTECTED INSIDE AND OUT so you can be sure that your meter is working and not in the repair shop. Drop it from 10 feet, apply 1000 volts overload and even apply volts on ohms accidentally and Sencore digitals keep right on working.

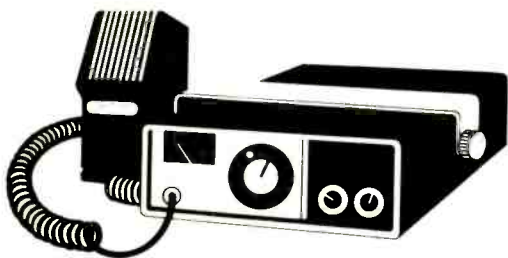

CB Scene

By Ray Newhall, KWI6010

MORE ON MOBILE ANTENNAS

MOST of us are aware that no real antenna radiates isotropically (equally well in all directions). Even if there were such an antenna, its radiation characteristics would be distorted by many external physical factors, such as height, surrounding terrain, mineral deposits, towers, buildings, etc. In a mobile installation, many of these factors are constantly changing and cannot be controlled. However, when an antenna is mounted on a vehicle which is largely composed of metal, the metal components exert the major influence on the antenna's directional characteristics.

Radiation Patterns. A convenient way to describe an antenna's perform-

ance and directionality is by studying its radiation pattern. Ideally, we would like to display the antenna system's signal strength like contour lines on a map. That is, we would like to know at what distance(s) from the antenna we could expect to see the same signal strength, just as pressure "isobars" are plotted on a weather map. Unfortunately, this type of measurement is very difficult to perform. Instead, radiation patterns are developed by observing the signal intensity at a fixed radius from the antenna. These observations are then plotted so that the distance from the center point can be interpreted in terms of decibels of signal strength. (Fig. 1).

Why should we be concerned about

Fig. 1. Typical horizontal radiation patterns for vertical whip on roof center (below), trunk lip (right), and left rear bumper (far right). Arrows indicate front of vehicle.

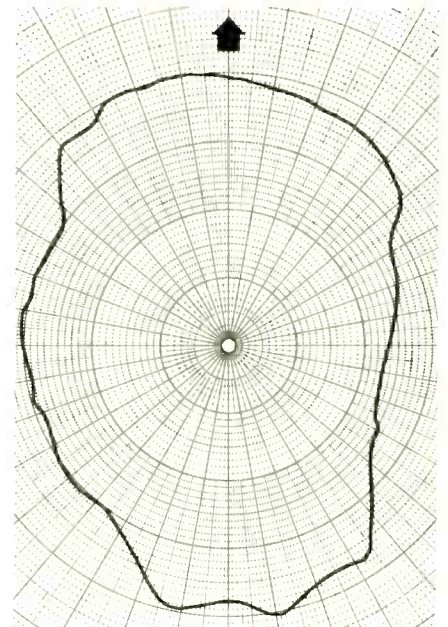



DVM36 \$148
3½ digit LED display,
.5% DCV accuracy,
battery or AC operated



DVM32 \$198
3½ digit LED display,
.5% DCV accuracy,
battery or AC operated
with automatic battery saver



DVM38 \$348
3½ digit LED display,
.1% DCV accuracy,
AC operated, auto-ranging,
auto-zero, king size pushbuttons



4 BATTERY SAVING FEATURES WHEN INSTRUMENT IS NOT IN USE so you can be sure that your meter will be ready the next time you need it. Push the button on the probe in the DVM35 and DVM36 and only then do you start drawing current from your battery. An automatic patented circuit does the same job for you automatically when you apply voltage to the DVM32. The DVM38 is AC operated.



5 100% MADE RIGHT LIFETIME GUARANTEE so you can be sure your meter was made right. If at any time you discover that a Sencore DVM was not made right, Sencore will make it right, parts and labor free of charge, for the lifetime of the product.

TEN DAY FREE TRIAL

6 10 DAY FREE TRIAL to be sure that Sencore digitals are all that we say they are. Simply march into your Sencore distributor and ask for a free trial or pay cash with a promise of a 10 day money back guarantee, if not 100% satisfied. Or, write Sencore, and we will see that our distributor contacts you.

Plus other "make sure" features such as - direct reading with no parallax error - no effect from magnetic fields such as motors & RF fields - lab accuracy with high resolution - auto-polarity auto-zeroing and auto-ranging on the DVM38 - and you can see why you can be sure more times, in more circuits, than with any other multimeter on the market today - and for less money than old fashioned analog meters.

SENCORE 3200 SENCORE DRIVE
SIOUX FALLS, S.D. 57107

CIRCLE NO. 57 ON FREE INFORMATION CARD

the directional characteristics of a mobile antenna? Primarily, because as we ride along the highways, we talk to those in front of and behind us (assuming the road is not curved). A directional antenna will reduce interference from the sides as it increases our range in the needed directions. The efficiency of the antenna system has a much greater in-

fluence upon your range than the power output of your rig.

There are three important factors to consider when installing a mobile antenna:

- Be certain that the radiation pattern is either circular, or favors the fore-and-aft direction.
- Be sure that it is radiating as much of

the r-f power supplied to it as possible.

- Keep the primary lobe of radiated energy as low as possible, closest to the horizontal plane.

Although we normally examine the radiation pattern by looking "down" onto the horizontal plane, we should not overlook the fact that the radiation pattern is actually three-dimensional. Most antennas have a doughnut-shaped pattern (Fig. 2). It is important to keep the "doughnut" as squat as possible and

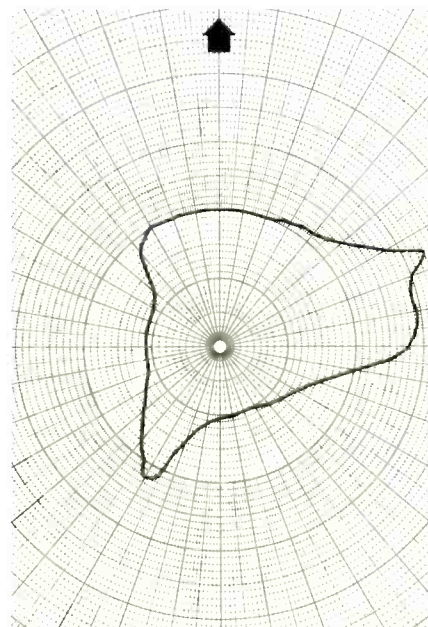
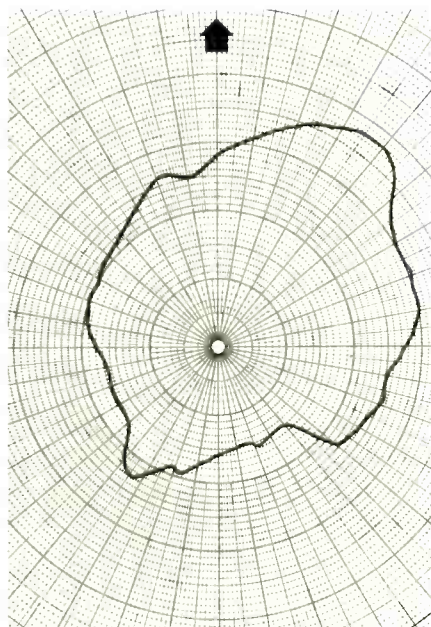

Fig. 2. Radiation pattern of a half-wave vertical antenna.

thus have the major lobe (most of the signal) down on the horizon where your contacts are.

Antenna Types. Most radiation studies to date on CB mobile antennas have dealt primarily with classic antenna

NEWS RELEASE 1976

OFFICIAL TESTING LAB RATES ALLISON #1... the BEST of ALL Ignition Systems!

The ALLISON "Opto" was Officially Rated #1 by a Foreign Government Testing Laboratory as the BEST "Fuel Saving" Ignition of ALL the Ignition Systems Tested, including Systems with C. D. "add-ons"!

NEW ALLISON 'OPTO XR-700'
with the Exclusive... "Built-In" SOLID-STATE VOLTAGE REGULATOR

The "XR-700" is a NEW, redesigned, EASIER TO INSTALL version of the Allison "Opto-Electric", with the New addition of the Voltage Regulator, making it the MOST RELIABLE and Fool-Proof Ignition System ever invented.

Allison replaced the mechanical Breaker-Points and Condenser with a "Highly Accurate" Optical Control. A Beam of Light, passing through a specially designed "ROTOR" precisely triggers a Heavy-Duty "POWER MODULE" that BOTH "Charges and Fires" the Ignition Coil, with the "FASTEST" High Voltage RISE TIME, producing the MAXIMUM "HIGHEST ENERGY" SPARK available.

Since there is NO Mechanical Friction, there are NO Parts to ever WEAR or need replacing, and ONCE properly Timed, it should NEVER need any Maintenance! OWELL never needs adjustment. It is PRE-SET to supply the OPTIMUM Performance at BOTH High and Low Speeds. The RPM Capability of the "XR-700" is Factory Tested to 15,000 RPM.

The "High-Energy" SPARK INTENSITY and DURATION... permits the Positive FIRING of Spark-Plugs, even under the MOST ADVERSE conditions, results in more COMPLETE COMBUSTION and Eliminates "Engine Misfire", hence fewer exhaust Emissions, IMPROVED Fuel Mileage, a HIGHER Performance Level... and helps keep Plugs FROM FOULING, which greatly extends the Spark-Plug LIFE!

Only the Highest Grade (U. S. Made) Solid-State Components are used... UNAFFECTED by Moisture or Vibration! The Allison "XR-700" was engineered to OUTLAST the LIFE OF YOUR CAR!

"EASY-TO-FOLLOW" INSTALLATION. (Not Necessary to Dismantle your Distributor.)

"CB" USERS: The XR-700 completely ELIMINATES the Major Cause of Primary (Ignition Noise) Interference.

U. S. & Foreign Patents Pending

* "XR-700"... Designed for those who want the BEST in Performance, Gas Mileage, Quicker Starting, Eliminate frequent Tune-Ups and Maintenance Costs.

FACTORY-BACKED 10-YEAR WARRANTY.
FREE Unit Repair or Replacement on ANY Defects

* **ORDER WITH CONFIDENCE...**
Remember, even if you PAY Three Times as much, you cannot get a better Ignition System than the "XR-700"!

* **SAVE! ORDER FACTORY DIRECT.**
Send Check or M. O., Car Make, Year, No. Cyl. (4, 6, or 8-Cyl.)

* You may use your MASTER CHARGE or BANKAMERICARD. Send us (1) Your Number, (2) Interbank No., (3) Exp. Date

* MC or BA Card Holders, ORDER by TOLL FREE PHONE: (800) 423-6525, Ext. 2 (When in Continental U. S. A.)

* **Before Buying ANY other Type Ignition System... Send Postcard for FREE BROCHURE.**

If you have already installed a "Capacitive-Discharge" Ignition...
* Convert Your "C-D" Unit to BREAKERLESS!
INCREASE ITS EFFICIENCY with "XR-CD"... Only \$34.95

* America's Oldest and Largest Manufacturer of Opto-Electronic Ignition Systems. ©

ALLISON * Our BEST Salesmen... are the USERS of our ALLISON Systems!
AUTOMOTIVE CO. 1267-EB, East EDNA Pl., COVINA, CAL. 91722



CIRCLE NO. 6 ON FREE INFORMATION CARD

theory as described by Jasik in the *Antenna Engineering Handbook* (McGraw-Hill). These studies reveal a combination of factors that strongly favor the quarter-wave antenna for mobile use.

The half-wave dipole is far too unwieldy in size (18-feet) for use on vehicles, although physically shortened versions are available for use on wood and fiberglass boats and other vehicles without adequate ground plane surfaces. However, the metal mass of most vehicles will provide a ground plane, whether it is needed or not. Even fiberglass vehicles possess large metal parts which affect the antenna system.

On the other hand, the quarter-wave antenna requires a ground plane to reflect its mirror-image, making it "look" like a half-wave dipole. Ideally, the ground plane should extend at least a quarter wavelength in all directions from the antenna base. In practice, the ground plane is seldom as large (a circle 18 feet in diameter) as it should be. The ground plane should be a flat surface perpendicular to the axis of the antenna. A sloping ground plane will distort the radiation pattern by presenting the image of a bent dipole, and it will also modify signal polarization.

The sloping ground plane, such as might be encountered on a hatch-back, will also tilt the major lobe both skyward in the front and into the ground towards the rear. The effects of an asymmetric or incomplete ground plane will normally tend to extend the major lobe in the direction of the largest ground plane area and suppress the lobe in the shortest direction of the ground plane.

Antenna Mounts. Ideally, the antenna should be placed at the geometric center of the highest horizontal metal surface, normally the roof. However, many people do not wish to punch holes in their automobiles, and instead mount the antenna on the trunk lid, the second most favorable location.

If the antenna is mounted on the left or right rain gutter or cowl, the pattern will be distorted, with the major lobe directed toward the opposite side of the car. A centerline location is far more desirable than either of these asymmetric locations. Similarly, an 108-inch whip mounted on the rear bumper will suffer the same deficiency. Even though it can offer a larger area for radiation and greater efficiency, its effectiveness is lost to the inadequate ground plane.

Another aspect which is important to an efficient antenna installation is the desirability of a "hard ground" directly to

If you don't need it for forever, don't build it for forever.

Here's an application for our ACE solderless breadboards you may not have thought of.

Next time you only need a circuit for a little while, build it up on an ACE. There's an ACE the right size for almost any circuit you have to build. And ACE is a more reliable solderless breadboard, so your circuit can stay functional for as long as you need it together. Then, when your need for the circuit disappears, just disassemble it and use everything over again. It's all good as new.

And what's true for ACE is also true for our versatile A P Super-Strips™, Terminal and Distribution Strips.

So if you have a special application circuit that you won't need around forever—a test jig, a set-up-and-calibrate hookup, you name it—put ACE to work for you. The time you save may be your own. ACE. The All Circuit Evaluator from A P Products.

Part No.	ACE Model No.	Tie Points	DIP Capacity	No. Buses.	No. Posts	Board Size (inches)	Price Each
923333	200-K (kit)	728	8 (16's)	2	2	4-9/16x5-9/16	\$18.95
923332	208 (assem.)	872	8 (16's)	8	2	4-9/16x5-9/16	28.95
923334	201-K (kit)	1032	12 (14's)	2	2	4-9/16x7	24.95
923331	212 (assem.)	1224	12 (14's)	8	2	4-9/16x7	34.95
923326	218 (assem.)	1760	18 (14's)	10	2	6-1/2x7-1/8	46.95
923325	227 (assem.)	2712	27 (14's)	28	4	8x9-1/4	59.95
923324	236 (assem.)	3648	36 (14's)	36	4	10-1/4x9-1/4	79.95

ACE solderless breadboards feature gold-anodized aluminum base/ground planes, non-corrosive nickel-silver terminals and four rubber feet.

Shipping/Handling
Up to \$10.00 \$1.00
10.01 to 25.00 1.50
25.01 to 50.00 2.00
50.01 to 100.00 2.50
100.01 to 200.00 3.00

Orders subject to acceptance at factory.

Company PO's FOB Painesville
No COD orders

DEALER INQUIRIES INVITED.

Ohio and California residents add sales tax.
Send for our new A P catalog,
The Faster and Easier Book.

For the name of the A P Products dealer near you, call our toll-free number: 800-321-9668

A P PRODUCTS INCORPORATED
Box 110-H
Painesville, OH 44077
(216) 354-2101
TWX: 810-425-2250



CIRCLE NO. 1 ON FREE INFORMATION CARD

the ground plane at the antenna base, as well as through the coaxial antenna cable.

Dual Antennas. As more and more newcomers have joined the CB ranks this year, I have noticed a proliferation of dual, co-phased antennas on every type of a vehicle from 18-wheelers to Volkswagens. Why are these twin systems being installed? I guess the major reason is that uninformed operators feel that, "If one antenna can get my signal out five miles, two antennas ought to do twice as well." Unfortunately for those who have spent large sums to put two antennas on their vehicles, it is simply not true.

Antenna design engineers know that co-phased antennas mounted on a perfect ground plane and separated by a half wavelength (18 feet) will exhibit about 3 dB gain (or double the effective radiated power) over a single antenna. However, when the spacing between them is reduced to 10 feet, the gain is only about 1 dB (the minimum gain detectable). With smaller separations, the gain is even less and the radiated signal has about the same strength as that from a single, properly mounted antenna.

There are some circumstances in which dual antennas serve very useful purposes. But these situations are very limited and are difficult to handle in any other manner. For example, on an 18-wheeler that has a high metal box behind it, co-phased antennas mounted as far apart as possible on the side mirrors may be the only viable solution for "reaching around" behind the vehicle. Likewise, on a recreational vehicle with an upper cab entirely composed of fiberglass, side-mounted 108" whips might provide a good answer. However, they would definitely function most effectively if mounted as close as possible to the fore-n-aft center of the vehicle, rather than at one end. In this case, the reason for using co-phased antennas is to improve the radiation pattern, and power gain is not significant.

To be at all successful, dual antennas must be "co-phased" properly. That is, the coaxial feed cables must be of the correct impedance and exactly the correct length to cause the two antennas to radiate or pickup signals in such a manner that they will work together *additively*. It is imperative that the cables supplied by the manufacturer not be shortened, and I suggest that you do not try to make a harness unless you are well versed in antenna theory and practice.

THINKING ABOUT YOUR OWN COMPUTER?



Join over 50,000 avid readers of BYTE, the magazine with rich, professionally edited articles on micro-computers . . . for building, expanding and having downright fun with your own system. You'll reread super articles on . . .

- detailed hardware/software designs by successful experimenters and hobbyists
- editorial on the fun of computers . . . electronic music, video games, hobbyist control systems, ideas for ham radio, model railroading and lots more
- reviews of upcoming general purpose systems
- tutorial background and sources full of ideas for home computers and computer science
- ads by firms with computer products you want
- club information and social activities

SUBSCRIBE TO BYTE NOW! IT'S FUN. . . AND GLITCH-PROOF!

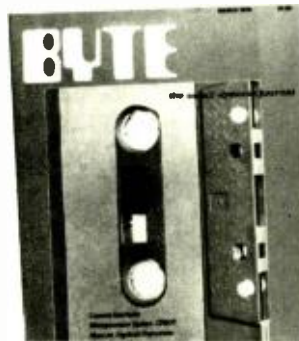

Send this coupon for a trial subscription to BYTE. Get your first issue by return mail. Read it from cover-to-cover. If it isn't everything you want, just write "CANCEL" on the bill and return it to us. The first copy is yours to keep.

BYTE PETERBOROUGH, NH 03458 PE-12

Please enter my trial subscription to BYTE . . .
 \$12 One Year \$22 Two Years \$30 Three Years
 I understand you will send the first issue by return mail and bill me later. If I don't like BYTE, I just write "CANCEL" across the invoice and return it. I will not be charged.

Name (Please Print) _____
 Address _____
 City _____ State _____ Zip _____

CIRCLE NO 15 ON FREE INFORMATION CARD

HEAR-IT-YOURSELF KIT



This is a Speakerlab 7, a 4-element acoustic suspension speaker kit you can assemble yourself in an hour with simple tools.

It saves you up to 50% over comparable ready made systems. Read about the S7 and other systems and raw speakers we sell in a new 40 page catalog. It's a fact-packed manual with chapters on acoustic theory, enclosures, choosing drivers and design principles.

And it's free. Just write us and ask for the most complete catalog/manual ever written on speaker building.

Speakerlab®
 Dept. PE10 5500 35th NE Seattle WA 98105

PRICE WAR

AMERICA'S #1 VALUE LEADER
STEREO CORPORATION OF AMERICA



AUDIO DISCOUNTING STARTED IN NEW YORK & NOW WITH THE END OF FAIR-TRADE WE ARE SURE THAT NO ONE CAN BEAT OUR PRICES:

- WE DISCOUNT OVER 60 MAJOR BRANDS
- OVER 10 YEARS OF RELIABLE SERVICE IN THE MAIL ORDER FIELD.
- LARGEST INVENTORY/LOWEST PRICES! WE GET THE BEST DEALS FROM THE MANUFACTURERS: YOU GET THE BEST DEAL FROM US. DON'T DELAY!!!

WRITE US NOW FOR LOWEST PRICE QUOTE

WRITE OR CALL FREE
 STEREO PRICE CATALOG

SHOP BY PHONE!
 (212) 253-8888
 N.Y. TIME
 9-5 MON. THRU SAT.
 MasterCard/BankAmericard

STEREO CORPORATION OF AMERICA

P-E 1629 Flatbush Ave., Brooklyn, New York 11210

CIRCLE NO 64 ON FREE INFORMATION CARD

Autoranging Frequency Counting to 60 MHz with 1 Hz Resolution



B&K-PRECISION MODEL 1801 \$240

- For laboratory, production line or maintenance applications
- Automatic ranging, 20 Hz to 40 MHz is guaranteed...readout to 60 MHz is typical
- TTL circuitry updates the six-digit display five times per second
- Resolution to 1 Hz obtained by suppressing digits above 1 MHz when switching to 1 SEC mode



MHz display of
3.579548 MHz input (AUTO mode)

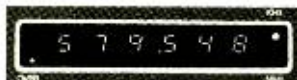

KHz display of overflow of
3.579548 MHz input (1SEC mode)

- Available for immediate delivery, from local B&K-PRECISION distributors
- 10-day free trial offer

B&K PRECISION
PRODUCTS OF DYNASCAN

6460 West Cortland Avenue
Chicago, Illinois 60635 • 312/889-9087
In Canada: Atlas Electronics, Toronto

CIRCLE NO. 13 ON FREE INFORMATION CARD

I was astounded the other day to hear that some of my neighbors have "found a way to double their power legally." It seems that they have determined that there is no rule against operating two rigs from one vehicle each feeding a separate antenna but, using the same microphone.

There is only one trouble with their theory: it won't work. Unless the two transmitters are driven from a common frequency determining device (and that is illegal), they will not operate at precisely the same frequency. The result will be a fluctuating signal as the two transmitters shift in and out of phase. This would produce unbelievably bad heterodynes. Also, doubling the output power will increase the received signal only 3 dB—about one half of an S unit. Don't do it!

Whips. Quarter-wave mobile antennas are generally classified in one of the following types:

- full-sized ¼-wave whip (108-inch length).
- base-loaded
- center-loaded
- top-loaded
- continuously loaded

The last three of these antenna types are sufficiently similar that they will be discussed as a single type.

Undoubtedly, the most efficient type is the full-length whip because it reaches higher, presents a greater radiation length than any of its loaded (physically shortened) cousins, and wastes no power heating up a coil. Unfortunately, a nine-foot antenna cannot be mounted in a position which will provide it with a full ground plane, as can many of its counterparts. Most of its plausible mounting locations result in radiation patterns which are badly distorted. For this reason, the shorter antennas are more popular and in most cases outperform the whip.

The workhorse of compact antennas has been the base-loaded whip. It requires an adequate ground plane and does not perform well without one. It features a low radiation angle, and is usually made of a slender steel spring shaft which offers little wind resistance and stands straight at highway speeds. The most favorable locations to mount a base-loaded antenna are the center of a steel roof or on the trunk lid of a sedan. It should be mounted on the vehicle's centerline.

The three final antenna types carry their loading coils higher on the antenna shaft. As a rule, the higher the coil is lo-

cated, the more efficient the antenna. Therefore, they are more efficient than base-loaded whips. However, these antennas are more prone to damage from low obstructions than base-loaded ones. The vertical angle of radiation is generally higher for these antenna types, but they perform better in locations where the ground plane is poor and are better suited to mirror or gutter mounting. For this reason, they are usually found in co-phased arrays. They also work well where there is a good ground plane, but if their loading coils are bulky they will offer more wind resistance. However, some of the newer continuously loaded fiberglass antennas are nearly as slender as a base-loaded steel whip.

Other Considerations. Antennas that sway in the wind usually produce varying signal strengths at the receiver. Antennas which bend over backwards at highway speeds radiate obliquely polarized signals which are not well received by vertically polarized antennas. Whatever the antenna type, it is strongly recommended that it be well grounded at the antenna base as well as through the coax.

Now that 40 channels have been authorized for Class D, the bandwidth is increased to 0.405 MHz. Some antennas might not give adequate performance across the entire band. There should be no trouble with antennas in excess of three feet in length; but the shorter the antenna, the more critical tuning becomes. The center frequency of the extended band will fall between channels 20 and 21, whereas the band center is now at channel 13. If you get a 40-channel rig, retune the antenna for optimum performance at the new center frequency. However, if you have a mini-whip, you might find it difficult to achieve an acceptable SWR across the entire band.

Speaking of SWR, it should be checked when the antenna is installed, and checked again periodically to insure that the antenna is still functioning properly. The SWR should be held under 3:1; and unless the rig is SWR protected, a higher SWR might severely damage your transmitter.

Following the guidelines given here, you should be able to plan an efficient mobile antenna system and select the proper antenna for your vehicle. You should buy a commercially available antenna of proven performance. If the mounting instructions are followed carefully, anyone who can handle a screwdriver should be able to install an antenna properly. ◇

LAMP CIRCUIT QUIZ

TO TEST YOUR ABILITY TO TRACE OUT LAMP CIRCUITS, WRITE THE DIGIT 1 INSIDE EACH CIRCLE REPRESENTING A LAMP IF IT LIGHTS TO ITS MAXIMUM POSSIBLE BRIGHTNESS, A 2 IF IT HAS ANYTHING LESS THAN FULL BRIGHTNESS, AND A 3 IF IT DOESN'T LIGHT AT ALL.

ASSUME THAT ALL OF THE LAMP FILAMENTS AND RESISTORS HAVE THE SAME VALUE OF RESISTANCE.

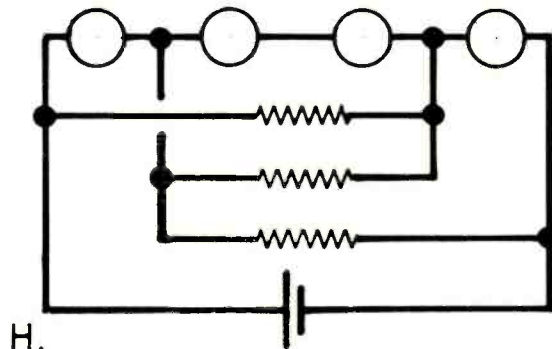
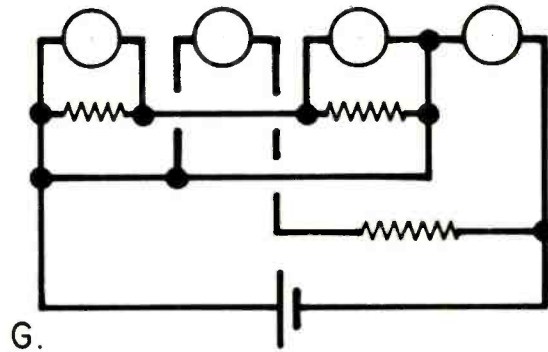
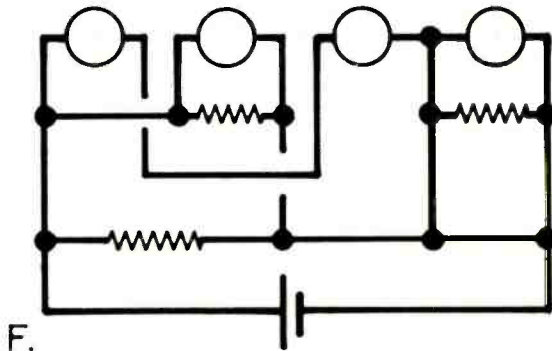
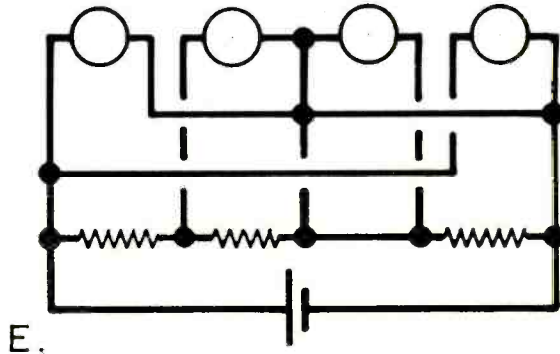
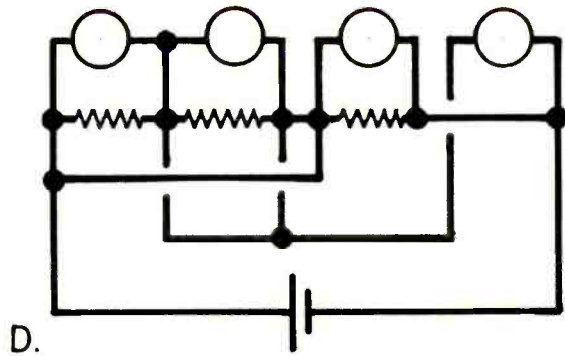
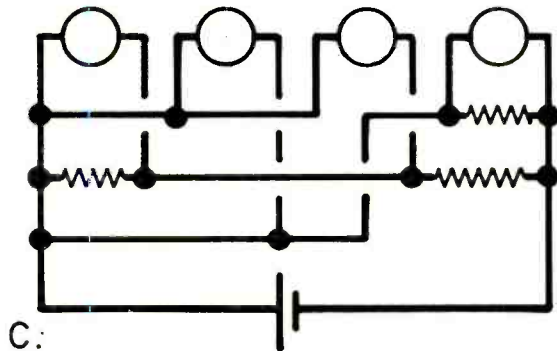
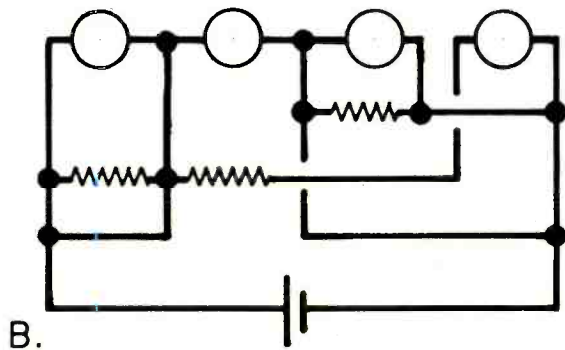
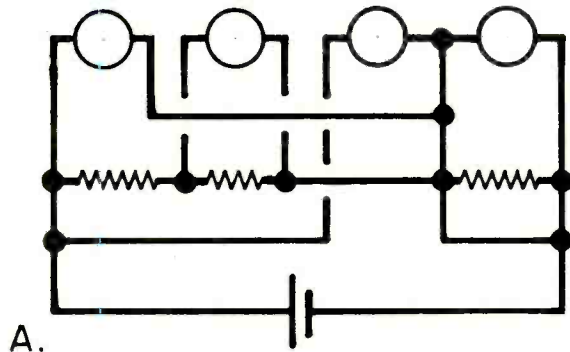

ANSWERS:
 A. 1-2-3-1
 B. 3-1-3-2
 C. 2-3-2-1
 D. 3-3-1-1
 E. 2-3-3-2
 F. 2-1-2-3
 G. 3-2-3-1
 H. 3-3-3-1

**CIE has
a terrific idea
for a few people
who know what
they want.**

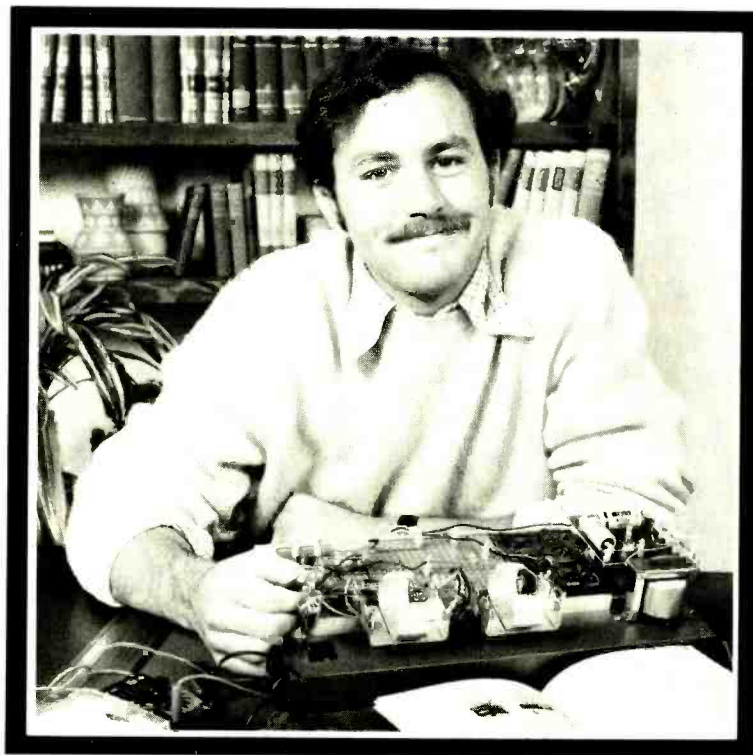

If you want success in electronics . . . if you want the skills people are glad to pay for . . . find out about CIE training.

It's a terrific idea that can get you on your way to success in electronics troubleshooting.

Let's face it, learning valuable new skills isn't something you just breeze through. Especially in a modern technological field like electronics troubleshooting. You've got to really *want* success if you're going to build your skills properly.

But, oh boy, the rewards when you do! In today's world, the ones who really *know* electronics troubleshooting find that people . . . even industries . . . look for their help.

What about you? How much do you want the thrill of success . . . of being in demand? Enough to roll up your sleeves and work for it?

Why it pays to build troubleshooting skills .

Suppose the automated production controls on an assembly line break down. Imagine how much money the manufacturer can lose when help doesn't come *fast!* And it takes a skilled electronics troubleshooter to move in . . . locate the problem . . . solve it . . . and get the lines moving again.

Or take a TV station. Breakdowns are costly in broadcasting where time is money. Viewers won't sit forever waiting for sound or the picture to come back. Before they change channels, the station needs to get back on the air again — with the help of a skilled troubleshooter.

No question about it. Building new skills in electronics troubleshooting is an investment in your future. It's well worth the effort.

Why you should get CIE to help you do it.

Troubleshooting starts with *ideas* . . . principles. CIE's Auto-Programmed® Lessons help you get the idea — at your own most comfortable pace. Step by step at home, you explore each principle — each theory — until you understand it thoroughly and completely. Then you start to use it.

How CIE helps you turn ideas into reality .

If you're a beginner, you start with CIE's Experimental Electronics Laboratory. You actually perform over 200 experiments to help you grasp the basics. Plus you use a 3-in-1 Precision Multimeter to get your first taste of the testing, checking, analyzing steps you take in troubleshooting!

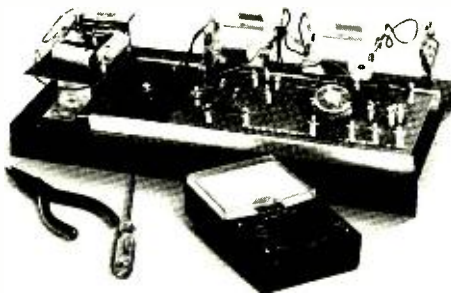

How 3 practical steps help you build troubleshooting skills .

You'll take your first practical step in professional troubleshooting when you build your own 5MHz triggered-sweep, solid-state oscilloscope.

As a trained troubleshooter, you'll use your oscilloscope the way a doctor uses his X-ray machine. As a student, you learn how to "read" waveform patterns on a big, 8cm. x 10cm. screen . . . how to "lock them in" for closer study . . . how to understand and interpret what they tell you.

Your second practical, skill-building step begins when you get your Zenith 19-inch diagonal, solid-state color TV — featuring nine removable modules! Now's your chance to apply the new skills you learned with your oscilloscope!

With CIE's guidance, you perform actual service operations — the kind you'd handle on the job as a trained troubleshooter! Using the TV, you learn to trace signal flow . . . detect and locate malfunctions . . . restore perfect operating standards . . . just as you would with any sophisticated electronics equipment.



Finally, step three rounds out your experience as you work with a completely solid-state color bar generator — actually a TV signal transmitter that produces ten different display patterns on your TV screen!

You study a gated color bar rainbow . . . crosshatch lines . . . dot patterns.

You explore digital logic circuits . . . observe the action of a crystal-controlled oscillator!

This practical, "hands on" training takes concentration and effort. But it's enjoyable and rewarding. And it's a great way to prepare for a troubleshooting career!

Why it's important to get your FCC License .

For some troubleshooting jobs, you *must* have your FCC License. For others, employers often consider it a mark in your favor. It's government-certified proof of specific knowledge and skills!

Almost 4 out of 5 CIE graduates who take the exam get their Licenses. More than half of CIE's courses can prepare you for it . . . and the broadest range of career opportunities!

Free catalog!

Mail the card. If it's gone, cut out and mail the coupon. If you prefer to write, mention the name of this magazine. We'll send you a copy of CIE's FREE school catalog — plus a complete package of independent home study information! For your convenience, we'll try to have a representative call to help you with course selection. Mail the card or coupon . . . or write: CIE, 1776 East 17th Street, Cleveland, Ohio 44114.

CIE Cleveland Institute of Electronics, Inc.

1776 East 17th Street, Cleveland, Ohio 44114
Accredited Member National Home Study Council

YES . . . I want to succeed in electronics. Send me my FREE CIE school catalog — including details about troubleshooting courses — plus my FREE package of home study information!

NAME (please print)

ADDRESS APT.

CITY

STATE ZIP

AGE PHONE (area code)

Check box for G. I. Bill information:
 Veteran Active Duty

Mail today!

PE-22

Take your world with you ... by land or by sea.



Computer Bits

BOOKS ON PROGRAMMING

By Stephen B. Gray
Senior Editor

PERHAPS the manual that came with your microcomputer kit is a little light on the software side, and doesn't tell you what you want to know about programming in assembly language. Or maybe there was no manual at all with the BASIC interpreter you bought, and you're not familiar with that language. So you start looking for a book. But first, a few words about both languages.

In talking with a number of computer hobbyists about what programming languages they use, it turns out that only a few are really into heavy assembly-language programming; most of them use BASIC. Assembly language, to quote from a Scelbi book, "is by far the most efficient method for packing a program

into a small amount of memory," and for that reason is widely used in business, where there is a demand for highly efficient programs. But since the average person is more interested in what can be accomplished with a program than in the program itself, or in its efficiency, BASIC is in much greater use in schools, colleges, and among computer hobbyists. However, since there is an interest in assembly language, and because a computer with a minimum amount of memory can be programmed only in assembly language, let's look at some books on that subject.

Assembly Language. Although there are several excellent books on as-

sembly language, there isn't one I've seen so far that's meant for the average electronics hobbyist—that is, a book that assumes the reader knows nothing at all about programming. Perhaps this is because assembly language is a rather difficult language for programming, as far as most hobbyists are concerned. I don't mean the "Computer Freaks," who enjoy working down at the machine-language level. I mean a person who knows little or nothing about computers, and who in fact may not even know what assembly-language programs are. Writing such programs requires a great amount of attention to tiny detail, as well as a great deal of time, in comparison with writing a program in BASIC (or other high-level language) to perform the same task.

The ideal (but nonexistent) book on assembly language should assume the reader is starting from zero. After a chapter or two on the elements of programming and flowcharting, it should introduce him to instructions such as LDA, MOV and STA, in small groups or one at a time, explain them thoroughly, and give a variety of short programs using them. It should fully explain how each program works and what it does.



Four great RCA product lines that let you enjoy yourself wherever you are, through TV reception, stereo radio or tape, scanners and CB... for your boat or RV.

RCA Mini-State TV Antenna System — housed in a weather-resistant 21" diameter case, this compact, rotating antenna pulls in VHF and UHF TV up to 35 miles over land or water.

RCA Stereo Radio and Tape Players — take your choice from RCA's full line of AM/FM radios and cassette or stereo-8 especially suitable for boats and RV's.

RCA CB Co-Pilot Two-Way Radios — top performance, transmitting or receiving. A "must" for emergencies or travel information. Can be installed in any boat or vehicle with 12 volt system.

RCA Scan-Aire Scanning Monitors — hear the real-life drama of public service broadcasts, as well as important information aired on weather, police or marine channels.

See your RCA dealer for detailed information, and start taking your world with you. Or contact RCA Distributor and Special Products Division, Bldg. 206-2, Cherry Hill, N.J. 08101.

RCA

CIRCLE NO 54 ON FREE INFORMATION CARD

The problem with creating such a book is that, in order to be as all-encompassing as it should be for the beginner, going into detail for each of the 78 instructions for the 8080 MPU, or the 158 for the Z-80, the book would have to be an inch or two thick. It's much easier to assume, as most of the current books do, that the reader is a programmer or an engineer, or at least has had quite a bit of exposure to computers and programming. This is similar to a manual on jet-engine repair that assumes you know all about tools and techniques.

Osborne. The best book I know of for learning about microcomputers won't tell you as much as you may want to know about programming, but it does an outstanding job of going into the hardware and software of seven of the top microprocessors. *An Introduction to Microprocessors*, published by Adam Osborne and Associates at \$7.50, starts out with six chapters on the fundamentals, going into binary arithmetic and Boolean algebra, microcomputer organization, what's in an MPU (microprocessor unit) and how it works, CPU logic, and the elements of programming (memory addressing, stacks, and in-

struction sets); in meticulous detail.

The programming chapter ends by creating a "complete, but hypothetical, microcomputer instruction set," and showing why each instruction is required. This hypothetical set becomes the standard to which the seven real sets are compared, those of the F8, PACE and SC/MP, 8080, 6800, PPS-8 (Rockwell), and 2650. A meaty 138-page chapter has a "look at the way in which a variety of manufacturers have chosen to implement the basic concepts which have been described in Chapters 1 through 6."

For each MPU, the book goes into the registers, addressing modes, status flags, pins and signals, interfaces, interrupts, DMA (direct memory access), and instruction set. This is not an easy book to read because a great deal is packed into it, in rather small type, and it moves at a very fast pace. But no other book available today contains so much information about microcomputers in such a small package—only a little larger than most paperbacks. It's included with every Imsai computer as part of the support documentation. IMS calls it "an excellent 460-page book that teaches how a computer is programmed and pre-

sents an overview of microcomputer technology."

The second edition of the Osborne book has been revised and expanded to two volumes, at \$7.50 each. Volume 1, "Basic Concepts," covers the first six chapters of the first edition, with new sections on chip-slice products and serial I/O. Volume 2, "Some Real Products," which expands on the original Chapter 7 to include more microprocessors, was due to be published late in October, as of this writing.

Scelbi. Scelbi was an early producer of a hobby computer kit. It later dropped out of the hardware business to concentrate on software. To date, Scelbi has produced half a dozen software manuals, on an assembler, editor and monitors for the 8080 MPU, and several others. They've just come out (at this writing) with a new book, a small paperback called *Scelbi 8080 Software Gourmet Guide & Cook Book*, at \$9.95. The book has eight chapters, on the 8080 stack, general-purpose routines, conversions routines, decimal arithmetic routines, floating-point routines, input/output processing, and search and sort routines plus a number of helpful appen-

dices for the computer enthusiast.

The book is meant for people with some knowledge of programming, as it goes right into a discussion of the instruction set, breaking up the 78 instructions into small groups and discussing them in moderate detail. From chapter two on, dozens of programs and subroutines are presented, with a full set of comments for each program. Flowcharts are provided for over 20 of the programs. Most of the programs are quite short, although several run to a couple of pages, such as the floating-point programs for add, multiply, and divide. This

book shows, better than most, the complexity of having to load a group of assembly-language programs into your computer, such as decimal-to-binary input, floating-point normalization, floating-point multiplication, binary-to-decimal output, operating program, etc. Of course, if you're interested only in simple programs, without decimals, for games or for control applications, then you don't need all those routines. How much simpler to work in BASIC, where all the necessary routines are included in one program!

This new Scelbi book, on the 8080, is

bound to become better known than their first best-seller, *Machine Language Programming for the 8008 and Similar Microcomputers*, at \$19.95 (twice the price as well as twice the size). This larger book (8½" x 11") has been recommended to me by several computer-kit manufacturers, and can be found on the shelves of many computer stores. It has nine chapters. They cover the 8008 instruction set, initial steps for developing programs, fundamental programming skills, basic programming techniques, mathematical operations, input/output programming, real-time programming, PROM programming considerations, and creative programming concepts.

The first chapters of the two books are pretty much the same, except that the 8080 book covers 78 instructions to the 8008 book's 48, but most of the remaining material is very different. The floating-point programs are almost identical, because the 8008 instruction set is a subset of the 8080 set. An 8008 program will run on an 8080 machine without having to be changed. For the 8080 book, the author has improved on the 8008 programs by taking advantage of some of the more powerful 8080 instructions, such as those for double-precision operations, not found in the 8008 set.

BASIC. Over 40 books about programming in BASIC have been written, and most of them are fairly good. The authors write with varying degrees of enthusiasm, ranging from "BASIC is great!" to "BASIC is OK, but let me tell you a little about FORTRAN." A small handful of these books is outstanding. Here are two of them.

Kemeny and Kurtz. The best book on BASIC is a classic, the standard by which all other such books must be measured. It was written by the originators of the language, John Kemeny (now president of Dartmouth) and Thomas Kurtz (Dartmouth's Director of Academic Computing). *BASIC Programming*, published by Wiley at \$8.50, pays very careful attention to every detail, taking great care that the reader will have as little difficulty as possible in learning BASIC. The first chapter presents and explains a five-line program that divides one constant by another.

The second program, although 17 lines long, is quite simple, and converts meters and centimeters to feet and inches, with a page and a half of explanation. An entire chapter is devoted to loops, the heart of many programs. The concept of rounding off numbers with

Listen to the music.

Noise in the form of hiss, hum and rumble—all the things that effectively cloud the clarity of records, tapes and FM broadcasts.

Ideally, music should be heard against a silent background. The Phase Linear 1000 achieves just that with two unique systems: AutoCorrelator Noise Reduction and Dynamic Range Recovery.

PHASE LINEAR 1000



The AutoCorrelator reduces noise by 10 dB without the loss of high frequency music and without pre-encoding.

The Dynamic Range Recovery System restores 7.5 dB of the overall dynamic range,

without the pumping and swishing associated with other systems.

The Phase Linear 1000 represents the most significant improvement in sound reproduction for the money... more than any other single piece of equipment you could add to your system. It is easily installed to any stereo receiver or preamplifier.

Ask your dealer for an audition, and listen to the music.

Not the noise.

Phase Linear
The Powerful Difference

Manufactured in the USA. Distributed in Canada by H. Roy Gray, LTD.

CIRCLE NO 50 ON FREE INFORMATION CARD

altair^{T.M.}

Number One in low-cost computing.

Altair, from Mits, is the number one name in microcomputers for home, business, personal and industrial applications. Because the Altair was first, it has set the standard in the industry. More Altair 8800's are now operational than all other microcomputers combined.

Whether you buy a \$395 complete computer kit* or a multi-disk system for under \$10,000; Mits will provide you with thorough and lasting support. Satisfied Altair users include schools, corporations, small businesses, students, engineers, and hobbyists.

Altair hardware includes three microcomputers; the Altair 8800a, 8800b, and 680b. Mits has a complete selection of Altair plug-compatible memory and interface options, including the new Altair 16K Static board and Altair multi-port serial and parallel I/O boards. Also available is a complete line of Altair peripherals including line printers, CRT's, and multiple disk systems.

Altair software is by far the most complete and best for any microcomputer. Our Extended BASIC and Disk BASIC have received industry wide acclaim for programming power and efficiency. Application packages are available at many Altair Computer Centers.**

The Altair computer is a revolution in low cost computing. Shouldn't you write for more information including our free, color catalogue.

*The Altair 680b turnkey model.

**Retail Altair computer outlets now opened in many large cities.



mits

MITS, Inc. 2450 Alamo S.E. / Albuquerque, New Mexico 87106

the INT statement is not simple, yet the authors, by going through each part of such a statement, have found what must be the simplest way of explaining it.

The chapter on simulation contains a baseball program that simulates the batting of one side in a nine-inning game, and one on the Knight's Tour problem. The section on harmony in music gives a long program that writes four-part harmony for a given melody.

Each chapter on applications provides a couple of projects, more complicated than the chapter exercises, that should

provide the reader who has a terminal with a very thorough workout of his knowledge of BASIC. Not all the chapters are easy to understand, since several go into areas such as vectors and matrices, statistics, and calculus. Although most of the book can be understood "with a background of three years of high school mathematics," these three math areas "are normally taught at the college level." Not everybody will dig into these chapters, but they're there for those who want to, and for those who will eventually learn the requisite math.

Dwyer and Kaufman. The best of the introductory texts, bright and sparkling, recommended for any young person, or in fact for anybody, is *A Guided Tour of Computer Programming in BASIC*, published by Houghton Mifflin at \$4.40, and written by Thomas A. Dwyer and Michael S. Kaufman, who do their best to make learning fun.

The book is in four parts. "Getting Ready for the Journey" covers the basics and LET, PRINT and END. Six more statements are introduced in "The Economy Tour." "Techniques for the Seasoned Traveler" brings in nine more statements plus library functions. Nine applications programs are presented in "Far Away Places." The book covers 20 statements altogether, all you'll need for most applications. Although it's meant to be used with a terminal, this book doesn't *have* to be.

As an indication of the book's ingenious variety, the applications programs in Part 4 include those for a hotel reservation system, generating brand names for soap, slot-machine games (cherries, lemons, oranges), monthly installment payments on a loan, and payroll.

One of the most important features is the many callouts to the programs, outlined in red, with a red line pointing to the line or lines they explain. Each of the four parts is divided into sections. At the end of each section is a review of the material covered, and there are several sets of exercises in each of the parts.

This fine book is mainly for young people, but it will be of value to anyone. It is full of detail, with many examples and much thought given to the use of graphics in teaching.

Your Favorite Book. If your favorite book on assembly language or BASIC isn't one of the five mentioned here, please don't fret. There are many other fine books, out of the 60 or more on the two languages. The ones discussed are among my favorites, given limited editorial space. However, future columns will refer to other books of interest, on both programming and applications. ◇

NOW FROM TEXAS INSTRUMENTS . . .
three machines in one.

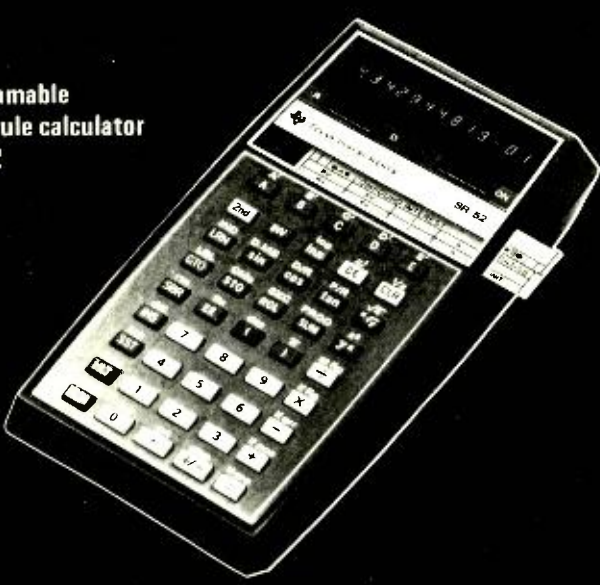

programmable
slide-rule calculator
SR-52

- 10 user defined keys
- 224 program storage locations
- 23 preprogrammed key functions
- 8 preprogrammed condition statements
- 20 independent addressable memory registers
- Permanent program storage on magnetic cards

It took TEXAS INSTRUMENTS to invent the SR-52 calculator. It took C & S MARKETING ASSOCIATES to offer it at a price you can afford, now only \$229.95. With such versatility and such an affordable price, you can not afford to be without the problem solving power of card programability. Now solve problems in seconds that would take hours with an ordinary calculator or slideruler if they could be done at all.

For more information or the answer to any question you may have about the SR-52 calculator, call toll free (800-251-6771)*. Tenn. residents call (800-262-6706). Other TEXAS INSTRUMENT models available from \$49.95.

Each TEXAS INSTRUMENT calculator comes with a 1-year warranty. Should your unit prove defective within 60 days, just return it for a new unit! Finally should you be dissatisfied with your calculator return it within 15 days for a prompt refund. * COD orders please add \$5.00 shipping and handling.

C & S MARKETING ASSOC.
P.O. BOX 165 ALGOOD, TENN. 38501

QTY. _____ PRICE 229.95 ea.

CHECK M.O. C.O.D.

NAME _____

ADDRESS _____

CITY, ST., ZIP _____

CIRCLE NO. 16 ON FREE INFORMATION CARD

ADDRESSES

Adam Osborne and Associates, Inc.,
2950 Seventh St., Berkeley, CA 94710

Scelbi Computer Consulting Inc., 1322
Rear Boston Post Road, Milford, CT
06460

John Wiley & Sons, Inc., 1 Wiley Drive,
Somerset, NJ 08873

Houghton Mifflin, Wayside Rd., Burling-
ton, MA 01803. Attn. College Order
Dept.



Electronics Library

ARRL ELECTRONICS DATA BOOK Edited by Doug DeMaw, W1CER

Here is a compilation of data useful to the electronics experimenter, regardless of his level of experience. It contains ten chapters, and among the subjects treated in depth are r-f circuit data, L, C, and R networks, broad and narrow band transformer design, filter design, antennas and feed systems, and a catalog of practical solid-state circuits. All chapters include pertinent simple equations with representative solutions. Toroidal designs are emphasized in the transformer chapter. Modern filter design covers two- and three-pole Butterworth derivations for most of the frequencies of interest to amateurs, and tables of practical filter values are included. Published by the American Radio Relay League, 225 Main Street, Newington, CT 06111. 128 pages (8½" x 11") \$4.00 soft cover.

AUTO ELECTRONICS SIMPLIFIED by Clayton Hallmark

Applications of electricity and electronics—from the basics of alternators to digital computer automotive analysis—are examined in this book. Topics discussed are electronic charging and ignition systems, safety appliances, emission and performance devices, radios and tape players, comfort and convenience systems, automotive test equipment, computers and cars today, computer basics, and advanced automotive technology. Both theory of operation and troubleshooting information are included. Schematics, line drawings, and illustrations supplement the text. Published by Tab Books, Blue Ridge Summit, PA 17214. 266 pages. \$5.95 soft cover.

RCA SOLID STATE REPLACEMENT GUIDE

The updated RCA Solid State Replacement Guide, SPG-202R, lists more than 103,000 industry types which are replaceable by only 250 RCA SK devices, including 32 new types. Significant ratings and characteristics are given for each device to aid selection of the optimum replacement semiconductor. Dimensional outlines of device packages and terminal diagrams are given, as well as a revised hardware replacement directory. Published by RCA Solid State Division, Box 3200, Somerville, NJ 08876. 156 pages. \$3.00 soft cover.

FREE

McIntosh CATALOG and FM DIRECTORY

Get all the newest and latest information on the new McIntosh Solid State equipment in the McIntosh catalog. In addition you will receive an FM station directory that covers all of North America.



MX 113

FM/FM STEREO - AM TUNER AND PREAMPLIFIER

SEND TODAY!

McIntosh Laboratory, Inc.
East Side Station P.O. Box 96
Binghamton, N.Y. 13904
Dept. PE

NAME _____

ADDRESS _____

CITY _____ STATE _____ ZIP _____

If you are in a hurry for your catalog please send the coupon to McIntosh.
For non rush service send the *Reader Service Card* to the magazine.

CIRCLE NO. 43 ON FREE INFORMATION CARD

CB

where the ACTION'S at

Millions of 2-way CB radios are in use—millions of new ones are being sold annually to new CBers and for replacing old units—what a market for repair service. It's the biggest thing in electronics since color TV. There's only one thing wrong with CB growth—the lack of technicians capable of servicing CB radios. That's why many TV shops are expanding into CB and why new CB shops are opening up all over the country. Going CB servicing rates run from \$12 to \$24 per hour.

To get into CB radio servicing, full-time or part-time, you need test equipment, a FCC operator license and to learn how. To learn how, you can buy the **CB RADIO REPAIR COURSE** for cash, on a monthly payment plan, or charge the cost to your BankAmericard or Master Charge account.

To make it easy to study, this 70-lesson course employs the **PROGRAMMED** teaching technique and sticks to the target—CB radio. Study at your own pace as you receive the self-examining lessons. We can't guarantee that you will become a CB expert since that depends on you.

To get the facts about this course, write a letter or card or mail the coupon below today. No salesman will call.

CB RADIO REPAIR COURSE, INC. Dept. P 126
531 N. Ann Arbor
Oklahoma City, OK 73127

Please send information about your Course to:

Name _____
Address _____
City _____ State _____ Zip _____

CIRCLE NO 73 ON FREE INFORMATION CARD



DON'T LET OUR NAME FOOL YOU

STEREO DISCOUNTERS

WE'RE ALSO CB DISCOUNTERS!

Save by buying from a high volume dealer.
Send for your Free Hi-Fi and CB Catalog ...
Or call for a price quote on our "Super Service" line ...

301-252-6880

Name _____
Address _____
City _____ State _____ Zip _____
STEREO DISCOUNTERS
7A Aylesbury Rd.
Timonium, Md. 21093

PE 12

CIRCLE NO 65 ON FREE INFORMATION CARD

WANT TO HOOK UP A CIRCUIT QUICK?

The PB-100 is only one of our family of solderless Proto-Board breadboarding units, designed to help you assemble, test and modify circuits as fast as you can push in or pull out a lead. *Preassembled* sockets with durable 5-point terminals provide low-resistance interconnections you can arrange and re-arrange at will.

Resistors, capacitors, transistors, DIP's, TO-5's, LED's etc. plug in without damage to leads. And jumper connections, where required, are lengths of #22 AWG solid wire. Models from 630 to 3060 tie-point (6 to 32 14-pin DIP) capacity available. For more information, see your CSC dealer, or write for our catalog and distributor list.



Proto-Board® 100. 760 solderless tie-points. Kit, \$19.95*

CONTINENTAL SPECIALTIES CORPORATION



EASY DOES IT

44 Kendall Street, Box 1942
New Haven, CT 06509 • 203-624-3103 TWX 710-465-1227
West Coast office, Box 7809, San Francisco, CA
94119 • 415-421-8872 TWX 910-372-7992
Canada Len Finkler Ltd., Ontario

© 1976, CSC

*Mfrs sugg. list

CIRCLE NO. 19 ON FREE INFORMATION CARD

Operation Assist

If you need information on outdated or rare equipment—a schematic, parts list, etc.—another reader might be able to assist. Simply send a postcard to Operation Assist, POPULAR ELECTRONICS, 1 Park Ave., New York, NY 10016. For those who can help readers, please respond directly to them. They'll appreciate it. (Only those items regarding equipment not available from normal sources are published.)

Hammarlund Model CB 212 transceiver. Need alignment instructions. Johnny "K," 267 Portion Rd., Lake Ronkonkoma, NY 11779.

Bendix Radio Facto Meter, Model 847 S, Field Test Receiver/AM and FM. Schematic diagram needed. Bill Coleman, Jr., 114 Circle Drive, Rocky Mount, NC 27801.

Crosley Model 146CS all-wave and FM 200-300-MHz receiver. Also BC342. Schematics needed. Monroe Penick, 509 St Johns Dr., Sherman, IL 62684.

GE Model 1-70 Radio, **Atwater Kent** Model 47, **Watterson Radio Mfg.**, Dallas TX, 5-tube table radio containing 2-6D6, 2-5L6, 2-5Z5, L55F. Schematics and/or service manuals needed. S.D. Canup, 902 S. Goliad, Rockwall, TX 75087.

Vespa Model 400 AM/FM/MPX receiver circa 1963. Schematic needed. Tom Sayen, 200 E. Montgomery A-1, Ardmore, PA 19003.

Knight-Kit Safari I CB transceiver circa 1965. Schematic and parts source needed. Andy Higgins, 915 Beechwood, Waukesha, WI 53186.

Hammarlund HQ-110C receiver. Schematic, alignment, and any other information. Mark D. Kokstis, R.R. 2, Box 329, Camp Point, IL 62320.

CG Electronics Corp. Model TR-2 Junction Transistor Tester. Schematic and/or operations manual, or address for the company (formerly Albuquerque, NM) Paul Van Auken, 23433 Friar St., Woodland Hills, CA 91364.

Any schematics or information on voice synthesizers or voice command switches. Craig Boyce, 176 E. 77 St., New York, NY 10021.

Heathkit Model OP-1 oscilloscope. Operating manual (not assembly manual) needed. Douglas Paradis, 807 Pembroke Ave., Columbia, SC 29208.

Superior Instruments Model TV-11 Tube and Condenser Tester, **Lafayette** Micro P 100-A police radio. Schematics, operations manuals, or any available info. Also interested in schematic for any type of electronic coin cleaner. Philip Hawkins, 124 Summer St., Central Falls, RI 02863.

EICO Model 400 oscilloscope serial 3789. Manuals and any other info. David Altfeld, 142-20 84th Drive, Jamaica, NY 11435.

Signal Corps detector plate choke, stock No. 3C317-3, 450 henries + 20%, -10%, Type 7447 for Frequency Meter SCR-211-T. Reference TM11-300T page 39. Source needed. Henry B. Gratton, R.D. 1, Box 140, Elliottsburg, PA 17024.

DeVry Tech. Inst. 5-inch scope with 5UP1 CRT, Model No. unknown. Need operating manual, schematic, and calibration data. A. Garvelink, Box 88, Lawton, MI 49065.

Sylvania Model 19TC11CA color TV, chassis No. DO3200. Need source for the color flyback, part No. 50-17314-1 (294-6539, or replacement. Joseph M. Nowinsky, PSC Box 4559, Howard AFB, APO New York 09020

IBT mini-manual for PBX installations. Latest edition needed. T. Schweig 500 H. St., NW, Washington, DC 20013.

Cherry T-47A/ART-13 transmitter with CRC-813 final. Schematic and any available info. Richard Caprarella, 550 Lynnfield St., Lynn, MA 01904.

Monsanto Model 6270A dual trace scope. Schematic and operations manual. Richard Bellnier, Tech., Auburn Board of Education, 130 South St., Auburn, NY 13021.

Tektronix Model 512 oscilloscope. Schematics and parts list. H.A. Ashdon, 108 Plymouth St., Holbrook, MA 02343.

Norelco Model 2401 cassette recorder. Parts source. Wesley Godfrey, 1022 SE Dogwood Lane, Milwaukie, OR 97222.

Hallcrafters Model S-40 receiver. Need a circuit with values for an S meter. A. McGinnis, 55 Patton St., Iselin, NJ 08830.

let's
make it
dynakit

Stereo components . . . easy to make kits or assembled.

Write for free 24 page color catalog **DYNACO**
Dynakit

Made in AMERICA
Dept. G-1, Box 88, Blackwood, N.J. 08012

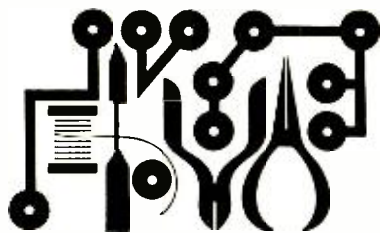

Experimenter's Corner

Put Professional Knowledge and a **COLLEGE DEGREE** in your Electronics Career through **HOME STUDY**



Earn Your DEGREE

by correspondence, while continuing your present job. No commuting to class. Study at your own pace. Learn from complete and explicit lesson materials, with additional assistance from our home study instructors. Advance as fast as you wish, but take all the time you need to master each topic. Profit from, and enjoy, the advantages of independent study.

The Grantham electronics degree program begins with basics, leads first to the A.S.E.T. degree, and then continues through the B.S.E.E. degree level. Our *free* bulletin gives complete details of the program itself, the degrees awarded, the requirements for each degree, and how to enroll. Write or phone (no collect calls please) and ask for BULLETIN E-77.

Grantham School of Engineering
2000 Stoner Ave., Los Angeles, CA 90025

• Telephone (213) 477-1901 •

Worldwide Career Training thru Home Study

CIRCLE NO. 34 ON FREE INFORMATION CARD

THE NEON GLOW LAMP

In this day of solid-state technology, the humble neon glow lamp still has much to offer to the experimenter. Besides its luminescence, the glow bulb displays negative resistance behavior. Because of this, it is often found in voltage regulator and relaxation oscillator circuits. Best of all, glow lamps are inexpensive. You can purchase them from advertisers in the Electronics Marketplace for as little as a nickel each in quantities of several dozen.

Before we look at some interesting glow lamp circuits, let's review some of the basic operating principles of this versatile component. Knowledge of its operating characteristics will enable you to design your own circuits.

An outline view of a typical glow lamp is shown in Fig. 1. Few electronic components are as structurally simple—a glow lamp consists merely of a gas-filled bulb and a pair of electrodes to which wire leads have been attached.

Normally, the resistance of the gas between the two electrodes is so high that the lamp can be considered an open circuit. But when the voltage across the lamp is raised to the critical *initial breakdown voltage*, the gas ionizes and becomes highly conductive. The ionized gas glows with a characteristic color. Neon, the most common filler gas, glows orange. Argon, which is sometimes used, has a blue glow.

Figure 2 shows the I-V characteristics of a typical neon bulb. Until the breakdown voltage V_B is reached, current through the lamp is very small. (This voltage will vary between 55 and 150 volts for commercially available bulbs.) When the bulb fires, it enters the *normal glow* region of its I-V curve. In this region, the soft, luminous glow is confined to the negative electrode, and the glow area increases directly with lamp current. The voltage-regulating properties of the neon lamp are self-evident in Fig. 2. A nearly constant voltage drop V_0 exists across the lamp even though the current varies over a wide range.

When current is so high that the entire surface of the electrode is covered by the glow, the voltage across the lamp rises. The neon lamp has then entered the *abnormal glow* region. If lamp current further increases, the lamp is operating in the *arc* region. Here, the voltage across the lamp drops and the orange-colored discharge becomes a bright point of bluish-white light centered on the cathode (negative) electrode. Prolonged operation in the abnormal glow region, and even a brief incursion into the arc region will destroy the lamp.

Although neon lamps operate at fairly high voltages, they consume small amounts of power, and most commercial devices are rated at a continuous current of 0.1 to 10 mA.

Fig. 1. Sketch of neon lamp's construction.

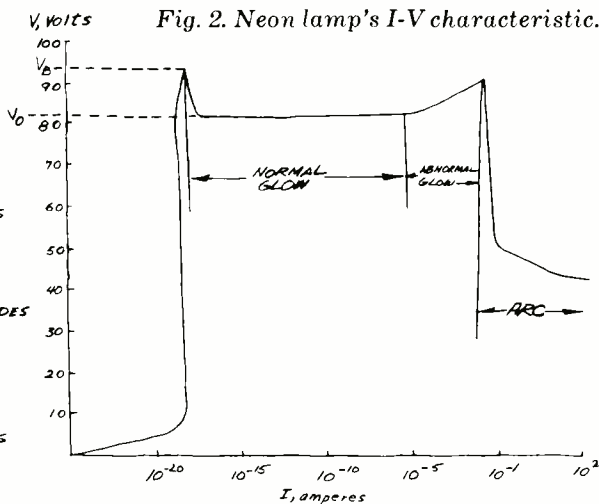
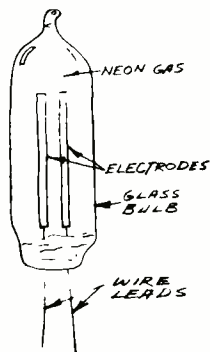

DIXIE SAVE ON

Brand Name Audio Components

BY MAIL

Write Today for Our FREE Audio Catalog

DIXIE is one of the oldest and largest audio component mail order houses in the country. Our prices on brand name components are actually LOWER than "Discounters". See our new catalog or call us for a price quote. Everything shipped factory-sealed with full manufacturer's warranty.

DIXIE HI-FIDELITY PE 12

2040 Thalbro Street, Richmond, Va. 23230
804-257-4241

Please rush me your FREE Audio Catalog and complete information. I understand there is no obligation.

Name _____
Address _____
City _____
State _____ Zip _____

Build a Microcomputer System With This \$7.95 Handbook.

At last, a practical, step-by-step approach to building an operational microcomputer for a bargain price. The **Iasis Microcomputer Applications Handbook** will guide you through all phases of actual design of a working 8080 microcomputer system including writing a system monitor program. Both development and OEM systems are covered in detail.



P.S. If the Microcomputer Applications Handbook isn't everything we say it is, return it within 15 days for a full refund.

ORDER BEFORE JAN. 14,
1977 AND WE'LL SHIP
YOUR HANDBOOK POST
PAID.

Here's my check or money order for \$7.95. Add \$5.50 for postage and handling if ordered after Jan. 14, 1976. (California residents please add \$5.52 state sales tax.) Overseas shipments will be made surface unless \$5.00 shipping is added.

Charge to the credit card number below:

BankAmericard No. _____

Master Charge No. _____

For Master Charge, add 4-digit number from right above name. It is _____

Here's my Signature _____

Credit card expiration date _____

FIRM _____

NAME _____

ADDRESS _____

CITY _____

STATE / ZIP _____

MAIL YOUR ORDER TO IASIS, INC
815 W. MAUDE AVE., SUITE 13
SUNNYVALE, CA 94086

Some Precautions. Neon glow lamps are simple to use, but you should be aware of a few special restrictions. First, these lamps are subject to what is called the *dark effect*. That is, ionization of the gas is much more easily accomplished in the presence of ambient light. In total darkness, the glow lamp operates erratically, and its breakdown voltage increases significantly. To overcome this problem, many neon lamps contain a minute amount of radioactive gas, which stimulates ionization.

A second operating restriction is the necessity to avoid excessive operating voltages. Too much voltage will cause the lamp to operate in the abnormal glow or arc region. The third consideration is current limiting. It is necessary to place a resistor in series with a continuously operated glow lamp. This ballast resistor limits the current through the lamp to a safe value. If we assume that an ionized glow lamp has practically no resistance but a voltage drop of 80 volts, Ohm's and Kirchoff's Laws dictate that a 100,000-ohm ballast resistor will allow a safe 200 μ A to flow through a glow lamp connected to a 100-volt dc source.

Glow Lamp Circuits. Now that we've covered some of the basics of glow lamp operation, let's examine several practical circuits. You can use the miniature dc-dc converter described in last month's column or a pair of 67 $\frac{1}{2}$ -volt batteries connected in series as a power supply.

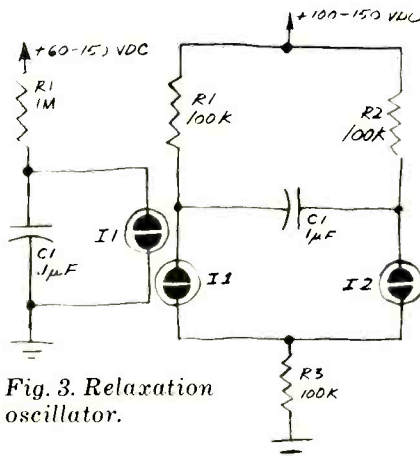

Fig. 3. Relaxation oscillator.

Fig. 4. Astable multivibrator.

The simplest circuit is the glow-lamp relaxation oscillator shown in Fig. 3. In operation, C_1 charges through R_1 until the breakdown voltage of the neon lamp is reached. At that point, C_1 discharges through the lamp and produces an orange flash. When the voltage across

A Logical Solution to your Digital Logic Problems!



THE NEW CATCH-A-PULSE® LOGIC PROBE!

- Multi-family
- Open circuit detection
- High input impedance
- Pulse stretching
- 60 Nsec pulse response
- Replaceable tip and cord

Compatible with RTL, DTL, TTL, CMOS, MOS, and Microprocessors using a 3.5 V to 15 V power supply. Thresholds automatically programmed for multi-logic family operation. Automatic resetting memory for single or multi-pulse detection. No adjustment required. Visual indication of logic levels, using LEDs to show high, low, bad level or open circuit logic and pulses. Highly sophisticated, shirt-pocket portable (protective cap over tip and removable coiled cord). Eliminates need for heavy test equipment. A definite plus in time and money for engineer and technician.



Introductory Price
\$24.95
Plus 1.25 shipping & handling
Calif. residents add 6% sales tax
AVR Electronics
P.O. Box 45167
San Diego, Ca 92145
(714) 566-1570

Dealer inquiries invited

CIRCLE NO. 2 ON FREE INFORMATION CARD

We have 400,000 reels of great recording tape to unload.

\$30.00 gets you thirty reels (\$225 value), or \$12.50 gets you ten reels (\$80 value). Call for quantity prices. These are government surplus, and fully guaranteed, professional quality mylar tapes on 10 $\frac{1}{2}$ plastic reels, $\frac{1}{4}$ " wide, 1 MIL with 3600 feet per reel.

Sounds crazy? We can sell brand name tapes at these ridiculous prices because we're the only supplier who bought up 400,000 reels.

Mail your order, name and address, with check or money order (N.Y. residents: add tax) to:

AMERICAN SURPLUS TRADING

Dept. P

332 Canal Street
New York, N.Y. 10013
(212) 966-5650

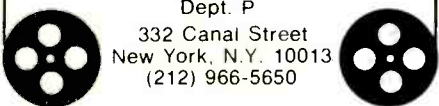

SAVE!

MONEY • TIME • FREIGHT

- QUALITY STEREO EQUIPMENT AT LOWEST PRICES.
- YOUR REQUEST FOR QUOTATION RETURNED SAME DAY.
- FACTORY SEALED CARTONS—GUARANTEED AND INSURED.
- SAVE ON NAME BRANDS LIKE:

A.D.C.	KLH
A.R.	SHURE
DYNACO	KOSS
SONY	FISHER

PIONEER
AND MORE THAN 50 OTHERS
BUY THE MODERN WAY
BY MAIL—FROM

illinois audio

Department 217S
12 East Delaware
Chicago, Illinois 60611
312-664-0020

$C1$ drops below the voltage necessary to keep the lamp conducting, the lamp goes dark. Then $C1$ begins to charge and the cycle repeats.

To see the glow-lamp flash you will have to use at least a 1-megohm resistor. Otherwise the flash rate will be faster than the 18 pulses per second discernible by the human eye and the lamp will appear continuously on. Also, use 200-volt capacitors in this and the following circuits because of the high voltages present.

You can connect an oscilloscope across $C1$ to verify that the circuit is oscillating if you choose to operate it at audio frequencies. Alternatively, you can connect an 8-ohm speaker between the glow lamp and ground or place the circuit near a radio to actually hear the oscillation frequency or its harmonics.

If you're familiar with neon-lamp relaxation oscillators, you probably know that several circuits like the one shown in Fig. 3 can be cascaded to produce a pseudo-random flashing effect. These circuits are often seen flashing away in electronics labs and are called "do-nothing boxes" or "idiot lights."

An astable multivibrator made from two glow lamps is shown in Fig. 4. If we assume $I1$ has a lower turn-on voltage than $I2$, $I1$ will turn on first after power has been applied. This permits $C1$ to charge through $R2$ and $I1$. When the voltage across $C1$ exceeds the turn-on voltage of $I2$, $I2$ turns on and $I1$ turns off. Now $C1$ charges through $R1$ and $I2$ until its charge fires $I1$. Lamp $I2$ then turns off, $C1$ begins charging through $R2$, and the cycle repeats.

The circuits described here incorporate a relaxation oscillator, and you can easily vary the repetition rates of the oscillators by altering the values for the resistor and capacitor which, together with the lamp, form the oscillator ($R1$ and $C1$ in Fig. 3, etc.). Higher values of resistance or capacitance will slow the repetition rate. But try to keep $R1$ above 100,000 ohms, and $C1$ below $1\mu F$.

If you do experiment with any of these circuits, be sure to observe standard safety precautions. Even a 67½-volt battery can deliver a sharp shock, and if the shock itself doesn't affect you, the resulting reflex action may dash your wrist or elbow into your work bench or chair.

For best results and optimum safety, stick to batteries or miniature high-voltage power supplies like the one described in last month's column. If you must use line power, never operate a glow-lamp circuit from the ac line without using a 1:1 isolation transformer. ◇

LEADER 5" QUALITY SCOPES COST LESS THAN EVER!

And They're Complete With Accessories!



LBO-506A
5" Dual Trace/Dual Channel Automatic Triggered Scope
Highly accurate — sync's to 35MHz. Auto trigger includes TV-V, TV-H, with variable h'z't'l sweep and vertical input. Features sep./simul. sw. mode; X5 mag; X-Y display; direct RF input; 10MHz b'width; 10mV-20 Vp-p/cm vert'l sens. in 11 calib. steps. Probes, leads, adapters incl.
A TREND SETTER!
\$599.95

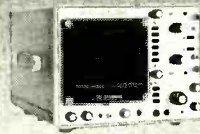

LBO-505
5" Trig Dual Trace/Dual Chan. Scope 15MHz Bandwidth
Outduals them all! With auto & trigg sweep; AC or DC c'pl'd per ch; 100 nsec/cm max. speed (X10mag.); sep. or simul. sweep mode display of ch 1 & 2, alter.; chop, algebra added, and vector (x-y); Sweep Range: 1µsec/cm to 0.5sec/cm, 17 steps calib. Probes, leads, adapt'rs. incl.
THE BEST... \$669.95



LBO-502
5" Triggered Scope w/Graded Scale
Ideal for most every electronic application; with easy pushbutton operation; 1-2-5 graded scale readings & 15 MHz b'width. Has auto and trig sweep, 17 steps calib.; X5 mag; and 10mV to 20mVp-p/cm vert. sensitivity. Complete with probe, leads and adapter.
SAVE \$80.00 NOW \$449.95



LBO-511
5" Solid State General Service Scope
Features recurrent sweep w/automatic sync and calib vert'l input — has 140° phase control; and TV-V & TV-H w/4 sweep ranges to 100KHz. DC coupling and push-pull amps provide distortion-free stability across the 10MHz b'width. Complete with probe, leads and adapter.
SAVE \$50.00 NOW \$299.95

LEADER
Instruments Corp.

Tests More... Tests Better... for Less.
151 Dupont Street, Plainview, N.Y. 11803 516-822-9300

CIRCLE NO. 42 ON FREE INFORMATION CARD

The quick charge iron with 16 different quick change tips.



ISOFTIP®
QUICK CHARGE
Cordless Soldering Iron completely recharges in 3½-4 hours. Low voltage, battery powered, ground free isolated tip design.

16 snap-in tips to fit any job plus a PC Drill.

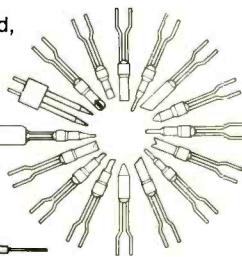

WAHL CLIPPER CORPORATION
ORIGINATORS OF PRACTICAL CORDLESS SOLDERING
• Sterling, Illinois 61081 • (815) 625-6525
"Manufacturing Excellence Since 1919"

CIRCLE NO. 69 ON FREE INFORMATION CARD



A Completely Portable, Polytonic Synthesizer System For Under \$140.00

CONJURE IT UP FROM:
THE GNOME MICRO-SYNTHESIZER kit no.3740 \$48.95 +4 lbs. shipping
— AND —
OZ-MINI-ORGAN & POLYTONIC PITCH SOURCE kit no.3760 \$84.95 +4 lbs. shipping
Hear them on our 24 hr. Demo-Line (405)843-7396 and get our FREE CATALOG with more

Magical Musical kits

FROM: **PAIA** ELECTRONICS DEPT. 12-P
1020 WEST WILSHIRE BLVD
OKLAHOMA CITY, OK 73116

CIRCLE NO. 75 ON FREE INFORMATION CARD

Popular Electronics®

INDEX VOLUMES 9 AND 10 JANUARY TO DECEMBER 1976

AUDIO

Audio Detective, Build the (Tenny)	May 41
Audio Electronics Today, The State of (Feldman)	Sept. 57
Audio "Room Expander", A New (Solomon)	May 55
"Bucket Brigade" Audio Delay Line, The (Roberts)	June 33
4-Channel Matrix Decoder, Build a Universal (Colman & Okawa)	Dec. 37
"Delta-Graph" Octave-Band Equalizer, Build the (Morrison)	Sept. 53
Out of Tune Correction	Oct. 8
Home-Brew Phono Preamp Design, Guide to (Bohn)	Sept. 60
LED-Readout Audio Power Meter, An (Henry)	Mar. 35
Out of Tune Correction	May 6, June 6
Mobile Stereo Amplifier, A High-Power (Braden)	Feb. 50
Panamix, Build (Barbarelo)	Oct. 50
Recording for Stereo with Four-Channel Tape (Linkletter)	Sept. 64
Tape Recorders, What's New In (Feldman)	Oct. 45
Ten Speaker Enclosure Fallacies (Weems)	June 39
Tips on How to Choose Speaker Systems (Sisk)	Sept. 66
Wireless Audio System for Remote Speakers, A (Sherwin)	Jan. 35

COMMUNICATIONS

Antenna Rotators, Buyer's Guide to (Carrole)	Aug. 39
BCB Loop Antenna for DX'ing, A (Fallon)	Mar. 51
CB Base Station Antennas, How to Choose (McVeigh)	Apr. 50
CB Equipment Terms Made Easy for Buyers	Apr. 62
CB/Ham Selective Calling Project, A (Meyer)	Nov. 41
CB Radio Range, How to Predict (Gerson)	Dec. 48
CB Transceiver and Antenna Manufacturers	Apr. 64
Dummy Antennas for Hams and CB'ers (Frye)	Feb. 65
DX Programs and DX Clubs on Shortwave (Wood)	Aug. 53
Electronic Keyer for Sending Morse Code, A Simple (Vancura)	Aug. 44
English-Language Shortwave Broadcasts for Mar. & Apr. 1976 (Wood)	Mar. 92
English-Language Shortwave Broadcasts for May - August 1976 (Wood)	May 84
English-Language Shortwave Broadcasts for Sept. & Oct. 1976 (Wood)	Sept. 112
English-Language Shortwave Broadcasts for Nov.-Feb (Wood)	Nov. 102
Five-Minute "On", One-Minute "Off" Timer, Build the (McVeigh)	Apr. 60
Guide to Choosing TV & FM Antennas (Green)	July 61
Install a CB Mobile Transceiver, it's Easy to (Davis)	Apr. 55
Mobile Communications: CB Vs. 2-Meter FM (Frye)	July 79
"Photophone", Talk Over a Sunbeam with a (Mims)	Feb. 54
Propagation Forecasts for Radio Communications	Nov. 34
"Roadmate" CB Converter, Build the (Todd)	Oct. 43
Temporary Permit Form 555-B for CB Radio	July 98
Tie Into Ham Repeaters with this Low-Cost Autopatch (Jarrett)	Nov. 47

COMPUTERS

Computer Codes, Introduction to (Robbins)	Apr. 46
Cosmac "Elf", Build the (Weisbecker)	Aug. 33
Cosmac "Elf", Build the, Part II (Weisbecker)	Sept. 37
In's and Out's of Computers for Beginners (Mitchell)	June 47
Pennywhistle-The Hobbyist's Modem, Build (Felsenstein)	Mar. 43
Out of Tune Correction	May 6
Select a Hobbyist Microcomputer, How to (Gray)	Dec. 51
Sol, An Intelligent Computer Terminal, Build (Marsh & Felsenstein)	July 35
TV Dazzler, Build the (Walker, Melen, Garland & Hall)	Feb. 31

CONSTRUCTION

A/D Temperature Converter, An (Prudhomme)	Dec. 62
Apartment Burglar Alarm, A Low-Cost (Soule)	July 50
Audio Detective, Build the (Tenny)	May 41
Automatic Diode Checker (Stitt)	June 57
Battery Multicharger, Build the (Tenny)	Feb. 67
BCB Loop Antenna for DX'ing, A (Fallon)	Mar. 51
"Bucket Brigade" Audio Delay Line, The (Roberts)	June 33
Capacitance Meter, Build this Low-Cost (McGahee)	Oct. 64
Car Ignition Monitor, Build a (Henry)	Oct. 37
CB/Ham Selective Calling Project, A (Meyer)	Nov. 41
4-Channel Matrix Decoder, Build a Universal (Colman & Okawa)	Dec. 37
Cosmac "Elf", Build the (Weisbecker)	Aug. 33
Cosmac "Elf", Build the, Part II (Weisbecker)	Sept. 37
Curve Tracer Checks Semiconductor Quality (Lyle)	Mar. 58
"Delta-Graph" Octave-Band Equalizer, Build the (Morrison)	Sept. 53
Out of Tune Correction	Oct. 8
Digital Electronic "Westminster" Clock (Roehl)	Nov. 57
Digital Fuel Gauge (Baxes)	Dec. 59
Digital Speedometer for Your Car, Build a (Fermoyle)	Sept. 42
Digital Stopclock for Short & Long Event Timing, A (Robbins)	Jan. 48
Dynadim II—Deluxe Home-Lighting Control, Build (Bik)	Sept. 48
Electronic Keyer for Sending Morse Code, A Simple (Vancura)	Aug. 44
Five-Minute "On", One-Minute "Off" Timer, Build the (McVeigh)	Apr. 60
Flasher/Battery Indicator, A (Hileman)	July 46
Flower Power (Squires)	Aug. 50
Gas and Fume Detector, Improved (Lewart)	Aug. 46
1-Hz to 1-MHz Frequency Counter, Build a Low-Cost (Huffnagle)	Aug. 48
High-Frequency Voltmeter, Build a \$25 (Sear)	Jan. 46
"Junk-Box" 5-Volt Power Supply, A (Foss)	May 66
LED Digital Clock for Vehicles, A (Green)	Oct. 41
LED-Readout Audio Power Meter, An (Henry)	Mar. 35
Out of Tune Correction	May 6, June 6
Logic Probe, A Simple (Leferts)	May 60
Out of Tune Correction	July 6
Measure the Sun's Energy with a Solar Radiometer (Jochem)	Dec. 45
Miniature Digital Stopwatch, Build a (Kashinsky)	Dec. 57
35-MM Slide Syncer, Build the (Lowenstein)	Nov. 74
Mobile Stereo Amplifier, A High-Power (Braden)	Feb. 50
Music Modules to Build Your Own Synthesizer (Lancaster)	June 59
Odds-On—A Game of Chance and Strategy, Build (Heisserman)	Nov. 64
Panamix, Build (Barbarelo)	Oct. 50
Pennywhistle-The Hobbyist's Modem, Build (Felsenstein)	Mar. 43
Out of Tune Correction	May 6
Power-Failure Alarm (Bresnik)	June 55
Out of Tune Correction	Dec. 8
Programmable Music Box, Part 2 (Waite & Brown)	Jan. 53
"Roadmate" CB Converter, Build the (Todd)	Oct. 43
Scientific Programmable Calculator, A (Meyer)	May 36
Out of Tune Correction	Aug. 6
Severe Weather Warning Alert (Lloyd)	May 44
Sine-Wave Inverter, Build a (Meyer)	June 43
Sol, An Intelligent Computer Terminal, Build (Marsh & Felsenstein)	July 35
Strobe Flasher for Night Cycling, A (Fitchbaum)	Oct. 68
Temperature Meter, Build a Low-Cost (Russo)	Feb. 70
Theft Alarm for Handheld Calculators (Tyler)	Mar. 42
Tie Into Ham Repeaters with this Low-Cost Autopatch (Jarrett)	Nov. 47

TV Dazzler, Build the (Walker, Melen, Garland & Hall)	Feb. 31
TV Electronic Game Projects	
Table Tennis (Waite & Brown)	Apr. 35
Add Scoring and Sound Effects to Table Tennis (Waite & Brown)	May 61
Space-War Game (Weisbecker)	Apr. 41
Out of Tune Correction	June 6, Aug. 6
Ultimate Metronome, Build the (Chestnut)	July 57
Out of Tune Correction	Dec. 8
Update Your Multimeter with a CMOS Millivoltmeter (Dage)	July 47
Wireless Audio System for Remote Speakers, A (Sherwin)	Jan. 35

DEPARTMENTS AND COLUMNS

Amateur Radio (Brier)	
Using Slow-Scan TV	Jan. 96
Emergency Communications and the Amateur	May 94
Lightning and the Radio Amateur	Aug. 86
250 Watts for Novices	Oct. 92
Art's TV Shop (Margolis)	
The Bewildering Brightness	Jan. 93
CB Scene (Wantz)	
How to Use CB Radio "Buzz" Words	Jan. 91
CB Scene (Newhall)	
The FCC and the CB'er	Feb. 96
Is Your Station Ready for an Emergency?	Mar. 95
Out of Tune Correction	Apr. 6
CB for Pleasure Craft	May 92
Avoiding CB Ripoffs	June 95
A CB Primer	July 97
Is Class E Dead?	Aug. 82
FCC Proposes New CB Radio Changes	Sept. 103
The Long and Short of Antennas	Oct. 86
40-Channel Expansion and Purac II	Nov. 94
More on Mobile Antennas	Dec. 94
Computer Bits (Ogdin)	
Interrupts & Real-Time	Jan. 88
Games for Learning	May 97
Computer Bits (Marsh)	
Computer Users Tape System	Mar. 88
Computer Bits (Chamberlin)	
Computer Graphics	July 86
Computer Music	Sept. 116
Computer Music Part II	Oct. 88
Mass Storage Systems	Nov. 106
Computer Bits (Gray)	
Books on Programming	Dec. 101
DX Listening (Hauser)	
Shortwave News From All Over	Mar. 91
Frequency Measurements	May 82
Listening to the Relays	Sept. 109
Change in the Air	Nov. 96
Editorial (Salsberg)	
Buzz Words & OEM Distributors	Jan. 4
Good News for Mail-Order Buyers	Feb. 4
New-Project Stumbling Blocks	Mar. 4
WARC-79 and Communications Hobbyists	Apr. 5
Project Kit Suppliers	May 4
The Second Golden Opportunity for CB	June 4
Who Killed TV Picture Quality?	July 4
Planting Electronics Hobby Seeds	Aug. 4
Consumer "Radiation" Protection	Sept. 4
Solar Energy	Oct. 4
Majority Rules—The Bitter Pill	Nov. 4
Turning the Electronics Corner	Dec. 4
English-Language Shortwave Broadcasts (Wood)	
March and April	Mar. 92
May thru August	May 84
September and October	Sept. 112
November 1976 thru February 1977	Nov. 102
Experimenter's Corner (Mims)	
Using an Optoisolator	Jan. 101
TTL Sequence Generator	Feb. 101
Percussion Instrument Synthesizer	Mar. 100
Pulse Modulation and Phase-Locked Loops	May 101
Applications for the TTL NAND Gate	June 102
The Avalanche Transistor	July 104
The 567 Tone Decoder	Aug. 91
The LM380 Power Amplifier	Sept. 121
High-Voltage DC/DC Converters	Oct. 107
The Silicon Solar Cell	Nov. 110
The Neon Glow Lamp	Dec. 111
Inside Basic Electronics	
Fixed and Variable Resistors	July 94
Inside Basic Electronics (Prensky)	
Using Resistances	Sept. 105
Capacitors and RC Circuits	Oct. 94
Capacitors and RC Circuits, Part 2	Dec. 86
Solid State (Garner)	
Prophecies for Next Year	Jan. 79
A Dandy Circuit	Feb. 92
Opting for Op Amps	Mar. 80
A Versatile New IC	Apr. 90
Out of Tune Correction	July 6
A Universal Light Emitting Diode	May 78
Programmable Schmitt Trigger	June 82
Build Your Own Sonar System	July 81
Simple Stopwatch Splits Seconds	Aug. 73

An IC That Is Also Dandy	Sept. 92
Rara Avis	Nov. 89
'Tis the Season to be Solid	Dec. 90
Stereo Scene (Salsberg)	
Audio Potpourri	Jan. 18
Stereo Scene (Hodges)	
Looking to the Future	Feb. 22
Tone Controls, Plain and Fancy	Mar. 20
Hi-Fi Upgrading Tips	Apr. 24
The World of Sound Contracting	May 18
Dateline 1976	June 20
Perfecting Phono	July 22
The Great Tube/Transistor Controversy	Aug. 14
Greetings From Nihon!	Sept. 14
Consumer Electronics Show—Summer 1976	Oct. 30
Mods and Modifiers	Nov. 22
Evaluating Four-Channel	Dec. 24
Test Equipment Scene (Solomon)	
Making Good Use of Noise	Jan. 83
Can Test Equipment Be Wrong?	Feb. 91
Using Your Oscilloscope	Mar. 83

FEATURES AND TUTORIALS

Active Filters, Understanding (Lancaster)	Dec. 69
Antenna Rotators, Buyer's Guide to (Carrole)	Aug. 39
Audio Electronics Today, The State of (Feldman)	Sept. 57
Audio "Room Expander", A New (Solomon)	May 55
CB Base Station Antennas, How to Choose (McVeigh)	Apr. 50
CB Bicentennial Highway Buddies, Your (Sweeney)	Apr. 59
CB Equipment Terms Made Easy for Buyers	Apr. 62
CB Radio Range, How to Predict (Gerson)	Dec. 48
CB Transceiver and Antenna Manufacturers	Apr. 64
Collecting Shortwave Folk Music (Stanbury)	May 39
Color TV Receivers, The New 1976 (Margolis)	Feb. 41
Computer Codes, Introduction to (Robbins)	Apr. 46
Designing Optimum-Q and Small Inductors (Martin)	Sept. 101
Digit Probe (Solomon)	Dec. 56
Diodes, What Do You Know About (Balin)	Feb. 73
Dummy Antennas for Hams and CB'ers (Frye)	Feb. 65
DX Programs and DX Clubs on Shortwave (Wood)	Aug. 53
Electrical Grounds for Electronic Equipment (French)	May 47
Electronic Switching with Transmission Gates (Pascoe)	Feb. 62
Envelope Generators & Sequencers for Electronic Music (Lancaster)	Jan. 58
Find the Hidden Electronics Words (Sear)	Oct. 71
Fusing Quiz (Balin)	Sept. 32
Guide to Choosing TV & FM Antennas (Green)	July 61
"Home-Brew" Phono Preamp Design, Guide to (Bohn)	Sept. 60
HP-45 Calculator As a Stopwatch or Elapsed-Time Indicator, How to Use the (Miller)	June 67
I ² L — A New Transistor Logic Family (Haffner)	Jan. 56
In's and Out's of Computers for Beginners (Mitchell)	June 47
Install a CB Mobile Transceiver, It's Easy to (Davis)	Apr. 55
Lamp Circuit Quiz (Balin)	Dec. 99
Learning Electronic Theory with Hand Calculators, Part I (Noll)	July 43
Out of Tune Correction	Sept. 6, Oct. 8
Learning Electronic Theory with Hand Calculators, Part II (Noll)	Aug. 58
Learning Electronic Theory with Hand Calculators, Part III (Noll)	Sept. 70
LED Bargraph Readouts (Mims)	Sept. 74
Microwave Ovens for the Home (Eva)	July 39
Minimize Scope/Probe Combination Errors, How to (Sear)	Mar. 54
Mobile Communications: CB Vs. 2-Meter FM (Frye)	July 79
Multiplexed LED Displays Simplify Circuits, How (Delaney)	Mar. 62
Out of Tune Correction	May 6
NiCd Batteries, The Care & Feeding of (Burr)	Mar. 39
Perf Board Wiring Techniques for Experimenters (Mangieri)	Apr. 66
"Photophone", Talk Over a Sunbeam with (Mims)	Feb. 54
Power Supply, Protecting Your (Arap)	Nov. 56
Professional Vs. Consumer Tape (Zide)	Nov. 66
Programmable Calculators, Here Are the New (Mims)	May 29
Propagation Delay—The Logic Gremlin (Tenny)	Dec. 64
Propagation Forecasts for Radio Communicators	Nov. 34
Radio Astronomy, An Introduction to (Heiserman)	Jan. 41
Recording for Stereo with Four-Channel Tape (Linkletter)	Sept. 64
Select a Hobbyist Microcomputer, How to (Gray)	Dec. 51
Tape Recorders, What's New In (Feldman)	Oct. 45
Temporary Permit Form 555-B for CB Radio	July 98
Ten Speaker Enclosure Fallacies (Weems)	June 39
Tips on How to Choose Speaker Systems (Sisk)	Sept. 66
Tools for Electronics Experimenters (Mangieri)	Oct. 55

TV Electronic Games, Roundup of (Carrole)	Dec. 32
Universal Interface Between Low-Power Logic and Load Drivers (Gregory)	June 94

PRODUCT TEST REPORTS

ADC Accutrac 4000 Record Player	Oct. 72
Alpha Wire Model STRP-25 Wire Strippers	Sept. 91
Bang & Olufsen Beogram Model 1900 Record Player	Aug. 68
B. I. C. Model 980 Multiple Play Manual Record Player	Jan. 68
B&K Precision Model 280 DMM	May 77
Browning Golden Eagle Mark III AM/SSB Base Station	Feb. 82
Continental Specialties "Design Mates"	June 80
Craig Model 4104 Mobile AM CB Transceiver	June 78
Crown Model IC-150A Pre-amplifier	Sept. 82
Dual Deluxe Cassette Deck	Feb. 78
Dual Model 1249 Automatic Record Player	Sept. 83
Epicure Model Four Pre-amplifier	May 74
Handic Model 2305 AM CB Transceiver	Sept. 84
Heathkit Model AN-2016 "Modulus" Control Center, Heathkit Models AA-1505 and AA-1506 "Modulus" Power Amplifiers	June 72
Heathkit Model GB-1201 Digital Stopwatch	Mar. 73
Heathkit Model TD-1006 4-Channel Color Organ Kit	Jan. 74
Hewlett-Packard Model 3476A Automatic DMM	Apr. 88
Hickok Model 370 Analog Multimeter	July 77
Jensen Model OPC-21 Speaker System	Feb. 80
Jerrold Model TRC-12 VHF TV Remote Control Accessory	Feb. 89
Kris Victor II AM Mobile CB Transceiver	May 76
Lafayette Com-Phone Mark II AM CB Base Station	Apr. 86
Luxman Model T-310 AM/Stereo FM Tuner	Apr. 76
Marantz Model 5220 Stereo Cassette Deck	Mar. 68
Micro-Acoustic Model 2002e Phono Cartridge	Oct. 74
Midland Model 13-882B Mobile AM CB Transceiver	Mar. 72
MXR Stereo Graphic Equalizer	July 75
Nikko Model 7075 AM/Stereo FM Receiver	July 66
OAE Model OP-80A TTY Paper Tape Reader	Sept. 90
Onkyo Model TX220 AM/Stereo FM Receiver	Mar. 70
Onkyo Model TX-4500 AM/Stereo FM Receiver	Aug. 66
Pace Model 145 AM CB Transceiver	Oct. 82
Pickering Model PP-1 Phono Pre-amplifier	Jan. 69
Pickering Model XV-15/625E Phono Cartridge	Nov. 79
Pioneer Model RG-1 Dynamic Processor	Apr. 80
Pioneer Model SF-850 Electronic Crossover	July 74
Phase Linear Model 200 Basic Power Amplifier	Oct. 76
Processor Technology Model VDM-1 Video Display Module	Oct. 84
Realistic Model TRC-57 Navaho CB Transceiver	Aug. 70
SBE Model 12SM Opti/Scan Digital Scanning Receiver	July 76
SBE Model 32CB Formula D Touch/Com CB Transceiver	Dec. 78
Schober Theatre Organ	Nov. 86
Sencore Model CR31 CRT Tester & Restorer	Jan. 73
Sencore Model DVM32 Portable DMM	Aug. 72
Sencore Model TF70 Portable Transistor Tester	Dec. 79
Shure Model M24H All-Format Phono Cartridge	Dec. 76
Siltronix Mohawk AM CB Mobile Transceiver	Nov. 84
Sound Concepts Model SD-50 Delay Unit	June 76
Spectro Acoustics Model 210 Graphic Equalizer	Nov. 78
Stax Model SR-5 Electrostatic Headphones	May 73
Technics Model SA-5460 Stereo Receiver	Dec. 74
Tram XL AM CB Transceiver	Jan. 70
Triplet Model 60 Multimeter	Feb. 88
Tri-Star "Tiger SST" CD Ignition System	Mar. 78

TEST EQUIPMENT AND TV SERVICING

A/D Temperature Converter, An (Prudhomme)	Dec. 62
Audio Detective, Build the (Tenny)	May 41
Automatic Diode Checker (Stitt)	June 57
Capacitance Meter, Build this Low-Cost (McGahoe)	Oct. 64
Color TV Receivers, The New 1976 (Margolis)	Feb. 41
Curve Tracer Checks Semiconductor Quality (Lyle)	Mar. 58
Digit Probe (Solomon)	Dec. 56
High-Frequency Voltmeter, Build a \$25 (Sear)	Jan. 46
1-Hz to 1-MHz Frequency Counter, Build a Low-Cost (Huffnagle)	Aug. 48
"Junk-Box" 5-Volt Power Supply, A (Foss)	May 66
Logic Probe, A Simple (Lefferts)	May 60
Measure the Sun's Energy with a Solar Radiometer (Jochem)	Dec. 45
Minimize Scope/Probe Combination Errors, How to (Sear)	Mar. 54
Temperature Meter, Build a Low-Cost (Russo)	Feb. 70
Update Your Multimeter with a CMOS Millivoltmeter (Dage)	July 47

Without our software, we're just another flasher.



Let's face it. No microcomputer is worth a dime if you can't make it work. Even E&L's Mini-Micro-designer would be just a "light flasher" if it weren't for our software system.

But the fact is that our tutorial software is the best in the business. Not just a pathetic rehash of chip manufacturers' specifications. But a clearly written, step-by-step instruction that teaches you all about the microcomputer. How to program it. How to interface it. How to expand it.

The teaching material is written by Rony/Larsen/Titus (authors of the famous Bugbooks). It's called Bugbook V. And it teaches through experiments designed specifically to get you up to speed on our Mini-Microcomputer (MMD-1). *And you don't need any prior knowledge of digital electronics!*

The best news? E&L's MMD-1 costs only \$380 in kit form, including all software and teaching material. Send your check or Money Order today (or complete BankAmericard/Master Charge information). We'll pay shipping charges anywhere in continental US.

CIRCUIT DESIGN, INC.

Division of E & L Instruments, P.O. Box 24, Shelton, Conn. 06484

I believe you, I am ready to order at \$380.00 for the MMD-1 Kit. Enclosed find my Check Money Order or charge information for BankAmericard or Master Charge (Make sure you sign the order blank)

Name: _____

Address: _____

City: _____ State: _____ Zip Code: _____

Signature: _____

Circuit Design will prepay shipping charges anywhere in the US. Contact the factory for additional charges elsewhere.

PS: If you want an assembled and tested unit order the MMD-1/A at \$540.00.

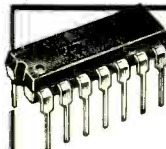

DIGI-KEY CORPORATION
Quality Electronic Components
Double-Digit Discounts
Save You Even More

2102-1 \$1.99 **8080A \$24.95** **LM3909 69¢**

MA1002A 12 Hour (AM-PM) Version \$10.50
MA1002C 24 Hour Version \$10.50

0.5" High LED Digits



Special transformer and 6 switches.
when ordered with module add \$3.45.

NATIONAL SEMICONDUCTOR CLOCK MODULES

MA1010A 12 Hour (AM-PM) Version . . . \$13.00
MA1010C 24 Hour Version \$13.00



0.84" High LED Digits

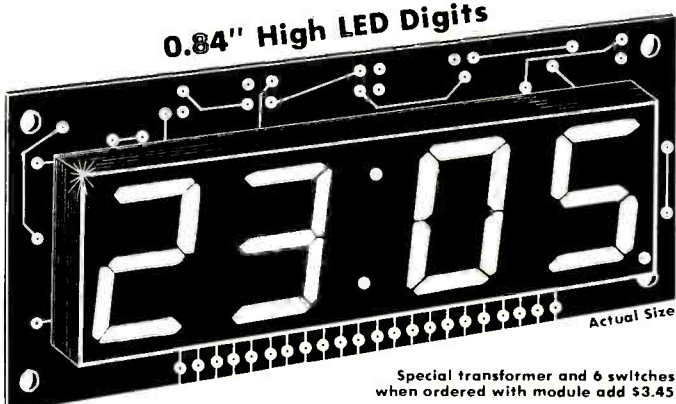

Special transformer and 6 switches.
when ordered with module add \$3.45.

Hobby-Wrap-30 \$5.95

Strips, Wraps and Unwraps 30 ga. wire on standard wire wrapping pins

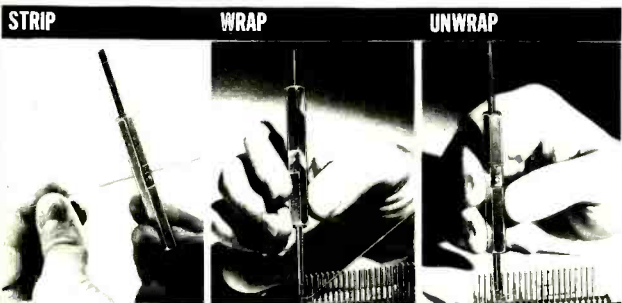

STRIP

WRAP

UNWRAP



MA1002 & MA1010 Series Electronic Clock Modules

The MA1002 & MA1010 Series Electronic Clock Modules are assembled and pretested modules which combine a monolithic MOS 151 integrated clock circuit, 4-digit LED display, power supply and other associated discrete components on a single printed circuit board to form a complete electronic clock movement. The user need add only a transformer and switches to construct a digital clock for application in clock-radios, alarm or instrument panel clocks. Time-keeping may be from 50 or 60 Hz inputs and 12 or 24 hour display formats may be chosen. Direct LED drive eliminates RF interference. Time setting is made easy through use of "Fast" and "Slow" scanning controls.

The MA1002A and MA1010A have a 12 hour display with an AM and PM indicator. The MA1002C and MA1010C have a 24 hour display.

Features include alarm "on" and "PM" indicators, "sleep" and "snooze" timers and variable brightness control capability. The modules are extremely compact, the MA1002 measuring 1.375" by 3.05", the MA1010 measuring 1.75" by 3.75". This small size is achieved by bonding the I.C. to the back of the circuit board.

It is highly recommended that the transformer be obtained with the clock module as it is a special dual secondary type not otherwise readily available.

Double Digit Discounts Save You Even More!

ACE201-K \$24.95
1,032 SOLDERLESS PLUG-IN TIE POINTS
CAPACITY: UP TO 12 14-PIN DIP's
TWO 5-way binding posts
Size: 4.9" x 1.6" by 7"
Kit form

WIRE WRAPPING WIRE
Red or Black Kynar insulated pre-cut and stripped 30 ga. wire
1" of insulation is removed from each end

Insulation Length	No. in Pkg.	Price per Pkg.
1" 100	100	\$2.50
2" 100	100	\$2.65
2.5" 100	100	\$2.70
3" 100	100	\$2.75
4" 100	100	\$2.80
4.5" 100	100	\$2.90
5" 100	100	\$3.00
6" 50	50	\$1.50
7" 50	50	\$1.70
8" 50	50	\$1.80
9" 50	50	\$1.90
10" 50	50	\$2.00
15" 50	50	\$2.50

SLIDE SWITCHES
Single Pole Single Throw
15 1.20/10 10.00/C
Double Pole Double Throw
23 2.00/10 19.00/C

BATTERY HOLDERS
1-AA . . . 26¢
2-AA . . . 42¢
1-C . . . 35¢
2-C . . . 42¢
1-D . . . 35¢
2-D . . . 42¢

BISHOP GRAPHICS Printed Circuit Drafting Aids are now available from Digi-Key

RADIAL ELECTROLYTICS

47/50V .08	65/10	22/50V .12	100/10	330/25V .23	1.86/10
1/50V .08	65/10	100/6.3V .09	75/10	470/10R .21	1.71/10
2/250V .08	65/10	100/10V .10	77/10	470/16V .23	1.81/10
3" 50V .08	65/10	100/16V .11	85/10	470/25V .29	2.35/10
4.7/35V .08	65/10	100/25V .13	110/10	1000/10V .24	1.96/10
4.7/50V .08	68/10	100/50V .21	1.71/10	1000/16V .29	2.35/10
10/16V .08	65/10	220/10V .13	1.08/10	1000/25V .42	3.33/10
10/25V .08	65/10	220/16V .15	1.16/10	2200/10V .42	3.33/10
10/50V .10	75/10	220/25V .21	1.71/10	2200/16V .54	4.30/10
22/16V .08	67/10	220/50V .29	2.35/10	2200/25V .58	4.67/10
22/25V .09	70/10	330/10V .15	1.16/10	3300/16V .89	7.14/10
		330/16V .21	1.66/10		

INTEGRATED CIRCUITS — TTL, CMOS, LINEAR & MOS

7400	7476	32	74181	215	4012	23	4520	1.14	
7401	7480	70	74182	79	4013	40	4527	1.68	
7402	7482	70	74184	219	4014	96	4528	88	
7403	7483	70	74185	219	4015	96	4585	1.23	
7404	7485	89	74188	550	4016	40	2102-1	1.99	
7405	7486	28	74189	350	4017	1.05	8080A	24.95	
7406	7489	219	74190	23	4018	25	CA3046	75	
7407	7490	44	74191	123	4019	23	LM2111N	1.25	
7408	7491	70	74192	88	4020	114	LM309K	1.80	
7409	7492	44	74193	88	4021	114	LM324A	1.26	
7410	7493	44	74194	88	4022	96	LM3401-5	1.25	
7411	7494	70	74195	88	4023	23	LM3401-6	1.25	
7412	7495	70	74196	88	4024	84	LM3401-8	1.25	
7413	7496	70	74197	88	4025	23	LM3401-15	1.25	
7414	89	74100	128	74198	49	4026	1.68	LM3401-12	1.25
7415	25	7496	40	74199	149	4027	40	LM3401-18	1.25
7416	25	74107	28	74200	89	4028	89	LM3401-24	1.25
7417	25	74109	33	74201	55	4029	114	LM3909N	88
7418	25	74121	35	74202	67	4030	23	LM3909N	69
7419	25	74122	44	74203	67	4031	1.51	MC1456V	1.50
7420	25	74123	61	74204	67	4032	3.50	MC1458B	53
7421	35	74125	40	74205	67	4033	1.50	MC1458B	53
7422	35	74126	40	74206	67	4034	3.50	MC1458B	53
7423	35	74127	33	74207	67	4035	1.14	MC1502P	1.15
7424	35	74128	33	74208	67	4040	114	NE5301	3.24
7425	35	74129	33	74209	67	4041	79	NE5401	2.04
7426	35	74130	33	74210	67	4042	79	NE555V	88
7427	35	74131	33	74211	67	4043	79	NE555A	88
7428	35	74132	33	74212	67	4044	70	NE560B	3.83
7429	35	74133	33	74213	67	4045	1.86	NE561B	3.83
7430	35	74134	33	74214	67	4046	1.86	NE562B	3.83
7431	35	74135	33	74215	16	4047	40	NE563A	88
7432	35	74136	33	74216	16	4048	40	NE564V	1.26
7433	35	74137	33	74217	16	4049	40	NE565V	1.26
7434	35	74138	33	74218	16	4050	40	NE567V	1.36
7435	35	74139	33	74219	16	4051	1.26	uA709CV	44
7436	35	74140	33	74220	16	4052	1.26	uA710CA	44
7437	35	74141	33	74221	16	4053	1.26	uA711CA	44
7438	35	74142	33	74222	16	4054	1.26	uA711CA	44
7439	35	74143	33	74223	16	4055	1.26	uA711CA	44
7440	35	74144	33	74224	16	4056	1.26	uA711CA	44
7441	35	74145	33	74225	16	4057	1.26	uA711CA	44
7442	35	74146	33	74226	16	4058	1.26	uA711CA	44
7443	35	74147	33	74227	16	4059	1.26	uA711CA	44
7444	35	74148	33	74228	16	4060	1.26	uA711CA	44
7445	35	74149	33	74229	16	4061	1.26	uA711CA	44
7446	35	74150	1.16	74230	16	4062	1.26	uA711CA	44
7447	35	74151	70	74231	16	4063	1.26	uA711CA	44
7448	35	74152	70	74232	16	4064	1.26	uA711CA	44
7449	35	74153	70	74233	16	4065	1.26	uA711CA	44
7450	35	74154	70	74234	16	4066	1.26	uA711CA	44
7451	35	74155	70	74235	16	4067	1.26	uA711CA	44
7452	35	74156	70	74236	16	4068	1.26	uA711CA	44
7453	35	74157	70	74237	16	4069	1.26	uA711CA	44
7454	35	74158	70	74238	16	4070	1.26	uA711CA	44
7455	35	74159	70	74239	16	4071	1.26	uA711CA	44
7456	35	74160	70	74240	16	4072	1.26	uA711CA	44
7457	35	74161	70	74241	16	4073	1.26	uA711CA	44
7458	35	74162	70	74242	16	4074	1.26	uA711CA	44
7459	35	74163	70	74243	16	4075	1.26	uA711CA	44
7460	35	74164	70	74244	16	4076	1.26	uA711CA	44
7461	35	74165	70	74245	16	4077	1.26	uA711CA	44
7462	35	74166	70	74246	16	4078	1.26	uA711CA	44
7463	35	74167	70	74247	16	4079	1.26	uA711CA	44
7464	35	74168	70	74248	16	4080	1.26	uA711CA	44
7465	35	74169	70	74249	16	4081	1.26	uA711CA	44
7466	35	74170	70	74250	16	4082	1.26	uA711CA	44
7467	35	74171	70	74251	16	4083	1.26	uA711CA	44
7468	35	74172	70	74252	16	4084	1.26	uA711CA	44
7469	35	74173	70	74253	16	4085	1.26	uA711CA	44
7470	35	74174	70	74254	16	4086	1.26	uA711CA	44
7471	35	74175	70	74255	16	4087	1.26	uA711CA	44
7472	35	74176	70	74256	16	4088	1.26	uA711CA	44
7473	35	74177	70	74257	16	4089	1.26	uA711CA	44
7474	35	74178	70	74258	16	4090	1.26	uA711CA	44
7475	35	74179	70	74259	16	4091	1.26	uA711CA	44
7476	35	74180	70	74260	16	4092	1.26	uA711CA	44
7477	35	74181	70	74261	16	4093	1.26	uA711CA	44
7478	35	74182	70	74262	16	4094	1.26	uA711CA	44
7479	35	74183	70	74263	16	4095	1.26	uA711CA	44
7480	35	74184	70	74264	16	4096	1.26	uA711CA	44
7481	35	74185	70	74265	16	4097	1.26	uA711CA	44
7482	35	74186	70	74266	16	4098	1.26	uA711CA	44
7483	35	74187	70	74267	16	4099	1.26	uA711CA	44
7484	35	74188	70	74268	16	4100	1.26	uA711CA	44
7485	35	74189	70	74269	16	4101	1.26	uA711CA	44
7486	35	74190	70	74270	16	4102	1.26	uA711CA	44
7487	35	74191	70	74271	16	4103	1.26	uA711CA	44
7488	35	74192	70	74272	16	4104	1.26	uA711CA	44
7489	35	74193	70	74273	16	4105	1.26	uA711CA	44
7490	35	74194	70	74274	16	4106	1.26	uA711CA	44
7491	35	74195	70	74275	16	4107	1.26	uA711CA	44
7492	35	74196	70	74276	16	4108	1.26	uA711CA	44
7493	35	74197	70	74277	16	4109	1.26	uA711CA	44
7494	35	74198	70	74278	16	4110	1.26	uA711CA	44
7495	35	74199	70	74279	16	4111	1.26	uA711CA	44
7496	35	74200	70	74280	16	4112			

ARIES brought you the first calculator kit, and the first digital clock kit . . . and now brings you three of the most innovative electronic kits ever made. The System 300 Electronic Music Synthesizer kit is the most advanced in the world today, regardless of price. The AR-781 is a space-age beauty for any decor. And the wholly solid state AR-830 does the work of a \$400.00 tape memory unit.



WARNING . . . if you're interested in a music synthesizer, don't make a move until you see our catalog first. It's more like a handbook than a catalog, with hundreds of in-depth photographs and descriptions to explain electronic music principles, and to show equipment to do the job. **ARIES** now offers a complete complement of modules, keyboards, and cases, matched to the most rigorous professional standards. Starter systems priced as low as \$395.00.

A clear, ruby-red cylinder shows off all six digits of this modern calendar clock. Easy-to-read numbers show the hours, minutes, and seconds, as well as the month and day every ten seconds.



Red LED 7-segment numerals are 0.33" high, in a sturdy cylinder 2-1/2" in diameter and 4-3/4" long, with finished hardwood ends. Time and calendar are controlled by 60 Hz line frequency, with a 12-month movement. Separate time and calendar adjustments. Includes all the components, PC boards, housing, and instructions. Shipping weight 2 lbs. **AR-781 Clock Kit** \$34.50

Add finger-touch operation to your old-fashioned dial telephone with an **ARIES AR-830 Automatic Digital Telephone Dialer**. This has the same layout and convenience as Ma Bell, plus other features she doesn't offer yet. For instance . . . AR-830 always remembers the last number you dialed, in case the line was busy and you want to try again later. Not only that, but the Dialer's memory can store as many as ten of your favorite numbers for one-touch dialing. AR-830 uses standard dialing and muting contacts; consult local tariffs before connecting. Sh. wt. 2 lbs. **AR-830 Dialer Kit** \$69.50



ARIES INC.
119 Foster Street
Peabody, Mass., 01960
(617) 532-0450

CIRCLE NO. 10 ON FREE INFORMATION CARD

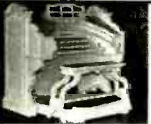

**ORGAN KITS
KEYBOARDS**
THE ULTIMATE IN DESIGN
AND SOUND
FREE LITERATURE

Wurlitzer reproductions
DEVTRONIX ORGAN PRODUCTS, Dept. C
5872 Amapola Dr. • San Jose, CA 95129

SURPLUS 'SMART' TERMINALS. components, serious music synthesizer kits, plans, parts, and more. Send SASE for FREE INFO Package. CFR Associates, POBF, Newton, N.H. 03858.

CANADA'S electronics bargain centre. Free Catalogue North American and offshore inquiries welcomed. CAN-MOS, Box 1690, Peterborough, Canada K9J 754.

FREE CATALOG Calculators \$4.95 each. Ultrasonic Devices, Digital Thermometers, Strobe Light Kits, Memories, Photographic Electronic Flash Units, Rechargeable Batteries, LEDs, Transistors, IC's, Piezoelectric Crystals, Toroidal Cores, Unique Components. Chaney's, Box 27038, Denver, Colo. 80227.

Tips on top CB/Ham operation

Channel 51 magazine includes tips, articles, and step-by-step guidelines to improve your CB/Ham operation. More meaty editorial per page than leading CB/Ham magazines! Learn to build, repair, and professionally operate your own unit. And more! For your Channel 51, send name, address, and \$1.50 now to:

Hufco Box 357, Dept. C51, Provo, Utah 84601 801/375-8566

CB RADIOS, monitors, crystals, CD ignitions. Southland, Box 3591-B, Baytown, Texas 77520

FERRIC CHLORIDE ETCHANT, 1/2 gallon \$5.50 Gallon \$9.50, Postpaid. CIRCOCLEX, Box 198, Marcy, N.Y. 13403.

DESIGNER MOTOR SET includes 1/40, 1/70, 1/150, 1/250, 1/500 horsepower. 3000 RPM. 115 VAC. \$27 postpaid. CIRCOCLEX, Box 198, Marcy, N.Y. 13403.

DIAGRAM SERVICE MANUAL, Television-Radio, sixteen volumes, regular \$62.50 value, only \$19.95, postpaid. Supreme Publications, 1760 Balsam, Highland Park, IL 60035.

10, 7 Mc 15 KHz Filter miniature tail filters, unused. \$5 each. Polar Electronics, N3191 Horten, Norway.

BLINK 'N' BOOPER
IS HERE!!!
The Memory Concentration Timing Game.
Send \$1.00 (refundable with order) for illustrative information packet . . . includes technical description circuit functions, component line-up, and game dynamics.
visulex P.O. Box 4204P Mountain View, CA 94040

130 PAGE detailed catalogue of European Electronic Parts many not otherwise available, send \$1 redeemable to: W. A. Components, 65 Granby Street, Toronto, Ontario, Canada M5B 1H8. U.S. Inquiries welcomed.

BUILD YOUR OWN SPEAKERS AND SAVE UP TO 50%
You can assemble your own high quality multi-element stereo speakers in a few hours and save up to half the cost of comparable speakers. Send for our free 32-page catalogue of speaker kits, raw speakers and accessories.
SPEAKERLAB
Dept. PE-9, 5500-35th N.E. Seattle, Washington 98105

ADVANCED MICROCOMPUTER PRODUCTS
NEW PRODUCTS

- NEW MOS/LSI TV GAME CHIP GI-AV3 8500 1 In Stock 6 TV Games on a Single IC
Unit Qty 39.95
Qty (5) 33.55
Qty (10) 29.95
- TV Kit 1 PCB, Chip Instructions 42.95
Video composite output
- TV Kit 2 PCB, Chip Switches 59.95
Caps, pots, speaker, vital etc. and all parts required for video output, instruction
- TV K 3 The ultimate in TV Games, etc. CHASSIS R multiplier, battery operation, partially assembled 99.95
- FUNCTION GENERATOR KIT 27.50
PCB, function chip, instructions, and external components
- MULTI-TEL KIT 50.00
PCB, instructions plus GI-AV3 9100 push button dialer AV3 9200 rotary dialer AV3 9400 Multi Freq gen AV3 9500 CMOS clock gen
- TOUCHTONE CONVERTER 554.95
Converts dial, obsolete to touchtone completely assembled
- AMI EVK 99 6800 based Microcomputer Kit \$149.00
Expandable to provide: EPROM programming, RAM 2048 Bytes R ROM 2048 Bytes EPROM, dual TTY selectable DMA 5V. Kit consists PCB 6800 6850 6820 6810 6812 6810 operating manual and complete instructions. Also Available: TTY Basic for 6800 Coming Soon. MK RAM Add on memory Write for More Details.
- 8080A Chip Set Special 79.95
1 AMD 8080A
32 AMD 9112 02 PC (500ms) Rams

Note: our products have been designed by people like you. If you have any ideas, drop us a line and we will show you how to participate.

IC MARKETPLACE

MICROPROCESSORS	GENERAL INSTRUMENTS	PERIPHERAL CIRCUITS	QUAD/DUALS/SPECIALS
AMD 8080A \$24.95	AV5-1013A Uart \$ 5.25	75450 thru 453 \$ 49	RC1458 CN 89
AMD 2901 31.00	AV5-1203 Clockchip 9.95	1488 1.45	RC1556 CN 99
AMI 6800 24.95	AV5-2376 Keyboard encoder 15.00	1489A 1.45	RC3403AD 2.30
GI CP1600 59.95	RO3-2513 Character Generator 10.95	74LS138 1.50	RC4131 CN 99
		8820N 1.95	RC4136 D 99
		8830N 1.95	RC4558 CN 1.90
		8831 1.95	RC4151 CN 6.50
		8832 1.95	XR 2556CP 2.95
		8T26B 2.95	XR 2240CP 2.95
		9601PC 1.25	XR 1310P 2.95
		9602PC 1.95	XR 2206CP 3.95
		9614PC 1.95	XR 2207CP 3.75
		9615PC 1.95	XR 1800 2.95
		9616PC 4.25	XR 567CP 1.95
		9617PC 3.50	
		9620PC 3.50	SENSE AMPS
		9621PC 3.50	7520N \$2.50
		P3101 3.25	7523AH 2.10
		4402 (4K Static) 12.95	HD3725CN 2.50
		4200 (4K Static) 13.95	
		AMD9130 13.95	CLOCK DRIVERS
		AMD9140 13.95	MM0262CN 4.50

7400 TTL	LINEAR	CMOS
SN7400N 14	SN74153N 16	SN74153N 85
SN7401N 14	SN74154N 16	LM105H 3.50
SN7402N 14	SN74155N 16	LM108N 3.50
SN7403N 14	SN74156N 16	LM111CN 1.75
SN7404N 14	SN74157N 16	LM112H 1.68
SN7405N 21	SN74158N 16	LM113CN 1.68
SN7406N 20	SN74159N 16	LM114CN 1.68
SN7407N 28	SN74160N 100	LM115CN 1.68
SN7408N 24	SN74161N 110	LM116CN 1.68
SN7409N 24	SN74162N 110	LM117CN 1.68
SN7410N 16	SN74163N 110	LM118CN 1.68
SN7411N 33	SN74164N 110	LM119CN 1.68
SN7412N 35	SN74165N 110	LM120CN 1.68
SN7413N 70	SN74166N 110	LM121CN 1.68
SN7414N 35	SN74167N 110	LM122CN 1.68
SN7415N 35	SN74168N 110	LM123CN 1.68
SN7416N 35	SN74169N 110	LM124CN 1.68
SN7417N 35	SN74170N 110	LM125CN 1.68
SN7418N 19	SN74171N 110	LM126CN 1.68
SN7419N 30	SN74172N 110	LM127CN 1.68
SN7420N 49	SN74173N 110	LM128CN 1.68
SN7421N 37	SN74174N 110	LM129CN 1.68
SN7422N 29	SN74175N 110	LM130CN 1.68
SN7423N 29	SN74176N 110	LM131CN 1.68
SN7424N 26	SN74177N 110	LM132CN 1.68
SN7425N 31	SN74178N 110	LM133CN 1.68
SN7426N 27	SN74179N 110	LM134CN 1.68
SN7427N 27	SN74180N 110	LM135CN 1.68
SN7428N 27	SN74181N 110	LM136CN 1.68
SN7429N 27	SN74182N 110	LM137CN 1.68
SN7430N 27	SN74183N 110	LM138CN 1.68
SN7431N 27	SN74184N 110	LM139CN 1.68
SN7432N 27	SN74185N 110	LM140CN 1.68
SN7433N 27	SN74186N 110	LM141CN 1.68
SN7434N 27	SN74187N 110	LM142CN 1.68
SN7435N 27	SN74188N 110	LM143CN 1.68
SN7436N 27	SN74189N 110	LM144CN 1.68
SN7437N 27	SN74190N 110	LM145CN 1.68
SN7438N 27	SN74191N 110	LM146CN 1.68
SN7439N 27	SN74192N 110	LM147CN 1.68
SN7440N 27	SN74193N 110	LM148CN 1.68
SN7441N 27	SN74194N 110	LM149CN 1.68
SN7442N 27	SN74195N 110	LM150CN 1.68
SN7443N 27	SN74196N 110	LM151CN 1.68
SN7444N 27	SN74197N 110	LM152CN 1.68
SN7445N 27	SN74198N 110	LM153CN 1.68
SN7446N 27	SN74199N 110	LM154CN 1.68
SN7447N 27	SN74200N 110	LM155CN 1.68
SN7448N 27	SN74201N 110	LM156CN 1.68
SN7449N 27	SN74202N 110	LM157CN 1.68
SN7450N 27	SN74203N 110	LM158CN 1.68
SN7451N 27	SN74204N 110	LM159CN 1.68
SN7452N 27	SN74205N 110	LM160CN 1.68
SN7453N 27	SN74206N 110	LM161CN 1.68
SN7454N 27	SN74207N 110	LM162CN 1.68
SN7455N 27	SN74208N 110	LM163CN 1.68
SN7456N 27	SN74209N 110	LM164CN 1.68
SN7457N 27	SN74210N 110	LM165CN 1.68
SN7458N 27	SN74211N 110	LM166CN 1.68
SN7459N 27	SN74212N 110	LM167CN 1.68
SN7460N 27	SN74213N 110	LM168CN 1.68
SN7461N 27	SN74214N 110	LM169CN 1.68
SN7462N 27	SN74215N 110	LM170CN 1.68
SN7463N 27	SN74216N 110	LM171CN 1.68
SN7464N 27	SN74217N 110	LM172CN 1.68
SN7465N 27	SN74218N 110	LM173CN 1.68
SN7466N 27	SN74219N 110	LM174CN 1.68
SN7467N 27	SN74220N 110	LM175CN 1.68
SN7468N 27	SN74221N 110	LM176CN 1.68
SN7469N 27	SN74222N 110	LM177CN 1.68
SN7470N 27	SN74223N 110	LM178CN 1.68
SN7471N 27	SN74224N 110	LM179CN 1.68
SN7472N 27	SN74225N 110	LM180CN 1.68
SN7473N 27	SN74226N 110	LM181CN 1.68
SN7474N 27	SN74227N 110	LM182CN 1.68
SN7475N 27	SN74228N 110	LM183CN 1.68
SN7476N 27	SN74229N 110	LM184CN 1.68
SN7477N 27	SN74230N 110	LM185CN 1.68
SN7478N 27	SN74231N 110	LM186CN 1.68
SN7479N 27	SN74232N 110	LM187CN 1.68
SN7480N 27	SN74233N 110	LM188CN 1.68
SN7481N 27	SN74234N 110	LM189CN 1.68
SN7482N 27	SN74235N 110	LM190CN 1.68
SN7483N 27	SN74236N 110	LM191CN 1.68
SN7484N 27	SN74237N 110	LM192CN 1.68
SN7485N 27	SN74238N 110	LM193CN 1.68
SN7486N 27	SN74239N 110	LM194CN 1.68
SN7487N 27	SN74240N 110	LM195CN 1.68
SN7488N 27	SN74241N 110	LM196CN 1.68
SN7489N 27	SN74242N 110	LM197CN 1.68
SN7490N 27	SN74243N 110	LM198CN 1.68
SN7491N 27	SN74244N 110	LM199CN 1.68
SN7492N 27	SN74245N 110	LM200CN 1.68
SN7493N 27	SN74246N 110	LM201CN 1.68
SN7494N 27	SN74247N 110	LM202CN 1.68
SN7495N 27	SN74248N 110	LM203CN 1.68
SN7496N 27	SN74249N 110	LM204CN 1.68
SN7497N 27	SN74250N 110	LM205CN 1.68
SN7498N 27	SN74251N 110	LM206CN 1.68
SN7499N 27	SN74252N 110	LM207CN 1.68
SN7500N 27	SN74253N 110	LM208CN 1.68
SN7501N 27	SN74254N 110	LM209CN 1.68
SN7502N 27	SN74255N 110	LM210CN 1.68
SN7503N 27	SN74256N 110	LM211CN 1.68
SN7504N 27	SN74257N 110	LM212CN 1.68
SN7505N 27	SN74258N 110	LM213CN 1.68
SN7506N 27	SN74259N 110	LM214CN 1.68
SN7507N 27	SN74260N 110	LM215CN 1.68
SN7508N 27	SN74261N 110	LM216CN 1.68
SN7509N 27	SN74262N 110	LM217CN 1.68
SN7510N 27	SN74263N 110	LM218CN 1.68
SN7511N 27	SN74264N 110	LM219CN 1.68
SN7512N 27	SN74265N 110	LM220CN 1.68
SN7513N 27	SN74266N 110	LM221CN 1.68
SN7514N 27	SN74267N 110	LM222CN 1.68
SN7515N 27	SN74268N 110	LM223CN 1.68
SN7516N 27	SN74269N 110	LM224CN 1.68
SN7517N 27	SN74270N 110	LM225CN 1.68
SN7518N 27	SN74271N 110	LM226CN 1.68
SN7519N 27	SN74272N 110	LM227CN 1.68
SN7520N 27	SN74273N 110	LM228CN 1.68
SN7521N 27	SN74274N 110	LM229CN 1.68
SN7522N 27	SN74275N 110	LM230CN 1.68
SN7523N 27	SN74276N 110	LM231CN 1.68
SN7524N 27	SN74277N 110	LM232CN 1.68
SN7525N 27	SN74278N 110	LM233CN 1.68
SN7526N 27	SN74279N 110	LM234CN 1.68
SN7527N 27	SN74280N 110	LM235CN 1.68
SN7528N 27	SN74281N 110	LM236CN 1.68
SN7529N 27	SN74282N 110	LM237CN 1.68
SN7530N 27	SN74283N 110	LM238CN 1.68
SN7531N 27	SN74284N 110	LM239CN 1.68
SN7532N 27	SN74285N 110	LM240CN 1.68
SN7533N 27	SN74286N 110	LM241CN 1.68
SN7534N 27	SN74287N 110	LM242CN 1.68
SN7535N 27	SN74288N 110	LM243CN 1.68
SN7536N 27	SN74289N 110	LM244CN 1.68
SN7537N 27	SN74290N 110	LM245CN 1.68
SN7538N 27	SN74291N 110	LM246CN 1.68
SN7539N 27	SN74292N 110	LM247CN 1.68
SN7540N 27	SN74293N	

Poly Pak's EXCLUSIVE

Ava. Ship. **\$1.98** Wt. 6 ozs.

BARREL KITS

YOUR CHOICE OF ANY KIT

Every kit carries a money back guarantee!

100'S OF BARRELS PURCHASED!

For the first time anywhere, Poly Pak merchandisers introduce a new way in buying the economical way. Raw stock from the "barrel". Remember the "good ole days"? They're back again. The same way merchandisers throughout the United States buy from various factories... their overruns in barrels. Poly Pak has done the same. Therefore you are getting the same type of material as the RE-TESTERS DO.

TEST 'EM YOURSELF 'N SAVE!

BARREL KIT #202
PLUGS, SOCKETS, RECEIVERS
100 for \$1.98

BARREL KIT #201
6V INDICATORS w/leads
15 for \$1.98

BARREL KIT #198
TRANSISTORS & DARLINGTONS
50 for \$1.98

BARREL KIT #196
YELLOW JACKET MYLARS
75 for \$1.98

BARREL KIT #193
MINI TRIM POTS
30 for \$1.98

BARREL KIT #182
JUMBO RED LEADS
15 for \$1.98

BARREL KIT #184
WATT METAL FILM
150 for \$1.98

BARREL KIT #181
MOLEX CONNECTORS
100 for \$1.98

BARREL KIT #179
ROCKER SWITCHES
25 for \$1.98

BARREL KIT #174
CLOCK CHIPS
20 for \$1.98

BARREL KIT #173
PANEL SWITCHES
30 for \$1.98

BARREL KIT #172
MINI MAGNETS
100 for \$1.98

BARREL KIT #171
PRECISION RESISTORS
100 for \$1.98

BARREL KIT #169
SLIDE VOLUME CONTROLS
10 for \$1.98

BARREL KIT #168
HOBBY LEDS
40 for \$1.98

BARREL KIT #167
NATIONAL IC BONAZZA
100 for \$1.98

BARREL KIT #166
CAPACITOR SPECIAL
100 pcs. for \$1.98

BARREL KIT #165
2 WATERS
100 for \$1.98

BARREL KIT #164
MIXED READOUTS
10 for \$1.98

BARREL KIT #163
MIXED READOUTS
10 for \$1.98

BARREL KIT #162
MIXED READOUTS
10 for \$1.98

BARREL KIT #161
MIXED READOUTS
10 for \$1.98

BARREL KIT #160
MIXED READOUTS
10 for \$1.98

BARREL KIT #159
MIXED READOUTS
10 for \$1.98

BARREL KIT #158
MIXED READOUTS
10 for \$1.98

BARREL KIT #157
MIXED READOUTS
10 for \$1.98

BARREL KIT #156
MIXED READOUTS
10 for \$1.98

BARREL KIT #155
MIXED READOUTS
10 for \$1.98

BARREL KIT #154
MIXED READOUTS
10 for \$1.98

BARREL KIT #153
MIXED READOUTS
10 for \$1.98

BARREL KIT #152
MIXED READOUTS
10 for \$1.98

BARREL KIT #151
MIXED READOUTS
10 for \$1.98

BARREL KIT #150
MIXED READOUTS
10 for \$1.98

BARREL KIT #149
MIXED READOUTS
10 for \$1.98

BARREL KIT #148
MIXED READOUTS
10 for \$1.98

BARREL KIT #147
MIXED READOUTS
10 for \$1.98

BARREL KIT #146
MIXED READOUTS
10 for \$1.98

BARREL KIT #145
MIXED READOUTS
10 for \$1.98

BARREL KIT #144
MIXED READOUTS
10 for \$1.98

BARREL KIT #143
MIXED READOUTS
10 for \$1.98

BARREL KIT #142
MIXED READOUTS
10 for \$1.98

BARREL KIT #141
MIXED READOUTS
10 for \$1.98

BARREL KIT #140
MIXED READOUTS
10 for \$1.98

BARREL KIT #139
MIXED READOUTS
10 for \$1.98

BARREL KIT #138
MIXED READOUTS
10 for \$1.98

BARREL KIT #137
MIXED READOUTS
10 for \$1.98

BARREL KIT #136
MIXED READOUTS
10 for \$1.98

BARREL KIT #135
MIXED READOUTS
10 for \$1.98

BARREL KIT #134
MIXED READOUTS
10 for \$1.98

BARREL KIT #133
MIXED READOUTS
10 for \$1.98

BARREL KIT #132
MIXED READOUTS
10 for \$1.98

BARREL KIT #131
MIXED READOUTS
10 for \$1.98

BARREL KIT #130
MIXED READOUTS
10 for \$1.98

BARREL KIT #129
MIXED READOUTS
10 for \$1.98

BARREL KIT #128
MIXED READOUTS
10 for \$1.98

BARREL KIT #127
MIXED READOUTS
10 for \$1.98

BARREL KIT #126
MIXED READOUTS
10 for \$1.98

BARREL KIT #125
MIXED READOUTS
10 for \$1.98

BARREL KIT #124
MIXED READOUTS
10 for \$1.98

BARREL KIT #123
MIXED READOUTS
10 for \$1.98

BARREL KIT #122
MIXED READOUTS
10 for \$1.98

BARREL KIT #121
MIXED READOUTS
10 for \$1.98

BARREL KIT #120
MIXED READOUTS
10 for \$1.98

BARREL KIT #119
MIXED READOUTS
10 for \$1.98

BARREL KIT #118
MIXED READOUTS
10 for \$1.98

BARREL KIT #117
MIXED READOUTS
10 for \$1.98

BARREL KIT #116
MIXED READOUTS
10 for \$1.98

BARREL KIT #115
MIXED READOUTS
10 for \$1.98

BARREL KIT #114
MIXED READOUTS
10 for \$1.98

BARREL KIT #113
MIXED READOUTS
10 for \$1.98

BARREL KIT #112
MIXED READOUTS
10 for \$1.98

BARREL KIT #111
MIXED READOUTS
10 for \$1.98

BARREL KIT #110
MIXED READOUTS
10 for \$1.98

BARREL KIT #109
MIXED READOUTS
10 for \$1.98

BARREL KIT #108
MIXED READOUTS
10 for \$1.98

BARREL KIT #107
MIXED READOUTS
10 for \$1.98

BARREL KIT #106
MIXED READOUTS
10 for \$1.98

BARREL KIT #105
MIXED READOUTS
10 for \$1.98

BARREL KIT #104
MIXED READOUTS
10 for \$1.98

BARREL KIT #103
MIXED READOUTS
10 for \$1.98

BARREL KIT #102
MIXED READOUTS
10 for \$1.98

BARREL KIT #101
MIXED READOUTS
10 for \$1.98

BARREL KIT #100
MIXED READOUTS
10 for \$1.98

BARREL KIT #195
CARD-FILM RESISTORS
75 for \$1.98

BARREL KIT #160
V. REGULATORS
15 for \$1.98

BARREL KIT #144
RCA PHONO PLUGS
40 for \$1.98

BARREL KIT #130
CRYSTALS
12 for \$1.98

BARREL KIT #115
MOLEX SOCKETS
200 for \$1.98

BARREL KIT #93
HALF WATERS
200 for \$1.98

BARREL KIT #81
SUBMINI RESISTORS
200 for \$1.98

BARREL KIT #61
POLYSTYRENE CAPS
100 for \$1.98

BARREL KIT #37
1 AMP "BULLET" RECTIFIERS
100 for \$1.98

BARREL KIT #194
CARBOFILM RESISTORS
800* for \$1.98

BARREL KIT #159
MODULAR SWITCHES
25 for \$1.98

BARREL KIT #142
DARLINGTON TRANSISTORS
40 for \$1.98

BARREL KIT #128
MINI DIP POTS
75 for \$1.98

BARREL KIT #112
MICRO MINI LEADS
40 for \$1.98

BARREL KIT #92
3 AMP EPOXY RECTIFIERS
100 for \$1.98

BARREL KIT #76
1-WATT ZENERS
100 for \$1.98

BARREL KIT #58
SLIDE SWITCHES
30 for \$1.98

BARREL KIT #36
GERMANIUM RECTIFIERS
200 for \$1.98

BARREL KIT #188
400 Parts
\$1.98

BARREL KIT #158
MAGNIFIED MAN-3'S
15 for \$1.98

BARREL KIT #141
10 WATT ZENERS
15 for \$1.98

BARREL KIT #127
AXIAL ELECTROS
40 for \$1.98

BARREL KIT #110
SUPERIOR DIODES
100 for \$1.98

BARREL KIT #91
SILVER MICAS
100 for \$1.98

BARREL KIT #75
400MW ZENERS
150 for \$1.98

BARREL KIT #56
POWERS! POWERS!
100 for \$1.98

BARREL KIT #35
NEON LAMP
30 for \$1.98

BARREL KIT #186
KEYBOARD CHIPS
10 for \$1.98

BARREL KIT #157
MOLEX CONNECTORS
100 for \$1.98

BARREL KIT #140
LAMP INDICATORS
20 for \$1.98

BARREL KIT #126
UPRIGHT ELECTROS
40 for \$1.98

BARREL KIT #109
TERMINAL STRIPS
100 for \$1.98

BARREL KIT #87
LITRONICS LED READOUTS
10 for \$1.98

BARREL KIT #73
TRANSISTOR ELECTROS
50 for \$1.98

BARREL KIT #54
8 DIGIT READOUTS
10 for \$1.98

BARREL KIT #31
METALLIC RESISTORS
100 for \$1.98

BARREL KIT #184
WATT METAL FILM
150 for \$1.98

BARREL KIT #149
ROCKER SWITCHES
25 for \$1.98

BARREL KIT #134
CALCULATOR CHIPS
15 for \$1.98

BARREL KIT #119
PRECISION RESISTORS
100 for \$1.98

BARREL KIT #104
SLIDE VOLUME CONTROLS
10 for \$1.98

BARREL KIT #86
HOBBY LEDS
40 for \$1.98

BARREL KIT #71
CAPACITOR SPECIAL
100 pcs. for \$1.98

BARREL KIT #68
2 WATERS
100 for \$1.98

BARREL KIT #46
G.E. 3.5 WATT AMPLIFIERS
25 for \$1.98

BARREL KIT #30
PREFORMED RESISTORS
200 for \$1.98

BARREL KIT #182
JUMBO RED LEADS
15 for \$1.98

BARREL KIT #154
CLOCK CHIPS
20 for \$1.98

BARREL KIT #133
PANEL SWITCHES
30 for \$1.98

BARREL KIT #117
MINI MAGNETS
100 for \$1.98

BARREL KIT #108
TO-5 PLASTIC TRANSISTORS
40 for \$1.98

BARREL KIT #87
NATIONAL IC BONAZZA
100 for \$1.98

BARREL KIT #77
CAPACITOR SPECIAL
100 pcs. for \$1.98

BARREL KIT #68
2 WATERS
100 for \$1.98

BARREL KIT #40
PNP HIGH-POWER TRANSISTORS
20 for \$1.98

BARREL KIT #181
MOLEX CONNECTORS
100 for \$1.98

BARREL KIT #179
ROCKER SWITCHES
25 for \$1.98

BARREL KIT #174
CLOCK CHIPS
20 for \$1.98

BARREL KIT #173
PANEL SWITCHES
30 for \$1.98

BARREL KIT #172
MINI MAGNETS
100 for \$1.98

BARREL KIT #171
PRECISION RESISTORS
100 for \$1.98

BARREL KIT #169
SLIDE VOLUME CONTROLS
10 for \$1.98

BARREL KIT #168
HOBBY LEDS
40 for \$1.98

BARREL KIT #167
NATIONAL IC BONAZZA
100 for \$1.98

BARREL KIT #166
CAPACITOR SPECIAL
100 pcs. for \$1.98

BARREL KIT #165
2 WATERS
100 for \$1.98

BARREL KIT #164
MIXED READOUTS
10 for \$1.98

BARREL KIT #163
MIXED READOUTS
10 for \$1.98

BARREL KIT #162
MIXED READOUTS
10 for \$1.98

BARREL KIT #161
MIXED READOUTS
10 for \$1.98

BARREL KIT #160
MIXED READOUTS
10 for \$1.98

BARREL KIT #159
MIXED READOUTS
10 for \$1.98

BARREL KIT #158
MIXED READOUTS
10 for \$1.98

BARREL KIT #157
MIXED READOUTS
10 for \$1.98

BARREL KIT #156
MIXED READOUTS
10 for \$1.98

BARREL KIT #155
MIXED READOUTS
10 for \$1.98

BARREL KIT #154
MIXED READOUTS
10 for \$1.98

BARREL KIT #153
MIXED READOUTS
10 for \$1.98

BARREL KIT #152
MIXED READOUTS
10 for \$1.98

BARREL KIT #151
MIXED READOUTS
10 for \$1.98

BARREL KIT #150
MIXED READOUTS
10 for \$1.98

BARREL KIT #149
MIXED READOUTS
10 for \$1.98

BARREL KIT #148
MIXED READOUTS
10 for \$1.98

BARREL KIT #147
MIXED READOUTS
10 for \$1.98

BARREL KIT #146
MIXED READOUTS
10 for \$1.98

BARREL KIT #145
MIXED READOUTS
10 for \$1.98

BARREL KIT #144
MIXED READOUTS
10 for \$1.98

BARREL KIT #143
MIXED READOUTS
10 for \$1.98

BARREL KIT #142
MIXED READOUTS
10 for \$1.98

BARREL KIT #141
MIXED READOUTS
10 for \$1.98

BARREL KIT #140
MIXED READOUTS
10 for \$1.98

BARREL KIT #139
MIXED READOUTS
10 for \$1.98

BARREL KIT #138
MIXED READOUTS
10 for \$1.98

BARREL KIT #137
MIXED READOUTS
10 for \$1.98

BARREL KIT #136
MIXED READOUTS
10 for \$1.98

BARREL KIT #135
MIXED READOUTS
10 for \$1.98

BARREL KIT #134
MIXED READOUTS
10 for \$1.98

BARREL KIT #133
MIXED READOUTS
10 for \$1.98

BARREL KIT #132
MIXED READOUTS
10 for \$1.98

BARREL KIT #131
MIXED READOUTS
10 for \$1.98

BARREL KIT #130
MIXED READOUTS
10 for \$1.98

BARREL KIT #129
MIXED READOUTS
10 for \$1.98

BARREL KIT #128
MIXED READOUTS
10 for \$1.98

BARREL KIT #127
MIXED READOUTS
10 for \$1.98

BARREL KIT #126
MIXED READOUTS
10 for \$1.98

BARREL KIT #125
MIXED READOUTS
10 for \$1.98

BARREL KIT #124
MIXED READOUTS
10 for \$1.98

BARREL KIT #123
MIXED READOUTS
10 for \$1.98

BARREL KIT #122
MIXED READOUTS
10 for \$1.98

BARREL KIT #121
MIXED READOUTS
10 for \$1.98

BARREL KIT #120
MIXED READOUTS
10 for \$1.98

BARREL KIT #119
MIXED READOUTS
10 for \$1.98

BARREL KIT #118
MIXED READOUTS
10 for \$1.98

BARREL KIT #117
MIXED READOUTS
10 for \$1.98

BARREL KIT #116
MIXED READOUTS
10 for \$1.98

BARREL KIT #115
MIXED READOUTS
10 for \$1.98

BARREL KIT #114
MIXED READOUTS
10 for \$1.98

BARREL KIT #113
MIXED READOUTS
10 for \$1.98

BARREL KIT #112
MIXED READOUTS
10 for \$1.98

BARREL KIT #111
MIXED READOUTS
10 for \$1.98

BARREL KIT #110
MIXED READOUTS
10 for \$1.98

BARREL KIT #109
MIXED READOUTS
10 for \$1.98

BARREL KIT #108
MIXED READOUTS
10 for \$1.98

BARREL KIT #107
MIXED READOUTS
10 for \$1.98

BARREL KIT #106
MIXED READOUTS
10 for \$1.98

BARREL KIT #105
MIXED READOUTS
10 for \$1.98

BARREL KIT #104
MIXED READOUTS
10 for \$1.98

BARREL KIT #103
MIXED READOUTS
10 for \$1.98

BARREL KIT #102
MIXED READOUTS
10 for \$1.98

BARREL KIT #101
MIXED READOUTS
10 for \$1.98

BARREL KIT #100
MIXED READOUTS
10 for \$1.98

Poly Paks C-R-A-C-K-S

Prices

Wow!

INCREDIBLE PRICES

BUY ANY 10 TAKE 15%

BUY 100 TAKE 25%

TYPE SALE	SNT74422	SNT74423	SNT74424
SNT7401N	SNT74425	SNT74426	SNT74427
SNT7402N	SNT74428	SNT74429	SNT74430
SNT7403N	SNT74431	SNT74432	SNT74433
SNT7404N	SNT74434	SNT74435	SNT74436
SNT7405N	SNT74437	SNT74438	SNT74439
SNT7406N	SNT74440	SNT74441	SNT74442
SNT7407N	SNT74443	SNT74444	SNT74445
SNT7408N	SNT74446	SNT74447	SNT74448
SNT7409N	SNT74449	SNT74450	SNT74451
SNT7410N	SNT74452	SNT74453	SNT74454
SNT7411N	SNT74455	SNT74456	SNT74457
SNT7412N	SNT74458	SNT74459	SNT74460
SNT7413N	SNT74461	SNT74462	SNT74463
SNT7414N	SNT74464	SNT74465	SNT74466
SNT7415N	SNT74467	SNT74468	SNT74469
SNT7416N	SNT74470	SNT74471	SNT74472
SNT7417N	SNT74473	SNT74474	SNT74475
SNT7418N	SNT74476	SNT74477	SNT74478
SNT7419N	SNT74479	SNT74480	SNT74481
SNT7420N	SNT74482	SNT74483	SNT74484
SNT7421N	SNT74485	SNT74486	SNT74487
SNT7422N	SNT74488	SNT74489	SNT74490
SNT7423N	SNT74491	SNT74492	SNT74493
SNT7424N	SNT74494	SNT74495	SNT74496
SNT7425N	SNT74497	SNT74498	SNT74499
SNT7426N	SNT74500	SNT74501	SNT74502
SNT7427N	SNT74503	SNT74504	SNT74505
SNT7428N	SNT74506	SNT74507	SNT74508
SNT7429N	SNT74509	SNT74510	SNT74511
SNT7430N	SNT74512	SNT74513	SNT74514
SNT7431N	SNT74515	SNT74516	SNT74517
SNT7432N	SNT74518	SNT74519	SNT74520
SNT7433N	SNT74521	SNT74522	SNT74523
SNT7434N	SNT74524	SNT74525	SNT74526
SNT7435N	SNT74527	SNT74528	SNT74529
SNT7436N	SNT74530	SNT74531	SNT74532
SNT7437N	SNT74533	SNT74534	SNT74535
SNT7438N	SNT74536	SNT74537	SNT74538
SNT7439N	SNT74539	SNT74540	SNT74541
SNT7440N	SNT74542	SNT74543	SNT74544
SNT7441N	SNT74545	SNT74546	SNT74547
SNT7442N	SNT74548	SNT74549	SNT74550
SNT7443N	SNT74551	SNT74552	SNT74553
SNT7444N	SNT74554	SNT74555	SNT74556
SNT7445N	SNT74557	SNT74558	SNT74559
SNT7446N	SNT74560	SNT74561	SNT74562
SNT7447N	SNT74563	SNT74564	SNT74565
SNT7448N	SNT74566	SNT74567	SNT74568
SNT7449N	SNT74569	SNT74570	SNT74571
SNT7450N	SNT74572	SNT74573	SNT74574
SNT7451N	SNT74575	SNT74576	SNT74577
SNT7452N	SNT74578	SNT74579	SNT74580
SNT7453N	SNT74581	SNT74582	SNT74583
SNT7454N			

BUILD YOUR OWN TV CAMERA!
— Ideal for home & business —



THE ECONOMIC ANSWER TO HOME MONITORING OF NURSERIES, ENTRANCES, DRIVEWAYS... BUSINESS AND INDUSTRIAL SURVEILLANCE... TV... AMATEUR... TV... PLUGS... HUNDREDS OF OTHER APPLICATIONS... MODEL XT-1A, SERIES D - KIT FORM SIBS... ASSEMBLED \$275. SOLID-STATE. WORKS ON ANY TV SET. OPTIONAL SOUND KIT \$28.95. PHONE OR WRITE for catalog. Dial 402-987-3771

1301 BROADWAY **ATV Research** DAKOTA CITY, NE. 68731

NON SEMI SURPLUS. Monthly picture flyer. Quality. Low prices. Send 25 cents. U.S. only. Startronics, Box 683, McMinnville, OR 97128.

MICROCOMPUTER \$90. Uses surplus components. Keyboards, 1K RAM, LED readouts. Information \$1. NBL-E, Box 1115, Richardson, Texas 75080.

DESIGN your own power supply and regulator circuits. Twenty pages of circuit analyses and design examples. 8-1/2 x 11, \$2.00. Midwest Design, Box 367, Harbert, Michigan 49115.

CB THEFT ALARM. Furnace thermostat timer. Random nite light timer. Plans \$2.00 each plus stamped, addressed envelope. Don Hopman, 6537W Paradise Lane, Glendale, Arizona 85306.

FREE FLYER from Colorado's fastest growing electronic parts distributor. Our second big year with outstanding buys on kits, parts, semi's, scientific items. Visit our retail outlet. J.B. Saunders Company, 3050 Valmont, Boulder, CO 80301.

CB PATROL CAR DOOR DECALS CB

SCARE THIEVES AWAY, PROTECT CB GEAR AND PROPERTY! Beautiful full color designs, made from weather resistant mylar, looks like smokes! Use for: car, truck, boat, home, rv, ect. Complete CB ID. kit of ten decals - ONLY \$6.95! Write decals.

Dept. PE, CAMPBELL CO, P.O. Box 201, SAN GABRIEL, CA, 91776

CB CRYSTALS over 20,000 standard and specials in stock from 6.0 MHz to 45.0 MHz. Call or write for information package. Dealer inquiries invited. Roberts Electronics Sales, 73563 29 Palms Highway, 29 Palms, California 92277 (714) 367-6235.

COMPUTERS-CALCULATORS. Parts, kits, interfaces, terminals, schematics, applications, programs, theory. Catalog 50 cents, refundable. COMTEK, P.O. Box 401462D, Garland, Texas 75040.

IC BONANZA

*Data Sheet included on these items

*2102	Good Cassettes, Used	\$.98
1K Static RAM		1.49
*5203K	Erasable PROM 2K	10.95
*MM5330	National DVM Chip	9.95
*50310	Slide Rule Calculator Chip	3.95
*50250	Alarm Clock Chip	4.45
304H	Neg. Regulator	.95
309K	5 Volt Regulator	.95
7805	5 Volt Pos. Reg. (TO-220)	.79
7812	12 Volt Pos. Reg. (TO-220)	.79
7815	15 Volt Pos. Reg. (TO-220)	.79
MAN 7	(HP-7730) 7 Seg. Display	1.15
MAN 3	7 Seg. Display	5/1.00
MCA 8	Monsanto Opto Switch	.75
LED	2 Red	6/1.00
LED	2 Yellow	5/1.00
LED	2 Green	5/1.00
LED	2 Red-Right Angle	5/1.00
LED	12 Red	7/1.00
LED	12 Yellow	6/1.00
LED	12 Green	6/1.00
1"	Perforator Tape, per roll	2.75
	7 Roll Canon	17.50

SEND FOR FREE CATALOG

Minimum order \$5.00, data sheets 25 cents each. Include 5% of order for postage and handling. Texas residents include 5% state sales tax.

BONANZA ELECTRONICS

P. O. Box 24767 Dallas, Texas 75224

EDLIE'S BARGAIN BONANZA

ONLY HIGHEST QUALITY PRODUCTS



- (IP017) COPPER CLAD BOARDS! Copper on one side, 1/16" thick. Excellent quality for either production or experimental work. 6 5/8" x 17 1/2" \$1.19 ea. 3/\$2.99
- Copper on both sides, 1/16" thick. Size 12" x 18" (IP018) \$1.99 ea. 3/\$4.99
- (IP134) 8 ROTARY SWITCHES Some multiple gang. \$1.00
- (IP128) 13 MINIATURE ELECTROLYTIC CAPACITORS Axial & upright, popular values. \$1.00
- (IP144) TRANSISTOR REPAIR KIT \$1.19 Various parts used to repair transistorized devices.
- (IP336) TO-3 TRANSISTOR SOCKETS 12 for \$1.00
- 9 V. BUZZER FOR ALARMS 99c ea. 6 for \$5
- (IP164) 4 ROLLS OF WIRE \$1.00 Approx 25 ft. per roll, 20 28ga
- (IP140) TAPE RECORDER SPARE PARTS KIT \$2.95 Parts for repairing most tape recorders: capacitors, meter, pilot lamp, jacks, and MUCH MORE.
- (IP167) 10 MINIATURE POTENTIOMETERS \$1.00
- (IP182) 2 MISC. METERS \$1.00 Miniature.
- (IP156) 60 DISC CAPACITORS \$1.00 Asst. from .0001 to .1, most 600v. Z5U, NPO, N750, etc.

SURPLUS TUBES

All guaranteed for 1 full year.

ANY 3 FOR \$1.49

Acquired from U.S. Defense depots or removed from equipment (new and used). These are laboratory tested and guaranteed for one full year. Most are of such standard makes as RCA, GE, etc.

3A3	6A07	6CG7	6T8
3BN6	6AT6	6CM7	6W4
3DG4	6AU6	6DE4	8SN7
3KT6	6AV6	6DR7	10EW7
3Q4	6AX4	6DW4	12AE7
3S4	6AX5	6EB8	12AL5
4BC5	6AY3	6EM7	12AU7
4BN6	6BA6	6GF7	12AV6
4BU8	6BG6	6GH8	12BH7
5V6	6BJ8	6K6	18FW6
6AF4	6B06	6K11	25L6
6AG5	6BZ6	6LB6	35EH5
6AL5	6CB6	6SN7	36AM3

FLAT WIRE RIBBON CABLE

Useful for IC connection 4 Conductor 25 ft. \$1.00

(IP155) TUBE BONANZA! 20 asst. popular tubes, untested. \$1.00

(IP142) 50 PRECISION RESISTORS \$1.00 All 1%, 1/2w and 1w. low and high ohmages.

(IP150) POWER TRANSFORMER Primary 117 volts. Sec. 1-11.1 volts; Sec. 2 17.7 volts; Sec. 3 15.9 volts; Sec. 4 27.7 volts. Each winding approx. 750 mils. Size 2 1/4" H x 2" D x 3 3/8" mounting centers. \$1.95

(IP175) 70 1/2w CARBON RESISTORS \$1.00 Asst. values. Some 5%.

(IP154) 150 CUT LEAD RESISTORS \$1.00 Carbon, all leads long enough for soldering.

(IP149) 20 POLYSTYRENE TOP GRADE CAPACITORS \$1.00

(IP132) 20 DUAL POTS \$1.00

(IP202) 99c ea 6 for \$4.99

24V. C.T. FILAMENT TRANSFORMER 1/2A. WITH 150V. TAP.

(IP202) 99c ea 6 for \$4.99

(IP202) 99c ea 6 for \$4.99

(IP202) 99c ea 6 for \$4.99

(IP202) 99c ea 6 for \$4.99

(IP202) 99c ea 6 for \$4.99

(IP202) 99c ea 6 for \$4.99

(IP202) 99c ea 6 for \$4.99

(IP202) 99c ea 6 for \$4.99

(IP202) 99c ea 6 for \$4.99

(IP202) 99c ea 6 for \$4.99

(IP202) 99c ea 6 for \$4.99

(IP202) 99c ea 6 for \$4.99

(IP202) 99c ea 6 for \$4.99

(IP202) 99c ea 6 for \$4.99

(IP202) 99c ea 6 for \$4.99

(IP202) 99c ea 6 for \$4.99

(IP202) 99c ea 6 for \$4.99

(IP202) 99c ea 6 for \$4.99

(IP202) 99c ea 6 for \$4.99

(IP202) 99c ea 6 for \$4.99

(IP202) 99c ea 6 for \$4.99

(IP202) 99c ea 6 for \$4.99

(IP202) 99c ea 6 for \$4.99

(IP202) 99c ea 6 for \$4.99

(IP202) 99c ea 6 for \$4.99

(IP202) 99c ea 6 for \$4.99

(IP202) 99c ea 6 for \$4.99

(IP202) 99c ea 6 for \$4.99

(IP202) 99c ea 6 for \$4.99

(IP202) 99c ea 6 for \$4.99

(IP202) 99c ea 6 for \$4.99

THIS MONTH'S SPECIALS!

TTL	7400	18c	7446	80c
	7401	18c	7447	80c
	7402	22c	7448	80c
	7403	23c	7473	49c
	7404	23c	7474	49c
	7405	23c	7475	85c
	7406	23c	747	53c
	7410	23c	7490	79c
	7411	27c	7492	79c
	7413	40c	7493	69c
	7420	23c	7495	79c
	7430	23c	74121	57c
	7440	30c	74122	57c
	7442	\$1.12	74123	67c

LINEARS

LM309K	5v Ia. reg.	\$1.15
555	Timer	.75c
556	Dual 555	\$1.00
566	Function gen.	\$1.75
567	Tone decoder	\$1.95
741	comp. op amp	.39c
2513	Char. gen.	\$5.95
8038	volt cont osc	\$4.25

CLOCK CHIPS WITH DATA

(MM5314)	6 dig clock	\$4.95
CT7001	Alarm & Date	\$5.95

LED'S

(IP223)	10 Asst LEDs	\$1.00
(IP242)	5 Jumbo Green LEDs	\$1.00
(IP242)	5 Med Yellow LEDs	\$1.00
(IP241)	5 Jumbo Red LEDs	\$1.00
(IP011)	5 Med Red LEDs	\$1.00
(IP012)	5 Mini Red LEDs	\$1.00
(IP293)	DL707 (equiv.) 7 seg red LED, .3" char., comm anode	\$1.50
(IP006)	DL 704 (equiv.) same as DL707 except comm cath	\$1.50
(IP007)	DL747 7 seg red LED, .6" char., comm anode	\$2.25
(IP013)	MAN 5 (equiv.) 7 seg green LED, .27 char., comm. anode	\$1.49

IC BREADBOARDS & TERMINALS

Boards have .042 holes. Made of 1/16" polyester glass.

(BB663)	3" x 4"	\$1.16
(BB664)	3" x 6"	\$1.34
(BB665)	4" x 6"	\$1.65
(BB666)	4" x 8"	\$2.12

Push-in terminals

(IP6601-20)	pkg	20/90c
(IP6601-100)	pkg	100/\$2.98

Push-in flanged pins

(BB6602-20)	pkg	20/90c
(BB6602-100)	pkg	100/\$2.98

Push-in flea clips

(BB6603-20)	pkg	20/90c
(BB6603-100)	pkg	100/\$2.98
(8008)	14 pin DIP sockets 3 for \$1	
(IP1104)	IC REMOVAL AND INSERTION TOOL	\$4.95

"Pul-n-teric" extracts and inserts ICS without damage.

REED RELAYS

(IP203)	SPST, 12V, 1000 ohms coil.	Price 79c
---------	----------------------------	-----------

Prices are subject to change without notice.

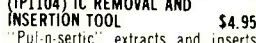

TANK! JUST ONE OF THE 16 GAMES YOU CAN PLAY WITH OUR NEW INCREDIBLE HAND HELD ELECTRONIC GAME. SPECIAL INTRODUCTORY PRICE ONLY: \$8.95 SATISFACTION GUARANTEED

INTERFAB, 27963 CABOT RD LAGUNA NIGUEL, CA. 92677

REGULATED Power Supplies. New. Fixed and adjustable one thru four outputs. T03 IC's. Single 1A \$14.95. Triple 2A \$27.95. Send \$2.00 for brochure refunded on first order. Mechelect, Inc., Box 911, Plymouth, Mass. 02360.

NEW 60/600MHZ PORTABLE COUNTER

- * Large .3" 7-digit LED display
- * C-MOS LSI construction
- * Small-ideal for field use
- * Portable battery operated
- * With NiCad batteries & charger
- * Internal crystal time base
- * Input overload protection
- * 1 Hz resolution on low range
- * 1 meg input-sensitivity 50 mv
- * 50 ohm input-sensitivity 100 mv
- * Size: 2" H x 2.75" W x 4" D

A 600 MHz FREQUENCY COUNTER THAT CAN GO ANYWHERE --- NOT A KIT

Dealer inquiries invited

CBS ENTERPRISE, P.O. BOX 1356 COCOA BEACH, FLA. 32931

SURPRISES GALORE! Projects, ham radio, music synthesizers, etc. IC's, pots, hardware, crystals, keyboards, resistors, etc. Send 13 cents stamp for catalogue. UTEP, Box 26231B, Salt Lake City, Utah 84125.

\$79.95 LIMITED TIME SPECIAL

B & K Model 280 Digital Multimeter

Regularly \$99.95

- 15% Discount on all other B & K items.
- FREE shipping in continental U.S.
- FREE 40 page catalog

SPACETRON

BOX 84-P • BROADVIEW, ILL. 60153

REVOLUTIONARY new electronics motor. 100 horsepower, 24V power source. "Digital-pulsed" and time-phased-programmed. Motor block diagram and test data included. 550 mile range prototype test electric car. Information. \$3.50. Wendell L. Daniels, Engineering Consultant, 8450 Anthony Wayne Ave., Cincinnati, OH 45216.

Digital Clock for Vehicles

As described in Popular Electronics October 1976.

\$29.95

+ \$2.50 P&H COMPLETE KIT LESS CASE

Kit includes all resistors, capacitors, transistors, diodes, IC's, crystal, etched and drilled PCB, assembled display board, switches, and step-by-step assembly instructions.

OPTIONAL CASE WITH LENS: \$4.50
COMPACT SIZE: 2.5" w x 1.2" h x 2.8" d
Outside U.S.A.: Add \$3.00 P&H ordinary mail, \$5.00 Air.

ALPHA ELECTRONICS (TEXAS), P.O. BOX 64726-P DALLAS, TEXAS 75206, PH: (214) 369-7309

THE KING OF ALTAJ

25.50



6-DIGIT ALARM CLOCK

THE KING FEATURES

- 1) 6 digit - 12 hr - 60 cycle or 24 hr - 50 cycle alarm clock.
- 2) Time sharing capability for the display of additional information.
- 3) Single 12v supply and a minimum of interface components.
- 4) AM PM and automatic power fail use indicators.
- 5) 10 minute snooze.
- 6) Intensity control of LEDs.

Kit No. 70250-1R (Red readouts)
Kit No. 70250-1G (Green readouts)
Kit No. 70250-1Y (Yellow readouts)
Kit No. 70250-2R (DL727 readouts) 5 in. \$29.50

All kits include components, PC Board, Transformer, case and construction manual.

THE KING'S HAREM

FATIMA 4-DIGIT TEMP. KIT

\$ 24.95

Features 4 digit temperature display, lamp-out temperature, optional C-Max qualification, uses 7002 4 digit counter.

Kit includes all components, PC Board and instructions for interfacing with THE KING. 6 digit alarm clock. Addition Number 1.



DELILA APPLIANCE STARTER \$9.95

(Example) Set your alarm for 7:00 am. Set timer for 15 min. At exactly 7:00 the audience will start at 7:15 your clock alarm will wake you.

Kit includes all components, PC Board and instructions for interfacing with THE KING 6 digit alarm clock. Addition Number 2.

TANYA 60 HZ CRYSTAL TIME BASE

ADDITIONAL FEATURES

- 1) Low Power Consumption.
- 2) Directly Interfaces with King MOS Clock Chip.
- 3) 60 Hz output with crystal time base accuracy.
- 4) Used for Cars, Boats & Computers.

\$5.95

Kit includes all components, PC Board and instructions for interfacing with THE KING.

6-Digit Alarm Clock. Addition Number 3.



FND 70
RED, 25 in. Chw.
15mA per segment
Common Cathode.
\$1.27

DL727

One of our best readouts.
5 in. high, 70mA per
segment. Common anode.
\$3.75



BURROUGHS 12 DIGIT
1088 1/2 inch diameter
dual 160kbit.
\$2.50



FND 800 CATHODE
New 5 in. display
by Fairchild
Common Cathode.
\$1.50

LEDS

12
15
20
25

Miniature
Jumbo size
Jumbo size
Jumbo size
\$1.00



T1
Fully multiplexed common cathode.
Gold plated. Ideal for mini 6 digit
clock.
\$1.00

DL33

1088 1/2 inch diameter
array of displays
one hour of
Common cathode.
\$1.45

TTL BOARDS

MEMOREX computer boards with TTL Diodes and Transistors, etc.

5 Boards including 150 250 IC's.
\$4.50

GE TRANSISTOR ASSORTMENT

1088 1/2 inch diameter
APN PNP, etc.

50 for \$1.90
100 for \$2.50
300 for \$5.00

LSI INTEGRATION

- MMS316 4 & 6 digit alarm clock, 40 pin d/w spec. \$ 4.25
- 7002 4 digit counter latch decoder, 7 segment and BCD output, 28 pin d/w spec. \$12.50
- 7005 4 digit counter latch decoder, 7 segment output only, 24 pin d/w spec. \$ 9.50
- 7007 4 digit counter latch decoder with BCD output only, 16 pin d/w spec. \$ 7.00
- 70250 4 & 6 digit alarm clock, 28 pin d/w spec. \$ 5.50
- PC Board for 70250 \$ 2.25
- 70389 4 digit non multiplexed radio alarm clock featuring direct drive display, output 40 pins w/spec. \$4.50
- PC Board for 70389 \$ 2.25
- 8008 6 bit parallel CPU \$19.50
- 2102 1K static RAM for 8008 \$ 2.25
- MMS203 2K UV erasable PROM \$12.25
- 75491 segment driver \$ 0.35
- 75497 liquid driver \$ 0.45
- 75499 6 function calculator chip with direct segment drive 8 input \$ 2.25
- 7020

TTL

CMOS

7400	21	7448	94	74151	80	4000	24	4018	149	4037	450
7402	21	7453	71	74153	84	4001	26	4019	159	4040	159
7404	21	7473	74	74154	100	4002	24	4020	159	4041	89
7406	29	7474	42	74161	104	4006	149	4021	149	4042	79
7408	21	7475	70	74163	124	4007	24	4022	119	4043	81
7410	21	7476	44	74164	134	4008	115	4023	119	4044	59
7413	94	7483	80	74165	154	4009	59	4024	99	4047	59
7420	21	7489	250	74174	134	4010	55	4025	24	4048	59
7422	29	7490	74	74181	280	4011	24	4027	59	4050	59
7430	21	7492	80	74175	134	4012	21	4028	99	4056	99
7437	44	7493	80	74187	130	4013	50	4029	39	74C02	29
7438	39	7495	80	74193	130	4014	49	4030	49	74C04	29
7440	21	7496	80	74195	84	4015	119	4034	325	74C07	129
7442	74	74121	43			4016	59	4035	139		
7447	94	74123	80			4017	129				

4 & 6 DIGIT PC BOARDS

- PC Board for 70250 \$2.75
- PC Board for 70389 \$2.75
- PC Board for 7002 \$3.50
- PC Board for 7005 \$3.50
- PC Board for 7007 \$3.50
- PC Board for 70250 \$2.25
- PC Board for 70389 \$2.25
- PC Board for 8008 \$19.50
- PC Board for 2102 \$2.25
- PC Board for MMS203 \$12.25
- PC Board for 75491 \$0.35
- PC Board for 75497 \$0.45
- PC Board for 75499 \$2.25
- PC Board for 7020 \$2.25



MSI

Wise move



MODULAR SCIENTIFIC INSTRUMENTATION

Now you can build some of the most advanced integral electronic instruments with our new series of low-cost modular scientific kits. These kits will expand the range of your electronic applications enormously and all at a surprisingly low cost.

The heart of the system is our 4-digit Decade Counter (Kit 012) which features a full 4 digit LED readout (you choose the size best suited to your application). Combine this with a 5 volt regulated power supply (Kit 030) and you have the basis of a wide range of sophisticated electronic instruments including:

- A Digital Voltmeter (DVM) Kit 012 - Kit 030 - Kit 017
- Frequency Counter Kit 012 - Kit 030 - Kit 016 - Time Base
- RPM Counter Kit 012 - Kit 030 - Kit 020 - Kit 018



4-DIGIT DECADE COUNTER KIT \$19.95

KIT 012

One chip 4 digit decade counter kit with both 7 segment and BCD output.

- 1) Chip features internal oscillator for scanning speed.
- 2) Overflow and count extend out puts.
- 3) Transfer, reset, count, blanking and train elimination control in puts.
- 4) PC Boards can be cascaded to 8 12 18 etc digits.
- 5) Kit includes counter chip, driver circuit for 4 cathode type displays and PC Board. (For read out board see FND 80 FND503).

KIT 016 FREQ. COUNTER

Features FET input front end with trigger output for measuring complex waveforms. Measures from 0.1Hz to 10MHz when used with Kit 015 or 019. Measures from 0.1Hz to 35MHz when used with Kit 013 and 014.

\$29.50



KIT 030 POWER SUPPLY

Output voltage 25V max. Output current 1 amp max. Load regulation 50mV. Output voltage 5V. The regulator Q1 requires a 20V transformer.

\$4.55

(Options of parts except transformer)

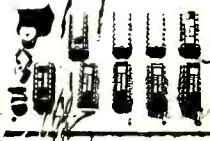

TIME BASES

1) MHz crystal chain time base shifter. Outputs 1MHz 100KHz 10KHz 1KHz 100Hz 10Hz 1Hz 0.1Hz. Accuracy better than .00% with coarse adjustment.

Kit 013 includes CMOS with PC board. \$15.75

Kit 014 Same as Kit 013, but with TTL. \$13.75

Kit 015 50KHz or 60Hz chain time base using line frequency as reference. Accuracy 0.10.0%. Outputs 10KHz 1Hz 0.1Hz. Compatible with CMOS shaped output and PC Board. \$3.75

Kit 016 Same as Kit 015, but with TTL and 60Hz only. \$7.75

Kit 018 60Hz chain time base using line frequency for Kit 020 RPM counter.

KIT 017 DVM

1.999V at base with accuracy indicators. 1 M ohm input impedance and accuracy to 1% if correctly adjusted.

\$16.50



KIT 020 RPM COUNTER

Lowest cost 100,000 RPM RPM counter kit contains components for PC Board.

\$8.95

MSI CLUB

Outputs 6 sec 100Hz of RPM
6 sec 10Hz of RPM
60 sec 1rpm revolution. \$9.75

Send for your membership card to the Modular Scientific Instrumentation Club and receive a big 10% off on future purchases of MSI Kits. Send \$3.00 with your name and address. We will promptly send you our very own registered membership card. Don't miss out on the scientific lifestyle!

Membership card for sale. Free after 6 months registration.



\$26.95

Ideal for Car, Boat, Camper, Etc. with Built-in Backup Power Supply.

THE TRAVELER 4-DIGIT AUTOMOBILE CLOCK

FEATURES:

- 1) 5" inch Displays
- 2) AC-DC Operation
- 3) Automatic Charge In and Recharging of Backup Power Supply
- 4) Able to Keep Time While Changing from House to Car or Car to Boat Using Built-in Backup Power Supply
- 5) Protected From Noise and Voltage Surges in Car and Boat
- 6) Direct Drive Outputs
- 7) Non-Multiplexed Output Circuitry

KIT INCLUDES

COMPONENTS, PC BOARD TRANSFORMER, and CONSTRUCTION MANUAL

\$\$\$ SAVE! 4-DIGIT ALARM CLOCK

KIT NO.1 \$13.95 (with PC Board)

FEATURES:

Complete kit with components, PC Board, Transformer, liquid driver chip and other low supply window. Includes 5 and 8 digit outputs. \$2.00

KIT NO.2

Complete kit with components, PC Board, Transformer, liquid driver chip and other low supply window. Includes 5 and 8 digit outputs. \$21.50

KIT NO.3

Complete kit with components, PC Board, Transformer, liquid driver chip and other low supply window. Includes 5 and 8 digit outputs. \$22.50



LIGHTS MUSIC 60 WATT COLOR ORGAN

Completely self contained unit with 20 w/ waver color included. \$2.00



- 555 Time Multiplier 0.65
- 555 Functional generator 4.25
- RCA 3043 FM Int. Aud. Preamp. 1.20
- 565 Tone Decoder 1.95
- 567V Tone Decoder 1.50
- LM723 Pos. Volt. Reg. 0.55
- LM309 5v 1 amp. Reg. 1.10
- LM380 2w. Audio Amp. 8 pin dip. 1.00
- LM741 Operational Amp. 0.25

- RF A3J01 115V 700 mA 0.25
- GE D40C1 NPN Diode 0.25
- 2N4435B 400VSA T0200 0.65
- 2N2222 NPN Gen. Amp. 0.20
- 2N3904 NPN Diode 0.25
- 2N1904 PNP Diode 0.15
- 2N4400 NPN 1.5w. sig. amp. 0.20
- 2N5401 PNP NPN driver 0.25
- 1N4004 400HV 1s. rec. 1.00
- 1N4007 1000HV 10 sec. 1.00
- 1N740 3.3V 4w. 4 pin 1.00
- 1N4148 Switch 70 for 1.00

ALTAJ ELECTRONICS

P.O. BOX 3854 Dallas, Texas 75208

TELEPHONE (214) 278 3561

Check for company name No. CDD

Telephone (214) 278 3561

TELEPHONE (214) 278 3561

TELEPHONE (214) 278 3561

TELEPHONE (214) 278 3561

TELEPHONE (214) 278 3561

LOOK!

From Altaj you can get:
Power Supply Kit 5 Volt 1 Amp. Reg. Line regulation 0.01% Load regulation 50mV
Kit includes: Component, PC Board, Liquid Driver, Fuse, Pilot Light, Nylon construction. \$6.50

HAPPY HOLIDAYS HOBBYISTS

A GREAT GIFT IDEA:

"Electronic Projects for Musicians" \$6.95

BY CRAIG ANDERTON; now in 2nd printing. This book has shown thousands of people how to assemble electronic projects. 73 says "a dandy book...fantastic music gadgets". Popular Electronics says "gets it all together". ElectroNotes says "highly recommended...it gives the essential information". Tells how to build 19 musician/audiophile projects. With soundsheet.

100 PIN EDGE CONNECTOR--NEW!

Specify wirewrap (illustrated) or solder-tail. Perfect for IMSAI machines



\$5 EACH OR 5/\$22

GODBOUT

BILL GODBOUT ELECTRONICS
BOX 2355, OAKLAND AIRPORT, CA 94614

TERMS. Add 50c handling to orders under \$10. Cal res add tax. No COD, to place BankAmericard® or Mastercharge® orders call (415) 562-0636, 24 hours.

CIRCLE NO. 32 ON FREE INFORMATION CARD

8 pin Minidip lo-profile sockets 10/\$1.60

25V 5/\$1.95 25V, 1000 uF
10uF 450V 5/\$1
Standard phenolic type. LTD QTY

PRICE	FIG	Pp	MAX	FOOTPRINT	PIN	EFFICIENCY	REMARKS
			@ 25°C	@ 2 GHz		@ 2 GHz	
\$4.95	A	3.5W	1.0W	310mm	30%		Sim. to RCA 2N5470
\$5.95	B	8.7W	2.5W	300mm	33%		Sim. to RCA TA8407
\$6.95	B	21W	5.5W	1.25W	33%		Sim. to RCA 2N6269
\$7.95	B	29W	7.5W	1.5W	33%		Factory selected part--2N6269

edge connectors-2/\$1

Right angle, 24 pin card edge connector for .062" (single-sided) cards. 0.156" spacing between leads. LIMITED QTY.

CHIPSET \$35.50

1-8080A and 8-2102L1s. Uses LOW power memories, guaranteed 450 ns over full comm. temp range. Factory new parts. 2102L1 available separately.....\$1.95
8080A available separately.....\$20.95

UHF transistors

NEW TS1755/GRM test sets for PRC25. \$30 shipped in U.S. Free catalog. BRAND X, Rt. 3, Box 223-11, Ontario, OR 97914. Dealers Inquiry

FLYING helmets, headsets with boom microphones, adapted to CB's. Amplifier, 10139 Apache, Richmond, VA 23235

PLANS AND KITS

FANTASTIC—Solderless breadboard kit with all parts for fascinating experiments with Flasher / Oscillator / Siren chip \$12.95 less battery. Catalog 50 cents (refundable). Satisfaction Guaranteed. Ego, Box 1331-pb. Thousand Oaks, California 91360.

FIVE OCTAVE Touch Sensitive Electronic PIANO KIT. Components \$229 airmail U.S.A., Canada. Clef Products, 31, Mountfield Road, Bramhall, Cheshire, England SK7 1LY

RECHARGE dry cells without electricity, batteries or solar Simple-inexpensive. Send \$2.00 for plans. Thayer, 2775 N.E. Wiberg Lane, Portland, Oregon 97213.

TAPE-SLIDE Synchronizer. Tap-dissolve, multiprojector audiovisual plans, \$8.50. Sampler, \$1.00. Millers, 1896 Maywood, S Euclid, OH 44121

TIGER SST SIMPLI-KIT

FOR THE DO-IT-YOURSELFER NOW! a high quality CD Electronic Ignition System in kit form.

Contains all components and solder to build complete Solid State Electronic CD Ignition System for your car. Assembled requires less than 3 hours

- Increases MPG 15%
- Increases horsepower 15%
- Plugs and Points last 50,000 miles
- Eliminates 4 of 5 tune-ups
- Instant starting, any weather
- Dual system switch

Fits only 12 volt neg ground Only \$21.95 postpaid

Tri-Star Corporation
P.O. Box 1727 Grand Junction, Colorado 81501

For faster service

USE ZIP CODE

on all mail

CB SPECIALS—R.F. DRIVERS—R.F. POWER OUTPUTS—FETS

2SC481	1.85	2SC76/15.75	2SC866	5.85	2SC1449-1	1.60	40081	1.50	
2SC482	1.75	2SC773	.85	2SC013	1.50	2SC475	1.50	40082	3.00
2SC495	1.10	2SC774	1.75	2SC1014	1.50	2SC1678	5.50	2SC608	4.85
2SC502	3.75	2SC775	2.75	2SC1017	1.50	2SC1679	4.75	SK3046	2.15
2SC517	4.75	2SC776	3.00	2SC1018	1.50	2SC1728	2.15	SK3047	3.75
2SC614	3.80	2SC777	4.75	2SC1173	1.25	2SC1760	2.15	SJ2095	3.50
2SC615	3.90	2SC778	3.25	2SC1226A	1.25	2SC1816	5.50	SK3048	3.25
2SC616	4.15	2SC797	2.50	2SC1237	4.50	2SC1908	.70	SK3054	1.25
2SC617	4.25	2SC798	3.10	2SC1239	3.50	2SC1957	1.50		
2SC699	4.75	2SC781	3.00	2SC1243	1.50	2SF8	3.00	2SK19	1.75
2SC710	.70	2SC789	1.00	2SC1306	4.75	HEP-S3001	3.25	2SK30	1.00
2SC711	.70	2SC796	3.15	2SC1306-14	4.90	2SD235	1.00	2SK33	1.20
2SC735	.70	2SC799	4.25	2SC1307	5.75	MRF8004	3.00		
2SC756	3.00	2SC802	3.75	2SC1307-16	6.00	4004	3.00	3SK40	2.75
2SC765	9.50	2SC803	4.00	2SC1377	5.50	4005	3.00	3SK45	2.75
2SC766	10.15	2SC839	.85	2SC1449	1.30	40080	1.25	3SK49	2.75

JAPANESE TRANSISTORS

2SA52	.60	2SB187	.60	2SC458	.70	2SC815	.75	2SC1569	1.25
2SA316	.75	2SB235	1.75	2SC460	.70	2SC828	.75	2SC1756	1.25
2SA473	.75	2SB303	.65	2SC478	.80	2SC829	.75		
2SA483	1.95	2SB324	1.00	2SC491	2.50	2SC830	1.60	2SD30	.95
2SA489	.80	2SB337	2.10	2SC497	1.60	2SC839	.85	2SD45	2.00
2SA490	.70	2SB367	1.60	2SC515	.80	2SC945	.65	2SD65	.75
2SA505	.70	2SB370	.65	2SC535	.75	2SC1010	.80	2SD68	.90
2SA564	.50	2SB405	.85	2SC536	.65	2SC1012	.80	2SD72	1.00
2SA628	.65	2SB407	1.65	2SC537	.70	2SC1051	2.50	2SD88	1.50
2SA643	.85	2SB415	.85	2SC563	2.50	2SC1061	1.65	2SD151	2.25
2SA647	2.75	2SB461	1.25	2SC605	1.00	2SC1079	3.75	2SD170	2.00
2SA673	.85	2SB463	1.65	2SC620	.80	2SC1096	1.20	2SD180	2.75
2SA679	3.75	2SB471	1.75	2SC627	1.75	2SC1098	1.15	2SD201	1.95
2SA682	.85	2SB474	1.50	2SC642	3.50	2SC1115	2.75	2SD218	4.75
2SA699	1.30	2SB476	1.25	2SC643	3.75	2SC1166	.70	2SD300	2.50
2SA699A	1.75	2SB481	2.10	2SC644	.70	2SC1170	4.00	2SD313	1.10
2SA705	.55	2SB492	1.25	2SC681	2.50	2SC1172B	4.25	2SD315	.75
2SA815	.85	2SB495	.95	2SC684	2.10	2SC1209	.55	2SD318	.95
2SA816	.85	2SB507	.90	2SC687	2.50	2SC1213	.75	2SD341	.95
		2SB511	.70	2SC696	2.35	2SC1226	1.25	2SD350	3.25
2SB22	.65			2SC712	.70	2SC1243	1.50	2SD352	.80
2SB54	.70	2SC206	1.00	2SC713	.70	2SC1293	.85	2SD380	5.70
2SB56	.70	2SC240	1.10	2SC732	.70	2SC1308	4.75	2SD389	.90
2SB77	.70	2SC261	.65	2SC733	.70	2SC1347	.80	2SD390	.75
2SB128	2.25	2SC291	.65	2SC739	.70	2SC1383	.75	2SD437	5.50
2SB135	.95	2SC320	2.00	2SC715	1.75	2SC1409	1.25		
2SB152	4.50	2SC352	.75	2SC762	1.90	2SC1410	1.25	C106B1	.50
2SB173	.55	2SC353	.75	2SC783	1.00	2SC1447	1.25		
2SB175	.55	2SC371	.70	2SC784	.70	2SC1448	1.25	MPS-U31	4.00
2SB178	1.00	2SC372	.70	2SC785	1.00	2SC1507	1.25	MPS-80001	2.25
2SB186	.60	2SC394	.70	2SC793	2.50	2SC1509	1.25		

POWER-TRANSISTORS HIGH-VOLT. TV. TYPE

BU204	1300V	3.90	BU207	1300V	6.20	2SC1172B	1100V	4.25
BU205	1500V	4.70	BU208	1500V	6.25	2SC308	1100V	4.95
BU206	1700V	5.90	2SC1170	1100V	4.00	2SC1325	1100V	4.95

OEM SPECIALS

1N270	.10	2N960	.55	2N2219A	.30	2N2913	.75	2N3740	1.00	2N4401	.20
1N914	.10	2N962	.40	2N2221	.25	2N2914	1.20	2N3771	1.75	2N4402	.20
		2N967	.50	2N2221A	.30	2N2916A	3.65	2N3772	1.90	2N4403	.20
2N173	1.75	2N1136	1.35	2N2222	.25	2N3019	.50	2N3773	3.00	2N4409	.20
2N178	.90	2N1142	2.25	2N2222A	.30	2N3053	.30	2N3819	.32	2N4410	.25
2N327A	1.15	2N1302	2.25	2N2270	.40	2N3054	.70	2N3823	.70	2N4416	.75
2N334	1.20	2N1305	3.00	2N2322	1.00	2N3055	.75	2N3856	.20	2N4441	.85
2N336	.90	2N1377	.75	2N2323	1.00	2N3227	1.00	2N3866	.85	2N4442	.90
2N338A	1.05	2N1420	2.00	2N2324	1.35	2N3247	3.40	2N3903	.20	2N4443	1.20
2N398B	.90	2N1483	.95	2N2325	2.00	2N3250	3.50	2N3904	.20	2N4852	.55
2N404	.30	2N1540	.90	2N2326	2.85	2N3375	6.50	2N3905	.20	2N5061	.30
2N443	1.75	2N1543	2.70	2N2327	3.80	2N3393	2.50	2N3906	.25	2N5064	.50
2N456	1.10	2N1544	.80	2N2328	4.20	2N3394	.17	2N3925	3.75	2N5130	.20
2N501A	3.00	2N1549	1.25	2N2329	4.75	2N3414	.17	2N3925	3.75	2N5133	.15
2N508A	.45	2N1551	2.50	2N2368	.25	2N3415	.18	2N3954	3.50	2N5133	.15
2N555	.45	2N1552	3.25	2N2369	.25	2N3416	.19	2N3954A	3.75	2N5138	.15
2N652A	.85	2N1554	1.25	2N2484	.32	2N3417	.20	2N3955	2.45	2N5198	3.75
2N677C	6.00	2N557	.15	2N2712	.18	2N3442	1.85	2N3957	1.25	2N5294	.50
2N706	.25	2N1560	2.80	2N2894	.40	2N3553	1.50	2N3958	1.20	2N5296	.50
2N706B	.40	2N1605	.35	2N2903	3.30	2N3563	.20	2N4037	.60	2N5306	.20
2N711	.50	2N1613	.30	2N2904	.25	2N3565	.20	2N4093	.85	2N5354	.20
2N711B	.60	2N1711	.30	2N2904A	.30	2N3565	.20	2N4124	.20	2N5369	.20
2N718	.25	2N1907	1.40	2N2905	.25	2N3638	.20	2N4126	.20	2N5400	.40
2N718A	.30	2N2060	1.85	2N2905A	.30	2N3642	.20	2N4141	.20	2N5401	.50
2N720A	.50	2N2102	.40	2N2906	.25	2N3645	.15	2N4142	.20	2N5457	.35
2N918	.35	2N2218	.25	2N2906A	.30	2N3645	.15	2N4143	.20	C103Y	.25
2N930	.25	2N2218A	.30	2N2907	.25	2N3646	.14	2N4220A	.45	C103D	.40
2N956	.30	2N2219	.25	2N2907A	.30	2N3730	1.50	2N4234	.95	C106B1	.50
				2N2907A	.30	2N3731	2.75	2N4400	.20	C106D1	.75

SILICON UNIJUNCTIONS

2N2646	.50	2N2160	.65
2N2647	.60	2N4870	.50
2N6027	.55	2N4871	.50
2N6028	.70	2N4891	.50

6 Digit LED Clock Kit - 12/24 hr.

\$995 QTY. 12
ea. OR MORE

\$1095 QTY.
ea. 6-11

\$1195 QTY.
ea. 1-5

- KIT INCLUDES**
- INSTRUCTIONS
 - QUALITY COMPONENTS
 - 50 or 60 Hz OPERATION
 - 12 or 24 HR OPERATION

6 LED Readouts(FND-359 Red. com. cathode)
1-MM5314 Clock Chip (24 pin)
13-Transistors
3-Switches
6-Capacitors
5-Diodes
9-Resistors
24-Molex Pins for IC socket

LARGE .4" DIGITS!
ORDER KIT #850-4
AN INCREDIBLE VALUE!

"Kit #850-4 will furnish a complete set of clock components as listed. The only additional items required are a 7-12 VAC transformer, a circuit board and a cabinet, if desired."

Printed Circuit Board for kit # 850-4 (etched & drilled fiberglass)\$2.95
Mini-Brite Red LED's (for color in clock display) pkg. of 5..... 1.00
Molded Plug Transformer 115/10 VAC (with cord)..... 2.50
NOTE: Entire Clock may be assembled on one PC Board or Board may be cut to remote display.
Kit # 850-4 will fit Plexiglas Cabinet II.



PLEXIGLAS CABINETS

Great for Clocks or any LED Digital project. Clear-Red Chassis serves as Bezel to increase contrast of digital displays.

Black, White or Clear Cover

CABINET I
3"H, 6 1/4"W, 5 1/2"D

CABINET II
2 1/2"H, 5"W, 4"D

ANY SIZE / COLOR

\$6.50 ea. 2/12.

RED OR GREY PLEXIGLAS FOR DIGITAL BEZELS

3"x6"x1/8"

95¢ ea. 4/3

MOBILE LED CLOCK

12 OR 24-HOUR OPERATION

12 VOLT AC or DC POWERED FOR FIXED OR MOBILE OPERATION.

SIX JUMBO .4" DIGITS!

KIT OR ASSEMBLED

MODEL
2001



ACCURATE TIME WITH ADJUSTABLE XTAL TIME BASE

BATTERY BACK UP FOR POWER FAILURE OR TRANSPORTING FROM HOUSE TO CAR, ETC.

Approx. Size:
1 3/4" H x 4" W x 4 1/2" D

- 6 JUMBO .4" RED LED'S BEHIND RED FILTER LENS WITH CHROME RIM.
- SET TIME FROM FRONT VIA HIDDEN SWITCHES • 12/24 HR. TIME FORMAT
- STYLISH CHARCOAL GRAY CASE OF MOULDED HIGH TEMP PLASTIC
- BRIDGE POWER INPUT CIRCUITRY - TWO WIRE NO POLARITY HOOK-UP
- OPTIONAL CONNECTION TO BLANK DISPLAY (Use When Key Off in Car, Etc.)
- TOP QUALITY PC BOARDS & COMPONENTS - EXCELLENT INSTRUCTIONS

KIT #2001 COMPLETE KIT (Less V. Battery) **2995** EA 3 OR MORE **\$2795** EA 115 VAC Power Pack #AC-1 **\$250** EA
ASSEMBLED UNITS W/ WIRE & TESTED (LESS 9V BATTERY) **\$3995** EA 3 OR MORE **\$3795** EA Assembled Units May Be Mixed With Kits. For Qty. Price

JUMBO RED LED'S 12/\$1.00 50/\$3.95

6 Digit-LED Clock-Calendar-Alarm Kit

This is a complete, top of the line, Kit for the person that wants the best. Some of the many features and options are: 12/24 time, 28-30-31 day calendar, alternates time (8 sec) and date (2 sec) or can display time only and date on demand, 24 hr alarm - 10 minute snooze, alarm set indicator, 50/60 HZ. line operation or use with Xtal time base (#TB-1), built in OSC for battery back-up / AC failure, Aux. timer. Large digits.

Kit #7001B 6-.4" Digits Man-64 \$39.95
Kit #7001C 4-.6" Digits & 2-.3" (seconds) \$42.95

Kits are complete (less cabinet) including PC boards, power supply, IC socket, 9 switches, 16 transistors and all parts required for above features and options (Ideal fit in Cabinet I above).

60 HZ.

XTAL TIME BASE KIT

Will enable Digital Clock or Clock-Cal. Kits to operate from 12VDC. Uses MM5369 and 3.58MHZ. XTAL. Req. 5-15VDC/2.5 MA. 1"x2" PC Board. Easy 3 wire hookup Accuracy: +- 2 PPM

#TB-1 [adjustable]
Complete kit \$4.95 ea
Wired & Cal. \$9.95 ea

PRINTED CIRCUIT BOARDS for CT-7001 Kits sold separately with assembly info. PC Boards are drilled Fiberglass, solder plated and screened with component layout. Specify for #7001B or #7001C (Set of 2) \$7.95

JUMBO DIGIT CLOCK KIT

A complete Kit (less Cabinet) featuring: six 5" digits, MM5314 IC, 12/24 Hr. time, 50/60 HZ., Plug-Transformer, Line Cord, Switches, and all Parts.
[Ideal Fit in Cabinet II]
Kit #5314-5 **\$1995 ea 2/38.**

JUMBO DIGIT CONVERSION KIT

Convert small digit LED clock to large .5" displays. Kit includes 6-.5" LED's, Multiplex PC Board & easy hook-up info.
Kit #JD-1CC For common Cathode **\$995 ea. 2/19.**
Kit #JD-1CA For common Anode

SCHOTTKY TTL		DTL		UART		EXAR		OP AMPS		
74S00	\$.35	930	\$.09	AY5-1013	\$ 6.95	XR 2556	\$ 1.75	301 DIP	3/\$1.00	
74S01	.40	932	.09			XR 2567	1.95	301 TO-5	301 TO-5	
74S04	.55	937	.09					709 DIP	709 DIP	
74S05	.60			DIODES		2N2222A	TO-18 5/\$1.00	741 DIP	741 M.DIP	
74S09	.55			IN 4002	1A, 100 PIV	12/\$1.00	2N3415	TO-92 5/\$1.00	741 TO-5	747 DIP
74S10	.40	7447	\$.95	IN 4003	1A, 200 PIV	11/\$1.00	2N3704	TO-92 5/\$1.00	747 TO-5	748 TO-5
74S15	.50	7448	.95	IN 4007	1A, 1000 PIV	10/\$1.00	2N4249	TO-92 5/\$1.00		
74S20	.50	75491	.65	RECTIFIER	2.5A, 1000 PIV	4/\$1.00	2N4400	TO-92 5/\$1.00		
74S22	.45	75492	.65	RECTIFIER	3A, 1000 PIV	3/\$1.00	2N4437	TO-92 5/\$1.00		
74S40	.45			IN 5400	3A, 50 PIV	5/\$1.00	2N5069	TO-92 5/\$1.00		
74S50	.45			IN 914	SIL SIGNAL	20/\$1.00				
74S51	.55			IN 4148	SIL SIGNAL	20/\$1.00				
74S60	.85			DIAC	2BV	4/\$1.00				
74S64	.55			PLUG TRANSFORMERS						
74S73	1.25			LM 309H TO 5	\$.95	ROCKER SPDT	6/\$1	DISCRETE LED'S	JUMBO RED	
74S74	.85			LM 309K TO 3	1.25	MINI SLIDE SPDT	5/\$1	12/\$1.00	12/\$1.00	
74S75	1.75	7805	TAB .95	12 VAC at 150 MA	\$ 2.50	REG SLIDE DPDT	6/\$1	50/\$3.95	100/\$7.50	
74S78	1.50	7812	TAB 1.25	12 VAC at 500 MA	3.50	PUSH BUTTON NO 3/\$1				
74S86	.95	7815	TO-3 1.25							
74S107	.95	7815	TAB 1.25							
74S112	.95	7815	TO-5 .75							
74S113	1.40	7824	TO-3 1.25							
74S114	.95	723	DIP .75							
74S121	.95	723	TO-5 .75							
74S133	.75									
74S134	.75									
74S138	1.75									
74S139	1.50									
74S151	1.95	MM 5312	\$ 4.95							
74S153	1.95	MM 5314	3.95							
74S155	1.95	MM 5375 AB	3.95							
74S156	1.95	CT 7001	7.95							
74S157	1.80	CT 7002	13.95							
74S158	2.50	50380	3.95							
74S174	2.50	MM 5369	2.50							
74S175	2.50									
74S181	2.95									
74S182	1.95									
74S251	2.75	3.579545 MHZ	\$ 1.95							

BUY 100 OR MORE IC'S [Any Mix] TAKE 10% DISCOUNT.

Fairchild Super Digit FND-359

4" Char. Ht. 7 segment LED. RED. Com. Cath. Direct pin replacement for popular FND-70.

95¢ ea. 10/\$8.50 100/\$79.00

SEE THE WORKS Clock Kit Clear Plexiglas Stand

- 6 Big 4" digits
- 12 or 24 hr time
- 3 set switches (back)
- Plug transformer
- all parts included

Plexiglas is Pre-cut & drilled. Size 6"H, 4 1/4"W, 3"D

A SUPER LOOKING CLOCK!
Kit #850-4 CP **\$2350 ea. 2/45.**

25 AMP BRIDGE \$1.95 ea. 3/\$5.00 100 PIV

25K 6/\$1.00
4.7K 6/\$1.00

TELEPHONE FORMAT KEYBOARD BY Chomerics

2-1/4"x3" 5/32" thick **\$4.95 6/28.**

7-SEG LED COMMON CATHODE

COLOR	HT. DEC PT.	PR. EA.
FND-359 RED	.4" RHDP	\$.95
FND-503 RED	.5" RHDP	\$1.35
DL 750 RED	.6" LHDP	\$2.95
XAN-654 GREEN	.6" NDP	\$2.95
XAN-664 RED	.6" NDP	\$2.95

COMMON ANODE

DL-747 RED	.6" LHDP	\$2.95
XAN-72 RED	.3" LHDP	\$1.25
XAN-81 YELLOW	.3" RHDP	\$1.75
XAN-351 GREEN	.3" RHDP	\$1.50
XAN-361 RED	.3" RHDP	\$1.50
XAN-362 RED	.3" LHDP	\$1.50
XAN-662 RED	.6" NDP	\$2.50
XAN-692 RED	.6" NDP	\$2.50

Form Inexpensive Sockets 100 for \$1.25 Reel of 1000 - \$8.50

OPTOELECTRONICS, inc.

BOX 219 • HOLLYWOOD, FLA. 33022 • (305) 921-2056



ORDER BY PHONE OR MAIL
COD ORDERS WELCOME
\$1.00 CHG.
Orders Under \$15 Add \$1.00 Handling
Fla. Res. Please Add 4% Sales Tax.

WE PAY ALL SHIPPING IN CONTINENTAL USA - OTHERS ADD 5% [10% FOR AIRMAIL]

Olson®

Parts and Accessories
SPECIALIZING IN ELECTRONICS FOR 35 YEARS



Under-Dash LOCK MOUNT

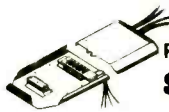

Reg. \$3
1.99

Locks player in place. Slides in & out 6 x 13/16 x 7". 6 or 12 VDC. Shipping weight 2 lbs.

CB Monitor Converter

Reg. \$17
11.99

• Covers Channels 1 thru 23
Converts AM auto radio to CB monitor. 12 VDC neg. grd. Styles may vary. Shpg. wt. 2 lbs.



8-TRACK 40-Minute Recording Tape TA-907

Reg. 69¢
39¢

Blank tapes. Erased, not used. Shpg. Ea. wt. 1/2 lb.

Three 60-Minute Blank Cassettes TA-879

Reg. 1.49
99¢

180 minutes of recording time. Shpg. wt. 1/2 lb.

PARTS & COMPONENTS

- 1/4 RPM Timing Motor, 117 V. AC
- 1 RPM Timing Motor, 117 V. AC
- 8 RPM Reversible Motor, 117 V. AC
- Tubular Capacitor Kit, 100 Pcs.
- Ceramic Capacitor Kit, 100 Pcs.
- 100 Ceramic Capacitors, values clearly marked
- 50 Asst. Electrolytic Capacitors, Axial/Radial
- 100 Asst. Carbon Resistors, 1/4-1/2 Watt Sizes
- 5 Asst. SCR's, 15 V. and Up, 100 MA to 1.6 AMP
- 500 MW Zener Diodes, 4.3-6.3-9.1-12 & 15 Volts
- 3 Unijunction Transistors, 40 V. 375 MW. 4 ON/S
- L.E.O. Pkg. of 5 Red, 2 Volt - 5 MA
- Ultra-Mini L.E.O. Pkg. of 5 Red, 2 V. 5 MA
- TI Calculator Key Board, 20 Keys
- 3 1/2 Digit Liquid Crystal Display
- Oarlington Amp. Transistor Kit, 6 Transistors
- Photo Transistor, 5 Pieces - Epoxy Type
- 6 Amp. Full Wave Bridge Rectifier 50 PIV
- 6 Amp. Full Wave Bridge Rectifier 400 PIV
- PNP Transistor Assortment Pkg. of 10
- NPN Transistor Assortment Pkg. of 10
- 7-Segment L.E.O. Display .3 In. Green
- 7-Segment L.E.O. Display .3 In. Red
- 7-Segment L.E.O. Display .3 In. Yellow
- Micro Type Switch Kit, 7 Assorted
- Knob Kit, 25 Pcs. Assorted
- Hobby Motor Kit, 3-6 V. DC, Pkg. 5

REG.	SALE
MO-277	.49 .30
MO-289	.49 .30
MO-393	2.50 .99
CC-229	2.00 1.29
CC-211	1.49 1.19
CC-210	1.29 .80
CO-407	5.00 2.00
RR-077	1.79 1.00
TR-298	1.79 1.00
01-052	1.00 .50
TR-441	1.29 .50
PL-233	1.19 .60
PL-289	1.29 .70
XM-523	5.00 1.60
XM-371	10.00 3.00
TR-507	2.00 1.50
TR-502	1.00 .60
DI-057	1.20 .80
01-058	1.90 1.00
TR-445	1.00 .60
TR-446	1.00 .60
XM-341	2.69 1.00
XM-370	2.00 1.00
XM-342	2.49 1.00
SW-430	1.89 1.49
KN-030	1.00 .69
MO-333	.59 .49

TOOLS - SPECIAL AND PRACTICAL

- Wire Wrap Tool, 30 Ga Wire on .025 Post
- IC Insertion/Extraction Tool
- IC Plug-in Test Adapter
- 12 Volt DC Soldering Iron, Pencil Tip
- Tuner/Contact Cleaner, 6 Oz. Can
- Dymo Label Maker, Uses 1/2 In. Tape
- Double Face Foam Tape 1/4 x 52 In.

TL-845	2.60	2.00
TL-846	1.25	1.00
TE-396	2.60	2.00
TL-793	4.00	3.00
TL-459	1.49	.80
TL-752	1.89	.90
TA-903	1.00	.80

OLSON ELECTRONICS, 250 S. FORGE ST.
DEPT IS AKRON, OHIO 44327

FREE CATALOG

NAME _____
ADDRESS _____
CITY _____ STATE _____ ZIP _____

SEND OLSON CATALOG FREE PA CATALOG
 SHIP THE FOLLOWING

HOW MANY	STOCK NUMBER	DESCRIPTION	PRICE EACH	TOTAL

ENCLOSE POSTAGE AND SALES TAX

World's Lowest IC Prices

* SPECIAL PRICES *

MEMORIES	74152	90	HIGH SPEED	4007	16	
Rams	74155	60	74H00	20	4008	70
2102	74157	60	74H01	20	4011	16
	74160	75	74H04	20	4012	16
Proms	74161	75	74H04	20	4013	30
82S23 S123	74162	75	74H10	20	4015	80
	74163	75	74H11	20	4016	35
TTL	74165	80	74H51	20	4019	70
7400	74173	1.25	74H52	20	4020	90
7402	74174	75	74H74	40	4021	95
7403	74175	75	74H103	50	4022	16
7404	74177	70	74H106	50	4024	75
7407	74180	80			4025	20
7410	74181	1.50	LOW POWER		4027	40
7420	74190	85	SCHOTTKY		4028	60
7427	74191	85	74LS00	29	4030	35
7432	74192	70	74LS02	29	4040	95
7437	74192	70	74LS08	29	4042	60
7438	74194	85	74LS10	29	4043	75
7440	74198	1.25	74LS27	30	4044	70
7441	9602	50	74LS73	35	4049	35
7444	9300	75	74LS75	65	4050	35
7445	9312	70	74LS151	1.10	4066	65
7447			74LS157	1.10	4068	16
7450	SCHOTTKY		74LS161	1.50	4071	16
7451	74S01	25	74LS163	1.50	4073	16
7473	74S02	25	74LS164	1.50	4075	16
7474	74S37	40	74LS174	1.10	4516	85
7475	74S38	60	74LS175	1.50	4528	75
7480	74S85	2.00	74LS193	1.50	4585	85
7483	74S113	80	74LS197	1.50		
7493	74S138	1.50	74LS221	1.50	LINEARS	
7495	74S140	50	74LS251	1.50	NE536T	2.75
74107	74S153	2.50	74LS253	1.50	NE555V	43
74109	74S172	4.50	74LS257	1.50	NE556A	90
74116	74S174	2.05	74LS258	1.50	1456V	75
74123	74S175	2.05	CMOS		1458V	52
74141	4001	16	4001	16	566V	1.25
74145	4002	16	4002	16	567V	1.35
74150	4006	90	4006	90	540L	2.00
74151						

Order: Minimum \$10.00. Add \$1.00 shipping and handling charge per order. California residents add 6% sales tax. All orders shipped First Class within 24 hours.

Order the famous IASIS 6 volume Programmed Learning Course "Microcomputer Design is a Snap" for \$99.50 and receive a special \$10.00 credit on any group of IC's.

Satisfaction 100% guaranteed.

C.O.D. Orders Phone (day or night) 408 354-1448

ELTRON

APO BOX 2542
Sunnyvale, CA 94087

Free monthly catalog—Just send us your name and address

CIRCLE NO. 29 ON FREE INFORMATION CARD

For faster service
USE ZIP CODE
on all mail

ABOUT YOUR SUBSCRIPTION

Your subscription to POPULAR ELECTRONICS is maintained on one of the world's most modern, efficient computer systems, and if you're like 99% of our subscribers, you'll never have any reason to complain about your subscription service.

We have found that when complaints do arise, the majority of them occur because people have written their names or addresses differently at different times. For example, if your subscription were listed under "William Jones, Cedar Lane, Middletown, Arizona," and you were to renew it as "Bill Jones, Cedar Lane, Middletown, Arizona," our computer would think that two separate subscriptions were involved, and it would start sending you two copies of POPULAR ELECTRONICS each month. Other examples of combinations of names that would confuse the computer would include: John Henry Smith and Henry Smith; and Mrs. Joseph Jones and Mary Jones. Minor differences in addresses can also lead to difficulties. For example, to the computer, 100 Second St. is not the same as 100 2nd St.

So, please, when you write us about your subscription, be sure to enclose the mailing label from the cover of the magazine—or else copy your name and address exactly as they appear on the mailing label. This will greatly reduce any chance of error, and we will be able to service your request much more quickly.

S. D. SALES CO.

P. O. BOX 28810 □
DALLAS, TEXAS 75228

4K LOW POWER RAM BOARD KIT THE WHOLE WORKS \$89.95

Imsai and Altair 8080 plug in compatible. Uses low power static 21L02-1 500 ns. RAM's, which are included. Fully buffered, drastically reduced power consumption, on board regulated, all sockets and parts included. Premium quality plated thru PC Board.

Stick It!

IN YOUR CLOCK!
IN YOUR DVM, etc.

HUGE SPECIAL PURCHASE!
NOT FACTORY SECONDS
AS SOLD BY OTHERS

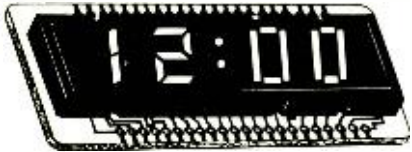

4 JUMBO .50 INCH DIGITS
ON ONE "STICK"!
(with colons and AM/PM Indicator)

\$3.95

BUY 3 FOR \$10.00

BOWMAR

4 DIGIT LED READOUT ARRAY

The Bowmar Opto-Stick. The best readout bargain we have ever offered. Has four common cathode jumbo digits with all segments and cathodes brought out. Increased versatility since any of the digits may be used independently to fit your applications. Perfect for any clock chip, especially direct drive units like 50380 or 7010. Also use in freq. counters, DVM's, etc. For 12 or 24 hour format.

MICROPROCESSORS AND THINGS

8080A	By AMD. Outperforms INTEL	\$24.00
8008-1	High Speed 8008	6.95
8212	I/O PORT	3.50
8224	Clock Generator	4.95
8820	Dual Line RCVR	1.75
8830	Dual Line Driver	1.75
8838	Quad Bus Transceiver	2.00
MC1488	RS232 to TTL	1.50
MC1489	TTL to RS232	1.50
2513	Character Gen.	10.00
MM5204	4K E Prom	12.00

*LOW COST
HIGH VALUE*

TTL INTEGRATED CIRCUITS

7400 - 19c	7430 - 19c	7476 - 35c	74153 - 75c
7402 - 19c	7432 - 34c	7480 - 49c	74154 - 1.00
74L04 - 29c	7437 - 39c	7483 - 95c	74157 - 75c
74504 - 44c	7438 - 39c	7485 - 95c	74161 - 95c
7404 - 19c	7440 - 19c	7586 - 45c	74161 - 1.10
7406 - 29c	7447 - 85c	7490 - 65c	74164 - 1.10
7408 - 19c	7448 - 85c	7492 - 75c	74174 - 95c
7410 - 19c	7451 - 19c	7495 - 75c	74181 - 2.50
7411 - 29c	7453 - 19c	7496 - 89c	74191 - 1.25
7413 - 50c	7473 - 39c	74121 - 38c	74192 - 1.25
7420 - 19c	7474 - 35c	74123 - 65c	74193 - 1.00
	7575 - 35c	74141 - 75c	74195 - 69c

2/\$10. 60HZ CRYSTAL TIME BASE FOR DIGITAL CLOCKS S.D. SALES EXCLUSIVE! **\$5.95**

KIT FEATURES:

- 60hz output with accuracy comparable to a digital watch
- Directly interfaces with all MOS Clock Chips
- Super low power consumption (1.5 Ma typ.)
- Uses latest MOS 17 stage divider IC
- Eliminates forever the problem of AC line glitches
- Perfect for cars, boats, campers, or even for portable clocks at ham field days.
- Small size, can be used in existing enclosures.

**KIT INCLUDES CRYSTAL, DIVIDER IC, PC BOARD
PLUS ALL OTHER NECESSARY PARTS & SPECS.**

JUMBO LED CAR CLOCK

**\$16.95
KIT**

You requested it! Our first DC operated clock kit. Professionally engineered from scratch to be a DC operated clock. Not a makeshift kluge as sold by others. Features: Bowmar 4 digit .5 inch LED array, Mostek 50252 super clock chip, on board precision time base, 12 or 24 hour real time format, perfect for cars, boats, vans, etc. Kit contains PC Board and all other parts needed (except case). 50,000 satisfied clock kit customers cannot be wrong!

FOR ALARM OPTION ADD \$1.50
FOR XFMR FOR AC OPERATION ADD \$1.50

50 HZ CRYSTAL TIME BASE KIT - \$6.95

All the features of our 60HZ kit but has 50HZ output. For use with clock chips like the 50252 that require 50HZ to give 24 hour time format.

UP YOUR COMPUTER!

21L02-1 1K LOW POWER 500 NS STATIC RAM TIME IS OF THE ESSENCE

And so is power. Not only are our RAM's faster than a speeding bullet but they are now very low power. We are pleased to offer prime new 21L02 - 1 low power and super fast RAM's. Allows you to STRETCH your power supply farther and at the same time keep the wait light off. **8 for \$12.95**

1000 MFD FILTER CAPS

Rated 35 WVDC. Upright style with PC leads. Most popular value for hobbyists. Compare at up to \$1.19 each from franchise type electronic parts stores.



S.D. Special
4 for \$1.00

WESTERN DIGITAL UART No. TR1602B. 40 pin DIP

This is a very powerful and popular part.
**NEW-\$6.95 with data
LIMITED QUANTITY**

C&K MINI TOGGLE SWITCH No. 7103 SUB MINI SPDT Center OFF.

SPECIAL - 99c

SLIDE SWITCH ASSORTMENT

Our best seller. Includes miniature and standard sizes, single and multi-position units. All new, first quality, name brand. Try one package and you'll reorder more. **SPECIAL 12/\$1.**



MOTOROLA POWER DARLINGTON

Back in Stock!
Like MJ3001, NPN 80V, 10A. HFE 6000 TYP. TO-3 case. We include a free 723 C volt reg. with schematic for power supply. **SPECIAL - \$1.99**

RESISTOR ASSORTMENT

1/4 W 5% and 10%. PC leads. A good mix of values. **200/\$2.**



74S200

256 Bit High Speed RAM
Same as 82S16
\$3.95

1K PROM BACK IN STOCK!

82S129. 256x4. Bipolar, 50NS.
FAST. WITH SPECS.
\$3.95

FAIRCHILD BIG LED READOUTS

A big .50 inch easy to read character. Now available in either common anode or common cathode. Take your pick. Super low current drain, only 5MA per segment typical. FND-510 Common Anode FND-503 Common Cathode **PRICE SLASHED! 59c each**

TERMS:

Money Back Guarantee. No COD. Texas Residents add 5% tax. Add 5% of order for postage and handling. Orders under \$10. add 75c. Foreign orders: US Funds ONLY!

SALE ON CUT LEAD SEMICONDUCTORS

Leads were cut for PCB insertion. Still very useable. All new, unused. Some House no.

1N914/1N4148	100/\$2.
1N4002 1 Amp 100 PIV	40/\$1.
1N4745A 16V 1W Zener	20/\$1.
EN2222 NPN Transistor	25/\$1.
2N3392 GE Pre-amp Xstr	25/\$1.
C103Y SCR. 800MA 60V	10/\$1.

**CALL YOUR BANK
AMERICARD OR MASTER
CHARGE ORDER IN ON
OUR CONTINENTAL
UNITED STATES TOLL
FREE WATTS:**

1-800-527-3460
Texas Residents Call Collect
214/271-0022

S.D. SALES CO.
P. O. BOX 28810 - □
Dallas, Texas 75228

SPEAKER Enclosure Plans—Modern Design, Build Yourself. For Info Send Stamp. Eidson, Box 5046, Torrance, Calif. 90503.

ETCH IT YOURSELF PRINTED CIRCUIT KIT. Photo-Positive Method — All the supplies for four P.C. Boards, Direct from magazine article in less than 2 hours. Only \$19.95. S.A.S.E. for details. Excel Circuits, 4412 Fernlee, Royal Oak, Michigan 48073.

AMAZING ELECTRONIC PRODUCTS

LASERS SUPER POWERED, RIFLE, PISTOL, POCKET — SEE IN DARK PYRO-TECHNICAL, DE-BUGGING, UNCRAMBLERS, GIANT TESLA, STUNWAND, TV DISRUPTER, ENERGY PRODUCING, SCIENTIFIC DETECTION, ELECTRIFYING, CHEMICAL, ULTRASONIC, CB, AERO, AUTO AND MOTO DEVICES, HUNDREDS MORE! ALL NEW PLUS INFO UNLTD PARTS SERVICE

INFORMATION unlimited
Box 268 Lord Jeffrey PZ • Amherst, N.H. 03031

CATALOG \$1

FREE KIT Catalog contains Test and Experimenter's Equipment. Dage Scientific Instruments, Box 1054P, Livermore, CA 94550.

SCIENCE supplies and kits, write for free catalog. Schubel & Son, Box 21484-F, Sacramento, CA 95821.

TAPE AND RECORDERS

RENT 4-Track open reel tapes—free brochure. Stereo-Parti, P.O. Box 7, Fulton, CA 95401.

1930-1962 Radio Programs. Reels, \$1.00 Hour! Cassettes, \$1.00 Show!... Mammoth Catalog, \$1.25. AM Treasures, Box 192PE, Babylon, N.Y. 11702.

RECORDS—TAPES! Discounts to 73%, all labels; no purchase obligations; newsletter; discount dividend certificates; 100% guarantees. Free details. Discount Music Club, 650 Main St., Dept 5-1276, New Rochelle, New York, N.Y. 10801.

GOVERNMENT SURPLUS

MANUALS for Govt Surplus radios, test sets, scopes. List 50 cents (coin). Books, 7218 Roanne Drive, Washington, D.C. 20021.

GOVERNMENT SURPLUS. Buy in your area. How, Where. Send \$2.00. Surplus, 30177-PE Headquarters Building, Washington, D.C. 20014.

HIGH FIDELITY

DIAMOND NEEDLES and Stereo Cartridges at Discount prices for Shure, Pickering, Stanton, Empire, Grado and ADC. Send for free catalog. LYLE CARTRIDGES, Dept. P, Box 69, Kensington Station, Brooklyn, New York 11218.

SAVE 50% build your own speaker system write: McGee Radio Electronics, 1901 McGee Street, Kansas City, Missouri 64108.

WANTED

GOLD, Silver, Platinum, Mercury wanted. Highest prices paid by refinery. Ores assayed. Free circular. Mercury Terminal, Norwood, MA 02062.

TUBES

RADIO & T.V. Tubes—36 cents each. Send for free Catalog. Cornell, 4213 University, San Diego, Calif. 92105.

TUBES receiving, factory boxed, low prices, free price list. Transleronics, Inc., 1365 39th Street, Brooklyn, N.Y. 11218A, Telephone: 212-633-2800.

TUBES: "Oldies", Latest. Supplies, components, schematics. Catalog Free (stamp appreciated) Steinmetz, 7519-PE Maplewood, Hammond, Ind. 46324.

REAL ESTATE

BIG... NEW... FREE... SPRING 1977 CATALOG! Over 2,600 top values coast to coast! UNITED FARM AGENCY, 612-EP, West 47th, Kansas City, MO 64112.

RECORDS

RECORD RATERS WANTED! Anyone qualifies. We ship you nationally released LP's to rate. We pay postage and handling. You pay nothing for LP's. All you pay is small membership fee. Applicants accepted "first come basis." Write: E.A.R.S., Inc., Dept PE, Box 10245, 5521 W Center Street, Milwaukee, Wisconsin 53210.

FREE... Fascinating NEW XENON FLASH TUBE Catalog...

OVER 100 ELEVAM XENON FLASH TUBES ILLUSTRATED

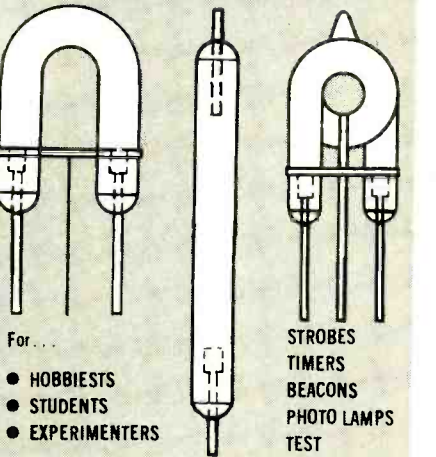

For...
 ● HOBBISTS
 ● STUDENTS
 ● EXPERIMENTERS

STROBES
 TIMERS
 BEACONS
 PHOTO LAMPS
 TEST SYSTEMS
 ... and more.

UNSURPASSED QUALITY AND PRICES

CALL OR WRITE FOR YOUR FREE ELEVAM CATALOG

TEC/WEST (U.S.A.) INC.
 Kirkeby Center-Suite 1220 10889 Wilshire Blvd.
 Los Angeles, CA 90024 (213) 477-9529

DECEMBER SPECIALS

CMOS	MICROPROCESSOR COMPONENTS	TTL	LINEAR
4001 \$.19	1101 256 BIT STATIC RAM 1.29	7402 \$.12	301 mDIP \$.22
4002 .20	1103 1024 BIT DYNAMIC RAM .95	7410 .12	733 TO-5 .79
4009 .39	2102 1024 BIT STATIC RAM 1.49	7430 .17	739 DIP .79
4081 .39	5261 1024 BIT DYNAMIC RAM .95	7438 .19	741 mDIP .25
74C00 .14	F93410 256 BIT BI-POLAR RAM 1.39	7490 .39	1458 mDIP .49
74C73 .69	1702A 2048 BIT POLAR 9.95	74193 .72	75150 DIP .99

8 Digit Clock Kit
 MM5318 with 4 MS17 27" displays 2 P.C. boards... \$14.95

4 Digit Clock Kit
 MM5318 and 4 MS17 27" displays 12-24 hours... \$10.95

Transformers
 117VAC - 12V 300 ma wall mount \$3.95
 117 VAC - 12V 300 ma wall mount \$4.95

Temperature Transmitter Kit
 Portable, self-contained, solid state... \$34.95

AUTO CLOCK KIT
 4 digit 75" red led's... \$33.95

Electronic Games
 A great idea for the coast own family entertainment center... \$23.95

Electronic Roulette
 Dimensions 6 1/2" x 3 1/2" x 1 1/2" \$23.95

Electronic Craps
 Dimensions 6 1/2" x 3 1/2" x 1 1/2" \$14.95

UNIVERSAL BREADBOARD
 Silver plated copper circuit board... \$1.80 ea.

CMOS

4000A	.26	4018A	1.39	4066A	.89
4001A	.25	4020A	1.72	4068A	.84
4002A	.25	4021A	1.18	4069A	.44
4006A	1.35	4022A	.94	4071A	.26
4007A	.26	4023A	.25	4072A	.35
4008A	1.52	4024A	.89	4073A	.39
4009A	.57	4025A	.25	4075A	.39
4010A	.54	4027A	.59	4078A	.39
4011A	.29	4028A	.98	4082A	.35
4012A	.25	4030A	.84	4518A	1.56
4013A	.45	4015A	1.27	4528A	1.56
4014A	1.27	4040A	1.39	4585A	2.10
4015A	1.27	4042A	1.47		
4016A	.48	4049A	.59		
4017A	1.01	4050A	.59		

IC BREADBOARD
 Accommodates 5 16 pin IC's with additional interconnection holes... \$1.80 ea.

CALCULATOR CHIPS

CT5002	1.95	CLOCK CHIPS	
CT5005	4.45	MM5311	4.45
MM5215	2.49	MM5312	4.45
MM5236	1.95	MM5314	4.45
MM5274	.95	MM5316	4.95
MM5279	.95	5375AA	4.95
		CT7001	5.95

DISPLAYS

MAN1	\$1.45	DISCRETELED'S	
MAN2	3.95	ME4	\$.29
MAN3A	.19	MV50	.12
MAN5	2.25	NSL100	.12
MAN6	2.49	NSL101	.12
MAN7	1.49	NSL102	.15
MAN8	2.25	MV4020	
MAN9a	2.25	RED	.15
DL10A	2.19	GREEN	.15
FND501	1.89	AMBER	.15
MS711	1.39	CLEAR	.15

FREE CATALOG AVAILABLE ON REQUEST

Satisfaction guaranteed. Shipment will be made postage prepaid within 3 days from receipt of order. Payment may be made with personal check, charge card (include number and exp. date), or money order. Phone Orders — BoiA and M/C card or C.O.D.

Add \$1.00 to cover shipping and handling if order is less than \$10.00. California residents add sales tax. Include shipping expense for orders shipped out of U.S. and Canada approx. 10% of order.

INTERNATIONAL ELECTRONICS UNLIMITED
 P.O. BOX 3036-R MONTEREY, CA. 93940 USA
 PHONE (408) 659-3171

10% OFF WITH \$25 ORDER
 15% OFF WITH \$100 ORDER

THESE DISCOUNTS APPLY TO TOTAL OF ORDER — SPECIALS INCLUDED

POCKET CALCULATOR KIT
 5 function plus constant — addressable memory with individual recall — 8 digit display plus overflow — battery saver — uses standard 0.9" rechargeable battery — all necessary parts in ready to assemble form — instructions included

Calc. Kit. Kit only \$9.95
 Batteries (alkaline, disp.) 2.00
 Adapter 3.95

TANTALUM CAPACITOR KIT \$19.95
 48 solid dipped tantalum capacitors — 50% voltage capacitors in a durable styrene carry box — with color code charts

1 each	1 ufd 35V	33 ufd 35V	1 ufd 35V	2.2 ufd 35V
47 ufd 10V	4.7 ufd 10V	47 ufd 15V	15 ufd 20V	10 ufd 25V
22 ufd 20V	33 ufd 20V	10 ufd 25V	10 ufd 30V	10 ufd 35V

TTL

7400	.13	7451	.17	74153	.89
7401	.16	7453	.17	74154	1.20
7402	.15	7454	.17	74155	.97
7403	.15	7460	.35	74156	.97
7404	.16	7464	.35	74157	.99
7405	.19	7465	.30	74158	1.79
7406	.20	7470	.30	74160	1.23
7407	.28	7472	.30	74161	.97
7408	.18	7473	.35	74162	1.39
7409	.19	7474	.28	74163	1.09
7410	.16	7475	.49	74164	.99
7411	.25	7476	.30	74165	.99
7413	.43	7483	.68	74166	1.25
7414	.65	7485	.98	74170	2.10
7416	.35	7486	.40	74171	1.49
7417	.35	7489	2.25	74172	1.33
7420	.16	7490	.43	74173	1.23
7422	.30	7491	.75	74176	.89
7423	.29	7492	.48	74177	.84
7425	.27	7493	.48	74180	.90
7426	.26	7494	.78	74181	2.45
7427	.29	7495	.79	74182	.79
7430	.20	7496	.79	74184	1.90
7432	.23	74100	.98	74185	2.20
7437	.25	74105	.44	74187	5.75
7438	.25	74107	.37	74190	1.15
7440	.15	74121	.38	74191	1.25
7441	.89	74122	.38	74192	.95
7442	.59	74123	.65	74193	.85
7443	.73	74125	.54	74194	1.25
7444	.73	74126	.74	74195	.74
7445	.73	74132	.89	74196	1.25
7446	.81	74141	1.04	74197	.73
7447	.79	74145	1.04	74198	1.73
7448	.79	74150	.97	74199	1.69
7450	.17	74151	.79	74200	5.45

IC SOCKETS

Solder Tail - low profile

8 pin	\$.17	24 pin	.42
14 pin	.20	28 pin	.59
16 pin	.22	40 pin	.69
18 pin	.29		

with WRAP - gold plate

14 pin	.49
--------	-----

LINEAR

301	.29	124	1.52	560	3.39
302	.53	139	1.58	562	3.39
304	.80	140A	1.69	565	1.39
305	.71	170	1.20	567	1.95
307	.26	372	2.93	568	1.95
308	.89	373	2.42	709	.26
309A	1.35	176	1.68	710	.35
110	1.07	480	1.46	711	.26
111	.93	480-B	1.25	739	1.07
119	1.19	381	1.75	741	.32
1201	1.39	382	1.75	742	.71
120A	1.39	540	2.95	75491	.71
122	1.70	556A	1.19	75492	.80

OPTO ISOLATORS

MCD2	Opto isolator diode	1.09
MCT2	Opto isolator transistor	.70

FREE CATALOG AVAILABLE ON REQUEST INCLUDES RESISTORS ±1% & ±5%, TANTALUM CAPACITORS, POWER SUPPLY KITS, CLOCK KITS, TOOLS, RESISTOR & CAPACITOR KITS & MISCELLANEOUS DEVICES

Data included with order on request. Add \$.30 ea. if item is priced below \$1.00.

FAIRCHILD

ANNOUNCES THE

FAIRCHILD

SOLID STATE TECHNOLOGY KIT

- FOR THE EXPERIMENTER WITH TASTE FOR "STATE OF THE ART" PRODUCTS
- COMPLETE SPECIFICATIONS ARE PRINTED ON THE BACK OF EACH TECHNOLOGY KIT

FTK0020

FTK0020

FTK0106

PN FTK0020
SOLID STATE
**TECHNOLOGY
KIT**



TEN RED LED LAMPS

TECHNOLOGY BY
FAIRCHILD

The FTK0020 is a red light emitting diode (LED) array kit. The kit consists of ten red LEDs mounted on a common cathode substrate. The LEDs are arranged in a circular pattern and are designed to be used in a variety of applications. The kit includes ten red LEDs, ten mounting clips, and ten mounting adapters. The LEDs are rated for a maximum current of 10 mA and a maximum forward voltage of 1.8 V. The kit is designed to be used in a variety of applications, including indicator lights, displays, and clocks.

FEATURES:

- SOLID STATE - NO REPLACEMENT REQUIRED
- NO SOCKET REQUIRED
- HIGH ON/OFF CONTRAST
- EASY TO INSTALL - NO SOLDERING REQUIRED
- LOW POWER CONSUMPTION MEANS ECONOMY

ABSOLUTE MAXIMUM RATINGS

Maximum Temperature and Humidity	125°C
Storage Temperature	55°C to 150°C
Operating Temperature	55°C
Maximum Power Dissipation	100 mW
Forward Current (I _F)	10 mA
Reverse Current (I _R)	1.0 μA
Forward Voltage (V _F)	1.8 V
Reverse Voltage (V _R)	5 V

PIN CONNECTIONS

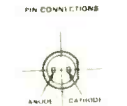

TYPICAL APPLICATION

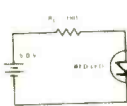

SOLID STATE
TECHNOLOGY KIT
automobile clock

TELEPHONE NO.
FAIRCHILD



CARD FRONT

CARD BACK

CARD FRONT

DIGITS			PHOTO ARRAYS		
FTK0001	0.5" High Common Cathode Digit	\$1.00	FTK0040	9-Element Tape Reader Array	16.00
FTK0002	0.5" High Common Anode Digit	1.00	FTK0041	12-Element Card Reader Array	24.00
FTK0003	.357" High Common Cathode Digit	.75	FTK0042	Reflective Opto Coupler	4.00
FTK0004	0.8" High Common Cathode Digit	2.00	COUPLERS		
FTK0005	0.8" High Common Anode Digit	2.00	FTK0050	3 General Purpose Opto Couplers	1.00
0.8" HIGH DISPLAY ARRAYS			FTK0051	Darlington Opto Coupler	1.00
FTK0010	12 Hour, 3½ Digit Clock Display	7.00	MOS CLOCK CIRCUITS		
FTK0011	24 Hour, 4 Digit Clock Display	8.00	FTK0400	Digital Clock/Calendar Circuit (FCM7001)	7.00
LED LAMPS			FTK0401	Digital Clock/Calendar with BCD Outputs (FCM7002)	7.00
FTK0020	10 Red LED Lamps	1.00	FTK0402	Direct Drive Digital Clock Circuit with AC Output (FCM3817A)	5.00
FTK0021	5 Mixed Colored LED Lamps	1.00	FTK0403	Direct Drive Digital Clock Circuit with DC Output (FCM3817D)	5.00
FTK0022	10 LED Mounting Clips	1.00	FTK0405	Direct Drive Digital Clock/Calendar Circuit (FCM7015)	6.00
FTK0023	5 Three Piece LED Mounting Adapters	1.00	KITS		
PHOTO TRANSISTORS			FTK0106	Automobile Clock Kit	40.00
FTK0030	5 Flat Lens Photo Transistors	1.00			
FTK0031	5 Round Lens Photo Transistors	1.00			
FTK0032	3 Flat Lens Photo Darlington	1.00			
FTK0033	3 Round Lens Photo Darlington	1.00			

- THESE PRODUCTS ARE PACKAGED FOR OUTSTANDING WALL DISPLAY APPEARANCE

• FULL **FAIRCHILD** PRODUCT LINE TO FOLLOW

Satisfaction Guaranteed. \$5.00 Min. Order. U.S. Funds.
California Residents — Add 6% Sales Tax
Send a 24¢ Stamp (postage) for a Free 1977 Catalog

NOW OPEN SATURDAYS

JAMES

1021-A HOWARD AVE., SAN CARLOS, CA. 94070
PHONE ORDERS WELCOME — (415) 592-8097

- DEALER'S AND WHOLE-SALER'S INQUIRIES INVITED — PRICE LIST AVAILABLE.
- BUY WITH PRIDE THE PRODUCTS BUILT BY THE INDUSTRY'S LEADER — **FAIRCHILD**

U.S. GOV'T ELECTRONIC SURPLUS

• Nationally Known - World Famous SURPLUS CENTER offers finest, most expensive, Government Surplus electronic units and components at a fraction of their original acquisition cost.



300-AMP., 200-VOLT RECTIFIER

• (ITEM #22-1048) - FOUR STAR SPECIAL WEST-INGHOUSE, heavy duty unit. Excellent for use in 12 or 24-volt fast chargers, high current power supply systems, etc. 3-5/8" x 1-3/8". 7/8" stud. (1 lb.)

\$6.95 List Over \$20.00

SNAP-AROUND VOLT-AMMETER



• (ITEM #21-1028) - "MINIPROBE" clamp type AC ammeter-voltmeter. Small enough to carry in shirt pocket. Will measure 0 to 50-ampères, 0 to 250-volts. Furnished with test leads. Overall size 4-1/2" x 2-3/4" x 1". (1 lb.) List \$33.00

\$22.95



STANDARD DIAL TELEPHONE

• (ITEM #715) - Same as used on commercial systems in U.S.A. Use as extension to private system. Connect several together for local intercom system. Instructions furnished.

\$8.79

Original Cost \$24.50 (9 lbs.)

RUNNING TIME METER



• (ITEM #2188) - Record number of operating hours of electric lights, electrical devices such as refrigerators, furnaces, etc. Records total hours, tenths and hundredths to 9,999.99 hours. For 115-volts, 60-cycles. 4 1/4" x 3" x 2 1/2". (2 lbs.)

Cost **\$29.00**
\$4.39

SPECIAL SALE Correspondence Course In ELECTRICAL ENGINEERING



Prepaid in U.S.A. **\$11.79**
Outside U.S.A. **\$12.79**

• (ITEM #9-181) - Technical training at low cost! Lincoln Engineering School suspended Correspondence Course because of rising costs. Limited number of Electrical Engineering Courses are available without exams and grading services. Consists of fifteen lesson books, each with associated exams and standard answers. Book showing how to build prize-winning Home Experimental Laboratory Bench included at no extra cost.



ALL ITEMS SHIPPED F.O.B. LINCOLN, NEBR.
Order Direct From Ad - - Send For FREE Catalog

SURPLUS CENTER

DEPT. PE 126 LINCOLN, NEBR. 68501



DELTA

DELTA ELECTRONICS CO.
P.O. BOX 2, AMESBURY, MASS. 01913



SOLAR POWER FUN

The solar cells are both rated at 430mV. The larger cell is rated at 500 mA, and the smaller cell rated at 130mA. The smaller cell will run the small motor and the larger cell will run the larger motor. And also the larger cell will run the smaller motor.

Large cell STK NO. P1001 **\$8.95**

Small cell STK NO. P5465 **2.50**

Larg mtr STK NO. P5456 **3.95**

Small mtr STK NO. P5457 **2.50**

If you buy the large motor and cell together.....**12.00**

If you buy the small motor and cell together.....**4.50**



LINCOLN CONTINENTAL RADIO

These are rugged solid state sets featuring push button tuning. And a hefty output stage. Built in fader control for front and rear speakers. 100% Guaranteed.

STOCK NO. P5443 **\$16.95** 2/32.00

Send for latest free catalog. Minimum order \$5, phone orders welcome: (617) 388-4705. Include sufficient postage; excess refunded. BankAmericard & Mastercharge welcome, ALL numbers needed for processing. Min. charge \$15.

INSTRUCTION

LEARN ELECTRONIC ORGAN SERVICING at home all makes including transistor. Experimental kit—trouble-shooting. Accredited NHSC. Free Booklet. NILES BRYANT SCHOOL, 3631 Stockton, Dept. A. Sacramento, Calif. 95820.

EARN ELECTRONICS DEGREE by correspondence. Free information bulletin. Grantham, 2000 Stoner Avenue, Los Angeles, California 90025.

F.C.C. EXAM MANUAL

PASS FCC EXAMS! Memorize, study — "Test Answers" for FCC 1st and 2nd class Radio Telephone licenses. Newly revised multiple-choice questions and diagrams cover all areas tested in FCC exams plus "Self-Study Ability Test." \$9.95 postpaid. Moneyback Guarantee.

COMMAND PRODUCTIONS P.O. BOX 26348-P
RADIO ENGINEERING DIVISION SAN FRANCISCO, CALIF. 94126

SCORE high on F.C.C. Exams... Over 300 questions and answers. Covers 3rd, 2nd, 1st and even Radar, Third and Second Test, \$14.50; First Class Test, \$15.00. All tests, \$26.50. R.E.I., Inc., Box 806, Sarasota, Fla. 33577

UNIVERSITY DEGREES BY MAIL! Bachelors, Masters, Ph.D's. Free revealing details. Counseling, Box 317-PE12, Tustin, California 92680.

SELF-STUDY CB RADIO REPAIR COURSE. THERE'S MONEY TO BE MADE REPAIRING CB RADIOS. This easy-to-learn course can prepare you for a career in electronics enabling you to earn as much as \$16.00 an hour in your spare time. For more information write: CB RADIO REPAIR COURSE, Dept. PE126, 531 N. Ann Arbor, Oklahoma City, Okla. 73127.

LEARN WHILE ASLEEP! HYPNOTIZE! Astonishing details, strange catalog free! Autosuggestion, Box 24-ZD, Olympia, Washington 98507.

GRANTHAM'S FCC LICENSE STUDY GUIDE — 377 pages. 1465 questions with answers/discussions — covering third, second, first radiotelephone examinations \$10.70 postpaid. GSE, 2000 Stoner, Los Angeles, California 90025.

INTENSIVE 5 week course for Broadcast Engineers. FCC First Class license. Student rooms at the school. Radio Engineering Inc., 61 N. Pineapple Ave., Sarasota, FL 33577 and 2402 Tidewater Trail, Fredericksburg, VA 22401.

FREE Educational Electronics Catalog Home study courses. Write to: Edukits Workshop, Department 719D, Hewlett, N.Y. 11557.

FCC License. New course material, new low prices. Free home study catalog. Genn Tech, 5540 Hollywood Blvd., Hollywood, CA 90028.

LEARN Computer Programming (BASIC and FORTRAN) with ITI's effective correspondence courses. Also Mathematics, Electronics (including FCC). Free information: Intermountain Technical Institute, Box 258, Jerome, Idaho 83338.

BUSINESS OPPORTUNITIES

I MADE \$40,000.00 Year by Mailorder! Helped others make money! Free Proof. Torrey, Box 318-NN, Ypsilanti, Michigan 48197.

FREE CATALOGS. Repair air conditioning, refrigeration. Tools, supplies, full instructions. Doolin, 2016 Canton, Dallas, Texas 75201.

MAILORDER MILLIONAIRE helps beginners make \$500 weekly. Free report reveals secret plan! Executive (1K12), 333 North Michigan, Chicago 60601.

GET RICH with Secret Law that smashes debts and brings you \$500 to \$5 Million cash. Free report! Credit 4K12, 333 North Michigan, Chicago 60601.

HIGHLY PROFITABLE ONE-MAN ELECTRONIC FACTORY

Investment unnecessary, knowledge not required, sales handled by professionals. Postcard brings facts about this unusual opportunity. Write today! Barta-DL, Box 248, Walnut Creek, CA 94597.

FREE SECRET BOOK "2042 UNIQUE, Proven Enterprises" Fabulous "Little Knowns". Work home! Haylins-B, Carlsbad, Calif. 92008

HOW TO MAKE \$2,000 WEEKLY at home using other people's money. Guaranteed. Free Details. Richlieu, Box 25277, Dept. F12, Houston 77005.

BROADCAST STATION—FM or CABLE: excellent income, free tapes-records. Free details. "Broadcasting," Box 5516-AL, Walnut Creek, CA 94596.

PLANNING TO MOVE?

Let us know 8 weeks in advance so that you won't miss a single issue of POPULAR ELECTRONICS.

Attach old label where indicated and print new address in space provided. Also include your mailing label whenever you write concerning your subscription. It helps us serve you promptly.

Write to: P.O. Box 2772, Boulder, CO 80323, giving the following information:

Change address only Extend my subscription

ENTER NEW SUBSCRIPTION

1 year \$9.98 Payment enclosed
Allow 30-60 days for delivery. (1 extra BONUS issue)
 Bill me later

NEW ADDRESS HERE 0191

Name _____

please print

Address _____

City _____

State _____ Zip _____

Additional postage per year: For Canada add \$3. For countries outside U.S. and Canada, add \$5—cash in U.S. currency only.

—AFFIX OLD LABEL—

If you have no label handy, print OLD address here.

Name _____

please print

Address _____

City _____

State _____ Zip _____

BOOKS AND MAGAZINES

FREE book prophet Elijah coming before Christ. Wonderful bible evidence. Megiddo Mission, Dept. 64, 481 Thurston Rd., Rochester, N.Y. 14619.

POPULAR ELECTRONICS INDEXES For 1975 now available. Prepared in cooperation with the Editors of "P/E." This index contains hundreds of references to product tests, construction projects, circuit tips and theory and is an essential companion to your magazine collection. 1975 Edition, \$1.50 per copy. 1972, 1973 and 1974 editions \$1.50 each, or \$5.50 for the set of four (1972 thru 1975). Add \$.25 per order for postage and handling. INDEX, Box 2228, Falls Church, Va. 22042.

FREE CATALOG Aviation and Space Books. Aero Publishers, 329PE West Aviation, Fallbrook, California 92028.

THE AUDIO AMATEUR—A quarterly publication for the serious audio constructor. Free prospectus. The Audio Amateur, Box 176Z, Peterborough, N.H. 03458.

MICROCOMPUTER Hobbyists - Dictionary of Micro-computer Terminology. Hundreds of definitions. For beginners and experienced. \$2.00. Owen Products, Box 16116, Irvine, CA 92713.

DISCOVER how liberty may soon become the exclusive privilege of an elite few. Revealing 176 page hard-bound book. "American Dilemma—Then and Now". Please send \$5.95 payable to author, William Ingram, Box 758PE, Roswell, GA 30077.

CRIMEFIGHTERS, Debugging, Shoplifting, Lockpicking. Free Information. Quimtronix, Box 548-PE, Seattle, Washington 98111.

"UNUSUAL" BOOKS! 40 for \$5! 5 lb. GraBag \$6. Free Catalog! International, Box 7798PE, Atlanta, GA 30357.

HYPNOTISM

SLEEP learning. Hypnotic method. 92% effective. Details free. ASR Foundation, Box 23429EG, Fort Lauderdale, Florida 33307.

FREE Hypnotism. Self-Hypnosis. Sleep Learning Catalog! Drawer H400, Ruidoso, New Mexico 88345.

AMAZING self-hypnosis record releases fantastic mental power. Instant results! Free trial. Write: Forum (AA12), 333 North Michigan, Chicago 60601.

SOLVE YOUR TEST CONNECTION PROBLEMS WITH EZ-HOOK

E-Z Hooks have been designed and field tested throughout the industry to save time and money in commercial electronic production and servicing. The spring-loaded hook attaches firmly, yet so gently it will not damage component — frees hands while testing. Durably constructed and fully insulated to a single contact point assuring true readings. Meets exacting laboratory and space age computer technology requirements. AVAILABLE IN 10 RETMA COLORS: Red, black, blue, green, orange, yellow, white, violet, brown or gray.

 <p>Specify color. Order No. Length Price 204X12 12" \$1.70 204X24 24" 1.70</p>	<p>EXTRA LONG MINI HOOK ORDER XL-1</p> <p>XL-1 Mini Hook (5.0" long) combines all the proven features of the X100W with an extra long body. It will make safe, short-free test connections in card racks and through deep wiring nest up to 4" — \$1.25 ea.</p>
 <p>Order No. Length Price 204 12W 12" \$1.60 204 24W 24" 1.60</p>	 <p>Specify color. Order No. Length Price 204XL1-12 12" \$2.80 204XL1-24 24" 2.80</p>
 <p>Order No. Length Price 201XM 32" \$1.40 Specify color.</p>	 <p>Specify color. Order No. Length Price 201XL-1 32" \$1.95 Specify color.</p>
 <p>Order No. Length Price 201W 32" \$1.35 Specify color.</p>	<p>COMPLETE SET \$7.95 ORDER YOUR XMS MICRO HOOK SET TODAY! (Includes 1 ea. red, black, blue, green, orange, yellow, white, brown, violet and gray Micro Hook) At this low price you can afford more than one set.</p>

CONTINENTAL SPECIALTIES

PROTO BOARDS

Build & test circuits as fast as you think!

PB-6	6 IC cap breadboard kit	\$15.95
PB100	10 IC cap breadboard kit	19.95
PB101	10 14-DIP cap, 5-way post, 940 solderless tie points, 5.8 x 4.5"	29.95
PB102	12 14-DIP cap., like PB101 with 1,240 tie points, 7.0 x 4.5"	39.95
PB103	24 14-DIP cap., 4.5-way posts, 2,250 tie points, 6.0 x 9.0"	59.95
PB104	32 14-DIP cap., 3,060 solderless tie points, 8.0 x 9.76"	79.95

LOGIC MONITOR 1

Simultaneously displays static and dynamic logic states of DTL, TTL, HTL or CMOS DIP ICs. Pocket size. \$74.95

LOGIC MONITOR 2

Displays static and dynamic states of digital ICs such as CMOS HTL, TTL, DTL & RTL. Selectable threshold control.

LOGIC PROBE LP-1

Compact circuit provides multifunction logic probe. Multi-family compatibility. DTL/TTL/HTL/CMOS. Traces logic levels and pulses through digital circuitry. \$44.95.

CARBON FILM RESISTORS (5%)

Only in Multiples of 100 pcs per value (ohms)

10	100	1.0K	10K	100K	1.0M
11	110	1.1K	11K	110K	1.1M
12	120	1.2K	12K	120K	1.2M
13	130	1.3K	13K	130K	1.3M
15	150	1.5K	15K	150K	1.5M
16	160	1.6K	16K	160K	1.6M
18	180	1.8K	18K	180K	1.8M
20	200	2.0K	20K	200K	2.0M
22	220	2.2K	22K	220K	2.2M
24	240	2.4K	24K	240K	2.4M
27	270	2.7K	27K	270K	2.7M
30	300	3.0K	30K	300K	3.0M
33	330	3.3K	33K	330K	3.3M
36	360	3.6K	36K	360K	3.6M
39	390	3.9K	39K	390K	3.9M
43	430	4.3K	43K	430K	4.3M
47	470	4.7K	47K	470K	4.7M
51	510	5.1K	51K	510K	5.1M
56	560	5.6K	56K	560K	5.6M
62	620	6.2K	62K	620K	6.2M
68	680	6.8K	68K	680K	6.8M
75	750	7.5K	75K	750K	7.5M
82	820	8.2K	82K	820K	8.2M
91	910	9.1K	91K	910K	9.1M

ALUMINUM ELECTROLYTIC CAPACITORS

(RADIAL LEAD)

MF	V	MF	V	MF	V	MF	V
1	35	33	68	16	40	1	35
15	35	33	6.8	35	45	40	35
22	35	33	10.0	16	42	40	35
33	35	33	10.0	25	45	35	33
47	35	33	10.0	25	45	35	33
68	35	33	15.0	20	45	35	33
1.0	35	33	15.0	35	1.32	0.12	630
1.5	35	40	22.0	16	45	0.15	400
2.2	20	33	33	20	1.32	0.18	400
2.2	35	40	47.0	20	1.53	0.22	400
3.3	35	42	68.0	16	1.62	0.27	400
4.7	35	45				0.33	250

MF 10V 16V 25V 35V 50V
1 12 13 14 15 16
5 13 14 17 20 24
10 14 15 18 22 26
22 15 16 21 23 28
33 16 17 22 24 30
47 17 18 22 25 32
100 18 20 26 30 35
220 23 25 35 40 50
330 30 33 40 45 55
470 35 40 45 60 80
680 40 45 55 70 100
2200 ——— 1.30 1.60 2.50

MATSUO DIPPED TANTALUM CAPACITORS

MF	V	MF	V	MF	V	MF	V
1	35	33	6.8	16	40	1	35
15	35	33	6.8	35	45	40	35
22	35	33	10.0	16	42	40	35
33	35	33	10.0	25	45	35	33
47	35	33	10.0	25	45	35	33
68	35	33	15.0	20	45	35	33
1.0	35	33	15.0	35	1.32	0.12	630
1.5	35	40	22.0	16	45	0.15	400
2.2	20	33	33	20	1.32	0.18	400
2.2	35	40	47.0	20	1.53	0.22	400
3.3	35	42	68.0	16	1.62	0.27	400
4.7	35	45				0.33	250

7400N TTL

7400	-18	7432	32	7480	80	74128	60	74175	1.20
7401	20	7433	44	7482	1.50	74132	1.50	74176	1.20
7402	18	7437	36	7483	.82	74136	1.80	74177	1.20
7403	20	7438	35	7485	1.20	74145	1.20	74178	1.80
7404	21	7439	36	7486	62	74151	1.20	74181	1.40
7405	23	7440	20	7489	2.20	74147	2.00	74180	1.20
7406	30	7441	90	7490	.56	74148	1.80	74181	3.10
7407	36	7442	66	7492	60	74150	1.70	74182	1.00
7408	28	7443	78	7493	.62	74151	1.20	74183	2.80
7409	28	7444	105	7494	.88	74152	1.20	74185	2.90
7410	22	7445	75	7495	.90	74153	1.20	74188	5.00
7411	26	7446	105	7496	.80	74154	2.00	74190	1.40
7412	36	7447	98	7497	5.00	74155	1.10	74191	3.30
7413	54	7448	90	74100	1.20	74156	1.20	74192	1.20
7414	98	7450	15	74105	.90	74157	1.20	74193	1.20
7416	42	7451	16	74107	40	74158	1.40	74194	1.20
7417	42	7453	18	74109	45	74160	1.30	74195	1.00
7420	15	7454	18	74110	40	74161	1.40	74196	1.40
7421	38	7455	25	74111	1.00	74162	1.90	74197	1.40
7422	60	7460	19	74116	2.00	74163	1.50	74198	1.40
7423	35	7470	40	74118	2.00	74164	1.50	74199	1.40
7425	40	7472	40	74121	60	74165	1.60	74200	1.00
7426	37	7473	42	74122	48	74166	1.60	74221	1.40
7427	36	7474	42	74123	95	74167	2.00	74229	1.20
7428	50	7475	70	74125	55	74173	1.90	74298	1.80
7430	26	7476	44	74125	60	74174	1.20		

PROTO-CLIP

For power-on/hands off signal tracing. Bring IC leads up from PC board surface for fast trouble shooting.

PC14	14-pin	\$4.50
PC16	16-pin	4.75
PC24	24-pin	8.50

SOCKETS & BUS STRIPS

Plug-in, wire, test, modify or expand without patchcords or solder. Snap together to form breadboard needed.

PN/Description	Term's	Price
QT595 Socket	118	\$12.50
QT598 Bus	20	2.50
QT475 Socket	94	10.00
QT478 Bus	16	2.25
QT358 Socket	70	8.50
QT358 Bus	12	2.00
QT185 Socket	36	4.75
QT125 Socket	24	3.75
QT185 Socket	16	3.25
QT175 Socket	14	3.00

RESISTOR ASSORTMENTS

Each assortment contains 5 pcs each of 10 different values. Values included are shown in (Ohms)

Ass't. 1:	10, 12, 15, 18, 22, 27, 33, 39, 47, 56 ohm
Ass't. 2:	68, 82, 100, 120, 150, 180, 220, 270, 330, 390 ohm
Ass't. 3:	470, 560, 680, 820 ohm, 1K, 1.2K, 1.5K, 1.8K, 2.2K, 2.7K
Ass't. 4:	3.3K, 3.9K, 4.7K, 5.6K, 6.8K, 8.2K, 10K, 12K, 15K, 18K
Ass't. 5:	22K, 27K, 33K, 39K, 47K, 56K, 68K, 82K, 100K, 120K
Ass't. 6:	150K, 180K, 220K, 270K, 330K, 390K, 470K, 560K, 680K, 820K
Ass't. 7:	1M, 1.2M, 1.5M, 1.8M, 2.2M, 2.7M, 3.3M, 3.9M, 4.7M, 5.6M
Ass't. 8R:	(All seven assortments above)

1/2w, 5%, 150 pcs total... \$1.75
1/4w, 5% (50 pcs total)... \$1.85
1/2w, 5%, 350 pcs total... \$10.95—1/2w, 5%, 350 pcs total \$11.55

DECEMBER SPECIALS

— ONLY ONE ORDER PER CUSTOMER —

pcs per pkg	\$	pcs per pkg	\$	pcs per pkg	\$	pcs per pkg	\$	
10	4000AE	90	10	7406N	1.90	10	7420N	1.40
10	4002AE	1.30	10	7408N	1.90	10	7425N	2.50
10	4007AE	4.70	10	7409N	2.20	10	7437N	2.20
10	4011AE	1.80	10	7412N	2.50	10	7438N	2.20
10	4012AE	1.70	10	7415N	3.10	10	7439N	2.20
10	4013AE	3.80	10	7417N	6.70	10	7440N	1.40
100	4013AE	34.50	10	7488N	3.10	10	7440N	1.40
10	4025AE	8.90	10	7489N	3.10	10	7440N	1.40
10	4027AE	4.30	10	7490N	3.10	10	7440N	1.40
100	4027AE	38.50	10	7491N	6.70	10	7440N	1.40
10	4030AE	3.80	10	7492N	6.70	10	7440N	1.40
10	4039AE	3.80	10	7493N	6.70	10	7440N	1.40
100	4039AE	34.10	10	74157N	6.10	10	7440N	1.40
10	4050AE	3.80	10	EXAR	16.00	10	7440N	1.40
100	4050AE	34.10	10	XR567CN	16.00	10	7440N	1.40
10	4510AE	9.90	10	XR567CN	140.00	10	7440N	1.40

Valid only until December 31, 1976.

PROTO BOARDS

With built-in regulated short-power supplies

PB203	5V, 1 amp regulated power supply	\$ 75.00
PB203A	5V, 1 amp and 2.5V, 1/2 amp regulated power supply	120.00

DESIGN MATES

DESIGN MATE 1... CIRCUIT DESIGNER

With built-in, regulated, metered power supply to design unusual circuits fast... \$54.95

DESIGN MATE 2... FUNCTION GENERATOR

Complements Design Mate 1. Produces clean, accurate wave forms with variable amplitude and frequency controls. \$69.95

DESIGN MATE 3... R/C BRIDGE

Saves design time by measuring and selecting capacitors and resistors to better than 5% instantly! \$59.95

DESIGN MATE 4... MULTIPURPOSE PULSE GENERATOR

With the precision and versatility of a laboratory instrument, ideal wherever a source of clean, fast output pulses compatible with virtually all logic families and discrete circuits is needed... \$124.95

POWER SUPPLIES - ADTECH

Model No.	Vdc	Amps	Price
APS5-3	5	3.0	
APS12-1.6	12	1.6	
APS15-1.5	15	1.5	
APS24-1	24	1.0	\$30.95
APS28-0.8	28	0.8	
APS5-6	5	6.0	
APS12-4	12	4.0	
APS15-3	15	3.0	\$50.40
APS24-2.2	24	2.2	
APS28-2	28	2.0	
APS5-10	5	10.0	
APS12-7	12	7.0	
APS15-6	15	6.0	\$71.20
APS24-5	24	5.0	
APS28-4	28	4.0	

WAVEFORM GENERATOR KIT EXAR XR205K

Here's a highly versatile lab instrument at a fraction of the cost of conventional units. Kit includes 2 XR 205 ICs, data and applications, a PC board (etched and assembled, ready for assembly) and detailed instructions. \$25.00

BREADBOARD JUMPER WIRE KIT

Each kit contains 350 wires cut to 14 different lengths from 0.1" to 5.0". Each wire is stripped and leads are bent 90° for easy insertion. Wire length is classified by color coding. All wire is solid tinned 22 gauge with PVC insulation. The wires come packed in a convenient plastic box, BK-1... \$9.95

PLESSEY SAMPLER

300 METALIZED CAPACITORS 18 DIFFERENT STD. VALUES \$26.00

CMOS

4000AE	20	4023AE	24	4051AE	1.70	4093AE	1.65
4001AE	24	4024AE	35	4052AE	1.40	4095BE	1.95
4002AE	24	4025AE	24	4053AE	1.70	4098AE	2.50
4006AE	1.30	4026AE	2.50	4058AE	1.95	4099AE	2.90
4007AE	24	4027AE	85	4059AE	1.99	4502AE	1.50
4008AE	1.40	4028AE	1.00	4060AE	2.10	4507BE	60
4009AE	50	4029AE	1.20	4063AE	2.50	4508BE	2.20
4010AE	50	4030AE	48	4066AE	90	4510AE	1.40
4011AE	24	4033AE	2.00	4068AE	44	4512AE	1.30
4012AE	24	4035AE	1.30	4069AE	44	4515AE	1.75
4013AE	30	4040AE	1.20	4070AE	60	4518AE	3.00
4014AE	1.20	4041AE	1.25	4071AE	45	4519AE	

BULLET ELECTRONICS

P.O. BOX 19442P • DALLAS, TEXAS 75219 • 214/823-3240

PS-01 POWER SUPPLY KIT

Imagine! A power supply with a well filtered, regulated output in three voltages. The PS-01A has quality IC regulators, semiconductors and components. The transformer is custom designed and well made. Features 10mv load regulation.

YOU GET:

- Drilled and plated board
- Complete kit of components
- Heatshinks
- Complete instructions

\$14.95

NOTE: +5 and ±12VDC supply is available at same price. Order PS-01/B.

BUILD A COMPLETE COI IGNITION KIT AT A FRACTION OF THE COST OF OTHER UNITS. A special buy allows us to sell the complete kit at this low price! Up to 40,000 volts from your present ignition without changing the coil. Simple connections.

- INCLUDES:**
- Special toroid transformer
 - Drilled and plated board
 - Complete instructions
 - All resistors and caps
 - All semiconductors

\$9.95

(Does not include heatsink or case.) For 12V negative ground systems.



QUALITY METAL PROJECT CASES

Cases are heavy gauge aluminum with baked white finish and black vinyl floor.

	A	B	C	
Small:	2 7/8" x 2 1/2" x 1 1/2"			\$1.60
Medium:	4 1/2" x 2 1/2" x 1 7/8"			2.15
Medium:	4 13/16" x 3 1/2" x 2"			3.50
Large:	7" x 4" x 2 3/8"			4.35

UNMARKED - TESTED GOOD

BA 200V TRIACS



Guaranteed!
.49

VOLTAJE REGULATORS
UNMARKED - TESTED GOOD

7500 Ohm Reg. 50¢
7500 Ohm Reg. 60¢
500 Ohm
1 to 30 Volts
10mA

Can be used with terminal block transistor (not included)

ULTRASONIC SENDE-RECEIVER KIT

A special buy on a high quality ultrasonic transmitter allows us to offer this kit at a super price. But hurry, quantities are limited! You can build intrusion alarms, motion detectors, remote controls, echo ranging or liquid level measurement equipment. We supply the basic transmitter and receiver electronics including a drilled and plated PC board. The units work at 20KHZ with a range of 20 ft. and can be positioned opposite each other or side-by-side and bounced off a solid surface. The output will sink up to 300ma to drive a relay, alarm circuit, etc.

ORDER US-01 **\$19.95**

WAFLE ALARM Kit A WAFLE 10 WATTS of dual tone noise that can't be ignored! Perfect for burglar alarms, warning devices, or to call your kids home for supper! Complete with PC Board, 4-wt. speaker or switch. Features 6 to 15 VDC.

ORDER US-02 **\$19.95**

CIRCLE NO. 14 ON FREE INFORMATION CARD

CLASSIFIED ADVERTISING ORDER FORM

Please refer to heading on first page of this section for complete data concerning terms, frequency discounts, closing dates, etc.

1	2	3	4	5
6	7	8	9	10
11	12	13	14	15
16	17	18	19	20
21	22	23	24	25
26	27	28	29	30
31	32	33	34	35

WORD COUNT: 15 WORD MINIMUM. Include name and address. Name of city (Des Moines) or of state (New York) counts as one word each. Zip Code numbers not counted. (Publisher reserves right to omit Zip Code if space does not permit.) Count each abbreviation, initial, single figure or group of figures or letters as a word. Symbols such as 35mm, CDD, PD, AC, etc., count as one word. Hyphenated words count as two words. Telephone numbers count as one word.

Words **\$2.25 (Commercial Rate) \$1.35 (Reader Rate)**

Payment of \$ _____ enclosed for _____ insertion(s).
 CHARGE American Express BankAmericard Master Charge Diners Club

for _____ insertion(s). You will be billed monthly.
 Account # _____ Expiration Date _____

Master Charge Interbank # (4 digits above name) _____
SIGNATURE MUST BE PROVIDED BELOW

PRINT NAME _____

ADDRESS _____

CITY _____ STATE _____ ZIP _____

SIGNATURE _____ PE-1276

EMPLOYMENT OPPORTUNITIES

ELECTRONICS/AVIONICS EMPLOYMENT OPPORTUNITIES. Report on jobs now open. Details FREE. Aviation Employment Information Service, Box 240E, Northport, New York 11768.

PERSONALS

MAKE FRIENDS WORLDWIDE through international correspondence. Illustrated brochure free. **Hermes-Verlag**, Box 110660/Z, D-1000 Berlin 11, Germany.

2522 STAT SR	\$2.75
INTEL 8080 CPU	\$24.50
2518 HEX 32 BIT SR	\$9.00
2102 1 1024 BIT RAM	\$1.80
5280 4K DYNAMIC RAM	\$12.50
5202A UV PROM	\$12.50
MM5203 UV PROM	\$12.50
1702A UV PROM	\$10.75
5204 4K PROM	\$24.95
MINIATURE MULTI TURN TRIM POTS	
100, 500, 2K, 5K, 10K, 100K, 200K	\$1.50 ea.
5.75 each	\$3.20
MULTI TURN TRIM POTS Similar to Bouras	
3010 style 3/16" x 5/8" x 1 1/4" 50, 100, 1K, 10K, 50K ohms	\$1.50 ea.
LIGHT ACTIVATED SCR's	\$3.40
LD-18, 200V 1A	\$1.75

TRANSISTOR SPECIALS

2N3585 NPN Si TO 66	\$.95
2N3772 NPN Si TO 3	\$ 1.60
2N4908 PNP Si TO 3	\$ 1.00
2N6056 NPN Si TO 3 Darlington	\$ 1.70
2N5086 PNP Si TO 92	\$ 1.00
2N4898 PNP TO 66	\$.60
2N404 PNP GE TO-5	5/5 1.00
2N3919 NPN Si TO 3 RF	\$ 1.50
MPSA 13 NPN Si TO 92	3/5 1.00
2N3767 NPN Si TO 66	\$.70
2N2222 NPN Si TO 18	5/5 1.00
2N3055 NPN Si TO 3	\$.80
2N3904 NPN Si TO 92	5/5 1.00
2N3906 PNP Si TO 92	5/5 1.00
2N5296 PNP Si TO 220	\$.50
2N5109 PNP Si TO 220	\$.55
2N3638 PNP Si TO 5	\$ 5.00
2N6517 NPN TO 92 Si	3/5 1.00

C/MOS (DIODE CLAMPED)

74C02 22 4015 95 4035 110
74C10 22 4016 40 4047 200
4001 22 4017 1.05 4047 2.00
4002 22 4018 1.00 4049 40
4006 1 20 4019 22 4050 40
4007 22 4022 95 4066 80
4009 42 4027 40 4071 22
4010 42 4028 88 4076 70
4011 22 4029 110 4081 22
4012 22 4030 22 4520 115
4013 40

LED READOUTS

FND 500 5" C.C	\$1.95
HP 7740 .3" C.C	\$1.40
MAN 7 .3" C.A	\$1.25
NS 33-3 3mm array	\$1.35
DL 747	\$2.50

Send 25¢ for our catalog featuring Transistors and Rectifiers
 145 Hampshire St., Cambridge, Mass.

PRINTED CIRCUIT BOARD

4 1/2" x 6 1/2" SINGLE SIDE EPOXY BOARD 16" thick, unetched
 3.50 ea. \$5/2.00
 VECTOR BOARD 1" SPACING
 4.5" x 6" SHEET \$1.25

7 WATT LD-65 LASER DIODE \$8.95

2N 3820 P FET	\$.45
2N 5457 N FET	\$.45
2N 4891 UJT	\$.35
TIS 43 UJT	\$.45
ER 900 TRIGGER DIODES	4/1 \$1.00
2N 6028 PROG. UJT	\$.65

VERIPAX PC BOARD

This board is a 16" single sided paper epoxy board, 4 1/2" x 6 1/2" DRILLED and ETCHED which will hold up to 21 single 14 pin IC's or 8, 16, or LSI DIP IC's with buses for power supply connector. \$4.00

MV 5691 YELLOW/GREEN	
BIPOAR LED	\$1.25
FP 100 PHOTO TRANS	\$.50
RED, YELLOW, GREEN OR	
AMBER LARGE LED's	ea. \$.70
14 PIN DIP SOCKETS	\$.25
16 PIN DIP SOCKETS	\$.28
MOLEX PINS	100/\$1.00
8 PIN MINI DIP SOCKETS	1000/\$7.50
10 WATT ZENERS 3.9, 4.7, 5.6, 8.2, 12, 15, 18, 22, 100, 150 oh 200V	ea. \$.60
1 WATT ZENERS 4.7, 5.6, 10, 12, 15, 18 OR 22V	ea. \$.75

Silicon Power Rectifiers

PRV 1A	3A	12A	50A	125A
100	60	14	30	80
200	07	20	35	140
400	09	25	50	4.25
600	11	30	70	1.80
800	15	35	90	2.30
1000	20	45	110	2.75

SILICON SOLAR CELLS

2 1/4" diameter
 .4V at 200 ma. . . . \$5.00 ea., 6/\$27.50

REGULATED MODULAR POWER SUPPLIES

+15 VDC at 100ma	\$27.95
115VAC INPUT	\$27.95
5VDC AT 1A 115VAC INPUT	\$24.95
12 VDC AT 5 AMP	\$24.95
(IN 4148 (1N914)	15 \$1.00

TANTULUM CAPACITORS

22UF 35V 5/\$1.00	4 7UF 35V 4/\$1.00
47UF 35V 5/\$1.00	6.8UF 35V 3/\$1.00
68UF 35V 5/\$1.00	22UF 35V \$.40
11UF 35V 5/\$1.00	33UF 35V \$.40
2 2UF 20V 5/\$1.00	10UF 6V 5/\$1.00
3.3UF 35V 4/\$1.00	100UF 35V \$.50

M/001 ALARM CLOCK CHIP \$6.00

NATIONAL MOS DEVICES

MM1402 1 75	MM5057 2 25
MM1403 1 75	MM5058 2 75
MM1404 1 75	MM5059 2 75
MM5013 2 50	MM5061 2 50
MM5016 2 70	MM5555 4 75
MM5017 2 70	MM5556 4 75
MM5055 2 25	MM5210 1 95
MM5056 2 25	MM5260 1 75

TTL IC SERIES

7400 14	7442 52	74125- 40
7401- 14	7445 70	74126 40
7402 14	7446 70	74127 40
7403 14	7447 70	74151- 70
7404 18	7448 70	74154 110
7405 18	7450 20	74155 70
7406 20	7472 30	74157- 70
7407 25	7473 30	74161 85
7408 21	7474 30	74164 95
7409 21	7475 45	74169 120
7410 15	7476 35	74165 105
7411 - 20	7480 35	74173- 140
7412 20	7483 70	74175 92
7413 45	7485 88	74177 79
7414 70	7486 30	74188 70
7415 25	7489 1.85	74181- 210
7417 25	7490 45	74190 120
7420 20	7491 70	74191 120
7425 28	7492 50	74192- 85
7426 25	7493 45	74193 85
7427 30	7494 70	74194 85
7430 20	7495 70	74195 75
7432 25	7496 70	74196 98
7437 25	74107 32	75324 175
7438 25	74121 35	75491 65
7440 16	74123 65	75492 65
7441 85		

MINIATURE DIP SWITCHES

CTS-206 4 Four SPST switches	\$1.75
in one minidip package	
CTS-206 B Eight SPST switches in a 16 pin DIP package	\$2.85

AY 5 1013 A30K ser./par. pin ser. uni. versal UART \$6.95

ALLO MINIATURE TOGGLE SWITCHES
 MTA 100 SPDT \$1.20
 MTA 206 DPDT \$1.70

Full Wave Bridges

PRV 2A	6A	25A
200 .95	1.25	2.00
400 1.15	1.50	3.00
600 1.35	1.75	4.00

SANKEN AUDIO POWER AMPS

Si 1019 G 10 WATTS	\$ 6.90
Si 1020 G 20 WATTS	\$13.95
Si 1050 G 50 WATTS	\$24.95
CCD 110 LINEAR 256 X1 BIT SELF SCANNING IN-CHEARGE COUPLED DEVICE	\$99.00
CCD 201 100 x 100 CHARGE COUPLED DEVICE	\$135.00

LINEAR CIRCUITS

LM307 Op Amp	\$ 30
LM309K 5V 1A REGULATOR	\$115
723 40 40V VOLT REGULATOR	\$ 50
301 748-Hi Perf. Op. Amp.	\$ 31
320T 5, 12, 15, or 24V NEG REG	\$150
109C Op. Amp.	\$ 75
741A or 741C OP AMP	\$ 31
710 COMPARATOR	\$ 35
CA 3047 Hi Perf. Op. Amp.	\$.95
340T 5, 6, 8, 12, 15, 18, 24V POS REG. TO 220	\$150
101 OPER AMP HI PERFORM	\$ 75
LM 308 Op. Amp., Low Power	\$ 95
747 DUAL 741	\$ 65
556 DUAL TIMER	\$1.00
537 PRECISION OP AMP	\$1.70
LM 3900 QUAD OP AMP	\$ 49
LM 324 QUAD 741	\$1.50
560 PHASE LOCK LOOP	\$2.00
561 PHASE LOCK LOOP	\$2.00
565 PHASE LOCK LOOP	\$1.25
566 FUNCTION GEN.	\$1.65
567 TONE DECODER	\$1.50
LM 1310N FM STEREO DEMOD.	\$2.75
8038 IC VOLTAGE CONT OSC.	\$3.50
LM 370 AGC SQUELCH AMP	\$1.15
555 741 7 HR. TIMER	\$.45
553 QUAD TIMER	\$2.50
FCD 810 OPTO-ISOLATOR	\$ 60
1458 DUAL OP AMP	\$.60
LM 380 2W AUDIO AMP	\$.95
LM 377 2W Stereo Audio Amp	\$2.50
LM 381 STEREO PREAMP	\$1.50
LM 382 DUAL AUDIO PREAMP	\$1.50
LM 311 HI PER COMPARATOR	\$.90
LM 319 Dual Hi Speed Comp.	\$1.25
LM 339 - QUAD COMPARATOR	\$1.50

TRIACS SCR'S

PRV 1A	10A	25A	1.5A	6A	35A
100	40	70	1.30	40	50
200	70	110	1.75	60	70
400	110	160	2.60	100	120
600	170	230	3.60	150	300

SOLID STATE SALES
 P.O. BOX 74A
 SOMERVILLE, MASS. 02143 TEL. (617) 547-4005

WE SHIP OVER 95% OF OUR ORDERS THE DAY WE RECEIVE THEM

Popular Electronics

DECEMBER 1976
ADVERTISERS INDEX

READER SERVICE NO.	ADVERTISER	PAGE NO.
1	A P Products, Inc.	96
2	AVR Electronics	112
	Acoustic Fiber Sound Systems, Inc.	5
3	Adva Electronics	135
4	Advanced Microcomputer Products	118
6	Allison Automotive	96
7	Altaj Electronics	123
8	American Surplus Trading	112
9	Anrona Corp.	133
10	Aries Inc.	118
11	Associated Electronics	93
	Audio-Technica U.S., Inc.	47
13	B-K Product of Dynascan	22, 98
14	Butlet Electronics	134
15	Byte	97
	CREI Capitol Radio Engineering Institute	82, 83, 84, 85
16	C&S Marketing	108
	Circuit Design, Inc.	115
	Cleveland Institute of Electronics, Inc.	100, 101, 102, 103
17	Cobra, Product of Dynascan	SECOND COVER
18	Continental Specialties Corporation	29
19	Continental Specialties Corporation	110
20	Delta Electronics Co.	132
21	Delta Products, Inc.	43
22	Deltagraph	89
23	Digi-Key Corporation	1
24	Discwasher Group	110
	Dynaco, Inc.	
25	EICO	77
26	Edlie Scientific	122
27	Edmund Electronics Co.	136
28	Edsyn, Inc.	93
28	Eltron	128
30	Empire Scientific Corp.	79
31	Fluke	31
32	Godbout Electronics, Bill	126
34	Graham School of Engineering	111
35	Handic U.S.A. Inc.	80
36	Hewlett-Packard	10, 11
	IMS Associates, Inc.	13
	lasis, Inc.	112
37	Illinois Audio	112
38	International Electronics Unlimited	130
39	JBL	21
40	James	124, 125
41	James	131
33	Johnson Co., E. F.	FOURTH COVER
42	Leader Instrument Corp.	113
43	McIntosh Laboratory Inc.	109
76	MTS	2
49	MTS	6, 7
77	MTS	107
44	Mallory Distributor Products Co.	35
	NRI Schools	16, 17, 18, 19
	National Technical Schools	87
45	New-Tone Electronics	126
46	OK Machines & Tool Corporation	20
47	Olson Electronics	128
48	Optoelectronics	127
75	PAIA	113
50	Phase Linear Corporation	106
51	Poly Paks	121
52	Polymorphic Systems	50
	Processor Technology Co.	73
53	Quest Electronics	116
54	RCA Electronic Instruments	104, 105
	Radio Shack	23
55	SBE Inc.	9
56	S. D. Sales Co.	129
57	Sencore	94, 95
58	Shure Brothers Inc.	81
59	Solid State Sales	134
60	Sound Guard	68
61	Southwest Technical Products Corporation	67
	Speaker Labs	97
63	Stanton Magnetics, Inc.	THIRD COVER
64	Stereo Corporation of America	97
65	Stereo Discounters	109
74	Tec West U.S.A.	132
66	Technics by Panasonic	25
72	Telex	44
68	Vernitron Corporation	88
69	Wahl Clipper Corporation	113
70	Wawasee Electronics	91
71	Weller-Xcelite, Inc.	8
67	Yamaha	27

CLASSIFIED ADVERTISING
116, 118, 122, 126, 130, 132, 134, 135

HOME ENTERTAINMENT FILMS

SHOP EARLY THE CONVENIENT WAY — BY MAIL ... buy Sportlite Films for Christmas: Almost Unlimited Choice — the NFL Super Bowl 1967 thru Super Bowl X — each a separate Super 8 B&W or Color film. B&W, \$8.95; Color, \$19.95 ea + \$0.75 ea for shipping & handling. Or, order 400" Super 8 Color Mag Sound Films of Super Bowl IX & X; or '75 World Series; or 1975 Stanley Cup Playoffs for \$49.95 each POSTPAID. Other choices include: Armour Golf (6 asstd), Standard or Super 8 B&W 200' reels, \$7.95 ea; or Indy "500" Standard 8 Color — 67, 8 & 9 at a closeout price of only \$14.95 ea PPD. Still puzzled? Send \$1.00 for new Columbia & Castle (Universal) catalogs & Sportlite forms. Or call (312) 326-8955. Limited offer — treat yourself or a friend. SPORTLITE, Elect 12-X, 20 N. Wacker, Chicago, IL 60606.

INVENTIONS WANTED

INVENTORS: Manufacturers Need New Products. Free "Recommended Procedure," by a creative fee-based invention service company. Washington Inventors Service, 422-T Washington Building, Washington, D. C. 20005.

INVENTORS

**RECOGNITION... FINANCIAL
REWARD... OR CREDIT
FOR "INVENTING IT FIRST" MAY BE YOURS!**

If you have an idea for a new product, or a way to make an old product better, contact us, "the idea people." We'll develop your idea, introduce it to industry, negotiate for cash sale or royalty licensing.

Write now without cost or obligation for free information. Fees are charged only for contracted services. So send for your FREE "Inventor's Kit." It has important Marketing Information, a special "Invention Record Form" and a Directory of 500 Corporations Seeking New Products.

RAYMOND LEE ORGANIZATION
230 Park Avenue North, New York, NY 10017

At no cost or obligation, please rush my
FREE "Inventor's Kit No. A-112".

Name Please Print

Address

City State Zip

DO-IT-YOURSELF

MODULAR TELEPHONES now available. Sets and components, compatible with Western Electric concept. Catalog 50 cents. Box 1654W, Costa Mesa, California 92626.

ORGANS — PA SYSTEMS, Electronic Pianos — String Synthesizers — Speakers — Guitar Amplifiers — Electronic Sound Rotators. Modern integrated circuitry. Factory assembled or easy-to-build custom kits. Send one dollar (refunded with first purchase) to: WERSI Electronics, Dept. D, Box 5318, Lancaster, PA 17601.

U-BUILD Power Tools, Engraving Machine. Lathes. Profitable Projects. Poor Man's Catalog 50 cents. Box 23-PE, Highland, Maryland 20777.

MUSICAL INSTRUMENTS

UP TO 60% DISCOUNT. Name brand instruments catalog. Freeport Music, 114 G. Mahan St., W. Babylon, N.Y. 11704.

30% to 60% DISCOUNT! Any model! Guitar, Amp, Drums. Free Catalog! Warehouse, PE-6, Box 11449, Ft. Worth, Texas 76109.

ORGANS — PA SYSTEMS, Electronic Pianos — String Synthesizers — Speakers — Guitar Amplifiers — Electronic Sound Rotators. Modern integrated circuitry. Factory assembled or easy-to-build custom kits. Send one dollar (refunded with first purchase) to: WERSI Electronics, Dept. D, Box 5318, Lancaster, PA 17601.

RUBBER STAMPS

RUBBER ADDRESS STAMPS. Free Catalog. 45 type styles. Jackson's, Dept. K, Brownsville Rd., Mt. Vernon, Ill. 62864.

FREE

IC or FET'S WITH
\$5 & \$10 ORDERS.†
DATA SHEETS
WITH MANY ITEMS.

DIODES	TRANSISTORS	TRANSISTORS	TRANSISTORS	LINEAR IC'S
ZENERS & RECTIFIERS	2N706 50.24	2N4091 3/51	2N6538 2/51	LM308K 5 \$1.75
1N4656 6/51	2N120 48	2N4121 3/51	2N5449 2/51	LM301 5 1.75
1N4658 6/51	2N518 3/51	2N4122 3/51	CP650 5.00	LM307 12 1.75
1N4832 6/51	2N1513 50.29	2N4124 5/51	CP651 5.00	LM307 15 1.75
1N488 6/51	2N1711 29	2N4268 5/51	CP652 5.00	LM307 24 1.75
1N485 6/51	1N4830 38	2N4269 5/51	E101 3/51	LM378M 55
1N758 6/51	1N1933 38	2N4250 4/51	E102 3/51	LM377N 2.50
1N914* 15/51	2N2219 24	2N4274 5/51	E175 3/51	LM380N 1.29
1N952 10 4/51	2N2222 6/51	2N4302 50.29	MPF102* 3/51	LM393 2.51
1N974 6/51	2N2234 5/51	2N4302 50.29	MPF104 3/51	LM565A 50.90
1N3064 6/51	2N2369 5/51	2N4338 51	MPF112 4/51	LM705CH 29
1N3500 6/51	2N2606 10 5/51	2N4360M 2/51	MP56515 3/51	LM705CN 29
1N4001* 12/51	2N2609 50.24	2N4391 5/51	MP5651 4/51	LM741C 2/51
1N4002 12/51	2N2905 50.24	2N4392 5/51	SE1002 4/51	LM723M 3/51
1N4003 12/51	2N2956A 24	2N4416 2/51	SE2001 4/51	LM739N 51.00
1N4004 12/51	2N2977 5/51	2N4416A 50.80	SE2002 4/51	LM741C 3/51
1N4005 10/51	2N3553 51.50	2N4556 10 5/51	SE3001 3/51	LM741CN 4.93
1N4006 10/51	2N3562 6/51	2N4561 2/51	SE3003 3/51	LM741CN 4.34
1N4007 10/51	2N3564 4/51	2N4567E 2/51	SE5020 53.00	LM747CN 95
1N4148 15/51	2N3565 10 6/51	2N4568E 2/51	T1573 10 3/51	748C DIP 1.00
1N4150 25/51	2N3568 10 6/51	2N4568E 2/51	T1573 10 3/51	748C DIP 1.00
1N4370 10 2/51	2N3538 6/51	2N4888 51	SE5001 10 3/51	844C mDIP .80
1N4372 2/51	2N3639A 5/51	2N4955 3/51	MMS329N 52.95	LM1309N 1.15
1N4454 15/51	2N3641 5/51	2N5007 4/51	SN7400N 16	LM211N 1.40
1N4729 10 3/51	2N3652 5/51	2N5008 4/51	SN7410N 16	LM2700 1.95
1N4752 10 3/51	2N3643 6/51	2N5126 10 6/51	SN7410N 16	LM2556CP 1.55
1N5231 10 4/51	2N3644 4/51	2N5135 3/51	SN7440N 16	27400E 1.95
1N5236 4/51	2N3646 4/51	2N5138 5/51	SN7451N 16	LM3046 94
	2N3650 10 3/51	2N5139 5/51	SN7451N 16	LM3075M1 1.45
	2N3658 10 3/51	2N5163 3/51	SN7473N 35	LM3075M 1.45
	2N3691 10 4/51	2N5197 55.00	SN7476N 35	CA3066* .55
	2N3694 10 4/51	2N5199 25.00	SN7490N 44	LM3500N 55
	1N5139 52	2N3821 50.80	2N5210 3/51	RC1947K 2.50
	DS 144MHz \$5	2N3822 50.80	2N5208 2/51	LINEAR IC'S
	F 432MHz \$1	2N3823 40	2N5297 51.50	LM100H \$7.50
	MV330 \$1	2N3866 .75	2N5422 1.90	LM100H 27
	MV370 \$1	2N3903 10*	2N5427 2/51	LM101H 27
	MV1620 \$1	2N3938 6/51	2N5458 50.38	LM308N 88
	MV1634 \$1	2N3919 55.00	2N5484 3/51	LM309K 125
	MV1866 \$1	2N3922 5.00	2N5486 2/51	LM311N 90
	MV1872 \$1	2N3954 3.20	2N5453 53.00	LM320K 5 1.35
	MV2201 \$1	2N3958 1.15	2N5454 12.00	LM320K 12 1.35
	MV2205 \$1	2N3970 1.00	2N5561 25.00	LM320K 15 1.35
				DM7492 8.75

*SUPER SPECIALS:

1N914 100V/10mA Diode	20/51	MPF102 200MHz RF Amp	3/51
1N4001 100V/1A Rect.	15/51	40673 MOSFET RF Amp	\$1.75
1N4154 30V 1N4154	25/51	LM324 Quad 741 Op Amp	.94
BR1 50V 1/4 Bridge Rec	4/51	LM376 Pos Volt Reg mDIP	.55
2N2222A PNP Transistor	6/51	NE555 Timer mDIP	2/51
2N2907 PNP Transistor	6/51	LM723 2-37V Reg DIP	3/51
2N3055 Power Xistor 10A	.69	LM741 Comp Op Amp mDIP	4/51
2N3904 NPN Amp/Sw 100	6/51	LM1458 Dual 741 mDIP	3/51
2N3906 PNP Amp/Sw 100	6/51	CA3086 5 Trans Arry DIP	.55
CP650 Power FET 1/4 Amp	55	RC4195DN ±15V/50mA mDIP	1.25
RF391 RF Power Amp Transistor 10-25W @ 3-30MHz 20	\$5.00		
555X Timer 1/4 1N Diff. pinout from 555 (w/data)	3/51		
RC4194TK Dual Tracking Regulator ±0.2 to 30V @ 200mA TO-66	\$2.50		
RC4195TK Dual Tracking Regulator ±15V @ 100mA (TO-66)	\$2.25		
8038 Waveform Generator 1.7V Wave With Circuits & Data	\$3.75		

ADVA KITS:

LOGIC PROBE KIT—Use with CMOS, TTL, DTL, RTL, HTL, HNIL and most MOS IC's. Built in protection against polarity reversal and overvoltage. Draws only a few mA from circuit under test. Dual LED readout. Complete kit includes case and clip leads \$8.95

VARIABLE REGULATED POWER SUPPLY KIT—Continuously variable from 3 to over 150 Volts. Short-circuit proof with electric current limiting at 300 mA. Compact size and typical regulation of 0.1% make this a great bench or lab power supply. \$11.95

FIXED REGULATED POWER SUPPLY KITS—Short-circuit proof with thermal current limiting. Compact size and typical regulation of 0.5% make these ideal for most electronic projects. Available for 5V @ 500mA, 6V @ 500mA, 9V @ 500mA, 12V @ 400mA, 15V @ 300mA. Specify voltage when ordering. \$8.95 ea.

†These easy-to-assemble kits include all components, complete detailed instructions and plated fiberglass PC boards. Power supply kits do not include case or meters. Add \$1.25 per kit for postage and handling.

MAIL NOW! FREE DATA SHEETS supplied with many items from this ad. FREE ON REQUEST—741 Op Amp with wavy order of \$5 or more—749 Dual Op Amp or 2x0 E100 FET's with wavy order of \$10 or more, postmarked prior to 12/31/76. One free item per order.

ORDER TODAY. All items subject to prior sale and prices subject to change without notice. All items are new surplus parts. 100% functionally tested.

WRITE FOR FREE CATALOG #76 offering over 350 semiconductors carried in stock. Send 13¢ stamp.

TERMS: Send check or money order (U.S. funds) with order. We pay 1st Class postage to U.S., Canada and Mexico (except on h.v.). \$1.00 handling charge on orders under \$10. Calif. residents add 6% sales tax. Foreign orders add postage. COD orders add \$1.00 service charge.

ADVA ELECTRONICS

BOX 4181 EE, WOODSIDE, CA 94062
Tel. (415) 851-0455

CIRCLE NO. 3 ON FREE INFORMATION CARD

TREASURE FINDERS

DISCOVER true treasure hunting with world-famous deep-detecting mineral/metal detectors from White's! Locate gold, silver, rings, coins, artifacts and more! Sold, serviced, warehoused world wide. Priced from \$79.50. Free Catalog! White's Electronics, Dept. PD67, 1011 Pleasant Valley Rd., Sweet Home, OR 97386.

MISCELLANEOUS

WINEMAKERS: Free illustrated catalog yeasts, equipment, Sempex. Box 12276P, Minneapolis, Minn. 55412.

FREE! Consumer Service Division Catalog. Includes a wide variety of products associated with the special interests of readers of Ziff-Davis magazines — PSYCHOLOGY TODAY, POPULAR PHOTOGRAPHY, STEREO REVIEW, POPULAR ELECTRONICS, BOATING, FLYING, CAR & DRIVER, CYCLE, SKIING. Send for YOUR free catalog today. Consumer Service Div., 595 Broadway, Dept. CL, N.Y., NY 10012.

LIVE IN THE WORLD OF TOMORROW... TODAY!

And our FREE 164 PAGE CATALOG is packed with exciting and unusual values in electronic, hobby and science items — plus 4,500 finds for fun, study or profit... for every member of the family.

A BETTER LIFE STARTS HERE

KNOW YOUR ALPHA FROM THETA!

For greater relaxation, concentration, monitor your Alpha Theta brainwaves w/ audible or visible signal on Biosone II. Has 3 feedback modes, outputs to monitor logic signal, filter sel. feedback, broad sensitivity control; other professional feats. of \$200-up units. Easily operated 4-lb. portable has total brainwave monitoring capability! 2 9v tr. batteries.



- No. 1668 AV (9 1/2" x 5 1/4" x 4 1/4") \$149.95 Ppd.
- LOW COST STARTERS' UNIT (PORTABLE)
- No. 71,809 AV (4 1/2" x 2 3/4" x 4 1/4") \$55.00 Ppd.

SUPER POWER FOR ANY AM RADIO

New antenna assist turns a tiny transistor into a tiger, has pulled in stations up to 1000+ miles away! Just set beside radio (no wires, clips, grounding) and fine-tune Select-A-Tenna's dial to same frequency — "gangbusters"! Great for clearing weak signals in radio depressed areas, off-coast islands, crowded frequency stations. Solid state—uses no electricity, batts., tubes.



- Stock No. 72,095AV \$19.95 Ppd.
- ULTRA SELECT-A-TENNA
- No. 72,147AV ("OVER 1000 MI.") \$24.95 Ppd.

NASA-CHOSEN FOR APOLLO/SOYUZ

157 mi. out in space, the Astronauts used this super 20x60 binocular (modified) to view Earth! Our biggest, most powerful for distance. Far-off objects come in big, clear & sharp to the edge through big 60mm objective lenses; 173-ft. field of view at 1000 yds. Relative brightness, 9.0. Fully coated optics; 20X spcl design eye lenses. Coated BK-7 Porro prism. Extra long All-American style with fold-down rubber eyecups. Includes case & straps.



- No. 1556AV ... (9 1/4" x 8 1/2"; 47.5 oz.) \$99.95 Ppd.
- 8x30 European Style
- No. 1559AV ... (4 1/2" x 6 1/4"; 19 oz.) \$29.95 Ppd.

PRO ELECTRONIC SOUND CATCHER

Parabolic mike w/ 18 3/4" transparent reflecting shield & 2 I.C.'s in amplifier magnifies signals 100x that of omni-direction mikes. Catch sounds never before heard! Highest signal to noise ratio poss. Earphones, tape recorder output, tripod socket; req. two 9v trans. batt. (not incl).



- No. 1649AV ... (5 1/2 LB.) \$299.00 Ppd.
- LOW COST MODEL: NO EARPHONES, ELECTR. CIRC.
- No. 1665AV \$149.95 Ppd.
- LOWER SENSITIVITY ECON. MOD. W/O ELECTR.
- No. 80,242AV \$89.50 Ppd.

GREAT FOR CHRISTMAS GIFTS!
A UNIQUE SELECTION OF MEMORABLE,
LONG-LASTING GIFTS FOR ALL AGES.

NEW! THE UNIQUE EDMUND

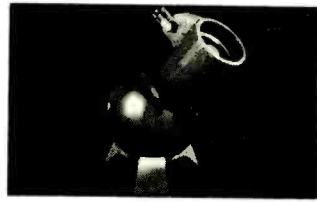

4 1/4" NEWTONIAN RICHEST FIELD REFLECTOR TELESCOPE

Clearer, brightest, most spectacular wide angle views of moon, stars, comets, galaxies ever — and portable! See heavenly wonders! Sets up in seconds (precollimated, ready to use). Pop the eyepiece in, focus — and zing! 3 1/2" field of view gives you more stars in a single view than any other type 'scope! Bright, crisp, finely resolved images. For sky gazing and earth gazing! Take it anywhere (only 17", 10 lb.), easily use it over your shoulder, (has adjustable carrying strap), in your lap, on a tripod; rotate the spherical base on its own mount for use on a table, car hood. Top quality optical system features 4 1/4", f/4 parabolic primary mirror (1/2 wave, 17" F.L.); std. 28mm Kellner eyepiece (15X). No other telescope like it. Great Christmas gift — it's even bright red!

- No. 2001AV \$129.95 Ppd.
- Spcl. Introductory Price! Goes to \$149.95 Dec. 25, 1976

SEE MUSIC IN PULSATING COLOR



New 3-Channel Color Organ adds to music listening pleasure, lets you modulate 3 independent strings of colored lamps with intensity of your music to create an audio "light show." They flash, vary in brightness related to music's rhythm, pitch, volume—pulsating lighting performance to music! Fully assembled & priced half that of others, the Edmund Sound To Light Control is a terrific value. Plug in, turn on!

- No. 42,309AV ... (ASSEMBLED) \$17.95 Ppd.
- No. 42,336AV ... (UNASSEMBLED) \$14.95 Ppd.

LOW COST PORTABLE INFRA-RED EYE



For Infra-red crime detection surveillance, security system alignment, I.R. detection, laser checking, nite wildlife study, any work req. I.R. detection & conversion to visible spectrum. Self-cont. scope incl. I.R. light source (90' nite vision!), 6032 I.R. converter tube, f/3.5 obj. lens, adjust. triplet eyepiece, auto lighter adapter, 1.6X focuses 10' to inf.; 6, 12v DC. Not avail. to CA res. exc. authd. pers. (sci., educ).

- No. 1683AV ... (11 x 14 1/2 x 3") \$299.95 Ppd.
- BINOCULAR STYLE: AS ABOVE, BUT 2.5X
- No. 1685AV ... (SUPER BRIGHT I.R. EYE) \$329.95 Ppd.

QUALITY DETECTOR UNDER \$40



New Edmund-developed, fully transistorized BFO unit capable of locating quarter at 18" — powerful 6-trans. oscillator-amplifier circuit. Easily compares to others priced 50% higher! Aluminum pole and housing—not plastic! 6" waterproof search coil (Faraday shielded to elim. outside interference); long 50-hr. battery 1-knob on-off tune control. Perfect balance;

- (9V) life; powerful 2" speaker; lightweight (2 lbs.). Great buy!
- Stock No. 80,222 AV \$39.95 Ppd.



MAIL COUPON FOR GIANT FREE CATALOG!

164 PAGES • MORE THAN 4500 UNUSUAL BARGAINS

Completely new 1977 edition. New items, categories, illustrations. Dozens of electrical and electromagnetic parts, accessories. Enormous selection of Astronomical Telescopes. Unique lighting and ecological items. Microscopes, Binoculars, Magnifiers, Magnets, Lenses, Prisms. Hard-to-get surplus bargains. Ingenious scientific tools. 1000's of components.

EDMUND SCIENTIFIC CO.
300 Edscorp Building, Barrington, N. J. 08007
Please rush Free Giant Catalog "AV"

Name _____
Address _____
City _____ State _____ Zip _____

COMPLETE & MAIL WITH CHECK OR M.O.

EDMUND SCIENTIFIC CO. 300 Edscorp Building, Barrington, N.J. 08007

How Many Stock No.	Description (609) 547-3488	Price Each	Total
<input type="checkbox"/>	PLEASE SEND GIANT FREE CATALOG "AV"		
Charge my <input type="checkbox"/> American Exp. <input type="checkbox"/> BankAmericard <input type="checkbox"/> Master Chg.			
Interbank No.		Add Service and Handling Charge \$1.00	
My Card No. Is		I enclose <input type="checkbox"/> check <input type="checkbox"/> money order for TOTAL \$	
Card Expiration Date		Signature _____	
30-DAY MONEY-BACK GUARANTEE. You must be satisfied or return any purchase in 30 days for full refund.		Name _____	
		Address _____	
		City _____ State _____ Zip _____	

WKLS, Atlanta, broadcasts 100% disc-to-air. That's why it uses Stanton's 681 series... exclusively.



Bob Helbush, Chief Engineer, making a quality control check using a 681 cartridge.

Top notch broadcasters who capture a large share of the listening audience, are critically aware of the necessity to achieve a superior quality of sound. Station WKLS is just such a station.

As Bob Helbush, chief engineer, states: "We broadcast 100% disc-to-air except for some commercials. So, for maximum quality sound and phase stability, we use the Stanton 681 SE for on-the-air use. We consider it the ideal answer for that application. And our program director uses Stanton's 681 Triple-E for auditioning new releases before we air them".

And Don Waterman, General Manager, added: "Today, every station in the SJR Communications group . . . all eight of them, all in Major Markets . . . use Stanton 681 cartridges on every turntable".

There are good reasons for this vast acceptance. Stanton's 681 Calibration Series cartridges offer improved track-

ing at *all* frequencies. They achieve perfectly flat frequency response to beyond 20 Kc. And the top-of-the-line, superb 681 Triple-E has an ultra miniaturized stylus assembly with substantially less mass than previously, yet it possesses even greater durability than had been thought possible to achieve.

Each 681 Series cartridge is guaranteed to meet its specifications within exacting limits and each one boasts the most meaningful warranty. An individually calibrated test result is packed with each unit.

Whether your usage involves recording, broadcasting or home entertainment, your choice should be the choice of the professionals... the STANTON 681.

Write today for further information to Stanton Magnetics, Terminal Drive, Plainview, N.Y. 11803.



CIRCLE NO. 63 ON FREE INFORMATION CARD

HIT THE ROAD WITH THE AUTOMATIC CB. JOHNSON.

You've got four hundred miles of dotted white line stretched out in front of you. And a couple of dozen tons riding in back.

That's why you keep the automatic CB sitting at your side. No hassle, no gadget controls, just the crisp, clean Johnson sound all day long. Automatically.

Johnson's exclusive voice tailored circuitry automatically drops off unwanted frequencies to give you clear



reception. Our automatic noise limiter keeps reception clean and built-in gain control prevents "blasting" and "fading."

Johnson's unique electronic speech compression automatically selects and compresses the clearest voice frequencies to produce

uniform, high-level modulation and maximum transmit range. All automatically.

When you hit the road, go with Johnson CB. We back every Johnson with a full year parts and labor warranty and walk-in service at more than 850 locations. See a Johnson CB dealer and take off on the great American adventure.



JOHNSON

E. F. JOHNSON COMPANY, WASECA, MINN. 56393
In Canada: A. C. Simmonds & Sons Ltd.

JOHNSON CB. THE GREAT AMERICAN ADVENTURE.

CIRCLE NO. 33 ON FREE INFORMATION CARD

www.americanradiohistory.com