

STEREO SCENE: HI-FI UPGRADING TIPS

Popular Electronics®

WORLD'S LARGEST-SELLING ELECTRONICS MAGAZINE

APRIL 1976/75c

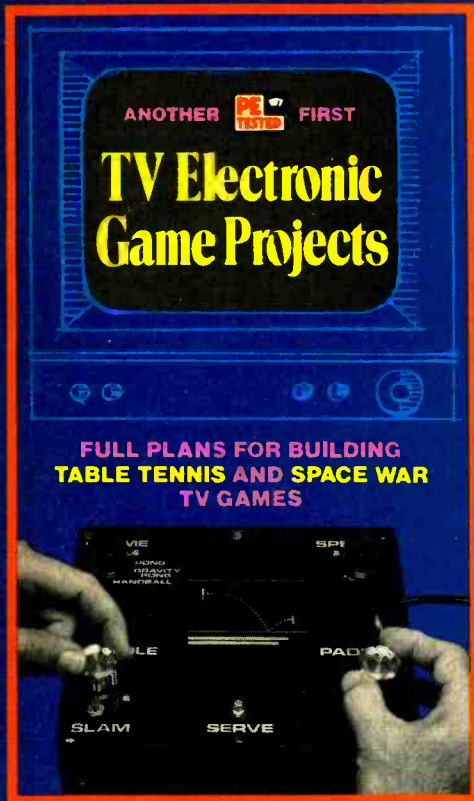

**Perf Board
Wiring Techniques**

**Introduction to
Computer Codes**

TEST REPORTS:

**LUXMAN STEREO
FM/AM TUNER**

**PIONEER DYNAMIC
PROCESSOR**

16-page Bonus!

Special Focus on CB RADIO

including:

- How to Choose CB Base Station Antennas
- It's Easy to Install a CB Mobile Transceiver
- Your CB Bicentennial Highway Buddies
- Five-minute "on" One-minute "off" Timer
- CB Equipment Terms Made Easy for Buyers



Experience is the best teacher. You might settle for any CB first time around. Understandably. A lot of people think they're all pretty much alike. But you'll soon discover that, like everything else, there are exceptions.

Ask the pros. America's long distance truckers. These guys talk CB day in and day out. And they demand the best. That's why truckers refer to the Cobra 29 as "The Diesel Mobile."

Listen to Cobra. You'll hear a big difference. Because the Cobra 29 gives you features which assure crystal clear reception. Like switchable noise limiting and blanking, to cut out practically all pulse and ignition interference. Add squelch control and RF gain and you've got exceptional—adjustable—receiver clarity. Even in the heaviest CB traffic. You also get Delta Tuning which makes up for the other guy, because even off-frequency transmitters are pulled in. Perfectly.

Talk to Cobra. And you know you're punching through. One glance at the

29's over-sized illuminated meter tells you just how much power you're punching out and pulling in. For voice modulation the DynaMike delivers at 100%. Same way with power: The 29 transmits at maximum power levels.

Sooner or later you'll get a Cobra. And you'll get engineering and craftsmanship second to none. Performance that will make your first CB seem obsolete. Reliability and durability that have set standards for the industry. Above all, you'll get power. The power to punch through loud and clear like nothing else. Because when it comes to CB radio, nothing punches through loud and clear like a Cobra.



Punches through loud and clear.

Cobra Communications, Products of Dynascan Corp.
1801 W. Belle Plaine, Chicago, Illinois 60613

CIRCLE NO. 14 ON FREE INFORMATION CARD

IF YOUR FIRST CB ISN'T A COBRA YOUR SECOND ONE WILL BE.



IMSAI®

COMMERCIAL GRADE COMPUTER – PRICED FOR THE INDIVIDUAL KIT BUILDER



QUALITY FEATURES INCLUDE:

- A commercial grade cabinet, made of heavy gauge aluminum, custom designed for this specific product. Rack mounting is optional.
- Lucite display panel with a photographically reproduced legend and LED display mask. In addition to standard lights and switches, the heavy duty front panel has an extra 8 program controlled LED's.
- Rugged commercial grade paddle switches backed up by reliable debouncing circuits.
- Gold plated contacts on board edge connectors to assure corrosion free contact at all locations.
- A heavy duty power supply to handle lots of extra cards, the power supply delivers up to 20 amperes at 8 volts, and 3 amps each at +16 and -16 volts. A 30 ampere supply is optional.
- A sturdy card cage to properly support up to 22 printed circuit boards.
- Plug removable front panel board that eliminates the normal wiring harness between front panel and back plane. For special dedicated uses, the front panel board may be removed from the unit.
- A full line of peripheral devices to build truly powerful and complete systems.
- An exclusive shared memory facility from the company that pioneered shared memory microprocessing. Shared memory facilities allow multiple microprocessors in the same cabinet to share the same memory, yet run different programs in parallel with each other.
- A full compliment of board options.

BASIC COMPUTER INCLUDES: 8080A Processor Board, Front Panel Control Board, lights and switches, power supply, Expander Board, Cabinet . . . and . . . Software (Assembler, Monitor, Text Editor, Loader and 4K BASIC).

PRICES: KIT . . . \$499 ASSEMBLED . . . \$931 4K RAM KIT . . . \$165 ASSEMBLED . . . \$299

OPTIONS: Rack mount, RAM & PROM boards, Parallel & Serial I/O Boards, an 8 level Priority Interrupt/Clock Board, Shared Memory Boards, Interface Boards.

PERIPHERALS: Floppy Disk Drives, 80 Column/300 LPM Printer, 50 Megabyte Disk Drive, 30 character per second Printer with Plotting Mode.

TERMS: Check or Money Order, BankAmericard, Master Charge, 25% deposit on COD orders. On all orders under \$1,000, add 5% for handling. California residents add 6% tax.

SEND FOR FREE CATALOG OF IMSAI MICROCOMPUTER PRODUCTS – DEALER INQUIRIES INVITED

SPECIAL NOTICE TO ALTAIR 8800 OWNERS

If you would like to step-up to the superior quality of an IMSAI 8080, you will be pleased to know that your ALTAIR 8800 boards are "plug-in" usable—without modification—in the IMSAI 8080 cabinet. Furthermore, by acquiring IMSAI's unique Memory Sharing Facility, your ALTAIR MPU Board and IMSAI MPU Board can co-exist in the same cabinet, operate in parallel with each other, and share all memory in common. This is the technology that laid the foundation for IMSAI's powerful HYPERCUBE Computer and Intelligent Disk systems (recently featured in Computerworld, Datamation and Electronics magazines.)

IMS ASSOCIATES, INC., 1922 REPUBLIC AVENUE, SAN LEANDRO, CA 94577
(415) 483-2093

16 ways to move ahead in electronics!



Choose the one that's just right for you... the one that can make your future more rewarding, more secure, more enjoyable... starting now! These ways to move ahead are yours from Electronics Technical Institute... the finest electronics home study courses and programs ever offered!

Fundamental Electronics

Get a solid foundation for entering the fast-moving world of electronics where today is great, and tomorrow will be greater. Learn it the simple, easy, step-by-step, programmed way called *Autotext*, exclusive with ETI!

Electronics Drafting

Learn a vitally needed specialty that translates new technological concepts and developments to the practical drawing board. Become a specialist-in-demand, through ETI's training. Learn it at home... get your future moving now!

Color TV Servicing

There's a real future waiting for the established color television technician. You become that technician through this program that takes you step-by-step to *theoretical and practical* mastery of color TV. Get your tomorrow started today!

Master TV/Radio Servicing

Here is true "master" preparation for a career that can take you as far as you want to go into radio and television servicing, both black and white, and color. The helpful, practical ETI way can be your way to more money, security, success!

Communications

ETI's communications program opens up a whole range of career development possibilities in electronics. Solid-state receivers, solid-state audio equipment, communications equipment, CATV, as well as preparation for FCC-licensed positions in commercial broadcasting and mobile communications. You can find a real future here!

Industrial Electronics

You open great career opportunities through this program, as instrumentation technician, electronic equipment maintenance technician, electronic calculating machine technician and audio technician. It also prepares you to move into and up in communications, automation and industrial electronics!

Digital Technology

Join the digital revolution which is radically altering our lives today and tomorrow. Get solidly trained in the new digital specialties that can lead to a real future as a digital control technician, electronic calculating machine technician, field representative, computer sales representative, manufacturer's representative.

Electronics Technology

Learn electronics across the board! You'll be ready for real career advancement with training that can lead to technical positions in communication, automation and industrial electronics, and can also help you in sales positions, management and administration.

Computers

ETI offers training opportunities in Computer Technology and Computer Programming. Learn at home, and get ready to enter a field where incredible developments are sure to continue. It's practical, useful—the step-by-step ETI way!

Advanced Electronics

Want greater challenges and career advancement? This course is for you. It can be valuable preparation not only for a technical career, but also for the fields of sales, management and administration. Make your move now!

Digital Electronics—Advanced

Here's a special course for those already in the field of digital electronics, ready to move into more advanced areas. This is how to move up in sales, management and administration. Here's your tomorrow!

Black and White TV Servicing—Advanced

This can be your own "advance" course to black-and-white TV competence from A to Z. You'll construct a receiver yourself, if you wish. A key to lifetime success!

Industrial Instrumentation—Advanced

Move up in the world... the wonderful electronics world! This course opens up a whole range of careers in the industrial field, as instrumentation technician, laboratory technician, process control technician or electronic calculating machine technician. Get ready... and go!

Color TV Servicing—Advanced

Here is the "graduate" course in color TV for those who already know television fundamentals. You'll learn color TV from top to bottom, build your own set if you choose. A great way to build your future!

Solid-State Electronics—Advanced

Applications of transistors are increasing all the time and the transistor may be a breakthrough

comparable in importance to the development of nuclear energy. Solid-state can mean your solid career development, too, through ETI!

FCC License Preparation

Here is real down-to-earth practical preparation to take your 3rd, 2nd or 1st class Federal Communication Commission Radiotelephone License examinations. Get yourself ready now for any of the FCC-licensed positions involving broadcasting, mobile communications, microwave communications links, marine communications equipment or in many other positions in solid-state, communications, CATV. Get ready for tomorrow... today!

Get all the facts... free!

Send the coupon now for ETI's colorfully illustrated new

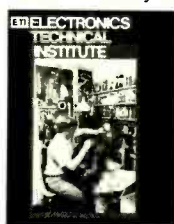

44-page catalog giving you all the details. You owe it to yourself.

There's no obligation, and no salesman will call. Send for yours today!

Electronics Technical Institute

Division of Technical Home Study Schools

Electronics Technical Institute, Dept. 2-473-046
Little Falls, New Jersey 07424

Send me the Electronics Technical Institute Catalog.

Name _____ (please print)

Address _____

City _____ State _____ Zip _____

Interested in another field? Check the Technical Home Study School program that interests you most. No salesman will call. PLEASE CHECK ONLY ONE.

- | | |
|---|--|
| <input type="checkbox"/> Typewriter and Office Machine Repair | <input type="checkbox"/> Locksmithing |
| <input type="checkbox"/> Upholstery and Decorating | <input type="checkbox"/> Legal Investigation |
| <input type="checkbox"/> Accident and Insurance Claim Adjusting | <input type="checkbox"/> Security/Alarm Business |
| <input type="checkbox"/> Outdoor Careers in Conservation | <input type="checkbox"/> Photography |

Check here for information on Veterans Benefits.

Check here for information on learning by cassettes.

Popular Electronics®

WORLD'S LARGEST SELLING ELECTRONICS MAGAZINE

FEATURE ARTICLES

INTRODUCTION TO COMPUTER CODES	R. T. Robbins	46
<i>Binary, octal, hexadecimal and BCD codes explained.</i>		
PERF BOARD WIRING TECHNIQUES FOR EXPERIMENTERS	Adolph Mangieri	66
<i>New boards and accessories for quick assembly and alterations.</i>		

CONSTRUCTION ARTICLES

TV ELECTRONIC GAME PROJECTS		
PONGTRONICS	Mitchell Waite & Larry Brown	35
<i>Play table tennis, handball, gravity pong, etc.</i>		
SPACE-WAR GAME	Joseph Weisbecker	41
<i>Space ships fire missiles at their opponents.</i>		

SPECIAL FOCUS ON CB RADIO

HOW TO CHOOSE CB BASE STATION ANTENNAS	John J. McVeigh	50
IT'S EASY TO INSTALL A CB MOBILE TRANSCEIVER	Stephen R. Davis	55
YOUR CB BICENTENNIAL HIGHWAY BUDDIES	James B. Sweeney	59
BUILD THE FIVE-MINUTE "ON", ONE-MINUTE "OFF" TIMER	John J. McVeigh	60
CB EQUIPMENT TERMS MADE EASY FOR BUYERS		62
CB TRANSCEIVER AND ANTENNA MANUFACTURERS		64

COLUMNS

STEREO SCENE	Ralph Hodges	24
<i>Hi-Fi Upgrading Tips.</i>		
SOLID STATE	Lou Garner	90
<i>A versatile New IC.</i>		
APRIL HOBBY SCENE	Marcia Swampfelder	99

PRODUCT TEST REPORTS

LUXMAN MODEL T-310 AM/STEREO FM TUNER	76
PIONEER MODEL RG-1 DYNAMIC PROCESSOR	80
LAFAYETTE COM-PHONE MARK II AM CB BASE STATION	86
HEWLETT-PACKARD MODEL 3476A AUTOMATIC DMM	88

DEPARTMENTS

EDITORIAL	Art Salsberg	5
<i>WARC-79 And Communications Hobbyists.</i>		
LETTERS		6
OUT OF TUNE		6
<i>"CB Scene" March 1976</i>		
NEWS HIGHLIGHTS		9
NEW PRODUCTS		14
TIPS & TECHNIQUES		101
ELECTRONICS LIBRARY		105
OPERATION ASSIST		108
ADVERTISERS INDEX		127

POPULAR ELECTRONICS, April 1976, Volume 9, Number 4. Published monthly at One Park Avenue, New York, NY 10016. One year subscription rate for U.S., \$6.98; U.S. Possessions and Canada, \$7.98; all other countries, \$8.98. Second Class postage paid at New York, NY and at additional mailing offices. Authorized as second class mail by the Post Office Department, Ottawa, Canada and for payment of postage in cash. Subscription service and Forms 3579, P.O. Box 2774, Boulder, CO 80302.

POPULAR ELECTRONICS including ELECTRONICS WORLD. Trade Mark Registered. Indexed in the Reader's Guide to Periodical Literature.

COPYRIGHT © 1976 BY ZIFF-DAVIS PUBLISHING COMPANY ALL RIGHTS RESERVED.

Ziff-Davis also publishes Boating, Car and Driver, Cycle, Flying, Modern Bride, Popular Photography, Skiing and Stereo Review.

Editorial correspondence: POPULAR ELECTRONICS, 1 Park Ave., New York, NY 10016. Editorial contributions must be accompanied by return postage and will be handled with reasonable care; however, publisher assumes no responsibility for return or safety of manuscripts, art work, or models.

Forms 3579 and all subscription correspondence: POPULAR ELECTRONICS, Circulation Dept., P.O. Box 2774, Boulder, CO 80302. Please allow at least eight weeks for change of address. Include your old address, enclosing, if possible, an address label from a recent issue.

Ziff-Davis Publishing Co., One Park Ave., New York, NY 10016

Hershel B. Sarbin, President; Charles B. Seton, Secretary; Vincent Perry, Financial Vice President and Treasurer

To SBE

in·no·va·tion

is not just another word

In fact, "innovation" is *the* word that guides SBE engineers in their quest for better ways to improve personal communications equipment.

An example of SBE innovation at its imaginative best is OPTI/SCAN. This compact 10-channel scanning monitor requires no crystals but is capable of scanning over 16,000 radio frequencies between 30 MHz and 510 MHz.

The secret of such electronic wizardry lies in the unique use of digital frequency synthesis, combined with an exclusive optical scanner and program card system. The "memory" for specific frequencies to be monitored is programmed in 10-frequency groups on a small plastic card no larger than a credit card. Frequency bands can be mixed on the same card; and frequency groups to be scanned can be changed instantly simply by replacing one pre-programmed card with another.

SBE innovation has transformed the scanning monitor from a fixed, inflexible unit of limited range and scope into an infinitely versatile electronic marvel that puts a limitless range of frequencies at your fingertips, wherever you are, wherever you may travel.

The same innovative skill and imagination that goes into OPTI/SCAN is reflected in the full SBE line of communications equipment: citizens band, land mobile, marine and special application.

Discover how *you* can benefit from SBE's electronic innovations.



SBE Better Communications through Creative Technology[®]

For information write: SBE, Inc., 220 Airport Blvd., Watsonville, CA 95076

INTERNATIONAL OFFICES: E.S. Gould Marketing Co. Ltd., Quebec, Canada/Linear Systems S.A. Geneva 1, Switzerland

CIRCLE NO. 53 ON FREE INFORMATION CARD

www.americanradiohistory.com



Editorial

Popular Electronics®

EDGAR W. HOPPER
Publisher

ARTHUR P. SALSBERG
Editorial Director

LESLIE SOLOMON
Technical Editor

JOHN R. RIGGS
Managing Editor

ALEXANDER W. BURAWA
Feature Editor

EDWARD I. BUXBAUM
Art Director

JOHN McVEIGH
Associate Editor

ANDRE DUZANT
Technical Illustrator

PATRICIA BROWN
Editorial Assistant

**LOU GARNER
GLENN HAUSER
JULIAN D. HIRSCH
RALPH HODGES
ART MARGOLIS
FORREST MIMS
JERRY OGDIN
WILFRED M. SCHERER**
Contributing Editors

JOSEPH E. HALLORAN
Advertising Director

JOHN J. CORTON
Advertising Sales

LINDA BLUM
Advertising Service Manager

PEGI McENEANEY
Executive Assistant

STANLEY NEUFELD
Associate Publisher

WARC-79 AND COMMUNICATIONS HOBBYISTS

The year 1979 will be a milestone in the world of communications. This is when the World Administrative Radio Conference (WARC) of the International Telecommunications Union (ITU) will be held to reexamine uses of the radio spectrum and institute changes reflecting needs and new technology for the remainder of the century.

For hams and SWL'ers, this conference will likely be the most important "happening" in a long, long time. To a lesser extent, CB'ers will be interested in the outcome of WARC-79 because it is hoped that CB will be recognized as an international service.

The present division of the radio spectrum is based largely on major changes made in 1947. At that time, meetings were dominated by the leading nations in science and technology—the U.S., U.S.S.R., U.K. and France. The same was essentially true at the last meeting in 1959. But the passing of 20 years promises a dramatic change.

Expanded by the entry of new countries, the membership at WARC-79 can be expected to be about one-third higher than at the 1947 conference. Because each country has an equal vote (as in the General Assembly of the United Nations), any under-developed country's vote holds as much weight as the U.S.'s. More importantly, decisions are binding in the sense of being international agreements. And clearly, cooperation and agreement are most desirable to maintain orderly radio "traffic."

Many of the new nations to be represented at WARC-79 are indifferent to the radio-advanced nations and couldn't care less about some radio services. The advancement of amateur radio could conceivably suffer because of these attitudes. As an example of what 1979 might harbor, consider the experiences at the Geneva Space Radio Conference (1971). New Zealand proposed that five amateur bands be considered individually for close study of spectrum allocations, with the purpose of getting a small portion of higher frequencies for hams. Statements supporting this view were made by the U.S., U.K., Canada, Italy, Denmark, Israel and the Philippines. Statements against were made by Cuba, Syria and Sweden. New Zealand's proposal lost by a vote of 38 to 26 with 6 abstentions. As a result, amateur use of these higher frequencies was put to a second test on a "should they" or "should they not" proposition. The amateur group lost: 46 against, 18 for, 7 abstentions.

With the radio spectrum expected to expand up to 275 GHz, it's important for amateur radio to stake out its claim for the future. Over the years, amateur radio spectrum space has been chipped away in one region or another. Unfortunately, there don't seem to be too many countries today that will give strong support to amateur radio. Furthermore, the "third-world" countries are heavily dependent upon point-to-point communications in the high-frequency bands. Accordingly, there might be an effort to slice away at present international shortwave allocations to favor national interests. And "CB radio" is not beloved in many countries either. So we in the U.S., with only one vote, need all the friends we can marshal at the upcoming WARC-79.

Art Salsberg

ZIFF-DAVIS PUBLISHING COMPANY
Popular Electronics
Editorial and Executive Offices
One Park Avenue New York, New York 10016
212-725-3500

Hershel B. Sarbin, President
Furman Hebb, Executive Vice President
Vincent Perry, Financial Vice President and Treasurer
Phillip T. Heffernan, Senior Vice President, Marketing
Edward D. Muhlfield, Senior Vice President, Sports Division
Philip Sine, Senior Vice President
Frank Pomerantz, Vice President, Creative Services
Arthur W. Butzow, Vice President, Production
Lawrence Sporn, Vice President, Circulation
George Morrissey, Vice President
Sydney H. Rogers, Vice President
Sidney Holtz, Vice President
Al Traña, Vice President
Philip Korsant, Vice President
Paul H. Chook, Vice President, Market Planning
Charles B. Seton, Secretary
Edgar W. Hopper, Vice President, Electronics Div.
William Ziff, Chairman
W. Bradford Briggs, Vice Chairman

Midwestern Office
The Pattis Group, 4761 West Touhy Ave.,
Lincolnwood, Illinois 60644, 312 679-1100
GERALD E. WOLFE, THOMAS HOCKNEY
Western Office
9025 Wilshire Boulevard, Beverly Hills, CA 90211
213 273-8050; BRadshaw 2-1161
Western Advertising Manager, BUD DEAN
Japan: James Yagi
Oji Palace Aoyama, 6-25, Minami Aoyama
6 Chome, Minato-Ku, Tokyo 407-1930/6821,
582-2851



Member Audit Bureau
of Circulations



The publisher has no knowledge of any proprietary rights which will be violated by the making or using of any items disclosed in this issue.



Letters

FROM BARK TO WHIMPER

Frustrated by many fruitless attempts to eliminate the ignition noise in my pickup

truck, I decided to put into practice the hints given in the February 1975 CB Scene. The solution was simple but none too pretty. I reduced the bark in my spark to a whimper ... as a result the noise level went from S7 to S2 ... can run my rig with squelch wide open and noise blanker off. Now to convince Detroit and/or other motorists to clean up their ignition noise problems.—*W.A. Fuller, Friendswood, Texas*

PARTS AVAILABILITY

The part of the January 1976 Editorial that laments the shortage of walk-in elec-

tronics parts retail stores with broad inventories certainly hits home. I have most mail-order catalogs and can attest to the fact that it takes a lot of searching for particular parts (or equivalent substitutes) called for in projects. There is no doubt in my mind that serious hobbyists would welcome at least one broad-range parts supplier to relieve them of hunting down what they need and then having to order from more than one source.—*Benjamin H. Lane, Jr., Oklahoma City, OK*

I didn't like your Editorial on parts availability. POPULAR ELECTRONICS is one of the principal causes of the shortage of suppliers. With PE as much in the business of selling as in publishing articles, the hobbyist is not required to find sources for his projects, which means that he doesn't have to approach the OEM suppliers. Hence, the suppliers are led to believe that hobbyists don't provide much of a market.—*A. D. Ac-ton, Washington, MI.*

POPULAR ELECTRONICS does not sell kits or profit from their sales. We are exclusively in the publishing business. Where possible, we often obtain suppliers of kits for construction projects so that readers can obtain parts that are not available from most other sources. Complete kits from a single source are listed for those who don't want to "hunt around." We decided to perform this service only after sources of supply began to dry up years ago, and devices proliferated.

FOR RADIO ASTRONOMY BUFFS

Readers of "An Introduction to Radio Astronomy" (January 1976) will be interested to know that there is a magazine titled *The Radio Observer* that is devoted entirely to this hobby. The magazine provides a forum where amateurs can share their progress in observing and equipment, and where newcomers can find help to get started in the hobby. Address is *The Radio Observer*, 657 Circle Dr., Santa Barbara, CA 93108.—*Richard H. Peterson, Editor.*

QUIZ WHIZ KID

I very much enjoyed the "Black Box Quiz" that appeared in the December 1975 issue, but I must admit that it was a little too easy. I'm hoping for more quizzes like this in the future.—*Don D. Lavanway, Lasalle, Ill.*

You're known by the company you keep!



Owners of Citizens Band radios represent a unique consumer group whose word-of-mouth product opinions are voiced using the product itself! These users, who "tell it like it is," have established Browning as the industry's quality leader. In the status-conscious CB fraternity, owning a Browning Golden Eagle means owning the very best—a fact that has been substantiated by actual user resale prices for the past ten years.

As pioneer in the electronics industry for over half a century, Browning has established a heritage of craftsmanship that CBers know and trust. Be it base station or mobile, every Browning unit is backed by an outstanding service policy unequalled in the industry.

For further information about Browning, talk to any of the more than 4,000,000 licensees or write for your free full-color brochure of all Browning products from

browning
laboratories inc.
LACONIA, N.H. 03246
(603) 524-5454

Out of Tune

In the March 1976 "CB Scene," the dc power leads of the transceiver should be connected to the de-energized contacts of the upper poles of the relay, not to the energized contacts as shown.

An Extraordinary Offer to introduce you to the benefits of Membership in

ELECTRONICS BOOK CLUB

take any **3** of these unique electronics books—value to \$58.70 ...for only **99¢** each

with a Trial Membership in the Book Club that guarantees to save you 25% to 75% on a wide selection of electronics books



667 (\$6.95)

671 (\$7.95)

812 (\$9.95)

715 (\$15.90)

582 (\$9.95)

821 (\$8.95)

101 (\$17.95)

672 (\$7.95)

510 (\$17.90)

COUNTS AS ONE

COUNTS AS ONE

COUNTS AS ONE

COUNTS AS ONE

COUNTS AS ONE

667 (\$6.95) **Electrical Wiring & Lighting for Home & Office**

671 (\$7.95) **Amateur-FM Conversion & Construction Projects**

812 (\$9.95) **The Feasibility of RABO Construction**

715 (\$15.90) **Small Appliance Repair Guide Vol. 2**

582 (\$9.95) **Commercial FCC License Handbook**

821 (\$8.95) **TV Troubleshooting**

101 (\$17.95) **Understanding & Using the VOM & EVM**

672 (\$7.95) **Understanding & Using the VOM & EVM**

510 (\$17.90) **Electronic Circuit Diagrams**

667 (\$6.95) **Dictionary of Electronics**

676 (\$8.95) **Practical Triac SCR Projects**

722 (\$8.95) **Amateur-FM Conversion & Construction Projects**

640 (\$15.90) **Channel Stereo**

586 (\$14.90) **The Feasibility of RABO Construction**

715 (\$15.90) **Small Appliance Repair Guide Vol. 2**

582 (\$9.95) **Commercial FCC License Handbook**

821 (\$8.95) **TV Troubleshooting**

672 (\$7.95) **Understanding & Using the VOM & EVM**

510 (\$17.90) **Electronic Circuit Diagrams**

SPECIAL BONUS
Save us invoicing costs (and your postage) by remitting with application and we'll send you this \$4.95 paperback **FREE!**

101-ELECTRONIC CIRCUIT DESIGN HANDBOOK. GIANT 416-p. circuit-designer's cookbook with 639 designs. 8 1/2" x 11 1/2" 416p. 966i. List \$17.95

487-544-p. TRIPLE SELECTION: 64 Hobby Projects for Home & Car. A host of unique fun-to-build gadgets bound to please everybody! 192p. 159ii. List \$7.95

NEW IC FET Principles & Projects. Learn about today's FETs by building useful projects from simple devices to sophisticated logic circuits. 160p. 701i. List \$6.95

Practical Triac SCR Projects. Balanced blend of thyristor theory and practical circuits. 192p. 146ii. List \$7.95

510-512-p. DOUBLE SELECTION: How to Read Electronic Circuit Diagrams. Anyone can quickly learn his way around circuits and trace signals. 256p. 191ii. List \$8.95

672-328-p. DOUBLE SELECTION: Beginner's Guide to TV Repair. Ideal handbook for anyone who wants to learn the basics of TV repair. 160p. 80ii. List \$7.95

Installing TV & FM Antennas. How to get clean, interference-free signals to your receiver—in all locations. 168p. 158ii. List \$7.95

582-COMMERCIAL FCC LICENSE HANDBOOK. Everything you need to know to pass the 1st, 2nd, 3rd class exams is included. 444p. 150ii. List \$9.95

586-368-p. DOUBLE SELECTION: Fascinating World of Radio Communications. Covers the romance of listening to all the bands. 176p. 56ii. List \$6.95

Understanding & Using Radio Communications Receivers. Semi-technical approach to help upgrade performance. 192p. 75ii. List \$7.95

640-476-p. DOUBLE SELECTION: Selecting & Improving Your Hi-Fi System. Tells you what to look for to expect and to avoid. 224p. 122ii. List \$7.95

Channel Stereo. From Source to Sound. All the simplified theory and how it's done. Info shows how you can get started with a couple of speakers and a mixer that costs less than a dollar! 252p. 102ii. List \$7.95

667-MINIATURE PROJECTS for ELECTRONIC HOBBYISTS. 20 practical, useful projects using miniature solid-state components. 168p. 77ii. List \$6.95

671-ELECTRICAL WIRING & LIGHTING FOR HOME & OFFICE. Do complete home or office wiring jobs, incl. illumination systems. 204p. 155ii. List \$7.95

672-UNDERSTANDING & USING THE VOM & EVM. Modern guide to every possible application of the VOM. 192p. 167ii. List \$7.95

676-SIMPLIFIED COMPUTER PROGRAMMING. Really makes programming simple. Stresses RPG system. 240p. 177ii. List \$8.95

681-QUESTIONS & ANSWERS ABOUT TAPE RECORDING. Has ALL the answers plus ALL the circuits, sketches, and wiring diagrams you'll ever need! Covers just about any problem you might encounter. 264p. 102ii. List \$8.95

683-PICTORIAL GUIDE TO CB RADIO INSTALLATION & REPAIR. Step-by-step approach to installing CB and ham gear in home or car. How to reduce interference, tune the antenna, maintain equipment, etc. 256p. 300ii. List \$8.95

701-CET LICENSE HANDBOOK. Covers all you need to pass the exam, including new audio & industrial exams. Includes replica test. 276p. 289ii. List \$8.95

722-AMATEUR FM CONVERSION & CONSTRUCTION PROJECTS. Covers it all—from the simple to the complex. 276p. 187ii. List \$8.95

715-406-p. DOUBLE SELECTION: Small Appliance Repair Guide. Shows how easy appliances are to repair. If you know how they work, come apart, and go back. 210p. 111ii. List \$7.95

Home Appliance Clinic. Meaty treasure trove of hard-to-come-by info on wiring & appliance repair. 196p. 61ii. List \$7.95

732-JAP CONSUMER ELECTRONICS SCHEMATIC/SERVICING MANUAL. Good mine of 89 hard-to-find schematics, plus all the service data needed for radios, tape players, phonos, etc. 87ii. 11 196p. 240ii. List \$8.95

812-RADIO CONTROL FOR MODELS. Most complete R/C handbook ever. Covers literally everything—planes, boats, cars, helicopters, tanks, etc. 350p. 417ii. List \$9.95

821-TV TROUBLESHOOTER'S HANDBOOK. GIANT quick-reference fingertip sourcebook for 100's of tried-and-tested solutions to tough-dog TV troubles. Thumb-indexed. Covers Admiral to Zenith. 448p. 300ii. List \$8.95

300-BONUS BOOK IF YOU REMIT NOW! Dictionary of Electronics. Handy reference for all electronics. Defines 10,000 terms. 420p. 487ii. List \$4.95

TYPICAL CLUB SELECTIONS and List Club prices. Master Handbook of 1001 Practical Electronic Circuits \$12.95 \$7.95—Microprocessor/Micro-programming Handbook \$9.95 \$5.95—OP AMP Circuit Design & Applications \$9.95 \$5.95—Electronic Music Circuit Guidebook \$9.95 \$5.95—Build Your Own Working Robot \$8.95 \$5.95—Introduction to Medical Electronics \$9.95 \$6.95—CB Radio Operators Guide \$8.95 \$5.95—Microelectronics \$8.95 \$5.95—21 Simple Transistor Radios You Can Build \$6.95 \$3.95—Ham Radio Advanced Class License Study Guide \$8.95 \$4.95—Small-Screen TV Servicing Manual \$9.95 \$5.95—Aviation Electronics Handbook \$11.95 \$7.95—Practical CB Radio Troubleshooting/Repair \$8.95 \$5.95—Advanced Applications For Pocket Calculators \$8.95 \$5.95—Handbooks of Multichannel Recording \$10.95 \$7.95—Radio Astronomy for the Amateur \$8.95 \$5.95

May we send you your choice of three of the practical, time-and-money-saving books on these pages as part of an unusual offer of a Trial Membership in Electronics Book Club?

Here are quality hardbound volumes, each especially designed to help you increase your know-how, earning power, and enjoyment of electronics.

These handsome, hardbound books are indicative of the many other fine offerings made to Members—important books to read and keep, volumes with your specialized interest in mind.

Whatever your interest in electronics—radio and TV servicing, audio and hi-fi, industrial electronics, communications, broadcasting, electronics as a hobby—you will find Electronics Book Club will help you get the job you want, keep it, improve it or make your leisure hours more enjoyable. With the Club providing you with top quality books, you may broaden your knowledge and skills to build your income and increase your enjoyment of electronics too.

This Special Offer is just a sample of the help and generous savings the Club offers you. For here is a

Club devoted exclusively to seeking out only those titles of direct interest to you. Members are annually offered over 50 authoritative books on all phases of electronics.

This extraordinary offer is intended to prove to you, through your own experience, that these very real advantages can be yours... that it is possible to keep up with the literature published in your areas of interest... and to save substantially while so doing. As part of your Trial Membership, you need purchase as few as four books during the coming 12 months. You would probably buy at least this many anyway... without the savings offered through Club Membership.

To start your Membership on these attractive terms, simply fill out and mail the coupon today. You will receive the books of your choice for 10-day inspection. YOU NEED SEND NO MONEY! If you are not delighted, return them within 10 days and your Trial Membership will be cancelled without cost or obligation.

ELECTRONICS BOOK CLUB P.O. Box 10, Blue Ridge Summit, Pa. 17214

Facts About Club Membership

- The 3 introductory books of your choice carry publishers' retail prices of up to \$58.70. They are yours for only 99¢ each (plus postage and handling) with your Trial Membership.
- EXTRA BONUS! If you act now and send remittance with Membership Application, we will pay all shipping and handling on your introductory books, and you will also receive the \$4.95 paperback book, "Dictionary of Electronics," giving you a total value of up to \$53.65.
- You will receive the Club News describing the current Selection, Alternates and other offerings, every 4 weeks (13 times a year).
- If you want the Selection, do nothing; it will be sent to you automatically. If you do not wish to receive the Selection, or if you want to order one of the many Alternates offered, you simply give instructions on the reply form (and in the envelope) provided, and return it to us by the date specified. This date allows you at least 10 days in which to return the form. If, because of late mail delivery, you do not have 10 days to make a decision and so receive an unwanted Selection, you may return it at Club expense.
- Personal service for your account—no computers used!
- To complete your Trial Membership, you need buy only four additional monthly selections or alternates during the next 12 months. You may cancel your Membership any time after you purchase these four books.
- All books—including the Introductory Offer—are fully returnable after 10 days if you're not completely satisfied.
- All books are offered at low Member prices plus a small postage and handling charge. Prepaid orders shipped postpaid.
- Continuing Bonus: If you continue after this Trial Membership, you will earn a Dividend Certificate for every book you purchase. Three Certificates, plus payment of the nominal sum of \$1.99, will entitle you to a valuable Book Dividend of your choice which you may choose from a list provided Members.

ELECTRONICS BOOK CLUB

P.O. Box 10
Blue Ridge Summit, Pa., 17214

Please send the 3 books circled below and invoice me.

My remittance is enclosed. Send me the 3 books circled plus "Dictionary of Electronics."

Please open my Trial Membership in ELECTRONICS BOOK CLUB as I have indicated above. I understand the cost of the books I have selected is only 99¢ each, plus a small shipping charge. If not delighted, I may return the books within 10 days and owe nothing, and have my Trial Membership cancelled. I agree to purchase at least four additional books during the next 12 months, after which I may cancel my membership at any time.

640	101	487	510	672	563	582	586
	701	715	722	732	812	821	

Name _____ Phone _____

Address _____

City _____

State _____ Zip _____

(Foreign and Canada add 10%) PE-46

Blueprint for Flat Frequency Response

In the graph below, frequency response was measured using the CBS 100 Test Record, which sweeps from 20-20,000 Hz. The vertical tracking force was set at one gram. Nominal system capacitance was calibrated to be 300 picofarads and the standard 47K ohm resistance was maintained throughout testing. The upper curves represent the frequency response of the right (red) and left (green) channels. The distance between the upper and lower curves represents separation between the channels in decibels. The inset oscilloscope photo exhibits the cartridge's response to a recorded 1000 Hz square wave indicating its resonant and transient response.

Smooth, flat response from 20-20,000 Hz is the most distinct advantage of Empire's new stereo cartridge, the 2000Z.

The extreme accuracy of its reproduction allows you the luxury of fine-tuning your audio system exactly the way you want it. With the 2000Z, you can exaggerate highs, accentuate lows or leave it flat. You can make your own adjustments without being tied to the dips and peaks characteristic of most other cartridges.

For a great many people, this alone is reason for owning the Z. However, we engineered this cartridge to give you more. And it does. Tight channel balance, wide separation, low tracking force and excellent tracking ability combine to give you total performance.

See for yourself in the specifications below, then go to your audio dealer for a demonstration you won't soon forget.

The Empire 2000Z.

Already your system sounds better.

Frequency Response—20 to 20K Hz ± 1 db using CBS 100 test record

Recommended Tracking Force— $\frac{3}{4}$ to 1 $\frac{1}{4}$ grams
(specification given using 1 gram VTF)

Separation—20 db 20 Hz to 500 Hz
30 db 500 Hz to 15K Hz
25 db 15K Hz to 20K Hz

I.M. Distortion—(RCA 12-5-105) less than .08% .2K Hz to 20K Hz @ 3.54 cm/sec

Stylus—0.2 x 0.7 mil diamond

Effective Tip Mass—0.2 mg

Compliance—lateral 30×10^{-6} cm/dyne
vertical 30×10^{-6} cm/dyne

Tracking Ability—0.9 grams for 38 cm per sec @ 1000 Hz
0.8 grams for 30 cm per sec @ 400 Hz

Channel Balance—within $\frac{3}{4}$ db @ 1 kHz

Tracking Angle—20°

Recommended Load—47 K Ohms

Nominal Total System Capacitance required 300 pF

Output—3mv @ 3.5 cm per sec using CBS 100 test record

D.C. Resistance—1100 Ohms

Inductance—675 mH

Number and Type of Poles—16 Laminations in a 4 pole configuration

Number of Coils—4 (1 pair/channel—hum cancelling)

Number of Magnets—3 positioned to eliminate microphonics

Type of Cartridge—Fully shielded, moving iron

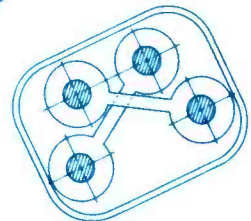
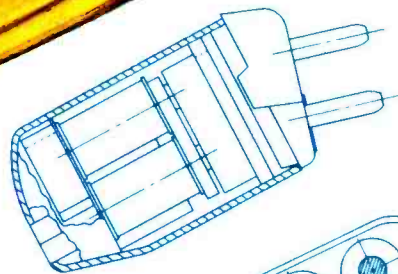
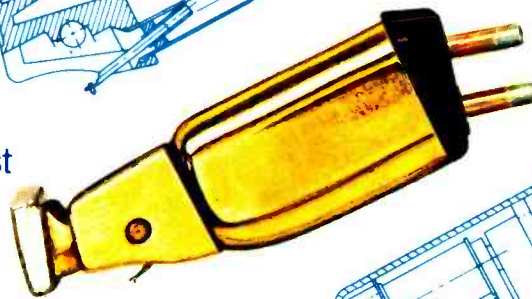
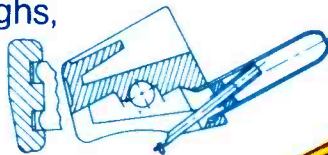
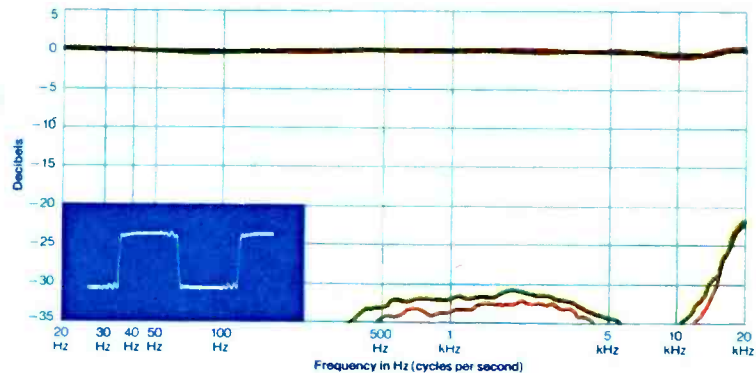

NEWS HIGHLIGHTS

Biorhythm Calculator

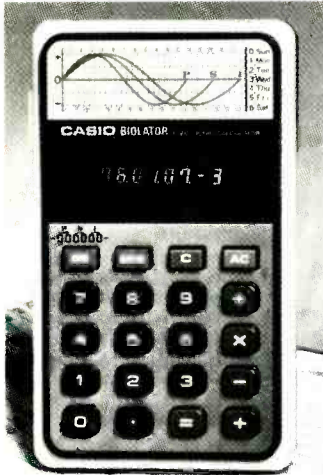

A new calculator which measures an individual's biorhythm in three significant areas — physical, sensitive (emotional), and intellectual — is being introduced by Casio as the "Biolator." A person's biorhythm is said to fluctuate in cycles of 23 days for physique, 28 days for sensitivity, and 33 days for intellect. A biorhythm graph is provided above the calculator's numerical display. Although the

company has expressed no opinion as to the validity of the biorhythm theory, for adherents of the idea, the calculator offers a quick and inexpensive means of determining biorhythm guide numbers. Aside from the machine's biorhythm capabilities, it also performs regular mathematical functions of addition, subtraction, multiplication, and division. Priced at \$29.95.

Drops Receiving Tubes & Test Instruments

Faced with a sharp decline in demand for receiving tubes, RCA has announced that it is closing its receiving tube plant in Harrison, NJ. The continuing shift to solid-state devices in consumer, industrial, and defense electronic systems is responsible for the decision. Sales in number of tubes dropped 80% since 1966. RCA is presently the sole source of about 110 tube types and plans to continue to sell tubes. Hopefully, there will be a buyer on the horizon. At the same time, RCA has sold its electronic instrument business to Viz Manufacturing Co., of Philadelphia, which will manufacture and distribute RCA's VOM's, scopes, signal generators, probe assemblies, and battery testers.

"Inching" Toward Metric

Although the metric system of weights and measures has been legal for use in the U.S. since 1866 by an Act of Congress, legislation to place the United States on a course toward voluntary conversion to the metric system was only recently signed into law. Under the new policy, industrial and commercial enterprises will be encouraged to export products made to metric dimensions, thus meeting the needs of foreign purchasers and, hopefully, providing a stimulus to international trade. The National Bureau of Standards, which has had primary responsibility for providing metric information, will hand over its duties to a 17-member United States Metric Board. NBS will continue to make availa-

ble metric information, including the NBS Metric Kit and "What About Metric," a booklet that explains metric in layman's terms. NBS Metric Information Office, Washington, D.C. 20234 is the place to write.

NBS Measures 148 THz

Researchers at the Boulder Laboratories of the National Bureau of Standards have extended the realm of directly measurable frequencies to 147.91585 THz (terrahertz, or 10^{12} Hz), with a probable error of one part in ten million. This frequency is only a factor of three below the red end of the visible spectrum, which is the next target of the NBS physicists. Frequency measurement in the near infrared was carried out without the benefit of stabilized lasers. Had they been used, accuracy could have been improved to the level of one part in 10 billion or better. A high, accurately known frequency is synthesized by heterodyning, usually by irradiating a metal-to-metal point-contact diode with laser and klystron oscillators. Then, the known signal is mixed with an unknown on the same diode. If the beat (difference) frequency is not too large, it can be measured with ordinary instruments. Thus, the unknown frequency is the sum of the difference frequency and the known laser/klystron frequency.

Computer-Generated Art Exhibit

"A Total Environment of Computer Art and Design" will be the theme of the 1976 National Computer Conference's computer art exhibit. The exhibit will demonstrate the varied forms of computer-generated art, including wall hangings, computer music, and computer films, plus computer-created objects for space planning, such as furnishings and fabric designs. The Conference will be held at the New York Coliseum from June 7 through 10. According to a Committee member, much of the material on exhibit will be auctioned for the benefit of those who participate. Requests for facsimile entries will go out shortly to individuals, companies, and educational institutions. Further details are available from American Federation of Information Processing Societies, Inc., 210 Summit Ave., Montvale, NJ 07645.

London To Honor Blumlein

The Greater London Council will erect a commemorative plaque on the wall of Alan Dower Blumlein's home in London in recognition of his many achievements in science and technology. Blumlein was the inventor of modern recording techniques, of stereo, the closely coupled inductive ratio-arm bridge, the cathode-follower circuit, and the so-called "Miller" integrator, among others. The BBC adopted Blumlein's specification in the 1930's for the 405-line, 50-frame interlaced TV system still used by the BBC today. During his short working life, Blumlein was awarded an average of one patent each six working weeks. The official unveiling of the plaque will take place on or about June 7, 1977, the anniversary of his death.

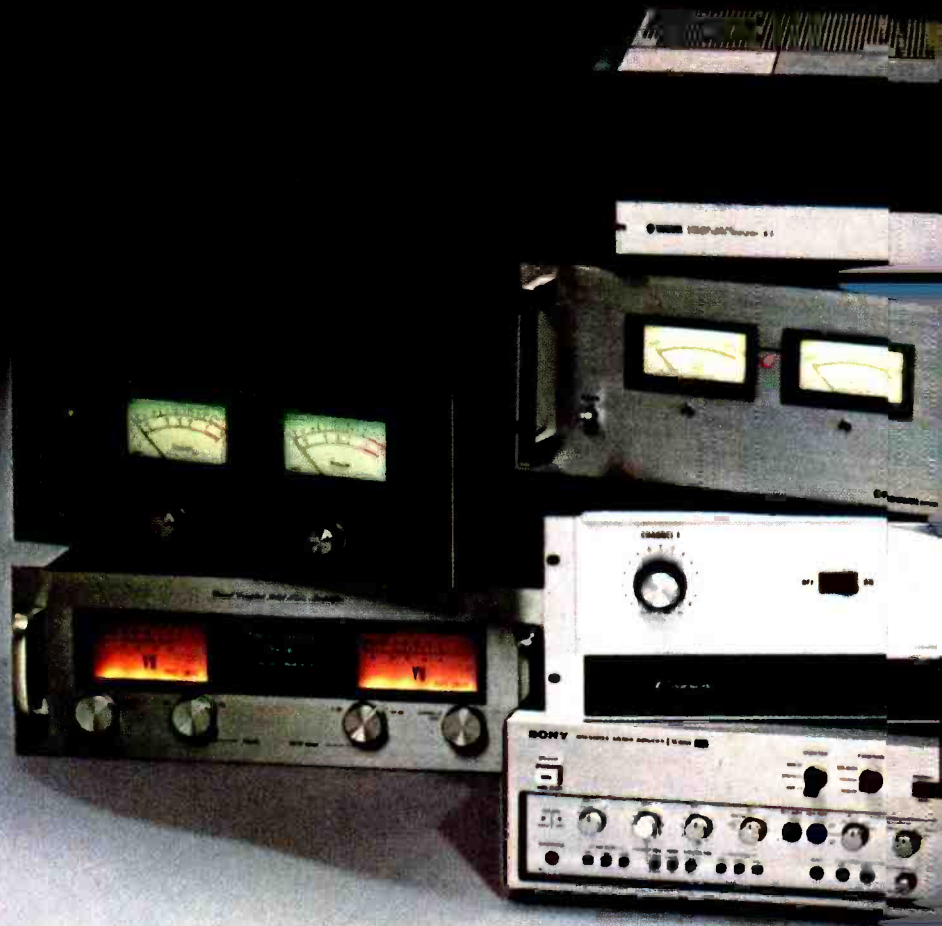

**IN THE LAST 24 MONTHS
11 COMPANIES
HAVE INTRODUCED
“SUPER AMPLIFIERS”
THAT YOU CAN’T FULLY
APPRECIATE UNTIL YOU
HEAR THEM THROUGH
THESE SPEAKERS.**



HPM-200

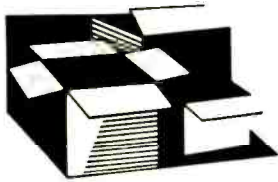

New Products

Additional information on new products covered in this section is available from the manufacturers. Either circle the item's code number on the Reader Service Card inside the back cover or write to the manufacturer at the address given.

POWER-BOOSTER AMPLIFIERS

Two power-booster amplifiers that electronically boost the audio output of a car stereo or radio are being marketed by Boman Industries. The PB-50 increases power to 50 watts "peak" and has input jacks for an electric guitar or public-address microphone. PB-40 boosts power to 40 watts "peak." Both units measure 7 $\frac{3}{4}$ " D x 5" W x 2" H, and have independent volume controls.

CIRCLE NO. 85 ON FREE INFORMATION CARD

JVC STEREO CASSETTE DECK

The Model CD-1950 stereo cassette deck

from JVC America features a front-load configuration and 0.1% wow and flutter rating. In addition, the unit offers pushbutton control mechanisms, independent capstan



and reel disc drive belts, a capstan flywheel, and an automatic noise reduction system. Other features include a 3-digit tape counter, headphone jack, left/right mike jacks, and VU meters. The deck weighs 17 lb (7.5 kg) and measures 16 $\frac{1}{2}$ " W x 11 $\frac{3}{4}$ " D x 5 $\frac{1}{8}$ " H (42 x 30 x 13 cm). It comes with one cassette tape, two head-cleaning sticks, and two connecting cords.

CIRCLE NO. 86 ON FREE INFORMATION CARD

HEADPHONES FOR CB

Three headphones, designed specifically for CB applications, have been introduced by Superex Electronics Corporation. All three models have a built-in gain-limiting circuit which automatically and instantaneously cuts volume when a strong signal is received. CB-10-2 is a base-station unit (\$25.00); CB-10-2S is a single-ear mobile unit (\$20.00); CB-10-2S-M is a mobile unit phone with 200-ohm boom mike attached, featuring remote-control PTT switch (\$40.00). The series comes in black and stainless styling.

CIRCLE NO. 87 ON FREE INFORMATION CARD

AUDIO EQUALIZER

Ace Audio Co. has announced a new audio equalizer, the AE 2002, which is being offered in kit or wired versions. The equalizer has 5 bands/channel, each covering a range of two octaves. Rated at 2 V output to a 10,000-ohm load, maximum output is 8 V rms; distortion is less than 0.5% IM or harmonic; hum and noise is -80 dB. There are switches for power, tape monitor, and equalizer in-out. An unswitched ac outlet is provided. Uses include adjusting speaker response, room acoustics, program material, and tape recordings. The unit is housed in an aluminum chassis with brushed aluminum faceplate and maple end caps. Measures: 12 $\frac{1}{4}$ " W x 7" D x 3 $\frac{1}{2}$ " H (32 x 17.5 x 9 cm) and weighs 3 lb (2.7 kg). \$84.25 (kit), \$133.75 (wired).

CIRCLE NO. 88 ON FREE INFORMATION CARD

HAND-HELD DIGITAL MULTIMETER

Non-Linear Systems has added the LM-3.5 "Volkmeter Plus" to its line of digital multimeters. The instrument has 3 full digits

KRIS Model XL 23

MOBILE AM CITIZEN BAND



a true masterpiece of engineering, the Kris XL-23 has the elegant styling, rich vibrant tones, and unexcelled exclusive* features you'd expect from Kris

Remember if it's Kris...it's Class

KRIS INC.

Pioneer Road, Cedarburg, Wisconsin 53012
Phone (414) 377-5700

EXCLUSIVE* AND DISTINGUISHED FEATURES

- * S-Meter Jack for Larger, Optional Kris S-Meter
- * Internal/External Speaker Switch
- * NO/NC Contacts - Allows Tandem Operation of Tape Deck, AM/FM Radio, Burglar Alarm System or Other Equipment
- Solid-State Reliability
- Acoustically Isolated, Self-Contained Speaker System
- Illuminated, Easy-To-Read S/RF Meter
- ANL - Automatic Noise Limiter
- Squelch Control - 0.5 uv or Less Sensitivity
- CB/PA Switch for External PA Operation
- Illuminated Channel Selector
- 23 AM Channels from 26.965 to 27.255 MHz
- Great Receiver Sensitivity - 0.5 uv for 10 db s/n
- Maximum Legal Output
- 100% Transmitter Modulation
- Transmit Light
- TVI Adjustment
- Rugged Push-to-Talk Dynamic Mic
- Compact (8 $\frac{1}{2}$ x 6 $\frac{1}{2}$ x 2 $\frac{1}{2}$)
- Easy 12VDC Installation
- Positive or Negative Ground

Kris XL-23... for the discriminating buyer... a distinguished mobile communications system

FCC TYPE ACCEPTED

See your Local Kris Distributor for our complete line of communication equipment and accessories.

1854

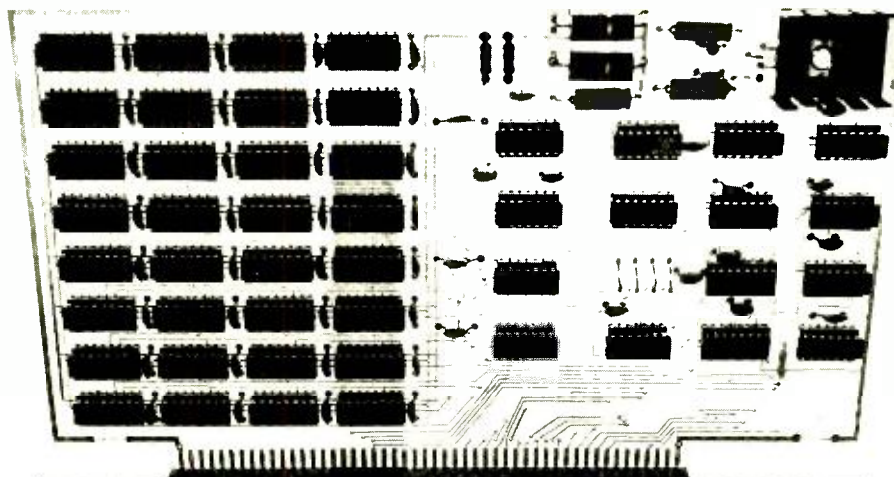

The One and Only

Altair® 4K Static.

Altair 4K Static from MITS is unquestionably the finest 4K static memory available anywhere. It is also the fastest.

Altair 4K Static uses Intel 2102 A-4 memory chips which have a worst case access of 450 nanoseconds at 70°C. At normal system temperatures the access times are typically less than 300 nanoseconds.

Altair 4K Static is fully isolated from the system bus by Schmitt™ Triggers. Thus, the excessive capacitive loading caused by other 4K static memories is eliminated. Use of these triggers on all Altair 4K static inputs greatly reduces noise. Internal data collection nodes also use Schmitt Triggers, which prevents internal data bus noise from being transmitted to the system data bus.

Altair 4K Static is the only 4K static supported by MITS. Owners of Altair 4K Static are eligible to qualify for discounts on Altair BASIC and other MITS products.

Altair 4K Static is the only 4K static that comes with all the required Altair hardware including edge connectors and card guides.

Altair 4K Static is the answer for Altair owners who need static memory for special applications such as the TV Dazzler from Cromemco.

PRICES:

Altair 4K Static Kit	\$159
Altair 4K Static Kit with 2K Memory	\$134
Chip set to convert 2K to 4K	\$ 45

SPECIAL—Altair Documentation Notebook. Contains catalog, price sheet, Computer Notes newspaper, Software Information Package, technical data on Altair hardware, list of authorized Altair dealers, list of computer clubs, survey of home computing market, and much more. All in top quality three ring binder. Only \$5 plus \$1 for postage and handling. Offer expires April 30, 1976.

MAIL THIS COUPON TODAY

Enclosed is check for \$ _____
 BankAmericard # _____ or Master Charge # _____
 Altair 4K Static Altair 2K Static
 Include \$3 for postage and handling
 Please send me the Altair Documentation Notebook. Enclosed is \$5 plus \$1 for postage and handling.
 Please send free catalog and price sheet.

NAME _____
 ADDRESS _____
 CITY _____ STATE & ZIP _____

MITS/2450 Alamo SE/Albuquerque, NM 87106/505-262-1951

Prices, delivery and specifications subject to change.

mits

2450 Alamo SE/Albuquerque, NM 87106/505-262-1951

CIRCLE NO. 37 ON FREE INFORMATION CARD

One mother is enough for your Altair.

Our single-piece Mother Board takes the place of either three or four separate 88-EC's. It's totally compatible with your 8800 system, and you can gain full sixteen-card capacity with a single installation.

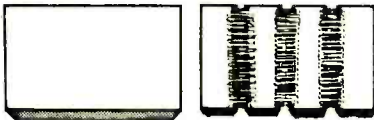

OUR MB-1 FOUR 88-EC'S

The rugged MB-1 is a full 1/8" thick, with a sturdy sixteen-slot card guide assembly that mounts directly onto the chassis. Because the MB-1 is one solid piece, you won't have to solder 300 tiny wires in four separate installations. And you'll have our exclusive bus terminator which provides greater reliability by terminating signals with the correct impedance. Both the MB-1 (replacing 4 88-EC's) and the MB-12 (replacing 3 88-EC's) are \$70, postpaid. (Master Charge accepted.)

Write us.
For details on our other compatible 8800 plug-in modules.

Processor Technology

6200-P Hollis Street
Emeryville, CA 94608

plus 100% overrange and is a multi-function, multi-range meter that fits in the palm of the hand. Self-contained rechargeable NiCd batteries permit portable operation or 117-V ac operation with the charger unit (batteries and charger included). Features include four ranges of dc and ac volts to 1000 V dc or peak ac with 1 mV resolution on the 2-V range, ohms with 1-ohm resolution and five ranges from 2k to 20M full-scale, ac and dc current in 3 ranges using shunts supplied, and automatic polarity. Input impedance is 10M on all voltage ranges to eliminate circuit loading. 4" D x 2.7" W x 1.9" H (10 x 6.5 x 5 cm).



Price \$147 including input leads, batteries, charger, and current shunts. Optional accessories include leather case, high-voltage probe, and desk stand.

CIRCLE NO. 89 ON FREE INFORMATION CARD

105W/CH POWER AMPLIFIER

Phase Linear has introduced the Model 200 stereo power amplifier. Power output is 105 W/ch minimum rms at 8 ohms from 20 to 20,000 Hz at 0.25% THD. Hum and noise is rated at least 100 dB below rated power. The amplifier features a peak-responding power-output display using LED's and an



electronic protection circuit which interrupts the amplifier output whenever hazardous input is present. The amplifier also includes a current-feedback-reducing switch. A walnut cabinet is available as an accessory. 19" W x 8 3/4" D x 5 1/2" H (48 x 22 x 14 cm). Weight 16 lb (7 kg). \$389.00.

CIRCLE NO. 91 ON FREE INFORMATION CARD

TRIGGERED-SWEEP SCOPE

The Model 1471 dual-trace 10-MHz triggered-sweep scope from B&K-Precision has 18 calibrated sweep ranges from 1 μs/cm to 0.5 s/cm and sweeps to 200 ns/cm. It will display characters directly from TTL drives. The scope is suitable for

logic and digital design applications and for troubleshooting phase-locked loops, DMM's, synthesizers, counters, and calculators. Deflection factor is 0.01 V/cm to 20 V/cm ±5% in eleven ranges. Calibration accuracy is maintained from 105 V to 130 V ac. Rise time is rated at 35 ns. Measures: 16 1/8" D x 9 7/8" W x 7 7/8" H (41 x 25 x 20 cm); and weighs 19.6 lb (8.9 kg). \$495.00.

CIRCLE NO. 92 ON FREE INFORMATION CARD

RECTILINEAR FLOOR SPEAKER SYSTEM

Rectilinear Research Corp. introduces the "Rectilinear 7" floor-standing speaker system, a new top-of-line system in its Contemporary Laboratory Series. A four-way system, it employs six drivers: a 12" woofer, 7" upper-bass midrange, two 1 1/2" upper-midrange tweeters, and two 1" super tweeters. Minimum amplifier power, 30 W rms, maximum power handling, 350 W rms. Uses a filter network rather than conventional crossover, set for uniform energy output; no level controls. Claimed frequency response, 32 to 20,000 Hz ±2 dB. Oiled walnut cabinet made of high-density fibrous material. Measures 35" H x 18" W x 12" D (88.9 x 45.7 x 30.5 cm) and weighs 80 lb (36.28 kg). \$399.00.

CIRCLE NO. 93 ON FREE INFORMATION CARD

24-PIN IC TEST CLIP

A new 24-pin test clip for IC's from Continental Specialties, the Proto-Clip 24, has a narrow throat to bring IC leads up from high-density pc boards. It can be used to inject signals and wire unused circuits to other boards. Scope probes and test leads lock onto the gripping contact teeth, freeing hands for other work. Noncorrosive nickel/silver contacts provide simultaneous wiping action. \$8.50.

CIRCLE NO. 94 ON FREE INFORMATION CARD

CORDLESS SOLDERING IRON

An 11-piece soldering iron kit, Model WC100K which contains a cordless iron and standard outlet power charger, three different tips, screwdriver, solder, soldering aid tool, sponge, instruction booklet, and plastic carrying case with tool tray has



Quality speaker systems distribute the audio load between a combination of two or more speakers. Low frequency sounds are produced by the larger woofers, while high frequency sounds are generated by the tweeters. The sound is projected by the dome or horn driver or an electrostatic speaker.

WHICH SPEAKERS ARE BEST FOR YOUR LISTENING TASTE, AND EVEN IF YOU DON'T AGREE.

The sensible way to buy speakers is to listen to the ones you are considering. A-B test the two favorites by having a friend play music back and forth between the two systems. Differences in sound will be noted. (Keep the volume level the same.) Always note the power requirements of the other components.

Most turntables are driven by the indirect method, whereby the platter is turned either by idler wheels or by a belt device (better) connecting the motor to the platter. The most sophisticated units employ the direct drive method which eliminates idler wheels by coupling the driveshaft of the motor to the platter.

DOES IT "WOW" YOU. The most common cause of wow is speed variation. The percentage of wow should be less than one percent.

Wow is caused by a variation in speed below 20 cycles per second. For quality, the percentage of wow should be less than one percent.

Wow changes above 30 cycles per second. It is also caused by idler wheels. Idler wheels have a flutter rating, less than one percent.

Wow is usually related to the quietness of the drive of the signal. 45 and 78 rpm are 45 and 78 dB.

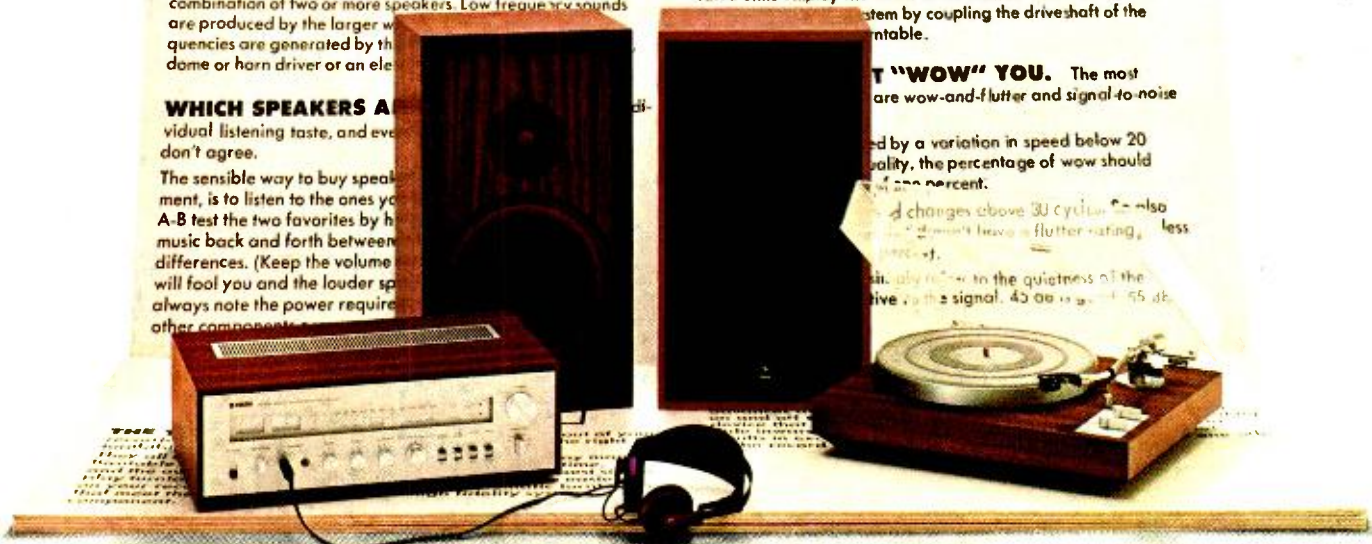

AN INTRODUCTION TO STEREO.

At Yamaha, we feel uniquely qualified to introduce you to the joys of true stereo high fidelity sound.

Since 1887, Yamaha has been making some of the finest musical instruments in the world. Pianos, organs, guitars, woodwinds, and brass.

With our musical instruments, we've defined the standard in the production of fine sound. And today, with our line of state-of-the-art stereo components, we're defining the standard of its reproduction.

However, at one time, owning a Yamaha stereo system tended to be a rather expensive proposition. Our "ultimate" system, for example, hailed by the critics for such innovations as Vertical-FET circuitry and beryllium dome speakers, carries a suggested retail price of over \$7,000.

But now, Yamaha introduces a selection of new stereo components that let your Yamaha audio dealer create a high quality system for a suggested retail price of around \$700.

What you're getting is the same performance and design concept of our most expensive system, but without the frills. Also, each component has been specially selected and matched to enhance the performance of the other components.

The Receiver: There's a lot more than power to our new CR-450 stereo receiver.

You'll enjoy brilliant tonality resulting from super low distortion—0.1% intermodulation and total harmonic distortion. (These figures are amazing, considering most other competitive receivers are typically .5% to 1.0%.)

In addition, Yamaha offers a full complement of functional features on the CR-450. Twin meters for precise tuning. High and Low Filters to eliminate noise interference. And two headphone jacks, so you don't have to listen alone. Plus our own exclusive Variable Loudness Control, which gives you full tonal balance—even at low volume levels.

The Turntable: Yamaha's new high-performance YP-450 shares many of the features of our "ultimate" system turntable, the YP-800.

A low mass tonearm, with adjustable height and anti-skating, allows the stylus to track flawlessly at the lightest pressure. And the cue control is viscous-damped in both directions to prevent record damage.

A handsome walnut-grained base and a dust cover are standard.

The Speakers: By the careful refine-

ment of proven acoustic and electronic engineering principles, Yamaha's NS-2 rivals the sound quality of many larger, more expensive speakers.

The NS-2's soft dome tweeter and high compliance, foam surrounded woofer (the same design principles featured in our superlative NS-690 speaker) offer excellent high frequency dispersion as well as clean, accurate bass reproduction.

Underneath the NS-2's removable grille cloth, quality construction is evident in the fully finished front cabinetry.

The Headphones: Yamaha's patented new Orthodynamic design HP-2 combines the smooth highs of the best electrostatic headphones with the full, rich bass of the best dynamic types.

In addition, the HP-2 features comfortable featherlight styling by famous Italian designer Mario Bellini.

An Introduction to Stereo. Chances are, when it comes to understanding terms like watts, dB's and signal-to-noise ratios, you're probably a little confused. So we've prepared a booklet that explains the basics of the world of sound.

Appropriately enough, it's titled "An Introduction to Stereo."

To get your free copy, just send us the coupon.

Then, once you know the basics, visit your local Yamaha audio dealer. His knowledgeable salesmen and extensive demonstration facilities can save you a great deal of time and money in helping you select a system. And his first-class service will keep you happy.

So talk to your Yamaha audio dealer. His experience and your ears make the perfect introduction to stereo.

Yamaha International Corporation,
Audio Division, P.O. Box 6600-L,
Buena Park, Calif. 90620
Please send my free copy of
"An Introduction to Stereo."

NAME _____
ADDRESS _____
CITY _____
STATE _____ ZIP _____

YAMAHA

been introduced by Weller. Designed to handle repairs at sites where there is no line power available, the 5¼-ounce iron, with fingertip control and safety lock, heats in six seconds and develops a constant tip temperature at 700°F. It uses long-life rechargeable NiCd batteries and has a built-in work light. Price \$29.95.

CIRCLE NO. 95 ON FREE INFORMATION CARD

HAM COMPUTER TERMINAL

Computronics' "Morsetyper" computer terminal, Model BDC, can store over six "Quick Fox" sentences or 256 "V" characters in its five registers. It will use this memory capacity in two modes, QSO or

QST, at speeds from 5 to 200 w/m. Both modes allow random speed touch-in while the machine outputs uniformly at any set speed. A 56-pad touch keyboard provides 36 alphanumeric, 8 punctuation, 7 pro-signs, 5 prowords, and error. Distress messages or bulletins can be endlessly repeated, making the machine a solid-state equivalent of a tape recorder but with the advantage of instant reprogramming. Three status lights and a monitor allow the functions of the Morsetyper to be seen and heard. The unit will operate from 120/240V, 50/60 Hz ac. It measures 13.75" W x 8.5" D x 4" H (35 x 22 x 10 cm); shipping weight is 10 lb (4.5 kg). \$495.

CIRCLE NO. 96 ON FREE INFORMATION CARD

THE YOUNGEST REVOLUTIONARY



From the deep jungles of jumbled software, from the rivers of mysterious circuits, he came. Mini-Micro Designer. He was tough and smart. And he glowed with purpose. To teach the people microcomputers.

Learn from the leader in the modern electronics revolution. E&L's Mini-Micro Designer (MMD-1) comes with a series of educational "modules" that teach you how to design and use a microcomputer. And you get complete documentation and full software support. MMD-1 features the 8080A central processor chip, direct keyboard entry of data/instructions, LED status indicators, and all the apparatus needed to make your first microcomputer. Novice or expert, MMD-1 gets you into action fast. Put a revolutionary on your side. Send for more information today.



Prices start at \$125.00 in kit form.

CIRCUIT DESIGN, INC.

Division of E&L Instruments
P.O. Box 24
Shelton, Conn. 06484

CIRCLE NO. 13 ON FREE INFORMATION CARD

CD IGNITION SYSTEM

Delta Products, Inc. now has a new high-energy capacitive discharge ignition system — Mark Ten C. Designed for modern-day engines with or without emission con-



trol devices, the system uses "Vari Spark" circuitry plus improved thermal output energy, new dc-to-dc converter/transformer, and high output energy to help overcome problems caused by poor manifold, lean mixtures, and variations in gasoline. Available fully assembled at \$69.95.

CIRCLE NO. 97 ON FREE INFORMATION CARD

BASE-STATION FILTER FOR CB

Cornell-Dubilier has added a susceptibility base-station filter to its line of CB noise filter products, the Model CBBS-1. It is designed to remove interfering power-line signals entering base-station receptacles through the ac power lines. The filter is applied at the base station.

CIRCLE NO. 98 ON FREE INFORMATION CARD

AUDIO SIGNAL-TO-NOISE SQUELCH

"Sound Off" is a self-compensating signal-to-noise squelch that operates directly on the audio signal. It can be placed anywhere in the audio line and will squelch the signal whenever speech or other information is removed. Applications include vhf communications, SSB communications, telephone circuit systems, and voice-operated tape recorders. It operates from its own ac power supply and automatically compensates for changes in atmospheric noise and is insensitive to false triggering by impulse or other noise. Heart of



the unit is a patented miniature signal analyzer which constantly monitors the content of the channel and determines if information or noise is present. Kahn Communications, Inc., 74 N. Main St., Freeport, N.Y. 11520.

POPULAR ELECTRONICS

When you've got a Pace CB radio, you've got the world by the ears.

Pace gives you the power to make people listen. With information on the weather ahead. Reporting emergencies . . . "boiled over radiator at 18th and Grove" . . . In obtaining information . . . "just drove into town, where's the cheapest gas?" . . .



NEW

Pace CB 166 is the CB radio with frequency synthesis and digital logic. Utilizing Phase Lock Loop circuitry. Or, more simply stated: Phase Lock Loop generates the proper selected frequency and keeps you on that frequency by utilizing computer technology.

Engineered to give you maximum power. And ask your dealer about the strength of Pace's warranty.

PACE . . . BEST SELLING CB IN THE WORLD*

((P)) PATHCOM INC. PACE® TWO-WAY RADIO PRODUCTS

24049 S. Frampton Ave., Harbor City, CA. 90710

Available in Canada from Superior Electronics Inc. Export (all other parts of the world): 2200 Shames Dr., Westbury, N.Y. 11590

*Based on Pathcom estimates.

02102

The real way to learn digital electronics!

NRI is the only school to train you at home on a real digital computer.

Learn computer design, construction, maintenance and programming techniques on your own programmable digital computer.

Qualified technicians are urgently needed for careers in the exciting new field of digital

and computer electronics . . . and the best way to learn digital logic and operations is now available to you in NRI's Complete Computer Electronics course.

This exclusive course trains you at home on your own digital computer! This is no beginner's "logic trainer", but a complete programmable digital computer that contains a memory and is fully automatic. You build it yourself and use it to define and flow-chart a program, code your program, store your program and data in the memory bank. Press the start button and the computer solves your problem and displays the result instantly.

The NRI digital computer is one of 10 kits you receive in the NRI Complete Computer Electronics Course. You build and use your own TVOM, and experiment with NRI's exclusive electronics lab. You perform hundreds of experiments, building hundreds of circuits, learning organization, operation, troubleshooting and programming.

New NRI Memory Expansion Kit

The Model 832 NRI Digital Computer now comes with a new Memory Expansion Kit. Installed and checked out in 45 minutes, it doubles the size of the computer's memory, significantly increasing the scope and depth of your knowledge of digital computers and programming. With the large-scale IC's you get the only home training in machine language programming . . . experience essential to troubleshooting digital computers.



Only NRI offers you five TV/Audio Servicing Courses



NRI can train you at home to service TV equipment and audio systems. You can choose from 5 courses, starting with a 48-lesson basic

course, up to a Master Color TV/Audio Course, complete with 25" diagonal solid state color TV and a 4-speaker SQ® Quadraphonic Audio System. NRI gives you both TV and Audio servicing for less than you'd pay for either course at the next leading home study school!

All courses are available with low down payment and convenient monthly payments. All courses provide professional tools and "Power-On" equipment along with NRI kits engineered for training. With the Master Course, for instance, you build your own 5" wide-band triggered sweep solid state oscilloscope, TV color pattern generator, CMOS digital frequency counter, and NRI "Discovery" electronics lab.



*trademark of CBS, Inc.

NRI's complete communication course includes your own professional 500-channel VHF transceiver



NRI prepares you for a career in the rapidly expanding field of communications . . . a field destined to double in the next decade! You can train at home for one of the thousands of service and maintenance jobs opening in Citizens

Band, AM and FM transmission and reception, TV broadcasting, microwave systems, teletype, radar, marine electronics, mobile communications, and aircraft electronics. You train on your own 500-channel, digitally-synthesized VHF Transceiver and AC power supply; CMOS digital frequency counter; with bite-size lessons leading to your FCC radiotelephone license and the communications field of your choice.

You pay less with NRI training and you get more for your money.

NRI employs no salesmen, pays no commissions. We pass the savings on to you in reduced tuitions and extras in the way of professional equipment, testing instruments, etc. You can pay more, but you can't get better training.

More than one million students in 62 years have learned at home the NRI way.

Mail the insert card and discover for yourself why NRI is the recognized leader in home training. No salesman will call. Do it today and get started on that new career.



APPROVED FOR CAREER TRAINING UNDER GI BILL
Check box on card for details.

MAIL THE INSERT CARD FOR YOUR
FREE NRI CATALOG No salesman will call



NRI SCHOOLS
McGraw-Hill Continuing Education Center
3939 Wisconsin Avenue,
Washington, D.C. 20016



Stereo Scene

By Ralph Hodges

HI-FI UPGRADING TIPS

THIS COLUMN is addressed mainly to those who, having recently acquired their first audio systems and installed them in a mad rush of anticipation, have never gotten around to those last, fussy little details and adjustments necessary to bring performance up to its peak. There are also some notes on routine maintenance, and a couple of items that might be called helpful hints of interest even to old timers.

The War With the Neighbors. You apartment dwellers who risk eviction proceedings every time you turn up the volume control may appreciate this item. It is amazing—even astonishing—to discover how much intra-building noise is transmitted, not through the air, but through the structure of the building itself. A heavy speaker resting on a bare floor will inevitably impose vibration on the underlying supports, and these impulses can travel with very little loss to the strangest and most remote places. The solution is to shock-mount the speaker at the points where it rests on the building structure. Experience shows that the smallest expenditure can yield great improvements. Even the simple rubberized squares intended to be placed under the legs of furniture will, in many cases, completely pacify a disturbed neighbor. Layers of carpet underneath the speaker should do better still. For problem cases you might construct a “sandwich” of plywood sheets with a slab of polyurethane foam in between, making sure that the foam is not compressed so much that it loses its resiliency.

My speakers sit on a wood platform constructed of 2 × 3's and plywood flooring. Every point where the platform contacts wall or floor is buffered with a rubber socket. I think I may have overdone it, because aside from those few privileged guests who have been

invited to the inner sanctum to hear the system in all its glory, no one else in the building seems to know it exists.

Incidentally, another prime factor in noise transmission is the ventilating ducts found in apartments with interior bathrooms or kitchens. Usually these can be blocked off with chunks of foam for listening sessions, but even closing strategic doors around the apartment before you turn on the music may do the trick.

Wiring Yourself For Sound. Now it's time to look at that rat's tangle you call your speaker cables. Any conductor that connects speaker to amplifier will enable the speaker to make a noise, but inadequate wiring will waste amplifier power, degrade the damping factor, and subtly but measurably affect frequency response. Rarely will any of this be grossly audible, but why ask for trouble? The nomograph of Fig. 1 (courtesy Crown International) reflects the practices of professional installers. If you're in doubt or too lazy to measure the required cable lengths, number 16 lamp cord is adequate for most home installations where amplifier and speakers share the same room.

Cleanliness Counts. Air circulates in generous amounts through an audio amplifier when it is in use, and the air brings dust with it. When it collects on heat sinks and chassis, the dust tends to contain the heat, which then has a chance to do its dirty work on capacitors and other circuit components. At least once a year it's a good idea to take the cover off your amplifier (and other electronic components) and wipe it down with a rag dampened with a mild cleaning agent. Vacuum tubes, if any, should be removed and thoroughly swabbed, and the fans on the backs of capstan motors in tape recorders deserve a careful going-over. The little finned

assemblies often attached to circuit-board transistors are also heat sinks that require the cleaning treatment. There will usually be a greasy substance in the vicinity of driver and power transistors. Novices have been known to react to its presence with horror, but it is merely a silicon compound to improve the efficiency of the heat sinks, and it should be left undisturbed as much as possible.

While the covers are off, you might (if you're equipped with a proper voltmeter) want to check that the power-supply voltage(s) is within tolerance, and that none of the coupling capacitors are “leaking.” The presence of appreciable dc levels on the “cold” sides of coupling capacitors is often a sure prophecy of puzzling sonic degradation in the near future. If supply voltages and coupling capacitors are holding up, you can clap the cover back on the unit with reasonable confidence of good performance in the coming year. But before you close things up squirt all controls and switches with a good TV tuner cleaner. And when you reinsert the component into the system, make sure that all connections are tight and that interconnecting cables are not intermittent.

Getting Needed. Surprisingly, a major contributor to bad sound is a dirty phono stylus. I once thought that the enormous pressures involved with tracking a phonograph record would pulverize and then wipe away any contaminants that might build up on the stylus, but authorities tell me otherwise. Anyway, there is certainly no question about the horrendously bad sound that a dirty stylus can produce.

You can pick your own solution to dirty styli. Any grain alcohol will do, although I prefer vodka when I can get it. Simply fold your cocktail napkin to form a sharp point, dip said point quickly into the alcohol and rub it gently around the tip and base of the stylus. In a short time the tiny diamond chip should begin to exhibit a (usually) yellowish highlight, and the job is virtually done. Afterward, the stylus should be kept clean by stroking, with a soft brush, after every record. The experts say you should brush only from back to front, but for many years I have had no problem with brushing every which-way. I do keep the speakers on when I brush, however. (A noise loud enough to harm the stylus is also likely to destroy the speakers, so you

AU+TU=VALU

The great Sansui equation

For those who want and can appreciate superior high fidelity, here are three great values. These integrated amplifiers and tuners are both matched and designed to give you incredibly clean tonal quality, versatility, and performance.

The AU-5500 integrated amplifier with 32 watts per channel, min. RMS, both channels driven into 8 ohms from 20 Hz to 20kHz, has no more than 0.15% total harmonic distortion. Features triple tone controls with a middle frequency control to add pleasure to your music;

high and low cut off filters; 7 position tape play/dubbing switch for creative recording versatility. The AU-5500 is matched with the TU-5500 tuner, with a $1.9\mu\text{V}$ sensitivity and a selectivity of better than 60 dB.

The AU-7700 integrated amplifier offers a power output of 55 watts per channel, min. RMS, both channels driven into 8 ohms, from 20Hz to 20kHz and no more than 0.1% total harmonic distortion. Features a 7-position tape play/dubbing switch for creative recording versatility; selectable phono input impedance. It is matched with the TU-7700 tuner, featuring a $1.8\mu\text{V}$ sensitivity for picking up even the weakest signals. Selectivity of better than 80 dB.

Sansui also offers an AU-4400 integrated amplifier and TU-4400 tuner which display the same Sansui high quality performance and many of the same features as the other pairs in this series of separates.

If you should not be as yet a devotee of separate components, any of these pairs is sure to make you one. Stop in soon at your nearest Sansui franchised dealer to select any of the three combinations for musical enjoyment you will value for many years to come.

TU4400
AU4400

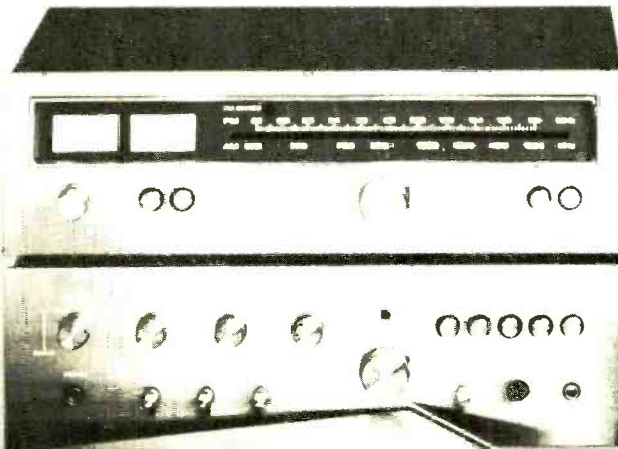

TU5500
AU5500



TU7700
AU7700



Sansui

SANSUI ELECTRONICS CORP.

Woodside, New York 11377 • Gardena, California 90247

SANSUI ELECTRIC CO., LTD., Tokyo, Japan • SANSUI AUDIO EUROPE S.A., Antwerp, Belgium

In Canada: Electronic Distributors

CIRCLE NO. 55 ON FREE INFORMATION CARD

www.americanradiohistory.com

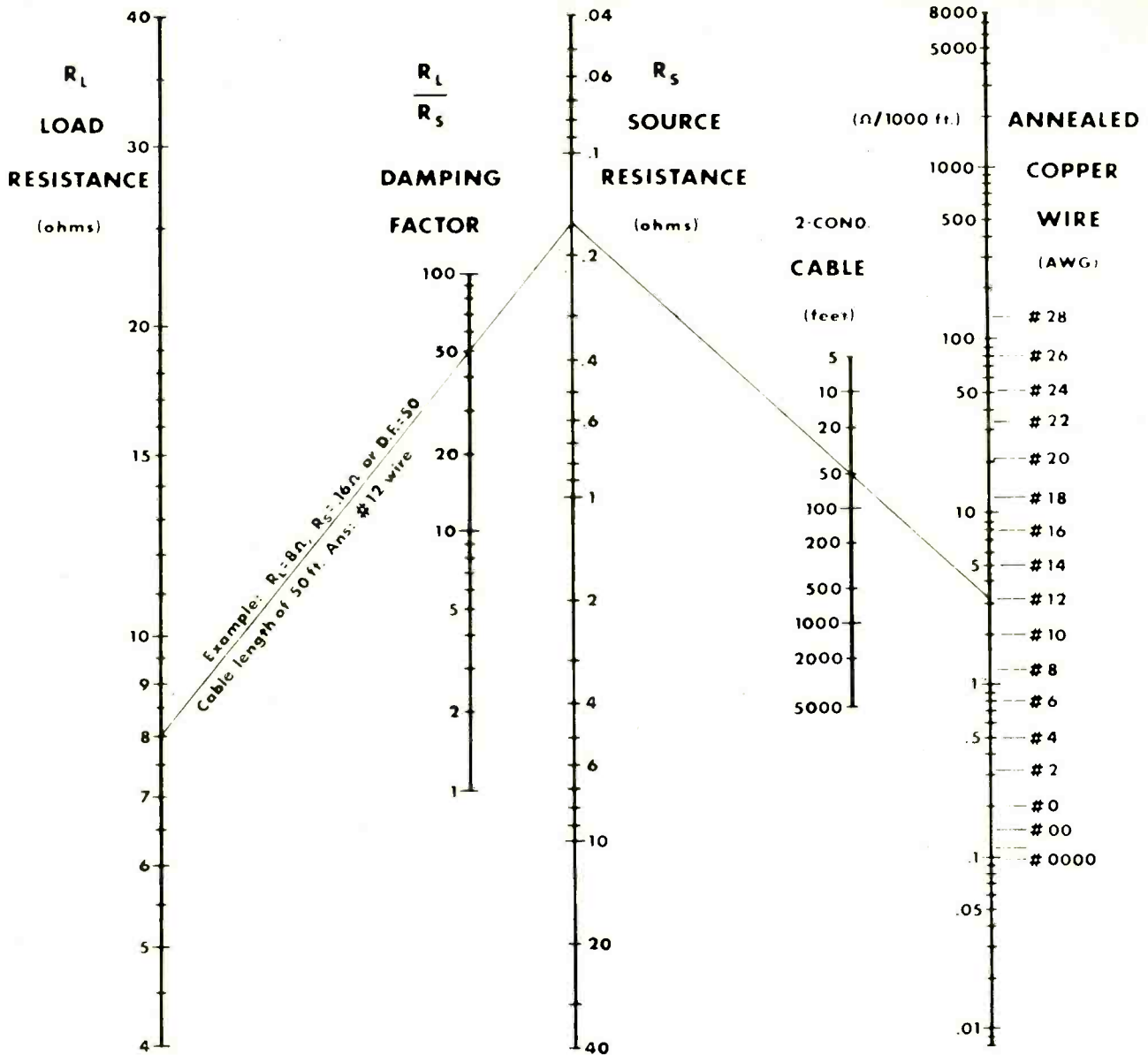

Fig. 1. Nomograph relating cable length, wire size, and damping factor. For a given load resistance and damping factor, wire size and length can be determined.

generally know where you are). And I use *reasonable* care!

When it's time to get your stylus checked for wear (twice a year for heavy users is advisable), go to a place with a good microscope designed for the purpose. However, be aware that many microscopes have insufficient depth of field, improper lighting, or other limitations. Insist on examining the stylus yourself, after the salesman has had his look. This is not to forestall hanky-panky (although it has happened that people have been sold new styli when the old was perfectly adequate), but to familiarize yourself with the appearance of a worn stylus. It is not always easy to judge when a diamond tip has passed the point of usability. Some elliptical styli never

acquire the flat spots and chisel edges that are such a risk to records; instead, they grow more rounded, finally becoming virtually conical (or spherical) in profile. In this case, the sound you get from your records remains the best indicator of excessive wear. When the stylus starts snagging the bottom of the record groove (usually indicated by an intolerable increase in noise), it has had it.

I don't want to play down the damage a worn stylus can do to a record; it is a very real and sobering fact.

Alignment Aggravations. A cartridge's stylus assembly must be properly aligned with the record groove or the record won't be traced in the intended way. I have heard

numerous testimonials to the effect that cartridge alignment is not critical, but I am still not so sure. Alignment, I feel, can have an effect on the sound you hear, particularly with difficult records. The trouble is that perfect alignment is very difficult to achieve in practice.

The lateral tracking-angle adjustment attempts to assure that the front-to-back axis of the cartridge is precisely parallel to the tangent of the record groove at the point where the stylus contacts it. This tangency is most important at the inner grooves, where the curvature of the grooves is greatest, and where recorded wavelengths are short. The stylus overhang adjustment on many record players can be used to try to achieve this

HOW TO SAVE HUNDREDS OF DOLLARS ON PARTS. PAINLESSLY.

STRETCH YOUR BUDGET FURTHER WITH DESIGN MATE 2

Precision function generator lets you test all kinds of equipment, with 1Hz-100kHz signals. Low-distortion sine waves, high-linearity triangle waves, fast-rise-time square waves. Five decade ranges, accurate to 5% of dial setting, with variable 100mV-10V P-P output and constant 600-ohm impedance. At \$64.95*, it's a lot of signal for very little money.



SAVE MONEY AND TIME WITH DESIGN MATE 1

This precision all-in-one unit combines a solderless plug-in breadboarding system with a built-in better-than-1%-regulated variable 5-15V supply and 0-15V voltmeter. Gives you everything you need to design and test circuits faster than you ever could before. Saves money by eliminating lead damage and heat damage to components. Lets you re-use parts over and over again, to save even more. All for just \$49.95*



SAVE MORE MONEY AND TIME WITH DESIGN MATE 3

Accurate R/C bridge helps you use "bargain" components. Quickly and easily measures resistance 10 ohms-10 meg; capacitance 10pF-1 μ F—both in decade ranges to within 5% of dial setting. Simple, 2-control operation and positive LED indication make measurements in seconds. At \$54.95*, it pays for itself in no time.



At CSC, we've developed a family of ingenious Design Mate™ test equipment that gives you professional quality and precision at very *un*professional prices. Each unit can save you money—and time—in a number of interesting ways. For more information on these, or any other CSC products, see your dealer or write for our catalog and distributor list.

CONTINENTAL SPECIALTIES CORPORATION



EASY DOES IT

44 Kendall Street, Box 1942
New Haven, CT 06509 • 203-624-3103 TWX 710-465-1227
West Coast office: Box 7809, San Francisco, CA
94119 • 415-421-8872 TWX: 910-372-7992
Canada: Len Finkler Ltd., Ontario

*Manufacturer's suggested list. Prices and specifications subject to change without notice. © 1976, Continental Specialties Corp.

CIRCLE NO. 15 ON FREE INFORMATION CARD

avanti's CB mobile antennas

offer:

- Quality construction
- Long range
- Mounting versatility

This is the Avanti Racer 27 mobile antenna. A first quality instrument, it is one of the most popular antennas in the entire CB field. That's because experienced CBers appreciate the benefits of a good, dependable long-range antenna that offers quiet performance.

The Racer 27 is readily adaptable to a wide variety of mounting assemblies:

- a fold-over mount for campers and vans
- a no-hole trunk mount (no drilling into your car)
- a mirror bracket mount for trucks
- a dual assembly for increased performance on all vehicles
- Avanti makes the famous MOONRAKER CB BASE ANTENNA

The Racer 27 is Avanti Model AV-327. Suggested retail \$23.95

This is only one of many Avanti antennas for car, boat or home. Send today for FREE full-color catalog.



avanti

RESEARCH AND DEVELOPMENT, INC.
340 Stewart Ave., Addison, Illinois 60101

(Drawing from Shure owner's manual.)

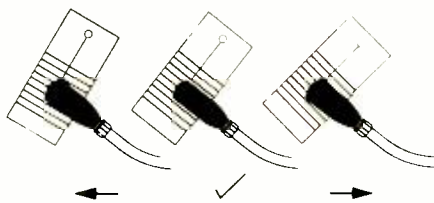

Fig. 2. Center sketch shows correct alignment of cartridge.

tangency, but many turntables are sold without specific instructions on how to make the adjustment. If that is your problem, you can construct the alignment protractor shown in Fig. 2. A 3 x 5 index card should serve your purpose. Drill or cut a hole in one end to fit the turntable spindle snugly. Then draw a straight "radius" line from the center of the hole to the other end of the card. Draw several perpendiculars to this line. Then make a tiny pinhole in the middle of the radius line about 2½ inches away from the spindle hole. If you fit the spindle hole over the turntable spindle and place the phono stylus in the pinhole, the outline of the tonearm's cartridge shell, as viewed from directly above, should be square with the perpendicular lines on the protractor. If it is not, moving the cartridge forward or back in the shell will make it so. And then, assuming that the cartridge is mounted straight within the shell, you have done the best job of lateral alignment that the naked-eye approach permits.

The vertical tracking-angle adjustment is also a line-of-sight operation. The object is to make sure that the cartridge, viewed from the side, is precisely parallel to the record surface. (The reference plane for this adjustment is usually the top of the cartridge, although there is doubt about this in some cases). If the cartridge is not parallel, shimming it with spacers on its mounting screws, or raising or lowering the tonearm base, will get it into shape. Note that this is a compromise adjustment that will not be absolutely correct for every record.

Azimuth adjustment (ensuring that the stylus is vertical to the record surface when viewed from the front) is the easiest adjustment to make. The procedure usually recommended is to place a pocket mirror on the turntable platter, lower the stylus onto it, and adjust until the cartridge and its reflection are aligned (Fig. 3). Unfortunately, most pocket mirrors are silvered on their undersides, so the reflection is some distance away from the car-

tridge, complicating the adjustment. As a substitute for the mirror, you can use an actual record, which when properly lighted and viewed from the right angle will give an adequate reflection.

How About a New Turntable? The quickest thing to wear out in an inexpensive system is usually the record changer, which may become erratic in its changing mechanism or just generally tired and rumbly. If you're willing to get involved with its innards, even an inexpensive compact system can often be connected to an external

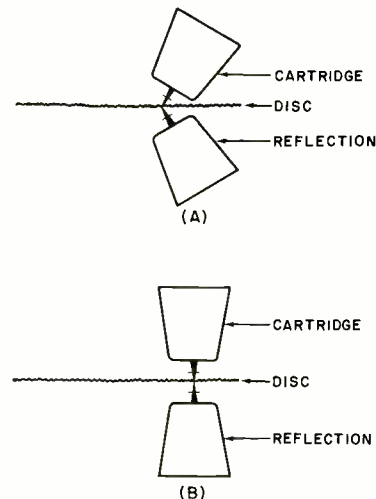

Fig. 3. Cartridge should line up with its reflection in mirror.

turntable, bypassing the packaged unit. And if it is of reasonably good quality, the outboard turntable will preserve your record collection until you can afford the "ultimate" system.

An obstacle to this plan may arise since most modest record players use ceramic phono cartridges, whereas a good turntable is customarily designed to accept a comparatively light-tracking cartridge of high compliance. As a rule, this means a magnetic cartridge, since there is a severe dearth of high-quality ceramic pickups. However, to meet the requirements of an amplifier designed for ceramic cartridges, the output of a magnetic pickup must be equalized and somewhat amplified. You'll need, therefore, an outboard phono preamplifier to go with the turntable. Such devices are in good supply, ranging from deluxe (and costly) units from Shure and All-Test, among others, to Pickering's and Shure's inexpensive Models PP-1 and M64, respectively. Interfacing these with almost any amplifier should involve no insurmountable problems, although you'll have to pay attention to ground connections. ♦

POWER



IN DRESS ATTIRE.

There's plenty of power packed in this beautiful receiver. Muscle your receiver needs for more than just sound volume. Power produces clear distortion-free sound. And it gives it to you even at low volume.

The Lafayette LR-3500 has a well-developed 47 watts per channel minimum RMS. Both channels driven at 8 ohms from 20-20,000 Hz with no more than 0.5% total harmonic distortion.

The top of the Lafayette line, the LR-3500 AM/FM stereo FM receiver has all the features you've come to expect as the trappings of power. It has state-of-the-art electronics, complete power controls to personalize the sound. And many convenience features like dual tape monitors, and FM mute.

Power is yours with the Lafayette LR-3500. It's \$399.95 at your Lafayette dealers. There are dealers coast to coast. Or shop from our free catalog.

The Lafayette LR-3500 can make your dreams for power come true.

Electronically Speaking,
Who Knows Better Than

Lafayette

Radio Electronics & Shopping Centers

© Lafayette Radio Electronics Corporation 1976 • 111 Jericho Turnpike, Syosset, N.Y. 11737

CIRCLE NO. 34 ON FREE INFORMATION CARD

www.americanradiohistory.com

The better the training the better you'll

Send for
FREE
illustrated
career
guide

NTS guide
to careers in
Electronics

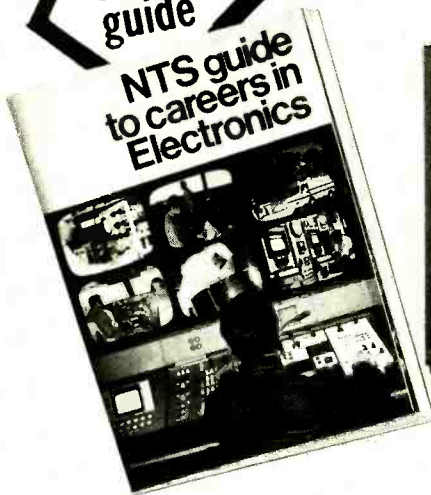

IN-CIRCUIT TRANSISTOR TESTER
COMPU-TRAINER
TROUBLESHOOTER
VOM

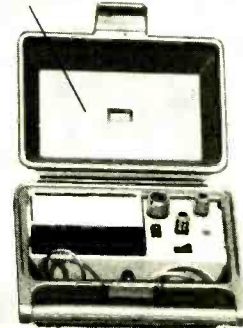

SOLID-STATE
OSCILLOSCOPE

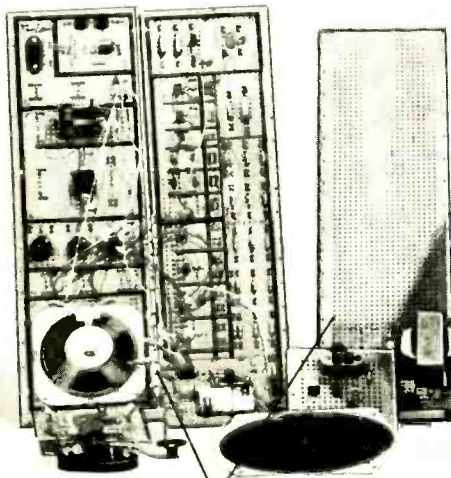
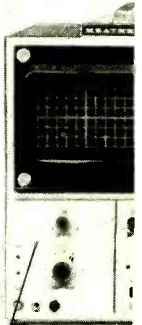

ELECTRO-LAB

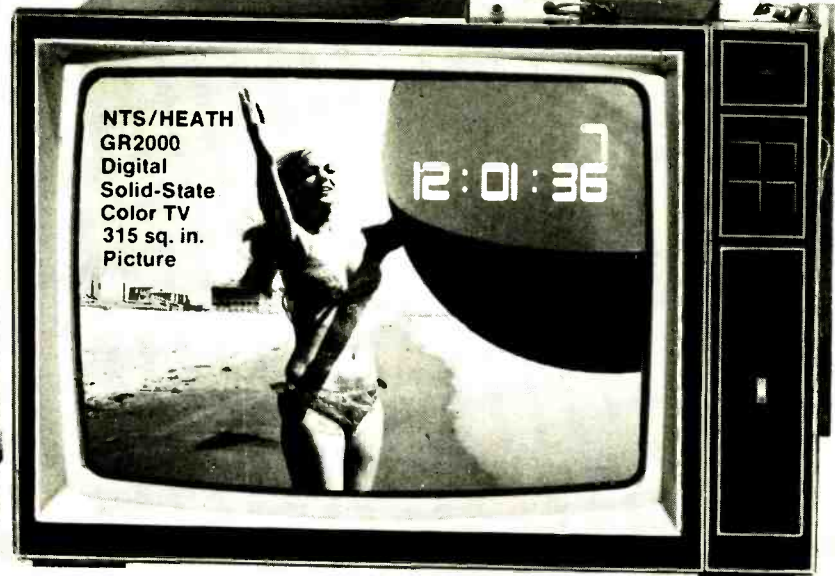

(Simulated TV Reception)

As an NTS student you'll acquire the know-how that comes with first-hand training on NTS professional equipment. **Equipment you'll build and keep.** Our courses include equipment like the **NTS/Heath Digital GR-2000 Solid State color TV** with first-ever features like silent varactor diode tuning; digital channel selection, (with optional digital clock), and big 315 sq. in. ultra-rectangular screen.

Also pictured above are other units — 5" solid state oscilloscope, vector monitor scope, solid-state stereo AM-FM receiver with twin speakers, digital multimeter, and more. It's the kind of better equipment that gets you better equipped for the electronics industry.

This electronic gear is not only designed for training; it's field-type — like you'll meet on the job, or when you're making service calls. And with NTS easy-to-read, profusely illustrated lessons you learn the theory behind these tools of the trade.

Choose from 12 NTS courses covering a wide range of fields in electronics, each complete with equipment, lessons, and manuals to make your training more practical and interesting.

Compare our training; compare our lower tuition. We employ no salesmen, pay no commissions. You receive all home-study information by mail only. All Kits, lessons, and experiments are described in full color. Most liberal refund policy and cancella-

and the equipment be equipped.

**COMPARE OUR
KITS AND LESSONS.
COMPARE OUR
TUITION.**

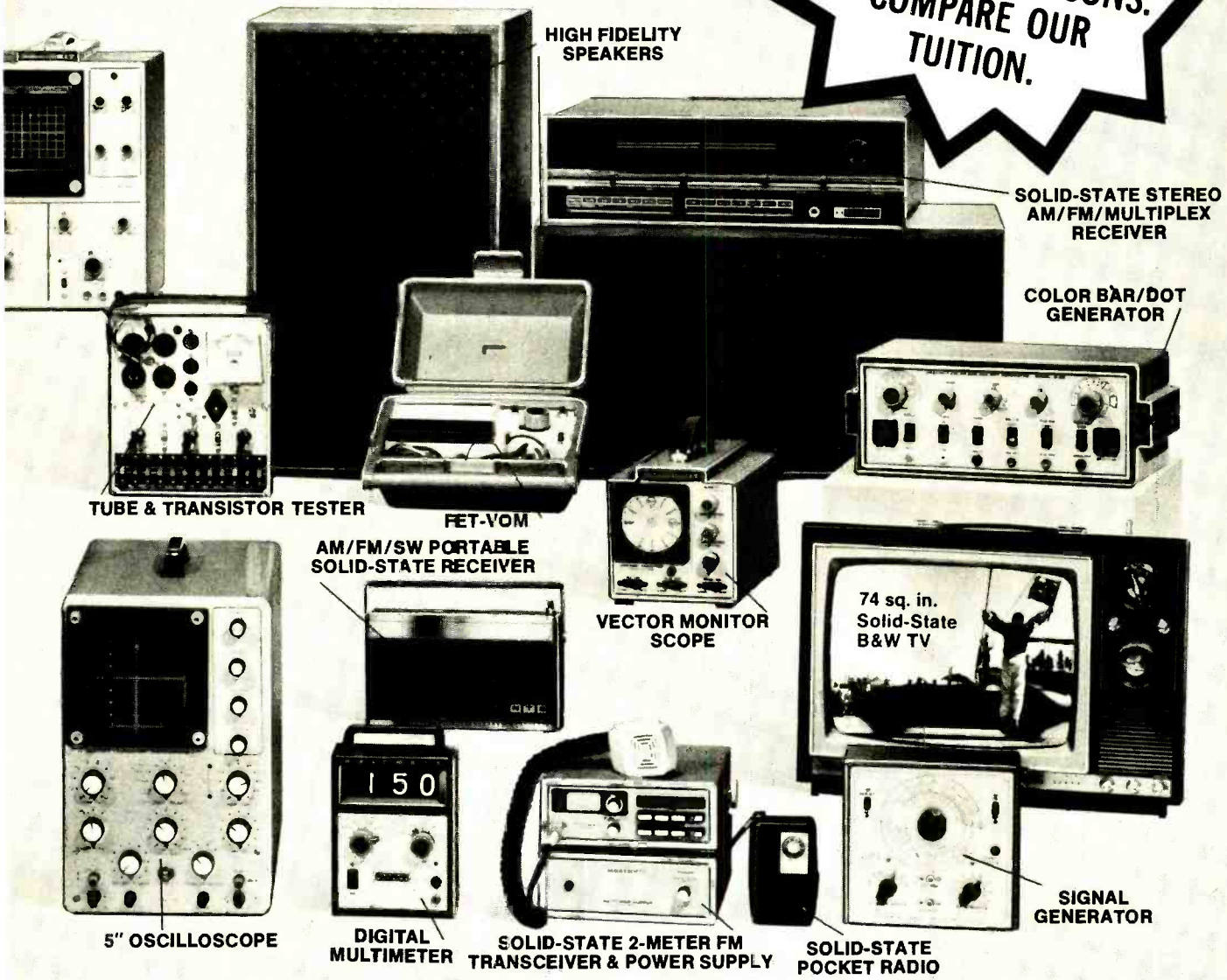

tion privileges spelled out. Make your own comparisons, your own decision. Mail card today, or clip coupon if card is missing.

NO OBLIGATION. NO SALESMAN WILL CALL

APPROVED FOR VETERAN TRAINING

Get facts on new 2-year extension

NATIONAL TECHNICAL SCHOOLS

TECHNICAL-TRADE TRAINING SINCE 1905
Resident and Home-Study Schools
4000 So. Figueroa St., Los Angeles, Calif. 90037

NATIONAL TECHNICAL SCHOOLS Dept. 205-046
4000 South Figueroa St., Los Angeles, Calif. 90037
Please send FREE Color Catalog and Sample Lesson.
NO OBLIGATION. NO SALESMAN WILL CALL.

Color TV Servicing
 B & W TV and Radio Servicing
 Electronic Communications
 FCC License Course

Electronics Technology
 Computer Electronics
 Basic Electronics
 Audio Electronics Servicing

NAME _____ AGE _____

ADDRESS _____ APT # _____

CITY _____ STATE _____

Please fill in Zip Code for fast service _____

Check if interested in G.I. Bill information.
 Check if interested ONLY in classroom training in Los Angeles.

John Buckner, independent installer says:
**“Winegard Chromstar
 has proved it does
 a beautiful job.”**

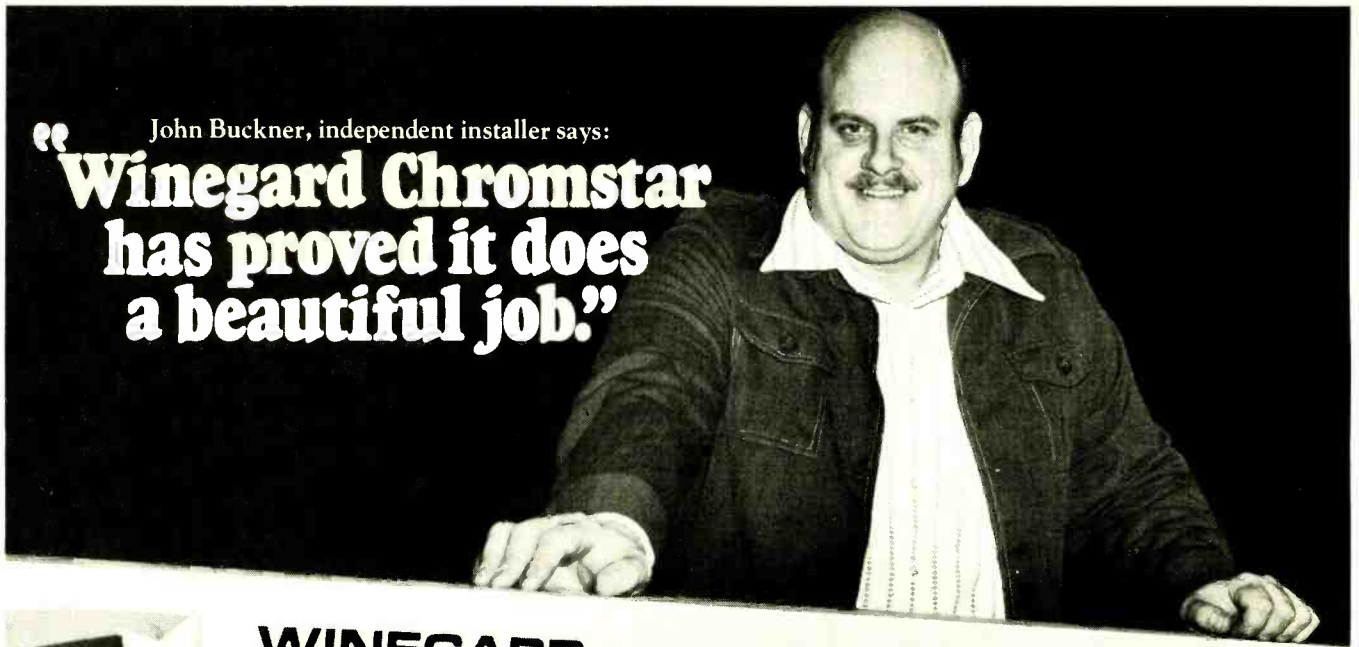

WINEGARD
Chromstar tv antenna

“... quality of Winegard products,
 ... far surpasses other brands ...”

“We depend on the Winegard Chromstar
 Antenna for quality color reception.”

“... tremendously pleased with the
 reception the Winegard Chromstar
 antenna gets in our area.”

Get all the facts from your Winegard Distributor.
 Free Spec Charts on all models.

These statements are from John A. Buckner, President of Buckner Co., Lyndon, Kentucky, who adds in his letter,* “We have a unique situation in the Louisville area, with all television signals coming from a ridge west of town, and their power output varying greatly. We have two VHF stations — Ch. 3 and 11 — and four UHF stations— Ch. 15, 32, 41, and 68. We must cover a broad range of signals, and an even wider variation of power output levels from these stations. The Winegard Chromstar antenna has proved to us and our customers that it does a beautiful job.”

*A copy of Mr. Buckner’s letter will be sent to you on request.

LOOK TO CHROMSTAR FOR QUALITY AND PERFORMANCE

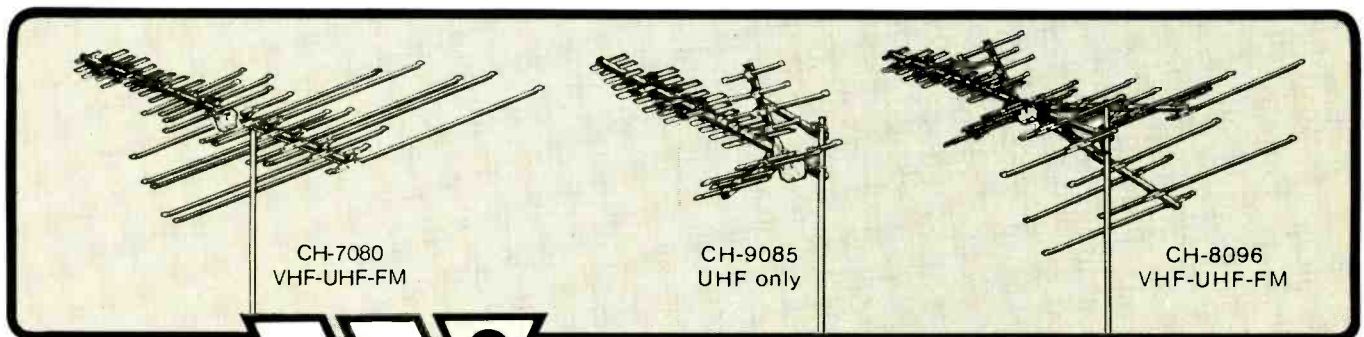

WINEGARD®
C O M P A N Y
 3000 Kirkwood • Burlington, Iowa 52601

TV ANTENNAS MORE PEOPLE LOOK UP TO.

CIRCLE NO. 66 ON FREE INFORMATION CARD

TV ELECTRONIC GAME PROJECTS

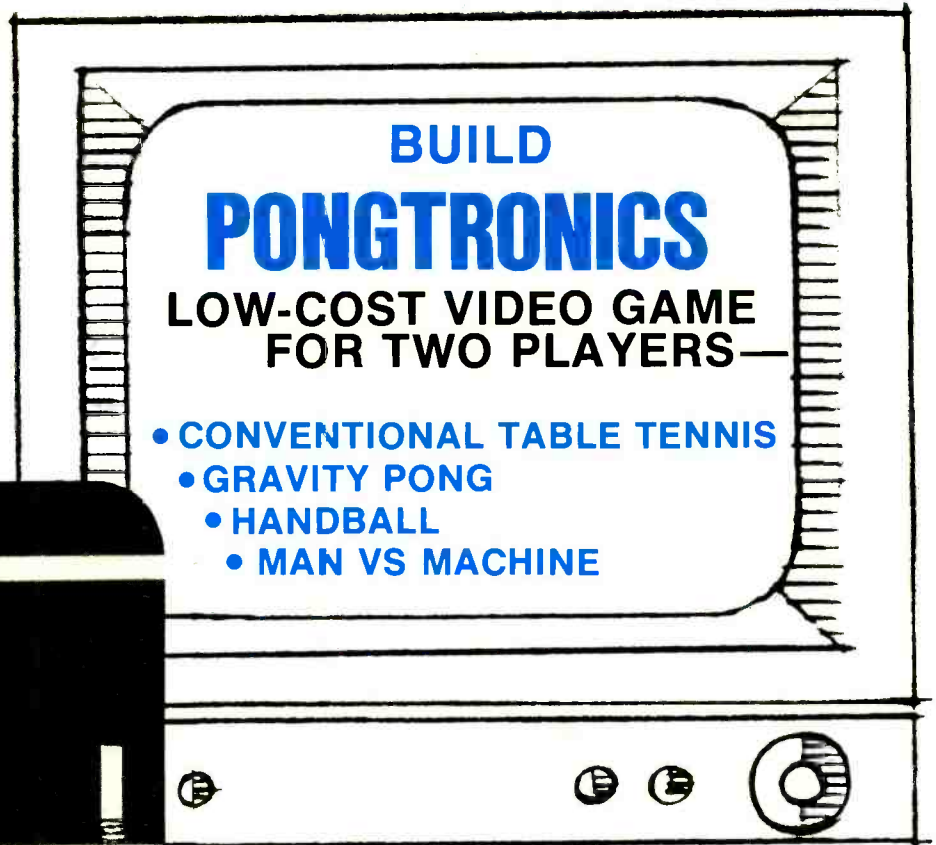
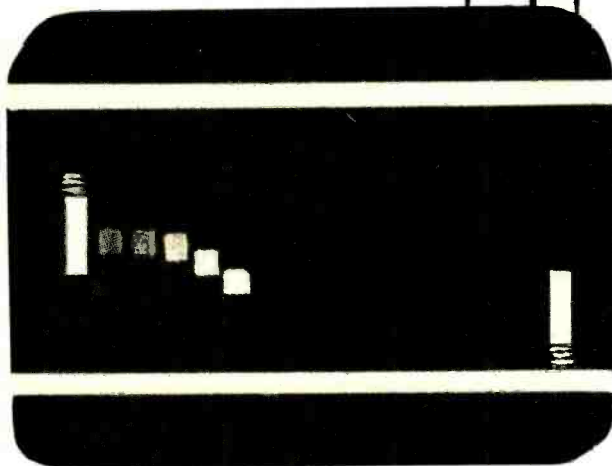

BY MITCHELL WAITE AND LARRY BROWN

EVER since Magnavox introduced its "Odyssey" TV game for home use, the popularity of such items has been increasing. Coin-operated games simulating tennis and hockey now appear in shopping centers, airports, etc., and are challenging conventional electro-mechanical pinball machines in popularity.

Pongtronics, described here, lets you play conventional table tennis on TV, with the ball bouncing back and forth between two paddles and off either the top or bottom walls of the "court." You can also play "gravity pong," where the ball bounces in an arc simulating the influence of gravity, except that in this case it may even reverse gravity. Finally, you can play handball, which converts one paddle

into a full court wall on one side.

The Pongtronics is also designed to let one player pit himself against the machine or even have the machine play against itself. In the latter case, you can set the system up so that one paddle has the advantage over the other. The machine-play feature requires the addition of a single switch and a couple of resistors.

Automatic "English" can be put on the ball. How much English depends on which portion of the paddle strikes the ball. If the ball strikes the upper portion of the paddle, it rebounds upward, and vice versa. Hit the ball with the center of the paddle, and it rebounds off in a direction perpendicular to the paddle's plane.

The speed of the ball can be con-

trolled over a relatively wide range from rather slow to quite fast. You can even try to catch your opponent off guard by operating a SLAM pushbutton, to speed up the ball.

In a future issue, we will describe how to add an optional scoring and sound-effects board to the basic Pongtronics game. Provisions are already on the board for this added assembly. (A kit of parts for the addition will be \$33.00.)

About the Circuit. The entire schematic diagram of the Pongtronics is shown in Figs. 1 through 4.

Gates *IC1A* and *IC1B* form the horizontal sync generator whose on time is controlled by *C1*, *R2*, and *R3* and off time is controlled by *C1* and *R4* (*D1*

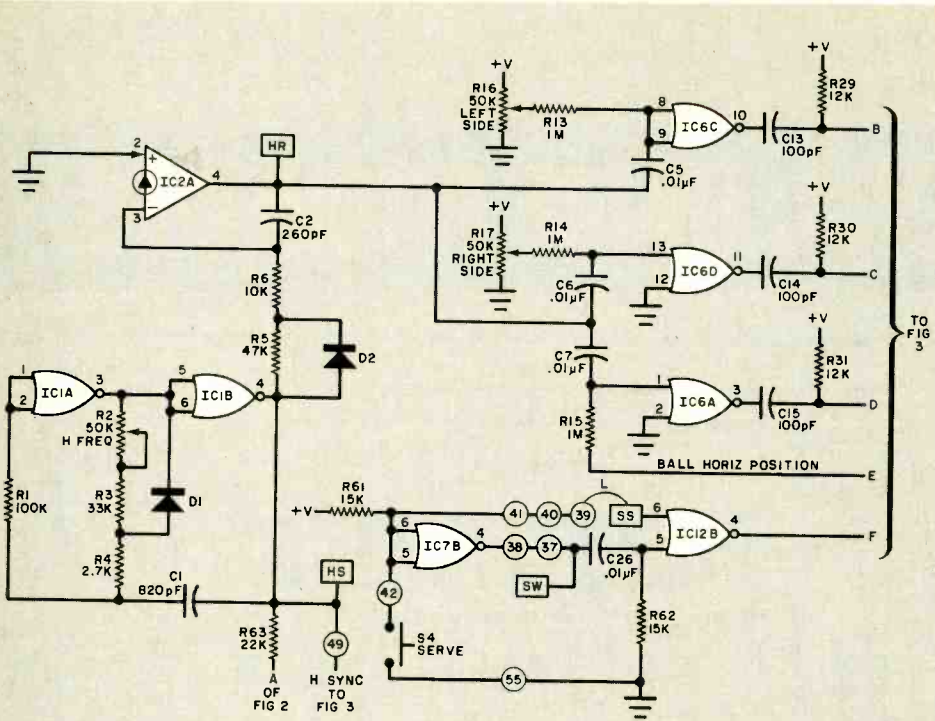

Fig. 1. Horizontal sync and ramp generator and associated comparators.

shorts out $R2$ and $R3$ during this interval). The output from $IC1B$ drives integrator $IC2A$, which ramps up during the on time and resets during the off time. Diode $D2$ improves the fall time of the integrator.

The vertical pulse generator, made up of gates $IC1C$ and $IC1D$ and integrator $IC2D$, operates in exactly the same manner as the horizontal sync generator, except for the repetition rate and the fact that it generates both the vertical sync and vertical ramp.

The horizontal ramp from the output of $IC2A$ is coupled through $C5$, $C6$, and $C7$ to left paddle, right paddle, and ball horizontal position comparators

$IC6C$, $IC6D$, and $IC6A$, respectively. By controlling the trip point of the comparators with $R16$ and $R17$, the horizontal position of the right and left side of the court (paddles) are set on the TV screen. Differentiators $C13/R29$ and $C14/R30$ set the horizontal width of the paddles, while differentiator $C15/R31$ determines the horizontal width of the ball.

The vertical ramp from $IC2D$ couples through $C8$ to $C12$ to the left and right paddles, top and bottom wall, and vertical ball position comparators. Paddle controls $R24$ and $R25$ set the trip points of the comparators to position the paddles vertically on

the screen. Trimmer control $R26$ sets the vertical center reference position of the ball, $R27$ the vertical position of the top wall of the court, and $R28$ the vertical position of the bottom wall.

Differentiator $R32/C16$ at the output of $IC9A$ determines the vertical height of the left paddle; $R33/C17$ at the output of $IC9B$ the vertical height of the right paddle; and $R35/C19$ and $R36/C20$ at the outputs of $IC9D$ and $IC9C$ determine the thickness of the top and bottom walls.

Gates $IC7A$, $IC7C$, and $IC7D$ combine the vertical, and horizontal pulses for the paddles and balls. The top and bottom wall pulses and ball and paddle information are summed in four-input gate $IC8B$ to produce the object video signal. The horizontal and vertical sync pulses are summed in $Q1$, while $Q2$ accepts the object video signal. Resistors in the $Q2$ circuit maintain the black level at about 30%.

The composite video/sync signal is generated across 75-ohm load resistor $R55$. The signal can then be ac coupled into the video amplifier of a TV receiver, or it can be used to modulate an FCC-certified class-1 device for r-f operation into the antenna input of the receiver, on an unused channel.

The left-to-right and right-to-left horizontal movement of the ball is controlled by position integrator $IC2B$, which in turn is driven by horizontal ball control flip-flop $IC4B$. This flip-flop sets and resets each time the ball strikes a paddle. The ball/paddle coincidence signal causes the Q output to change states and $IC2B$ to start ramping in the opposite direction. Since the output of $IC2B$ connects to ball horizontal position comparator $IC6A$, the horizontal motion of the ball reverses. The horizontal speed of the ball is controlled by $R37$, $R38$, and $R39$. SLAM pushbuttons $S2$ and $S3$ can momentarily short out $R38$ and $R39$ to increase the ball's speed.

The vertical angle and position of the ball are controlled by differential integrator $IC2C$, analog sample-and-hold circuit $IC12A$, the transmission gates in analog switch $IC5$, and bounce flip-flop $IC4A$. The rebound angle can be controlled by varying the rate at which the vertical integrator charges. With the horizontal rate of the ball a constant, any change in the vertical rate will change the angle of the ball.

Operation begins when the circuit produces a pulse at the exact moment

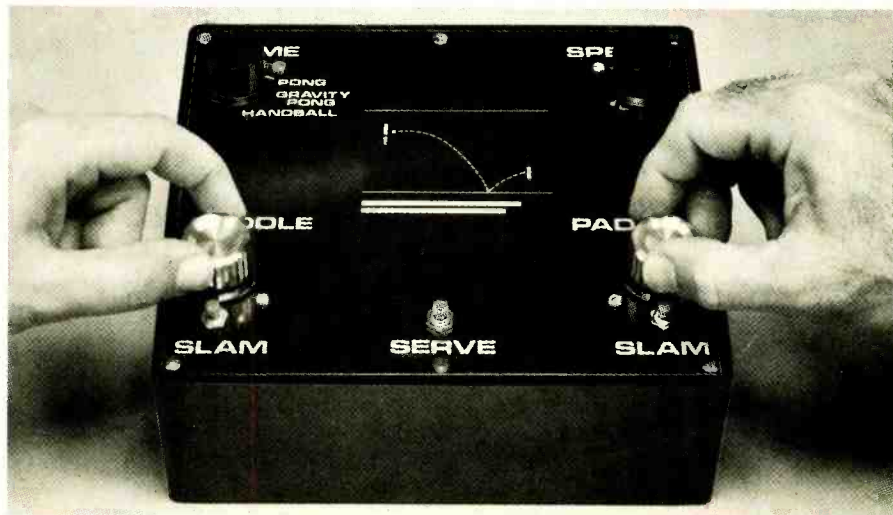

One way to assemble the controls and switches is in single chassis.

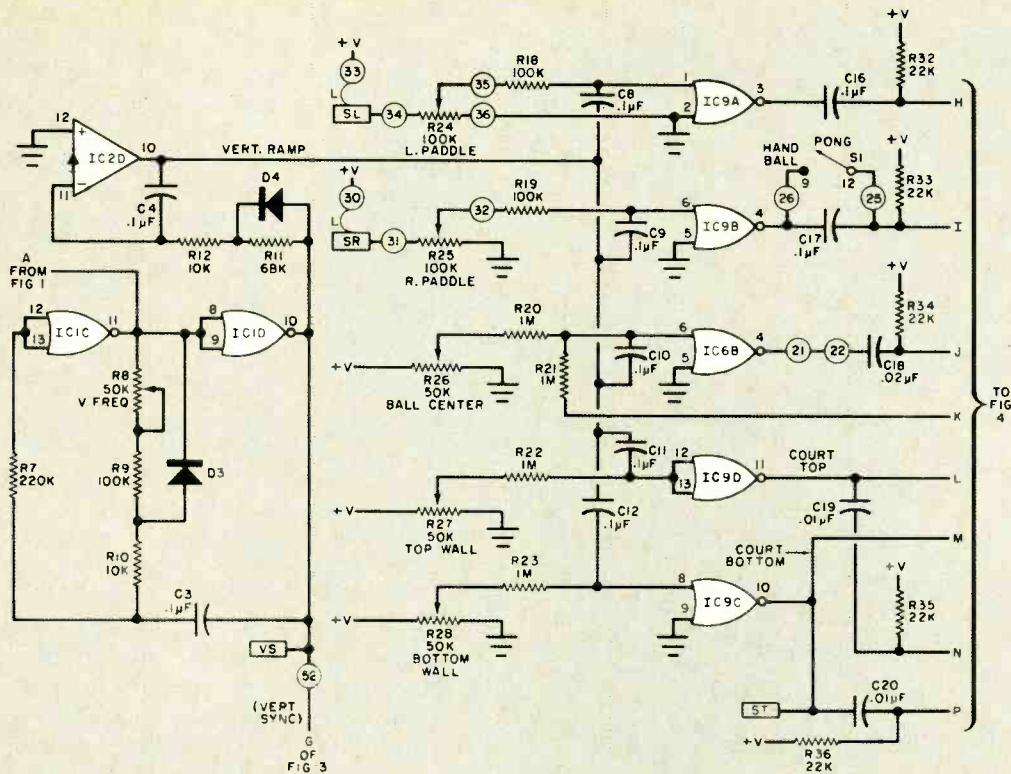

Fig. 2. Vertical sync and ramp generator and related circuits.

the ball hits the paddle (*IC10C*). The hit pulse sets change-angle RS flip-flop *IC12C* and *IC12D*, causing electronic switch *IC5D* to close. At the same instant, *IC5A* is momentarily closed by differentiator *C21/R45* to zero the charge on integrator *IC12A*, which then begins to charge.

When the vertical scan detects the bottom of the paddle, NAND gates *IC11A*, *IC11B*, and *IC11C* reset change-angle flip-flop *IC12C/IC12D* to open the *IC5D* electronic switch. Integrator *IC12A* stops charging and holds its output voltage. (Only a CMOS device could be used as a gate element and sample-and-hold integrator.) The voltage now at the output of the sampling integrator represents where the ball hit vertically on the paddle. This voltage is then used to set the charge rate of vertical ball position integrator *IC2C*.

Differential integrator *IC2C* and analog switches *IC5B* and *IC5C* apply the angle-reference voltage held at the output of *IC12A* to the integrator inputs. The states of *IC5B* and *IC5C* are, in turn, controlled by bounce flip-flop *IC4A*, which keeps track of the ball's direction. Exclusive-OR gate *IC10B* applies the correct information to the *IC4A* D input so that, when a bounce from a wall occurs, the integrator changes its direction of charging in

PARTS LIST

B1—9-volt battery
 C1—820-pF, 5% silver mica capacitor
 C2—260-pF, 5% silver mica capacitor
 C3, C4, C8 through C12, C16, C17, C29 through C35, C37—0.1- μ F, 10% Mylar capacitor
 C5, C6, C7, C19, C20, C26, C36—0.01- μ F, 10% Mylar capacitor
 C13, C14, C15—100-pF, 5% silver mica capacitor
 C18, C22—0.02- μ F, 10% Mylar capacitor
 C21—0.002- μ F, 10% Mylar capacitor
 C23, C38—3.3- μ F, tantalum capacitor
 C24—1.5- μ F tantalum capacitor
 C25—0.68- μ F tantalum capacitor
 C27, C28—100- μ F, 16-volt electrolytic capacitor
 D1 through D6—1N4148 diode
 D7—6.2-volt, 400-mW zener diode
 IC1, IC6, IC9—34001 quad two-input NOR gate (Fairchild). Do not substitute.
 IC2—LM3900 quad op amp (National)
 IC3—4081 quad two-input AND gate
 IC4—4013 dual JK flip-flop
 IC5—4016 quad bilateral switch
 IC7, IC12—4001 quad two-input NOR gate
 IC8—4002 dual four-input NOR gate
 IC10—4030 quad two-input XOR gate
 IC11—4011 quad two-input NAND gate
 Q1, Q3—2N4401 transistor
 Q2—2N3638A transistor
 The following resistors are 1/4-watt, 5%:
 R1, R9, R18, R19, R38—100,000 ohms
 R3—33,000 ohms
 R4, R41—2700 ohms
 R5, R47—47,000 ohms
 R6, R10, R12, R58—10,000 ohms
 R7—220,000 ohms
 R11—68,000 ohms
 R13, R14, R15, R20, R21, R22, R23, R42—1 megohm
 R29, R30, R31—12,000 ohms
 R32 through R36, R40, R43, R45, R63—22,000 ohms
 R37—270,000 ohms
 R46—10 megohms
 R48, R53, R54, R59, R61, R62—15,000 ohms

R49, R50—470,000 ohms
 R51, R52—390,000 ohms
 R55—75 ohms
 R56—270 ohms
 R57—1000 ohms
 R60—100 ohms
 R64, R65—30,000 ohms
 R2, R8, R16, R17, R26, R27, R28, R44—50,000-ohm, 1/8-watt trimmer potentiometer
 R24, R25—100,000-ohm linear-taper potentiometer
 R39—500,000-ohm potentiometer
 S1—Three-pole, three-position rotary switch
 S2, S3, S4—Normally open spst pushbutton switch
 S5—Dpdt, center-off miniature toggle switch
 S6—Spst switch (part of R39)
 Misc.—Printed circuit board; IC sockets (12) or Molex Soldercons; control knobs (4); suitable case; coaxial cable; battery holder; machine hardware; hookup wire; solder; etc.
 Note: The following items are available from Cal Kit, P.O. Box 877, Sebastopol, CA 95472:
 No. TV-1 plated epoxy-type pc board for \$12.00
 No. TV-3 complete kit of game parts less battery, sound/score option, and case for \$55.00
 No. TV-6 set of IC's for game for \$15.50
 No. TV-8 set of sockets for game for \$6.00
 No. TV-10 FCC type-approved r-f modulator; write for details
 No. TV-11 drilled and silk-screened case for \$12.50
 All items postpaid and insured. Add \$2.00 for handling. No COD's. California residents, please add sales tax.

Editor's Note: New 22" video monitor, with audio, available from GBC Closed Circuit TV Corp., 74 Fifth Ave., NY, NY 10011 for \$119.50. NY residents, add sales tax.

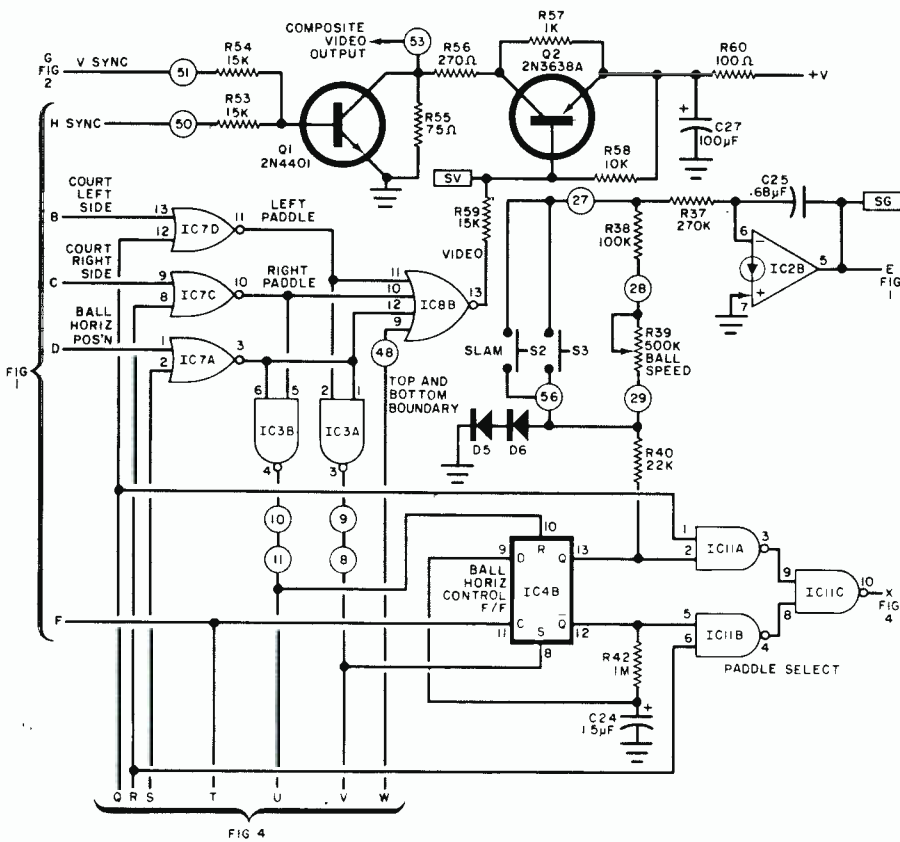

Fig. 3. Six gates operate on ball-paddle contact to reverse motion.

step. The current angle voltage is compared with the instantaneous vertical position voltage by IC10B.

Bounce flip-flop IC4A is also controlled by the paddle and ball coinci-

dence circuits. A paddle/ball coincidence generates a hit pulse that resets IC4A, deflecting the ball upward when it hits the upper half of the paddle and downward when it hits the lower half.

The GRAVITY portion of S1 applies a small dc voltage to the integrator to cause the angle of the reference voltage to decay as the ball moves across the screen.

Initiating gate IC10A is used to get the vertical motion of the ball in sync with the bounce flip-flop. It is also used to invert the ball video and put a vertical line on the screen for purpose of alignment.

Without the scoring and sound circuit, IC7B and IC12B simply debounce SERVE switch S4. When the scoring option is used, the link between the two gates is removed. The scoring circuit then senses when the SERVE switch is operated and uses this information to start a new game. After a brief period, determined by the time constant C26 and R62, it allows the game to start by pulsing IC12B and clocking the horizontal flip-flop.

As shown in Fig. 5, power is supplied to the circuit by a single 9-volt battery through a series regulator made up of Q3 and D7 and decoupled by C28. Capacitors C29 through C33 decouple the CMOS IC's connected to the 5.5-volt line.

Also shown in Fig. 5 is CYBERNETIC switch, S5, an option that might prove of interest to you. This is the switch that allows you to play against the machine or have the machine play against itself.

GAME switch S1 allows you to select

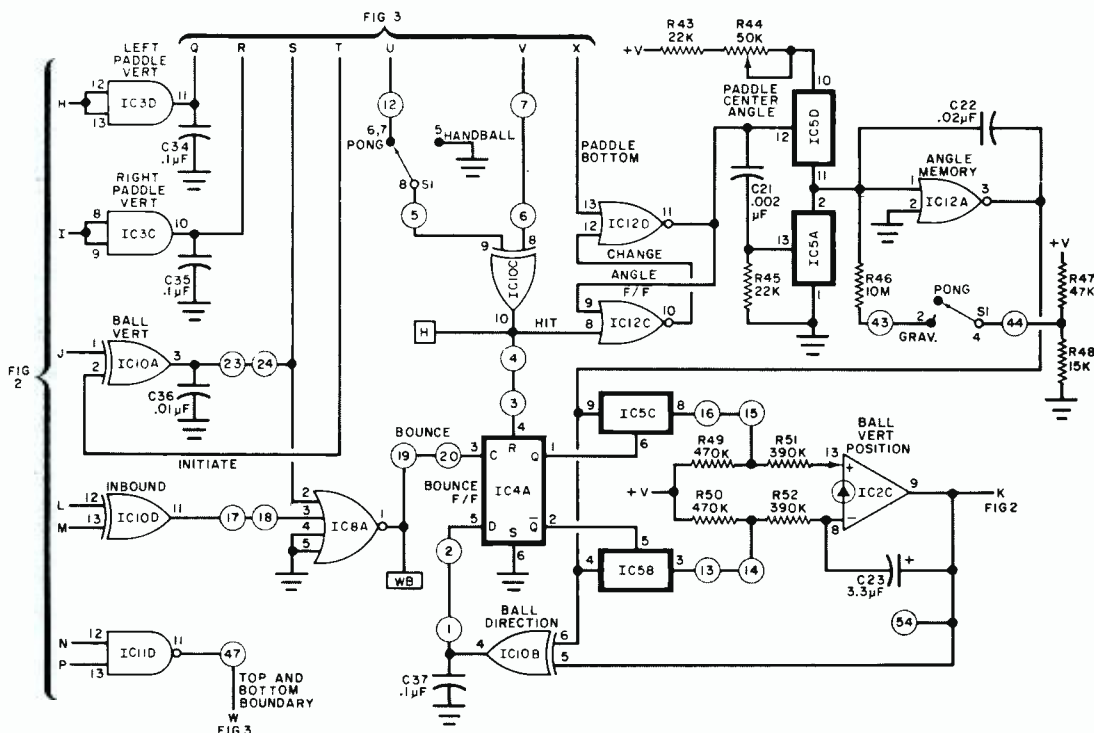

Fig. 4. Circuit to determine "English" and change type of game.

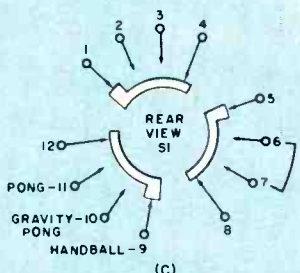
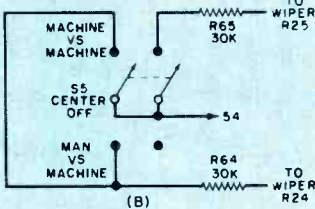
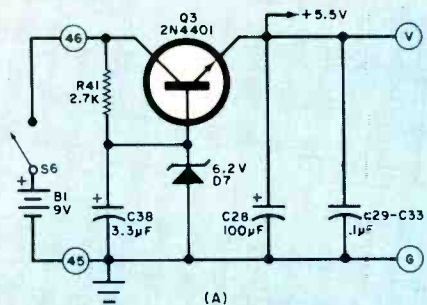

Fig. 5. Circuits for battery power supply (A); optional "cybernetic" switch (B); and wiring for game switch (C).

position, C17 is shorted out to extend the right paddle's vertical height to the top and bottom of the screen. Also, the "hit" information is overridden by grounding one input to IC10C. The right paddle becomes a wall that deflects the ball according to where the ball strikes it.

Construction. Because of the number of IC's used and the complexity of the associated wiring, a printed-circuit board is highly recommended for assembling the Pongtronics. If you plan to make your own pc board, you can use the actual-size etching and drilling guide shown in Fig. 6. Once the board is prepared, you can mount the components on it as shown. Note that all components, including PADDLE potentiometers, SERVE pushbuttons, GAME select switch, and BALL SPEED control can be mounted directly on the board. Alternatively, these controls can be mounted separately and

Fig. 6A. Actual-size etching and drilling guide for pc board. Component layout guide is on next page, with wiring table for connections to numbered pads.

the game you want to play. In the PONG position, the Pongtronics operates as a conventional TV table tennis game. In the GRAVITY position, IC12A is reconfigured, while in the HANDBALL

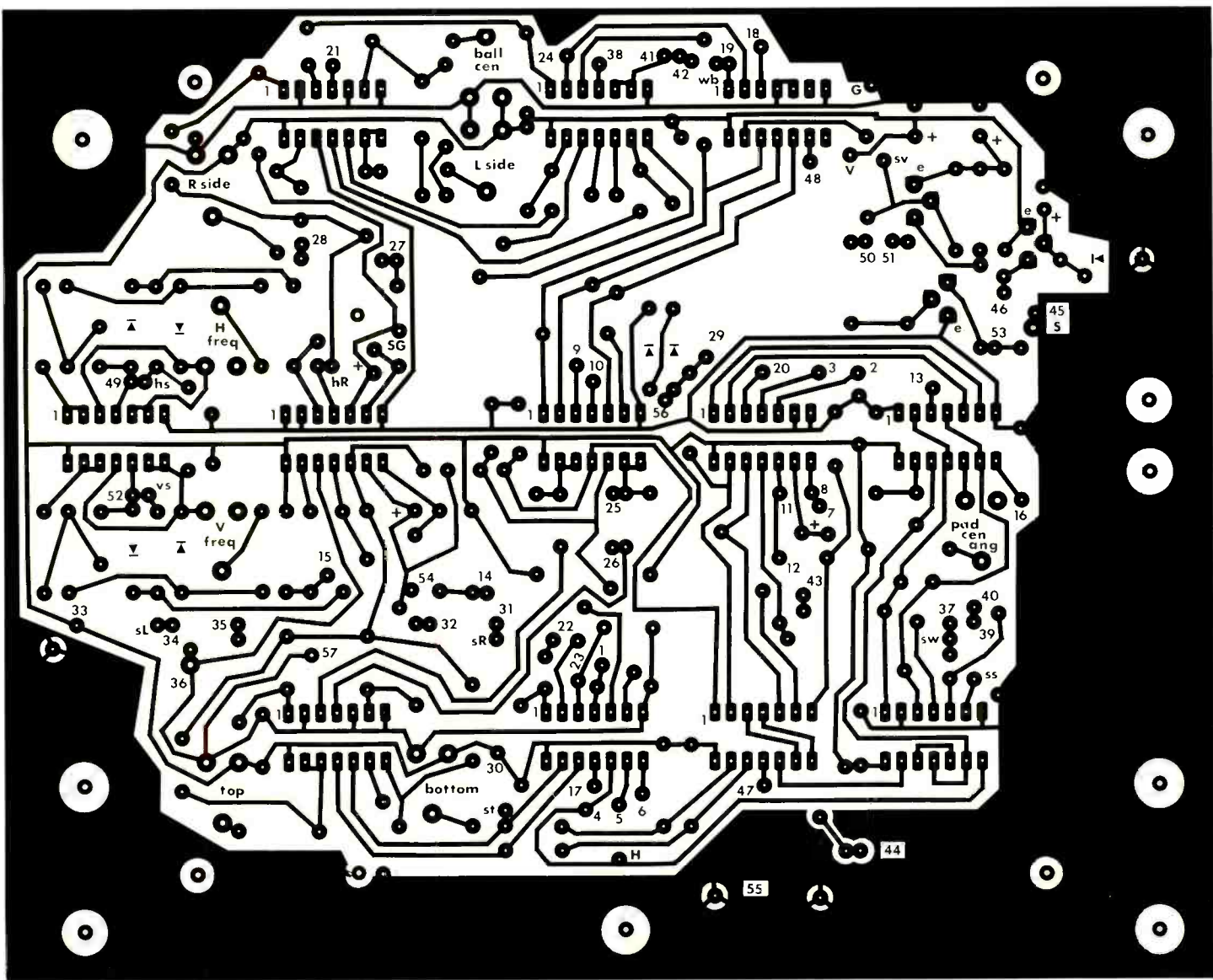

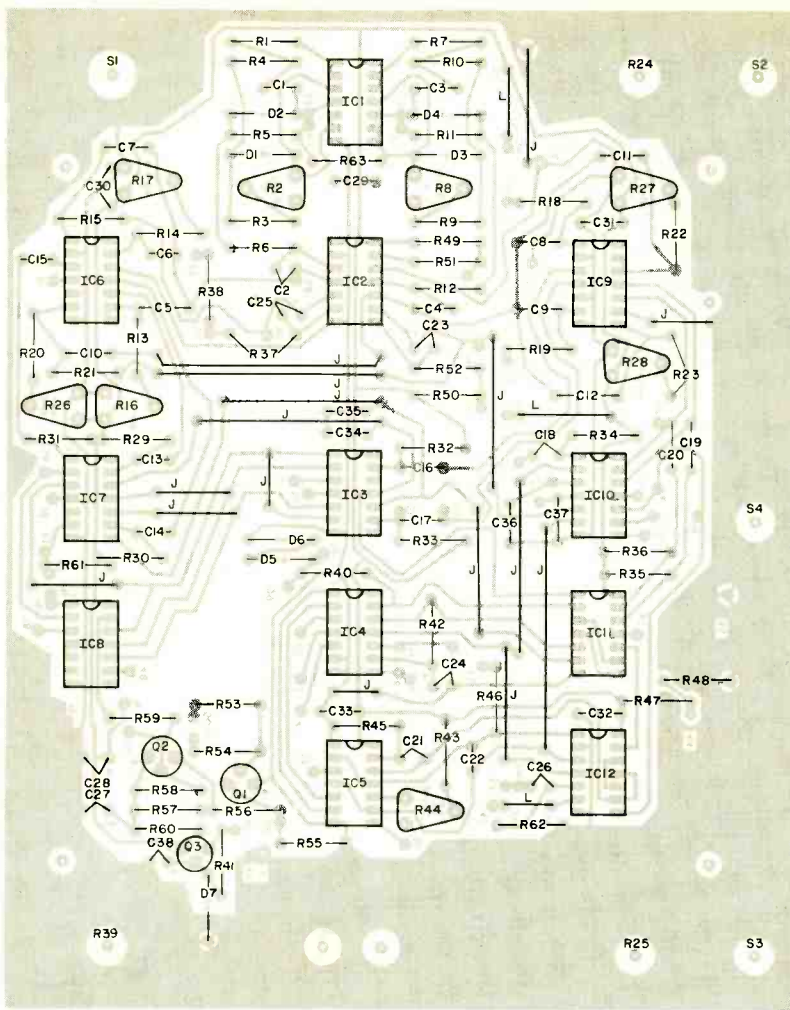

Fig. 6B. Component layout and wiring table.

WIRING TABLE

From	To	From	To
1	2	33	SL (link)
3	4	34	R24, +V side
5	S1 lug 8	35	R24 wiper
6	7	36	R24,R25 GND
8	9	37	38
10	11	39	SS (link)
12	S1 lugs 6,7	40	41
13	14	42	S4 (serve)
15	16	43	S1 lug 2
17	18	44	S1 lug 4
19	20	45	B1-
21	22	46	S6 (on R39)
23	24	47	48
25	S1 lug 12	49	50
26	S1 lug 9	51	52
27	S2 & S3	53	Video output
28	R39	54	S5
29	R39,S2,S3	55	S4 GND
30	SR (link)	56	S2 & S3
31	R25, +V side	57	S1 lug 5
32	R25 wiper		

Note: Pads on the board with letter legends are for optional scoring/sound board.

Adjustments. There are two ways to have the Pongtronics fed to your TV receiver. One is an ac connection to the receiver's video amplifier input, the other is to use an FCC type-approved r-f modulator that permits you to feed the game into the antenna input of your receiver and operate on an unused channel in your area. If you elect video feed, you can install a switch that lets you select between normal TV operation from the receiver's video detector or game operation

connected to the board with cables.

Circled numbers in the schematic represent numbered pads on the foil side of the board. Interconnections for these points are detailed in the table that accompanies Fig. 6. (The small squares containing letters in the schematic are the points in the circuit to which the optional scoring and sound-effects board connect.)

To make insertion and removal easier, you can mount the IC's in the circuit with sockets. All controls and switches (except S5) can mount directly on the board. You'll have to drill suitable holes to accommodate the controls and mount them from the foil side of the board. Don't forget to mount the jumpers and three "links" (marked L) wires on the board. The three link wires will be removed if and when you install the optional scoring and sound-effects subassembly.

Use the Wiring Table and Fig. 7 to install the various interconnects. Then install the 9-volt battery in a holder secured to the foil side of the printed circuit board.

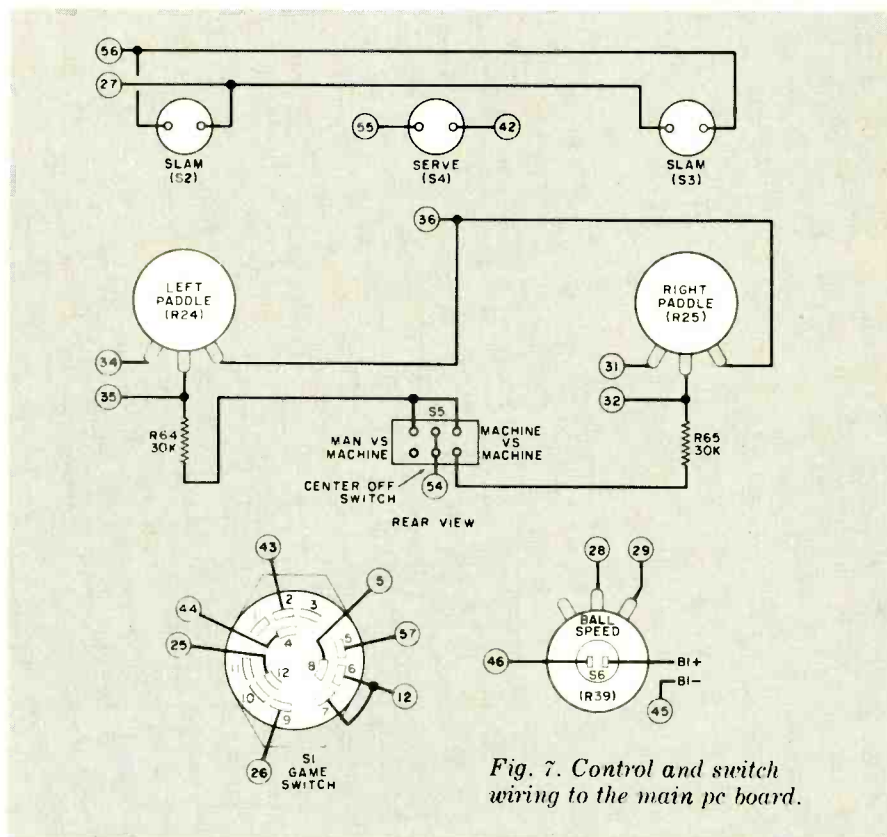

Fig. 7. Control and switch wiring to the main pc board.

through a chassis-mounted connector for the Pongtronics' output.

Assuming your receiver's horizontal and vertical controls have been set for a stable picture, connect the Pongtronics to the receiver through the desired input. Turn on the power to the receiver and Pongtronics, in the latter case rotating the BALL SPEED control clockwise. If you notice that the picture is rolling, adjust trimmer potentiometer *R8* until the frame locks. If you notice horizontal "tearing," adjust *R2* for stable horizontal lock. You can now adjust the receiver's BRIGHTNESS and CONTRAST controls for a sharp picture with a black or dark gray background and white paddles, ball, and court walls.

Adjust trimmer potentiometer *R27* until the upper wall of the court is about 1" (2.54 cm) from the top of the screen. Then adjust *R28* so that the

bottom wall is the same distance away from the bottom of the screen. Adjust *R16* to set the left paddle about 1" from the left side of the screen and *R17* to position the right paddle. One or both paddles may initially be off the screen, so you may have to start your paddle adjustments by first getting the paddles onscreen.

Hold down the SERVE button. A vertical white line with a small "hole" in the middle should appear on the screen. This hole corresponds to the ball. The line will rebound back and forth between the paddles. Adjust *R26* to center the hole on the screen.

The angle of rebound between ball and paddle is controlled by *R44*. Adjust this trimmer potentiometer until the ball rebounds in a straight line across the screen when the ball hits the center of the paddle. A simple way to do this is to temporarily bring the

two paddles close together and narrowing the court to form a small rectangle with the paddles. When the ball is trapped inside the rectangle, *R44* is properly adjusted. Return the paddles and walls to their proper positions.

The Pongtronics is now ready to use. Bear in mind that each time you turn on the game it may be necessary to touch up your receiver's horizontal and vertical controls as the agc circuit locks up in the wrong direction. Momentarily changing channels may also break the sync lock. You can also hold down the SERVE button to initiate the game and allow the Pongtronics' flip-flops to get into synchronization.

After operating the SERVE button, you may have to wait for up to five seconds, depending on the setting of the BALL SPEED control, for the ball to appear on the screen. ♦

BY JOSEPH A. WEISBECKER



Popular among people who use computers is a "war" game in which space ships are positioned on the screen of a computer terminal and simulated missiles or laser beams are fired at them by the opponent. Since most people don't have access to a computer for such games, the simple version described here has been devised to be used with any TV set.

Signals are generated to produce two space ships (small white squares), one on each side of the screen. Each player can move his ship up or down by means of a single control. When one player thinks he is within range, he operates a pushbutton switch to make it appear that a "laser beam" is being fired from his ship to the opponent's. If he scores a hit, the oppo-

nent's ship disappears from the screen and the game is over. It can be restarted by the operation of a reset switch.

However, once a player has fired his laser (and it can only be fired in a single burst), it takes several seconds for it to be "recharged." During this period of time, his ship is helpless against the opponent and all he can do

PARTS LIST

- B1, B2—9-volt battery
 C1—100-pF polystyrene capacitor
 C2, C14, C15—0.05- μ F disc capacitor
 C3, C4—0.01- μ F disc capacitor
 C5, C6—4.7- μ F, 6-V electrolytic capacitor
 C7, C8—220-pF polystyrene capacitor
 C9, C11—10- μ F, 60-V electrolytic capacitor
 C10, C16, C17—1- μ F, 100-V electrolytic capacitor
 C12—1000- μ F, 16-V electrolytic capacitor
 C13—0.1- μ F Mylar capacitor
 D1 to D9—1N4148 diode
 IC1—4049 CMOS hex inverter
 IC2, IC3—4024 CMOS 7-bit counter
 IC4—4012 CMOS dual 4-input NAND gate
 IC5, IC6—555 timer
 IC7, IC8—CMOS triple 3-input NAND gate
 IC9, IC10—CMOS quad 2-input NOR gate
 Q1—2N5129 transistor
 The following are 5%, 1/4-watt resistors unless otherwise noted:
 R1, R7, R10, R14, R16—100,000 ohms
 R2—15,000 ohms
 R3, R4, R5, R21—47,000 ohms
 R6—33,000 ohms
 R8, R11—3900 ohms
 R9, R12—250,000-ohm potentiometer
 R13, R15—39,000 ohms
 R17—22,000 ohms
 R18—10,000 ohms
 R19—47 ohms
 R20—100 ohms
 R22, R23—10,000-ohm potentiometer
 R24—5000-ohm potentiometer
 S1—Spst slide switch
 S2 to S4—Spst normally open pushbutton switch
 Misc.—Suitable chassis, extension cable, remote enclosure, knobs (2), battery holders, mounting hardware, etc.
 Note—The following is available from Southwest Technical Products, 219 W. Rhapsody, San Antonio, TX 78216: complete kit (SW-1) including chassis at \$39.50, postpaid. Texas residents, please add sales tax.

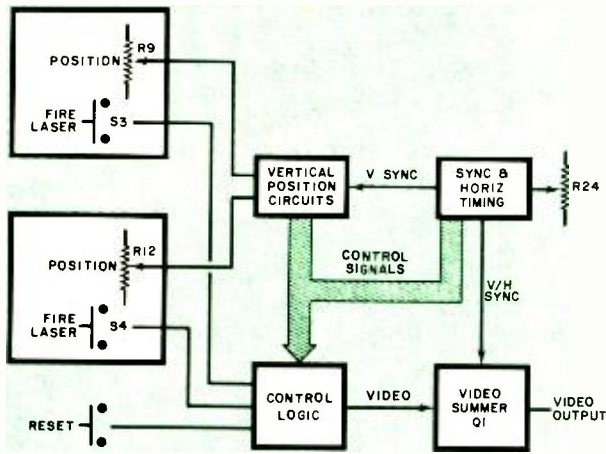

Fig. 1. Logic diagram shows how various stages are connected.

is try to keep out of the line of fire. Also, during this period, the ship of the player who fired is flashing on and off. When the flashing stops, his laser is recharged and ready to fire again. This feature discourages continuous firing and encourages the use of caution and strategy.

The block diagram (Fig. 1) shows how the system operates. Note that the output is a composite of sync and video signals. It can be applied directly to the video amplifier of a TV receiver or, through an FCC type-approved r-f device, to the TV receiver's antenna input using a locally unoccupied channel.

Circuit Operation. The sync and horizontal timing circuit is shown in Fig. 2. Basic timing is performed by two inverters in IC1, which is wired as an oscillator operating at a nominal 122.88-kHz frequency. Resistor R1 in-

creases the stability of the circuit, while C1 and the combination of R2 and R24 are used to adjust the frequency. The output is a square wave with a period of 8.14 microseconds.

This signal drives a 14-stage binary counter formed by IC2 and IC3. Diodes D1, D2, and D3 decode the 000 output of IC2 to form an 8.14- μ s pulse occurring 16.28 μ s after the beginning of each horizontal sync pulse. This pulse, if applied alone to the receiver, would produce a vertical bar on the left side of the screen. Diodes D7, D8, and D9 decode the 110 output to provide an 8.14- μ s pulse 48.8 μ s after the horizontal sync pulse. This pulse alone would produce a vertical bar on the right side of the screen.

The differentiator formed by C2 and R6 provides a negative-going vertical sync pulse 60 times per second. This pulse in about 2 milliseconds with the component values shown.

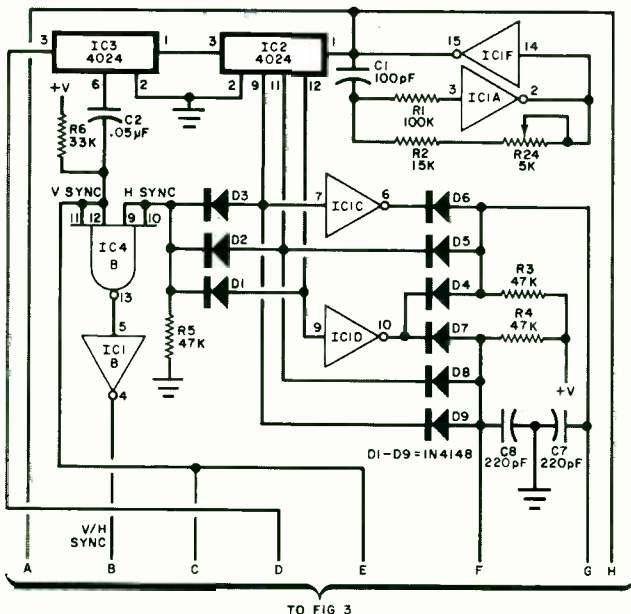

Fig. 2. Sync pulses and timing are generated by this circuit.

The horizontal and vertical sync pulses are combined in one section of IC4, a dual 4-input NAND gate. The composite positive-going sync is fed to the r-f circuit.

In this circuit, 256 horizontal sync pulses occur for each vertical sync pulse. However, once the oscillator is adjusted (by R24) for a good TV vertical sync lock, the small deviation from conventional TV line rate is easily tolerated by the receiver.

The vertical position circuits (Fig. 3) use two 555 timers in IC5 and IC6. Both are connected as monostable (one-shot) multivibrators and are triggered (pin 2) by the negative-going sync pulse from IC3. The duration of the output waveform is determined by the value of the RC network connected to pins 6 and 7. The width of the output pulse is determined by the amount of dc voltage applied to pin 5. For example, the width of the output pulse from pin 3 of IC5 is determined by the adjustment of R9. Since IC5 is

triggered by the vertical sync pulse, the rising edge of the output waveform coincides with the vertical sync pulse. Changing the value of $R9$ varies the time at which the trailing edge of the pin-3 waveform occurs relative to the sync pulse. Capacitor $C3$ and resistor $R7$ provide a negative-going pulse from this trailing edge that can be positioned between the vertical sync pulses by $R9$. This signal alone would produce a horizontal line on the screen, moved up and down by $R9$.

Similarly, $IC6$ and its associated components provide a horizontal line that can be moved by $R12$.

Note that each timer control pin (5) is connected to ground through a large capacitance ($C5$ and $C6$). The charging and discharging of these capacitors produce a lag in the vertical movement of the displayed signals. The lag is deliberately introduced to improve the playing of the game.

The horizontal and vertical signals for each side of the screen are combined in the circuit shown in Figs. 3 and 4. Figure 3 also includes the laser firing circuit.

The horizontal pulse on line G is applied to pin 1 of $IC7B$. If laser switch $S3$ is not depressed, pin 13 of $IC7C$ will be low, causing its pin 10 to be high. This forms the signal for pin 8 of $IC7B$. If the reset switch has been operated, the two flip-flops ($IC9A$, $IC9B$, $IC10A$, $IC10B$) are in their reset states, providing a low signal at pin 13 of $IC9D$. The vertical signal from pin 3 of $IC5$ is then inverted at pin 11 of $IC9D$ and pin 2 of $IC7B$. Thus, the negative-going pulse at pin 9 of $IC7B$ represents the intersection of the horizontal and vertical pulses and part of the video output of $IC4A$. The video output produces a small white rectangle on the left side of the screen for one of the space ships. The right-hand space ship is generated in a similar manner using the other gates.

When laser switch $S3$ is depressed, a high level is applied to pin 13 of $IC7C$. A positive pulse is also applied to pin 3 of $IC7A$. The duration of this pulse is determined by the values of $C16$ and $R14$. The pulse gates the inverted vertical signal at pin 4 of $IC7A$ to the video output. The vertical signal would normally form a line across the TV screen at the same position as the left space ship. The line appears dotted because of the 8.14- μ s square wave on pin 5 of $IC7A$ and it forms the "laser beam" fired by that space ship.

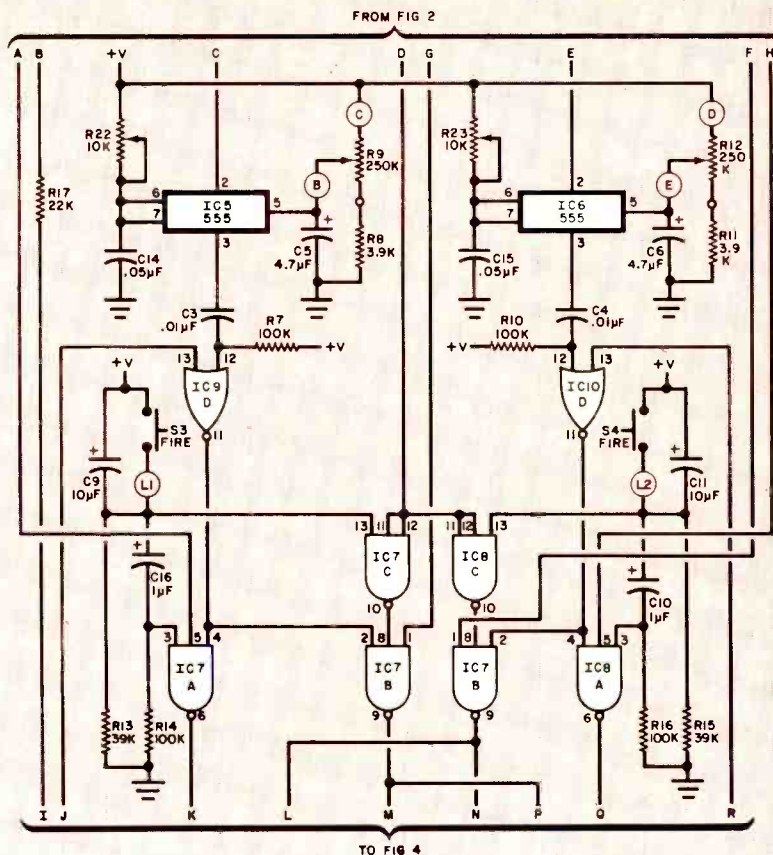

Fig. 3. One 555 timer is used for each spaceship. Though both are synced to the same vertical pulse, each has its own independent vertical position potentiometer. The high capacitance at each pin 5 makes vertical positioning "soft" to keep players on their toes. This circuit also produces "laser" effect and determines "helpless" time.

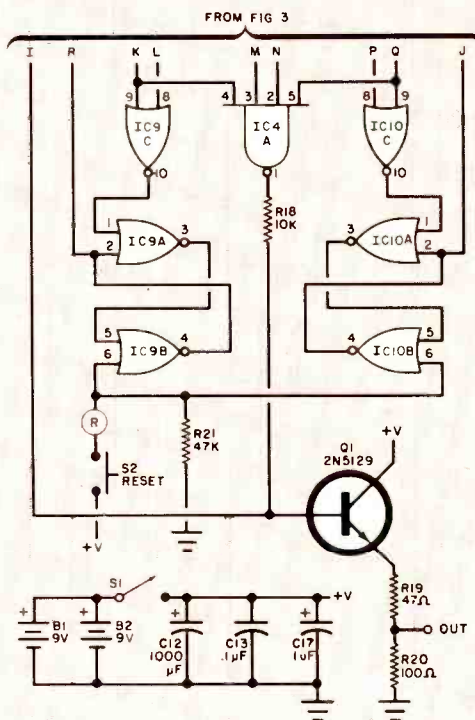

Fig. 4. Each set-reset flip-flop locks out the other space ship when it is "hit" by opposing laser. Power supply circuit is also shown here.

The position of the right space ship is represented by pulses at pin 9 of IC8B. A pulse at pin 10 of IC9C indicates a coincidence of the left laser beam and the right space ship. This is a "hit" pulse which sets the IC9A-IC9B flip-flop to cause pin 13 of IC10D to go high. This turns off IC8A and IC8B, causing the ship to disappear from the screen. If coincidence between pin 6 of IC7A and pin 9 of IC8A does not occur while the pulse at pin 3 of IC7A is present, the left ship did not hit the right one and the game continues.

When laser switch S3 is depressed, only one laser pulse occurs at pin 3 of IC7A due to the action of C16 and R14. However, pin 13 of IC7C remains high as long as S3 is depressed. This causes the signal at pin 9 of IC7B to be modulated by the square-wave input and the space ship flashes on and off at about 8 times per second as long as pin 13 of IC7C is at a high level.

When S3 is released, pin 13 of IC7C remains high until C9 discharges through R13 to about half of the supply voltage. This time constant holds pin 13 of IC7C high for several seconds after the laser pushbutton has been released. Pin 13 of IC7C must be low before S3 is operated to provide a sufficient voltage swing to generate a laser pulse at pin 3 of IC7A. The time constant of C9/R13 keeps the space ship flashing for a few seconds and also inhibits firing again for the same period of time. The values of C9 and R13 can be changed if desired.

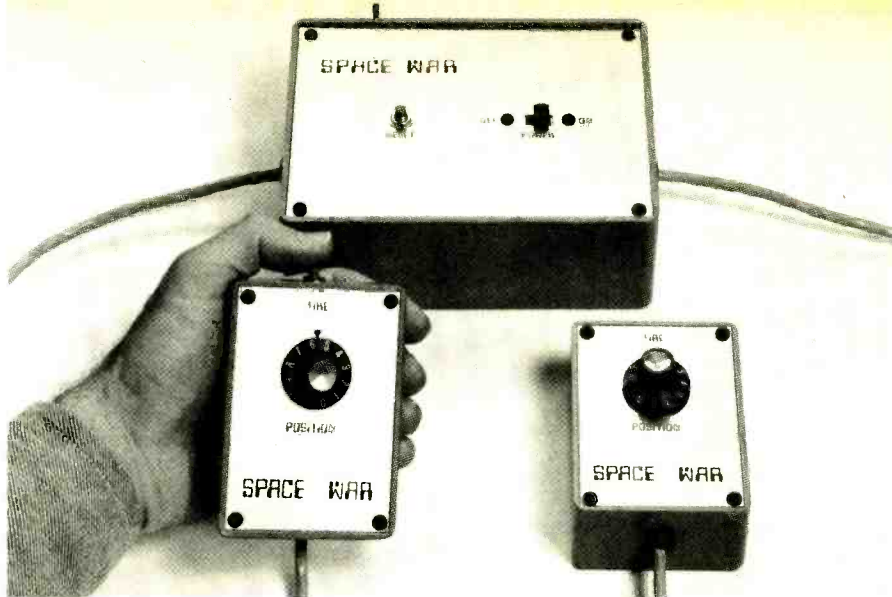

Photo shows main control box with two control stations as arranged for the prototype.

The logic circuit for the other space ship is similar.

The reset circuit and the power supply are shown in Fig. 4. Note the use of filter capacitors to smooth switching transients. Transistor Q1 sums both the video and sync and presents a

low-impedance composite video signal for use by the video amplifier of the TV receiver or an FCC-approved class-1 device.

Construction. The circuit is easily assembled on a pc board such as that

Fig. 5. Actual-size etching and drilling guide is at right. Component layout guide is below.

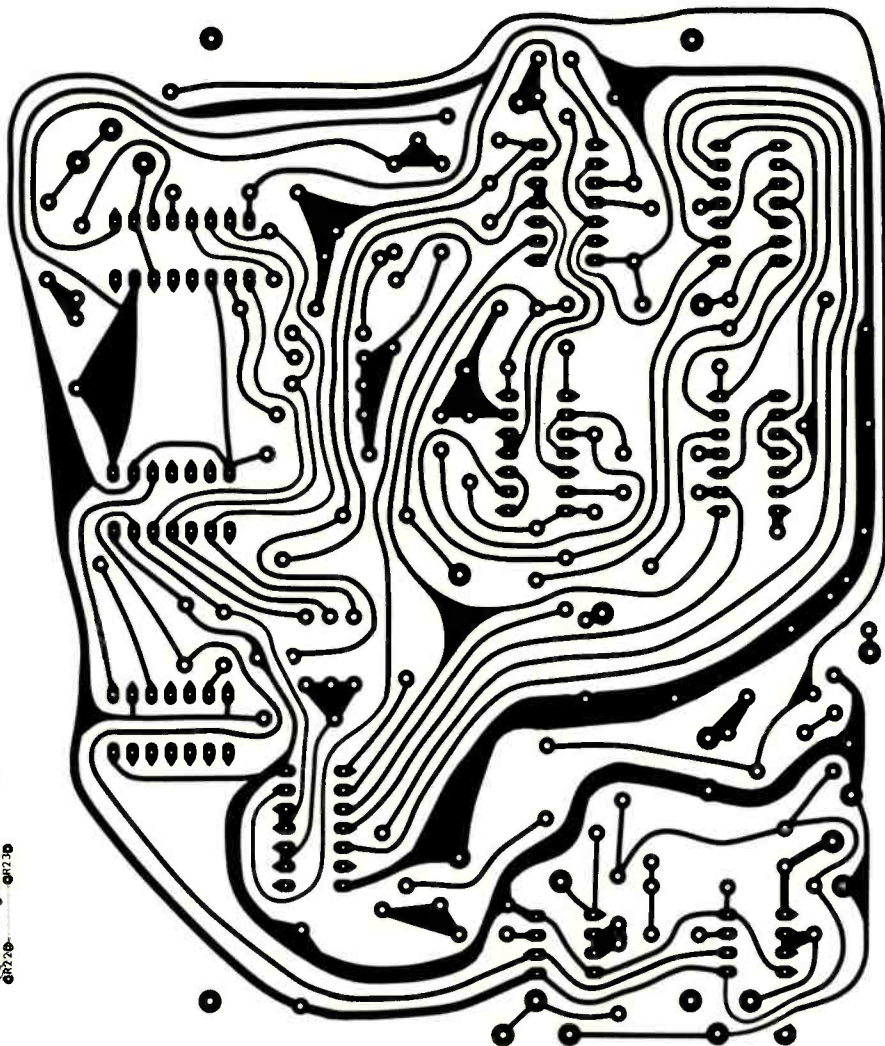
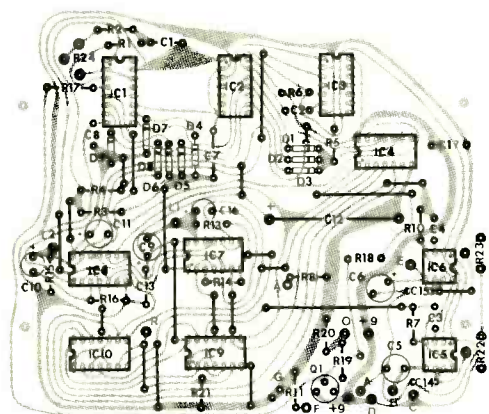

shown in Fig. 5 (which also shows component installation). Position controls and laser firing switches can be mounted in separate small enclosures with cables connecting them to the main board. The latter (including battery holders) is mounted in its own enclosure. The power switch (S1) and reset switch (S2) should be on the front panel. The composite video/sync signal should be brought out through a phono connector.

Testing. Check all wiring before turning on the power. Connect the game to the set's video amplifier. Turn on the space game (S1) and operate the reset switch (S2). Adjust R24 (Fig. 2) for proper vertical sync. If necessary, trim R2 for a stable vertical sync.

If the system is working properly, you will see two white squares (the space ships) on the edges of the screen. Turn up the contrast and turn down the brightness until the squares are clear white on a black background.

You should be able to move the space ships up and down using the appropriate controls. The width of the space ships can be altered by changing the values of C7 and C8 (Fig. 2). Their heights are determined by R7 and R10 (Fig. 3). The larger the spaceship, the easier the game is to play. About 8 to 10 TV lines is a good height.

Adjust both position potentiometers until the spaceships are at the lowest point on the screen. If they are not even, determine which is higher, and adjust the appropriate potentiometer (R22 or R23) to get them even. Then position both at the top of the screen. If they are not even, adjust R8 or R11.

Depress laser switch S3 to check the firing. A streak of white dots should extend from the left ship to the other side of the screen. If the right ship is hit, it should disappear. Check the other side in a similar manner. If the firing or recover times differ appreciably from one side to the other, adjust R13 and R14 or R15 and R16. ♦

Editor's Note—The Magnavox Company, 1700 Magnavox Way, Fort Wayne, IN 46804, has exclusive worldwide rights to certain patents pertaining to electronic television games such as the ones described in this article. Magnavox has indicated that any making, using or selling of such electronic TV games may come within the purview of these patents and the U.S. patent laws.

IF YOU'RE NOT DESIGNING WITH A CSC PROTO-BOARD® LOOK AT ALL YOU'RE MISSING.

Versatility—Use with virtually all types of parts, including resistors, capacitors, transistors, DIP's, TO-5's, LED's, transformers, relays, pots, etc. Most plug in directly, in seconds.

Accessibility—All parts are instantly and easily accessible, for quick signal tracing, circuit modifications, etc.

Adaptability—Use in design, packaging, inspection, QC, etc. Works with most types of circuits, in many, many applications.

Expandability—Proto-Board units can be instantly interconnected for greater capacity

Utility—Models are available with or without built-in regulated power supplies (fixed or adjustable).

Variety—A wide variety of models are available with capacities ranging from 630 to 3060 solderless tie-points (6 to 32 14-pin DIP's), to fit every technical and budget requirement.

Speed—Assemble, test and modify circuits as fast as you can push in or pull out a lead. Save hours on every project.

Flexibility—Use independently, or in conjunction with other accessories, such as scopes, counters, CSC Proto-Clip™ connectors, Design Mate™ test equipment, etc. One Proto-Board unit can serve a thousand applications.

Durability—All Proto-Board models are carefully constructed of premium materials, designed and tested for long, trouble-free service.

Economy—Eliminate heat and mechanical damage to expensive parts. Save money by re-using components.

Visibility—All parts are instantly and easily visible, for quick circuit analysis and diagramming.

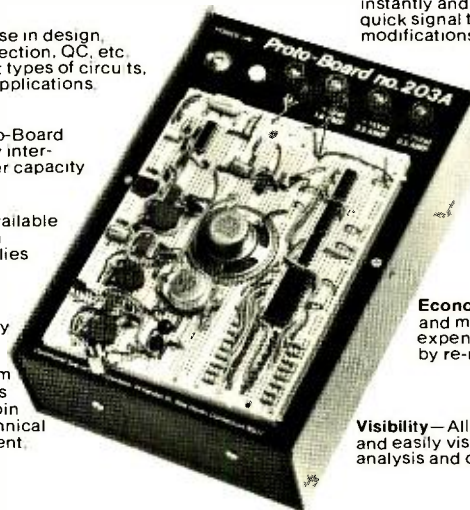

Whatever type of electronic circuits you work with, you can do more in less time with CSC's solderless Proto-Board™ systems. As fast and easy as pushing in or pulling out a lead, you can design, test and modify circuits at will. Components plug into rugged 5-point terminals, and jumpers, where needed, are lengths of #22 AWG solid wire. In the same time you took to read this ad, you could be well on your way to assembling a new circuit. For more information, see your CSC dealer, or write for our catalog and distributor list.

CONTINENTAL SPECIALTIES CORPORATION



EASY DOES IT

44 Kendall Street, Box 1942
New Haven, CT 06509 • 203-624-3103 TWX: 710-465-1227
West Coast office: Box 7809, San Francisco, CA
94119 • 415-421-8872 TWX: 910-372-7992
Canada: Len Finkler Ltd., Ontario

© 1976 Continental Specialties Corp.
Prices and specifications subject to change without notice.



COMPUTERS and other digital equipment communicate in "languages" based on 1's and 0's that must be mastered if any meaningful communication between human and machine is to be accomplished. There are four number systems in common use in electronics today. For human-to-human communication, we use the 0 through 9 "decimal," or base-10 (n_{10}), number system. The other three are the digital 1/0-based systems, which include: binary (base-2, or n_2), octal (base-8, or n_8), and hexadecimal (base-16, or n_{16}).

Converting from one to any other numbering system is a relatively simple matter. Let us review how these systems compare with each other and interact.

The Binary System. The binary code is the basic digital machine numbering system. In essence, it is a simple 1/0 representation of the decimal system. Its great disadvantage, and the reason it is rarely used in computers, is that binary equivalents of decimal numbers become increasingly ponderous with each succeeding number.

To illustrate how to use the binary numbering system, let us convert 69_{10} , 230_{10} , 1976_{10} , and 52801_{10} to binary. (Note: It is important to use subscripts to identify the numbering system when more than one system appears in your notes. The numbering system subscripts are detailed above.) The

Introduction to COMPUTER CODES

*The foundation for
programming
computers—binary,
octal, hexadecimal,
and BCD codes.*

BY R. T. ROBBINS

four numbers we have selected at random will illustrate the drawback of the binary system.

The binary system is a simple 1/0

format. Going from right to left, as each position is filled by a 1 and another 1 is added to it, the result is 0 and a 1 is carried to the next place to the left. A table of binary equivalents for the decimal numbers 0 through 15 would appear as follows:

Decimal	Binary
0	0
1	1
2	10
3	11
4	100
5	101
6	110
7	111
8	1000
9	1001
10	1010
11	1011
12	1100
13	1101
14	1110
15	1111

Note the logical progression of the numbers in binary and the increasing number of digits used as you count up. Note also that the points at which you add digits to the left occur at the power-of-two (2^n) points—2,4,8,16,32, etc. And one final note: 0 is always considered a number possibility in all digital machine languages.

Now we can make some step-by-step conversions. The first step is to list across the page the decimal equivalent of each power of two that will be required for making the conversion, as shown in Fig. 1. Each location will

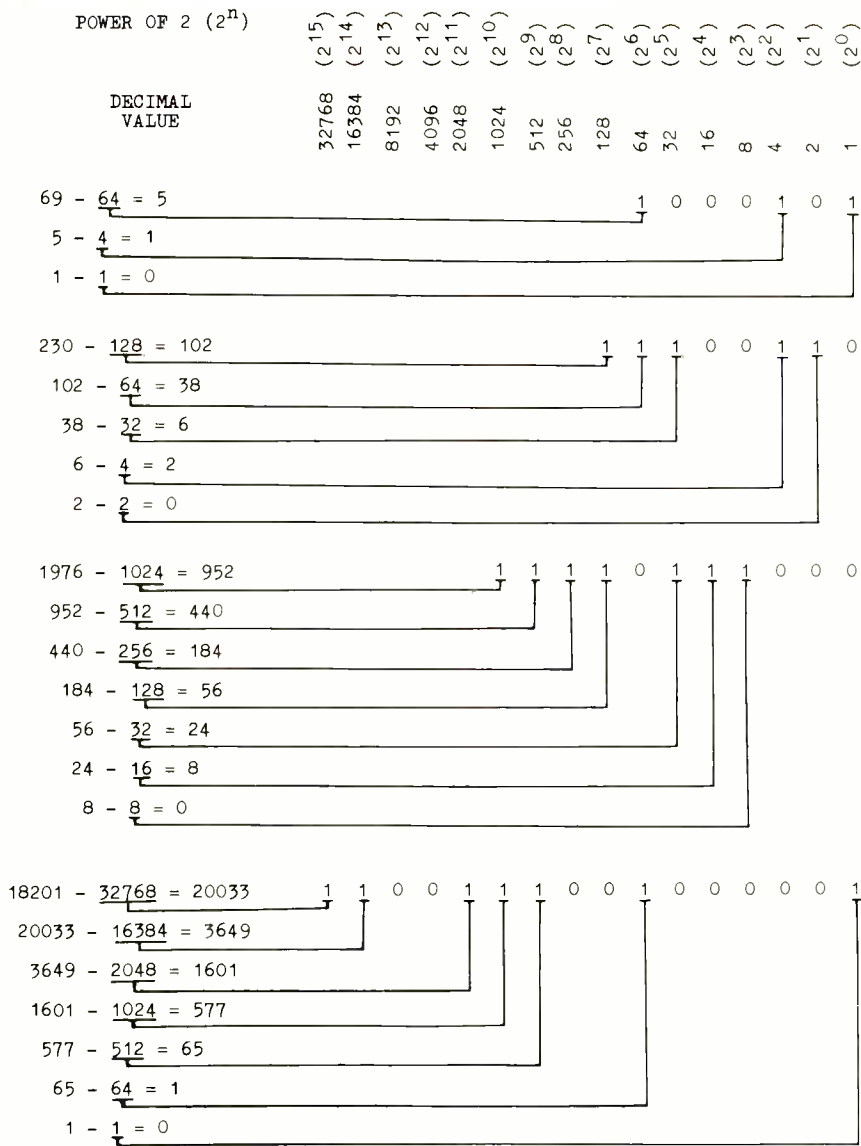

Fig. 1. Converting decimal numbers to equivalents in binary code. The final binary conversions are at the right.

$$69_{10} = 1000101_2$$

$$230_{10} = 11100110_2$$

$$1976_{10} = 11110111000_2$$

$$52801_{10} = 1100111001000001_2$$

be filled in with a 1 or a 0 (binary "bit"), depending on whether or not its value is used during computations. If the value is used, you enter a 1; otherwise, you enter a 0. (Leading 0's need not be entered.)

Start your conversion by placing a 1 under the largest decimal number that doesn't exceed the number you're converting. Next, subtract the number under which you placed a 1 from the number you're converting to determine which is the next number under which you must place a 1. Always keep in mind that you must never have a negative result. Only positive results or 0 after subtraction are acceptable. If you must skip numbers to enter a 1, fill in the blank spaces with 0's. Continue

subtracting numbers until you've filled each column and your final result equals exactly zero. If, after obtaining a 0 result, you still have empty spaces to the right, fill in 0's. To double-check your conversion, simply add all the power-of-2 numbers under which you've entered 1's and check that the result is the decimal number with which you started. (Note: This is the procedure to use when converting any binary number back to its decimal equivalent.)

The final conversions to binary for our sample decimal numbers are shown at the bottom of Fig. 1. Note how many more digits must be filled in as the numbers increase in magnitude.

Once you understand the binary code, the octal and hexadecimal codes are much easier to understand and learn.

The Octal Code. Much of the ponderousness of the binary code can be eliminated by switching to the more efficient octal code. An octal number is only one-third as long as its binary equivalent. Once a number has been converted from decimal to binary, separate it into groups of three digits, working from right to left.

In any group of three digits, the minimum will be 000 and the maximum will be 111. Now, to get the equivalent octal number, simply translate the three binary numbers back to decimal, which means the smallest number you will have will be 0 (000) and the largest will be 4+2+1=7 (111). Bearing in mind that 0 is always a number possibility, you now have a base-8 number system:

Decimal	Binary	Octal
0	0	0
1	1	1
2	10	2
3	11	3
4	100	4
5	101	5
6	110	6
7	111	7
8	1000	10
9	1001	11
10	1010	12
11	1011	13
12	1100	14
13	1101	15
14	1110	16
15	1111	17

When converting from binary to octal, you may end up with only one or two digits in the left-end group. To handle this situation, simply assume that the missing digits are 0's.

The octal equivalents of the sample decimal numbers chosen above are shown in Fig. 2.

The Hexadecimal Code. Greatest efficiency is obtained when the hexadecimal code is used to format decimal numbers. Here, the binary number is separated into four-digit slices (right to left). Now, the maximum number capable of representation is 1111₂, or 8+4+2+1=15₁₀. You still count up from 0 in the usual decimal manner, but only to 9. This still leaves six numbers to fill in to reach the 16 maximum. However, you cannot enter 10 as the next numeral because that is the first numeral

FREE EICO CATALOG

346 Ways To Save On Instruments, Burglar Alarms, Automotive & Hobby Electronics!

The more you know about electronics, the more you'll appreciate EICO. We have a wide range of products for you to choose from, each designed to provide you with the most pleasure and quality performance for your money. The fact that more than 3 million EICO products are in use attests to their quality and performance.

"Build-it-Yourself" and save up to 50% with our famous electronic kits.

For latest EICO Catalog on Test Instruments, Automotive and Hobby Electronics, Eicocraft Project kits, Burglar-Fire Alarm Systems and name of nearest EICO Distributor, check reader service card or send 50¢ for fast first class mail service.

**EICO—283 Malta Street,
Brooklyn, N.Y. 11207**

*Leadership in creative electronics
since 1945.*



in the second hexadecimal set. So, you continue counting with alphabetic letters from A to F:

Decimal	Binary	Octal	Hexadecimal
0	0	0	0
1	1	1	1
2	10	2	2
3	11	3	3
4	100	4	4
5	101	5	5
6	110	6	6
7	111	7	7
8	1000	10	8
9	1001	11	9
10	1010	12	A
11	1011	13	B
12	1100	14	C
13	1101	15	D
14	1110	16	E
15	1111	17	F

The conversion to hexadecimal code from decimal requires that you first convert your decimal number to binary. Then break the binary number into groups of four digits. Each four-digit binary group is then assigned a hexadecimal equivalent. The conversions for our sample decimal numbers are derived as shown in Fig. 3.

When converting hexadecimal back to a decimal number, first convert the hex number into binary and then the binary into the decimal number.

Binary Coded Decimal. This coding system, also commonly known by its initials BCD, is the easiest to obtain from a decimal number. Instead of considering the decimal number as a whole, treat each digit in the number as a separate entity when converting

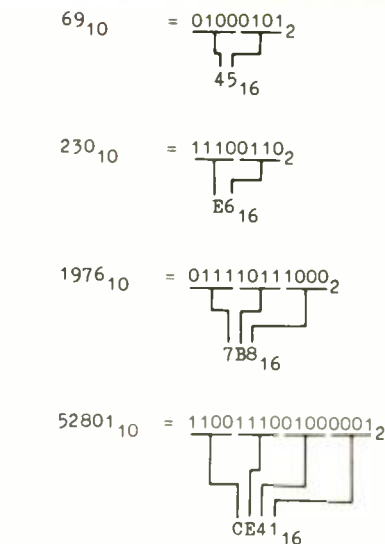

Fig. 3. Hexadecimal conversions for sample decimal numbers.

to BCD. Each digit must be assigned a four-bit, strictly binary number. The reason for assigning a four-bit number is that decimal covers a range of 10 numbers (0 through 9). Therefore, the lowest number you can have will be 0000 and the highest 1001, which represent 0 and 9, respectively.

The BCD equivalents for our sample decimal numbers are as follows:

Decimal	BCD
69	0110 1001
230	0010 0011 0000
1976	0001 1001 0111 0110
52801	0101 0010 1000 0000 0001

Note that when a BCD number is written, an obvious space must be left between each four-bit binary slice for identification purposes. BCD is the only numbering system that should have such spaces. Therefore, it doesn't need a subscript, except in the special case where only a single decimal digit is to be converted, in which case you can use a BCD subscript.

Summing Up. We have discussed four basic numbering systems used in digital equipment. Of these, hexadecimal is the most efficient but has the disadvantage of requiring both numeral and alphabet symbols. Slightly less efficient, the octal system has the advantage of employing only easy-to-understand decimal numbers. The least efficient numbering systems are binary and BCD. BCD is by far the least efficient numbering system, requiring five times the number of spaces (including the required blank space) of its equivalent decimal number. ♦

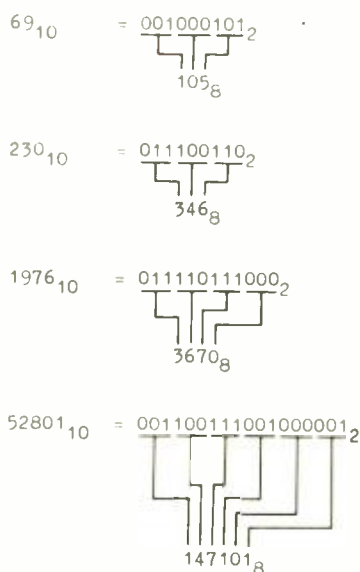
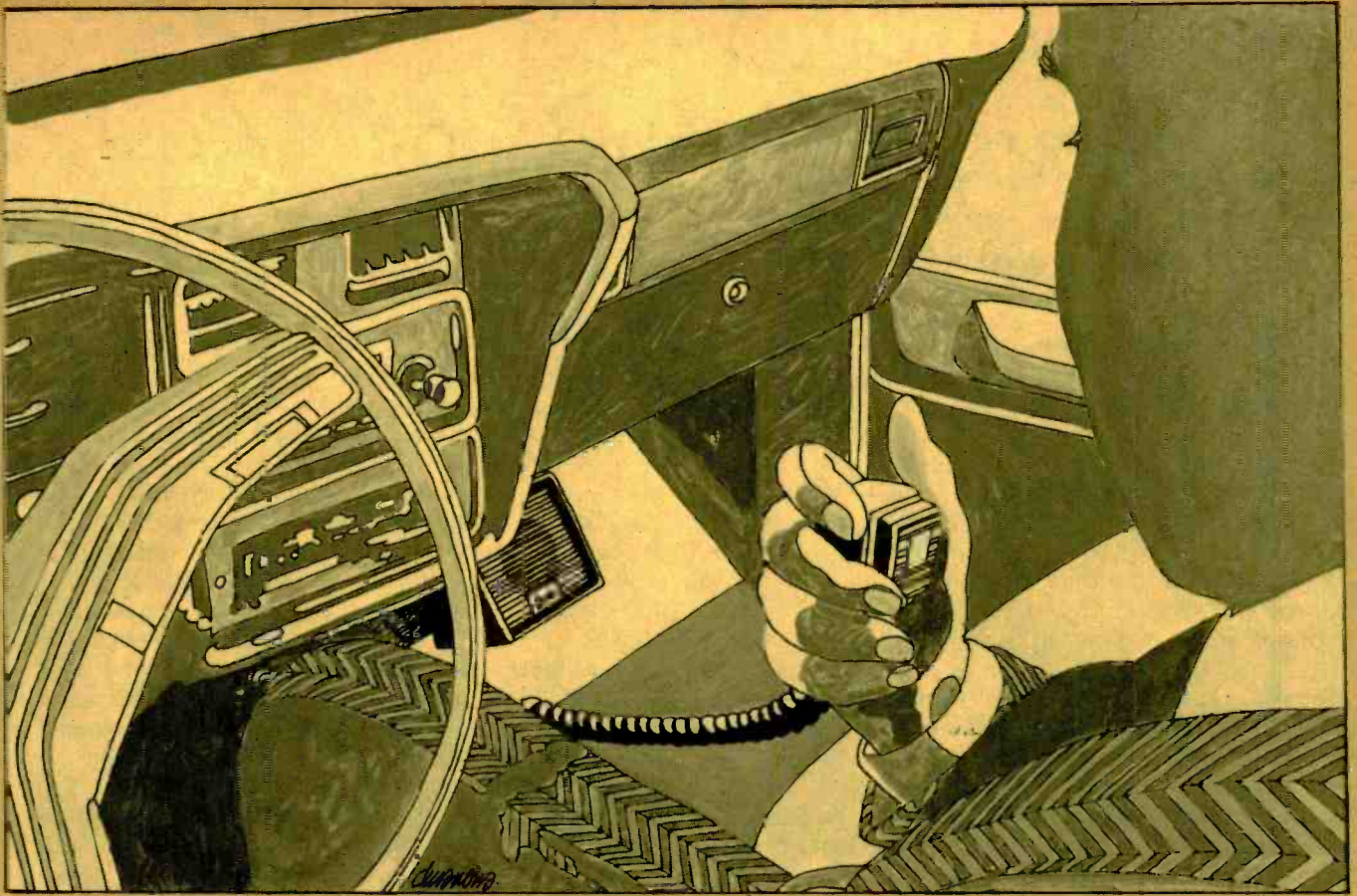

Fig. 2. Octal equivalents of four decimal numbers.



Popular Electronics®

Special Focus on CB RADIO

MORE and more people are turning to Citizens Band Radio to satisfy their two-way radio communication needs. They might be motivated by a desire to have an emergency line in an automobile, check on traffic conditions by listening to trucker's conversations (now mostly on Channel 19 rather than Channel 10), participate in public service activities, develop new friends, enjoy general conversations when alone in the home, contact the business office while driving, and so on.

Coupled with the no-test requirement and relatively low equipment cost, it's not surprising that the growth of CB Radio (Class D) has been astonishingly great. As an example, the last report received from the FCC indicated that almost 300,000 new CB license applications were received in the month of November 1975! And the FCC projects that there will be about 15-million CB'ers in the U.S.A. by 1979.

This certainly has been a good year for CB. Operating restrictions were relaxed (including removal of the "hobby" prohibition), license fees were reduced from \$20 to \$4 for five years, and interstation chan-

nels were increased, among other benefits. By relaxing CB rules, however, the FCC expects full compliance with present restrictions, which include use of one's Call Letters, transmission-time limits, no obscene language, etc. It's to every CB'ers advantage to press for compliance with the rules. Remember, what the FCC gives it can take away!

This special 16-page insert examines a variety of CB areas: (1) Base-station CB antennas, which can significantly increase communication range, are given authoritative treatment. (2) A pictorial presentation shows how easy it really is to install a mobile CB system. (3) A CB highway assistance program in Washington, D.C. underlines the important public service performed by many CB'ers. (4) An easy-to-build communication timer simplifies complying with the new FCC ruling on communication time. (5) A glossary of CB equipment terms will enable buyers to understand specification and feature claims in product literature. (6) Finally, a list of CB radio equipment and antenna manufacturers and addresses for reference purposes.

How to Choose CB Base Station Antennas

BY JOHN J. McVEIGH, Associate Editor

A MAJOR concern of many CB'ers is extending their reliable communications range beyond, say, five miles or so. Since there is a 4-watt r-f power output limit imposed by the FCC, the only way to extend the range legally is to do something about the antenna. Due to physical limitations and other factors, not much can be gained by improving a mobile antenna. But it's a different story with base antennas. A dramatic jump in range can often be obtained by using the right antenna and mounting it properly.

Bewildered by so many different antenna shapes and sizes, most CB'ers end up asking, "How can I choose the right base antenna without studying to become an antenna engineer?" To answer, let's take a quick look at some antenna basics and consider the various types available.

Antennas, whether mobile or base station models, are designed to perform two functions: (1) Accept r-f power from the transmitter section and radiate it into space. (2) Capture a portion of signals passing by and convert them into small voltages that are processed by the receiver section. But that's where similarities end!

Antennas can be differentiated according to four basic characteristics: polarization, directivity, radiation angle, and feedpoint impedance.

Polarization concerns the plane in which the electric field is set up by the antenna. (Radio waves have electric and magnetic fields at right angles to each other.) Most often, polarization of signals radiated by the antenna lies in the same plane as its active element(s), as shown in Fig. 1. Therefore, a vertical antenna (such as a mobile whip) radiates vertically polarized signals, whereas an antenna element mounted at right angles to a vertical mast is horizontally polarized.

Does the foregoing make a difference to a base station antenna buyer? Yes! If you anticipate communicating mainly with mobile units, it is best to have a *vertically* polarized base antenna since most mobile signals are vertically polarized. However, if you're primarily interested in a few fixed stations, get together with those operators and install *horizontally* polarized antennas at each location. Choosing a "horizontal" antenna will also bring a degree of noise immunity to the user since most electrical noise is vertically polarized.

It's important to note that an antenna polarized in one plane can still pick up signals in the other. It just won't receive them as efficiently, resulting in poorer reception on weak signals. For example, a ground-wave signal (one travelling along the earth's surface) received by a cross-polarized antenna will generally be attenuated about 20 dB (3.3 "S" units). Considering the low power levels in CB work—4 watts *maximum*—it's to your great advantage to have as efficient an antenna as possible.

Directivity. When an antenna performs better in one direction than another, it's said to be directive. One that works equally well in all directions is omnidirectional. Coupled with an antenna's directivity is its *gain*, which shows how much more it favors one direction than another.

Gain is usually expressed in dB, referenced to either an isotropic source (a theoretical antenna radiating equally well in all directions) or a dipole, which is a simple antenna radiating best at right angles to itself. A dipole has a gain of 2.1 dB compared to an isotropic source. When comparing antenna gain, be sure to know what the reference is—the same antenna will have a gain of 8 dB or 10.1 dB, based on a dipole and isotropic antenna, respectively. Sometimes "dBi" will be used to express gain over an isotropic reference antenna.

It's easy to understand these concepts by looking at the *polar diagram* of an antenna. The response of an isotropic antenna is shown in Fig. 2A. The intensity of radiation is represented by the radius of a circle, since it is constant at all points around the antenna at a given distance. (Of course, the radiation gets weaker the farther away from the antenna you measure it.) A dipole has a response like that shown in Fig. 2B. Note that the maximum signal is radiated broadside to the antenna. Thus, it is moderately directive.

A very directional antenna has a response like that in Fig. 2C. It "beams" its power toward one direction in a single major "lobe." Consequently, it can increase the apparent signal strength in the favored direction by as much as 10 dB or more. This is equivalent to radiating 40 watts from your transceiver—legally! (10 dB represents a 10-fold increase in power. See the nomograph of Fig. 3.) The technical term for this apparent power level is *effective radiated power*, or simply *erp*.

Directional antennas are just as useful on receive as transmit. With them, you can reduce interference to a station in the desired area by boosting its strength. At the same time you'll be cutting down the strength of those from other directions.

But you don't get something for nothing. What you gain in signal level in one direction is taken from other directions. This means, in many cases, that, if you want a stronger signal in more than one direction, you must physically rotate the antenna to aim it the right way. Although this can be done with an electric motor (a rotator), it does boost the cost of the antenna system.

Radiation Angle describes how the signal "takes off" from the antenna. If the radiation angle is near zero, most of the signal runs parallel to the earth's surface as a "ground wave." This is most desirable. As the radiation angle increases, more and more of the radiated signal is sent up into the "blue." Although these signals are some-

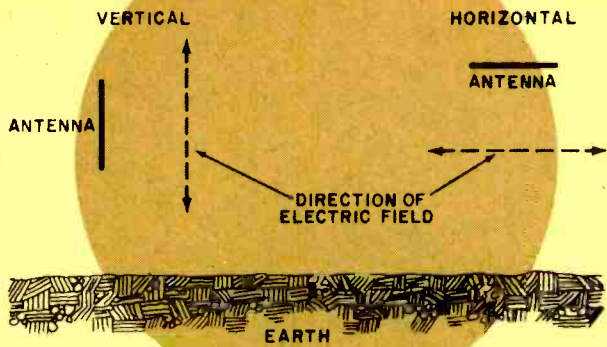

Fig. 1. Vertical polarization (left) and horizontal (right).

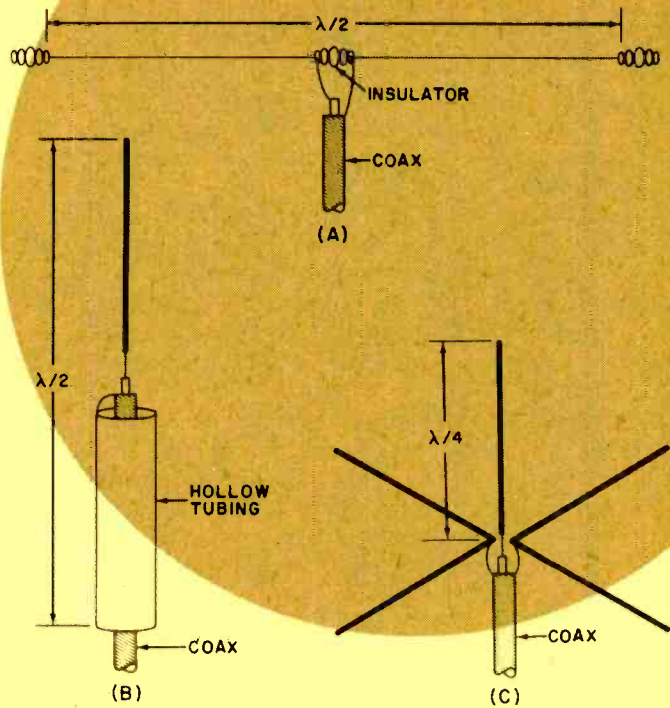

Fig. 4. Three simple antennas: (A) horizontal dipole; (B) vertical (coaxial) dipole; (C) ground plane.

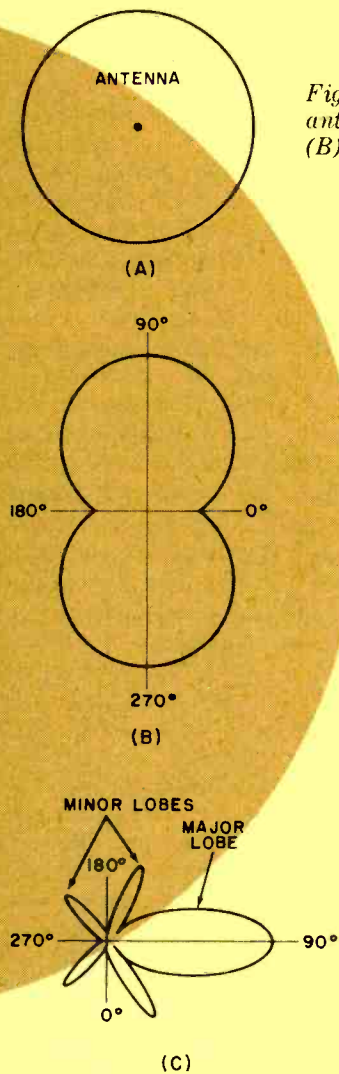

Fig. 2. Polar diagrams for antennas: (A) isotropic; (B) dipole; (C) beam.

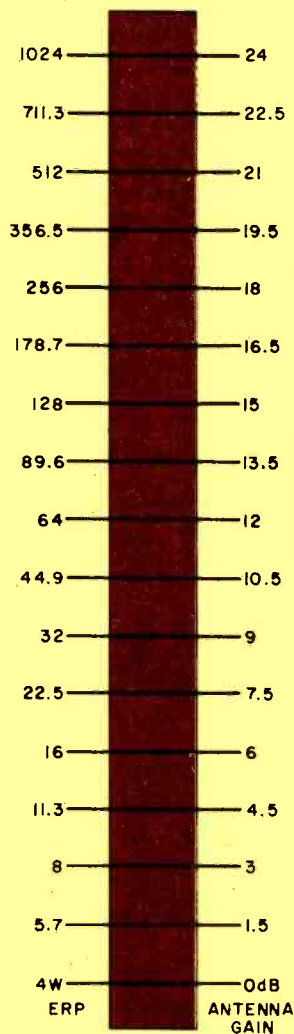

Fig. 3. Nomograph of antenna gain versus effective radiated power. (Feedline loss neglected.)

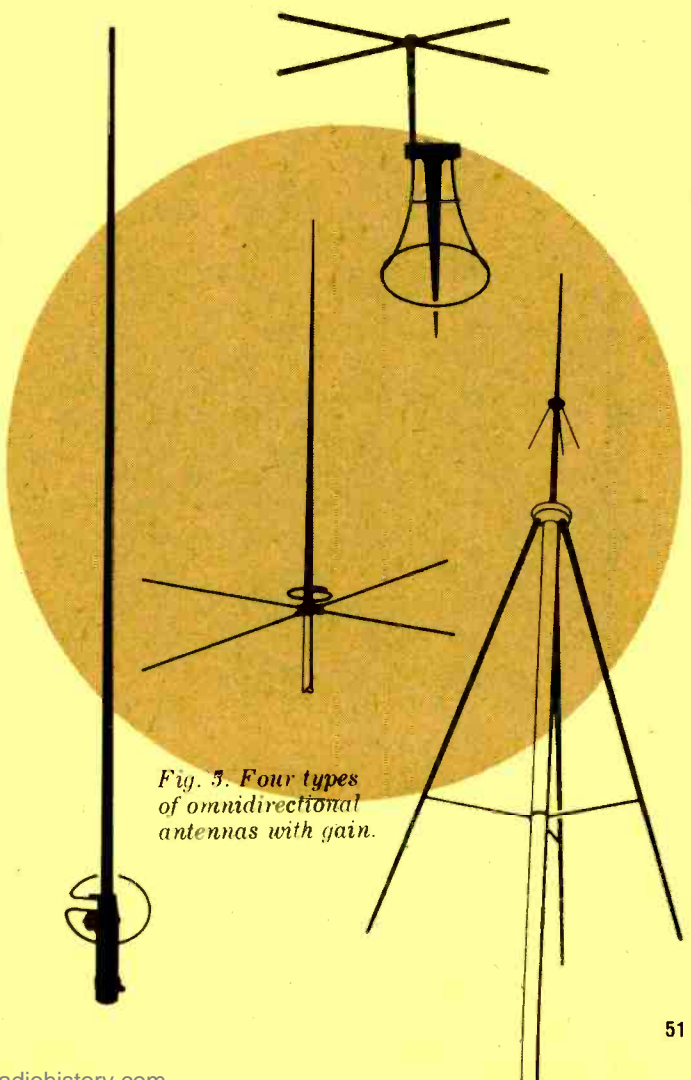

Fig. 5. Four types of omnidirectional antennas with gain.

times reflected back to earth many hundreds or thousands of miles away ("skip" signals), they are not the basis of good CB communications. Apart from legal considerations (the FCC limits CB communication range to 150 miles), "skip" is a transient phenomenon at best. For reliable communications, most of the radiation should be ground wave.

The radiation angle is as much a function of the antenna design as it is of the way the antenna is mounted. Generally, the higher the antenna is placed above actual or artificial ground, the lower the radiation angle becomes. As a rule, vertical antennas tend to have lower radiation angles than horizontal ones mounted at the same height.

Feedpoint Impedance, expressed in ohms, is the amount of opposition the antenna exhibits to the flow of r-f current into it. But don't draw a common-sense conclusion from this that you'll want the minimum opposition possible, or 0 ohms. Without delving into theory, let's just say that all impedances of the communications system—the input impedance to the receiver, the output impedance of the transmitter, the "characteristic" impedance of the coaxial transmission line, and the feedpoint impedance of the antenna—should be equal.

The common feedpoint impedance of CB antennas is 52 ohms, and the same holds for the other impedances mentioned. When one or more of these varies, part of the output of the transmitter is reflected back into it, and "standing waves" are set up. These represent lost signal power. (The same holds true for received signals entering the receiver.)

The standing wave ratio (SWR) is an index of how well the antenna system is matched. When all impedances are equal, the SWR is one or "1:1" ("one to one"). It is obtained by forming the ratio of antenna impedance to feedline impedance, or feedline impedance to transmitter output impedance, etc. So, if a 50-ohm-output transmitter is connected through a 50-ohm transmission line to a 100-ohm antenna, the SWR is 2:1, which is commonly accepted as the maximum tolerable SWR.

Some antennas have matching or loading coils. These are used to convert the "actual" antenna impedance to the desired 52 ohms. Other things being equal, antennas with these coils will not perform as efficiently as those whose "actual" impedance is 52 ohms. Coils, even if they are wound from silver or gold wire, still introduce losses. Some of the r-f power applied to them simply heats the coil, rather than being radiated as useful signal power.

Armed with these concepts, let's examine the common CB base station antenna designs from which you will have to choose.

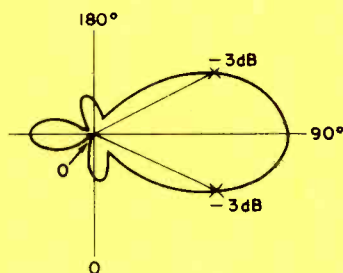

Fig. 7. Half-power (-3-dB) points determine angular bandwidth of a directional antenna.

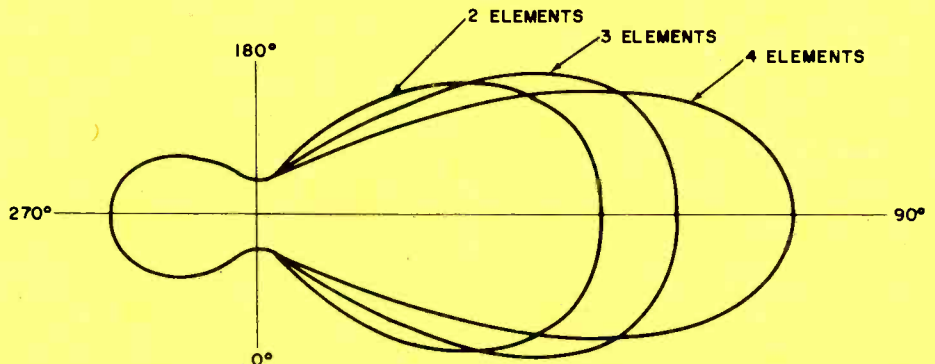

Fig. 8. Adding elements to a Yagi increases directivity.

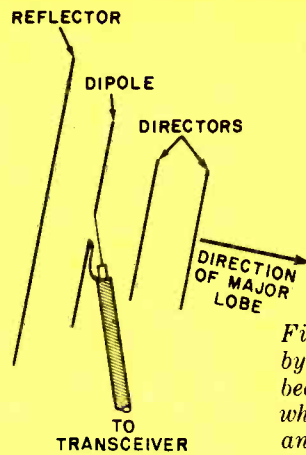

Fig. 6. A dipole surrounded by "parasitic" elements becomes a Yagi beam, which can have high gain and good directivity.

Simple Antennas. The two basic antennas that are used in communications are the *dipole* and *ground plane*. Dipoles are formed by splitting a piece of wire one-half wavelength (the distance a radio wave travels in 180° of one cycle), and feeding it with a transmission line. The antenna can be installed in either the horizontal (A) or vertical (B) plane, as shown in Fig. 4. The *coaxial* dipole is often used because it is vertically polarized. One half of the dipole is a rod or wire connected to the inner conductor of the coaxial feedline. The other half is a piece of tubing tied to the outer conductor or "braid" of the coaxial line. Each element of the dipole is one-quarter wavelength ($\lambda/4$) or about 9 feet.

The ground plane (Fig. 4C) is a commonly used CB antenna, consisting of a vertical quarter-wavelength rod, and three or four "radials" of the same length ($\lambda/4$). The result is an omnidirectional antenna with a fairly low radiation angle. Often, the radials will droop. This is done to raise the feedpoint impedance to the desired 52 ohms. If the radials were rigid, the impedance would be in the neighborhood of 30 ohms, and a mismatch would result.

The advantages of these antennas include simplicity of construction (you can build your own) and ease of installation. They also tend to last a long time in the face of high winds. However, don't expect high gain or directionality.

Omnidirectional Antennas with Gain. This class of antennas offers some gain over the simple types without sacrificing directivity. No, that's not a contradiction of what was said previously. (You don't get something for nothing.) The increased power is taken from signal components that would be radiated at higher angles. The polar diagrams shown in Fig. 2 are two-dimensional—but antennas radiate in *three* dimensions. So, the radiation pat-

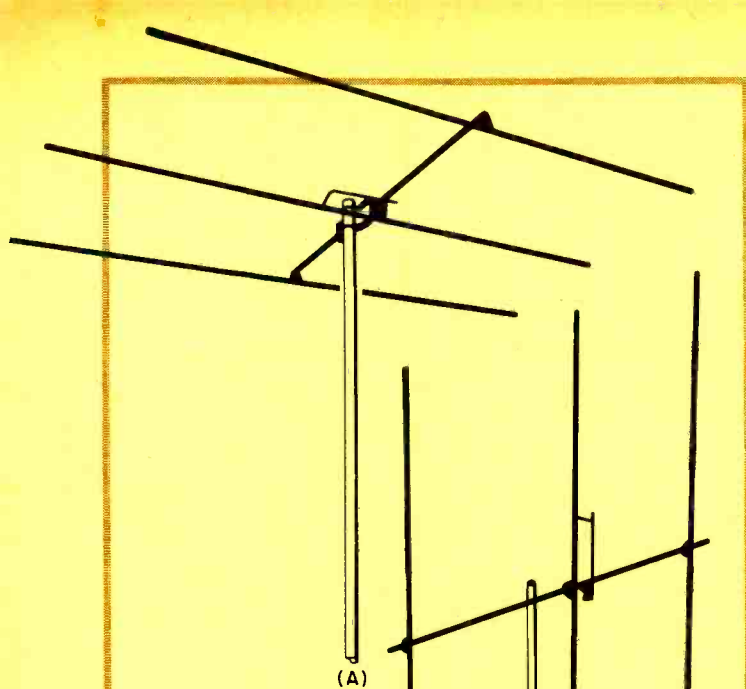

Fig. 9. A Yagi beam can be mounted for horizontal (A) or vertical (B) polarization.

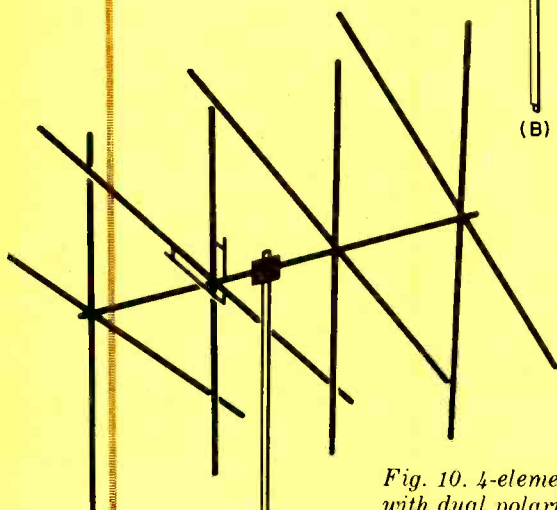

Fig. 10. 4-element Yagi with dual polarization.

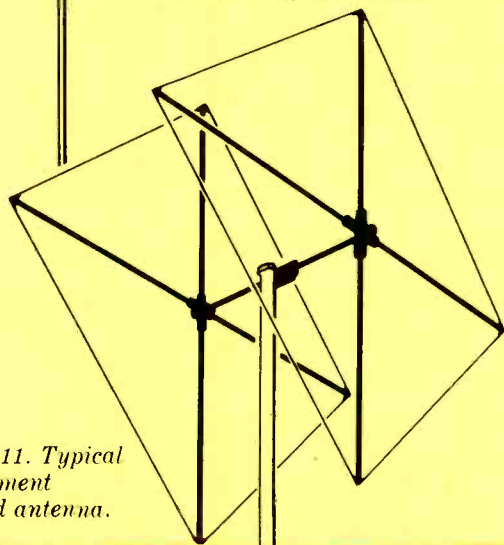

Fig. 11. Typical 2-element Quad antenna.

tern of an isotropic source is really a sphere, a cross section of which was presented earlier. A dipole is surrounded by a doughnut-shaped field, which, in two dimensions, looks like the figure-8 of Fig. 2B.

When speaking of omnidirectionality, we confine ourselves to low radiation angles. Consequently, if we compress the isotropic's "balloon" or the dipole's "doughnut," we end up with greater field strength in the ground wave by adding that portion that would otherwise be wasted as sky-wave signal. This is usually done through capacitive loading (by means of a metallic "hat" or similar structure), extending element length (say, to $5\lambda/8$), or phasing effects between different antenna components. Realizable gain is generally on the order of 3 to 6 dB over an isotropic source. Figure 5 shows typical antenna configurations that are all vertically polarized.

There are a few antennas which can be used as omnidirectionals with a certain amount of gain, or as directionals with more gain. They rely on a control box to set phasing, which in turn governs directivity and gain. However, their patterns can usually be focused in one of three or four directions. Maximum gain is about 8 dBi.

Yagi Beams. This class of antenna has enjoyed great popularity among amateur, CB, and commercial radio operators. It has both directionality and gain due to phasing effects among its elements, which number two or more.

A Yagi beam (Fig. 6) consists of a dipole, called the *driven element*, and one or more rods about the same length mounted on a common "boom" and spaced about $\lambda/10$ away. These rods are called *parasitic elements*, since they are parasitically coupled to the driven element by electric fields. If an element is slightly longer than the driven element, it is called a *reflector*. In operation, it absorbs power coming toward it from the driven element and re-radiates it in the opposite direction. In other words, it reflects the signal back toward the driven element. If a parasitic element is slightly shorter than the driven element, it focuses or directs the signal into a narrower beam travelling in the direction from which it came. Such a parasitic element is called a *director*.

A two-element beam generally consists of a driven element and a reflector. It has a gain of about 7.1 dBi in the direction away from the reflector. Adding a director yields an additional 3 dB, and narrows the beam width. The width of the signal "beam" is often referred to in the specifications as the *half-power beam width*, in degrees. It is measured by finding the points on the major lobe where the radiated signal power is exactly one-half (-3 dB) of the value at right angles to the antenna (Fig. 7). Then lines are drawn from these points on the polar diagram to the graph's origin and the angle formed is measured. The smaller this angle is, the more directional the antenna. The lengths of these lines are proportional to signal strengths at those points.

Directionality and gain can be increased by adding more parasitic elements (usually directors). Practical considerations generally limit the total to five elements. Gain increases are shown in the table, and the effects on beamwidth and radiation pattern are shown in Fig. 8.

A typical three-element beam is shown in Fig. 9. When the beam is mounted at right angles to its vertical mast, as in (A), the antenna is horizontally polarized. When it is mounted as in (B), it is vertically polarized.

It is possible to mount two Yagi beams on the same "boom" to provide switchable polarization (Fig. 10). In this case, separate feedlines would have to be run down to the transceiver, with a coaxial switch to select the desired polarization. But it is also possible, through the use of a coaxial phasing harness, to feed both beams simultaneously and radiate signals polarized in the two planes. Each beam accepts half of the total output power, which means that 3 dB of gain is lost in each plane. The advantage of this system is that both horizontally and vertically

COMPARISON OF ANTENNA CHARACTERISTICS

Type	Gain Over Dipole (dB)	Gain Over Isotropic (dB)	Radiation Angle	Polarization
Isotropic (theoretical)	-2.1	0	All angles	All planes
Ground plane $\lambda/2$ dipole	-1.8	0.3	Low	V
$5\lambda/8$ vert.	0	2.1	Varies inversely with mounting height	Same as mounting plane
Yagi Beam:			Gen. low	V
2-element	1.2	3.3	Varies inversely with mounting height	Same as mounting plane
3-element	5.0	7.1		
4-element	8.0	10.1		
5-element	10.0	12.1		
Cubical Quad:			Varies	Determined
2-element	7.0	9.1	inversely	by feed-point
3-element	10.0	12.1	with mounting height	(see Fig. 12)
4-element	12.0	14.1		

polarized signals will be received equally well. To calculate the gain for each plane, subtract 3 dB from the gain of the active antenna. Referring to the table, horizontal and vertical gains for the four-element beams is 9.1 dBi.

Cubical Quads. This type of antenna made its debut in the late 1940's, and is very popular. It consists of a driven element and one or more parasitic elements, as does a Yagi beam. But the Quad's elements are wire loops, not metal rods. The driven element measures $\lambda/4$ on each side, with a total perimeter of one wavelength.

Standing alone, a full-wave loop has a gain of about 2 dB over a half-wave dipole. Placing a slightly larger loop near the driven one will produce reflective action, much like the reflector on a Yagi. Slightly smaller loops placed on the other side of the driven element act as directors. Adding a parasitic element near the driven element will produce about the same amount of gain obtained by adding one to a Yagi. However, since the driven element inherently has the 2-dB advantage of a dipole (the Yagi's driven element), a Quad will have 2 dB more gain than a beam with the same number of elements.

Quads have other advantages over beams. For a given antenna height, a Quad will have a lower angle of radiation

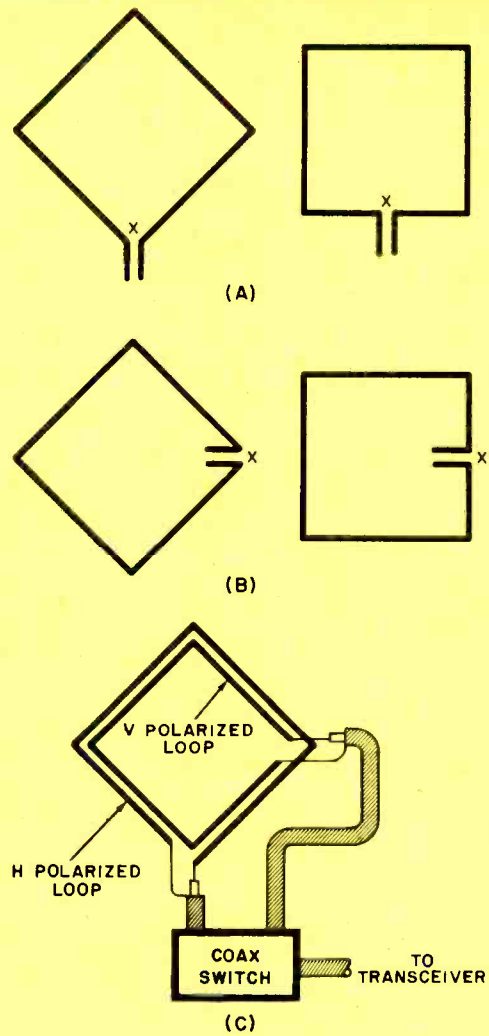

Fig. 12. Polarization of a Quad depends on feedpoint geometry. Diamond and square Quads can be horizontally polarized (A), vertically polarized (B), or both (C).

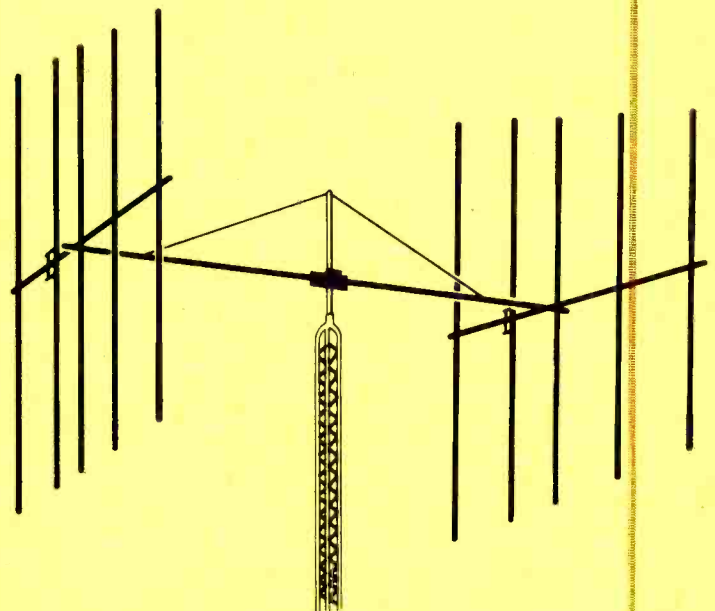

Fig. 13. Stacking two beams in the same plane yields a 3-dB increase in gain.

than a beam. Also, Quads are lighter than Yagis. A typical two-element Quad is shown in Fig. 11. The actual antenna consists merely of the two rectangular loops of wire. The rest of the structure is a supporting framework, made of bamboo, fiberglass, or light-weight metal tubing. (The latter two materials are more durable, and more expensive.) The Quad offers less wind resistance than a beam. This, combined with its lower weight, means that a lighter-duty rotator can be used with the Quad to aim it in the desired direction. For these reasons, many experienced operators prefer Quads to beams.

As shown in Fig. 12, a Quad can be either a square or a diamond in shape. It will perform equally well in either configuration. Its polarization depends only on the feedpoint (where the transmission line is attached to the antenna). By feeding the Quad as shown in Fig. 12A, horizontal polarization is obtained. Attaching the transmission line to the feedpoint (point X) as shown in Fig. 12B will result in vertical polarization. Switchable polarization is accomplished in much the same way as with Yagi's. Figure 12C shows a driven element that is actually composed of two separate loops. One is vertically polarized, the other horizontally. A weatherproof relay mounted near the antenna selects the appropriate loop, and thus the polarization. Also, a special phasing harness can be used to feed both loops simultaneously, so that horizontally and vertically polarized signals are radiated. Gain in each plane is 3 dB lower, as we noted in the similar Yagi case.

Stacking. Effective radiated power can be doubled (an additional 3-dB gain) if directional antennas are "stacked." Figure 13 shows a "king-size" antenna system composed of two stacked 5-element beams. (Note that both

beams are vertically polarized.) A total gain of 17.1 dBi is obtained—14.1 dBi (the gain of a single 5-element beam) plus 3 dB (for stacking) equals 17.1 dBi. That means the ERP of this system, when driven by 4 watts of r-f (neglecting feedline losses), will be 205 *legal* watts! Such an installation requires a lot of space, as well as tolerant family and neighbors.

Conclusion. As you can see, there are a myriad of base station antenna types from which to choose. They range in price from about \$13 to \$375, so anyone's pocketbook can be satisfied. Add to this the material costs for a mast, mounting accessories and cable. For a sophisticated installation, you might want to include a rotator, a small tower, etc.

Don't overlook legal restrictions when planning your base antenna system. If you live near an airport, special limitations must be observed (see FCC part 95 Rules and Regulations). Also, an omnidirectional antenna cannot be higher than 60' above ground level or natural formation. Other regulations: on an existing antenna structure for a licensed transmitter in another service, an omni cannot exceed 60' above ground nor higher than the structure. Directionals cannot be more than 20' above ground or a building, or exceed the 20' point on an existing antenna structure.

Local zoning ordinances should be checked for antenna height restrictions. Sometimes a lease or covenant prohibits outdoor antennas entirely. In the latter case, there are inexpensive, back-of-set, center-loaded antennas and so-called "apartment" 1/4-wave antennas. However, using these antennas won't get you the "reach" that's possible with outdoor types. ♦

It's Easy to Install a CB Mobile Transceiver

BY STEPHEN R. DAVIS

WHILE it is true that many CB retailers do not have installation facilities, this should not deter anyone from enjoying the benefits of a mobile CB communication system. Installation—both from a technical and a cosmetic point of view—is simple. You can do it yourself.

Assembly kits for transceivers, antennas, and external speakers contain easy-to-follow instructions. Only a few standard tools, already owned by most people, are needed. Usually, a screwdriver and a wrench or pliers will suffice. Sometimes a drill is needed, though even this is often not required.

Before You Start. At this point, three notes of caution should be mentioned: (1) Do not attempt to operate your transceiver until the antenna is connected. (2) Don't operate the system until you have checked out the antenna/



Parts and tools for do-it-yourself mobile CB installation.



2 Mounting transceiver under dash.

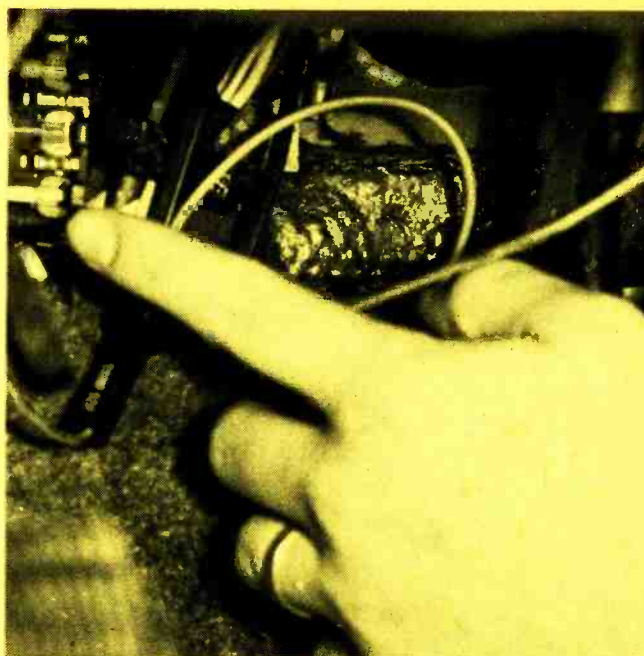

3 Attaching line to unused fuse terminal.

transceiver impedance match with a Standing Wave Ratio (SWR) bridge. An SWR greater than 3:1 can damage the transceiver or greatly reduce output power and usable range. (3) Don't communicate with other operators or test the system on the air until you have received your CB license from the FCC. It is easily obtained, costs only \$4, and the required application is packed in the transceiver's shipping carton.

Installation Procedure. Start by laying out all the required tools and hardware, as shown in Fig. 1. Choose the mounting location carefully (usually under the dash). Be sure the transceiver and the external speaker (if used) do

not interfere with the safe operation of the vehicle or hamper leg movement.

In many vehicles, you'll find mounting screws already in place under the dash. If so, they will accommodate the transceiver's mounting bracket. Obviously, it's easier to use them than to drill into the dash. (It might be necessary to redrill the bracket.) Mount the bracket and, if necessary, secure the microphone retaining clip to the transceiver case. Then, using protective washers, fasten the transceiver to the mounting bracket (Fig. 2).

Now you must connect the power cord to a +12-volt tie point. The transceiver's power lead is only one wire; the antenna feedline serves as the ground. You may decide to

6 Tightening down the antenna coil.

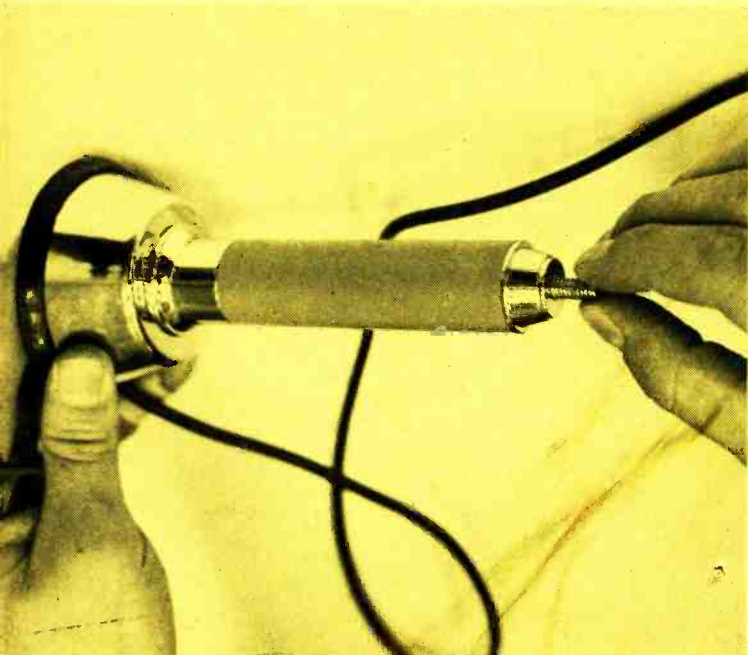

7 Centering antenna on the trunk lid.

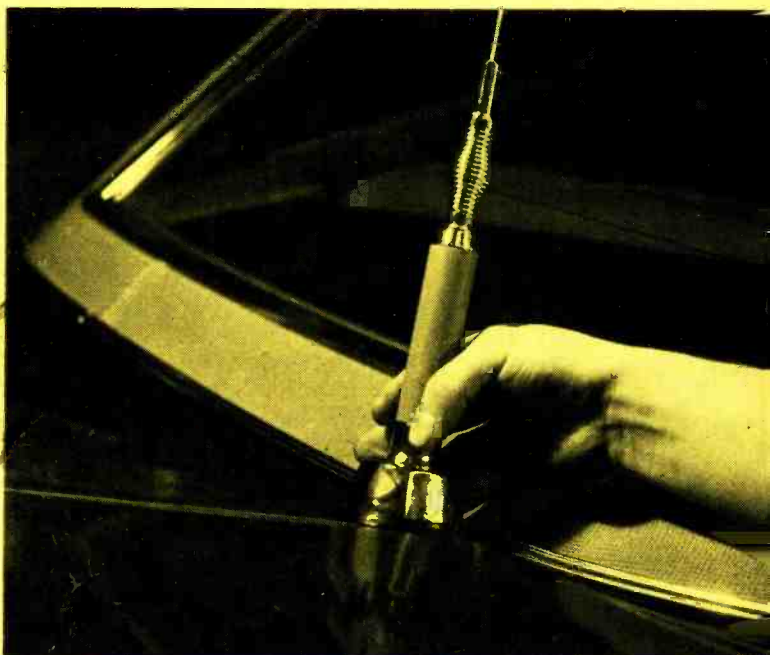



4 Transceiver and external speaker in place.

use the auxiliary fuse on your vehicle's fuse block. If so, attach a female spade connector to the power lead and slip it onto the appropriate "hot" point (Fig. 3). You have a choice of wiring the transceiver so that it will be powered with or without having the ignition switch on. Therefore, check the electrical system's schematic for the right tie point. Some transceivers come with a self-stripping tap connector. With it, getting power to the rig requires only sliding the connector onto any hot lead and crimping it with pliers.

Speaker Installation. Next, mount the external speaker, if one is to be used. Again, you'll probably find

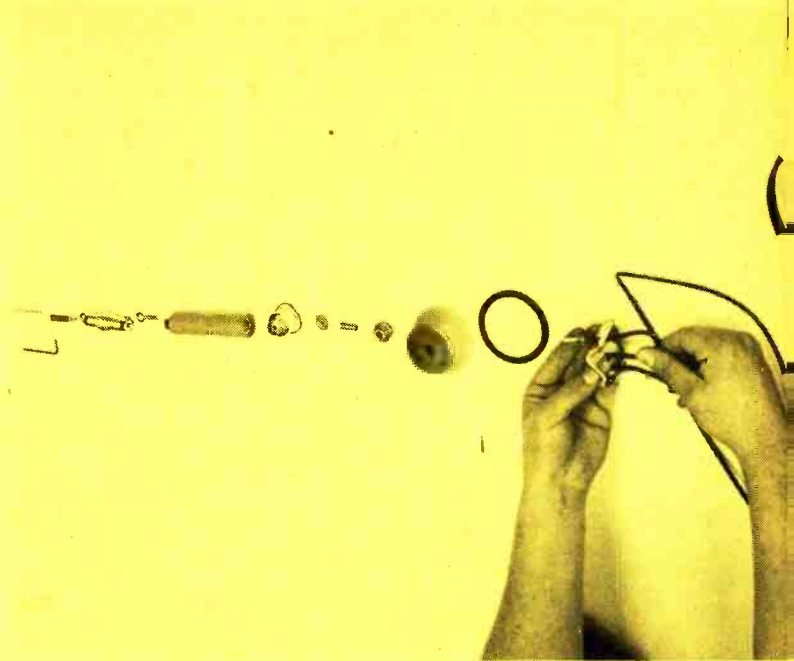

5 Threading coax into antenna mounting bracket.

usable screws in place under the dash—but be sure not to impair the use of the glove compartment door when positioning the speaker. Mount the bracket, attach the speaker, and connect the speaker wire to the appropriate jack on the transceiver. Although the power lead can be cut to the right length, you should not shorten the speaker lead. You might want to move the speaker at some future time, so simply coil up the excess cable and tape it up under the dash. At this point, the installation should look like Fig. 4.

Antenna Installation. Here's where things get a little more complex. Using a trunk mount, the coaxial cable is

8 Pulling the cable from trunk into car.

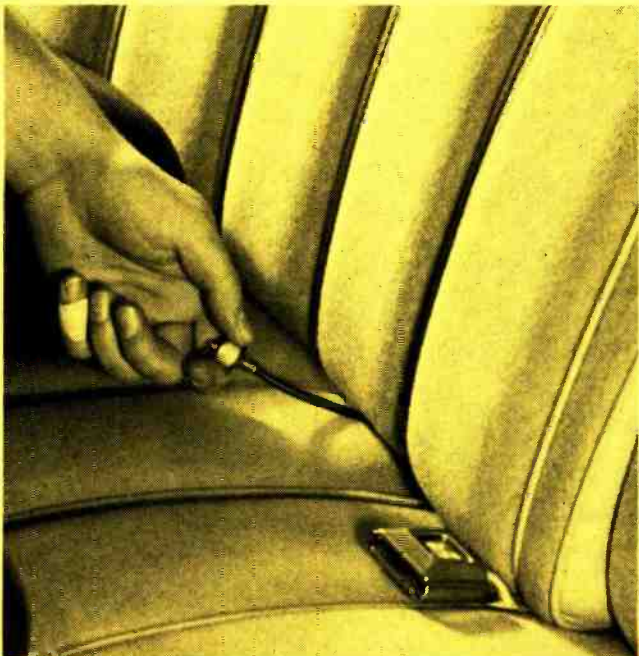

9 Working coax under carpet retaining plate.

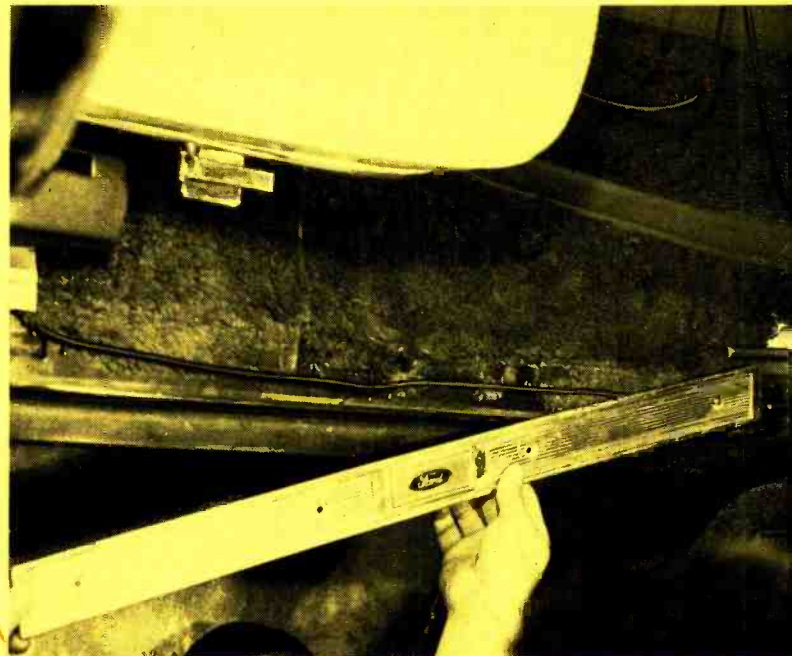

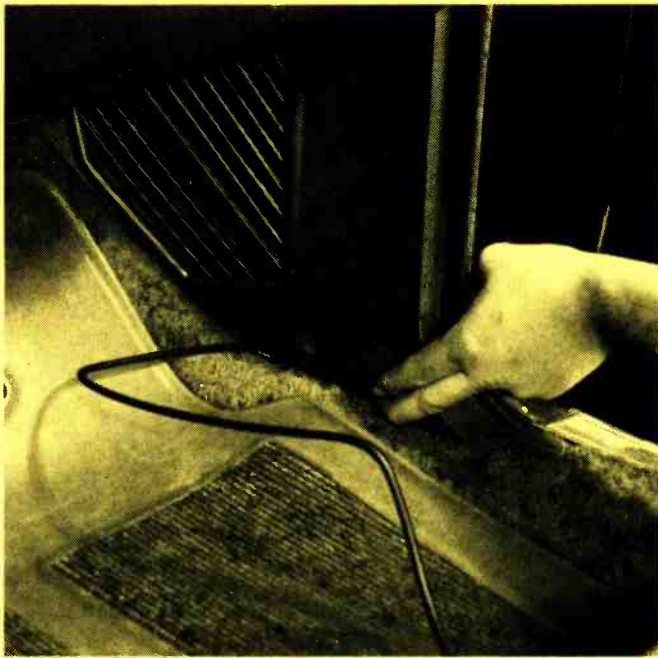

10 Slipping the coax behind the kick plate.



11 Testing with a standing-wave meter.

fed into the trunk lip bracket and brought up through the cup (Fig. 5). Remove the vinyl outer jacket and foam inner insulator according to the dimensions given in the antenna assembly instructions. Then, slide on and secure the cable clamping assembly, mount the cable adaptor, loading coil, spring, and whip adaptor, tightening each securely (Fig. 6). The antenna whip is secured with a set screw, but its height will probably have to be adjusted slightly to achieve a good impedance match.

Now you're ready to secure the trunk-lip-mounted antenna in place. It should be mounted at the center of the trunk lip (Fig. 7) for best all-round radiation. (Using this location makes running cable trickier than a front cowl position, but increased reception and transmission range make it worthwhile.) Two set screws hold the antenna base to the inside edge of the trunk lip. Tighten them, but be sure to save the allen wrench supplied for this purpose in the event you wish to remove the antenna and stow it in the trunk for security reasons. Apply silicone grease compound for protection against the elements.

How do you get the antenna feedline from the trunk to the transceiver? Well, the easiest way is to simply poke a hole in the insulation behind the rear seat with a screwdriver. Then feed the cable through. Get into the car, shove your hands between the cushion and the back of the seat, locate the cable and pull it through. As shown in Fig. 8, you do *not* have to remove the rear seat to do this.

Next, work the cable down the side of the seat. Remove the carpet retaining plate and run the cable under it (Fig. 9). Replace the plate, taking care to keep the cable away from the retaining screws. Pull out the kick panel and slip the coax behind it, feeding it up and under the dash (Fig. 10). Finally, plug the cable's coaxial connector into the antenna jack on the back of the transceiver. Under no circumstances should you trim the coax. It is "tuned" for the specific length to present a proper impedance.

System Checkout. As noted before, you should not operate the transceiver before the antenna system is tested. This can be done with a directional wattmeter or an impedance bridge. If neither of these is available, a reflectometer or SWR bridge (Fig. 11) can be used. (Some transceivers have built-in SWR meters.)

Key the microphone but don't talk. With the SWR bridge in the forward mode, set the sensitivity control so the meter pointer just reaches the full-scale calibration point. Then switch the bridge to the reflected mode. If the meter indicates an SWR of 2:1 or less, you're in good shape. A reading up to 3:1 is barely tolerable. If the SWR reads on the high side, try adjusting the length of the whip. If neither shortening or lengthening the whip improves matters, check to see if the base of the antenna is properly grounded. If the antenna is properly installed, then perhaps the coax was inadvertently shorted.

Remember that any time you remove the antenna, it must be replaced in exactly the same spot. Otherwise the SWR might rise and/or the antenna's radiation pattern become skewed.

Conclusion. Figure on spending anywhere from 30 minutes to two hours on the installation. If you're not handy or fearful of drilling a hole in your car, head for a skilled installer. It might cost \$25, depending on the area and whether or not you purchased the equipment from a retailer who does installations.

However, whether you have an installer nearby or not, this rundown has shown that the installation of a mobile CB unit in your car is really not too difficult. If you can't do it, surely you have a friend who can.

Illustrated in this article is the installation of an E.F. Johnson Messenger 123A CB 23-channel Transceiver, an AFS/Kriket KC35 Voice Communications Speaker, and an Antenna Specialists Model 176 Mobile Antenna. ♦

Your CB Bicentennial Highway Buddies

BY JAMES B. SWEENEY

VISITORS to the Washington, D.C. area will welcome a new, local highway assistance service. Called the "Courtesy Highway Patrol," it consists of CB operators who formed a volunteer body to patrol the main vehicle traffic arteries around the nation's capital in order to assist motorists.

The patrol deploys three pickup trucks, each equipped with CB Class-D transceivers. Trucks are painted bright orange, equipped with flashing lights, and labelled "Courtesy VA. Highway Patrol" in large black letters. Volunteers wear orange uniforms and white hardhats. Truck teams (two CB'er volunteers) carry battery jumper cables, minor repair tools, first-aid kits, selected auto spare parts, extra gasoline and diesel fuel, and even lollipops for restless children. And all service and parts are free!

This CB service concept was originated by John Sullivan, president of the Virginia CB Radio Association. He was motivated by a sudden upsurge in violent crimes committed against helpless motorists stranded along the superhighways in the D.C. area. Although local CB'ers had always done whatever they could to assist such persons, they were rarely able to be of immediate help. Either they weren't in the area or did not have extra fuel, auto parts, etc. Sullivan decided that what was really needed was a number of organized CB patrols covering assigned areas of highway, night and day, on weekends.

Sullivan proposed his highway patrol idea at a meeting of his CB club, the Mt. Vernon 4 Wheelers. It received a hearty endorsement from 97 club members. He then turned to the thousands of CB'ers in the Washington-Virginia-Maryland area of the beltway encircling the capital, seeking volunteers. This was an effective approach, since many of the CB'ers were already organized into clubs, had a record of assistance to the public, and were generally acquainted with one another through CB contact on the air.

He originally started his patrol with his own pickup truck, organizing those who offered their services into two-man teams, each patrolling a fixed area for a specific number of hours. From the moment his truck rolled onto the highway, it was swamped with calls channelled through the CB base station headquarters set up in Sullivan's own house. During the first five weekends of operation, almost 600 people were aided. Highway accidents, empty gas tanks, flat tires, over-heated engines, a heart attack and a woman about to give birth were among the situations encountered.

At first, the public service group anticipated that their highway assistance would largely concern helping families in disabled cars. But the volunteers soon discovered that numerous tractor-trailers were calling for assistance. A breakdown in the early morning hours places a

driver in a tough spot. Since so many commercial drivers are into CB, it proved to be a natural way to communicate.

Finances are tight, of course. Sullivan notes that expansion of the association's services is badly needed to cover other than main arteries. A gratifying source of income stems from truckers and motorists who were given assistance. "Once safe on their home turf," Sullivan points out, "many will mail in small amounts of money to offset the cost of fuel and parts we've given them. Checks come in from as far away as California. Each contribution helps put someone's stranded vehicle back in operation.

The Courtesy Highway Patrol assisting a motorist.



NATIONAL CB ORGANIZATIONS.

The main CB emergency service organization on the national level is REACT International, Inc., a non-profit association. Since 1962, REACT teams have handled an estimated 55 million emergency calls including about 12 million highway accident-related messages. Over 200,000 volunteers have provided a total of approximately 100 million man-hours in public services through local REACT team projects. A formal cooperative understanding exists between the American National Red Cross and REACT, and many team members have taken Red Cross first-aid training.

ALERT (Affiliated League of Emergency Radio Teams) is represented in all 50 states by more than 400 emergency teams. Its Washington-based headquarters serves as CB'ers voice before government bodies. It also coordinates organization efforts of local clubs; sponsors junior

auxiliaries; distributes a bi-monthly bulletin with news, views, and comments of interest to all CB'ers, as well as reporting on local assistance activities.

Ten-4 International is a newly-formed association of CB users. Ten-4 will publish a roster of local club affiliates and a periodic newsletter for members featuring FCC news, new products, and technical information.

Addresses:

REACT International, Inc., 111 East Wacker, Chicago, IL 60601.

ALERT National Headquarters, Suite 818A, National Press Building, Washington, D.C. 20004.

Ten-4 International, National Headquarters, 427 Birchwood Avenue, Deerfield, IL 60015.

Sullivan has the satisfaction of seeing his dream of volunteer service in operation. He has further plans for expansion, including a training center for the 5,000 CB volunteers he thinks are required to patrol all the traffic

areas around the capital. Satisfying, too, is the knowledge that this group serves as an example for other CB groups around the country, some of which are duplicating the efforts in their communities. ♦

BUILD THE "Five-minute on" One-minute off" Timer

BY JOHN J. McVEIGH, Associate Editor

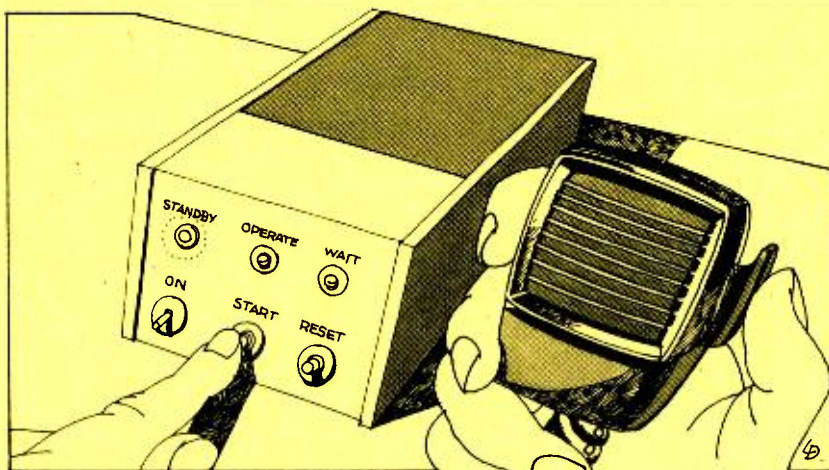

ONE section of the recently relaxed FCC regulations for the Citizens Radio Service deals with duration of communications. Now, interstation communications are limited to five minutes "on," followed by a one-minute silent period, instead of five minutes "on," and 5 minutes "off." That sounds simple enough—but how can you carry on CB communications without a stopwatch? The Timer described here will do the job. It uses IC's and three LED's to indicate the "status" of your activities—standby (yellow), operate (green), and wait (red).

About the Circuit. Three 555 timing chips form the heart of the circuit (Fig. 1). Two of them (IC1 and IC2) are

monostable multivibrators or "one-shots." After they are triggered, their outputs go high for a predetermined time, and then low. The third timer is a free-running square-wave oscillator which is triggered by the second one-shot.

When switch *S1* is depressed, the output of IC1 (pin 3) is connected to the +12-volt supply, and remains high for 5 minutes. This time is determined by the equation $t = 1.1(R5 + R6)C2$. LED1 glows green for this period, signifying that communications can be conducted. At the end of five minutes, pin 3 goes low, extinguishing LED1 and triggering the second one-shot, IC2. The output of IC2 (pin 3) goes high for one minute. This period is determined by the equation $t = 1.1(R6 + R7)C4$. As long as this output is high,

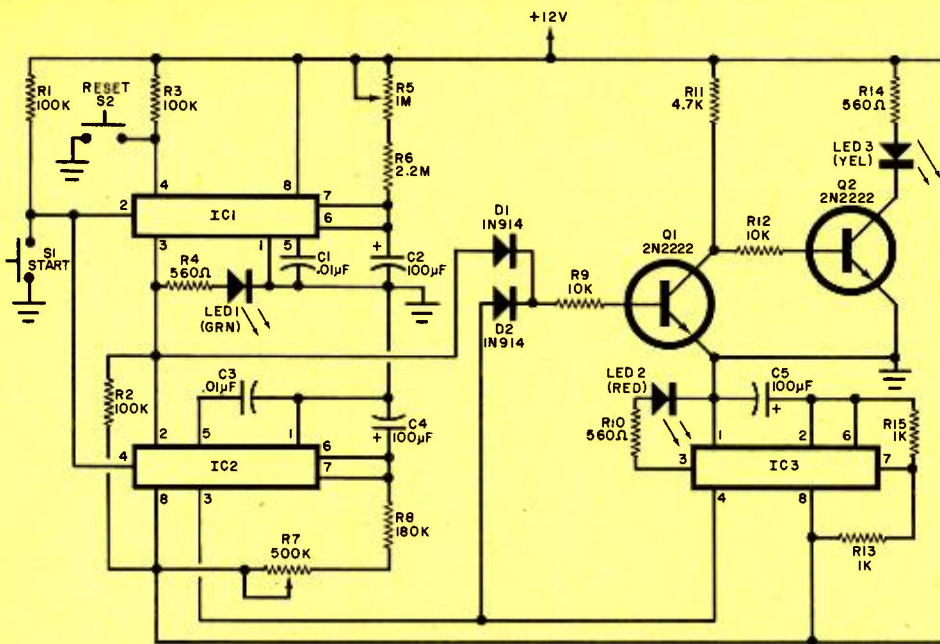

PARTS LIST

- C1, C3—0.01- μ F, 50-V disc capacitor
 C2, C4, C5—100- μ F, 25-volt tantalum capacitor
 D1, D2—1N914 switching diode
 IC1-IC3—555 timer
 LED1-LED3—20-mA light emitting diodes
 Q1, Q2—2N2222 npn switching transistor
 The following resistors are 1/2-watt, 10% unless otherwise noted:
 R1, R2, R3—100,000-ohm resistor
 R4, R10, R14—560-ohm resistor
 R5—1-megohm trimmer potentiometer
 R6—2.2-megohm, 5% resistor
 R7—500,000-ohm trimmer potentiometer
 R8—180,000-ohm, 5% resistor
 R9, R12—10,000-ohm resistor
 R11—4700-ohm resistor
 R13, R15—1000-ohm resistor
 S1, S2—Normally open momentary pushbutton switch
 Misc.—Printed circuit or perforated board, suitable enclosure, hookup wire, rubber grommets, machine hardware, etc.

Fig. 1. 555 timer IC's control status of LED's.

the free-running oscillator IC3 is allowed to operate. When one minute is up, IC3 stops oscillating. The operating frequency of this timer is about 5 Hz, and LED2 will flash on and off at this rate while IC3 is activated. This signals the operator to end the contact, and to remain off the air as long as LED2 is blinking.

After the one-minute silent period is up, the Timer goes into a standby mode. Both LED1 (green) and LED2 (red) are dark, and LED3 (yellow) comes on. This LED will only glow when both one-shot outputs are low. The circuit will remain in this state until S1 is depressed again.

If your communications do not last for the full five-minute period, depress S2. This will disable IC1, which in turn will trigger IC2. The free running oscillator will be activated for one minute, flashing LED2. Then LED3 will come on and glow until S1 is depressed again, and the entire sequence will be repeated.

Construction. The simple circuit can be built on pc or perforated board, depending on the builder's preference.

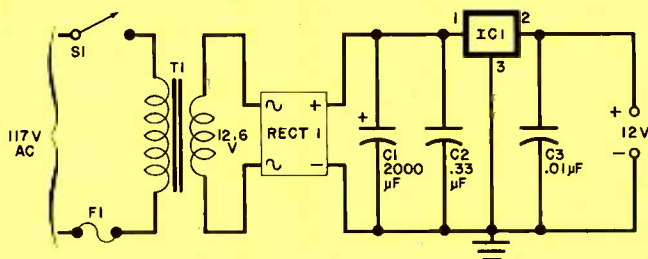

PARTS LIST

- C1—2000- μ F, 50-volt electrolytic capacitor
 C2—0.33- μ F, 50-volt Mylar capacitor
 C3—0.01- μ F, 50-volt disc capacitor
 F1—1/4-ampere fuse
 IC1—78L12 voltage regulator IC (Radio Shack 276-801 or equivalent)
 RECT1—50-PIV, 2-ampere bridge rectifier
 S1—Spst switch
 T1—12.6-volt, 300-mA transformer
 Misc.—Line cord, fuseholder, hookup wire, solder, terminal strips, suitable enclosure, machine hardware, etc.

Fig. 2. Circuit for Timer's power supply

General purpose LED's, switching diodes (D1 and D2), and switching transistors (Q1 and Q2) can be used. The only components that require close tolerances are C2, C4, C5, R6, and R8. The capacitors should be tantalum components. They are usually within 20% of their rated values. Printed circuit board potentiometers (R5 and R7) are used to compensate for these variations. Resistors R6 and R8 should be close-tolerance (5% or better) units.

Because a 12-volt dc source is required, the CB Timer can be used in base or mobile environments. At home, a dc supply such as that shown in Fig. 2, will be needed. Of course, if you have access to a +12-volt bus, you can take advantage of it. Maximum current demand is about 50 mA. Both the power supply and the timing circuitry can be mounted in a small utility box.

Adjustment. After you have completed assembly, connect the Timer to a suitable voltage source. The yellow STANDBY LED should glow. Then depress S1. The green OPERATE LED should glow, and remain on for somewhere between 3 1/4 and 7 minutes. When that LED extinguishes, the red WAIT LED will flash for 15 to 90 seconds. Next, the yellow STANDBY LED will glow as soon as the flashing LED goes dark. If the green LED glows for less than 5 minutes, increase the setting of R5. If the LED remained on too long, back down on R5. With R5 properly adjusted, the green LED will glow for 300 seconds.

Similarly, the length of time that the red LED flashes can be set to the desired 60 seconds by adjusting R7. When the two timers are "on the nose," depress S1 once again. At some point before 300 seconds have passed, depress S2. The green LED will immediately go dark and the red LED will flash for one minute. Then the circuit will revert to the STANDBY mode and the yellow LED will glow.

Using the Timer. As soon as communications begin, depress S1 momentarily. Continue the contact (if necessary) until the red WAIT LED starts flashing. Immediately terminate the contact and stay off the air until the WAIT LED goes dark and the STANDBY LED comes on. If communications do not last five minutes, depress S2, and wait until the red LED goes dark to start again. ♦

CB Equipment Terms Made Easy for Buyers

A-f Output. The power in watts that the transceiver will deliver to a speaker of a given *impedance* at a given level of *distortion*. Typical usage — 2 watts a-f output into 8 ohms at 5% distortion. One watt is usually sufficient, but more power might be needed in noisy locations. Distortion can run as high as 10% without serious loss of intelligibility.

A-f Response. In the receiver section, a measure of the uniformity or flatness of the a-f output over the range of the human voice. In the transmitter, it indicates how uniformly the signal is modulated over the same range. Typical usage — $\pm X$ dB or from $-X$ dB to $+Y$ dB from 300 to 3000 Hz. Usual deviation limits are 3 or 6 dB.

AGC. Automatic Gain Control; a means of controlling gain of the receiver section through feedback to suit the strength of the incoming signal. Ideally, the output level at the speaker should remain constant over a wide range of input signals. For low-level inputs, the feedback signal is small and gain is high. For stronger signals, the feedback loop cuts gain to prevent overload.

AM. A method of transmitting information by amplitude modulation or varying the strength of a carrier wave in step with the modulating (voice) signal. The composite AM signal contains a carrier and two sidebands, which are mirror images of each other and contain the transmitted information.

AML. Abbreviation for Automatic Modulation Limiting. A circuit that uses an AGC effect to prevent overmodulation. As a stronger voice signal is applied, this stage reduces the gain of the audio amplifier(s), keeping the modulation level below 100%.

Clarifier. A control on SSB transceivers. It is a fine-tuning control that is carefully adjusted so the received signal sounds natural. Its effective range is usually ± 600 to ± 1500 Hz.

Coax. Popular term for coaxial cable, the transmission line used to couple signals from the transceiver to the antenna, and vice versa. It is made up of a center conductor embedded in plastic or foam insulation (dielectric), around which a copper or aluminum braid is woven. Foam cable is better than plastic, since the dielectric contains much air, which is a very good insulator. Premium coax uses a copper tube in place of a braid, and small glass or foam beads spaced at regular intervals to separate the inner conductor from the tube. All coax causes some signal loss, which is specified in dB per 100 feet. Its characteristic *impedance* in CB work is usually 50 or 52 ohms, and the cable is identified by an RG number. (RG-58-U is low-power 52-ohm coax, RG-8-U can handle higher power levels and has lower loss.)

Crystal. A quartz crystal which exhibits piezoelectric properties. That is, when physically compressed, a voltage develops across it. Crystals also behave as tuned circuits. With external components, they oscillate at a frequency determined by the size and shape of the crystal, the way it is cut, circuit parameters, etc. Crystals are often used to generate signals in oscillators, as well as in filters, microphones and earphones.

dB. An abbreviation for decibel, a measure of signal strength when compared to a specified reference. For voltage, the dB ratio is determined by the formula $\text{dB} = 20 \log V_1/V_2$. For power, the relation is $\text{dB} = 10 \log P_1/P_2$. When power is doubled, there is a gain of 3 dB. When power is multiplied by ten, the gain is 10 dB. Decibels are often used to express how much a stage will amplify a signal, how much greater a signal is than background noise (*S/N* or signal-to-noise ratio), or how an output varies over a given frequency range.

Delta Tune. A control or switch similar in function to a *clarifier*, found on many AM transceivers. It compensates for signals off the center frequency of a CB channel. Although its effective

range is about the same as that of a *clarifier*, adjustment is not as critical.

Desensitization. The effect on the receiver section tuned to one channel that is caused by a strong signal on another channel. It is an AGC-type effect whereby the desired signal's strength appears to be decreased by the presence of a nearby signal. This effect will influence a receiver's overall *selectivity*.

Distortion. An unwanted modification of a signal's phase and/or amplitude that occurs when an amplifier stage is behaving nonlinearly. All amplifiers display some nonlinearity, but good ones are designed so that the nonlinearities are as small as possible. A nonlinear amplifier will produce a signal that looks distorted when viewed on an oscilloscope, and that contains energy at frequencies other than that of the input signal. *Harmonics* are such products, as are intermodulation distortion, phase distortion, etc. Nonlinearities occur in a-f as well as r-f amplifiers.

Filters. In the broadest sense, filters are networks that favor or attenuate one group of frequencies more than others. A low-pass filter will allow all frequencies below a cutoff frequency to flow unimpeded, but will attenuate any above it. Such a filter is often placed at the output of a CB transceiver to attenuate any *harmonics* that could cause TV interference (TVI). A high-pass filter works in the opposite manner, passing all signals above the cutoff frequency. Bandpass filters allow signals between upper and lower limits to flow at the expense of signals outside the passband. Bandpass filters are used in the i-f sections of receivers to boost *selectivity*. They are usually made in modular form, using *quartz crystal*, mechanical, or ceramic elements. Less critical filters, such as low- and high-pass types, are usually made from discrete coils and capacitors.

Frequency Synthesis. A means of generating several different frequencies without using separate oscillators governed by *crystals* specially ground for each frequency. For example, a synthesizer composed of ten crystals (not all used simultaneously) can generate transmit and receive frequencies for the 23 CB channels. A more recent development, the digital synthesizer, uses only one reference crystal, a phase-locked loop, and a digital counter to generate a large number of stable frequencies. These circuits are used to reduce dependence on individual crystals, which are relatively expensive.

Frequency Tolerance. Indicates how much the actual frequency generated inside the transceiver for a particular channel will vary from the ideal value. This deviation can be caused by slight changes in the oscillating *crystal*, the surrounding circuitry, wide variations in ambient temperature, supply voltage, etc. The maximum legal frequency tolerance is 0.005%, or about 1350 Hz on the CB band.

Harmonics. Undesired signals that appear at multiples (2, 3, etc.) of the desired fundamental frequency. They are produced by nonlinear amplifiers and can cause interference to TV receivers and other services. The second harmonic is the strongest, followed by the third, then the fourth, and so forth. For example, the strong second harmonic (54 MHz) of a 27-MHz CB carrier can cause severe interference to TV channel 2 (54-60 MHz).

Impedance. The opposition a circuit element, transmission line, or antenna displays toward an ac or r-f signal. Although measured in ohms, like a resistance, it is a composite of resistive and reactive effects. The common impedance of CB gear is 50 or 52 ohms, and all equipment should be matched to this value.

Modulation Indicator. A relative indicator (usually a small lamp) that glows brighter and brighter as the modulation level ap-

proaches 100%. It gives the operator some idea of how fully he is modulating the carrier.

Noise Blanker. Another circuit for reducing noise interference. It is usually placed in the r-f section, or at the beginning of the i-f section of the receiver, before the high-selectivity circuits. A noise blanker samples the received signal, and actually *squelsches* the receiver for a very short period of time (the width of the noise spike). Noise blankers are more effective than noise limiters, but their circuitry is more complex.

Noise Cancelling Mike. A microphone that is built in such a way as to minimize transmission of any background noise at the transmitting site.

Noise Limiter. Sometimes called a series-gate noise limiter, a circuit that shaves off the noise spikes riding on the desired signal. Usually, diodes are used to obtain the clipping action. When the circuit operates at a predetermined threshold without any user activation, it is called an automatic noise limiter or *antl*. These diode noise limiters are usually in the i-f or a-f sections of the receiver.

PEP. Abbreviated form of Peak Envelope Power. The power input or output of an SSB transceiver is measured in watts PEP. Unlike an AM transceiver, an SSB rig only develops output power when modulated, so that terms like "rms carrier power" are meaningless. (There is no carrier to speak of.) The only practical way of measuring SSB output power is by determining the power contained in the signal at the maximum (peak) amplitude. The peak envelope power of a given transmitter is closely related to the amount of distortion that is considered tolerable. It is hard to measure PEP accurately, especially under practical operating conditions. Envelope peaks occur sporadically and are short-lived. Almost all meter movements are too sluggish to catch them, and readings will be averaged over several cycles of the modulating signal. (Note that these remarks are made in the context of voice signals, not "pure" sine waves!) The relationship between average power or rms power and PEP varies widely with individual voice characteristics. When one person modulates a given transceiver, 12 watts PEP of output power (the legal limit) might be developed, while the average power output is only 4 watts. In that case the ratio of PEP to average power is 3:1. When someone else modulates the same transceiver, the PEP output might remain at 12 watts, but the average power is only 3 watts. In this case, the PEP/average ratio is 4:1. Other voices will develop lower values — say, 8 watts PEP and 4 watts average, or 2:1.

Phase-Locked Loop. An electronic network consisting of a voltage controlled oscillator (VCO), a phase comparator, a low-pass filter, and an amplifier. The PLL can be used as an FM detector of extreme linearity, as a tunable filter, and as an extremely stable oscillator. When combined with an external reference oscillator and $\pm N$ circuit, it will function as a *frequency synthesizer*, yielding stable outputs at various frequencies.

Pi Network. A tuned circuit at the output stage of a transmitter to match it to the antenna/feedline. Sometimes a transceiver will have screwdriver adjustments which allow the pi network to make the optimum *impedance* match for a given antenna.

PTT. Abbreviation for Push to Talk. Usually a pushbutton on the microphone case that activates the transmitter when depressed.

R-f Gain Control. A manual control that sets the gain of the receiver section. It is included on some transceivers to supplement the AGC circuit. Some signals are simply too strong for the AGC to handle, and will overload the receiver unless gain can be further reduced by this control.

R-f Power Output. For an AM transmitter, this specification rates the amount of carrier (in watts) that is delivered to the antenna jack. The legal limit for AM is 4 watts, and most transceivers deliver that amount (or close to it). The r-f power output of an SSB transceiver is rated in watts PEP, as previously described.

"S" Meter. A meter that gives relative indications of the strength of received signals. It is calibrated in "S" units and dB. Nominally, each S unit equals 6 dB. Above S9, most meters are calibrated in 10-dB increments. Sometimes, a manufacturer will specify what input level (usually between 50 and 100 μ V) is required for a reading of S9. But this can vary widely even among transceivers

of the same model number. Again, S meters are intended to be relative, rather than absolute, indicators. They are useful to an extent in comparing the strength of two stations, or the performance of two antennas at one location.

Selectivity. Basically, this relates to how well a receiver can differentiate between the signal to which the receiver is tuned and an adjacent one. It is also expressed as Adjacent Channel Rejection. The figure (a ratio in dB) shows how much stronger an adjacent channel signal (10 kHz away) must be to interfere with intelligible reception of the desired signal. Sometimes, selectivity is stated as the i-f passband; that is, the "window" the receiver can see through to detect signals of a specified strength. It is stated, "X kHz at Y dB down." For example, at X kHz away from the operating frequency a signal will be reduced in strength by Y dB. In AM transceivers a typical bandwidth is about 3 kHz at 6 dB down, and 30 kHz at -60 dB. For proper AM reception, the window should be no narrower than 2500 Hz (2.5 kHz). SSB requires greater selectivity for best results, and a rating of 2.1 kHz at 6 dB down is not uncommon.

Sensitivity. Another key receiver specification. It describes the minimum signal strength that the receiver can work with to provide an intelligible output at the speaker. The signal strength is measured in microvolts, and the second part of the rating is called the signal-to-noise (S/N) ratio (See S/N), expressed in dB. A transceiver with an AM sensitivity of 1 μ V for a 10-dB S+N/N will produce an output that is ten times louder than the background noise. That's a typical figure, although some AM transceivers will produce a 10-dB S+N/N with as little as 0.25 μ V of signal applied to the input. SSB receivers are generally a little "hotter" than AM units, with ratings of 0.15 μ V for 10 dB S+N/N regularly achieved. In general, any rating below 1 μ V for a 10 dB S+N/N is adequate.

S/N. Abbreviation for signal-to-noise ratio. Expressed in dB, it relates how much louder a signal is than the background noise. It is measured at the speaker, and is used in sensitivity ratings. Often, S+N/N is used, as it is easier to measure. It is the ratio of the signal and background noise to the background noise, and will yield an apparently higher sensitivity than straight S/N.

Speech Compression. A means of boosting the average level of voice signals to provide increased "talk power" or higher average modulation levels. The human voice has a low average level with sharp, transient peaks. If the voice signal is not compressed, the carrier will not be modulated more than 20% or so most of the time, but will be fully modulated on voice peaks. Overall efficiency will be low. But if the peaks are clipped and the average level boosted, the average degree of modulation will rise. This form of processing is called speech clipping. Another technique, speech compression, has an AGC-type amplifier which cuts down gain on voice peaks while amplifying the average low levels. Clipping or compression can be introduced in the audio or r-f sections of the transceiver. R-f methods are more effective, and clipping produces better results than compression, but requires extensive shielding and filtering within the transceiver.

Spurious Emissions. Undesirable r-f energies appearing at the antenna jack. They often are at frequencies far removed from the operating channel. Harmonics, mixer products and parasitic oscillations are all considered spurious emissions. They should all be at least 50 dB below the desired output signal.

Spurious Response. This describes how the receiver section handles undesired signals, especially ones generated inside the transceiver itself. Spurious response should be at least 25 or 35 dB down.

Squelch. A circuit that silences the receiver in the absence of signals above a certain level of signal strength. This *squelch threshold* is usually adjustable by a front-panel control. When properly adjusted, it will stop background noise from reaching the speaker, but will activate the receiver when an intelligible signal is detected.

SSB. Abbreviation for Single Sideband. A type of amplitude modulation in which one sideband and the carrier are not transmitted. This gives SSB a 6:1 efficiency advantage over AM, and thus greater range per watt of output power. SSB occupies 1/2 of a conventional AM (double sideband) channel. So one can get 46

SSB channels + 23 DSB channels, though SSB can't be used at the same time as DSB, and vice versa. However, transceiver circuitry for SSB is more complex and tuning methods are more critical than for AM. For these reasons, additional controls like *clarifiers* must be included, making SSB units more expensive than AM transceivers with similar features.

Superheterodyne. A common type of receiver in which the incoming signal is translated in frequency by means of frequency converters or mixers. The signal is translated to an intermediate frequency or i-f. A receiver that has one i-f is called a *single conversion* receiver. One with two i-f's is a *dual conversion* receiver. I-f stages are used to provide selectivity and good spurious signal rejection.

SWR. Abbreviation for Standing Wave Ratio. When *impedances* within a communications system are not equal, reflections are set up, sending power back toward the transceiver away from the antenna. As a result, standing waves of voltage and current are

set up on the transmission line. The SWR can be determined mathematically by the formula $SWR = Z_1/Z_2$ with the higher impedance on top. So, if a 50-ohm transmission line feeds a 50-ohm antenna, the SWR is 1:1 or "one to one." Under these conditions all power (neglecting feedline losses) delivered at the transceiver output reaches the antenna. If the antenna impedance is 100 ohms or 25 ohms, the SWR is 2:1. This figure is considered the upper limit that SWR should reach in a good communications system. SWR is usually measured by a reflectometer or SWR bridge. Such devices are available as external accessories, but are included in some CB transceivers.

VOX. Voice-Operated Transmitter. When the operator speaks into the microphone, the VOX circuitry automatically activates the transmitter without depressing the PTT switch. When speech ends, the *VOX Delay* circuit holds the transceiver in the transmit mode for an adjustable period of time. This prevents relay chatter between syllables or words. ◆

CB TRANSCEIVER MANUFACTURERS

Alaron, B&B Import-Export Inc., 185 Park St., Troy, MI 48084
Browning Laboratories Inc., 1269 Union Ave., Laconia, NH 03246
Courier, Fanon/Courier Corp., 990 S. Fair Oaks Ave., Pasadena, CA 91005
Craig Corp., 921 W. Artesia Blvd, Compton, CA 90220
Demco, Command Electronics, Inc., 11830 Shaver Rd., Schoolcraft, MI 49807
Dynascan Corp., 1801 W. Belle Plaine Ave., Chicago, IL 60613
Echo Communications, Inc., Cedarburg, WI 53012
Fanon/Courier Corp., 990 S. Fair Oaks Ave., Pasadena, CA 91005
Fieldmaster Radio Corp., 21212 Vanowen St., Canoga Park, CA 91303
Gemtronics, Gem Marine Products Inc., P.O. Box 1408, Lake City, SC 29560
Hallicrafters, Div. of Breaker Corp., 110 Great Southwest Pkwy., Arlington, TX 76011
Handic of USA, 14340 N. W. 60th., Miami Lakes, FL 33014
Hitachi Sales Corp., 401 W. Artesia Blvd., Compton, CA 90220
J.I.L. Corporation of America, 737 W. Artesia Blvd., Compton, CA 90220
Johnson, E.F., Co., Waseca, MN 56093
Kraco Enterprises Inc., 2411 N. Santa Fe, Compton, CA 90224
Kris, Inc., Cedarburg, WI 53012
Lafayette Radio Electronics Corp., 111 Jericho Turnpike, Syoset, NY 11791
Lake Electronics, Inc., 1948-E Lehigh Rd., Glenview, IL 60025
Midland International Corp., P.O. Box 19032, Kansas City, MO 64141
Motorola Communications Div., 1301 Algonquin Rd., Schaumburg, IL 60172
Olson Electronics, 260 S. Forge St., Akron, OH 44327
Pace Communications, Pathcom Inc., 24049 S. Frampton Ave., Harbor City, CA 90710
PAL Electronics Co., 2962 W. Weldon, Phoenix, AZ 85017
Panasonic, Matsushita Electric Corp. of America, One Panasonic Way, Secaucus, NJ 07094
Pearce-Simpson, Div. Gladding Corp., P.O. Box 520800 Biscayne Annex, Miami, FL 33152
Radio Shack, A Tandy Corp. Company, 2617 W. 7th St., Fort Worth, TX 76107
Ray Jefferson, Main & Cotton Sts., Philadelphia, PA 19127
Regency Electronics Inc., 7707 Records St., Indianapolis, IN 46226
Robyn International, Inc., P.O. Box 478, Rockford, MI 49341
SBE, Inc., 220 Airport Blvd., Watsonville, CA 95076
Sharp Electronics Corp., 10 Keystone Place, Paramus, NJ 07652
Siltronix, Div. of Cubic Corp., 269 Airport Rd., Oceanside, CA 92054
Sonar Radio Corp., 73 Wortman Ave., Brooklyn, NY 11207
Sony Corporation of America, 714 Fifth Ave., New York, NY 10019
Standard Communications Corp., 108 W. Victoria St., Carson, CA 90248

Superscope Inc., 8150 Vineland Ave., Sun Valley, CA 91352
Surveyor Manufacturing Corp., 29245 Stephenson Highway, Madison Heights, MI 48071
Teaberry Electronics Corp., 4655 Massachusetts Ave., Indianapolis, IN 46218
Tram/Diamond Corp., Lower Bay Rd., Winnisquam, NH 03289
Unimetrics, Inc., 1534 Old Country Rd., Plainview, NY 11803
Utac, I.A. Sales Co. of California, 766 Lakefield Rd., Suite H, Westlake Village, CA 91361
XTAL, Far Eastern Research Lab, Inc., 9749 Shirley Ave., Northridge, CA 91324
Zodiac Communications Corp., Chrysler Bldg., New York, NY 10017

CB ANTENNA MANUFACTURERS

Alaron, B&B Import-Export Inc., 185 Park St., Troy, MI 48084
Anixter-Mark, 5439 W. Fargo Ave., Skokie, IL 60076
Antenna, Incorporated, 23850 Commerce Park Rd., Cleveland, OH 44106
Antenna Specialists Co., The, Div. of Orion Industries, Inc., 12435 Euclid Ave., Cleveland, OH 44106
Avanti Research & Development, Inc., 340 Stewart Ave., Addison, IL 60101
Blue Streak, CPD Industries, Inc., 200 E. Wilshire Ave., Santa Ana, CA 92705
Breaker Corp., 110 Great Southwest Parkway, Arlington, TX 76011
Cushcraft Corp., 621 Hayward St., Manchester, NH 03103
Francis Industries, 431 W. Broad St., Pataskala, OH 43062
GC Electronics, Div. Hydrometals, Inc., 400 S. Wyman St., Rockford, IL 61101
Gotham, 2051 Northwest 2nd Ave., Miami, FL 33127
Hustler, New-Tronics Corporation, 15800 Commerce Park Dr., Brook Park, OH 44142
Hy-Gain Electronics Corp., R.R. #3, Lincoln, NB 68505
Lafayette Radio Electronics Corp., 111 Jericho Turnpike, Syoset, NY 11791
Radio Shack, A Tandy Corp. Company, 2617 W. 7th St., Fort Worth, TX 76107
Robyn International, Inc., P.O. Box 478, Rockford, MI 49341
Shakespeare Industrial Fiberglass Div., P.O. Drawer, Columbia SC 29202
Taylor Radio Company, Inc., 3329 Commerce Dr., North Leg Industrial Park, Augusta, GA 30904
Tenna Corporation, 19201 Cranwood Pkwy, Cleveland, OH 44128
Turner Company, Inc., Div. of Conrac Corp., 909 17th St. N.E., Cedar Rapids, IA 52402
Unarco-Rohn, Box 2000, Peoria, IL 61601
Valor Enterprises, Inc., 185 W. Hamilton St., West Milton, OH 45383
Wilson Electronics Corp., 4288 S. Polaris, Las Vegas, NV 89103



Kriket[®]

VOICE COMMUNICATIONS SPEAKERS

**AFS KC-35
REMOTE SPEAKER
LEADS THE CB FIELD
WITH SUPER
SOUND - AND THAT'S
A BIG
10-4!**

Hey, all you truckers and four wheelers. Tired of garbled voices and CB static? Now, you can hear better with our KC-35 Kriket[®] mobile speaker. Better than you believed possible.

Because AFS offers the first acoustically designed voice communications speaker. And, that means you get outstanding intelligibility and clarity across the entire voice range.

AFS -- the only company with a full line of voice communications speakers, each designed for a specific application -- mobile, remote outdoor and base station. Absolutely superior voice quality reception.

**SPEAKERS ARE OUR ONLY BUSINESS.
THEY HAVE TO BE BETTER!**

Available at CB dealers everywhere



Acoustic Fiber Sound Systems, Inc.

2831 North Webster

Indianapolis, Indiana 46219

National Warehousing Facilities

All Kriket[®] speakers are manufactured in the U.S.A. using American materials and craftsmen.

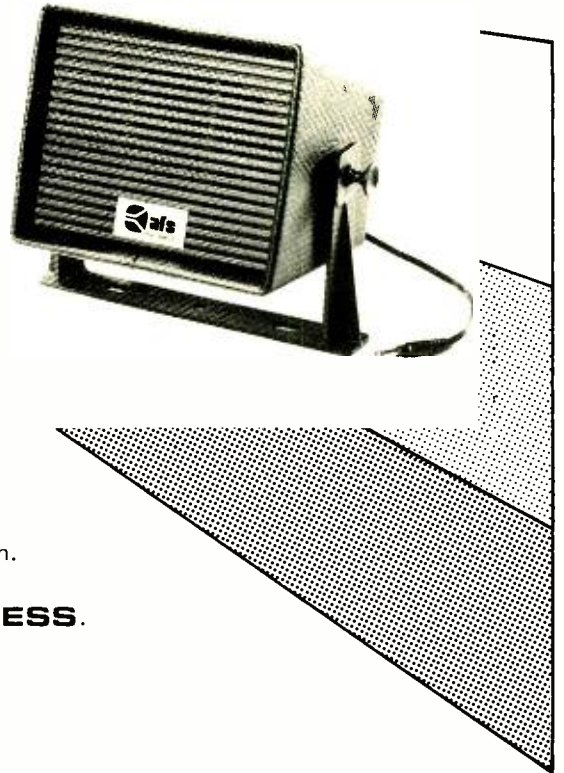

PERF BOARD WIRING TECHNIQUES FOR EXPERIMENTERS

Rapid circuit assembly and alteration methods using perforated board.

BY ADOLPH MANGIERI

Useful tools include (left to right) pin insertion tool, wiring pencil, manual wire wrapping tool and unwrapping tool.

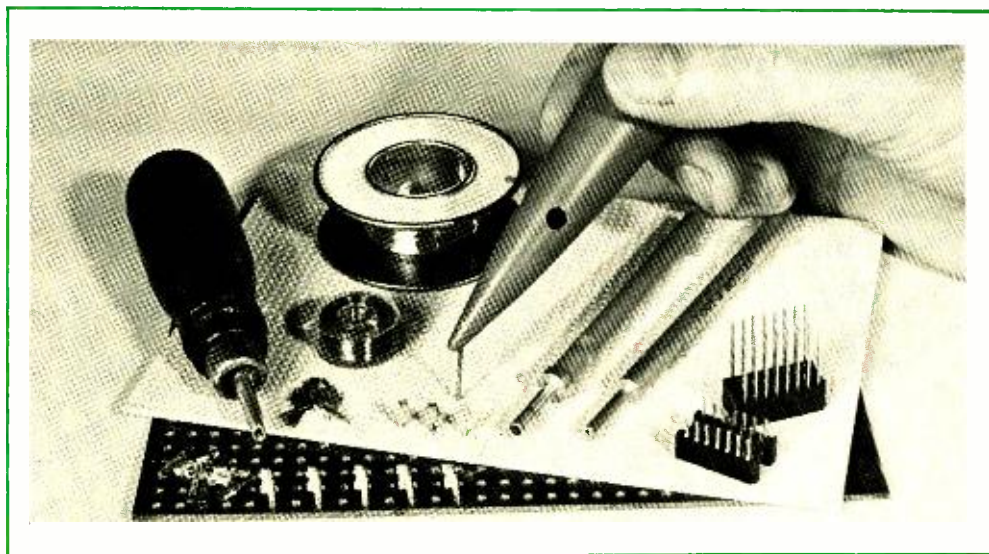

MOST electronic projects are best assembled on either printed circuit or perforated board. Both types have advantages and disadvantages which should be considered before starting a project. The pc board permits compact assemblies but impedes experimentation and circuit alterations. Perf board, on the other hand, permits rapid assembly and easy circuit alterations but tends to take up more room for the same circuit. With few exceptions, any project you can build on a pc board can also be assembled on perf board.

Perf board construction has another important advantage over the pc board. It eliminates the need for using chemicals and drilling holes. This might be an important consideration if you're pressed for time and want to get right to assembly after de-

signing a layout. Needless to say, the perf board technique is a very attractive alternative to project assembly, especially if you do a lot of experimenting.

Perf Board Materials. The first step in working with perf boards is to familiarize yourself with the various types of boards, tools, and hardware available. Perf boards are letter-coded according to patterns, sizes, and spacing of holes. Furthermore, you have a choice of XXX phenolic, paper epoxy, and epoxy fiberglass material and unclad (plain) and clad blanks. Add to this list a choice of board thicknesses.

The Table lists the most popular perf board configurations (from two typical sources) according to letter code, the various push-in terminals and insertion tools, and prepunched bus

strips to be used with each. It is obvious that you can choose the materials to meet the requirements for your project. For example, use P-pattern board for IC's in dual in-line packages (DIP's) and either P- or G-pattern board for round (TO-5) transistors. A less desirable alternative would be to use F-pattern board and drill extra holes as necessary. For heavy-weight projects, such as power supplies, you can use A-pattern board with extra thickness and the large No. T9.4 push-in terminals. (For general use, 1/16"-thick board is an excellent choice, while 3/32"-thick board is recommended for the majority of the heavier duty jobs.)

Bus strips are flat, prepunched and tinned and made of copper for use as power supply and common buses. They eliminate wiring complexity and

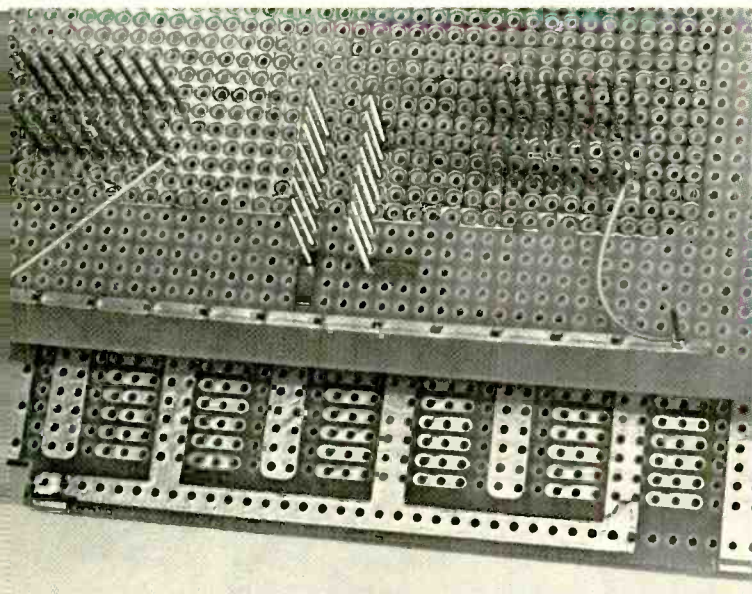
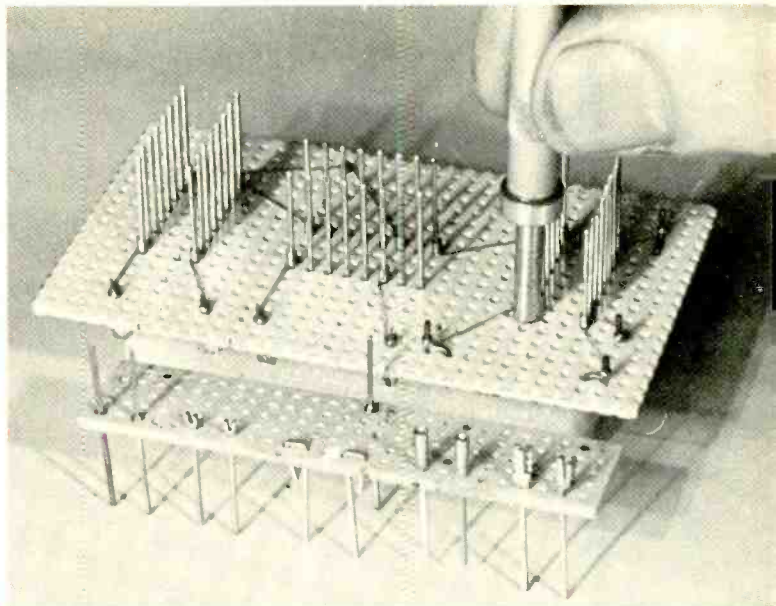
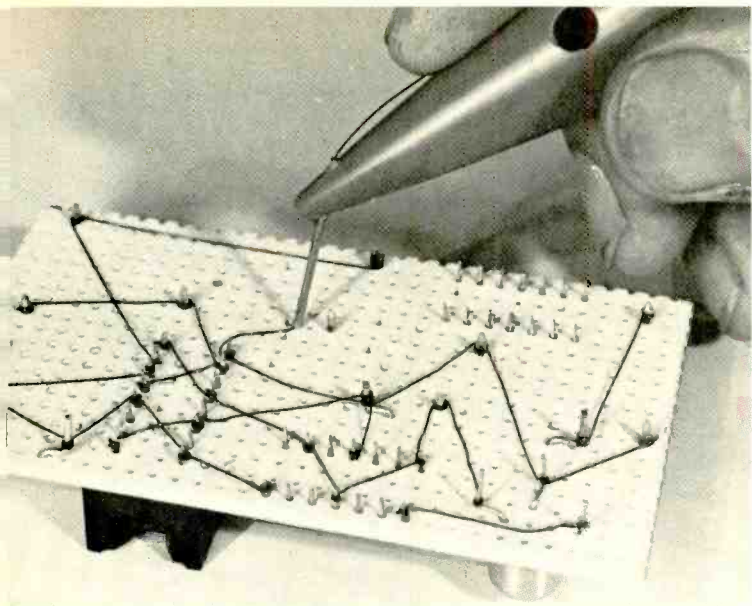

1	2
3	
4	5

- 1 *Wiring pencil wraps solder-through insulated wire on leads of resistors, IC's and transistors.*
- 2 *Wrapping tool used on solderless connections. Terminals in foreground facilitate wire wrapping.*
- 3 *Ground-plane board at top has terminals for ground connections. Below is interdigitated bus board.*
- 4 *Clad perf board requires cutting of circle pad for isolation of socket and board terminals.*
- 5 *Clad ground-plane board requires drilling and line and circle pad cutting. Pad cutter at right.*

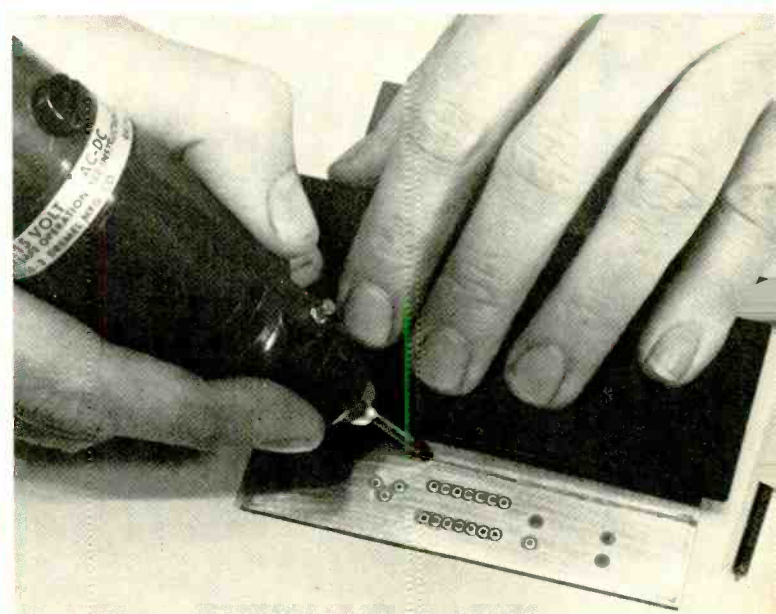
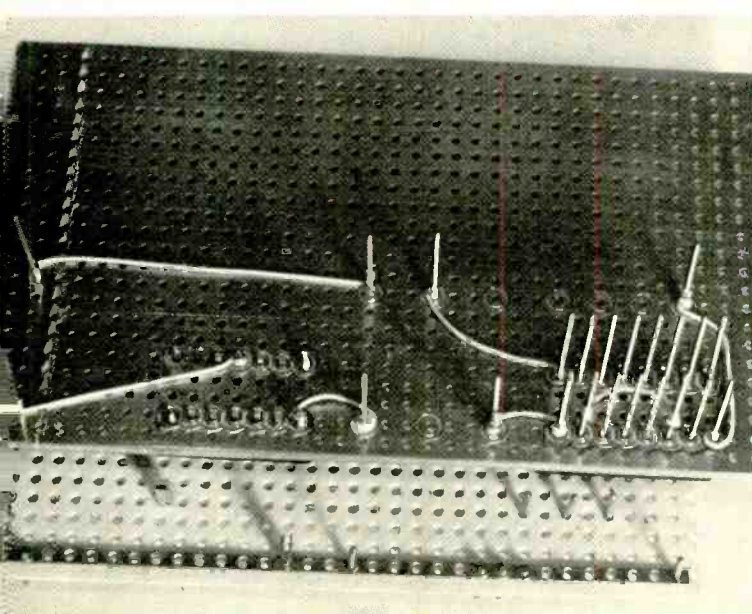

reduce the chance of ground loops that create circuit instabilities. Low-cost solder pin insertion tools permit you to install pins safely and speedily.

Accommodating most semiconductor devices (including IC's) and accepting an almost endless variety of board pins, the 1/16" thick P-pattern board will prove to be the most versatile for many projects.

Conventional Wiring Method. As is the case when doing pc work, careful layout planning will be rewarded with neater perf board assemblies and error-free wiring. You can design a parts layout and wiring guide for perf board with the aid of the grid paper available for most board patterns or even ordinary graph paper. To a large extent, your parts layout will follow the schematic diagram for your project. Of course, you'll have to trial-fit the components on the board, making allowance for the pattern and spacing of the holes.

Once you know how a board is to be laid out and wired, you can install push-in terminals, transistor and IC sockets, and power and common buses. If you choose to omit bus strips, use 20-gauge (or heavier) solid bare hookup wire in their place.

When making interconnections, 28-gauge solid wire is suggested for easy handling and manipulation with tools. Wherever possible, use bare wire; but if you must make crossover connections, switch to insulated wire. Use 24- or 26-gauge insulated stranded hookup wire between the board assembly and off-the-board components. When your project includes DIP (dual in-line package) IC's, avoid confusion by labelling pin 1 of each. Better yet, use E-Z-Code self-sticking pin number marking strips.

Fitting wire with longnose pliers can prove to be a trying task, particularly when using P-pattern board and DIP sockets. You can save a great deal of time and avoid much frustration by using a manual tool to wrap the wire on a terminal (such as the Vector No. P160-2 or similar). This tool neatly forms a tight wrap on either socket solder tabs, No. T42.1 flea-clip tails, component lead ends, or directly on DIP IC pins. These aren't true Wire Wraps®, which means that every connection must also be soldered to assure good mechanical and electrical bonds.

After wiring a project, it's always good practice to check for errors be-

fore applying power. Look for reversed installation of diodes, electrolytic capacitors, LED's, etc.; IC's and transistors plugged in backwards; and transposed connections to battery clips and holders.

"Pencil Wiring." Recently, a new approach to wiring perf board assemblies has been introduced. Vector's new Model P173 wiring pencil promises to become a very popular tool for perf board work. Applied Manufacturing of Texas has a similar tool for making Solder Wraps®.

The wiring pencil eliminates having to cut wires to size and strip away insulation. The pencil dispenses and wraps 36-gauge solder-through insulated solid wire around any size post or terminal. Much faster than point-to-point wiring, pencil wiring permits you to interconnect a number of terminals with an unbroken length of wire. Once the wire is wrapped around a terminal, you apply heat directly to the joint. The insulation immediately vaporizes to allow you to flow solder into the connection. A very important advantage of pencil wiring is that it permits you to omit all sockets and most solder terminals.

As shown in Fig. 1, the wiring pencil feeds the wire from a bobbin containing 250' (76.2 m) of wire through the tool's barrel, out one of two holes, and down through a hollow "needle." Wire feed and tension are controlled by finger pressure on the wire where it comes out of the hole in the body of the tool. (The two holes are provided so that either right or left handed people can use the tool.) At the end of a run, you simply twist the pencil, and the point of the needle quickly and neatly clips the wire.

Sockets and solder clips can be omitted during assembly by using the pencil to wire directly to protruding leads and lugs. To use this technique, however, the components must be staked to the board (leads bent to mechanically secure parts in place) as shown in Fig. 1. You can use longnose pliers for staking, but Vector's No. P174 staking tool makes the job easier. Components can also be cemented to the board with a quick-set adhesive, and eyelets make excellent solderable anchors for problem components.

You can avoid having to stake components by isolating circular pads on copper-clad perf board (discussed later under Ground Plane Methods).

Solder upright ends of component leads and socket tabs to the circle pads to anchor the parts in place. Use pre-punched bus strips on the top of the board (unclad side) for the power buses. For feedthroughs, use either No. T42-1 flea clips, double-ended No. K31C round-shank pins inserted with a No. P133-A tool, or the single-ended No. T50 round-shank series shorting pin. Using clad perf board, you can dispense with bus strips altogether by isolating strips of copper (also discussed later).

Here are a few useful hints when working with a wiring pencil. Form your wraps slightly away from the board's surface to avoid marring the board with heat during soldering. Use a soldering pencil that has a tip temperature of at least 650° F (343° C) and "wet" the tip with solder before applying heat to a joint or wrap. To prevent wire breakage, dress the wire close to the board and secure lengthy runs with drops of quick-drying cement. Isolated round-shank pins make good pivot points for routing wires around obstacles. Alternatively, you can use a No. P179WS plastic wire spacer for grouping wires in a bundle. In a pinch, you can use 30-gauge bare solid wire, at least for ground returns.

Wire Wrapping. Wrapping wires around terminals, either with or without solder, offers wiring flexibility to permit rapid circuit changes. The standard wrapped connection consists of six to eight turns of wire applied under tension to square, sharp-edged wrap posts. The modified wrap, or anti-vibration wrap for extreme conditions, includes an additional one or two turns of insulated wire at the start of the wrap.

If you plan to use this technique, you'll need an efficient and easy-to-load manual wrapping tool, such as Vector's No. P160-2. The No. P160-1 is an unwrapping tool for easy removal of wrapped connections. The preferable wire size for wrapping is 28-gauge bare or Kynar insulated (Vector No.'s 2323A-28-3 or 2323A-28-4). Pre-cut and pre-stripped wire (Cambion sells a 30-gauge No. 601-2515 wire kit) will speed assembly but, unless trimmed as you go, will leave a maze of slack wires.

You can assemble an entire project using wrapped wire and the appropriate pins as shown in Fig. 2. From left to right, the pins shown include pairs of Vector No.'s. T46-3 double-ended

How to get started in microcomputer design...

for less than 75¢ a month

A new magazine from Schneider Publications brings you the fascinating world of microcomputers, every month — for just pennies a day.

If you're an alert student of electronics (and that's the only way to advance in this industry), you've undoubtedly noticed the excitement caused by the microcomputer revolution. But, if you're like most busy people, you just haven't had the time to sort out all the details.

Now there's a quick and inexpensive way to get started in microcomputer design — **MICROTREK Microcomputer Magazine**. It's loaded with creative projects and stimulating articles designed to help you master the hardware and software (programming) concepts. Here's why **MICROTREK** is the easiest and most effective way to learn about the latest in microcomputer design:

Each exciting issue is packed with practical design and programming articles, including fully illustrated build-it-yourself projects.

MICROTREK Kit Reviews show you how to get the most for your computer dollar. Here's where your subscription will pay for itself in the time and money you save.

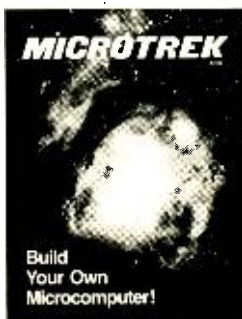

Computer Clubs and user groups are a great way to explore this remarkable new hobby-profession. Club listings and activities will be published in **MICROTREK**.

Debugging a microcomputer can be a frustrating experience. **MICROTREK** comes to the rescue with inexpensive debugging aids and powerful problem-isolation techniques.

New Products Department and **Book reviews** keep you posted on the latest technological developments.

That's not all! There's more — like applications in amateur radio, test equipment, music systems . . .

Special Charter Subscription rate for MICROTREK is just \$8.95 — a savings of over 40% off the regular cover price . . . Order before April 15, 1976 to take advantage of this introductory offer!

There has never been a better time, nor a better opportunity, to enter the fascinating world of microcomputer design . . . order your charter subscription now, just mail the coupon below with your check or money order to: Schneider Publications, Inc., Dows Building, Cedar Rapids, Iowa 52401.

Please enter my charter subscription for the first 12 issues of **MICROTREK**

I have enclosed my check or money order for \$8.95

IMPORTANT READER SURVEY QUESTIONS TO HELP US SERVE YOU BETTER:

I am especially interested in:

- Circuit design/construction
- Programming techniques
- Applications/systems

At the following level:

- Basic
- Intermediate
- Advanced

Mail to: **Schneider Publications, Inc.**
Dows Building
Cedar Rapids, Iowa 52401

PLEASE ALLOW 6-8 WEEKS TO RECEIVE YOUR FIRST ISSUE.
Additional postage: add \$1 for Canada,
\$2 for all other countries outside the U.S.

Charge my subscription to:

Bank Americard Master Charge

Acct. No. _____ Exp. Date _____

Signature _____

Name _____

Address _____

City _____

State _____ Zip _____

PERFORATED BOARD CONFIGURATIONS

Board Pattern	Hole Size	Hole Spacing	Push-in Terminal		Insertion Tool (Vector)	Bus Strip (Vector)
			Vector	Radio Shack		
A	0.093"	0.265"	T9.4	—	P122B	T58
B	0.062"	0.188"	T28	270-1394	P91A	—
F	0.062"	0.20"	T28	270-1394	P91A	T104
G*	0.062"	0.20x.10"	T28	270-1394	P91A	T104
P	0.042"	0.10"	T42.1	270-1392	P191A	T107

*Alternate rows staggered .10".

wrap posts that should be inserted with tool No. P133-A; T44 Miniwrap posts (No. A13 insertion tool); K32 J pins; R32 socket pins; and the versatile T49 Klipwrap post (No. P156 insertion tool). All this hardware is designed to fit P-pattern perf board.

It's difficult to insert a pin perpendicular to a board's surface unless you have an alignment block, such as Vector's No. MB45-20-062. It consists of 10 pieces of 1/16" P-pattern board glued in a stack. If you wish, you can make a small version from scrap board for use in tight places.

Forming perfect wrapped connections is a simple procedure, but it takes some practice to get the knack of handling the tool for positioning and dressing the wire. Use bare wire wherever possible. As with the wiring pencil, you can wrap a number of posts with an unbroken length of wire by passing the wire down through the handle of the wrapping tool.

Practice loading the wire until you can do it instinctively. The wrapping tool has a central hole that fits over the post. The end of the wire fits into a smaller off-center hole or tunnel near an index mark. If you're using 28-gauge insulated wire, strip away 3/4" (about 2 cm) of insulation. Hold the tool about horizontal with its index mark up. Catch the end of the wire in the cross slot of the tool's recessed tip near the index mark and insert into the wire tunnel. If the wire bottoms out before accepting the entire stripped end, it's in the wrap post hole. You'll have to withdraw and try again. Once the wire is properly inserted, anchor it in place by withdrawing half way, bend the wire about 30°, and push home before making the final right-angle bend.

Projects requiring numerous wrapping card sockets are best assembled with a cordless power wrapper, such as the Vector No. P160-4, which accepts the No. P160-2 manual wrapper.

Ground Plane Methods. Having a large area of copper at ground potential, the ground plane affords minimum ground circuit impedance and permits the shortest possible connections to ground. This not only eliminates instability in broadband vhf amplifiers, it also minimizes noise and ringing in digital circuits. To achieve these benefits, keep lead lengths as short as possible and inputs and outputs well separated.

Beginning with P-pattern etched ground-plane board (Vector No. 3677-7), the copper surrounding the board holes is pre-etched, leaving circles of insulation around the holes (Fig. 3). Primarily intended for wire wrapping, this board can also be used with any other wiring method. To ground a wrap post to the ground plane, push a self-fastening No. T112-1 bus link onto the post with a No. P133A insertion tool and solder the tab to the plane.

With all ground-plane wiring methods, it is best to run insulated wire right up to the pin to avoid short circuits. Better yet, wrap a turn of insulated wire on the pin nearest the board. This is easily accomplished with the No. P160-2 wrapping tool by pushing a bit of wire insulation into the recessed tip before bending the wire at a right angle. Alternatively, you can bend the wire on the insulation before loading the wrapping tool. (You can also use this tip to form antivibration-wrapped connections.)

Etched padboards that have generous interdigitized ground and supply buses (Vector No. 3677-6) closely approximate the full-ground type plane. Assign ground to buses passing between socket pads. By jumpering common-ground and supply buses, a further reduction in ground and supply bus impedance can be effected. The padboard lends itself well to any wiring scheme. A manual line cutting chisel (Vector No. P139) permits you

to safely cut through a bus or pad to isolate it.

Fully clad (one side only) perf board can be used for ground planes (Fig. 4). For P-pattern board, you'll need a circle pad cutter, such as Vector's No. P138C tool. Cut circle pads at all pin locations where the circuit must be isolated from ground. Grounded points should not be isolated. To avoid rapid cutter wear and tearing out pads, use a low drilling speed. (Hint: With high-speed power tools, like those made by Dremel under the "Moto" brand name, use a solid-state speed control set for about 45 volts ac.) You can avoid drilling too deeply into the board by backing the board with a metal plate to serve as a stop for the cutter bit's pilot pin. If the cut is too shallow and doesn't remove enough copper, place an index card between board and plate.

Accidents are bound to occur. So, if you do tear out a pad, install a No. T102 or T103 eyelet with flange on the clad side of the board. Pads not required for use as anchors or supports are best removed with an Xacto knife to reduce the chance of solder bridging or wiring shorts to ground. If you capture a pad within the cutter, remove it with a large needle or awl. Before you start wiring a circuit, check all pads with a magnifying glass and re-drill any that have copper bridges to ground.

Use No. T107 bus strips on the unclad (top) side of the board, or section off a strip of copper on the bottom of the board using an electric line cutter. A tungsten carbide router bit (Dremel No. 9909 or Vector No. P141A) chucked into a Dremel Moto tool will make short work of line cutting, as shown in Fig. 5.

You can make a line cutting guide by cementing a 4"L×1½"W×1/16"T (10.2×3.8 cm×1.6 mm) piece of insulation board to a block of 1/4" (6.4-mm) thick plywood, overlapping it by 1/4" along the long dimension. Cement a sheet of nonskid rubber to the bottom of the plywood. To use the block, place the guide along the line to be cut and hold the cutting tool at about a 45° angle to the board's surface and held firmly against the guide edge. Don't try to cut the line in one pass; make several light passes until all copper is removed along the line. A prepackaged line cutting kit containing a Dremel Model 260 drill, router bit, and several accessories is available from Vector as the No. P141B kit. ♦

MOS KIM-1 microcomputer system

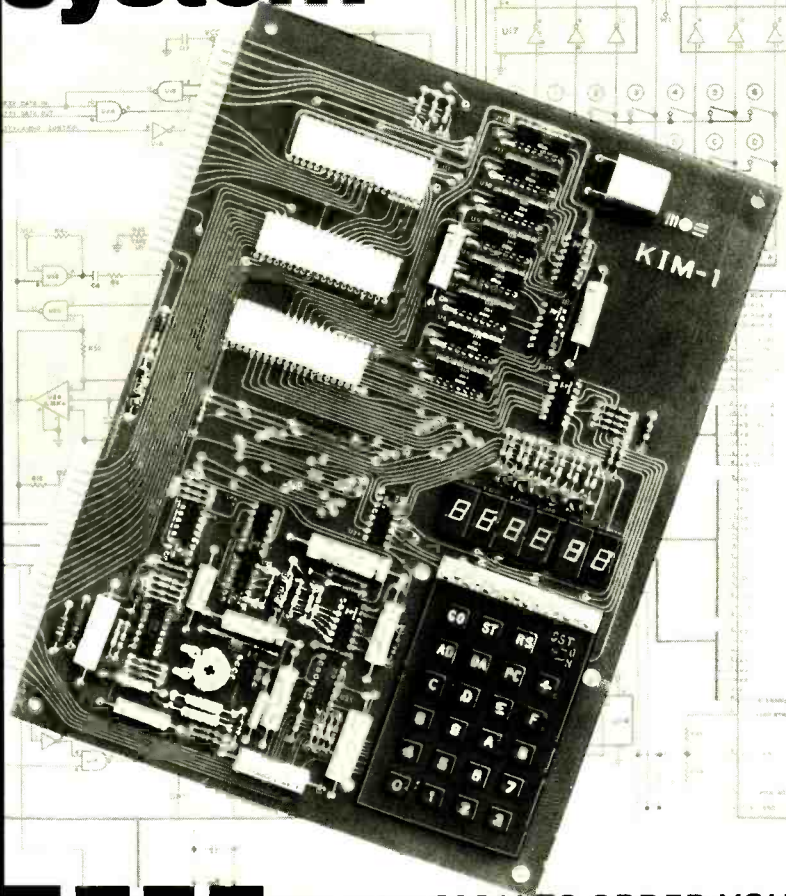

- A COMPLETE MICROCOMPUTER
- ONLY \$245
- NOT A KIT!
 - FULLY ASSEMBLED
 - FULLY TESTED
 - FULLY WARRANTED
- OPERATES WITH
 - KEYBOARD & DISPLAY
 - AUDIO CASSETTE
 - TTY
- KIM-1 INCLUDES
 - HARDWARE
 - KIM-1 MODULE WITH
 - 6502 μ P ARRAY
 - 6530 ARRAY (2)
 - 1 K BYTE RAM
 - 15 I/O PINS
 - SOFTWARE
 - MONITOR PROGRAMS (STORED IN 2048 ROM BYTES)
 - FULL DOCUMENTATION
 - KIM-1 USER MANUAL
 - SYSTEM SCHEMATIC
 - 6500 HARDWARE MANUAL
 - 6500 PROGRAMMING MANUAL
 - 6500 PROGRAMMER'S REFERENCE CARD

USE THIS FORM TO ORDER YOUR KIM-1 TODAY!

PE-46

Send to:

MOS
MOS TECHNOLOGY, INC.
KIM-1, 950 Rittenhouse Rd.
Norristown, PA 19401

Please ship me _____ KIM-1 Systems at a cost of \$245.00 per system plus \$4.50 for shipping, handling and insurance (U.S. and Canada only) PA residents add 6% sales tax.

(International sales subject to U.S. Commodity Control Regulations.
Add \$20.00 per system for shipping and handling of international orders.)

My check or money order is enclosed for \$ _____

Name _____

Address _____

City _____ State _____ Zip _____

Engineers design electronic circuits —so can you!

**Only CREI offers you a choice
of 18 home study programs
in electronics with circuit design,
plus special arrangements
for engineering degrees**

Circuit design is perhaps the one qualification that distinguishes advanced technical personnel and engineers from the average electronics technician.

If you can design electronic circuits, you can more readily understand the circuitry of all types of electronic equipment. Thus you can more easily handle the repair and maintenance of such equipment, as well as assist in the development of new electronic systems.

The ability to design electronic circuits to solve practical engineering problems is one of the most valuable skills you can possess. Those with this ability are sought after and command positions of far greater responsibility, prestige and pay than the average technician.

If you are going to have a worthwhile career in the field of electronics, the ability to design circuits is a skill you will want to acquire.

Circuit design in all CREI programs

CREI covers circuit design in its home study programs in electronics. This is one of the factors that makes CREI training different from most other home study schools. CREI programs, of course, are college level—the same level of training you will find in any college or university offering programs in electronic engineering technology.

CREI training, however, is designed for home study. The programs give you effective, step-by-step training to help you move up in your career in electronics by using your spare time for technical self improvement.

Unique Design Lab

CREI gives you both theory and practical experience in circuit design with its Electronic Design Laboratory Program. The professional equipment included in this program allows you to construct, test out and correct the circuits you design until you have an effective circuit.

This Lab Program helps you understand advanced electronics. It also gives you practical experience in many other important areas of electronics, as in prototype construction, breadboarding, test and measurement procedures, circuit operation and behavior, characteristics of electronic components and how to apply integrated circuits.

Career Training at Home

Only CREI offers this unique Lab Program. It is a complete college lab and, we believe, better than you will find in most colleges. The "Lab" is one of the factors that makes CREI training interesting and effective. And the professional equipment in this program becomes yours to keep and use throughout your professional career after you complete the training.

Engineering Degree

CREI offers you special arrangements for earning engineering degrees at certain colleges and universities as part of your home study training program. An important advantage in these arrangements is that you can continue your full time job while "going to college" with CREI. This also means you can apply your CREI training in your work and get practical experience to qualify for career advancement.

Wide Program Choice

CREI gives you a choice of specialization in 14 areas of electronics. You can select exactly the area of electronics best for your career field. You can specialize in such areas as computer electronics, communications engineering, microwave, CATV, television (broadcast) engineering and many other areas of modern electronics.

FREE Book

In the brief space here, there isn't room to give you all of the facts about CREI college-level, home study programs in electronics. So we invite you to send for our free catalog (if you are qualified to take a CREI program). The catalog has over 80, fully illustrated pages describing your opportunities in advanced electronics and the details of CREI home study programs.

Qualifications

You may be eligible to take a CREI college-level program in electronics if you are a high school graduate (or the true equivalent) and have previous training or experience in electronics. Program arrangements are available depending upon whether you have extensive or minimum experience in electronics.

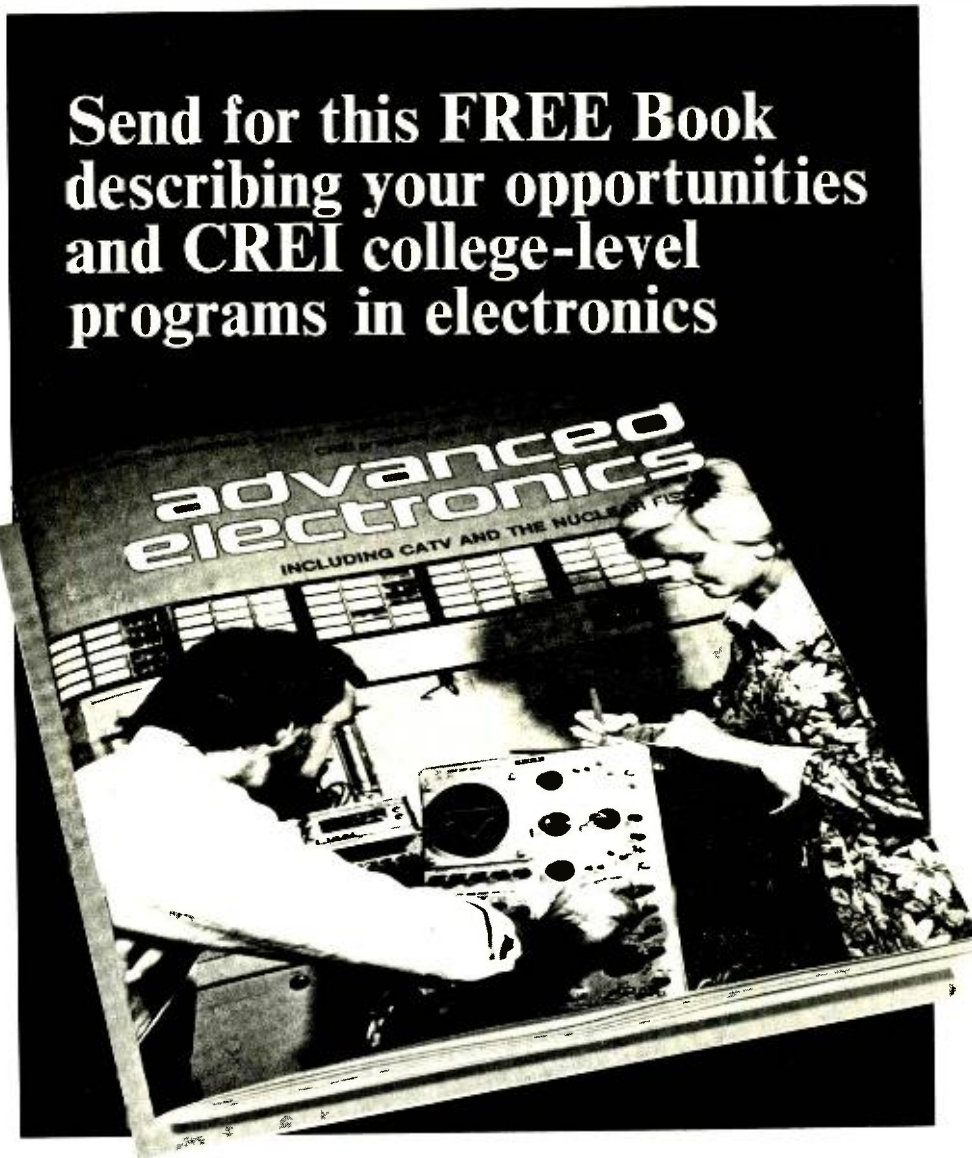

Send for this **FREE** Book describing your opportunities and CREI college-level programs in electronics

Mail card or write describing qualifications to

CREI **CAPITOL
RADIO
ENGINEERING
INSTITUTE**

McGraw-Hill Continuing Education Center
3939 Wisconsin Avenue Northwest
Washington, D.C. 20016

Accredited Member National Home Study Council

GI Bill

CREI programs are approved for training of veterans and servicemen under the G.I. Bill.





Product Test Reports

ABOUT THIS MONTH'S HI-FI PRODUCTS

The Luxman T-310 AM/Stereo FM Tuner is one of a growing number of tuners having built-in Dolby decoding circuits. Most metropolitan areas are already served by at least one FM station broadcasting Dolby-encoded programs, and a tuner with a built-in decoder makes listening to them more convenient than to have to include a separate "black box" in the system. Luxman has also made the Dolby circuits in the tuner accessible for use with an external tape recorder that doesn't have decoding circuitry for playing back Dolby-encoded tapes. In addition to its Dolby system, the rich-looking Luxman tuner is a fine performer.

Pioneer's RG-1 Dynamic Processor is a volume expander for use as an accessory to any stereo system. It restores much of the program dynamic range sacrificed during recording or broadcast by the use of limiters or compressors. Up to 14 dB of expansion is possible, considerably enhancing the realism of reproduction, with virtually no undesired side effects. An extra fillip is the 6 dB of noise reduction.

—Julian D. Hirsch

LUXMAN MODEL T-310 AM/STEREO FM TUNER

High-quality tuner features Dolby circuits.



A line of deluxe audio components now marketed in the U.S.

under the Luxman brand name includes a high-performance AM/stereo FM tuner with built-in Dolby circuits. The Model T-310 tuner is designed so that the Dolby circuits can be used to decode the playback of Dolbyized tapes or cassettes from an external recorder as well as process incoming Dolbyized FM signals. In the FM mode, the tuner's internal de-emphasis is automatically switched from the usual 75 μ s to the Dolby standard of 25 μ s.

The tuner comes with a handsome rose-wood cabinet. It measures

19"W×11"D×6 $\frac{5}{8}$ "H (48.3×28×16.8 cm) and weighs 21 $\frac{1}{2}$ lb (9.7 kg). It retails for \$595.

General Description. The FM "front end" of the tuner employs a dual-gate MOSFET r-f amplifier and mixer stages and three tuned circuits for high rejection of image and other spurious signals. The i-f section features a linear-phase five-pole filter preceding each of its two IC amplifier stages. Next come an IC limiter and a Foster-Seeley discriminator. The muting circuit is comparable to the i-f circuit in complexity, and IC's are used for the multiplex decoder and several other circuit functions. The Dolby section, however, is made up of discrete

components. The AM tuner has a tuned r-f amplifier, self-oscillating mixer, and two i-f stages. Unlike any other AM tuner we have seen, this one has interstation noise muting.

The right side of the front panel is devoted to a large blackout dial area and the TUNING knob. An indicator lights when a stereo FM broadcast is received, and small red and amber lights indicate the FM and AM reception modes. The pointer's illumination also changes from red to amber when AM is selected.

Within the dial area are the two tuning meters. A zero-center meter indicates correct tuning for FM, while the other meter indicates relative signal strength for both FM and AM. The latter also serves as a Dolby-level indicator when two small pushbuttons on the panel are pressed. This allows the Dolby circuits to be calibrated against the playback from a standard Dolby level tape or cassette. (In the FM mode, the calibration is internal and is factory set.)

The FM dial scale is linearly calibrated at 100-kHz intervals. Both the tuning scales and the meters are lit in white when the tuner is on. The POWER switch is a pushbutton at the lower left of the panel.

To the left of the dial are the small Dolby TAPE CAL buttons mentioned above and a MODE switch for selecting AM, stereo FM (with automatic stereo/mono switching), stereo FM only (the tuner unmutes only when a stereo signal is received), or mono FM operation. Three-position lever switches are provided for controlling the muting, noise filtering, and Dolby operation. The MUTING switch has OFF, NORMAL, and VARIABLE settings. The NORMAL position provides the factory set muting threshold, while VARIABLE transfers control to a knob in the rear of the tuner so that the muting threshold can be adjusted over a wide range. The NOISE FILTER switch, in its FM position, blends the stereo channels at high audio frequencies to reduce hiss without affecting frequency response. In the AM position, it introduces a steep (18-dB/octave) audio low-pass filter. Finally, the DOLBY switch (OFF in its center position) connects the Dolby system to the FM tuner outputs and changes the deemphasis to 25 μ s in the FM position, and in the TAPE position its input and output terminals are available in the rear of the tuner (together with left and right channel level adjustments for calibra-

The Black Watch kit

At \$29.95, it's

★**practical**—easily built by anyone in an evening's straightforward assembly.

★**complete**—right down to strap and batteries.

★**guaranteed.** A correctly-assembled watch is guaranteed for a year. It works as soon as you put the batteries in. On a built watch we guarantee an accuracy within a second a day—but building it yourself you may be able to adjust the trimmer to achieve an accuracy within a second a week.



The Black Watch by Sinclair is unique. Controlled by a quartz crystal . . . powered by two hearing aid batteries . . . it's also styled in the cool prestige Sinclair fashion: no knobs, no buttons, no flash . . . just touch the front of the case to show hours and minutes and minutes and seconds in bright red LEDs.

The Black Watch kit is unique, too. It's rational—Sinclair have reduced the separate components to just four.

It's simple—anybody who can use a soldering iron can assemble a Black Watch without difficulty. From opening the kit to wearing the watch is a couple of hours' work.

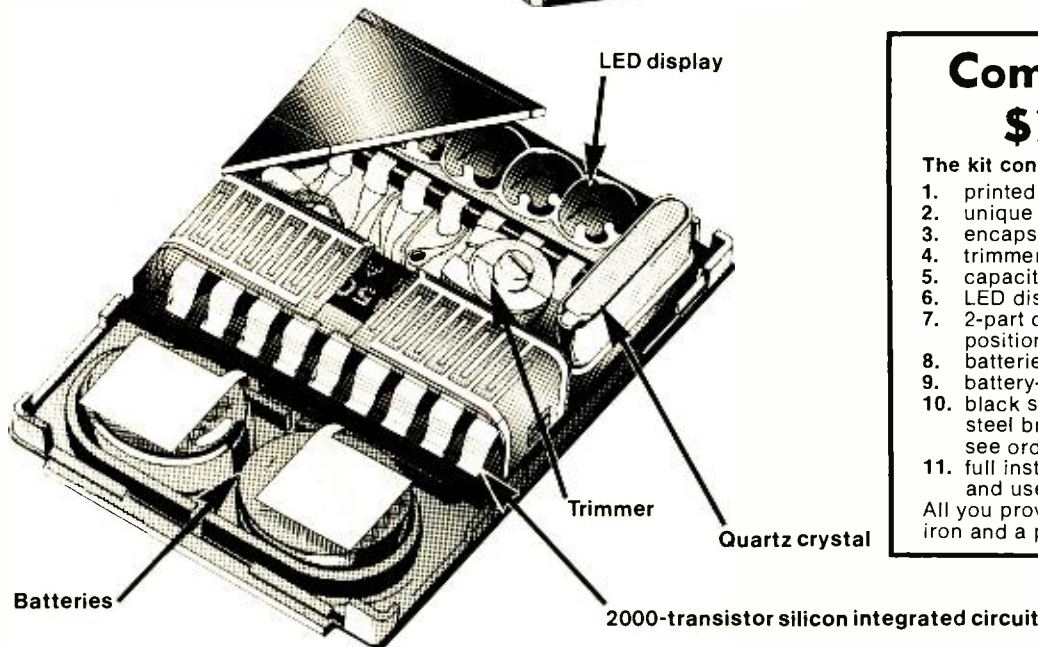

**Complete kit
\$29.95!**

The kit contains

1. printed circuit board
2. unique Sinclair-designed IC
3. encapsulated quartz crystal
4. trimmer
5. capacitor
6. LED display
7. 2-part case with window in position
8. batteries
9. battery-clip
10. black strap (black stainless-steel bracelet optional extra—see order form)
11. full instructions for building and use.

All you provide is a fine soldering iron and a pair of cutters.

Take advantage of this no-risks, money-back offer today!

The Sinclair Black Watch is fully guaranteed. Return your kit within 10 days undamaged and we'll refund the cost of your kit without question.

sinclair
SINCLAIR RADIONICS
375 Park Avenue
New York, N.Y. 10022

Please send me _____ Sinclair Black Watch kit(s) at \$29.95 (Plus \$2.50 per unit, shipping and handling). Stainless steel band \$4.00. Available assembled \$49.95.
 Enclosed is my check for _____

Name _____

Address _____

City _____

State _____ Zip Code _____

Mail to: Sinclair Radionics Inc. PE4, 375 Park Ave., New York, N.Y. 10022
N.Y. Residents add sales tax.

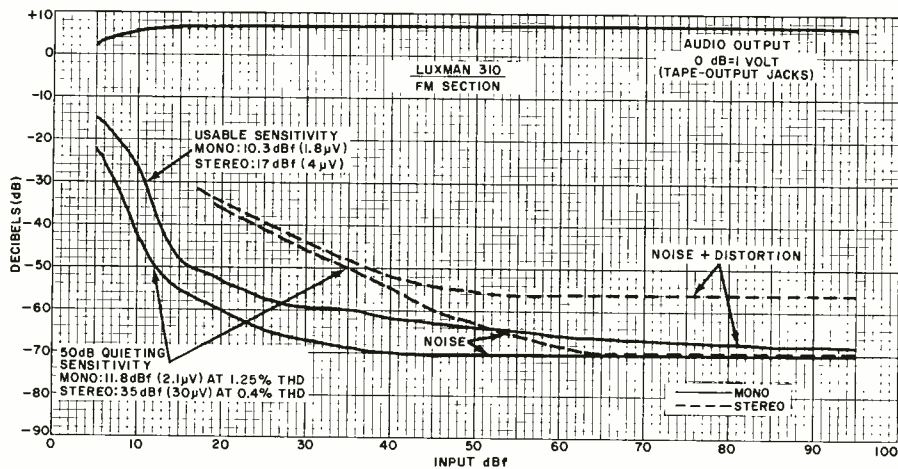

tion). When the front panel TAPE CAL buttons are pressed, a Dolby-level tone is present at the tape recording outputs of the tuner for the purpose of calibration.

On the rear apron of the tuner are two pairs of audio outputs, a small level control knob, REC OUT and TAPE PLAY jacks for connecting the Dolby system to an external tape recorder, and the Dolby calibration controls. Two small knobs permit setting the AM and FM (variable) muting thresholds.

Output jacks are provided for the vertical and horizontal inputs of an oscilloscope, which can be used as a multipath distortion indicator. There is also an output for a future 4-channel decoder. Slide switches permit changing the illumination intensity of the dial scales, the FM deemphasis (in the FM Dolby mode), and introducing a nominal 12-dB attenuation in the antenna circuit to prevent strong-signal overload. There are terminals for 300- and 75-ohm FM antennas and an AM wire antenna. (A fixed AM ferrite rod antenna is located inside the tuner.) Finally, on the rear apron is a single unswitched ac outlet.

Laboratory Measurements. The IHF Usable Sensitivity on FM was 10.3 dBf (1.8 μ V) in mono and 17 dBf (4 μ V) in stereo. The latter was determined by the stereo switching threshold. A 50-dB quieting was achieved at 11.8 dBf (2.1 μ V) in mono, with 1.25% distortion. In stereo, 50-dB quieting occurred at 35 dBf (30 μ V) with 0.4% distortion. At 65 dBf (1000 μ V) the total harmonic distortion was a very low 0.047% in mono and 0.16% in stereo, and the unweighted noise level was -70 dB in mono and -69.5 dB in stereo.

The stereo FM frequency response

was flat within ± 0.5 dB from 30 to 13,000 Hz and down 1.9 dB at 15,000 Hz. Channel separation was between 34 and 37 dB from 30 to 5000 Hz, reducing to 26 dB at 15,000 Hz. The capture ratio at 45 dBf (100 μ V) was 1.85 dB, the AM rejection an excellent 70 dB. The effectiveness of the selective r-f circuits of the FM tuner was demonstrated by its outstanding 92-dB image rejection. The alternate-channel selectivity of 79 dB was also well above average. The fixed muting threshold was 5 μ V, and the variable threshold could be set between 3 and 13 μ V. The 19-kHz pilot carrier in the audio outputs was 70 dB below the 100% modulation level.

We did not make separate tests of the Dolby system, except to check its internal calibration level against the standard 50% FM modulation level established by Dolby as the standard. The tuner appeared to be calibrated some 3 dB below standard Dolby level. (The specifications indicate that 40% modulation has been set as the internal Dolby level, so that the circuit performance was within 1 dB of the factory rating, if not of the more generally accepted value recommended by Dolby Laboratories.)

The frequency response of the AM tuner was quite flat, although it was not particularly wide. It was down 2 dB at 120 and 3300 Hz and down 6 dB at 100 and 4500 Hz. The steep AM noise filter rolled off the response sharply above 2000 Hz, to -6 dB at 2700 Hz.

User Comment. In general, the measured performance of the tuner met or surpassed the published specifications. The few cases where our sample tuner fell slightly short were more than compensated for by the many cases in which it exceeded

its rated performance. Clearly, this is a first-rate tuner, noteworthy for its low distortion (below the measurement capability of the best signal generators in the mono mode), exceptional weak-signal sensitivity, excellent selectivity and spurious-response rejection, and overall operating flexibility.

Some of the most effective FM Dolby reception we have yet heard was obtained with a definite reduction in noise compared to reception without Dolby and with standard 75- μ s de-emphasis. This was in spite of the apparent calibration-level discrepancy noted earlier.

The antenna attenuator, which had some 16.5 dB of attenuation, shouldn't be required in most cases, since we never experienced any cross modulation or spurious responses in spite of some very strong local signals.

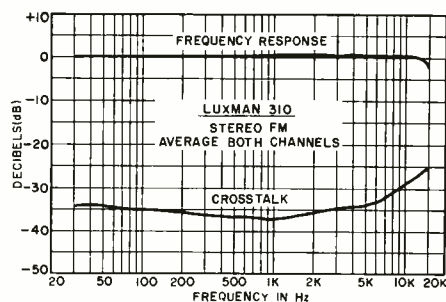

The AM section sounded much like any other AM tuner we have heard, with noticeable restriction in its high-frequency response. Otherwise, it sounded clean, and the AM muting was effective in removing the buzzes and other noises usually heard between stations.

We did observe some minor flaws to contrast with the otherwise high performance of the tuner. The FM muting, although quite good, allowed some transient noise to pass through as the tuner was slowly tuned on or off a station. This situation didn't occur during fast tuning across the dial. Also, the FM calibration, with 100-kHz markings, had significant error at some points. Finally, while tuning is easy and noncritical using the zero-center meter, the signal-strength meter saturated rapidly. It gave the same reading for any signal level exceeding about 100 to 150 μ V.

Our test results confirm the excellent performance of this tuner in a

Everything you need to know about CB is in this new book

by Radio Shack

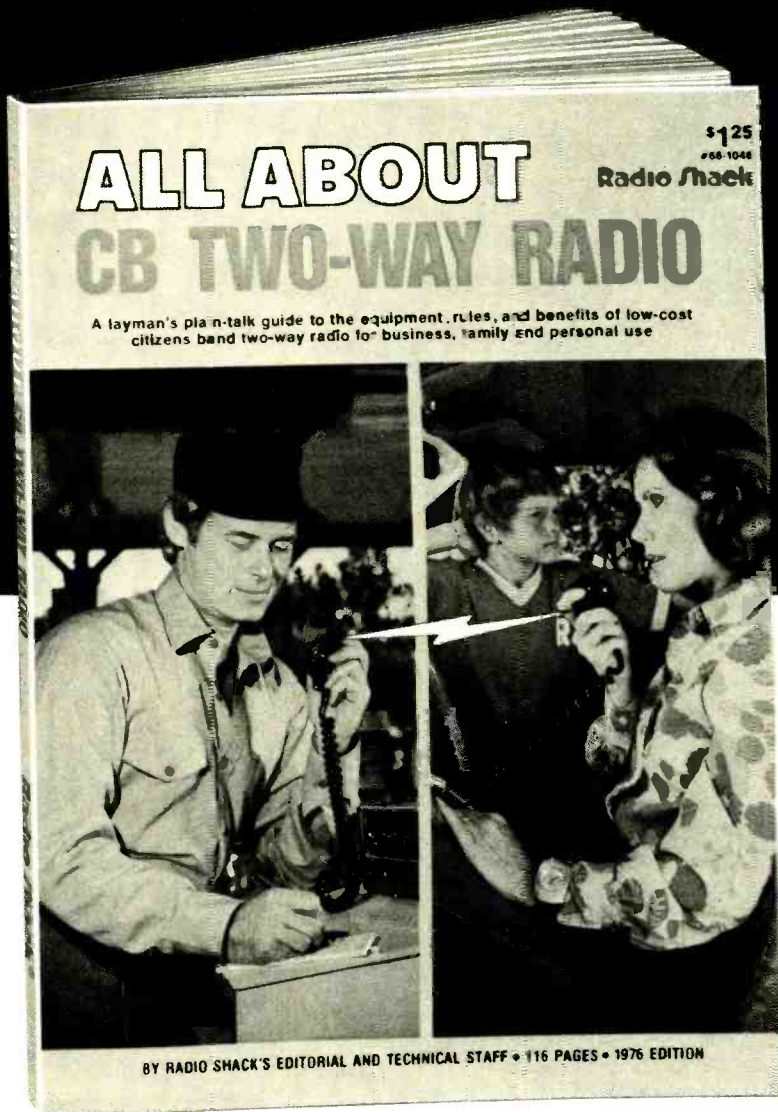

SPECIAL INTRODUCTORY OFFER!

Reg. \$1.25 CB Book

25¢

* WITH THIS COUPON

Offer Good at Participating Radio Shack Stores and Dealers

NCNE SENT BY MAIL

705

9 Plain-Talk Chapters:

- Personal Two-Way Communications
- Taking the Mystery Out of CB
- Parts of the System
- How Far You Can Expect to Talk
- Equipment Selection
- Installation
- FCC Regulations
- CB Tomorrow
- Detailed Glossary

— Plus —

- 10-Codes ■ CB Slang
- FCC Field Offices
- Over 100 Pictures

Our just-published 116-page CB pocket-size book is available now at Radio Shack stores at a "give-away" price of just 25¢, prior to its listing in our catalog at \$1.25. If you're into CB 2-way radio or getting in (as who isn't!) you'll want this book to avoid costly errors.

Edited by the folks who started our famous Realistic® CB line in 1959, it's authoritative, very easy to read, and tells all about CB for business, family and personal use. *Get your \$1-off copy—bring this coupon to any nearby participating Radio Shack store or dealer TODAY!

Radio Shack LEADING THE WAY IN CB SINCE 1959
A TANDY COMPANY

high-quality music system. Not reflected in the results is the high quality of the materials used in the tuner and

its rich-looking appearance. One final note: If the \$595 price is beyond your budget, and you already have Dolby

facilities externally, you can get the exact tuner without Dolby (Model T-300) for \$100 less.

CIRCLE NO. 80 ON FREE INFORMATION CARD

PIONEER MODEL RG-1 DYNAMIC PROCESSOR

Restores dynamic range of program material.

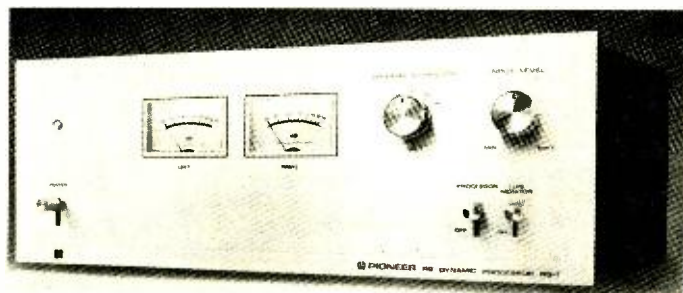

**HIRSCH-
HOUCK**
LAB
REPORT

The Pioneer Model RG-1 Dynamic Processor is designed to restore some of the dynamic range of the original program (stereo or mono) to compressed or limited recordings and radio broadcasts. In general, the correction process is one of expansion, in which high-amplitude signal levels are made even higher by an automatic gain increase, while soft signals are made softer by a gain reduction. The unit also provides some noise reduction.

The Model RG-1 measures 13 $\frac{3}{4}$ "W x 12 $\frac{5}{8}$ "D x 5 $\frac{1}{2}$ "H (35x32x13.7 cm) and weighs 11 lb, 10 oz (5.3 kg). \$175.

General Description. The processor is a single-ended device that can be used with any program source. Its expansion (gain) is controlled by the characteristics of the signal itself. The two basic components of a dynamic expander are a voltage-controlled amplifier, and a circuit that senses the program level and frequency content and creates a control signal from them. The latter is usually the most critical part of the system, since it is easy to create unnatural effects by an incorrect choice of attack and decay time constants.

At the heart of the Model RG-1 is a peak detector (proprietary). Its output is virtually free of ripple and needs little or no filtering. This allows the operating time constants to be optimized without the handicap of the large time constant imposed by the usual detector or rectifier filter. The attack time is 0.5 ms and the decay (release) time is 80 ms.

Entirely separate control and

amplifier sections are used for the two stereo channels. However, the outputs of the control circuits are partially blended so that a signal appearing in only one channel will also control the gain of the other (but to a lesser degree than signals in its own input). This is necessary to preserve stereo positioning, which might otherwise wander from side to side as the channel gains are varied.

The gain-controlled amplifiers have a flat frequency response. The rated maximum output of each channel is 6.5 volts, with less than 1% total harmonic distortion (THD). At a nominal 1-volt output level, the THD is less than 0.1%. The "sensor" section has a shaped frequency response broadly peaked at 2500 Hz and sloping off at 6 dB/octave on either side. This is done so that the processor will respond most readily to the frequency range containing a strong musical content (either harmonics or fundamentals) and will be less subject to control by less audible signals at low and high frequencies. The amount of expansion desired can be selected by a front-panel switch, which has positions for 6, 8, 10, 12, and 14 dB. The processor's circuit is fairly complex, containing two IC's, 22 transistors, and 20 diodes.

On the front panel are the DYNAMIC EXPANSION switch, and an INPUT LEVEL control. The latter is used to set the level at which expansion takes place. There's a meter for each channel, too. They constantly display the amount of expansion, or gain boost, provided. Three toggle switches on the front panel control the power, bypass and switch in the expander circuits, and restore the tape monitoring facility of

the associated amplifier or receiver. (The processor normally connects to the tape recorder input and output jacks.) The input impedance is 70,000 ohms, while the output impedance is 300 ohms. There is a constant 3-dB insertion loss when the expander is used. The residual noise in the output is specified at less than 65 μ V or about 84 dB below a nominal 1-volt output level. On the rear apron are the signal inputs and outputs, tape recorder connection, and a single unswitched ac outlet.

Laboratory Measurements. The input/output transfer characteristic of the processor was measured over an input signal range of 70 dB (from 1 mV to more than 2 V), using the full 14 dB of expansion. The maximum level was limited by the clipping output of the unit, which was about 8 volts. As the instruction manual advises, operation is linear for low signal levels up to about 10 mV (at the maximum INPUT LEVEL setting). From 10 to about 200 mV, a 26-dB range, the gain is increased by the selected amount of expansion, relative to its unexpanded value. From 200 mV to 2 volts, or a 20-dB change, the characteristic is again linear. The meter readings agreed closely with the actual amount of expansion we measured. The test was made on only one channel, and the gain of the unused channel was increased by 3 dB less than the controlled channel, due to the blending of the sensor outputs.

At maximum sensitivity, an input of 0.2 volt at 1000 Hz, or 0.15 volt at 2500 Hz, was sufficient to produce full expansion. The output noise was below our 100 μ V measurement capability, or better than 80 dB below 1 volt. The THD in the output, masked by the noise up to about 1 volt output, was 0.062% at that level. It increased smoothly to 0.09% at 3 volts, and 0.225% at the rated 6.5-volt maximum output.

It was not possible for us to measure the actual frequency response of the processor since gain was varied by the frequency-sensitive control circuit as the input frequency was changed. Our tests confirmed that this circuit was broadly peaked at 2500 Hz. The attack

The easy-to-read 630 makes learning easy.

The Model 630 V-O-M is priced at a thrifty \$78.

The rugged, general purpose Triplet Model 630 is the kind of dependable V-O-M that both teachers and students appreciate. And for the same reasons the electronic and electrical maintenance professionals do. Uncompromising accuracy. Sturdy lightweight (only 3 lbs. with batteries). Simplified single switch operation holds errors to a minimum, and diode overload protection for the meter suspension movement reduces the chance of tester damage when mistakes do occur.

With long, clean scales covering 27 ranges in only four arcs, the Triplet Model 630 is remarkably easy-to-read.

It's packed with major features:

1. Diode overload-protected suspension movement V-O-M; single range switch minimizes error.
2. 4 Ohmmeter range with 4.4 ohms center scale.
3. Simplified scale—only 4 arcs for all 27 ranges.

Sensitivity is 20,000 Ohms per Volt DC, 5000 Ohms per Volt AC. Accuracy is an excellent 2% on DC, and 3% on AC. Measures resistance to 100 megohms, with 6,000 Volt AC and DC capability.

Handles DC microamperes 0-60, and DC milliamperes 0-120, both at 250 mV, and can read DC amperes 0-12.



Rugged black molded plastic case with removable black leather carrying strap. All this for just \$78.

Get the same convenience and operating advantages plus 1½% DC accuracy and mirrored scale with the Triplet Model 630-A, priced at only \$90.

See them for yourself. Just ask a Triplet distributor or sales represen-

tative to give you a free demonstration of the tester that fits your needs. You'll be glad you did. So, do it today. Triplet Corporation, Bluffton, Ohio 45817.

TRIPLET
ALL YOU'LL EVER NEED IN V-O-M'S.

Triplet. The easy readers.

CIRCLE NO. 68 ON FREE INFORMATION CARD

www.americanradiohistory.com



The United States of America

FEDERAL COMMUNICATIONS COMMISSION

RADIO TELEPHONE OPERATOR LICENSE

FIRST CLASS
(General Radiotelephone Certificate)

This license is for **JOHN R. DOE**

SEX	HEIGHT	WEIGHT	COLOR EYES	COLOR HAIR	DATE OF BIRTH
M	5 ft. 10 in.	185	BLUE	BROWN	MONTH 02 DAY 22 YEAR 1946

IS A LICENSED RADIO OPERATOR AUTHORIZED SUBJECT TO ANY SPECIAL ENDORSEMENT PLACED HEREON TO OPERATE THE CLASSES OF LICENSED RADIO STATIONS FOR WHICH THIS CLASS OF LICENSE IS VALID UNDER THE ORDERS, RULES AND REGULATIONS OF THE FEDERAL COMMUNICATIONS COMMISSION ANY STATE OF THE UNITED STATES, AND ANY TREATY TO WHICH THE UNITED STATES IS A PARTY.

THIS LICENSE IS GRANTED UNDER THE AUTHORITY OF THE COMMUNICATIONS ACT OF 1934 AS AMENDED AND THE TERMS AND CONDITIONS HEREOF AND OF ALL LEGISLATIVE ACTS, EXECUTIVE ORDERS AND TREATIES TO WHICH THE UNITED STATES IS A PARTY, AND ALL ORDERS, RULES AND REGULATIONS OF THE FEDERAL COMMUNICATIONS COMMISSION WHICH ARE BINDING UPON RADIO OPERATORS, ARE MADE A PART HEREOF AS THOUGH SPECIFICALLY SET OUT IN FULL HEREIN.

NEITHER THIS LICENSE NOR THE RIGHTS CERTIFIED TO HEREIN SHALL BE ASSIGNED OR OTHERWISE TRANSFERRED TO ANY OTHER PERSON.

PLACE AND DATE OF ISSUANCE **WASH., D.C. MARCH 31, 1945**

DATE AND TIME OF EXPIRATION **MARCH 31, 1980** AT THREE O'CLOCK A.M. EASTERN STANDARD TIME.

SPECIAL ENDORSEMENT

SHIP RADIO ENDORSEMENT **WASH., D.C. MARCH 31, 1945**

Paul J. Harris
John R. Doe

Paul J. Harris
DIRECTOR

SPECIMEN

NOT VALID UNTIL SIGNED

CIE's Warranty says a lot to you!

A lot about CIE's FCC License training programs...and a lot more about our school.

Our FCC License Warranty means just what it says. If you enroll in any CIE career course that includes FCC License preparation and successfully complete your training . . . you'll pass the Government FCC exam. We *warrant* that you'll succeed.

CIE can make this no-nonsense warranty because we're confident of our in-depth career training programs. You see, we have *specialized exclusively* in Electronics education-by-mail for more than 40 years. Just Electronics. And, the courses we offer today are the result of these years of teaching experience and proven methods of training.

Our courses of study are written in easy-to-understand language, so you can progress at your own learning pace, at home, in your spare time. And, there are never any classrooms to attend.

CIE courses challenge your thinking . . . help you develop your understanding of important electronics theories and applications . . . enable you to learn new skills and knowledge. Our courses are thorough. They have to be.

You see, we're training you for a career in Electronics. And, if an FCC "ticket" is part of your goal, you'll have to pass a tough licensing exam administered by the Federal Communications Commission (an agency of the U.S. Government). And you'll be prepared.

CIE is willing to warrant that you will pass! The reason is . . . we have every reason to expect that *you will* do exactly that. Based on a series of continuing surveys, *close to 9 out of 10 CIE grads pass* their FCC exams!

What's a license worth?

An FCC License can be worth a lot if you're interested in any area of Electronics involving communications. In some fields, federal law requires that you must have one. And, even in careers where a license is not required, it is

Government certification of certain electronics knowledge and skills.

What about other CIE courses?

In every CIE career course, you'll find the same time-tested instructional techniques that have made CIE's FCC License preparation programs so successful.

Each CIE career course is built on the principle that the best way for you to *learn* and *retain* what you've learned is to *explain*; then to *check* your understanding; then to *reinforce* your comprehension with practical applications. In some courses, you will perform experiments and tests with your CIE Experimental Electronics Laboratory using authentic electronic components and gear. And, if you select a course that includes Color TV technology, you will not only build and keep a 25" diagonal Color TV which features digital circuitry . . . you'll also learn how to troubleshoot your TV.

The CIE course you select (beginner, intermediate, or advanced college-level), will be a complete educational program, designed by *experts* to give you the best in Electronics home-study education.

Send for FREE school catalog

Discover more about the career opportunities open to people with electronics training. *Learn* how CIE career courses can help you build new skills and knowledge and prepare you for a meaningful, rewarding career. Whether you are just starting out in Electronics or are a college-trained engineer in need of updating, (or anywhere in between), CIE has a course designed for *you*. And, more than half of CIE's career courses include FCC License preparation.

Send today for our FREE school catalog and booklet on FCC License information. For your convenience, we will try to have a representative call to assist in course selection. Mail reply card or coupon to CIE . . . or write: Cleveland Institute of Electronics, Inc., 1776 East 17th Street, Cleveland, Ohio 44114. Do it TODAY.

G.I. Bill benefits

All CIE *career* courses are approved for educational benefits under the G.I. Bill. If you are a Veteran or in service now, check box for G.I. Bill information.

CIE's FCC LICENSE WARRANTY OF SUCCESS

CIE warrants that when you enroll in any CIE course which includes FCC License preparation, you will, upon successful completion of the course and the FCC License material, pass the Government FCC Examination for the License for which your course prepared you. If you do not pass the appropriate FCC Examination, you will be entitled to a full refund of an amount equal to the cash price for CIE's "First Class FCC License Course," No. 3. This warranty will remain in effect from the date of your enrollment to 90 days after the expiration of the completion time allowed for your course.

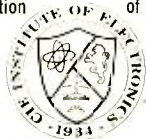

Dr. G. O. Allen
Dr. G. O. Allen President

CIE Cleveland Institute of Electronics, Inc.

1776 East 17th Street, Cleveland, Ohio 44114
Accredited Member National Home Study Council

Yes, I want your FREE school catalog and career information package today.

I am especially interested in: PE-97
 Electronics Technology Industrial Electronics
 FCC License Preparation Electronics Engineering
 Color TV Maintenance Other _____
 Mobile Communications _____

Print Name _____

Address _____ Apt. _____

City _____

State _____ Zip _____ Age _____

Check box for G.I. Bill information. Veteran On Active Duty

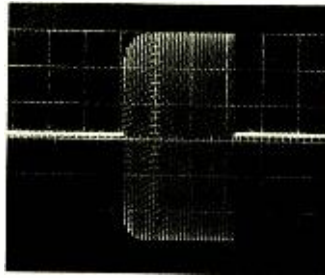
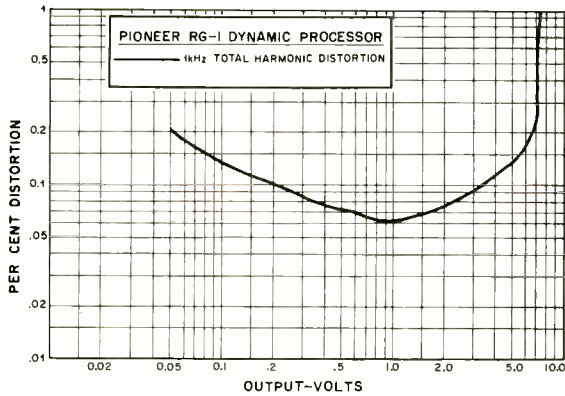

Tone-burst response at 10,000 Hz.

time of the expander was measured with a tone burst of a 10,000-Hz sine wave. An oscilloscope photo showed that the output reached its fully expanded level in 0.5 ms, as rated. When we pulsed the input with a 28-dB level change in a 1000-Hz signal, feeding the output to a chart recorder, the attack and decay times were shorter than the 200-dB/second response of the recorder pen would show. However, the decay trace, after dropping 25 dB almost instantly, required another 1.5 seconds to decay the final 3 dB linearly.

User Comment. Although our laboratory tests confirmed that the processor easily met or surpassed its published specifications, a device such as this can be judged only in actual use. We connected it into several music systems and listened to a variety of program material over a period of weeks. We found its action to be completely natural and under most conditions undetectable. It is easy to become accustomed to hearing pro-

grams with an enhanced dynamic range, to the point where "unexpanded" music seems bland and artificial.

The major weakness of most expanders is a tendency to "pump," producing unnatural surges in program level or "swishes" of background noise. We concentrated on trying to trick the Model RG-1 into this sort of misbehavior, with generally unsuccessful results. Occasionally, when using the full expansion on a solo instrument or voice, one gets the impression that the volume is varying more than it should. This is not the fault of the processor. It simply indicates that too much expansion is being used for the program material. By using less expansion with solos and chamber music, as suggested in the instructions, we were always able to clear up the problem.

If a program is fairly noisy (a weak stereo FM signal, non-Dolbyized cassette, or an old record), it is possible under some conditions to hear the modulation of the background noise

level by the expander's gain changes. However, to put the matter into perspective, one must really search for such programs and use the full expansion of the processor to create this swishing effect.

Using the processor intelligently and according to instructions, it is as nearly perfect an expander as we have heard. By appropriate settings of the input level and expansion controls, it is possible to use it as an upward expander (making loud passages louder, but leaving soft passages unchanged), a downward expander (high-level signals are not changed, but soft passages and noise are appreciably reduced) or in some combination of these modes. The dynamic range enhancement is equally effective in all modes; and we found the noise reduction to be one of the most useful features of the device. It is compatible with most other noise reduction systems; and, when used in conjunction with these systems, produces spectacular results.

The Pioneer Model RG-1 Dynamic Processor is a most worthwhile addition to any music system. It is certainly reasonably priced for the benefits it offers. To appreciate fully what it can do—restore dynamics compressed by the recording studio and provide about 6 dB of noise reduction (in addition to any other noise reduction in a system)—you've got to listen to the RG-1 at home with program material you're familiar with. Under these conditions, its contribution to making music reproduction more realistic is very evident.

CIRCLE NO. 81 ON FREE INFORMATION CARD

LAFAYETTE COM-PHONE MARK II AM CB BASE STATION

Handset Base Station uses synthesizer.



THE Com-Phone Mark II is the base station version of the Lafayette Radio Electronics Com-Phone mobile transceiver reviewed here in February 1975. Like its mobile counterpart, the

Mark II features an all solid-state design and frequency synthesis to provide full 23-channel coverage. It has two special features. One is a telephone-type handset that permits

private listening and lessens noise interference from outside sources. The second is a HI/LO button that can be used to reduce the transmitter's output power to 1 watt for nearby communication.

The transceiver has a built-in loudspeaker that can be switched in and out and a nominal 117-volt ac power supply. Among its other features are a full-time noise limiter (anl), variable squelch, "range boost" for automatic modulation control (amc), PA operation, external-speaker and tape recorder jacks, S/r-f meter, and transmitter-on lamp.

The transceiver retails for \$229.95.

The Receiver. Double conversion is employed in the receiver section,

POPULAR ELECTRONICS

WHY SETTLE FOR LESS— THAN A COMPLETE 6800 SYSTEM

MEMORY—

All static memory with selected 2102 IC's allows processor to run at its maximum speed at all times. No refresh system is needed and no time is lost in memory refresh cycles. Each board holds 4,096 words of this proven reliable and trouble free memory. Cost—only \$125.00 for each full 4K memory.

INTERFACE—

Serial control interface connects to any RS-232, or 20 Ma. TTY control terminal. Connectors provided for expansion of up to eight interfaces. Unique programmable interface circuits allow you to match the interface to almost any possible combination of polarity and control signal arrangements. Baud rate selection can be made on each individual interface. All this at a sensible cost of only \$35.00 for either serial, or parallel type

PROCESSOR—

"Motorola" M6800 processor with Mikbug[®] ROM operating system. Automatic reset and loading, plus full compatibility with Motorola evaluation set software. Crystal controlled oscillator provides the clock signal for the processor and is divided down by the MC14411 to provide the various Baud rate outputs for the interface circuits. Full buffering on all data and address busses insures "glitch" free operation with full expansion of memory and interfaces.

POWER SUPPLY—

Heavy duty 10.0 Amp power supply capable of powering a fully expanded system of memory and interface boards. Note 25 Amp rectifier bridge and 91,000 mfd computer grade filter capacitor.

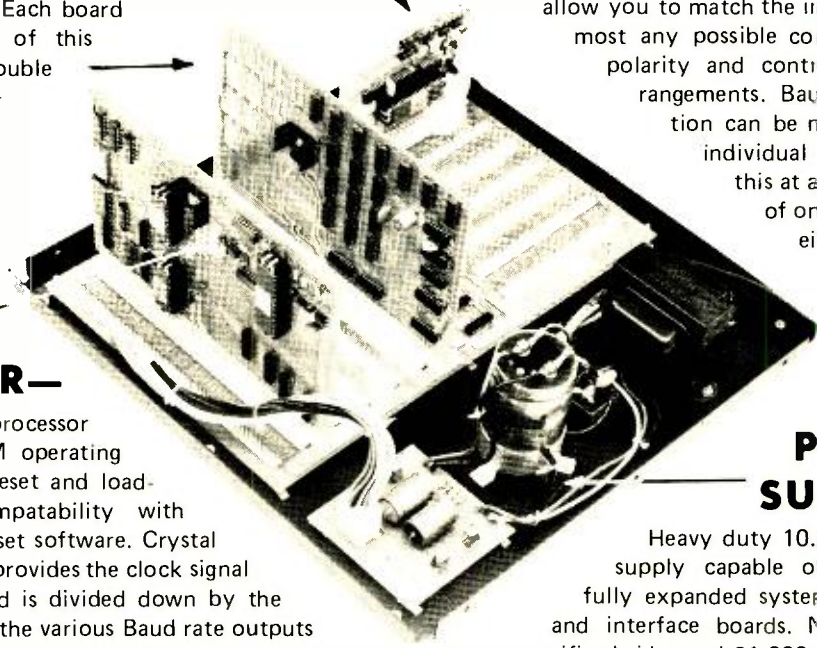

DOCUMENTATION—

Probably the most extensive and complete set of data available for any microprocessor system is supplied with our 6800 computer. This includes the Motorola programming manual, our own very complete assembly instructions, plus a notebook full of information that we have compiled on the system hardware and programming. This includes diagnostic programs, sample programs and even a Tic Tac Toe listing.

Mikbug[®] is a registered trademark of Motorola Inc.

SwTPC 6800
Computer System

with serial interface and 2,048 words of memory. \$395.00



Enclosed is \$395 for my SwTPC Computer Kit Send Data

or BAC _____ # _____

or MC _____ Ex Date _____

NAME _____

ADDRESS _____

CITY _____ STATE _____ ZIP _____

Southwest Technical Products Corp., Box 32040, San Antonio, Texas 78284

using the common frequency-conversion scheme of 10.695 to 10.595 MHz and 455 kHz first and second i-f's. Six synthesizer crystals in the 37.7-MHz and four in the 10.160-MHz ranges are used to derive the i-f's.

High sensitivity and low noise are obtained from a grounded-base r-f amplifier and a crystal-diode second mixer. A 455-kHz ceramic filter provides the selectivity. A three-stage audio system has the usual class-B push-pull speaker amplifier. (This audio section is also used as the transmitter's modulator.)

In our tests, the receiver's sensitivity (rated at 0.7 μ V) measured slightly better than 0.5 μ V for 10 dB (S+N)/N with 30% modulation and a 1000-Hz test tone. Selectivity or adjacent-channel rejection was an excellent 60 dB minimum, referred to 0.5 μ V. Primary-image (CB channel frequency plus two times the first i-f) rejection was 80 dB, while secondary-image (CB frequency plus two times the second i-f) rejection was 35 to 40 dB. First i-f signal rejection measured 38 dB, and other unwanted spurious responses were down a minimum of 40 dB. The agc held the audio output change to within 10 dB from an 80-dB input change at 1 to 10,000 μ V. (About 8 dB of the output variation occurred at 1 to 10 μ V.) A 150- μ V signal level was needed to drive the meter to S9.

The performance of the series-gate anl was good. At the onset of clipping, with a 1000-Hz test tone, the audio output measured 2.5 watts with 11% distortion into 8 ohms and almost 4 watts with 10% THD into 16 ohms.

The Transmitter. A synthesizer mixer and r-f, driver, and power amplifiers make up the usual transmitter configuration employing four synthesizer crystals in the range of 10.625 MHz along with 37.7-MHz crystals. A two-section pi-type network matches the transmitter's 50-ohm output to the antenna system and filters out harmonics. Antenna switching is accomplished electronically, while other circuits are transferred by a relay.

The r-f carrier output measured 4 watts with both our wattmeter and the meter built into the transceiver. The Mark II's meter is calibrated directly in watts for operation into a 50-ohm non-reactive (1:1 SWR) load. A built-in electronic voltage regulator made it possible to maintain this output power over wide variations of the 117-volt ac line potential.

With a 1000-Hz tone, the "range boost" (amc) held the modulation to a sine wave at about 90% modulation with a 20-dB increase in audio input level above that required for 50% modulation. Without amc, this would have occurred with only about a 5-dB input increase. Total harmonic distortion (THD) under the available high degree of compression held to within 10%.

Under dynamic conditions (voice operation), the modulation held to just 100% with adjacent-channel splatter down a nominal 55 dB. The 6-dB audio response was approximately 550 to 7000 Hz, and the maximum r-f frequency deviation for any channel was within 0.002%.

User Comment. The Mark II's styling is different from the usual CB base station. Its cabinet has a sloping top panel, at the rear of which rests the handset in its cradle. A HANDSET/SPEAKER pushbutton on the control panel lets the user choose his type of listening. With the button pushed in, both the speaker and handset earphone are live. With it out, the speaker is live until the handset is removed from its cradle, silencing the speaker and transferring the sound to the handset. During PA operation, only the external speaker is operational and the volume control serves as the microphone gain control.

We obtained typical telephone-type audio quality with the handset. Improved response, with a more natural sound, was obtained from the built-in speaker.

The handset is detachable. If desired, a standard desk-type microphone can be substituted when operating in the speaker listen mode.

The meter is of a good size for easy readability. The receiver is exceptionally quiet when no signals are present, quiet enough in fact so that one might mistake it as being off when no transmission is being received. However, even a weak signal will come in clear, thanks to an excellent sensitivity characteristic. Couple this with the fine selectivity, listening versatility, and exceptional range-boost amc performance for maintaining high modulation without adverse splatter, and the Mark II is a good choice for a CB base station.

CIRCLE NO. 82 ON FREE INFORMATION CARD

HEWLETT-PACKARD MODEL 3476A AUTOMATIC DMM

Luxury-performance, medium-cost instrument.



HEWLETT-PACKARD's new medium-priced Model 3476A digital multimeter offers features and functions normally found in only the most expensive DMM's. The instrument measures ac and dc voltage and current and resistance, with display on an expanded 3½-decade display, and polarity shown automatically. An autorange feature permits the user to

turn on the power, select the function, and connect test leads to obtain an unambiguous display reading that doesn't have to be interpreted.

The DMM measures 8.1"D×6.6"W×2.3"D (20.6×16.8×5.8 cm) and weighs 1 lb 9 oz (0.71 kg). It retails for \$225 (ac operation only). It is also available in a rechargeable-battery model that permits ac/dc operation as

the Model 3476B for \$275. Optional items include: No. 11067A test-lead kit for \$5; No. 11068A soft carrying case for \$20; and No. 11096A r-f (10 kHz to 700 MHz) kit that includes adaptors for \$87.

General Description. The DMM can measure from 100 μ V to 1000 V on dc and from 300 μ V to 700 V on ac. Typical accuracy on dc is better than 0.5%, while on ac it depends on the frequency of the voltage being measured. The dc input resistance is 10 megohms, and ac input impedance is 10 megohms, with less than 30 pF input capacitance.

Current can be measured from 100 μ A to 1.1 A on dc and from 300 μ A to 1.1 A on ac. Accuracy here is 0.1% or better on dc and depends on the fre-

quency on ac. Input impedance is specified at a constant 1 to 1.5 ohms. The current-measuring functions are fuse-protected to 1.5 amperes.

The resistance measuring range is from 1 ohm to 11 megohms, with an accuracy of 0.6% at the high end of the range and 0.4% at the low end. The open-circuit potential at the probe tips is less than 4 volts.

The DMM is protected to 1100 volts peak on all voltage and current ranges. The fuse that protects the resistance function comes into play at 30 V rms. No special fuses are required. If ever a fuse must be replaced, there is no need to disassemble the instrument; you simply slide back a panel on the right side of the case, replace the fuse, and slide the panel back into place.

The front panel of the DMM contains the bright seven-segment LED displays behind a red filter window. A light shield molded into the instrument's case minimizes the possibility of overhead lighting washing out the display. The display is rather unique. Aside from providing the usual numerals 0 through 9 in the standard seven-segment format and minus sign (+ is implied), decimal points are located in each digit within the box formed by segments c, d, e, and g. When a decimal point is to be displayed, the digit in which it is to appear is blanked. This places the decimal point where it can be easily seen.

The control complement on the front panel includes six locking-type pushbutton switches. At the left, directly following the display, is the push-push POWER switch. Next comes the dc/ac selector switch, which has graphic legends to indicate which is selected. With this switch out, the DMM is set up for measuring dc, in for ac. The next three switches, labelled v (volts), A (amperes), and k Ω (kilohms), are interlocking types. The final (push-push) switch is labelled RANGE. This gives the user a choice of operating the DMM on autoranging (AUTO) or a specific range (HOLD). To use the HOLD function, you simply measure a parameter in the AUTO function and press in the RANGE switch. Thereafter, the autoranging circuits are switched out and the instrument will measure only the range selected.

Attached to the DMM's case is a bail that does double duty as a carrying handle and tilt stand. The bail can be adjusted to position the instrument for bench-top use. Alternatively, it can be

swung back to allow the DMM to sit on the floor at an easy-to-view angle when there's no place on the bench to put it.

User Comment. The first thing we did with the DMM was check out its accuracy as best we could. (It is difficult to find calibration sources that will verify such tight accuracy.) Using our close-tolerance voltage and current sources and a number of special high-precision resistors, we verified that the DMM gave consistently accurate readings within our measurement limits.

One thing we liked during our tests and use was the fact that the least-significant digit at the far right of the display was free of the "bobble" usually characteristic of digital multimeters. We also noted that the overrange indication in any function was displayed as all g segments on.

The autoranging feature operated very smoothly. While the DMM may be automatic in operation, its autoranging circuit still works with ten ac/dc voltage, two ac/dc current, and five resistance ranges. As the ranges increase, there is a slight overlap. Consequently, the display counts up to slightly beyond its nominal top end, goes to an overrange indication, and then pops into the next range to continue the count. This is a good check to verify that the autoranging function is operating.

We couldn't resist the temptation to open up and look inside the DMM. What we saw was a relatively uncluttered circuit board. The bulk of the electronics is contained inside a custom hybrid IC, composed of two chips. One is an n-MOS control circuit, the other a tantalum-nitride thin-film precision resistor array. The control chip contains counters, buffer storage, display scanner, 3500-bit ROM storage, and solid-state analog switch circuits. The resistor array contains 19 precision resistors, matched to 0.02% tolerance by a laser trimming process. The resistor array keeps down the cost of the instrument. Had discrete high-tolerance resistors of the required values been used, the DMM's price would doubtlessly have cost more.

If you're considering shelling out more than \$200 for a good DMM, we suggest you give the Model 3476 serious consideration. It has much to offer in terms of accuracy and operating convenience.

CIRCLE NO. 83 ON FREE INFORMATION CARD



In a class by itself.

The Phase Linear 400 Power Amplifier has only one serious competitor when it comes to advanced design, superior performance, made-one-at-a-time craftsmanship, proven reliability, elegant appearance . . . and incomparable value. And that's the Phase Linear 700B. Hear them both at your dealer soon.

Phase Linear 400

THE POWERFUL DIFFERENCE

201 watts per channel, min. RMS at 8 ohms from 20 Hz-20 kHz with no more than .25% total harmonic distortion.

PHASE LINEAR CORPORATION
20121 - 48th Avenue S.W.
Lynnwood, Washington 98036

CIRCLE NO. 47 ON FREE INFORMATION CARD

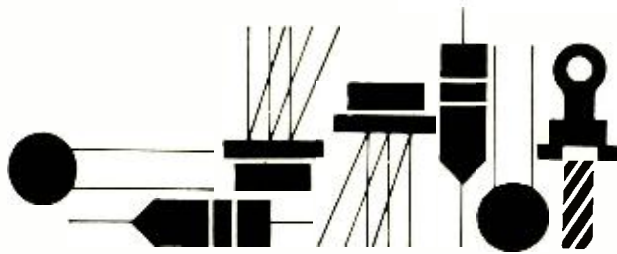

Solid State

By Lou Garner

A VERSATILE NEW IC

FOLLOWING a tradition established a number of years ago, Raytheon Semiconductor (350 Ellis St., Mountain View, CA 94040) has announced the world's first monolithic IC Voltage-to-Frequency Converter (VFC). Old timers will recall that Raytheon (then in Newton, MA) introduced the world's first low-cost experimenter's transistor way back in the early 1950's—the famous, though now obsolete, CK722.

Designated type 4151, Raytheon's newest device converts an analog dc input voltage (or current) into a stream of constant duration pulses; the higher the applied input voltage, the greater the number of pulses per second at the output. The IC's frequency range is from 0 to 10 kHz, while its operating bandwidth is 10 to 100 kHz. Its pulsed output signal is compatible with all standard logic, including TTL, CMOS, DTL, MOS, and I²L. The chip is offered in three versions: the premium RM4151, with a temperature range of -55°C to +125°C; the commercial type RC4151, with a range of 0°C to +70°C; and the automotive type RV4151, with a range of -40°C to +85°C. The device is available in two standard packages, an 8-pin plastic mini-DIP, identified by an "NB" suffix, and a TO-5 style 8-pin metal case, carrying a "T" suffix. Suitable for operation on single-ended dc sources from +8 to +22 volts, all three versions have internal power dissipation ratings of 500 mW and are capable of sinking output loads up to 20 mA.

The 4151 can be used in a variety of experimenter and hobbyist projects. Depending on external connections, the single device can serve as either a voltage-to-frequency or frequency-to-voltage converter. With this dual capability, the 4151 can be used in control systems, programmable power supplies, electronic music instruments, medical monitors and tachometers. It can also be used in minicomputer and microprocessor interface applications and in digital AM, FSK, and opto-isolated analog data transmission and communications systems. As an analog-to-digital converter, the device can be used in many types of test instruments and in conjunction with temperature, pressure and light sensors. In fact, its range of applications is limited only by the imagination and skill of the circuit designer.

Referring to the simplified block diagram (Fig. 1), the 4151 comprises a voltage comparator, a one-shot, a logic buffer amplifier, and a switched current source. The positive input voltage is compared to the instantaneous dc voltage developed across an external RC network, $R_B C_B$. If the input voltage is higher than the network voltage, the comparator triggers the one-shot which, in turn, delivers an output signal to the buffer amplifier. At the same time, the one-shot switches on the current source momentarily, injecting a charge into the RC network, thus raising the

instantaneous dc voltage across it by a small amount. If this charge has not increased the network's voltage enough to equal or slightly exceed the input voltage, the comparator again triggers the one-shot, repeating the operation. This process continues until the RC network's voltage equals or exceeds the input voltage. At this point, the current source remains off and the network voltage decays until it again equals the input voltage. When this condition is achieved, the circuit operates in a steady-state mode. The one-shot is triggered and switches on the current source at a rate fast enough to keep the network's voltage equal to or slightly greater than the input voltage. Since capacitor C_B 's discharge rate depends on the ratio of the voltage across it to the value of resistor R_B , the circuit's switching frequency is directly proportional to the input voltage.

Typical applications for the 4151 as a voltage-to-frequency converter and as a frequency-to-voltage converter are shown in Figs. 2A and 2B, respectively. Requiring single-ended dc power sources and standard passive components, both circuits are taken from the product specification bulletin for the 4151 published by Raytheon Semiconductor. Resistors can be either 1/4- or 1/2-watt types, while the capacitors can be either low-voltage ceramic or plastic-film types. Neither circuit is overly critical as far as layout and lead dress are concerned. Any standard construction technique may be used, provided good wiring practice is observed.

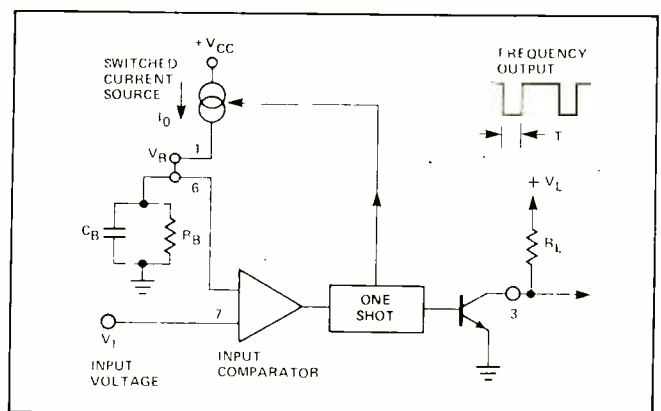

Fig. 1. Simplified block diagram of the 4151.

Suitable for operation on dc supplies of 15 to 22 volts, the voltage-to-frequency converter, Fig. 2A, is designed to accept dc input levels of 0 to +10 volts, delivering proportional pulse output signals of 0 to 10 kHz. The circuit's output frequency at 10 volts input can be established by adjusting the 5-k trimmer potentiometer which, with a 12-k

fixed resistor, forms the current output set resistor, R_C . The one-shot's period (hence the duration of the output pulse) is determined by the equation $T = 1.1 R_C C_{01}$. With the component values specified in the diagram, T is approximately 76 microseconds.

The frequency-to-voltage converter (Fig. 2B) delivers a dc output of 0 to +10 volts proportional to the frequency of the square-wave input signal. The resistor bias networks connected to pins 6 and 7 hold the input comparator in an off state under zero signal conditions. A negative-going pulse applied to pin 6 (or a positive-going pulse to pin 7) will be detected by the voltage comparator. This triggers the one-shot which, in turn, delivers a current pulse to the output integrator $C_{01}R_{01}$. The dc voltage developed across the integrator's capacitor depends on the number of current pulses received in a given period and, therefore, on the frequency of the applied input signal.

For proper circuit operation, the triggering pulse width must be less than the period of the one-shot ($1.1 R_C C_{01}$). If the input signal is a 5-volt, p-p, square wave of 10 kHz or less, the differentiator formed by the 0.022- μ F coupling capacitor and the resistor bias network develops pulses adequate to trigger the one-shot. On the other hand, if the circuit is to be driven with a triangular or sinusoidal input, an external voltage comparator (such as types 311 or 339) or a Schmitt trigger should be used between the signal source and the 4151 input to "square up" the applied signal.

The circuit's component values can be changed to meet special operating conditions. For example, the coupling capacitor and bias network making up the input differen-

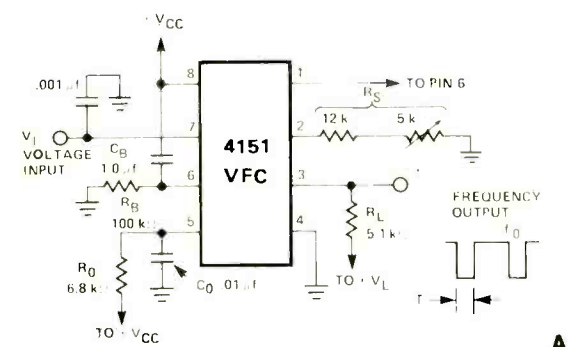

A

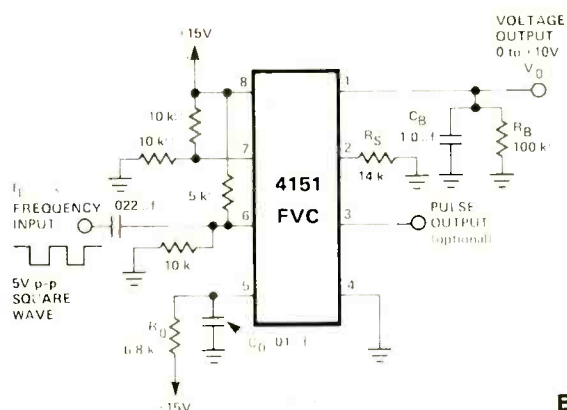

B

Fig. 2. Basic applications for the 4151: (A) voltage-to-frequency converter; (B) frequency-to-voltage converter.

the tougher the trail the more you need the best cb antenna you can buy.

Don't gamble on CB communications failing when you need it most. Insist on genuine Antenna Specialists brand antennas, field proven for 18 years in more than 3 million mobile installations. Designed and constructed with components identical to our professional antennas, such as 17-7 PH stainless steel whips that won't snap off on a low branch . . . and triple-plated brass hardware that won't rust on your first trip. Look for the Stripes of Quality. It's your assurance of performance and reliability over the long haul.

**the antenna
specialists co.**



® "Stripes of Quality"

a member of The Allen Group Inc.
12435 Euclid Ave., Cleveland, Ohio 44106
Export: 2200 Shames Drive, Westbury, L.I., N.Y. 11590
Canada: A.C. Simmonds & Sons, Ltd



Number one by a country mile!

Who builds the best electronics around?

You Do! when you build these exciting Heathkit products... all in our new spring catalog

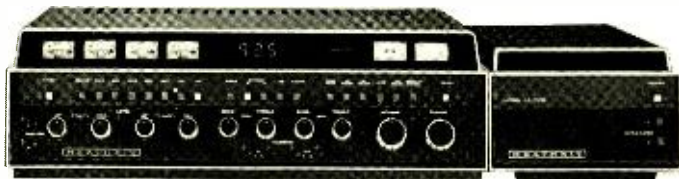

Our sensational Modulus™...the music system with total flexibility for your changing listening needs



The GB-1201 programmable digital stopwatch lets you keep track of time...for rallies, races, trips, efficiency studies



ET-3300 Lab Breadboard... makes circuit design and development fast and easy



IO-4550 Dual-Trace DC to 10 MHz scope... featuring brighter trace and faster writing speed



HW-2021 Hand-held 2-meter transceiver... 1 watt out, 5 receive and 10 transmit channels

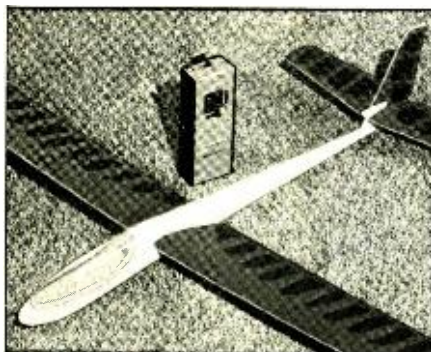

A complete line of Radio Control devices and systems... and a sleek new glider to go with them!

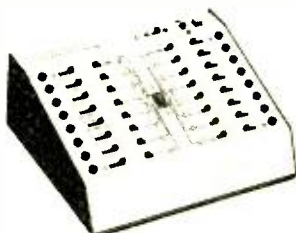

IT-5230 CRT Tester/ Rejuvenator handles the new IN-LINE COLOR tubes without adapters

IT-7400 Digital IC Tester...for RTL, DTL, TTL, CMOS, others...real versatility for your bench

HEATHKIT

The Pioneer Spirit made America Great. Self-reliance, independence, individual participation. You get a taste of that spirit when you build a Heathkit product. Declare your independence, now!

SPRING 1976

- NEW - RVC Older
- NEW - CRT Tester/ Rejuvenator
- Update the Speaker/ Clock Indicator
- NEW - Emergency Power Supply
- NEW - 1000 Micro-processor Spectrum Analyzer
- Handheld 2-meter Transceiver
- Programmable Stopwatch

PLUS... over 400 other electronic kits you can build and enjoy!

© 1976 Heath Company. See Index on page 3. Heathkit's small order shipping \$5.00. "Heath" and "Heathkit" are registered trademarks of Heath Company.

Who learns electronics the easy, effective, low-cost way?

You Do! when you study using the exclusive Heathkit Individual Learning Programs.

What better way to learn electronics than from people whose *business depends* on making it as easy to understand and work with as possible?

These Heathkit Individual Learnings Programs will give you a thorough background in basic electronics, while letting you study and learn at your own pace. There are four programs presently available: DC electronics, AC electronics, Semiconductor devices, and for the advanced, Digital Techniques. Each program includes a text written by the same people who write the world-famous Heathkit instruction manuals, audio records to reinforce and "personalize" text materials, and parts for hands-on experiments using low-cost electronic trainers which provide signal sources, power supplies and controls. Find out more about them, send for the FREE catalog below.

**HEATHKIT
CONTINUING
EDUCATION**



FREE! Read all about them!

The new Spring '76 Heathkit catalog describes those kits above, plus over 400 other money-saving electronic kits that are easy and fun to build! Send coupon or postcard today for your FREE copy. Heath Company, Dept. 10-16, Benton Harbor, Michigan 49022

Complete, accurate, HONEST descriptions of over 400 electronic kits including:

- Automotive, Aircraft and Boating Aids
- Test Instruments
- Stereo Hi-Fi Components
- Amateur and Shortwave Radio
- Color TV • Security Systems
- Educational Self-Study

Use coupon or postcard today!



HEATH Schlumberger	Heath Company, Dept. 10-16, Benton Harbor, Michigan 49022
Please indicate area of interest:	
<input type="checkbox"/> Color TV <input type="checkbox"/> Hi-Fi <input type="checkbox"/> Automotive	
<input type="checkbox"/> Test Equipment <input type="checkbox"/> Amateur <input type="checkbox"/> Shortwave	
<input type="checkbox"/> Security <input type="checkbox"/> Self-Study	
Send me my FREE Heathkit Catalog.	
Name _____	
Address _____	
City _____	State _____
CL-593	Zip _____

Mark Ten Electronic Ignitions put lightning under the hood.

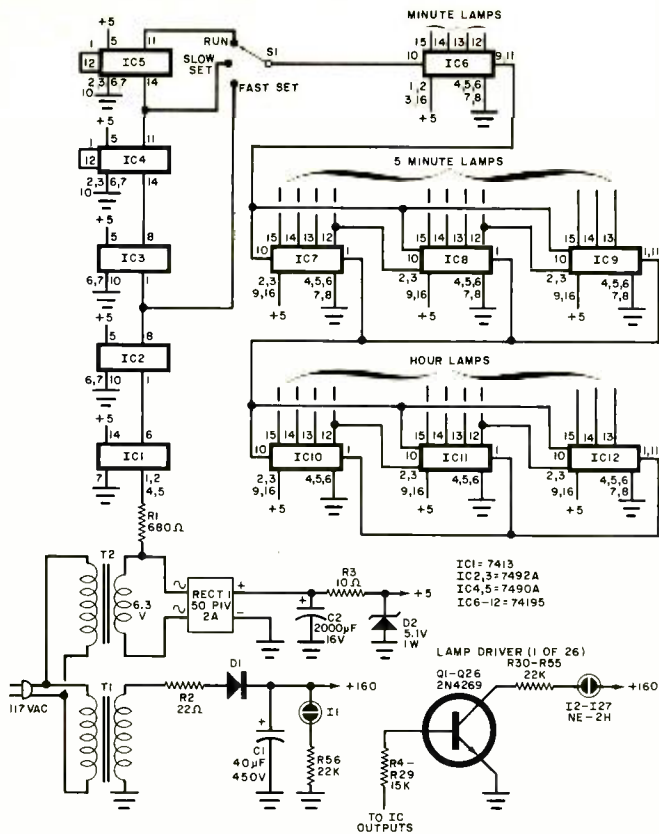

Fig. 3. Schematic of digital electronic clock with an unusual readout system.

5-minute shift register, in turn, delivers clock pulses to the 11-bit, 1-hour shift register, IC10 to IC12, at hourly intervals, switching all of its own displays off as it does so. Thus, the 5-minute and 1-hour shift registers operate in similar fashion to the 1-minute shift register, with each lamp in the corresponding group lit in turn until all are on, then all extinguished simultaneously at the next clock pulse. Switch S1 permits portions of the initial divider to be bypassed, providing a more rapid counting rate for setting the clock initially.

Although the clock circuit uses a relatively large number of IC's, it is not an overly costly project, for virtually all of the components are quite inexpensive. Kenneth writes that his total cost was less than thirty dollars. The integrated circuits are 7400 series devices which are available for less than a dollar each through most surplus outlets. Resistors R1 and R4 to R29 are 1/4-watt types; R2 and R3 are 1 watt; and R30 to R56 are 1/2-watt. The isolation transformer, T1, is a Stancor Model P-6441 (Lafayette 3380946), and T2 is a 6.3-V, 1.2-A filament transformer (Radio Shack 273-050). The time set switch, S1, is a single-pole, 3-position, shorting rotary type (Centralab 1461).

With neither parts placement nor wiring dress critical, you can pretty much follow your own preferences in construction methods. Kenneth assembled his model on perf boards, mounting these behind a piece of plywood in which he drilled holes for the neon lamps. He enclosed the whole assembly in a frame and mounted a piece of smoked plexiglass in front of the lamps so that they would be visible only when on.

For some, the most interesting part of the project will be the design of the readout display pattern. Kenneth ar-

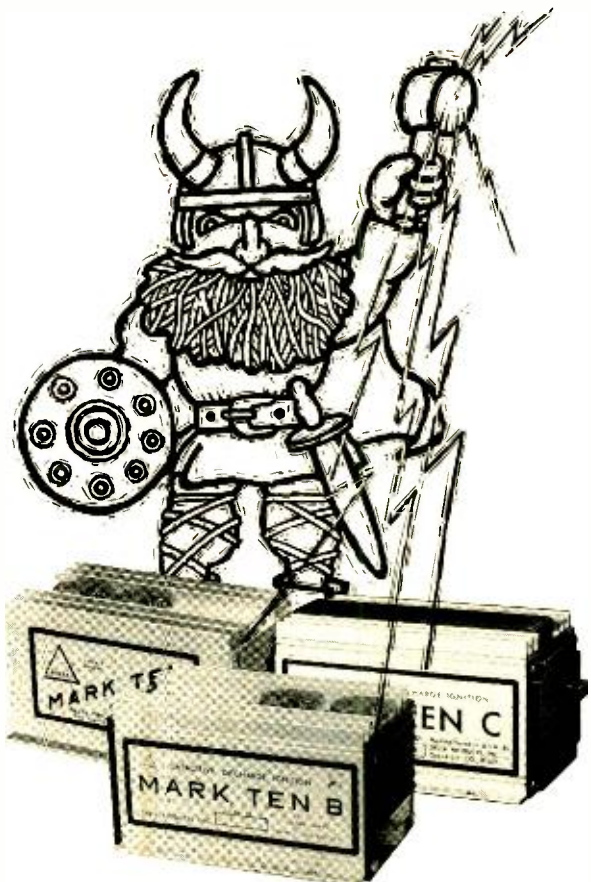

It's like having a bolt of lightning under the hood of your car when you feel it burst into action. And that's not all you'll feel with one of Delta's three HOT, HOT ignition systems. You'll feel the contentment of knowing your car will start INSTANTLY no matter how hot or cold the weather, the relief of fast, safe entry onto teaming freeways with POWERFUL ACCELERATION, and the satisfaction of pocketing all that money you'll save, not only from INCREASED GAS MILEAGE, but from all the TUNE-UPS you can forget about (at least 2 out of 3). And that's just for starters. Send today for free, color brochure jam-packed with helpful facts on how Delta's Mark Ten, Mark Ten B and Mark Ten C Capacitive Discharge Electronic Ignitions can help make driving a better experience for you.

I want to know more about Mark Ten DCI's. Send me complete nonsense information on how they can improve the performance of my car.

Name _____

Address _____

City _____ State _____ Zip _____

DELTA PRODUCTS, INC.

P.O. Box 1147, Grand Junction, Colo. 81501
(303) 242-9000 Dept. PE

ranged the lamps in an arrow display, with the hour lamps forming the arrowhead, the 5-minute lamps the shaft, and the minute lamps the tail. A geometric pattern, such as concentric circles, or an abstract design might be suitable for a den, office, or recreation room.

Setting the clock is a relatively simple procedure. After the wiring has been double checked for errors and correct dc polarities, power is applied. At this point, the clock should read 1:00 (only pilot *I1* on). Switching *S1* to FAST SET will cause the hour lamps to cycle about once every 10 seconds. After establishing the correct hour, switch *S1* to SLOW SET for the correct 5-minute and 1-minute readings, then immediately switch to the RUN position. Finally, stand back and admire your masterpiece!

Device/Product News. The Fairchild Camera and Instrument Corp. (464 Ellis St., Mountain View, CA 94042) has introduced a new low-cost static n-channel 1,024-bit random-access memory (RAM) that will be of interest to experimenters, hobbyists or engineers working with minicomputers or microprocessors. Offered in two versions, the new device, No. 3542, features a maximum access time of 150 ns, while its companion type, the 3542-2, features a maximum access time of 120 ns over the temperature range of 0° to 70°C. Organized as a 1024 X 1 bit array requiring a single 5-volt dc supply, the new RAM's are completely compatible with standard TTL. Both versions are supplied in 16-pin ceramic DIP's

A single-package successive approximation register containing all the random logic needed for a TTL analog-

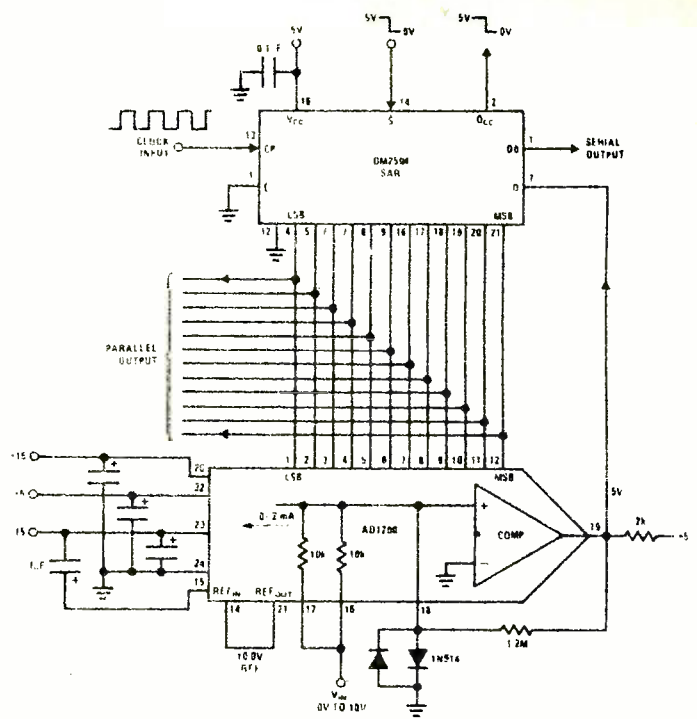

Fig. 4. A 12-bit A/D converter using National Semiconductor successive approximation register.

to-digital converter is available from the National Semiconductor Corp. (2900 Semiconductor Drive, Santa Clara, CA 95051). Intended for use with a digital-to-analog converter, as shown in Fig. 4, the new device is offered in three versions. The DM2502 features an 8-bit capacity and serial capability but is not expandable; the 8-bit DM2503 is expandable but without serial capability; and, finally, a 12-bit version, the DM2504, is both expandable and has serial capability. Compatible with D-to-A converters using any logic code, the new IC's can operate in short-cycle or expanded as well as continuous or start-stop modes and offer either active-low or active-high logic outputs. All three are available in three different types of packages: ceramic flatpacks and molded Epoxy-B or ceramic DIP's. The 8-bit devices are manufactured in 16-pin and the 12-bit type in 24-pin packages.

In addition to its new successive approximation register, National also has announced a new low-cost, six-digit, floating decimal point calculator circuit. Identified as the MM5777, the new IC uses a metal gate, p-channel MOS design and comes in a 24-pin Epoxy-B DIP. A complete four-function, six-digit calculator with leading and trailing zero suppression, algebraic key entry notation, floating point input and output, and provision for chain operation would require only a keyboard, an NSA1161 LED display, a DS8977 digit driver, and a 9-volt battery (in addition to the MM5777).

The General Instrument Corp. (600 West John St., Hicksville, NY 11802) is offering a new TTL compatible C/MOS quad multifet/multiplex driver. The new device, type MEM 4900, consists of four independent drivers on a single monolithic silicon chip. Each driver will accept input signals of 3 to 15 volts and supplies output signals up to 15 volts, p-p. An inhibit control is included to disable all four drivers when at logic one. Suitable for use in TTL-to-MOS level converters and as a driver for analog switches and multiplexers, the MEM 4900 is supplied in a 14-pin plastic DIP configuration.

THE COMPLETE DVM

\$348

FOR FASTER, MORE RELIABLE MEASUREMENTS

A NEW STANDARD IS BORN
High accuracy you can trust
Versatile measuring capabilities
An efficient, easy to operate meter
All at an affordable price
That's the DVM38 . . . The complete DVM that sets new performance standards in 4 key areas.

A NEW ACCURACY STANDARD
The 3½ digit, .1% accuracy is backed by a 15 meg Ω input impedance, compared to 10 meg Ω input of conventional DVM's, which guarantees up to 50% greater accuracy with 1/3 less circuit loading on every measurement for high accuracy you can trust.

A STANDARD IN CAPABILITIES
The DVM38 is more accurate in MORE circuits with these versatile ranges: 100μV to 2000V DC, 1KV AC; .01 Ω to 20 meg Ω; 0.1μA to 2A . . . Plus

Hi and LO ohms and a 50KVDC range with accessory Hv probe.

A NEW STANDARD IN SPEED AND EASE OF OPERATION
Large pushbuttons and callouts — no need to hunt and peck. Large 4" L.E.D.'s with direct readout, down to V and mV indicators. SINGLE STEP AUTO-RANGING for maximum resolution and efficiency. 2KV DC protection minimizes downtime.

THE AFFORDABLE STANDARD
There are few .1% DVM's less expensive—there are none as complete in this price range, plus backed by a LIFETIME guarantee against factory workmanship errors.

THE DVM38 A NEW STANDARD IN DVM'S FOR SPEED, VERSATILITY AND ACCURACY.

DVM38 BACKED BY SENCORE'S 100% MADE RIGHT LIFETIME GUARANTEE

SENCORE 3200 Sencore Drive, Sioux Falls, S.D. 57107
Phone 1 605 339-0100 TWX 910 660-0300

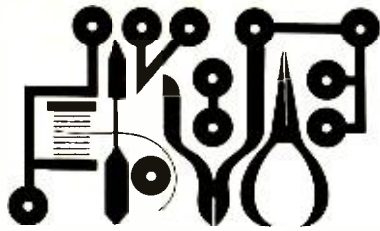

April Hobby Scene

By Marcia Swampfelder

ENCROACHING HI-FI

Q. I have a Colcord XW15 4-channel amplifier. The louder I play it, the longer it gets. It totaled a fourteenth century Ming vase by pushing it off the end of the bookshelf. Is this normal?

A. Colcord has a policy of using as many interchangeable parts as possible on their electronic and small appliance lines. The output transformer in the XW15 is made of a special high-nickel alloy core. They were able to get a *magnetostriction effect* (change of core size with winding current—see diagram) that's far more than usual. This way, the same com-

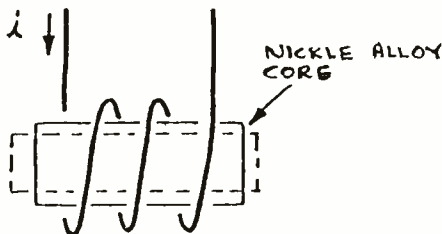

ponent that's used as an output transformer on the XW15 doubles as the drive motor on the orange juicer and as the impuser on their power nut cracker.

Your instruction manual should clearly warn you not to put anything within 6 cm (about 2 3/8") of the right side of the amplifier. Two other solutions to your problem are to buy the companion clip-on juicer and self-pour snout, or else simply put things on your bookshelf only while the unit is at maximum volume. This way, it will move away from other things on the shelf as volume is lowered.

IDENTIFYING SCOPE PROBES

Q. What is the meaning of the term "10 to one" or "10:1" on a scope probe?

A. This is just engineering slang.

There is no real technical meaning. The term apparently started due to the extreme amount of scope-probe proliferation that goes on in large electronics labs. If you turn your back on your probes, they ten to one away. Hence, the term.

GOLDEN OLDIES

Q. I found an apparently brand-new, unused 1934 Majestic "Mighty Monarch of the Air" radio in the hayloft of an old barn, still in its original factory carton. After I carefully reformed the wet electrolytics, it seems to work perfectly, except for one minor detail. All it gets is 1934 music. Why?

A. This is a beautiful example of the time lapse or *Ohaco Retrograde*, named after the historian, Dr. Chevelon Ohaco, who has long been using factory-fresh 1942 surplus command receivers to reconstruct World War II battles.

Many people using the effect, prefer to keep their receivers as they are — rather than resetting them for more recent program material. If you really want to update, you can add a Time Lapse Compensator, such as the Springer Labs. TLC-995. You usually put the time lapse compensator module between the second detector valve and the grid leak of the first audio triode. The compensators are tapped for various amounts of update, so if you are a "golden oldies" fan, you can simply select a tap or two closer to the input. Full instructions are provided with the compensator. One tip — be extremely careful never to select a tap that exceeds the time difference between the exact date of manufacture and the date the unit was originally unpacked and powered.

NEW INTEGRATED CIRCUITS

Q. I've been wanting to get into T²L

The UN-COMPUTER



Introducing a new way to begin an Altair system. The MICRO-ALTAIR™ from Polymorphic Systems is a complete computer system requiring just a keyboard and TV monitor (or modified receiver) for use.

The MICRO-ALTAIR™ consists of our video board with graphics capability, CPU/ROM/RAM board, backplane with power supply, and cabinet.

The CPU board includes an 8080 processor, 512 bytes of RAM, space for 3K bytes of ROM and vectored interrupts. Several CPU boards may be plugged into the same backplane for parallel processing.

The backplane design is unique in that it allows many backplanes to be plugged together for easy system expansion. Each backplane contains its own power supply (transformer mounted externally) rated at 8 volts at 6 amps and 18 volts at 1/2 amp. 5 boards may mount in each backplane assembly.

Included with each system is a resident operating system contained on a PROM which plugs into the CPU board. The operating system implements a versatile file system, provides program debugging aids, handles input and output concurrently with program execution, provides job scheduling and a real time clock. Data may be entered and listed in octal, hexadecimal, or ASCII and edited on the TV screen. Files may be read from or written onto external devices such as a cassette tape. Program debugging aids include software breakpoints which allow all CPU registers to be displayed at any point in the program execution.

An important feature of the MICRO-ALTAIR™ is its compatibility with Altair peripherals and software which are available from several manufacturers.

PRICES

Cabinet and power supply	\$ 155.00
Processor board (includes RAM, real time clock and vectored interrupt)	195.00
Video interface board (with 8-bit input port)	160.00
Operating system on PROM	65.00
2 100 pin connectors	17.00
The complete system purchased separately	\$ 592.00
SPECIAL: INTRODUCTORY OFFER	\$ 475.00

This offer applies only to orders accompanied by check or money order and postmarked before April 15, 1976. We believe this is one of the best deals going in a computer kit, check our Prices and compare. Delivery 60 days.



Video Interface. Plugs into the Altair or IMSAI 8800 bus and connects to standard TV monitor (or modified receiver). 8-bit input connects to almost any keyboard. Characters are displayed as 16 lines of 64 or 32 characters each on a 7.9 dot matrix. (64 character line requires a high resolution monitor or extensively modified receiver). The character set includes 128 upper and lower case ASCII characters and 64 graphics characters for plotting a 48x128 (or 64) grid. Characters are stored in the onboard memory and may be accessed directly by the computer.

\$160 Kit \$230 Assem. and tested (Add \$25 for 64 character optional) delivery 30 days

Analog Interface. This board is a complete interface for a CRT graphics display or an X-Y plotter, and provides 8 channels of software controlled A/D conversion. There are 1 or 2 channels of analog with 10 bit resolution (0-10v or ±5v out), 6 bits of latched digital output and 8 analog comparators.

1 channel (0-10v) \$135 Kit \$175 Assem. and tested
2 channels (0-10v) \$185 Kit \$235 Assem. and tested
(Bipolar option (±5v) add \$8 for 1 ch., \$12 for 2) delivery 30 days

All prices and specifications subject to change without notice. Prices are USA only. Calif. res. add 6% sales tax.

POLYMORPHIC SYSTEMS
737 S. Kellogg, Goleta, CA 93017 (805) 967-2351

BankAmericard and Master Charge Accepted

SOLID STATE...BREAKERLESS ELECTRONIC IGNITION.

**The BEST...The ULTIMATE
of All Ignition Systems**

**ALLISON
'OPTO-ELECTRIC'**



★ No Breaker-Points or Condenser to EVER wear out or need any maintenance.



★ Once installed and properly timed
your Distributor will give you
CONTINUOUS PEAK PERFORMANCE!



● The Allison OPTO-ELECTRIC System ELIMINATES the Points and Condenser, replacing them with an OPTO-Electronic Trigger, using a Light-Emitting Diode and Phototransistor. This System operates on a BEAM of LIGHT. There is NO "Breaker-Point Wiper-Arm" to wear down, Point bounce and erosion are completely eliminated thereby giving longer Timing ACCURACY than any System using "Mechanical" Breaker-Points. (and NO Timing Fluctuation as with Magnetic Impulse Units). ACCURATE Timing gives the BEST in Engine EFFICIENCY...and that's the name of the Game for the BEST in GAS MILEAGE and ECONOMY.

● The Allison's "Built-in" DWELL never needs adjustment, it is PRE-SET to supply the OPTIMUM Performance at BOTH High and Low speeds. The RPM capability of the "OPTO-ELECTRIC" unit exceeds that of any known automotive internal combustion engine. Positive spark intensity and duration helps eliminate "mistfire" and extends the Spark-Plug life.

● The Allison "OPTO-ELECTRIC" was engineered to OUT-LAST the LIFE OF YOUR CAR. Only the Highest Grade Solid-State Components are used. UNAFFECTED by Moisture or Vibration! Easier engine starting under ANY Weather Condition. Solid, DEPENDABLE PERFORMANCE.

★ Installed in your Distributor in same location as Points.
COMPLETE INSTRUCTIONS FURNISHED.
(Not Necessary to Dismantle your Distributor)

● America's Oldest and Largest Manufacturer of Opto-Electronic Ignition Systems.

★ **PROVEN RELIABILITY**
Factory Tested to 15,000 RPM
Road and Race PROVEN
(Opto-Electric Systems Won at
INDY Two Years in a Row)

★ **ORDER with CONFIDENCE . . .**
FACTORY-BACKED 10-YEAR
Free Repair or Replacement on ANY
Defects in Materials or Workmanship

★ **SAVE! ORDER FACTORY DIRECT**

● Send Check or M.O.
State Make, Year, Engine Size, (4, 6, or 8-cylinder)

● You may use your **MASTER CHARGE** or **BANKAMERICARD**.
Send us (1) Your Number, (2) Interbank No., (3) Exp. Date
MC or BA Card Holders, ORDER by TOLL FREE PHONE
(800) 423-6525, Ext. 2 (When in Continental U.S.A.)

★ Before Buying any other Type Ignition system . . .
Send Postcard for our FREE BROCHURE.

★ If you have already installed a "Capacitive-Discharge" Ignition
Modernize and Increase its Efficiency
CONVERT YOUR "C-D" UNIT TO BREAKERLESS!
Opto-Electric "TRIGGER UNIT" . . . Only \$34.95.

Only **\$59.95**
COMPLETE
(Calif. Res. add Tax)
...that's EVERYTHING!
including
Postage & Insurance.



ALLISON Our BEST Salesmen are the USERS of our ALLISON System!
AUTOMOTIVE COMPANY 1267 - E8 East EDNA PL., COVINA, CAL. 91722

CIRCLE NO. 3 ON FREE INFORMATION CARD

or "Tee Squared Ell" integrated circuits for quite some time now. However, I've never had a drafting course, and I don't even own a tee square. What do you suggest?

A. Offhand, we'd recommend hanging, decoupage, or aquaculture.

MOS PROBLEMS

Q. Are there really any special problems when you use MOS integrated circuits?

A. MOS IC's and transistors have extremely high input impedances. Early versions of these devices were extra easy to destroy by static electricity. Simply scuffing across a carpet or using a styrofoam storage block were enough to ruin the units. Just about all MOS IC's today include very good input and output protection methods, which almost entirely eliminate these problems.

However, one thing that's never mentioned in the MOS literature and hasn't yet been solved is the extreme geomagnetic sensitivity of MOS devices. They can only be used on the north side of your circuit. They are thus unsuitable for portable equipment of any sort unless a compass and clear alignment marks are provided.

NEEDS A MOUNTING BRACKET

Q. Where and when can I get the left mounting bracket for a Gentry-Heber PLX-201 combination home laser fusion power source and psychedelic lighting center?

A. Between the energy crunch and the unique lighting fad, the demand for these 5-kilowatt home units has been incredible. This is particularly true after the writeup in the "Home Power Quarterly" (Deer Springs Press, Vol XII, No. 4, p 167-185). The main problem with the bracket is that Gentry-Heber is going through a metrification program so that export units will use the same parts as the standard model. They estimate another six months to work out the backlog on this part. Meanwhile, several readers have reported working out suitable substitutes using ordinary railroad ties. Be absolutely sure there is at least 10-cm (4") clearance between the bracket and the Deuterium return line.

**FREE McIntosh CATALOG
and FM DIRECTORY**

Get all the newest and latest information on the new McIntosh Solid State equipment in the McIntosh catalog. In addition you will receive an FM station directory that covers all of North America.



MX 113

FM/FM STEREO - AM TUNER AND PREAMPLIFIER

**SEND
TODAY!**

McIntosh Laboratory, Inc.
East Side Station P.O. Box 96
Binghamton, N.Y. 13904
Dept. PE

NAME _____
ADDRESS _____
CITY _____ STATE _____ ZIP _____

If you are in a hurry for your catalog please send the coupon to McIntosh.
For non rush service send the Reader Service Card to the magazine.



Tips & Techniques

LED MONITORS BATTERY VOLTAGE

A new voltage-sensing LED (Hewlett-Packard 5082-4732) can be used to monitor battery voltages in-circuit. Since a good battery will keep its load voltage to at least 85% of its open circuit value, we can employ the LED and a zener diode to give a GOOD/BAD indication. The LED contains a reference voltage and a comparator, which triggers at a nominal threshold of 2.5 volts. The LED will abruptly extinguish below this

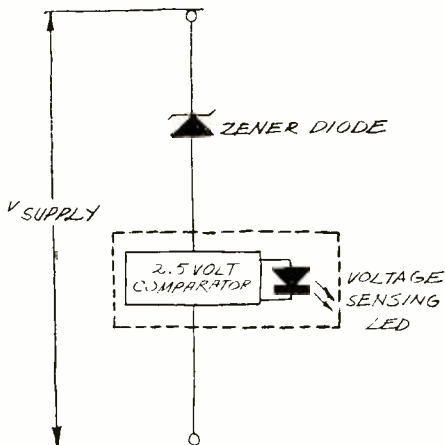

voltage. If we have a circuit powered by a 9-volt transistor battery, we want the supply voltage to stay above 7.6 V (85% of 9 V). In this case, we connect a 5.1-volt zener diode as shown, so that the LED will glow at the desired minimum voltage (5.1 V + 2.5 V = 7.6 V). Other zeners may be used to monitor various voltages. For example, connecting a 2.1-volt zener will have the LED indicate when a 5-volt TTL supply is within 90% of its optimum value (2.1 V + 2.5 V = 4.6 V). Other applications are limited only by the user's imagination.—Sol D. Prensley

HANDY WEATHERPROOF ENCLOSURES

It is sometimes necessary to have a small weatherproof enclosure for a circuit that must be mounted outdoors. Plastic "air-tight" containers, such as those used for storing leftover food, adapt themselves to this application. They come in a wide variety of shapes and sizes and are inexpensive. If it is necessary to bring leads into the enclosure, cut out or drill a small hole, and put in a tight-fitting rubber grommet. Feed the lead(s) through the grommet and fill any gaps with a good sealant.—W. T. Howatt

APRIL 1976

CHEAP SUBSTITUTE FOR ETCH RESIST PENS

An inexpensive alternative to etch resist pens can be found in your local stationery shop. "Permanent waterproof" markers work just as well at about a fourth of the price. To make any corrections, use a Q-tip dipped in acetone.—Tom Dycus

FILM SPOOL SOLDER DISPENSER

The most economical way to buy solder is in one-pound bulk spools. But a bulky spool is hardly the most convenient way to handle solder. A 35-mm film cartridge

makes a handy, refillable solder dispenser. Open the cartridge and drill a small hole in the spool near the flange. Push the solder through the hole and wind it neatly in several layers. Reassemble the cartridge, passing the end of the solder through the film slot. The cartridge may be color-coded or labelled to designate the solder's composition and size.—Raymond F. Arthur

DATING BATTERIES & CAPACITORS

Components with a limited shelf life, such as batteries and some capacitors, present servicing problems when their installation

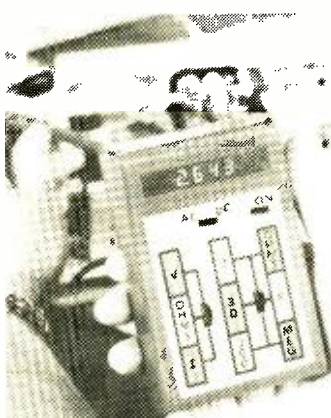

the PROFITMETER
AUTO ZERO/POLARITY
3½ DIGIT MULTIMETER KIT
WITH BRIGHT RED LED DISPLAY
\$79.95 +2.95 P & H
 LESS TEST LEADS
 & BATTERIES
CALL 1-305-636-6951
ALPHA ELECTRONICS
 DEPT 1 PO BOX 1005
 MERRITT ISLAND, FLA. 32952

<p>EXAMPLES</p> <p>TTL IC's</p> <p>7400 6/1.00 7490 2/1.00 74193 2/1.80</p> <p>DIODES</p> <p>1N4004 10/1.00 1N4148 20/1.00 1N4736 5/1.00</p> <p>C-MOS</p> <p>4000 6/1.00 4011 4/1.00 4047 2.25</p> <p>LINEAR IC'S</p> <p>LM309K 1.00 LM741M 3/1.00 NE555V 2/1.00</p>	<p>FREE NE 555 V [Timer]</p> <p>Give us your name & address. We will send you an NE555V & our catalogue with 1,000's of the best deals you have seen.</p> <p>Video Game Kits, Hobby Kits, TTL-LINEAR C-MOS-MEMORY IC's, Hardware, Switches, Resistors, & many more.</p>	<p>EXAMPLES</p> <p>MEMORY IC's</p> <p>P1101A 2.25 C1702A 15.00 N8223B 3.50</p> <p>TTL Low Power</p> <p>74L00 5/1.00 74L42 2/1.65 74L86 2/1.00</p> <p>TRANSISTORS</p> <p>2N2219A 5/1.00 2N2904A 6/1.00 2N4918 2/1.15</p> <p>7500 Series</p> <p>75450A 3/1.00 75452 3/1.35 75491 3/1.00</p>
---	--	--

JADE Co
 P.O. Box 4246 -Torrance, Ca. 90510
 Telephone 213-320-1250

CIRCLE NO. 69 ON FREE INFORMATION CARD

The Defender

stands guard over super CB performance

- Connects to base station rig
- Constant control of SWR
- Constant check on power output
- Constant check on modulation
- Easy to use and install—coax connections only



Shakespeare

Shakespeare Antenna Group, P. O. Box 246, Columbia, S. C. 29202
 In Canada, Len Finkler, Ltd., Ontario

CIRCLE NO. 58 ON FREE INFORMATION CARD

Sphere Offers You A Real Computer!

A REAL COMPUTER IS:

1. A SYSTEM: One that begins at the beginning with an attractive chassis to put everything in and consists of:
- A. CPU—To give the greatest computing power for the lowest cost ever. Motorola 6800 Microprocessor. The most advanced microprocessor available today.
 - 1K PROM...The Computer Operating Program turns on instantly.
 - 4K RAM...For storage and operating capacity for many programs.
 - REAL TIME CLOCK...To program and monitor events outside and inside the computer.
- B. CRT—To display in human language on video everything going on inside the computer. (512 characters total in 16 lines by 32 characters.)
- C. KEYBOARD—So you can talk to your Computer as fast as you can type. (72 keys of alpha-numeric style typewriter keyboard.)



DELIVERY: 60-90 DAYS

- 2. AND A REAL COMPUTER ALLOWS YOU TO: Record and reload programs and data with inexpensive audio cassette recorder.
- D. SIM BOARD—So you can interface to teletype, audio cassette recorders and phone. (RS232c, TTL, TTY at 60ma and 20ma (Teletype), Modem, and 2 cassette recorders.
- 3. A REAL COMPUTER ALLOWS YOU TO: Add more memory so you can do more processing and have more storage space.
- E. 16K MEM BOARD—About 20 pages of close type-written material (more memory up to 64K is available if needed.)
- 4. A REAL COMPUTER ENDS UP BY ALLOWING YOU TO: Remember huge quantities of information, and then print it out on paper when you need reports, records, checks, P.O.s, Invoices, etc., etc., etc.
- F. PIM BOARD—To interface the computer with the line printer and floppy disk storage.
- G. FLOPPY DISK—To remember 1/2 million characters (about 150 pages of typed material) on line with the computer.
- H. LINE PRINTER—To print 65 lines per minute on 8 1/2" wide paper up to 4 legible copies.

THAT'S A COMPUTER!!!!

Please Contact One Of Our Distributors—

Computer Way—Huntington Beach, California
 Bargain Electronics—LaMeda, California
 Comput-O-Mat Systems—Rye, New York
 The Computer Workshop, Inc.—Montgomery County, Maryland
 Computer Mart Corporated—Boston, Massachusetts
 The Computer Mart of New York—New York City, New York
 Comunicacions S.A.—San Jose, Costa Rica
 Computer Country—Denver, Colorado

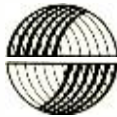

SPHERE
CORPORATION

791 South 500 West Bountiful, Utah 84010
(801) 292-8466

CIRCLE NO. 60 ON FREE INFORMATION CARD

date is unknown. A simple way to keep track of this is to attach self-adhesive labels on the package. Then write the purchase and/or installation date on the labels with a waterproof felt-tip marking pen.—*Ross Thompson*

ELECTRONIC EQUIPMENT INDICATORS

Excellent indicators can be made from the teeth of small plastic combs, as shown in the figure. They can be used as directional pointers for radios, tape recorders, etc.,

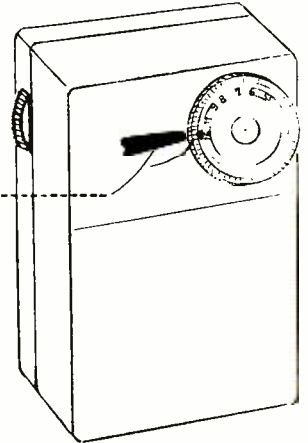

and will not wear off as printed indicators do. The teeth, which are available in many colors, are cut and filed to the required shape, and cemented in place with plastic cement.—*Frank Shore*

SERVICING CRT'S

On some TV receivers, the picture tube's external aquadag coating is not grounded when the chassis is pulled from the cabinet. The coating can be connected to the chassis by folding a piece of aluminum foil into a 2" x 1" (5.1 x 2.5 cm) rectangle. Tape half of the rectangle to the coating, and attach a clip lead to the free end of the rectangle. Then connect the other end of the lead to the chassis. When the servicing is finished, cut off the free end of the foil, since removing the tape will peel off some of the aquadag coating.—*Harry J. Miller*

TRANSISTOR STORAGE

Due to their small size, TO-92 plastic case transistors can be difficult to store. Common plastic drinking straws, however, make excellent storage tubes for them. Transistors can't rotate and jam, and all units may be quickly counted through the translucent plastic without opening. An eight-inch straw will hold about 15 devices. Pinch and seal one end of the straw with tape, or use a small tapered plug. The tubes can then be "flagged" with masking tape bearing the appropriate 2N numbers. For extra convenience, mount in a grooved or drilled wood block.—*John A. Haase*
(Continued on page 104.)

The Grabbers!

(30mHz Kit)
\$ **69**.95

(250mHz Kit)
\$ **119**.95



Six Digit Frequency Counters

For: HAMS, CBers, SERVICE TECHS, EXPERIMENTERS!

- 6 Digits
- 100Hz READOUT
- 1Hz OPTIONAL
- Wired & Tested Available
- HAM, CB & Commercial Bands
- Crystal Time-Base
- M. Chg/B. Americard OK
- Add \$2 Shipping

We have a whole wonderful line of unbelievable counters starting at \$45.95! All counters are also available factory wired and tested. Drop us a line or give us a call today.

P.O. Box 357, Dept. 23, Provo, Ut. 84601
(801) 375-8566

Hufco

An ounce here, an ounce there

Turner puts a bit
extra in all
the right places.

When it comes to building antennas, Turner doesn't mind being a bit heavier. Frankly, Turner builds Signal Kickers to last. And they come out

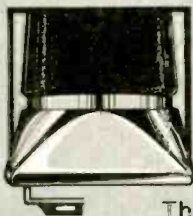

looking beautiful. Like this popular 200 series trunk lip mount.

The sturdy mounting bracket is covered with a die-cast, chrome-plated metal base.

The screw-on coil has a spring-loaded contact ball to make sure there's still a positive connection after repeated removals at the car wash.

The coil form and coil cover are molded

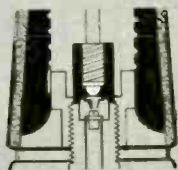

of impact-resistant Noryl, not cut from stock plastic tubing. The Noryl doesn't get soft or brittle at extreme temperatures.

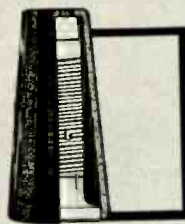

Optional swivel balls and shock springs are generously chrome plated for lasting luster. The stainless-steel whip is built to stand straight at highway speeds. And all



Signal Kickers have a reserve power-handling capacity of 500 watts.

For a heavy-duty antenna, remember Signal Kicker, the antenna built in the USA by Turner, 716 Oakland Rd. N.E., Cedar Rapids, Iowa 52402, and available through thousands of Turner CB dealers.

TURNER
MICROPHONES
ANTENNAS

CIRCLE NO. 74 ON FREE INFORMATION CARD

TURNER
*Signal Kicker*TM
ANTENNAS

B&K-PRECISION

**CRT
RESTORER/
ANALYZER**

MODEL 470
\$179



**Pays
for itself
in weeks!**

Has all the important features
of more expensive
restorer/analyzers.

- Power emission restoration system, restores better than 95% of tubes.
- Automatic timing prevents tube burn-out.
- Tests and restores each gun separately.
- Restores color and black and white tubes.
- Same basic test procedures used for all CRT's, including "in-line" and "signal-gun" types.
- Uses G-2 current test technique and measures only usable dynamic beam current.
- Removes shorts and leakage.
- Condition of tube displayed on large, multi-color scale meter for easy customer viewing.
- Supplied with 6 most popular tube adapters.
- Continuous update on adapters and CRT data ensures against tester obsolescence.
- In stock at your distributor.

B&K PRECISION

PRODUCTS OF DYNASCAN
1801 W. Belle Plaine Avenue
Chicago, IL 60613. 312/525-3990

PROBE HOLDER

A broom holder can also be a convenient holding rack for scope or meter probes. These holders can be obtained in almost any hardware store—*Thomas LaChé.*

DETERMINING TRANSFORMER POLARITIES

Here's a simple way to determine the phasing polarity of an unmarked transformer secondary. Apply an ac voltage across the

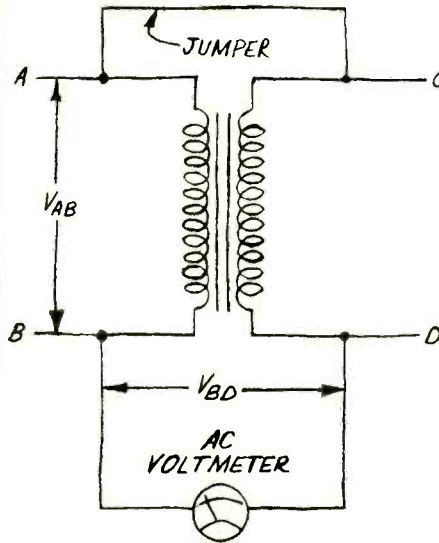

primary (points A and B) and read V_{AB} with an ac voltmeter. Then connect a jumper from point A to point C, and read V_{BD} . If this reading is higher than V_{AB} , point C has the same polarity as point B. If the reading is less, point C has the same polarity as point A. When there are more than two windings, the same test can be performed, but must be repeated for each set of coils.—*Douglas Koepke*

VHF / UHF LOOP ANTENNA

A fairly directional loop antenna can be made from a pc board about 5.1 cm (2 inches) square. Etch conductors 0.3 cm

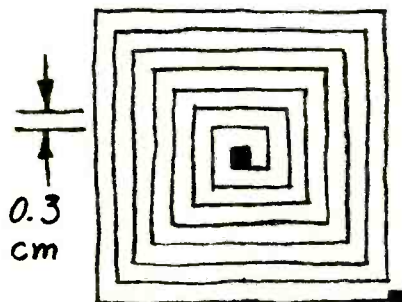

(0.125 inch) apart. It will function well over a range of 470-890 MHz (the conductive path is 70 cm or 1.16λ at 500 MHz), and will also be useful at about 180 MHz ($\lambda=140$ cm).—*Henry Troup*

GENERATION-III



FROM: PAIA

THIRD GENERATION MUSIC SYNTHESIZER KITS from PAIA feature state-of-the-art design still at incredibly low prices.

Have you seen "POLYPHONY"? The PAIA User's Group magazine. Information for musicians, from musicians. Write today for your free sample issue.

24 HR. DEMO LINE (405) 843-7396

FREE CATALOG

PAIA ELECTRONICS, INC.

DEPT. 4-P

1020 W. WILSHIRE BLVD.
OKLAHOMA CITY, OK 73116

CIRCLE NO. 45 ON FREE INFORMATION CARD



LISTEN!

We're one of the country's largest Mail Order Houses of Stereo Equipment

Our volume buying power enables us to pass the savings on to you. Listen to us ... You can't go wrong.

Fill out this coupon and mail to address below for our latest Free Catalogs.

Name _____
Address _____
City _____
State _____ Zip _____

AUDIO CATALOG

PE-4

**STEREO
DISCOUNTERS**

7A AYLESBURY ROAD □ TIMONIUM, MD. 21093

[301] 252-6880

CIRCLE NO. 52 ON FREE INFORMATION CARD

POPULAR ELECTRONICS



Electronics Library

UNDERSTANDING CMOS INTEGRATED CIRCUITS

\$1 by Roger Melen and Harry Garland

In a building-block approach, the authors first discuss logic gates, circuits, flip flops and decoders. Then, semiconductor physics is discussed, with emphasis on the diode, MOS transistor, and CMOS parasitic devices. Succeeding chapters deal with CMOS fabrication technology, monolithic CMOS design and design rules, transmission gates and memories (with emphasis on interfacing and debugging), multivibrators, oscillators, PLL's, and divide-by-n circuits. A/D and D/A conversion, multiplexing, and microprocessors are also discussed. A final chapter on CMOS systems examines a code-practice radio transmitter, a photo delayed-release timer, a capacitance meter, a multichannel oscilloscope adapter, and an electronic wrist-watch. Commonly available IC's are used, and an appendix contains pinouts for 33 selected devices.

Published by Howard W. Sams & Co., 4300 W. 62nd St., Indianapolis, IN 46206. 144 pages. \$4.95 soft cover.

ELECTRONIC CIRCUITS AND SYSTEMS

by Robert King

The author, a Senior Lecturer at Imperial College in London, uses this book in his electrical engineering classes and in courses for electronics undergraduates. While no previous knowledge of electronic devices is assumed, the reader should have a working knowledge of ac network theory. Like most classroom texts, each chapter includes a number of problems of increasing complexity to test the student's grasp of the subject matter. The presentation is concise, no-nonsense and mathematical. Those working with this text will have to sharpen their equation-solving skills or drop behind within the first chapter.

Published by Halsted Press Div., John Wiley & Sons, Inc., New York NY. 350 pages. \$13.50 hard cover.

HANDBOOK FOR TRANSISTORS

by John D. Lenk

This book helps bridge the gap between the primers and engineering treatments of transistors. It combines basic theory with practical test procedures and provides no-math "cookbook" design approaches for those who work with unijunction, bipolar, and FET types. The writing is

In any hi-fi system, the one component most likely to wear out is the phono cartridge. Or more specifically, the phono stylus.

While you're relaxing to your favorite music, the stylus is riding miles of groove, withstanding accelerations that would black out an astronaut.

Which is why the Shibata stylus, used on the top models of Audio-Technica



cartridges, is so important. Its shape reduces tracking pressure at any given tracking force. Even with a setting as high as 2 grams it will outlast an elliptical stylus tracking at a fraction of a gram. Which

means the good sound of Audio-Technica lasts longer. And so do your records.

Audio-Technica with a Shibata stylus: lower cost per record/mile and better sound in the bargain!

audio-technica 
INNOVATION / PRECISION / INTEGRITY

When you shop for better sound ask about good mileage!

AUDIO-TECHNICA U.S., INC., Dept. 46P, 33 Shiawassee Ave., Fairlawn, Ohio 44313
Available in Canada from Superior Electronics, Inc.

HOOK-UP WITH A GOOD THING.

Save time and money designing and testing circuits with our solderless QT Sockets and Bus Strips* All types of components—from resistors to DIP's—connect with plug-in ease, and rearrange just as quickly, without damage. (Jumpers, where needed, are lengths of #22 AWG solid wire.) And QT components interlock for unlimited expansion. Next project, spend more time designing and less time soldering, for as little as \$3.00.**

Ask your dealer about CSC QT Sockets and Bus Strips, or write for our catalog and distributor list

*U.S. Pat. No. D 235,554
**Manufacturer's suggested list QT-7S
Prices and specifications subject to change without notice

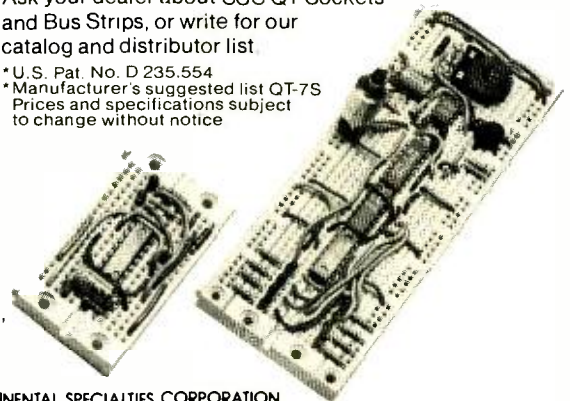

CONTINENTAL SPECIALTIES CORPORATION



EASY DOES IT

44 Kendall Street, Box 1942
New Haven, CT 06509 • 203-624-3103 TWX. 710-465-1227
West Coast office: Box 7809, San Francisco, CA
94119 • 415-421-8872 TWX 910-372-7992
Canada: Len Finkler Ltd., Ontario
CIRCLE NO. 17 ON FREE INFORMATION CARD

now 9 midget driver sets BY Xcelite®



FOR DOUBLE DUTY ON DOZENS OF POPULAR SCREWS AND NUTS



Three new assortments have joined Xcelite's family of "Compact Convertibles." Each an Xcelite "original." No-where will you find such a variety of sizes and types in a midget set, for driving slotted, Phillips, Allen, Scrulox®, hex, and clutch head screws. And hex nuts.

All of professional quality, precision made of finest materials. All doing "double duty" with torque amplifier handle that slips over color-coded midget tools for longer reach, greater driving power. Each easily identifiable on the bench or in the service kit thru Xcelite's exclusive, optically clear, plastic "show case" that closes securely with positive snap-lock.



NEW!

PS130 — 3 slot tip, 2 Phillips screwdrivers, 5 nutdrivers

PS140 — 4 slot tip, 3 Phillips screwdrivers, 3 nutdrivers

PS6 — 3 slot tip, 3 Phillips screwdrivers

PLUS — PS88, PS120, PS7, PS89, PS44, and PS-TR-1 with varying selections of screwdrivers and nutdrivers.



Ask your local distributor or write . . .

Weller-Xcelite Electronics Division



The Cooper Group

P. O. BOX 728,
APEX, NORTH CAROLINA 27502

CIRCLE NO. 65 ON FREE INFORMATION CARD

straightforward and the text has been enhanced by the copious use of diagrams, tables, graphs, and schematics. While designed as a textbook, the extensive subject index makes it easy to use as a reference for material on particular circuits and/or parameters.

Published by Prentice-Hall, Inc., Englewood Cliffs, N.J. 292 pages. \$15.95 hard cover.

INTEGRATED CIRCUIT GUIDEBOOK

by Ken Tracton

Here is a three-in-one handbook for electronic hobbyists: it covers not only interesting and useful projects (about half the content) but a theoretical section and a group of informational appendices for ready reference. Among the circuits described are a 4-channel, full-logic SQ decoder; FM multiplex demodulator; SCA decoder; metronome, waveform generators; etc. Each schematic is clear and complete, accompanied by an easy-to-read parts list.

Published by Tab Books, Blue Ridge Summit, PA 17214. 191 pages. \$5.95 soft cover.

MICROCOMPUTER DESIGN SYSTEMS AND HARDWARE FOR THE 8008/8080

by Donald P. Martin

This book presents both basic and advanced information on designing with microprocessors. It assumes that the reader is familiar with digital circuits, especially with TTL. Best used in conjunction with the MPU manufacturer's instruction manual, the book covers such topics as: timing logic, handling interrupts, input/output designs, interval timers, RAM, ROM, etc. Design of bread-boardable nine- and nineteen-chip microcomputers is also given. The book, in a loose-leaf binder, contains many schematics, logic and timing diagrams, and program lists.

Published by Martin Research Ltd., 1825 S. Halsted St., Chicago, IL 60608. Over 300 pages (8½" x 11"). \$75.00.

HOW TO SELECT AND USE A CALCULATOR

by P.R. Jamele

This book is intended to aid those who are considering the purchase of an electronic calculator. Thus, the principle theme of the first three chapters is the variety of models available. The balance of the book is devoted to the four-function calculator, and how to use it to solve "more sophisticated" problems, such as extracting roots, raising a number to a power, algebraic and geometric problems, interest and annuities, and metric and other conversions. All calculations are based on a floating decimal/constant key "four banger."

Published by Crescent Publications, 5410 Wilshire Blvd., Suite 410, Los Angeles, CA 90036. 91 pages. \$1.95 soft cover.

SAVE!

MONEY • TIME • FREIGHT

- ♪ QUALITY STEREO EQUIPMENT AT LOWEST PRICES.
- ♪ YOUR REQUEST FOR QUOTATION RETURNED SAME DAY.
- ♪ FACTORY SEALED CARTONS—GUARANTEED AND INSURED.
- ♪ SAVE ON NAME BRANDS LIKE:

A.D.C.	KLH
A.R.	SHURE
DYNACO	KOSS
SONY	FISHER

PIONEER
AND MORE THAN 50 OTHERS
BUY THE MODERN WAY
BY MAIL—FROM

illinois audio

Department 217S
12 East Delaware
Chicago, Illinois 60611
312-664-0020

CIRCLE NO. 32 ON FREE INFORMATION CARD



Our whole family helped assemble this wonderful Schober Organ... and now we all play it!

Talk about real family fun! We all worked together, for a few hours almost every day. Almost too soon, our Schober Organ was finished. Our keen-eyed daughter sorted resistors. Mom soldered transistor sockets, although she'd never soldered anything before. And it did our hearts good to see the care with which our son—he's only 12—installed the transistors. Me? I was the quality control inspector—they let me do the final wiring.

Our completed Schober Organ compares favorably with a "ready-made" one costing twice as much! (The five models range from \$650 to \$2850.)

Just send the coupon for the fascinating Schober color catalog (or enclose \$1 for a 12-inch LP record that lets you hear as well as see Schober quality).

The Schober Organ Corp., Dept. PE-65
43 West 61st Street, New York, N.Y. 10023

- Please send me Schober Organ Catalog.
- Enclosed please find \$1.00 for 12-inch L.P. record of Schober Organ music.

NAME _____
ADDRESS _____
CITY _____ STATE _____ ZIP _____

CIRCLE NO. 56 ON FREE INFORMATION CARD
POPULAR ELECTRONICS

Now-have fun with electronics- **BUILD YOUR OWN BURGLAR ALARM...** **motor oil checker...** **metal locator...** **listening device...** **mini-computer...** **oscillator...** **amplifier...** **and more!**



129R2

Try this library of tested, easy-to-follow guides that tell you the parts you need... where to get them... then lead you step-by-step through building and operating useful electronic devices! Your satisfaction is guaranteed.



ELECTRONIC CIRCUITBOOK Project Construction
 This brand-new book provides all the background you need to begin building electronic devices right away. Explains common circuit components, covers power supplies, even helps you select and use tools. **\$2.95**



HOW TO BUILD PROXIMITY DETECTORS & METAL LOCATORS. Hunt treasure, find jewelry and coins in the sand. Locate pipes and studs in walls and floors. This is just a sample of what you can do with devices this book helps you build. There are projects for novices and technicians alike. **\$4.50**



BUILD-IT BOOK OF FUN AND GAMES
 Put rhythm in your music—"sniff out" energy losses in radio equipment—make an electronic football game. All this and more can be done with a handful of parts—just for the fun of it. **\$3.95**

BUILD-IT BOOK OF FUN AND GAMES
 Put rhythm in your music—"sniff out" energy losses in radio equipment—make an electronic football game. All this and more can be done with a handful of parts—just for the fun of it. **\$3.95**



INTEGRATED CIRCUIT PROJECTS. Expand your electronics know-how—delve into IC technology. This clearly written, challenging volume helps you sharpen your skills by building a stereo headphone amplifier, tone encoder and decoder, waveform generator, voice scrambler, and more. **\$4.95**



BUILD-IT BOOK OF CAR ELECTRONICS
 Now you can monitor your car's electrical system from the comfort of your seat. You'll build devices to check oil and battery, analyze circuits, warn about lights and turn signals that shouldn't be on... and much more. **\$3.95**

BUILD-IT BOOK OF CAR ELECTRONICS
 Now you can monitor your car's electrical system from the comfort of your seat. You'll build devices to check oil and battery, analyze circuits, warn about lights and turn signals that shouldn't be on... and much more. **\$3.95**



SOLID-STATE ELECTRONIC PROJECTS. Three chapters help you understand burglar alarms inside-out. Parts lists help you protect your home by building them. This book also helps you construct metal locators, music circuits, a long-range listening device, and more. **\$3.95**

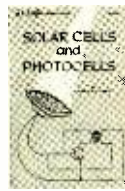

SOLAR CELLS AND PHOTOCELLS
 Here's an easy guide to the electric eye for science fair students and electronics technicians, too. You'll learn how to build photocells—and also how to use them in some fascinating experiments and projects. **\$3.95**

SOLAR CELLS AND PHOTOCELLS
 Here's an easy guide to the electric eye for science fair students and electronics technicians, too. You'll learn how to build photocells—and also how to use them in some fascinating experiments and projects. **\$3.95**



HI-FI PROJECTS FOR THE HOBBYIST. This book takes nothing for granted—not even your budget. Shows you tools, techniques, terms, where to buy, what and how to build. Install a small speaker enclosure with big sound, loudness or balance controls, a four-channel adapter, and more. **\$3.95**



5-MINUTE ELECTRONIC PROJECTS. Learn basics about electronics the easy way—by setting up projects and demonstrations yourself. This picture-packed book features devices that take minutes of building, but hours of using and enjoying. Included are oscillators, generators, transmitters, a crystal radio, and more. **\$3.95**



PROJECTS IN SIGHT, SOUND, AND SENSATION. Build a digital ESP testing machine yourself? This book makes it possible—along with six other unique projects. Advance from simple novelty devices to a sophisticated biofeedback machine for muscle relaxation. Theory, diagrams, and parts lists are featured with plenty of illustrations. **\$4.95**

Build a library of these fascinating fun-to-use books. They're less than \$5.00 each!

Clip out... mail today

MAIL TODAY FOR 15-DAY FREE TRIAL

YES—send me the book(s) checked below to examine for 15 days free. If not completely satisfied, I may return my order and owe absolutely nothing. Otherwise, I will pay the amount on the invoice accompanying my book(s), including shipping and handling.

CHECK HERE AND SAVE 10%! I have checked at least 3 of the books offered. So 10% of the cost is deducted.

- | | |
|--|---|
| <input type="checkbox"/> ELECTRONIC CIRCUIT-BOOK I 21241 \$2.95 | <input type="checkbox"/> INTEGRATED CIRCUIT PROJECTS 21113 \$4.95 |
| <input type="checkbox"/> BUILD-IT BOOK OF FUN AND GAMES 21219 \$3.95 | <input type="checkbox"/> SOLID-STATE ELECTRONIC PROJECTS 20921 \$3.95 |
| <input type="checkbox"/> BUILD-IT BOOK OF CAR ELECTRONICS 21308 \$3.95 | <input type="checkbox"/> HI-FI PROJECTS FOR THE HOBBYIST 20925 \$3.95 |
| <input type="checkbox"/> SOLAR CELLS AND PHOTOCELLS 21175 \$3.95 | <input type="checkbox"/> 5-MINUTE ELECTRONIC PROJECTS 20968 \$3.95 |
| <input type="checkbox"/> HOW TO BUILD PROXIMITY DETECTORS & METAL LOCATORS 20881 \$4.50 | <input type="checkbox"/> PROJECTS IN SIGHT, SOUND & SENSATION 21125 \$4.95 |

NAME _____ (please print)

ADDRESS _____

CITY _____ STATE _____ ZIP _____

Save shipping and handling costs. Full payment enclosed.*
 Mail to: Howard W. Sams & Co., Inc./4300 W. 62nd St.
 Indianapolis, Ind. 46206
 *(Plus sales tax, if any.)

EB16

CB

where the
ACTION'S
at

Millions of 2-way CB radios are in use—millions of new ones are being sold annually to new CBers and for replacing old units—what a market for repair service. It's the biggest thing in electronics since color TV. There's only one thing wrong with CB growth—the lack of technicians capable of servicing CB radios. That's why many TV shops are expanding into CB and why new CB shops are opening up all over the country. Going CB servicing rates run from \$12 to \$24 per hour.

To get into CB radio servicing, full-time or part-time, you need test equipment, an FCC operator license and to learn how. To learn how, you can buy the **CB RADIO REPAIR COURSE** for cash, on a monthly payment plan, or charge the cost to your BankAmericard or Master Charge account.

To make it easy to study, this 70-lesson course employs the **PROGRAMMED** teaching technique and sticks to the target—CB radio. Study at your own pace as you receive the self-examining lessons. We can't guarantee that you will become a CB expert since that depends on you.

To get the facts about this course, write a letter or card or mail the coupon below today. No salesman will call.

CB RADIO REPAIR COURSE, INC.

Dept. P-46

531 N. Ann Arbor
Oklahoma City, OK 73127

Please send information about your Course to:

Name _____
Address _____
City _____ State _____ Zip _____

CIRCLE NO. 72 ON FREE INFORMATION CARD



**save on gas!
save on tune-ups!
save on maintenance!**

Electronic ignition is "IN"! So says Detroit.

Update your car with either a TIGER CD or a TIGER I breakerless system.

Enjoy the benefits of better gas mileage, quicker starting, elimination of tune-ups, 50,000 miles on points and plugs, and reduced maintenance expenses.

TIGER MAX CD	\$69.95
TIGER 500 CD	59.95
TIGER SST CD	42.95
SIMPLIKIT CD	31.95
TIGER I	45.95

Postpaid U.S.A. only.

Tri-Star Corporation

Dept. ZZ, P.O. Box 1727
Grand Junction, Colorado 81501

Operation Assist

If you need information on outdated or rare equipment—a schematic, parts list, etc.—another reader might be able to assist. Simply send a postcard to Operation Assist, POPULAR ELECTRONICS, 1 Park Ave., New York, NY 10016. For those who can help readers, please respond directly to them. They'll appreciate it. (Only those items regarding equipment not available from normal sources are published.)

Kent Model 82 Automatic Table Radio. Schematic. George W. Glass, 644 Woodward Ave., Chippewa Falls, WI 54729.

GE Radio Model H-31. Schematic. Lingkon So, 8-4 Georgian Ter., Troy, NY 12180

Dumont Oscillograph Type 164E. Need intensity control potentiometer. Mallory Y200MP, W.N.G. Preucel, 1147 Norsam Rd., Gladwyne, PA 19035

Navy Receiver R-892/URR-44. Schematic or instructional manual. Dave Prescott, 23 Stoneybrook Ave., San Francisco, CA 94112.

EI-Tronics Model WBO-50 Oscilloscope. Schematic and/or service manual. James H. Bunyan, 199-14 119 Ave., St. Albans, NY 11412.

Philco radios. Need a 7R7 and a 5A24 tubes. John Usinowski, RR #1, Box 379, Greenwich, NY 12834.

National Model HRO-60 Communications Receiver. Need operator's manual. R. Dennis Gibbs, 9214 Venetian Way, Richmond, VA 23229.

Morrow Model MB-6 Amateur Band Receiver and power supply. Schematic and/or service manual. Dave Olsen, 329 Glenmeade Ct., Gretna, LA 70053.

Eico Model 450 Oscilloscope. Schematic and parts list. N. Harel, 861 Liberty Ave., Union, NJ 07083.

Tektronix Model 535A Oscilloscope. Type CA plug-in, Type D plug-in, Type 53C plug-in, and TS-382 Audio Oscillator. Operations and maintenance manuals needed. Alan W. Otto, 6000 Rivers Ave., #68, Charleston Heights, SC 29405.

Dumont Type 350 Oscilloscope. Schematic and/or service manual. M. H. Cobb, P.O. Box 83, Falkland, NC 27827.

Sonar Model G CB Transceiver. Need schematic and service manual. Edward F. Maher, 489 Grand Blvd., Brentwood, NY 11717.

Towaco Model TSA-2 Telegraph Signal Analyzer. Need manuals and schematics. Dick Dawson 1308 "F", The Dalles, OR 97058.

GE Model HJ905 Radio Receiver. Need circuit diagram. A.L. Dolnick, GTE Sylvania, West Third Street, Emporium, PA 15834.

Jackson Model 648 Dynamic Tube Tester. Need source of updated tube chart roll. John E. Broome, 39 Monray Road, Glens Falls, NY 12801.

Ampex Micro 88 Cassette Recorder. Need parts, operator and service information. Alan Roemer, P.O. Box 79, Wapella, IL 61777.

Precision Apparatus Model #660 tube and transistor checker. Need operating manual and schematic. Loring B. Quimby, Quimby Road, Brookline, NH 03033.

Bowmar MX 55 Calculator. Need source of adapter with 11-volt ac output. Ernest S. Selig, 523 Harwood Ave., Baltimore, MD 21212.

Dumont Oscillograph Type 250 AH. Need operating and maintenance manuals. Mario Vaquera, 2010 N. Copia, El Paso, TX 79930.

Simpson VOM Model 260. Need service information and schematic and/or parts list. Bernard Grupe, 3012 Highland Drive, Cary, IL 60013.

Stromberg-Carlson 1940-41 radio/phono combination. Receiver # 1025 PF, Chassis Pc.#33264. Need schematic. John Rautio, P.O. Box 144, Iron River, WI 54847.

Supreme Model 561 AF & RF Signal Generator. Operations manual and schematic. Barry N. Shiffrin, 131 Pine Road, Endicott, NY 13760.

FREQUENCY?

MEASURE IT ANYWHERE
To 60 MHz with the FM-7.

NLS proudly announces a NEW Frequency Meter.



With Rechargeable Batteries & Charger Unit **\$195**

Features Include:

- Portable, battery operated for measurement anywhere!
- 10 Hz to 60 MHz input with LED 7-digit resolution.
- High sensitivity: 30 mV - 50 Hz to 30 MHz (100 mV - 10 Hz to 60 MHz).
- Input overload protection.
- Small, only 1.9" H x 2.7" W x 4" D.
- High stability internal time base.
- For field application, servicing or production testing.

See your local distributor!

Distributor inquiries invited.



Non-Linear Systems, Inc.

Originator of the digital voltmeter.
Box N, Del Mar, California 92014

Telephone (714) 755-1134 TWX 910-322-1132

CIRCLE NO. 43 ON FREE INFORMATION CARD

projection television

Convert color TV to Giant *50" Screen with the



New MIAMI Projection TV Screen and Lens Assembly

All necessary instructions included **\$325**

*Diagonally measured

MIAMI PROJECTION TELEVISION

304 N.E. 79th St., Miami, Florida 33138
(305) 759-3124

CIRCLE NO. 39 ON FREE INFORMATION CARD
POPULAR ELECTRONICS

ELECTRONICS MARKET PLACE

NON-DISPLAY CLASSIFIED: COMMERCIAL RATE: For firms or individuals offering commercial products or services. \$2.00 per word (including name and address). Minimum order \$30.00. Payment must accompany copy except when ads are placed by accredited advertising agencies. Frequency discount; 5% for 6 months; 10% for 12 months paid in advance. **READER RATE:** For individuals with a personal item to buy or sell. \$1.20 per word (including name and address.) No minimum! Payment must accompany copy. **DISPLAY CLASSIFIED:** 1" by 1 column (2-1/4" wide). \$230.00. 2" by 1 column. \$460.00. 3" by 1 column. \$690.00. Advertiser to supply film positives. For frequency rates, please inquire.

GENERAL INFORMATION: First word in all ads set in caps at no extra charge. All copy subject to publisher's approval. All advertisers using Post Office Boxes in their addresses **MUST** supply publisher with permanent address and telephone number before ad can be run. Advertisements will not be published which advertise or promote the use of devices for the surreptitious interception of communications. Ads are not acknowledged. They will appear in first issue to go to press after closing date. Closing Date: 1st of the 2nd month preceding cover date (for example, March issue closes January 1st. Send order and remittance to **POPULAR ELECTRONICS**, One Park Avenue, New York, New York 10016. Attention: Hal Cymes.

FOR SALE

FREE! Bargain Catalog—IC's, LED's, readouts, fiber optics, calculators parts & kits, semiconductors, parts Poly Paks, Box 942PE, Lynnfield, Mass 01940

GOVERNMENT Surplus Receivers Transmitters Sniperscopes, Radars, Parts, Picture Catalog 25 cents Meshna, Nahant, Mass. 01908

LOWEST Prices Electronic Parts Confidential Catalog Free KNAPP, 3174 8th Ave S.W. Largo, Fla 33540

ELECTRONIC PARTS semiconductors, kits FREE FLYER Large catalog \$1.00 deposit BIGELOW ELECTRONICS Bluffton, Ohio 45817

RADIO TV Tubes 36 cents each. Send for free catalog Cornell, 4213 University San Diego Calif 92105

AMATEUR SCIENTISTS Electronics Experimenters Science Fair Students Construction plans—Complete, including drawings, schematics, parts list with prices and sources Robot Man—Psychedelic shows Lasers Emotion Lie Detector Touch Tone Dial Quadrasonic Adapter—Transistorized Ignition Burglar Alarm Sound Meter over 60 items Send 50 cents coin (no stamps) for complete catalog Technical Writers Group, Box 5994 University Station Raleigh, N.C. 27607

METERS—Surplus, new used panel or portable Send for list Hanchett, Box 5577 Riverside CA 92507

MECHANICAL ELECTRONIC devices catalog 10 cents Greatest Values Lowest Prices Ferteks, 5249 D Philadelphia, Pa 19120

SOUND SYNTHESIZER KITS Surf \$12.95 Wind \$12.95 Wind Chimes \$17.95 Electronic Songbird \$6.95 Musical Accessories, many more Catalog free PAIA Electronics, Box J14359, Oklahoma City OK 73114

BUGGED??? New locator finds them fast Write Clifton, 11500-L NW 7th Avenue, Miami Florida 33168

DISCOUNT PRICES

B&K, SENCORE, LEADER, RCA
EICO, FLUKE, HICKOK, SIMPSON

Test Equipment

ICC Servicemaster RCA and Raytheon Tubes
Complete line of electronic supplies

Free Catalog

FORDHAM RADIO SUPPLY CO., INC.

558 Morris Ave Bronx, N.Y. 10451 (212) 585-0330

YOU WILL SAVE BIG MONEY! Surplus, Clearouts Bankruptcy, Inventory, Deals Catalog \$1 (redeemable) ETCOA Electronics Box 741 Montreal, H3C 2V2 U.S. Inquiries

TELEPHONE BUGGED? Countermeasures Brochure \$1.00 Negeye, Drawer 547 Pennsylvania W VA 26415

HEAR POLICE/FIRE Dispatchers! Catalog shows exclusive directories of confidential channels, receivers Send 10 cent stamp Communications, Box 56-PE Commack, NY 11725

CD IGNITIONS VHF UHF monitors, crystals, CB radios Southland, Box 3591-B Baytown, Texas 77520

SURPRISE! Build inexpensively, the most Unusual Test Instruments, Futuristic Gadgets using Numerical Readouts! Catalogue Free! GBS Box 100A Green Bank, West Virginia 24944

LEARN DESIGN TECHNIQUES Electronics Design Newsletter Digital, linear construction projects design theory and procedures, Annual subscription \$6.00, sample copy \$1.00 valley West, Box 2119-B Sunnyvale California 94087

TELEPHONES UNLIMITED equipment, supplies Catalog 50 cents, Box 1654E Costa Mesa, Calif. 92626

UNSCRAMBLERS Fits any scanner or monitor, easily adjusts to all scrambled frequencies Only 4 square \$29.95, fully guaranteed Dealer inquiries welcomed PDO Electronics, Box 841, North Little Rock, Arkansas 72115

PYROTECHNICAL chemicals, casings, fuse, tools, literature, supplies, Catalog \$1.00, with samples — \$2.00, Westech, Logan, Utah 84321.

SURPRISE! SURPRISE! Digital Piano Tuning Device tunes musical instruments Accurately! Perfectly! Inexpensively! Construction-Instruction-Plans Complete \$12.95 Armairied Postpaid! Moonlighting quickly repays \$40 electronics investment! GBS Box 100P Green Bank, West Virginia 24944

RECONDITIONED Test Equipment \$0.50 for catalog Walters Test Equipment 2697 Nickel, San Pablo CA 94806

FREE giant bargain electronic catalog listing thousands of components tubes transistors IC's, kits test equipment EDLIE S 2700-PB Hempstead Tpke Levittown NY 11756

P-1

wanted Citizens Band

DEALER-DISTRIBUTORS

Send this ad with Letterhead to:

PAL ELECTRONICS CO.

2962 W. WELDON - PHOENIX, ARIZ. 85017

BUILD THAT ELECTRONIC ORGAN YOU ALWAYS WANTED AT A PRICE YOU CAN AFFORD Third edition of Organ Builder's Guide, pictured product kit line, circuits, block diagrams design rationale using IC divider and independent generators with diode keying \$3.00 postpaid Also free brochure on keyboards DEVTRONIX ORGAN PRODUCTS Dept C 5872 Amapala Dr. San Jose CA 95129

FOR A New Electronic Experience, learn to control your brainwaves Aquarius Electronics, Box 96ZE, Albion, CA 95410

POLICE Fire monitors, scanners, crystals discount priced New crystal-less scanners Box 19224, Denver, CO 80219.

TELETYPE EQUIPMENT for sale for beginners and experienced computer enthusiast Teletype machines, parts, supplies, Catalogue \$1.00 to ATLANTIC SALES, 3730 Nautilus Ave., Brooklyn, NY 11224. Tel (212) 372-0349

JAPANESE TRANSISTORS all transistors original factory made Free catalog, West Pacific Electronics, P.O. Box 25837 W. Los Angeles, CA 90025.

COMPUTER PERIPHERAL TECHNICAL Reports, Project Supplies, Kits Catalog 751A 50 cents E/S Lab, Box 738, College Park, Maryland 20740

CB RADIO Scanners, Antennas The best for less Free List Capitol Sound, Box 3523, Des Moines, Iowa 50322

YOU WANT TO BUILD IT WE WANT TO HELP WE SELL CONSTRUCTION PLANS with an Engineering Service TELEPHONE Answering Machines, Speakerphones, Carphones, Phonovision, Touch Button Dialers TELEVISION VTR 1 Color TV Set, PONG \$25.00 Camera, COLOR PROJECTION TV HOBBYIST Electron Microscope, \$75 software programmable computer BROADCAST Special Effects Generator, Chroma Key, Audio Board, DA's COURSES Telephone Engineering \$52.00, Detective Electronics \$29.50, IC Engineering \$65.00, PLUS MUCH MORE NEW Super Hobby Catalog PLUS year's subscription to Electronic News Letter AIR MAILED \$1.00 Don Britton Enterprises, 6200 Wilshire Blvd., Los Angeles, Calif 90048



WORLD'S SMALLEST ELECTRONIC CALCULATOR...\$19.95!

Does Everything Big Ones Do

Small but mighty! 8-digit, 4-function electronic calculator even has automatic % key... for only \$19.95. Take it anywhere. Carry it in your pocket or purse — it's 2/3 the size of a pack of cigarettes. This 3 1/2-ounce dynamo features floating decimal, constant key, lead zero depression, clear entry, more! At Edmund's low price, the unit comes with a Ni-Cad rechargeable battery pack that can plug into any AC outlet. No need for special recharging adapters. Calculator overall is just 2 x 3 1/2 x 3/8" with plenty of room for most fingers. *Another Edmund first with advanced technology.* **\$19.95** ppd.

STOCK NO. 1945 AVC Only

GIANT FREE CATALOG!

NEW 164 Pages Over 4,500 Unusual Bargains for Hobbyists Schonis, Industry



JUST CHECK COUPON!

EDMUND SCIENTIFIC CO.
300 EDSCORP BUILDING
Barrington, N. J. 08007

America's Greatest
Science • Optics • Hobby Mart

COMPLETE AND MAIL COUPON NOW

EDMUND SCIENTIFIC CO. 300 Edscorp Bldg., Barrington, N. J. 08007

SEND FREE 164 PAGE CATALOG "AVC"
Charge my BankAmericard
Charge my Master Charge

Send me: _____ ELECTRONIC CALCULATOR(S)

@ \$19.95 ea. (No. 1945 AVC) \$_____

Service and handling charge \$_____ 1.00

Enclosed is check, money in amount of \$_____

Inter-bank No. _____

Card No. _____

Expiration Date _____

30-DAY MONEY-BACK GUARANTEE. You must be satisfied or return any purchase in 30 days for full refund

Name _____ Please print

Address _____

City _____ State _____ Zip _____

HELPING TO DEVELOP AMERICA'S TECHNOLOGY FOR OVER 30 YEARS.

CIRCLE NO. 23 ON FREE INFORMATION CARD

DESCRAMBLERS: Several Professional Models that work with all Scanners. Tone Encoders/Decoders, Scanmate, AAPP, Radar Detectors, Big Ears, Alarms, Books, Kits, parts Catalog 25 cents KRYSTAL KITS, Box 445, Bentonville, Ark 72712

FREE CATALOG Ultrasonic Devices, LEDs, Transistors IC's, Keyboards, Digital Thermometers, Unique Components Chaney's, Box 15431, Lakewood, Colo 80215

SEMICONDUCTOR AND PARTS Catalogue from the semiconductor specialists J & J Electronics, Box 1437, Winnipeg, Manitoba Canada U.S. Inquiries

ELECTRONIC ignition, Pointless, Transistor, Capacitor Vapor inductors, Auburn Sparkplugs Information 10 cents, Anderson Engineering, Epsom, N.H. 03234

TV PING PONG game Plays through your set's antenna terminals Plans \$3.25 ARS SYSTEMS Box 1922, Sunnyvale, CA 94088

6 MHZ CRYSTALS including schematic and info to generate 60 hz-12VAC to make your digital clock run on batteries \$10.50 pp in US Eastern Sales, Box 510 Raleigh, NC 27602

FREE CATALOG Kits and components ELS Electronics, Box 581, Westbury, N.Y. 11590

CARBON FILM RESISTORS Brand new as low as 17 cents Discounts of 20% Prompt delivery FREE samples/specifications COMPONENTS CENTER Box 134P, N.Y. N.Y. 10038

KEYBOARDS for synthesizers, organs Three octave, two buss \$65 Brinkwood Electronics, Box 26, Sandy Spring, MD 20860.

AMAZING cordless electric lawnmower FREE information No waiting plans \$10.00 Amonics, P.O. Box 1045, Norman, Oklahoma 73069

LEGAL ASPECTS OF INTERCONNECTION

1985 HARDBOUND

The complete reference book to your LEGAL RIGHTS as a telephone subscriber. Study customer-provided equipment, wiring, court hearings, tariffs and many more!

ALL TWENTY-FIVE OF OUR TELEPHONE-TYPE CONSTRUCTION PLANS PLUS THE LEGAL ASPECTS BOOK. SEND NOW!

Post Office Drawer 3450 Hollywood, CA 90028 USA

HOBBYISTS CRAFTSMEN Stainless nuts, bolts, screws, Catalog \$25 Caltronic Laboratory, 461 So. Cochran, Los Angeles, CA 90036

PRECISION, adjustable, solid state power supply, +15VDC at 1-1/2 amps, regulated simultaneously with 10VDC at 3 amps unregulated, plus over 900 parts worth \$400.00, 120 transistors, Semiconductor characteristics, circuit diagrams included, New Cartrivision VTR electronic units, \$19.95 plus \$1.50 shipping, 50 cents for brochure Madison Electronics Company, Inc., Box 369, D55, Madison, Alabama 35758

WHOLESALE C.B. Scanners, Antennas, Crystals Special cut, \$4.95, Monitor \$3.95, Send make, model, frequency, Catalog 25 cents, G Enterprises, Box 461P, Clearfield, UT 84015.

ELECTRONICS BARGAINS! New and surplus Catalog 25 cents, refundable with order ATLANTIS, Box 12654P Tucson, Arizona 85711.

DON'T LET VOLTAGE TRANSIENTS ZAP YOUR HI-FI Solid state equipment protector plugs into outlet protects any transistorized equipment \$6.95, Kopp Electronics, 1650 William St., Buffalo, N.Y. 14206 Free Brochure.

COMPLETE CONSTRUCTION PLANS — Telephone Answering Device, Automatic Dialer, "Black Box", Conference Bridge, Call Diverter, Central Dial Exchange, Call Limiter, Call Transferer, Hold Button, Line Relay, Multifrequency Encoder Network (pushbutton tone-box), Melodic Ringing Generator (for bell ringing signal), Recorder-Actuator, Remote Control Speakerphone System, Standard Telephone Schematics, Teletink Burglar Alarm, Toll-Charge Indicator, Unwanted Call Screener, Voice Scrambler (disguise telephone conversations) ELECTRONIC Bio-Feedback Conditioner, Horticulture Stimulator (provides increased plant growth of 300 per-cent!) HOBBYIST Photographic Pinhole Camera, Dodecahedron Polyhedron (12-sided speaker enclosure) PRICE \$3.00 each ALL OF THE CONSTRUCTION PLANS LISTED ABOVE ONLY \$24.95 Legal Aspects of Interconnection book (300 pages hardbound) \$29.95 (See our ad on this page) ALL OF THE MERCHANDISE CONTAINED HEREIN ONLY \$49.95 Don't forget about our magazine TEL (Telephone-Electronics Line) One Year subscription is only \$6.00 This, with the whole ad we'll give you for only \$54.95 (a 50 per-cent individual price savings) TELETRONICS COMPANY OF AMERICA, P.O. DRAWER 3450 HOLLYWOOD, CALIFORNIA 90028 USA

UNIVERSAL TTL/DTL/GMOS IC TESTER Tests 16/14 pin IC's! Illustrated Info/Plans \$2.00 NORTHSTAR ENGINEERING 3617 NORTHCREDE DRIVE, CHARLESTON WV 25302

CANADIANS Now operating full time and can fill your requests Free Catalog BRAND X Surplus, Box 444, Baker, Ore 97814.

WANT TO BUILD a Computer for an automation application? Such as automated light shows, music synthesis, scientific research, etc. General purpose minicomputer kits are expensive! The Atlantis Automation Computer is designed for automation applications only. You can save up to 50% of what it would cost to buy a general purpose minicomputer kit! We sell a kit consisting of our exclusive set of four LSI Control/Process Chips, Plans, Diagrams, Instructions. You supply all other components (readily available) chip + plan set \$39.95; Californians add 6% sales tax Supertronics, 29790 Tolay Creek, Sonoma, Calif. 95476 Information only \$2 (refundable).

BUILD YOUR OWN TV CAMERA!

Ideal for home & business



THE ECONOMICAL ANSWER TO HOME MONITORING OF BUSINESSES, ENTERTAINMENT DRIVENAYS, BUSINESS AND INDUSTRIAL SURVEILLANCE...TV...AMATEUR TV PLUS HUNDREDS OF OTHER APPLICATIONS. MODEL KIT, SERIES B KIT FORM \$199. ASSEMBLED \$275. SOLID-STATE, WORKS ON ANY TV SET. OPTIONAL SOUND KIT \$28.95. PHONE OR WRITE for catalog, Dial 402-967-3311

1301 BROADWAY ATV Research DAKOTA CITY, NE 68731

50W RMS from your CB P.A. or car stereo — No modifications to set — Schematics \$3.00 ppd Solar Electronics Enterprises Box 778, Edmonton, Alberta, Canada T5J 2L4, U.S. Inquiries

SVIA Power Supply \$7.50, PC Board \$1.60, Send 25 cents for catalog: IC Amps, Stereo projects RASSAG SYSTEMS, 9460 45 Ave., Elmhurst, N.Y. 11373

CRYSTAL Controlled 60Hz clock time base assembled and calibrated \$14.95 — DL 747 0 63 displays \$1.95 — DL 707 0 3 95 cents — TTL 7400, 7402 10 cents — catalog of electronic parts and kits 25 cents, DIAMONDBACK ENGINEERING PO BOX 194, Spring Valley, IL 61362.

TELEPHONES speakerphones, auto-dialers, PBX New / used / reconditioned ITT WE Automatic List 15 cents, Bearer, 65 W 69th, NYC 10023

WHY RENT EXTENSION TELEPHONES? Save hundreds of dollars by connecting your own legally New FCC ruling, effective April 1st, eliminates monthly rentals completely Details, \$1.00 QVTS Box 29002-P Queens Village, N.Y. 11429

ALTAIR 8800 users 8K Memory Board kit, clocked static, exceptionally low power, fast no wait states or refresh Prototyping Board 8800 bus compatible 8800 Octal Encoder Board kit does not require additional I/O board or software Send for our latest information and low prices, Electronic Control Technology Box 6, Union N.J. 07083

DISPLAYS \$3.95

9 DIGITS MINI OPTOSTICK, RED.

9 DIGITS MICRO OPTOSTICK, CLEAR.

1/8" CAR. HT. SEMI CIRCLE LENSES

.3" HT. LED \$1.20 Each

RED EAN 72 C.A. EAN 74 C.C.

YELLOW EAN 82 C.A. EAN 84 C.C.

DISCRETE LED LAMPS

.125" OR .190" DIA.

RED, YELLOW, GREEN

5 FOR \$1.00

UNBELIEVABLE

\$24⁸⁸

NOVIS 4510 SLIDE RULE



8-digit LED display slide rule with arithmetic, trigonometric and logarithmic functions. RPN logic with 3-level stack, floating decimal, fully accumulating memory with M+, M- and M*x2; degrees/radians conversions, Pi, square root, reciprocal, exchange and sign keys; low battery indicator. (Includes 9V battery)

Carrying Case . . . \$2.00

Will operate on AC Adaptor DC 920.

Specials of the Month

10 position single deck rotary switch, 1 1/2" shaft by OAK MFG., .39¢ each or 4 for \$1.00

7408	10 for \$1.00
7440	10 for \$1.00
7483	3 for \$1.00
74192	2 for \$1.00
LM 711 H	2 for \$1.00

I.C. marked 64 instead of 74

2N3904	6 for \$1.00
2N3906	6 for \$1.00
2N4402	6 for \$1.00
2N4403	6 for \$1.00
2N3055	2 for \$1.40
BU208	\$5.25

DC 920 UNIVERSAL

AC Adaptor/Charger. Convert line power to 7.9 VDC 5W. For Calculators, Tapes, Etc. \$3.95 each

Same Day Service

SEND FOR OUR FREE COMPONENTS CATALOG Transistors, Tubes, I.C., Resistors, Capacitors, etc.

LOW, LOW, LOW PRICES

Mail Order To:

ELECTRONIC WAREHOUSE INC.
1603 Aviation Blvd. Dept. P
Redondo Beach, CA 90278
(213) 376-8005

Minimum order \$5.00
Add .50¢ for postage and handling.

California residents add 6% sales tax.

Planning to move?

Let us know 8 weeks in advance so that you won't miss a single issue of **POPULAR ELECTRONICS**.

Attach old label where indicated and print new address in space provided. Also include your mailing label whenever you write concerning your subscription. It helps us serve you promptly.

Write to: P.O. Box 2774, Boulder, CO 80302, giving the following information:

- Change address only.
 Extend subscription. Enter new subscription.
 1 year \$6.98
 Payment enclosed (1 extra BONUS issue)
 Bill me later

AFFIX LABEL

If you have no label handy, print OLD address here.

name please print
address
city
state zip-code

name please print
address 0183
city zip code

Add'l postage per year: Add \$1 for Canada; \$2 for all other countries outside the U.S.

Poly Pak's 100'S OF BARRELS PURCHASED! BUY 'EM FROM THE "BARREL" AND SAVE!

Your choice
of any kit
\$1.98



THE BIGGEST INFLATION-FIGHTING VALUE EVER!
TEST 'EM YOURSELF 'N SAVE!
Every kit carries money back guarantee.

For the first time anywhere, Poly Pak merchandisers introduce a new way in buying the economical way. Raw

stock from the "barrel". Remember the "good ole days"? They're back again. The same way merchandisers throughout the United States buy from various factories... their overruns in barrels. Poly Pak has done the same. Therefore you are getting the same type of material as the RE-TESTERS DO!

BARREL KIT #1
SN7400 DIP IC'S
75 for \$1.98
Marked 14 and/or with 16 pin dips, may include gates, registers, flip flops, counters. Who knows! GUARANTEED SATISFACTION!
Cat.No.4E2415 Untested.

BARREL KIT #2
LINEAR OP AMPS
DIPS
75 for \$1.98
Un-
tested.
May include 700's, 741's, 703's, 660 series, 556 includes marked and unmarked.
Cat.No.4E2416

BARREL KIT #3
1N4148/914
SWITCHING DIODES
100 for \$1.98
Un-
tested.
You never saw this before. Imagine famous switching diodes at these prices!
Cat.No.4E2418 Untested.

BARREL KIT #4
"4000" RECTIFIERS
100 for \$1.98
Un-
tested.
These are the famous micro miniature rectifiers of the 1N4000 series. May include 2's, 5's, 100, 200, 400, 600, 800 and 1000 voltages.
Cat.No.4E2417

BARREL KIT #5
SCRS, TRIACS,
QUADRACS
40 for \$1.98
Un-
tested.
All the famous plastic power lab type. Raw factory stock! All the 10 amp types.
Cat.No.4E2419 Untested.

BARREL KIT #7
VOLUME CONTROL
BONANZAI
40 for \$1.98
100% good
Singles, duals, variety of values, styles, big ones - small ones.
Cat.No.4E2421

BARREL KIT #8
SUBMINIATURE
IF TRANSFORMERS
100 for \$1.98
Amazing, include 455kcs, one, antenna, who knows? From transistor radio manufacturers.
Cat.No.4E2422

BARREL KIT #10
ROMS-REGISTERS
50 for \$1.98
Un-
tested.
28 to 40 pin devices, marked, internal factory numbers.
Cat.No.4E2424

BARREL KIT #12
PUSH TAB
TRANSISTORS
40 for \$1.98
Un-
tested.
PNP, plastic TO220 type. Assorted 2N numbers.
Cat.No.4E2426 Untested.

BARREL KIT #13
RESISTOR NETWORKS
60 for \$1.98
Un-
tested.
By Corning Glass, in 14-pin dip packs.
Cat.No.4E2427

BARREL KIT #14
PRECISION RESISTORS
100% good
200 for \$1.98
Un-
tested.
Cat.No.4E2428

BARREL KIT #15
MOSFET TRANSISTORS
60 for \$1.98
Un-
tested.
All 4 leaders TO-18 case, includes CHF transistors too!
Cat.No.4E2429

BARREL KIT #17
LINEAR & 7400 DIPS
100 for \$1.98
Un-
tested.
Marked and unmarked, internal numbers of raw factory stock.
Cat.No.4E2431

BARREL KIT #18
ZENER-RECTIFIER MIX
200 for \$1.98
Un-
tested.
Subminiature, DOT's, includes asst. zeners and rectifiers. It's mixed at the factory, we can't separate.
Cat.No.4E2432 Untested.

BARREL KIT #19
DIPPED MYLARS
60 for \$1.98
Un-
tested.
Finest capacitors made, shiny finish. Imagine factory dumping 'em in barrels.
Cat.No.4E2597 100% good.

BARREL KIT #20
LONG LEAD DISCS
150 for \$1.98
Un-
tested.
Factory distributor stock "auction sale". Prime, marked only. Long leads.
Cat.No.4E2598 100% good.

BARREL KIT #24
HIGH VOLTAGE
RECTIFIERS
160 for \$1.98
Un-
tested.
Up to 12,000 volts, 4 mils. epoxy, axial leads.
Cat.No.4E2602

BARREL KIT #25
METAL CAN
TRANSISTORS
100 for \$1.98
Un-
tested.
Includes TO-5, TO-18, TO-18, etc. assorted 2N numbers, unmarked etc.
Cat.No.4E2603

BARREL KIT #26
PLASTIC
TRANSISTORS
100 for \$1.98
Un-
tested.
Type TO-92 (TO-18), all manufacturers, variety of 2N 2's.
Cat.No.4E2604

BARREL KIT #28
CERAMIC CAPACITORS
200 for \$1.98
Un-
tested.
Not only do the barrels contain dogbones, but factory dumped, Erie Central, lab. molded types too!
Cat.No.4E2606 100% good.

BARREL KIT #29
VITAMIN Q CAPS
75 for \$1.98
100% good.
Every type of oil-impregnated caps, some worth \$2. But the ole barrel sale gives you the bargain-of-a-lifetime.
Cat.No.4E2607

BARREL KIT #30
PREFORMED
RESISTORS
250 for \$1.98
Un-
tested.
We got barrels of 1/4 and 1/2" watters for pc use. You'll get even amount, 1000, 1/4, 100, 1" watters.
Cat.No.4E2608 100% good

BARREL KIT #31
METALLIC
RESISTORS
100 for \$1.98
100% good.
Made mostly by Corning, the finest resistor made. Mostly 1/2 watters, 1% to 5% tol., & a barrel of values.
Cat.No.4E2609

BARREL KIT #32
TRANSISTORS
WITH A HOLE IN IT
50 for \$1.98
Un-
tested.
Can't name factory but we bought barrels of 25 watters with mtg. hole in middle. PNP's and NPN's.
Cat.No.4E2610 Untested.

BARREL KIT #34
TUBE SOCKETS
100 for \$1.98
Un-
tested.
Good ole tube sockets, still in demand! Barrels and barrels, 4's, 5's, 7's, 8's, even computer types.
Cat.No.4E2612 100% good.

BARREL KIT #35
NEON LAMPS
40 for \$1.98
100% good.
Famous NE-2's. All prime, but factory made millions and barrel'd 'em, Your advantage.
Cat.No.4E2613

BARREL KIT #36
GERMANIUM DIODES
200 for \$1.98
Un-
tested.
Famous maker, popular item. Never grows old. But this is the way the RE-TESTERS buy 'em from the factories.
Cat.No.4E2614

BARREL KIT #37
1/2 AMP "BILLET"
RECTIFIERS
100 for \$1.98
Un-
tested.
Famous style, asst. voltages, silicon, axial includes up to 1KV.
Cat.No.4E2615

BARREL KIT #38
2 AMP RECTIFIERS
75 for \$1.98
Un-
tested.
"CYLINDER" type, silicon, Mallory, includes all voltages up to 1KV. Axial leads.
Cat.No.4E2616

BARREL KIT #39
2N3055 HOBBY
TRANSISTORS
15 for \$1.98
100% good.
From factory to you, these fellows are the famous 2N3055. We have 10 barrels.
Cat.No.4E2617

BARREL KIT #40
PNP HIGH-POWER
RECTIFIERS
20 for \$1.98
Un-
tested.
Popular germanium TO-3 case units, now available at "good ole barrel" prices.
Cat.No.4E2618 100% good.

BARREL KIT #42
ITT "GLASS 4000"
TRANSISTORS
150 for \$1.98
Un-
tested.
Just in! 1N4000 silicon rectifiers in glass, how in glass encase at barrel prices 50 to 1000v too!
Cat.No.4E2620

BARREL KIT #46
G.E. 3.5 WATT
AMPLIFIERS
25 for \$1.98
Un-
tested.
Hobby type, factory fallouts, we purchased them in barrels. These are unknowns.
Cat.No.4E2624

BARREL KIT #49
QUADSI QUADSI
50 for \$1.98
LM 3900
Un-
tested.
4 mirror op amps in one package. Why the factory barrelled these we don't know.
Cat.No.4E2627

BARREL KIT #50
SIGNAL SILICON
DIODES
200 for \$1.98
Un-
tested.
Includes many, many types of switching, signal silicon types, all axial leads. Some may be zeners.
Cat.No.4E2628 Untested.

BARREL KIT #51
HOBBY OPTO
COUPLERS
40 for \$1.98
Un-
tested.
We bot 1,000's unknown both the sensor or transmitter may be good, or both. WE DON'T KNOW! We don't know the types, 1600V isolation.
Cat.No.4E2629

BARREL KIT #52
DISCS!
500 for \$1.98
Un-
tested.
Cat.No.4E2630 100% good
The bargain of a lifetime! First time ever offered by Poly Pak for the economy-minded bargain hunters.

BARREL KIT #53
JUMBO RESISTOR PAK
100-pc. \$1.98
Un-
tested.
Catalorm metal films, precision, carbons, metal oxide powers, from 1/2 watt to 7 watts. Color coded & 100% good. Worth \$10.

BARREL KIT #55
3 DIGIT READOUTS
15 for \$1.98
Un-
tested.
National cleaned its warehouse... now we have barrels of NSN-33 type readouts.
Cat.No.4E2723

BARREL KIT #57
HI-POWER RECTIFIERS
15 for \$1.98
Un-
tested.
50-Amp studs; 6, 12, 24, 48V. 100% material. Factory rectifier "line" rejects.
Cat.No.4E2725 100% good.

BARREL KIT #58
SLIDE SWITCHES
30 for \$1.98
Un-
tested.
All shapes, sizes, spst, dpdt, momentaries, etc. Tremendous shop pak for 100% of switching projects.
Cat.No.4E2726 100% good.

BARREL KIT #59
POWER TRANSISTORS
40 for \$1.98
Un-
tested.
15 watt Bendix B-5000 bullet transistors, 22n, all good, purchased from a retester, have millions of 100% Good.
Cat.No.4E2727

BARREL KIT #60
DTL'S IC'S
75 for \$1.98
Un-
tested.
This is prime barrel material. Who wants DTL's? 930, 936, 946's. Your gain is our loss. They're marked too.
Cat.No.4E2728

BARREL KIT #61
POLYSTYRENE CAPS
100% good
100 for \$1.98
Un-
tested.
Finest caps made. As a sample we bought 10 barrels from factory, mixed values, all good.
Cat.No.4E2729

BARREL KIT #65
MIXED READOUTS
30 for \$1.98
Un-
tested.
Factory returns - such numbers as MAN-4's, MAN-7's, MAN-1's, 11 barrels & no time to separate.
Cat.No.4E2733 Untested.

BARREL KIT #67
10 WATT AMPLIFIERS
50 for \$1.98
Un-
tested.
Buy from the barrel 'n save! LM-380 types in dip packs. Are they good? We don't want to find out. We got millions.
Cat.No.4E2734

BARREL KIT #68
2 WATERS
100 for \$1.98
100% good.
Nobody seems to want 'em! So many suppliers don't count, but throw 'em in barrel. It's a 100 gold mine. All marked.
Cat.No.4E2735

BARREL KIT #71
CAPACITOR SPECIAL
100 pcs. \$1.98
Un-
tested.
Emptied stockrooms into barrels of mylar, poly's, mica, mullided, plastics, ceramics, discs, etc. Nifty 100% good.
Cat.No.4E2738

BARREL KIT #73
TRANSISTOR ELECTROS
50 for \$1.98
Un-
tested.
It "bugs" us why the factories dump 'em in barrels. We don't wish to separate wide ass voltages & values up to 300 mV.
Cat.No.4E2747

BARREL KIT #75
400MW ZENERS
100 for \$1.98
Un-
tested.
Factory out of biz! Amazing quality. 6, 8, 10, 12 to 30V. You test. Hermetically sealed glass pak. Double plug.
Cat.No.4E2740 Untested.

BARREL KIT #76
1 WATT ZENERS
100 for \$1.98
Un-
tested.
Factory same as 400mw's. Never-to-use-again offer. 6, 8, 10, 12, 15V. Under glass. Double plug.
Cat.No.4E2741

BARREL KIT #77
"BROWN" BODY
TRANSISTORS
40 for \$1.98
Un-
tested.
GE B-40 series; has hi-voltage. Darlington, hi-current, npn's. Factory line discontinued. Power tabs.
Cat.No.4E2742 Untested.

BARREL KIT #78
"RED" BODY
TRANSISTORS
40 for \$1.98
Un-
tested.
D-12 series. You test - to into your own biz! High current, hi-V. NPN. Untested.
Cat.No.4E2743

BARREL KIT #81
SUBMINI RESISTORS
200 for \$1.98
Un-
tested.
PC, upright type, color coded, 1/2 watt. Ass't values. Came to us in a barrel.
Cat.No.4E2746

BARREL KIT #82
8000 SERIES IC'S
50 for \$1.98
Un-
tested.
By National. From factory to you. Assortment of popular series factory fallouts, overruns. Untested.
Cat.No.4E2748

BARREL KIT #83
LM-340T
VOLTAGE
REGULATORS
15 for \$1.98
Un-
tested.
Factory rejected them for length of leads. May include 6, 8, 12, 15, 18, 24 volts. Power tab.
Cat.No.4E2635

BARREL KIT #84
HOBBY LEDS
25 for \$1.98
Un-
tested.
"THE CLAW", 5V 15 mils. LED hobby or experimental use, for understanding the working of "mini" or calculator readouts. A segment may be missing.
Cat.No.4E2679

BARREL KIT #86
NATIONAL IC BONANZA
40 for \$1.98
Un-
tested.
Wow! A Litronics dump of all kinds of mixed discrete from factory, mixed values, poor, etc.
Cat.No.4E2859

BARREL KIT #87
NATIONAL IC BONANZA
100 for \$1.98
Un-
tested.
Factory dumps into barrels. Types 8000, 7400 series, DTLs, ROMs, registers, clock & calc. chips, linears, etc.
Cat.No.4E2860 Untested.

BARREL #91
SILVER MICAS
100 for \$1.98
Un-
tested.
For the first time silver micas so low in price! Axial, red case, variety of physical sizes & values. Big savings from distributor prices. Wt. 1 lb.

BARREL KIT #94
"BUBBLE"
READOUTS
12 for \$1.98
Un-
tested.
DL-33B bubble magnifiers. Segs missing. Truthfully so many of 'em we don't care. Untested. 3 oz.
Cat.No.4E3046

BARREL KIT #99
PHOTO ELECTRIC
CELLS
10 for \$1.98
Un-
tested.
Asst. GE types, CDS types. Mixed by factory. Big job for us to separate. 100% Good.
Cat.No.4E3052

BARREL KIT #102
CLOCK CHIPS
5 for \$1.98
Un-
tested.
National is dumping! MM-6316 - what a wrong with 'em, we don't know, but we've got barrels. Hobby special. Wt. 2 oz.

BARREL KIT #104
SLIDE VOLUME
CONTROL
10 for \$1.98
Un-
tested.
Used in hi-fi, volume control maker unloads. Ass't values, what a buy. Worth \$1 ea. We've got barrels of 100% material.

BARREL KIT #107
SQUARE OHMS
60 for \$1.98
Un-
tested.
Factory people are sometimes "squares" when they topple prime square ohms into 'em in barrels. Ass't values watts. Wt. 1 lb.

BARREL KIT #108
TO-5 PLASTIC
TRANSISTORS
40 for \$1.98
Un-
tested.
Includes PNP, NPN, 2N-3638, 2N3641, 2N5000 series, etc. Untested, but guaranteed to a 60% yield.

BARREL KIT #109
TERMINAL STRIPS
150 for \$1.98
Un-
tested.
Wide asst. of terminal strip connectors. From 1 contact up. Strip manufacturers barrel dump in your gain. Wt. 1 lb.
Cat.No.4E3136

BARREL KIT #110
SUPPRESSOR DIODES
50 for \$1.98
Un-
tested.
Keeps ignition noises out of auto. Untested, but the of your eqpt., car, industrial, etc. Double plug.

BARREL KIT #111
MULTI DIGIT
READOUTS
8 for \$1.98
Un-
tested.
3, 4 ann/or 5 digit readouts to USA for us to separate. Untested.
Cat.No.4E3138

BARREL KIT #112
MICRO MINI LEDS
40 for \$1.98
Un-
tested.
All the tiny leds, axial, upright of Monsanto, Litronix, variety of colors. Yield 50% or better.
Cat.No.4E3139

BARREL KIT #113
STABISTORS
50 for \$1.98
Un-
tested.
Regulator, sensing and computer circuitry. Axial double plug type. Discontinued factory line. PIV 20 volts. 80% yield. U test 'n save!

BARREL KIT #114
PLASTIC SCRS
25 for \$1.98
Un-
tested.
Factory is changin' style, top grade yield 80% to 90%. Includes 15, 20, 60, 100, 150, 200 volts. TO-92. A buy? You betcha!
Cat.No.4E3143 Untested.

BARREL KIT #115
MOLEX SOCKETS
300 for \$1.98
Un-
tested.
Calculator maker dump! We got a zillion of 'em. Used for IC sockets, etc.
Cat.No.4E3144

BARREL KIT #116
BUTTONS 'N
FEEDTHRU'S
100 for \$1.98
Un-
tested.
100% good. Truthfully worth a small fortune. Wide asst. of button-feeder caps. HAMS TAKE NOTE! RF, UHF, etc. Wt. 1 lb.
Cat.No.4E3141

Terms: Add postage Rated: net 30
Phone : Wakefield, Mass. (617) 245-3829
Retail: 16-18 Del Carmine St., Wakefield,

C.O.D.'s MAY BE PHONED

POLY PAKS 20¢ CATALOG on 'IC's, Fiber Optics, Semi's, Parts
P.O. BOX 942E LYNNFIELD, MASS. 01940

APRIL SPECIALS

POCKET CALCULATOR

3 1/2 function plus constant — addressable memory with individual recall — 8 digit display plus overflow — battery saver — uses standard or rechargeable batteries — all necessary parts in ready to assemble form — instructions included.



Calc. Kit, Kit only	\$10.95
Batteries (alkaline, disp.)	2.00
Adapter 60Hz	3.95
Kit, Batteries & Adapter	15.95

MARKED — NO FACTORY LOGO GUARANTEED FUNCTIONAL

7400	\$.10	7420	\$.11	7460	\$.11
7402	\$.10	7437	\$.20	7474	\$.25
7403	\$.11	7440	\$.11	7493	\$.39
7404	\$.12	7445	\$.49	7496	\$.49
7406	\$.20	7450	\$.11	74195	\$.59
7408	\$.12	7453	\$.11		
7410	\$.11	7454	\$.11		

ALARM CLOCK CHIP

MM5375AA 4-6 digit, 12 hour, 60Hz snooze alarm, brightness control capability, alarm tone output 24 pin DIP \$4.95

8038 FUNCTION GENERATOR

Voltage controlled oscillator — sine, square, triangular output. 16 pin DIP with data \$3.95

7001 CLOCK CHIP

4-6 digit, 12-24 hr. alarm, timer and date circuits — with data \$6.95

6 DIGIT LED CLOCK KIT

INCLUDES: MM314 clock circuit 6 FND70 LED displays (250" red 7 segment) All necessary transistors, resistors & capacitors 1 double sided PC board accommodates LED's & clock circuitry Schematic & instructions Does not include 12V-300 ma transformer, switches & case \$11.95

CLOCK CHIPS WITH LED'S

CT7001 4-6 digit, 12-24 hour clock with alarm, timer & date circuits plus 4 MAN 66.6" LED display \$14.95
above items plus 2 MAN 1 for date \$17.95

MM5314 clock chip 12-24 hour 4-6 digits Plus choice of 6 MAN 5 green 7 SEG LED .27" 6 MAN 7 red 7 SEG LED .27" 6 MAN 8 yellow 7 SEG LED .27" \$9.95

UNIVERSAL BREADBOARD

Silver plated copper circuit board 3-3/16" x 5-1/16" 2 rows of 27 holes for DIP IC's — space for transistors, resistors & capacitors. Versatile and simple for breadboarding IC circuits \$1.50 ea. 50 pack \$1.00 ea.



UV ERASABLE PROM

1702A — 2048 bit static PROM 25x8 elect. programmable & erasable TTL/DTL comp. \$14.95

NEW ITEMS

TTL

74132	\$.89
74H101	\$.58
74H102	\$.58
74H103	\$.63
74H106	\$.63
74H108	\$.63

LOW POWER SCHOTTKY

741500	\$.38	741502	\$.36
741503	\$.38	741504	\$.36
741504	\$.45	741508	\$.38
741508	\$.52	741510	\$.36
741510	\$.38	741520	\$.36
741520	\$.38	741532	\$.38
741532	\$.45	741540	\$.45
741540	\$.38	741542	1.40
741542	\$.45	741574	\$.59
741574	\$.38	741590	1.30
741590	\$.38	741593	1.30
741593	\$.38	741595	2.09
741595	\$.38	7415107	\$.59
7415107	\$.52	7415164	2.50
7415164	\$.52	7415193	2.50
7415193	\$.38	7415197	2.20
7415197			

METAL FILM RESISTORS

QTY	PRICE EACH	PRICE PER VALUE	MINIMUM PER VALUE	PRICE PER VALUE
0 - 10	\$.20			
10 - 100	\$.20	\$.15		
100 - 1000		\$.10	\$.09	
1000 -		\$.10	\$.08	

RESISTANCE (OHMS)

22.6	71.5	182	887	11.8K	40.2K
23.7	78.7	187	11.5K	13.0K	45.3K
25.5	84.5	191	1.5K	15.0K	48.7K
30.9	105	205	2.49K	18.2K	54.9K
34.8	110	232	3.57K	19.1K	60.4K
40.2	115	243	4.75K	19.6K	64.9K
45.3	137	499	5.49K	22.6K	69.8K
51.1	147	604	6.04K	24.9K	84.5K
61.9	158	715	7.15K	28.0K	
64.9	178	806	8.25K	37.4K	

TANALUM CAPACITORS SOLID-DIPPED -20%

.1 mfd	35V	25 ea.	6.8 mfd	6V	30 ea.
.33 mfd	35V	25 ea.	6.8 mfd	50V	40 ea.
1 mfd	35V	25 ea.	10 mfd	25V	40 ea.
2.2 mfd	20V	25 ea.	15 mfd	10V	40 ea.
2.2 mfd	35V	30 ea.	33 mfd	10V	40 ea.
4.7 mfd	16V	30 ea.	47 mfd	6V	40 ea.

LINEARS

546	AM radio receiver subst. DIP	\$.75
733	Diff. video AMPL TO-5	\$.89
5556/		
MC1456	Int. compensated Op Amp mDIP	1.59
7525	Dual core mem. sense AMPL DIP	\$.96
CA3046	Transistor array 14 pin DIP	\$.89

TTL

7400	\$.14	7492	\$.71
7401	\$.16	7493	\$.60
7402	\$.15	7494	\$.94
7402	\$.15	7495	\$.79
7403	\$.16	7496	\$.79
7404	\$.19	74100	1.30
7405	\$.19	74105	\$.44
7406	\$.35	74107	\$.40
7407	\$.35	74121	\$.42
7408	\$.18	74122	\$.45
7409	\$.19	74123	\$.85
7410	\$.16	74125	\$.54
7411	\$.25	74126	\$.63
7413	\$.55	74141	1.04
7416	\$.35	74145	1.04
7417	\$.35	74150	\$.97
7420	\$.16	74151	\$.79
7422	\$.26	74153	\$.99
7423	\$.29	74154	1.25
7425	\$.27	74155	1.07
7426	\$.26	74156	1.07
7427	\$.29	74157	\$.99
7430	\$.20	74158	1.79
7432	\$.23	74160	1.39
7437	\$.35	74161	1.25
7438	\$.35	74162	1.49
7440	\$.17	74163	1.39
7441	\$.98	74164	1.59
7442	\$.77	74165	1.59
7443	\$.87	74166	1.49
7444	\$.87	74170	2.30
7445	\$.89	74173	1.49
7446	\$.93	74174	1.62
7447	\$.89	74175	1.39
7448	1.04	74176	\$.89
7450	\$.17	74177	\$.84
7451	\$.17	74180	\$.90
7453	\$.17	74181	2.98
7454	\$.17	74182	\$.79
7460	\$.17	74184	2.29
7464	\$.35	74185	2.29
7465	\$.35	74187	5.95
7470	\$.30	74190	1.35
7472	\$.30	74191	1.35
7473	\$.35	74192	1.25
7474	\$.35	74193	1.19
7475	\$.57	74194	1.25
7476	\$.39	74195	\$.89
7483	\$.79	74196	1.25
7485	1.10	74197	\$.89
7486	\$.40	74198	1.79
7489	2.48	74199	1.79
7490	\$.59	74200	5.90

5% OFF ON ORDERS OVER \$50.00
10% OFF ON ORDERS OVER \$100.00
15% OFF ON ORDERS OVER \$250.00

LINEAR CIRCUITS

300	Pos V Reg (super 723)	TO-5	\$.71
301	Hi perf op amp	mDIP	\$.29
307	Op AMP (super 741)	mDIP	\$.26
308	Micro Pwr Op Amp	mDIP	\$.89
309K	5V 1A regulator	TO-3	1.35
310	V Follower Op Amp	mDIP	1.07
311	Hi perf V Comp	mDIP	\$.95
319	Hi Speed Dual Comp	DIP	1.13
320T	Neg Reg 5, 12, 15, TO-3		\$1.39
320K	Neg Reg 5, 12, 15 TO-3		1.39
324	Quad Op Amp	DIP	1.52
339	Quad Comparator	DIP	1.58
340K	Pos. V. reg. (5V, 6V, 8V, 12V, 15V, 18V, 24V)	TO-3	1.69
340T	Pos. V. reg. (5V, 6V, 8V, 12V, 15V, 18V, 24V)	TO-220	1.49
370	AGC/Squelch AMPL	DIP	\$.71
372	AF-IF Strip detector	DIP	2.93
376	Pos. V. Reg	mDIP	2.42
380	2w Audio Amp	DIP	1.13
380-B	.6w Audio Amp	mDIP	1.52
381	Lo Noise Dual preamp	DIP	1.52
382	Pres V Reg	DIP	\$.89
383	Timer	mDIP	\$.89
556A	Dual 555 Timer	DIP	1.49
560	Phase Locked loop	DIP	3.95
562	Phase Locked loop	DIP	3.95
565	Phase Locked loop	DIP	2.38
566	Function Gen	mDIP	2.25
567	Tone Decoder	mDIP	2.66
709	Operational AMPL	DIP	\$.26
710	Hi Speed Volt Comp	DIP	\$.35
723	V Reg	DIP	\$.62
739	Dual Hi Perf Op Amp	DIP	1.07
741	Comp Op Amp	mDIP	\$.32
747	Dual 741 Op Amp	DIP	\$.71
748	Freq Adj 741	mDIP	\$.35
1304	FM Multipl Stereo Demod	DIP	1.07
1307	FM Multipl Stereo Demod	DIP	\$.74
1458	Dual Comp Op Amp	mDIP	\$.62
1800	Stereo multiplexer	DIP	2.48
3900	Quad Amplifier	DIP	\$.35
8038	V contr. osc	DIP	4.95
8864	9 DIG Led Cath Dvr	DIP	2.25
75150	Dual Line Driver	DIP	1.95
75451	Dual Peripheral Driver	mDIP	\$.35
75452	Dual Peripheral Driver	mDIP	\$.35
75453	(151) Dual Periph. Driver	mDIP	\$.35
75491	Quad Seq Driver for LED	DIP	\$.71
75492	Hex Digit Driver	DIP	\$.80

MEMORIES

1101	256 bit RAM MOS	\$ 1.50
1103	1024 bit RAM MOS	3.95
2102	1024 bit static RAM	5.55
5203	2048 bit UV eras PROM	17.95
5260	1024 bit RAM	2.49
5261	1024 bit RAM	2.69
5262	2048 bit RAM	3.95
7489	64 bit ROM TTL	2.48
82523	Programmable ROM	3.69
74200	256 bit RAM tri-state	5.90

CALCULATOR & CLOCK CHIPS

5001	12 DIG 4 funct fix dec	\$3.45
5002	Same as 5001 exc btry pwr	3.95
5005	12 DIG 4 funct w/mem	4.95
MM5725	8 DIG 4 funct chain & dec	1.98
MM5736	18 pin 6 DIG 4 funct	4.45
MM5738	8 DIG 5 funct K & mem	5.35
MM5739	9 DIG 4 funct (btry sur)	5.35
MM5311	28 pin BCD 4 dig mux	4.45
MM5312	24 pin 1 pps BCD 4 dig mux	3.95
MM5313	28 pin 1 pps BCD 6 dig mux	4.45
MM5314	24 pin 6 dig mux	4.45
MM5316	40 pin alarm 4 dig	5.39

LED'S

MV10B	Red TO 18	\$.22
MV30	Axial leads	\$.18
MV5020	Jumbo Vis. Red (Red Dome)	\$.22
	Jumbo Vis. Red (Clear Dome)	\$.22
ME4	Infra red diode	\$.54
MAN1	Red 7 seq. 270"	2.19
MAN2	Red alpha num. 32"	4.39
MAN4	Red 7 seq. 190"	1.95
MAN5	Green 7 seq. 270"	3.45
MAN6	6" high solid seq.	4.25
MAN7	Red 7 seq. 270"	1.19
MAN8	Yellow 7 seq. 270"	3.45
MAN64	4" high solid seq.	2.95
MAN66	6" high spaced seq.	3.75
MC12	Opio-iso transistor	\$.61

CMOS

4015A	1.49	4049A	\$.59
4006A	\$.26	4016A	\$.56
4001A	\$.25	4017A	1.19
4002A	\$.25	4020A	1.49
4006A	1.35	4022A	1.10
4007A	\$.26	4023A	\$.25
4008A	1.79	4024A	\$.89
4009A	\$.57	4025A	\$.25
4010A	\$.54	4027A	\$.59
4011A	\$.29	4028A	\$.98
4012A	\$.25	4030A	\$.44
4013A	\$.45	4035A	1.27
40			

INDUSTRIAL QUALITY

E-Z-HOOK®



E-Z Hooks have been designed and field tested throughout the industry to save time and money in commercial electronic production and servicing. The spring-loaded hook attaches firmly, yet so gently it will not damage component — frees hands while testing. Durably constructed and fully insulated to a single contact point assuring true readings. Meets exacting laboratory and space age computer technology requirements. **AVAILABLE IN 10 RETMA COLORS:** Red, black, blue, green, orange, yellow, white, violet, brown or gray. The most unique field-serviceable test connectors available. Fast, safe, sure and trouble-free. **NOW AVAILABLE FROM ANCRONA...** the source you can trust for fine quality, industrial-grade electronic components and accessories.

SOLVE YOUR TEST CONNECTION PROBLEMS WITH E-Z-HOOK®

Jumper with XM Micro Hooks
 Part No. Length Price
 204XM-12 * 12" \$1.70
 204XM-24 * 24" 1.70



MICRO HOOK



XM Micro Hook (1.75" long, <1 gram) for difficult IC Testing. Permits hookups to delicate wires where weight and leverage may damage component. **\$.80 ea.**

MINI HOOK



X100W Mini Hook (2.25" long) combines rugged construction, miniature size and Finger-eze Hypo Action for all the best test connections. The hook is large enough for component leads, yet small enough to get into tight places. **\$.75 ea.**

Jumper with X-100W Mini Hooks
 Part No. Length Price
 204-12W* 12" \$1.60
 204-24W* 24" 1.60

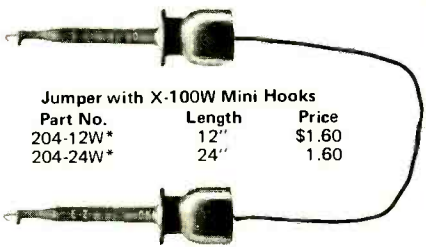

EXTRA LONG MINI HOOK



XL-1 Mini Hook (5.0" long) combines all the proven features of the X100W with an extra long body. It will make safe, short-free test connections in card racks and through deep wiring nest up to 4". **\$1.25 ea.**



Jumper with XL-1 Mini Long Hooks
 Part No. Length Price
 204XL1*-12 12" \$2.80
 204XL1*-24 24" 2.80

Jumper, XM Micro Hook to Banana Plug
 Part No. Length Price
 201XM* 32" \$1.40



Jumper with XL-1 Mini Hooks to Stacking Banana Plug
 Part No. Length Price
 201XL-1* 32" \$1.95

Jumper X-100W Mini Hook to Stacking Banana Plug**
 Part No. Length Price
 201W* 32" \$1.35



**Specify color. **Square hole tip for hooking laterally to leads or vertically over square wire-wrap pins.*

ANCRONA . . . YOUR FIRST SOURCE FOR INDUSTRIAL QUALITY ELECTRONIC COMPONENTS AND ACCESSORIES

Prices effective through April 30, 1976
 Minimum order \$10.00. Add \$1.00 to cover postage and handling.
 California resident add 6% sales tax.

SEND CHECK OR MONEY ORDER TO:



ANCRONA CORP.

Mail order: P.O. Box 2208P, Culver City, CA 90230. Phone order: (213) 641-4064
 Visit our Electronic Shop: 11080 Jefferson Blvd., Culver City, CA
 (Studio Village Shopping Center)
 Prices may vary at over-the-counter locations.

HOBBY/WORKSHOP WALL STORAGE CENTERS

These high-quality, exceptionally convenient units are perfect for the hobbyist or handyman with lots of tools and no place to store them. Also ideal for storage of small parts, hardware and components. Budget priced complete with pegboard wall.

WWSC3 HOBBY STORAGE CENTER
\$29.95

WWSC5 TRADESMAN STORAGE CENTER
\$69.95

WWSC4 HANDYMAN STORAGE CENTER
\$48.50

ADD \$1.00 TO COVER POSTAGE

WE OFFER ONLY THE
FINEST QUALITY PRODUCTS AVAILABLE

SEND CHECK OR MONEY ORDER TO:

ANCRONA CORP.

P.O. BOX 2208P
CULVER CITY, CA 90230 • (213) 641-4064

CIRCLE NO. 7 ON FREE INFORMATION CARD

IMSAI AND ALTAIR OWNERS!!

IMSAI 8080 COMPUTER

(ALL BOARDS COMPLETELY PLUG COMPATIBLE WITH ALTAIR 8800)

BASIC COMPUTER INCLUDES: MPU FRONT PANEL CONTROL BOARD, LIGHTS AND SWITCHES, POWER SUPPLY, EXPANDER BOARD AND CASE. \$599 KIT \$951 ASSEMBLED

SEE FULL PAGE AD IN THIS ISSUE FOR DETAILS

INTERCHANGEABLE MPU, MEMORY & I/O BOARDS

FULL IMSAI 8080/ALTAIR 8800 COMPATIBILITY, NO HARDWARE OR SOFTWARE MODIFICATIONS REQUIRED. JUST PLUG IN!!!!

PART #	DESCRIPTION	KIT	ASSEMBLED
MB1-A	8080 MPU BOARD	\$181.00	\$150.00
RAM 4-4	4K RAM ON 4K BOARD	\$165.00	\$209.00
RAM 4-1	1K RAM ON 4K BOARD	\$69.00	\$119.00
PRGM 4-2	2K EPROM ON 4K BOARD	\$175.00	\$144.00
EXT 1	1 K I/O CLK BOARD	\$171.00	\$43.00
PIC-8	COMB VECT INT & RT CLK	\$119.00	\$238.00

PARALLEL I/O BOARDS: 8 BIT PORTS!!

PIO 4-1 1 BYTE IN, 1 BYTE OUT, PLUS STROBES, INTERRUPT PROVISION FOR LEDs ON EACH OUTPUT BIT, AND EXPANDABLE TO 4 BYTES IN, 4 BYTES OUT. \$89 KIT \$140 ASSEMBLED

PIO 4-4 SAME AS PIO 4-1, BUT 4 BYTES IN, 4 BYTES OUT. \$149 KIT \$299 ASSEMBLED

SERIAL I/O BOARDS: HANDLE BOTH SYNCH AND ASYNCH COMM. (RS-232 PLUS CONTROL LINES PLUS TTL PLUS TTY)

SIO 2-1 ONE I/O CHANNEL \$119 KIT \$239 ASSEMBLED

SIO 2-2 TWO I/O CHANNELS \$149 KIT \$299 ASSEMBLED

NEW... UNIVERSAL CASSETTE RECORDER INTERFACE

JUMPER SELECT BETWEEN PEHITS SYSTEM AND NEW KANSAS CITY STANDARD. ALL ON ONE BOARD FOR BOTH THE IMSAI 8080 AND THE ALTAIR 8800

KIT \$19 ASSEMBLED AND TESTED \$99

THE INTEL DATA BOOK

CONTAINS COMPLETE SPECIFICATIONS AND DATA SHEETS ON INTEL 8080A AND ALL ASSOCIATED INTEL MEMORY AND PERIPHERAL CHIPS. ALSO INCLUDES PRELIMINARY SPECS ON "COMING" INTEL CHIPS. \$5.00

THE TTL DATA BOOK

CONTAINS COMPLETE ELECTRICAL SPECIFICATIONS FOR ALL 7400 SERIES TTL. THIS IS THE TTL "BIBLE". 640 pages \$10.00

THE PINOUT HANDBOOK

COVERS ENTIRE 7400/7400 SERIES D.T.P. I.C. S. PIN CONNECTIONS, FUNCTIONAL SPECS, CROSS REFERENCE. \$3.95

IMSAI ASSOCIATES, INC. 1922 REPUBLIC AVE. SAN LEANDRO, CALIF. 94577
TERMS: CHECK OR M.B. BANKAMERICARD, MASTERCARD, 25% DEPOSIT ON C.O.D.

ADD 5% POSTAGE AND HANDLING. CALIF. RESIDENTS ADD 6% SALES TAX.

PRICES SUBJECT TO CHANGE WITHOUT NOTICE.

CIRCLE 31 ON READER SERVICE CARD

ALTAIR 8800 Software Kits. 100's of high level Games, Pictures, Business packages, Inventory, Accounts Receivable, Engineering programs. Real Time interface and hardware kits. Send \$1 for catalog. Scientific Research, P.O. Box 83, Marcy, N.Y. 13403.

SCHEMATIC and ALIGNMENT data for your pre-1947 antique radio. \$5.00. J. Graves, 544 Russell, Brawley, Calif. 92227.

MINIATURE HOBBY MOTORS — Brand new. 100's of uses. 1-1/2-9 V D.C. Reversible. 3 assorted \$5.00. 7 assorted \$10.00. guaranteed. Motors, P.O. Box 26204, Tucson, Arizona 85726.

Send for your information packet today — which also includes circuit functions, component line up, and accessories. Information Packet \$1.00 (refundable with order).

visulex P. O. Box 4204P Mountain View, CA 94040

IC BONANZA

*Data Sheet included on these items

*MM5330	National DVM on a chip	\$ 9.95
*2102	1K Static Ram 450 NS	1.60
*5203 Q	Eraseable Prom 2K	11.95
*50310	Slide rule calculator chip	3.95
*50240	Top octave organ chip	5.95
*50250	Alarm clock chip	4.45
LM340K-5	5 Volt pos. regulator	.89
LM340K-12	12 Volt pos. regulator	.89
LM340K-15	15 Volt pos. regulator	.89
LM340K-24	24 Volt pos. regulator	.89
LM320K-5	5 Volt neg. regulator	.84
LM320-5.2	5.2 Volt neg. regulator	.84
LM320K-12	12 Volt neg. regulator	.84
N8252B	BCD to decimal decoder	.79
962	Triple 3 input hand gate	.09
2N6050	Darlington	.75
2N6051	Darlington	.79
2N6285	Darlington	.99
2N6286	Darlington	1.04

SEND FOR FREE CATALOG
Minimum order \$5.00, data sheets 25 cents each. Include 5% of order for postage and handling. Texas residents include 5% state sales tax.

BONANZA ELECTRONICS
P. O. Box 24767 Dallas, Texas 75224

BUILD YOUR OWN SPEAKERS AND SAVE UP TO 50%

You can assemble your own high quality, multi-element stereo speakers in a few hours and save up to half the cost of comparable speakers. Call operator PE9 at 1-800-426-7736 (toll free) for our free 32-page catalog of speaker kits, raw speakers and accessories. Or write:

SPEAKERLAB
Dept. PE9, 5500-35th NE
Seattle, WA 98105

DON'T ORDER electronic components until you check our prices! Send stamp. C. F. Enterprises, 8905 Holly, Kansas City, Missouri 64114

CRYSTAL TIMEBASE to make your digital clock run off car batteries. Fully assembled, with instructions. \$16.00. Looser, 4003 Sherwood Ave., Cincinnati, Ohio 45227

OSCILLATOR/tone synthesizer P.C. board 3" x 4" uses 555. Any frequency with or w/o speaker. Board and instructions \$4.95. Complete kit \$9.95. PACEMARKER GROUP, 1719 Pontius, West LA, Calif. 90025.

600 MHZ Frequency Counter, 8 Digit LED Readout, Crystal Timebase, Complete Kit including cabinet \$219.95. DAVIS ELECTRONICS, 639 Sheridan Dr., Tonawanda, N.Y. 14150 (716) 874-5848.

UNIVERSITY Degrees (phony) shipped immediately. Authentic Seal. State-7UT, Box 5222, Station F, Ottawa, Canada.

\$88 JERGENS for men 4 oz — \$5.00 \$7.99 Lavors Breath Spray — \$4.99. Write: Box C 421 West 162 St. NYC 10032

TV-GAMES construction plans Pong series — 5 game set \$5.00, big 12 game set \$12.00, Jaws-2 and Space Race — both games for \$8.00, Pinball 1&2 — both for \$8.00. Full description and specs — \$1.00. ADVANCED ELECTRONICS, P.O. Box 1128, Cupertino, Calif. 95014

TV TECHNICIANS, SERVICEMEN, HOBBYISTS — Vista Model 740 Digital Crosshatch Generator. Compact crystal divider for lowest-priced ultra-stable 5x7 crosshatch or 56 dot patterns. AC powered. \$31.95 complete kit. \$41.95 assembled. Postpaid in USA, Canada. Information available free. Photolume Corporation, Dept. PE-46, 118 East 28th Street, New York, New York 10016.

FREE DATA SHEETS

WITH EVERY ITEM.
IC or FET's WITH
\$5 & \$10 ORDERS.*

- MONEY-BACK GUARANTEE
- 24-HOUR SHIPMENT
- ALL TESTED AND GUARANTEED

TRANSISTORS (NPN)

2N918 TYPE RF Amp & Oscillator to 1 GHz	3/\$1.00
2N3563 TYPE RF Amp & Dsc to 1 GHz (pl. 2N918)	5/\$1.00
2N3565 TYPE Gen. Purpose Gain (TO-92/106)	5/\$1.00
2N3641 TYPE RF & GP Amp & Sw to 500 mA & 30 MHz	5/\$1.00
2N3866 TYPE RF Power Amp 1.5 W @ 450 MHz	\$1.50
2N3903 TYPE GP Amp & Sw to 100 mA and 30 MHz	5/\$1.00
2N3904 TYPE GP Amp & Sw to 100 mA hFE 100	5/\$1.00
2N3919 TYPE RF Power Amp 10.25 W @ 3-30 MHz	\$3.00
2N4274 TYPE Ultra-High Speed Switch 12 ns	5/\$1.00
2N5108 TYPE RF Power Amp 2 W @ 450, 1 W @ 1 GHz	\$2.50
MP56515 TYPE High-Gain Amplifier hFE 250	3/\$1.00
Assort. NPN GP TYPES, e.g. 2N3694, 2N3903, etc. (15)	\$2.00
2N3638 TYPE (PNP) GP Amp & Sw to 300 mA	5/\$1.00
2N3906 TYPE (PNP) GP Amp & Sw to 30 MHz	5/\$1.00
2N4249 TYPE (PNP) Low-Noise Amp 1/2 A to 50 mA	4/\$1.00

FET's:

N-CHANNEL (LOW-NOISE)

2N4091 TYPE RF Amp & Switch (TO-18/106)	3/\$1.00
2N4416 TYPE RF Amplifier to 450 MHz (TO-72)	2/\$1.00
2N5163 TYPE Gen. Purpose Amp & Sw (TO-106)	3/\$1.00
2N5486 TYPE RF Amp to 450 MHz (plastic 2N4416)	2/\$1.00
E100 TYPE Low-Cost Audio Amplifier	4/\$1.00
ITE4868 TYPE Ultra-Low Noise Audio Amp	2/\$1.00
TIS74 TYPE High-Speed Switch 400f	3/\$1.00
Assort. RF & GP FET's, e.g. 2N5163, MPF102, etc. (8)	\$2.00

P-CHANNEL:

2N4360 TYPE Gen. Purpose Amp & Sw (TO-106)	3/\$1.00
E175 TYPE High-Speed Switch 125f (TO-106)	3/\$1.00

APRIL SPECIALS:

2N2222 NPN TRANSISTOR GP Amp & Switch	6/\$1.00
2N2907 PNP TRANSISTOR GP Amp & Switch	6/\$1.00
2N3553 RF Power Amp 5 W @ 150 MHz, 7 W @ 50 MHz	\$2.00
E101 N-CHANNEL FET Low Current, Low Vp Amp/Sw	3/\$1.00
MPF102 N-CHANNEL FET RF Amp-200 MHz	3/\$1.00
556 DUAL 555 TIMER 1/2 sec to 1 hour (DIP)	\$1.00
723 VOLT. REGULATOR 3-30 V @ 1-200 mA (DIP/TO-5)	2/\$1.00
741 Op Amp, Freq. Comp., LM 741, uA741, etc. (MINI-DIP)	4/\$1.00
2740 FET Op Amp, Like NE536 and uA740 (TO-5)	\$2.40
uA7805 VOLTAGE REGULATOR 5 V @ 1 A (TO-220)	\$1.25
8038 WAVEFORM GENERATOR Wave w/ckts	\$4.50
1N4001 RECTIFIER 50 V PIV, 1A	15/\$1.00
1N4154 DIODE 30 V/10mA-1N914 except 30 V	25/\$1.00
BR1 BRIDGE RECTIFIER 50 V PIV, 500 mA (DIP)	3/\$1.00
MM5314 DIGITAL CLOCK CHIP-With Specs/Schematics	\$4.95

LINEAR IC's:

308 Micro Power Op Amp (TO-5/MINI-DIP)	\$1.00
309K Voltage Regulator 5 V @ 1 A (TO-3)	\$1.25
324 Quad 741 Op Amp, Compensated (DIP)	\$1.50
340T Volt. Reg.-1 Amp-Specify 5, 6, 12, 15 or 24 V-w/ckts	\$1.75
380 2-5 Watt Audio Amplifier 34 dB (DIP)	\$1.29
555 Timer 1/2 to 1 hr. NE555, LM555, etc. (MINI-DIP)	\$.65
709 Popular Op Amp (DIP/TO-5)	\$.29
739 Dual Low-Noise Audio Preamp/Op Amp (DIP)	\$1.00
1458 Dual 741 Op Amp (MINI-DIP)	\$.65
741 Freq. Comp. Op Amp (DIP/TO-5)	3/\$1.00

DIODES:

ZENERS - Specify Voltage 3.3, 3.9, 4.3, 5.1, 6.8, 8.2	400mW 4/\$1.00
9.1, 10, 12, 15, 16, 18, 20, 22, 24, 27, or 33V (+10%)	1 Watt 3/\$1.00
1N914 or 1N4148 TYPE General Purpose 100V/10mA	15/\$1.00
1N3893 TYPE RECTIFIER Stud Mount 400 V/1/2 A	2/\$1.00
D5 VARACTOR 5-50 W Output @ 30-250 MHz, 7.70 pF	\$5.00
F7 VARACTOR 1-3 W Output @ 100-500 MHz, 5-30 pF	\$1.00

*MAIL NOW! FREE DATA SHEETS supplied with every item from this ad. FREE ON REQUEST! 741 Op Amp with every order of \$5 or more. 749 Dual Op Amp or two E100 FET's with every order of \$10 or more, postmarked prior to 4/30/76. One free item per order.

ORDER TODAY! All items subject to prior sale and prices subject to change without notice. All items are new surplus parts. 100% functionally tested.

WRITE FOR FREE CATALOG #7510 offering over 350 semiconductor components in stock. Send 13¢ stamp.

TERMS: Send check or money order (U.S. funds) with order. We pay 1st Class postage to U.S., Canada and Mexico. \$1.00 handling charge on orders under \$10. Calif. residents add 6% sales tax. Foreign orders add postage. COD orders - add \$1.00 service charge.

ADVA ELECTRONICS

BOX 4181 BP, WOODSIDE, CA 94062
Tel. (415) 851-0455

CIRCLE NO. 2 ON FREE INFORMATION CARD

TREASURE FINDERS

FREE FACT-FILLED CATALOG! World's largest selection! Metal detectors starting at \$79.50. Two year guarantee! Three factories. U.S.-Canada. 1,200 dealers - Service Centers nationwide. Finest instruments at any price! Budget Terms. Dealer inquiries invited. Write White's Electronics, Inc. Dept. PD6R, 1011 Pleasant Valley Road, Sweet Home, Oregon 97386.

TREASURE FINDER locates buried gold, silver, coins, treasures. 6 powerful models. Instant financing available. Write or call for free catalog. Phone (713) 682-2728 day or night. Dealer inquiries invited. Reico, Dept. AA20, Box 10839, Houston, Texas 77018.

CLUBS

CB OWNERS join Ten-4 International. Receive pin, guide, newsletters, member benefits. Details free. Ten-4, 427C Birchwood Avenue, Deerfield, Illinois 60015.

CONTINENTAL SPECIALTIES

PROTO BOARDS
Build & test circuits as fast as you think!

PB100 10 IC cap breadboard kit, 4.5 x 6.0 x 1.35" \$19.95
10 14-DIP cap, 5-way post, 940 solderless \$29.95

PB102 12 pin DTP cap, like PB101 with 1,240 tie points, 7.0 x 4.5" \$39.95

PB103 24 14-DIP cap, 4.5-way post, 2,250 tie points, 6.0 x 9.0" \$59.95

PB104 32 14-DIP cap, 3,060 solderless tie points, 8.0 x 9.75" \$79.95

PROTO-CLIP

For power on/hands-off signal tracing. Bring IC leads up from PCB board surface for fast trouble shooting.

PC14 14 pin \$4.50
PC16 16 pin 4.75

LOGIC MONITOR

Simultaneously displays static and dynamic logic states of DTL, TTL, HTL or CMOS DIP ICs. Pocket size. \$84.95.

SOCKETS & BUS STRIPS

Plug-in wire, test, modify or expand without patch strips or solder. Snap together to form breadboard needed.

PN/Description	L. Hole-to-Hole Term's	Price
QTS95 Socket	6.5" 6.2"	118 \$12.50
QTS98 Bus	6.5" 6.2"	20 2.50
QTS99 Socket	5.3" 5.0"	94 10.00
QTS97 Socket	5.3" 5.0"	16 2.25
QTS95 Socket	4.1" 3.8"	70 8.50
QTS98 Bus	4.1" 3.8"	12 2.25
QTS99 Socket	2.1" 1.9"	36 4.75
QTS97 Socket	1.8" 1.5"	24 3.75
QTS95 Socket	1.4" 1.1"	16 3.25
QTS97 Socket	1.3" 1.0"	14 3.00

7400N TTL

7400N \$12	7442N	7400N	74164N	1.10
7401N	7443N	77	74100N	1.00
7402N	7444N	77	74106N	1.20
7403N	7445N	77	74105N	1.20
7404N	7446N	83	74107N	1.30
7405N	7447N	72	74109N	1.24
7406N	7448N	80	74110N	1.27
7407N	7449N	14	74111N	1.20
7408N	7451N	14	74112N	1.20
7409N	7453N	14	74121N	1.36
7410N	7454N	14	74122N	1.38
7411N	7459N	20	74123N	1.70
7412N	7460N	14	74125N	1.47
7413N	7470N	26	74126N	1.74
7414N	7471N	26	74128N	1.84
7415N	7472N	37	74132N	1.10
7416N	7473N	32	74136N	1.95
7417N	7474N	50	74141N	1.20
7418N	7475N	50	74145N	1.91
7419N	7476N	48	74147N	2.00
7420N	7477N	48	74148N	2.40
7421N	7478N	30	74151N	1.50
7422N	7479N	30	74152N	1.40
7423N	7482N	30	74153N	1.79
7424N	7483N	70	74154N	1.40
7425N	7484N	3.00	74155N	1.60
7426N	7485N	90	74156N	1.60
7427N	7486N	34	74157N	1.78
7428N	7487N	2.20	74158N	1.75
7429N	7488N	72	74159N	1.99
7430N	7489N	72	74161N	1.59
7431N	7490N	16	74162N	1.80
7432N	7491N	70	74163N	1.99
7433N	7492N	49	74158N	1.60
7434N	7493N	49	74160N	1.24
7435N	7494N	72	74161N	1.59
7436N	7495N	36	74162N	1.80
7437N	7496N	70	74163N	1.99

HIGH SPEED TTL

74H00N	33	74H20N	33	74H52N	36	74H73N	80
74H01N	25	74H21N	33	74H53N	36	74H74N	80
74H02N	33	74H22N	33	74H54N	36	74H76N	75
74H03N	33	74H23N	33	74H55N	36	74H102N	75
74H04N	33	74H24N	36	74H56N	36	74H103N	90
74H05N	33	74H25N	36	74H57N	36	74H106N	95
74H06N	33	74H26N	36	74H58N	36	74H107N	95
74H07N	33	74H27N	36	74H59N	36	74H108N	95

LOW POWER TTL

74L00N	24	74L10N	24	74L51N	34	74L90N	1.62
74L02N	24	74L20N	33	74L73N	43	74L93N	1.51
74L03N	39	74L42N	1.33	74L74N	90	74L95N	1.62
74L04N	33	74L50N					

74LS00

1-9 10up	1-9 10up	1-9 10up				
74LS00	38	74LS54	55	74LS160	3.00	2.90
74LS01	50	74LS55	39	74LS161	3.00	2.90
74LS02	39	74LS56	64	74LS162	2.25	2.20
74LS03	39	74LS57	65	74LS163	2.25	2.20
74LS04	45	74LS58	65	74LS170	5.80	5.70
74LS05	45	74LS59	92	74LS174	2.20	2.15
74LS06	39	74LS60	2.19	74LS175	2.40	2.35
74LS07	45	74LS61	65	74LS181	3.69	3.65
74LS08	39	74LS62	65	74LS190	2.85	2.80
74LS09	45	74LS63	65	74LS191	2.85	2.80
74LS10	42	74LS64	92	74LS192	2.85	2.80
74LS11	57	74LS65	92	74LS193	2.85	2.80
74LS12	57	74LS66	92	74LS194	2.25	2.20
74LS13	39	74LS67	1.29	74LS195	2.25	2.20
74LS14	56	74LS68	1.89	74LS196	2.06	2.00
74LS15	45	74LS69	1.89	74LS197	2.42	2.40
74LS16	45	74LS70	1.89	74LS198	1.89	1.85
74LS17	45	74LS71	1.89	74LS199	2.06	2.00
74LS18	52	74LS72	1.55	74LS200	5.70	5.70
74LS19	39	74LS73	1.55	74LS201	5.70	5.70
74LS20	58	74LS74	1.55	74LS202	5.70	5.70
74LS21	58	74LS75	1.55	74LS203	5.70	5.70
74LS22	58	74LS76	1.55	74LS204	5.70	5.70
74LS23	58	74LS77	1.55	74LS205	5.70	5.70
74LS24	58	74LS78	1.55	74LS206	5.70	5.70
74LS25	58	74LS79	1.55	74LS207	5.70	5.70
74LS26	58	74LS80	1.55	74LS208	5.70	5.70
74LS27	58	74LS81	1.55	74LS209	5.70	5.70
74LS28	58	74LS82	1.55	74LS210	5.70	5.70
74LS29	58	74LS83	1.55	74LS211	5.70	5.70
74LS30	58	74LS84	1.55	74LS212	5.70	5.70
74LS31	58	74LS85	1.55	74LS213	5.70	5.70
74LS32	58	74LS86	1.55	74LS214	5.70	5.70
74LS33	58	74LS87	1.55	74LS215	5.70	5.70
74LS34	58	74LS88	1.55	74LS216	5.70	5.70
74LS35	58	74LS89	1.55	74LS217	5.70	5.70
74LS36	58	74LS90	1.55	74LS218	5.70	5.70
74LS37	58	74LS91	1.55	74LS219	5.70	5.70
74LS38	58	74LS92	1.55	74LS220	5.70	5.70
74LS39	58	74LS93	1.55	74LS221	5.70	5.70
74LS40	58	74LS94	1.55	74LS222	5.70	5.70

SCHOTTKY TTL

74S00	44	74S32	80	74S113	1.50	74S174	3.30
74S01	76	74S40	65	74S114	1.20	74S175	2.90
74S02	60	74S48	75	74S115	1.20	74S176	2.90
74S03	75	74S56	80	74S116	1.20	74S177	2.90
74S04	55	74S64	80	74S117	1.20	74S178	2.90
74S05	76	74S72	80	74S118	1.20	74S179	2.90
74S06	76	74S80	80	74S119	1.20	74S180	2.90
74S07	76	74S88	80	74S120	1.20	74S181	2.90
74S08	76	74S96	80	74S121	1.20	74S182	2.90
74S09	76	74S104	80	74S122	1.20	74S183	2.90
74S10	55	74S112	1.15	74S123	1.20	74S184	2.90
74S11	65	74S120	1.15	74S124	1.20	74S185	2.90
74S12	65	74S128	1.15	74S125	1.20	74S186	2.90
74S13	65	74S136	1.15	74S126	1.20	74S187	2.90
74S14	65	74S144	1.15	74S127	1.20	74S188	2.90
74S15	65	74S152	1.15	74S128	1.20	74S189	2.90
74S16	65	74S160	1.15	74S129	1.20	74S190	2.90
74S17	65	74S168	1.15	74S130	1.20	74S191	2.90
74S18	65	74S176	1.15	74S131	1.20	74S192	2.90
74S19	65	74S184	1.15	74S132	1.20	74S193	2.90
74S20	65	74S192	1.15	74S133	1.20	74S194	2.90
74S21	65	74S200	1.15	74S134	1.20	74S195	2.90
74S22	65	74S208	1.15	74S135	1.20	74S196	2.90
74S23	65	74S216	1.15	74S136	1.20	74S197	2.90
74S24	65	74S224	1.15	74S137	1.20	74S198	2.90
74S25	65	74S232	1.15	74S138	1.20	74S199	2.90
74S26	65	74S240	1.15	74S139	1.20	74S200	2.90
74S27	65	74S248	1.15	74S140	1.20	74S201	2.90
74S28	65	74S256	1.15	74S141	1.20	74S202	2.90
74S29	65	74S264	1.15	74S142	1.20	74S203	2.90
74S30	65	74S272	1.15	74S143	1.20	74S204	2.90
74S31	65	74S280	1.15	74S144	1.20	74S205	2.90
74S32	65	74S288	1.15	74S145	1.20	74S206	2.90
74S33	65	74S296	1.15	74S146	1.20	74S207	2.90
74S34	65	74S304	1.15	74S147	1.20	74S208	2.90
74S35	65	74S312	1.15	74S148	1.20	74S209	2.90
74S36	65	74S320	1.15	74S149	1.20	74S210	2.90
74S37	65	74S328	1.15	74S150	1.20	74S211	2.90
74S38	65	74S336	1.15	74S151	1.20	74S212	2.90
74S39	65	74S344	1.15	74S152	1.20	74S213	2.90
74S40	65	74S352	1.15	74S153	1.20	74S214	2.90

9300 SERIES

9300PC	\$1.00	9318PC	2.30	9366PC	1.75	93L18	3.50
9301PC	1.50	9322PC	1.30	93L01	1.50	93L21	1.50
9302PC	1.50	9326PC	1.30	93L02	1.60	93L22	1.80
9303PC	6.90	9324PC	2.00	93L03	3.20		

PLANS AND KITS

FREE CATALOGUE KITS, COMPONENTS Audio equipment, Sinclair Kits, radio parts Gladstone Electronics, 1736 Avenue RD., Toronto, Canada, M5M 3Y7, U.S. Inquiries.

AMAZING ELECTRONIC PRODUCTS

LASERS SUPER POWERED, RIFLE, PISTOL, POCKET, SEE IN DARK - PYRO, TECHNICAL DEBUSSING, UNCRAMBLERS, CARTESIA, STARWIND TV, DISRUPTER, ENERGY PRODUCING, SCIENTIFIC DETECTION, ELECTRIFYING, CHEMICAL, ULTRASONIC, CB, AERO, AUTO AND MECH. DEVICES, HUNDREDS MORE... ALL NEW PLUS INFO UNLTD PARTS SERVICE

INFORMATION unlimited

Box 626 Lord Jeffrey PZ • Amherst, N.H. 03031

CATALOG \$1

MICROPROCESSOR M6800 INSTRUCTIONAL LAB - PREPROGRAMMED, includes CPU DEBUG ROM RAM ACIA PC Board, Teletype provision, Expandable, with Programming/Application Manuals, \$199.00 kit, Money Order, B.A.Cerd, Master Charge, COMPUTER SYSTEMS 18430 Morang, Detroit, Mich 48205 (313) 779-8700

PRINTED circuits directly from magazine articles in three hours. Datak ER-4 kit, only \$26.95. California and New Jersey residents include sales tax. Complete details from Datak, P.O. Box 38, Guttenberg, N.J. 07093.

EDUCATIONAL KITS. Introduction to digital IC's, Electronic games. Send stamp, NBL-E, Box 1115, Richardson, Texas 75080

FREE plans for building electronic thermometer with control. Send SASE, Data Scientific Instruments, Box 1054P, Livermore, CA 94550.

CMOS probe converts your voltmeter into FET input millivoltmeter. Free catalog, Data Scientific Instruments, Box 1054P, Livermore, CA 94550.

ELECTRONIC ROULETTE: "Wheel of Fortune" shown in October's Popular Electronics. Complete kits, \$24.95 with same day shipments from Hostell Electronics, 224 Opal Blvd., Steubenville, Ohio 43952.

SHORTWAVE LISTENING

NOW!! DRAKE SSR-1 Synthesized general coverage receiver. Precise tuning! \$3.25 SWL Guide, 414 Newcastle, Syracuse, NY 13219

BURGLAR ALARMS

BURGLAR-FIRE alarm supplies and information Free catalog Protecto Alarm Sales, Box 357-G, Birch Run, Michigan 48415

BURGLAR-Fire Alarm Equipment catalog \$1.00 (refundable), Thunderbird Security, Box 1302, Casa Grande, Ariz 85222

DIALING UNIT

This Dialing Unit is for use with a simple tape recorder to automatically make telephone calls for emergency or other use. The Unit includes both programmer and dialer so all you need is a simple tape recorder to complete the system.

\$29.95 **SIGHT & SOUND SYSTEMS** Model 672
Ph. 816 483-4612 Free literature
5619 St. John Avenue (Dept. 7) Kansas City, Mo. 64123

CALCULATORS

TEXAS INSTRUMENTS CALCULATORS DISCOUNT HOT LINE Toll Free (800) 638-8906. Phone us long distance free for the low discount price on the Texas Instruments Calculator of your choice SR-50A SR-51A SR-1611 T-2500II TI-1500, TI-2550II TI-5050. All of the great new Texas Instruments models. Capital Calculator Company 701 East Gude Drive, Rockville, Maryland 20850. The discount super market for top brand name calculators. Mail and phone orders accepted. BankAmericard and Master Charge accepted.

HIGH FIDELITY

DIAMOND NEEDLES and Stereo Cartridges at Discount prices for Shure, Pickering, Stanton, Empire, Grado and ADC. Send for free catalog LYLE CARTRIDGES Dept. P, Box 69, Kensington Station, Brooklyn, New York 11218

SAVE 50% Build your own speaker systems featuring Norelco, Eminence and CTS. Famous brands from world's largest speaker factories at lowest wholesale prices. Write for free catalog of speakers and electronic accessories McGee Radio & Electronic Corp., 1901 McGee Street, Kansas City, Missouri 64108

SGS-ATES AUDIO AMPLIFIERS

LOTS OF WATTS IN LESS SPACE

FOR A WIDE RANGE OF APPLICATIONS



TCA 940

Type	Supply Voltage Range (V)	Power (W)	THD@10% (dB)	Gain Range (dB)	Key Features	Price
TAA 611B12	6 to 15	115	210	8 to 12	28 to 53	\$1.95
TAA 621A11	6 to 27	2.80	4.20	8 to 18	30 to 57	3.00
TAA 621A12	6 to 27	1.40	2.20	8 to 18	30 to 57	1.80
TBA 641811	6 to 18	2.20	4.50	4 to 14	30 to 46	3.00
TBA800	5 to 30	4.70	2.80	8 to 18	30 to 53	2.55
TBA 810AS	4 to 20	2.50	6.00	4 to 16	Thermal Shut-Down	3.00
TBA820	3 to 16	1.75	1.80	4 to 9	Low Voltage Operation	1.65
TCA830	5 to 20	2.00	3.50	4 to 12	Thermal Shut-Down	2.25
TCA940	6 to 24	6.50	10.00	4 to 20	Fully Protected	4.50
TOA 2020	±18	10.00	15.00	8 to 15	40 Fully Protected	7.80

Minimum Order \$10.00. Add \$1.00 for Postage. Data Sheets \$2.50 ea.

IF IT ISN'T INDUSTRIAL QUALITY OR BETTER, WE WON'T SELL IT TO YOU.



ANRONA CORP.

SEND CHECK OR MONEY ORDER TO:
P.O. BOX 2208P
CULVER CITY, CA 90230 • (213) 641-4064

QUALITY ELECTRONIC COMPONENTS

NEW DISCOUNT SCHEDULE SAVES YOU EVEN MORE!

AMD 8080A \$39.95

MICROPROCESSOR
0-70°C 480 ns Clock Period

2102 \$1.99

1024 Bit Random Access Memory
500 ns Typical, 1000 ns Max

INTEGRATED CIRCUITS - TTL, CMOS, Linear & MOS

7400 .21	7473 .30	74174 .98	4001 .23	4073 .23
7401 .21	7474 .30	74175 .98	4002 .23	4075 .23
7402 .21	7475 .49	74176 .79	4006 1.23	4081 .23
7403 .21	7476 .32	74177 .79	4007 .23	4082 .23
7404 .21	7480 .70	74180 .70	4008 .79	4502 .79
7405 .21	7482 .70	74181 2.15	4010 .44	4510 1.14
7406 .25	7483 .70	74182 .79	4010 .44	4511 1.05
7407 .25	7485 .89	74184 2.19	4011 .23	4514 2.80
7408 .21	7486 .28	74185 2.19	4012 .23	4515 2.80
7409 .21	7489 2.19	74188 3.50	4013 .40	4516 1.23
7410 .21	7490 .44	74189 3.50	4014 .96	4518 1.14
7411 .21	7491 .70	74190 1.23	4015 .96	4520 1.14
7412 .21	7492 .44	74191 1.23	4016 .40	4527 1.68
7413 .25	7493 .44	74192 .88	4017 1.05	4528 .88
7414 .89	7494 .70	74193 .88	4018 1.05	4585 1.23
7416 .25	7495 .70	74194 .88	4019 .23	LM309K 1.80
7417 .25	7496 .70	74195 .88	4020 1.14	LM340T-1 2.25
7420 .21	74100 1.23	74196 .88	4021 1.14	LM340T-5 1.25
7421 .25	74107 .30	74197 .88	4022 .96	LM340T-6 1.25
7423 .35	74109 .33	74198 1.49	4023 .23	LM340T-8 1.25
7425 .35	74121 .63	74199 .49	4024 .64	LM340T-25 2.25
7426 .25	74122 .61	74201 .61	4025 .23	LM340T-15 1.25
7427 .33	74123 .61	74202 .61	4026 1.68	LM340T-18 1.25
7428 .28	74125 .40	74203 .67	4027 .40	LM340T-24 1.25
7430 .21	74126 .61	74204 .67	4028 .88	LM3900N .88
7432 .25	74132 .70	74207 .67	4029 1.14	NE536T 3.24
7433 .30	74141 .88	74208 .67	4030 .23	NE540L 2.04
7437 .25	74145 .70	74209 .67	4031 1.51	NE555V .48
7438 .25	74146 .65	74210 .67	4032 3.50	NE566A .88
7440 .21	74148 .88	74211 .65	4035 1.14	NE560B 3.83
7441 .88	74150 1.16	74212 .61	4040 1.14	NE561B 3.83
7442 .53	74151 .63	74213 .61	4041 .79	NE562B 1.28
7443 .63	74153 .65	74214 .61	4042 .79	NE565A 1.28
7444 .63	74154 .03	74215 .61	4043 .70	NE566V 1.25
7445 .70	74155 .70	74216 .61	4044 .70	NE567V 1.36
7446 .70	74156 .70	74217 .61	4046 1.68	UA709CV .44
7447 .70	74157 .70	74218 .61	4049 .40	UA710CA .44
7448 .70	74160 .88	74219 .40	4050 .40	UA711CA .53
7450 .21	74161 .88	74220 .40	4051 .64	UA723CA .40
7453 .21	74162 .88	74221 .40	4052 1.26	UA741LV .44
7454 .21	74163 .88	74222 .40	4053 .72	UA747CA .40
7460 .21	74164 .96	74223 .40	4054 1.58	UA748CV .49
7470 .21	74166 .28	74224 .40	4056 .79	MC4558V .48
7472 .30	74170 2.19	74225 .219	4071 .23	2102 2.65
7473 .30	74173 1.42	80023 .219	4072 .23	80B0A 49.95

AP SUPER STRIP II—Universal Breadboarding

Element with 840 Solderless Plug-in Tie-Points \$17.00



IC TEST CLIPS
14 pin TC-14 \$4.50
16 pin TC-16 \$4.75
24 pin TC-24 \$13.85 TC-16 TC-24

In a hurry?

All-Circuit Evaluators

7 models for fast building and testing of circuits

obsoletes ordinary breadboards

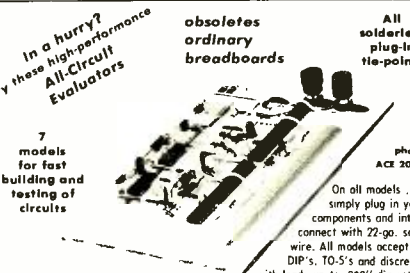

All solderless plug-in tie-points

On all models... simply plug in your components and interconnect with 22-ga. solid wire. All models accept all DIP's. TO-5's and discretes with leads up to .032" diameter.

Multiple buses can easily be linked for power and ground distribution, reset and clock lines, shift command, etc. Bases: gold-anodized aluminum. Terminals: non-corrosive nickel-silver. Four rubber feet included.

ACE Model No.	Tie Points	DIP No. of Capacity Buses	Board Size (inches)	Price Each
200C (assm)	728	8 (14x3)	7 2 4.9/16x5.9/16	\$18.95
208 (assm)	872	8 (16x3)	8 2 4.9/16x5.9/16	\$28.95
201K (kit)	1032	12 (14x3)	7 2 4.9/16x7	\$4.95
212 (assm)	1274	12 (14x3)	8 2 4.9/16x7	\$4.95
218 (assm)	1756	18 (14x3)	10 2 6.1/2x7-1/8	\$6.95
222 (assm)	2712	27 (14x3)	8 4 6.9/16x1/4	\$9.95
736 (assm)	3648	36 (14x3)	8 4 10-1/4x9-1/4	\$79.95

BISHOP GRAPHICS Printed Circuit Drafting

Aids are now available from Digi-Key

MONSANTO MAN 64 AL

0.4 INCH RED 7-SEGMENT DISPLAY

60°C

1702 AQ

2K ERASEABLE PROM WITH QUARTZ WINDOW

\$13.50

SILICON TRANSISTORS

MPS918, MPS930, MPS2222A, MPS2369A, MPS2712, MPS2907A, MPS3392, MPS3393, MPS3394, MPS3395, MPS3363, MPS3365, MPS3368, MPS3638A, MPS3640, MPS3641, MPS3643, MPS3645, MPS3646, 2N3904, 2N3906, 2N4124, 2N4126, 2N4401, 2N4403, 2N4410, PN4888, 2N5087, 2N5089, PN5129, PN5133, PN5134, PN5137, PN138, PN5139, 2N5210, PN5964 .16, \$1.55/10, \$13.60/100 of some part no.

MPF102 .36 \$30.60/C 2N5457 .48 \$41.00/C MPS413 .28 \$24.00/C 2N3055 .99 \$85.00/C

ELECTROLYTIC CAPACITORS

- Radial Lead - - Axial Lead - - Axial Lead - -

1uf/50v .08 .65/10	1uf/50v .11 .90/10	47uf/25v .17 1.30/10
2.2uf/50v .08 .65/10	2.2uf/50v .12 .90/10	100uf/16v .17 1.30/10
3.3uf/50v .08 .65/10	3.3uf/50v .12 .90/10	100uf/25v .29 1.55/10
4.7uf/50v .08 .65/10	3.9uf/50v .12 1.00/10	220uf/16v .29 2.30/10
4.7uf/50v .08 .70/10	4.7uf/25v .11 .90/10	220uf/25v .29 1.55/10
10uf/50v .10 .75/10	10uf/50v .11 .90/10	220uf/16v .29 2.30/10
10uf/50v .10 .75/10	10uf/50v .11 .90/10	330uf/16v .32 2.55/10
22uf/50v .12 1.00/10	10uf/50v .14 1.10/10	470uf/16v .32 2.55/10
100uf/16v .3v .75/10	22uf/16v .12 1.00/10	470uf/25v .37 3.00/10
100uf/16v .11 .85/10	22uf/25v .13 1.05/10	1000uf/16v .39 3.15/10
100uf/25v .13 1.10/10	33uf/16v .12 1.00/10	1000uf/25v .56 4.50/10
	33uf/25v .14 1.15/10	2200uf/16v .62 4.95/10
	47uf/16v .14 1.15/10	

DISC CAPS

100uf/500v .04 .36/10	1N5228B 3.3v .15 \$11/C	1N5236B 7.5v .15 \$11/C
220uf/500v .04 .36/10	1N5228 3.6v .15 \$11/C	1N5237B 8.2v .15 \$11/C
470uf/500v .04 .36/10	1N5229 4.3v .15 \$11/C	1N5238 8.2v .15 \$11/C
100uf/1000v .04 .37/10	1N5229B 4.3v .15 \$11/C	1N5239B 9.1v .15 \$11/C
220uf/1000v .04 .37/10	1N5230 4.7v .15 \$11/C	1N5240B 10v .15 \$11/C
470uf/1000v .04 .37/10	1N5230B 5.1v .15 \$11/C	1N5241B 11v .15 \$11/C
01uf/500v .06 .50/10	1N5231 5.6v .15 \$11/C	1N5242 12v .15 \$11/C
01uf/500v .03 .24/10	1N5231B 6.0v .15 \$11/C	1N5243B 13v .15 \$11/C
022uf/250v .03 .29/10	1N5232 6.2v .15 \$11/C	1N5244B 14v .15 \$11/C
047uf/250v .05 .42/10	1N5232B 6.8v .15 \$11/C	1N5245B 15v .15 \$11/C
1uf/25v .08 .62/10		

1/2 WATT ZENER DIODES

CMOS DATABOOK \$1.50

Specifications and pin-outs for 80 different 4000 series parts

REED RELAYS

1.5 Amp SPST N.O. Contacts

4.8v Coil \$1.70 \$125/C
6.0v Coil \$1.70 \$125/C
12v Coil \$1.70 \$125/C
24v Coil \$1.70 \$125/C

1/4 WATT 5% CARBON FILM RESISTORS

See each in multiples of 5 per value \$1.70/100 of same value. 10 ohm to 1.0 meg

RESISTOR ASSORTMENTS

5 ea. all 10% 1/4 W. Val. from 2.2 to 22 meg (425 pcs) \$12.00
5 ea. all 10% 1/4 W. Val. from 10 to 5.6 meg (150 pcs) \$12.00

I.C. SOCKETS

8 Pin Solder Tab	.17
14 Pin Solder Tab	.20
16 Pin Solder Tab	.22
18 Pin Solder Tab	.28
24 Pin Solder Tab	.39
28 Pin Solder Tab	.45
40 Pin Solder Tab	.63
8 Pin Wire-Wrap	.24
14 Pin Wire-Wrap	.26
16 Pin Wire-Wrap	.30
18 Pin Wire-Wrap	.35
24 Pin Wire-Wrap	.46
28 Pin Wire-Wrap	.56
40 Pin Wire-Wrap	1.00

SILICON DIODES

1N4148 .40/10 3.50/C	1N40004 70/10 5.95/C
1N4001 .64/10 5.50/C	1N4005 82/10 7.05/C
1N4002 .66/10 5.60/C	1N4006 90/10 7.75/C
1N4003 .68/10 5.80/C	1N4007 99/10 8.60/C

HARDWARE

2-56 1/4 Screw	.99/C 7.20/M
2-56 1/8 Screw	.99/C 7.65/M
4-40 1/4 Screw	.55/C 3.60/M
4-40 1/8 Screw	.55/C 4.05/M
6-32 1/4 Screw	.65/C 4.40/M
6-32 1/8 Screw	.75/C 4.85/M
8-32 3/8 Screw	.90/C 5.85/M
8-32 Hex Nut	.55/C 3.60/M
4-40 Hex Nut	.55/C 3.75/M
6-32 Hex Nut	.60/C 4.00/M
8-32 Hex Nut	.60/C 4.15/M
No. 2 Lockwasher	.85/C 5.25/M
No. 4 Lockwasher	.45/C 3.00/M
No. 6 Lockwasher	.45/C 3.00/M
No. 8 Lockwasher	.45/C 3.00/M

VOLUME DISCOUNT SCHEDULE

Merchandise Total	Discount	Merchandise Total	Discount
\$ 0.00 - 9.99	NET	\$ 100.00 - \$499.99	LESS 15%
\$ 10.00 - 24.99	LESS 5%	\$ 500.00 - \$999.99	LESS 20%
\$ 25.00 - 99.99	LESS 10%	\$1000.00 & up	LESS 25%

- Then Add the Standard Charge Below

STANDARD SHIPPING/HANDLING CHARGE

4 DIGIT ALARM CLOCK

\$15.95

KIT No. 1 (with PC Board)

Features the only LED direct drive clock chip on the market. Kit includes all parts (except transformer) for a 4 digit alarm clock kit. Uses .25 inch LED readouts.

Transformer for Kit No. 1 \$ 2.00

Kit No. 2 Complete Kit With Woodgrain Case and Display Window \$21.50
 Kit No. 3 Same as Above but with 1/2 inch Readouts \$22.50

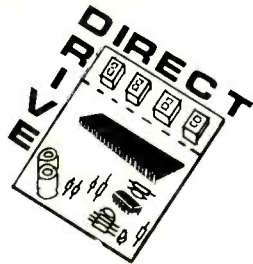

THE KING OF ALTAJ



Follow the King in future issues, and he will introduce a series of fantastic Maidens representing sophisticated circuits designed especially for the KING.



DIGITAL ALARM CLOCK



THE KING FEATURES:

- 1) 6 digit, 12 or 24 hour, 50 or 60 cycle alarm clock
- 2) Time sharing capability for display of additional information
- 3) Built-in alarm generator and automatic output for intensity control of LED's
- 4) Single 12v supply and a minimum of interface components
- 5) AM-PM and automatic power failure indicators
- 6) 10 minute snooze
- 7) Complete data and construction manual enclosed.

\$23.50

Kit No. 70250 1R (Red readouts) \$23.50
 Kit No. 70250 1Y (Yellow readouts) \$23.50
 Kit No. 70250 1G (Green readouts) \$23.50
 Kit No. 70250 2R (DL727 readouts) \$28.50
 Kit No. 70250 3R (DL747 readouts) \$28.50

Upon conclusion of our introductions you will have the most advanced timepiece on the market. Watch next issue for the King's first addition to his harem.

DL747

Jumbo 6 in. high, and only 20mA per segment. Common Anode. **2.75**

NEW HP7730

33 in. high read very bright readout, 25mA per segment. Common Anode. **1.20**

BURROUGHS 12 DIGIT DISPLAY

36 in. high Orange digits Ionization voltage 160V DC. We will send a free socket as a bonus. **3.25**

MAN'S GREEN MAN'S RED MAN'S YELLOW

Why not make a clock in 3 different colors, we tried it and it looks nice. 27 in. high digit. Common Anode. **1.25**

DL707

Red, 30 in. high 15mA per segment. Common Anode. **1.25**

727

Common Anode. One of our best Readouts, 5 in. high, 20mA per segment. **3.75**

DL33

If you like an array of displays, we have it, 10mA per segment. Common Cathode. **3.75**

FND503

We like it, you will love it, our new 5 in. common cathode type by Fairchild. **1.45**

5FOR-750

TEXAS INSTRUMENTS 6 DIGIT DISPLAY.

A perfect choice for your mini 6 digit clock or why not a stop watch. Fully multiplexed, common cathode 1 Class and goldplated. **1.30**

LEDs

Mini Red 12 cents ea
 Jumbo Red 15 cents ea
 Jumbo Green 20 cents ea
 Jumbo Yellow 25 cents ea

Nixie 85861ST

By Burroughs, 56 in. Orange Digit 160V Ionization potential. Only a limited supply in our stockroom. **1.50**

LSI INTEGRATION

MM5314	6 digit digital clock 24 pin dip w/spec.	\$ 3.75
MM5316	4 6 digit alarm clock 40 pin dip w/spec.	\$ 4.25
7002	4 digit counter/latch decoder. 7 segment and BCD outputs. 28 pin dip w/spec.	\$12.50
7005	4 digit counter/latch decoder. 7 segment output only. 24 pin dip w/spec.	\$ 9.50
7007	4 digit counter/latch decoder with BCD output only. 16 pin dip w/spec.	\$ 7.00
70250	4 6 digit alarm clock 28 pin dip w/spec.	\$ 5.50
70380	4 digit non-multiplexed radio alarm clock featuring direct drive display output 40 pin dip w/spec.	\$ 6.50
PC Board for 70250		\$ 4.25
PC Board for 70380		\$ 3.75
PC Board for 6 Displays type Man or DL707		\$ 2.25
PC Board for 4 Displays type FND503		\$ 2.00
PC Board for 6 DL747 or 3 DL727		\$ 3.00

TTL C-MOS

7400 16	CD4000 24
7402 16	CD4001 24
7404 16	CD4002 24
7406 24	CD4006 1.48
7408-16	CD4007 24
7410 16	CD4008 1.15
7413 49	CD4009 .59
7420-16	CD4011 24
7427 24	CD4012 24
7430-16	CD4013 .59
7437 39	CD4014 1.48
7438-35	CD4015 1.19
7440-16	CD4016 .59
7442 69	CD4017 1.29
7447 89	CD4018 1.49
7448 89	CD4019 .59
7453 37	CD4020 1.59
7473 37	CD4021 1.49
7474 37	CD4022 1.19
7475 65	CD4023 24
7476 39	CD4024 99
7483 85	CD4025 24
7490 69	CD4026 1.49
7492 75	CD4027 .59
7493 75	CD4028 .99
7495 75	CD4029 1.39
7496 75	CD4030 .49
74121 38	CD4032 24
74123 75	CD4033 1.49
74151 75	CD4035 1.39
74153 69	CD4040 1.59
74154 95	CD4041 89
74161 99	CD4042 79
74163 119	CD4044 50
74164 189	CD4049 59
74165 149	CD4050 58
74174 29	CD4066 99
74175 139	CD4077 39
74181 275	74C02 29
74192 125	74C04 29
74193 125	74C10 29
74195 79	74C101 29
74197 79	74C102 29

TRANSISTORS

2N3055 NPN	115W TO3 Power	0.85
RCA 200V	115W TO3 Power	1.25
GE D40C	NPN Darlingtion, Cut leads	0.25
2N4443 SCR	400V a 8Amp. TO220	0.65
2N2222 NPN	Gen. Amplification	0.20
2N2924 NPN	Gen. Amplification	0.15
2N3904 NPN	Driver	0.15
2N3906 PNP	Complementary 2N3904	0.20
2N4100 NPN	Low level noise	0.25
2N4402 PNP	Complementary 2N4100	0.25
2N4249 PNP	Low noise, High gain	0.25
2N1969 NPN	Similar to 2N2221	0.20
2N5401 PNP	Nixie driver 160V	0.25



LINEAR'S

555 Timer	Mini dip, Low Price	0.45
553 Timer	Quad, 14 pin dual	2.25
8038	Function Generator	4.25
RCA 3043	FM, IF, Audio Preamp.	1.20
565	Phase Locked Loop	0.95
567V	Tone Dec. Phase Locked Loop	1.50
LM 723	Pos. Voltage Regulator	0.55
LM 309	5 Volt 1 Amp. Regulator	1.10
LM 741	Operational Amplifier	0.25
LM 324	Quad Operational Ampl.	0.95

LOOK!

From Altaj to you, a special offer.
 Power Supply Kit, 5 Volt 1 Amp. regulated. Line regulation .005%. Load regulation 50mV.
 Kit includes: Components, PC board, Trans., Fuse, Pilot Light.
 Nothing else to buy: **\$ 5.50**

CPU'S

8008	8 bit parallel CPU	19.50
2102	1K Static RAM for 8008	2.25
MM5203 2K UV.	in aseable PROM.	12.25

6 Function Calculator

Chip 7020 with direct Segment Drive 8 Bright.
 Priced to Sell: **\$2.25**

RCA 3062

Photo detector with power amplifiers. **\$2.25**

LED Driver ICs

75491	Segment	.35
75492	Digit	.45

CAPS

Tantalum	1 uF	10V	20%	tol	0.20
Tantalum	4.7 uF	10V	20%	tol	0.25
Electrolytic	10 uF	25V	PC		0.15
Electrolytic	50 uF	25V	Ax		0.20
Electrolytic	100 uF	15V	PC		0.20
Electrolytic	200 uF	25V	PC		0.25
Electrolytic	470 uF	16V	Ax		0.30
Electrolytic	1000 uF	16V	PC		0.35
Electrolytic	2000 uF	16V	PC		0.45
Electrolytic	1500 uF + 2000 uF				
dual 30 Volt metal can, twist					0.85
Electrolytic	300 uF	250V	PC		0.45
Ceramic Discs	01uF	25V			0.05
Ceramic Discs	68pF	50V			0.05
Ceramic Discs	220pF	50V			0.05
Dipped Mica	150pF	100V	5%		0.10

LIGHTS MUSIC \$1.50

60 Watt COLOR ORGAN. Completely self-contained unit, with 120 volt power cord included.

TTL BOARDS

MEMOREX computer boards with TTLs, Diodes and Transistors, etc.
 5 Boards containing 150 - 250 ICs. **\$3.95**

TRANSFORMERS

No 1	8V	5 Amp	1.05
No 2	12V	CT 5 Amp	2.00
No 3	10V	3 VCT 1 Amp	1.95

DIODES

1N4004	400PIV	15 for 1.00
1N4007	1000PIV	10 for 1.00
1N746	3.3V Zen	4 for 1.00
1N4148	Switch	20 for 1.00

FM Transformers. \$1.00

Includes FORD 19 KHZ, 38 KHZ, Osc. Coils, etc. Used in AM-FM car radios. All New 10 PC. ASSMT

FREE! 9 Volt Battery with \$10.00 or more purchase

CSC 100 **new Proto Board**
\$19.95
 (Complete Kit)
 (Allow 2 weeks for Delivery)

Altaj Electronics Now offers a full line of Continental Specialty Proto Boards, Quick Sockets, Clips, Design Mates, Monitors, etc.

ALTAJ THANKS YOU

ALTAJ ELECTRONICS
 P.O. Box 38544, Dallas, Texas 75238
 TERMS: Check or money order. No COD.
 Telephone (214) 278-3561
 Texas Residents Add 5%

GODBOUT

BILL GODBOUT ELECTRONICS
BOX 2355, OAKLAND AIRPORT, CA 94614

FLYER: Circle the reader service number below for our NEW FLYER. Kits, components, tools--- everything for the electronics hobbyist.
TERMS: Orders under \$10 add 50¢. No COD. Cal res add tax. For Mastercharge® or BankAmericard®, call (415) 357-7007, 24 hours.

"Electronic Projects for Musicians" - \$6.95 + shpg

CRAIG ANDERTON'S BOOK TELLS YOU HOW TO BUILD 19 MUSICAL PROJECTS, EVEN IF YOU HAVEN'T BUILT ANYTHING BEFORE. INCLUDES 4 CHAPTERS ON BASIC ELECTRONICS, RECORDING THAT DEMONSTRATES THE PROJECT SOUNDS, & FORWARD BY JOE WALSH. PROJECTS INCLUDE PREAMP, RING MODULATOR, FILTERS, MINIAMP, HEADPHONE AMP, FUZZES, COMPRESSOR, EXPANDABLE MIXER, MUCH MORE. PRACTICAL, UNDERSTANDABLE, READABLE: THE IDEAL PRIMER FOR MUSIC/ELECTRONICS ENTHUSIASTS, REGARDLESS OF THEIR AGE OR EXPERIENCE. PS: WE ALSO SUPPLY PARTS KITS FOR ALL 19 PROJECTS!

CHERRY Switches and Keytops

CHERRY STOCK # M61-100.

CAVE



Lists for \$1.29--
5 times our price



SWITCHES: 5/\$1.00
SWITCH/KEYTOP combination 5/\$1.25.
KEYTOPS WHILE THEY LAST!
SORRY, NO CHOICE OF LEGEND.

5V 5A microprocessor power supply

Also +12V @ ½A and -12V @ ½A, plus an adjustable negative bias supply. Crowbar overvoltage protected; fold back current limiting; 5V regulation 1% or better. TOP QUALITY COMPUTER SUPPLY KIT, W/ HARDWARE & CHASSIS-- less line cord. \$44.95 + 8 lbs shpg.

PUSHBUTTON SWITCHES 4 FOR \$1.00 SPST MOMENTARY



10,000 µf PERFECT TONIC FOR SUPPLIES WITH A FARAD DEFICIENCY. 10 MVDC; \$1.25 EACH.

39µf Tantalum 10V 4/\$1.00

CIRCLE NO. 28 ON FREE INFORMATION CARD

EDLIE'S BARGAIN BONANZA

ONLY HIGHEST QUALITY PRODUCTS

- (AP015) TOP QUALITY RE-CORDING TAPE. Made by Scotch Sound-craft, or Ampex. On 101½" reels. ¼" x 3600' \$1.99 ea. 2 for \$1.75 ea. 10 for \$1.50 each.
- (AP017) COPPER CLAD BOARDS! Copper on one side. 1/16" thick. Excellent quality for either production or experimental work. B) 4"x16½" 99¢ ea. 3/\$2.69 D) 8"x16½" \$1.19 ea. 3/\$2.99 E) 6½"x17½" \$1.19 ea. 3/\$2.99

- (AP134) 8 ROTARY SWITCHES. Some multiple gang. \$1.00

- (AP128) 13 MINIATURE ELECTROLYTIC CAPACITORS \$1.00. Axial & upright, popular values.

- (AP144) TRANSISTOR REPAIR KIT \$1.19. Various parts used to repair transistorized devices.

- (AP336) TO-3 TRANSISTOR SOCKETS 12 for \$1.00

- (AP298) 1 WATT ZENERS 60c. available in 5V 9.1V, 12V, 20V

- (AP164) 4 ROLLS OF WIRE \$1.00. Approx. 25 ft. per roll, 20-28ga.

- (AP140) TAPE RECORDER SPARE PARTS KIT \$2.95. Parts for repairing most tape recorders: capacitors, meter, pilot lamp, jacks, and MUCH MORE.

- (AP167) 10 MINIATURE POTENTIOMETERS \$1.00

- (AP182) 2 MISC. METERS \$1.00. Miniature.

- (AP156) 60 DISC CAPACITORS \$1.00. Asst. from 0001 to 1, most 600v. Z5U, NPO, N750, etc.

SURPLUS TUBES
All guaranteed for 1 full year
ANY 3 FOR \$1.25

Acquired from U.S. Defense depots or removed

from equipment (new and used). These are laboratory tested and guaranteed for one full year. Most are of such standard makers as RCA, GE, etc.

3A3	6AU6	6EB8	12AL5
3AF4	6AV6	6EM7	12AU7
3BN6	6AX4	6CF7	12AV6
3OD4	6AX5	6GH8	12BE6
3K16	6AY3	6K6	12BH7
3Q4	6BA6	6X11	18FW6
4BC5	6BG6	6LB6	25L6
4BN6	6B18	6SN7	35EH5
4BU8	6B06	6T8	36AM3
4BZ7	6BZ6	6W4	50A5
5V6	6CB6	6X4	50L6
6AF4	6CG7	10CW7	
6AG5	6CM7	12AE7	
6AG7	6DE4		
6AL5	6DR7		
6AQ7	6DW4		
6AT6			

- (AP147) 4 lb. GRAB BAG SPECIAL \$1.00. Full or exotic and exciting electronics parts.

- (AP155) TUBE BONANZA! \$1.00. 20 asst. popular tubes, untested.

- (AP142) 50 PRECISION RESISTORS \$1.00. All 1% ½w and 1w, low and high ohmages.

- (AP150) 15 HI-FI KNOBS \$1.00. Every one superb! Purchased from Harmon, Kardon, Fisher, etc.

- (AP102) CALCULATOR KEYBOARD \$2.95. Wild Rover C-1380. Can be used with CT5001. 4 function, clear, clear entry and constant. 7 cm x 9 cm.

- (AP175) 70 ½w CARBON RESISTORS \$1.00. Asst. values. Some 5%.

- (AP154) 150 CUT LEAD RESISTORS \$1.00. Carbon, all leads long enough for soldering.

- (AP149) 20 POLYSTYRENE TOP GRADE CAPACITORS \$1.00

- (AP132) 20 DUAL POTS \$1.00

MONEY BACK GUARANTEE

Terms: Minimum order \$4.00. Include postage. Either full payment with order or 20% deposit, balance C.O.D.

- WRITE FOR FREE 1976 VALUE PACKED CATALOG. Listing thousands of components, tubes, transistor, IC's, kits, test equipment.

- BONUS FREE CAPACITOR KIT With Every \$5 Purchase

THIS MONTH'S SPECIALS!

- 74115 Schottky 3 inp pos AND O.C. 45c
- 739 Dual lo-noise pre-amp 85c
- M8815A Dual 4 inp. NOR 2 for \$1.00
- (M018) 4 LSD's in mini-DIP \$2.00

TTL			
<input type="checkbox"/> 7400	16c	<input type="checkbox"/> 7446	80c
<input type="checkbox"/> 7401		<input type="checkbox"/> 7447	80c
<input type="checkbox"/> 7402		<input type="checkbox"/> 7448	80c
<input type="checkbox"/> 7403	23c	<input type="checkbox"/> 7473	49c
<input type="checkbox"/> 7404	23c	<input type="checkbox"/> 7474	49c
<input type="checkbox"/> 7405	23c	<input type="checkbox"/> 7475	85c
<input type="checkbox"/> 7406	23c	<input type="checkbox"/> 7476	53c
<input type="checkbox"/> 7410	23c	<input type="checkbox"/> 7490	79c
<input type="checkbox"/> 7411	27c	<input type="checkbox"/> 7492	79c
<input type="checkbox"/> 7413	40c	<input type="checkbox"/> 7493	69c
<input type="checkbox"/> 7420	23c	<input type="checkbox"/> 7495	79c
<input type="checkbox"/> 7430	23c	<input type="checkbox"/> 74121	57c
<input type="checkbox"/> 7440	30c	<input type="checkbox"/> 74122	57c
<input type="checkbox"/> 7442	\$1.12	<input type="checkbox"/> 74123	67c

- LINEARS
- LM309K 5v la. reg. \$1.15
- 555 Timer 75c
- 556 Dual 555 \$1.00
- 566 Function gen. \$1.75
- 567 Tone decoder \$1.95
- 741 comp op amp 39c
- 2102 1024 bit RAM \$4.95
- 8038 volt cont osc \$4.25

- CLOCK CHIPS WITH DATA
- (MM5314) 6 dig clock \$4.95
- CT 7001 Alarm & Date \$5.95

- LED'S
- (AP223) 10 Asst LEDs \$1.00
- (AP242) 5 Jumbo Green LEDs \$1.00
- (AP242) 5 Med Yellow LEDs \$1.00
- (AP001) 5 Jumbo Red LEDs \$1.00
- (AP011) 5 Med Red Leds \$1.00
- (AP012) 5 Mini Red LEDs \$1.00
- (AP293) DL707 (equiv.) 7 seg red LED, 3" char, comm anode \$1.00

- (AP006) DL 704 (equiv.) same as DL707 except comm cath \$1.35

- (AP007) DL747 7 seg red LED, 6" char, comm anode \$1.95

- (AP013) MAN 5 (equiv.) 7 seg green LED, 27 char, comm anode \$1.49

- IC BREADBOARDS & TERMINALS. Boards have .042 holes. Made of 1/16" polyester glass.

- (AB663) 3"x4" 94c
- (AB664) 3"x6" \$1.29
- (AB665) 4"x6" \$1.65
- (AB666) 4"x8" \$2.12

- Push-in terminals
- (AP6601-20) pkg 20/90c
- (AP6601-100) pkg 100/\$2.89

- Push-in flanged pins
- (AB6602-20) pkg 20/90c
- (AB6602-100) pkg 100/\$2.89

- Push-in flea clips
- (AB6603-20) pkg 20/90c
- (AB6603-100) pkg 100/\$2.89
- (A008) 14 pin DIP sockets 3 for \$1.00

- (AP1104) IC REMOVAL AND INSERTION TOOL \$4.95. "Pul-n-sertic" extracts and inserts ICs without damage.

- (AP271) 1N4148 High Speed switching diode. Full leads. 12 for \$1.00

BUSINESS OPPORTUNITIES

I MADE \$40,000.00 Year by Mailorder! Helped others make money! Free Proof. Torrey, Box 318-NN, Ypsilanti, Michigan 48197.

FREE CATALOGS Repair air conditioning, refrigeration. Tools, supplies, full instructions. Doolin, 2016 Canton, Dallas, Texas 75201.

MAILORDER MILLIONAIRE helps beginners make \$500 weekly. Free report reveals secret plan! Executive (1K4), 333 North Michigan, Chicago 60601.

PIANO TUNING LEARNED QUICKLY AT HOME! Musical knowledge unnecessary. Free information. Empire School, Box 450327, Miami 33145.

\$200.00 DAILY in Your Mailbox! Your opportunity to do what mail-order experts do. Free details. Associates, Box 136-J, Holland, Michigan 49423.

FREE BOOK 2042 unique proven enterprises. Work home! Hayling-B, Carlsbad, CA 92008.

P-2

Wanted Citizens Band

DEALER-DISTRIBUTORS

Send this ad with Letterhead to:

PAL ELECTRONICS CO.

2962 W. WELDON - PHOENIX, ARIZ. 85017

GET RICH with Secret Law that smashes debts and brings you \$500 to \$5 Million cash. Free report! Credit 4K4, 333 North Michigan, Chicago 60601.

HIGHLY PROFITABLE ONE-MAN ELECTRONIC FACTORY

Investment unnecessary, knowledge not required, sales handled by professionals. Postcard brings facts about this unusual opportunity. Write today! Barta-DD, Box 248, Walnut Creek, CA 94597.

FM RADIO STATION Start your own. Fantastic income. Frequencies still available. Complete information \$3.00. Concept, Box 106, Lawrence, N.Y. 11559.

ASIA DIRECTORY WORLD PRODUCTS INFORMATION Both just \$1.00. World Trade Inquiries, Box 6224, Spokane, Washington 99207.

INVENTIONS WANTED

INVENTORS Manufacturers Need New Products. Free "Recommended Procedure" by a creative fee-based invention service company. Washington Inventors Service, 422-T Washington Building, Washington, D.C. 20005.

INVENTORS WANTED

RECOGNITION... FINANCIAL REWARD... OR CREDIT for "inventing it first" may be yours!

If you have an idea for a new product, or a way to make an old product better, contact us, "the idea people." For a fee, we'll develop your idea, introduce it to industry, negotiate for cash sale or licensing. Send for our FREE "Inventor's Kit." It has a Directory of 500 Corporations Seeking New Products, a special "Invention Record Form," and important Marketing Information.

RAYMOND LEE ORGANIZATION
230 Park Avenue North, New York, NY 10017
Yes, I'd like to find out how to take action on my idea. Rush your FREE INVENTOR'S KIT No. A-112

Name Please Print

Address

City State Zip

A Fee-Based Invention Service Company

FREE PAMPHLET "Tips on Marketing Your Invention," from an experienced fee-based invention service company. Write United States Inventors Service Company, Dept. T, 1435 G Street, NW, Washington, D.C. 20005.

**HEWLETT
PACKARD**



H.P. IS BACK!

No Rejects or Retests here — You Want Quality? You have it with this popular 0.3" L.E.D. by Hewlett Packard. Fits Standard I.C. Socket. Right hand DP.
5082-7740 — Common Cathode \$1.25
6 for \$8.00



FAIRCHILD BIG LED READOUTS

A big .50 inch easy to read character. Now available in either common anode or common cathode. Take your pick. Super low current drain, only 5 MA per segment typical.

FND - 510 Common Anode **YOUR CHOICE**
FND - 503 Common Cathode **\$2 ea.**

DO YOU NEED A LARGE COMMON ANODE READOUT AT A FANTASTIC PRICE?



S. D. presents the MAN-64 by Monsanto - .40 inch character. All LED construction - not reflective bar type, fits 14 pin DIP. Brand new and factory prime. Left D.P.
\$1.50 ea. 6 for \$7.50

HIGH V. TRANSFORMER Primary 117V, two secondaries:
24 VAC 500 MA 175 VAC 100 MA. \$1.25 ea.

2102 1K RAM's - 8 FOR \$12.95

New units ————— We bought a load on a super deal, hence this fantastic price.
Units tested for 500NS Speed.

INTEL 1702A 2K ERASEABLE PROM'S \$6.95

We tell it like it is. We could have said these were factory new, but here is the straight scoop. We bought a load of new computer gear that contained a quantity of 1702A's in sockets. We carefully removed the parts, verified their quality, and are offering them on one heck of a deal. First come, first served. Satisfaction guaranteed.

SIGNETICS 1K P-ROM

82S129. 256 X 4 Bipolar, much faster than MOS devices. 50 NS. Tri-state outputs. TTL compatible. Field programmable, and features on chip address decoding. Perfect for microprogramming applications. 16 pin DIP. With specs. \$2.95 ea

PROMS!



\$2.95

PROFESSIONAL QUALITY STEREO HEADPHONES

Here is the kind of super deal that S. D. is famous for. Treat your ears to a super sound at a super price. Soft padded ear cushions, lightweight, fully adjustable headband, long coiled cord, wide response. \$6
NEW IN ORIGINAL FACTORY BOXES

INSTRUMENT KNOBS

Black with brushed aluminum insert. Medium size, very attractive style.
SPECIAL 5 FOR \$1

MV-50 TYPE LED's

by LITRONIX
10 for \$1
Factory Prime!

3 DIGIT LED ARRAY — 75c

by LITRONIX
DL33MMB. 3 MAN-3 Size Readouts in one package. These are factory prime, not retested rejects as sold by others. compare this price! 75c 3 for \$2.



SALE ON CUT LEAD SEMICONDUCTORS

Leads were cut for PCB insertion. Still very useable.

- 1N914/1N4148 100/\$2
- 1N4002 1 Amp 100 PIV 40/\$1
- 1N4745A 16V 1W Zener 20/\$1
- EN2222 NPN Transistor 25/\$1
- EN2907 PNP Transistor 25/\$1
- 2N3904 NPN Driver Xstr. 25/\$1
- 2N3392 GE Pre-amp Xstr. 25!\$1
- C103Y SCR. 800MA. 60V. 10/\$1

**ALL NEW.
UNUSED.
SOME ARE
HOUSE #**

NATIONAL MM5375AA ALARM CLOCK CHIP

Second generation alarm chip. Six digits, internally generates alarm tone, snooze, power failure indicator, etc. Very easy to use. Outperforms older types like 5316, 5370, etc. Perfect for use with our HP 5082-7740 LED readouts.
S.D. SPECIAL PRICE: \$3.50
WITH DATA

MOSTEK MK50380 DIRECT DRIVE ALARM CHIP

Drives LED readouts direct, eliminates transistor or IC interface circuitry. 4 digit output is non-multiplexed to eliminate RFI in clock radio applications. Has sleep and snooze features. 40 pin DIP. Makes a JUMBO alarm clock by using our FND 503 readouts. We show you how.
INTRODUCTORY PRICE: \$3.95

SLIDE SWITCH ASSORTMENT

Our best seller. Includes miniature and standard sizes, single and multi-position units. All new, first quality, name brand switches. Try one package and you'll reorder more. Special — 12 for \$1 (Assortment)



DISC CAP ASSORTMENT

PC leads. At least 10 different values. Includes .001, .01, .05, plus other standard values.
60 FOR \$1



UPRIGHT ELECTROLYTIC CAPS

47 mfd 35 V-10/\$1 68 mfd 25V-8/\$1
Brand new by Sprague. PC leads.

1000 MFD FILTER CAPS



Rated 35 WVDC. Upright style with P.C. leads. Most popular value for hobbyists. Compare at up to \$1.19 each from franchise type electronic parts stores. S.D. Special 4 for \$1

RESISTOR ASSORTMENT

1/4 W 5% and 10%. PC leads.
A good mix of values. 200/\$2



LARGE SIZE LED LAMPS



Similar to MV5024. Prime factory tested units. We include plastic mounting clips which are very hard to come by.
Special 5 for \$1

VERNIER DIAL

From a close out of metal detector manufacturer. 1/2 Turn, 8 to 1 ratio. Internal stops easily removed to make unit multi-turn.

LIMITED QUANTITY - \$.99 EACH

741C OP AMPS

Prime, factory tested and marked. Full spec on all parameters. Not re-tested, functional only, units as sold by others.
741 CH - TO-5 8 Lead Metal Can ... 3/\$1
741CV - 8 Lead Mini Dip 4/\$1



DUAL 741C (5558) OP AMPS

Mini dip. New house numbered units
by RAYTHEON.
4 FOR \$1

FET'S BY TEXAS INSTRUMENTS — SPECIAL 5 for \$1

#TIS-75 but with an internal house number. TO-92 plastic case. N. Channel, Junction type FET.

Signetics, TRI-State Hex Buffer. MOS and TTL interface to TRI-State Logic.
Special: \$1 **8T97B**

TRANSISTORS
2N3904 - NPN
2N3906 - PNP
8 for \$1

TI POWER TRANSISTORS

TIP29 NPN Silicon. TO-220. 4/\$1

CT-5005 WITH FOUR-FUNCTION MEMORY!

CALCULATOR CHIP
By CalTex. 12 Digits.
With Specs. \$1.49
Factory prime. Not retested

We do not sell junk. Money back guarantee on every item. No C.O.D. Texas Res. add 5% tax. Postage rates went up 30%! Please add 5% of your total order to help cover shipping.

S. D. SALES CO.

P.O. BOX 28810
DALLAS, TEXAS 75228

TUBES

RADIO & TV Tubes—36 cents each. Send for free Catalog. Cornell, 4213 University, San Diego, Calif. 92105.
 TUBES receiving, factory boxed, low prices, free price list Transleteronic, Inc., 1365 39th Street, Brooklyn, N.Y. 11218A Telephone: 212-633-2800
 TUBES "Oldies", latest. Lists free. Steinmetz, 7519 Maplewood, Hammond, Indiana 46324.
 TUBES Send 10 cents for large conclusive list. Low Prices. T-J Specialties, Box 43, Bradley Beach, New Jersey 07720.

ELECTRICAL SUPPLIES & EQUIPMENT

PLATING Equipment, Portable Platers, Supplies and "Know-How" Build your own tanks for nickel, chrome, etc. Easy-to-install PVC liners. Rectifier components—all sizes. Schematics, parts lists, formulas, operating instructions for all plating. Guaranteed to save you 25%-75% Some good used units for sale. Write for details. Platers Service Company, 1511-PE Esperanza, Los Angeles, Calif. 90023.

TAPE AND RECORDERS

RENT 4-Track open reel tapes — free brochure. Stereo. Part. P.O. Box 7, Fulton, CA 95401.
 1930-1962 Radio Programs, Reels, \$1.00 Hour! Cassettes, \$1.00 Show! Mammoth Catalog, \$1.25. AM Treasures, Box 192PE, Babylon, N.Y. 11702

HYPNOTISM

SLEEP learning. Hypnotic method, 92% effective. Details free. ASR Foundation, Box 23429EG, Fort Lauderdale, Florida 33307.
 FREE Hypnotism, Self-Hypnosis Sleep Learning Catalog! Drawer H-400, Ruidoso, New Mexico 88345
 AMAZING self-hypnosis record releases fantastic mental power. Instant results! Free trial. Write Forum (AA4), 333 North Michigan, Chicago 60601.

**For faster service
 USE ZIP CODE
 on all mail**

This month's special

Electronic Watch Kit \$24.95

5 function LED. Large readout unmagnified. Easy to solder and assemble.

M5 Large numeric readout \$24.95

M8 Alpha/Numeric readout \$27.95

Finished modules also available

Watch Case & Strap Handsomely styled

C6 All metal \$15.50 C7 Leather (watch case) \$14.00



TERMS:
 \$5.00 min. order U.S. funds.
 Calif. residents add 6% tax.

Same Day Shipment. First line parts only. Guaranteed satisfaction. Listed below is just a small sample of the complete lines available. A broad line of IC's at low factory prices. Try us. You'll like the quality and the service!

74LS00 TTL	7403	14	MOS/MEMORY	LINEAR
74LS00	29	7405	2102P	2.50 301AP
74LS02	29	7406	2102-2P	2.60 301AT
74LS04	35	7408	6331J	2.60 709CP
74LS10	29	7423	82S123	2.90 723CP
74LS74	49	7438	8223	3.10 723CT
74LS90	99	7447	1404AT	1.80 741T
74LS93	99	7473		741CP
74LS107	47	7474		747CP
74LS151	114	7476		4000
74LS157	114	7490		4001
74LS163	189	7493		4011
		74107		4099
		74154		4050
7400 TTL	17	74161		
7400	17	74163		
7401	14	74192		
7402	17			

This month's special extra—EVERYTHING YOU NEED TO SELECT IC'S IN ONE MANUAL IC Update Master 1976 Manual

Complete Integrated Circuit data from all manufacturers, with free quarterly updates. **14,000 cross references** . . . by device, manufacturer, product category, functional characteristics, key product data and application note directory. Offered at \$50. **You Pay Only \$30**, complete with Update service. **Money Back Guaranteed** if not satisfied within first week.

CIRCLE NO. 51 ON FREE INFORMATION CARD

POLY PAKS
 CELEBRATES THE BICENTENNIAL WITH A "ONE-CENT" ENNIAL
HONEST ABE
SALE

Order by Cat. No. 4E1983 & Type. No. below

Type	Sale	2 for	Type	Sale	2 for
SN7400	.22	.23	SN7490	1.00	1.01
SN7401	.22	.23	SN7491	.91	.92
SN7402	.22	.23	SN7494	.82	.83
SN7403	.22	.23	SN7495	.86	.87
SN7404	.24	.25	SN7496	.86	.87
SN7406	.36	.37	SN7498	1.50	1.51
SN7407	.46	.47	SN74112	.89	.90
SN7408	.22	.23	SN74125	1.29	1.30
SN7409	.52	.53	SN74126	1.29	1.30
SN7410	.22	.23	SN74132	1.95	1.96
SN7411	.27	.28	SN74140	2.50	2.51
SN7414	2.75	2.76	SN74141	1.12	1.13
SN7416	.44	.45	SN74145	1.69	1.70
SN7417	.62	.63	SN74148	3.25	3.26
SN7420	.22	.23	SN74150	1.12	1.13
SN7421	.55	.56	SN74151	1.12	1.13
SN7423	.47	.48	SN74154	1.53	1.54
SN7425	.37	.38	SN74155	1.39	1.40
SN7426	.27	.28	SN74157	1.09	1.10
SN7430	.22	.23	SN74158	1.55	1.56
SN7432	.36	.37	SN74160	1.59	1.60
SN7437	.42	.43	SN74161	1.25	1.26
SN7438	.42	.43	SN74163	1.50	1.51
SN7440	.22	.23	SN74164	1.79	1.80
SN7442	.97	.98	SN74165	1.79	1.80
SN7443	.97	.98	SN74166	1.86	1.89
SN7444	.97	.98	SN74173	1.69	1.70
SN7445	.97	.98	SN74174	1.42	1.43
SN7446	1.10	1.11	SN74175	1.45	1.46
SN7447	1.10	1.11	SN74176	1.59	1.60
SN7448	1.10	1.11	SN74177	1.59	1.60
SN7450	.22	.23	SN74179	2.50	2.51
SN7451	.27	.28	SN74180	2.45	2.46
SN7453	.22	.23	SN74181	3.75	3.76
SN7454	.22	.23	SN74182	1.09	1.10
SN7455	.22	.23	SN74184	2.19	2.20
SN7456	.22	.23	SN74190	2.75	2.76
SN7457	.22	.23	SN74191	2.75	2.76
SN7473	.44	.45	SN74193	1.29	1.30
SN7475	1.00	1.01	SN74194	2.19	2.20
SN7480	.64	.65	SN74195	.89	.90
SN7482	.99	1.00	SN74196	2.19	2.20
SN7483	.99	1.00	SN74197	2.25	2.26
SN7485	1.41	1.42	SN74198	2.25	2.26
SN7488	.47	.48	SN74199	2.25	2.26
SN7488	3.95	3.96			
SN7489	2.25	2.26			

MINIMUM ORDER — \$6.

Phone : Wakefield, Mass. (617) 245-3829
 Terms: Add postage. Rated: net 30

POLY PAKS
 P.O. BOX 942E LYNNFIELD, MASS. 01940

C.O.D.'S MAY BE PHONED

CLASSIFIED ADVERTISING ORDER FORM

Please refer to heading on first page of this section for complete data concerning terms, frequency discounts, closing dates, etc.

1	2	3	4	5
6	7	8	9	10
11	12	13	14	15
16	17	18	19	20
21	22	23	24	25
26	27	28	29	30
31	32	33	34	35

WORD COUNT: 15 WORD MINIMUM. Include name and address. Name of city (Des Moines) or of state (New York) counts as one word each. Zip Code numbers not counted. (Publisher reserves right to omit Zip Code if space does not permit.) Count each abbreviation, initial, single figure or group of figures or letters as a word. Symbols such as 35mm, COD, P.O., AC, etc. count as one word. Hyphenated words count as two words. Telephone numbers count as one word.

_____ Words \$2.00 (Commercial Rate) \$1.20 (Reader Rate)

Payment of \$ _____ enclosed for _____ insertion(s).

CHARGE: American Express BankAmericard Master Charge Diners Club

for _____ insertion(s). You will be billed monthly.

Account # _____ Expiration Date _____

Master Charge Interbank # (4 digits above name) _____

SIGNATURE MUST BE PROVIDED BELOW

PRINT NAME _____

ADDRESS _____

CITY _____

STATE _____

ZIP _____

SIGNATURE _____

PE-476

WANTED

QUICKSILVER, Platinum, Silver, Gold, Ores Analyzed. Free Circular. Mercury Terminal, Norwood, Mass. 02062.

TOUCH-TONE Panelphone, Touch-A-Matic, Speakerphone. Mr. Baker, 735 11th, Washington, DC 20001.

MUSICAL INSTRUMENTS

UP TO 60% DISCOUNT. Name brand instruments catalog. Freeport Music, 114 N. Mahan St., W. Babylon, N.Y. 11704. WHOLESALE! Professional Guitars, PA Systems, Altec Speakers, 240W RMS Amplifiers. Free Catalog, Carvin, Escondido, Calif. 92028.

Olson ELECTRONIC PARTS AND ACCESSORIES

Reg. Sale

TA-854 40 Min. 8 Track Tape 1.29 .89c
 TA-855 80 Min. 8 Track Tape 1.59 1.09
 TA-879 3 Pak C-60 Cassette 1.49 .99c
 PL-233 Pkg. 5 Red LED 1.19 .69c
 XM-501 Pkg. 40 Terminal Lugs 1.30 .59c
 XM-367 Mechanical 4 Digit Counter 1.49 .69c
 TT-092 2500 Ohm Output Transformer 1.09 .69c
 SW-581 117 VAC Solenoid 1.49 .79c
 TR-446 Pkg. 25 Asstd. SCR 2.69 .99c
 XM-343 7 Segment 6" LED Display 5.00 1.99

Send to: Olson Electronics, Dept. IJ 260 S. Forge St., Akron Ohio 44327. Allow for Postage, C.O.D. 20% Deposit. Ohio Residents Add 4% Sales Tax.

FREE! Ask for our Catalog when you Order

CIRCLE NO. 44 ON FREE INFORMATION CARD

GIANT NIXIE TUBE ASSEMBLY

Giant NIXIE tube assembly with 2 Burroughs B7971 15 segment ALPHA-NUMERIC tubes with 2 1/2" characters. Mounted in 2 sockets on a driver board with 33 transistors. Perfect for large clocks & alpha-numeric displays. We supply tube data. 2 lbs.

STOCK NO. P6001 \$6.95 per set, 2/12.00

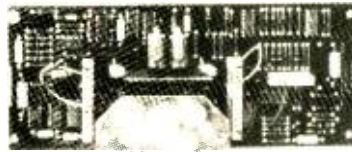
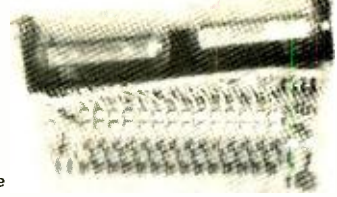

PROGRAMMABLE COUNTER

2 digit programmable counter with 2 NIXIE tube readouts. Set the desired count on the 10 position rotary switches, and the logic will count up, giving an output at the desired count. The board contains 2 74141 decoders, 2 7490 decade counters, and 7 ITT High Noise Immunity Logic ICs. Easily worth the price for the chips alone! 4 1/4" x 10 1/2". 1 lb.

STOCK NO. P6283 \$7.95 each, 2/15.00



MOTOROLA OPTICAL COUPLER

Optical coupler in 6 pin mini-DIP. GaAs diode source, NPN phototransistor. Optical couplers have essentially an infinite isolation between input & output, making them ideal

for controlling AC with TTL, controlling high voltage with TTL, interfacing any 2 logic families, or anyplace a buffer is needed.

STOCK NO. P4524 \$1.00 each, 6/5.00

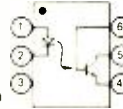

Send for new 88 page Catalog 16, bigger than ever. MASTERCHARGE & BANKAMERICARD now accepted. Minimum cash order \$5, minimum charge order \$15. Phone orders accepted. Include sufficient postage, excess refunded.



DELTA ELECTRONICS CO.

BOX 1, LYNN, MASSACHUSETTS 01903
 Phone (617) 388-4705

CIRCLE NO. 18 ON FREE INFORMATION CARD

CB SPECIALS-R.F. DRIVERS-R.F. POWER OUTPUTS-FETS

2SC481 1.85	2SC7671 15.75	2SC866 5.85	2SC1449-1 1.60	40081 3.00
2SC482 1.75	2SC773 85	2SC013 1.50	2SC475 1.50	40082 3.00
2SC495 1.10	2SC774 1.75	2SC1014 1.50	2SC1678 5.50	2SC608 4.85
2SC502 3.75	2SC775 2.75	2SC1017 1.50	2SC1679 4.75	SK3046 2.15
2SC517 4.75	2SC776 3.00	2SC1018 1.50	2SC1728 2.15	SK3047 3.75
2SC614 3.80	2SC777 4.75	2SC1173 1.25	2SC1760 2.15	SJ2095 3.50
2SC615 3.90	2SC778 3.25	2SC1226A 1.25	2SC1816 5.50	SK3048 3.25
2SC616 4.15	2SC797 2.50	2SC1237 4.50	2SC1908 .70	SK3054 1.25
2SC617 4.25	2SC798 3.10	2SC1239 3.50	2SC1957 1.50	
2SC699 4.75	2SC781 3.00	2SC1243 1.50	2SF8 3.00	2SK19 1.75
2SC710 .70	2SC789 1.00	2SC1306 4.75	HEP-S3001 3.25	2SK30 1.00
2SC711 .70	2SC796 3.15	2SC1306-14 90	2SD235 1.00	2SK33 1.20
2SC735 .70	2SC799 4.25	2SC1307 5.75	MRF8004 3.00	
2SC756 3.00	2SC802 3.75	2SC1307-16 4.00	4004 3.00	3SK40 2.75
2SC765 9.50	2SC803 4.00	2SC1377 5.50	4005 3.00	3SK45 2.75
2SC766 10.15	2SC839 85	2SC1449 1.30	40080 1.25	3SK49 2.75

JAPANESE TRANSISTORS

2SA52 .60	2SB187 .60	2SC458 .70	2SC815 .75	2SC1569 1.25
2SA316 .75	2SB235 1.75	2SC460 .70	2SC828 .75	2SC1756 1.25
2SA473 .75	2SB303 .65	2SC478 .80	2SC829 .75	
2SA483 1.95	2SB324 1.00	2SC491 2.50	2SC830 1.60	2SD30 .95
2SA489 .80	2SB337 2.10	2SC497 1.60	2SC839 85	2SD45 2.00
2SA490 .70	2SB367 1.60	2SC515 .80	2SC945 65	2SD65 .75
2SA505 .70	2SB370 .65	2SC535 .75	2SC1010 80	2SD68 .90
2SA564 .50	2SB405 .85	2SC536 .65	2SC1012 80	2SD72 1.00
2SA628 .65	2SB407 1.65	2SC537 .70	2SC1051 2.50	2SD88 1.50
2SA643 .85	2SB415 .85	2SC563 2.50	2SC1061 1.65	2SD151 2.25
2SA647 2.75	2SB461 1.25	2SC605 1.00	2SC1079 3.75	2SD170 2.00
2SA673 .85	2SB463 1.65	2SC620 .80	2SC1096 1.20	2SD180 2.75
2SA679 3.75	2SB471 1.75	2SC627 1.75	2SC1098 1.15	2SD201 1.95
2SA682 .85	2SB474 1.50	2SC642 3.50	2SC1115 2.75	2SD218 4.75
2SA699 1.30	2SB476 1.25	2SC643 3.75	2SC1166 .70	2SD300 2.50
2SA699A 1.75	2SB481 2.10	2SC644 .70	2SC1170 4.00	2SD313 1.10
2SA705 .55	2SB492 1.25	2SC681 2.50	2SC1172B 4.25	2SD315 .75
2SA815 .85	2SB495 .95	2SC684 2.10	2SC1209 .55	2SD318 .95
2SA816 .85	2SB507 .90	2SC687 2.50	2SC1213 .75	2SD341 .95
	2SB511 .70	2SC696 2.35	2SC1226 1.25	2SD350 3.25
2SB22 .65		2SC712 .70	2SC1243 1.50	2SD352 .80
2SB54 .70	2SC206 1.00	2SC713 .70	2SC1293 85	2SD380 5.70
2SB56 .70	2SC240 1.10	2SC732 .70	2SC1308 4.75	2SD389 .90
2SB77 .70	2SC261 .65	2SC733 .70	2SC1347 80	2SD-390 .75
2SB128 2.25	2SC291 .65	2SC739 .70	2SC1383 75	2SD437 5.50
2SB135 .95	2SC320 2.00	2SC715 1.75	2SC1409 1.25	
2SB152 4.50	2SC352 .75	2SC762 1.90	2SC1410 1.25	C106B1 .50
2SB173 .55	2SC353 .75	2SC783 1.00	2SC1447 1.25	
2SB175 .55	2SC371 .70	2SC784 .70	2SC1448 1.25	MPS-U31 4.00
2SB178 1.00	2SC372 .70	2SC785 1.00	2SC1507 1.25	
2SB186 .60	2SC394 .70	2SC793 2.50	2SC1509 1.25	

POWER-TRANSISTORS HIGH-VOLT. TV. TYPE

BU204 1300V 3.90	BU207 1300V 5.40	2SC1172B 1100V 4.25
BU205 1500V 4.70	BU208 1500V 6.25	2SC308 1100V 4.95
BU206 1700V 5.90	2SC1170 1100V 4.00	2SC1325 1100V 4.95

APRIL 1976

CIRCLE NO. 42 ON FREE INFORMATION CARD

OEM SPECIALS

1N270 .10	2N960 .55	2N2219A .30	2N2913 .75	2N3740 1.00	2N4401 .20
1N914 .10	2N962 .40	2N2221 .25	2N2914 1.20	2N3771 1.75	2N4402 .20
	2N967 .50	2N2221A .30	2N2916A 3.65	2N3732 1.90	2N4403 .20
2N173 1.75	2N1136 1.35	2N2222 .25	2N3019 .50	2N3773 3.00	2N4409 .20
2N178 .90	2N1142 2.25	2N2222A .30	2N3053 .30	2N3819 .32	2N4410 .25
2N327A 1.15	2N1302 .25	2N2270 .40	2N3054 .70	2N3823 .70	2N4416 .75
2N334 1.20	2N1305 .30	2N2322 1.00	2N3055 .75	2N3856 .20	2N4441 .85
2N336 .90	2N1377 .75	2N2323 1.00	2N3227 1.00	2N3866 .85	2N4442 .90
2N338A 1.05	2N1420 .20	2N2324 1.35	2N3247 3.40	2N3903 .20	2N4443 1.20
2N398B .90	2N1483 .95	2N2325 2.00	2N3250 .50	2N3904 .20	2N4852 .55
2N404 .30	2N1540 .90	2N2326 2.85	2N3375 6.50	2N3905 .20	2N5061 .30
2N443 1.75	2N1543 2.70	2N2327 3.80	2N3393 .20	2N3906 .25	2N5064 .50
2N456 1.10	2N1544 .80	2N2328 4.20	2N3394 .17	2N3925 3.75	2N5130 .20
2N501A 3.00	2N1549 1.25	2N2329 4.75	2N3414 .17	2N3954 3.50	2N5133 .15
2N508A .45	2N1551 2.50	2N2368 .25	2N3415 .18	2N3954A 3.75	2N5138 .15
2N555 .45	2N1552 3.25	2N2369 .25	2N3416 .19	2N3955 2.45	2N5198 3.75
2N652A .85	2N1554 1.25	2N2484 .32	2N3417 .20	2N3957 1.25	2N5294 .50
2N677C 6.00	2N557 .15	2N2712 .18	2N3442 1.85	2N3958 1.20	2N5296 .50
	2N1560 2.80	2N2894 .40	2N3553 1.50	2N4037 .60	2N5306 .20
2N706B .40	2N1605 .35	2N2903 3.30	2N3563 .20	2N4093 .85	2N5354 .20
2N711 .50	2N1613 .30	2N2904 .25	2N3565 .20	2N4124 .20	2N5369 .20
2N711B .60	2N1711 .30	2N2904A .30	2N3638 .20	2N4126 .20	2N5400 .40
2N718 .25	2N1907 4.10	2N2905 .25	2N3642 .20	2N4141 .20	2N5401 .50
2N718A .30	2N2060 1.85	2N2905A .30	2N3643 .15	2N4142 .20	2N5457 .35
2N720A .50	2N2102 .40	2N2906 .25	2N3645 .15	2N4143 .20	C103Y .25
2N918 .35	2N2218 .25	2N2906A .30	2N3646 .14	2N4220A 45	C103D .40
2N930 .25	2N2218A .30	2N2907 .25	2N3730 1.50	2N4234 95	C106B1 .50
2N956 .30	2N2219 .25	2N2907A .30	2N3731 2.75	2N4400 .20	C106D1 .75

SILICON UNIJUNCTIONS

2N2646 50	2N2160 65
2N2647 60	2N4870 50
2N6027 .55	2N4871 50
2N6028 .70	2N4891 50
D5E37 .25	2N4892 50
	2N4893 50
	2N4894 .50
	MU10 .40

INTEGRATED CIRC.

UA703C .40
709C OP. AMP. .25
741C OP. AMP. .25
7400 .15
7404N .18
7430N .19
9L00/74LS00 .35
74H55N .35

RECTIFIERS

	10	100
IN4001	60	5.00
IN4002	70	6.00
IN4003	80	7.00
IN4004	90	8.00
IN4005	1.00	9.00
IN4006	1.10	10.00
IN4007	1.20	11.00



New-Tone Electronics
 P.O. Box 1738 A
 Bloomfield, N.J. 07003
 Phone: (201) 762-9020

ALL PARTS GUARANTEED AND TESTED ON PREMISES.

N.J. residents add 5% sales tax. Minimum order \$5.00. All orders add \$1.00 postage. Dealers write or phone for discount prices.

VIDEO CAMERA KIT

A UNIQUE ALL SOLID STATE CAMERA KIT
FEATURING A... 100 X 100 BIT
SELF SCANNING CHARGED
COUPLED DEVICE

INCLUDES THE FOLLOWING
UNIQUE FEATURES
FOUND IN FAR MORE
EXPENSIVE CAMERAS
IF AVAILABLE

- LOW VOLTAGE SUPPLY (OR BATTERIES) + 5 AND +15 VOLTS WELL AS VISIBLE LIGHT
- SENSITIVE TO INFRARED AS WELL AS VISIBLE LIGHT
- MAY BE USED FOR IR SURVEILLANCE WITH AN IR LIGHT SOURCE
- EXCELLENT FOR STANDARD SURVEILLANCE WORK BECAUSE OF ITS LIGHT WEIGHT AND SMALL SIZE
- ALL COMPONENTS MOUNTED ON TWO PARALLEL 3" X 5" SINGLE SIDED BOARDS. TOTAL WEIGHT UNDER 2 LBS
- MAY BE WIRED BY PERSON WITH SOME TECHNICAL EXPERIENCE IN 4-6 HRS



SUPER UNBELIEVABLE
ONLY **\$225.00**

ADD \$2.00 POSTAGE AND HANDLING PLUS \$4.00 FOR ALL IC SOCKETS (Optional)

MAY BE USED WITH AMATEUR RADIO FOR VIDEO

USED FOR CHARACTER RECOGNITION FOR COMPUTERS WITH EXTERNAL CIRCUITS

MAY BE USED IN A VACUUM, UNDER WATER, HIGH ALTITUDE, AND IN MAGNETIC ENVIRONMENT BECAUSE THERE IS NO HIGH VOLTAGE OR MAGNETIC DEFLECTION

WE SUPPLY ALL SEMICONDUCTORS, BOARDS, DATA SHEETS, DIAGRAMS, RESISTORS AND CAPACITORS

SORRY WE DO NOT SUPPLY THE CASE, BATTERIES (OR SUPPLY) THE LENSE (NOT SUPPLIED) DEPENDS UPON THE USE

F8 MICROPROCESSOR KIT

WE'VE GOT THE F8 MICROPROCESSOR KIT, ONE OF THE MOST ADVANCED MCU SYSTEMS ON THE MARKET TODAY FOR ONLY **\$179.00**

The three chip microprocessor system has the following advantages:

- 1) Driven by a +5 and +12 volt power supply
- 2) Two I/O ports on the CPU chip and ROM, making 32 bidirectional lines
- 3) 64 bytes of fast RAM scratchpad built into the CPU chip
- 4) A built-in clock generator and power on reset built into the CPU chip
- 5) A programmable internal timer built into the ROM chip
- 6) 80% of the instructions are 1 byte
- 7) TTL I/O compatibility
- 8) consumes less than 300mw of power per chip
- 9) A local interrupt with automatic address vector
- 10) expandable to 64K bytes (2102 2) of memory

The F8 Kit has enough parts and instructions to demonstrate microprocessor programs up to 1K byte, and to debug those programs

We supply:

1. 3850 CPU
1. 3851A FAST-BUG programmed storage unit provides the programmer with all its I/O subroutine and allows the programmer to display or alter memory and register contents via a teletype terminal
1. 3853 Static memory interface
- 2 102 2
1. Plus CMOS gates and buffers, PC card, instruction manuals, programming guide and time sharing guide

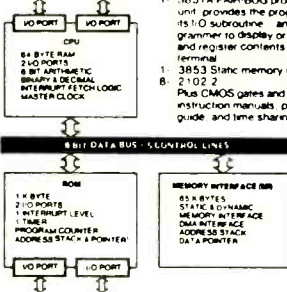

INTEL 8080 CPU	\$37.50
8008 8 BIT MICRO PROCESSING CHIP (with Data Book)	\$19.00
2102 2 1024 BIT RAM	\$ 2.95
5202A UV PROM	\$12.50
MM5203 UV PROM	\$12.50
1702A UV PROM	\$12.50
5204 4K PROM	\$24.95
MINATURE MULTI-TURN TRIM POTS	100, 500
5K 10K 25K 50K 100K 200K	\$ 7.50 ea.
MULTI-TURN TRIM POTS Similar to Bouras 3010 style 1/4" x 1/4" x 1/4", 50, 100, 10,000 ohms	\$15.00 ea.
LIGHT ACTIVATED SCR's TO 18 200V 1A	\$17.75

PRINTED CIRCUIT BOARD	
4 1/2" x 6" SINGLE SIDED EPOXY BOARD 1/16" thick, unetched	\$5.50 ea.
VECTOR BOARD 1" SPACING 4.5" x 6.5" SHEET	\$1.50
4 WATT IR LASER DIODE	\$7.95
2N5480T FET	\$ 45
2N5457 N FET	\$ 45
2N 4891 UJT	\$ 45
TS 43 UJT	\$ 35
IR 900 TRIGGER DIODES	4/81.00
2N 6028 PROG UJT	\$ 85

VERIPAX PC BOARD	
This board is a 1/4" single sided paper epoxy board 4 1/2" x 6 1/2" DRILLED and ETCHED which will hold up to 21 single 14 pin IC's or 8, 16, or LSI DIP IC's with buses for power supply connector \$5.25	
MV 5691 YELLOW-GREEN BIPOLAR LED	\$1.25
MT 2 PHOTO TRANS	\$ 60
RED YELLOW GREEN OR AMBER LARGE LED'S	ea. \$ 20
14 PIN DIP SOCKETS	\$ 35
16 PIN DIP SOCKETS	\$ 38
MOLEX PINS	100/\$1.00 1000/\$8.00
8 PIN MINI DIP SOCKETS	\$ 30
10 PIN TO 5 TEFLOON PC SOCKETS	\$ 60
10 WATT ZENERS 3.9 4.7 12 18 OR 22V	ea. \$ 60
1 WATT ZENERS 4.7 5.6 10 12 15 18 OR 22V	ea. \$ 25

Silicon Power Rectifiers	
PRV 1A 3A 12A 50A 125A	
100 06 14 30 80	
200 07 20 35 115 4 25	
400 09 25 50 1 40 6 50	
600 11 30 70 1 80 8 50	
800 15 35 90 2 30 10 50	
1000 20 45 110 2 75 12 50	

REGULATED MODULAR POWER SUPPLIES	
+ - 15VDC AT 100ma	
115VAC INPUT	\$24.95
5VDC AT 1A 115VAC INPUT	\$24.95
12V 5A	\$24.95
IN 4148 (IN914)	15/\$1.00
1103 1024 bit RAM	\$2.75
NEC 6003 2048 bit RAM	\$8.00
1101 256 bit RAM	\$1.40
7489 RAM	\$2.30
7 POLE 1 THROW TO 5 MINATURE ROTARY SWITCH	
5-30V LOW CURRENT	\$1.15

TRANSISTOR SPECIALS	
2N3585 NPN Si TO-92	\$ 95
2N4722 NPN Si TO-18	\$1.00
2N4901 PNP Si TO-3	\$ 85
2N5086 PNP Si TO-92	4/81.00
2N4898 PNP TO 66	\$ 60
2N404 PNP GE TO-5	5/51.00
2N3919 NPN Si TO-3 RF	\$1.50
MPSA13 NPN Si TO-92	3/51.00
2N1367 NPN Si TO-66	\$ 95
2N2222 NPN Si TO-18	\$1.00
2N3055 NPN Si TO-3	\$ 80
2N3904 NPN Si TO-92	5/51.00
2N3906 PNP Si TO-92	5/51.00
2N5296 NPN Si TO-220	\$ 50
2N6109 PNP Si TO-220	\$ 55
2N3866 NPN Si TO-5	\$ 75
2N3638 NPN Si TO-5	\$ 95
2N6517 NPN TO-92 Si	3/1.00

TANTULUM CAPACITORS	
22UF 35V 5/51.00	6.8UF 35V 3/51.00
47UF 35V 5/51.00	33UF 25V \$ 40
68UF 35V 5/51.00	300UF 6V \$/51.00
1UF 35V 5/51.00	150UF 20V \$ 50
47UF 35V 4/51.00	

CT7001 ALARM CLOCK CHIP		\$5.75
FPA 711-7 LEVEL Diode Array Optical Tape Readers		\$5.95
MM1402-3 20	MM5057-4 00	
MM1403-3 20	MM5058-4 95	
MM1404-2 50	MM5080-4 95	
MM5013-7 75	MM5081-4 30	
MM5016-3 50	MM5555-6 25	
MM5017-4 75	MM5556-6 25	
MM5056-1 00	MM5210-1 95	
MM5058-4 00	MM5280-2 95	

TTL IC SERIES	
74L00- 26	7476- 35
7400- 14	7480- 48
7401- 15	7483- 75
7402- 15	7485- 105
7403- 15	7486- 34
7404- 18	7490- 49
7405- 18	7491- 79
7406- 35	7492- 49
7407- 33	7493- 49
7408- 18	7495- 74
7409- 18	7496- 75
7410- 15	74107- 34
7411- 25	74121- 38
7412- 30	74123- 74
7413- 45	74125- 54
7414- 145	74126- 54
7416- 33	74150- 92
7417- 33	74151- 69
7420- 15	74153- 79
7425- 27	74154- 105
7426- 24	74155- 105
7427- 27	74157- 75
7430- 15	74161- 95
7432- 24	74164- 110
7437- 29	74165- 110
7438- 29	74173- 35
7439- 15	74175- 95
7441- 95	74177- 75
7442- 59	74181- 230
7445- 79	74192- 110
7446- 87	74193- 110
7447- 87	74194- 115
7448- 85	74195- 74
7472- 28	74196- 95
7473- 34	75324- 75
7474- 35	75491- 110

ALCO MINATURE TOGGLE SWITCHES	
MTA 106 SPDT	\$1.20
MTA 208 DPDT	\$1.70

CMOS (DIODE CLAMPED)		
74C02- 26	4013- 45	4028- 95
74C10- 30	4015- 124	4029- 120
4001- 24	4017- 115	4030- 49
4002- 24	4018- 214	4035- 150
4006- 135	4019- 50	4042- 75
4007- 24	4022- 124	4046- 275
4009- 50	4023- 24	4047- 350
401- 50	4025- 24	4050- 49
4011- 24	4026- 190	4055- 195
4012- 24	4027- 55	4066- 100

FND 503 5°C C	\$1.75
HP 9740 3°C C	\$1.40
MAN-4 25°C A	\$1.20
MAN-7 3°C A	\$1.25
DL 747 6°C A	\$1.95
NS 33-3 dig array	\$1.35

Full Wave Bridges	
PRV 2A 6A 25A	
200 95 125 200	
400 1 15 1 50 3 00	
600 1 35 1 75 4 00	

CD 110 LINEAR 256 BIT SELF SCANNING CHARGED COUPLED DEVICE		\$125.00
SANKEN AUDIO POWER AMPS		\$1.95
SI 1010 G 10 WATTS		\$ 6.90
SI 1020 G 20 WATTS		\$13.95
SI 1050 G 50 WATTS		\$24.95

LINEAR CIRCUITS		
LM 309K 5V 1A REGULATOR	\$1.00	
723 - 40 x 40V REGULATOR	\$.54	
301/748 Hi Per Op Amp	\$.28	
320T 5 12 15 OR 24V		
NEGATIVE REG		\$1.50
741A or 741C OP AMP	\$ 31	
709C OPER AMP	\$ 25	
307 OP AMP	\$ 25	
CA 3047 HI PERF OP AMP	\$1.95	
CA 3089 FM I/O SYSTEM	\$3.25	

REG TO 220	
101 OPER AMP HI PERFORM	\$ 75
LM 308 Oper Amp Low Power	\$1.05
747 - DUAL 741	\$ 85
556 - DUAL TIMER	\$ 95
537 - PRECISION OP AMP	\$2.60
540 70W POWER DRIVER	\$2.50
LM 3900 - QUAD OP AMP	\$ 49
LM 324 - QUAD 741	\$1.50
560 - PHASE LOCK LOOP	\$2.50
565 - PHASE LOCK LOOP	\$2.50
565 - PHASE LOCK LOOP	\$1.50
566 FUNCTION GEN	\$2.50
567 - TONE DECODER	\$1.50
LM 1310N FM STEREO DEMOD	\$2.75
8038 IC VOLTAGE CONT OSC	\$3.80
LM370 - AGC SQUELCH AMP	\$1.15
555 - 2/5 - 1 HR TIMER	\$ 53
553 QUAD TIMER	\$3.50
FCD 810 OPTO ISOLATOR	\$ 85
1458 DUAL OP AMP	\$ 55
LM 380 - 2W AUDIO AMP	\$ 80
LM 377 - 2W Stereo Audio Amp	\$2.50
LM 381 - STEREO PREAMP	\$1.00
LM 382 - DUAL AUDIO PRE AMP	\$1.00
LM 311 - HI PER COMPARTOR	\$1.95
LM 319 - Dual Hi Speed Comp	\$1.10
LM 339 - QUAD COMPARTOR	\$1.25

TRIACS	
PRV 1A 10A 25A 15A 6A 35A	
100 40 70 130 40 50 1 20	
200 70 10 1 75 60 70 1 60	
400 1 10 1 60 2 60 1 00 1 20 2 20	
600 1 70 2 30 3 60 1 50 3 00	

Send 20c for our catalog featuring Transistors and Rectifiers
145 Hampshire St Cambridge Mass

INSTRUCTION

LEARN ELECTRONIC ORGAN SERVICING at home all makes including transistor Experimental kit-trouble-shooting Accredited NHSC Free Booklet: NILES BRYANT SCHOOL 3631 Stockton Dept A Sacramento Calif 95820.

LEARN WHILE ASLEEP Hypnotize! Strange catalog free Auto-suggestion. Box 24-ZD Olympia Washington 98501.

ELECTRONICS College Degree FCC License Either both through correspondence Catalog Grantham 2000 Stoner Avenue Los Angeles California 90025

INTENSIVE 5 week course for Broadcast Engineers F C C First Class License Radio Engineering Incorporated 61 N Pineapple Ave Sarasota Florida 33577 and 2402 Tidewater Trail, Fredericksburg VA 22401.

F.C.C. EXAM MANUAL

PASS FCC EXAMS! Memorize, study - Test Answers for FCC 1st and 2nd Class Radio Telephone licenses. Newly revised multiple choice questions and diagrams cover all areas tested in FCC exams plus "Self-Study Ability Test." \$9.95 postpaid. Moneyback Guarantee.

COMMAND PRODUCTIONS P.O. BOX 26348-P
800D (RENTING) BLDG SAN FRANCISCO, CALIF. 94126

SCORE high on F C C Exams Over 300 questions and answers Covers 3rd 2nd 1st and even Radar Third and Second Test, \$14.50 First Class Test, \$15.00 All tests, \$26.50 R E I Inc. Box 806 Sarasota Fla 33577

UNIVERSITY DEGREES BY MAIL! Bachelors Masters Ph D's Free revealing details Counseling Box 1162-PE4, Tustin California 92680

SELF-STUDY CB RADIO REPAIR COURSE THERE'S MONEY TO BE MADE REPAIRING CB RADIOS This easy-to-learn course can prepare you for a career in electronics enabling you to earn as much as \$16.00 an hour in your spare time. For more information write CB RADIO REPAIR COURSE Dept PE046 531 N Ann Arbor Oklahoma City Okla 73127

NO FCC LICENSE? Tried every way but the right way? It's time for Genn Tech Home Study Free Catalog 5540 Hollywood Blvd., Los Angeles Calif 90028

BROADCAST STATION - Start your own at home school church business Free details Broadcast Development, Box 5516-AC Walnut Creek CA 94596

LEARN Basic Digital Troubleshooting by correspondence Information Free Educational Technologies, Box 224 Reynoldsburg Ohio 43068

AMATEUR Radio Complete no-textbook correspondence U.P. Code and Theory license courses Ron Reed Electronics Institute 12217 Santa Monica Blvd. Los Angeles Calif. 90025

DIGITAL Design Newsletter theory construction kits Sample \$1.00 ROM ASSOCIATES Box 296P Weston Mass 02193

GOVERNMENT SURPLUS

GOVERNMENT Surplus How and Where to Buy in Your Area. Send \$2.00 Surplus 30177-PE Headquarters Bldg., Washington D C 20014

MANUALS for Govt Surplus radios, test sets, scopes. List 50 cents (coin) Books, 7218 Roanne Drive Washington D C 20021

JEEPS TRUCKS Typically From \$52.40 Automobiles, Boats, Motorcycles, Airplanes, Oscilloscopes, Tools, Clothing Sports Camping Photographic Electronics Equipment 200,000 Bid Bargains Nationwide Direct From Government Low as 2 cents on Dollar! Surplus Catalog and Sales Directory \$1.00 (refundable first order). National Surplus Center, 240 Eastcass-PEL Joliet IL 60432

PERSONALS

MAKE FRIENDS WORLDWIDE through international correspondence. Illustrated brochure free. Hermes Berlin 11, Box 110660/ZD Germany

Ph.D.S MASTER'S BACHELORS - official nonresident College Degrees easily acquired through major Universities. Complete Revealing Directory - \$2 Counseling Connection, 5495 Claremont, No BSG Oakland CA 94618

NEW LUXURY CAR without cost! Free details CODEX-DD Box 6073, Toledo, Ohio 43614

RUBBER STAMPS

RUBBER ADDRESS STAMPS Free Catalog 45 type styles Jackson's, Dept. K, Brownsville Rd., Mt. Vernon, Ill. 62864

SOLID STATE SALES

P.O. BOX 74A
SOMERVILLE, MASS. 02143 TEL. (617)547-4005

WE SHIP OVER 95% OF OUR ORDERS THE DAY WE RECEIVE THEM

APRIL 1976
ADVERTISERS INDEX

READER SERVICE NO.	ADVERTISER	PAGE NUMBER
	A P Products	96
	Acoustic Fiber Sound Systems, Inc.	65
2	Adva Electronics	118
3	Allison Automotive Company	100
	Alpha Electronics	101
4	Altaj Electronics	121
5	Ancrona Corp	117
6	Ancrona Corp	118
7	Ancrona Corp	119
8	Ancrona Corp	120
10	Antenna Specialists Co	91
	Audio Technica U.S. Inc.	105
11	Avanti Research & Development, Inc.	26
73	B & K Precision, Product of Dynascan	104
12	Browning Laboratories Inc	6
72	C B Radio	108
	CREI Capitol Radio Engineering Institute	72, 73, 74, 75
13	Circuit Design, Inc.	18
	Cleveland Institute of Electronics, Inc.	82, 83, 84, 85
14	Cobra, Product of Dynascan	SECOND COVER
15	Continental Specialties Corporation	27
16	Continental Specialties Corporation	45
17	Continental Specialties Corporation	105
18	Delta Electronics Co	125
19	Delta Products, Inc.	97
20	Digi-Key Corporation	120
21	EICO	48
22	Edie Electronics, Inc.	122
23	Edmund Scientific Co	109
24	Edmund Scientific Co	128
25	Electronics Distributors Inc.	127
70	Electronic Warehouse Inc	110
26	Electronics Technical Institute	2
27	Empire Scientific	8
28	Godbout Electronics, Bill	122
5	Heath Company	92, 93, 94, 95
29	Hufco	103
30	IMS Associates Inc	1
31	IMS Associates Inc	118
32	Illinois Audio	106
34	International Electronics Unlimited	116
69	Jade Co	101
35	James	114, 115
33	Johnson Co., E F	FOURTH COVER
75	Kris, Inc.	14
36	Lafayette Radio Electronics	29
40	McIntosh Laboratory, Inc.	100
41	McKay Dymek Co	96
37	MIIS	15
38	MOS Technology Inc	71
39	Miami Projection Television	108
	NRI Schools	20, 21, 22, 23
	National Technical Schools	30, 31, 32, 33
42	New-Tone Electronics	125
43	Non-Linear Systems, Inc.	108
44	Olson Electronics	125
45	PAIA Electronics Inc	104
46	Pathcom Inc	19
47	Phase Linear Corporation	89
48	Poy Paks	113
49	Poy Paks	124
50	Polymorphic Systems	99
	Processor Technology	16
51	Quest Electronics	124
52	Radio Shack	79
53	S B E Inc	4
54	S D Sales Co	123
	Sams Co., Howard W	107
55	Sansui Electronics Corp	25
	Schneider Publications, Inc.	69
56	Schober Organ Corp., The	106
57	Sencore	98
58	Shakespeare Antenna Group	101
	Sinclair Radionics, Inc.	77
59	Solid State Sales	126
71	Southwest Technical Products Corporation	87
60	Sphere Corporation	102
61	Stanton Magnetics, Inc.	THIRD COVER
62	Stereo Discounters	104
63	Tab Books	7
64	Tri-Star Corporation	108
68	Triplet	81
74	Turner	103
1	U S Pioneer Electronics	10, 11, 12, 13
65	Weiler-Xcelite Electronics Division	106
66	Winogard Company	34
67	Yamaha International Corporation	17

APRIL 1976

PRO SPORTS ACTION FILMS

WE'RE NOT FOOLING! SPECIAL FOR APRIL Apollo 15, The Ride of The Rover, 200' Super 8, B & W, \$3.95 ea PPD — you save \$5.00! World Cup Soccer — Italy vs. Brazil; Germany vs. Italy, 200' Super 8, B & W, \$4.95 ea PPD. '72 Super Bowl (Cowboys vs. Dolphins), Super 8, B & W, 200' reel, \$5.95 ea PPD WHILE THEY LAST. Also, '70 Super Bowl (Chiefs vs. Vikings), Standard 8, 200', B & W, \$4.95 per reel PPD. NEW Castle catalog, 45 cents. Sportlite and Columbia order forms, 50 cents. WRITE NOW order these Sportlite Specials! SPORTLITE, Elect-4, Box 24-500, Speedway, Indiana 46224

RECORDS

OLDIES 45rpm Free Catalog. Corry's Record Shop, Box 166TE, Mason, Ohio 45040.

FREE RECORD COLLECTION Reviewers wanted. Anyone qualifies. We ship you new records to review. You pay postage. Records are free. Applicants accepted "first come" basis. Write Research PE, 6162 Washington Circle, Milwaukee, Wisconsin 53213

PRINTING

PRINTING Type, Cuts, Ornaments. Your monogram cut and list \$1.00. Moneyback Guarantee. Superior, Box 487, Lee's Summit, MO 64063

BOOKS AND MAGAZINES

FREE book prophet Elijah coming before Christ. Wonderful bible evidence. Megiddo Mission, Dept. 64, 481 Thurston Rd., Rochester, N.Y. 14619

POPULAR ELECTRONICS INDEXES Detailed and complete subject indexes available to magazine years 1974, 1973, and 1972. Hundreds of subject references to help you quickly find that special project article or product test. 1972, 1973 and 1974 editions \$1.50 each. All three editions only \$4.00. INDEX Box 2228, Falls Church, Va 22042

FREE CATALOG Aviation and Space Books. Aero Publishers, 329PE West Aviation, Fallbrook, California 92028

THE AUDIO AMATEUR A quarterly publication for the serious audio constructor. Free prospectus. The Audio Amateur Box 176Z Peterborough, N.H. 03458

AVOID SPEEDING TICKETS A complete book on defensive driving tactics showing step by step procedures in dealing with radar speed control. \$1.95 plus 30 cents handling. Write Booklet, 6728 Harvest Glen, Dallas, Texas 75240

1976 Electronic Experimenter's Handbook



This latest edition helps you get it together with a score of mind-absorbing, build-it-yourself projects—all with complete construction plans, including parts lists and printed circuit board patterns. Many products are unique designs, not available anywhere else. And in all cases, you save money by building your own! Only \$1.85!

Order your copy from the Ziff Davis Publishing Company, Consumer Service Division, 595 Broadway, New York, N.Y. 10012. Enclose \$1.85 (\$1.50 plus 35c for postage and handling). Outside U.S.A. \$3.00, postpaid. Residents of Calif., Col., Fla., Ill., Mich., Mo., N.Y., State, D.C. and Tex. add applicable sales tax (postage and handling charges are non-taxable).

DO-IT-YOURSELF

TELEPHONES, All Types Equipment, Supplies, Keyed, Regular, Decorator Catalog, 50 cents Box 1654J, Costa Mesa, California 92626

TV PROBLEMS? Send symptoms / copy schematic / self addressed-stamped envelope with \$3.00. Troubleshooter, Box 4553-PE, Downey, Calif. 90241.

EMPLOYMENT OPPORTUNITIES

ELECTRONICS/AVIONICS EMPLOYMENT OPPORTUNITIES. Report on jobs now open. Details FREE Aviation Employment Information Service, Box 240E Northport, New York 11768.

CALIFORNIA companies hiring Engineers and Technicians. Current openings bulletin \$3. Dynamics, Box 1867-K, Covina, Calif. 91722.



4-RANGE DIGITAL READOUT INTERVAL TIMER KIT

• 4 time functions 1.99 Sec., 1.99 Sec., 1.99 Min., 1.99 Min. • 1/2" High Nixie Tube Readouts • For darkroom use in both processing & enlarging processes • As a timer for sport & contest events (Stop switch) • Provides timed 120V AC output and S.P. NO contact to trigger buzzer alarm or visual signals. • Full Wiring Instructions included — No Cabinet Or Case Available For Timer

100.00 VALUE

SPECIAL 19.99



24-KEY DESK CALCULATOR KEYBOARD

• Touch tone type contacts • Complete on circuit board • Frame bolts easy and simple switches • 7 3/8" S x 3 11/16" D x 1 1/4" height • 1/2" x 1 1/4" lowest point • Shipping w/ 10

1.99 3/5.50



12 VOLT DC SPDT MINIATURE COAXIAL RELAY

• 75 Ohm coil • Designed for eff. Cent transfer of RF energy at extremely low loss



INDOOR/OUTDOOR LIGHTING TRANSFORMER

• 8 Volt 6 Amp • Use for lighting signs, holiday decorations, outdoor lighting of low voltage — no worry of high voltage • Power factor 100% • 100% efficiency • Main used for the hobbyist or professional • The outdoor alarm systems which employs the use of automatic timer, alarm, or remote control. • Complete, installed 117V AC primary 8 amp or more. Fuse for outdoor use.

2.88

99

SPERRY 9-DIGIT SP-425-09 PLANAR PLASMA DISPLAY



Features: Character height 0.25 inch • Brightness 70 foot lamberts • Viewing distance 15 feet

1.19 3/3.00



6 to 7 1/2-VOLT CASSETTE MOTOR

• Made For Low Voltage Cassette Players • Measures 1 3/8" x 1 3/4" Dia • Pulley Shaft Extends 3/8" Above Motor

1.49 3/4.00

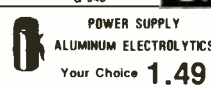

POWER SUPPLY ALUMINUM ELECTROLYTICS

Your Choice 1.49 3/4.20 10/13.00

• Especially suitable for transistORIZED circuit where high capacitance is required

Value	Length
1.745	5500 25V DC
1.748	8200 25V DC
1.749	10000 25V DC
1.749	15000 25V DC
1.749	20000 25V DC
1.749	30000 25V DC

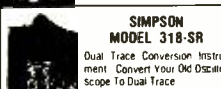

SIMPSON MODEL 318-SR LOW VOLTAGE POWER SUPPLY

Dual Trace Conversion Instrument. Convert Your Old Oscilloscope To Dual Trace. Simpson Regular Suggested Price...\$189.95

29.99



SOLID STATE SPECIALS (ALL PRIME MERCHANDISE)

EDI PT. NO.	Part	Pkg. of 10	Pkg. of 100
E-229	IN4003	.69/Pkg.	.69/Pkg.
E-228	IN270	.17 ea	.17 ea
E-228	TTL-7440E	.89 ea.	.89 ea.
E-227	TTL-7448	.29	10/2.50
G.E.	C103B	.69	.69
E-205	LM380	.39	3/1.00
E-65	741	.69	.69
E-214	747	.69	.69
E-213	LM565	1.49	3/3.80
E-215	LM309K	.69	.69
E-216	ML-741CS	.69	.69
E-217	TTL-7447	.69	.69
E-237	2SB473	1.29	10/12.00

Send for free catalog - satisfaction guaranteed. Min. Order \$3.00 - Allow For Postage. Ill. Residents Add 5% Sales Tax. Prices good thru May 1, 1976 or while stocks last.

ELECTRONIC DISTRIBUTORS, INC. DEPT. PE 2-4900 ELSTON CHICAGO, ILL. 60630 Tel: 312 283-4800

CIRCLE NO. 25 ON FREE INFORMATION CARD

REAL ESTATE

BIG NEW SUMMER CATALOG Free! Over 2,600 top values coast to coast! UNITED FARM AGENCY, 612-EP West 47th, Kansas City, MO 64112.

MAGNETS

PERMANENT MAGNET MOTION. Foucault Drives. Virtual Perpetual Motion Details \$3.00. MAGNETRIKS, 6064 N. Paulina, Chicago, IL 60660.

MISCELLANEOUS

WINEMAKERS Free illustrated catalog yeasts, equipment, Semplex, Box 12276P, Minneapolis, Minn. 55412.

DISCOUNTERS of Stained Glass Supplies. Send \$1.00 for catalog. Nervo Distributors, 650 University Ave., Berkeley, CA 94710.

LIVE IN THE WORLD OF TOMORROW... TODAY!

And our FREE 164 PAGE CATALOG is packed with exciting and unusual values in electronic, hobby and science items — plus 4,500 finds for fun, study or profit... for every member of the family.

A BETTER LIFE STARTS HERE

WORLD'S SMALLEST ELECTRONIC CALCULATOR!

Small but mighty! 8-digit, 4-function *electronic* calculator does everything big ones do—even has automatic % key... for only \$19.95. Take it anywhere. Fits in your pocket— $\frac{3}{4}$ size of cigarette pack. 3½ oz. dynamo features floating decimal, constant key, lead zero depression, more! Includes plug-in rechargeable Ni-Cad battery pack. 2 x 3½ x 9/16" with plenty of room for most fingers. Another Edmund first with advanced technology.



Stock No. 1945AV \$19.95 Ppd.

SUPER POWER FOR ANY AM RADIO

New antenna assist turns a tiny transistor into a tiger, has pulled in stations up to 1000+ miles away! Just set beside radio (no wires, clips, grounding) and fine-tune Select-A-Tenna's dial to same frequency — "gangbusters"! Great for clearing weak signals in radio depressed areas, off-coast islands, crowded frequency stations. Solid state—uses no electricity, batts., tubes.



Stock No. 72,095AV \$15.95 Ppd.
ULTRA SELECT-A-TENNA
 No. 72,147AV (*OVER 1000 MI.) \$22.95 Ppd.

KNOW YOUR ALPHA FROM THETA!

For greater relaxation, concentration, monitor your Alpha/Theta brainwaves w/ audible or visible signal on Biosone II. Has 3 feedback modes, outputs to monitor logic signal, filter sel. feedback, broad sensitivity control; other professional feats. of \$200-up units. Easily operated 4-lb. portable has total brainwave monitoring capability! Req. 2 9v tr. batteries.



No. 1668 (9½ x 5¾ x 4¼") \$149.95 Ppd.
LOW COST STARTERS' UNIT (PORTABLE)
 No. 71,809 AV (4½ x 2¾ x 4¼") \$55.00 Ppd.

SEE MUSIC IN PULSATING COLOR

New 3-Channel Color Organ adds music listening pleasure, lets you modulate 3 independent strings of colored lamps with intensity of your music to create an audio "light show." They flash, vary in brightness related to music's rhythm, pitch, volume—pulsating lighting performance to music! Fully assembled & priced half that of others, the Edmund Sound to Light Control is a terrific value. Plug in, turn on!



No. 42,309AV... (ASSEMBLED) \$17.95 Ppd.
 No. 42,336AV... (UNASSEMBLED) \$13.95 Ppd.

WHEN YOU COME TO PHILADELPHIA BE SURE TO SEE
FREE BICENTENNIAL LIGHT SHOW
 IN BARRINGTON, N.J. ONLY 10 MINUTES AWAY AT
EDMUND FACTORY STORE

He-Ne LASERS FROM \$115.00



Edmund quality, TEM₀₀ mode, cold cathode for long life. Completely self-contained units; solid state power supply; 110v AC. 0.3mW min — GREAT GENERAL PURPOSE LASER: 1.2mm beam dia., 2.0mRad beam Diverg.

Stock No. 79,061AV \$115.00 Ppd.
 1.0mW min — HI-PERFORMANCE LAB LASER: 1.2mm beam dia., 1.0mRad beam Diverg.
 Stock No. 79,050AV \$180.00 Ppd.
 3.0mW min — DEPENDABLE HI-POWERED LASER: 1.0mm beam dia., 0.8mRad beam Diverg.
 Stock No. 79,052AV \$350.00 Ppd.

CAN'T SLEEP, RELAX? TRY THIS!

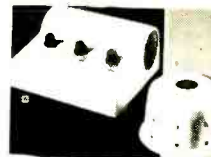

Electronic sound conditioner simulates 4 kinds of soothing sounds of ocean surf and rain. "White sound" helps mask unwanted noise, adds restful, intriguing background sound. Program the solid-state unit to your own need: 2 surf, 2 rain, or "white sound", proven by medical tests to have analgesic effects. Great for meditation, restlessness, sleeplessness psychology.

(A)-No. 71,997AV... (7½ x 7 x 3½") 110V AC \$89.95 Ppd.
 (B)-AS ABOVE, BUT "WHITE SOUND" ONLY
 No. 71,980AV... (6" Rd. x 3½" Hi) \$28.00 Ppd.

AN ALPHA MONITOR FOR \$34.95?



Yes, because you build it! Use your ability to tune in your brainwaves, an aid to relaxation, concentration. Kit incl. everything you need (except 9v trans. batt.) to own a portable self-cont. BIOFEEDBACK unit for a

pitance: steth. earphones, electrode headband, solid-state circuitry; 5 microvolt sensitivity, more! Compl. assembly instructions & op. manual. With basic electronics knowledge you can do it!

No. 61,069AV... (KIT) \$34.95 Ppd.
 No. 71,809AV... (FULLY ASSEMBLED) \$55.00 Ppd.

LOW COST 7X INFRA-RED VIEWER



For infra-red crime detection surveillance, security system alignment, I.R. detection, laser checking, nite wildlife study, any work req. I.R. detection & conv. to visible spectrum. Self cont. scope w/everything incl I.R. light source.

6v or 12v power, 6032 I.R. converter tube, f/4.5 objective lens, adjust. triplet eyepiece. Focuses from 10' to infinity.
 No. 1659AV (11 x 14¼ x 3") \$285.00 Ppd.
 WITHOUT LIGHT SOURCE
 No. 1663AV \$225.00 Ppd.

SOLAR CELL CONCENTRATOR PANEL

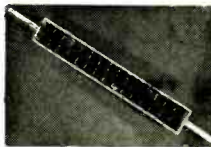

World's first! Takes up to 10 suns... without burning out (normal ones can't use over 3)! Specially designed panel (four 2x2cm super cells) delivers .125 amps @ 1.5V w/1 sun; over 1 amp @ 1.5V w/ten! Requires concentration system (build

Crab Eye or mount on std. telescope drive.) Water-cooled, so it's also a hot water generator. Detailed instructions incl.

No. 61,103AV... (6 x 2 x ¾") \$175.00 Ppd.
LARGE CONCENTRATION PANEL (19 x 2 x ¾")
 No. 72,195AV... (30 CELLS; 15w) \$575.00 Ppd.



MAIL COUPON FOR GIANT FREE CATALOG!

164 PAGES • MORE THAN 4500 UNUSUAL BARGAINS

Completely new 1976 edition. New items, categories, illustrations. Dozens of electrical and electromagnetic parts, accessories. Enormous selection of Astronomical Telescopes. Unique lighting and ecological items. Microscopes, Binoculars, Magnifiers, Magnets, Lenses, Prisms. Hard-to-get surplus bargains. Ingenious scientific tools. 1000's of components.

EDMUND SCIENTIFIC CO.
 300 Edscorp Building, Barrington, N. J. 08007
 Please rush Free Giant Catalog "AV"

Name _____
 Address _____
 City _____ State _____ Zip _____



COMPLETE & MAIL WITH CHECK OR M.O.

EDMUND SCIENTIFIC CO. 300 Edscorp Building, Barrington, N.J. 08007

How Many	Stock No.	Description (609) 547-3488	Price Each	Total
<input type="checkbox"/>	PLEASE SEND GIANT FREE CATALOG "AV"			
<input type="checkbox"/>	Charge my BankAmericard			
<input type="checkbox"/>	Charge my Master Charge			
Add Service and Handling Charge \$1.00				
Interbank No. _____				
My Card No. is _____				
I enclose <input type="checkbox"/> check <input type="checkbox"/> money order for TOTAL \$ _____				
Signature _____				

Card Expiration Date _____
30-DAY MONEY-BACK GUARANTEE. Name _____
 You must be satisfied or return any purchase in 30 days for full refund. *\$15.00 minimum City _____ State _____ Zip _____

Capitol Records Tests, Calibrates, Evaluates, Approves, Repairs, Quality Controls, and Reviews with the Stanton 681 Cartridge Series

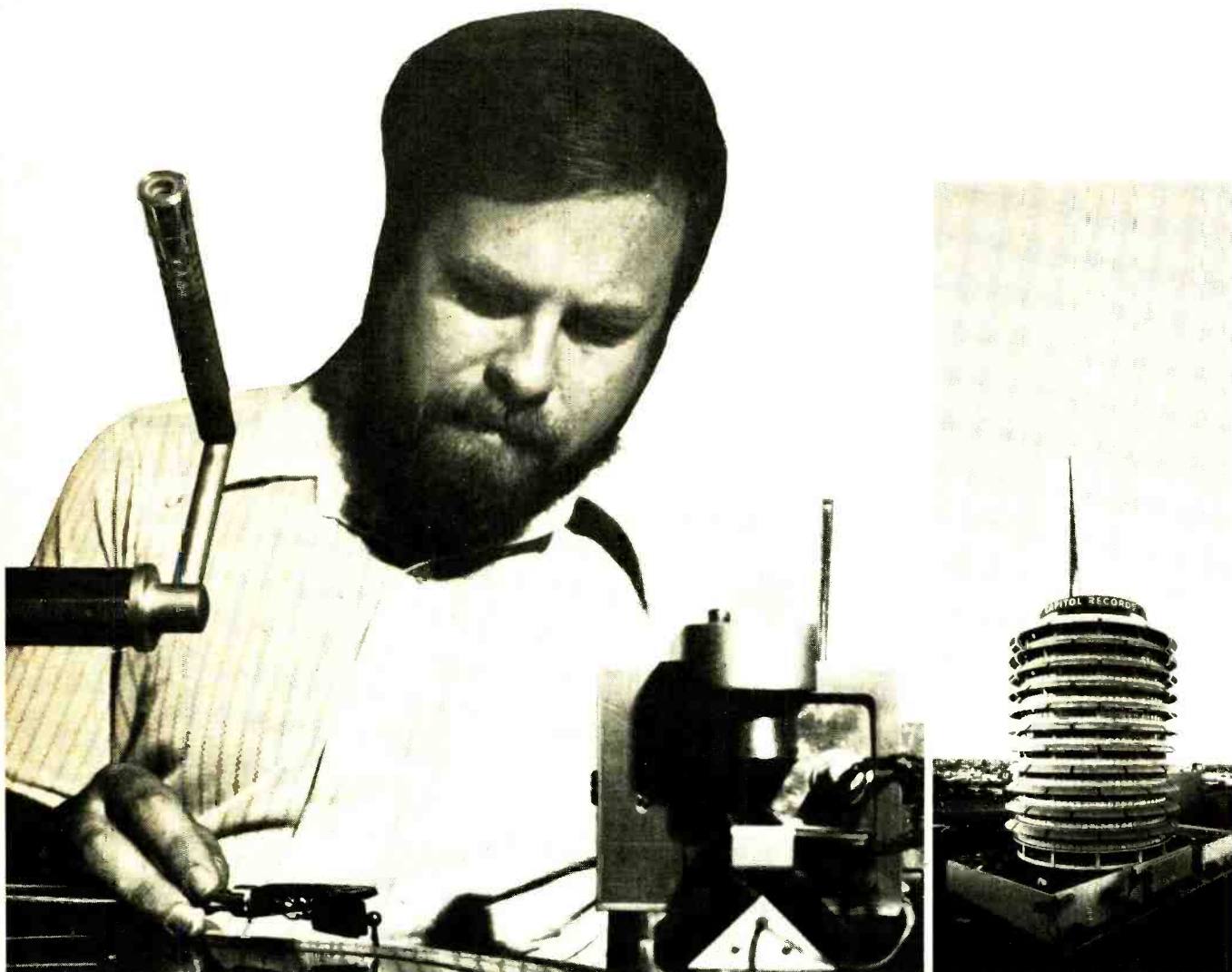

The physical process of making phonograph records is not for amateurs. It is a job for craftsmen of the highest order, craftsmen who know exactly what they are doing. Naturally, they need the precisely right tools to do the job.

In the case of Capitol Records, the highest quality tools are employed throughout the process. That is why Stanton 681 Calibration Standard Series Cartridges are used, with various styli that are designed specifically for each critical measuring and listening job.

It has proven to be a great advantage to Capitol Records to standardize their entire operation with the 681 Series and three basic styli:

The D6807A — for cutting system check-outs.

The D6300EEE (our famous Triple-E) — for the most critical listening.

The D6872AMC — for tough nickel-plated "mothers".

The Stanton 681 Calibration Standard Series enjoys almost universal acceptance throughout the Recording Industry. After all, it

was created in order to satisfy the need for a cartridge of sufficient sophistication to be used as a primary Calibration Standard in system checkouts for linearity and equalization. Stanton Magnetics met this need by producing an "absolute" cartridge standard . . . stereo cartridges of such linearity and overall quality as to gain immediate acceptance within the Recording and Broadcasting Industries.

The fact that Capitol has selected the Stanton 681 Calibration Standard Series for use throughout the operation is a testament to its quality.

All Stanton Calibration Standard Cartridges are guaranteed to meet specifications within exacting limits. Their warranty comes packed with each unit . . . The calibration test results for that individual cartridge.

Whether your usage involves Recording, Broadcasting or Home Entertainment, you can enjoy professional audio quality with Stanton Products.



For further information, write: Stanton Magnetics, Inc. Terminal Drive, Plainview, N. Y. 11803.

CIRCLE NO. 61 ON FREE INFORMATION CARD

www.americanradiohistory.com



state-of-the-art in receiver design...

**engineer's
triumph...
operator's
dream.**

Improving what is already the best is the ultimate challenge for the engineer. And the ultimate reward for the discerning CB operator. In the new Messenger 323A you can experience the incredible interference rejection of the only *dual cascaded crystal filtering system* available in any CB radio. Plus the exceptional noise rejection of both an efficient RF-type noise blanker and a new fully-automatic noise limiter system that adjusts itself for the cleanest, clearest reception possible. Equally important are the features we *didn't* change — the large, easy-to-read meter, easy-to-handle control knobs, built-in electronic speech compression, P.A. function, and rugged steel cabinetry. It's the dream rig you can own for \$249.95.



JOHNSON

E. F. Johnson Company, Waseca, Minn. 56093

In Canada: A. C. Simmonds & Sons, Ltd.