

**BUILD A DIGITAL AUTO/MARINE TACHOMETER**

# Popular Electronics®

WORLD'S LARGEST-SELLING ELECTRONICS MAGAZINE

JUNE 1975/75c

## HOW TO DESIGN YOUR OWN POWER SUPPLIES

- **Getting Started With Op Amps**
- **Filter Sharpens CW Reception**
- **Electronic Music Timbre Circuits**

## TEST REPORTS:

- Burwen 1201 Dynamic Noise Filter**
- Sony TC-645 Open-Reel Tape Deck**
- Telephonics 4-Channel Headphones**
- Pace 2300 AM CB Mobile Transceiver**
- Danameter**
- Liquid-Crystal DVOM**

## New Modules Simplify Building Stereo Power Amp

"TITAN" HIGH-POWER-OUTPUT KIT



# Radio Shack "Range Busters" SSB/AM CB at its Best!

You can't beat the extra power and extra reliability of SSB when you're using CB 2-way radio. If you're in a heavy-CB-usage area, SSB really multiplies the chance of getting your signal through. It's added insurance when you need it most. And now you can get immediate delivery on both these great Realistic® SSB transceivers.

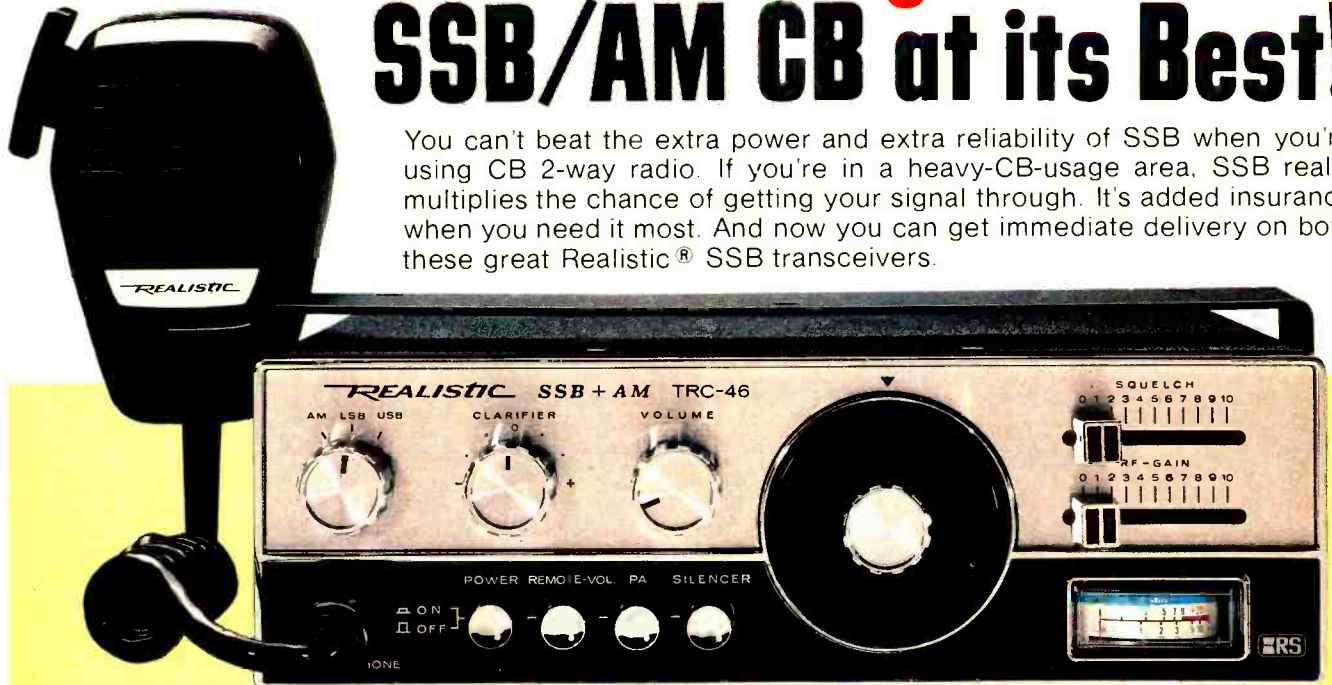

**329<sup>95</sup>**

## BASE/MOBILE TRC-46

The one with everything! 12-watts P.E.P. output, combined with Range-Boost circuit, for the ultimate in power. Total 69-channel capability—46 on SSB, 23 on AM—and you get crisp, clear performance on them all. A "clarifier" to shift both the transmitter and receiver for Net operation. A PA switch that lets you use the set as a public address amplifier and still receive incoming CB calls. Even an extra, remote volume control on the mike—a real convenience for mobile use. With all crystals, mobile mounting bracket, 110 VAC and 12 VDC power cables. U.L. listed. FCC Type Accepted. #21-146

## TRC-47 — OUR FINEST MOBILE TRANSCEIVER



Linear sideband circuitry gets through when AM won't—and the dual conversion receiver captures the faintest signals. 12-watts P.E.P. output, 69-channel capability, clarifier and RF gain controls, superb specs. With all crystals, mobile bracket, cables. FCC Type Accepted. #21-147. **249<sup>95</sup>**

## FREE New 1975 Radio Shack Catalog

OVER 2000 PRODUCTS  
EXCLUSIVES ON EVERY PAGE  
BEAUTIFUL FULL COLOR

Stereo • Quadraphonic • Phonographs  
TV Antennas • Radios • Citizens Band  
Kits • Recorders • Tape • Tools  
Auto Tune-Up • Electronic Parts  
Test Instruments • More!



164 pages of the finest in home and hobby electronics. Respected brand names like Realistic, Micronta, Archer, Science Fair — and they're available only at Radio Shack stores and dealers nationwide! See what's really new in electronics by getting this catalog now.

SEND FOR YOURS TODAY!  
FILL OUT COUPON BELOW

1975 Mail to Radio Shack, P. O. Box 1052, 525  
Catalog Ft. Worth, Texas 76101. (Please print.)

Name \_\_\_\_\_ Apt. No. \_\_\_\_\_

Street \_\_\_\_\_

City \_\_\_\_\_

State \_\_\_\_\_ ZIP \_\_\_\_\_

There's only one place you can find them . . .



Master Charge or  
Bank Americard at  
participating stores

# Radio Shack®

A TANDY CORPORATION COMPANY

OVER 3000 STORES • 50 STATES • 7 COUNTRIES

Retail prices may vary at individual stores

CIRCLE NO. 39 ON READER SERVICE CARD



# INSIDE the Altair Computer

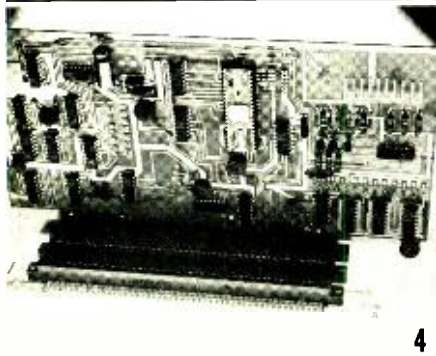
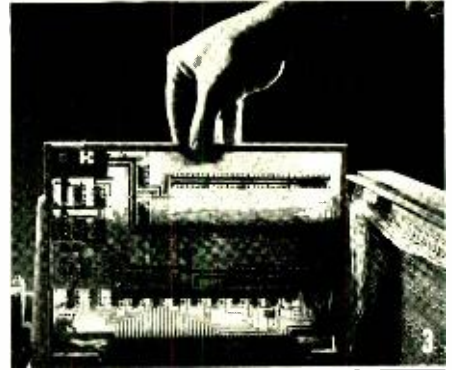
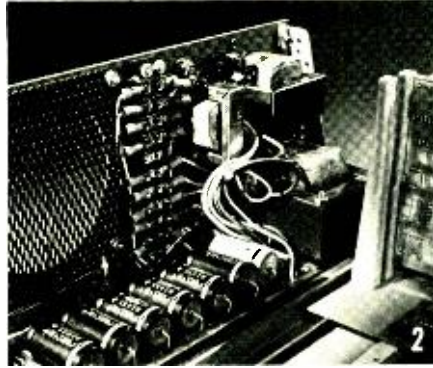
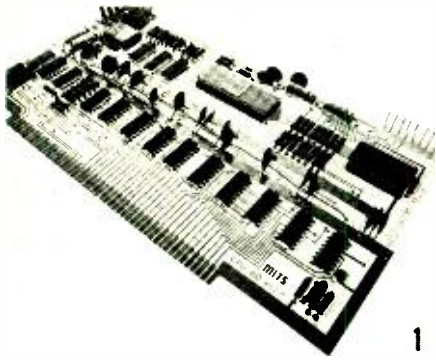

**1. Central Processing Unit (CPU) Board.** This double-sided board is the heart of the Altair. It was designed around the powerful Intel 8080 microprocessor—a complete central processing unit on a single LSI chip using n-channel silicon gate MOS technology. The CPU Board also contains the Altair System Clock—a standard TTL oscillator with a 2.000 MHz crystal as the feedback element.

**2. Power Supply.** The Altair Power Supply provides two +8, a +16 and a -16 volts. These voltages are unregulated until they reach the individual boards (CPU, Front Panel, Memory, I/O, etc.). Each board has all the necessary regulation for its own operation. The Altair Power Supply allows you to expand your computer by adding up to 16 boards inside the main case. Provisions for the addition of a cooling fan are part of the Altair design.

**3. Expandability and custom designing.** The Altair has been designed to be easily expanded and easily adapted to thousands of applications. The basic Altair comes with one expander board capable of holding four vertical boards. Three additional expander boards can be added inside the main case.

**4. Altair Options.** Memory boards now available include a 256 word memory board (expandable to 1024 words), a complete 1024 word memory board, and a 4,096 word memory board. Interface boards include a parallel board and 3 serial boards (RS232, TTL and teletype). Interface boards allow you to connect the Altair Computer to computer terminals, teletypes, line printers, plotters, and other devices.

Other Altair Options include additional expander boards, computer terminals, audio-cassette interface board, line printers, ASCII keyboards, floppy disc system, alpha-numeric display and more.

**5. All aluminum case and dress panel.** The Altair Computer has been designed both for the hobbyist and for industrial use. It comes in an all aluminum case complete with sub-panel and dress panel.

**6. It all adds up to one fantastic computer.** The Altair is comparable to mini-computers costing 10-20 thousand dollars. It can be connected to 256 input/output devices and can directly address up to 65,000 words of memory. It has over 200 machine instructions and a cycle time of 2 microseconds.

You can order the Altair Computer by simply filling out the coupon in this ad or by calling us at 505/265-7553. Or you can ask for free technical consultation or for one of our free Altair System Catalogues.

MITS/6328 Linn NE, Albuquerque, NM, 87108 505/265-7553

**MITS INC.**  
"Creative Electronics"

Prices and specifications subject to change without notice. Warranty: 90 days on parts for kits and 90 days on parts and labor for assembled units.

## PRICES:

Altair Computer kit with complete assembly instructions \$439.00  
 Assembled and tested Altair Computer \$621.00  
 1,024 word memory board \$176.00 kit and \$209.00 assembled.  
 4,096 word memory board \$264.00 kit and \$338.00 assembled.  
 Full Parallel Interface board .....\$92.00 kit and \$114.00 assembled.  
 Serial Interface board (RS232) ..... \$119.00 kit and \$138.00 assembled.  
 Serial Interface board (TTL or teletype) .....\$31.00 kit and \$146 assembled.  
 Expander Boards \$16.00 kit and \$57.00 assembled.

**SPECIAL:** Altair Computer plus 256 words of memory (save \$45.00) Only \$497.00\*

**NOTE:** Altair Computers come with complete documentation and operating instructions. Altair customers receive software and general computer information through free membership to the Altair User's Club. Software now available includes a resident assembler, system monitor, text editor and BASIC language.

\*In quantities of one per customer only.

Offer expires June 30, 1975

## MAIL THIS COUPON TODAY!

- Enclosed is check for \$ \_\_\_\_\_  
 BankAmericard # \_\_\_\_\_  
 or Master Charge # \_\_\_\_\_  
 Credit Card Expiration Date \_\_\_\_\_  
 Altair Computer     Kit     Assembled  
 Options (list on separate sheet)  
 Include \$8.00 for postage and handling.  
 PLEASE SEND FREE ALTAIR SYSTEM CATALOGUE

NAME \_\_\_\_\_

ADDRESS \_\_\_\_\_

CITY \_\_\_\_\_ STATE & ZIP \_\_\_\_\_

MITS/6328 Linn NE, Albuquerque, NM, 87108  
 505/265-7553

# Now there's a CB radio with too much talk power.



Put punch in your voice, from a block away to the fringes of your range. New Dyna-Mike gain control puts out absolute modulation. So much talk power you'll have to turn it down.

An important feature, but only one that makes this fantastically low-priced CB radio the best CB value on today's market.

The Cobra 21 with crystal filter, dual conversion receiver; transmits and receives on all 23 AM channels.

Features 60 dB adjacent channel rejection that completely eliminates bleedover.

Extra large Power S Meter let's you monitor your set's performance easily even when it's tucked under the dashboard.

And you get switchable automatic noise limiter, P.A./external speaker jack, large built-in speaker and detachable mike.

It's all wrapped up in a beautiful, compact cabinet only 6" wide x 2½" wide x 7½" deep. Meets FCC requirements.

Ask your CB Dealer for the Cobra 21. The radio with too much talk power for not much money.



**COBRA 21**  
WITH EXCLUSIVE DYNA-MIKE

Product of DYNASCAN CORPORATION • 1801 W. Belle Plaine • Chicago, Illinois 60613



# Popular Electronics®

WORLD'S LARGEST SELLING ELECTRONICS MAGAZINE

## FEATURE ARTICLES

<b>TIMBRE &amp; VOICING CIRCUITS FOR ELECTRONIC MUSIC</b> .....	Don Lancaster	31
<b>HOW TO DESIGN YOUR OWN POWER SUPPLIES</b> .....	Jim Huffman	36
<i>Step-by-step procedure allows you to design circuit to meet your needs.</i>		
<b>A SIMPLE METHOD FOR BIASING TRANSISTORS</b> .....	Myron Cherry	42
<b>UNDERSTANDING THE UART</b> .....	Roger L. Smith	43
<i>A data communication integrated circuit.</i>		
<b>TAMING STATIC ELECTRICITY</b> .....	John T. Frye	75
<i>Equipment and techniques to use in detecting and preventing damage.</i>		

## CONSTRUCTION ARTICLES

<b>THE TITAN MODULAR STEREO POWER AMPLIFIER</b> .....	Roy Harvey	27
<i>Super op amps deliver high power, reduce construction time.</i>		
<b>BUILD A DIGITAL MARINE/AUTO TACHOMETER</b> .....	Michael D. Hilker	40
<i>Measures rpm in thousands and hundreds for car or boat.</i>		
<b>GETTING STARTED WITH OP AMPS</b> .....	Sol D. Prenskey	46
<i>Use a solderless socket for easy experimenting.</i>		
<b>ACTIVE FILTER SHARPENS CW RECEPTION</b> .....	John E. Portune	49
<i>Outboard op-amp circuit has a selectivity better than 100 Hz.</i>		

## COLUMNS

<b>STEREO SCENE</b> .....	Ralph Hodges	16
<i>Non-technical Demonstration Records.</i>		
<b>SOLID STATE</b> .....	Lou Garner	63
<i>The Voltage Comparator</i>		
<b>TEST EQUIPMENT SCENE</b> .....	Leslie Solomon	67
<i>Grounding.</i>		
<b>COMPUTER BITS</b> .....	Jerry Ogdin	69
<i>A New Breed of Hobbyists</i>		
<b>CB SCENE</b> .....	Len Buckwalter	78
<i>Handling the VSWR Problem.</i>		
<b>HOBBY SCENE</b> .....	Editorial Staff	84

## PRODUCT TEST REPORTS

<b>BURWEN MODEL 1201 DYNAMIC NOISE FILTER</b> .....	56
<b>TELEPHONICS MODEL TEL-101F 4-CHANNEL HEADPHONES</b> .....	57
<b>SONY MODEL TC-645 OPEN-REEL TAPE DECK</b> .....	59
<b>PACE MODEL 2300 MOBILE CB TRANSCEIVER</b> .....	60
<b>DANA LABORATORIES "DANAMETER" DMM</b> .....	62

## DEPARTMENTS

<b>EDITORIAL</b> .....	Art Salsberg	4
<i>The Videodisc Cometh</i>		
<b>LETTERS</b> .....		8
<b>NEW PRODUCTS</b> .....		12
<b>NEW LITERATURE</b> .....		15
<b>NEWS HIGHLIGHTS</b> .....		24
<b>ELECTRONICS LIBRARY</b> .....		85

POPULAR ELECTRONICS, June 1975, Volume 7, Number 6. Published monthly at One Park Avenue, New York, NY 10016. One year subscription rate for U.S. \$6.98; U.S. Possessions and Canada, \$7.98; all other countries, \$8.98. Second Class postage paid at New York, NY and at additional mailing offices. Authorized as second class mail by the Post Office Department, Ottawa, Canada and for payment of postage in cash. Subscription service and Forms 3579, P.O. Box 2774, Boulder, CO 80302.

POPULAR ELECTRONICS including ELECTRONICS WORLD, Trade Mark Registered. Indexed in the Reader's Guide to Periodical Literature.

COPYRIGHT © 1975 BY ZIFF-DAVIS PUBLISHING COMPANY. ALL RIGHTS RESERVED.

Ziff-Davis also publishes Boating, Car and Driver, Cycle, Flying, Modern Bride, Popular Photography, Skiing and Stereo Review.

Forms 3579 and all subscription correspondence should be addressed to POPULAR ELECTRONICS, Circulation Dept., P.O. Box 2774, Boulder, CO 80302. Please allow at least eight weeks for change of address. Include your old address, as well as new—enclosing, if possible, an address label from a recent issue. Send editorial correspondence to POPULAR ELECTRONICS, 1 Park Ave., New York, NY 10016. Editorial contributions must be accompanied by return postage and will be handled with reasonable care; however, publisher assumes no responsibility for return or safety of manuscripts, art work, or models.

**EDGAR W. HOPPER**  
Publisher

**ARTHUR P. SALSBERG**  
Editorial Director

**LESLIE SOLOMON**  
Technical Editor

**JOHN R. RIGGS**  
Managing Editor

**ALEXANDER W. BURAWA**  
Associate Editor

**EDWARD I. BUXBAUM**  
Art Director

**JOHN McVEIGH**  
Assistant Editor

**ANDRE DUZANT**  
Technical Illustrator

**HERBERT S. BRIER**  
**LEN BUCKWALTER**  
**LOU GARNER**  
**GLENN HAUSER**  
**JULIAN D. HIRSCH**  
**RALPH HODGES**  
**ART MARGOLIS**  
Contributing Editors

**JOSEPH E. HALLORAN**  
Advertising Director

**JOHN J. CORTON**  
Advertising Sales

**LINDA BLUM**  
Advertising Service Manager

**PEGI McENEANEY**  
Executive Assistant

**STANLEY NEUFELD**  
Associate Publisher

**FURMAN H. HEBB**  
Group VP, Electronics & Photo

ZIFF-DAVIS PUBLISHING COMPANY  
Popular Electronics  
Editorial and Executive Offices  
One Park Avenue New York, New York 10016  
212-725-3500

Hershel B. Sarbin, President  
Furman Hebb, Executive Vice President and Treasurer  
Phillip T. Helfernan, Senior Vice President, Marketing  
Edward D. Muhlfeld, Senior Vice President, Sports Division  
Philip Sine, Senior Vice President  
Frank Pomerantz, Vice President, Creative Services  
Arthur W. Butzow, Vice President, Production  
Lawrence Sporn, Vice President, Circulation  
George Morrissey, Vice President  
Sydney H. Rogers, Vice President  
Sidney Holtz, Vice President  
Charles B. Seton, Secretary  
Edgar W. Hopper, Vice President, Electronics Div.

William Ziff, Chairman  
W. Bradford Briggs, Vice Chairman

Midwestern Office  
The Patis Group, 4761 West Touhy Ave.,  
Lincolnwood, Illinois 60644, 312 679-1100  
GERALD E. WOLFE, GEORGE B. MANNION  
DAVID ALLEN

Western Office  
9025 Wilshire Boulevard, Beverly Hills, CA 90211  
213 273-8050, BRAdshaw 2-1161  
Western Advertising Manager, BUD DEAN

Japan: James Yagi  
Oji Palace Aoyama, 6-25, Minami Aoyama  
6 Chome, Minato-Ku, Tokyo 407-1930/6821,  
582-2851



The publisher has no knowledge of any proprietary rights which will be violated by the making or using of any items disclosed in this issue.



## Editorial

### THE VIDEO DISC COMETH

After many false starts, manufacturers seem to be closing in on marketing of videodisc playback systems for consumers. Should it materialize, we'll all be winners when you consider that one could own a copy of the latest motion picture for the price of two theatre admissions plus babysitter fee. It would likely cost less to have a videodisc of a set of golf lessons, step-by-step TV cooking recipes, guitar lessons, still pictures of priceless paintings in your living room, and so on. Doubtlessly, some enterprising dealers will spring up to rent and exchange programs for even lower costs.

Naturally, there are a host of competing systems, including: Philips/MCA, with an optical laser sensor; Zenith (in collaboration with France's CSF Thomas), with a similar though incompatible system; Teldec (Germany's Telefunken and Britain's Decca), with a diamond-in-a-groove mechanical approach; RCA's capacitive pickup; Bogen-Rabe's magnetic system; and I/O Metrics' optical-photo system.

Playing a simple disc to produce color or B&W motion pictures with synchronized sound on a conventional TV receiver is a most appealing concept. You can view and listen to what you want when you want to. What's more, it has great potential for relatively low cost and fast access time (two challenges not yet met by videotape). So I was attracted to the first videodisc drumbeat in the East today—a presentation by Philips/MCA. I wasn't disappointed.

The Philips/MCA machine looks like a sleek waffle maker. One simply connects wires to a TV set's antenna terminals, positions what appears to be an aluminum-coated polyethylene LP disc on a turntable, closes the top, and presses a "play" button. The program appears on your TV screen—in beautiful color. Other pushbuttons control slow motion, frame freeze, reverse, and frame selection (with digital index readout on the screen). Two discrete audio channels with a 20-kHz top end are available, plus a technological opportunity for 4-channel sound. Turntable speed is 1800 rpm. With no physical contact between the optical pickup and the disc, the disc doesn't "wear out." Videodisc programs will retail for \$2 to \$10, depending on program content and length. (Each disc has an uninterrupted 30-minute play time at present.) Anticipated videodisc player price is \$500 and target date for market entry is the fall of '76.

Gone is MCA's pre-merger entry of an optical laser system that used a floppy disc and a top-mounted pickup, giving way to Philips' 0.2 mm-thick rigid disc and bottom-mounted sensor. Philips, in turn, secures MCA's vast programming resources (Universal Pictures, for example), while MCA also garners Magnavox's manufacturing and sales resources. (Philips owns 84% of Magnavox.) So Philips/MCA is a videodisc power to be reckoned with! And since some Zenith TV

consoles and videodiscs were displayed, I'd speculate that Zenith will be a Philips/MCA licensee.

Will Philips/MCA win all the videodisc marbles? I think not. Judging from the past, there will probably be two or three incompatible systems. Perhaps they will all vie for the same broad mass market. Or maybe, one will eventually dominate the affluent, adult market, while others will capture the remaining market with lower-priced systems.

In any event, I believe that videodiscs will be the next truly big family-entertainment product in the United States, though still a few years away. All the ingredients are there.

Philips/MCA Videodisc System



*Art Salsberg*



# Royce

Listen to the  
Royce  
difference!



Royce Model 1-600  
23-Channel  
Mobile Transceiver.

## Engineering makes a great value better!

- NEW! ADDITIONAL I.F. STAGE for even better selectivity.
- NEW! MICROPHONE with better frequency response and sound quality.
- POSITIVE AND NEGATIVE GROUND.
- SYNTHESIZED 23-CHANNEL CIRCUIT. No extra crystals to buy.
- LARGE 1-1/4" COMBINATION S-RF METER. Turns red on transmit.
- P.A. SWITCH which converts the unit to a full 4-Watt public address system.
- RUGGED, ALL-METAL CABINET with woodgrain trim.
- DUAL CONVERSION SUPERHETERODYNE RECEIVER. With ceramic filter for razor-sharp sensitivity.
- BUILT-IN AUTOMATIC NOISE LIMITER. Plus 12-V DC line filter.
- ACTIVE AGC. Prevents fading and blasting.
- FULL VARIABLE SQUELCH CONTROL.
- TUNED RF STAGE. For superior sensitivity.

**LISTEN TO THE ROYCE DIFFERENCE** before you buy any mobile transceiver. See the Model 1-600 at your Royce Dealer today! Suggested Retail Price \$124.95

Get our new literature... write to address below!

## Royce electronics corporation

1142 Clay St., North Kansas City, Mo. 64116  
CALL: (816) 842-0252 • TELEX: 426-145

... here Today!  
**"IGNITION OF THE FUTURE"**  
**ALLISON**  
**"OPTO-ELECTRIC"**

☆ The BEST...the ULTIMATE...  
of ALL the Ignition Systems!

● (We challenge ANYONE  
to dispute this Fact.)

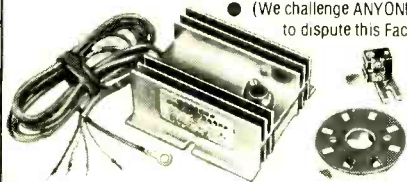

● Never wears out or needs any Maintenance!



● Does more than Pay for itself in  
**GAS SAVINGS**

...it gives you Maximum Power  
with continuous **PEAK PERFORMANCE**

...while reducing Maintenance  
and Operating Costs!



● The Allison OPTO-ELECTRIC System eliminates the Points and Condenser, replacing them with an OPTO-ELECTRONIC TRIGGER, using a Light-Emitting Diode and Photo Transistor. As there are NO moving parts in rubbing contact... Timing adjustments are PERMANENT. The only "TRUE" Electronic Ignition... that you can buy for under \$100.

● Gives 40-Times more Timing Accuracy than ANY system using "Mechanical" Breaker-Points! UNLIMITED RPM! "Electronically-Controlled" DWELL automatically supplies HIGHEST Performance at both Low and High speeds. Spark strength does not fall off at high RPM. POSITIVE SPARK helps eliminate "Misfire" for faster acceleration and improved Engine Performance! Smoother running (No timing fluctuation as with Magnetic Units). Easier Starting under any condition! Sparkplugs LAST 3 to 10-Times LONGER.

All SOLID-STATE Components. UNAFFECTED By Temperature, Moisture, or Vibration! Highest grade materials Guarantee you solid, Dependable Performance.

★ Perfect Timing and Dwell never change.

Pays for itself! Eliminates ignition Tune-Ups forever!  
"INFINITE LIFE"... Once installed... Never needs replacing.

● PERFECT TIMING INCREASES Engine Efficiency and Gas Mileage. SAVES Precious Fuel! Allison gives you MAXIMUM Engine Efficiency 100% of the time... and that's the name of the game for BETTER Gas Mileage and Economy.

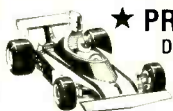

★ **PROVEN RELIABILITY!**

Dyno Tested up to 15,000 RPM.  
Road and Race Proven.  
(Opto-Electric Systems won at  
INDY Two years in a row!)

● **QUICK AND EASY INSTALLATION**

★ If you want the BEST, and SAVE! This is IT!

● ORDER with CONFIDENCE...

**1-YEAR FACTORY WARRANTY.**

Only \$49.95  
**COMPLETE.**

● As you can see, you're not taking any chances at all! Send your Order Today

State Make, Year, Engine Size. (Calif. Res. add Tax).  
● (So New...it's Sold ONLY FROM FACTORY DIRECT).

You may use your MASTER CHARGE or BANKAMERCARD.  
Send us (1) Your Number, (2) Interbank No., (3) Exp. Date.

● Before buying any other Type ignition system...

Send Postcard for our FREE BROCHURE.

★ If you have already installed a C-D ignition system,  
Modernize and Increase its Efficiency...

**CONVERT YOUR "C-D" UNIT TO BREAKERLESS!**  
Opto-Electric "TRIGGER UNIT"... Only \$34.95

● Our BEST Salesmen are the owners  
and users of our ALLISON System!



**ALLISON**  
**AUTOMOTIVE COMPANY**  
1269 - P, East EDNA PL., COVINA, CAL. 91722

CIRCLE NO. 3 ON READER SERVICE CARD

# Letters

## NO-KEY IGNITION TURN-ON

Anyone who incorporates Mr. Reckling's "Auto Lights Warning Buzzer" (Tips & Techniques, March 1975) in his vehicle will be in for a real surprise when he tries to switch off the engine with the lights on. Examination of the circuit indicates that, with the diode connected as shown, the ignition switch will be bypassed by the light switch through the added diode. This circuit will allow the engine to be started without using an ignition key.

The way to obtain a properly operating

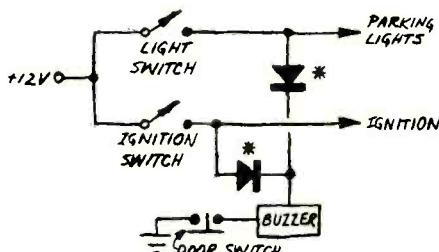

\* FOR POSITIVE-GROUND, REVERSE DIODES.

circuit is to use two diodes in an OR-gate arrangement as shown in my schematic.

DuBy D. Todd  
Grissom AFB, IN

## UNIVERSAL DIGITAL PROBE

Reference was made to a 72720 dual differential comparator integrated circuit in "Build a Universal Digital Probe" (February 1975). The question is, what dealer handles this particular IC? I've searched through a number of catalogs and manuals and have had no success in locating this item. Can you help?

B. R. RAYFORD  
Hayward, CA

In the article on the Universal Digital Probe, the foil pattern was said to be "actual size." It looks to me as if it is twice up.

JAMES E. BRONSON  
Manchester, N.H.

The 72720 dual comparator is a new IC from Texas Instruments, available from any authorized TI dealer. However, if you are having trouble locating this IC locally, you can substitute the 1458 (available from many dealers; see the back of PE) or any other dual comparator IC. Just make certain that you make the necessary pin changes.

The foil pattern for the probe was printed twice up for clarity, but was mistakenly called actual size.

## MORE ELECTRONIC ORGANS

I have just finished reading your article titled "How to Choose Electronic Organs" (March 1975). Some of the advances the author writes about had their beginnings with the Hammond Organ. One example is the reverberation unit that other organ manufacturers buy from Hammond. The author writes about LSI, but no connection with the subject is given to Hammond. The Hammond Organ is total LSI.

JERRY ORSONI  
Eau Claire, WI

We have also been recently reminded that Miner Industries, Inc. manufactures and markets home entertainment products. Three of its subsidiaries make electronic organs: Opsonar Organ Corp. (which makes the Optigan); Estey Organ Co.; and Magnus Music Corp.

## ANOTHER EM KEYBOARD SUPPLIER

In "How To Select EM Keyboards and Controllers" (July 1974), you closed with the request for information on sources for professional but inexpensive keyboards. In response to this request, I would like to recommend Synectic Music Systems, P.O. Box 30531, Seattle, WA 98103 as such a source. This company offers a variety of keyboards, all of which are usable in electronic music. Prices start at about \$1.00/key.

WILLIAM REED  
Seattle, WA

## HOBBY SCENE SCHEMATICS

In the Transistor Tester circuit shown in the March 1975 Hobby Scene, I believe that the npn and pnp LED's are transposed. LED1 should be pnp, while LED2 should be for npn indication.

DEAN ISLER  
Blocksburg, S.C.

The Mobile CB Power Supply featured in the April 1975 Hobby Scene column will not work as shown. The addition of a connection between the anode of the bottom diode and negative plate of the lower filter capacitor and the negative output terminal will make the power supply operational.

ERIC R. BEAN  
Elkhart, IN

## TEMPLATES NO SOLUTION

I have a suggestion that can help you improve the service you offer your readers. Why not print templates of the printed circuit layouts for the projects that appear in POPULAR ELECTRONICS and sell them at or near cost? The templates could be stamped on plastic sheets so that they could be placed on copper-clad board and slightly heated with a lamp to make them lie flat.

TOM PAGE  
Batesville, AR

We've been asked this question a number of times in the past. Templates are impractical. They are prohibitively expensive.



sive. More important, they are increasingly impractical as a given pc guide becomes more complex. The only type of practical template for a multi-IC guide with many closely spaced conductors and hole centers that must be critically placed would be a silk screen, which is too costly.

#### CONVERTING GMT TO LOCAL TIME

I noticed in "Shortwave Newscasts in English" (March 1975) that the times given are in Greenwich Mean Time (GMT). My question is, where can I get information on how to convert from the GMT schedule given to my local time?

JESSE L. ROSS  
Fort Worth, TX

There's a simple rule for converting from GMT to your local time. When the U.S. is on Standard Time the Eastern, Central, Mountain, and Pacific Time Zones are 5, 6, 7, and 8 hours behind GMT, respectively, which means that you subtract 5, 6, 7, or 8 from the listed GMT, depending on your time zone, to obtain local time. (For Daylight Savings Time, the figures are 4, 5, 6, 7 hours, respectively.) Then convert from 24-hour time to 12-hour time. If the GMT is 2300, for example, your time in Fort Worth during Standard Time would be 2300 - 600 = 1700 or 5:00 pm.

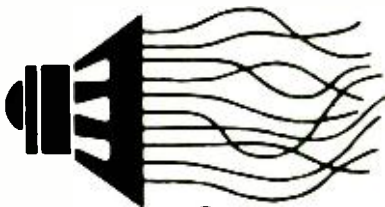

## Out of Tune

In "Getting to Know the Liquid Crystal Display" (April 1975), the schematic shown in Fig. 4 was incorrect. The corrected schematic is shown below. Also, to clarify understanding the theory behind LCD's, CMOS is preferred over TTL for driving the display because the output switches between the supply voltage and ground (instead of from about 4.7 volts and about 0.6 volt, as in TTL). This minimizes the undesirable effects of dc offset voltages.

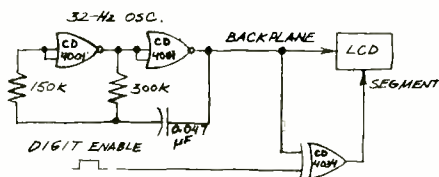

In "Build a Muscle Feedback Monitor," (May 1975, p 39), on the component layout, two resistors were labelled R22. The one connected to terminals 4 and 8 of IC4 should have been R24.

JUNE 1975

# NEW! PACE MAXI-MINI

## THE LATEST MAXI-MUM TALK POWER WITH MINI-MUM SIZE



Pace CB 143 feature-packed: 23 channel synthesized design • (+) or (-) ground • separate jack for remote speaker • 'S' meter to monitor incoming signal strength • transmit indicator light • PA system. Only \$129.95.

See your distributor and  
pickup your "Maxi-Mini" today!

((p))

Pace Communications, Div. of Pathcom Inc., 24049 S. Frampton Ave., Harbor City, Ca. 90710. Available in Canada from Superior Electronics Ind. 62

CIRCLE NO. 37 ON READER SERVICE CARD

# FREE

## McIntosh CATALOG and FM DIRECTORY

Get all the newest and latest information on the new McIntosh Solid State equipment in the McIntosh catalog. In addition you will receive an FM station directory that covers all of North America.



### MX 113

FM/FM STEREO - AM TUNER AND PREAMPLIFIER

# SEND TODAY!

McIntosh Laboratory, Inc.  
East Side Station P.O. Box 96  
Binghamton, N.Y. 13904  
Dept. PE

NAME \_\_\_\_\_  
ADDRESS \_\_\_\_\_  
CITY \_\_\_\_\_ STATE \_\_\_\_\_ ZIP \_\_\_\_\_

If you are in a hurry for your catalog please send the coupon to McIntosh.  
For non rush service send the Reader Service Card to the magazine.

CIRCLE NO. 30 ON READER SERVICE CARD

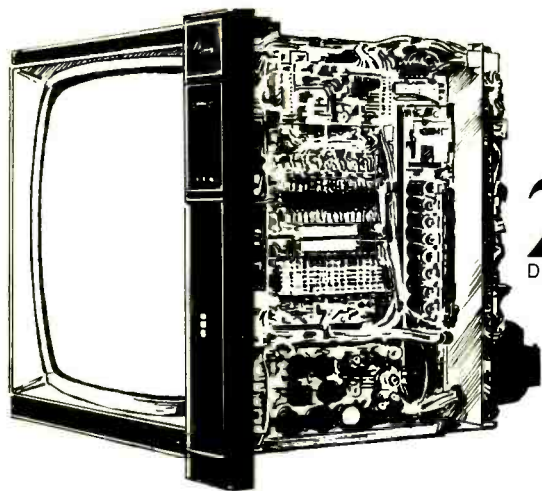

You get the same  
**25"** hobby-kit color  
DIAGONAL  
TV from three  
different schools.



You get  
this designed-  
for-learning  
**25"** color TV only  
DIAGONAL  
with NRI training.



No other home-study school gives you a TV like the one you build with NRI's Master Course in Color TV/Audio servicing. Some schools give you three or four plug-in sub-assemblies off the production line to put together a commercial set. Others give you a hobby-kit bought from outside sources. And because neither type was originally designed to train people for TV servicing, lessons and experiments must be "retro-fitted" to the set as it comes.

That's why we went to the trouble to engineer our own, exclusive solid-state TV. It's the only way a student can (1) get the feel of typical commercial circuitry, (2) learn bench techniques while building a complete set from the "ground" up, (3) perform over 25 "in-set" experiments during construction, and (4) end up with a 25" diagonal solid-state color TV with console cabinet and all the modern features you'll find on sets you'll service. Nobody else can give you this combination of advantages because nobody else invested the time and money to design a set with learning in mind.



## More know-how per dollar

That's what it all boils down to, the quality of training you get for the money you spend. In our 60-year history, more than a million students have come to NRI and we're fully approved for career study under the G.I. Bill. We must be teaching something right.

Some of those "right" things are bite-size lessons to ease understanding and speed learning . . . personal grading of all tests, with comments or explanations where needed . . . a full-time staff of engineer/instructors to help if you need it . . . plenty of "real-life" kits and experiments to give you hands-on training . . . and fully professional programs oriented to full- or part-time career needs.

## Widest choice of career opportunities

NRI offers not one, but five excellent TV/Audio servicing courses so you can tailor your training to your budget. Or, you can study other opportunity fields like Computer Electronics, Communications, Aircraft or Marine Electronics, Mobile Radio, and more. Free catalog describes them all, showing lesson plans, equipment and kits, and career opportunities. There's no obligation and no salesman will ever call, so send for your copy today. See for yourself why NRI experience, selection, and exclusives give you something no other school can.

If card is missing, write to:

**NRI**  
**McGraw-Hill**  
**NRI SCHOOLS**  
 McGraw-Hill Continuing Education Center  
 3939 Wisconsin Avenue,  
 Washington, D.C. 20016

## NRI passes the savings on to you

You don't pay a big premium to get this unique TV as part of your training, because NRI engineering eliminates the cost of buying from an outside source. And we pay no salesman's commission. We enroll students by mail only. We pass the savings along to you in the form of low tuition fees, extras like a cabinet for the TV, a solid-state radio you learn on as you build, and actual instrument kits for servicing TVs . . . triggered sweep oscilloscope, integrated circuit TV pattern generator, and 3½ digit digital multimeter. You can pay hundreds of dollars more for a similar course and not get a nickel's worth more in training and equipment.



## New Products

Additional information on new products covered in this section is available from the manufacturers. Either circle the item's code number on the Reader Service Card inside the back cover or write to the manufacturer at the address given.

### LARSEN MAGNETIC ANTENNA MOUNT

Using a new type of permanent magnet to achieve maximum magnetic pull, Larsen Antenna's mobile mount, available in five different models, will accommodate all popular types of mobile antennas. The units come with 12 feet of RG58/AU coax and plug. Just screw the antenna to the base and place the base on any flat surface (vehicle roof, fender, trunk) and run the coax to the equipment. The magnet is guaranteed permanent, according to the company, and will stay put at any highway speed.

CIRCLE NO. 70 ON READER SERVICE CARD

### ADVENT FM RADIO

A compact monophonic FM receiver, Model 400, is being introduced by the Advent Corporation. The radio consists of two compact white molded cabinets, one containing the tuner/amplifier, and the other



housing an acoustic-suspension speaker system. A 40-foot speaker cable connects the two units. The receiver has volume, bass and treble controls and a vernier tuning dial, as well as an output jack for tape recording and an input jack for playing a high-level source through the system. The receiver was designed to have good sensitivity and front-end overload characteristics. Its i-f stages (incorporating two IC's) are said to produce high selectivity and ease of tuning. The speaker driver, in conjunction with an LCR shaping filter, is said to provide good bass and treble response as well as satisfying tonal balance. The receiver section measures 6 $\frac{5}{8}$ " H  $\times$  6" D  $\times$  4 $\frac{1}{2}$ " W (16.8  $\times$  15.2  $\times$  11.4 cm), and the speaker enclosure measures 11" W  $\times$  6 $\frac{5}{8}$ " H  $\times$  6" D (27.9  $\times$  16.8  $\times$  15.2 cm).

CIRCLE NO. 71 ON READER SERVICE CARD

### AVANTI TVI FILTERS

Avanti Research and Development introduces two filters for TVI problems associated with CB operations. The first filter is a low-pass unit for installation in the

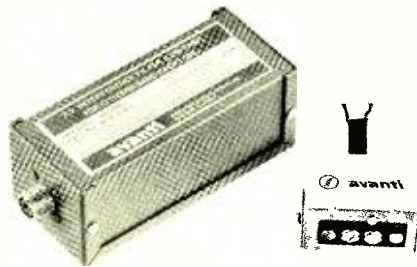

coaxial feedline between transceiver and antenna. Any spurious high-frequency signals (harmonics) emitted from the transceiver will not be allowed to pass to the antenna. The second filter is a high-pass unit which should be installed at the TV receiver's antenna terminals. This filter is useful in curing those TVI problems caused by receiver overload and not by harmonic radiation. It lets TV signals through, but blocks the interfering 27-MHz CB signals. The high-pass filter is designed for use with 300-ohm feedlines, and the low-pass filter is to be used with 52-ohm coax.

CIRCLE NO. 72 ON READER SERVICE CARD

### MOTOROLA TONE/FREQ. METER

Motorola's new Model SLN-6401A tone/frequency meter allows radio technicians to make high-accuracy measurements on low-frequency tones in two-way radios. This autoranging unit incorporates a phase-lock/frequency multiplier technique that is said to resolve to 0.002 Hz in only one second. Because of this ultra-fast counting speed, it is possible to read tones transmitted on two-way radio channels by reading them directly from the recovered audio of a receiver or communications service monitor. In the auto mode, the unit automatically provides maximum resolution of the six-digit display; in manual mode, a pushbutton selects a coarser resolution with increased counting speed. The unit also functions as a standard frequency counter over the range of 20 Hz to 2 MHz. Address: Motorola Communications and Electronics, Inc., 1301 E. Algonquin Rd., Schaumburg, IL 60172.

### BOMAN AUTO CASSETTE PLAYER/RADIO

The Boman Astrosonix Model BM-1335 stereo cassette player/AM-FM radio is an in-dash unit with adjustable control shafts

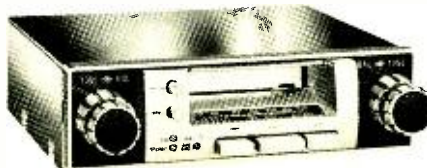

CIRCLE NO. 75 ON READER SERVICE CARD

(5 $\frac{1}{8}$ " to 6 $\frac{9}{32}$ " or 13 to 16 cm) for easy mounting. The player/radio has tone, volume, balance, and tuning controls, as well as pushbuttons for FM/AM, Stereo, Eject, Fast-Forward, and Rewind. Indicator lights are provided for FM, AM, Stereo, and Tape End. FM sensitivity is claimed to be 6  $\mu$ V and stereo separation 30 dB. Wow and flutter is said to be under 0.4% and tape separation 35 dB, frequency response is 80-10,000 Hz, and power output is 8.4 watts rms/channel into 4 ohms at 1% distortion. The Model BM-1335 weighs 4.5 lbs (2 kg) and measures 7 $\frac{1}{8}$ " W  $\times$  6 $\frac{1}{2}$ " D  $\times$  2 $\frac{1}{8}$ " H (17.8  $\times$  16.5  $\times$  5.4 cm). \$184.95.

CIRCLE NO. 73 ON READER SERVICE CARD

### STANTON MAGNETIC SUSPENSION TURNTABLE

The new 33 $\frac{1}{3}$  and 45 rpm Stanton Model 8004-II manual turntable uses a Gyro-prise<sup>TM</sup> magnetic suspension system in which the 12-inch platter makes no physical contact with its 24-pole synchronous motor's structure. Other features include belt drive, Unipoise<sup>TM</sup> single-point tone-arm suspension, anti-skate control for all types of styli, stylus-force slide (0.4 grams), viscous-damped cueing control, and low-



capacitance cables. Wow and flutter is claimed to be less than 0.7% weighted and weighted rumble better than 60 dB down. The Model 8004-II comes with a walnut veneer base, dust cover, and a Stanton calibrated 681EEE cartridge. The turntable measures 14 $\frac{3}{4}$ "  $\times$  13"  $\times$  7" (37.5  $\times$  33  $\times$  17.8 cm) and weighs 12 lbs (5.4 kg). \$199.95. A 4-channel version, Model 8004-IV, is priced at \$224.95.

CIRCLE NO. 74 ON READER SERVICE CARD

### SONY PARABOLIC REFLECTOR

Superscope has added the Model PBR-400 portable parabolic reflector to its line of Sony recording equipment. It is designed to pick up high-quality sound from a distance and, depending on climatic conditions and surroundings, has an effective recording range of up to several hundred yards. According to the company, the PBR-400 will improve the sound sensitivity of most omnidirectional mikes 10 to 20 dB over rated sensitivity. Weighing under 3 pounds, the unit is hand operable but comes with a stand adapter for tripod use, a mike stand adapter, carrying case with shoulder strap, and internal accessory pouch. \$79.95

CIRCLE NO. 75 ON READER SERVICE CARD



### CORVUS 24-HOUR GMT DIGITAL CLOCK

Designed for amateur radio operators, the ac-powered Corvus Zulu 10 is a solid-state digital clock with a 24-hour display of time (GMT) and a 10-minute station identification alarm/timer. It features a single MOSIC and LED display. The Zulu 10 is housed in a miniature 2½-inch plastic case with all switches and controls hidden from view. The case is silver color and chrome with a full-face red lens for wide-angle viewing. The 10-minute timer is reset by turning the clock upside-down with a "flick of the wrist." \$39.95. Corvus Corp. 13030 Branch View Lane, Dallas, Texas 75234.

### HICKOK 10-MHZ DUAL TRACE SCOPE

The Hickok Model 512 Dual-Trace Oscilloscope uses a 5-inch CRT, has a claimed bandwidth of dc to 10 MHz (ac or dc coupled), normal or auto triggering, and 1-megohm input impedance shunted by 30 pF. Vertical sensitivity can be varied from 5 mV/cm to 50 V/cm (uncalibrated), or from 10 mV/cm to 50 V/cm (with 3% accuracy) in 12 calibrated steps. Sweep rate is variable from 0.1 µs/cm to 1 s/cm (uncalibrated), and from 0.5 µs/cm to 0.2 s/cm (with 5% accuracy) in 18 calibrated steps. The Model 512 can display either signal A or B alone, simultaneously, or alternately, as well as chopped (100 kHz) A and B, A plus B, or A minus B. A Z-axis (blanking)



feature is also included. For TV work, trigger coupling can be chosen from among TV Field (Vertical), TV Line (Horizontal), VITS Field 1, and VITS Field 2. Among accessories included are two combination 10:1/direct probes, viewing hood and overlay for TV Field, VITS, and Vectorscope work. Front-panel controls are color coded. The 512 weighs 17 lbs (7.7 kg), and measures 17"D x 10½"W x 10"H (43.2 x 26.7 x 25.4 cm). \$675.

CIRCLE NO. 77 ON READER SERVICE CARD

### ECD DIGITAL CAPACITANCE METER

The new Model 100 Digital Capacitance Meter by ECD has a 3½-digit display and autoranging. The hand-held, battery-powered meter measures values over a

**MAKES**

# SYNTHESIZER

**KITS**

KEYBOARD MODELS  
PRICED FROM  
\$230



**but  
did you know  
we also have ....**

**THE SURF  
A BIRD  
THE WIND  
PING-PONG  
WIND CHIMES  
DRUMMER BOY  
SYNTHESPIN MK-II  
THE PYGMY AMP  
A CHATTER JAMMER  
INFINITY PLUS SUSTAIN  
BALANCED MODULATOR  
THE SEQUENCER & MIXER  
GNOME MICRO-SYNTHESIZER  
AND MANY MORE IN OUR  
FREE CATALOG .....**

**PAIA ELECTRONICS**  
BOX P14359, OKLAHOMA CITY, OK 73114

CIRCLE NO. 36 ON READER SERVICE CARD

## You don't have to buy a new car to get an electronic ignition.

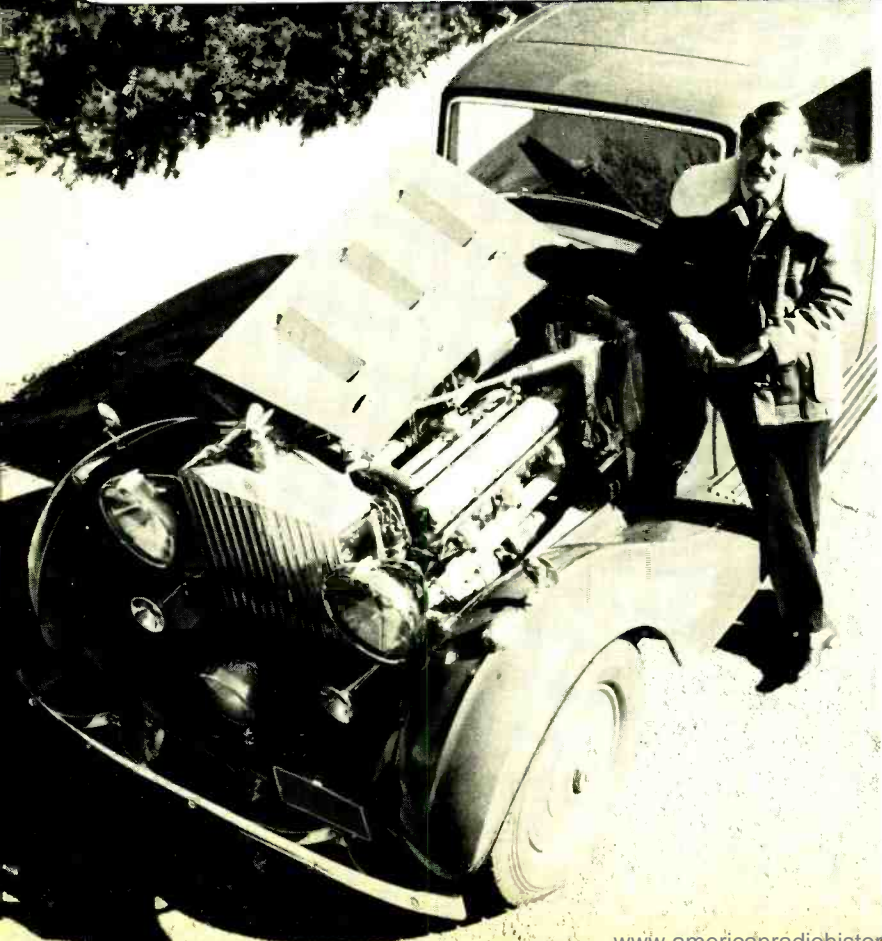

Let's face it. After 37 years, even a Phantom III can use a lift. That's why I put a Delta Mark Ten B Capacitive Discharge Ignition on my Phantom ... to give her a spark I'd pit against any '75 model car. I went to Delta because they aren't Johnny-come-latelys. Delta's been making electronic ignition systems for over a decade.

Whatever kind of car you drive, you can give it the same great Delta performance I gave mine.

- Mark Ten B Capacitive Discharge Ignition Systems are manufactured by Delta Products, Inc., a company with a conscience, and with a proven record of reliability both in product and in customer relations.
- The Mark Ten B really does save money by eliminating the need for 2 out of 3 tune-ups. Figure it out for yourself. The first tune-up or two saved pays for the unit, the rest is money in your pocket. No bunk!
- Because the Mark Ten B keeps your car in better tune, you actually can save on expensive gasoline.
- With a Mark Ten B, spark plugs stay clean and last longer ... fouling is virtually eliminated.



I want to know more about Mark Ten B CDI's. Send me complete no-nonsense information on how they can improve the performance of my car.

Name \_\_\_\_\_

Address \_\_\_\_\_

City \_\_\_\_\_ State \_\_\_\_\_ Zip \_\_\_\_\_

**DELTA PRODUCTS, INC.**  
 P.O. Box 1147, Dept. PE, Grand Junction, Colo. 81501  
 303-242-9000

Mark Ten B, assembled	\$64.95 ppd	Standard Mark Ten, assembled	\$49.95 ppd
Mark Ten B, kit	\$49.95 ppd	Deltakit®	\$34.95 ppd

CIRCLE NO. 16 ON READER SERVICE CARD

# FREE EICO CATALOG

## 346 Ways To Save On Instruments, Burglar Alarms, Automotive & Hobby Electronics!

The more you know about electronics, the more you'll appreciate EICO. We have a wide range of products for you to choose from, each designed to provide you with the most pleasure and quality performance for your money. The fact that more than 3 million EICO products are in use attests to their quality and performance.

**"Build-it-Yourself" and save up to 50% with our famous electronic kits.**

For latest EICO Catalog on Test Instruments, Automotive and Hobby Electronics, Eicocraft Project kits, Burglar-Fire Alarm Systems and name of nearest EICO Distributor, check reader service card or send 50¢ for fast first class mail service.

**EICO—283 Malta Street,  
Brooklyn, N.Y. 11207**

*Leadership in creative electronics  
since 1945.*



CIRCLE NO. 18 ON READER SERVICE CARD

wide dynamic range—from 200 pF to 200,000  $\mu$ F in 10 automatically selected ranges. Mounted test clips are useful for measuring small capacitors, and a pair of test leads is provided for large electrolytics. Measurement is accomplished by pushing a single pushbutton. An offset control is included to cancel out stray lead or clip capacitances. The display consists of a 0.6-inch high, 3 $\frac{1}{2}$ -digit LCD and four LED's to indicate units. Accuracy is claimed to be 0.1% to 200  $\mu$ F, and 1% from 200 to 200,000  $\mu$ F, over a temperature range of 59°F to 95°F (15°C to 35°C). Measurement time is said to be less than  $\frac{1}{2}$ -second for values up to 200  $\mu$ F, and increases to 5 seconds for 200,000  $\mu$ F. The meter measures 5.9"W x 3.2"H x 2.3"D (15 x 8 x 5.7 cm) and weighs 15 oz (425 g). \$289.00.

CIRCLE NO. 78 ON READER SERVICE CARD

### YAMAHA FET POWER AMPLIFIER

The Yamaha Model B-1 basic stereo amplifier uses recently developed high-power FET's in output stages, as well as FET drivers. Rated output is 150 watts rms/channel (both channels driven into 8 ohms, 20-20,000 Hz) with THD and IM each 0.1% at rated power. Hum and noise level is reported to be -110 dB, input sensitivity is



0.775 V into 50 kilohms, and speaker load impedance is 4 to 16 ohms. A separate control unit, Model UC-1, is also available to provide switching and control functions for the power amplifier. The control unit features two peak-reading meters calibrated in both watts and dB, rumble filter, switch and level controls for five speaker pairs, separate overload warning indicators, and a thermal overload indicator.

CIRCLE NO. 79 ON READER SERVICE CARD

### RUSSOUND AUDIO CONTROL

Russound's MP-2 multi-play audio control can serve as a miniature control center for an entire hi-fi system and provide switching capability for one or two signal sources. It allows outputs to be fed to one, two, three, or four pairs of stereo speakers. Each of the four stereo output channels has its own instant-impedance "L" pad volume control and any assortment of speaker efficiencies and impedance ratings may be combined in the MP-2 without overloading the amplifier's output stage. The walnut vinyl cabinet measures 8 $\frac{1}{16}$ " W x 3 $\frac{7}{8}$ " D x 3 $\frac{1}{16}$ " H (20 x 10 x 8 cm). \$69.95

CIRCLE NO. 80 ON READER SERVICE CARD

### DATA PRECISION MULTIFUNCTION COUNTER

A 7-digit, 100-MHz counter/timer, Data Precision's Model 5740, is designed to measure frequency, period, period average, elapsed time and total events. It features LED displays (about  $\frac{1}{2}$ -inch high), and measures frequency from 5 Hz to 100 MHz, single period (sine wave) time from 1 microsecond to 0.2 sec., period average with 1 nanosecond resolution to 99,999.99  $\mu$ sec, event counting from 0 to 99,999.99 and time interval from 0 to 99,999.99 seconds. Sensitivity is 10 mV to 20 MHz, rising linearly to 50 mV at 100 MHz. The instrument also has a front-panel trigger level control, a 20/1 attenuator, and an input impedance of 1 megohm shunted by 25 pF. Four separate gate times (10 sec, 1 sec, 0.1 sec, and 0.01 sec) are selected from the front panel. The unit can also count and resolve random pulses. Measurement capability can be extended to  $\pm$  250 V. Options include remote start/stop for time and events, a 50-ohm input termination, and BCD interface and logic control. The 5740 measures 9 $\frac{1}{2}$ " W x 7 $\frac{3}{4}$ " D x 3 $\frac{1}{2}$ " H (21.6 x 18.5 x 8.9 cm) and weighs 5 lbs (2.27 kg). \$295.00.

CIRCLE NO. 81 ON READER SERVICE CARD

### DIP MARKER STRIP LABELS

A new line of press-on marker labels from the Vector Electronic Co. identifies DIP socket pins and circuit board hole locations on tenth-tenth Micro-Vectorboard. The 14-pin DIP markers, Model MS-9, have double sequential number lines from 1 to 7 on one side and from 8 to 14 on the other. Similar strips (Model MS-10) for 16-pin DIP sockets and IC's are also available. The circuit board markers also come in pairs of single line strips, numbered 1 through and 8 through 14 for 14-pin DIP's (MS-9A) and numbered 1 to 8 and 9 to 16 for 16-pin DIP's (MS-10A). MS-9 and MS-10 marker strips are priced at \$1.98 per package of 36. MS-9A and MS-10A are \$2.45 each per 36 pairs. Vector Electronic Company, Inc., 12460 Gladstone Ave., Sylmar, CA. 91342.

### LED VU/S METER

A new VU meter, the Model M-241 by Pulse Dynamics Manufacturing Corp. uses seven LEDs to monitor signal levels from -15 to +3 VU in 3-dB steps. LED VU meters have no mechanical inertia and therefore no overshoot. The M241 is also available as an S meter. In both cases, the meter is offered with either vertical or horizontal scales. When a 0.775V rms sine wave is applied across the input, the Model M-241 indicates 0 VU. This calibration level is adjustable over  $\pm$  10% range. The meter is reported to have a flat response over the audio range. A degree of slow decay is built-in to allow easy viewing of signal peaks. Power required is 12-15 V dc at 30 mA. P.D.M.C., Dept. 29, Colchester, IL 62326.

POPULAR ELECTRONICS





# New Literature

## CONTINENTAL BREADBOARDING CATALOG

A 16-page short-form catalog, "Spring 1975 Edition New Breadboarding Prototest Devices," has been released by Continental Specialties Corp. This illustrated catalog shows all the current breadboard Prototest equipment produced by the firm, including its new Logic Monitor. Other items described include QT sockets and bus strips, and a line of Proto Boards (one model has a built-in short-proof 5-volt, 1-amp regulated supply), and the Proto-Clip for power-on signal tracing. A special section is devoted to typical applications and answers frequently asked questions about breadboarding. Address: Continental Specialties Corp., Box 1942, New Haven, CT 06509.

## TELEX HEADPHONE CATALOG

Telex Communications' 8-page catalog covers its expanded line of Broadcast/Communications headphones and accessories. Among equipment described are the Cameraman's series headsets, the Sportscaster with "push-to-cough" switch, the IC-10 headset intercom, the 1325 series broadcast stereo headphones, and the 1320 series communications headsets. Also included are general-purpose headphones, pillow speakers, and connecting cables. Address: Telex Communications, Inc., Broadcast/Industrial Sales Dept., 9600 Aldrich Ave. South, Minneapolis, MN 55420.

## SHURE PROFESSIONAL PRODUCTS CATALOG

Shure Brothers' line of Professional Products is presented in a 24-page catalog. Among items covered are: unidirectional condenser, dynamic, cardioid and bidirectional ribbon microphones; omnidirectional and utility dynamic microphones; lavalier and miniature microphones, mixers, feedback controllers, and stereo preamplifiers. Also described are microphone accessories, including mounts, connectors, series transformers, windscreens, stands, attenuators, power supplies and component carrying cases. Shure's line of "stereo dynetic" phono cartridges are included, as well as tone arms, test records, and a stylus force gauge. Address: Shure Brothers, Professional Products, 222 Hartrey Ave., Evanston, IL 60204.

JUNE 1975

## CAR STEREO BOOKLET

RCA's 14-page booklet presents features and facts about its newly broadened line of car stereo players and speakers. Entitled "Come Drive With Us," this convenient pocket-sized brochure includes illustrations and technical specifications. It covers under-dash 8-track units, an in-dash AM/stereo FM/8-track unit, an automatic cassette player, and FM converter. A variety of accessory items, such as speakers and key-lock mounting brackets are also described. Address: RCA Parts and Accessories, Box 100, Deptford, NJ 08096.

## SPEAKERLAB CATALOG

Speakerlab's 29-page catalog describes its loudspeaker system kits and components. The company's kitted systems, which range from two-driver, two-way bookshelf systems to four-driver, three-way systems, include grille cloth, frame, and instructions. The catalog also includes a summary of design and construction techniques. Address: Speakerlab, 5500 35th NE, Seattle, WA 98105.

## EICO TEST INSTRUMENTS CATALOG

Eico Electronic Instrument offers a condensed version catalog featuring its line of kit and wired test instruments. These include: oscilloscopes, VTVMs, VOMs, tube and transistor testers, power supplies, probes, and auto testers. The six-page booklet carries product descriptions and illustrations. Address: Eico Electronic Instrument Co., 283 Malta St., Brooklyn, NY 11207.

## BURGLAR/FIRE ALARM CATALOG

The Silmar Electronics' 1975 Spring catalog contains new alarms, accessories, and components, as well as other items in its line. The 12-page catalog also features illustrated and diagrammed installation instructions. Address: Silmar Electronics, 133 S.W. 57th Ave., Miami, FL 33144.

## SOLID-STATE SWITCH SELECTION GUIDE

A 12-page product sheet describing two families of solid-state switches and a variety of actuating magnets is offered by Micro Switch. Product Sheet SR/SS/MG describes features and applications of the SR 5SS and 6SS series of Hall-effect sensors, which can interface directly with many electronic circuits. A detailed description of calibrated Hall elements helps users select the correct solid-state switch. The product sheet includes selection guides, sample gauss calibration curve diagrams for current sinking and sourcing, simple linear output and differential linear output circuits, mounting dimensions, a review of analog magnetic field sensors, and a description of seven special magnets. Address: Micro Switch, 11 W. Spring St., Freeport, IL 61032.

*All New*  
**PROBE IV**

CAT. NO.  
5114

**CHECK FOUR FUNCTIONS WITH ONE INSTRUMENT!**

- Continuity
- Polarity
- Voltage
- Digital Logic

LIGHTWEIGHT - POCKET SIZE  
PROTECTIVE VINYL CARRYING  
POUCH. SEE YOUR FAVORITE  
ELECTRONICS DISTRIBUTOR

**LIFT-IT!**

"COPY ANY CIRCUIT"

The All-New, **Quick And Easy** Way To Reproduce Printed Circuits. Get Your Kit From Your Favorite **CALECTRO Electronics** Distributor Today!

CAT. NO.  
J4-828

**GC ELECTRONICS**  
DIVISION OF HYDROMETALS, INC.  
ROCKFORD, ILLINOIS 61101 U.S.A.

## Coming Up In The July Popular Electronics

Blackout Emergency Light  
Programming Read-Only Memories  
Hear Apollo/Soyuz Transmissions  
What's New in Marine  
Radiotelephone



# Stereo Scene

By Ralph Hodges

## NON-TECHNICAL DEMONSTRATION RECORDS

**T**HERE have never been so many demonstration records available from audio-equipment manufacturers as there are today. In fact, this brief overview will ignore, for now, non-music test records. (By my arbitrary definition, a demo record is a software package intended either to show off or trip up an audio system's ability to handle music that's reasonably listenable.)

Many of these demo discs are furnished with ample instructions on what to listen for, so my specific remarks are merely supplementary. Even skilled listeners find it hard to judge the accuracy of reproduced sound without an absolute standard of reference—such as the live performance—for comparison. Lacking this, I find it helpful to concentrate on technical details of the performance. Is the string sound controlled in articulation and especially in tone, which is something professional musicians strive for? Are the unisons in unison and is there good sense of ensemble, shape, and smoothness?

These are real musical values, as well as tip-offs to the stridency, raggedness, and feeling of "coming apart" that characterize flawed reproduction.

**"Sessions."** This JBL album was evidently put out to create a little excitement over the company's extensive connections with the professional sound industry. (JBL builds studio monitor speaker systems among other professional products.) This two-record set, while not exactly "listening for pleasure" fare, contains a lot that is potentially instructive. One disc traces the progress of a pop recording and mixing session, demonstrating such techniques as overdubbing, equalization, artificial reverberation, and the general symbiotic relationship between technician and artist in modern recording. The other disc is devoted to speaker evaluation under two categories: speaker "definition" and "coloration."

The session disc is most valuable for its excellent introduction to studio

practice. Those of you with scopes will be interested to see that most instruments and vocals are mixed in mono. Only when an echo chamber is used to process the vocal track does the characteristic "fried-egg" stereo trace appear on an X-Y scope display. The very last cut on the record, introduced by the narrator as a tribute to music, is to this listener a striking example of what happens when studio equalization gets completely out of hand. Scope owners should note the considerable asymmetry of the musical waveform on this cut. Apparently some heavy waveform peak limiting has been used to introduce outlandish amounts of distortion—the type commonly associated with unbalanced amplifier-output stages.

The speaker-evaluation disc offers great riches. The terms "definition" and "coloration" are not really strictly defined (nor can they be, since the two factors are so closely interrelated), but some of the tests should prove uniquely useful. For example, a cut well into Side One features a close-miked female vocalist with very prominent speech sibilants. This is a fine demonstration of how a good, clean recording of this sort should sound. Loud sibilants have a tendency to unglue even the finest systems, especially phono cartridges and preamplifiers. Properly recorded, they have a delicate quality that suggests the soft passage of breath over the palate and teeth. When troubles occur, sibilant sounds thicken or rasp. Since the recorded levels on the disc are moderate, a phono cartridge has a fighting chance of tracking the cut properly, allowing you to hear how the rest of your system copes with this kind of signal.

Then there's the plucked acoustic bass on Side Two—just about the best test I've come across to pinpoint rattling objects in the listening room (Venetian blinds, bric-a-brac on shaky shelves, flimsy lampshades, brass spittoons, etc.). Often these furnishings chime or buzz only at the loudest moments of musical hysteria, when there is so much sonic stimulus around that they get mistaken for speaker problems or amplifier clipping. But this very strong solo bass line, ranging over the full register of the instrument, will give them away instantly as the culprits they are. (It should be pointed out that this and other bass material on the record will almost certainly bring out any acous-

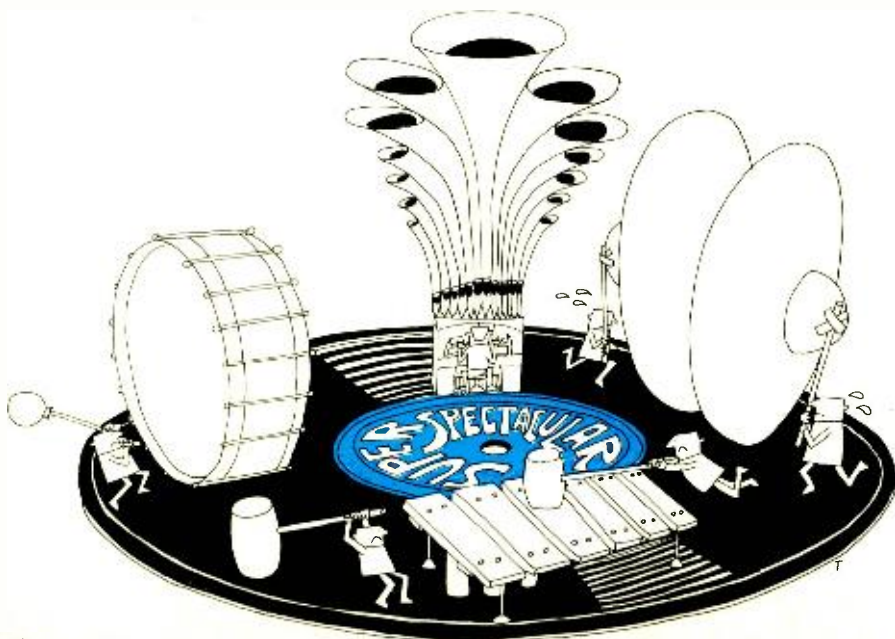



# Now Heathkit digital-design Color TV comes in two screen sizes



**21" diagonal 599<sup>95</sup>\*** less cab.



**25" diagonal 669<sup>95</sup>\*** less cab.

Now you can enjoy what Popular Electronics editors call "the color TV of the future" in either of two sizes, the original GR-2000 with 25" picture tube or the new GR-2050 with 21" tube. They have identical technology and features... just choose the picture size you prefer.



**On-screen electronic digital channel numbers** — big, bright, and easiest to read.

**On-screen electronic digital clock time**—low cost insurance against missed programs.

**Silent, electronic, touch-tuning**, thanks to the combination VHF-UHF varactor tuner. No knobs to turn, no contacts to clean, no noisy turrets, no humming motors, nothing to wear out. Just touch a button to tune.

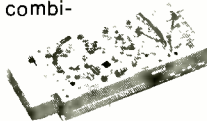

**Programmable Digital Counter/Channel Selector** — a computer-like programming board for you to pre-program any 16 stations, UHF or VHF, or both, in any order, even repeating if you choose, so there is never any need to have unused channels again. When activated by touching the tune button or remote control, the counter silently sweeps up or down through the 16 programmed channels; release the button and the selected channel is locked in. And you can change the programming any time you wish, such as when new stations come on the air, or you move to a new locality... just slide out the Service drawer and re-program.

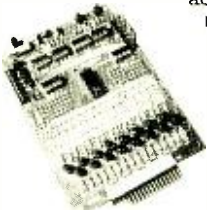

**HEATHKIT ELECTRONIC CENTERS** — Units of Schlumberger Products Corporation Retail prices slightly higher.

ARIZ.: Phoenix; CALIF.: Anaheim, El Cerrito, Los Angeles, Pomona, Redwood City, San Diego (La Mesa), Woodland Hills; COLO.: Denver; CONN.: Hartford (Avon); FLA.: Miami (Hialeah), Tampa; GA.: Atlanta; ILL.: Chicago, Downers Grove; IND.: Indianapolis; KANSAS: Kansas City (Mission); KY.: Louisville; LA.: New Orleans (Kenner); MD.: Baltimore, Rockville; MASS.: Boston (Wellesley); MICH.: Detroit; MINN.: Minneapolis (Hopkins); MO.: St. Louis (Bridgeton); NEB.: Omaha; N.J.: Fair Lawn; N.Y.: Buffalo (Amherst), New York City, Jericho (L.I.), Rochester, White Plains; OHIO: Cincinnati (Woodlawn), Cleveland, Columbus, Toledo; PA.: Philadelphia, Pittsburgh; R.I.: Providence (Warwick); TEXAS: Dallas, Houston; VA.: Norfolk (Va. Beach); WASH.: Seattle; WIS.: Milwaukee.

**Exclusive Heathkit fixed ten-section LC bandpass filter** — does away with critically adjusted traps yet eliminates adjacent-channel and in-channel carrier beats to give you truly superior color reception in multiple-transmitter urban areas or where multi-channel cable service is available. And it will never need periodic instrument alignment — it's adjusted and sealed at the factory so you have better pictures longer.



**100% solid-state** — more ICs than any other set in the world — 33 in all with remote control and clock — for greater reliability, less interference, truer colors, more precise tints, improved sensitivity, and better picture interlace for remarkable definition. Both sizes of picture tubes are black (negative) matrix types with full illuminated dots and black "surround" for brighter, more vivid pictures.

**Easier to build, easier to service.** Built-in digital-design dot generator, check-out meter, and easy-access adjustments for service you can do yourself. Modular circuit boards, wiring harnesses, and fewer chassis-mounted parts make it easier to build this color TV of the future.

Optional remote control, \$89.95.\* Cabinets from \$114.95.\*



**See the complete line of Heathkit Color TVs and 350 other easy-to-build kits in this FREE Catalog.**



<b>HEATH</b>		Heath Company,	
<b>Schlumberger</b>		Dept. 10-06	
		Benton Harbor, MI 49022	
Please send my free 1975 Heathkit Catalog.			
NAME _____			
ADDRESS _____			
CITY _____	STATE _____	ZIP _____	
*PRICES ARE FACTORY MAIL ORDER, FOB			
PRICES & SPECIFICATIONS SUBJECT TO CHANGE WITHOUT NOTICE.			
			CL-567



# Join "THE TROUBLESHOOTERS"

**They are paid good money  
for keeping today's  
electronic world running**

**Suddenly the whole world is going electronic! And behind the microwave towers, push-button phones, computers, mobile radio, television equipment, guided missiles, etc., stand THE TROUBLESHOOTERS — the people needed to inspect, install, and service these modern miracles. They enjoy their work, and are paid good money for it. Here's how you can join their ranks — without having to quit your job or go to college in order to get the necessary training.**

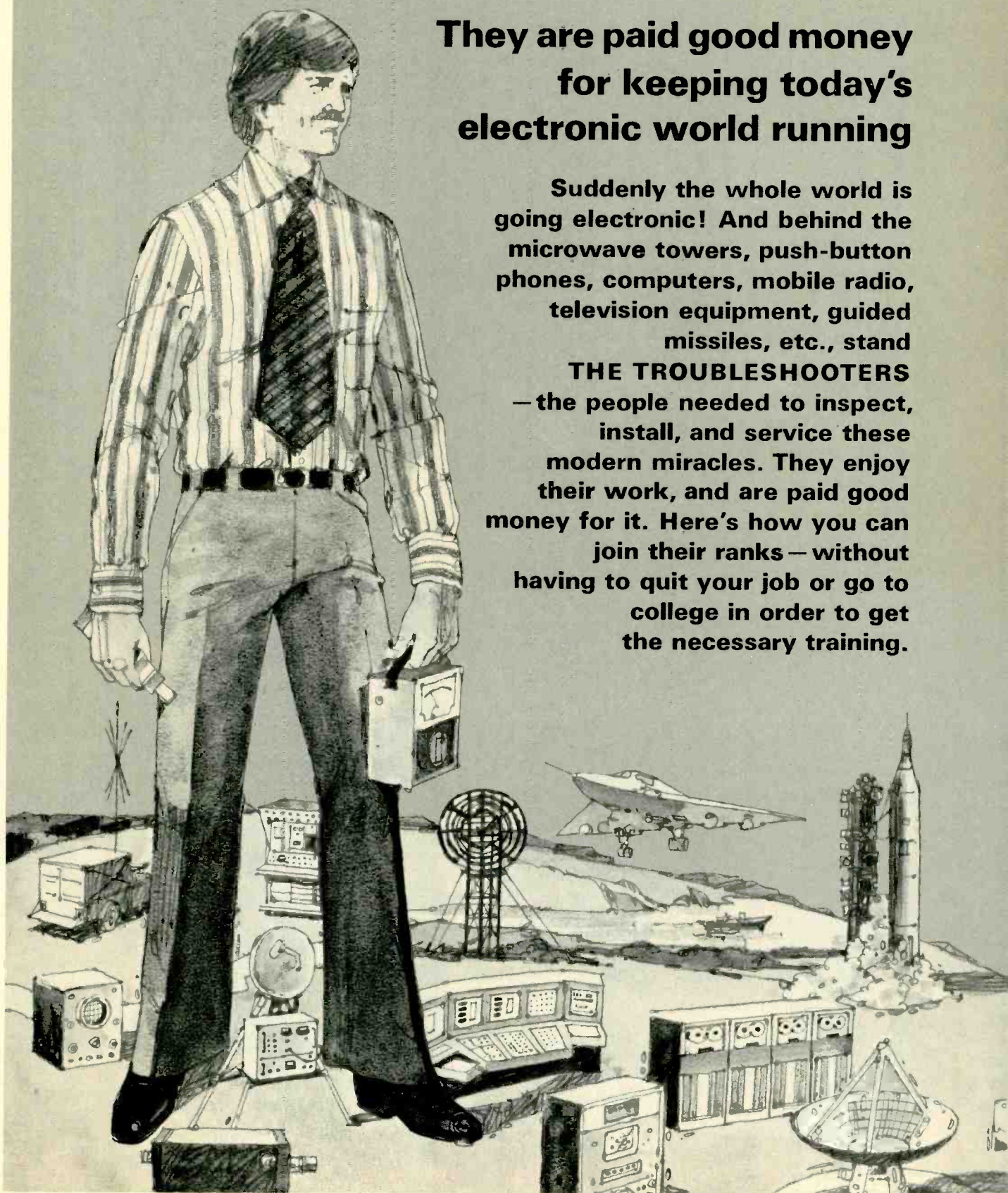



Just think how much in demand you would be if you could prevent a TV station from going off the air by repairing a transmitter . . . keep a whole assembly line moving by fixing automated production controls . . . prevent a bank, an airline, or your government from making serious mistakes by servicing a computer.

Today, whole industries depend on Electronics. When breakdowns or emergencies occur, someone has got to move in, take over, and keep things running. That calls for one of a new breed of technicians — The Troubleshooters.

The troubleshooters have many names. In radio or TV, they're the Broadcast Engineers. In other industries, their titles may be Technical Representative or Customer Engineer.

What do you need to break into the ranks of The Troubleshooters? You might think you need a college degree, but you don't. What you need is know-how — the kind a good service technician has — only lots more.

### Learn at Home . . . In Your Spare Time

As one of The Troubleshooters, you'll have to be ready to tackle a wide variety of electronic problems. You may not be able to dismantle what you're working on — so you must be able to take it apart "in your head." You'll have to know enough Electronics to understand the engineering specs, read the wiring diagrams, and calculate how the circuits should test at any given point.

Surprisingly, you'll find that you can learn the tech skills you have to know without setting foot in a classroom . . . without giving up your present job and its steady income.

For more than 40 years, CIE — Cleveland Institute of Electronics has **specialized** in teaching Electronics at home. We've developed independent home-study techniques that make it possible for you to learn Career Electronics even if you have had no previous electronics experience. Our Auto-Programmed® Lessons help you build a thorough knowledge of Electronics just as you would build a wall . . . building block by building block . . . moving ahead at your own pace, in your spare time, until you have reached your goal.

You mail your lesson exams to CIE where our Instruction Department checks your thinking, grades your work and refers any questions to the instructor best suited by experience to help you. That way, you benefit from the combined knowledge of the entire specialized CIE instruction staff.

Exams received any weekday before noon will be graded and mailed back to you the same day. Then you can review the CIE staff comments while the work is still fresh in your memory.

### You learn by doing

With CIE you can learn by doing . . . two ways: with your head and with your hands. In some CIE courses, you learn by doing "hands on" projects with actual components to solve "real world" problems . . . working with CIE's Experimental Electronics Laboratory. You'll become adept at handling components, pick up the self-confidence you'll need to handle the toughest on-the-job challenges. In other CIE courses, you'll go on to build . . . and keep . . . a big screen, solid-state color TV. After assembling the set, you'll learn the troubleshooting techniques of a TV technician with emphasis on digital electronics. The "learn by doing" method is so effective, some leading companies

use CIE courses to train their own employees.

### Get an FCC License

For troubleshooting jobs in broadcasting . . . television, AM or FM radio . . . or even in the repair and maintenance of mobile, two-way communication systems, federal law requires a Government FCC License. A number of CIE career courses include preparation for the FCC License exam. If that is your goal, we are confident that you can successfully earn your license because the vast majority of CIE graduates have. In fact, in continuing surveys, close to 9 out of 10 CIE graduates have passed their FCC exams. So we know our courses work.

That's why we offer this Warranty: when you successfully complete any CIE career course which includes FCC License preparation, you will be able to pass the Government FCC Examination for the License for which the course prepared you or you will be entitled to a full refund of an amount equal to the cash price of tuition for CIE's Course No. 3, "First Class FCC License," in effect at the time you enrolled. This warranty is good from the date you enroll until the last date allowed for completion of your course.

### Send for FREE school catalog

**Discover** the opportunities open to people with electronics training. **Learn** how CIE career courses can help you build new skills and knowledge and prepare you for a meaningful, rewarding career. We have courses for the beginner, for the hobbyist, for the electronics technician, and for the electronics engineer. Whether you are just starting out in Electronics or are a college-trained engineer in need of updating, (or anywhere in between), CIE has a course designed for you.

Send today for our FREE school catalog and complete package of career information. For your convenience, we will try to have a representative call to assist in course selection. Mail reply card or coupon to CIE . . . or write: Cleveland Institute of Electronics, Inc., 1776 East 17th Street, Cleveland, Ohio 44114. Do it TODAY.

### Approved Under G.I. Bill

All CIE career courses are approved for educational benefits under the G.I. Bill. If you are a veteran or in service now, check box for G.I. Bill information.

## CIE Cleveland Institute of Electronics, Inc.

1776 East 17th Street, Cleveland, Ohio 44114  
Accredited Member National Home Study Council

Please rush me your FREE school catalog and career information package today.

I am especially interested in:

- |  |  |
|--|--|
| <input type="checkbox"/> Electronics Technology  | <input type="checkbox"/> Industrial Electronics  |
| <input type="checkbox"/> FCC License Preparation | <input type="checkbox"/> Electronics Engineering |
| <input type="checkbox"/> Color TV Maintenance    | <input type="checkbox"/> Other _____             |
| <input type="checkbox"/> Mobile Communications   | _____  |

Print Name \_\_\_\_\_

Address \_\_\_\_\_ Apt. \_\_\_\_\_

City \_\_\_\_\_

State \_\_\_\_\_ Zip \_\_\_\_\_ Age \_\_\_\_\_

Check box for G.I. Bill information.

- |                                  |   |
|----------------------------------|---|
| <input type="checkbox"/> Veteran | <input type="checkbox"/> On Active Duty |
|----------------------------------|---|

PE-83

tic resonance in the listening room, so don't hasten to blame your speakers for any grotesque exaggerations of certain notes until you've experimented further with their placement.)

I question one test on the record that I can't get to work for me. It consists of a solo violin passage that is progressively limited in high-frequency response from a maximum of about 20,000 Hz down to 10,000 Hz. The narrator implies that no difference will be heard with a 15,000-Hz cutoff, but that losses below that frequency should be audible. I must confess that even with this violin's wealth of alley-cat overtones *and* using the very fine electrostatic headset that I finally resorted to, I could hear no significant difference—even when the bandwidth was limited to 10,000 Hz. Ordinarily, this wouldn't surprise me, since the overtones of the violin are very weak above 10,000 Hz. But I'm naturally uncomfortable when I don't hear something that I'm told is there. I suppose it's possible that a system introducing significant amounts of intermodulation distortion would "pass" this test in the prescribed way, but at the moment I'm completely in the dark.

Some final things I might mention: a few people have said they find this record strangely lacking in upper-mid-range and sometimes high-frequency energy, and I agree for certain cuts. The narrator's voice is also excessively "heavy" during much of the album, and not all of the instruments sound entirely natural to someone accustomed to hearing them from more than an inch or two away. However, "Sessions" is a very interesting record and could provide a genuine education in many ways.

(Available through JBL dealers or from James B. Lansing Sound, Technical Information Dept., 3249 Casitas Ave., Los Angeles, CA 90039. Price: \$2.)

**Acoustic Research Demo Record.** The first of a projected series, this disc is almost exclusively classical, recorded for the most part by the Ensayo group in Spain. It is truly a high-fidelity production right down to the pressing, which in my copy is superior. Except for a Britten excerpt for string orchestra, the emphasis is on small instrumental groups and solos: a little Stravinsky, some Mozart, Kodaly, Spanish classics, and the first section from the now-familiar Bach *D*

*Minor Toccata and Fugue*. The latter is the only selection that disappoints. A hoary old contribution from the Everest catalog, it sounds a little technically dated, and my best efforts have not been enough to get it to sound as clean as the liner notes suggest it should.

Particularly interesting is an excerpt from *Iberia* by Isaac Albeniz. This is one of the most difficult passages to reproduce well that I've encountered in a long time. Mercilessly exposed with virtually no reverberation, the upper register of the solo piano is pounded in a series of full-force chords and runs that offer a drastic test of cartridge tracking ability. On this material you *will* be able to hear audible differences between pickups. I tried several (and several phono preamplifiers as well) with widely differing results. As far as I can tell, the recording is clean and undistorted, but it will take an exceptionally good system to make it sound so.

Other attractions include the violin of Side One, Band Two, which is typically high, bright, and forward without ever being shrill; the magnificent solo cello of the Kodaly; the guitar of Manitas de Plata (if you've never heard the recordings the Connoisseur Society made of this celebrated Flamenco guitarist, don't wait another moment), and the jazz quartet on Side Two. Despite a little groove echo, this cut is as perfect an evocation of close-up jazz in a natural acoustic environment as I've ever heard. A pity that the music is a string of clichés.

(Available from Acoustic Research, 10 American Drive, Norwood, MA 02062. Price: \$4.98.)

**Motional Feedback Demo Record.** No, this is not an invitation to modern dance. It is Philips' commemoration of the RH 532 speaker system, which employs electronic feedback techniques to "correct" speaker errors at the amplifier.

The disc's two sides are divided into light classical and light pop selections. Philips, which is of course one of the world's finer record companies as well as an equipment manufacturer, has evolved its own approach to recorded sound. This seems to consist of rather close miking, a heavy admixture of reverberation, and robust bass. I wouldn't call the end result entirely natural, but it is certainly virile. The first classical selection, from Liszt's *Danse Macabre*, illustrates this well.

Another cut you might take note of is *Tuxedo Junction* on the opposite side, a rare insight into the artifice behind art. Listen to the way the back-up brass, recorded with a very "dry" sound on the left channel, is tamed with a wash of reverberation on the right. I'll bet you a pair of RH 532 speakers that this touch is courtesy of the control room rather than the natural acoustics of the recording site, but I think it comes off well. Technically, the record is well executed, and gives you a concentrated introduction to a recording philosophy that is distinctly unAmerican at the present time.

(Available from Philips Audio/Video Systems Corp., Video Division, 1 Philips Parkway, Montvale, NJ 07645. Price: \$5.75.)

**"Odyssey."** This Altec-produced record draws on ten A & M releases to provide a selection of mostly MOR (middle-of-the-road) rock material. It's pleasant enough, though rarely profound. Apropos its technical merits, I am moved to comment on the state of recordings from the big California studios and their derivatives elsewhere. Many of them specialize in a peculiarly remote, reverberationless sound (incidentally, this also applies to much of the JBL album's content). Rarely do they go for the lush and the rich-sounding, with occasional exceptions in the bass line and for some vocal tracks. Undoubtedly they get the results they want, but the appeal of the sound may not be universal.

As one example, take the typical cymbal sound on the Altec and JBL records—effervescent but a bit bodiless, distant, and "tizzy." Compare it with the jazz cut on the AR record, or even with some of the Philips selections, where the instrument rings out with a genuine brassy clang and impact. Many modern recording outfits mike the percussion in a section of the studio that is very dead acoustically. This helps to keep the drum sound from leaking into the microphones for other instruments. Whether it also "eats up" the cymbal is not for me to speculate on. But I do wish I had the records from which these selections were taken to see if their sonics differ.

Another aspect of multi-track recording that I'm increasingly aware of might be called "dynamic perspective." In the studio, a typical pop artist tends to hammer away in pretty vigorous style. If the producer feels he



should be quieter, he turns him down at the mixing console. Now if on the final version you hear a drummer who is obviously playing loud, but is being drowned out by the acoustic guitar, you (or your ear-brain mechanism) have to conclude that he's some distance away. Perhaps you can accept this until, for some special effect, the producer suddenly turns him up and he practically pops into your lap. There are a few such curiosities on the Altec record; for example, a tom-tom might jump forward for a few beats.

Notwithstanding, "Odyssey" is a competent job. The pressing may not be quite immaculate, and my copy has a slightly off-center spindle hole that troubles (with wow) the piano that's prominent on a few cuts. But I plan to listen to it again, for pleasure.

(Available from Altec Lansing Marketing Services, 1515 S. Manchester Ave., Anaheim, CA 92803. Price: \$1.25.)

**Home-Made with Teac.** I wish I could get recording results like this in my living room. But anyway, according to the record, the sounds heard were indeed captured in a domestic setting, with audiophile equipment. The (pop) group featured is the "Hello People," who sing, play, and talk about their affection for the Teac 3340, the rather expensive tape deck with four-channel multi-track capabilities that was ostensibly used to make the recording. The presentation abounds in humor and plausibility, however, and there's much to interest the home recordist as well as one who wants to learn about studio techniques. The sound is generally quite good: up-front, alive, and with none of the dead-as-a-stick studio ambience.

(Available through Teac dealers. Price: \$2.00.)

**Bose Salutes the Sound of Mercury Records.** Many audiophiles remember fondly the early Mercury "Living Presence" series of classical

stereo recordings, some of which are now almost two decades old. They were high points of their era, although often prone to "overachievement" in recorded levels and creative equalization. Some of the better excerpts are presented in this Bose record, selected for their sonic interest, and intelligently remastered. All of them are orchestral, and none of them is less than exemplary, except for the brief excerpt from the Beethoven *Fifth Piano Concerto* with its strangely stipitated piano sound.

I consider this material to be in the best tradition of symphonic recording—bright, spacious, impactful, and delicately detailed. There is some tape hiss, but surprisingly little for pre-Dolby days. The pressing is good, although on the several copies auditioned I've preferred the processing on Side One. If you yearn for the sounds of better days, the Bose record may be obtainable by hounding an obliging Bose dealer. Unfortunately, the company does not sell the disc direct to consumers.

**The Real Thing.** Among the most interesting demo records are those said to be made with no electronic doctoring whatsoever—no mixing beyond what is accomplished by microphone placement, no equalization, and usually no noise-reduction processing. Two discs now available from equipment manufacturers fall into this category.

Ambiphon Records, of which I wrote some months ago in connection with its remarkable four-channel tape recordings, has decided to broaden its market by issuing some disc records. The first is devoted to solo pianist Natalie Ryshna. (The record, incidentally, is not four-channel, although it could presumably be enhanced by playback through a matrix decoder.) Unhappily, this first offering is plagued with hiss, which was entirely absent on the tapes I heard. Apparently the noise crept in somewhere in

the tape-to-disc transfer process or afterward, since it is present even between cuts. As for the piano sound itself, I think it is admirable, but not remarkable. That is, I have a few commercial piano recordings that I consider equally good. The four-channel tapes I heard were remarkable, however, adding a whole new dimension to the performance.

Ambiphon hopes to clear up the noise problem in the next production run, and this should add much to the record's impact. Distribution is through ESS (which is what qualifies the production as an equipment manufacturer's demo disc).

(For dealers carrying the record, write ESS Special Products, 9613 Oates Dr., Sacramento, CA 95827. Price: \$11.75.)

Mark Levinson, a manufacturer of spare-no-pains audio electronics in Hamden, CT, has been live-recording for a number of years and is now up to Volume Three in his "Pure Acoustic Master Tape Reference Recording Series." I have Volume One—organ and choral selections performed in a rather intimate chapel setting. This material is remarkable for its wide, easy range, and particularly for the stability and scope of its stereo image. The latter is almost never as clear and palpable on commercial recordings in similar acoustic environments.

The acoustics are rather live, as the applause between selections demonstrates and, on my system, the sibilants from the chorus are prominent. This should raise the usual havoc with equipment that performs poorly in this area. But when all is well, the Levinson disc sounds real and untampered. I am told that the later volumes (piano and percussion, respectively), which I have not heard, are all-out attempts to capture the full dynamic range of the performances.

(Vols. One, Two, and Three are available from Mark Levinson, 55 Circular Ave., Hamden, CT 06514. Price: \$10.50 each.) ♦

## UPCOMING AUDIO SHOWS

October 10-12  
October 31-November 3

November 6-10  
February 12-16, 1976  
March 12-14, 1976

BALTIMORE HI-FI SHOW  
AUDIO ENGINEERING SOCIETY  
(52nd Convention)

PHILADELPHIA HI-FI SHOW  
DETROIT HI-FI SHOW  
SAN DIEGO HI-FI SHOW

Location to be determined  
Waldorf-Astoria Hotel, NYC

Benjamin Franklin Hotel  
Cobo Hall  
San Diego Community Concourse

# NEWS HIGHLIGHTS

## **Bell Licenses Coupler**

The Bell System has licensed Phone-Mate, Inc. to manufacture the new "Authorized Protective Connecting Module" for connection of Phonemate automatic telephone answerers to the System's telephone network. The coupling module allows an automatic answerer to be plugged into an ordinary four-prong telephone jack. Previously, subscribers who purchased their own answerers could attach these devices only through a Protective Connecting Arrangement, provided by Bell and requiring an installation charge and monthly rental fee. Under the new arrangement, answerers may be connected to the lines through the module into any extension jack.

## **CB and Amateur Radio Fees Reduced**

As of March 1, 1975, the FCC fee for a CB license was reduced from \$20 to \$4; and for an amateur radio license, from \$9 to \$4.

## **Hi Fi Tape Training Console**

A mini recording studio may soon appear in your local hi-fi emporium. The Creative Tape Center by TEAC, being introduced in 48 western hi-fi stores, will enable tape-machine owners to realize the creative potential they possess. The Center will teach mixdown techniques, overdubbing, basic mono and stereo techniques, and specialized effects like echo and sound-on-sound. The console uses TEAC two- and four-channel open-reel decks, a cassette deck with Dolby noise reduction, a mixing panel, three microphones and a mixer.

## **"Laserium" Concerts at Planetariums**

Planetariums across the country have been the scene of "Laserium" concerts. They consist of projections of laser light in brilliant patterns in conformity with recorded music, which ranges through the works of Copeland, Strauss, Respighi, Billy Preston, Gustav Holst, and Emerson, Lake and Palmer, among others. The concerts, which last less than an hour, begin with the familiar sky scenes and then the laser light streaks and bobs over the dome in reds, greens, blues, and whites. The instrument that performs all this magic is a 1000-milliwatt laser projection system assembled by Laser Images, Inc. of Van Nuys, California. Although the basic program is fairly standardized, the keyboard operator can introduce variations of his own.

## **"NOAA" Now Official Radio Alert**

The Executive Office of the President has officially selected the National Oceanic and Atmospheric Administration (NOAA) system as the sole government-operated radio system for communicating attack or weather disaster warnings direct to the public. There are 77 transmitter locations covering one-half of the U.S. population with the tone-alert service. National

coverage is expected by the end of 1978, depending on Congressional appropriations. Acquisition and use of a home-warning receiver will be optional with each individual citizen.

According to the national Weather Service, additional cities that will start continuous weather broadcasts this spring are: Philadelphia; Buras and Morgan City, La.; Daytona Beach, Ft. Myers, Key West, Melbourne, and Tallahassee, Fla.; Port Lavaca, Tex.; Bay City, Ironwood, and Travis City, Mich.; Coos Bay and Newport, Ore.; Crescent City, Ft. Bragg, San Luis Obispo, Santa Barbara, and Santa Rosa, Calif.; Hoquiam, Port Angeles, Yakima, and Coachella, Wash.; Columbus, O.; Nashville, Tenn.; Rochester, N.Y., and Burlington, Vt.

## **WWV and WWVH Want Your Views**

The Time and Frequency Division of the National Bureau of Standards is calling on users of its precise time and frequency stations, WWV and WWVH, for assistance in determining user demand. Last year, a 50-percent power output reduction was proposed by NBS for WWVH for the frequencies 5, 10, and 15 MHz. This action was postponed due to objections received from users of WWVH. Due to the government-wide efforts to reduce operating costs and conserve energy, the NBS is again soliciting users' views via a postage-paid questionnaire which is obtainable from Time and Frequency Service Section, NBS, Boulder, CO 80302.

## **RCA Space Mountain at Walt Disney World**

The latest attraction at Walt Disney World is the RCA Space Mountain—a further example of the fantastic effects that are achieved at the Park through the use of sophisticated electronics. A key feature of the Space Mountain is a thrill ride (similar to a roller coaster) that simulates a ride in space. Cars are shaped like rockets with phosphorescent side panels, and "g" forces and weightlessness are simulated by sharp dips and inclines. Many visual effects, such as strobe-light acceleration and fiery re-entry tunnels, meteor swarms and passing spacecraft, heighten the sensation of being in space.

According to Disney engineers, the ride is a good example of process control. A Data General Nova 2 minicomputer with 16K of memory space is used to oversee the operation of the ride. Data General I/O interface circuitry links the computer to car-position sensors and electromechanical control devices. Magnetic reed switches detect car positions and pneumatic caliper brakes grip a fin beneath the car to slow it down. A back-up logic system composed of high-reliability telephone-type relays takes control of the ride in the event of computer or interface failure.

Another feature of the Space Mountain is the "Home of the Future." Here, animated figures controlled by DACS (Disney Animation Control System), are seen using small computer terminals for shopping, business and research; watching entertainment on wall-size televisions, etc.



# Checkbook with a brain

Never make another checkbook error with America's first computerized banking center in a case.



The new CheckMaster is a checkbook holder with a built-in computer—a time-saving device that will keep you in perfect balance for every check you write, every day of the year.

## YOUR BANK WILL LOVE YOU

If you're like most Americans, your checkbook is a disaster area. And your electronic calculator isn't helping much.

Now, there's a great new space-age product called the CheckMaster designed specifically to keep you in perfect balance, for every check you write, every day of the year. And it's actually easier to use than a calculator.

## HERE'S HOW IT WORKS

Open your checkbook holder and turn on the built-in computer. Press the "Balance" key, and your bank balance is recalled on the display. The CheckMaster memory is so powerful that it never forgets your balance—even months after you last recall it.

Enter the amount of your check, and press the "Check" key. The check amount is automatically deducted from your balance, and your new balance is displayed—and all with just one key stroke.

Or enter the amount of a deposit, and press the "Deposit" key. Your deposit is automatically added to your balance, and again, your new balance is displayed.

## MANY EXTRA FEATURES

The CheckMaster does so much, so easily, and it's great fun to use. Here are seven reasons why:

**1. Easily corrects mistakes** If you enter the wrong digits, press the "Clear" key. Only your mistake will be cleared—never the balance.

**2. Worry-free decimal** Just enter the digits. The unit's dollar-position decimal always keeps the decimal point where it belongs.



**3. Low battery signal** The unit's penlight batteries will last one year with average use. A low battery signal on the display will indicate when it's time to replace them.

**4. Overdraft alert** CheckMaster will signal an overdrawn account plus show the overdraft amount and help you avoid the embarrassment of having a check accidentally bounce.

**5. Safety switch** If you forget to turn off your computer, don't worry. Whenever you close your case, your unit shuts off automatically.

**6. Private viewing angle** Don't worry about anyone seeing your balance. The red display can only be viewed by the user and registers up to \$9,999.99 or any six digits.

**7. Perfect size** The CheckMaster's handsome tan and cream-colored case measures 7/8" x 3 5/8" x 6 3/4" and weighs only 8 ounces.



To find out your exact balance, even months after you've last recalled it, simply open your case and press the balance key. CheckMaster's memory never forgets. Designed for both men and women, CheckMaster holds any standard-sized personal checks, check register, credit cards and important papers.

## RUGGED AND SHOCKPROOF

Drop it, sit on it, drop it again—CheckMaster's shock-proof case will withstand plenty of abuse. The integrated circuit is hermetically sealed for a lifetime of trouble-free service. A spot of gold is even used in the circuit's final sealing process to insure CheckMaster's very high level of reliability.

## CONTROL YOUR PURCHASES

Take CheckMaster with you to the supermarket. Set a dollar limit on what you intend to buy. Then enter each item you purchase as if you were writing a check. When your balance reaches your limit, stop buying and head for the check-out counter. It's a great way to control your budget and prevent overcharging by the check-out clerk.

## THE PERFECT GIFT

CheckMaster makes the ideal gift for your wife, husband, friend or anybody who has a personal checking account. Even a person who already owns a calculator will appreciate CheckMaster's value and convenience.

CIRCLE NO. 25 ON READER SERVICE CARD

**\$39.95** NATIONAL INTRODUCTORY PRICE

The CheckMaster is perfect insurance against bounced checks, overdrafts, arithmetic errors and bank errors. Its powerful memory, simple operation, and many extra features make it another example of how space-age technology has made fun out of one of the most time-consuming household tasks.

## MORE THAN GUARANTEED

The CheckMaster will make such an improvement in helping you balance your checkbook that we make the following unusual money-back guarantee: use the CheckMaster until your next bank statement arrives or for one full month. If the CheckMaster does not balance your checkbook perfectly and actually pay for itself in either convenience or actual savings, return it for a prompt and courteous refund. You can't lose.

## A NATIONAL INTRODUCTORY PRICE

The American-made CheckMaster is manufactured for JS&A by Mostek Corporation, a leading consumer electronics manufacturer, and the first company to manufacture the pocket calculator integrated circuit. JS&A is the world's largest single source of electronic calculators, digital watches and other space-age products. We have decided to offer the CheckMaster directly to consumers, exclusively through the mail, for only \$39.95 during our national introduction.

## HOW TO ORDER

Credit card buyers may call our national toll-free number or any of the local numbers listed below. Or you may send your check or money order for \$42.45 per unit (\$39.95 plus \$2.50 postage, insurance and handling—Illinois residents add 5% sales tax) to the address shown below. But act quickly! See for yourself how easy it is to keep your checkbook in perfect balance every day of the year. Order your CheckMaster at no obligation today.

## ONE YEAR WARRANTY

CALL TOLL-FREE.....(800) 323-6400  
In the State of Illinois call.....(312) 498-6900  
In the Los Angeles area call.....(213) 629-1190  
In the San Francisco area call....(415) 391-1700  
In the New York City area call... (212) 964-0690  
In Montreal Canada call.....(514) 332-9523  
In Toronto Canada call.....(416) 445-8136  
In Australia call.....Melbourne 53 5286

**JS&A NATIONAL SALES GROUP**  
DEPT. POE 4200 DUNDEE ROAD  
NORTHBROOK, ILLINOIS 60062  
(312) 564-9000 © JS&A Group, Inc., 1975



# CT-1024 TERMINAL SYSTEM

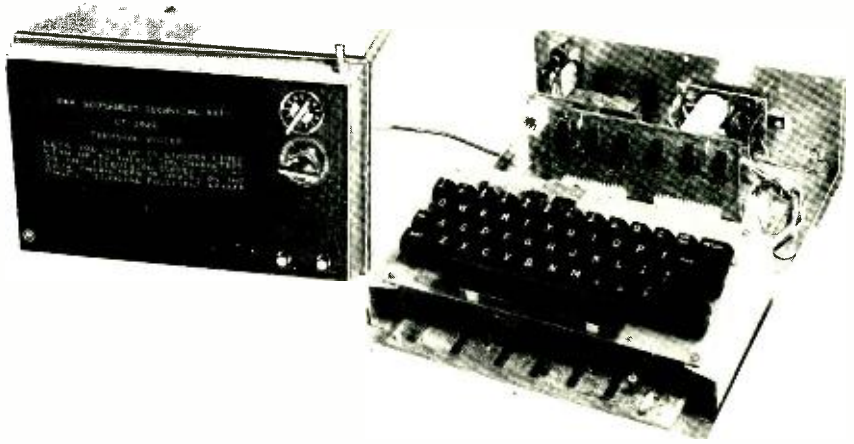

When we designed the CT-1024 we knew that there were many applications for an inexpensive TV display terminal system. Even so, we have been surprised at the many additional uses that have been suggested by our customer in the last four months since we introduced this kit.

The basic kit, consisting of the character generator, sync and timing circuits, cursor and 1024 byte memory gives you everything you need to put a sixteen line message on the screen of any TV monitor, or standard set with a video input jack added to it. Input information to the CT-1024 may be any ASCII coded source having TTL logic levels. Two pages of memory for a total of up to one thousand and twenty four characters may be stored at a time. The CT-1024 automatically switches from page one to page two and back when you reach the bottom of the screen. A manual page selector switch is also provided. The main board is 9½ x 12 inches. It has space provided to allow up to four accessory circuits to be plugged in. If you want a display for advertising, a teaching aid, or a communication system then our basic kit and a suitable power supply is all you will need.

**CT-1 TERMINAL SYSTEM with MEMORY KIT** .....\$175.00 ppd  
Power supply kit to provide + 5 Volts @ 2.0 Amps and - 5 Volts, -12 Volts @ 100 Ma. required by the CT-1 basic display system.  
**CT-P POWER SUPPLY KIT**.....\$15.50 ppd

A very nice convenience feature at a very reasonable cost is our manual cursor control plug-in circuit. The basic kit allows you to erase a frame and to bring the cursor to the upper left corner (home up). By adding this plug-in, you can get Up, Down, Left, Right, Erase to End of Line and Erase to End

of Frame functions. These may be operated by pushbutton switches, or uncommitted keyswitches on your keyboard. Although not essential to terminal operation, these features can be very helpful in some applications.

**CT-M MANUAL CURSOR CONTROL KIT**.....\$11.50 ppd

If you plan to use your terminal with a telephone line modem, or any other system that requires a serial data output; you will need our serial interface (UART) plug-in circuit. This circuit converts the ASCII code from a parallel to a serial form and adds "Start" and "Stop" bits to each character. The standard transmission rate for this circuit is 110 Baud, but optional rates of 150, 300, 600 and 1200 Baud may be obtained by adding additional parts to the board. The output of this circuit is an RS-232 type interface and may be used to drive any type modem, or coupler system using this standard interface.

**CT-S SERIAL INTERFACE (UART) KIT**.....\$39.95 ppd

If you are using the CT-1024 as an IO (input - output) device on your own computer system, you will probably

want to connect it to the computer with a parallel interface system. A direct parallel interface allows for much faster data transmission and reception and is basically a simpler device than a serial interface system. Our parallel interface circuit contains the necessary tristate buffers to drive either a separate transmit and receive bus system, or a bidirectional data bus system. TTL logic levels are standard on this interface. Switch selection of either full, or half duplex operation is provided. The terminal may write directly to the screen, or the computer may "echo" the message and write to the screen.

**CT-L PARALLEL INTERFACE KIT**.....\$22.95 ppd

We would be happy to send you a complete data package describing the CT-1024 and a schematic. If you want this additional information, circle our number shown below on your reader information service card. The CT-1024 kit has complete assembly instructions with parts location diagrams and step-by-step wiring instructions. If you would like to check the instruction manual before you purchase the kit, please return the coupon with \$1.00 and we will rush you the manual and the additional data mentioned above.

### MAIL THIS COUPON TODAY

- Enclosed is \$ \_\_\_\_\_  or Master Charge # \_\_\_\_\_
- or BankAmericard # \_\_\_\_\_ Card Expiration Date \_\_\_\_\_
- CT-1024 Kit  CT-M Cursor Control Kit
- CT-S Serial Interface Kit  CT-L Parallel Interface Kit

NAME \_\_\_\_\_

ADDRESS \_\_\_\_\_

CITY \_\_\_\_\_ STATE \_\_\_\_\_ ZIP \_\_\_\_\_

\$1.00 Enclosed send manual and data package

Southwest Technical Products Corp., Box 32040, San Antonio, Texas 78284



# The TITAN Modular Stereo Power Amplifier

*Super op amps  
deliver high power,  
reduce  
construction time.*

BY ROY HARVEY

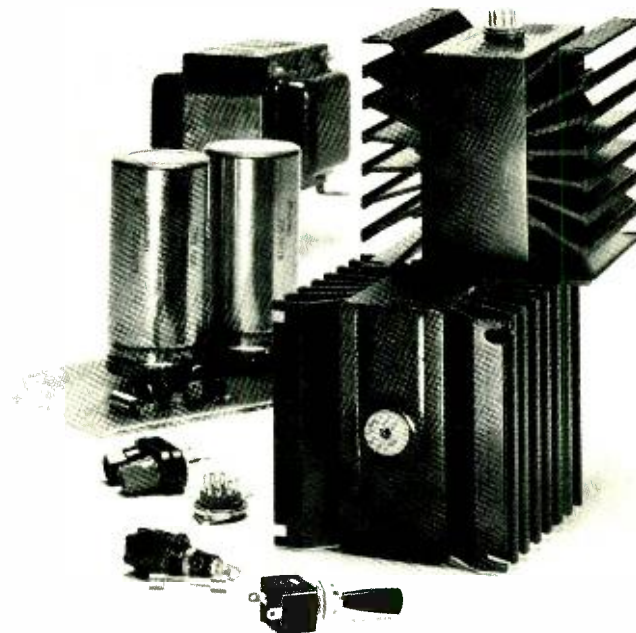

**T**ITAN is a high-performance high-power audio amplifier that is unusually easy to build because of the modular concept used in the circuit design. Power modules simply "plug in" to a socket.

The major parts of the complete stereo amplifier consist of two power modules, a power transformer, and one 8" x 4½" pc board to accommodate only a handful of components. With the unique power modules, the amplifier delivers a conservative 80 watts per channel. (Details on the modules, which eliminate considerable component mounting during assembly, are given in an accompanying box.)

Another interesting attribute of

Titan is that you can choose your power output requirements—25 W, 50 W, or 80 W per channel—by specifying which power transformer to use.

The chassis measures approximately 13½"L x 8½"W x 6¾"H (34 x 22 x 17 cm) with the outboard-mounted power modules adding 4" to the length.

**Circuit Operation.** The schematic of one channel of the amplifier is shown in Fig. 1. The power module (PM1) is shown as an operational amplifier, since that is essentially how it functions. In this circuit, it is a non-inverting amplifier (input connected to + terminal) with ac coupling at the input and direct coupling at the out-

## AMPLIFIER SPECIFICATIONS

**Power Output:** 80 watts per channel (rms) into 8 ohms, both channels driven.

**Harmonic Distortion:** Better than 0.2% from 20 Hz to 20 kHz at rated power. Typically 0.05% at 1 kHz.

**Intermodulation Distortion:** 0.2% maximum into 8 ohms at rated power.

**Power Bandwidth:** 8 to 35 kHz ±1 dB at rated power.

**Hum and Noise:** 100 dB below 80 W into 8 ohms.

**Input Sensitivity:** 1.0 volts rms for full power.

Fig. 1. The power module is a "super" 741 op amp that can deliver up to 100 watts across the audio range.

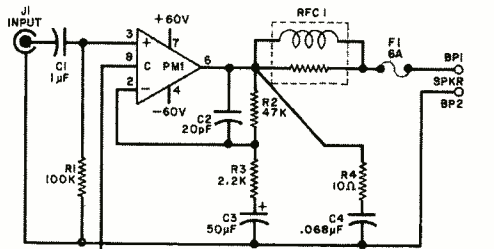

### PARTS LIST

(Except where marked\*, two of each are needed for stereo amplifier).

- BP1, BP2—Five-way binding post (red and black)
- C1—1- $\mu$ F, 100-V capacitor
- C2—20-pF, 20-V disc capacitor
- C3—50- $\mu$ F, 20-V electrolytic capacitor
- C4—0.068- $\mu$ F, 100-V disc capacitor
- C5, C6—7100- $\mu$ F, 75-V electrolytic capacitor (Mallory CGS or similar)\*
- D1 to D4—200-V, 6-A rectifier (HEP-R0102 or similar)\*
- F1—6-A fast-blow fuse and holder
- F2—4-A slow-blow fuse and holder\*
- J1—Phono connector
- LED1—Any red LED\*
- PM1—IS741H150 power module (available only as noted below)
- R1—100,000-ohm, 1/2-W resistor
- R2—47,000-ohm, 1/2-W resistor
- R3—2200-ohm, 1/2-W resistor
- R4—10-ohm, 2-W resistor
- R5—2700-ohm, 2-W resistor
- RFC1—25 turns, #18 wire wound on a 10-ohm, 2-W resistor
- S1—Spst switch
- T1—72-V, CT, 4-A transformer\*\*

- Misc.—Suitable chassis, 9-pin socket (2), spacers, rubber grommet, shielded cable (6 in.), mounting hardware, line cord.
- Note—The following are available from Integral Systems, 500 Waltham St., North Wilmington, MA 01887; pc board at \$4.00; power transformer at \$25.00\*\*; power modules at \$70 each; complete stereo kit including the above with chassis at \$199.00.
- \*\*Select transformer on basis of desired power output (for heavy commercial use, don't exceed 50 W/ch.):
- |             |             |
|-------------|-------------|
| 8-ohm Spkr. | Trans. Sec. |
| 25 W/ch.    | 36 VCT, 5 A |
| 50 W/ch.    | 56 VCT, 4 A |
| 80 W/ch.    | 72 VCT, 4 A |

**Construction.** The etching and drilling guide for a printed circuit board and a component layout are shown in Fig. 3. Also shown are the connections between the board and power modules, transformer, light, and terminals. In assembling the board, be sure to observe the polarities of the diodes and electrolytic capacitors.

Connections to the power modules are made through a vacuum-tube-type 9-pin socket. The modules also have four slots on the same side as the socket for mounting with machine hardware.

The photographs show the components of the prototype. Note that the power modules mount so that the heat-sink fins run vertically to provide "chimneys" for the heat.

The power modules do not have built into them protection circuits to guard against damage resulting from sustained short circuits across their outputs. Therefore, it is essential that the "hot" output lines be fused as shown in Fig. 1.

Use a red binding post for the "hot" speaker terminal on each channel and a black binding post for the common terminal. Mount the LED in a tight-fitting rubber grommet.

Use shielded audio cable for the two input lines going from the jacks to the amplifier assembly and #18 or heavier hookup wire for the power, output, and ground connections.

**Operation.** Before putting the power modules into their sockets, turn on the power and make sure that LED1 is illuminated and that there is +60 volts

Photo shows assembled amplifier and two of the power modules.

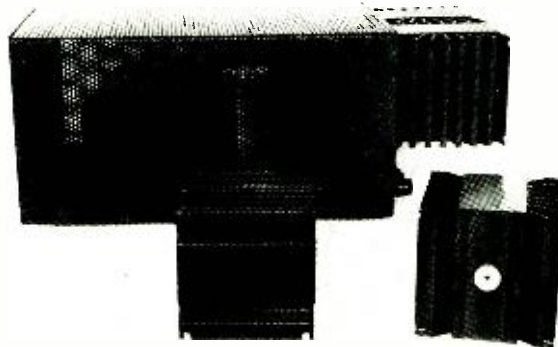

put. Capacitor C1 and resistor R1 provide dc isolation from the source and a 100,000-ohm input impedance. Resistors R2 and R3 determine the gain of the amplifier, which is about 25. Thus, a 1 1/2-volt rms input produces about 30 volts at the output, which is more than enough to provide 110 watts to an 8-ohm load (3.75 amperes).

Capacitor C2 provides a rolloff of gain at high frequencies to prevent ringing and oscillation, while C3 forces the op amp to act as a unity-gain voltage follower for dc signals. The latter lowers the output offset voltage.

The power supply (Fig. 2) is a heavy-duty, dual-polarity supply that uses a conventional bridge rectifier and filter system. Power-on indicator LED1 is across the +60-volt supply.

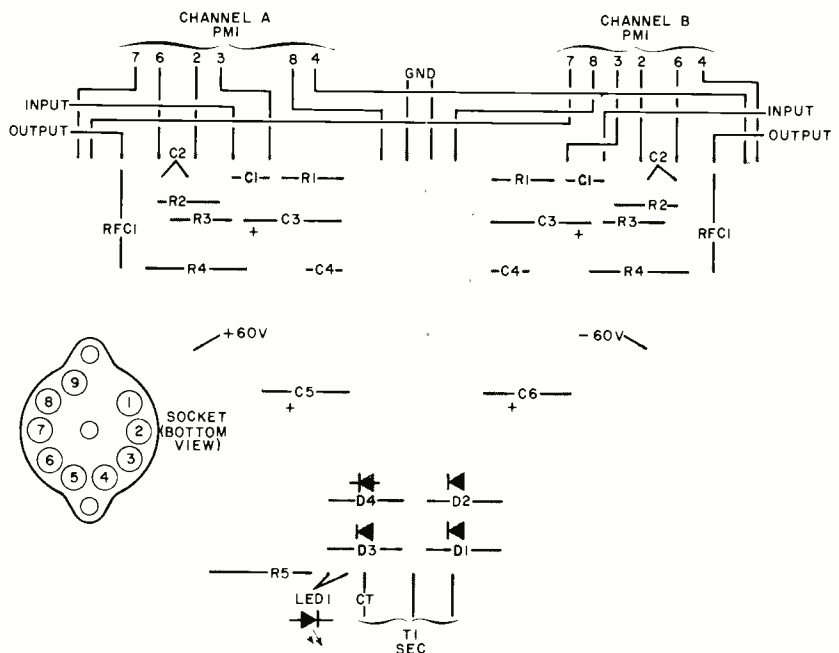



at pin 7 and -60 volts at pin 4 of each module socket. Then turn off the power and mount the modules.

(Note: It is extremely important that the module pins and the socket be clean and free of oxide "scale" and that the "fit" between the two be tight to insure good electrical contact.)

Connect an ac meter (30 volts) or an oscilloscope to each of the output terminals and apply a signal of less than 1 volt amplitude to the appropriate amplifier input. Note that the

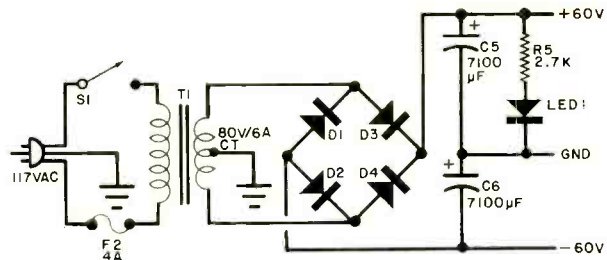

Fig. 2. Power supply can deliver up to 2 amperes and will suffice for a two-channel amplifier.

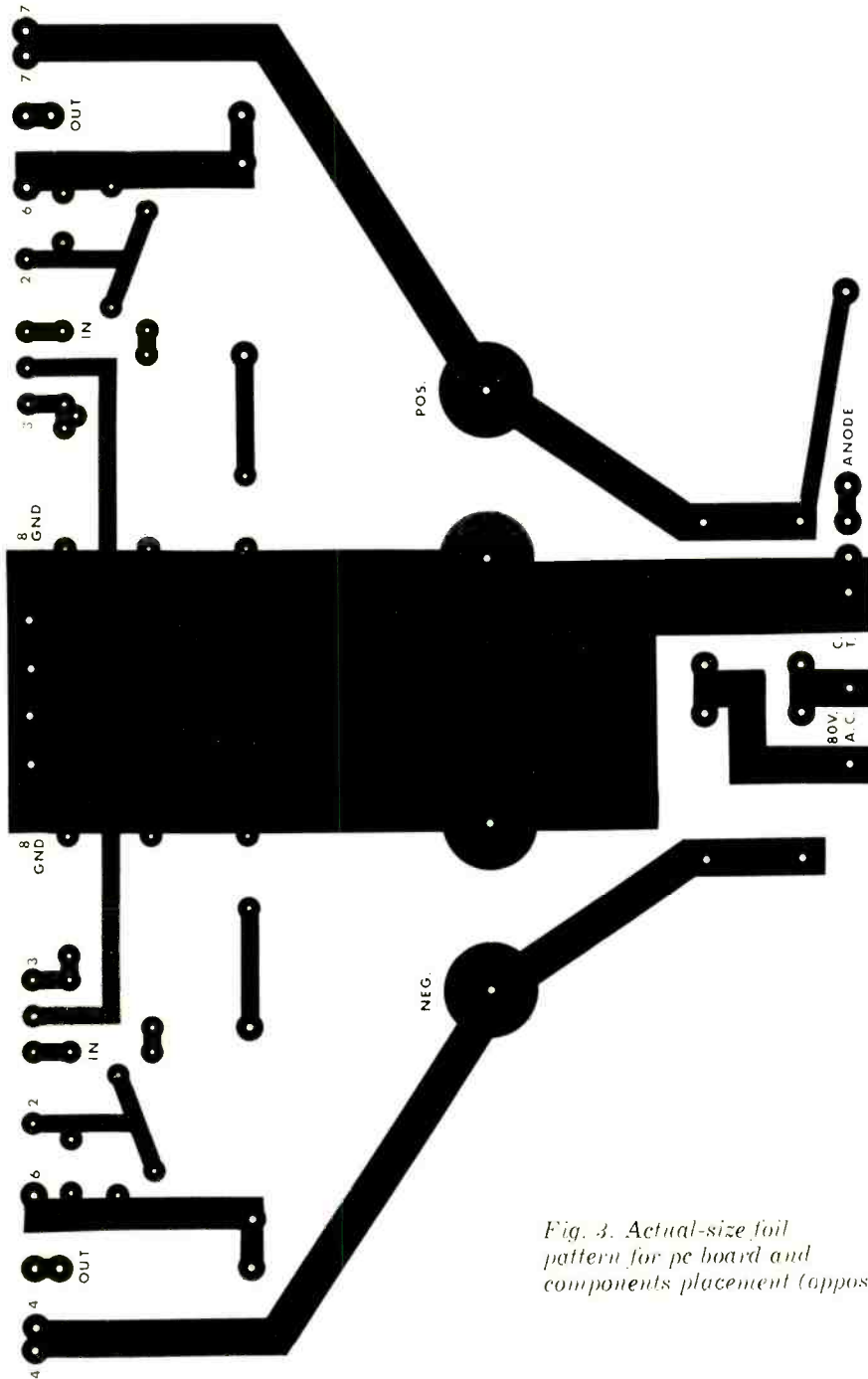
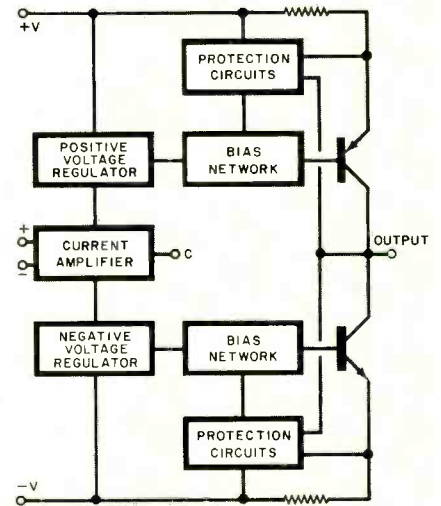

Fig. 3. Actual-size foil pattern for pc board and components placement (opposite).

## ABOUT THE POWER MODULE



The Integral Systems 741H150 module (patent pending) is a cast hybrid structure with true differential inputs and full complementary output. The current amplifier sinks current through terminal C from either of the two voltage regulators depending on the instantaneous polarity of the signals at the positive and negative inputs. The regulators and bias circuits relay this information to the complementary output transistors.

Common-mode damping eliminates any tendency for the output devices to turn on simultaneously, as often happens in conventional amplifiers. Crossover bias current in the output stage is determined by the interplay of the damper and bias circuits. Thus, the collector output push-pull configuration, which has high gain but is unstable in many designs, is stabilized by the integral epoxy construction of the module and the resulting thermal equilibrium of the components.

The module also contains special circuitry to protect the output devices when operating conditions approach the danger point.

The 741H150 module performs as a conventional 741 op amp, except that it can deliver up to 10 amperes of current and can operate with supply voltages up to 120 volts.

output waveform is proper and that there is no large dc offset.

Turn off the power, connect 8-ohm

speakers and a preamplifier to the Titan. Be sure the gain control in the preamplifier is turned down be-

fore turning on either the preamp or the Titan to avoid damaging the speakers. ♦

## TITAN MODULAR STEREO AMPLIFIER (A Hirsch-Houck Labs Report)

We tested the Titan amplifier with both channels driven into 8-ohm loads. (Since the amplifier is specifically not recommended for use with 4-ohm loads, 4-ohm-load laboratory instrument tests were not conducted.) The full rated power of 80 watts/channel was used as the maximum output power in all our tests, except that we briefly went to a higher power level to determine the amplifier's clipping level, which measured 120 watts/channel. It met all its claimed specifications.

At the 80-watt output power level, total harmonic distortion (THD) measured less than 0.02% between 20 and 600 Hz. It rose smoothly with increasing frequency to 0.17% at 20,000 Hz. Operation at half and one-tenth power did not significantly change the distortion characteristics, although the low-frequency distortion increased slightly, to a maximum of 0.04% at 20 Hz.

The 100-Hz THD decreased smoothly from 0.18% at 0.1 watt to between 0.03% and 0.04% at power outputs from 4 to 80 watts. Intermodulation (IM) distortion increased from about 0.025% at 0.1 watt to 0.1% at 5 watts output. At 80 watts out, it measured 0.13%.

A 0.34-volt input drove the Titan to a reference output of 10 watts. The output noise in a 25,000-Hz measurement bandwidth was 95 dB below the 10-watt level. Using the rated 80 watts/channel as a reference, the input sensitivity measured about 1 volt. The noise level was a very good -104 dB.

The frequency response of the amplifier within the audio band was down 0.4 dB at 20 Hz and 0.65 dB at 20,000 Hz. (It dropped to -3dB between 5 and 10 Hz and at 50,000 Hz.) The square-wave rise time was 10  $\mu$ s, and the amplifier was stable with a 2- $\mu$ F load in parallel with 8 ohms.

There were one or two cycles of damped ringing at about 30,000 Hz when we used the capacitive load.

**User Comment.** During the course of testing the 80-watt/channel version of the Titan (we also tested a 100-watt/channel version), we blew out the power module. This, we believe, was caused by two conditions. First, we exceeded the recommended output power levels by a considerable margin. And dirt in the power module's socket plus an improper fit were possibly secondary causes. Cleaning the socket, plugging in a new module, and keeping the maximum output power levels reasonably near the maximum recommended avoided a repetition of this breakdown.

It is obvious from our lab test-bench report that the Titan amplifier is an excellent performer. Its measured performance, in fact, was excellent in every respect. Although the "music-power" rating has fallen into disfavor, the characteristics of the Titan do give it a very high music-power capability. In fact, the amplifier is able to deliver more than 120 watts/channel with very low distortion. If a typical waveform peak-to-average

power ratio of at least 10 dB is assumed, the power modules can loaf along at a comfortable 10 to 12 watts average power, yet still be able to deliver 120 watts peak without distortion.

As with many high-power amplifiers, if the Titan is to be operated at high power levels or in an enclosed space, an external fan to remove excessive heat from the power module heat sinks should improve reliability. If you intend to operate the amplifier for heavy-duty use, we recommend that you go to a lower output power rating than the specified 80 watts/channel maximum, which one can do by choosing the proper power transformers (see parts list). This way, you will avoid overheating the modules.

The Titan was put through a worst-case operating situation by connecting it to an AR-LST 1, a 4-ohm speaker that has a very low impedance curve at the high-frequency end. Playing the amplifier for a few hours at high listening levels (average 87 dB in mono, about 90 dB in stereo) did not have any harmful effect on it, although the epoxy body did get pretty hot, as one would expect. So, clearly, the Titan can be used under any normal home-listening conditions, although aforementioned precautions should be followed, such as derating power, if one wishes to use it for a rock concert. Further, our project builder advised that it was the easiest power amplifier he had ever assembled, requiring less than an hour's time for assembly of the electronics.

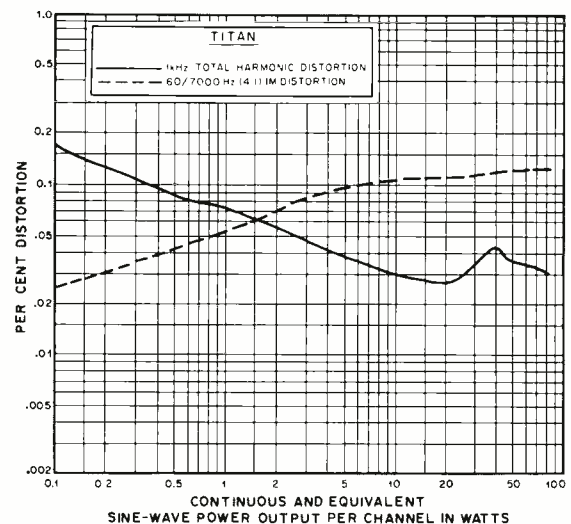
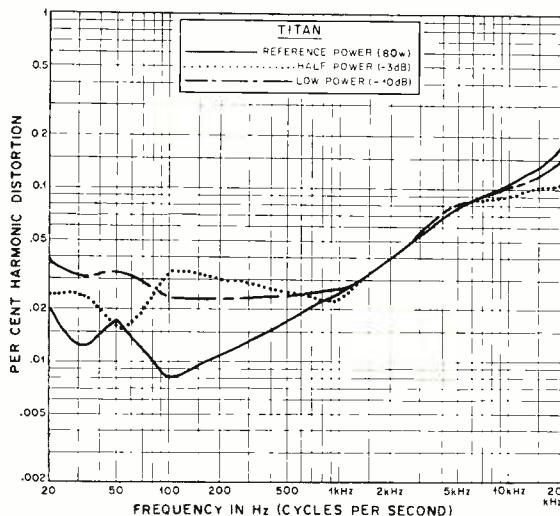



# TIMBRE & VOICING CIRCUITS FOR ELECTRONIC MUSIC

BY DON LANCASTER

## *Techniques for converting basic frequency references to elaborate musical notes.*

**T**HE majority of electronic musical instruments generate tonal frequency references in whatever waveform happens to be handy. To convert a sine, sawtooth, or square wave into varied and interesting musical sounds, the signal's time and frequency structure must be altered so that it simulates the sound of a traditional musical note or provides a new type of note or special effect.

To alter the time structure of the envelope of a tone (see "Keyers and VCA's," January and February 1975), a suitable waveform with the attack, fallback, sustain, decay, snubbing, and echo desired is combined with the required frequency reference. The envelope waveform is then multiplied by the frequency or tonal information to give the overall tone time shape desired.

But this is only half of the problem. A steady-sounding trumpet is very different from a steady-sounding clarinet, even when both instruments are sounding the same note and attack and time differences are ignored. The differences in sound between different

types of musical instruments are called color or timbre. Circuits that alter timbre are called voicing circuits, filters, tracking filters, and voltage-controlled filters (vcf's). Only when suitable voicing is combined with a selected envelope does the final musical note result.

**Elements of Tonal Color.** Color differences between notes are obtained by the presence of harmonics, nonharmonic but related multiples of the basic pitch, multiple tones in chorus and warmth situations, and "extra" sources of noise (chiff, buzzes, random noise and variations, and other unrelated audio energy sources). By selecting the correct combination of these things, almost any desired timbre waveshape can be generated. Multiply the waveshape by an envelope, and the note can have any color you want.

Harmonics are the easiest with which to deal, but they are not by any means the whole story. If the zero-

crossing points of a musical waveshape always occur at the same fixed fundamental frequency, that waveshape can be broken down into a fundamental-frequency sine wave and a series of harmonic sine waves of various phases through a mathematical process known as Fourier Analysis.

In Fig. 1 is shown how sine waves and their harmonics can be combined to build three basic musical waveforms, the square, sine, and sawtooth waves. Creating a new complex waveform is known as synthesis. While direct analysis and synthesis are often the best ways to find out what color you want and how to go about obtaining it, you rarely use direct synthesis to do the actual coloring process. This is because you can generate a square wave (for example) much easier with a digital flip-flop than by summing dozens of sine waves.

The undistorted sine wave has no

*EMS "Synthi KS" Digital Sequencer Keyboard*



harmonics present and is close to a flute-like tone. The square wave consists of diminishing odd harmonics only and produces a nominally hollow or "woody" sound like that associated with such woodwinds as the clarinet and stopped organ pipes. The sawtooth wave has all harmonics present in a uniformly decreasing series and produces a "bright" tone like that of a stringed instrument or, with bandpass modifications, a trumpet or other horn. Since everything needed is available in the sawtooth wave, it often represents a good "universal" waveform with which to work in electronic music because it is easy to use it to build a lot of realistic voices. Other basic waveforms can lead to voicing difficulties. The triangle waveform, for instance, does not have enough harmonic strength to be useful and the impulse has far too much strength.

The methods of getting back and forth between the basic waveforms are shown in Fig. 2. A sine or triangle becomes a square wave by heavily amplifying and then limiting it, but this can be done only to one sine wave at a

time if intermodulation distortion is to be avoided. A sawtooth linearly becomes a square wave if minus one-half the second harmonic is summed with itself. This is called "outphasing," a technique that can handle many notes at once.

Getting from a square wave to a sawtooth wave can be accomplished by using a binary divider and a staircase generator. This particular approximation sounds much better than it looks. In a 16-step staircase, the first missing harmonic is the 16th, the next is the 32nd, and so on. Otherwise, the waveform is identical to a sawtooth.

Finally, to get from the more complex waveforms back to a sine wave, the fundamental can be sharply band-pass or low-pass filtered. A high Q needed for good second- and third-harmonic rejection directly conflicts with the need to handle many notes of different frequencies simultaneously. So either a tracking filter or fixed filters of only one-third—or at most one-half—an octave can be used.

Harmonics permit us to build many instrument imitations. Nonharmonic

multiples can also be very important and are usually much more difficult to handle electronically. Nonharmonic multiples in the piano are "almost harmonics" caused by lateral stiffness of the strings, particularly on the low-frequency end. These almost-harmonics are called "partials" and get progressively sharper (higher in pitch) with harmonic number. For this reason, piano keyboards are not tuned to absolute pitch because, if they were, the nonharmonic partials of the low notes would sound out of tune with respect to the higher notes. Instead, piano keyboards are stretched while tuning to make the low notes flatter and the high notes sharper than they really are. The result is a warmer, fuller sound character.

Another feature of piano notes is that the hammer usually strikes three strings simultaneously. The strings are almost but not quite tuned in unison. This gives the characteristic warmth to a piano tone. It also explains why a chorus or an orchestra full of violins sounds richer than a single violin. Chorus and warmth effects can be introduced electronically by using several tone sources, differentially delaying ("Doppler modulating") one tone source, or using special-purpose tape delay units.

Yet another example of nonharmonic multiples are carillons and bells, which produce strong sequences of fifths (5:3 frequency) and others present in the characteristic cast-bell tone. Any other situation where you are intentionally generating chord sequences takes tonal groups related by something other than simple harmonics. It is often possible simply to use multiple combinations of notes already in hand.

The final noise effects—chiff, buzzes, etc.—are usually tacked on as an afterthought. In traditional musical instruments, they are inherent and unwanted byproducts or defects of the instrument's physical characteristics. Obvious examples are the wind noise in a pipe organ, steam in a calliope, resonance buzzes in a poorly designed or low-cost violin or guitar, sympathetic vibrations, etc. One time you do *not* tack on noise effects is when the note is predominantly filtered noise, such as that used for some percussion effects. In this case, the usual practice is to start with white or pink noise and filter it, the sharpness of the filtering determining how close you want to get to a well-defined fundamental tone. Small amounts of

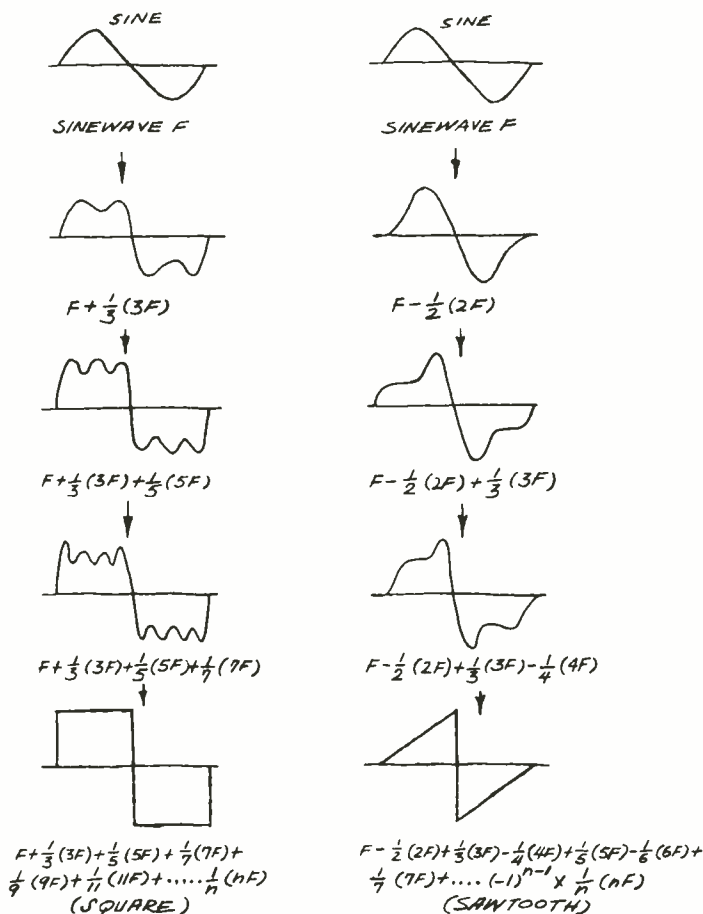

Fig. 1. Complex waveforms can be broken down into a series of sine waves and vice versa.



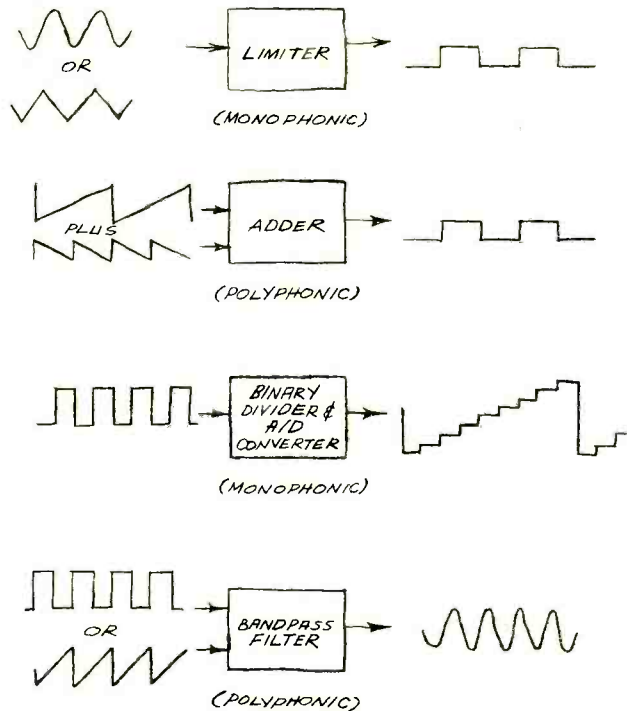

Fig. 2. Ways of transforming basic waveforms.

noise and frequency shifting can be introduced to slightly randomize or break up the exactitude of electronic pitch generation systems.

**Harmonic Structure.** Once you have decided what you want in harmonics, you have a second decision to make: whether you want identical harmonics on every note, changing harmonics as the notes change in frequency, or some combination of the two.

Musical instruments are basically some sort of acoustical bandpass filter. The horn on a trumpet is a pipe resonator. The guitar or violin is more or less a cavity resonator. These resonances are physical constants. Since they do not change, the harmonic structure of the notes passed through them evidently must change for notes of different frequencies. So, almost all traditional instruments introduce fixed-frequency filtering that alters the harmonic content from note to note. A fixed filter gives a variable harmonic content. If your primary goal is to imitate traditional instruments, fixed-frequency selective emphasis and de-emphasis of various frequency ranges is called for.

The sound once (and still) referred to as the "Hammond sound" is now called "synthesizer sound." Its characteristic is that all the notes have identical harmonic structures, evolving from the Hammond organ's electromechanical system in which syn-

chronously rotated steel cams were used. As the cams rotated, each generated a series of harmonics that could be selectively added to a fundamental. All notes were treated identically and had identical harmonic structure. You can obtain the

same effect in a synthesizer by using a tracking or voltage-controlled filter. Hence you need a moving or variable filter for a fixed harmonic structure.

Neither of the above techniques is "better" than the other. The one you use depends on what you are after. Traditional instrument synthesis will often sound phony if you use fixed harmonic structure. On the other hand, the fixed-harmonic-structure notes offer much in the way of flexibility and new sounds. (These two basic filter techniques are compared in Fig. 3.) One big advantage of a synthesizer is that you can handle both types quite easily.

Another reason for using variable or tracking filters is to let the harmonic content of the note change during the envelope time. In many musical instruments, higher harmonics decay faster than do the lower ones, while in the piano, sympathetic resonances may actually build up harmonics with time. These effects can often be obtained by adding an electrically variable filter to the output of the fixed formant filter, sliding the filter down as the note decays. A changing harmonic structure with envelope time, particularly with the decay cycle, is the key to realistic traditional instrument syn-

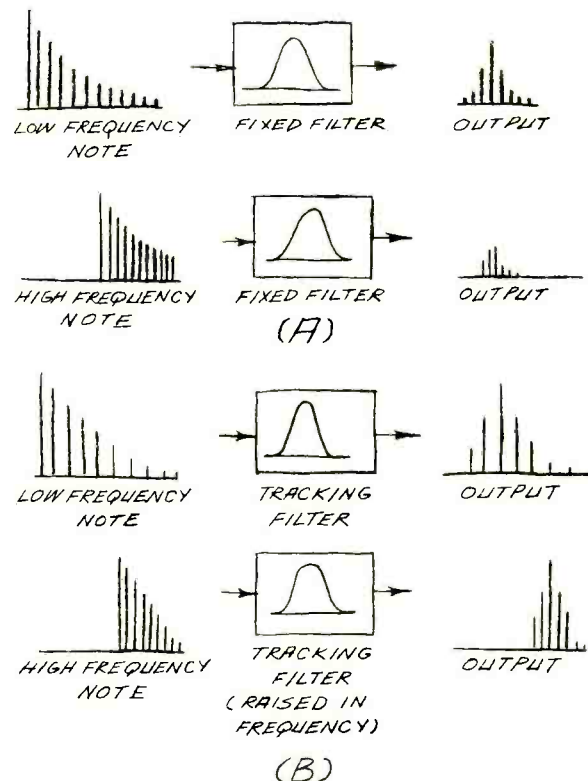

Fig. 3. Fixed filter (A) alters harmonic content from note to note. With tracking filter (B), output tone spectrum is independent of input.

thesis. It also provides many new possibilities for far-out sounds. (We will take a close look at what the traditional instruments need in harmonics and envelope in a future article in this series.)

**Voicing Techniques.** As a general rule, there are four basic ways to electronically generate a suitable musical voice. Starting with a waveform or waveforms containing more harmonics in a different structure than are needed, filtering, or a "subtractive" method, can be used. Also called formant filtering, it is by far the most popular fixed-filter method used today in both electronic organ and synthesizer circuits.

An "additive" method can be used. Here, harmonically related sine waves are combined in the correct proportions to yield the desired note. While this approach was often used in older electromechanical organs, it is generally complex and difficult to program, and it is somewhat limited, requiring too many harmonics to achieve good synthesis. Too, if you are attempting to synthesize the sound of a traditional musical instrument, you must also provide for changing harmonic content with changing pitch.

A third approach is called the "non-linear" method of voicing, where a fundamental frequency is run through a diode or other highly nonlinear component to generate harmonics. The harmonics are then filtered by the subtractive method. Some monophonic pedal circuits in home organs half-wave rectify a sine wave to get the strong second harmonic needed for diapason pipe synthesis. There are serious limitations to the nonlinear method. The input amplitudes may be critical if the nonlinear system is to generate the proper harmonic structure. Also, it is strictly a one-note-at-a-time monophonic technique; two notes fed into a nonlinear circuit at the same time will produce intolerable intermodulation distortion.

The fourth method of voicing is "replication." Here, the note wanted is generated directly in exactly the shape desired by starting with some sort of model or "replica" of the tone to be produced. For example, a binary-addressed read-only memory (ROM) could be followed by a digital-to-analog (D/A) converter. Stored in the ROM would be the exact wave shape desired. The faster the ROM is clocked or addressed, the higher the output

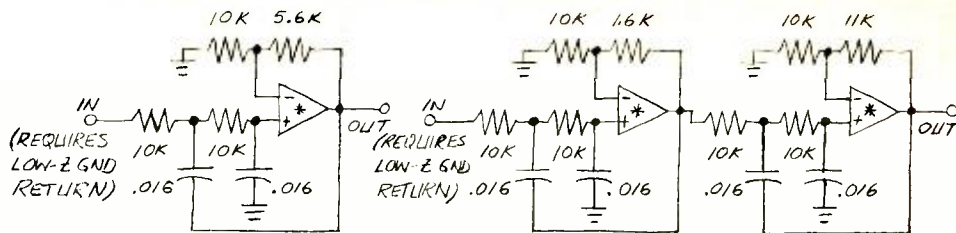

1-KHz LOW-PASS BUTTERWORTH ACTIVE FILTERS  
\* 741 OR LM318 (A)

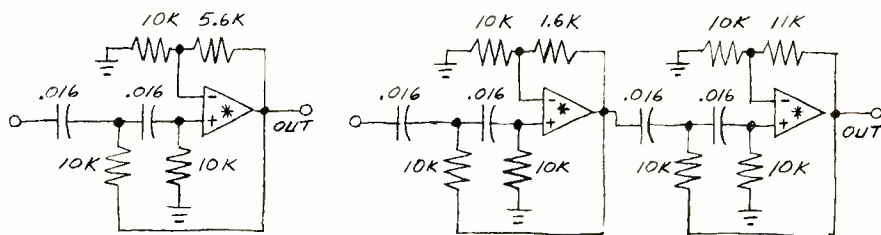

1-KHz HIGH-PASS BUTTERWORTH ACTIVE FILTERS  
(B)

Fig. 4. Active filters on left have 12 dB/octave slopes. On right, are 24 dB/octave filters.

pitch, but the shape would remain the same, as would the harmonic structure. The same thing could be done with a you-program-it computer lashup in which the timbre and envelope are simultaneously programmable. Important advantages of the replication technique are its tremendous flexibility and extreme simplicity, especially when new voices are to be added to the system. You can

easily try a starting system with a binary counter, 7489 ROM, and MC1406 or MC1408 (both by Motorola) D/A converter. Cost is less than \$10 for the system.

We might call "noise" technique a fifth basic approach to timbre generation, but it is really a form of subtractive filtering. Instead of removing or emphasizing harmonics of a fixed tone, various portions of a noise spec-

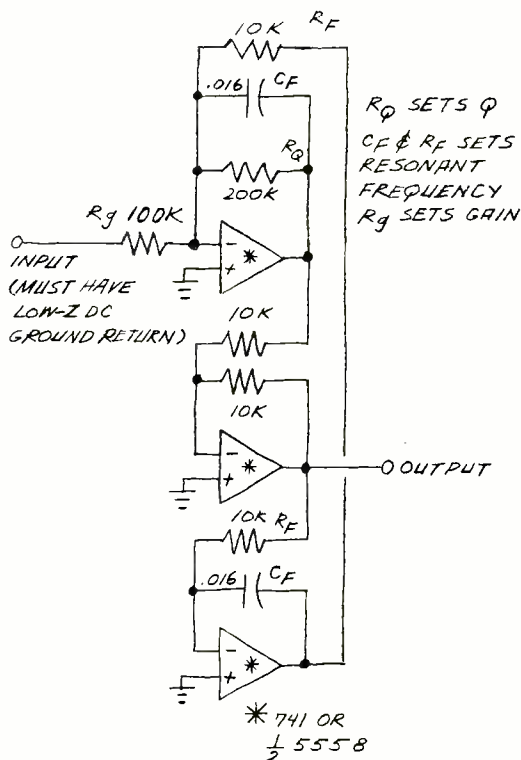

Fig. 5. Biquadratic bandpass filter set to 1 kHz resonance and  $Q = 20$ .



trum are emphasized or de-emphasized. Both are essentially subtractive filter techniques.

**Filter Circuits.** The subtractive filter technique is by far the most popular used in today's electronic music systems. Originally, fixed RC filters were used, with an expensive inductor or two thrown in only where absolutely necessary. This accounts for some of the rather poor instrument imitations produced by some older economy organs.

Today, we have a new approach: active filters. The active filter combines resistors, capacitors, and operational amplifiers (usually the inexpensive 741 op amp) to simulate exactly the type of filter you could normally build only with expensive, large, adjustable inductors.

Important advantages of active filters are their low cost and easy tuning and the total absence of loading problems. The last lets you combine and cascade sections in many arrangements without interaction. Better yet, is the ability of certain active-filter circuits to be electronically controllable to permit you to electronically shift the cutoff frequencies or bandwidths under voltage or digital-word control. This lets you move the filter from note to note or change the harmonic structure during the envelope time.

Pairs of high-pass and low-pass active Butterworth filters with 12- and 24-dB/octave slopes are shown in Fig. 4, while a single-pole active bandpass filter circuit is shown in Fig. 5. For higher frequencies and higher Q's, premium op amps like the National LM318 should be used to replace the 741 device, for which it is a direct pin-for-pin replacement.

To change the cutoff or resonance of the above filters, simply scale down the values of all the capacitors. For instance, doubling the capacitive values moves the 1000-Hz response of the figures down to 500 Hz. You can also scale down the resistor values, but you must keep all frequency-determining resistors and all capacitors identical in value.

The fixed active filter can be used for formant synthesis of traditional instruments, usually by starting with a sawtooth for most voices, except for some woodwinds that are better off with a square wave. Heavy sine-wave filtering can be used for flute and piccolo and certain bland organ voices. ♦

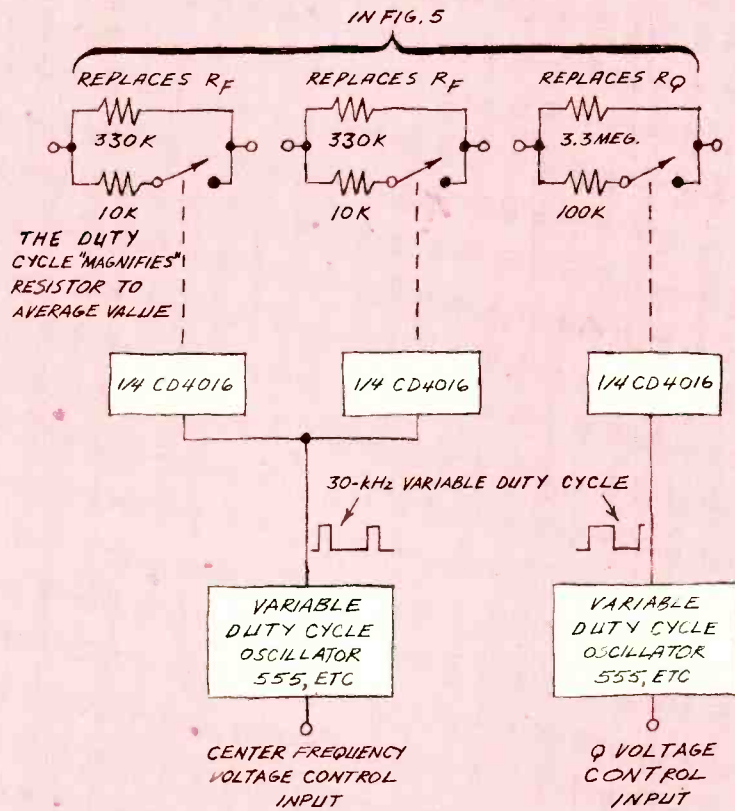

CMOS switch is added to circuit in Fig. 5 to make a high-performance voltage-controlled bandpass filter.

### ELECTRONIC TRACKING

How is it possible to vary electronically the cutoff frequency of an active filter? The answer is that anything that can change the value of a resistor under voltage control—such as a FET, incandescent lamp, or LED and photocell—will do the job. However, linearity, power, "insertedness," and cost might be objectionable. The CA3080 circuit on page 37 of the February 1975 issue provides good filter control.

Today, there is a new and easy way to build a tracking filter, working with the inexpensive CD4016 (RCA) or MC14016 (Motorola) CMOS integrated analog switch circuit. It works in an active-filter circuit that is basically an integrator, such as the low-pass versions in Fig. 4 and the bandpass circuit in Fig. 5. The details are shown in the circuit above.

The key to the process is to make a fixed resistor appear to be variable. If the value of a pair of fixed resistors can be electronically controlled, the same thing could be done as varying a dual potentiometer and automatically tracking any note you want. Better yet, if you want to, you can change parameters during the note's envelope, providing all sorts of synthesis possibilities.

The CD4106 is a quad analog switch that rapidly lets you turn a given resistor on and off. If you vary the off-to-on duty cycle, you can make the resistor look—on the average—like any resistance you want, from its actual value to infinity. The only requisite is that the switching be much faster than the highest frequency of interest so that the capacitors in the circuit average out the on/off switching into an essentially proportional resistance. In a 400-Hz bandpass filter, for example, an 8000-Hz minimum switching rate is recommended, with proportionately higher ultrasonic frequencies needed for higher cutoff frequencies.

The switches can be driven from an ultrasonic source of rectangular waves with a variable duty cycle. This is easily accomplished with CMOS logic. Alternatively, you can use the 555 or 8038 IC devices for initial tests, switching over to a voltage-controlled duty cycle modulator later on. (Incidentally, really good wide-range active bandpass filters that are stable and track have not been available at reasonable cost before. Both these techniques give you a wide open field for serious electronic music experiments.)

# HOW TO DESIGN YOUR OWN POWER SUPPLIES

*Following a step-by-step procedure, you can build a line-operated, professional power supply to your personal requirements.*

BY JIM HUFFMAN

**A**LL active electronic projects and equipment require a power supply. The battery supply, of course, is convenient for low-power and portable applications. For the majority of applications, however, the ac, or line-operated, power supply is more practical for equipment which requires moderate or high power and where portability is unimportant.

This article tells you how to design line-operated power supplies. Our building-block approach starts off with the power transformer/rectifier/filter system that is basic to all line-operated supplies. Then we introduce voltage and current regulation and finish up with the error amplifier used in the power supplies found in the most sophisticated electronic equipment. You merely design your power supply to suit your needs.

**From the Beginning.** The schematic diagram of a very basic power supply is shown in Fig. 1. The power transformer steps down (or up for high-voltage supplies; in this article emphasis is on the low-voltage supply) the input voltage from the ac line to roughly the voltage needed for the project. The low voltage at the transformer's secondary then goes through a rectifier system, where it is converted to pulsating dc. The filter system then smooths out the pulsations to make the dc voltage at the supply's output more like the steady-state dc characteristic of batteries.

The choice of transformer depends mainly on the supply voltage and current demands of the project for which the power supply is designed. Let us assume that the circuit requires 12 volts at a maximum of 500 mA (0.5 A). A commonly available 12.6-V, 0.5-A transformer will do nicely. If you can't find a transformer with the exact ratings for your project, a higher secondary voltage and/or current rating will do. For the higher voltage rating, you will have to devise a dropping or regulating system to reduce the supply's output voltage to the proper level. Note that lower voltage and current ratings should never be used.

To insure safety in your projects, always design a fuse into the power supply. Determining the current rating of the fuse is simple. First, divide the line voltage by the transformer's secondary voltage. Divide the secondary current by the result. Then multiply your answer by 5 if you intend to use a slow-blow fuse (by 10 if you intend to use a fast-blow fuse). For convenience, you can round out the line voltage to 115 or 120 volts and drop fractions of a volt in secondary voltages.

Applying this procedure to our sample problem we get:  $120\text{ V}/12\text{ V} = 10$ . Then,  $500\text{ mA}/10 = 50\text{ mA}$ , which is the primary current. Finally  $50\text{ mA} \times 5 = 250\text{ mA}$  (1/4 A) for slow-blow or  $50\text{ mA} \times 10 = 500\text{ mA}$  (0.5 A) for the fast-blow fuses.

The three basic rectifier schemes used in single-phase power supplies

are shown in Fig. 2. The half-wave rectifier is difficult to filter and should be used only in projects that have no critical circuitry. The full-wave and bridge rectifiers have twice the output ripple (120 pps in a 60-Hz setup) as the half-wave scheme and are easier to filter for projects in which critical circuits are used.

The full-wave rectifier scheme requires the use of a center-tapped transformer that can deliver twice the secondary voltage of a transformer used with a bridge rectifier to obtain the same output voltage. Its current rating, however, need be only half that required by the bridge-circuit transformer. The individual rectifiers in a bridge scheme must have peak inverse voltage (PIV) ratings of at least two times the rms voltage at the transformer, while the diodes in the full-wave and half-wave schemes must be rated at four times (minimum) the rms voltages at their transformer secondaries.

To design the filter system, first cal-

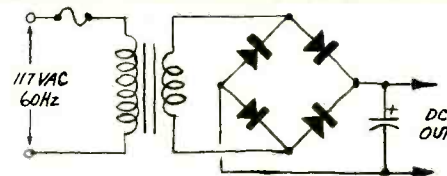

*Fig. 1. Schematic of a basic power supply. The transformer steps the voltage down, the diodes rectify the voltage, and the capacitor smooths the output.*



culate the power supply's load resistance by dividing the output voltage by the load current (12 V/0.5 A = 24 ohms). Then calculate the ripple period, or time constant, by finding the reciprocal of the ripple frequency (1/120 pps = 8.3 ms). Now, you can calculate the required filter capacitor value.

The value of the filter capacitor should be chosen to provide a time constant of at least three times the ripple period. In equation form,  $C = 3TC/R = (3 \times 8.3 \text{ ms})/24 \text{ ohms} = 1000 \mu\text{F}$ , which is the absolute minimum value you should consider practical. You would be better off going to a 5000- $\mu\text{F}$  value.

The voltage rating of the capacitor is equally important. It must be greater than the peak secondary voltage. In our example, 12.6 V is an rms value. To convert it to peak, multiply by 1.414:  $12.6 \text{ V rms} \times 1.414 = 18 \text{ V peak}$ . A safe rating for the capacitor would, therefore, be 25 volts.

**Further Considerations.** The power supply we have just designed has an inherent problem: its short-term stability isn't very good. Without some form of regulation, the output voltage will vary with changes in load and even with changes in input voltage. While poor regulation might be acceptable for some applications, it can present problems in critical digital circuits, test equipment, and even audio gear.

The output voltage curves of a 12-volt power supply with 1 ohm of internal resistance are shown in Fig. 3. Notice that as the current drawn by the load increases toward 1 ampere, the output voltage decreases. The output drops 1 volt, leaving only 11 volts available. It is possible to obtain essentially the zero-resistance curve shown by electronically reversing the output curve in a voltage regulator.

In our design example, the actual no-load voltage depends mainly on the resistance of the transformer windings. The output could well be as high as 18 volts no load and drop to 16 volts under full load, a difference of 2 volts. This means that the internal resistance of the power supply must add up to that required to cause a 2-volt drop at the 500-mA full load. Using Ohm's law,  $R = E/I = 2\text{V}/500 \text{ mA} = 4 \text{ ohms}$ . The curves for the power supply with the 4-ohm internal resistance and with an additional 8 ohms used to yield a 12-volt output (from the no-load

18-volt maximum) are shown in Fig. 4.

If you use a transformer whose output voltage is higher than required by your project, you can either include or leave out the dropping resistor, depending on whether or not you plan to add a regulator to the circuit. Before you make this decision, however, carefully weigh the alternatives and study Fig. 4. The change in output from 18 volts no-load to a 500-mA full load is 2 volts, representing 11% regulation. The change in output voltage at 100 mA is 0.4 volt, and regulation is 2%—still not great but an improvement. So, a simple method of providing a degree of regulation is to draw only a small percentage of the available current from the power supply.

Another alternative is to "bleed" the supply by placing a load resistor permanently across the output of the supply so that the variations between no load and full load are kept to a minimum. Neither this nor the dropping resistor method provides much defense against line-voltage variations. The best alternative for this problem is to go to electronic voltage regulation.

**Voltage Regulation.** The reverse-biased diode is perhaps the simplest electronic voltage regulator around. Once it reaches its breakdown voltage, the diode will maintain the same voltage over a varying current range until the current reaches the point where the diode ultimately burns up. Except for burning up, this is exactly what the typical zener diode is designed to do. The point at which the zener diode breaks down is known as the "zener voltage" (same as regulator voltage).

Zener diodes are available in a wide variety of regulator voltages and powers. All current popular low voltages used in modern circuits are represented, as are most of the low- and medium-power ranges.

Designing a zener regulator into a power supply consists of calculating the resistance and power rating for the series resistor and determining the maximum amount of power the zener diode must be capable of handling in the circuit.

From the curves shown in Fig. 5, you can see that the zener regulation is good up to the point where the load current almost equals the zener current. Therefore, the current through the zener diode must be more than that required by the load. With a

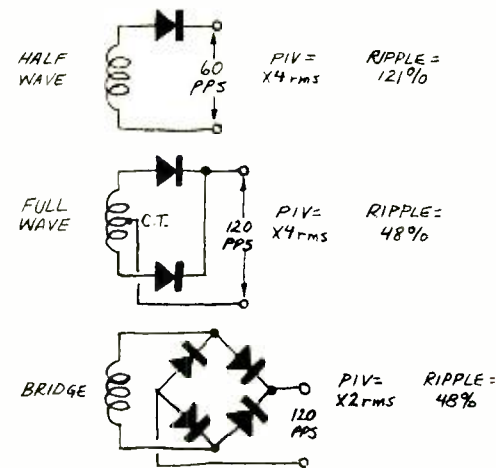

Fig. 2. Three types of single-phase rectifier circuits with some of their characteristics.

0.5-ampere load current, the zener current would be best at five times this value, or 2.5 amperes. Using the power formula  $P = IE$ , at 12 volts,  $P = 2.5 \text{ A} \times 12 \text{ V} =$  a whopping 30 watts. That's an expensive zener diode. Hence, it is practical to use zener diode regulation by itself only for low- and medium-

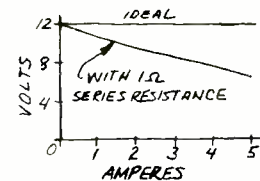

Fig. 3. Ideal output voltage occurs at all current levels. Actually, the voltage drops due to internal resistance of the power supply.

current applications. For example, a 12-volt, 1-watt zener diode would operate with a zener current of 83.3 mA, providing reasonable regulation up to almost 83 mA as shown in Fig. 5.

In the case of our sample power supply, the voltage coming from the

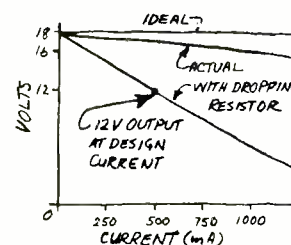

Fig. 4. Ideal and actual voltage output of ac/dc converter and filter as described in the text.

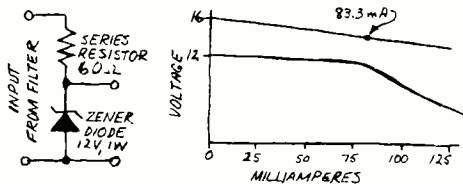

Fig. 5. Zener diode regulator is shown at left. The output is close to ideal (top) except when high current levels are reached.

rectifier bridge will be on the order of 17 volts. The zener diode will be regulating this at a 12-volt level, leaving a difference of 5 volts. So, we calculate the zener's series resistor value from  $R = E/I = 5 \text{ volts}/83.3 \text{ mA} = 60 \text{ ohms}$ . The calculated 60 ohms, however, is a minimum value for the resistor; any higher voltage and the zener current could cause the zener diode to burn up. So, make certain you base your design calculations on the *maximum*

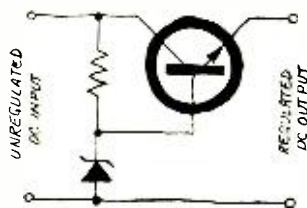

Fig. 6. Basic regulator circuit using a zener diode and emitter-follower pass transistor. This circuit provides current gain with no gain in voltage.

voltage drop that can be expected across the resistor. Then figure the power rating needed for the resistor from  $P = IE = 5 \text{ volts} \times 83 \text{ mA} = 0.4 \text{ watt}$ , which is the minimum rating; play it safe by using a 1-watt resistor.

The zener diode regulator is simple to design, but it is uneconomical in high-current power supplies. However, it can still be used—and most often is—as a low-current input to a current amplifier.

**Pass Transistor Regulator.** Using a zener diode as a reference regulator, the power supply's output regulation can be improved by employing an emitter-follower pass transistor to obtain current gain with no gain in voltage. The configuration of this circuit is shown in Fig. 6.

The zener regulator described above can't cope with the 500-mA demand assumed for our sample power supply. So, the pass transistor design is a natural for our purposes. First, however, we must know the biasing and power requirements for the transistor.

The current gain of the pass transistor determines the power rating of the zener diode, and vice versa. For example, a gain of 10 would permit the power supply to safely handle 833 mA of current, based on the calculations given above. The higher the  $\beta$ , then, the better; in fact, two transistors can be connected in a Darlington circuit configuration to multiply the gain of the pass transistor as in Fig. 7.

If the output coming from the unregulated power supply's filter is 16 volts and you want only 12 volts, the difference is 4 volts that must be dropped across the pass transistor. Since the maximum current from the supply will be 500 mA, the transistor must be rated at a minimum of  $600 \text{ mA} \times 4 \text{ V} = 2.4 \text{ watts}$ . It is obvious, then, that most pass transistors require proper heat sinking for safe operation.

To determine the minimum base current for the transistor, divide the required load current by the transistor's  $\beta$ :  $I_{\text{bmin}} = I_{\text{max}}/\beta = 500 \text{ mA}/10 = 50 \text{ mA}$ . Multiplying this figure by 2 provides a margin of safety in the design; so, the zener diode used as the voltage reference need be rated at only 100 mA or 1.2 watts ( $P = IE = 100 \text{ mA} \times 12 \text{ V} = 1.2 \text{ W}$ ). If you can't obtain a 1.2-watt zener diode, you have the option of using a pass transistor with a higher  $\beta$ . For example by going to a transistor with a  $\beta$  of 20, the base current would be only 25 mA, and doubling this yields 50 mA, requiring that the diode have a power rating of only 600 mW (0.6 watts).

By using the pass transistor, we reap another benefit—capacitance multiplication. The base capacitance is reflected to the emitter-collector circuit. We can bypass the zener diode with an electrolytic capacitor to make the emitter-follower pass transistor appear to the ripple as a capacitance equal to  $\beta$  times the value of the base capacitor. (Calculate the bypass capacitor from the formulas used earlier for calculating the filter's value.)

You can make the output of the supply variable by placing a potentiometer across the zener diode and feeding the base of the pass transistor with the variable output voltage from the pot. Bear in mind that for good regulation, the current through the pot should be at least several times the current required in the base of the pass transistor. The current through the zener diode should be a couple of times greater than the current through the potentiometer.

**Error Amplifier Regulator.** The pass-transistor scheme isn't without its shortcomings. For example, it does not efficiently combat output variations resulting from line voltage variations. You can improve the operation of your power supply by detecting the output variations and sending the inverse of the variations back to the pass transistor. Thus, you would have a supply that would in effect turn down the output voltage level when it attempted to rise, and vice versa, which is what the sense, or error, amplifier is designed to do.

The error amplifier can be a common-emitter amplifier stage, which gives an inverted output (Fig. 8). The error amplifier must operate only on voltages other than the regulated output potential. This can be done in a couple of ways, the most common

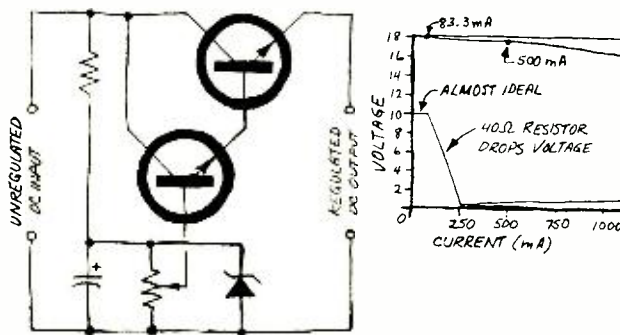

Fig. 7. Complete emitter-follower regulator. The second transistor lessens the requirements placed on the zener diode, and potentiometer is added to provide a variable output.



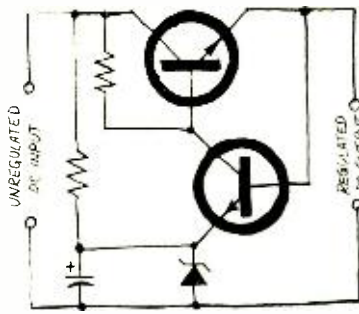

Fig. 8. Regulation using a sensing amplifier. The circuit component values are given in the text.

being the application of a voltage equal to the desired regulator output potential to the emitter of the error amplifier.

In the circuit shown in Fig. 8, the zener diode is the voltage reference. When the output voltage attempts to exceed the reference voltage, the stage conducts and reduces the output voltage. Regulation in this circuit is good for both load and line variations.

The calculations for the required drive current in the base circuit of the pass transistor and zener current remain as before. The value of the error amplifier's collector load resistor must be selected to give the desired base current for the pass transistor. In our design example, the difference between the desired 12-volt output and actual 16-volt level is 4 volts. At 4 volts, a 160-ohm resistor is needed to get 25 mA of base drive current, while an 80-ohm resistor would be needed to get 50 mA. A compromise might have to be struck if your calculations reveal

that you need a non-standard resistor value. You might have to trade an exact 25-mA current if you can't find an 80-ohm resistor, but if you use a 100-ohm resistor, your compromise won't be great.

If you wish to make the power supply variable, you can vary the zener diode's output voltage as described earlier. You can also put a potentiometer in the base of the error amplifier to vary the voltage supplied to it. The problem with the latter method is that you also divide the output voltage variations and reduce the sensitivity of the error amplifier.

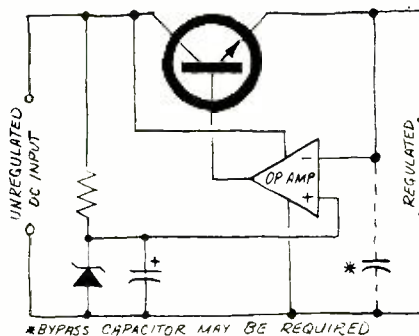

Fig. 9. Using an op amp as a sensing amplifier. High gain is an advantage of the op amp.

The sensitivity (or gain) of the error amplifier is important. In fact, the best system is one where the value of the collector resistor of the amplifier is relatively large so that gain can be high. In this manner, smaller variations in output voltage cause a larger reaction in the pass transistor circuit.

There are several possibilities for

increasing stage gain. You can use a Darlington pair for the pass transistor system so that the collector resistor's value can be made larger. Another alternative is to use multiple-stage, high-gain amplifiers—inexpensive operational-amplifier (op amp) IC's.

**IC Regulated Supply.** The IC op amp makes an excellent regulator circuit. When used to feed a high-current pass transistor, it can regulate any load current. Using it as an error amplifier is very simple.

The non-inverting, or +, input of the op amp can be set to any desired reference level around which the power supply will regulate. The inverting, or -, input acts as an error amplifier. The signal at this input is inverted by the op amp and sent to the pass transistor. The advantage of applying inputs to both input lines of the op amp is that a much smaller current rating is required of the zener diode as a result of the IC's high gain.

Shown in Fig. 9 is an example of an op amp sensing system for an error amplifier. Designing the op amp into a power supply to serve as an error amplifier is easy. All you have to do is carefully adhere to the IC's ratings given on the specification sheet.

**Current Limiting.** The schematic of a "deluxe" power supply is shown in Fig. 10. This design has built into it a means for limiting the current to the load. To design current limiting into your power supply, you simply select the component values that will deliver the current to the load limited to the maximum safe current. ♦

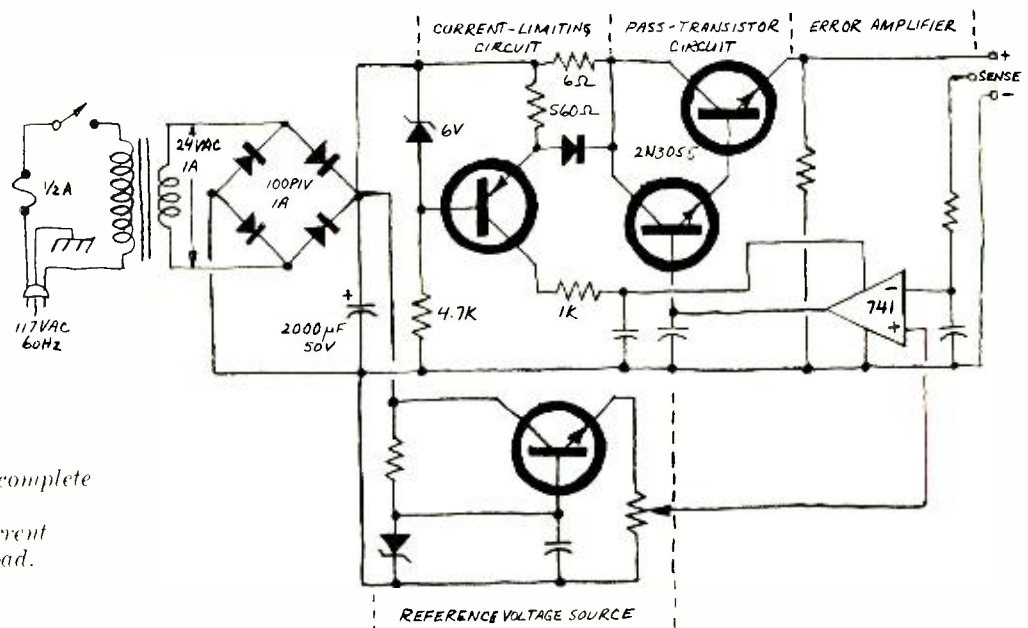

Fig. 10. Schematic of a complete "deluxe" power supply. This design includes current limiting to protect the load.

BUILD A

# DIGITAL MARINE/ AUTO TACHOMETER

BY MICHAEL D. HILKER

*Measures rpm in thousands*

*and hundreds for car or boat engine*

**T**HE analog meter movement, which has been the traditional display device for automotive and marine tachometers, suffers from two primary disadvantages. First, it is inherently inaccurate. More important, however, it requires the driver or boater to divert some of his attention away from navigating to interpret the meaning of the meter's pointer swing against its scale. In congested traffic, that attention is better given to watching other drivers.

The digital tachometer overcomes the two main disadvantages of the analog-meter tach. It can be made to indicate rpm with a high degree of accuracy. And, because it displays numbers that need no interpretation, instead of having to guess at an ambiguous pointer swing, you can give your whole attention to your driving.

The digital tachometer described in this article can be used with engines with two, three, four, six, eight, 12, or 16 cylinders that operate in the two- or the four-cycle mode. The TTL

system derives its power from any 6- to 24-volt dc negative-ground automotive or marine electrical system. It employs a voltage regulator and an inexpensive 555 timer IC clocking oscillator time base.

**About the Circuit.** The schematic diagram of the auto/marine digital tach is shown in Fig. 1. It is basically a frequency counter that is modified for tachometer use. Only two decades of display are used, with *DIS1* indicating hundreds and *DIS2* indicating thousands of rpm. (Tens and units displays are not used because they would wander so fast that they would

be distracting. In any event, two decades of display are sufficient for a tachometer.)

Because only thousands and hundreds of rpm displays are used, without the tens and units displays, the otherwise poor update of the frequency (between 6.6 Hz at 100 rpm and 659 Hz at 9900 rpm for a four-cycle, eight-cylinder engine) is improved by having the master clock count for only 150 ms. This provides a display update rate of approximately seven times per second.

Each display has its own 7490 decade counter (*IC5* and *IC8*), 7475 latch (*IC6* and *IC9*), and 7447 decoder/driver (*IC7* and *IC10*). The displays themselves can be incandescent or green or yellow common-anode LED-type 7-segment devices. (Note: *It is illegal to use red displays for anything but an emergency indicator in an automobile.*)

The master clock oscillator circuit (*IC3*) must be initially adjusted, according to the type of engine with

ENGINE TYPE		DISPLAY READOUT
Stroke/Cylinders		at 60 Hz ( $\times 100$ rpm)
2/4	4/4	18
2/3	4/6	12
2/4	4/8	9
2/6	4/12	6
2/8	4/16	4*

\*Halfway between 4 and 5



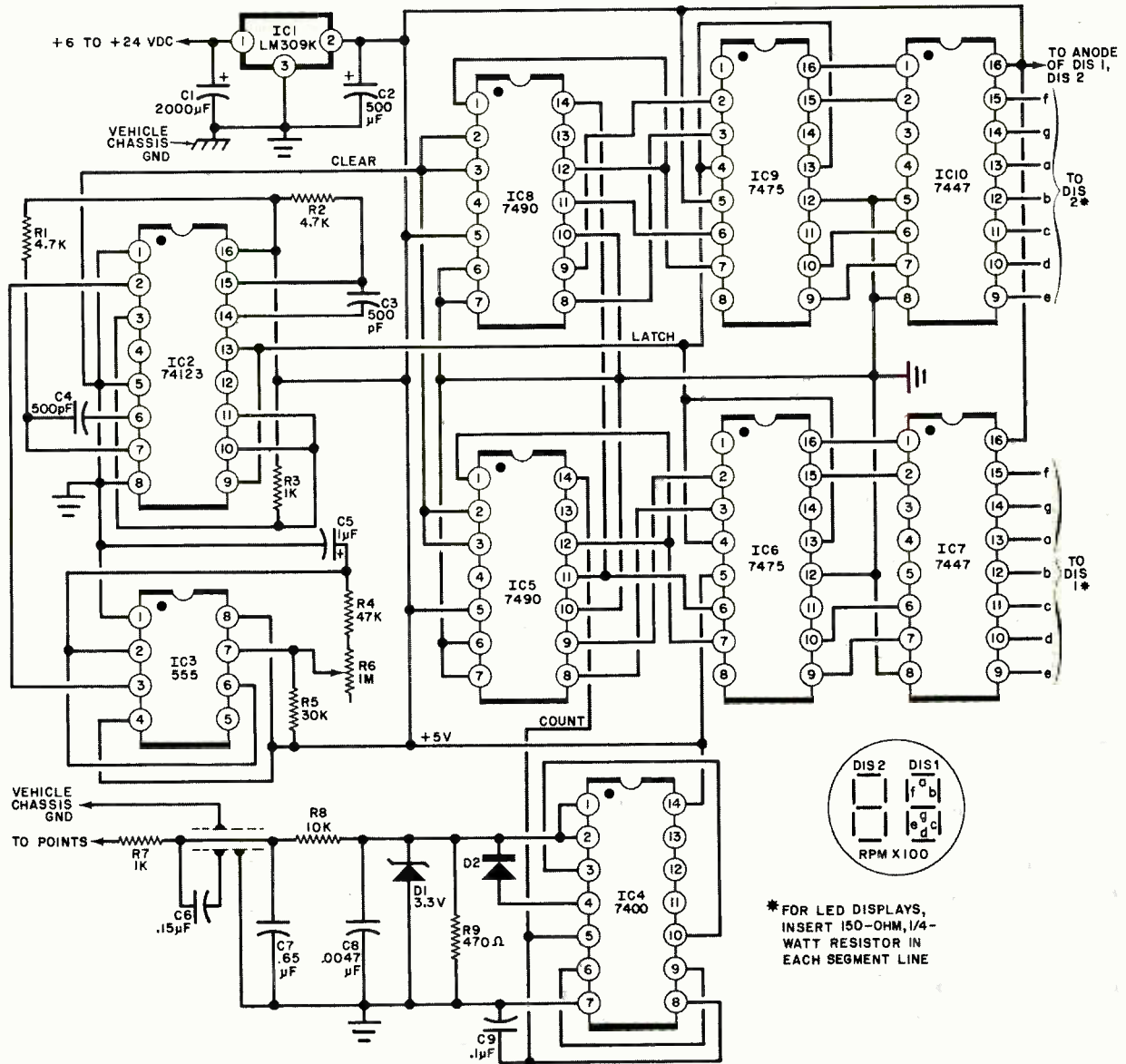

Fig. 1. The tachometer circuit is basically a frequency counter with two decades of display

### PARTS LIST

C1—2000- $\mu$ F, 30-volt electrolytic capacitor (voltage rating must be greater than actual input potential)  
 C2—500- $\mu$ F, 10-volt electrolytic capacitor  
 C3, C4—500-pF tantalum disc capacitor  
 C5—1- $\mu$ F, 10-volt electrolytic capacitor  
 C6—0.15- $\mu$ F disc capacitor  
 C7—0.65- $\mu$ F disc capacitor  
 C8—0.0047- $\mu$ F disc capacitor  
 C9—0.1- $\mu$ F disc capacitor  
 D1—3.3-volt, 500-mW zener diode (HEP-Z0206 or similar)

D2—1N4001 or similar silicon rectifier diode  
 DIS1, DIS2—7-segment display (see text)  
 IC1—LM309K 5-volt regulator  
 IC2—74123 integrated circuit  
 IC3—555 timer integrated circuit  
 IC4—7400 integrated circuit  
 IC5, IC8—7490 integrated circuit  
 IC6, IC9—7475 integrated circuit  
 IC7, IC10—7447 integrated circuit  
 R1, R2—4700-ohm, 1/4-watt resistor  
 R3, R7—1000-ohm, 1/2-watt resistor

R4—47,000-ohm, 1/2-watt resistor  
 R5—30,000-ohm, 1/2-watt resistor  
 R6—1-megohm potentiometer  
 R8—10,000-ohm, 1/2-watt resistor  
 R9—470-ohm, 1/2-watt resistor

Misc.—Printed circuit or perforated board and sockets for IC's and displays; suitable housing; heat sink for IC1 (Wakefield No. 680-12 or similar); dry-transfer lettering kit; filter for display; shielded cable; mounting hardware; hookup wire; solder; etc.

which the tach is to be used, before you can operate the tach properly. This, however, is the only calibration required of the system, via potentiometer R6. Once set, this adjustment need not be touched again unless you remove the tach and use it with a different type of engine. The number of

pulses counted between each update is then equal to approximately 0.167 times the actual number of hertz and corresponds to the engine's rpm, which is displayed by DIS1 and DIS2.

The 74123 dual retriggerable monostable multivibrator IC provides the clear pulses for decade counters

IC5 and IC8 and latch pulses for latches IC6 and IC9, keyed to the output of IC3. The 7400 quadruple dual-input NAND gates in IC4 provide the gating required for proper operation of the tachometer.

Integrated circuit IC1 is a 5-volt regulator. Potentials between +6 and

+24 volts dc applied to pin 1 of IC1 result in a +5-volt regulated output.

**Construction.** The entire auto/marine digital tachometer can be assembled on two 4" × 3" (10.2 × 7.6-cm) pieces of epoxy-fiberglass (G-10) board that has holes pre-drilled on 0.1" (2.54-mm) centers. Use perforated board that has no copper on either side, sockets for the IC's and displays, a heat sink for IC1, and push-in solder clips for component mounting.

You can house the tach in any suitable enclosure, including a cylindrical plastic one that can sit on top of the dashboard, or mount the system in the dash panel in an unused instrument cutout. Don't forget to use shielded cable for the hookup between the engine's points and the tach's input.

**Calibration & Use.** Before you install the tach in your car or boat, it must be properly calibrated. For calibration purposes, you will need a low-

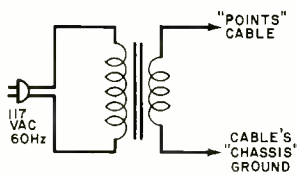

Fig. 2. Low-level 60-Hz source for calibrating tachometer.

level 60-Hz signal source. You can wire the circuit shown in Fig. 2 to obtain the low-level signal required. Wire the secondary of the 6.3-volt power transformer to the inner conductor (labeled "to points" in Fig. 1), via R7, and the shield of the tach's input cable.

Connect the lead from the tach labeled "+6 to +24 V dc" and the lead on the other side of C1, labeled "vehicle chassis ground," to the vehicle's electrical system or any other dc source capable of delivering about 1 ampere at the appropriate voltage.

Now, referring to the table, adjust R6 for the proper display reading according to the type of engine with which the tach is to be used. The tach is now calibrated and need not be readjusted again unless it is to be used with a different type of engine.

You can now install the tach in your car or boat. After installing the tach, connect the various cables to the appropriate points in your vehicle's electrical system. Then the only thing left to do is use a dry-transfer lettering kit to label the legend "RPM × 100" on the display's filter. ♦

# A Simple Method For Biasing TRANSISTORS

An easy step-by-step way to design stable amplifier stages using Ohm's law.

BY MYRON CHERRY

**H**ERE is a simple way of determining the proper biasing of a bipolar transistor amplifier. It works for the majority of applications and has built-in protection against thermal runaway. All you need to know is the material of which the transistor is made (silicon or germanium) and Ohm's law.

First, there are some basic assumptions that can be made based on the superior quality of today's transistors. (1) Collector-to-base leakage current can be ignored. (2) The current gain (beta) is high enough that the base current can be ignored (or considered as a small part of the "bias" current). (3) Emitter current equals collector current. Based on these assumptions, we can use the simplified circuit model shown in the diagram.

The design of the bias circuit then consists of nine steps:

**Step 1.** Determine the collector current (same as the emitter current). Often this is determined by the load, or the test current given in the transistor specifications can be used. If the power supply is a battery, choose a small current for longer battery life. Typically, medium-signal transistors have a collector current of 1 to 10 mA.

For a small-signal transistor, it would be perhaps 0.1 mA.

**Step 2.** Determine the supply voltage. This is usually a standard value: 9, 12, or 24 volts depending on the battery or supply.

**Step 3.** We assume that the emitter voltage is to be 10% of the supply voltage so the emitter resistor is  $R_e = 0.1V_s/I_e$ .

The assumption for the emitter voltage provides thermal stability, allows for wide variations in beta and protects the emitter-base junction from a possible current overload.

**Step 4.** Calculate the base voltage. This depends on the semiconductor material, which determines the drop across the junction. For silicon, the drop is 0.7 V, and for germanium, it is 0.3 V. The base voltage is then the emitter voltage plus 0.7 or 0.3

**Step 5.** Assume that the "bias" current through R1 and R2 is 10% as much as the collector current. This is easier than considering that R<sub>e</sub> times beta is in parallel with R2. In fact, we do not need to know beta if it is high enough because 10% or 20% variation in R1 and R2 would cause more change in bias current than the small base current in today's high-beta transistors. In fact, beta often varies from 100 to 300 for the same type of transistor.

**Step 6.** Calculate R2 using base voltage and bias current.

$$R2 = V_{\text{base}}/I_{\text{bias}} = V_{\text{base}}/0.1I_c$$

**Step 7.** Calculate R1

$$R1 = (V_s - V_{\text{base}})/I_{\text{bias}}$$

**Step 8.** Choose collector voltage. Except for an emitter follower, the output signal is always taken from the collector. To avoid clipping, let  $V_c = 0.5V_s$ .

**Step 9.** Calculate R<sub>c</sub> from I<sub>c</sub> and V<sub>c</sub>.  $R_c = V_c/I_c = 0.5V_s/I_c$ .

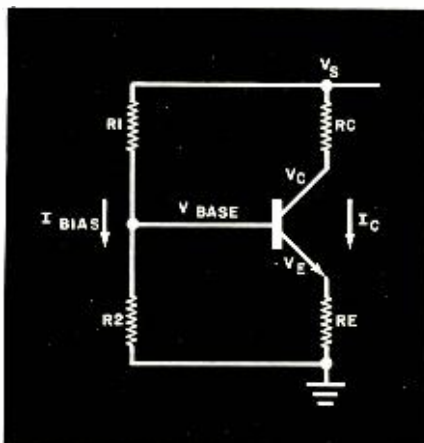



**P**ERHAPS you have already heard about the universal asynchronous receiver/transmitter—commonly referred to by its acronym UART. If not, you soon will because UART may become an important part of data-handling systems in all areas of electronics where information must be routed from one location to another. In a UART, the transmitter converts parallel data bits into serial form for transmission over two-wire lines. The receiver section does the reverse operation.

You could use a UART with a video display to communicate with a computer or another type of display. Coupling it with suitable circuitry, you could use a UART to record ASCII data from a keyboard on a tape recorder. Use it with a modem (modulator/demodulator) and telephone coupler or Data Access Arrangement (DAA), and you could transmit data over telephone lines. UART's can also be used in centrally monitored burglar and fire alarms, intersection traffic control, and ecological data gathering. In fact, the applications in which UART's can be used are almost limitless. (See Fig. 1 for diagrams of typical applications for the device.)

**General Information.** In Fig. 2 are shown the transmitting section of one UART (left) and the receiving section of another UART (right), in logic diagram format. For these UART's to operate properly together, they must both be referenced to the same clock rate, which must be 16 times the desired line transmission rate. For example, if we communicate with a Teletype®, the bit transmission rate is 110 bits/second. Therefore, the clock pulses delivered to pins 17 and 40 must be  $110 \times 16 = 1760$  Hz. (The clocking signal can come from a crystal oscillator, but it is usually sufficient to use any stable oscillator that has an accuracy of 1% or better.

The UART has separate clock input pins for the receiver and transmitter sections so that receiving rates can be different from transmitting rates. For example, different rates might be used between terminals and from a terminal to a computer. Here, the transmission rate would be increased, to perhaps 1200 baud. (A baud is generally defined as a bit per second.) For another example, when the data comes from a

manual keyboard, a rate of 150 baud should be adequate.

Before the UART can be operated, its internal registers and detectors must be cleared. This is usually accomplished automatically during power-up by pulsing reset pin 21 with a high (logic-1) pulse. You can do this with a resistor to ground and a capacitor to the +5-volt line.

Each half of the UART contains character-format mode control flip-flops that can be computer-controlled if the device is to be used with a computer. If the modes are to remain constant, the control pins can be hard-wired or connected to manual switches.

The controls that are available in a UART include:

$I_{2SB}$  (pin 36)—transmitter stop bit control. A logic 0 causes one stop bit, and a logic 1 (+5 V) causes two stop bits to be transmitted.

$I_{NP}$  (pin 35)—no-parity control. A logic 1 eliminates the parity bit from the transmitted data, disables the receiver parity check, and forces receiver parity error ( $O_{PE}$ ) pin 13 to go to logic 0.

$I_{PS}$  (pin 39)—parity select. A logic 0 inserts and checks odd parity, and a logic 1 inserts and checks even parity.

$I_{NB1}, I_{NB2}$  (pins 38, 37)—select character length of 5, 6, 7, or 8 bits/character.

$I_{CS}$  (pin 34)—mode control strobe. A logic 1 enters the above controls into the holding register. This control can be hard-wired.

Once the control pins are either hard-wired or selected by computer, transmission can begin. Although the control pins serve both halves of the UART and both halves must operate in the same data format, they can be bussed in by the same lines that carry the data to be transmitted. The commands are then strobed into the holding flip-flops by pin 34; so, the computer can forget about them unless they must be changed.

**Sending Data.** Assuming all control pins have been selected, the transmission begins when a key is depressed. The ASCII, IBM Selectric®, Baudot, or other code appears at the UART's input pins (pins 26 through 33 if all eight bits are used). After a delay of 1 or 2 ms to allow the inputs to settle, a pulse must be sent to pin 23 ( $I_{DS}$ ). This negative-going pulse is generated by

# UNDERSTANDING THE UART

## A DATA COMMUNICATION INTEGRATED CIRCUIT

*Here are details  
about the  
UART  
to help you  
in using it  
in a data terminal.*

BY ROGER L. SMITH

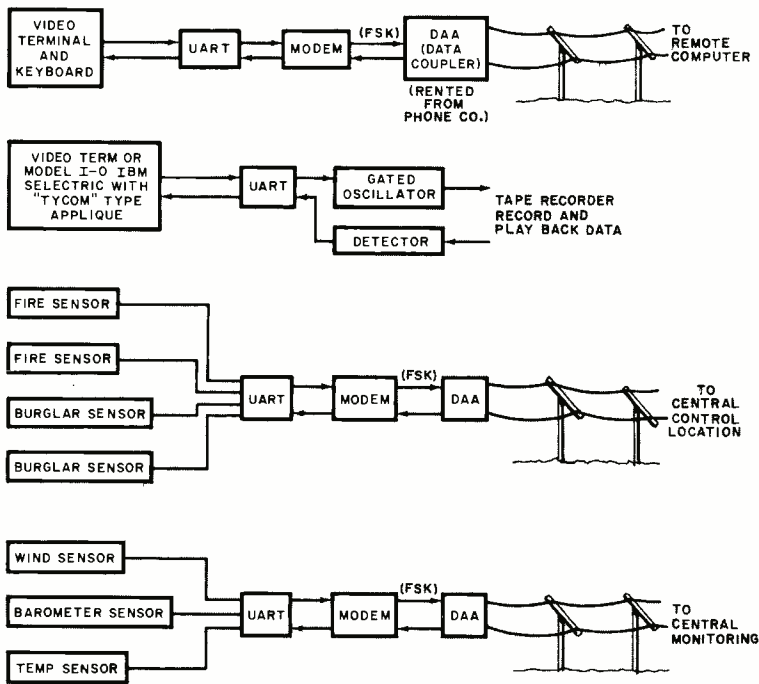

Fig. 1. Applications for UART include video systems, fire and burglar alarms, and weather monitoring.

logic on the keyboard. It enters the data into the input holding register. The transition of the pulse back to logic 1 causes a start bit to appear at serial output ( $O_{SO}$ ) pin 25 after the next negative-going clock transition.

The UART is now transmitting the data out on pin 25 at a rate of one bit for every 16 clock pulses. The start bit is first, followed by the data, with the least-significant bit (LSB) first and the most-significant bit (MSB) last. This is

followed by the parity and stop bits. The UART executes the formatting commands as set up on the control pins. It then computes and adds the proper parity bit, if any. Just as it added a start bit preceding the data, it also adds one or two stop bits after the data. (The number of stop bits is determined by the logic level at pin 36.) If all possible bits were transmitted, they would number 12, including one start, eight data, one parity, and two stop bits. The minimum number transmitted can be seven: one start, five data, and one stop bits.

Since the transmitter section has an input holding register as well as an output shift register, it can receive a second keystroke input immediately following the first. If this should happen, both the holding and shift registers would be full and this would be indicated by a logic 0 on pin 22. This pin goes to logic 1 when the UART is ready to accept additional data (transmitter input holding register empty,  $O_{TBMT}$ ).

Normally, the output of the transmitter portion (pin 25) is boosted to the standard RS-232C interface levels to be sent to other devices. For example, the data could go to a modem to be

Fig. 2. At near right is the transmitting section of one UART. Receiving section of another UART is on opposite page.

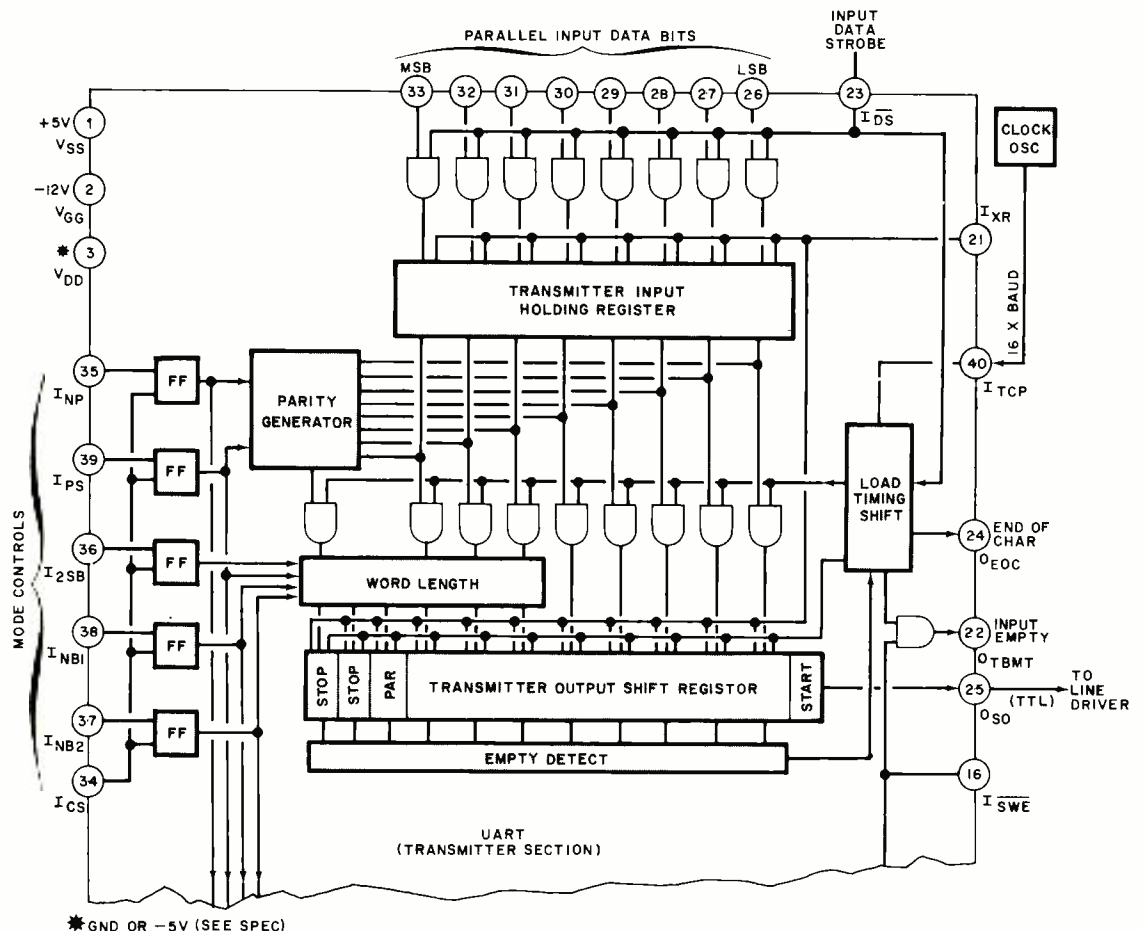



converted to fsk (frequency-shift, or two-tone, keying). It can then go via either an acoustic coupler or a DAA to the phone line and some remote terminal or computer location where it is demodulated, converted to RS-232C and TTL levels, and then possibly to the receiver input of another UART.

**Receiving Data.** The TTL input level on pin 20 of the UART is normally logic 1, and the receiving section monitors this pin for any transition to logic 0. When a logic 0 transition occurs, a counter is started, clocked by the input on pin 17 at a 16 times baud rate.

When the counter reaches 8, which should be the center of the incoming bit, the UART again checks the level at pin 20 to ascertain that it is still at logic 0. If it is, a valid start bit has been received, and the UART begins to count in increments of 16 clock pulses to go from center to center of the incoming bit "cells." (Some designs check the input during all of the first 8 counts after a transition to logic 0. Whichever the case, noise spikes are not likely to cause false starts.)

Each time the counter reaches 16, the center of a bit cell has been reached and a *shift* pulse is applied to

the input register. In this manner, all *data* bits are loaded into the shift register (LSB first), followed by *parity* and *stop* bits. Since the character length command was previously set up on pins 37 and 38, internal gating insures that the incoming signal word ends up all the way to the right.

The UART's error-detection circuits check the incoming data according to the previously selected controls. The *data* bits and *parity* bits are tallied and must be odd or even, as selected on pin 39 (logic 0 is odd, and logic 1 is even). If there is a parity error, the flag flip-flop (to pin 13) is set by going to logic 1. The center of the cell that follows the *parity* bit is tested to see that it is a logic 1. This is the *stop* bit; if it is not present, the framing error flag flip-flop (to pin 14) is set to logic 1.

After the incoming serial data has completely shifted down, a "register-full" condition is detected and the data is transferred in parallel to the output holding register. The "data-available" flag flip-flop, whose output is pin 19, is set, indicating that a character has been received and is ready to be strobed out.

The status bits (parity error on pin 13, data available on pin 19, transmit-

## UART MANUFACTURERS

Following is a list of the manufacturers currently making UART's. The numbers in parentheses are the manufacturers' catalog designations.

**American Micro-Systems**, 3800 Homestead Rd., Santa Clara, CA 95051 (S1757, S1883)

**General Instrument**, Box 600, Hicksville, NY 11802 (AY-5-1013A)

**Intel**, 3060 Bowers Ave., Santa Clara, CA 95051 (8201)

**Signetics**, 811 E. Arques Ave., Sunnyvale, CA 94086 (2536)

**SMC Microsystems**, 35 Marcus Blvd., Hauppauge, NY 11787 (COM 2017, COM 2502)

**Texas Instruments**, Box 5012, Dallas, TX 75222 (TMS 6010NC, TMS 6012)

**Western Digital**, 19242 Red Hill Ave., Newport Beach, CA 92663 (TR1402, TR1602)

ter input holding register empty on pin 22, framing error on pin 14, and receiver overrun on pin 15) are enabled when pin 16 is at logic 0. Pin 16 is usually hard-wired to ground, except in cases where several UART's are serviced on a common bus. In these cases, each UART is queried by applying a ground pulse to pin 16 of successive UART's. If a data-available condition is detected on pin 19, the processor can read out the data by applying a logic 0 to received data-enable pin 4 of the UART.

Once data is available (as indicated by a logic 1 on pin 19), it must be removed before the next character is shifted all the way into the first register, because new data is written over the old. External circuitry must also clear the data-available flip-flop by applying a logic-0 pulse to reset data available pin 18. If this is not done, the overrun flag flip-flop (pin 15) will be set.

**In Conclusion.** As you can see, the UART could be termed a micro-processor in many respects. Its processing is specialized, dedicated to only the handling of data. Consequently, the UART is "transparent" to the data, since the data is not altered logically in passing through it. What goes into the UART is what comes out.

Considering the number of standard logic gates and register IC's it replaces, you can readily see that the UART is one of the best buys available at its current price of \$10 to \$15. ♦

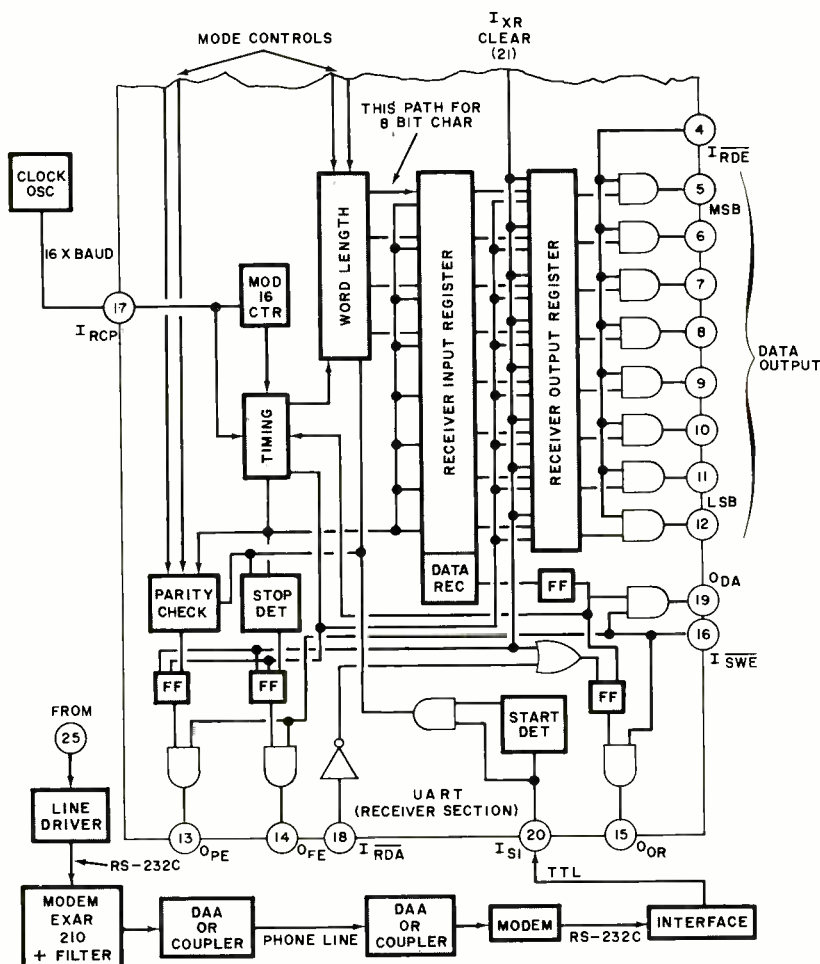

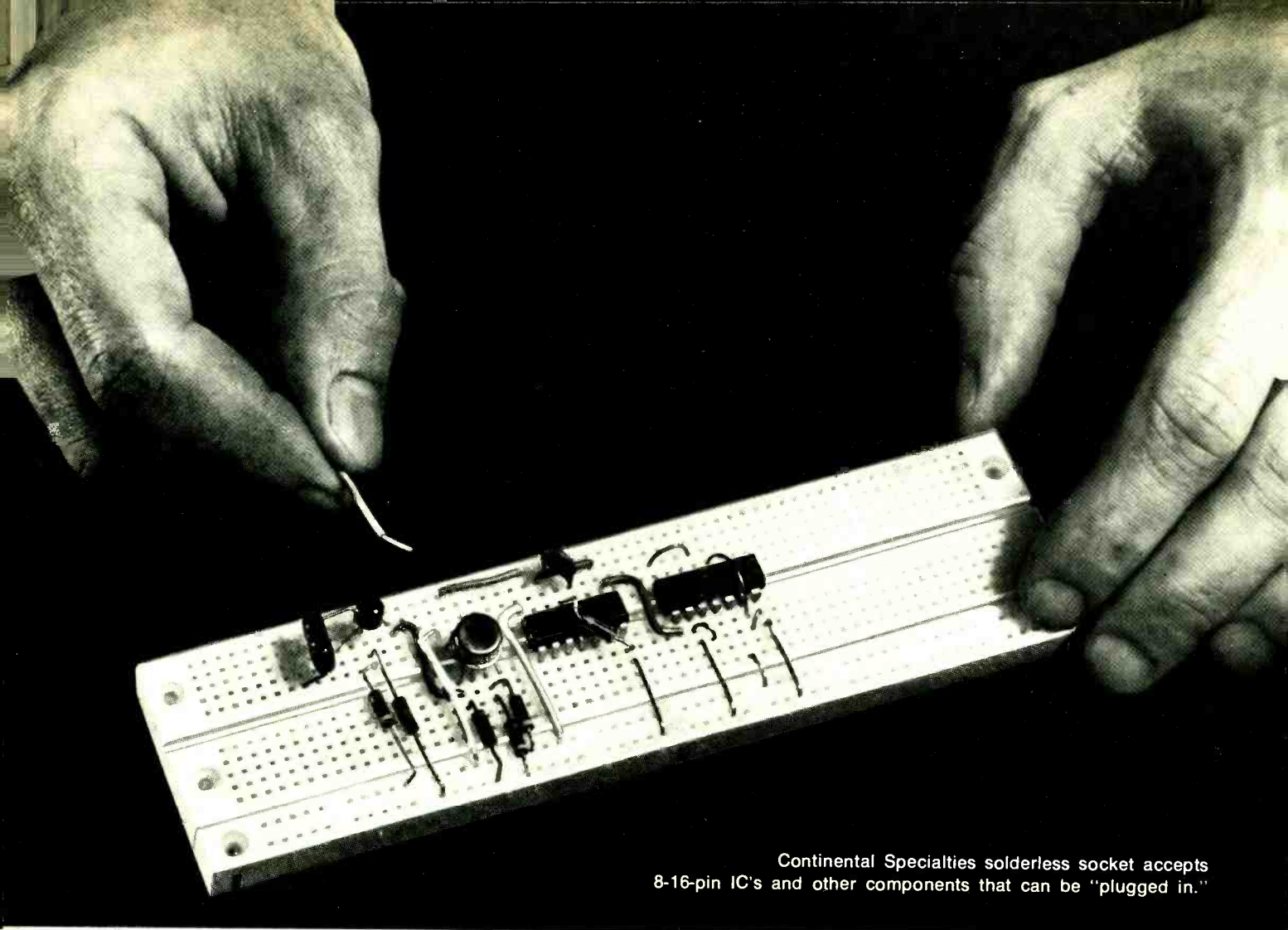

Continental Specialties solderless socket accepts 8-16-pin IC's and other components that can be "plugged in."

# Getting Started with Op Amps

*A solderless socket, a handful of parts, and you are ready to experiment with these versatile devices.*

BY SOL D. PRENSKY

**M**ANY hobbyists have avoided experimenting with op amps because they haven't had an easy means of breadboarding circuits with the multi-pin IC packages. Fortunately, a new concept that overcomes the breadboarding obstacle has been developed—the multi-receptacle solderless socket.

The socket is available in a number of different sizes, ranging from a one-IC block to a large block that can accommodate a half dozen IC's and their associated components with room to

spare. All solderless sockets, regardless of size, are made in the same manner. Each consists of two sets of five series-connected receptacles in each row, with block size determining the number of rows in a given socket. The smallest socket has eight rows and can accommodate IC's with up to 16 pins. The receptacles are housed in a tough molded plastic block. Access to the receptacles is provided through a hole "matrix" in the block.

Running the length of the block, midway between the pairs of contacts,

is a shallow groove. The IC must be inserted so that it straddles the groove, leaving four receptacle holes unoccupied for component hookups to each IC pin. Interconnections are made with lengths of #20 or #22 solid hookup wire and components with lead diameters averaging the same size as those found on 1/4-watt resistors and disc capacitors. (You can use 1/2-watt resistors, but the larger diameter of their leads will require additional insertion force.)

One or more of the solderless sock-



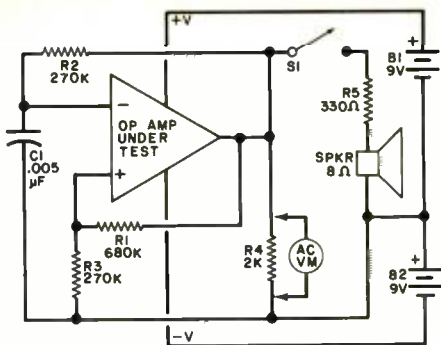

Fig. 1. Simple op amp tester has meter and audio outputs.

ets can be mounted on a sheet of perforated board. Connections to external devices—such as power supply, input and output connectors, meters, etc.—can be made via spring clips or binding posts that can be “plugged” into the holes in the perf board. Mount a rubber foot at each corner of the board, and you’re in business.

Once you have an appropriate breadboarding system, experimenting with op amps becomes a simple matter. The op amps we selected for the following experiments are the types 709 and 741, both of which are low cost and widely available. These IC’s are available in a number of different packages. The box shows the package configurations and pin designations.

**Op-Amp Testing.** The first experiment to try with your op amp is shown schematically in Fig. 1. This is an op-amp test circuit, a multivibrator arrangement where the IC acts as a free-running oscillator that produces a square-wave output.

The “quality” of the op amp is quickly determined by monitoring the output voltage, preferably peak-to-peak with a high-impedance voltmeter, or at a correspondingly lower average ac level with a 5000-ohms/volt

VOM. The output voltage across the 2000-ohm load should be at least two-thirds of the  $\pm 9$ -volt supply (at least 12 volts peak-to-peak).

When S1 is closed, an audible tone should be heard from the speaker, and the measured potential should drop to about 6 volts p-p. Bear in mind that the average meter indication with a VOM will be about half the peak-to-peak value. The oscillator frequency is determined by the R2-C1 time constant. If you change the value of either (or both) component, the frequency will change accordingly.

This test circuit can handle many different types of op amps. In addition to the internally compensated op amps, of which the 741 is an example, the tester will also work with externally compensated op amps without circuit changes because the use of a compensating capacitor is not necessary in this setup. The LM107, 741, MC1556, CA3100S, and HEP-6052P are examples of internally compensated op amps, while the LM101A, NE531, 709, 748, and HEP6053P are examples of externally compensated op amps.

Because the dual in-line package (DIP) IC’s have two parallel rows of leads, they are easy to insert into the solderless socket. If you have round metal-can op amps, you can form the leads into the correct in-line configuration with the aid of long-nose pliers; work carefully. Fig. 2 illustrates how the circuit is breadboarded.

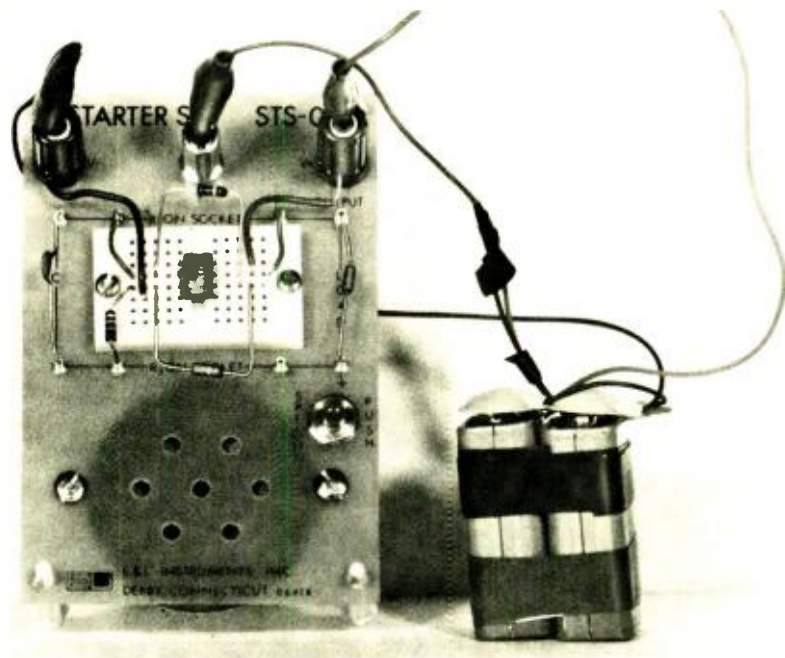

Fig. 2. Commercially available “starter kit” from E&L Instruments illustrates breadboarding of the test circuit in Fig. 1.

**LED Experiment.** The light-emitting diode, or LED, is a natural companion for the op amp. The LED requires only about 1.6 volts at 20 mA for proper operation, which is well within the output capabilities of the op amp.

The circuit shown in Fig. 3 uses an op amp to pulse a LED at a visible rate. This circuit can also be used as a clocking oscillator for digital circuits so that countdown action can easily be followed.

The basic circuit in Fig. 3 is similar

Fig. 3. A 1-Hz op amp oscillator can drive either a single LED on the positive-going cycles, or a pair of LED’s alternately.

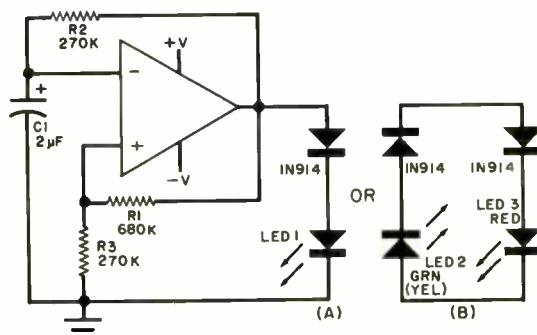

to that shown in Fig. 1, except that the value of  $C1$  has been greatly increased to slow down the repetition rate to about 1 Hz (1 pps). Display circuit A shows the addition of a conventional silicon diode and a LED (any color) that will pulse on with each positive-going portion of the oscillation pulse. The variation shown in circuit B employs two differently colored LED's. Arranged with silicon diodes, the LED's pulse on and off in step with the op amp's oscillator signal. (Note: some of the older type green and yellow LED's require more drive current than do red LED's, which means that they might not glow as brightly. If you use the newer GaP green or yellow LED's, you will encounter no difficulty in glow light level.) The two-color circuit can also serve as a polarity indicator for other circuits, if you assume the red LED to be on for one polarity and the green LED on for the other polarity.

**Microphone Amplifier.** The basic simplicity of op-amp amplification is shown in Fig. 4. The two modes—low- and high-input impedance—correspond to the two differential op-amp input connections. In using a single-ended input for a microphone, you

have a choice of using either the inverting (–) or non-inverting (+) input. In either case, the closed-loop gain is substantially the same and is determined by the ratio of  $R1$  to  $R2$ .

The choice of input is determined by the greatly differing input impedances for each connection. In circuit A, the input impedance is approximately the same as the value selected for  $R1$ . Hence, for this mode, you can make the input impedance any reasonably low value (by selecting the proper value for  $R1$ ) and determine the required gain by selecting the appropriate value for  $R2$ . In circuit A, the gain is  $R2/R1 = 240,000/1200 = 200$  or 46 dB.

If you need a high-impedance input, in the range of hundreds of megohms, feed the input signal to the non-inverting (+) input as shown in circuit B. If you wish to use a crystal or ceramic microphone in this mode, you must shunt it by about 1 megohm to provide a dc path for the bias on the + input. The load in both circuits is a 2000-ohm earphone because of the limited ability of the op amp to supply substantial output current.

At these high gains, the 741 op amp will cover only the speech frequencies. For extended bandwidth, you will

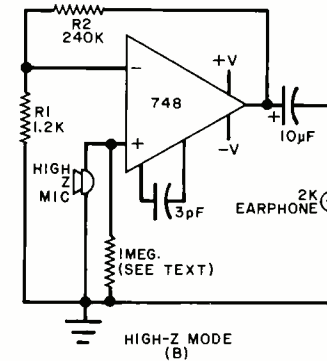
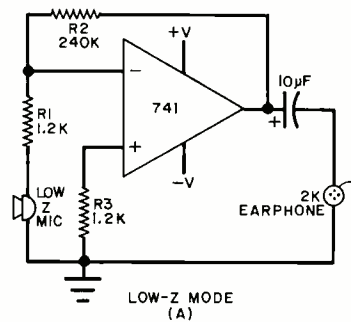

Fig. 4. Low-impedance microphone can be used with circuit (A) and a high-impedance unit with (B). Since 741 is frequency-limited, a 748 (externally compensated) can be used to extend the range.

have to use an externally compensated 748 op amp in place of the 741. For loudspeaker operation, replace the earphone with an equivalent value fixed resistor and use this signal to drive an audio amplifier.

If you want to make a simple audio mixer for two or more signal sources (microphones, turntables, tape recorders, receivers, etc.), use a separate  $R1$  for each source in the Fig. 4A circuit in a summing mode.

**In Conclusion.** There are an almost unlimited number of relatively simple op-amp experiments you can perform, many of which have been published in these pages in the past. Most such experiments can be assembled and tested for educational purposes or modified as the experiment progresses. They can be taken apart and reassembled in only a few seconds using the solderless-socket breadboard approach.

While in this article we have stressed the use of the solderless socket as a breadboarding system for linear (op-amp) circuits, this does not preclude their use in digital IC experiments and projects. Using one of the largest sockets, you can breadboard a complete logic system in only minutes.

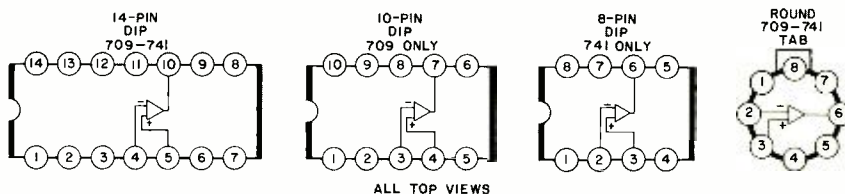

#### PIN ARRANGEMENTS

Following is a table of pin designations and the various package configurations for the popular 709 and 741 op amp IC's shown above.

Pin No.	14-Pin DIP		10-Pin DIP	8-Pin DIP	Round Package	
	709	741	709	741	709	741
1	NC	NC	NC	Offset Null	Input Comp	Offset Null
2	NC	NC	Input Comp	–Input	–Input	–Input
3	Input Comp	Offset Null	–Input	+Input	+Input	+Input
4	–Input	–Input	+Input	–V	–V	–V
5	+Input	+Input	–V	Offset Null	Output Comp	Offset Null
6	–V	–V	Output Comp	Output	Output	Output
7	NC	NC	Output	+V	+V	+V
8	NC	NC	+V	NC	Input Comp	NC
9	Output Comp	Offset Null	Input Comp			
10	Output	Output	NC			
11	+V	+V				
12	Input Comp	NC				
13	NC	NC				
14	NC	NC				

Note: NC = No Connection

The 10-pin configuration is a flat pack that cannot be used with solderless sockets. It is shown only to illustrate all packages used with IC op amps.



# ACTIVE FILTER SHARPENS CW RECEPTION

*Outboard op-amp  
circuit has a  
selectivity  
better than 100 Hz!*



BY JOHN E. PORTUNE  
WB6ZCT

**O**NE of the greatest assets a receiver can have is sharp selectivity, as anyone who has tried to copy CW on a crowded band can attest. Very selective receivers, using multiple conversion and ceramic or crystal filters, are priced beyond the reach of many amateurs. But, a simple outboard audio filter can change the picture. With it, an inexpensive receiver can become a razor-sharp CW rig without internal modifications.

The active filter described here can be connected to any receiver and provides a 6-dB selectivity of less than 100 Hz. That's an impressive figure for a circuit that costs less than \$15.

**About the Circuit.** The use of audio filters to enhance CW reception is not new. However, until recently, sharply selective audio filters required impractically large inductors and capacitors. Op-amp technology has made these passive filters obsolete.

The heart of the filter is a 741 operational amplifier connected as shown in Fig. 1. The gain of the amplifier,

$V_o/V_i$ , (also called  $A_f$ ), is determined by the following equation:  $V_o/V_i = A_f = A_o (R_f/R_1)$ , where  $A_o$  is some fixed value. It is evident, therefore, that the larger  $R_f$  is with respect to  $R_1$ , the greater the gain of the amplifier. We will take advantage of this property in designing the active filter.

Now, let's look at the schematic diagram of the filter, Fig. 2. In place of the fixed feedback resistor,  $R_f$ , the op amp,  $IC1$ , uses an R-C network, composed of  $R1$ ,  $R2$ ,  $R3$ ,  $C1$ ,  $C2$  and  $C3$ . One of the properties of the network is that at its center frequency,  $f_c$ , its impedance is a maximum. This is so because at this frequency the currents in the upper and lower arms are equal in magnitude and opposite in phase. The currents cancel each other out, so no resulting current flows through the feedback loop (which is the same as saying that  $R_f$  is infinite). The op amp's gain at  $f_c$  is very large. At other frequencies, however, this phase relationship is not a completely canceling one, so the effective  $R_f$  (and the op-amp's gain) is lower.

In other words, the gain of the op amp is very large at the center frequency, but drops off very quickly on either side. Fig. 3 shows the frequency response of  $IC1$ . For the values given for the filter, the center frequency is 750 Hz. If another CW note is preferred, these values will have to be changed. For example, if an  $f_c$  of 1200 Hz is desired,  $R1$  and  $R2$  are changed to 2200 ohms.  $R3$  would become 180 ohms. Capacitance values remain the same.

The receiver audio output is coupled to the active filter by the cable attached to  $PL1$ , which is plugged into the receiver's speaker jack.  $R4$ , a 10-ohm, 2-watt resistor absorbs most of the audio output. A fraction of the audio passes through  $R5$  and appears across the non-inverting input of  $IC1$ , and the audio component at  $f_c$  receives a great deal of amplification, as outlined above. The inverting input of  $IC1$  is loaded to insure stable operation. Since the output of  $IC1$  is not large enough to drive a speaker, another stage of audio amplification is

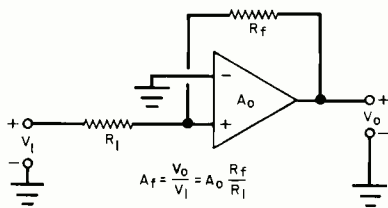

Fig. 1. Basic op amp circuit. Voltage gain depends on the amount of feedback.

included (IC2). A common one-watt IC audio amplifier is used for this purpose. This output level is sufficient to drive almost any communications speaker or pair of headphones, plugged into jack J1.

The op amp requires a bi-polar power supply. Since the audio module requires +9 volts, we decided to use a ±9-volt supply for both IC's. This can be obtained from a small full-wave zener-regulated power supply (Fig. 4). Alternatively, two 9-volt transistor batteries can be used, but you might find that they will run down rather quickly. Unless portable operation is desired, it's best to use the line-powered supply suggested.

**Construction.** Component layout and cabinet mounting are not critical. The circuit may be built on a pc board or a piece of perf board. Etching and drilling and component placement guides are shown in Fig. 5. An etched pre-drilled board is also available (see parts list). Be sure to use shielded cable from filter switch S1 to the board to avoid excessive hum. Also, use an insulated phone jack for J1 to avoid shorting out the power supply.

While 5% resistors and common disc capacitors are specified for the filter network (R1, R2, R3, C1, C2, C3), better results will be obtained using thin-film precision resistors and mica, glass, or polystyrene capacitors.

The active filter can be mounted either in a small utility box or, because of its small size, directly inside the receiver or speaker enclosure. One note of caution—if you are mounting the filter inside the receiver, try not to position it too close to the receiver power supply. Otherwise, you might encounter hum problems.

**Using the Active Filter.** While the active filter is very easy to use, it may

take a little practice before you can realize its advantages. Turn on the receiver and the filter power supply, but leave filter switch, S1, in the FILTER OUT position. Tune around the band until you hear a CW station that you want to copy. Carefully tune the signal in until its note corresponds to the center frequency you have chosen. (It might be helpful to listen to this note on an audio signal generator a few times so that you will recognize it.) When the signal's note sounds like that of  $f_c$ , switch S1 to the FILTER IN position. You should immediately note a drop in all QRM and most QRN. If the desired signal's level drops considerably, you have not centered it in the filter's passband. Try again! Don't touch the receiver's audio gain control once the filter is in the signal chain, because distortion might rise considerably. Instead, tune in the signal for maximum volume.

Since the passband of the active filter is so narrow, it is very difficult to tune around the band with S1 in the FILTER IN position. Furthermore, it will not be possible to zero-beat a signal or listen to AM or SSB transmissions

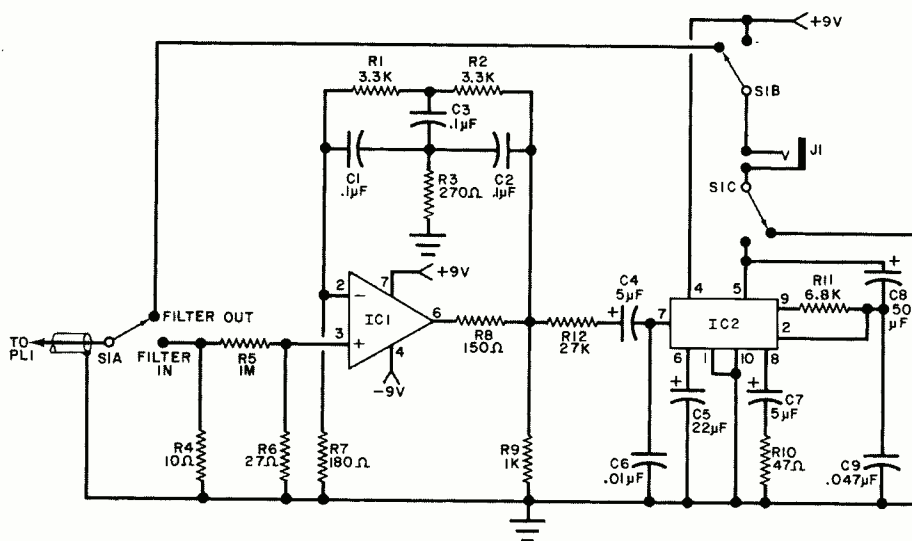

Fig. 2. Schematic for the active filter. The twin-T network determines the center frequency of the filter. When applied to any receiver, it will sharpen and improve CW reception.

## PARTS LIST

- C1, C2, C3—0.1-μF, 50-volt disc ceramic capacitor
- C4, C7—5-μF, 15-volt electrolytic capacitor
- C5—22-μF, 15-volt electrolytic capacitor
- C6—0.01-μF disc capacitor
- C8—50-μF, 15-volt electrolytic capacitor
- C9—0.047-μF, 50-volt disc ceramic capacitor
- IC1—741C op amp
- IC2—1-watt IC audio module (Radio Shack 276-016 or equiv.)
- J1—Open-circuit insulated phone jack
- PL1—Phone plug
- R1, R2—3300-ohm, ½-W 5% resistor
- R3—270-ohm, ½-W 5% resistor
- R4—10-ohm, 2-W resistor
- R5—1 megohm resistor
- R6—27-ohm resistor
- R7—180-ohm resistor
- R8—150-ohm resistor
- R9—1000-ohm resistor
- R10—47-ohm resistor
- R11—6800-ohm resistor
- R12—27,000-ohm resistor
- All resistors ½-watt, 10% unless otherwise specified.
- S1—3pdt switch
- Misc: Perf or pc board, shielded audio cable, utility box, wire, solder, hardware, etc. An etched, pre-drilled pc board is available from P.O. Box 15, Hawthorne, CA 90250, \$3.95, postpaid.



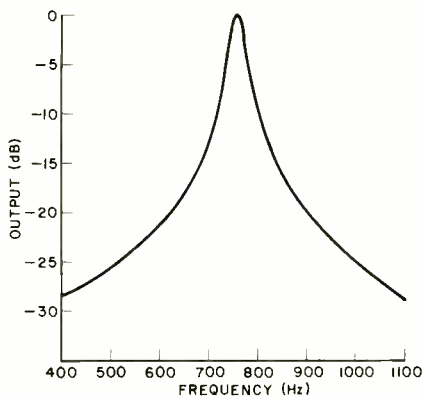

Fig. 3 Frequency response of IC1. Bandpass is less than 100 Hz.

while using the filter. However, it is possible to design a filter with a 2- or 3-kHz passband for phone use. Several filters, each with a different  $f_c$ , would have to be connected in parallel. Their outputs would then be combined by an op amp acting as a summer. Such a filter would have skirts as steep as the active filter we have described. Why not think about it? Op amps are very versatile and can make the job of sorting out signals on the crowded ham bands an easy one. QRM can become (for the most part) a thing of the past! ♦

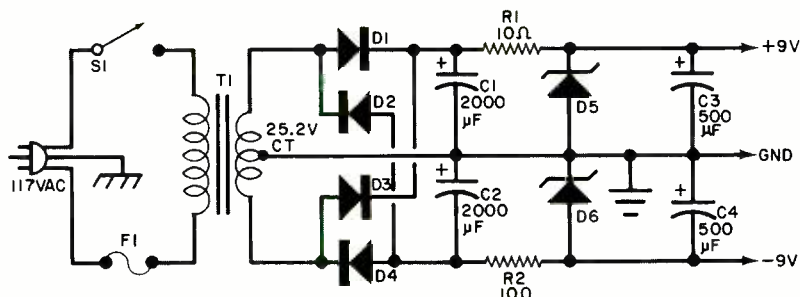

Fig. 4. Power supply for the filter. Bipolar supply features zener regulation.

#### PARTS LIST

C1,C2—2000- $\mu$ F, 15-volt electrolytic capacitor  
 C3,C4—500- $\mu$ F, 15-volt electrolytic capacitor  
 D1 to D4—1-A, 50-PIV diode (HEP R0050 or equiv.)

D5,D6—9.1-volt, 5-watt zener diode (HEP Z2513 or equiv.)  
 F1— $\frac{1}{4}$ -A fuse  
 R1,R2—10-ohm, 10-W resistor  
 S1—Spst switch  
 T1—25.2-volt CT transformer (Stancor P-8180 or equiv.)  
 Misc: Terminal strips, line cord, fuse holder, wire, solder, hardware, etc.

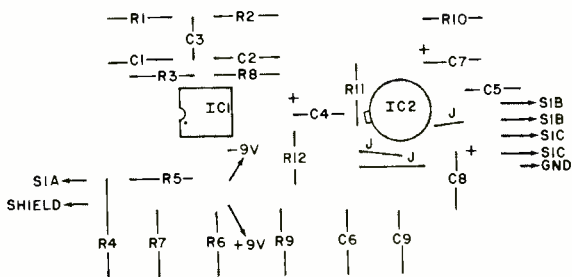
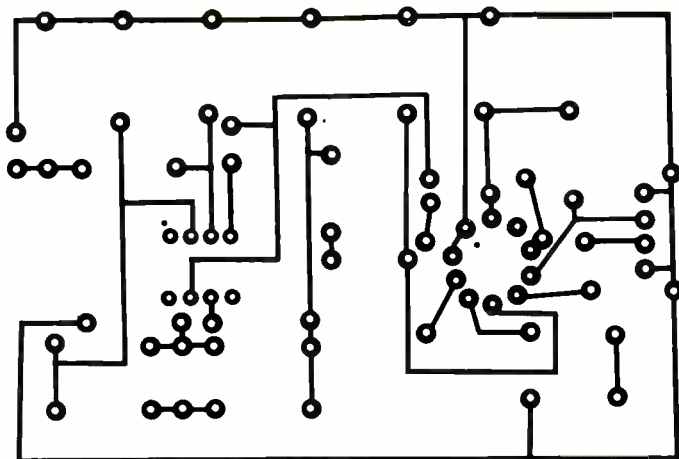

Fig. 5. Etching and drilling guide (below) and component placement for pc board (left).



# TAKE YOUR CHOICE



**Mini-Scan™**  
 is the pocket scanner that works a week on just 4 penlight cells.

A breakthrough we call "mini-miser circuitry" makes it possible ... and it's actually 2½ to 5 times more efficient than any other pocket scanner we tested!\* Just 4 alkaline penlight cells power it for a full week, 8 hours a day, on a tough 50-50 duty cycle (50% full volume, 50% squelched). And its performance is bred from our experience in public safety two-way radio ... so it also gives you the crispest, clearest messages possible. Just \$119.95 with built-in ferrite antenna (batteries, crystals and optional flexible antenna extra.)

\*Test results gladly supplied on request.



## Johnson MINI-SCAN™

... the professional pocket scanner

E. F. JOHNSON CO., WASECA, MINNESOTA 56093  
 IN CANADA: A. C. SIMMONDS & SONS, LTD.  
 CIRCLE NO. 33 ON READER SERVICE CARD

# The better the training the better you'll

Send for  
**FREE**  
illustrated  
career  
guide

NTS guide  
to careers in  
Electronics

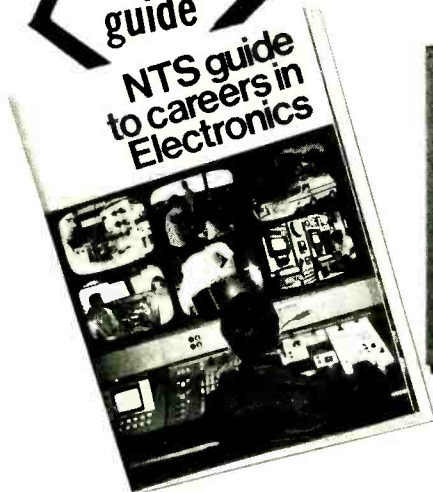

IN-CIRCUIT TRANSISTOR TESTER

COMPU-TRAINER

TROUBLESHOOTER  
VOM

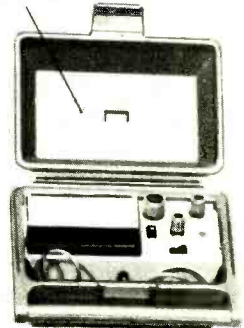
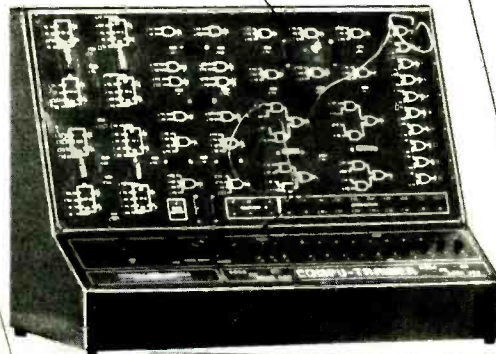

SOLID-STATE  
OSCILLOSCOPE

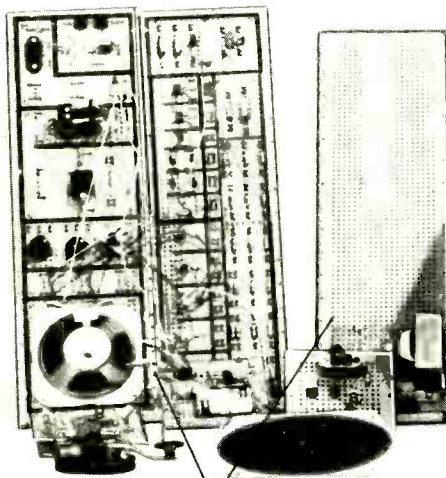

ELECTRO-LAB



(Simulated TV Reception)

As an NTS student you'll acquire the know-how that comes with first-hand training on NTS professional equipment. **Equipment you'll build and keep.** Our courses include equipment like the **NTS/Heath Digital GR-2000 Solid State color TV** with first-ever features like silent varactor diode tuning; digital channel selection, (with optional digital clock), and big 315 sq. in. ultra-rectangular screen.

Also pictured above are other units — 5" solid state oscilloscope, vector monitor scope, solid-state stereo AM-FM receiver with twin speakers, digital multi-meter, and more. It's the kind of better equipment that gets you better equipped for the electronics industry.

This electronic gear is not only designed for training; it's field-type — like you'll meet on the job, or when you're making service calls. And with NTS easy-to-read, profusely illustrated lessons you learn the theory behind these tools of the trade.

**Choose from 12 NTS courses** covering a wide range of fields in electronics, each complete with equipment, lessons, and manuals to make your training more practical and interesting.

**Compare our training; compare our lower tuition.** We employ no salesmen, pay no commissions. You receive all home-study information by mail only. All Kits, lessons, and experiments are described in full color. Most liberal refund policy and cancella-







# Product Test Reports

performance than the company's professional noise filters, it is an effective means for combating noise—and it sells for only a small fraction of the cost of professional units. Retail price is \$299.95.

**General Description.** As with most signal-processing accessories, the noise-filter is best installed in an audio system through its tape monitoring circuit. The filter's 50,000-ohm input and 50-ohm output impedances are designed for just this type of hookup.

One of five pushbutton switches on the front panel is for controlling power. The remaining pushbuttons are for switching in and out the filter's operating modes. The OUT switch bypasses the filter altogether. The active operating modes include PHONO, PHONO 78, and TAPE/FM. The last, with its fast attack, provides the most effective noise reduction in most cases. PHONO is similar but with a slower attack time to reduce the effect of record ticks and scratches. PHONO 78 is slower still, providing more drastic hiss reduction.

Another mode, most effective with program material like piano music, can be engaged by leaving all buttons out (off). This provides the bandwidth characteristics of TAPE/FM with a slow attack time.

The filter has a slide-type SENSITIVITY control that can be adjusted to provide the optimum compromise between noise reduction and subjective loss of high-frequency response. A red LED comes on when the filter is in the SUPPRESSION mode, while a green LED comes on in the WIDEBAND mode (when the signal has effectively removed the filter from the system).

Burwen's specifications for the Model DNF 1201 include: 10 to 30,000 Hz  $\pm 0.5$  dB frequency response; response down 3 dB at 500 Hz, after which it falls off at a rate of 9 dB/octave at maximum effectiveness; between 6 and 14 dB of hiss reduction; 0.77-volt (0 dBm) nominal input signal level; less than 100  $\mu$ V output noise between 20 and 20,000 Hz; 0.2% maximum harmonic distortion with 3-volt input and maximum sensitivity between 20 and 10,000 Hz. Normally, the filter's cutoff frequency varies continuously and smoothly between 500 Hz and 30,000 Hz according to the program requirements.

The filter measures 11  $\frac{3}{8}$ "W  $\times$  8 $\frac{7}{8}$ "D  $\times$  3 $\frac{3}{4}$ "H (29  $\times$  23  $\times$  10 cm).

## ABOUT THIS MONTH'S HI-FI TEST REPORTS

In this month's audio test reports, we're examining two products that are off the mainstream path in hi-fi—a dynamic noise-reduction unit and 4-channel headphones. Rounding out the audio section is a complete report on a good-quality, moderately priced open-reel tape recorder.

A handful of ingenious techniques have been devised to reduce noise, principally hiss, in audio systems. Burwen Laboratories' new DNF-1201, a consumer version of its professional equipment, is unusual since it materially reduces hiss with little or no effect on program content.

The Fidler-designed TEL-101F 4-channel headphones manufactured by Telephonics are substantially different in design from other quadraphonic headphones. They come close to achieving the seemingly impossible result of a 360° response through a pair of phones.

Cassette decks have virtually driven low-priced open-reel stereo tape recorders out of the marketplace, leaving open-reel tape buffs a choice of expensive or very expensive decks. So, we're pleased to report on the Sony TC-645 open-reel stereo tape deck that is competitively priced with the finer cassette recorders.

—Julian D. Hirsch

## BURWEN MODEL DNF 1201 DYNAMIC NOISE FILTER

Signal-processing accessory removes last vestiges of hiss.

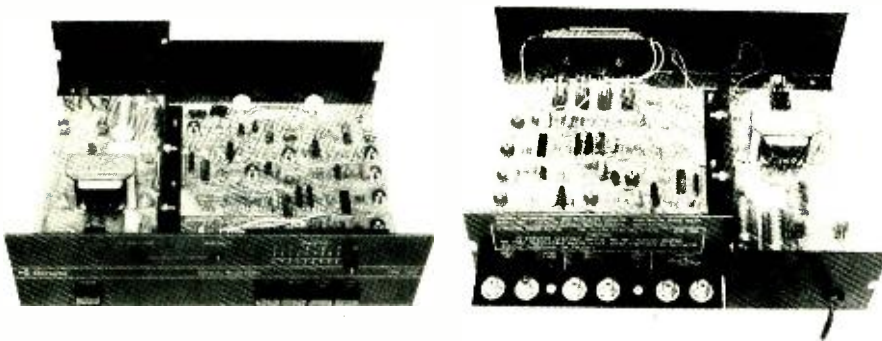

The bandwidth of a dynamic filter (a type of noise reduction system) is controlled by the characteristics of the audio signal passing through it. Ideally, the control should substantially reduce noise without loss of audible program bandwidth. To accomplish this, the filter's bandwidth must follow the changes in program level and frequency distribution, with careful attention given to how rapidly it responds to the changes in the program material.

If the response is too fast, a burst of noise can be introduced by a short transient, such as a record tick or pop. A slow response will dull the impact of the transient and can audibly reduce high-frequency response. (Most dynamic noise filters for the consumer market have proved to be unsuccessful because of their transient response deficiencies.)

Now, Burwen Laboratories, designers of very sophisticated and expensive professional noise reduction devices, is marketing a consumer-type dynamic noise filter. Although its Model DNF 1201 is less refined in its



**Laboratory Measurements.** Because dynamic measurements are almost impossible to make from outside the filter, our lab tests were performed on a steady-state basis. The filter's dynamic characteristics were judged subjectively.

The WIDEBAND frequency response was  $\pm 0.5$  dB from 20 to 20,000 Hz. The output noise measured 130  $\mu$ V (78 dB below 1 volt). In the SUPPRESSION mode, the noise was 80  $\mu$ V (-82 dB). In short, it was far below the noise level that normally exists at the point where the filter is connected into an audio system.

The filter's output clipped at a surprisingly high 9.2 volts. At a 3-volt output at 1000 Hz, THD was 0.013% on WIDEBAND and 1.5% in the SUPPRESSION mode, where the output was down to 2 volts. At 100 Hz, THD was 0.009% on WIDEBAND and 0.022% on SUPPRESSION. (The 100-Hz frequency is well below the "knee" of the filter curve, so the output remained at 3 volts in both modes.) In practical terms, the distortion produced by the dynamic filter is negligible.

The gain of the filter system is adjustable from zero (off) to a 4.5-dB maximum. (Screwdriver controls are provided for adjusting the gain.) For our tests, the gain was set at unity.

After a number of unsuccessful attempts to measure the filter's characteristics with simple external signals, we plotted the transition frequency between the WIDEBAND and SUPPRESSION modes as a function of signal level. We established a 3-volt output as a 0-dB reference level and set the SENSITIVITY control to maximum.

At inputs of from 0 to -80 dB, we varied the frequency until the red and green LED's glowed with equal intensity, indicating that the filter was be-

ginning to go into action. At 0 dB, this took place at 50 Hz, revealing that high-level signals at very low frequencies would open the filter completely. (They would also mask the hiss.) At lower signal levels, the transition frequency moved upward so that the filter "gate" could be opened by -30-dB signals at 600 Hz, -60-dB signals at 5500 Hz, and even -80-dB signals at 10,000 Hz.

It might appear that the usual -60-dB program hiss level would open the filter and allow the noise to pass through. Under the test conditions, this would be the case. But in normal use, the SENSITIVITY control would be set much lower so that the hiss would be suppressed, while any listenable program level would be able to open up the filter.

**User Comment.** To use the noise filter effectively, it is necessary to adjust the SENSITIVITY control for the actual program level and requirements of the particular program. In this respect, the Burwen filter differs from some other noise reduction schemes that are calibrated only once.

Adjusting the SENSITIVITY control is an extremely simple operation, though. Starting with a maximum setting, the control is adjusted until the green LED's come on when a signal is present and the red LED's come on when there is no signal. The noise level drops steadily as the control is adjusted. If it is set too low, the high frequencies will be noticeably attenuated. In almost every case, we found it possible to obtain worthwhile noise reduction without detectable loss of highs.

We would rate the subjective noise reduction of the filter as being comparable to the Dolby B system. It has the advantage that prerecorded pro-

grams are not needed and the disadvantage that its action can occasionally be detected.

In common with every dynamic filter system that does not use encoded material, the effectiveness of the Burwen filter depends on the transient nature of the program and its background noise level. In severe cases (such as a solo piano against a relatively high background noise level), it is often necessary to sacrifice either bandwidth or noise reduction to avoid hearing a "swish" as the filter's bandwidth opens on the attack of the piano note. On other types of program material, there can occasionally be a hardly detectable trace of dulling on the high-frequency transients when an otherwise satisfactory level of noise reduction is used. Subjectively, the full frequency range appears to be present at all times.

We found the filter to be especially useful for removing the last vestige of hiss from Dolby-encoded programs. It is easy to adjust the filter to eliminate the already attenuated hiss left by the Dolby system, with no effect on the program material.

The filter's response time is *extremely fast*. Even a single low-level bell or triangle note, or a record pop, is sufficient to open the filter's bandwidth, especially in the TAPE/FM mode. The PHONO 78 mode is much slower and relatively immune to transient record noise, but its noise and bandwidth reduction are too drastic to be used with modern records and tapes.

In our judgment, the Burwen Model DNF 1201 is a most effective dynamic noise filter. Under most conditions, it does a highly effective job of unobtrusively reducing or even eliminating background hiss.

CIRCLE NO. 65 ON READER SERVICE CARD

## TELEPHONICS MODEL TEL-101F 4-CHANNEL HEADPHONES

*Quadraphonic phone produces fascinating effects.*



Simultaneous with the development and evolution of 4-channel sound for the home, there has been a concerted effort to develop quadraphonic headphones. The objective has been (and still is) to make the phones recreate the same spatial effect produced by a good 4-channel speaker system setup. Until recently, however, quadraphonic

phones have failed to produce a truly convincing 4-channel effect.

Jon Fixler, a pioneer of 4-channel matrix encoding and decoding, designed the unusual Telephonics Model TEL-101F quadraphonic phones reviewed here. Price is \$59.95. At the same time, we also evaluated the performance of the Model TEL-101A "Quadramate" passive synthesizer accessory that derives the rear channels from stereo programs. It sells for \$26.95.

**General Description.** As with all

4-channel phones, the Model TEL-101F has relatively bulky earcups that extend ahead of and behind the wearer's ears. Each cup contains two dynamic drivers. But instead of positioning the drivers in the usual locations in front of and behind the ears, the front driver faces to the rear and the rear driver faces to the front.

The combined outputs from the drivers couple to the ears through a single opening located midway between the drivers. A gently curved foam-rubber pad cushions the phones against the sides of the head. In combination with internal foam padding, this helps to produce the desired frequency response from the phones.

In spite of their bulk, the phones were surprisingly light in weight, weighing less than 19 ounces (0.54 kg). With this weight distributed over a large area by the ear pads, the phones were exceptionally comfortable to wear, even for extended periods of listening.

The phones come with an integral 10' (3-m) long cord that is not coiled. The cord is fitted with separate three-circuit plugs for the front and rear channels. A control knob located under the left earcup provides a means for adjusting the separation between the two front channels.

The impedance of the phones is compatible with amplifier outputs rated at from 4 to 100 ohms. The phones can handle 400-mW/channel of continuous power.

The Quadramate accessory is housed in a compact plastic case that measures 4¼"L × 2½"H × 1⅞"D (10.8 × 6.4 × 2.9 cm). It comes with an integral 6' (2-m) cord fitted with a standard stereo phone plug. Two phone jacks at the end of the box opposite where the cord enters are for the front and rear plugs of the TEL-101F phones.

Two slide-type controls on the box are marked FOCUS and PERSPECTIVE, and a slide switch has positions for 2 CH and 4 CH. The adjustment procedure for the accessory requires that the amplifier's balance control be set for full left-channel output with both slide controls at their right limits. The PERSPECTIVE control must then be moved until the sound appears to come from behind the listener's left ear. Then the balance control on the amplifier can be set to its normal position, while the FOCUS control can be set as desired for the optimum 4-channel effect.

**Laboratory Measurements.** We measured the frequency response of the phones as we would with an ordinary set of stereo headphones. The phones (either front or rear sections, which we measured separately) were driven through a 100-ohm resistance from a power amplifier, to simulate normal operation, at a constant 3-volt level.

The two sections had essentially similar frequency-response and output levels. As with most phones measured on a coupler, the TEL-101F's produced an irregular response curve, with a definite drop-off below 500 and beyond 10,000 Hz. Their efficiency was moderate, with a 3-volt input producing sound pressure levels between 95 and 105 dB.

When measuring one earcup at a time, the QUADRABLEND control on the left earcup had the effect of reducing the front channel output by about 15 dB at its fully blended setting. However, when listening to the phones in a normal manner, the only effect was to gradually move the sound toward the center of the listener's head as it was blended.

The impedance of each earcup was a fairly constant 80 or 100 ohms over most of the audio range. The front driver had a slightly lower impedance than the rear driver, possibly due to loading by the QUADRABLEND control's resistance. A well-damped resonance increased the impedance by about 20% at 130 to 140 Hz.

We repeated these measurements with the phones connected to the synthesizer accessory. With the controls on the accessory set to their right limits, the response was essentially unaffected by the accessory. However, the impedance rose to 250 ohms. When we set the switch to 2 CH, the output level dropped 13 dB and the impedance doubled to 500 ohms. In the 4 CH mode, the output level through the accessory was about 6 dB less than when the phones were used by themselves. Our tests of the Model TEL-101A accessory were limited to listening.

**User Comment.** We did not expect our laboratory measurements to give any clues to the effectiveness of the Fixler system in a listening situation. They were just to reveal the basic properties of the TEL-101F as a headphone system. Judging from the response curves we obtained, always a risky business, we would have ex-

pected the sound to be lacking in bass but generally well balanced over the frequency spectrum. In listening tests, however, the subjective bass was much better than the curves would suggest.

We used the phones with a 4-channel receiver, using SQ and QS matrixed records, CD-4 discrete discs, and stereo FM broadcasts. With matrixed sources, the sound was full, with a suggestion of rear-channel presence, but little identifiable directionality. This was to be expected, since the decoder in the receiver used lacked logic assistance and did not incorporate Variomatrix circuitry.

With CD-4 discs, whose directionality through speaker systems was unmistakable, the phones produced some fascinating effects. The rear channels were definitely to the rear, while the front channels appeared more or less centered to the left and right of the wearer's head. It was as though a 4-channel speaker setup was arranged with the front speakers on a line with the listener and the rear speakers to his rear. On some records with "gimmicked" effects, in which sounds moved through a 360° circle, the effect was very nearly as good with the phones as it was through speakers. In fact, it was positively dazzling at times.

The phones are not among the most efficient we have tested and are even less so when used with the Quadramate accessory. This, combined with their high impedance, prevents these phones from being used with most tape decks or preamplifiers that are equipped with phone outputs. We found that most amplifiers rated at 15 watts/channel or more produced very comfortable listening levels, although low-powered receivers had to be operated at high volume settings.

Do not make the mistake of thinking that 4-channel sound heard through these headphones, as good as they are, is the equal of what you can get with speaker systems. Even stereo phones do not sound like stereo speakers. The same limitations apply—even more so—in the case of four channels. The reason is that phones cannot provide the time delays inherent in listening to normally spaced speakers. With CD-4 and other discrete 4-channel program sources, however, these phones come remarkably close to simulating the effect of a quadraphonic sound field.

The Quadramate accessory appears



to be a passive "ambience-recovery" system that synthesizes the rear-channel signals from ordinary stereo programs. We found that it gave about the same subjective results with most stereo programs that the unaided phones did with matrixed discs played through a basic matrix decoder, with a strong sense of ambience and occa-

sional hints of solid directionality.

The FOCUS control had a very slight effect that is difficult to define. On the other hand, the PERSPECTIVE control unmistakably shifted the sound around to behind the left ear during the adjustment procedure.

The purpose of the 2 CH mode eludes us, since it drastically cut the

volume level and gave the sound a sometimes "constricted" character.

In conclusion, we feel that the TEL-101F phones and TEL-101A accessory make a remarkably good 4-channel listening team when used with a moderate- to high-power amplifier or receiver.

CIRCLE NO. 66 ON READER SERVICE CARD

## SONY MODEL TC-645 OPEN-REEL TAPE DECK

*Four-track stereo deck boasts wide dynamic range.*



According to Superscope, which distributes the Sony Model TC-645 stereo tape

deck, the unit was designed for "ambitious home recordists." To back this up, the deck features: three tape heads (Sony's own "F&F" ferrite and ferrite design); three motors in a solenoid-controlled transport; separate recording bias and equalization switching for a variety of tape formulations; and a four-track record/playback format.

The recorder's microphone and line inputs have separate concentric gain controls. Furthermore, the inputs can be mixed through facilities built into the recorder. A single control is provided for adjusting the output levels of both channels simultaneously. The transport has a two-speed— $3\frac{3}{4}$  ips (9.5 cm/s) and  $7\frac{1}{2}$  ips (19 cm/s)—mechanism.

The recorder measures  $14\frac{7}{8}$ "H  $\times$   $14\frac{5}{8}$ "W  $\times$   $8\frac{7}{8}$ "D (37.8  $\times$  37  $\times$  22.5 cm) and weighs only about 41 pounds (19 kg). It retails for \$549.95.

**General Description.** The transport's solenoid control levers latch mechanically. This permits the deck to be set up in advance for unattended recording and turned on by an external timer connected between the recorder and ac line. The tape tensioning arm shuts off the transport and

disengages the pinch roller when the tape runs out.

The supply and take-up hubs accept reels up to 7" (17.8 cm) in diameter. A four-digit index counter is located at the top of the transport between the hubs.

The tape follows a straight-line path from one reel to the other. It is not necessary to remove the tape head cover to load the tape or clean the heads, but the removal of two thumbscrews makes removing the cover a simple operation.

On the scales of the illuminated meters are red lights that come on whenever either or both channels are in the record mode. If only one channel is in record only the appropriate meter's light comes on.

Separate pushbutton-switch L and R RECORD interlocks are provided. A second pair of pushbuttons is used for connecting the L and R LINE outputs to either the SOURCE or the TAPE playback program. A third pair of switches is for selecting HIGH or LOW bias and NORMAL or SPECIAL equalization for different tape formulations.

The five transport control levers are for record, rewind, stop, forward, and fast forward. Below the levers are the jack for 8-ohm stereo headphones, the LINE OUT level control, and the pushbutton power switch. The microphone input jacks are located below the meters, while the LINE input and output jacks are located on the rear apron, together with a single unswitched ac accessory outlet. A patch cable is supplied with the recorder for interconnecting the LINE outputs and inputs for making SOUND-ON-SOUND or ECHO recordings through the microphone inputs.

**Laboratory Measurements.** We tested the deck with PR-150 and high-performance SLH-180 tapes, both from Sony, using the bias and equalization settings recommended in the

instruction manual that accompanied the recorder. The playback frequency response, measured with Ampex test tapes, was quite similar at both speeds. There was a slight rise below 200 Hz to about +3 dB at 50 Hz. The response was flat within  $\pm 0.5$  dB from 500 Hz to the upper limits of the tapes, which were 7500 and 15,000 Hz at  $3\frac{3}{4}$  ips and  $7\frac{1}{2}$  ips, respectively.

With Sony SLH-180 tape, using LOW bias and SPECIAL equalization, the overall record/playback response at a -20-dB level was  $\pm 3$  dB from 25 to 16,000 Hz at  $3\frac{3}{4}$  ips and between 20 and 23,000 Hz at  $7\frac{1}{2}$  ips. A more "standard" tape, Sony's PR-150, operated with LOW bias and NORMAL equalization yielded a  $\pm 3$ -dB response of 25 to 11,500 Hz at  $3\frac{3}{4}$  ips and 22 to just beyond 20,000 Hz at  $7\frac{1}{2}$  ips.

Other characteristics of the deck were measured with the SLH-180 tape. The input for a 0-dB recording level was 40 mV on LINE and 0.125 mV on MIC. The playback output was 0.82 volt. The MIC inputs overloaded at 76 mV—a safe level for most applications and purposes.

At a 0-dB recording level, the playback distortion at 1000 Hz was a very low 0.6% at  $7\frac{1}{2}$  ips and 0.82% at  $3\frac{3}{4}$  ips. A 200-nanoweber/meter test tape played back with a 0-dB meter reading.

To reach the reference 3% THD, the recording level had to be increased to +10 dB at  $7\frac{1}{2}$  ips and to +8 dB at  $3\frac{3}{4}$  ips. The playback noise levels at these speeds, referred to the 3% THD signal level, were -61.8 and -58.5 dB, respectively. These were unweighted readings. Applying IEC A weighting to correlate with the audibility of the noise, these figures improved to -71.3 and -67.5 dB, truly excellent for any tape recorder. Through the microphone inputs at maximum gain, the noise increased by 10 dB. But at more "normal" settings, the added noise was much less.

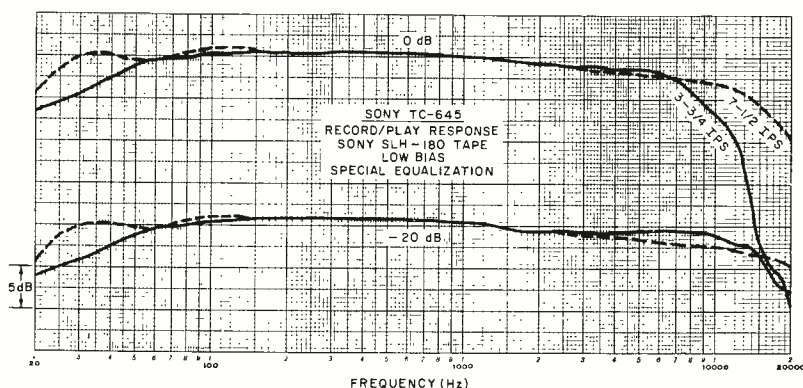
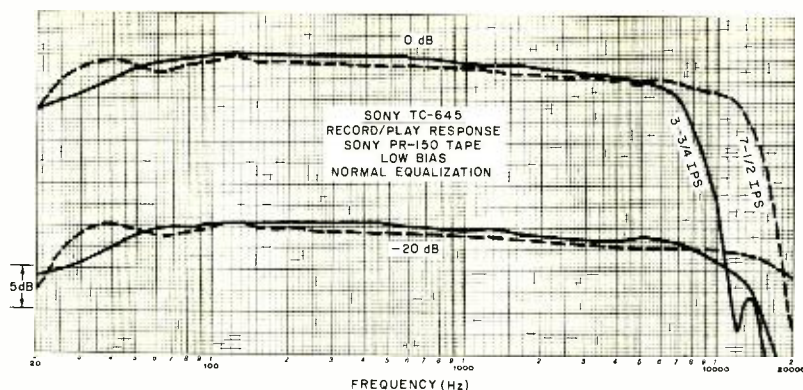

The wow was unmeasurable, being less than 0.02% residual of the test tape. Unweighted rms flutter, the NAB standard, measured 0.09% at 7½ ips and 0.11% at 3¾ ips. The operating speeds were slightly fast, by about 1% at 3¾ ips and 0.5% at 7½ ips. In fast

forward or rewind 66 seconds were required to pass an 1800' (550-m) reel of tape from one reel to the other.

**User Comment.** This was a very simple, straightforward deck to operate. The levers moved smoothly and

positively. It was almost as though they controlled the transport directly through an extraordinarily light pressure linkage. The tape handling was smooth, and shuttling back and forth with the fast speed levers, we found it impossible to spill the tape under any conditions we could devise—including interrupting the power during fast winding.

The considerable "headroom" above the 0-dB meter readings before tape saturation sets in makes recording a relatively uncritical procedure. As Sony points out, the maximum recording level can be allowed to reach 0 dB with little chance of overdriving the tape on program peaks. For "live" recording, a maximum meter indication of -3 to -5 dB is recommended.

When we recorded FM interstation hiss, at 0 dB, and compared the playback to the original, there was virtually no difference in sound between the two at 7½ ips. Only a trace of dulling of the very highest frequencies appeared at 3¾ ips. This is a severe test of tape recorder dynamic range. Few recorders at any price could pass this test as well as did the Model TC-645. Combined with very low noise levels, this gives the recorder a dynamic range well in excess of what most home recordists—even "ambitious" ones—will ever require.

CIRCLE NO. 67 ON READER SERVICE CARD

## PACE MODEL 2300 MOBILE CB TRANSCEIVER

*AM rig uses crystal-controlled frequency synthesis.*

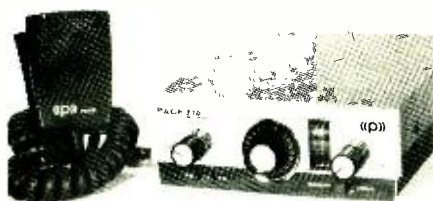

**C**RYSTAL-CONTROLLED frequency synthesis is used in the Pace Model 2300 mobile CB transceiver to provide full 23-channel Class-D AM coverage. As a result, the unit incorporates only 14 crystals. Included with the transceiver at its \$219.95 retail price are a detachable microphone and mobile mounting hardware. A theft preventive feature is provision for use of a padlock at a snap-on mounting clamp.

In addition to the usual volume

control, there is also an adjustable squelch control on the transceiver. PA operation is available through a jack for an external speaker. There is a second output jack for receiver use.

A DISTANCE/LOCAL switch allows the receiver gain to be reduced by about 15 dB when set to the latter position to cope with possible adverse effects from very strong local signals. The received signal strength registers in S units on an edgewise-mounted panel meter. The transmitter operates at full legal power, and full modulation is easy to maintain.

The transceiver is designed to operate from negative- or positive-ground dc sources capable of delivering 10 to 16 volts. A line filter is included in the negative leg of the supply, and reverse-polarity protection is incorporated into the system to protect it from electrical damage. Where necessary,

zener diodes are used to provide voltage regulation.

The transceiver measures 8.4"D × 6.9"W × 2.6"H (21.3 × 17.5 × 6.6 cm) and weighs 5.5 pounds (2.5 kg).

**The Receiver.** The receiver section employs a double-conversion design. The first i-f is 7966 to 8006 kHz, obtained by heterodyning the incoming CB signal with one of six crystal oscillator signals from the synthesizer in the 35.221- to 34.971-MHz range. The result is converted to the 455-kHz second i-f using one of four crystals in the 8421- to 8461-kHz range.

Selectivity at the second i-f is obtained via six tuned circuits in a band-pass configuration. This setup, along with the a-f system, resulted in an overall 6-dB response of from 350 to 2300 Hz and a 10-kHz adjacent-channel rejection of nominally 50 dB.

The diode-protected input amplifier provided a 0.4-μV sensitivity for 10 dB (S + N)/N at 30% modulation with a 1000-Hz signal. The image rejection



measured 50 dB, while other spurious responses were down by a minimum of 40 dB.

An amplified agc system controls the r-f, mixer and first i-f stages, while the resulting changes in the r-f amplifier's collector current controls an amplified squelch. The threshold of the squelching action was adjustable for signals ranging from 0.25 to 50  $\mu$ V. The agc held the a-f output to within 9 dB with an 80-dB r-f input change (at 1 to 10,000  $\mu$ V). The meter registered S9 with a 100- $\mu$ V input signal.

The full-time noise limiter is a series-gate affair. The a-f chain consists of four cascaded stages in a single-ended arrangement that delivered slightly more than 2 watts of power into a 3.2-ohm speaker (1 watt into an 8-ohm speaker) with 10% distortion at 1000 Hz. The a-f section also doubles as the modulating system for the transmitter.

**The Transmitter.** During transmit, the carrier signal is obtained by combining, in the mixer stage, one of the nominal 35-MHz synthesizer frequencies with one of four frequencies in the 7966- to 8006-kHz range. The difference frequency is extracted for the on-channel signal that is then applied to the driver and the power amplifier stages, both of which are collector modulated. Harmonic filtering and matching to a 50-ohm load is accomplished with a triple-section output network. A relay is used for antenna transfer.

We measured a 4-watt power output when the transmitter was powered by a 13.8-volt dc source. Using a 1000-Hz tone, full modulation with a sine wave was obtained at 9% distortion. With a 6-dB increase in microphone input signal level, clipping set in, resulting in 14% distortion. Using EIA's standard test tone of 2500 Hz, the measured adjacent-channel splatter was down 45 and 30 dB, respectively, under the above modulating conditions. However, with dynamic operation under voice conditions, the splatter held to better than 50 dB down.

The overall response of the transmitter/modulator system at the 6-dB points was nominally from 250 to 4000 Hz.

**User Comment.** Aside from providing good performance, the Model 2300 transceiver presented a clean utilitarian appearance in its simulated wood-grain metal cabinet. The illum-

# BUILD & TEST CIRCUITS AS FAST AS YOU THINK!

- POWER FOR THE PROFESSIONAL
- ECONOMY KITS FOR THE HOBBYIST
- A MODEL AND A PRICE FOR EVERYONE



## PROTO BOARD 203

**Breadboard Prototyping with 5 Volt, 1 AMP Regulated Power Supply included!**  
A total ready-to-use power breadboard prototyping device with a built-in regulated, short-proof power supply. Just plug-in and start building! 2 extra floating 5-way binding posts for external signals. Self-contained with power switch indicator lamp and power fuse. 24-14 pin DIP capacity. Attractive two-tone quality case. All metal construction. 9 $\frac{3}{4}$ "L x 6 $\frac{1}{2}$ "W x 2 $\frac{3}{4}$ "H. 5 lbs. Order today!

**\$75**

Add \$2.50 shipping/handling

A modestly priced kit for the economy-minded experimenter . . .

## PROTO BOARD 100

A low cost, big 10 IC capacity breadboard kit with all the quality of QT sockets and the best of the Proto Board series . . . complete down to the last nut, bolt and screw. Includes 2 QT-35S Sockets; 1 QT-35B Bus Strip; 2 5-way binding posts; 4 rubber feet; screws, nuts, bolts; and easy assembly instructions.

**19<sup>95</sup>**

Add \$1.50 shipping/handling.



**PROTO-CLIP  
for Power-On,  
Hands-Off Signal  
Tracing. No more  
shorting leads.  
Costs less than . . .**

**\$5**

Bring IC leads from pc board for fast signal tracing and troubleshooting. Inject signals. Wire unused circuits into boards. Scope probes and test leads lock onto Dynagrip inset (see circle) for hands-off testing. Plastic construction eliminates springs, pivots. Non-corrosive nickel/silver contacts for simultaneous low resistance connections.

PC-14, 14-pin Proto Clip, \$4.50 ea.  
PC-16, 16-pin Proto Clip, \$4.75 ea.

Add 75¢ shipping/handling.

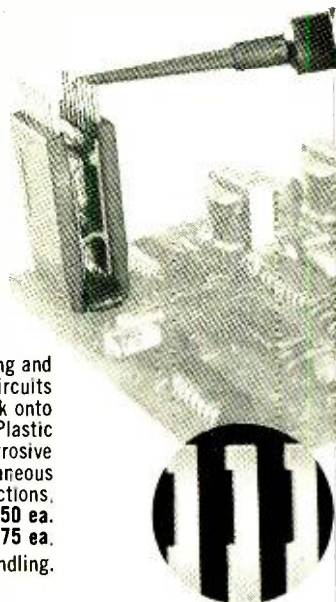

Order today off-the-shelf from CSC or local distributor. Charge: BAC, MC, AX. Write for free catalog. Free English/Metric Slide Rule with each order. Dealer inquiries invited.

Foreign orders add 15%.

Patents Pending Made in USA  
Prices subject to change

**CSC Continental Specialties Corp.**

Box 1942, New Haven, CT 06509 • 203/624-3103

W. Coast Off.: Box 7809, S. Francisco, CA 94119 • 415/383-4207  
Canada: Available thru Len Finkler Ltd., Ontario  
CIRCLE NO. 14 ON READER SERVICE CARD

nated edgewise-mounted meter glows a soft white, except in transmit when it glows red.

The rig's squelch operation was exceptionally smooth without "popping" when it came into action. The threshold was stable with varying vehicular-motor speeds. The anl's operation was also good. It held noise pulses down to the equivalent of near

1  $\mu$ V. The audio reproduction from received signals was good coming from a 6"  $\times$  2" loudspeaker located along the left side of the cabinet.

The transmitter's microphone gain is fixed so that, along with the transmitting characteristics, full modulation could be maintained with normal voice levels, while heavy overmodulation and adverse splatter were held

down even when the voice was raised to a shout directly into the microphone. For PA operation, the volume control serves as the microphone gain control. (The microphone must be plugged into its jack to make the transceiver's built-in speaker operative.)

CIRCLE NO. 68 ON READER SERVICE CARD

## DANA LABORATORIES "DANAMETER" DMM

*3½-digit battery-powered multimeter has liquid-crystal display.*

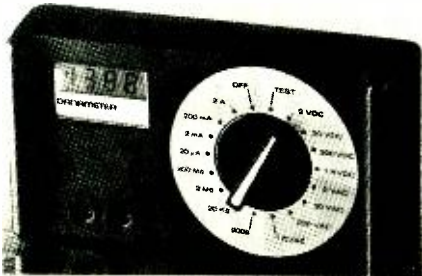

**D**IGITAL multimeters usually employ either high-current LED or high-voltage gas-discharge-type displays. A notable departure from this tradition is Dana Laboratories' "Danameter," a full-function digital multimeter that employs an extremely low-current liquid-crystal display. Teaming the LCD with even lower power MOS devices has resulted in very long life from ordinary replacement-type batteries in a DMM circuit that measures ac and dc voltages, direct current, and resistance.

The Danameter is housed in a virtually unbreakable Cycloc-T plastic case. A carrying handle that doubles as a tilt stand for the DMM folds away when not needed.

The DMM measures 7¼"W  $\times$  3¾"H  $\times$  2¼"D (18.4  $\times$  9.6  $\times$  5.7 cm) and weighs a scant 1 lb. (0.45 kg). It retails for \$199.95.

**Technical Details.** The DMM's readout system consists of a 3½-digit field-effect liquid crystal display. The display forms ½" (12.7-mm) high black numerals against a very pale colored background to provide maximum visibility and contrast.

The instrument is designed to measure dc voltages of from 2 V to 1000 V full-scale in four ranges. Resolution is 1 mV on the 2 V position of the function/range switch. Input resistance on all dc voltage ranges is 10 megohms. (Polarity is automatically indicated in the display. Positive volt-

ages generate a + sign, while negative voltages generate a - sign in the display.)

There are also four ranges set aside for ac voltage measurements. In this mode, the measurement range is from 1 mV to 700 V over a frequency range of from 45 Hz to 10,000 Hz. The input impedance is 2 megohms.

The DMM measures dc (but not ac) current in four ranges, from as low as 10 nA to as high as 2 A. This function is protected by a fuse for up to 250 V at the test inputs. Finally, there are four resistance ranges that provide a measuring capability of from 100 milliohms to 199.9 megohms.

The instrument can accept overloads of up to 250 volts dc or rms on all resistance and current ranges, 250 V dc or 1000 V peak ac on all ac voltage ranges, and 1000 V dc or peak ac on all dc voltage ranges. (The overload indication on the display is OL.)

Because of the instrument's very low power requirements, a single 9-volt transistor battery should power the Danameter for about a year. A position is provided on the function/range switch for testing the battery.

Several optional accessories are available for use with the Danameter. These include a pair of probes for 5- and 50-kV ranges, an r-f probe that can be used to 200 MHz, an ac current shunt that enables ac current measurements to one ampere, a carrying case, and a multiple-tip test-lead set for various applications.

**User Report.** We checked out the Danameter in our usual manner. The dc voltage ranges were tested with the aid of a laboratory standard voltage source, while the resistance ranges were tested out with a number of high-tolerance precision resistors. The instrument displayed readings that were well within its published specifications.

Because Dana claims that the Danameter is housed in a "virtually unbreakable" plastic case, and being well aware of the rigors to which field service gear is put, we "field tested" the DMM by dropping it from a height of 1 meter onto a hardwood floor. Physical examination revealed no damage to the case, LCD, or function/range switch. To verify that the DMM was undamaged electrically, we again subjected it to the specification tests. There was no electrical damage.

Despite the fact that the LCD readout does not glow (like a LED or gas tube), and has no source of illumination, the large display is easy to read, even from a few feet away on the bench. But, since this power-saving system depends on ambient light for its brightness, it cannot be easily read in dimly lit areas.

With 3½ decades of display and high-accuracy measurement capability, the Danameter makes an excellent bench DMM. Its high impedance input gives it fine solid-state capability in a small package. Additionally, the battery-powered instrument's small size, light weight, and ruggedized construction make it an ideal portable test meter in all but very poorly lighted situations.  $\blacklozenge$

CIRCLE NO. 69 ON READER SERVICE CARD



"While I was waiting, I assembled this stereo kit I picked up on the way over."

POPULAR ELECTRONICS





# Solid State

By Lou Garner

## THE VOLTAGE COMPARATOR

**S**UITABLE for use in a variety of applications in logic, control and instrumentation equipment, voltage comparators are available from most large semiconductor manufacturers as well as a number of the smaller specialty firms. In its basic form, the voltage comparator is essentially a modified differential amplifier with two stable output states, responding when an applied input voltage crosses a pre-established threshold level.

Typical of currently available voltage comparators, the "111 family" consists of three standard types offered in a variety of packages by at least two major suppliers, RCA's Solid State Division (Somerville, NJ 08876) and the National Semiconductor Corporation (2900 Semiconductor Drive, Santa Clara, CA 95051). The RCA types are identified as the CA111, CA211 and CA311, while the corresponding

The 111 family devices can be operated on dual power supplies of up to  $\pm 15$  volts or on single dc supplies down to 5 volts. They can drive lamps or relays, and can switch voltages up to 50 volts (40 volts for the 311) at currents of up to 50 mA. The three devices in the family are similar as far as maximum ratings, general specifications, and applications are concerned, differing primarily in their ambient operating temperature ratings and, in the case of the 311, in maximum input offset and bias current specifications. In all three devices, both the inputs and outputs can be isolated from system ground, permitting the output to drive loads referenced to ground, the negative supply, or the positive supply. Their common response time is specified at 200 ns.

Both the RCA and equivalent National Semiconductor devices are supplied in 8-lead TO-5 style case with identical terminal connections. In addition, National Semiconductor offers both the 111 and 211 devices in 10-lead flat packages and 14-lead DIPs, with the 311 offered in a special 8-pin DIP as well. National Semiconductor identifies its TO-5 packaged devices with an "H" suffix, its flat packages with an "F" suffix, its 14-pin DIP with a "D" suffix, and its special 8-pin DIP with an "N" suffix.

Extremely versatile, voltage comparators may be used in a broad range of circuit applications, both individually and in conjunction with other IC's and discrete devices. Because of their versatility, these devices are ideal for many hobbyist and experimenter projects.

A simple zero-crossing detector suitable for use in switching, control, and instrument applications is given in Fig. 1(A). Here, the voltage comparator is used to drive a MOSFET which, in turn, serves as the output switching element.

The low-voltage adjustable reference supply circuit shown in Fig. 1(B) utilizes two npn transistors, Q1 and Q2, in conjunction with the basic voltage comparator. Potentiometer R3 serves as the output level control. As indicated, output filter capacitor C1 should be a solid tantalum-type electrolytic.

Two 100-kHz signal sources are illustrated in Fig. 2—a free-running multivibrator featuring a square-wave output signal at (A) and a crystal-controlled oscillator at (B). Each requires but a single IC and is designed to operate on a single-ended 5-volt dc source. The multivibrator may be used as a clock source in counters and timers or even as part of a secondary frequency standard.

Finally, a type 111 voltage comparator is teamed with a 101A op amp and discrete devices in the 10-Hz to 10-kHz voltage-controlled oscillator (VCO) circuit given in Fig. 3. Supplying both triangular and square-wave output signals simultaneously, this circuit could be used as part of a function generator or an electronic musical instrument. A

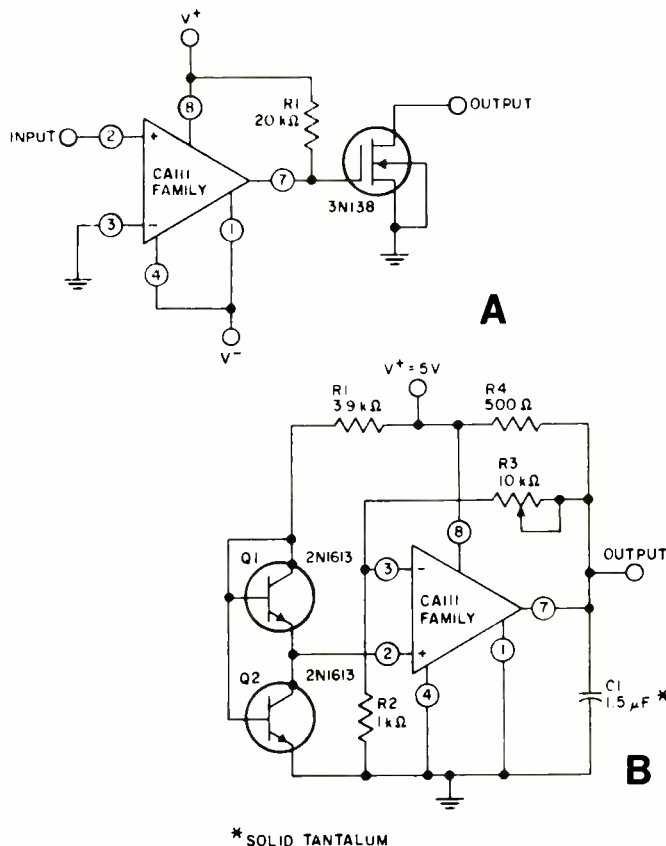

\* SOLID TANTALUM

Fig. 1. Type 111 comparator in a zero-crossing detector (A), and an adjustable reference supply (B).

National Semiconductor devices are designated the LM111H, LM211H and LM311H, respectively. All three types are fabricated using monolithic silicon chips. The basic "111" circuit comprises 24 transistors, two zener diodes, and 19 resistors.

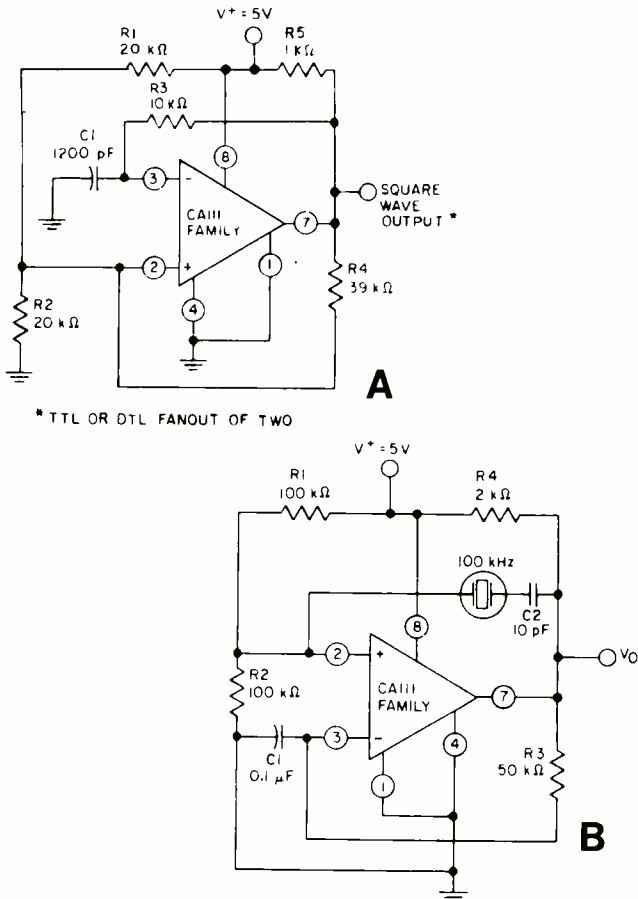

\* TTL OR DTL FANOUT OF TWO

Fig. 2. A 100-kHz free-running multivibrator (A), and 100-kHz crystal-controlled oscillator (B).

dual 15-volt dc power supply is required for circuit operation. In practice, the circuit's instantaneous operating frequency is determined by its input control voltage (from 5 mV to 5 V), while its maximum frequency is established by feedback capacitor C1. Potentiometer R8 serves as a semi-fixed symmetry control and is adjusted for a symmetrical square-wave output when the minimum (5 mV) control voltage is applied to the input terminal.

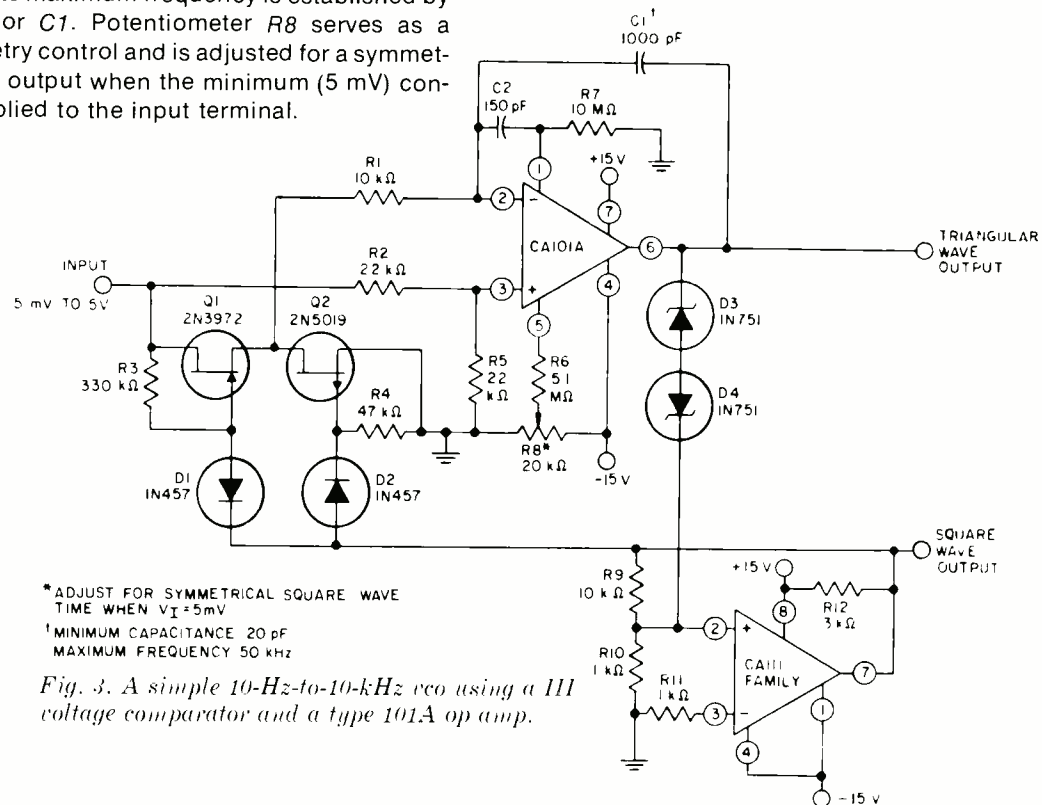

\* ADJUST FOR SYMMETRICAL SQUARE WAVE TIME WHEN  $V_I = 5\text{mV}$   
 † MINIMUM CAPACITANCE 20 pF  
 MAXIMUM FREQUENCY 50 kHz

Fig. 3. A simple 10-Hz-to-10-kHz vco using a 111 voltage comparator and a type 101A op amp.

The three circuits we've examined are but a small sampling of those described in manufacturers' published literature. Among the other circuits found in both RCA and National Semiconductor publications are a *digital transmission isolator, solenoid driver, precision squarer, strobed relay driver, precision photodiode comparator, magnetic transducer detector, both positive and negative peak detectors, and switching power amplifiers*, all of which further illustrate the voltage comparator's amazing versatility.

**Readers' Circuits.** John M. King (1194 Idylberry Road, San Rafael, CA 94903), who submitted the low-light indicator circuit featured in last September's column, has come up with another winner. As his previous circuit, John developed the project to solve a problem encountered by his son, who received a slot car racing set for Christmas. After a while, John and his son found that the 45-ohm rheostat speed controllers supplied with the set were far from satisfactory. If the cars were operated at slow speeds, they would tend to stall with even minor load increases, such as a slope or increased friction on some track sections. If additional power were supplied to pull up an incline, the cars would tend to speed up and crash off the track on the downhill side. John's solution, illustrated in Fig. 4, was a voltage-regulated dc power supply with both a continuous "speed" control and a "top speed" fixed adjustment.

Referring to the schematic diagram, line voltage is stepped down by T1, rectified by a full-wave bridge rectifier (RECT.), and filtered by capacitor C1. A commercial 3-terminal voltage regulator, IC1, establishes a constant output voltage. The regulator, in turn, is supplied with a variable control voltage pedestal by a voltage-divider consisting of speed control R2, top-speed adjustment R3, fixed resistor R4, and reference dc voltage obtained from zener diode D1. Capacitor C2 provides filtering



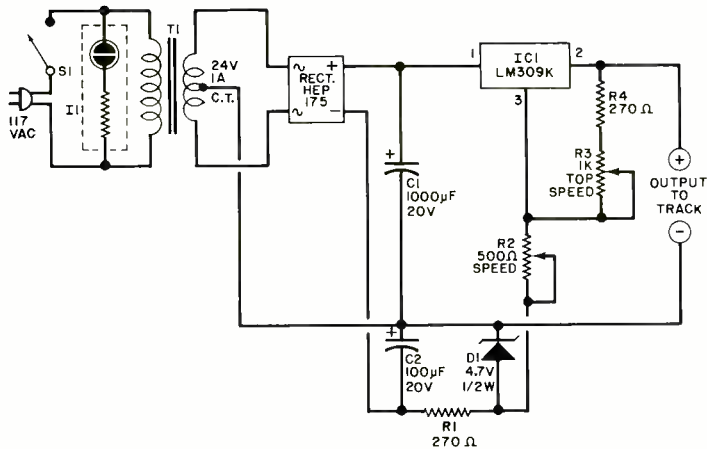

Fig. 4. Speed control circuit for slot cars and HO model trains as submitted by a reader.

for the reference voltage while series resistor  $R1$  limits the zener's current.

John used standard, readily available components in assembling his model. Power switch  $S1$  is a spst rotary type mounted on the 500-ohm speed-control potentiometer,  $R2$ . A 115-volt neon-type lamp assembly (with integral dropping resistor) serves as pilot lamp  $I1$ .

Since layout and lead dress are not critical, conventional construction techniques may be used for assembling the project. John built his original model in a 4"×5"×3" aluminum box, using the box itself as a heat sink for the voltage-regulator IC. With relatively few components needed, he used point-to-point wiring, providing a terminal strip to support the smaller parts.

With a maximum output of from 4.5 to 12 volts dc (depending on  $R3$ 's setting) at approximately 1 A, the controller can be used with HO gauge model trains as well as slot cars. Separate controllers are needed, naturally, for each car in multi-car set-ups or for each train layout.

Anticipating that some builders might wish to use the power supply for other than model train or slot car control applications, John checked the circuit's overall performance. He measured a ripple of 25 mV at 10 volts output with a drain of 1 A, and found that the ripple could be reduced to less than 1 mV by adding a 50-µF capacitor between the negative output terminal and pin 3 on the regulator IC. The ripple at full output is somewhat higher, but the output voltage change is less than 2% from zero to full load.

Suggested by reader John Hornibrook (Box 1165, Silver City, NM 88061), the circuit shown in Fig. 5 might be called a *seeing aid* for the blind. Basically a light-controlled oscillator, the circuit provides an audible signal which changes in pitch with different light levels, thus permitting a user to "scan" the area in his immediate vicinity for changes in light contrast. John indicates that little practice is required for the user to detect objects in his immediate path, such as trees, telephone poles, other persons, walls, and so on, and thus to avoid collisions.

Except for photocell  $PC1$ , the circuit is a conventional collector-coupled multivibrator. The circuit's frequency will vary as  $PC1$ 's instantaneous resistance varies and this, in turn, depends upon the amount of light falling on the photocell's sensitive area. Base resistor  $R2$  is made adjustable to permit the user to pre-adjust the circuit's frequency to a comfortable tone under average light conditions. The circuit's output signal, generated across emitter resistors

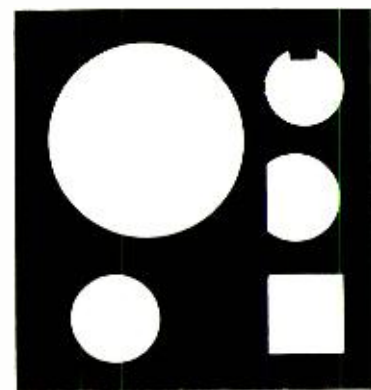

## Put more punch in your work.

With a Greenlee Chassis Punch you can punch clean, true holes in seconds. Round, square, key or D. In 16-ga. metal, hard rubber, plastic or epoxy. Available at radio and electronics parts dealers. Write for catalog E-730. Greenlee Tool Co, Rockford, Ill. 61101.

## GREENLEE TOOL CO



CIRCLE NO. 20 ON READER SERVICE CARD

## BUILD YOURSELF A SPEAKER SYSTEM AND SAVE!

You know specs, but you want speakers to speak for themselves. CTS speakers do; they sound just the way you like. For example, choose a CTS STARRSOUND™ system. Let CTS dealer/consultants tell you how to install it in an ideal enclosure. You'll know why many famous manufacturers use CTS speakers in their brand-name products! Write, send coupon or circle reader service number for our catalog on speakers for home, musical instruments, auto and other uses. Then visit your CTS dealer and hear them!

The ones that speak for themselves.

**CTS OF PADUCAH, INC.**

SUBSIDIARY OF CTS CORPORATION, ELKHART, INDIANA



CTS of Paducah, Inc.  
1565 North 8th St.  
Paducah, Kentucky 42001  
Please send me your latest catalog.

NAME \_\_\_\_\_

ADDRESS \_\_\_\_\_

CITY \_\_\_\_\_

STATE \_\_\_\_\_

ZIP \_\_\_\_\_

CIRCLE NO. 10 ON READER SERVICE CARD

# SAVE!

MONEY • TIME • FREIGHT

- QUALITY STEREO EQUIPMENT AT LOWEST PRICES.
- YOUR REQUEST FOR QUOTATION RETURNED SAME DAY.
- FACTORY SEALED CARTONS—GUARANTEED AND INSURED.
- SAVE ON NAME BRANDS LIKE:
 

A.D.C.	KLH
A.R.	SHURE
DYNACO	KOSS
SONY	FISHER

AND MORE THAN 50 OTHERS

BUY THE MODERN WAY  
BY MAIL—FROM

## illinois audio

Department 217S  
12 East Delaware  
Chicago, Illinois 60611  
312-664-0020

CIRCLE NO. 21 ON READER SERVICE CARD

# BE A LOCKSMITH



You'll EARN MORE, LIVE BETTER Than Ever Before in Your Life

You'll enjoy your work as a Locksmith because it is more fascinating than a hobby—and highly paid besides! You'll go on enjoying the fascinating work, year after year, in good times or bad because you'll be the man in demand in an evergrowing field offering big pay jobs, big profits as your own boss. What more could you ask!

**Train at Home—Earn Extra \$\$\$\$ Right Away!** All this can be yours FAST! regardless of age, education, minor physical handicaps. Job enjoyment and earnings begin AT ONCE as you quickly, easily learn to CASH IN on all kinds of locksmithing jobs. All keys, locks, parts, picks, special tools and equipment come with the course at no extra charge. Licensed experts guide you to success.

**Illustrated Book, Sample Lesson Pages FREE** Locksmithing Institute graduates now earning, enjoying life more everywhere. You, can, too. Coupon brings exciting facts from the school licensed by N. J. State Department of Ed., Accredited Member, Natl. Home Study Council. Approved for Veterans Training.

**LOCKSMITHING INSTITUTE**  
Div. Technical Home Study Schools  
Dept. 1473 065 Little Falls, N. J. 07424

KEY MACHINE locks, picks, tools supplied with course.



LOCKSMITHING INSTITUTE, Dept. 1473 065  
Div. Technical Home Study Schools  
Little Falls, New Jersey 07424 Est. 1948

Please send FREE illustrated Book—"Your Big Opportunities in Locksmithing," complete Equipment folder and sample lesson pages—FREE of all obligation—(no salesman will call).

Name.....  
(Please Print)

Address.....

City/State/Zip.....

Check here if Eligible for Veteran Training

CIRCLE NO. 29 ON READER SERVICE CARD

R4 and R5, is coupled to an external earphone through jack J1.

The circuit can be wired on perf board sized to fit and mounted on spacers inside a metal box or similar case small enough to be held conveniently in one's hand. The inside of the box should be blackened and all cracks covered with tape to make it light-tight. A lens should be provided to focus incoming light on the photocell. This is cemented behind a small (3/16") hole drilled in one end of the case, with the photocell mounted in the lens's focal plane. The photocell is modified by covering with opaque black tape, except for a 1/16" vertical slit on its face. John used a 1" diameter lens with a 3" focal length, but other small lenses may be used if the photocell is positioned at the proper focal point.

To use the completed instrument, plug a moderate impedance earphone into jack J1. Switch on and adjust R2 for a pleasing tone with the lens pointed towards an open area. Next, move the unit back and forth to "scan" the area. As the instrument is moved past objects of varying contrast, there should be a change in the pitch of the audio signal. The instrument's effective sensitivity will depend on one's hearing acuity, on the degree of light contrast between detected objects and background lighting, and, to some extent, on R2's adjustment, as well as upon the degree of skill acquired through practice.

**Device/Product News.** A new LED digit driver specifically designed for use in digital clocks and desk-top calculators has been introduced by *National Semiconductor Corp.* Identified as the DS8863, the new IC contains eight independent channels, each capable of sinking up to 500 mA. Intended for use in display systems employing LED's in the common-cathode multiplexed configuration, the device can be used with displays up to 0.6 inch high and even with digits made up of individual lamps. Featuring high-gain Darlington circuits and requiring a maximum input drive of only 2 mA, the DS8863 interfaces directly with MOS clock and calculator circuits.

If you're using round case TO-5 type IC's, but have a breadboard or circuit layout designed for DIP's, you'll want to check into a series of inexpensive mounting pads now available from *Bivar, Inc.* (1617 Edinger Ave., Santa

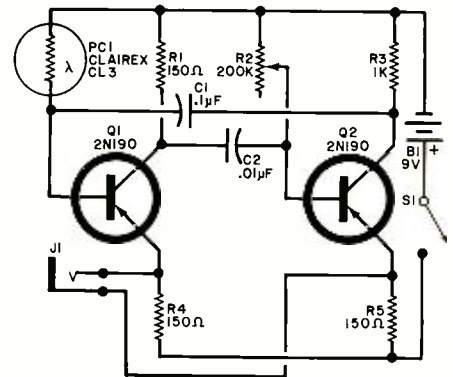
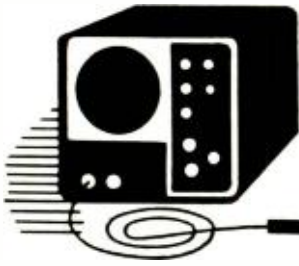

Fig. 5. Audible signal varies with different light levels.

Ana, CA 92705). Molded of high-strength plastic, these handy components have funnel-shaped, self-aligning entry holes which will accept devices with circular patterned leads, forming the leads into a DIP pattern at exit. Posts on the top and feet on the bottom of the pads provide extra lead exposure for heat dissipation and permit easy probe insertion for circuit tests. Three color-coded versions of the mounting pads are currently available: an 8-lead blue pad, Part No. 808-187, a 10-lead red pad, Part No. 810-187, and a 12-lead white pad, Part No. 812-187. All three versions are priced at \$9.05 per hundred in quantities of 100 to 499, dropping to \$36.25 per thousand in quantities above 10,000.

Thinking about assembling a digital watch? There's good news from the West Coast—a new low-voltage CMOS IC chip which contains all of the LSI circuitry required to make a digital watch is now available from *Siliconix, Inc.* (2201 Laurelwood Road, Santa Clara, CA 95054). In addition to the chip, type DF111, all that is required for watch assembly are a 32.768-kHz crystal, a battery, a LED display with drivers, and three switches, plus, of course, a case and hardware. Options are provided for sensors to indicate low-battery conditions and ambient light level. Functional down to 2.2 volts typical, the chip's nominal voltage range is 2.7 to 3.4 volts, supplied by two silver-oxide cells. The DF111 provides for a multiplexed four-digit, seven-segment LED display which will indicate days (date), hours, minutes, and seconds. Days, hours, and minutes may be set independently, and seconds may be synchronized from another time source. Optional displays are 12 or 24 hours, and an AM indicator is available with the 12-hour option. ♦





# Test Equipment Scene

By Leslie Solomon

## GROUNDING

**W**HEN you use test equipment, you probably connect a signal across the input and an oscilloscope across the output of the circuit under test and watch the scope's CRT screen. What you may not realize is that in many cases what you see is not what the device under test is really capable of doing. In fact, what you might be looking at is what the test equipment and the device under test is adding to the input signal (exclusive of distortion products).

What accounts for this strange phenomenon? The name of the culprit is "ground." The way many of us handle this ground in performing tests is simple. We merely connect one ground point to another, using some convenient wire or test leads. It is the lack of understanding the meaning of "ground" that causes a lot of grief at the testbench.

**What is Ground?** Since all electrical measurements are relative, a voltage or signal must be compared to a reference—usually zero or ground. When we refer to ground, ground is literally what we mean, since the local potential of the planet Earth was chosen as our arbitrary zero reference.

There are many ways of connecting to this zero reference, each with its good and bad points. Many people swear by a metal rod driven into the soil. But the rod must be driven deep enough to contact a low-resistance layer, or the rod and surrounding soil must be kept moist to maintain a low earth resistance. Just driving a rod into the ground is not enough. As a general rule, the deeper the rod is driven into the earth, the better.

The second and perhaps best approach to achieving a good earth ground is to use a cold-water pipe as the ground connection. In almost all cases, this pipe makes intimate contact with the surrounding soil over a large area because it must lie below

the local frost line. At such a depth, chances are good that the pipe will lie in a layer of low-resistance soil.

Contact with the cold-water pipe can be made with a brazed, soldered, or clamped-on connector. There may be a problem here. Although most cold-water pipes are metal, there may be plastic joints or even sections of plastic pipe. Plastic is not a conductor. If such is the case, you can bridge over the non-conductors—assuming you have access to them—with heavy-duty wire braid, making good electrical connections on both sides of the non-conductive break.

The idea of using the wall socket's junction box as a ground should be discarded. True, in some areas of the country, metal armored cable is prevalent. The armor is usually connected to the metal junction box and to earth ground at some point. Unfortunately, there are many places where plastic-insulated power lines are the norm; although in such a system the third (green) conductor is supposed to be at ground potential, there is always the possibility that it is not.

*Do not use the so-called "grounded" side of the ac power line as a ground. Because it is not a perfect conductor, there will be an unwanted signal generated across the wire resistance. Besides, if you happen to use the wrong side of the line, it could prove disastrous.*

If you occasionally use the metal finger stop on your telephone dial as a ground, that's not a good idea, either. The phone company frowns on this practice. But more importantly, circulating currents may exist in such a hookup.

### Origins of Unwanted Signals.

Now, let us take a look at the origins of those unwanted signals. Sketch A shows a typical three-conductor power feed. Because the wire used is not a perfect conductor, differences in

# EXAR

## IC'S AND KITS

NOW AVAILABLE FROM:  
JAMES ELECTRONICS

### FUNCTION GENERATOR KIT

Introductory Offer

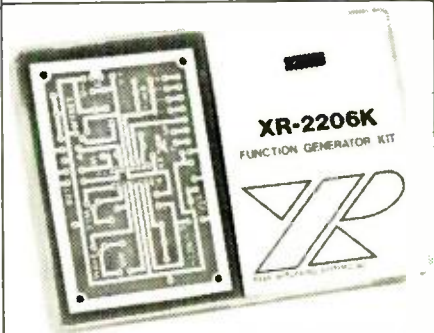

The Function Generator Kit features sine, triangle and square wave; THD 0.5% typ.; AM/FM capability.

#### XR-2206KA

Includes monolithic function generator IC, PC board, and assembly instruction manual.

**\$19.95**

#### XR-2206KB

Same as XR-2206KA above and includes external components for PC board.

**\$29.95**

### MONOLITHIC IC'S

#### TIMERS

XR-555CP	Monolithic Timer	\$1.10
XR-320P	Precision Timer	1.55
XR-556CP	Dual-555 Timer	1.85
XR-2556CP	Dual Timing Circuit	3.20
XR-2240CP	Programmable Counter/Timer	4.80

#### PHASE LOCKED LOOPS

XR-210	FSK Demodulator	5.20
XR-215	High Frequency PLL	6.60
XR-567CP	Tone Decoder (mini DIP)	1.95
XR-567CT	Tone Decoder (TO-5)	1.70

#### STEREO DECODERS

XR-1310P	PLL Stereo Decoder	3.20
XR-1310EP	PLL Stereo Decoder	3.20
XR-1800P	PLL Stereo Decoder	3.20

#### WAVEFORM GENERATORS

XR-205	Waveform Generator	8.40
XR-2206CP	Monolithic Function Generator	5.50
XR-2207CP	Voltage-Controlled Oscillator	3.85

#### OTHER EXAR IC'S

XR-1468CN	Dual $\pm 15V$ Tracking Regulator	3.85
XR-1488N	Quad Line Driver	5.80
XR-1489AN	Quad Line Receiver	4.80
XR-2208CP	Operational Multiplier	5.20

Satisfaction Guaranteed. \$5.00 Min.  
Order—1st Class Mail No Charge/  
California Residents Add 6% Sales Tax

# JAMES

P.O. BOX 822, BELMONT, CA. 94002  
PHONE ORDERS — (415) 592-8097

CIRCLE NO. 24 ON READER SERVICE CARD

67

# trigger fast soldering action

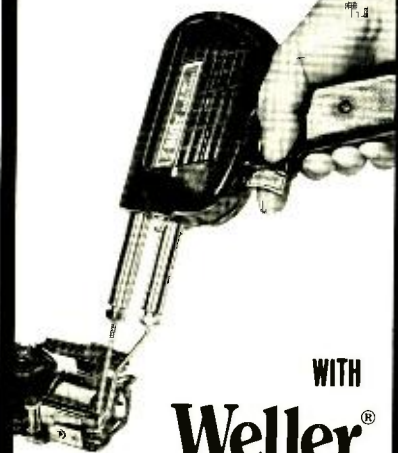

WITH  
**Weller**<sup>®</sup>

## COMFORT-GRIP GUNS

Dual-action trigger permits instant choice of 2 heats in all Weller's professional quality guns, the most comfortable, best-balanced units anywhere. Pre-focused light for hard-to-see work areas like TV or under-dash auto service. Premium copper tips get up to temp faster... pre-tinned for instant soldering. Cutting or smoothing tips also, UL-listed and factory pre-tested. Models for any service including solid-state. Guns alone or kits with case, spare tips, and accessories.



Ask your local distributor or write...

**Weller-Xcelite  
Electronics Division**



**The Cooper Group**

P. O. BOX 728,  
APEX, NORTH CAROLINA 27502  
CIRCLE NO. 49 ON READER SERVICE CARD

potential can and often do exist between two points of a grounding system if any current flows in the system.

The sketch illustrates the phantom wire resistance that forms the common signal point. Note that any instrument plugged into the three-wire outlet is essentially coupled to all other outlets via an interlocking set of phantom resistors.

If you connect a couple of line-powered test instruments as shown in

In using the ungrounded adapter, there is a potential danger if the "hot" power line within the instrument touches the metal chassis. So, before using this approach, make certain that all internal wiring is sound.

In multi-instrument setups, there may be more than one ground connection, creating more than one ground loop. Any one of these loops can introduce a problem. Since shielded cables are often used to in-

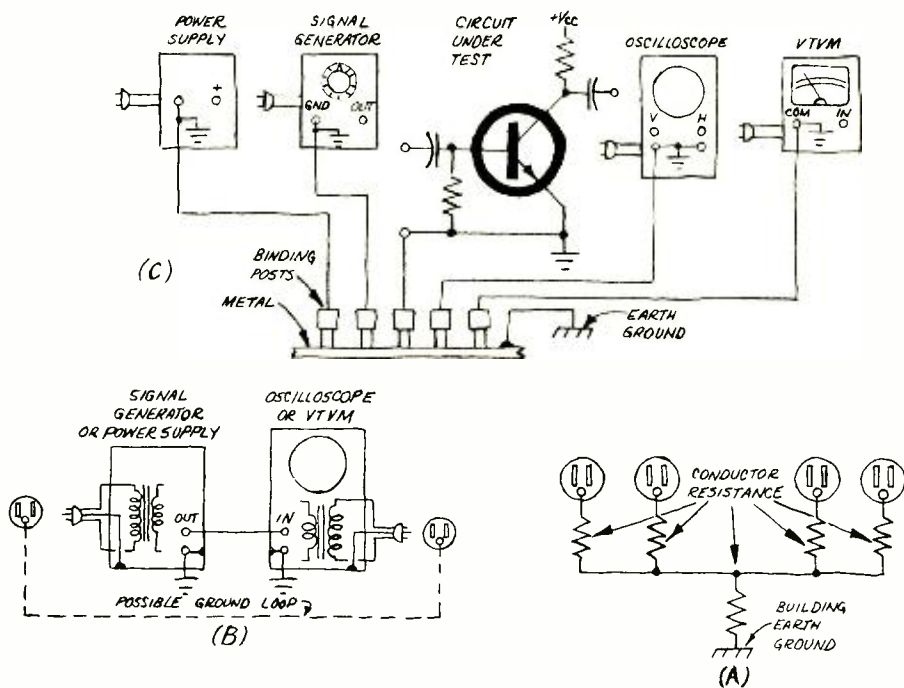

How grounding problems originate. (A) shows how differences in wire resistances create potential differences. (B) shows ground loop in building power line which introduces a false signal. At (C) is a typical test-bench setup with 2-wire plugs to eliminate loops.

sketch B, a ground loop can occur. The metal chassis of both instruments are grounded via the third (green) wire of the receptacle. In some cases, there may be some real capacitors between the ac line and chassis. In all cases, there is the phantom capacitance across the power transformer. Hence, if any current is flowing within the building's power-line "ground," this signal will be "felt" by the measuring system, which will introduce a false signal into the measurement loop.

To break the ground loop and remove false signals, the third wire at one of the instrument power plugs must be broken. (Use a three-wire to two-wire adapter.) As a result, the system is grounded at only one point and, since the ground loop is now broken, false signals produced by ground currents are eliminated.

terconnect a system, especially in audio, all shields should be connected together and then tied to ground at the same point used by the measurement system.

A typical bench setup is shown in sketch C, where two-wire power plugs are used to eliminate the possibility of ground loops. In general, if more than one point in a system must be connected to ground, the ground connections must be made only at the same point where the input is grounded.

There are two excellent books that deal with the subject of grounding when working with test equipment. One is *Basic Electronic Instrument Handbook* by Clyde F. Coombs, Jr. (McGraw-Hill) and the other is *Guide to Electronic Measurements and Laboratory Practice* by Stanley Wolf (Prentice-Hall).





# Computer Bits

By Jerry Ogdin

## A NEW BREED OF HOBBYISTS

**F**OR many years, the thought of having one's own digital computer was only a dream because they could cost anywhere from \$100,000 to several million.

But in the late 1960's, Digital Equipment Corp. announced its \$24,000 PDP-8, raising hopes of forward thinkers for that elusive home computer. With the 1970 introduction of the microprocessor IC (CPU-on-a-chip), representing the "heart" of a full-blown digital computer in a single IC package, they knew it was just a matter of time before prices dropped.

Not content to wait, amateur computer users banded together during the early '70s to share ideas and equipment. In fact, many of the successful applications of microprocessors on the market today owe their origination to these hardy souls, who experimented with building personal computers.

The breakthrough in low-cost microprocessors occurred just before Christmas 1974, when the January 1975 issue of POPULAR ELECTRONICS reached readers with the first relatively inexpensive unit—about \$400 in kit form—that competed in performance with much costlier commercial units. The aftermath is heartwarming to electronics hobbyists—CPU prices are plummeting, and at least one major manufacturer drastically cut the price of its microprocessor.

People interested in computers fall into three major groups: (1) Strong background in "hardware," the physical electronics equipment; weak in "software," the instruction programs needed to make the computer perform some useful task. (2) Strong background in "software," weak in "hardware." (3) Interested amateurs who have no experience in either sector, but find the world of computers an exciting challenge they'd like to tackle.

So it's not surprising to learn that

small hobbyist groups are springing up all over the country, where competent and enthusiastic programmers who cannot read a wiring or logic diagram share ideas with electronic engineers and technicians who work with computers daily, but still find the mysteries of software virtually a black art. For example, a recent letter addressed to POPULAR ELECTRONICS from Hal Singer (hardware editor) and Steve Diamond (software editor), Cabrillo Computer Center, 4350 Constellation Road, Lompoc, CA 93436, stated that they represent a user group of 300 hobbyists actively constructing microcomputers, and would like to encourage participation in their group by persons planning to build the *Altair 8800* computer that debuted in POPULAR ELECTRONICS' January 1975 issue. The group published four newsletters, which can be received by sending a self-addressed manila envelope with 50¢ stamp to the address above.

**What's a Computer?** A computer is a deceptively simple kind of device if you look at it from a "black box" viewpoint, not trying to understand all the electronic "innards."

All computers are fundamentally alike from the largest to the smallest. And the humblest of computers can perform the same work as a huge computer can, except that it takes more time to do it! With a suitable program (software) in its memory, a computer can be a game player, a home accounting machine, or an environmental controller; and in many cases, it can be all of these things at the same time.

No matter how large or small, a computer must have five basic elements, as illustrated.

1. The Arithmetic Logic Unit (ALU) performs additions, subtractions, and all the other arithmetic and logical operations on the input data (something on the order of a super calculator). It is

the features of the ALU that determine the ultimate potential power of the computer.

2. The Control portion orchestrates the movement of data and instructions from one part of the computer to another by taking the operational instructions that were inserted (programmed) into the memory and using these to perform some function to change the input data to output data.

3. The Memory (more properly called Storage, but the two words are used interchangeably) is used to hold operational instructions for the computer, and store intermediate results, commonly used tables, and other pertinent data.

4. The Input Circuit allows the computer to accept data from the outside world. The actual input can come

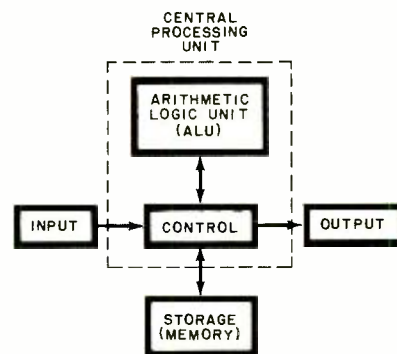

*Five basic parts of any computer.*

from a single sensor, a two-wire system, or a complex network of things to be monitored. Anything that can be converted into computer-acceptable data can be used as the input.

5. The Output Circuit delivers the data generated by the computer to some form of device that does the appropriate work. Without output capabilities, the computer serves no useful purpose.

The ALU and Control circuits are often combined and called a Central Processing Unit (CPU). Years ago, the CPU was awesome—a few feet high, a couple of feet deep, and several feet long. With the advent of large-scale integration (LSI), a complex CPU can now be contained within a single integrated circuit having 40 or less pins. Interestingly, there are now over 25 microprocessors to choose from, if you elect to build your own computer.

All of the current microprocessors have been described in a publication called "The New Logic Notebook," issued monthly. Its premier issue included a "Microprocessor Scorecard" that summarizes the major features of all known CPU's (since publi-

# Bell & Howell Schools invites you to **BREAK INTO 4-C**

Pick up new professional skills in this exciting field as you build Bell & Howell's new quadraphonic audio center. It's the very first learn-at-home program of its kind!



You've probably heard a lot about 4-channel sound by now. It's the most talked about and impressive technical advancement in sound in years. Separately recorded channels literally wrap a room in sound for a totally new listening experience.

And the excitement doesn't stop there. Thanks to Bell & Howell Schools' brand new learning program, now you can explore quad sound for yourself—from the inside out—and master the technology behind this important advancement right in your own home!

It's your opportunity to break away from the everyday routine and learn new occupational skills that could lead you in exciting new directions. Mail the attached card, postage free, to get the facts today!

### **Take hold of opportunity with both hands now!**

The world around you is changing every day. Forging ahead. The man who keeps pace is the man who continues to learn and grow. He's in the mainstream of life. Interested in what's going on. And he's much more interesting, too.

Bell & Howell Schools' new 4-channel audio program was designed to help you learn and grow. To put you in the mainstream of audio electronics technology. Where you can delve into fascinating electronics principles. Solve challenging problems and get actual hands-on, build-it-yourself experience.

And where you can acquire a sense of satisfaction and accomplishment you may not currently be getting.

### **Completely different from the typical kind of school you grew up with.**

Learning all about quad sound with Bell & Howell Schools is a lot more interesting and convenient than "school" used to be. First of all, we know you can't afford to quit your job. So we set up a program that lets you work at home in your spare time.

There are no classes to attend. No dry lectures to sit through. Everything comes to you in the mail. Lesson by lesson. Exciting package after package. And you work at a flexible pace in the relaxed atmosphere of your workshop—or wherever your favorite spot may be.

### **Sure, books are important. But they're only the beginning.**

With this fascinating learn-at-home program, you do a lot more than just read about electronics. You'll conduct dozens of experiments . . . build your own laboratory equipment for testing out electronics principles . . . and also as part of this program you put together a 4-channel amplifier and FM/FM stereo tuner as you delve into advanced audio technology.



We try to make learning so interesting you look forward to receiving each new lesson. And enthusiastically dive into each new project we send you.

### **We'll start you off on the right foot.**

You may be thinking, "I don't have any training in electronics . . . I might be getting in over my head."

Well, you can stop worrying about that. You don't need previous experience. You'll begin with the basics and acquire a thorough understanding of the fundamentals before moving on.

And remember, it's not just reading. With your very first lesson you get our LAB STARTER KIT, consisting of a simple voltmeter and electronics "breadboard" you can experiment with right away.

Of course, if you're already into electronics, you might be thinking, "I already know the basics . . . I want to get into the advanced stuff right away!"

For you there's an advanced standing program that lets you skip the beginning lessons.

### **Next you build the exclusive Electro-Lab® electronics training system.**

Once you've mastered the basics, we'll send you everything you need to put together these three important testing instruments:

**The design console.** You use it to set up and examine various kinds of circuits. It's completely modular . . . no soldering!

**The digital multimeter.** Use it to measure voltage, current and resistance. Displays data accurately in big, clear numbers—just like on a digital clock.

**The solid-state "triggered-sweep" oscilloscope.** Use it to analyze modern,



# HANNEL AUDIO!



state-of-the-art integrated circuits. Triggered-sweep feature locks in signals for easier observation.

These three superb testing instruments are the basis of your own home electronics laboratory. You'll use them throughout the program as you move into more advanced electronics principles and work into audio technology.

### **Bell & Howell's high performance 4-channel audio center you actually build and experiment with yourself!**

You need practical experience with high caliber equipment to develop professional skills and understand the ins and outs of today's audio technology.

So we came up with a system that Bell & Howell is proud to have its name on:

*First, there's the sophisticated outstanding 4-channel amplifier with SQ full-logic decoding and front to back separator.*  
As you build and experi-

ment with this remarkable piece of equipment, you'll learn about matrix 4-channel and discrete—including CD-4 when processed through an external demodulator.

And with it you'll have the advanced circuitry you need to get into signal tracing low level circuits . . . troubleshooting high power amplifier stages . . . and checking the operation of tone control circuits.

*Next, the advanced FM-FM stereo tuner.* As you build this superb stereo tuner, you'll come to fully understand how the advanced, "state-of-the-art" features lead to such high performance specs.\* You'll learn about all solid-state construction, FET front end for superior sensitivity, crystal IF filters for wide bandwidth and the superior multiplex circuit that produces such excellent stereo separation.

### **A wealth of knowledge in digestible chunks.**

O.K.! So now you might be thinking, "It sounds really interesting . . . but kind of complicated." And you're right. But that is why we use the "hands on" teaching approach.

We've taken all the material and broken it down into short, simple-to-grasp lessons, so you can master one thing at a time before moving on. And we take you through it step by step. From the basics to advanced theory to applied audio technology. So you actually have an easier time with it.

\*"Electro-Lab®" is a registered trademark of the Bell & Howell Company

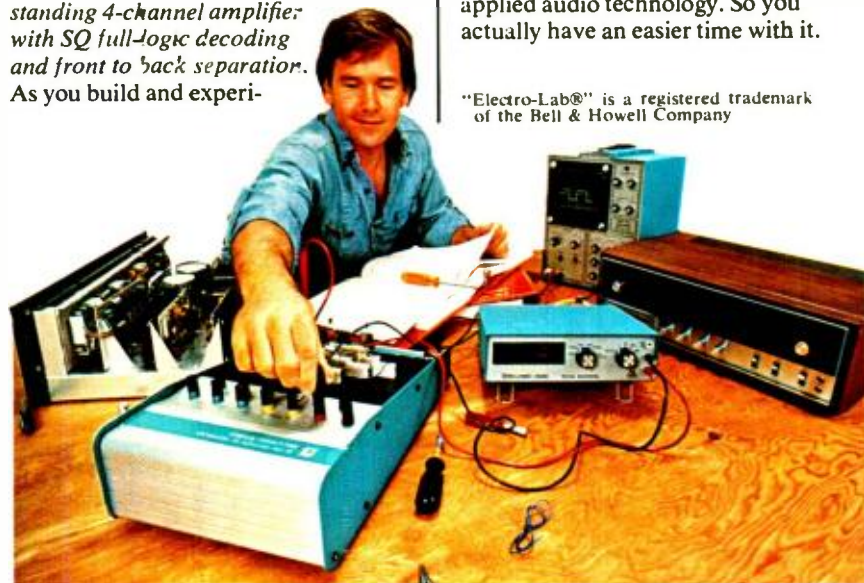

### **Special learning opportunities give you extra help and attention.**

In case you do run into a problem or two, we're ready to give you more help and personal attention than you'd expect from most learn-at-home programs.

For example, many home study schools ask you to mail in your questions. Bell & Howell Schools gives you a toll-free number to call for answers you need right away.

Few home study schools offer personal contact with instructors. Bell & Howell Schools organizes "help sessions" in 50 major cities at various times during the year—where you can discuss problems with fellow students and instructors in person.

### **And when you're done, you'll know a lot more than just 4-channel sound!**

You'll have covered the complete spectrum of electronics principles, leading to a full understanding of audio technology.

And while no school can promise you a job or income opportunity, you will have occupational skills necessary to become a full-service technician. With the ability to work on the entire range of audio equipment. Such as tape recorders, cassette players, FM antennas and commercial sound systems. You'll know audio technology from the inside out. And you'll be proud of it.

Plus you will have the basic skills that apply to the entire electronics field, including television technology and repair.

### **For more details, mail card today!**

Here's your chance to break out of the mold. And break into 4-channel audio with Bell & Howell Schools. Why not look into it today. Mail the attached postage-paid card now. There's no obligation!

Taken for vocational purposes, this program is approved by the state approval agency for Veterans' Benefits.

Wood cabinets available at extra cost.

35 watts per channel—Min. RMS into 8 ohms at less than 0.25% total harmonic distortion from 20-20,000 Hz, all channels fully driven.

**If card has been removed, write:**

An Electronics Home Study School  
DeVRY INSTITUTE OF TECHNOLOGY

766



ONE OF THE  
**BELL & HOWELL SCHOOLS**

4141 Belmont Chicago Illinois 60641



**LISTEN!**

We're one of the country's largest Mail Order Houses of Stereo Equipment and Musical Instruments.

Our volume buying power enables us to pass the savings on to you. Listen to us ... You can't go wrong.

Fill out this coupon and mail to address below for our latest Free Catalogs.

Name \_\_\_\_\_

Address \_\_\_\_\_

City \_\_\_\_\_

State \_\_\_\_\_ Zip \_\_\_\_\_

AUDIO CATALOG

MUSICAL INSTRUMENT CATALOG

PE

**STEREO DISCOUNTERS**

7A AYLESBURY ROAD □ TIMONIUM, MD. 21093

[301] 252-6880

CIRCLE NO. 46 ON READER SERVICE CARD

**Now...the most enjoyable, do-it-yourself project of your life—a Schober Electronic Organ!**

You'll never reap greater reward, more fun and proud accomplishment, more benefit for the whole family, than by assembling your own Schober Electronic Organ.



You need no knowledge of electronics, woodwork or music. Schober's complete kits and crystal-clear instructions show you—whatever your skill (or lack of it)—how to turn the hundreds of quality parts into one of the world's most beautiful, most musical organs, worth up to twice the cost of the kit.

Five superb models, with kit prices from \$575 to around \$2,300, each an authentic musical instrument actually superior to most you see in stores.

Join the thousands of Schober Organ builders who live in every state of the Union. Often starting without technical or music skills, they have the time of their lives—first assembling, then learning to play the modern King of Instruments through our superlative instructions and playing courses.

Get the full story FREE by mailing the coupon TODAY for the big Schober color catalog, with all the fascinating details!

The Schober Organ Corp., Dept. PE-60  
43 West 61st Street, New York, N. Y. 10023

Please send me Schober Organ Catalog.

Enclosed please find \$1.00 for 12-inch L.P. record of Schober Organ music.

NAME \_\_\_\_\_  
ADDRESS \_\_\_\_\_  
CITY \_\_\_\_\_ STATE \_\_\_\_\_ ZIP \_\_\_\_\_

CIRCLE NO. 42 ON READER SERVICE CARD

General Instrument introduced its CP1600, a 16-bit address chip). To obtain a free copy of the scorecard, write directly to Micro-computer Technique, Inc., 11227 Handlebar Road, Reston, VA 22091, enclosing a 9" × 12" self-addressed, stamped (10¢) envelope.

**The Biggest Problem.** It is not overly difficult nor expensive to build your own computer. The major problem that plagues hobbyists (and the computer industry as well), is an inexpensive and useful input/output device such as a terminal.

The first reaction is usually to sug-

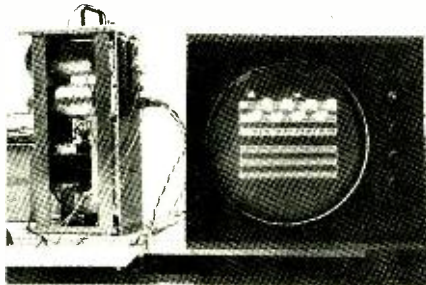

Graphics terminal (above left), designed by Hal Chamberlain, can draw pictures of music scores or logic diagrams, as at right.

gest using a teletypewriter such as Teletype Corp.'s 33ASR. However, this means connecting a \$1200 device to a \$400 computer—hardly a desirable match from the point of view of cost. There are, to be sure, some inexpensive teletypewriters on the surplus market, and many hobbyists have adapted them to computer use. However, there is still a major problem—this equipment is bulky, noisy, and slow.

The second reaction to the problem is almost always to consider using a TV set as the output display device and an inexpensive keyboard as the input medium. Connecting a keyboard to a computer is easy, of course, but driving a TV set with the output is a difficult task. At present, estimates run to a few hundred dollars to make this type of TV data display. (A couple of low-cost "computer terminals" are currently being advertised, but we have no experience with them to date.)

One solution to this problem has been the design of a graphics terminal by Hal Chamberlain, writing in "The Computer Hobbyist," Box 295, Cary, NC 27511. This terminal is controlled from an Intel 8008 microprocessor with as little as 1024 (eight bit) bytes of memory. In addition to alpha-

numerics, it is also capable of drawing pictures (for example: chessboards, music manuscripts and logic diagrams). When combined with a low-cost keyboard for the input device, this display can serve as the primary output device for a small computer.

**Sharing.** The sharing of hardware and software ideas depends upon common agreement as to symbols and media. Electronic circuits all conform to standardized schematic symbol rules. However, computer programs are usually too complicated to be so simply described. It is common,

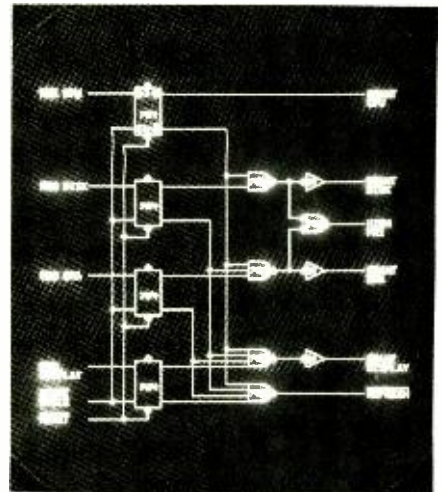

therefore, for programmers to share and exchange programs.

If you obtain a useful program from a friend, you'll often be faced with the problem of transcribing it into computer form through a keyboard. Not only is that time-consuming, but it is error-prone. As one expects, most computer centers exchange programs on magnetic tape, but the tape transports cost upwards of \$5,000. Users of mini-computers tend to use punched paper tape from a Teletypewriter, but few hobbyists will have a paper tape reader.

So what is the poor computer hobbyist to do? A neat, inexpensive solution will be offered in this column next time around. ♦

**Editor's Note.** It is hoped that this quarterly column will serve as a clearing house for computer hobbyist groups and others with interests in the field. If you are a member of such a group, or want to be, write to Computer Bits, Popular Electronics, 1 Park Ave., New York, NY 10016.





## Taming Static Electricity

By John. F. Frye, W9EGV

**T**HROUGH the open door of the service department, Mac watched Matilda typing in the outer office. She did not hear Barney, Mac's assistant, come in from the bright freezing weather outside. He quietly removed his snow boots and stealthily walked across the floor, sliding his feet on the carpet, until he was standing directly behind the absorbed girl. He slowly reached out a forefinger towards the nape of her neck, and she suddenly let out a shriek scattering the papers she was holding. Barney beat a hasty retreat to the service department with Matilda in hot pursuit.

"Let me kill him," Matilda begged, trying to dodge around Mac and get at Barney. "He stuck me with a pin."

"I did not," Barney denied, grinning down maddeningly. "I didn't even touch you."

### Static Electricity Is To Blame.

"He's right. I saw the whole thing," Mac said. "He gave you a shock with static electricity, and that gives me an excuse to continue a discussion of several months ago. Then we talked about the uses of static electricity for such things as smoke precipitation, ore separation, spray painting, and flocking. These are examples of static electricity on its good behavior—which it usually isn't! Most of the time it's causing shocks, unruly hair, clinging clothes, lightning strokes, and explosions; or it's fouling up printing and manufacturing processes or destroying IC's and transistors. Astronomy has been called the wise child of a foolish mother, astrology. In the same way, static electricity might be called the mischievous, annoying parent of a hardworking son, current electricity, which provides us with light, heat, telecommunication, and power. So now let's talk about how we can take the mischief out of static electricity."

"Amen!" Matilda said soulfully, rubbing the back of her neck.

"You both know from your high school physics or our previous discussion that, when certain substances are placed in firm contact and then separated, electrons transfer from atoms of one substance to atoms of the other. Atoms which lose electrons become positively charged ions, or cations; those gaining an electron become negatively charged ions, or anions. Both a potential difference and an electrostatic attraction develop between the separated, oppositely charged surfaces. In fact, if only one electron in 100,000 atoms of a surface is exchanged, that surface is very strongly charged. The substances vary widely, but one or both is usually a poor conductor. Some combinations are: glass and silk, wool and hard rubber, paper and a printing press roll, a fabric belt and a steel pulley, a rubber tire and the pavement, a cold dry stream of particle-bearing air and an airplane wing."

"Or the soles of a pair of size eleven clodhoppers sliding across a nylon carpet," Matilda injected tartly, glowering at Barney's feet.

"Electrostatic attraction is what makes your hair follow the comb on a snappy winter day such as this," Mac hastened to continue. "The passage of the comb leaves one type of charge on the hair and the opposite on the comb. But since the individual hairs have similar charges, they repel each other after the comb is taken away leaving you with a Phyllis Diller coiffure. Dampening the hair provides a conductive path for the charges to leak off the ends and permits you to comb it down."

"Here we have one rule for the control of static electricity problems: *provide a comparatively low resistance path for the charge to leak off as fast as it accumulates on a nonconductor or on the surface of an insulated conductor.* I say 'comparatively low resistance path' because a resistance as high as one megohm will or-

# free

The "NEW LOOK"  
**1975**  
**LAFAYETTE**  
Radio Electronics  
**CATALOG**

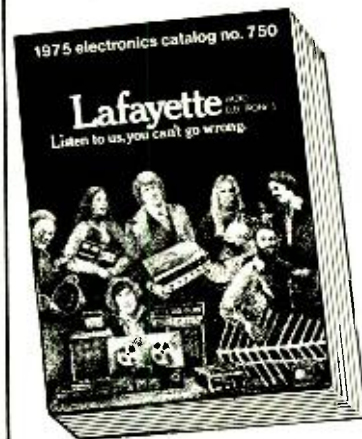

The ONLY Nationally Distributed Full-line Catalog with a Major Showing of the Newest NAME-BRAND electronics products for 1975.

**FREE**  
**SEND TODAY**

**SAVE on exclusive Lafayette Products plus MAJOR BRANDS**

• Stereo and 4-Channel Systems • Tape Equipment • Car Stereo • CB and Ham Gear • Police/Public Service Receivers • Antennas • Cameras • TV • PA and Test Equipment • Musical Instruments and Amplifiers • Books • Electronic Calculators • Security Systems • PLUS PARTS, TUEES, BATTERIES, HARDWARE, MORE!

## Lafayette

Listen to us, you  
can't go wrong.

Dept. 35065

Lafayette Radio Electronics  
111 Jericho Tpke., Syosset, L.I., N.Y. 11791

Send me your FREE 1975 Catalog

Name ..... Apt. ....

Street .....

City ..... State .....

Zip .....

Send a 1975 Catalog to my friend

Name ..... Apt. ....

Street .....

City ..... State .....

Zip .....

CIRCLE NO. 28 ON READER SERVICE CARD

# Eliminate Costly Components with the XR-2240 Timer/Counter



Only \$4.80 EA., P.P.

EXAR'S 2240 IS A . . . . . PROGRAMMABLE TIMER, BINARY COUNTER, DIGITAL SAMPLE AND HOLD, FREQUENCY SYNTHESIZER, PULSE COUNTER, PRECISION OSCILLATOR . . . . . ALL IN ONE.

PROVIDES DIRECT REPLACEMENT OF MECHANICAL OR ELECTRO MECHANICAL TIMING DEVICES.

Exar's new XR-2240 counter/programmable timer solves so many tough problems that designers will unanimously agree that it's really the universal timer.

With its unique combination of analog and digital timing methods, you can now replace inadequate and complex assemblages of monolithic and electro-mechanical timers with the much simpler XR-2240. As a bonus, you get greater flexibility, precision operation, and a reduction in components and costs for most applications. With a single XR-2240 you generate precision time delays from micro-seconds up to 5 days. Two timing circuits can be cascaded to generate time delays up to 3 years. Just think of the savings in components alone.

## BEC ELECTRONICS CORP.

1301 BRUMMEL, ELK GROVE VILLAGE, ILL. 60007

PLEASE SEND  XR 2240 TIMERS WITH COMPLETE SPEC SHEET  
 ENCLOSED FIND MY CHECK OR M.O. IN THE AMOUNT OF \_\_\_\_\_

NAME \_\_\_\_\_  
ADDRESS \_\_\_\_\_  
CITY \_\_\_\_\_  
STATE \_\_\_\_\_ ZIP \_\_\_\_\_

CIRCLE NO. 8 ON READER SERVICE CARD

# LARGE-LARGE DISCOUNTS LOW - LOW PRICES

NATIONALLY ADVERTISED STEREO EQUIPMENT AT LOWEST PRICES!

TURNTABLES \* SPEAKERS \* RECEIVERS  
AMPLIFIERS \* TAPE RECORDERS

WRITE FOR QUOTE ON  
NATIONALLY ADVERTISED BRANDS OF STEREO  
COMPONENTS. SATISFACTION  
GUARANTEED!

*Clifford's*

HI-FI WHOLESALERS  
P. O. Box 809  
Kankakee, Illinois 60901  
(815)-939-7868

CIRCLE NO. 12 ON READER SERVICE CARD

dinarily be adequate for preventing a potential buildup. When the relative humidity is raised above 70%, most insulators become conductive enough, either through absorption or hygroscopic action, to allow a static charge to leak away as fast as it is formed. Where static electricity causes the adhesion or repulsion of sheets of paper, layers of cloth, fibers, etc., humidifying the atmosphere has proved to be a solution in some industrial applications. Unfortunately, this sometimes brings on new problems with both materials and personnel.

"There is another way we can put moisture to work as a conducting path. That is by loading a plastic with a 'detergent' hygroscopic material or by spraying this material on a fabric or rug. This material will attract and hold water molecules forming a conductive path that prevents static buildup. Tomorrow, Matilda, I'll spray that rug out there with *Anti-Shock Spray*, marketed by Bigelow-Sanford, Inc., Greenville, S.C. Then you should be safe from Barney's shocking behavior until the humidity takes over in the summer."

"Then high relative humidity doesn't prevent the 'generation' of static electricity; it simply interferes with the accumulation of a charge high enough to be noticed," Barney observed. "Incidentally, how high a stored charge is 'high enough' to cause trouble?"

"Consider what happens in explosions of gases and vapors ignited by electrostatically produced sparks. The ability of such a spark to produce ignition depends on its energy, which is some fraction of the total stored energy. In a nonconductor, in which the charges are tightly bound, this fraction is low because only a small area can contribute to the spark; but with a conductor, through which charges move easily, the total charge contributes to the effect. That's why sparks between two nonconductors generating a charge seldom produce hydrocarbon gas explosions directly, but they induce charges in nearby conductors which are quite capable of producing such explosions.

"Stored energy is a function of both voltage and capacity. It can be calculated from the formula:  $E = \frac{1}{2} CV^2 \times 10^{-6}$ ; where E is the energy in millijoules, or thousandths of a watt-second; C is the capacity, related to the surface area, in picofarads; and V is the potential across the spark gap in

volts. It has been found that about 0.25 millijoules of stored energy is required for ignition of optimum mixtures of air and saturated hydrocarbon gases and vapors. Sparks arising from potential differences of less than 1500 volts are unlikely to be hazardous in these mixtures because of the short gap and the heat loss at the terminals. Plugging these minima into the formula, you come up with 222 pF., which is slightly less than the capacitance of a large man. As the voltage goes up, the minimum capacity goes down. The spark from Barney's finger to your neck, Matilda, was at least 1/4 inch long, which indicates his body had a charge of around 20,000 volts. At that voltage, a capacitance of only 1 1/4 pF., or about that of a 20-penny nail, could store enough energy to ignite gasoline fumes. Incidentally, remember when we used to see gasoline trucks dragging metal chains to ground static buildup? We don't see that any longer because it didn't work well. Now they bond the metal tank of the delivery truck to the ground tank before gasoline is pumped into or out of the truck tank.

"Electrostatic voltages far below the 1500-volt level can do expensive damage to the equipment we use here. Some MOSFET's will be permanently damaged if as little as 30 volts is applied across the thin oxide region from gate to source. If your body is charged, just touching a lead can destroy such a device. Safe handling of many IC's and transistors requires that everything coming in contact with them be devoid of static charges, which is another way of saying everything should be grounded."

**Special Products.** "Custom Materials, Inc., Chelmsford, Mass., manufactures a special electrically conductive plastic product called VELOSTAT<sup>®</sup> just for this purpose. The conductivity is inherent and not dependent on moisture attraction, as is the case with many other 'antistatic' materials. When workbench, stool seat, and floor mat are covered with Velostat; when the worker is wearing Velostat boots, apron, or gloves; and when all these Velostat items are bonded to each other and to ground with Velostat ribbon; there's no opportunity for damaging electrostatic charges to accumulate.

"Now, let's consider some other ways of eliminating static charges.

"The shape of a conductor has



much to do with the distribution of a charge on its surface. The mutually repelling action of like charges concentrates the charge on the portion with the least radius of curvature. On a needle point, where the radius is near zero, the charge can be so concentrated that it ionizes the air at the point and is absorbed in the process. The discharge in such a case starts at a much lower voltage than would be the case if the conductor did not have a sharp point. Static-discharging 'wicks' bolted to the trailing edges of airplane wings are often made of frayed copper braid to take advantage of this ability of small diameter points to dissipate a charge.

"If a series of needle-pointed conductors is fastened to a metal bar so as to form a 'comb' and this is mounted close to a fabric belt being electrostatically charged by running over a metal pulley, the belt charge will induce an opposite charge in the comb. An ionized path between the belt and the needle points then dissipates the charge as rapidly as it forms. This works equally well with paper passing over rollers.

"A battery of such combs can be made to ionize the air by placing a high voltage on them. Then a fan blowing this conducting ionized air across any area where troublesome static charges may form will bleed off the charge to some nearby grounded object it can accumulate."

"What's this picture of a handheld device that looks like a ray gun?" Barney asked.

"That's a picture of Custom Material's instrument for measuring



Custom Materials' Model CMI-7777M Static Meter

the potential of static electric charges from a safe distance. Here's a diagram of how it works. The meter, which is essentially at ground potential, is handheld at distance,  $d$ , from the charged object. A potential difference  $V$ , develops between the object and the gun tip setting up an electric field,  $E$ , directly proportional to  $V$  and in-

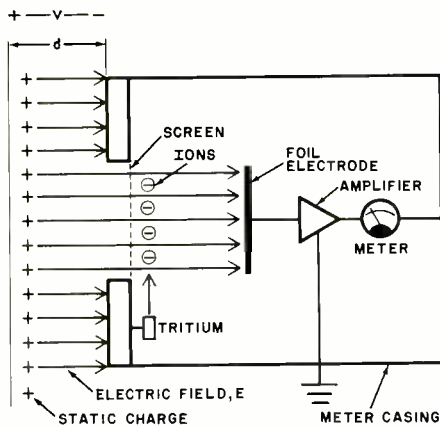

Diagram shows how meter to measure static buildup works.

versely proportional to  $d$ . An opening in the gun barrel is covered with a wire screen; and directly behind the screen and to the side is a small sample of radioactive tritium emitting beta rays or electrons toward the screen. Electron-bombarded air molecules are ionized to form a thin layer on which the electric field of the static charge impinges. Since a field exerts a force on a charge, the ionized air molecules move forward or backward, depending on the polarity of the charge, the amount of movement being related to the intensity of the charge.

"A metal electrode behind the layer of ionized air is connected to a sensitive FET amplifier and the current produced by the movement of the charged air molecules is displayed on a meter on the back of the gun. By holding the gun tip at distances of 2", 6", and 12" from the charged object and using a 3-position mechanical range selector, nine full-scale values covering a range of 500 to 200,000 volts are achieved.

"Now, we've got to knock it off and start earning a buck, although we've barely scratched the surface of the fascinating subject. We've talked before about lightning, the really big show of static electricity. Sometime, maybe we will discuss precautionary measures used in operating rooms, around explosives, in dusty locations, on helicopters, etc. ♦

## A Major Advance...

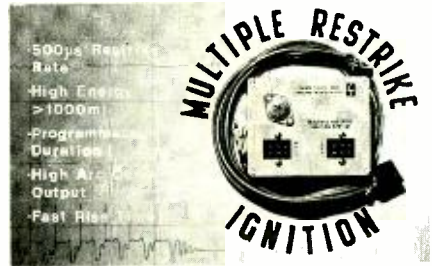

- \*INSURES PROPER COMBUSTION
- \*EASIER STARTING
- \*LONGER POINTS and PLUG LIFE
- \*INCREASE MILEAGE up to 40%
- \*EASY INSTALLATION (12v neg. grd.)

Labtronics' Multiple Restrike (M-R) Ignition produces a high energy repetitive spark on each power stroke to effectively ignite the air/fuel mixture. M-R statistically insures more complete combustion - resulting in greater energy and increased efficiency. Send for Labtronics' free literature on the M-R system. Better yet, experience M-R and enjoy the pleasure and the economy of a well-performing engine.

- Model VI \$79.95 - 1 Year Warranty -  
 - Model VI-B \$59.95  
 - Brochure 30 Day Money  
 P.P.D. in U.S.A. Back Guarantee  
 Send Check or Money Order to:  
**Labtronics, Incorporated**  
 3635 Hillside, Ypsilanti, Michigan 48197

CIRCLE NO. 27 ON READER SERVICE CARD

## DIXIE SAVE ON

### Brand Name Audio Components

**BY MAIL**

**Write Today for Our FREE Audio Catalog**

DIXIE is one of the oldest and largest audio component mail order houses in the country. Our prices on brand name components are actually LOWER than "Discounters". See our new catalog or call us for a price quote. Everything shipped factory-sealed with full manufacturer's warranty

Master Charge / BankAmericard honored on mail orders		

**DIXIE HI-FIDELITY**  
 5600 Second St., N. E., Washington, D. C. 20011  
 Phone: 1-202-635-4900

Please rush me your FREE Audio Catalog and complete information. I understand there is no obligation.

Name \_\_\_\_\_  
 Address \_\_\_\_\_  
 City \_\_\_\_\_  
 State \_\_\_\_\_ Zip \_\_\_\_\_ PE-6

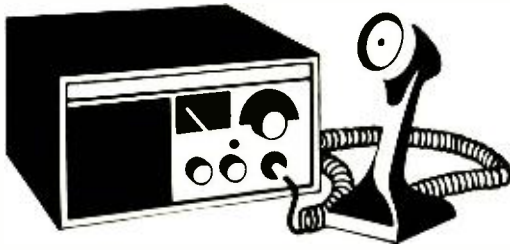

# CB Scene

By Len Buckwalter, K10DH

## HANDLING THE VSWR PROBLEM

**A** WHILE AGO I attended a meeting of microwave engineers. Up front, a speaker slashed the blackboard with a piece of chalk and said, "You've got to get rid of the vizz war!"

On another occasion, I heard an avionics technician, wriggling out of the fuselage of a light plane, exclaim triumphantly, "We just got rid of the vizz war!"

Of course, vizz war is not the latest skirmish to be debated at the United Nations. It's the way the "in crowd" pronounces VSWR, voltage standing wave ratio, sometimes called just plain SWR.

Most of the time, VSWR is as interesting to contemplate as a bubble surfacing in a pool of lava. It rarely intrudes if a CB system is comprised of standard components, in which a transceiver with a 50-ohm output impedance is connected to a 50-ohm transmission line that's hooked up to a 50-ohm antenna. There's a perfect match all around and r-f power flows smoothly from one to the other. But no marriage is forever perfect, as an escalating vizz war will indicate. Gradually, the coaxial jacket cracks, corrosion creeps into conductors and connectors, wires short out, a cold solder joint develops ohmic resistance, rust prevents a lug from making firm contact with ground or a base mount becomes isolated from a car's sheet metal. More dramatically, a heavy ice storm can cause radials to fall off, or a 200-pound bird comes to roost on your antenna. Any one of these troubles will draft you into fighting the vizz war.

**Measurements.** Since manufacturers appear to sell more SWR meters (also called "reflectometers") than any other CB accessory, they're worth a close look. Measuring an antenna's SWR (with a reflectometer) is a clever tactic, because troubleshooting an antenna system with other instruments would require the resources of

a NASA laboratory. You can put an r-f wattmeter on the transceiver output, but all it reveals is how much power is being delivered to the coaxial cable. Finding out if that power is being efficiently radiated by the antenna is another matter.

Ohm's Law doesn't really help because most operators lack the gear needed to measure the parameters of an antenna system operating at 27 MHz. For example, if your rig puts out 4 watts into a 50-ohm load, Ohm's Law says that the antenna current would be 300 milliamperes (mA). But an r-f ammeter that could accurately read 300 mA is priced beyond the means of many CBers. So unless you have access to fancy r-f instrumentation, a low-cost SWR meter is the most practical way to monitor impedance matches.

Since a transceiver should have its output circuitry factory-tuned for 50-ohm loads, one doesn't expect much of an SWR ripple where the transceiver meets the coaxial cable. The feedline itself should not produce a mismatch, because standard lines, such as RG58/U, display a constant 50-ohm impedance regardless of length when terminated with a 50-ohm load. If you suspect something's amiss in the transmitter tuning, connect an r-f wattmeter and a 50-ohm dummy load to the rig's output with short

pieces of coax. The output should nudge close to the 4-watt limit of the FCC. Use the procedure in the manufacturer's instruction manual to peak the output to the legal limit. (Remember to keep away from the frequency-sensitive controls, as these can only be adjusted by a technician with a valid FCC Commercial license. If in doubt, check with a tech.)

The happiest situation occurs when all the power delivered to the feedline is coupled to the antenna and radiated into space. In this ideal system, an r-f voltmeter placed across the transmission line, as shown in Fig. 1, will indicate a constant voltage anywhere along its length. With nary a voltage ripple, the line is said to be "flat." But the ravages of time and the elements eventually disturb this placid relationship.

The result is graphically shown in Fig. 2. Instead of accepting and radiating all the r-f power, the antenna bounces back part of the signal into the feedline. Two waves now travel on the line: a forward wave and a reflected one. The reflected wave opposes and cancels a portion of the forward wave, setting up a standing voltage wave. The r-f voltmeter will reveal this. Let's assume that voltmeter *M1* is put across the line at the point of maximum voltage (also called a loop or antinode) and reads a potential difference of 200 volts. The second voltmeter, *M2*, is placed across the line at the point of minimum voltage (called a node) and reads 100 volts. The standing wave ratio or SWR is then  $V_{max}/V_{min}$ , 200/100, or 2 (also expressed as 2:1 or "two-to-one"). If the two voltage extremes were 400 and 40 V, the SWR would be 10.

**CSWR.** We've been measuring voltage along the transmission line, but the same relationships hold for cur-

Fig. 1. In a perfectly matched system, the r-f voltage is constant all along the feedline.

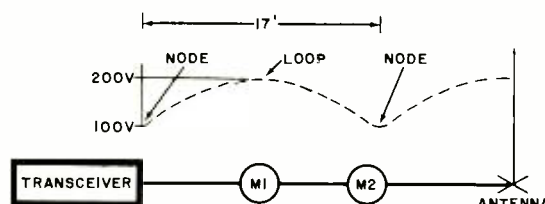
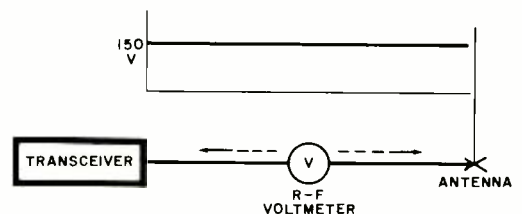

Fig. 2. When impedance mismatch occurs, standing wave appears on the transmission line. In the example shown here, the SWR is 2.



rent distribution. Current standing wave ratio is also meaningful. Incidentally, the loops (or nodes) in Fig. 2 are a half-wavelength apart from each other, or about 17 feet (approximately 5.5 m) at CB frequencies.

No practical system is perfect. An SWR of 1 occurs only in engineering textbooks. An acceptable ratio is 2 or less, but even at 2 the power loss is only 0.2 dB, or about 11%. That's much less than the 1-dB drop that occurs on a 50-foot (15-m) length of RG58/U from the transceiver to the roof. It's not worth trying to lower your SWR from 1.5 to 1.4, as power losses are small below 2 or 2.5. You should be wary, however, of an SWR of 3 because it usually means that something is drifting into the trouble area.

Losses due to high SWR pick up when it runs much above 3. At this value, about 25% of your power never makes it into the antenna. About half your r-f power is wasted when the SWR increases to 12. This is not as dramatic as it sounds. Losing half your power may seem like a lot, but that's only a 3-dB drop in signal strength (other things being equal) or about half an S unit.

SWR produces more serious effects than power loss. It can raise the voltage across the output circuitry to a critical value. Final transistors can blow out—as often happened in the early solid-state rigs. Today, however, engineers produce active devices with a high degree of SWR immunity. A high SWR can also heat up coaxial cables to the melting point, but this rarely happens at 4-watt CB power levels.

Besides keeping a watchful eye over your transceiver output stage, there's another advantage to monitoring the SWR of your system—it telegraphs the condition of your antenna system. While you sit comfortably at your operating position, you can judge how well your antenna is standing up to the hail and sleet storm raging outside. Any abrupt change in SWR warrants an inspection upstairs.

A typical SWR meter (Fig. 3) samples radiation traveling in two directions on a short piece of transmission line. Inside the cabinet, two "directional couplers" (short lengths of wire) run parallel to the line. A switch connects either pickup wire to a meter (through a diode rectifier, which converts the r-f signal to dc). When the switch is in the FORWARD position, the meter gives a relative indication of

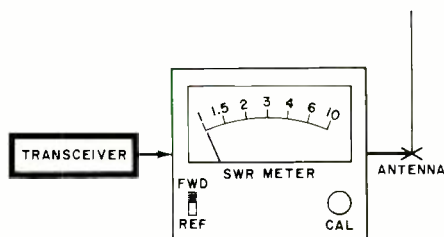

Fig. 3. An in-line reflectometer indicates the impedance match.

the strength of the wave traveling from the transmitter towards the antenna. You then adjust a calibrating pot to bring the needle to exactly full scale (using an unmodulated carrier). To read SWR, the switch is thrown to REFLECTED, which connects the meter to the other directional pickup. This samples the wave going back down the line from the antenna towards the transmitter. The meter indicates SWR directly, and some models are also calibrated in "Percent Reflected Power."

Many SWR meters have negligible insertion loss, so they can be left in-line for continuous monitoring. Others, however, have built-in dummy loads and no output jacks. These should be used only for peaking adjustments, as described above. Some models have limited power-handling capacities, but this is almost never a problem at CB power levels. Check the manufacturer's literature for details.

If your system's SWR reads suspiciously high after the antenna has been in service for a while, look for the trouble spots mentioned earlier. High SWR on a brand-new installation, might have some other cause. If you soldered coax connectors onto the cable yourself, doublecheck your work. When the coax was routed from the antenna to the rig, was it bent sharply? Did a nail or staple accidentally puncture the insulating jacket? If the antenna was positioned close to a large mass of metal, its feedpoint impedance might have been altered. At a base station, proximity to a large TV mast with a group of guy wires can cause this effect. Sheet-metal ducts, plumbing, metal flashing, or electrical cables can also create problems. Try to keep the antenna at least a half-wave (about 17 feet or 5.5 m) away from any large amount of metal.

Never try to reduce SWR by fiddling with transceiver controls. You might cause an apparent drop in SWR, but a better match is not obtained, merely a drop in transceiver output. Once the rig is optimized for 50-ohm loads, as described above, don't touch its innards anymore.

# BIG DISCOUNTS

## STEREO COMPONENTS

Largest selection of top name brands... try us and see...

It's worth a call  
**(301) 488-9600**

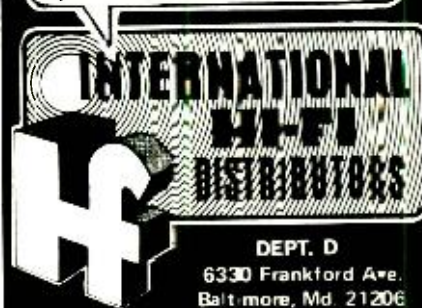

DEPT. D  
6330 Frankford Ave.  
Baltimore, Md. 21206

All mail answered within 24 hours

Phone Daily 9 AM to 9 PM  
Saturday 9 AM to 4 PM  
Phone (301) 488-9600

CIRCLE NO. 73 ON READER SERVICE CARD

## now available for the telephone experimenter

### COMPLETE CONSTRUCTION PLANS

TELEPHONE PLANS: \$3.00 each  
Answering Device, Automatic Dialer, "Black Box", Call Diverter, Call Limiter, Conference Bridge, Central Dial Echoes, Coinciding Ringing, Low-rater, Recorder, Actuator, Remote Control, Schematics, Speakerphone, Electric Burglar Alarm, Voice Scrambler, Dial/Line Converter, Tone/Dial Converter  
MISC. PLANS: \$4.00 each  
Biofeedback Conditioner, Multifrequency Encoder, Network Horticulture Stimulator, Dodecahedron Speaker Enclosure, Photographic Pinhole Camera

ALL OF THE CONSTRUCTION PLANS ABOVE: \$24.95 AIRMAILED

### LEARN THE SECRETS OF YOUR TELEPHONE



Have you ever wondered what lies behind that telephone dial? Now you can learn the tricks of the telephone trade. Get the inside story of telephone systems, their quirks and flaws, and remain up to date on vital occurrences within the telephone industry. TELEPHONE ELECTRONICS LINE is a publication designed for the telephone enthusiast. Phone Phreaks and experimenter contain interesting articles which offer a wealth of hard to find information. Technical theory is also discussed among the following items:  
**Current News Items • Code Numbers Illustrations • Games • Facts • Plans Projects • History • Comics • Stories**  
Facts previously Tel. Co. confidential is now published in TEL!  
One year subscription rate: United States \$6.00, Canadian & foreign \$7.00

ALL OF THE CONSTRUCTION PLANS ABOVE PLUS A ONE YEAR SUBSCRIPTION TO TELEPHONE ELECTRONICS LINE: \$24.95 AIRMAILED

### THE LEGAL ASPECTS OF INTERCONNECTION

\$29.95 AIRMAILED  
The complete reference book to your LEGAL RIGHTS as a telephone subscriber. Study toll evasion, tariffs, wiretapping, customer provided equipment, and many more!

ALL OF THE CONSTRUCTION PLANS ABOVE AND A ONE YEAR SUBSCRIPTION TO TEL PLUS "THE LEGAL ASPECTS OF INTERCONNECTION": \$29.95 AIRMAILED

TELETRONICS COMPANY OF AMERICA  
22035 BURBANK BLVD., WOODLAND HILLS CA 91364 USA

CIRCLE NO. 47 ON READER SERVICE CARD



IF YOU ARE READY FOR SERIOUS CAREER

# Learn College-Level





ADVANCEMENT NOW—

# Electronics at Home

## With CREI's unique Electronic Design Laboratory Program

There is only one way to a career in advanced electronics—through advanced training. You can get such training through a resident engineering college or you can take a CREI specialized college level electronics program at home.

**Wide Choice of Programs.** CREI offers you program arrangements with *fourteen* areas of specialization in advanced electronics. You can select exactly the area of specialization for the career you want.

CREI also offers program arrangements *both* for those with extensive experience in electronics *and* for those with only limited experience. All programs are college-level, except for a brief introductory level course, which is optional.

**Unique Laboratory Program.** CREI now offers a unique *Electronic Design Laboratory Program* to train you in the actual design of electronic circuits. You also get extensive experience in tests and measurements, breadboarding, prototype building and in other areas important to your career. The Lab Program makes it easier for you to understand the principles of advanced electronics. Only CREI offers this complete college type laboratory program.

The Lab Program includes professional equipment which becomes yours to keep. You will especially appreciate the Electronic Circuit Designer, which is available only through this program and which you will find extremely valuable throughout your professional career.

**College Credit.** You can actually earn college credit through CREI programs, which you can use at recognized colleges for an engineering degree. CREI maintains specific credit transfer arrangements with selected colleges in the U. S.

**Industry Recognized Training.** For nearly 50 years CREI programs have been recognized throughout the field of electronics. CREI students and graduates hold responsible positions in every area of electronics and are employed by more than 1,700 leading organizations in industry and government.

**Qualifications to Enroll.** To qualify for enrollment, you should be employed in electronics or have previous experience or practical training in the use of electronic equipment. You must also be a high school graduate or true equivalent.

**All CREI Programs are available under the G.I. Bill**

**Send for FREE Book.** If you are qualified, send for CREI's full color catalog describing these college-level programs and your career opportunities in advanced electronics. Mail card or write for your copy of this book.



**CREI** CAPITOL  
RADIO  
ENGINEERING  
INSTITUTE

McGraw-Hill Continuing Education Center  
3939 Wisconsin Avenue Northwest  
Washington, D. C. 20016



Accredited Member, National Home Study Council

**HUGE SAVINGS ON FAMOUS BRAND STEREO COMPONENTS**

**DISCOUNTS**

ON NATIONALLY ADVERTISED  
 TURNTABLES • CARTRIDGES  
 COMPACTS • RECEIVERS  
 AMPLIFIERS • TAPE RECORDERS

Wholesale Prices! Audio Warehouse Sales  
 One of the Capitals largest stereo whole  
 salers will fill and deliver all your mail  
 orders promptly in factory sealed cartons  
 at prices that will amaze you  
 Write for quote on Famous Brand,  
 Stereo Components. We guarantee  
 satisfaction.

**AUDIO WAREHOUSE SALES**  
 3310 NEW YORK AVE. N.E.  
 WASHINGTON, D.C. 20002  
 (202) 832-1616

CIRCLE NO. 7 ON READER SERVICE CARD



**WE'LL SAVE YOU MONEY**

ON FAMOUS BRAND  
 NATIONALLY ADVERTISED  
**STEREO COMPONENTS,  
 VIDEO & PROFESSIONAL  
 PRODUCTS EQUIPMENT**  
 WRITE TODAY FOR OUR QUOTE AND  
 OUR COMPLETE PRICE CATALOG  
 FAST DELIVERY IN FACTORY SEALED CARTONS  
**FOR IMMEDIATE QUOTE  
 CALL (202) 723-6060**  
 THE COST OF YOUR CALL WILL BE DEDUCTED  
 FROM ANY ORDER OVER \$200.00.

**A.D.R. AUDIO VIDEO**  
 6200 CHILLUM PLACE N.W.  
 WASHINGTON, D.C. 20011  
 Master Charge/ BankAmericard Honored on Mail Orders

CIRCLE NO. 1 ON READER SERVICE CARD

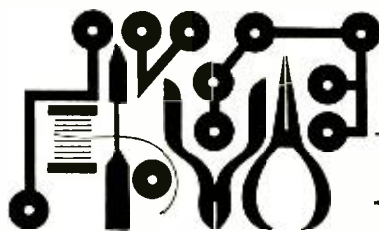

**Hobby Scene**

**LOUDNESS CONTROL FOR AUDIO AMPS**

**Q.** Could you explain the function of the Loudness control on many audio amplifiers? Is there an add-on circuit to realize this function?—Edward Cheung, London, Ontario

**A.** Loudness controls are incorporated into audio amplifiers because the ear has a nonlinear response. At low volume levels, we do not hear bass frequencies as well as the highs. Accordingly, the loudness control compensates by boosting the bass so that it sounds as loud as the treble material. The circuit shown here will function as a bass-boost or loudness con-

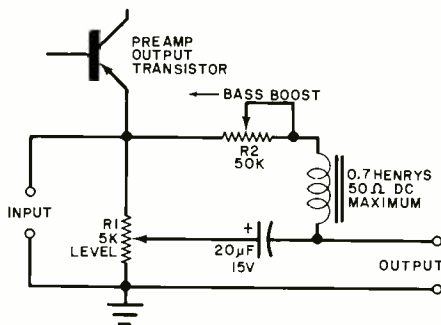

trol when placed between the preamplifier output and amplifier input. Set  $R_2$ , a 50-k, linear-taper potentiometer for maximum resistance. Adjust  $R_1$ , the level control, so that the program material sounds as loud as the original and adjust the treble control on the preamplifier for proper tone balance. Now the program level can be reduced to the desired listening level and  $R_2$  adjusted for the same acoustical bass response. With  $R_2$  set for maximum bass boost and  $R_1$  for a -40-dB output, the frequency response will agree to within 2 dB of the 55-phon Fletcher-Munson curve. Inductor  $L_1$  can be derived by using the yellow and green leads on the secondary of an Argonne AR-128 (Lafayette 33 F 85358) audio transformer.

**AM RADIO ANTENNA TERMINALS**

**Q.** I recently bought an old Silvertone radio at a garage sale. I am confused about the antenna terminals on the

back of the set. There is a two-terminal strip and a ground lug underneath. One of the terminals is marked ANT and the lug is marked GND. I understand what they signify, but the second terminal on the strip, marked DBL, mystifies me. What is the DBL terminal for?—Todd Gillespie, Barrington, Ill.

**A.** This configuration is often found on older BC and shortwave receivers. If an unbalanced antenna, such as a random-length, end-fed wire is used, it is connected to the ANT terminal. A wire should then be run from the GND terminal to a good earth ground (a cold water pipe is fine). If a balanced antenna, such as a center-fed dipole is used, one lead of the balanced feed-line (such as twinlead) should go to the ANT terminal, and the other lead to the DBL or Doublet (which is another name for a dipole) terminal. A good earth ground should be connected to the GND lug.

**NEON BULB FLASHER**

**Q.** I have an NE-34 neon light, and want to make a flasher circuit that will operate at about 2 Hz. Is there a simple way to do this?—David Bellevue, Wilmington, DE.

**A.** A high-voltage battery and a simple RC circuit can be combined with

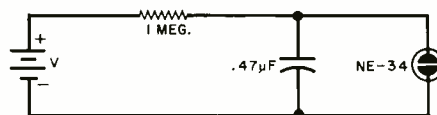

your neon bulb to produce a flasher. The switching rate depends on the product of R and C, which in this case is about a half-second. The lamp will blink about twice each second. Use two NEDA 200, 67½-volt batteries in series as a voltage source.

Have a problem or question on circuitry, components, parts availability, etc? Send it to Hobby Scene, Popular Electronics, One Park Ave., New York, NY 10016. Though all letters can't be answered individually, those with wide interest will be published.



# PRICES Slashed up to 50%

Take advantage of our new Volume Discount.

## SEMICONDUCTORS

Solid State Systems, Inc. has in stock a wide range of SEMICONDUCTORS including 7400 TTL, Linear IC's, Diodes, Transistors, and TRIAC's.

These items are ALL factory tested FIRST-RUN PRIME. All IC's are supplied in 18-, 14-, 16-, or 24-pin DIP plastic or ceramic package except for NE540 and SE540, which come in a TO-3 package.

Catalog Number	Description	Unit Prices
12-17501	NE501A Video Amplifier	2.50
12-27531	NE531V High Slew Rate OP Amp	2.60
12-37540	NE540L Power Driver	2.00
12-35540	SE540L Power Driver	4.00
12-17550	NE550A Precision Voltage Regulator	1.00
82-03554	SI 3554E, 5V 3 Amp Voltage Reg	7.50
12-27555	NE555V Timer	.80
12-25556	N5556V Operational Amp	1.50
12-25558	N5558V Dual Operational Amp	.68
12-17560	NE560B Phase Locked Loop	2.25
12-17561	NE561B Phase Locked Loop	2.25
12-17562	NE562B Phase Locked Loop	2.25
12-17565	NE565A Phase Locked Loop	2.25
12-27566	NE566V Function Generator	2.25
12-27567	NE567V Tone Decoder PLL	2.25
12-15595	N5595A Linear 4-Quad Multiplier	2.25
12-15596	N5596A Balanced Modulator-Demod	1.65
12-25709	709CV Operational Amp	.38
12-15710	710CA Voltage Comparator	.30
12-15711	711CA Dual Voltage Comparator	.32
12-15723	723CA Precision Voltage Reg	.85
12-15733	733CA Differential Video Amp	1.40
12-25741	741CV High Performance Op Amp	.45
12-15747	747CA Dual Operational Amp	.95
12-25748	748CV High Performance Op Amp	.35

### DIODES

21-10270	1N270 Germanium Switching Diode	.12
42-14001	1N4001, 1Amp, 50PRV, Rec Diode	.07
42-14002	1N4002, 1Amp, 100PRV, Rec Diode	.08
42-14003	1N4003, 1Amp, 200PRV, Rec Diode	.09
42-14004	1N4004, 1Amp, 400PRV, Rec Diode	.10
42-14005	1N4005, 1Amp, 600PRV, Rec Diode	.11
42-14006	1N4006, 1Amp, 800PRV, Rec Diode	.12
42-14007	1N4007, 1Amp, 1000PRV, Rec Diode	.13

## 7400 SERIES

Catalog Number	Unit Price	Catalog Number	Unit Price
7400	.20	7484	2.80
7401	.20	7485	1.40
7402	.20	7486	.45
7403	.20	7489	3.50
7404	.21	7490	.68
7405	.21	7491	1.00
7406	.40	7492	.68
7407	.40	7493	.68
7408	.22	7494	.98
7409	.22	7495	.98
7410	.20	7496	.98
7411	.21	74100	1.25
7413	.45	74104	.60
7416	.38	74105	.60
7417	.38	74107	.42
7418	.30	74121	.48
7420	.20	74122	.60
7421	.20	74123	1.00
7423	.40	74141	1.25
7425	.40	74145	1.21
7426	.26	74150	1.42
7430	.20	74151	1.00
7437	.44	74153	1.25
7438	.44	74154	1.95
7440	.20	75155	1.25
7441	1.00	74156	1.25
7442	1.00	74157	1.30
7443	1.00	74158	1.30
7444	1.00	74161	1.50
7445	1.20	74162	1.50

## SCHOTTKY TTL

SPECIAL CLOSEOUT SALE on 74S00 series Schottky TTL. This is a one-time offer, as we are discontinuing our line of this fast TTL. These items are offered at our cost, but only while they last. These items will NOT be backordered and credit will be issued for all items SOLD OUT. Get them while they are still in stock!

Catalog Number	Unit Price
74S01	.50
74S03	.50
74S04	.55
74S05	.55
74S09	.50
74S15	.50
74S20	.50
74S21	.50
74S22	.50
74S40	.55
74S50	.50
74S51	.50
74S60	.50
74S65	.50
74S74	.99
74S76	.99
74S78	.99
74S107	.99
74S112	.99
74S113	.99
74S114	.99

## CMOS

## 4000 SERIES

Catalog Number	Description	Unit Prices
4000	Dual 3-Input Positive NOR Gate Plus Inverter	.29
4001	Quad 2-Input Positive NOR Gate	.29
4002	Dual 4-Input Positive NOR Gate	.29
4006	18 Stage Static Shift Register	2.55
4007	Dual Complimentary Pair Plus Inverter	.29
4008	4-Bit Full Adder W/Parallel Carry Out	1.36
4009	Hex Buffer, Inverting Type	.74
4010	Hex Buffer, Non-Inverting Type	.74
4011	Quad 2-Input Positive NAND Gate	.29
4012	Dual 4-Input Positive NAND Gate	.29
4013	Dual D-Type Flip Flop W/Set-Reset	.67
4014	8 Stage Static Shift Register	1.86
4015	Dual 4-Stage Static Register	1.79
4016	Quad Bilateral Switch	.67
4017	Decade Counter/Divider W/Decoded Outputs	1.69
4018	Hex Inverter	1.86

# FREE

DATA SHEETS  
WITH EVERY ITEM  
739/749 IC WITH  
EVERY \$10 ORDER\*

- REDUCE YOUR PROJECT COSTS
  - MONEY-BACK GUARANTEE
  - 24-HOUR SHIPMENT
  - ALL TESTED AND GUARANTEED
- TRANSISTORS (NPN):
 

2N3563 TYPE RF Amp & Osc to 1 GHz (pl 2N918)	6/\$1.00
2N3565 TYPE Gen. Purpose High Gain (TO-92/106)	6/\$1.00
2N3567 TYPE High-Current Amplifier/Sw 500 mA	4/\$1.00
2N3866 TYPE RF Pwr Amp 1-2 W @ 100-600 MHz	\$1.50
2N3903 TYPE GP Amp & Sw to 100 mA and 30 MHz	6/\$1.00
2N5108 RF POWER AMP 2 W @ 450 MHz, 1 W @ 1 GHz	\$2.50
2N3919 TYPE RF Pwr Amp 3.5 W @ 330 MHz	\$3.00
2N4274 TYPE Ultra-High Speed Switch 12 ns	4/\$1.00
MPS6515 TYPE High-Gain Amplifier h <sub>FE</sub> 250	3/\$1.00
Assort. NPN GP TYPES, 2N3565, 2N3641, etc. (115)	\$2.00
2N3638 TYPE (PNP) GP Amp & Sw to 300 mA	4/\$1.00
2N4249 TYPE (PNP) Low-Noise Amp 1 μA to 50 mA	4/\$1.00
  - FET's:
 

N-CHANNEL (LOW-NOISE)	
2N4091 TYPE RF Amp & Switch (TO-18/106)	3/\$1.00
2N4416 TYPE RF Amplifier to 450 MHz (TO-72)	2/\$1.00
2N5163 TYPE Gen. Purpose Amp & Sw (TO-106)	3/\$1.00
2N5486 TYPE RF Amp to 450 MHz (plastic 2N4416)	3/\$1.00
E100 TYPE Low-Cost Audio Amplifier	4/\$1.00
ITE4868 TYPE Ultra-Low Noise Audio Amp.	2/\$1.00
T1S74 TYPE High-Speed Switch 40Ω	3/\$1.00
Assort. RF & GP FET's, 2N5163, 2N5486, etc. (8)	\$2.00
P-CHANNEL:	
2N4360 TYPE Gen. Purpose Amp & Sw (TO-106)	3/\$1.00
E175 TYPE High-speed Switch 125Ω (TO-106)	3/\$1.00

## JUNE SPECIALS:

1N4154 DIODE 30 V/10mA 1N914 exc. 30 V	20/\$1.00
2N3904 NPN TRANSISTOR GP Amp & Switch	5/\$1.00
2556 DUAL 555 TIMER 1 μsec to 1 hour (DIP)	\$1.00
2N2222 NPN TRANSISTOR GP Amp & Switch	5/\$1.00
2N2907 PNP TRANSISTOR GP Amp & Switch	5/\$1.00
2N3553 RF POWER AMP 5 W @ 150 MHz	2.00

- LINEAR IC's:
 

308 Micro-Power Op Amp (TO-5/MINI-DIP)	\$1.00
309K Voltage Regulator 5 V @ 1 A (TO-3)	\$1.50
324 Quad 741 Op Amp, Compensated (DIP)	\$1.90
380 2.5 Watt Audio Amplifier 34 Ω (DIP)	\$1.29
555X Timer 1 μs-1 hr. Df. pinout from 555 (DIP)	\$ .85
709 Popular Op Amp (DIP TO-5)	\$ .29
723 Voltage Regulator 3.30 V @ 1.250mA (DIP/TO-5)	\$ .58
739 Dual Low-Noise Audio Preamp/Op Amp (DIP)	\$1.00
1458 Dual 741 Op Amp (MINI-DIP)	\$ .85
741 Freq. Comp. OP AMP (DIP/TO-5/MINI-DIP)	3/\$1.00
- DIODES:
 

1N3600 TYPE Hi-Speed Sw 75 V/200 mA	3/\$1.00
1N3893 TYPE RECTIFIER 500 mA	3/\$1.00

AUTHENTIC, INSTRUMENTED, FLYING ROCKETS for casual or serious experimenters. Over 80 scale original, multi-stage or ready-to-fly models. Solid-propellant engines for safe electric launch system liftoffs up to 2,500 feet. Measure altitude, temp inversions, more! Real telemetry, electronic tracking, aerial still and movie photography with super-miniaturized equipment. New detailed tech manual and full-color catalog. 25 cents from ESTES INDUSTRIES Dept. 18K, Penrose, Colo. 81240.

LIFE-GUARD The finest HEAT-SMOKE-GAS Alarm available. 100% solid state. COSMIC ELECTRONICS, Box 282, Lawrence, NY 11559.

DIGITAL ELECTRONICS! Highly effective course brings immediate results. \$10.00 Satisfaction or \$11.00 refunded! Plans, Projects, Free Literature DYNASIGN, Box 60A7, Wayland, Mass. 01778.

UNSCRAMBLERS Fits any scanner or monitor, easily adjusted to all scrambled frequencies. Only 4" square \$29.95, fully guaranteed. Dealer inquiries welcomed. PDQ Electronics, Box 841, North Little Rock, Arkansas 72115.

ELECTRONIC parts, low prices, free flyer. DARTEK ELECTRONICS, Box 2460, Dartmouth, Nova Scotia, Canada. U.S. Inquiries.

FREE! Diodes and catalog. BDJ Electronics, 11 Revere, Tappan, New York 10983.

HOLD-IT! A new precision electronics product. Details free. INNOVATIVE CONCEPTS, 4018 Clarke, Ft. Worth, Texas 76107.

ALPHA-THETA Biofeedback Instruments. \$29.95 hobbyist models to professional models with on time Digital Recorder. DIGITAL Heart Monitor, Thermometer, VOM, Frequency Counter, Function Generator, Logic Probe with readout, Tach and Dwell meter, etc. Free Catalog. COSMIC ELECTRONICS, Box 282, Lawrence, NY 11559.

SURPRISE! SURPRISE! Digital Piano Tuning Device tunes musical instruments. Accurately! Perfectly! Inexpensively! Construction-Instruction-Plans Complete \$12.95. Armed Postpaid! Moonlighting quickly repays \$40 electronics investment! GBS, Box 100P, Green Bank, West Virginia 24944.

PYROTECHNICAL chemicals, casings, fuse, tools, literature, supplies, Listing-50 cents, with samples — \$1.00. Westech, Logan, Utah 84321.

## ABOUT YOUR SUBSCRIPTION

Your subscription to POPULAR ELECTRONICS is maintained on one of the world's most modern, efficient computer systems, and if you're like 99% of our subscribers, you'll never have any reason to complain about your subscription service.

We have found that when complaints do arise, the majority of them occur because people have written their names or addresses differently at different times. For example, if your subscription were listed under "William Jones, Cedar Lane, Middletown, Arizona," and you were to renew it as "Bill Jones, Cedar Lane, Middletown, Arizona," our computer would think that two separate subscriptions were involved, and it would start sending you two copies of POPULAR ELECTRONICS each month. Other examples of combinations of names that would confuse the computer would include: John Henry Smith and Henry Smith; and Mrs. Joseph Jones and Mary Jones. Minor differences in addresses can also lead to difficulties. For example, to the computer, 100 Second St. is not the same as 100 2nd St.

So, please, when you write us about your subscription, be sure to enclose the mailing label from the cover of the magazine—or else copy your name and address exactly as they appear on the mailing label. This will greatly reduce any chance of error, and we will be able to service your request much more quickly.



1N747A, 3.6V, 5%, 400MW, Zener Diode	.15
1N748A, 3.9V, 5%, 400MW, Zener Diode	.15
1N749A, 4.3V, 5%, 400MW, Zener Diode	.15
1N750A, 4.7V, 5%, 400MW, Zener Diode	.15
1N751A, 5.1V, 5%, 400MW, Zener Diode	.15
1N752A, 5.6V, 5%, 400MW, Zener Diode	.15
1N753A, 6.2V, 5%, 400MW, Zener Diode	.15
1N754A, 6.8V, 5%, 400MW, Zener Diode	.15
1N755A, 7.5V, 5%, 400MW, Zener Diode	.15
1N756A, 8.2V, 5%, 400MW, Zener Diode	.15
1N757A, 9.1V, 5%, 400MW, Zener Diode	.15
1N758A, 10V, 5%, 400MW, Zener Diode	.15
1N759A, 12V, 5%, 400MW, Zener Diode	.15

### TRANSISTORS TRIACS

2N3860 2N3860 NPN General Purpose Transistor	.21
45-03003 3mA Gate 50V 3 Amp. TRIAC	1.21
45-03203 3mA Gate 200V 3 Amp. TRIAC	1.69
45-03403 3mA Gate 400V 3 Amp. TRIAC	2.11
45-10903 10mA Gate 50V 3 Amp. TRIAC	1.09
45-10203 10mA Gate 200V 3 Amp. TRIAC	1.56
45-10403 10mA Gate 400V 3 Amp. TRIAC	1.76
45-25002 25mA Gate 50V 3 Amp. TRIAC	.85
45-25203 25mA Gate 200V 3 Amp. TRIAC	1.19
45-25403 25mA Gate 400V 3 Amp. TRIAC	1.63
45-50010 50mA Gate 50V 10 Amp. TRIAC	.84
45-50015 50mA Gate 50V 15 Amp. TRIAC	1.31
45-50210 50mA Gate 200V 10 Amp. TRIAC	1.06
45-50215 50mA Gate 200V 15 Amp. TRIAC	2.33
45-50410 50mA Gate 400V 10 Amp. TRIAC	1.72
45-50415 50mA Gate 400V 15 Amp. TRIAC	2.55
46-50010 50mA Gate 50V 10 Amp. TRIAC	.78
46-50015 50mA Gate 50V 15 Amp. TRIAC	1.18
46-50215 50mA Gate 200V 15 Amp. TRIAC	2.13
46-50410 50mA Gate 400V 10 Amp. TRIAC	1.50
46-50415 50mA Gate 400V 15 Amp. TRIAC	2.60

**SEND YOUR ORDER TO:**

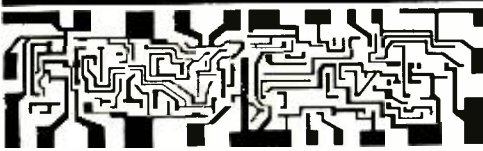

7454	.20	74175	2.00
7454	.20	74176	1.75
7459	.20	74177	1.75
7460	.20	74180	1.00
7470	.32	74181	3.95
7472	.29	74182	.95
7473	.40	74192	1.25
7474	.40	74193	1.25
7475	.64	74196	1.95
7476	.42	74197	1.95
7480	.50	74198	2.65
7482	.93	74199	2.65
7483	1.30		

If your merchandise total is between:

**STANDARD CHARGES**

\$ 0.00 - \$ 4.99 ..... add ..... \$2.00  
 \$ 5.00 - \$24.99 ..... add ..... \$0.75  
 \$ 25.00 - \$49.99 ..... add ..... \$0.50  
 \$ 50.00 - \$99.99 ..... add ..... \$0.25  
 \$100.00 and up ..... NO CHARGE

The above charges include shipping via First Class or UPS (your Choice), and insurance for all domestic shipments.

**SPECIAL CHARGES**

COD ..... \$1.00—additional  
 Air Mail ..... \$0.50—additional  
 Postal Insurance ..... \$0.25—additional  
 Special Delivery ..... \$0.75—additional

**VOLUME DISCOUNT SCHEDULE**

Merchandise Total	Discount
\$ 0.00 - \$ 9.99	..... NET
\$ 10.00 - \$ 24.99	..... Less 5%
\$ 25.00 - \$ 99.99	..... Less 10%
\$ 100.00 - \$499.99	..... Less 15%
\$ 500.00 - \$999.99	..... Less 20%
\$1000.00 and up	..... Less 25%

4017	Presetable Divide-By-1 Counter	
4018	Quad AND-OR "Select" Gate	.67
4020	14-Stage Ripple-Carry Binary Counter/Divider	1.86
4021	8-Stage Static Shift Register	1.75
4022	Divide-By-8 Counter W/A decoded outputs	1.60
4023	Triple 3-Input Positive NA ND Gate	.24
4024	7-Stage Binary Counter	1.43
4025	Triple 3-Input Positive NOP. Gate	.28
4026	Decade Counter/7 Seg. Decoder, Disp. Enabls	2.00
4027	Dual J-K Master-Slave Flip Flop W/Set & Reset	.04
4028	BCD-To-Decimal Decoder	1.43
4029	Presetable Up/Down Counter, Binary or BCD	2.11
4030	Quad Exclusive-OR Gate	.67
4033	Decade Counter/7-Seg. Decod. & Ripple Blank.	3.23
4035	4-Stage Shift Register (Parallel In, Parallel Out)	1.86
4040	12-Stage Ripple-Carry Bin. Counter/Divider	1.86
4041	Quad True/Compliment Buffer	1.35
4042	Quad Clock "D" Latch	1.28
4043	Quad NOR R/S Latch	1.26
4044	Quad NAND R/S Latch	1.26
4049	Hex Buffer/Converter, Inverting Type	.72
4050	Hex Buffer/Converter, Non-Inverting Type	.72
4051	Single 8-Channel Multiplexer	2.11
4052	Differential 4-Channel Multiplexer	2.11
4053	Triple 2-Channel Multiplexer	2.11
4060	14-Stage Ripple-Carry Bin. Count./Div. W/Osc.	2.55
4066	Quad Bilateral Switch	1.26
4071	Quad 2-Input OR Gate	.36
4072	Dual 4-Input OR Gate	.36
4081	Quad 2-Input AND Gate	.36
4082	Dual 4-Input AND Gate	.36
4502	Stoebd Hex Inverter/Buffer	1.28
4510	BCD Up/Down Counter	1.96
4511	BCD-To-7 Seg. Latch/Decoder/Driver	1.96
4512	8-Channel Data Selector	2.13
4514	4-Bit Latch/4--16-Decoder(Hi)	2.47
4515	4-Bit Latch/4--16-Decoder(Lo)	2.47
4516	Binary Up/Down Counter	1.96
4518	Dual BCD Up Counter	2.04
4520	Dual Bin. Up/Down Counter	2.04
4528	Quad Monostable Multivibrator	1.69
4585	4-Bit Magnitude Comparator	2.13

**OR CALL: 800-325-2981**

**SOLID STATE SYSTEMS, INC.**  
**P. O. BOX 617**  
**COLUMBIA, MISSOURI 65201**  
 CIRCLE NO. 52 ON READER SERVICE CARD



2.91/00  
 2/S1.00  
 1N914 or 1N4148 Type Gen. Purp. 100V/70-nA 10/S1.00  
 1N749 ZENER 4.3 Volt (+10%) 400 mW 4/S1.00  
 1N753 ZENER 6.2 Volt (+10%) 400 mW 4/S1.00  
 1N755 ZENER 7.5 Volt (+10%) 400 mW 4/S1.00  
 1N757 ZENER 9.1 Volt (+10%) 400 mW 4/S1.00  
 1N758 ZENER 10 Volt (+10%) 400 mW 4/S1.00  
 1N965 ZENER 15 Volt (+10%) 400 mW 4/S1.00  
 1N968 ZENER 20 Volt (+10%) 400 mW 4/S1.00  
 D5 VARACTOR 5-50 W Output @ 70-250 MHz, 7.70 pF \$5.00  
 F7 VARACTOR 1-3 W Output @ 100-500 MHz, 5.30 pF \$1.00

\*MAIL NOW! FREE DATA SHEETS supplied with every item from this ad. FREE 739 or 749 Low-Noise Dual Op Amp included (\$1.00 value) with every order of \$10 or more, postmarked prior to 7/31/75  
**ORDER TODAY**—All items subject to prior sale and prices subject to change without notice. All items are new surplus parts — 100% functionally tested.

**WRITE FOR FREE CATALOG** offering hundreds of semiconductors not listed here. Send 10¢ stamp.

**TERMS:** All orders must be prepaid. We pay postage: \$1.00 handling charge on orders under \$10. Calif. residents add sales tax. Foreign orders — add postage. COD orders — add \$1.00 service charge.

# ADVA ELECTRONICS

BOX 4181 AG, WOODSIDE, CA 94062

Tel. (415) 851-0455

CIRCLE NO. 2 ON READER SERVICE CARD

**ELECTRONIC IGNITION** Capacitor, transistor, pointless Auburn sparkplugs information 10 cents. Anderson Engineering, Epsom, NH 03234

**WHOLESALE SCANNERS, CB Crystals, Directories SSP/AM, Catalog 25 cents G—Enterprises, Box 461P, Clearfield, Utah 84105.**

**LEARN DESIGN TECHNIQUES** Electronics Design Newsletter Digital, linear construction projects, design theory and procedures. Annual subscription \$6.00, sample copy \$1.00. Valley West, Box 2119-B, Sunnyvale, California 94087.

**TELEPHONES UNLIMITED,** equipment, supplies. Catalog 50 cents. Box 1654E, Costa Mesa, Calif. 92626.

**DIGITAL IC Manual—Latest Edition—1500 types** by types/diagram number \$3.95. 32—function digital computer kit—IC, transistors, instructions. \$14.00. IC applications manual—numerous circuits—Analog/Digital. \$3.95. Electronics, P. O. Box 127, Hopedale, Mass. 01747.

**ELECTRONIC COMPONENTS—**all kinds, send for free catalog. Epic, Box 20152A, Minneapolis, Minn. 55420.

**COMPUTER SCHEMATICS** 256 bits, expandable to several K. Many other schematics available SP Electronics, Box 5E, Prospect Heights, Illinois 60070.

CONVERSION TABLES Equipment, SO50 for catalog Walter, 2697 Nickel, San Pablo, CA 94806

## 7400 SERIES T.T.L. PINOUT HANDBOOK

COVERS ENTIRE 7400/7400 SERIES D.L.R. I.C.'S  
PIN CONNECTIONS - FUNCTIONAL SPEC'S  
CROSS REFERENCE - ONLY \$2.95 FROM  
T.T.L. PINOUT HANDBOOK, INC. ASSOCIATES, INC.  
1998 E. 14TH ST., SAN LEANDRO, CALIF. 94577  
PH. (510) 535-7000 FAX (510) 535-7000

**BURGLAR-FIRE ALARM** components, hardware. Free catalog, Information: Simar, 133 SW 57 Ave., Miami, Florida 33144

**COMPUTER** countless uses. 8 bit word, powerful instruction set. Complete \$225. Brochure 10 cents. RAECO, Box 14, Readville, Mass 02137.

**GROUND FAULT DETECTORS, TESTERS** Audible and Visual Continuity testers, Tone Generators, Music tone synthesizers. Direct Manufacturer Sales. Write for Brochures. Kabo Electronics, Box 477, Natick, Mass 01760

**ALTAIR 8800** components, memories, interfaces, substantial savings. Other microprocessor component kits available including Mark 8 2111 memories, \$12.50; 1702A \$27.50, 8008, \$47.50; 8080, \$179.95, UART, \$9.95. ASCII keyboard \$40.00. Lowest prices 2102 memories Mini Micro Mart, 1618 James, Syracuse, NY 13203.

**MONITOR RECEIVER,** Preamp, Scanner, UHF Converter kits. Hamtronics, 182 Belmont, Rochester, NY 14612

**FREE** giant bargain electronic catalog listing thousands of components, tubes, transistors, IC's, kits, test equipment EDLIE'S, 2700-PD Hempstead Tpke., Levittown, NY 11756

**CONSTRUCTION PROJECTS** Laser \$2.00 TV Camera, \$3.95 Catalog Technologic, Box 5262, Orchard Lake, Michigan 48033

**FREE Bargain Catalog** Ultrasonic devices, LEDs, transistors, IC's, keyboards, X'tals, unique components Chaney's, Box 15431, Lakewood, CO 80215.

**CARBON FILM RESISTORS** Brand new as low as 2-1/4 cents. FREE samples and specifications. COMPONENTS CENTER—PE, Box 134, New York, NY 10038

**UNPRINTED** circuit board. Save time. Save dollars. No messy chemicals. New, original circuit board technique. Send \$3.00. Satisfaction or money back. Jncompany, P.O. Box 1, Lee's Summit, Mo. 64063.

*Plans to move*

Let us know 8 weeks in advance so that you won't miss a single issue of **POPULAR ELECTRONICS**.

Attach old label where indicated and print new address in space provided. Also include your mailing label whenever you write concerning your subscription. It helps us serve you promptly.  
**Write to:** P.O. Box 2774, Boulder, CO 80302, giving the following information:

- Change address only.  
 Extend subscription.  Enter new subscription.  
 1 year \$6.98  
 Payment enclosed (1 extra BONUS issue)  
 Bill me later

**AFFIX LABEL**

**If you have no label handy, print OLD address here.**

name      please print

---

address

---

city

---

state

---

zip code

---

0173

name      please print

name      please print

---

address

---

city

---

state

---

zip code

---

0173

Add postage per year: Add \$1 for Canada; \$2 for all other countries outside the U.S.



**C-MOS**

4000AE	44	.38
4001AE	44	.38
4002AE	44	.38
4004AE	5.94	5.84
4006AE	3.49	3.29
4007AE	44	.38
4008AE	2.89	2.69
4009AE	44	.38
4010AE	54	.53
4011AE	47	.44
4012AE	44	.38
4013AE	44	.38
4014AE	2.79	2.49
4015AE	2.79	2.49
4016AE	.89	.74
4017AE	1.79	1.69
4018AE	2.79	2.59
4019AE	.84	.59
4020AE	2.79	2.59
4021AE	2.19	1.89
4022AE	1.79	1.59
4023AE	.47	.41
4024AE	1.99	1.39
4025AE	.44	.31
4026AE	8.39	7.89
4027AE	.89	.79
4028AE	1.69	1.49
4029AE	2.19	1.99
4030AE	.79	.59
4033AE	3.39	2.89
4035AE	1.99	1.79
4040AE	2.19	1.99
4041AE	1.19	.89
4042AE	1.19	.89
4043AE	1.99	1.39
4044AE	1.19	.89
4047AE	3.09	2.99
4048AE	1.44	1.34
4049AE	.99	.79
4050AE	.99	.79
4051AE	3.34	2.89
4052AE	2.14	2.04
4053AE	2.89	2.79
4055AE	2.69	2.59
4056AE	3.44	3.40
4060AE	3.29	2.99
4066AE	1.19	.99
4069AE	.79	.59
4071AE	.44	.37
4076AE	1.69	1.49
4081AE	.44	.38
4510AE	1.99	1.79
4516AE	2.89	2.79
4518AE	3.29	3.19
4520AE	1.89	1.69
4901AE	.44	.37
4911AE	.44	.37

**WAVEFORM GENERATOR**  
XR205K KIT Only \$25.00

Here's a highly versatile lab instrument at a fraction of the cost of conventional units. Kit includes two XR205 IC's, data & applications, PC board (etched & drilled, ready for assembly) and detailed instructions.

**7400N TTL**

7400N	\$ 14	7444N	\$1.05	7496N	\$ .85	74161N	1.28
7401N	.17	7445N	1.04	74100N	1.30	74162N	1.50
7402N	.14	7446N	1.10	74104N	1.25	74163N	1.48
7403N	.17	7447N	1.00	74105N	.45	74164N	1.70
7404N	.20	7448N	1.00	74107N	.40	74165N	1.78
7405N	.20	7449N	.37	74108N	.37	74166N	1.50
7406N	.35	7451N	.20	74110N	.72	74170N	2.60
7407N	.45	7453N	.20	74111N	.92	74173N	1.55
7408N	.18	7454N	.26	74114N	.92	74174N	1.20
7409N	.23	7455N	.37	74115N	.92	74175N	1.60
7410N	.18	7460N	.25	74118N	1.51	74176N	1.30
7411N	.27	7462N	.37	74121N	.50	74177N	1.30
7412N	.52	7464N	.37	74122N	.50	74180N	1.05
7413N	.65	7465N	.37	74123N	.90	74181N	3.20
7414N	1.80	7470N	.30	74125N	.60	74182N	.75
7415N	.37	7471N	.49	74126N	.64	74184N	2.90
7416N	.36	7472N	.33	74128N	.95	74185N	2.29
7417N	.37	7473N	.38	74132N	1.80	74188N	4.90
7420N	.17	7474N	.35	74136N	.92	74190N	1.49
7421N	.60	7475N	.60	74140N	2.50	74191N	1.49
7422N	.27	7476N	.45	74141N	1.19	74192N	1.40
7423N	.48	7478N	.55	74145N	1.08	74193N	1.29
7425N	.34	7480N	.60	74147N	2.90	74194N	1.35
7426N	.27	7481N	1.19	74148N	2.20	74195N	.80
7427N	.31	7482N	.90	74150N	.95	74197N	1.49
7428N	.30	7483N	.80	74151N	.84	74197N	.80
7430N	.20	7484N	3.02	74152N	1.50	74198N	2.00
7432N	.27	7485N	2.50	74153N	1.05	74199N	2.90
7433N	.62	7486N	.40	74154N	1.48	74200N	5.09
7437N	.36	7489N	2.40	74155N	1.08	74221N	1.75
7438N	.35	7490N	.60	74156N	1.18	74221N	1.75
7439N	1.00	7491N	1.00	74157N	1.18	74278N	1.25
7440N	.16	7492N	.84	74158N	1.44	74279N	1.10
7441N	.95	7493N	.60	74160N	1.50	74293N	.95
7442N	.78	7494N	1.20			74298N	2.55
7443N	.95	7495N	.80				

**DUAL LOW NOISE OP AMP**  
LM331N  
V<sub>io</sub> 6mV  
I<sub>b</sub> = 1000 nA  
I<sub>e</sub> = 2000 nA  
Noise = 1.5dB  
\$2.20

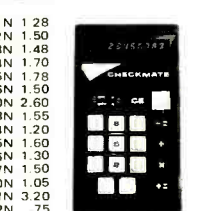

**CALCULATORS (Limited Qty.) \$19.00**

**1024-BIT N-Channel RAM**

2601-1	11.40
2601-21	11.40
2602B	8.00
2602-1B	8.00
2602-2	8.00
2602-102P	11.40
7552-1CPE	8.00
7552-2CPE	8.00

**DISPLAYS**

OPCOA		
SLA1	Red	2.25
SLA11	Green	3.50
SLA21	Yellow	3.50
SLA7	Red	1.60
LITRONIX		
DL80	Red	6.00
DL81	Red	6.00
DL10	Red	6.00
DL100	Red	4.00
DL101	Red	4.90
DL57	Red	9.90
DL61	Red	12.00
DL402	Red	4.00
DL33	Red	4.00
DL44	Red	6.00
DL700	Red	4.00
DL701	Red	3.40
DL704	Red	2.25
DL707	Red	2.35
DL747	Red	2.50
XCITON		
XAN72	Red	2.00
XAN52	Green	2.00

**LEDs**

.125" dia.	
209 Red	\$ .25
209 Yellow	.35
209 Green	.35
.160" dia.	
216 Red	.25
216 Yellow	.30
216 Green	.30
.200" dia.	
220 Red	.25
220 Yellow	.30
220 Green	.30
LOW PROFILE	
226 Red	\$.25
226 Yellow	.30
226 Green	.30
226 Orange	.30
5053 Red	.35
5053 Yellow	.40
5053 Green	.40
5053 Orange	.40
216 = MV5024	
5053 = MV5053	
MV50 Red	\$3.30

**9300 SERIES**

74LS00	58	74LS76	.92	9300PC	1.00
74LS01	58	74LS78	.92	9301PC	1.20
74LS02	58	74LS107	.92	9304PC	1.50
74LS03	58	74LS109	.92	9306PC	6.90
74LS04	58	74LS112	.92	9308PC	2.50
74LS06	53	74LS113	.92	9309PC	1.50
74LS08	58	74LS114	.92	9310PC	1.50
74LS09	58	74LS138	2.38	9311PC	2.30
74LS10	58	74LS139	2.38	9312PC	2.30
74LS11	58	74LS151	2.10	9314PC	1.30
74LS12	58	74LS153	2.38	9316PC	1.50
74LS15	58	74LS157	2.10	9318PC	2.30
74LS22	58	74LS158	2.40	9321PC	1.20
74LS21	58	74LS162	2.70	9322PC	1.30
74LS22	58	74LS161	2.70	9324PC	2.00
74LS27	64	74LS170	5.92	9328PC	2.50
74LS30	58	74LS174	3.02	9334PC	2.95
74LS32	64	74LS175	2.90	9338PC	3.30
74LS51	58	74LS181	3.72	9340PC	5.00
74LS55	58	74LS251	2.55	9341PC	4.10
74LS56	58	74LS253	3.05	9342PC	1.15
74LS73	.92	74LS260	.58	9360PC	1.75
74LS74	.92			9366PC	1.75

**1-AMP RECTIFIERS**

	10	100	1000
1N4001	1.00	7.00	60.00
1N4002	1.10	8.00	70.00
1N4003	1.20	9.00	80.00
1N4004	1.30	10.00	90.00
1N4005	1.40	11.00	100.00
1N4006	1.50	12.00	110.00
1N4007	1.60	13.00	120.00

**PHASE-LOCKED LOOPS**

LM567CM Mini-dip 1.80

**DECODED READ/WRITE RAM**

P1103 \$6.20

**SCHOTTKY TTL**

74S00N	45	74S74N	1.30	74S161N	4.70
74S02N	80	74S85N	6.10	74S174N	3.30
74S03N	75	74S86N	2.70	74S175N	3.30
74S04N	75	74S112N	2.20	74S181N	10.20
74S08N	80	74S113N	1.50	74S189N	5.10
74S10N	75	74S132N	3.60	74S194N	3.30
74S11N	75	74S133N	90	74S195N	3.30
74S20N	80	74S138N	2.40	74S251N	2.40
74S30N	80	74S139N	2.40	74S252N	2.40
74S32N	80	74S140N	.90	74S257N	2.40
74S40N	80	74S151N	2.40	74S258N	2.40
74S51N	80	74S153N	2.40	74S260N	.90
74S64N	80	74S157N	2.40	74S280N	5.70

74S158N	2.40
74S160N	2.40
74S162N	2.40
74S164N	2.40
74S166N	2.40
74S168N	2.40
74S170N	2.40
74S172N	2.40
74S174N	2.40
74S176N	2.40
74S178N	2.40
74S180N	2.40
74S182N	2.40
74S184N	2.40
74S186N	2.40
74S188N	2.40
74S190N	2.40
74S192N	2.40
74S194N	2.40
74S196N	2.40
74S198N	2.40
74S200N	2.40

**LOW POWER TTL**

74L00N	.34	74H00N	.34	74H53N	.36
74L02N	.34	74H01N	.34	74H54N	.36
74L03N	.39	74H04N	.38	74H55N	.36
74L04N	.39	74H05N	.37	74H60N	.36
74L10N	.34	74H08N	.36	74H61N	.36
74L12N	.39	74H10N	.36	74H62N	.36
74L20N	.62	74H11N	.36	74H71N	.80
74L21N	.34	74H20N	.36	74H72N	.74
74L23N	.74	74H21N	.36	74H73N	.90
74L24N	.89	74H22N	.36	74H74N	.87
74L26N	1.62	74H30N	.36	74H76N	.80
74L28N	1.62	74H31N	.36	74H77N	.80
74L30N	1.62	74H40N	.36	74H101N	.80
74L32N	1.62	74H50N	.36	74H102N	.80
74L34N	1.62	74H51N	.36	74H103N	1.10
74L36N	1.62	74H52N	.36	74H106N	.95

**HIGH SPEED TTL**

74S158N	2.40
74S160N	2.40
74S162N	2.40
74S164N	2.40
74S166N	2.40
74S168N	2.40
74S170N	2.40
74S172N	2.40
74S174N	2.40
74S176N	2.40
74S178N	2.40
74S180N	2.40
74S182N	2.40
74S184N	2.40
74S186N	2.40
74S188N	2.40
74S190N	2.40
74S192N	2.40
74S194N	2.40
74S196N	2.40
74S198N	2.40
74S200N	2.40

**BIPOLAR MEMORY**

C3101	6.50	P1101A	6.90	C2102-2	8.00
P3101	4.90	P1101A1	8.50	P2102-2	6.00
C3101A	7.30	1A02AN	5.40	2505K	3.30
P3101A	5.80	1A03AN	8.00	2512K	5.50
IM5501CDE	7.30	1A04AN	5.40	2521V	

**CLASSIFIED ADVERTISING ORDER FORM**

Please refer to heading on first page of this section for complete data concerning terms, frequency discounts, closing dates, etc.

1	2	3	4	5
6	7	8	9	10
11	12	13	14	15
16	17	18	19	20
21	22	23	24	25
26	27	28	29	30
31	32	33	34	35

**WORD COUNT:** Include name and address. Name of city (Des Moines) or of state (New York) counts as one word each. Zip Code numbers not counted. (Publisher reserves right to omit Zip Code if space does not permit.) Count each abbreviation, initial, single figure or group of figures or letters as a word. Symbols such as 35mm, C.O.D., P.O., A.C., etc., count as one word. Hyphenated words count as two words. Telephone numbers count as two words, as three words with area code.

\_\_\_\_\_ Words    \$ 1.80 (Commercial Rate)    \$ 1.10 (Reader Rate)

Payment of \$ \_\_\_\_\_ enclosed for \_\_\_\_\_ insertion(s).

CHARGE:  American Express     BankAmericard     Master Charge     Diners Club

for \_\_\_\_\_ insertion(s). You will be billed monthly.

Account # \_\_\_\_\_ Expiration Date \_\_\_\_\_

Master Charge Interbank # (4 digits above name) \_\_\_\_\_

SIGNATURE MUST BE PROVIDED BELOW

PRINT NAME \_\_\_\_\_

ADDRESS \_\_\_\_\_

CITY \_\_\_\_\_ STATE \_\_\_\_\_ ZIP \_\_\_\_\_

SIGNATURE \_\_\_\_\_ PE-675



FLEXIBLE-DISC drives with complete electronics. The lowest prices available on a first time offering of industry's latest designed magnetic storage drives, provides 2.5 megabits of memory for Altair 8800 or other minicomputers. Dealer inquiries invited. Send S.A.S.E. for information. WESTERN DATA SYSTEM, P.O. BOX 24915, SAN JOSE, CALIF. 95154.

ELECTRONIC educational kits. Build electronic games. Information 10 cents. NBL-E. Box 1115, Richardson, TX 75080.

TOUCH switch. Very reliable and versatile. Plans—Application. \$3.00. The Mail Shop, Box, 1203, Stillwater, Okla. 74074.

DIGITAL panel meter sale. Big savings. Many models. Write Betz, Box 14942, Portland, Oregon 97214.

ALPHA BRAINWAVE MONITOR—New from EICO Model BW300 Kit. \$34.95. Wired, \$59.95 Postpaid. Send check or money order. M&K Electronic Corp., 135-33 Northern Blvd., Flushing, N.Y. 11354.

FOR A New Electronic Experience. learn to control your brainwaves. Aquarius Electronics, Box 96ZE, Albion, CA 95410.

SEND SASE for information on Shielded Ignition Systems described on page 80 of February PE. Summit Enterprises, 20 Elder St., Yarmouthport, Mass. 02675.

COMPUTERS! You are capable of designing your own. Why not find out how. Design procedure and construction manual \$5.00. Free Literature. Digitronics, 667 East 1700 South, Orem, Utah 84057.

**DESCRAMBLERS**

Several models to choose from... operates with all scanner and monitor receivers.

**WRITE or CALL for Catalog**  
Phone (501) 273-5340

**KRYSTAL KITS, Box 445, BENTONVILLE, ARK. 72712**

ELECTRONIC MUSICAL CHIME. Program any 10 note melody. Plans \$3.50. TV PING PONG game. Plays through your set's antenna terminals. Plans \$3.25. ARS SYSTEMS, Box 1922F, Sunnyvale, CA 94088.

DESIGN guide for building your own quality DC power supplies and regulators. Easy to use with short-cut equations and schematics including multivoltage micro-processor supplies \$1.75. Kits also available. Lamp-lighters, Dept. E, Box 14796, Cincinnati, Ohio 45214.

TELEPHONES and ACCESSORIES. Wide color selection. Free Catalog. Flemco, 2072 37th Ave. N.E., Seattle, Wash. 98155.

CIRCUIT Collections 20 useful circuits you can build. Includes schematics, parts list, description, \$3.98. RJE Company, 28 Park Street, Jamestown, N.Y. 14701.

BLURB! Free, value-packed listing of electronic products and components. Midwest Design, Box 163, Stevesville, Michigan 49127.

EAVESDROPPERS Got You BUGGED???... Rid Electronic Snoopers Fast!!! Confidential Countermeasure Equipment Catalog \$1.00. CAL-TRONIX, 1102 College, Santa Rosa, California 95404.

BASIC TELEPHONE WIRING—Unique report gives complete details. \$3.50 postpaid. Queens Village Telephone Supply, Box 29002-Q, Queens Village, NY 11429

FREE Solar Energy Catalogue. Send Stamp. Centerline, 401T South 36th Street, Phoenix, Arizona 85034.

**Japanese Transistors**

2SA52	60	2SB463	1.65	2SC605	1.00	2SC1237	2.00
2SA101	70	2SB471	1.75	2SC619	70	2SC1239	2.80
2SA103	70	2SB474	1.75	2SC620	.80	2SC1293	.85
2SA221	60	2SB481	2.10	2SC627	1.75	2SC1317	.60
2SA473	85	2SB492	1.25	2SC644	.70	2SC1347	.80
2SA495	65	2SB495	.95	2SC645	85	2SC1377	6.75
2SA497	55	2SB605	2.00	2SC681	2.50	2SC1383	.75
2SA505	65	2SB606	2.00	2SC684	2.10	2SC1393	.60
2SA562	.70	2SC15	.65	2SC687	2.50	2SC1409	2.75
2SA607	2.25	2SC24	.65	2SC696	2.35	2SC1410	2.75
2SA613	1.00	2SC32	.65	2SC710	70	2SC1450	1.00
2SA643	85	2SC33	.65	2SC711	70	2SC1454	2.75
2SA647	2.75	2SC41	4.00	2SC712	.70	2SD30	.95
2SA673	85	2SC49	.80	2SC713	70	2SD45	2.00
2SA679	2.25	2SC56	.95	2SC732	70	2SD64	.75
2SA682	.95	2SC143	3.50	2SC733	70	2SD65	.75
2SA699	1.30	2SC154	3.75	2SC735	.70	2SD68	7.00
2SA699A	2.00	2SC162	3.75	2SC739	70	2SD72	1.00
2SA705	55	2SC163	4.50	2SC756	1.50	2SD88	1.50
2SA714	2.50	2SC185	1.00	2SC774	1.75	2SD120	.85
2SA720	.70	2SC202	1.00	2SC775	2.00	2SD130	1.50
2SA733	.65	2SC206	1.00	2SC778	3.00	2SD141	2.25
2SB22	.65	2SC240	1.10	2SC783	1.00	2SD151	2.50
2SB54	70	2SC261	.65	2SC784	70	2SD170	2.00
2SB56	70	2SC291	.65	2SC785	1.00	2SD180	3.00
2SB77	.70	2SC320	.75	2SC792	3.00	2SD198	2.50
2SB128	2.50	2SC352	.75	2SC793	2.50	2SD201	2.50
2SB135	.95	2SC353	.75	2SC828	.75	2SD218	5.00
2SB152	4.50	2SC371	.70	2SC829	.75	2SD235	1.00
2SB172	55	2SC372	.70	2SC833	70	2SD261	.80
2SB173	55	2SC380	.70	2SC838	.70	2SD291	.85
2SB175	55	2SC387	.70	2SC839	.85	2SD292	.85
2SB178	1.00	2SC394	.70	2SC930	.65	2SD300	2.50
2SB186	60	2SC458	.70	2SC945	.65	2SD315	.75
2SB187	60	2SC460	.70	2SC1010	.80	2SD318	.95
2SB235	1.95	2SC478	.80	2SC1012	.80	2SD341	.95
2SB303	.65	2SC482	1.75	2SC1013	1.50	2SD350	3.50
2SB324	1.00	2SC491	2.50	2SC1014	1.50	2SD352	.80
2SB337	2.10	2SC495	.70	2SC1018	1.50	2SD389	.95
2SB364	.65	2SC497	1.60	2SC1030	3.25	2SD390	.75
2SB365	.65	2SC515	.80	2SC1051	2.50	2SD437	6.00
2SB367	1.60	2SC535	.95	2SC1061	1.65	2SD458	.80
2SB370	1.10	2SC536	.65	2SC1096	1.20	2SD1111	3.50
2SB379	.65	2SC537	.70	2SC1098	1.15	2SD1115	3.75
2SB380	.70	2SC563	2.50	2SC1115	2.75	2SK19	2.25
2SB405	1.00	2SC564	.70	2SC1166	.70	2SK30	1.25
2SB407	2.10	2SC568	.70	2SC1173	1.25	2SK40	1.60
2SB415	1.05	2SC582	.85	2SC1213	.75		
2SB461	1.25	2SC591	2.50	2SC1226	1.25		

400mw-50w Zeners — Field Effect Transistors — Power Germanium Transistors 10-65 amp — Power Germanium Tetrodes from 15.00 — Write for complete list of prices!

**ALL PARTS GUARANTEED AND TESTED ON PREMISES. WRITE FOR FREE CATALOG AND LG. QUANTITY DISCOUNTS.**

**SPRING CLEARANCE SALE!**

TRANSISTOR SPECIALS			METAL		EPOXY				
Power Units Similar to Jecoc Nos. Hardware Included.			2N718	27	15	2N2222A	35	.22	
2N441	To-36	2 1.00	2N918	55	25	2N2369	18	13	
2N458A	To-3	4 1.00	2N930	25	18	2N2484	75	35	
2N538	Mt-36	3 1.00	2N1420	25	15	2N2904	50	20	
2N1015	Mt-1	1 1.00	2N1613	65	30	2N2905	50	20	
2N1725	To-61	2 1.50	2N1711	65	30	2N2905A	85	35	
2N2288	To-3	2 1.00	2N2218	50	22	2N2906	40	20	
2N3054	To-66	5 1.00	2N2219	50	22	2N2907	40	20	
2N3055	To-3	4 1.00	2N2219A	75	30	2N3053	20	16	
2N5002	To-59	3 2.00	2N2221	25	17	2N3251	75	35	
2N5296	Tip31	To-220	7 1.00	2N2222	23	17	2N4036	75	35

CITIZEN BAND APPLICATION			POWER TRANSISTORS		RECTIFIERS	
NPN Silicon 27 MH Band RF Power Transistors			High Voltage TV Transistors			
2SC781	3.25	2SC782	4.75	BU204	1300v	4 00
2SC783	5.75	2SC1306	6.75	BU205	1500v	4 75
2SC1307	6.75	2SC517	4.75	BU206	1700v	5 80
2SC517	4.75	2SC517	4.75	BU207	1300v	5 50
2SC517	4.75	2SC517	4.75	BU208	1500v	6 75
2SC517	4.75	2SC517	4.75	BU209	1700v	8 25
2SC517	4.75	2SC517	4.75	2SC1170	1100v	4 00
2SC517	4.75	2SC517	4.75	2SC1172B	1100v	4 50
2SC517	4.75	2SC517	4.75	2SC1308	1100v	5 00
2SC517	4.75	2SC517	4.75	2SD380	1100v	6 00

EXTRA VALUES!		SILICON UNIJUNCTIONS		CMOS					
SCRs and Triacs To 19 To 18 To 64 To 48		2N2646	To-18	50	SS4001AE	55	SS4025AE	55	
Sil. glass rectifiers		2N2647	To-18	65	SS4002AE	65	SS4027AE	1 35	
Germ. glass rect.		2N6027	PUT	To-92	55	SS4011AE	55	SS4028AE	2 80
1N94 1/2" fast switch		2N6028	PUT	To-92	75	SS4012AE	55	SS4030AE	65
FET 2N5457 N channel To 92 plastic		2N1671	To-5	1 00	SS4013AE	1 30	SS4049AE	1 35	
NPN To 92 25v CEO HFE 25 100		D5E37	To-18	4 100	SS4015AE	3 00	SS4050AE	1 35	
100-300 and 300-500 @ 2MA					SS4023AE	55			
C1061									
Hobbyist's 16 pins Digital IC Guaranteed									
709C Hi-Perf. op. amp.									
IR 128 Heat Exchanger									
IR Selenium Booster Rectifier									
IR Selenium Bridge Rectifier									
IR Silicon Replacement Rectifier									
IR Selenium 5 pin. Convergence Rectifier									
IR Universal Selenium Focus Rectifier									
Onmite variable regulated Resistor									
GE X6 Cadmium sulfide PhotoCell									
GE 6GD1 Dual Diode									
GE 6GX1 Dual Diode									

BRIDGES		CHECK OR MONEY ORDER	
PRV 2 AMP	PRV 2 AMP	NO CODS INCLUDE 10% FOR POSTAGF AND HANDLING	
200	95	600	1 25
100	1 10	1000	1 75

**NTS** **New-Tone Electronics** 201 762-9020  
P.O. BOX 1738 A  
BLOOMFIELD, N.J. 07003

90 CIRCLE NO. 34 ON READER SERVICE CARD www.americanradiohistory.com POPULAR ELECTRONICS









**DIP SOCKETS**  
 8 PIN PCB \$-.22      24 PIN PCB \$-.75  
 14 PIN PCB -.26      40 PIN PCB 1.25  
 16 PIN PCB -.30      14 PIN WIRE WRAP -.35

**POTTER & BRUMFIELD**  
  
 Type KHP Relay 4 PDT 3A Contact—  
 24 VDC (650 coil) ea. \$1.50 10/\$14.00  
 120 VAC (10.5 MA coil) ea. \$1.75 10/\$15.75

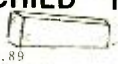
**CARBON RESISTORS**  
 Carbon Resistors 1/4-watt 5% full prime, all values in stock, 10 per value (minimum quantity) ten for \$1.45

**FAIRCHILD "TRIMPOTS"**  
  
 ea. only \$1.89      11 for \$7.50  
 Brand new 20 turn precision trimmers. These are prime parts mostly individually packed in sealed envelopes. These values in stock:  
 50 OHM      1 K      5 K      15 K  
 500 OHM      2 K      10 K

**DIODE ARRAY**  
  
 10 IN914 Silicon Signal Diodes in one package, 20 leads spaced .10", no common connections. ea. \$1.25 10 for \$12.25

**8270 DIP 4-BIT SHIFT REGISTER**  
 4 Bit Shift Register—parallel and serial input and output data entry is accomplished with clock pulse.  
 ea. \$1.50      10 for \$15.00

**2N3055 NPN TRANSISTOR**  
 2N3055 Transistor (power) PD-115W, VCL 60V, HFL 50, FT-50K, Case-10-3  
 ea. \$1.15      10 for \$11.50

**2102-2 MOS 1024 BIT MEMORY**  
 FULLY DECODED STATIC RANDOM ACCESS MEMORY DIRECTLY TTL COMPATIBLE INPUTS AND OUTPUT SINGLE 5V SUPPLY — NO CLOCKS OR REFRESH  
**\$695 EA. (DIP) & FOR \$4995**

**7400 DIP TTL SPECIAL**  
 7400 DIP TTL Special Signetic/House Numbered. ea. \$1.17 10 for \$11.50

**7404 DIP TTL**  
 7404 DIP TTL Special Hex Inverter, Signetic/House Numbered  
 ea. \$1.17      10 for \$11.50

**SEND FOR FREE FLYER!**      C.O.D., PHONE ORDERS ACCEPTED—\$10 MINIMUM  
 All parts surplus and tested leads plated with gold or solder. Orders for \$5 or more are shipped prepaid; smaller orders add 5% handling. Residents add Sales Tax. ICs shipped within 48 hours.  
**BABYLON ELECTRONICS**      P. O. Box 41727  
 Sacramento, Ca. 95841  
 (916) 334-2161

CIRCLE NO. 9 ON READER SERVICE CARD

COMPLETE CONSTRUCTION PLANS. Many new solid state projects. Send for free catalog. Robert Delp, Box 1026G Fremont, CA 94538

REGULATED Power Supply. +5 volts 4 amps, -9 volts 2 amps. \$44.95 postpaid. Guaranteed. Free specs available. Mullers, Rt. 4, Box 371, Auburn, Maine 04210.

CB Equipment at Discount Prices. Send for Free List. Capitol Sound, Box 3523, Des Moines, Iowa 50322.

TEST EQUIPMENT—DISCOUNT PRICES: B&K, Sencore, Leader, EICO, Lectrotech, M&K Electronic Corp., 135-33 Northern Blvd., Flushing, N. Y. 11354.

PRESSURE sensitive miniature cable for burglar alarm systems. Place under carpet in any contour for intrusion detection or secret switching. \$4.95 for twenty feet. Cable Switch Corp., Box 72-PE, West Long Branch, N.J. 07764

SURPLUS BARGAINS. Computer Accessories, Equipment, Energy Conservation, Technical Reports, Kits, Semiconductor Specifications, 20% — 90% Discounts. Catalog 751, 50 cents. E/S Lab, Box 738, College Park, Maryland 20740.

**wanted** Citizens Band  
**DEALER-DISTRIBUTORS**  
 Send this ad with Letterhead to  
**PAL ELECTRONICS CO.**  
 2962 W. WELDON - PHOENIX, ARIZ. 85017

SUMMER SPECIALS—ICM8038 Function Generator \$3.50—Mostek MK5025D "beeper" 6-digit alarm clock IC \$5.95—Jumbo 0.6" 747 LED display \$1.35—0.33" 707 display 85 cents—Solar cells 2x2cm. 0.5v at 50ma, only .020" thick! \$1.50 each, 10/\$9.95. Bargain catalog 25 cents redeemable. Diamondback Engineering, P.O. Box 194, Spring Valley, Ill. 61362

**GODBOUT** BOX 2355  
 OAKLAND AIRPORT, CA 94614

SEND US YOUR NAME AND ADDRESS & A STAMP AND WE'LL SEND YOU THE STORY ON OUR CMOS, TTL, LEDS, LINEARS, KITS, COMPONENTS, AND MORE. OUR FLYER TELLS ALL. SEND FOR IT! BE SURPRISED.

**HOBBYWRAP** \* \* \* **calculator**  
**TOOL \$41.95** \* \* \* **\$17.95**



**WHY WORRY? NOW YOU CAN AFFORD TO WIRE WRAP. CORDLESS FOR EASY HANDLING. COMES WITH CHARGER, NICADS, BIT, INSTRUC.**

TERMS: ITEMS IN THIS AD SHIPPED PPD US. CAL RES ADD TAX. CALL (415) 357-7007 FOR MASTERCARD OR BANKAMERICARD. SORRY, NO COD ORDERS ACCEPTED.

**CALCULATOR OWNERS** Use your +—x— Calculator to compute square roots, trigonometric functions, logarithms, and more! Quickly, Accurately, Easily! Send today for the First and Best Calculator Manual... now in use throughout the world... still only \$2.00 Postpaid with Unconditional Money-Back Guarantee! Mallmann Optics and Electronics, Dept.-25A, 836 South 113, West Allis, Wisconsin 53214.

**BUILD YOUR OWN TV CAMERA!**  
 — Ideal for home & business —  
 THE ECONOMICAL ANSWER TO HOME MONITORING OF SURVEILLANCE, DRIVEWAYS, BUSINESS AND INDUSTRIAL SURVEILLANCE, TV, AMATEUR TV PLUS HUNDREDS OF OTHER APPLICATIONS. MODEL #T-10, SERIES 9 - KIT FORM BUILT ASSEMBLED 2776 SOLID-STATE, WORKS ON ANY TV SET. OPTIONAL SOUND KIT \$28.00. PHONE OR WRITE for catalog. Dial 400-967-3771  
 1301 BROADWAY ATV Research DAKOTA CITY, NE 68731

COMPLETE, assembled five volt, 1 amp power supply. 1% regulation. \$7.50. Plans \$2.00. Catalog Free. Danron, 581 Dixmyth, Cinn., Ohio 45220.

BURGLAR ALARM COMPONENTS. Below wholesale prices. Catalog information \$1.00 (refundable). Ellin, 161-R Bonad, Chestnut Hill, Mass. 02167

**FREE CALCULATOR COMPARISON CHART**  
 from Technology Marketing the calculator specialists  
 Purchase your calculator wisely.  
 Send 25¢ for postage and handling.  
**Box 183 Great Neck N.Y. 11021**

**PLANS AND KITS**  
 AUDIO PROCESSING CIRCUITS... Audio Processing Circuits... designs, kits, units Laboratory tested designs for hobbyist through professional use—limiters, compressors, equalizers, phasers, mixers and more! Send now—\$1.00 (refundable) for complete catalog—CIRCUIT RESEARCH LABS, 3920 E. Indian School, Phoenix, AZ 85018  
 AMAZING ELECTRONIC PRODUCTS—Pocket Laser. See-In-The-Dark, Scramblers, Penlight Strobe, Energy Devices, TV Disruptor, Many More. All New. Catalog \$1.00. INFORMATION UNLTD., West St., Milford, N.H. 03055

**MiniMicroMart**  
 Attention  
**Altair 8800 Owners\***

Also Mark 8, Mod. 8, Homebrews.  
 Adapt your system to our 16K Memory Expansion Mother Boards. Comes with 8 connectors, installed **\$49.95**

**2K x 8 Memory Boards w/500ns Static Memory IC's \$98.00**  
**I/O Expansion Mother Board**  
 Comes with 8 Connectors, installed for use with 24 8 bit input or output ports **\$49.95**  
 Input or Output Cards 3 - 8 bit ports **\$24.95**  
 Teletype I/O Card **\$24.95**

**Absolute lowest prices on all Memories, and CPU's — 8008's, 8080's, 1101A's, 2102's, 1103's, 8101's.**

Due to rapidly fluctuating market conditions write or call for current prices.

**2K 2102 and 1702A Boards available, plated through holes**

**Famous 1702A PROM, 256 x 8**  
 Programmable & erasable ROM memory. Perfect for mini-computer software applications. Now only **\$27.50**, and if purchased prior to June 30, 1975, free programming certificate.

**UART (Universal Asynchronous Receiver/Transmitter) \$9.95**

**TV Typewriter II, Feb. R-E, all IC's w/memories, \$79.95.**

**Scientific Calculator Interface**  
 Uses 40 Key MOS Technology MPS 2529-103 Calculator Chip. For any 8 bit microprocessor. Trig, and inverse trig functions, Log, Anti-log, exponentiation, factorials, etc. Complete kit, all IC's including MPS 2529-103, circuit board, and software. Now only **\$69.95**. Floating point or scientific notation, two parenthesis levels, eight digit mantissa, two digit exponent. (Added to your microprocessor you have the equivalent or better than HP-65).

**Mini Computer Kits**  
**Basic Kits starting at \$179., w/PC boards, CPU, memory. Mark 8 IC's \$72., not including CPU and memory. IC's for MOD 8 and Scelbi.**

**Basic 8080 Kit \$289.00.**

**Audio Cassette Interfaces**  
 for Mark 8 — Scelbi — Altair\* — Others

**Power Supply Kits**  
 Components for any required supply.

Write for details on above and any other items. Send stamped, self addressed for fast response.

**Mini Micro Mart**  
 1618 James Street  
 Syracuse, New York 13203  
 (315) 422-4467

\*Registered Trademark, MITS, Inc.  
 CIRCLE NO. 51 ON READER SERVICE CARD



# Altaj Electronic Bargains

PRICES SLASHED! WE WANT YOUR BUSINESS. SATISFACTION GUARANTEED ON EVERY ITEM



**CALCULATOR BASIC KIT WITH TI CHIP**  
Includes case with matching all function keyboard, and 9 digits of LED readouts plus a Texas Instruments TMS 103 NC calculator chip. (Same style chip as in TI Datamath calculator). All the basics for building your own hand held calculator. Special — \$9.95 Quantity Limited.



**BURROUGHS PANAPLEX II  
12 DIGIT READOUT**

#BR13251 Neon 7 segment readout. Latest design for calculators, etc. Requires 160 VDC. Right hand decimals. Brand new, factory fresh. We include mating socket FREE \$4.95  
NOTE: With purchase of above readout array we offer motorola 2N5401 PNP High Voltage driver transistor for 10¢ each.



**LM309K**  
TO-3 Case, 1 AMP 5 VDC Voltage Regulator. Brand New By National \$1.19

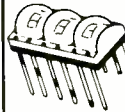

**3 DIGIT LED READOUT ARRAY**  
Like Litronix DL-33. 3 MAN-3 style readouts in one package. Factory new units Designed for calculators. Special — \$1.39 (3 Digits)

**LITRONIX DL707  
READOUTS**  
.30 IN. CHAR. Common Anode.  
SPECIAL — \$1.19



**MAN-3 LED READOUTS**  
Brand new, factory prime units. .12 in. character. Common cathode. Perfect for calculators. 39¢ ea. Best Price Anywhere!

**CALCULATOR CHIP BONANZA  
PRICES SLASHED!**

The newest and easiest to use chips available today. Made by famous US mfg. All are 28 pin DIP. Features: direct LED segment drive, low power consumption, internal keyboard debounce, internal clock oscillator, single supply voltage, internal keyboard encoding, and floating decimal point. Does not require many external components as do older types like CT5001, 5002, 5005, etc. We offer the most sophisticated functions for the lowest price anywhere.  
Chip #1 — 8 Digit, Constant, Six Function (+, -, x, +, %, √) — \$3.95  
Chip #2 — 8 Digit, Memory, Six Function (+, -, x, +, %, √, M) — \$4.95  
Chip #3 — 8 Digit, Memory, Six Function (+, -, x, +, %, 1/x) — \$4.95

**DIGITAL ALARM CLOCK IC**  
The newest and easiest to use alarm chip on the market today. Features:



1. Single supply voltage.
2. LED intensity control
3. Simple time set.
4. 4 or 6 Digit LED Display
5. AM-PM Indication
6. 24 Hr. Alarm.
7. 10 minute snooze.
8. Outperforms MM5316

Order #70250 — \$6.95 (2 FOR \$12)

**MM5314 NATIONAL CLOCK CHIP**

The most popular clock chip around. We made a huge special purchase of factory fresh, prime units. Lowest price in USA. 24 Pin DIP. 4 or 6 Digits. With Specs. \$4.95

**MINI CORE MEMORY SPECIAL**  
Mfg. by DATARAM. Stores 180 words of 18 bits each. With sense amps and associated drive circuits. A complete memory system. We include 50 pages of data and schematics. Data only \$2.50 Brand New. Special \$24.95



**DIGITAL WRIST WATCH CRYSTAL**

Brand new, mfg. by CTS-KNIGHT. 32,768 KHZ. Standard, most popular type. Special \$1.95

**COLOR ORGAN CONTROL MODULE**  
Completely self-contained. Has SCR circuitry. AC line cord. etc. From a close out by a mfg. of color organs. New unused \$1.95

**GE POWER TRANSISTOR ASSORTMENT**  
Plastic power devices. Includes NPN and PNP, darlington, high voltage, high current, and various other types. Cases are color coded for easy sorting. Untested but includes many useable units.  
SPECIAL — 20 FOR \$1

**1024 BIT SIGNETICS P-ROM**  
82S1291-256x4 bipolar, field programmable ROM. Fully TTL compatible. 50 ns. max address access time. Much faster than MOS type units. Perfect for code conversions, microprogrammers, hand-wired algorithms, controllers, etc. With specs. Regular \$35 ea. SPECIAL — \$6.95  
BEST MEMORY BUY IN USA!

**8 TRACK TAPE TRANSPORT**  
Brand new units. Same as found in expensive home units. Very limited qty.  
\$13.95

**\$1 VALUE-FREE BONUS**  
Free 28 Pin Socket with purchase of any clock or calculator chip.  
**POCKET CALCULATORS**  
8 Digit. LED various styles. These are complete units, but are customer returns for various reasons. We got these from the mfg. and have not checked them out or culled through them. Includes 4, 5, and even 6 functions. No choice. A super value just for parts.  
SPECIAL — \$7.95  
Sorry — no Data Available — Sold as is —

**7805 STYLE REGULATORS**  
TO-220 Plastic Case 5VDC Regulator. Brand New by National — 99¢

**FACTORY NEW LED'S**  
Jumbo Red-Like MV5024-8/\$1  
Jumbo Green-Like MV5222-5/\$1  
Jumbo Yellow-5/\$1  
Mini Red-Like MV50-10/\$1

**8008 MICROPROCESSOR**  
Computer on a chip. 8 Bit Parallel CPU. Can address 16k x 8 bits of memory. With specs. Factory tested units.  
\$39.95  
2102-1K RAM's for above — \$6.95 ea.

**CT7001 BY CAL-TEX**  
Digital alarm clock chip with calendar feature. 4 or 6 digits. Also has timing circuitry for radio ON-OFF control factory fresh.  
\$6.95

**JUMBO LED READOUT**  
Twice the size of regular readouts. .65 inches. Like Litronix DL747. Outperforms and easier to read than SLA-3. only 20 MA per segment. Our best readout for digital clocks.  
\$2.95 ea (6 FOR \$15) Common Anode

**LINEAR IC SPECIALS**  
555V-75c 567V-\$1.95 723CH-59c 741CV-39c  
LM324 by National — Quad 741C in one DIP — \$1.79

**ELECTROLYTIC CAPACITOR SPECIAL**  
220 MFD at 25 WVDC. AXIAL Leads by GI. Brand New 6 for \$1

**FILTER CAPS**  
1000 MFD 16VDC upright style.  
4 FOR \$1

**PRIME TTL DIP IC'S**

7400-16c	7448-89c	74151-75c
7402-16c	7453-16c	74153-89c
7404-16c	7473-37c	74154-95c
7406-24c	7474-37c	74157-99c
7408-16c	7475-65c	74161-99c
7410-16c	7476-39c	74163-1.19
7413-49c	7483-85c	74164-1.29
7420-16c	7490-69c	74165-1.49
7427-24c	7492-75c	74174-1.29
7430-16c	7493-75c	74175-1.39
7437-39c	7495-75c	74181-2.75
7438-35c	7496-75c	74192-1.25
7440-16c	74121-38c	74193-1.25
7442-69c	74123-75c	74195-79c
7447-89c	74150-70c	74197-79c

**8038 FUNCTION GENERATOR**  
Brand new Voltage controlled oscillator. Has sine, square wave, and triangular outputs. \$4.50 each.

**IN4148 DIODES**  
High speed switching diodes. Brand new units, however, leads are cut and bent for PC board insertion, still plenty long. 30 For \$1

**POLAROID FILTERS**  
The real thing by Polaroid Corp. Pale green in color. 2.3 x 12 inches. Use with various readouts or for optical experiments. Limited Qty. 2 For \$1.

**PHASE LOCKED LOOP**  
565A by Signetics. Extremely stable. High linearity, wide frequency range. TTL compatible. Perfect for tone decoders, FSK, SCA receivers, frequency multiplication and division — \$1.75.  
WITH SPECS

**MOTOROLA POWER TRANSISTOR**  
MJ3029 — T03 Case — NPN Silicon High Voltage — VCEO — 250V Used in horiz. and vert. TV Circuits. Regular Price \$4. Our Price 95¢

**ELECTROLYTIC CAPACITORS**  
10MFD 25WVDC — Upright — 7c  
50MFD 15WVDC — Upright — 10c  
50MFD 15WVDC — Axial — 10c  
100MFD 15WVDC — Upright — 14c

**PLASTIC SILICON TRANSISTORS**  
Use for drivers in clock or calculators.  
MPS2222A — NPN  
MPS2714 — NPN  
MPS3704 — NPN  
2N 3904 — NPN  
2N 3906 — PNP  
2N 4249 — PNP  
YOUR CHOICE  
6 FOR \$1  
ALL NEW UNITS

**ZENERS**  
IN746 — 400MW — 3.3V  
IN752 — 400MW — 5.6V  
YOUR CHOICE  
8 FOR \$1

**TTL IC ASSORTMENT**  
Various types. Most are marked. Our best selling assortment. Untested but includes many useable devices.  
200 PCS FOR \$3.95

Our lower prices and superior quality have made ALTAJ one of the fastest growing electronic suppliers in the USA. Put your trust in our unconditional money back guarantee.

**ALTAJ ELECTRONICS**  
P.O. BOX 38544  
DALLAS, TEXAS 75238

TERMS: Check or money order. No COD. Add 10% Pstg. and Hdlg. Tex Res. add 5%.

EM Synthesizer Studio/lab quality. Send SASE or 25 cents. CFR ASSOCIATES, POB F, Newton, NH 03858.

NEW ORGAN KIT BUILDER'S GUIDE \$3.00. Circuits, block diagrams, details on diode keyed IC divider and independent oscillator designs. Many new kits and models. Keyboards also for synthesizers. Manual cost refundable with purchase. DEVTRONIX ORGAN PRODUCTS, Dept. C, 5872 Amapola Dr., San Jose, CA 95129.

FREQUENCY counter, Digital Clock, Logic Probe and more to come. Complete kits or PC Boards, reasonable priced full details \$3.00. Refundable. East Coast Electronics, 50 Scott, Hamburg, New York 14075.

**SAVE ELECTRIC POWER!**

Save up to 80% electrical power with this unique, inexpensive, portable, permanent and legal method applicable for shops, homes, factories, businesses, farms, sites. 100% Refund Guaranteed if not scientifically sound or if it employs gimmicks.

Information \$1.00

**CONSUMERTRONICS CO.**

P.O. Box 1399 Alamogordo, N.M. 88310

CYCLOPS TV CAMERA KIT, featured on cover of February PE, available from CROMEMCO, 26655 Laurel, Los Altos, California 94022

SUB-MINI OR WRIST BAND CALCULATOR. Build for under \$20.00. Square roots, powers, pi, memory, chain, reciprocals. Kit includes miniature data input board, miniature resistors, instructions, \$7.95. KJ Electronics, P. O. Box 872, Mishawaka, Indiana 46544. Add 50 cents handling. Patent applied for.

NEW FROM EICO—Listen to official FCC-Licensed background music (SCA) on your FM radio without commercials. EC5000 Kit, \$12.95 Postpaid, M&K Electronic Corp., 135-33 Northern Blvd., Flushing, N. Y. 11354.

PROFESSIONAL Power Supplies for your digital and analog projects. +5, -12 VDC, +15 VDC. Kits include chassis, solder, everything, from \$14.95. Request free brochure number 12. Dage Scientific Instruments, 1931 Tobruk, Livermore, CA 94550

COMPLETE units, parts or plans for windmills up to 20,000 watts; generator plants, transformers; inverters; phase adders; chargers; welders; electric vehicles; war surplus motors and generators. 89 more. Catalog \$2.00. DanRan, Box D, Reno, Nevada 89506.

CONVERT any transistorized T.V. Tuner to a Tuner Substituter. Plans \$2.00, \$35.00 for completed and tested Super Substituter. Radio Television Training, Box 279, P-35, Syracuse, N.Y. 13206.

**HIGH FIDELITY**

DIAMOND NEEDLES and Stereo Cartridges at Discount prices for Shure, Pickering, Stanton, Empire, Grado and ADC. Send for free catalog. LYLE CARTRIDGES, Dept. P, Box 69, Kensington Station, Brooklyn, New York 11218.

**LISTEN TO SPECTACULAR 4-CHANNEL SOUND!**

Expand your stereo to quadraphonic Hi-Fi. Build the VISTA Full Logic "SQ" Decoder. Latest CBS licensed circuitry using 3 IC's to provide Full Logic and Wave Matching. Exclusively ours. Kit \$151 \$37.50. Shipped prepaid in USA & CANADA. Send for information.

**PHOTOLUME CORPORATION**

118 East 27th Street, New York, N.Y. 10016

**WANTED**

QUICKSILVER, Platinum, Silver, Gold, Ores Analyzed. Free Circular. Mercury Terminal, Norwood, Mass. 02062.

**TUBES**

RADIO & T.V. Tubes—36 cents each. Send for free Catalog, Cornell, 4213 University, San Diego, Calif. 92105.

RECEIVING & INDUSTRIAL TUBES TRANSISTORS All Brands — Biggest Discounts. Technicians, Hobbyists, Experimenters — Request FREE Grant Catalog and SAVE! ZALYTRON, 469 Jericho Turnpike, Mineola, N.Y. 11501.

TUBES receiving, factory boxed, low prices, free price list. Translertonic, Inc., 1306 40th Street, Brooklyn, N.Y. 11218A, Telephone 212-633-2800.

TUBES "Oldies", latest Lists free. Steinmetz, 7519 Maplewood, Hammond, Indiana 46324

CASH PAID FOR OBSOLETE RECEIVING TUBES WE300B, WE300A, WE350B, WE252A, WE274A/B, WE284D, RCA45, RCA50, Small and large quantities, and movie theatre equipment, amplifier WE86A, WE59A, WE30A, WE91A/B, pick-up WE9A, WE10A, etc. Contact: M. Takabe, 303 Fifth Ave., N.Y.C. 10016. Tel: (212) 679-1970.

**ELECTRICAL SUPPLIES & EQUIPMENT**

PLATING Equipment, Portable Platers, Supplies and "Know-How." Build your own tanks for nickel, chrome, etc. Easy-to-install PVC liners. Rectifier components—all sizes. Schematics, parts lists, formulas, operating instructions for all plating. Guaranteed to save you 25%-75%. Some good units for sale. Write for details Platers Service Company, 1511-PE Esperanza, Los Angeles, Calif. 90023.

**TAPE AND RECORDERS**

RENT 4-Track open reel tapes—all major labels—3,000 different — free brochure. Stereo-Parti, 55 St. James Drive, Santa Rosa, Ca. 95401.

1930-1962 Radio Programs, Reels, \$1.00 Hour! Cassettes, \$2.00 Hour!, Mammoth Catalog, \$1.25. AM Treasures, Box 192F, Babylon, N.Y. 11702.

**CASSETTE LABELS**

Plain white cassette labels, Norelco cassette cleaners, famous brand cassettes, Metal 107 reels. Send for open reel and cassette discount mailing.

Cassette Labels (Multiples of 10)	10 99	100	1000	10M
Norelco Cassette Cleaner	02	015	01	006
Scottish Cassette SC90HE	60	55	50	45
10 1/2" Metal NAB Reel, Used	3 25	3 10	2 95	2 80
1/2" Buy 10 SC90HE, Get 5 Free	1 00	90	80	75

Plus Postage by Weight and Zone

Minimum Order: \$5.00  
1376 COLUMBIA ROAD, N.W., WASHINGTON, D.C. 20005

**SAXITONE TAPE SALES**

OLD RADIO BROADCASTS. Cassettes, Reels, \$2.50-\$3.00 / hour. Catalog \$1.00 refundable. Airwaves, 201B Eagle Heights-PE Madison, Wisconsin 53705.

OLD RADIO SHOWS ON CASSETTES. \$1.50 per show. Catalog 25 cents. Radio Classics, Box 804a, MattlucK, N.Y. 11952.

**SPECIAL PURCHASE LED DISPLAY MAN 3M**  
\$25 ea. 5/\$1.00 8/\$1.50

**NINE DIGIT LED ARRAY FAIRCHILD 37 .17" DIGITS** with clear magnifying lens \$5.95 ea.

**NINE DIGIT SPERRY GAS DISCHARGE DISPLAY SP-425-09 1.25" x 3" overall** — .25" digits — connects to 18 lead edge connector — hi voltage — prime quality \$1.99 ea.

**4 DIGIT DISPLAY HP 50827414 Comm. Cathode** \$2.75 ea.

**5 DIGIT DISPLAY HP 50827405** \$2.95 ea.

**JUNE SPECIALS**

**16 BIT MICROPROCESSOR CHIPS**

**MM5750** Arithmetic and logic unit \$30.00 ea.

**MM5751** Control and read only memory \$40.00 ea. (Imp-16 standard set or extended set)

Set of 4 MM5750 and 1 MM5751 \$120.00

**CTS002 CALCULATOR CHIP** 12 digit — 4 function — chain operation — battery operation — 28 pin \$2.95 ea.

**567 TONE DECODER** 8 pin DIP \$2.75 ea.

**POCKET CALCULATOR KIT**

5 function plus constant — addressable memory with individual recall — 8 digit display plus overflow — battery save — uses standard or rechargeable batteries — all necessary parts in ready to assemble form — instructions included. \$24.95 ASSEMBLED \$20.95

**2102 MEMORY**

1024 bit N-chan. Static Ram \$5.95

**5262 MEMORY**

2048 bit RAM \$5.95

**8038 FUNCTION GENERATOR**

Voltage Controlled Oscillator Sine, Square, Triangular Output 16 Pin Dip \$4.95

**CT7001 CLOCK CHIP**

4 or 6 digit — 12, 24 hr — alarm — timer & date circuits. \$6.95 ea.

**TTL**

7400	\$	19	7485	\$1.39
7401		19	7486	.44
7402		19	7489	2.75
7403		19	7490	.76
7404		22	7491	1.29
7405		22	7492	.79
7406		39	7493	.79
7407		39	7494	.89
7408		25	7495	.89
7409		25	7496	.89
7410		19	74105	.49
7411		29	74107	.49
7413		79	74121	.57
7415		39	74122	.53
7416		39	74123	.99
7417		39	74125	.69
7420		19	74126	.79
7422		29	74141	1.23
7423		35	74145	1.15
7425		39	74150	1.09
7426		29	74151	.89
7427		35	74153	1.29
7430		22	74154	1.59
7432		29	74155	1.19
7437		45	74156	1.29
7438		39	74157	1.29
7440		19	74161	1.39
7441		1 09	74163	1.59
7442		99	74164	1.89
7443		99	74165	1.89
7444		1 10	74166	1.65
7445		1 10	74173	1.65
7446		1 15	74175	1.89
7447		1 15	74176	1.65
7448		1 15	74177	.99
7450		24	74180	1.09
7453		27	74181	3.65
7454		39	74182	.89
7460		19	74190	1.59
7464		39	74192	1.49
7465		39	74193	1.39
7472		43	74194	1.39
7473		43	74195	.99
7474		43	74196	1.85
7475		75	74197	1.15
7476		47	74198	2.19
7483		1 11	74199	2.19

Data sheets supplied on request. Add \$ .50 for items less than \$1.00

10% Off on orders over \$25.00  
15% Off on orders over \$100.00  
20% Off on orders over \$250.00

**LINEAR CIRCUITS**

301	Hi perf. op amp	mDIP	\$ .32
307	Dp amp	mDIP	.29
308	Micro pwr op amp	mDIP	.99
309K	5V reg 1A	TD.3	1.50
310	V follr. Dp Amp	mDIP	1.19
311	Hi perf. V comp	mDIP	1.05
319	Hi speed dual comp	DIP	1.29
320	Neg regulator		
	(5V, 5.2V, 12V, 15V)	TD3	1.25
324	Quad op amp	DIP	1.89
339	Quad comp	DIP	1.69
340T	Pos V reg (5V, 6V, 8V, 12V, 15V, 18V, 24V)	TD-220	1.75
372	AG-IF strip det.	DIP	.79
376	Pos V reg	mDIP	.59
377	2 w stereo amp	DIP	2.69
380	2w audio amp	DIP	1.29
380.8	.6w audio amp	mDIP	.89
381	Lo noise dual preamp	DIP	1.69
550	Prec. V reg	DIP	.79
555	Timer	mDIP	.99
560	Phase locked loop	DIP	2.75
562	Phase locked loop	DIP	2.65
565	Phase locked loop	DIP	2.65
566	Function gen	mDIP	2.50
567	Tone Decoder	mDIP	2.95
709	Dp amp	DIP	.29
710	Hi speed V comp	DIP	.39
723	Volt reg.	DIP	.69
739	Dual hi perf amp	DIP	1.19
741	Comp. op amp	mDIP	.35
747	Dual 741	DIP	.79
748	Freq adj 741	mDIP	.39
1304	FM mux st demod	DIP	1.19
1307	FM mux st demod	DIP	.82
6458	Dual Comp op amp	mDIP	.69
1800	Stereo Multiplexer	DIP	2.75
3900	Quad amp	DIP	.39
7524	Core mem sense amp	DIP	.79
7525	Core mem sense amp	DIP	.95
75451	Dual prl. driver	mDIP	.39
75452	Dual prl. driver	mDIP	.39
75453	Dual prl. driver	mDIP	.39
75491	Quad seq driver	DIP	.79
75492	Hex dig driver	DIP	.89

Data sheets supplied on request. Add \$ .50 for items less than \$1.00

**MEMORIES**

1101	256 bit RAM MOS	\$1.75
1103	1024 bit RAM MOS	3.95
2101	1024 bit static RAM	6.95
5203	2048 bit UV eras PROM	19.95
5260	1024 bit RAM	2.95
5261	1024 bit RAM	2.95
5262	2048 bit RAM	7.95
7484	64 bit ROM TTL	2.75
8223	Programmable ROM	3.95
74200	256 bit RAM tri-state	7.95

**CALCULATOR & CLOCK CHIPS**

5001	12 DIG 4 funct fix dec	3.95
5002	Same as 5001 exc btry pwr	4.95
5005	12 DIG 4 funct w/mem	5.95
MM5725	8 DIG 4 funct chain & dec	2.25
MM5736	18 pin 6 DIG 4 funct	4.95
MM5738	8 DIG 5 funct K & Mem	5.95
MM5739	9 DIG 4 funct (btry sur)	5.95
MM5311	28 pin BCD 6 dig mux	4.95
MM5312	24 pin 1 pps BCD 4 dig mux	4.45
MM5313	28 pin 1 pps BCD 6 dig mux	4.95
MM5314	24 pin 6 dig mux	4.95
MM5316	40 pin alarm 4 dig	5.95

**LED'S AND OPTO ISOLATORS**

MV10B	Red TD 18	\$ .25 ea.
MV50	Axial leads	.20
MV5020	Infra red visible red	.25
ME4	Junro red diff. dome	.60
MAN1	Red 7 seg. 270"	2.50
MAN2	Red alpha num. 32"	4.95
MAN4	Red 7 seg. 190"	2.15
MAN5	Green 7 seg. 270"	2.95
MAN7	Red 7 seg. 270"	1.35
MAN8	Yellow 7 seg. 270"	3.95
MAN66	60" high dir. view	4.65
DL707	Red 7 seg. 3"	2.15
NICT2	Opto iso transistor	.69

**CMOS**

4000 AE	\$ .40	4019 AE	\$2.10	4066 AE	\$1.05
4001 AE	.40	4020 AE	2.20	4068 AE	.40
4002 AE	.40	4021 AE	2.05	4069 AE	.40
4006 AE	1.75	4023 AE	.40	4071 AE	.40
4007 AE	.40	4024 AE	1.45	4072 AE	.40
4008 AE	2.45	4025 AE	.40	4073 AE	.40
4009 AE	.80	4027 AE	1.20	4075 AE	.40
4010 AE	.80	4028 AE	1.75	4078 AE	.40
4011 AE	.40	4030 AE	.85	4081 AE	.40
4013 AE	.80	4042 AE	1.90	4082 AE	.40

**INTERNATIONAL ELECTRONICS UNLIMITED**

P.O. BOX 1708 MONTEREY, CALIF. 93940 USA

Satisfaction is guaranteed. Shipment will be made via first class mail — postage paid — in U.S., Canada and Mexico within three days from receipt of order. Minimum order — \$5.00. California residents add sales tax.



(408) 659-3171



**EMPLOYMENT OPPORTUNITIES**

ELECTRONICS/AVIONICS EMPLOYMENT OPPORTUNITIES Report on jobs now open. Details FREE. Aviation Employment Information Service, Box 240E, Northport, New York 11768.

**MUSICAL INSTRUMENTS**

UP TO 60% DISCOUNT Name brand instruments catalog. Freepost Music, 455N Route 110, Melville, N.Y. 11746.

WHOLESALE! Professional Guitars, PA Systems, Altec Speakers, 240W RMS Amplifiers. Free Catalog, Carvin, Escondido, Calif. 92028.

**TREASURE FINDERS**

FREE FACT-FILLED CATALOG! World's largest selection! Metal detectors starting at \$79.50. Two year guarantee! Three factories, U.S.-Canada. 1,200 dealers - Service Centers nationwide. Finest instruments at any price! Budget Terms. Dealer inquiries invited. Write White's Electronics, Inc. Dept PD5T, 1011 Pleasant Valley Road, Sweet Home, Oregon 97366

TREASURE FINDER locates buried gold, silver, coins, treasures. 6 powerful models. Instant financing available. Write or call for free catalog. Phone (713) 682-2728 day or night. Dealer inquiries invited. Reico, Dept AA20, Box 10839, Houston, Texas 77018.

**REAL ESTATE**

BIG... FREE... SUMMER CATALOG! 256 pages! Over 2,600 top values in 40 states coast to coast! UNITED FARM AGENCY, 612-EP, West 47th St., Kansas City, MO. 64112.

**RECORDS**

OLDIES 45rpm Free Catalog. Corry's Record Shop, Box 166TH, Mason, Ohio 45040.

For faster service USE ZIP CODE on all mail

**GIANT SOPHISTICATED BOARDS**

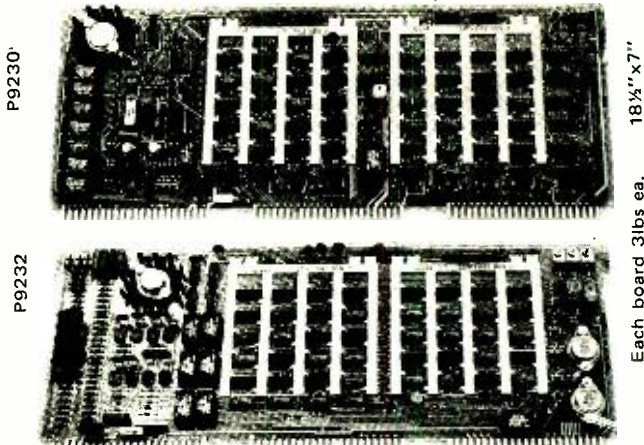

**P9230**...contains 63 ICs, all 7400 TTL series, & DTL 900 series. 9 P&B reed relays, including 2 latching. P&B series JR. LM-309 regulator, 2 TO-5 linear circuits, Dipped tantalum caps, 23 2N4401 transistors, 1 2N4403, 3 2N5061 SCRs, 2 G.E. C106 SCRs, 1/2 & 1/4 watt resistors and capacitors. Parts value over \$200.00. STOCK NO P9230 \$12.95 ea. 2/25.00

**P9232**...Contains 8 Op amps, 49 ICs, 7400 TTL series, and DTL 900 series. 7 P&B reed relays, LM309 regulator & heat sink, 4 5K Trimpots, 2 power transistors, TO-3, 5 G.E. C106 SCRs, 2 2N4401 transistors, 2 2N5061 SCRs. Rectifier and small signal diodes, 1/2 & 1/4 watt resistors, dipped tantalum caps, and other caps. STOCK NO. P9232 \$14.96 2/28.00  
One each of above boards \$26.00. We supply data for most of the parts on these boards.

Please include sufficient postage; excess will be refunded. Send for new Summer catalog 14, 64 pages of electronic bargains.

**DELTA ELECTRONICS CO.**  
BOX 1, LYNN, MASSACHUSETTS 01903  
Phone (617) 388-4705

CIRCLE NO. 15 ON READER SERVICE CARD

TTL		CMOS		LINEAR	
7400* .17	7401* 1.00	C04000 \$ .48	LM3000 \$ .69	LM739N \$1.29	
7401 23	7402 95	C04001 .48	LM301H/N .29	LM741H/N .31*	
7402 23	7403 95	C04002 .48	LM302H .69	LM747N .69	
7403 17	7404 97	C04003 3.75	LM304H .89	LM748N .35*	
7404 25	7405 95	C04009 .55	LM305H/N .89	LM1303N .79	
7405 24	7406 95	C04010 .59	LM307H/N .35	LM1304N 1.00	
7406 50	7407 1.50	C04011 .48	LM308H/N 1.05	LM1307N .79	
7407 50	7410 4.1	C04012 .48	LM309K 1.25*	LM1310P 3.25*	
7408 25	7411 5.5	C04013 1.00	LM310H/N .19	LM1458N .69	
7409 25	7412 4.7	C04016 1.00	LM311H/N .95	LM1496N .89	
7410 17	7413 1.05	C04017 2.65	LM318N 1.69	LM1556V .95	
7411 30	7414 8.0	C04019 1.15	LM319 1.19	CA3013 1.70	
7412 40	7415 8.0	C04020 1.50	LM324 1.85	CA3035 2.15	
7413* 75	7416 1.15	C04022 1.50	LM329N 1.95	CA3039 2.35	
7416 45	7417 1.15	C04023 4.8	LM349K 1.89	CA3046 2.46	
7417 45	7418 2.95	C04024 1.95	LM340T 1.75	CA3058 2.46	
7418 25	7419 2.95	C04025 4.8	LM376N 1.05	CA3060 2.80	
7420 23	7420 1.10	C04027 1.15	LM373N 2.05	CA3065N .75	
7421 27	7421 1.20	C04028 2.65	LM380 1.00	CA3080 .85	
7423 32	7423 1.50	C04029 3.95	LM380N 1.25*	CA3083 1.60	
7425 27	7424 1.25	C04030 1.00	NE531T 3.00	CA3086 7.00	
7426 31	7425 1.30	C04035 2.65	NE536T .75	CA3089 3.25	
7427 32	7426 1.30	C04040 3.95	NE550N 3.00	CA3091 8.25	
7429 40	7427 1.55	C04042 2.75	NE555N .89*	CA3122 1.85	
7430 33	7428 1.60	C04044 2.75	NE556N .85	CA3600 1.75	
7432 16	7429 1.65	C04046 2.75	NE560 2.50	LM3900 55	
7437 45	7430 2.50	C04047 2.75	NE561 2.50	LM3905 55*	
7438 50	7431 1.65	C04049 1.00	NE562 2.50	LM3905 1.75*	
7439 50	7432 1.65	C04051 3.95	NE565V 2.00*	8038B 3.95*	
7440 23	7433 1.75	LM3400 3.95	LM565H 1.50*	LM9601 .55	
7441 110	7434 1.85	LM3400 3.95	LM566 2.00*	LM9602 .75	
7442 105	7435 1.85	LM3400 3.95	NE567V 2.00*	75450 .39	
7443 110	7436 1.85	LM3400 3.95	LM703H/N 1.50*	75451 .39	
7444 115	7437 1.85	LM3400 3.95	LM703H/N 2.9	75491 .79	
7445 110	7438 1.85	LM3400 3.95	LM710H/N 29	75492 .89	
7446 125	7439 1.85	LM3400 3.95	LM710H/N 1.15	75493 .89	
7447* 89	7440 1.00	LM3400 3.95	LM723H/N 1.55	75494 .89	
7448 125	7441 3.75	LM3400 3.95	LM733H/N .75	75324N 1.75*	
7449 25	7442 1.00	LM3400 3.95			
7450 25	7443 2.30	LM3400 3.95			
7451 27	7444 2.30	LM3400 3.95			
7453 27	7445 2.30	LM3400 3.95			
7454 40	7446 2.30	LM3400 3.95			
7455 25	7447 1.50	LM3400 3.95			
7456 25	7448 1.50	LM3400 3.95			
7457 45	7449 1.50	LM3400 3.95			
7458 40	7450 1.50	LM3400 3.95			
7459 25	7451 1.50	LM3400 3.95			
7460 25	7452 1.50	LM3400 3.95			
7470 45	7453 1.25	LM3400 3.95			
7472 41	7454 1.25	LM3400 3.95			
7473* 39	7455 1.25	LM3400 3.95			
7474 47	7456 1.05	LM3400 3.95			
7475* 75	7457 1.25	LM3400 3.95			
7476* 40	7458 1.05	LM3400 3.95			
7477 50	7459 7.00	LM3400 3.95			
7482 1.75	7460 2.75	LM3400 3.95			
7483 1.15	7461 7.00	LM3400 3.95			
7485* 1.10	7462 5.00	LM3400 3.95			
7486 47	7463 5.00	LM3400 3.95			
7488 4.00	7464 5.00	LM3400 3.95			
7489* 2.25	7465 5.00	LM3400 3.95			
7490* .69		LM3400 3.95			

TTL		CMOS		LINEAR	
7400* .17	7401* 1.00	C04000 \$ .48	LM3000 \$ .69	LM739N \$1.29	
7401 23	7402 95	C04001 .48	LM301H/N .29	LM741H/N .31*	
7402 23	7403 95	C04002 .48	LM302H .69	LM747N .69	
7403 17	7404 97	C04003 3.75	LM304H .89	LM748N .35*	
7404 25	7405 95	C04009 .55	LM305H/N .89	LM1303N .79	
7405 24	7406 95	C04010 .59	LM307H/N .35	LM1304N 1.00	
7406 50	7407 1.50	C04011 .48	LM308H/N 1.05	LM1307N .79	
7407 50	7410 4.1	C04012 .48	LM309K 1.25*	LM1310P 3.25*	
7408 25	7411 5.5	C04013 1.00	LM310H/N .19	LM1458N .69	
7409 25	7412 4.7	C04016 1.00	LM311H/N .95	LM1496N .89	
7410 17	7413 1.05	C04017 2.65	LM318N 1.69	LM1556V .95	
7411 30	7414 8.0	C04019 1.15	LM319 1.19	CA3013 1.70	
7412 40	7415 8.0	C04020 1.50	LM324 1.85	CA3035 2.15	
7413* 75	7416 1.15	C04022 1.50	LM329N 1.95	CA3039 2.35	
7416 45	7417 1.15	C04023 4.8	LM349K 1.89	CA3046 2.46	
7417 45	7418 2.95	C04024 1.95	LM340T 1.75	CA3058 2.46	
7418 25	7419 2.95	C04025 4.8	LM376N 1.05	CA3060 2.80	
7420 23	7420 1.10	C04027 1.15	LM373N 2.05	CA3065N .75	
7421 27	7421 1.20	C04028 2.65	LM380 1.00	CA3080 .85	
7423 32	7423 1.50	C04029 3.95	LM380N 1.25*	CA3083 1.60	
7425 27	7424 1.25	C04030 1.00	NE531T 3.00	CA3086 7.00	
7426 31	7425 1.30	C04035 2.65	NE536T .75	CA3089 3.25	
7427 32	7426 1.30	C04040 3.95	NE550N 3.00	CA3091 8.25	
7429 40	7427 1.55	C04042 2.75	NE555N .89*	CA3122 1.85	
7430 33	7428 1.60	C04044 2.75	NE556N .85	CA3600 1.75	
7432 16	7429 1.65	C04046 2.75	NE560 2.50	LM3900 55	
7437 45	7430 2.50	C04047 2.75	NE561 2.50	LM3905 55*	
7438 50	7431 1.65	C04049 1.00	NE562 2.50	LM3905 1.75*	
7439 50	7432 1.65	C04051 3.95	NE565V 2.00*	8038B 3.95*	
7440 23	7433 1.75	LM3400 3.95	LM565H 1.50*	LM9601 .55	
7441 110	7434 1.85	LM3400 3.95	LM566 2.00*	LM9602 .75	
7442 105	7435 1.85	LM3400 3.95	NE567V 2.00*	75450 .39	
7443 110	7436 1.85	LM3400 3.95	LM703H/N 1.50*	75451 .39	
7444 115	7437 1.85	LM3400 3.95	LM703H/N 2.9	75491 .79	
7445 110	7438 1.85	LM3400 3.95	LM710H/N 29	75492 .89	
7446 125	7439 1.85	LM3400 3.95	LM710H/N 1.15	75493 .89	
7447* 89	7440 1.00	LM3400 3.95	LM723H/N 1.55	75494 .89	
7448 125	7441 3.75	LM3400 3.95	LM733H/N .75	75324N 1.75*	
7449 25	7442 1.00	LM3400 3.95			
7450 25	7443 2.30	LM3400 3.95			
7451 27	7444 2.30	LM3400 3.95			
7453 27	7445 2.30	LM3400 3.95			
7454 40	7446 2.30	LM3400 3.95			
7455 25	7447 1.50	LM3400 3.95			
7456 25	7448 1.50	LM3400 3.95			
7457 45	7449 1.50	LM3400 3.95			
7458 40	7450 1.50	LM3400 3.95			
7459 25	7451 1.50	LM3400 3.95			
7460 25	7452 1.50	LM3400 3.95			
7470 45	7453 1.25	LM3400 3.95			
7472 41	7454 1.25	LM3400 3.95			
7473* 39	7455 1.25	LM3400 3.95			
7474 47	7456 1.05	LM3400 3.95			
7475* 75	7457 1.25	LM3400 3.95			
7476* 40	7458 1.05	LM3400 3.95			
7477 50	7459 7.00	LM3400 3.95			
7482 1.75	7460 2.75	LM3400 3.95			
7483 1.15	7461 7.00	LM3400 3.95			
7485* 1.10	7462 5.00	LM3400 3.95			
7486 47	7463 5.00	LM3400 3.95			
7488 4.00	7464 5.00	LM3400 3.95			
7489* 2.25	7465 5.00	LM3400 3.95			
7490* .69		LM3400 3.95			

**Calculator Chips**  
MM5311 \$4.95  
MM5312 4.95  
MM5313 4.95  
MM5314 4.95  
MM5316 6.95

**Clock Chips**  
5001 \$3.95  
5005 5.95  
5007 6.95  
5030 7.95  
7001 9.95

**\*Special Requested Items\***  
8008 Processor \$49.95  
101 256 x 1 RAM 2.25  
2102 1024 RAM 6.95  
AY5 1013 UART 3.95  
RC4194 TK 5.95

8263 \$7.00  
8267 4.00  
2513\* 11.00  
2518 7.00  
4024P 4.00  
8193T 3.00

2524\* \$3.50  
2525 5.00  
2529\* 4.00  
4024P 2.25  
8193T 3.00

**WALL or T.V. DIGITAL CLOCK**  
25" VIEWING DISTANCE  
Walnut Case-6" x 3" x 1"  
Hr. & Min. 5" High  
Seconds 3" High  
KIT All Comp. & Case  
Wired & Assembled  
115 Vac \$39.95  
\$44.95

**SWITCHES**  
SLIDE SWITCHES  
DPDT Locking 0.5A-DC  
Part No. 1 19 10-29 30 up  
223 462061 B .39 30 .27

**PB PUSH-BUTTON SERIES - (SPDT)**

**BUSINESS OPPORTUNITIES**

I MADE \$40,000.00 Year by Mailorder! Helped others make money! Free Proof. Torrey, Box 318-NN, Ypsilanti, Michigan 48197.

FREE CATALOGS Repair air conditioning, refrigeration. Tools, supplies, full instructions Doolin, 2016 Canton, Dallas, Texas 75201.

MAILORDER MILLIONAIRE helps beginners make \$500 weekly. Free report reveals secret plan! Executive (1K6), 333 North Michigan, Chicago 60601.

PIANO TUNING LEARNED QUICKLY AT HOME! Tremendous field! Musical knowledge unnecessary. GI approved. Information free. Empire School, Box 450327, Miami 33145.

\$200.00 DAILY In Your Mailbox! Your opportunity to do what mail-order experts do. Free details. Associates, Box 136-J, Holland, Michigan 49423.

FREE BOOK "2012 unique proven enterprises." Work home! Hayling-B, Carlsbad, CA 92008.

100 MONEY making formulas! \$2.00, no further investment! Carousel, 10331 Carousel, Wisconsin Rapids, Wisc 54494.

MAKE two times your cost on Gift items, novelties, 1001 others. \$2.00 (refundable first order) brings Giant Catalog, MC DONOUGH, 1931FT AIDA AVE, TUCSON, ARIZONA 85710.

ELECTRONIC Assembly Business. Big profits. Start home, spare time. Investment, knowledge, experience unnecessary. Free illustrated literature. Barta, Box 248CS, Walnut Creek, Calif. 94597.

**wanted** **Citizens Band** **DEALER-DISTRIBUTORS**

Send this ad with Letterhead to:

**PAL ELECTRONICS CO.**

2962 W. WELDON - PHOENIX, ARIZ 85017

**RUBBER STAMPS**

RUBBER address stamps. Free catalog. 45 type styles. Jackson's, Box 443G, Franklin Park, Ill. 60131.

**INTEL 80088 BIT MICROPROCESSOR CHIP** (with data book) \$64.50  
 2102-2 1024 BIT RAM \$6.95  
 1702A UV PROM \$24.00  
 MM5203 UV PROM \$24.00

**MINIATURE TRIM POTS**  
 5K, 10K, 25K, 50K, 100K.  
**\$ .75 EA. 3/\$2.00**

**MULTI-TURN TRIM POTS**  
 Similar to Bourns 3010 style 3-16" x 5/8"  
 1 1/4" 50, 100, 500, 2000, 5000, 10,000  
 ohms **\$1.50**

**LIGHT ACTIVATED SCR'S**  
 TO-18 200V 1A **\$1.75**

**PRINTED CIRCUIT BOARD**  
 4 1/2" x 6 1/2" single sided epoxy board, 1/16" thick, unetched  
**\$ .50 ea. 5/\$2.20**

**MC14435 & MC1405L**  
 A two piece 3 1/2 digit A/D converter system for panel meters and with schematics DVM'S **\$39.95**

TIS 73 N FET \$ .50  
 2N4891 UJT \$ .50  
 ER900 TRIGGER DIODES 4/\$1.00  
 2N6028 PROG. UJT \$ .75

**VERIPAX PC BOARD**  
 This board is a 1/16" single sided paper epoxy board, 4 1/2" x 6 1/2" DRILLED and ETCHED which will hold up to 21 single 14 pin IC's or 8, 16 or LSI/DIP IC's with buffers for power supply connections. Is also etched for 22 pin connector **\$5.25**

FCD 811 OPTAL COUPLER \$1.20  
 RED/GREEN BIPOLAR LED \$1.35  
 MT-2 PHOTO TRANS \$ .60  
 GREEN GAP OSL-16 LED \$ .40  
 RED GAP OSL-3 LED \$ .30  
 14 PIN DIP SOCKETS \$ .40  
 16 PIN DIP SOCKETS \$ .50

10 WATT ZENERS  
 3.9, 4.7 OR 18V \$ .75 EA  
 1 WATT ZENERS 5.6, 10, 12, 15, 18 OR 22V \$ .40 EA.

Silicon Power Rectifiers				
PRV	1A	3A	12A	50A
100	.06	.14	.30	.80
200	.07	.20	.35	1.15
400	.09	.25	.50	1.40
600	.11	.30	.70	1.80
800	.15	.35	.90	2.20
1000	.20	.45	1.10	2.75

**REGULATED MODULAR POWER SUPPLIES**  
 --15VDC AT 100ma  
 115VAC INPUT **\$24.95**  
 5VDC AT 1A, 115VAC INPUT **\$19.95**  
 12V 6A **\$24.95**  
 IN 4148 (IN 914) **\$141.00**

Terms: FOB Cambridge Mass. Send check or Money Order. Include Postage. Minimum Order \$5.00

**TRANSISTOR SPECIALS**

2N4898 PNP TO-66 \$ .60  
 2N404 PNP GE TO-5 \$45.100  
 2N3919 NPN Si TO-3 RF \$1.50  
 MPSA13 NPN Si TO-92 \$31.00  
 2N256 PNP GE TO-3 \$ .40  
 2N3767 NPN Si TO-66 \$ .70  
 2N2222 NPN Si TO-18 \$51.00  
 2N3055 NPN Si TO-3 \$1.00  
 2N3904 NPN Si TO-92 \$45.100  
 2N3906 PNP Si TO-92 \$45.100  
 2N5296 NPN Si TO-220 \$ .50  
 2N6109 PNP Si TO-220 \$ .55  
 2N3866 NPN Si TO-5 Si \$ .75  
 RF POW  
 MJ2252 NPN Si TO-66 \$ .90  
 2N3638 NPN Si TO-5 \$51.00  
 2N2218A NPN Si TO-5 \$45.100

**CAPACITORS**

35V at 6.8 UF TANT3 \$1.00  
 20V at 200 UF TANT5 \$ .40  
 6V 30 UF TANT .5 \$1.00  
 12V 200 UF ELECT \$ .30  
 200V 4.7 UF ELECT \$ .30  
 10 UF 12V ELECT 5 \$1.00

1103 1024 bit RAM \$4.75  
 NEC 6003 2048 bit RAM \$9.50  
 1101 256 bit RAM \$1.75  
 5260 RAM \$4.50  
 7487 RAM \$2.75

MM5203-2048 BIT ERASABLE PROM **\$24.00**  
 8223 PROM **\$4.75**

100x100 IMAGE SENSOR CHARGED COUPLE DEVICES USED IN SOLID STATE CAMERAS, WITH APPLICATIONS **\$198.00**

Conductive Elastometer low profile calculator keyboard, A 2 3/4" x 3 3/4" x 1/2" flex key, 195K-6 keyboard having 0-9, ., /, \*, =, -, +, K+C buttons with off, on switch **\$6.00**

**TTL IC SERIES**

74100-30 7475-45  
 7400-17 7480-61  
 7401-17 7483-99  
 7402-17 7485-130  
 7403-17 7486-48  
 7404-21 7490-71  
 7405-21 7491-110  
 7406-37 7492-75  
 7407-37 7493-71  
 7408-23 7495-85  
 7410-17 7496-85  
 7411-27 8267-195  
 7412-45 74107-45  
 7413-73 74121-55  
 7416-37 74123-91  
 7417-37 74125-65  
 7420-17 74126-70  
 7425-37 74150-99  
 7426-27 74151-85  
 7427-31 74153-105  
 7430-17 74154-149  
 7432-27 74155-105  
 7437-41 74157-119  
 7438-35 74163-149  
 7440-17 74164-179  
 7441-95 74165-179  
 7442-95 74173-155  
 7445-105 74175-180  
 7446-110 74177-150  
 7447-110 74181-350  
 7448-110 74192-145  
 7472-33 74193-130  
 7473-41 74195-89  
 7474-41 75324-175  
 7475-71 75491-110

8038C IC VOLT CONT. OSC **\$4.95**

**C/MOS (DIODE CLAMPED)**

74C 02 \$ .55 CD 4019 \$ .95  
 74C 10 \$ .60 CD 4022 \$2.10  
 74C 157 \$2.15 CD 4023 \$ .48  
 74C 165 \$3.50 CD 4024 \$1.80  
 CD 4001 \$ .48 CD 4025 \$ .48  
 CD 4002 \$ .48 CD 4026 \$5.00  
 CD 4006 \$3.50 CD 4027 \$1.20  
 CD 4007 \$ .48 CD 4028 \$2.20  
 CD 4009 \$ .80 CD 4029 \$4.00  
 CD 4010 \$ .65 CD 4030 \$ .53  
 CD 4011 \$ .48 CD 4035 \$2.30  
 CD 4012 \$ .48 CD 4042 \$2.75  
 CD 4013 \$ .90 CD 4046 \$3.75  
 CD 4015 \$2.80 CD 4047 \$3.10  
 CD 4016 \$1.05 CD 4050 \$1.05  
 CD 4017 \$2.60 CD 4055 \$2.70

MAN-1, Red or Yellow	Full Wave Bridges
LED READOUT <b>\$2.50</b>	PRV 2A 6A 25A
MAN-3 READOUT <b>\$1.75</b>	200 .95 1.25 \$3.00
MAN-3 READOUT <b>\$2.00</b>	400 1.15 1.50 \$4.00
SLA 3 <b>\$4.50</b>	600 1.35 1.75 \$5.00

CD 110 256x1 bit linear charged couple device image sensor used for 1 line scanning, with schematics **\$150.00**

2516 64x6x8 STATIC CHARACTER GEN **\$9.95**

**SANKEN AUDIO POWER AMPS**  
 Si 1010 G 10 WATTS \$ 6.40  
 Si 1020 E 20 WATTS \$13.95  
 Si 1050 E 50 WATTS \$24.95

**LINEAR CIRCUITS**

LM 309K 5V 1A REGULATOR **\$1.50**  
 723 -40 +40V REGULATOR **\$ .58**  
 301/748 -Hi Perf Op. Amp **\$ .30**  
 LM 320 -5 or 15V REGULATOR **\$1.75**  
 LM 376 -V to 37V POS REG **\$ .58**  
 741A or 741C OP. AMP. **\$ .31**  
 709C OPER AMP **\$ .25**  
 340T-5 12, 15, 18, 24V POS. REG. TO-220 **\$ .31**  
 101 OPER AMP HI PERFORM **\$1.75**  
 LM 308 OPER AMP, LOW POWER **\$1.05**  
 747-DUAL 741 **\$ .75**  
 711 COMPARATOR **\$ .31**  
 537-PRECISION OP AMP **\$2.60**  
 LM 3900-QUAD OP AMP **\$ .49**  
 LM 324-QUAD 741 **\$2.20**  
 560-PHASE LOCK LOOP **\$2.50**  
 561-PHASE LOCK LOOP **\$2.50**  
 565-PHASE LOCK LOOP **\$2.50**  
 567-TONE DECODER **\$2.85**  
 703-RF-IF AMP **\$ .41**  
 LM 370-AGC SQUELCH AMP **\$1.15**  
 555-2 μs - 2 HR. TIMER **\$ .88**  
 FCD 810 OPTO-ISOLATOR **\$1.30**  
 1456 OPER AMP **\$ .95**  
 LM 380-2W AUDIO AMP **\$1.39**  
 LM 377-2W STEREO AUDIO AMP **\$2.50**  
 LM 381-STEREO PREAMP **\$1.69**  
 LM 382-DUAL AUDIO PREAMP **\$1.69**  
 LM 311-HI PER COMPARATOR **\$ .95**  
 LM 319-DUAL HI SPEED COMP **\$1.15**  
 LM 339-QUAD COMPARATOR **\$1.45**

TRIACS			SCR'S			
PRV	1A	10A	25A	1.5A	6A	35A
100	.40	.70	1.30	.40	.50	1.20
200	.70	1.10	1.75	.60	.70	1.60
400	1.10	1.60	2.60	1.00	1.20	2.20
600	1.70	2.30	3.00			3.00

**INVENTIONS WANTED**

CASH-ROYALTIES for patented, unpatented inventions. Global Marketing Service, 139-P Lake Merced Hill South, San Francisco, California 94132.

INVENTORS: Protect your ideas! Free "Recommended Procedure" Washington Inventors Service, 4227 Washington Building, Washington, D.C. 20005

FREE PAMPHLET "Tips on Safeguarding Your Invention." Write: United States Inventors Service Company, 708-T Carry Building, Washington, D.C. 20005

**inventors**  
**...Manufacturers Need New Products**

If you have an idea for a new product, or a way to make an old product better, contact us, "the idea people." We'll develop your idea, introduce it to industry, negotiate for cash sale or licensing. Send for our FREE "Invention Kit." It has a special "Invention Record Form," an important brochure, "Your Invention - Its Development, Protection & Marketing," and a Directory of 500 Corporations Seeking New Products. You'll learn how ideas become a reality!

**RAYMOND LEE ORGANIZATION**  
 230 Park Avenue, New York, N.Y. 10017

I'd like to find out how to take action on my idea. Send Free "Invention Kit No. A-112"

Name \_\_\_\_\_ Please Print  
 Address \_\_\_\_\_  
 City \_\_\_\_\_ State \_\_\_\_\_ Zip \_\_\_\_\_

SAN FRANCISCO LOS ANGELES TORONTO VANCOUVER DENVER CHICAGO

**INVENTIONS IDEAS WANTED**

Manufacturers Need New Products. Your invention, new product or idea developed for cash / royalty sales by Professional Organization.

**"No Idea Is Too Small"\***

Free Booklet: "How to Safeguard, Develop and Market Your Ideas to Industry"

**LAWRENCE PESKA ASSOCIATES**  
 500 Fifth Ave., Dept. MM, N.Y.C. 10036  
 Phone (212) 354-9696

A trademark of Lawrence Peska Associates, Inc.

**INSTRUCTION**

LEARN ELECTRONIC ORGAN SERVICING at home all makes including transistor. Experimental kit-troubleshooting. Accredited NHSC. Free Booklet NILES BRYANT SCHOOL, 3631 Stockton, Dept. A, Sacramento, Calif 95820.

LEARN WHILE ASLEEP. Hypnotize! Strange catalog free. Auto-suggestion. Box 24-ZD, Olympia, Washington 98501.

DEGREE IN ELECTRONICS through correspondence. Free catalog. Grantham 2000 Stoner Avenue, Los Angeles, California 90025.

INTENSIVE 5 week course for Broadcast Engineers. F.C.C. First Class license. Radio Engineering Incorporated, 61 N Pineapple Ave., Sarasota, Florida 33577 and 2402 Tidelwater Trail, Fredericksburg, VA 22401

**EXAM F.C.C. MANUAL**

PASS FCC EXAMS! Memorize, study - "Test Answers" for FCC 1st and 2nd class Radio Telephone license. Newly revised multiple choice questions and diagrams cover all areas tested in FCC exams plus "Self-Study Ability Test." \$9.95 postpaid. Moneyback Guarantee.

COMMAND PRODUCTIONS P.O. BOX 26348-P  
 RADIO ENGINEERING DIVISION SAN FRANCISCO, CALIF. 94126

FCC License, electronics design, satellite communications, through correspondence. Free catalog. Genn Tech, 5540 Hollywood Blvd., Los Angeles, CA 90028.



READER SERVICE NO.	ADVERTISER	PAGE NUMBER
1	A.D.R. Audio Video	84
2	Adva Electronics	88
3	Allison Automotive Company	6
4	Altai Electronics	95
6	Anrona Corp	89
7	Audio Warehouse Sales	84
8	B E C Electronics Corp	76
9	Babylon Electronics	94
	Bell & Howell Schools	70, 71, 72, 73
	CREI Capitol Radio Engineering Institute	80, 81, 82, 83
10	CTS of Paducah, Inc	65
11	Cleveland Institute of Electronics, Inc.	18, 19, 20, 21
12	Clifford's Hi-Fi Wholesalers	76
13	Cobra, Product of Dynascan Corporation	2
14	Continental Specialties Corp	61
15	Delta Electronics Co	97
16	Delta Products, Inc	13
17	Digi-Key Corporation	99
53	Discwasher	85
	Dixie Hi-Fidelity	77
18	EICO	14
19	Edmund Scientific Co	100
24	Exar Integrated Systems, Inc	67
	G C Electronics	15
20	Greenlee Tool Co	65
5	Heath Company	17
21	Illinois Audio	66
22	International Electronics Unlimited	96
23	International Hi-Fi Distributors	79
25	JS&A National Sales Group	25
26	James	97
33	Johnson Co., E.F.	51
27	Labtronics, Incorporated	77
28	Lafayette Radio Electronics	75
29	Locksmithing Institute	66
30	McIntosh Laboratory, Inc	7
50	McKay Dymek Co	85
31	MITS	1
51	Mini-Micro Mart	94
	NRI Schools	8, 9, 10, 11
	National Technical Schools	52, 53, 54, 55
32	New Electronics	86
34	New-Tone Electronics	90
36	PAIA Electronics	13
37	Pace Communications	7
38	Poly Paks	93
39	Radio Shack	SECOND COVER
40	Royce Electronics Corporation	5
41	Sansui Electronics Corp	FOURTH COVER
42	Schober Organ Corp., The	74
43	Solid State Sales	88
52	Solid State Systems, Inc	87
44	Southwest Technical Products	26
45	Stanton Magnetics, Inc.	THIRD COVER
46	Stereo Discounters	74
47	Teletronics Company of America	79
48	Tri-Star Corporation	85
49	Weller, Xcelite, Inc	68
	CLASSIFIED ADVERTISING	86, 88, 90, 94, 96, 97, 98, 99

UNIVERSITY DEGREES BY MAIL! Bachelors, Masters, Ph.D's. Free revealing details. Counseling, Box 1162-PE6, Tustin, California 92680.

UNLOCK Your Future. Become professional Locksmith by spare time homestudy. \$13 in an hour possible. All tools, equipment included. Facts FREE. Send name. Locksmithing Institute (homestudy), Dept. 1373-065, Little Falls, N.J. 07424.

SELF-STUDY CB RADIO REPAIR COURSE. THERE'S MONEY TO BE MADE REPAIRING CB RADIOS. This easy-to-learn course can prepare you for a career in electronics enabling you to earn as much as \$16.00 an hour in your spare time. For more information write: CB RADIO REPAIR COURSE, Dept. PE065, 531 N. Ann Arbor, Oklahoma City, Okla. 73127.

SCORE high on F.C.C. Exams... Over 300 questions and answers. Covers 3rd, 2nd, 1st and even Radar. Third and Second Test, \$14.50; First Class Test, \$15.00. All tests, \$26.50. R.E.I., Inc., Box 806, Sarasota, Fla. 33577.

### HOME ENTERTAINMENT FILMS

THE 1974 INDY "500" (Johnny Rutherford) 200', Super 8, Vivid Color Film is ready! SPECIAL, \$17.95 ea PPD till June 30th, 1975. LIKE BOXING? Order Ali-Foreman, 200' reel, Color or B&W, Standard 8 or Super 8, \$8.95 ea B&W, \$18.95 ea Color (you save \$1.00 on every print you buy!) Or, start your collection by catalog shopping. Send for revised Castle, Columbia or SportLite Catalogs, 30 cents each (coins or stamps, please). SPORTLITE, Elect. Dept.-6, Box 24-500, Speedway, Indiana 46224.

### GOVERNMENT SURPLUS

GOVERNMENT Surplus How and Where to Buy in Your Area. Send \$2.00. Surplus 30177-PE Headquarters Bldg., Washington, D.C. 20014.

MANUALS for Govt Surplus radios, test sets, scopes. List 50 cents (coin). Books, 7218 Roanne Drive, Washington, D.C. 20021

### PERSONALS

MAKE FRIENDS WORLDWIDE through international correspondence. Illustrated brochure free. Hermes, Berlin 11, Box 110660 ZD, Germany

### REPAIRS AND SERVICES

DYNACO, A-R TRANSISTORS, Repairs — Boards & Units. Speaker Service. Send for Prices and Details BEAR ELECTRONICS-PE 177 Hillcrest Road, Mt Vernon, N.Y. 10552.

### BOOKS AND MAGAZINES

FREE catalog aviation/electronic/space books. Aero Publishers, 329PE Aviation Road, Fallbrook, California 92028.

FREE book prophet Elijah coming before Christ. Wonderful bible evidence. Megiddo Mission, Dept. 64, 481 Thurston Rd., Rochester, N.Y. 14619.

POPULAR ELECTRONICS—Complete run, 247 issues, Vol. 1, No. 1, October 1954 to date. \$75.00 FOB. Hugo Kurtzner, 6 Barnswallow, Pittsford, NY 14534.

### MOVIE FILMS

8MM-SUPER 8-16MM MOVIES! Biggest Selection! Lowest Prices! Free Catalog! Cinema Eight, Box PE, Chester, Connecticut 06412.

### HYPNOTISM

SLEEP learning. Hypnotic method. 92% effective. Details free. ASR Foundation, Box 23429EG, Fort Lauderdale, Florida 33307

FREE Hypnotism, Self-Hypnosis, Sleep Learning Catalog! Drawer H400, Rudoso, New Mexico 88345.

AMAZING self-hypnosis record releases fantastic mental power. Instant results! Free trial. Write: Forum (AA6), 333 North Michigan, Chicago 60601.

### MISCELLANEOUS

WINEMAKERS Free illustrated catalog yeasts, equipment. Semplex, Box 12276P, Minneapolis, Minn. 55412.

## Quality Electronic Components

SPECIAL SAVINGS DISCOUNT ON LINEAR AND DIGITAL INTEGRATED CIRCUITS

Discount 4% from the total of your I.C. order if it exceeds \$25.00 based on single list prices, 7% for \$50.00 or more, 10% for \$100.00 or more. Additional large quantity discounts offered.

TTL & CMOS INTEGRATED CIRCUITS									
7400N	25c	7445N	81c	7495N	90c	74193N	\$1.17	4027AE	67c
7401N	25c	7446N	81c	7496N	81c	74198N	\$2.75	4028AE	\$1.09
7402N	25c	7447N	81c	74107N	32c	74199N	\$2.25	4029AE	\$1.42
7403N	25c	7448N	90c	74121N	38c	4000AE	30c	4030AE	50c
7404N	25c	7450N	23c	74122N	45c	4001AE	30c	4033AE	\$1.67
7405N	25c	7451N	23c	74123N	\$1.08	4002AE	30c	4034AE	\$3.34
7406N	25c	7452N	23c	74141N	99c	4006AE	\$1.50	4035AE	\$1.42
7407N	25c	7453N	23c	74150N	\$1.44	4007AE	25c	4036AE	\$1.67
7408N	25c	7459N	25c	74151N	90c	4008AE	\$1.17	4041AE	92c
7409N	25c	7460N	23c	74153N	81c	4009AE	67c	4042AE	84c
7410N	25c	7470N	36c	74154N	\$1.44	4010AE	67c	4043AE	67c
7411N	25c	7472N	36c	74155N	81c	4011AE	30c	4044AE	67c
7413N	25c	7473N	32c	74156N	81c	4012AE	30c	4046AE	\$2.51
7416N	25c	7474N	32c	74157N	72c	4013AE	53c	4049AE	58c
7417N	25c	7475N	54c	74158N	\$1.53	4014AE	\$1.67	4050AE	58c
7418N	25c	7476N	36c	74160N	\$1.26	4015AE	\$1.17	4051AE	\$1.50
7420N	25c	7480N	72c	74161N	\$1.17	4016AE	63c	4052AE	\$1.50
7421N	25c	7481N	72c	74162N	\$1.26	4017AE	30c	4053AE	30c
7423N	72c	7483N	72c	74163N	\$1.26	4018AE	\$1.67	4060AE	\$1.67
7426N	25c	7485N	\$1.40	74164N	\$1.35	4019AE	58c	4066AE	\$1.00
7430N	25c	7486N	32c	74165N	\$2.45	4020AE	\$1.67	4071AE	30c
7433N	25c	7489N	\$4.47	74166N	\$2.00	4021AE	\$1.50	4072AE	30c
7438N	25c	7490N	50c	74175N	\$1.40	4022AE	30c	4073AE	30c
7440N	25c	7491N	81c	74180N	81c	4023AE	30c	4075AE	30c
7441N	\$1.17	7492N	50c	74181N	\$2.25	4024AE	\$1.00	4081AE	30c
7442N	65c	7493N	50c	74182N	90c	4025AE	30c	4082AE	30c
		7494N	81c	74192N	\$1.26	4026AE	\$1.67		

LINEAR INTEGRATED CIRCUITS	
555V MINIDIP TIMER	82.5c
558V MINIDIP DUAL AMP	75.0c
565A DIP PLL	\$3.38
567V MINIDIP DECODER	\$3.38
741V MINIDIP OP AMP	50.0c
723A DIP VOLTAGE REG.	82.5c
748V MINIDIP OP AMP	42.0c
747A DIP DUAL AMP	97.5c
L129 5 VOLT REG	\$1.80
LM3909 DIP QUAD AMP	60.0c
L131 15 VOLT REG	\$1.80
L130 12 VOLT REG	\$1.80
LM309K 5 VOLT REG	\$1.75

### MINIATURE ALUMINUM ELECTROLYTIC CAPACITORS

AXIAL LEAD TYPE

-40°C plus 85°C tolerance		-10 plus 50% (greater than 47 uFD)		+10 plus 75% (+4.7 uFD or less)	
1 uFD/50V	14c	12c	11c	33 uFD/16V	15c
2.2 uFD/50V	14c	12c	11c	33 uFD/25V	44c
3.3 uFD/50V	14c	12c	11c	33 uFD/50V	44c
4.7 uFD/50V	14c	12c	11c	47 uFD/16V	17c
10 uFD/16V	14c	12c	11c	47 uFD/25V	49c
10 uFD/25V	14c	12c	11c	47 uFD/50V	49c
22 uFD/16V	14c	12c	11c	1000 uFD/16V	49c
22 uFD/25V	15c	13c	12c	1000 uFD/25V	75c
				2200 uFD/16V	75c

### 1 AMP SILICON RECTIFIERS

1N4001 50 PIV 12/51 100/56 1000/548 1N4005 600 PIV 8/51 100/59 1000/570

1N4007 1000 PIV 6/51 130/511 1000/588

### SILICON SIGNAL & SWITCHING DIODE

1N4148 (1N914 equiv.) 12/51 100/57 1M/550 5M/5220

### MOLEX SOLDERCON IC TERMINALS

100/51 500/54.20 1000/58.20 5000/538.20 50,000/5275

### LED 7 SEGMENT DISPLAYS

DATALIT-704 \$1.00 DATALIT-707 \$1.50

### MACHINE SCREWS, NUTS & LOCKWASHERS

MACHINE SCREWS, NUTS & LOCKWASHERS		REED RELAYS	
2-56 1/4 Screw .90c/c	2-56 1/4 Screw .98c/c	6 AMP SPST N.O. CONTACTS	
4-40 1/4 Screw .96c/c	4-40 1/4 Screw .96c/c		
6-32 1/4 Screw .92c/c	6-32 1/4 Screw .80c/c		
8-32 3/8 Screw \$1.05/c	8-32 5/8 Screw \$1.35/c	5V \$2.00 \$1.50	
2-56 Hex Nut .5145/c	2 Lock Washer .45c/c	6V \$2.00 \$1.50	
4-40 Hex Nut .5145/c	4 Lock Washer .45c/c	12V \$2.00 \$1.50	
6-32 Hex Nut .5145/c	6 Lock Washer .45c/c	24V \$2.00 \$1.50	
8-32 Hex Nut .5150/c	8 Lock Washer .45c/c		

### DISC CAPACITORS

DISC CAPACITORS		I.C. SOCKETS					
100 pf/500V	7c	5.5c	4.5c	3.6c	8 pin Solder	27c	21c
220 pf/500V	7c	5.5c	4.5c	3.6c	14 pin Solder	29c	23c
470 pf/500V	7c	5.5c	4.5c	3.6c	16 pin Solder	32c	25c
001/500V	7c	5.5c	4.5c	3.6c	18 pin Solder	34c	26c
0022/500V	7c	5.5c	4.5c	3.6c	24 pin Solder	54c	42c
0047/500V	7c	5.5c	4.5c	3.6c			
01/500V	10c	7.5c	6.5c	5.0c			
01/25V	6c	4.5c	3.0c	2.4c	8 pin W.W.	38c	30c
02/25V	6c	4.0c	3.0c	2.7c	14 pin W.W.	50c	39c
04/25V	9c	6.0c	5.3c	4.2c	16 pin W.W.	54c	42c
1/25V	12c	9.0c	7.5c	6.0c	18 pin W.W.	88c	68c
					24 pin W.W.	99c	80c

### 1/2 & 1/4 WATT CARBON COMP. RESISTORS

5 each of the 85 standard 10% values (2.2-22M) 1/2 W Resistors (425 pcs.) Sorted by value \$12/set 2-4 are \$11/set 5-9 are \$10/set.

5 each of the 70 standard 10% values (10-5.6M) 1/4 W Resistors (350 pcs.) Sorted by value \$12/set 2-4 are \$11/set 5-9 are \$10/set.

### SILICON TRANSISTORS

SILICON TRANSISTORS	
EN918	TO-106 21c 18.5c 16.5c
EN930	TO-106 21c 18.5c 16.5c
EN222	TO-106 21c 18.5c 16.5c
EN2369A	TO-106 21c 18.5c 16.5c
EN2905	TO-106 21c 18.5c 16.5c
2N2712	TO-98 18c 16.0c 14.5c
2N3391A	TO-98 22c 19.0c 17.5c
2N3392	TO-98 22c 19.0c 17.5c
2N3393	TO-98 22c 19.0c 17.5c
2N3394	TO-98 22c 19.0c 17.5c
2N3543	TO-106 20c 17.5c 17.5c
2N3545	TO-106 20c 17.5c 16.0c
2N3638	TO-105 20c 17.5c 16.0c
2N3638A	TO-105 20c 17.5c 16.0c
2N3640	TO-106 22c 19.0c 18.0c
2N3641	TO-105 20c 17.5c 17.5c
2N3643	TO-105 20c 17.5c 16.0c
2N3645	TO-106 20c 17.5c 16.0c
2N3638	TO-105 20c 17.5c 16.0c
2N3638A	TO-105 20c 17.5c 16.0c
2N3640	TO-106 22c 19.0c 18.0c
2N3641	TO-105 20c 17.5c 17.5c
2N3643	TO-105 20c 17.5c 16.0c
2N3645	TO-106 20c 17.5c 16.0c
2N3638	TO-105 20c 17.5c 16.0c
2N3638A	TO-105 20c 17.5c 16.0c
2N3640	TO-106 22c 19.0c 18.0c
2N3641	TO-105 20c 17.5c 17.5c
2N3643	TO-105 20c 17.5c 16.0c
2N3645	TO-106 20c 17.5c 16.0c

### FIELD EFFECT TRANSISTORS

MPF102 TO-92 44 380 350 2N5457 TO-92 47 420 375

### NPN DARLINGTON TRANSISTOR

MPS-A13 TO-92 Min. DC Current Gain of 5,000 at 10mA .36 320 290

Send for Free Catalog or Mail Readers Service Card  
COD ORDERS ACCEPTED FOR SAME DAY SHIPMENT  
CALL 218-681-6674

Orders Less than \$10.00 add 50c Service Charge—Others Postpaid  
"Only Quality Components Sold!"

**DIGI-KEY CORPORATION**  
P.O. Box 126 Thief River Falls, MN 56701

CIRCLE NO. 17 ON READER SERVICE CARD

# LIVE IN THE WORLD OF TOMORROW... TODAY!

And our FREE 180 PAGE CATALOG is packed with exciting and unusual values in electronic, hobby and science items — plus 4,500 finds for fun, study or profit... for every member of the family.

## A BETTER LIFE STARTS HERE

### TOTAL KIRLIAN PHOTOGRAPHY SET

Explore "aura" photography w/ superb new self-contained Kirlian Electrophotography Research Unit. Terrific value — introduced at \$99.95 (\$140 in Sept.)! Has everything but vinyl photo changing bag. Ideal for color or b&w 35mm, sheet or Polaroid film for photos up to 5x7" all without camera or lens. Variable voltage 12v to 32kv. Ultimate safety design—fully encased in plastic; patented electronics. Instrs.

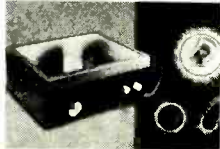

No. 72,104AV... (3x5 7/8x7 7/8") ..... \$99.95 Ppd.  
No. 42,240AV... (CHANGING BAG) ..... \$ 6.50 Ppd.

### 12v WIND-POWERED GENERATOR

Cheapest continuous source of electricity available! Attach to 12v truck batt. (not incl) and get free electricity from the wind. Needs only 7 mph wind — 15 amps output in 23 mph wind; double the watt-hour output of ordinary radio chargers. Remote area and alternate energy source; use on floating rig! 6' propeller (Albers Air-Foil princ.) turns 200w generator; governor prevents overcharging/action. Price includes packing & shipping.



No. 19,189AV... (10'-145 LB.) ..... \$475.00 Ppd.

### FUEL MISER RECLAIMS HEAT

Save your 40% wasted heat to warm a basement, garage or rec room at no extra cost! Instead of going "up the chimney" it goes where you want it. Remove part of furnace exhaust pipe, slip Heat Exchanger in. At 125° fan automat. forces clean air through unit which heats to over 200°F., can be ducted to 20 ft. from unit. 110v AC. Inst.



No. 19,194AV (5" DIA.) Shpg. 17 lb. .... \$99.00 FOB  
No. 19,195AV (6" DIA.) Shpg. 17 lb. .... \$99.00 FOB  
No. 19,198AV (7" DIA.) Shpg. 17 lb. .... \$99.00 FOB

### HI-VOLTAGE ELECTROSTATIC GENERATOR

Van De Graaf low-amp type. 2000,000 volt potential, yet completely safe. Demonstrates lightning, St. Elmo's fire, repulsion of charges, electrostatic dust collection, many other electrical wonders. Meter, 110v, 60 cycle, AC. Humidity range, 0-90%. Current, 1.5 to 2.5 microamps. Aluminum base, frame and charge collector. Unbreakable plastic. Insulating column, 17" height, 6 3/4" diam. Full instructions.



Stock No. 70,264AV ..... \$72.00 Ppd.  
STATIC ELECTRICITY GENERATOR  
Stock No. 70,070AV ..... \$21.50 Ppd.



## MAIL COUPON FOR GIANT FREE CATALOG!

180 PAGES • MORE THAN 4500 UNUSUAL BARGAINS

Completely new 1975 edition. New items, categories, illustrations. Dozens of electrical and electromagnetic parts, accessories. Enormous selection of Astronomical Telescopes. Unique lighting and ecological items. Microscopes, Binoculars, Magnifiers, Magnets, Lenses, Prisms. Hard-to-get surplus bargains. Ingenious scientific tools. 1000's of components.

EDMUND SCIENTIFIC CO.  
300 Edscorp Building, Barrington, N. J. 08007  
Please rush Free Giant Catalog "AV"

Name \_\_\_\_\_  
Address \_\_\_\_\_  
City \_\_\_\_\_ State \_\_\_\_\_ Zip \_\_\_\_\_



## COMPLETE & MAIL WITH CHECK OR M.O.

EDMUND SCIENTIFIC CO. 300 Edscorp Building, Barrington, N.J. 08007

How Many	Stock No.	Description	Price Each	Total
<input type="checkbox"/>		PLEASE SEND GIANT FREE CATALOG "AV"		
<input type="checkbox"/>		Charge my BankAmericard		
<input type="checkbox"/>		Charge my Master Charge *		
Interbank No. <input type="text"/>		Add Handling Chg.: \$1.00, Orders Under \$5.00, 50¢, Orders Over \$5.00		
My Card No. is <input type="text"/>		I enclose <input type="checkbox"/> check <input type="checkbox"/> money order for TOTAL \$ <input type="text"/>		
Card Expiration Date <input type="text"/>		Signature _____		
30-DAY MONEY-BACK GUARANTEE. Name _____		You must be satisfied or return any purchase in 30 days for full refund. *\$15.00 minimum		
City _____ State _____ Zip _____		City _____ State _____ Zip _____		

WHEN YOU COME TO PHILADELPHIA BE SURE TO SEE  
**FREE BICENTENNIAL LIGHT SHOW**  
IN BARRINGTON, N. J. ONLY 10 MINUTES AWAY AT  
**EDMUND FACTORY STORE**

### 3-CHANNEL COLOR ORGAN KIT



Easy to build low-cost kit needs no technical knowledge. Completed unit has 3 bands of audio frequencies to modulate 3 independent strings of colored lamps (i.e. "lows"-reds, "middles"-greens, "highs"-blues. Just connect hi-fi, radio, power lamp etc. & plug ea. lamp string into own channel (max. 300w ea.). Kit features 3 neon indicators, color intensity controls, controlled individ SCR circuits; isolation transformer; custom plastic housing; instr.

Stock No. 41,831AV ..... \$18.95 Ppd

### AM RADIO FITS IN/ON YOUR EAR!



Wear it inconspicuously *everywhere*, listen as you work (lawn, yard, office), watch (game, beach) or wait. Instant music, news, sports. No gimmick, our 6/10-oz. technological wonder has integrated circuit, 11 transistors, patented ferrite antenna/tuner/volume dial. Uses normal silver oxide hearing aid batt. (incl) for approx. 100 hrs. playing. New batt. to slip in avail. at drug stores (about 50¢). No lengthy wires, bulky cases, or power-packs!

Stock No. 42,275AV ..... \$14.95 Ppd.

### KNOW YOUR ALPHA FROM THETA!



(L.E.D.) feedback. Reliable, easy-to-use unit comparable to costlier models. Completely safe. Comprehensive instruction booklet.

No. 1635AV (8x3x4; 24 oz.) ..... \$134.50 Ppd.  
DELUXE "ON" TIME MONITOR—Measures and records % LOW COST "STARTER" UNIT  
No. 1652AV ..... (15x10x6") ..... \$349.50 Ppd.  
No. 71809AV ..... \$55.00 Ppd.  
DO-IT-YOURSELF KIT ..... No. 61,069AV ..... \$34.95 Ppd.

### QUALITY DETECTOR UNDER \$40



New Edmund-developed, fully transistorized BFO unit capable of locating quarter at 18" — powerful 6-trans. oscillator-amplifier circuit. Easily compares to others priced 50% higher! Aluminum pole and housing—not plastic! 6" waterproof search coil (Faraday shielded to elim. outside interference); long 50-hr. battery

(9V) life; powerful 2" speaker; lightweight (2 lbs.). Great buy!  
Stock No. 80,222 AV ..... \$39.95 Ppd.

### 4 1/4" ASTRONOMICAL TELESCOPE



See moon craters, rings of Saturn, double stars. New equatorial mount, f/10, 1/4 wave mirror (Pyrex®). Gives theoretical limit of resolution. Rack & pinion focusing. Aluminum tube, 6X finder, 1" F.L. 45X Kellner achromatic eyepiece and Barlow lens to double & triple power up to 135X. Free Star Chart plus 2 Books.

Stock No. 85,105AV (Shipping Wt. 42 lbs.) ..... \$149.50 FOB  
4 1/4" WITH CLOCK DRIVE ..... No. 85,107AV ..... \$189.50 FOB  
6" REFLECTOR TELESCOPE (48X to 360X) ..... No. 85,187AV ..... \$249.50 FOB  
6" WITH CLOCK DRIVE ..... No. 85,086AV ..... \$285.00 FOB  
3" DELUXE REFLECTOR (30X to 90X) ..... No. 80,162AV ..... \$ 79.95 Ppd.  
STANDARD 3" REFLECTOR ..... No. 85,240AV ..... \$ 49.95 Ppd.



# Introducing the NEW Stanton Gyropoise® turntable

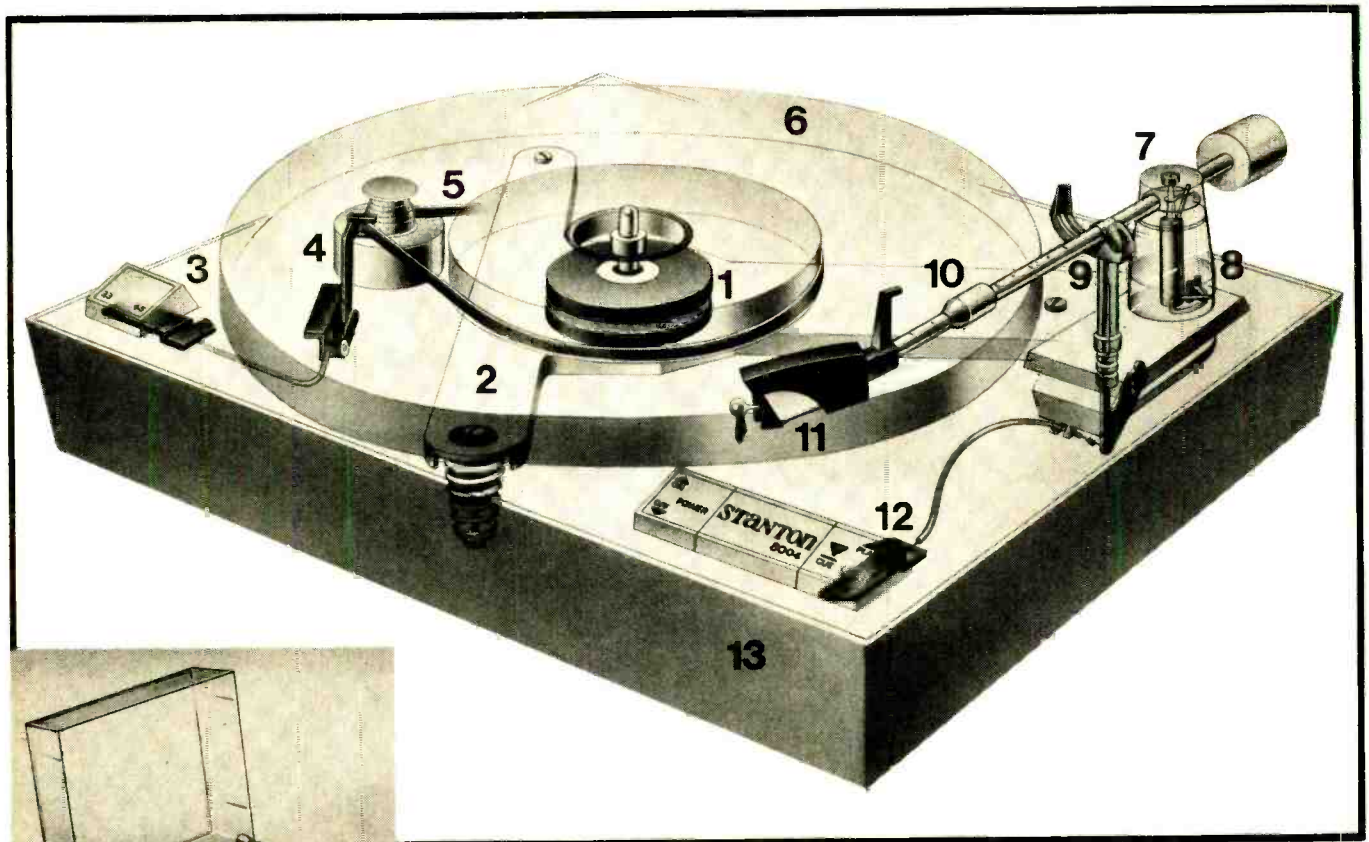

**Look at all these quality features,  
many of them exclusively ours!**

1. Gyropoise®—frictionless magnetic suspension of the platter.
2. Die cast aluminum T-Bar for sturdy structure.
3. 2-Speed changer for 33 rpm and 45 rpm playback.
4. 24-Pole synchronous high torque motor.
5. Belt drive for noiseless operation.
6. 12" die cast machined high polish aluminum platter.
7. Unipoise®—single point tone arm suspension.
8. Anti-skate control adaptable to all types of styli.
9. Magnetic hold bar for tone arm convenience.
10. Stylus force slide (range 0 - 4 grams).
11. Stanton state-of-the-art stereo or discrete cartridge.
12. Viscous damped cueing control for featherlight lowering of stylus.
13. Handsome walnut veneer base (comes complete with dust cover).

#### ADDITIONAL FEATURES:

- (a) Comes equipped with low capacitance cables
- (b) Wow and Flutter— $\leq .07\%$  din 45507 weighted
- (c) Rumble— $\leq -60$  dB din 45539 weighted

It's the important exclusive features that make the difference. Only Stanton Turntables have Gyropoise®, the patented frictionless magnetic suspension bearing—thus the platter makes no vertical contact with the body of the structure. This isolation eliminates vertical rumble.

Only Stanton Turntables have Unipoise®, the patented single point tone arm suspension. The arm is supported by a single pivot for both lateral and vertical movement.

Only Stanton Turntables come equipped with a state-of-the-art Stanton cartridge, either the 681 Triple-E calibrated to the tone arm for stereo playback, or the magnificent 780/4DQ for discrete.

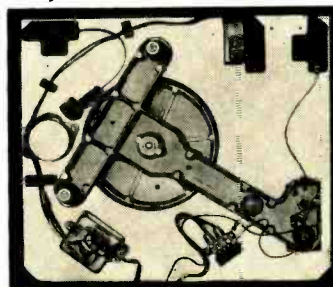

Bottom view shows simplicity of design.

See your franchised Stanton dealer for a demonstration of this great new product.



**STANTON**

MADE IN U.S.A.

For further information, write: Stanton Magnetics, Inc., Terminal Drive, Plainview, N.Y. 11803

CIRCLE NO. 45 ON READER SERVICE CARD



# Tops all of ours and all of theirs too

## the Sansui 881



SANSUI 881 is our finest hour.

The most advanced model in the long line of our already famous AM/FM stereo receivers and it's not only our best, it's the best on the market today.

Specs: 63 watts per channel minimum RMS into 8 Ohm load from 20 Hz to 20 KHz with no more than 0.3% total harmonic distortion. 1.8 microvolts sensitivity.

Hear the SANSUI 881 at your nearest SANSUI franchised dealer - and be sure to pick up your free copy of "The Sounds of SANSUI" or write directly to us.

**SANSUI ELECTRONICS CORP.**  
Woodside, New York 11377 • Gardena, California 90247 • SANSUI ELECTRIC CO. LTD. Tokyo, Japan  
SANSUI AUDIO EUROPE S.A. Antwerp, Belgium • ELECTRONIC DISTRIBUTORS (Canada) B.C.



CIRCLE NO. 41 ON READER SERVICE CARD