

**MATCHING TAPE DECKS TO MAGNETIC TAPE**

# Popular Electronics

WORLD'S LARGEST-SELLING ELECTRONICS MAGAZINE

MAY 1975/75¢

## NEW BIOFEEDBACK MONITOR EASES MUSCLE TENSION

**How Frequency Synthesizers Work**

**Build a Photometer Exposure Meter**

**Latest Shortwave English Broadcast Listings**

### TESTED IN THIS ISSUE

- Sansui 771 FM Stereo Receiver**
- SAE Mark IVD Stereo Power Amplifier**
- Nakamichi 500 Stereo Cassette Deck**
- Pearce-Simpson "Bengal" CB Transceiver**
- Heath SG-1271 Function Generator**

## Converter Turns Counter Into A Digital VOM

**HIGH ACCURACY/LOW COST**

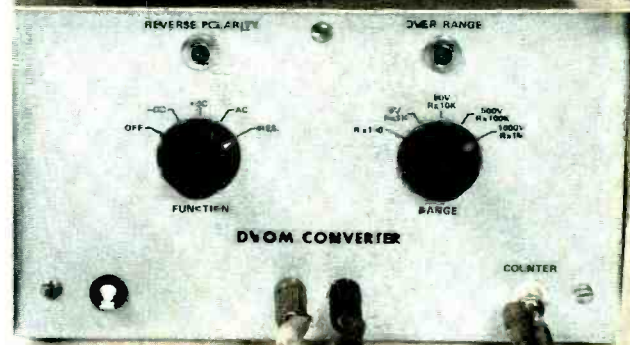

510076 BLU 0220098 64ID N8V75  
 HR ADDL PH L BALUKA  
 220 DOMING AVE  
 FLORISSANT MO 63021

# 4-channel high fidelity substantial savings.

SAVE OVER \$225\*



 **PIONEER**<sup>®</sup>  
when you want something better

Actual selling price of this system will be set by individual dealers at their own discretion. The manufacturer's suggested resale price is \$749.95, a reduction from the original suggested prices of the components sold separately. The suggested resale price of the components sold separately was \$989.90.

# Now! Own a Pioneer 4 channel system at sub

Never before has a Pioneer quadraphonic music system been available at such an unbelievably low price.

As the leading high fidelity craftsmen in the world, Pioneer has assembled a superb quality 4-channel music system that includes everything you need for unlimited enjoyment in the new and exciting world of 4-channel sound.

The control center of this spectacular system is the Pioneer QX-646 4-channel receiver. It places at your fingertips every form of music known to man. And the beauty part is that you get flawless reception of 4-channel and 2-channel FM broadcasts, records and tapes, as well as AM programs, just by turning a selector switch. It's that simple.

There's also four magnificent sounding Pioneer Project 60 loudspeakers that faithfully reproduce the complete tonal range of the human voice as well as every instrument in an orchestra.

Pioneer completes this exceptional system with their PL-10 record

player. This professional quality turntable plays all 33 $\frac{1}{3}$  and 45 rpm records. Its specially designed tone-arm comes completely equipped with a 4-channel cartridge, including a diamond stylus.

For the technically-inclined, this versatile system is able to handle all types of currently-available quad program material: CD-4 discrete 4-channel, SQ matrix 4-channel and regular matrix (QS) 4-channel. No external decoders or other adaptors are required. One front-panel mode selector and the sophisticated internal electronic circuitry do it all.

**Take advantage of this one time offer and save over \$225\***

We urge you to hear this incomparable music system as soon as possible. Selected Pioneer dealers in your area are presenting this sensational limited time system offer at savings of more than \$225\*. Don't pass up this unique opportunity to own a great 4-channel music system at a great price.

## These quality components can add extra enjoyment to your Pioneer 4-channel high fidelity music system, or to any system you may already own.

Here are just a few of the quality components available to increase the versatility of this magnificent system.

### **RT-1020L Open Reel Tape Deck.**

Records stereo programs and plays back 2-channel and 4-channel tapes. Endless hours of listening pleasure with 10 $\frac{1}{2}$ -inch reels. \$649.95. Other studio-quality models from \$599.95.

### **CT-7171 Stereo Cassette Deck.**

The finest performing cassette deck in its price range. Maximum convenience

with all controls and illuminated cassette compartment on front panel. Can be stacked above or beneath other components. Many professional type features, including Dolby noise reduction system. \$369.95. Other models from \$179.95.

### **SE-505 Stereo Headphones.**

Enjoy hours of outstandingly natural sound in complete privacy. Volume and tone controls on each kid soft earpiece. 16 $\frac{1}{2}$ -foot coil cord and permanent storage case. \$59.95. Complete selection of Pioneer headphones starting at \$24.95.



U.S. Pioneer Electronics Corp., 75 Oxford Drive, Moonachie, N. J. 07074.  
West: 13300 S. Estrella, Los Angeles 90248 / Midwest: 1500 Greenleaf, Elk Grove Village, Ill. 60007  
Canada: S. H. Parker Co.

[www.americanradiohistory.com](http://www.americanradiohistory.com)

\*The actual price represents a reduction from the original price.

**You can't expect  
great music,  
unless you have a  
great music system.**

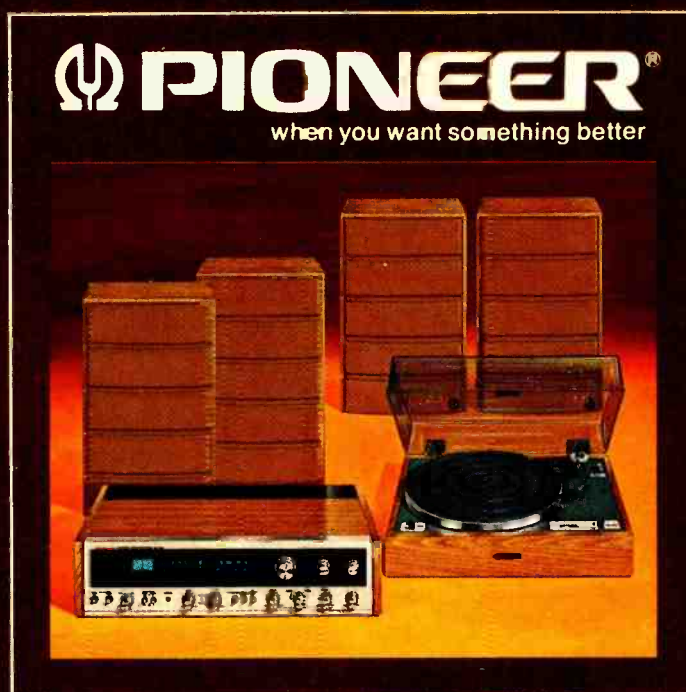

**You are about to read  
the most exciting offer ever made  
on a great music system.**

**ALABAMA**

**Auburn**  
Herbert Music  
**Birmingham**  
ABC Wide World of Music  
**Huntsville**  
Hi Fi Int'l. Sound  
**Sheffield**  
Powell Electronics Inc.

**ALASKA**

**Fairbanks**  
Hoitt's Music Shop

**ARIZONA**

**All Stores of Bill's Records & Audio Custom Hi-Fi Center Hessler's**  
**Mesa**  
Hi Fi Sales, Inc.  
**Phoenix**  
ABC Wide World of Entertainment Audio Specialists  
La Belle's Dist.  
**Scottsdale**  
La Belle's Dist.  
**Tempe**  
Audio Specialists  
**Tucson**  
Sid's Appliance Center

**ARKANSAS**

**Little Rock**  
Walloch's TV  
**Wynne**  
Sounds Investments

**CALIFORNIA**

**All Stores of Cal Stereo**  
**Anaheim**  
Now Sound  
**Chico**  
Sound World  
**Daly City**  
Matthew's  
**El Centro**  
Radio Shack  
**Hemet**  
National Auto Glass  
**Los Angeles**  
Andes Company  
International TV Corp.  
Shelley's Audio  
**Montebello**  
Now Sound  
**Monterey**  
Gramophones & Things  
**Redding**  
Stereo Tape Center  
**Sacramento**  
Handy Andy  
**San Francisco**  
Macy's  
**Santa Ana**  
Shelley's Audio  
**Santa Monica**  
Shelley's Audio  
**Van Nuys**  
Shelley's Audio  
**West Los Angeles**  
Now Sound  
**Yuba City**  
Specialty Stereo

**COLORADO**

**All Stores of Burstein-Applebee Team Electronics**  
**Arvada**  
Sound Track  
**Denver**  
La Belle's Dist.  
SDC

**CONNECTICUT**

**Farmington**  
Tech TV & Stereo  
**Groton**  
France Electronics, Inc.  
**Meriden**  
Sound of Music  
**New Haven**  
Audio Den, Inc.

**FLORIDA**

**Altamonte Springs**  
Wide World of Music  
Wolfman Mason's  
**Clearwater**  
Towers Distributing Co.  
**Daytona Beach**  
Cox's Appliance City  
**Ft. Lauderdale**  
Bell Hi Fi Stores  
Kay's Electronics  
Kennedy & Cohen  
**Ft. Walton Beach**  
Grice Electronics

**Key West**

Swift Camera  
**Lake Worth**  
Sound Shack  
**Lakeland**  
Dome Electronics  
**Lauder Hill**  
Kay's Electronics  
**Miami**  
21st Century Electronics  
**North Miami Beach**  
Sound Systems  
**Ocala**  
Stafford Electronics  
**Orlando**  
21st Century Electronics  
Wolfman Mason's  
**Panama City**  
Grice Electronics  
**Pensacola**  
Grice Electronics  
**Pompano Beach**  
Kennedy & Cohen  
**Sarasota**  
Sound Emporium  
**Tampa**  
Tampa Stereo  
**West Palm Beach**  
Kennedy & Cohen

**GEORGIA**

**Athens**  
Custom Sound  
**LaGrange**  
Audio City

**ILLINOIS**

**All Stores of Musicraft Pacific Stereo Team Electronics York Electronics**  
**Canton**  
Stereo Village  
**Chicago**  
Levitz  
The Warehouse  
**Chicago Heights**  
Sights & Sounds  
**McHenry**  
Tone's Music  
**Moline**  
Audio Dimensions

**INDIANA**

**Anderson**  
Sound Enterprises  
**Bedford**  
W.H.O. Electronics  
**Columbus**  
Music Box  
**Crawfordsville**  
Lew's Stereo Shop  
**Elkhart**  
Sound Masters  
Templin's Music  
**Fort Wayne**  
Classic Stereo  
York Electronics  
**Gary**  
Audio Fidelity  
**Indianapolis**  
Playback  
**Jasper**  
Sound of Music  
**Kokomo**  
Music Machine  
Warehouse Sales  
**Lafayette**  
C.W.Y. Electronics  
York Electronics  
**Michigan City**  
Audio Fidelity  
Tri State Electrical  
**Mishawaka**  
Playback  
Templin's  
**North Manchester**  
Hire Electric  
**Richmond**  
Cornell Appliance  
**South Bend**  
Sound Masters  
**Valparaiso**  
Casbon Electric  
**West Lafayette**  
C.W.Y. Electronics

**IOWA**

**All Stores of Playback Team Electronics Cartridge City**  
**Cedar Falls**  
Sampson's Hi Fi  
**Storm Lake**  
Ryan's Musicland

**KANSAS**

**All Stores of Burstein-Applebee Team Electronics**

**Prairie Village**

Audio Electronics  
**Wichita**  
Electronics

**KENTUCKY**

**Lexington**  
Pieratt's Appliance  
Playback  
**Louisville**  
P. I. Burks Company  
Bacon's  
Bacon's St. Matthews  
Dixie Appliance  
Playback  
**Shively**  
Bacon's

**LOUISIANA**

**Baton Rouge**  
Kadair's  
**Lake Charles**  
Jay's Stereo  
**Metairie**  
Tape City U.S.A.  
**Monroe**  
Specialty Sound  
**Shreveport**  
Shreveport Refrig.

**MAINE**

**Portland**  
New England Music

**MARYLAND**

**All Stores of Atlantis Sound George's**  
**Catonsville**  
Stereo Discounters  
**Cumberland**  
Sound World  
**Dundalk**  
Stansbury Stereo  
Center  
**Moravi**  
International Hi Fi  
**Timonium**  
Stereo Discounters  
**Woodlawn**  
Stereo Discounters

**MASSACHUSETTS**

**All Stores of Atlantis Sound Lechmere Sales Tech Hi-Fi**  
**Boston**  
Copley Camera Shop  
**Cambridge**  
Tweeter, etc.  
**Chestnut Hill**  
Tweeter, etc.  
**Fitchburg**  
Fitchburg Music Store  
**Holyoke**  
Paysaver  
**Springfield**  
Paysaver

**MICHIGAN**

**All Stores of E. J. Korvettes Highland Appliance Lafayette Playback Tech Hi-Fi**  
**Ann Arbor**  
Mr. Music  
**Bay City**  
Boulevard Electronics  
**Coldwater**  
J. B. Branch  
**Dearborn**  
Adray Appliance  
**Detroit**  
Mister Music  
National Gift Shop  
Stereo City  
**Escanaba**  
Felton Radio  
**Flint**  
Boulevard Elec.  
TV Engineers  
**Lansing**  
Mister Music  
Rogers Distr. Co.  
**Livonia**  
Audioland  
**Marquette**  
Sound Center  
**Midland**  
Boulevard Elec.  
**Mt. Clemens**  
Audioland  
**Mt. Pleasant**  
Dart Electronics  
**Petoskey**  
Petoskey Elec.  
**Saginaw**  
Boulevard Elec.  
Mister Music

**Saint Louis**

Shirley's Sound  
Connection  
**Sault Ste. Marie**  
Kings Radio & TV  
**Southgate**  
Brothers Appliance  
**Traverse City**  
Kurtz Music & Sound  
**Wyandotte**  
Mister Music  
Stereo City

**MINNESOTA**

**All Stores of Dayton's Team Electronics**  
**Bemidji**  
Stereo One  
**Brainerd**  
Stereo One  
**Brooklyn Center**  
La Belle's  
**Burnsville**  
Kennedy & Cohen  
**Duluth**  
Sound America  
**Fergus Falls**  
Leyguist Sound  
Idea Store  
**Marshall**  
Flash Radio & TV  
**Minneapolis**  
Audio King  
**Minnetonka**  
La Belle's  
**Morris**  
Leyguist Sound  
Idea Store  
**Richfield**  
La Belle's  
**Roseville**  
Kennedy & Cohen  
**St. Paul**  
La Belle's

**NEW MEXICO**

**Albuquerque**  
Sound Equipment  
Company

**NEW YORK**

**All Stores of Arrow Audio Atlantis Sound Churchill Stereo Harvey Sound E. J. Korvettes Macy's Newmark & Lewis Sam Goody's**  
**Albany**  
Sounds Great  
**Baldwin Place**  
Radio Shack  
**Bay Shore**  
World Audio  
**Bronx**  
Cam Electronics  
**Brooklyn**  
Designers Audio  
Mateco Electronics  
Municipal Radio  
**Buffalo**  
Purchase Radio  
**Corning**  
Chemung Electronics  
**Elmira**  
Chemung Electronics  
**Freeport**  
World Audio  
**Hicksville**  
Electronic City, Inc.  
**Herkimer**  
Valley Stereo Center  
**Ithaca**  
Stereo Shack  
**Kenmore**  
Stereo Shack  
**Manhattan**  
Arrow Audio  
**Atlantic Sound**  
Borger's  
Churchill Stereo  
Harvey Sound  
E. J. Korvettes  
Leonard  
Macy's  
Morel Electronics  
Packard Electronics  
Sound & Sight  
Sam Goody  
Tech Hi Fi  
Willoughby/Peerless  
**New Paltz**  
Vista Camera  
**Newburgh**  
Vista Camera  
**Niagara Falls**  
Market Radio  
**Patchogue**  
Square Deal  
**Pittsford**  
Maynard's  
**Rockville Center**  
Rockville Hi Fi  
**Rosevelt Field**  
Audio Exchange  
**Scarsdale**  
Forbes  
**Syracuse**  
Gordon Electronics  
Sounds Great

**MONTANA**

**Great Falls**  
Team Elec.  
**Missoula**  
Team Elec.

**NEBRASKA**

**Omaha**  
Team Elec.

**NEVADA**

**Las Vegas**  
Garhime Music  
**Reno**  
Music 'N Things

**NEW HAMPSHIRE**

**Plaistow**  
Ashmont Electronics

**NEW JERSEY**

**All Stores of Atlantis Sound Churchill Stereo E. J. Korvettes Macy's Sam Goody's Tech Hi-Fi Vornado, Inc.**  
**Bergenfield**  
Arco  
**Cherry Hill**  
Sound Associates

**Eatontown**

U.S. Stereo Center  
**Edison**  
Music Den  
**Elizabeth**  
American Recording  
**Flanders**  
Acro Sound  
**New Brunswick**  
Hi Fi Haven  
**North Plainfield**  
Stereo Tape City  
**Northfield**  
Lafayette Radio  
Rainbow Electronics,  
**Parsippany**  
Par Troy Sound Center  
**Paterson**  
H. Bogard & Co.  
**Ramsey**  
Interstate Electronics  
**Shrewsbury**  
Monmouth Stereo  
Center  
Radio Shack  
**Toms River**  
Rand Camera  
**Totowa**  
Arrow Audio  
**Washington Township**  
Washington Stereo  
Center  
**Woodbridge**  
Woodbridge Stereo  
Center

**Tonawanda**

Purchase Radio  
**West Seneca**  
Purchase Radio  
**White Plains**  
Westchester Stereo  
**Yonkers**  
Westchester Stereo

**NORTH CAROLINA**

**All Stores of Atlantis Sound**

**NORTH DAKOTA**

**All Stores of Team Electronics**  
**Bismarck**  
Music City  
**Grand Forks**  
Mr. Music Man  
**Williston**  
Russ Nelson Appliance

**OKLAHOMA**

**All Stores of Burstein-Applebee Team Electronics**  
**Lawton**  
Hawkin's TV  
**Norman**  
Thompson's Sound

**OHIO**

**Akron**  
Auto Home Stereo  
Olson Electronics  
**Alliance**  
Sound World  
**Canton**  
Auto Home Stereo  
Walkeradio  
**Cincinnati**  
Hi Fi Audio  
Swallen's  
**Cleveland**  
B & B Appliance  
Olson Electronics  
**Columbus**  
Sun TV  
**Dayton**  
Budco Sales  
Custom Electronics  
**East Liverpool**  
TV Parts  
**Fairborn**  
Custom Electronics  
**Fremont**  
American Audio  
**Hollansburg**  
Davis TV  
**Kent**  
Custom Sounds  
**Mansfield**  
Servex Electronics  
**Marion**  
Servex Electronics  
**Newark**  
Sun TV  
**New Philadelphia**  
Lahmer's TV  
**Northwood**  
Mister Music  
**Sandusky**  
Servex Electronics  
**Sheffield Lake**  
I.L.G. TV  
**Springfield**  
Custom Electronics  
**Sylvania**  
Mister Music  
**Toledo**  
Jamieson Hi Fi  
Burstein Applebee  
**Warren**  
Custom Sounds  
**Wooster**  
Servex Electronics  
**Youngstown**  
Custom Sounds

**OREGON**

**Bend**  
Bend Sound Center  
**Corvallis**  
O.S.U. Bookstores  
**Eugene**  
Thompson's Lafayette  
**Medford**  
Larson's Appliance  
**Salem**  
Shogren's

**PENNSYLVANIA**

**All Stores of Wander Sales TV Parts**  
**Allentown**  
The Eastern Light Co.  
High Fidelity House  
**Altoona**  
Book and Record  
**Erie**  
Mace Electronics

**Greensburg**

Pat's Stereo  
**Meadville**  
Mace Electronics  
**Natrona Hts.**  
Sound Shack  
**Philadelphia**  
Radio 437, Inc.  
**Pittsburgh**  
Sound World  
**Rockwood**  
Phillippi Elec.  
**Sharon**  
Stereo Shop  
**Spring House**  
Sound Logic  
**Uniontown**  
Sound World

**RHODE ISLAND**

**E. Providence**  
Impulse Inc.  
**Woonsocket**  
Listening Post

**TENNESSEE**

**Chattanooga**  
Capital Audio Visuals,  
**Clarksville**  
Radio Shack  
**Knoxville**  
England Sound, Inc.  
**Memphis**  
Modern Music

**TEXAS**

**Amarillo**  
Capitol Electronics  
**Austin**  
Texas Stereo  
**Beaumont**  
Dyer Electronics  
Finger's Furniture  
Sterling Electronics  
**Corpus Christi**  
Tape Town  
**Houston**  
Custom Hi Fi  
Finger's Furniture  
Sterling Electronics  
**Lubbock**  
Edward's Electronics  
**Odessa**  
Tape Town  
**South Houston**  
Sterling Electronics  
**Victoria**  
Parris Electronics

**UTAH**

**Bountiful**  
Circle Sound  
**Salt Lake City**  
Inkley's  
La Belle's Dist.

**VIRGINIA**

**All Stores of Atlantis Sound George's**

**WASHINGTON**

**Bellingham**  
Quad Corner  
**Lacey**  
Roberts & Company  
**Olympic**  
Music Bar  
**Seattle**  
American Mercantile  
ABC Wide World of  
Entertainment  
Jafco  
Pearl Electronics  
**Spokane**  
Huppin's Hi Fi  
**Tacoma**  
Lakewood Villa Stereo

**WASHINGTON, D.C.**

Atlantis Sound  
George's

**WEST VIRGINIA**

**Huntington**  
Mack and Daves  
**Parkersburg**  
Tape Mall  
**Morgantown**  
Sound World

**WISCONSIN**

**All Stores of Playback Team Electronics**  
**Ashwaubenon**  
Kohl's Lombardi Plaza  
**Green Bay**  
A. B. Communication/  
Hi Fi Haven  
**Madison**  
American TV  
**Milwaukee**  
Port of Sound

# Radio Shack "Range Busters" SSB/AM CB at its Best!



You can't beat the extra power and extra reliability of SSB when you're using CB 2-way radio. If you're in a heavy-CB-usage area, SSB really multiplies the chance of getting your signal through. It's added insurance when you need it most. And now you can get immediate delivery on both these great Realistic® SSB transceivers.



**329<sup>95</sup>**

## BASE/MOBILE TRC-46

The one with everything! 12-watts P.E.P. output, combined with Range-Boost circuit, for the ultimate in power. Total 69-channel capability—46 on SSB, 23 on AM—and you get crisp, clear performance on them all. A "clarifier" to shift both the transmitter and receiver for Net operation. A PA switch that lets you use the set as a public address amplifier and still receive incoming CB calls. Even an extra, remote volume control on the mike—a real convenience for mobile use. With all crystals, mobile mounting bracket, 110 VAC and 12 VDC power cables. U.L. listed. FCC Type Accepted. #21-146

## TRC-47 – OUR FINEST MOBILE TRANSCEIVER



Linear sideband circuitry gets through when AM won't—and the dual conversion receiver captures the faintest signals. 12-watts P.E.P. output, 69-channel capability, clarifier and RF gain controls, superb specs. With all crystals, mobile bracket, cables. FCC Type Accepted. #21-147. **249<sup>95</sup>**

## FREE New 1975 Radio Shack Catalog

OVER 2000 PRODUCTS  
EXCLUSIVES ON EVERY PAGE  
BEAUTIFUL FULL COLOR

Stereo • Quadraphonic • Phonographs  
TV Antennas • Radios • Citizens Band  
Kits • Recorders • Tape • Tools  
Auto Tune-Up • Electronic Parts  
Test Instruments • More!



164 pages of the finest in home and hobby electronics. Respected brand names like Realistic, Micronta, Archer, Science Fair — and they're available only at Radio Shack stores and dealers nationwide! See what's really new in electronics by getting this catalog now.

SEND FOR YOURS TODAY!  
FILL OUT COUPON BELOW

1975 Mail to Radio Shack, P. O. Box 1052, 512  
Catalog Ft. Worth, Texas 76101. (Please print.)

Name \_\_\_\_\_ Apt. No. \_\_\_\_\_

Street \_\_\_\_\_

City \_\_\_\_\_

State \_\_\_\_\_ ZIP \_\_\_\_\_

There's only one place you can find them . . .



Master Charge or  
Bank Americard at  
participating stores

# Radio Shack®

A TANDY CORPORATION COMPANY

OVER 3000 STORES • 50 STATES • 7 COUNTRIES

Retail prices may vary at individual stores.

POPULAR ELECTRONICS

# Popular Electronics®

WORLD'S LARGEST SELLING ELECTRONICS MAGAZINE

## FEATURE ARTICLES

<b>MATCHING TAPE DECKS TO MAGNETIC TAPE</b> .....	Leonard Feldman	34
<i>How to obtain optimum performance from any tape formulation.</i>		
<b>HOW ACCURATE IS YOUR AC DIGITAL CLOCK?</b> .....	R. L. Conhaim	38
<b>HOW FREQUENCY SYNTHESIZERS WORK</b> .....	Thomas R. Sear	43
<i>Many highly accurate frequencies can be generated from single crystal.</i>		
<b>WHAT DO YOU KNOW ABOUT TRANSFORMERS?</b> .....	Robert P. Balin	51
<b>ENGLISH LANGUAGE SHORTWAVE BROADCASTS</b> .....	Roger Legge	67
<i>What's in store for the summer months—May to August?</i>		

## CONSTRUCTION ARTICLES

<b>CONVERTER TURNS COUNTER INTO A DIGITAL VOM</b> .....	Robert S. Stein	27
<i>Turn your counter into a highly accurate 3¼-digit DVOM.</i>		
<b>UNIQUE CONTINUITY TESTER</b> .....	J. von Muecke	33
<i>Two-transistor VCO generates only 50 microamperes.</i>		
<b>HI-LO PASS FILTER</b> .....	Raymond George Ross	38
<i>An easy-to-build accessory for your CB rig.</i>		
<b>BUILD A MUSCLE FEEDBACK MONITOR</b> .....	Mitchell Waite	39
<i>New biofeedback technique helps to reduce tensions.</i>		
<b>LOW-COST REMOTE CONTROL OF APPLIANCES &amp; LIGHTS</b> .....	George A. Ellson	46
<i>Ordinary flashlight is used to trigger this control.</i>		
<b>BUILD A WIDE-RANGE PHOTOMETER AND ENLARGER EXPOSURE METER</b> .....	A. A. Mangieri	48
<i>Darkroom accessory covers broad spectrum of light intensities.</i>		

## COLUMNS

<b>STEREO SCENE</b> .....	Ralph Hodges	15
<i>Good Stereo.</i>		
<b>DX LISTENING</b> .....	Glenn Hauser	68
<i>Try a little TV DX-ing this summer.</i>		
<b>CB SCENE</b> .....	Len Buckwalter	70
<i>Microphone Techniques.</i>		
<b>SOLID-STATE</b> .....	Lou Garner	76
<i>A Look at DC Converters.</i>		
<b>TEST EQUIPMENT SCENE</b> .....	Leslie Solomon	86
<i>Tuning the VITS.</i>		
<b>HOBBY SCENE</b> .....	Editorial Staff	88

## PRODUCT TEST REPORTS

<b>SANSUI 771 AM/STEREO FM RECEIVER</b> .....	56
<b>SAE MARK IVDM BASIC POWER AMPLIFIER</b> .....	58
<b>NAKAMICHI MODEL 500 CASSETTE DECK</b> .....	59
<b>PEARCE-SIMPSON BENGAL AM/SSB CB TRANSCEIVER</b> .....	60
<b>HEATH/SCHLUMBERGER MODEL SG-1271 FUNCTION GENERATOR</b> .....	66

## DEPARTMENTS

<b>EDITORIAL</b> .....	Art Salsberg	4
<i>Testing ... Testing</i>		
<b>LETTERS</b> .....		6
<b>NEW PRODUCTS</b> .....		12
<b>NEW LITERATURE</b> .....		14
<b>ELECTRONICS LIBRARY</b> .....		89

POPULAR ELECTRONICS, May 1975, Volume 7, Number 5. Published monthly at One Park Avenue, New York, NY 10016. One year subscription rate for U.S., \$6.98; U.S. Possessions and Canada, \$7.98; all other countries, \$8.98. Second Class postage paid at New York, NY and at additional mailing offices. Authorized as second class mail by the Post Office Department, Ottawa, Canada and for payment of postage in cash. Subscription service and Forms 3579; P.O. Box 2774, Boulder, CO 80302.

POPULAR ELECTRONICS including ELECTRONICS WORLD. Trade Mark Registered. Indexed in the Reader's Guide to Periodical Literature. COPYRIGHT © 1975 BY ZIFF-DAVIS PUBLISHING COMPANY. ALL RIGHTS RESERVED.

Ziff-Davis also publishes Boating, Car and Driver, Cycle, Flying, Modern Bride, Popular Photography, Skiing and Stereo Review.

Forms 3579 and all subscription correspondence should be addressed to POPULAR ELECTRONICS, Circulation Dept., P.O. Box 2774, Boulder, CO 80302. Please allow at least eight weeks for change of address. Include your old address, as well as new—enclosing, if possible, an address label from a recent issue. Send editorial correspondence to POPULAR ELECTRONICS, 1 Park Ave., New York, NY 10016. Editorial contributions must be accompanied by return postage and will be handled with reasonable care; however, publisher assumes no responsibility for return or safety of manuscripts, art work, or models.

**EDGAR W. HOPPER**  
Publisher

**ARTHUR P. SALSBERG**  
Editorial Director

**LESLIE SOLOMON**  
Technical Editor

**JOHN R. RIGGS**  
Managing Editor

**ALEXANDER W. BURAWA**  
Feature Editor

**EDWARD I. BUXBAUM**  
Art Director

**JOHN McVEIGH**  
Assistant Editor

**ANDRE DUZANT**  
Technical Illustrator

**HERBERT S. BRIER**  
**LEN BUCKWALTER**  
**LOU GARNER**  
**GLENN HAUSER**  
**JULIAN D. HIRSCH**  
**RALPH HODGES**  
**ART MARGOLIS**  
Contributing Editors

**JOSEPH E. HALLORAN**  
Advertising Director

**JOHN J. CORTON**  
Advertising Sales

**LINDA BLUM**  
Advertising Service Manager

**PEGI McENEANEY**  
Executive Assistant

**STANLEY NEUFELD**  
Associate Publisher

**FURMAN H. HEBB**  
Group VP, Electronics & Photo

ZIFF-DAVIS PUBLISHING COMPANY  
Popular Electronics  
Editorial and Executive Offices  
One Park Avenue New York, New York 10016  
212-725-3500  
Hershel B. Sarbin, President  
Furman Hebb, Executive Vice President  
Vincent Perry, Financial Vice President and Treasurer  
Phillip T. Heffernan, Senior Vice President, Marketing  
Edward D. Muhlfeid, Senior Vice President, Sports Division  
Philip Sine, Senior Vice President  
Frank Pomerantz, Vice President, Creative Services  
Arthur W. Bulzow, Vice President, Production  
Lawrence Sporn, Vice President, Circulation  
George Morrissey, Vice President  
Sydney H. Rogers, Vice President  
Sidney Holtz, Vice President  
Charles B. Seton, Secretary  
Edgar W. Hopper, Vice President, Electronics Div.

William Ziff, Chairman  
W. Bradford Briggs, Vice Chairman

Midwestern Office  
The Pattis Group, 4761 West Touhy Ave.,  
Lincolnwood, Illinois 60644, 312 679-1100  
GERALD E. WOLFE, GEORGE B. MANNION  
THOMAS HOCKNEY

Western Office  
9025 Wilshire Boulevard, Beverly Hills, CA 90211  
213 273-8050; BRadshaw 2-1161  
Western Advertising Manager, **BUD DEAN**

Japan: James Yagi  
Oji Palace Aoyama, 6-25, Minami Aoyama  
6 Chome, Minato-Ku, Tokyo 407-1930/6821  
582-2851

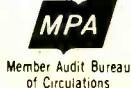

## Editorial

### TESTING . . . TESTING . . .

Readers regularly request that we test certain products, ask why we haven't examined others, and wonder why all our test reports are, essentially, "good."

Our policy on Product Test Reports is simple. With limited space, covering from four to six diverse electronic products every issue, we cannot hope to test all brands and models. We therefore select products that we believe will be of most interest to readers and are, outwardly, of reasonable value and good design.

If a brand is not covered in our product test department, it means one of four things: we did not think the product offered the potential of good value and design; the manufacturer did not wish his product reviewed; the product failed to meet important claims made for it; or we simply didn't have the time or space to report on a product.

It might seem strange to consumers to hear that some (very few) manufacturers do not wish their products reviewed, passing up the obvious publicity they would garner. But several don't—for a variety of reasons. For example, at least one manufacturer feels that reviewing the product would be unfair to his company because our tests do not cover longevity and reliability, factors that contribute to the line's seemingly high cost. We, of course, can only allude to the potential for both since we're not going to live with a product for a year and then retest it. (By that time, it's likely that the model would have been superseded by a later one anyway.)

Some others decline because they say sales are so great that they cannot fill their dealer pipelines, and therefore cannot spare a single unit.

Other products fail our tests miserably. In such instances, we request a second unit, assuming there was shipping damage or we had gotten a "lemon." If after testing the second one, it too fails, we unhappily ship it back to the manufacturer and refuse to examine another one. Since we're always pressed for enough room to cover products that are of good value for the money, we don't complete costly evaluations of such equipment, and therefore don't publish the results.

In line with the above, we returned a second model of a CB unit today that usurped our time and energy without hard copy to show for it. Both units exceeded FCC output limits by a substantial margin, and the second unit had no output on lower sideband, agc action deteriorated audio quality, the automatic noise control killed audio output and switching the selector knob produced horrendous audio clicks. We stopped our lab tests right there!

Thus, equipment tested and reported in POPULAR ELECTRONICS is at least worthy of buying consideration. All our comments and reported specifications are *not* totally favorable, however. Deficiencies and tradeoffs are duly noted: "good," "excellent," "superior," and other adjectives pinpoint equipment attributes. Keep in mind, though, that superlatives that are valid one year may no longer be true two years later when technology has advanced. You'll also be interested to know that *no one* is permitted to change a single technical specification reported by our independent laboratories, whether good or bad and whether it is an advertiser's product or not. We're proud of this policy.

*Art Salsberg*

The publisher has no knowledge of any proprietary rights which will be violated by the making or using of any items disclosed in this issue.





# CT-1024 TERMINAL SYSTEM



When we designed the CT-1024 we knew that there were many applications for an inexpensive TV display terminal system. Even so, we have been surprised at the many additional uses that have been suggested by our customer in the last four months since we introduced this kit.

The basic kit, consisting of the character generator, sync and timing circuits, cursor and 1024 byte memory gives you everything you need to put a sixteen line message on the screen of any TV monitor, or standard set with a video input jack added to it. Input information to the CT-1024 may be any ASCII coded source having TTL logic levels. Two pages of memory for a total of up to one thousand and twenty four characters may be stored at a time. The CT-1024 automatically switches from page one to page two and back when you reach the bottom of the screen. A manual page selector switch is also provided. The main board is 9 1/2 x 12 inches. It has space provided to allow up to four accessory circuits to be plugged in. If you want a display for advertising, a teaching aid, or a communication system then our basis kit and a suitable power supply is all you will need.

**CT-1 TERMINAL SYSTEM with MEMORY KIT** .....\$175.00 ppd  
Power supply kit to provide + 5 Volts @ 2.0 Amps and - 5 Volts, -12 Volts @ 100 Ma. required by the CT-1 basic display system.

**CT-P POWER SUPPLY KIT**.....\$15.50 ppd

A very nice convenience feature at a very reasonable cost is our manual cursor control plug-in circuit. The basic kit allows you to erase a frame and to bring the cursor to the upper left corner (home up). By adding this plug-in, you can get Up, Down, Left, Right, Erase to End of Line and Erase to End

of Frame functions. These may be operated by pushbutton switches, or uncommitted keyswitches on your keyboard. Although not essential to terminal operation, these features can be very helpful in some applications.

**CT-M MANUAL CURSOR CONTROL KIT**.....\$11.50 ppd

If you plan to use your terminal with a telephone line modem, or any other system that requires a serial data output; you will need our serial interface (UART) plug-in circuit. This circuit converts the ASCII code from a parallel to a serial form and adds "Start" and "Stop" bits to each character. The standard transmission rate for this circuit is 110 Baud, but optional rates of 150, 300, 600 and 1200 Baud may be obtained by adding additional parts to the board. The output of this circuit is an RS-232 type interface and may be used to drive any type modem, or coupler system using this standard interface.

**CT-S SERIAL INTERFACE (UART) KIT**.....\$39.95 ppd

If you are using the CT-1024 as an IO (input - output) device on your own computer system, you will probably

want to connect it to the computer with a parallel interface system. A direct parallel interface allows for much faster data transmission and reception and is basically a simpler device than a serial interface system. Our parallel interface circuit contains the necessary tristate buffers to drive either a separate transmit and receive bus system, or a bidirectional data bus system. TTL logic levels are standard on this interface. Switch selection of either full, or half duplex operation is provided. The terminal may write directly to the screen, or the computer may "echo" the message and write to the screen.

**CT-L PARALLEL INTERFACE KIT**.....\$22.95 ppd

We would be happy to send you a complete data package describing the CT-1024 and a schematic. If you want this additional information, circle our number shown below on your reader information service card. The CT-1024 kit has complete assembly instructions with parts location diagrams and step-by-step wiring instructions. If you would like to check the instruction manual before you purchase the kit, please return the coupon with \$1.00 and we will rush you the manual and the additional data mentioned above.

### MAIL THIS COUPON TODAY

Enclosed is \$ \_\_\_\_\_  or Master Charge # \_\_\_\_\_

or BankAmericard # \_\_\_\_\_ Card Expiration Date \_\_\_\_\_

CT-1024 Kit  CT-M Cursor Control Kit

CT-S Serial Interface Kit  CT-L Parallel Interface Kit

NAME \_\_\_\_\_

ADDRESS \_\_\_\_\_

CITY \_\_\_\_\_ STATE \_\_\_\_\_ ZIP \_\_\_\_\_

\$1.00 Enclosed send manual and data package

Southwest Technical Products Corp., Box 32040, San Antonio, Texas 78234

# FREE EICO CATALOG

## 346 Ways To Save On Instruments, Burglar Alarms, Automotive & Hobby Electronics!

The more you know about electronics, the more you'll appreciate EICO. We have a wide range of products for you to choose from, each designed to provide you with the most pleasure and quality performance for your money. The fact that more than 3 million EICO products are in use attests to their quality and performance.

### "Build-it-Yourself" and save up to 50% with our famous electronic kits.

For latest EICO Catalog on Test Instruments, Automotive and Hobby Electronics, Eicocraft Project kits, Burglar-Fire Alarm Systems and name of nearest EICO Distributor, check reader service card or send 50¢ for fast first class mail service.

**EICO—283 Malta Street,  
Brooklyn, N.Y. 11207**

*Leadership in creative electronics  
since 1945.*



CIRCLE NO. 17 ON READER SERVICE CARD



## Letters

### WANTED: MAILING LABEL REMOVER

Do you know of any chemical or process for removing the mailing labels from POPULAR ELECTRONICS and other magazines without destroying the covers?

HENRY M. PROVEAUX  
North Charleston, S.C.

*Try rubber cement thinner, available from most art supply stores. Saturate the label with the thinner. Then very slowly peel away the label. The gummy residue left on the cover can be removed with additional thinner and a soft tissue, but you run the risk of smearing the inks. Alternatively, you can set the magazine aside until the residue has completely set. Caution: the thinner is highly flammable and volatile.*

### WHO'S THE MANUFACTURER?

Can you tell me the name of the company that manufactures the image sensor used in the "Cyclops" solid-state TV camera published in the February 1975 issue?

PETER VANDER WEL  
Modern Video Engineering Co.  
Muskegon, Mich.

*The 1024-element image sensor is specially made for the authors and is available only from them. Thus, we listed no manufacturer's number.*

### GETTING TV WITHOUT PICTURES

I record many programs off the air from my AM/FM and TV receivers. I would like to record the sound from selected TV broadcasts without having to turn on a picture as well. What I would really like is a reasonably priced, easy-to-operate tuner that provides only the sound portions of TV broadcasts. Does such a device exist?

FLOYD E. COX  
Halifax, Mass.

*Rhoades Model TE-300 vhf/uhf television high-fidelity audio tuner retails for \$169. Write to Rhoades National Corp., P.O. Box 817, Hendersonville, TN 37075.*

### MATH ERROR

The sample problem given in the Scientific Calculator Project article (January 1975) was incorrectly solved. While it is

true that "no memory or external scratch pad was required to find the solution," the keying sequence given and answer arrived at are both incorrect for the stated problem. The statement " $X = \sin(A)^3$ " is not identical to " $X = (\sin A)^3$ ," as the keying sequence would have us believe. The correct answer, using the correct keying sequence, should have been  $x = 2.858770 \times 10^{-5}$ .

ROBERT J. BURKE  
San Jose, Calif.

*A number of readers have written to inform us that the method of solving our sample problem and the answer arrived at are incorrect. The correct answer is  $2.85869 \times 10^{-5}$  (2.85869-05 on the display). To obtain this answer, the last five steps in the keystroke sequence should be: 1/x, x<sup>3</sup>, 3, =, sin. This way, the sine function isn't cubed with the rest of the problem.*

### IN REBUTTAL

We were pleased that Len Buckwalter mentioned our condensed Marine Radiotelephone Operation Procedures card in his October 1974 "CB Scene." But we regret that he missed the whole purpose of the card. He stated that such a step-by-step listing of emergency radio procedures, as well as the proper use of "Mayday," "Security," and "Pan" are "nonsense."

Our Radio Card closely parallels the Coast Guard's recommended simplified radio procedures for both emergency and non-emergency radio calls. In summary, to answer Mr. Buckwalter's question as to what good is our Radio Procedures Card, simply stated, it is to save lives and property.

KENNETH J. ENGLERT  
Technical Information Services  
Los Angeles, Calif.

### WANTS OSCILLOSCOPE PROJECT

The "Auto Polarity, Auto Zero Digital Multimeter" project featured in the January 1975 issue was just what I had been waiting for. I am constantly amazed at how POPULAR ELECTRONICS manages to remain in the forefront of electronic developments in article after article. So, it surprises me that you have not come up with a full-feature, triggered-sweep oscilloscope, preferably dual-beam in design, project. After all, if you can reduce a \$400 DDM to sell for less than \$100 in kit form, imagine the savings that can be reaped by kitting a \$400 scope for less than \$100.

C. Y. MIRROW  
Pittsburgh, Penn.

*Right now, it is best to buy a kit or assembled scope from commercial manufacturers.*

POPULAR ELECTRONICS

## IDENTICAL PROBLEM . . . ALMOST

Being a TV serviceman myself, I found the February 1975 "Art's TV Shop" thoroughly enjoyable because I recently had to repair the same Sony model receiver with the same problem described in the column. Not having the appropriate ac adapter with the receiver, I was forced to run the receiver on our variable dc power supply. The receiver ran OK up to about 8 volts. At higher voltages, the picture would tear, fold, etc., even though it still didn't fill the screen. The trouble was traced to the same filter capacitor mentioned in the column—but with no transistor problems.

ALAN SCOTT DODGE  
A&A Electronics  
Albertson, N.Y.

## PREDICTION IS "OLD HAT"

It appears that Lou Garner is a few years behind the times in one of his predictions for 1975 made in "Solid State" (January 1975). I am referring to "the development . . . of solid-state energy control centers for homes and offices." My job consists of controlling heating and cooling systems, monitoring security, temperature, humidity, etc., and reporting abnormal conditions of customer buildings to proper authorities from a remote location by computer via telephone lines.

CHARLES R. MORFORD  
Honeywell, Inc.  
Detroit, Mich.

## BETTER CONTROL FOR HO TRAINS

As an electronics hobbyist and railroad modeler, I was very pleased to see "IC Speed Controller for HO Model Railroads" in the January 1975 issue. I would, however, like to suggest a couple of alterations in the circuit design to meet the demands of those people who wish to operate the controller in a more prototypical fashion.

First, replace STOP switch S3 with a three- or four-position rotary switch. Connect one of the poles of the switch directly to the top of momentum capacitor C3 and the other poles through different-value resistors to the same point in the circuit. This permits true momentum braking at different rates. Secondly, replace INCREASE and DECREASE speed switches S1 and S2 with a single three-position rotary switch, reserving the center position of the switch for "coasting."

Finally, I suggest that builders of the controller add a 1- or 2-ampere protection diode in the output circuit of REVERSE switch S5 if it is anticipated that the controller will ever be used for multi-cab operation in conjunction with other power packs on the same layout.

DAN W. CRIMMINS  
Moscow, Idaho

MAY 1975

## Coming Up in The June Popular Electronics

- Power-Output-Stage Modules Save Stereo Amp Construction Time
- Getting Started With Integrated Circuits
- How To Design Solid-State Power Supplies

TEST REPORTS: Burwen 1201 Dynamic Noise Filter  
Superscope TC-645 Open-Reel Stereo Tape Deck  
Telephonics 4-Channel Headphones

# 20 hi-fi watts in 1.2 cubic inches

What a powerhouse! SK3154 packs a 20-watt RMS audio amplifier in one small module. With virtually flat response from 15 Hz to 70 kHz. In the SK3154 package you'll find all the information you need. Just follow the instructions for adding 12 easy-to-get

passive components, power supply and hardware — and you've got one channel of a fine stereo or quad amplifier. The fun — and a super finished product — are yours. (Ten and 15-watt SK modules also available.) Start now! See your RCA electronics distributor.



### Solid fun in 399 pages

Electronic organ, temperature alarm, tachometer, light-operated switch — 68 useful solid-state projects in one book. Complete instructions plus some theory. \$2.95 optional price. At your RCA electronics distributor.

RCA Solid State, Box 3200,  
Somerville, N.J. 08876.

CIRCLE NO. 38 ON READER SERVICE CARD

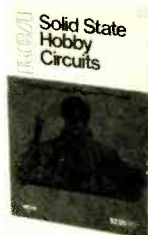

# RCA

# Prepare for a high-paying career in Complete Communications

Including CB design, installation  
and maintenance...in actual practice



The field of communications is bursting out all over. In Citizens Band alone, estimates predict a growth in equipment sales from \$514 million in 1973 to \$1.2 billion dollars in 1982! That means a lot of openings in service and maintenance jobs. NRI can train you at home to fill one of those openings... including your FCC license and solid-state 2-way radio service.

NRI's Complete Communications Course will qualify you for a First Class Commercial License or you get your money back! It covers AM and FM Transmission Systems, Teletype, Radar Principles, Marine Electronics, Mobile Communications, and Aircraft Electronics.

You will learn to service and/or adjust CB equipment... using your own 23-channel Johnson Transceiver and AC power supply for hands-on experience as well as your own personal use.

With NRI's training program, you can learn this important skill easily, at home in

Get 2-way radio training with this solid-state  
23-channel transceiver and power supply!



Your CB training will be up-to-the-minute when you experiment with this solid-state transceiver unit. Mount it in your car or use it with your AC power as a base station. You get "hands-on" experience that puts your course theory into practice the practical way.

your spare time. You get 8 training kits, including your own 3½ digit digital multimeter for digital experiments and precise measurements. You'll learn from bite-size lessons, progressing at your own speed to your FCC license and then into the communications field of your choice.



## Only NRI offers five choices in TV/Audio Servicing



NRI can train you at home to service and repair commercially-built color and black-white TV, hi-fi equipment, AM-FM radios and sound systems. You can choose from 5

courses, starting with a basic servicing course with 65 lessons... up to a Master Color TV course, complete with 25" diagonal solid state color TV in handsome woodgrain cabinet. All courses are available with low down payments and convenient monthly payments to fit your budget. And all courses provide professional equipment along with NRI-designed kits for hands-on training. With the Master Course, for instance, you receive your own 5" wide band, solid-state triggered sweep oscilloscope, TV pattern generator, 3½ digit digital multimeter, and a high quality NRI 25" diagonal solid state television receiver expressly designed for color TV training.

### YOU PAY LESS WITH NRI TRAINING AND YOU GET MORE FOR YOUR MONEY

NRI employs no salesmen, pays no commissions. We pass the savings on to you in reduced tuition costs and extras in the way of professional equipment, testing instruments, etc. You can pay more, but you can't get better training.

## Step into the digital age with NRI's Complete Computer Electronics Course



Digital electronics is the career area of the future... and the best way to learn it is with NRI's Complete Computer Electronics Course. You can become a computer or digital technician with NRI's unique

and fascinating home training... while you build and use a real digital computer in your home! This is no beginner's "logic trainer". It's a complete programmable digital computer. And it's just one of ten kits you receive, including a professional digital multimeter for experiments and precise measurement. It's the quickest and best way to learn digital logic, and computer operation.

### NEARLY ONE MILLION STUDENTS IN 60 YEARS HAVE LEARNED AT HOME THE NRI WAY...

Mail the insert card and discover for yourself why NRI is the recognized leader in home study training. No salesman will call. Do it today and get started on that new career.

#### APPROVED UNDER GI BILL

For the career minded, we are approved for veterans benefits. Check box on card for details.

### MAIL THE INSERT CARD FOR YOUR FREE NRI CATALOG

No salesman will call



#### NRI SCHOOLS

McGraw-Hill Continuing Education Center  
3939 Wisconsin Avenue,  
Washington, D.C. 20016

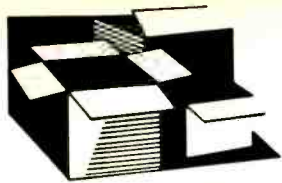

# New Products

Additional information on new products covered in this section is available from the manufacturers. Either circle the item's code number on the Reader Service Card inside the back cover or write to the manufacturer at the address given.

## TEAC TWO-TRACK TAPE DECK

Teac's Model A-6100 is a half-track recorder with 10½-in. reel adaptors, and four heads, one of which is a quarter-track playback head that is switchable on the head bridge. This allows the recordist to reproduce half-track or quarter-track stereo tapes. The unit has three motors, and the Teac hysteresis synchronous capstan drive system. Two VU meters (with dual scales for standard and high-energy tapes) and two peak-reading LED's monitor signal levels. The A-6100 has two-position bias and equalization switches, and micro-switch push-button transport control. A cue control allows cueing in the fast wind or pause modes, as well as manual reel rotation during editing. Other features include automatic stop in rewind, zero-VU click-stop on the output level control, and mike attenuator pad. \$999.50.

CIRCLE NO. 70 ON READER SERVICE CARD

## KENWOOD KA-8006 AMPLIFIER

Kenwood's newest stereo amplifier, the Model KA-8006, boasts a power output of 70 W rms/channel into an 8-ohm load, with no more than 0.2% THD. Among the

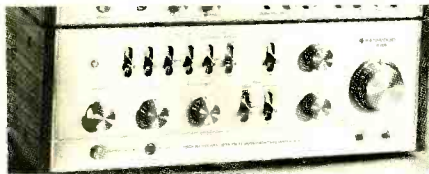

amplifier's unusual features are complementary driver and output stages, an IC phono equalizer preamp, which provides wide dynamic range while adhering closely to the RIAA curve, and the "tape-through" circuit, which allows tape-to-tape dubbing even when the amplifier is using another program source. Also included are two low-frequency and two high-frequency filters, and outputs for three speaker systems. \$439.95.

CIRCLE NO. 71 ON READER SERVICE CARD

## ECCOCOAT EPOXY COATING

Emerson & Cuming's Eccocoat 341, a low-cost, one-part conductive epoxy coating is said to provide electrical conductivity comparable to the best silver lacquers and

a one-component air-dry epoxy resin base. The product can be applied by brush, spray, or dip to wood, plastics, metal, ceramic, and concrete. An 8-mil (0.2-mm) coating has a surface resistivity of 0.3 ohm per square. Use temperature is from -65 to +350 degrees F (-54 to 177 C). It is useful in various r-f shielding applications. Address: Emerson & Cuming, Inc., Microwave Products Div., Canton, MA 02021.

## JENSEN "OPC" SPEAKER

Jensen's Model 22 speaker system incorporates the company's optimum-performance control which allows the user to select a preferred listening pattern for any type of music. The system features a 10" Flexair woofer and 2" cone tweeter with Syntox-6 ceramic magnets for high-range efficiency. Manufacturer's specs include: frequency range, 32-20,000 Hz with cross-



over at 4000 Hz; nominal impedance, 8 ohms; dispersion, 160 degrees. Minimum driving power is 10 watts with a maximum of 45 watts (IHF wattage). The walnut-grained vinyl cabinet has a removable translucent acrylic dust cover to protect the control. The cabinet has a two-tone double-knit acoustic fabric grille cloth. 22½" H x 10¾" W x 2¼" D (57 x 27 x 6 cm). \$99.00

CIRCLE NO. 72 ON READER SERVICE CARD

## UNGAR SOLDERING STATION

A portable, rechargeable soldering station (No. 194), made by Ungar, incorporates a rechargeable nickel-cadmium battery. The lightweight pencil iron features an indicator light, operating trigger control with interlock "off" switch, and built-in lamp. It accepts two interchangeable tips. The high-impact plastic charging holder has a tip-cleaning sponge receptacle and is rated at 120-V ac input; 3.2-V ac at 120 mA output.

CIRCLE NO. 73 ON READER SERVICE CARD

## CONTINENTAL'S LOGIC MONITOR

A compact, self-powered pocket-sized IC logic monitor has been announced by Continental Specialties Corp. The instrument requires no calibrations nor adjustments as it simultaneously displays static and dynamic logic states of DTL, TTL, HTL, or CMOS DIP IC's. Designed for troubleshooting and signal tracing, the monitor makes it

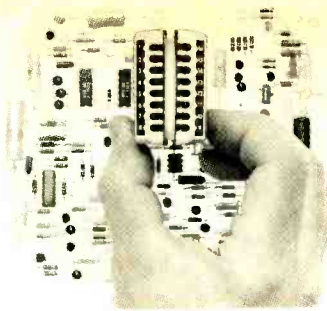

possible to watch signals work their way through counters, shift registers, etc. High-intensity LED's turn on when lead voltages exceed a 2-V threshold. Input voltages range from 4 V minimum to 15 V maximum across any two or more inputs. Measures 4" L x 2" W x 1.5" H (10 x 5 x 4 cm). \$84.95

CIRCLE NO. 74 ON READER SERVICE CARD

## EICO CONVERTER/CHARGER

A solid-state power supply, Model 1040, which permits auto stereo tape players or mobile CB rigs to be operated at home, has been introduced by Eico Electronic Instrument. Twelve-volt dc equipment can be operated from 120-V ac lines or can be checked out prior to installation in a car or boat. It can also be used as a charger for 12-V batteries. Input: 120-V ac, 50-60 Hz; output: 12-V dc at 4 A continuous. \$19.95 (wired only).

CIRCLE NO. 75 ON READER SERVICE CARD

## PIONEER "PRO" TURNTABLE

A professional direct-drive turntable featuring an automatic tonearm return and an S-shaped low-mass tonearm with low-capacity cable has been introduced by Pioneer as its Model PL-55X. The platter is driven by a brushless dc servo-controlled motor and operates at 33½ and 45 rpm (changed electronically). Speed can be ad-



justed to ±2%. Wow and flutter are 0.05% W rms and S/N ratio exceeds 58 dB, according to the manufacturer. It accommodates cartridges weighing 4 grams (min.) to 14 grams (max.). In addition, the turntable includes an anti-skating device, lateral balancer, plug-in headshell, and stylus-pressure direct-readout counterweight. Wood base measures 18 29/32" W x 16 5/32" D x 7 9/32" H (48 x 41 x 18 cm). \$249.95

CIRCLE NO. 76 ON READER SERVICE CARD

POPULAR ELECTRONICS

# Portable Digital Multimeter at an Analog Price

ONLY  
**\$99<sup>95</sup>**

less batteries and optional AC adapter/charger



**MODEL 280**  
*Shown actual size*

**BK PRECISION**  
PRODUCTS OF DYNASCAN  
1801 W. 31st Plaine Ave. Chicago, IL 60613

## 9 reasons why our new meter should be your next:

- 1. ANALOG PRICE**
- 2. RELIABLE**  
Fully overload protected  
Built-in battery check  
Impact-resistant Cyclocac® case
- 3. EASY TO READ**  
Large 3-digit LED readout  
Automatic polarity, decimal point and out-of-range indication
- 4. COMPLETELY PORTABLE; USE IT ANYWHERE**  
Only 4.38 x 6.38 x 2" deep  
Operates from 4 ordinary "C" cells or AC with optional adapter/charger
- 5. HIGH-LOW POWER OHMS**  
Measures accurately in solid state circuitry
- 6. HIGH RESOLUTION**  
1mV, 1μA, 0.1 ohm
- 7. DIGITAL ACCURACY**  
DC volts typically ±1% F.S.; AC volts and ohms typically ±2% F.S. except ±2.5% on highest range
- 8. RANGES**  
DC and AC volts, 0-1, 10, 100, 1000V;  
DC and AC current, 0-1, 10, 100, 1000mA;  
Ohms, 0-100, 1K, 10K, 1 meg, 10 megs.  
10 meg industry standard input impedance
- 9. IN STOCK AT YOUR DISTRIBUTOR**

# A PRECISION WAVEFORM GENERATOR AT A PRICE YOU CAN AFFORD.



The Hickok Model 270 Function Generator gives you a lot more waveform generating capability than you'd expect for its price.

- Puts stable, calibrated, high quality sine, square and triangle waveforms from 1 Hz to 500 kHz at your fingertips.
- With external connections you can produce logic pulses, sweeps and ramps, AM and FM outputs, phase and frequency shift keying signals, tone bursts and more.
- Its an audio generator and much more.

Before you buy another function generator, check out the Hickok Model 270. Ask your Hickok distributor for full details or write us for our 4-page technical brochure.

## \$166<sup>00</sup>

# HICKOK

the value innovator

INSTRUMENTATION & CONTROLS DIVISION  
THE HICKOK ELECTRICAL INSTRUMENT CO.  
10514 Dupont Avenue • Cleveland, Ohio 44108  
(216) 541-8060 • TWX: 810-421-8286

CIRCLE NO. 21 ON READER SERVICE CARD

## PANAWISE "THIRD HAND"

Builders of projects involving pc boards and other small, fragile components will find PanaVise's Model 396 the equivalent of a "third hand" at their workbenches.

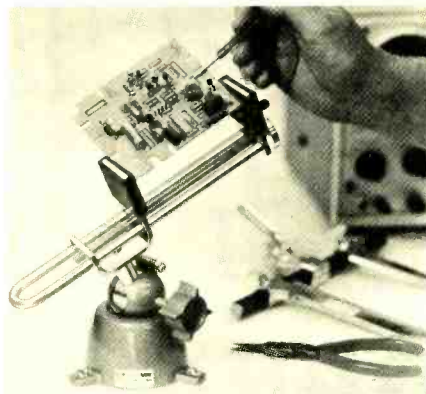

Offered with various bases and heads, all interchangeable, the basic unit tilts, turns, and rotates to any position while holding delicate parts gently yet firmly.

CIRCLE NO. 77 ON READER SERVICE CARD

## ELECTRA'S 4-BAND SCANNER

The Bearcat IV has a 4-band automatic scanning capability which permits monitoring all four of the authorized emergency and public service broadcast bands simultaneously. Includes new 470 MHz-512 MHz uhf band. This new unit from

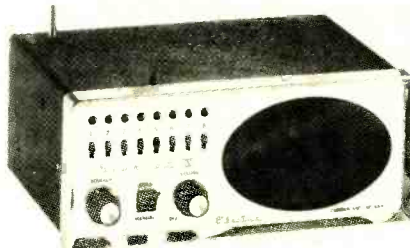

Electra boasts such features as LED's, a manual/scan switch, front-mounted speaker, single-conversion circuitry, and electronically tuned antenna. It comes with a mobile mounting bracket, 12-V dc/117-V ac power supplies, and telescoping antenna. Crystals not included. \$179.95

CIRCLE NO. 78 ON READER SERVICE CARD

## HEATHKIT ELECTRONIC WORKSHOP

Budding scientists can build up to 35 different experiments while learning electronics basics with the new Heathkit Jr. JK-18A Electronic Workshop. Connections are solderless spring terminals and power is supplied by four "D" cells. Each experiment is accompanied by a simple schematic to help teach circuit and component identification. Circuits which can be built with the kit include code flasher, continuity tester, battery and diode testers, rain alarm, timing relay, and intercoms. \$34.95 (mail order, less batteries)

CIRCLE NO. 5 ON READER SERVICE CARD

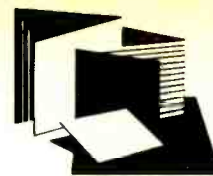

## New Literature

### BELDEN ALARM SECURITY CATALOG

A second edition of Belden's Alarm Security catalog reflects new product demands and additional new product coverage. Features such as an index and product listings make the catalog easier to use. Described in the catalog are two- and multi-conductor cables, coaxial camera cables, trap and hook-up wire and telephone cables and cords. Address: Belden Corporation, 2000 S. Batavia Avenue, Geneva, IL 60134.

### RCA'S SOLID-STATE DATABOOKS

The SSD-200C seven-volume, 4482-page set of 1975 Databooks, covers RCA's complete line of linear integrated circuits, discrete MOS devices, COS/MOS digital IC's, power transistors, thyristors, rectifiers, diacs, r-f and microwave devices, and high-reliability IC's and discrete devices. The series contains complete technical data sheets and application notes on all standard types in the company's line. The seven volumes are separated according to product lines and each includes a comprehensive subject index and type-number index for all devices covered. Individual volumes are \$3.00, the set \$19.00. Address: RCA Solid State Division, Box 3200, Somerville, NJ 08876.

### BOWMAN "MODUKIT" CATALOG

A four-page condensed catalog featuring the Modukit line of solid-state electronic projects for experimenters, students, and electronic hobbyists is now available. The brochure lists 21 kits as well as the company's line of factory-assembled power supplies and strobos, color organs, etc. Address: Bowman Electronics Inc., 116 South Ave., Garwood, NJ 07027.

### CTS COMPONENT SPEAKERS

Ten pre-engineered Starrsond™ speaker systems, complete with speakers, crossover components, wiring schematics, and suggested enclosure dimensions are covered in an 8-page brochure for the "do-it-yourself" speaker builder. The line includes speakers designed for hi-fi, PA, musical instrument, and heavy-duty applications. Address: CTS of Paducah, Inc., 1565 N. 8th St., Paducah, KY 42001.

POPULAR ELECTRONICS





# Stereo Scene

## GOOD STEREO

By Ralph Hodges

**A**CCORDING to *Abitare*, the elegant Italian journal of industrial design: "Stereo is merely the technique of recording and reproducing sound for the purpose of making it impossible for the listener to tell where the sound comes from." That's tersely put, though you can't help but feel that something was lost in translation.

Good stereo—and this is a value judgment on my part—results in sound that is nonlocalized, as well as precisely localized, both at the same time. The nonlocalized sound provides the sense of space that surrounds the performers, and ideally the listener as well. The localized sound is that which we perceive as coming directly from the musicians, enabling us to locate them to the left or right and, to a certain extent, to the front or back.

Recordings differ enormously with regard to the ratio of localized to nonlocalized sound. One extreme is exemplified by "reprocessed for stereo" releases which are made from mono master tapes. On these discs the performance emerges from a blur extending between the two speakers rather than from a well-defined central point, as would a true mono rendition. At the other extreme we find the so-called "multi-track mono" productions in which the musicians are isolated dots scattered here and there, with no sonic/spatial connection. The former have no localized and the latter no nonlocalized sounds. The ear seems to yearn for a happy medium.

I think we all can agree on the value of good localization or *directionality* in stereo reproduction. When thinking of a nondirectional stimulus, two anecdotes come to mind. The first, from Tom Horrall of Bolt Beranek and Newman, tells about some of his experiences in trying to install sound systems in large office spaces to provide a quiet background "hiss" of carefully selected frequency characteristics. (This is the so-called "sonic perfume" that has been found effective in inducing relaxation.) The first

version of the system was not well-received, evidently because the office workers could readily identify the speakers as the source of the sound. They finally found it necessary to design a "stereo" hiss system—one in which the various speakers were driven by signals whose phase relationship was random rather than identical signals. This rendered the sound non-directional and thus (it seems) much more pleasing.

The second story, from Bob Carver of Phase Linear, refers to the time when he was seeking acceptance for his remarkable noise-reduction system. He was able to show listeners that, at the flick of a switch, an astonishing amount of hiss was removed from recordings and FM broadcasts. But he could not persuade all of them that an indefinable "something else" had not also been lost! After a time, Carver concluded that two mechanisms were operating: (1) the presence of hiss gave listeners a constant reassuring reminder that the sound system was able to reproduce high frequencies even though the program contained none at a given moment; and (2) the hiss, being random-phase for stereo reproduction, in a sense extended the space seemingly occupied by the performance. That is, it was stretched out fully between the two speakers and

often beyond. He then tried some demonstrations with mono programs, and found that the disappearance of hiss was more recognizably an improvement in mono than in stereo.

## Directionality And The Ear.

Before this begins to read like a eulogy in praise of hiss, let's review some of what we know about stereo's capacity for pleasing our ears. We sense the direction of sound sources, at least in three recognized ways. One is arrival time. For sounds directly in front or behind, the arrival times are identical; but for sounds off to the side, one ear gets the onset of the "message" a fraction of a millisecond before the other. This interaural time difference (ITD) is useful to the ear-brain mechanism in judging direction. The second is interaural amplitude difference (IAD). Here the ear closer to the sound source hears it a bit louder which is also a clue to directionality. (In real-life situations, ITD and IAD usually reinforce each other.) The third way concerns spectrum/frequency characteristics. Apparently, masking effects of the head and outer ear discriminate against various frequencies at almost every angle of impinging sound (Fig. 1). The full importance of this in determining our sense of sonic direction is largely unknown.

Of the three, ITD appears in many respects to be the most potent. However, the stereo effect, as achieved through modern recording techniques, depends much more heavily on IAD. To illustrate this, as well as to explain the philosophy of modern stereophony, we can refer to the classic experiment of Fig. 2. Here we have two loudspeakers, A and E, equidis-

(Continued on page 22)

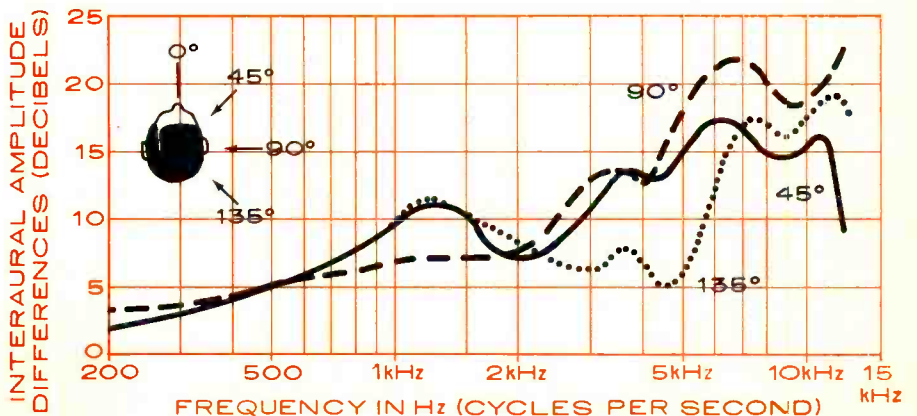

Fig. 1. The brain uses interaural differences to localize off-axis sound sources.

# The Quadriophile's

Features and specs, like money, aren't everything, but they can help a lot. Take a look at the comparison chart on the opposite page. You will find there many reasons why Sansui 4-channel technology is superior and why every Sansui 4-channel receiver is the best buy in its category. Of course, only a demonstration can really show you Sansui's ingenuity and what the famous Sansui sense of sound can do for you and your musical enjoyment. Only a Sansui 4-channel receiver with vario-matrix\* can give you outstanding 4-channel separation, a clear sense of location and full musicality.

A Sansui 4-channel receiver can synthesize any of your favorite stereo records or tapes into fascinating quadraphonic sound. And they also contain the Sansui universal decoding system which permits decoding from any 4-channel source, including SQ and CD-4. Of course, the best way is to listen to 4-channel from 4-channel records or QS broadcasts.

Look carefully at the chart on the opposite page and then go to your nearest Sansui franchised dealer and listen to a demonstration. Prove to yourself what Sansui can do for you. Or write today for the brochure "What you should know about 4-Channel Sound."

\* vario-matrix is the only 4-channel technology which offers highest interchannel separation, full frequency response, wide dynamic range, low distortion.

**Sansui**

**SANSUI ELECTRONICS CORP.**  
Woodside, New York 11377  
Gardena, California 90247  
SANSUI ELECTRIC CO. LTD. Tokyo, Japan  
SANSUI AUDIO EUROPE S.A. Antwerp, Belgium  
ELECTRONIC DISTRIBUTORS (Canada) B.C.

## The Sansui QRX-3000



## The Sansui QRX-3500



## The Sansui QRX-6001



## The Sansui QRX-7001



# Comparison Chart

## Power Range: 9-15 Watts

MANUFACTURER MODEL	SANSUI QRX-3000	Fisher 334	Kenwood KR-6340	Pioneer QX-646	Sony SQR-4750	Technics SA-8000X
QS DECODING	Built-in VARIO-MATRIX	—	Simple RM	Simple RM	—	Adjustable RM
SQ DECODING	Built-in VARIO-MATRIX	Simple SQ	Simple SQ	Simple SQ	Full logic SQ	—
SYNTHESIZING SURROUND	Built-in VARIO-MATRIX	—	—	—	—	—
SYNTHESIZING HALL-AMBIENCE	Built-in VARIO-MATRIX	—	—	—	Simple Matrix	—
CD-4 DEMODULATING	Adaptor	Built-in	Adaptor	Built-in	Adaptor	Built-in

## Power Range: 16-24 Watts

MANUFACTURER MODEL	SANSUI QRX-3500	Fisher 534	Harman Kardon 800+	Marantz 4240	Pioneer QX-747	Sony SQR-6750
QS DECODING	Built-in VARIO-MATRIX	—	Simple RM	Adjustable RM	Simple RM	—
SQ DECODING	Built-in VARIO-MATRIX	Full Logic SQ	Simple SQ	—	Simple SQ	Full Logic SQ
SYNTHESIZING SURROUND	Built-in VARIO-MATRIX	—	—	—	—	—
SYNTHESIZING HALL-AMBIENCE	Built-in VARIO-MATRIX	Matrix	—	—	—	Simple Matrix
CD-4 DEMODULATING	Adaptor	Built-in	Built-in	Adaptor	Built-in	Adaptor

## Power Range: 25-34 Watts

MANUFACTURER MODEL	SANSUI QRX-6001	Harman Kardon 900+	Kenwood KR-8340	Marantz 4270	Sony SQR-8750	Technics 6E00
QS DECODING	Built-in VARIO-MATRIX	Simple RM	Simple RM	Adjustable RM	—	Simple RM
SQ DECODING	Built-in VARIO-MATRIX	Simple SQ	Simple SQ	—	Full Logic SQ	—
SYNTHESIZING SURROUND	Built-in VARIO-MATRIX	—	—	—	—	—
SYNTHESIZING HALL-AMBIENCE	Built-in VARIO-MATRIX	—	—	—	Simple Matrix	Simple Matrix
CD-4 DEMODULATING	Built-in	Built-in	Adaptor	Adaptor	Adaptor	Built-in

## Power Range: 35-45 Watts

MANUFACTURER MODEL	SANSUI QRX-7001	Fisher 634	Kenwood KR-8840	Marantz 4300	Pioneer QX949	Sylvania EQ-3747
QS DECODING	Built-in VARIO-MATRIX	—	Simple RM	Adjustable RM	Simple RM	—
SQ DECODING	Built-in VARIO-MATRIX	Full Logic SQ	Full Logic SQ	—	Simple SQ	Simple SQ
SYNTHESIZING SURROUND	Built-in VARIO-MATRIX	—	—	—	—	—
SYNTHESIZING HALL-AMBIENCE	Built-in VARIO-MATRIX	Simple Matrix	—	—	—	—
CD-4 DEMODULATING	Built-in	Built-in	Built-in	Adaptor	Built-in	Adaptor

<sup>tm</sup>  
SQ - CBS Inc.

<sup>tm</sup>  
CD-4 - JVC Inc.

<sup>tm</sup>  
QS - Sansui Electric Co., Ltd.

# The better the training the better you'll

Send for  
**FREE**  
illustrated  
career  
guide

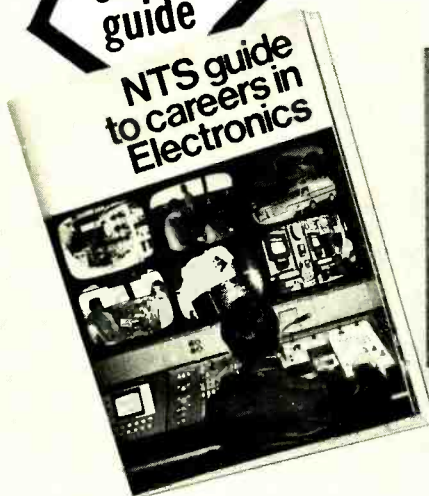

IN-CIRCUIT TRANSISTOR TESTER  
COMPU-TRAINER

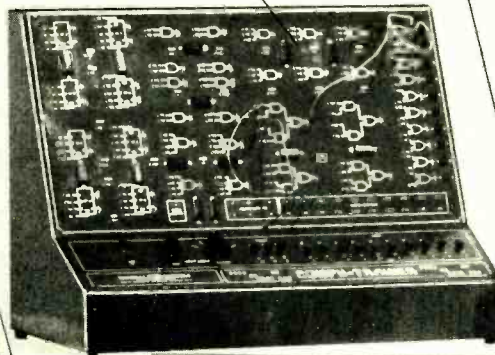

TROUBLESHOOTER  
VOM

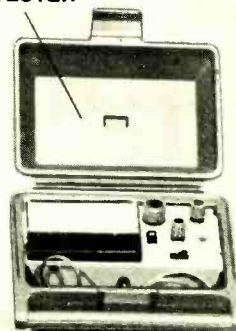

SOLID-STATE  
OSCILLOSCOPE

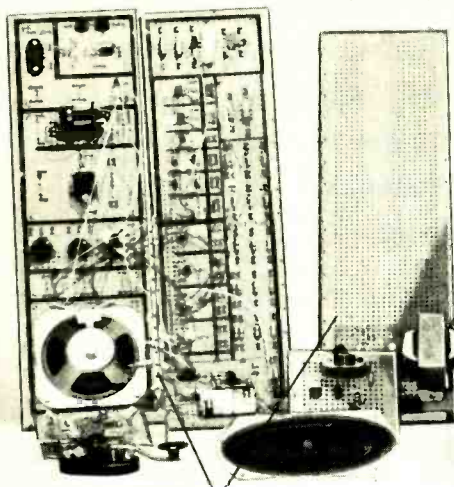

ELECTRO-LAB

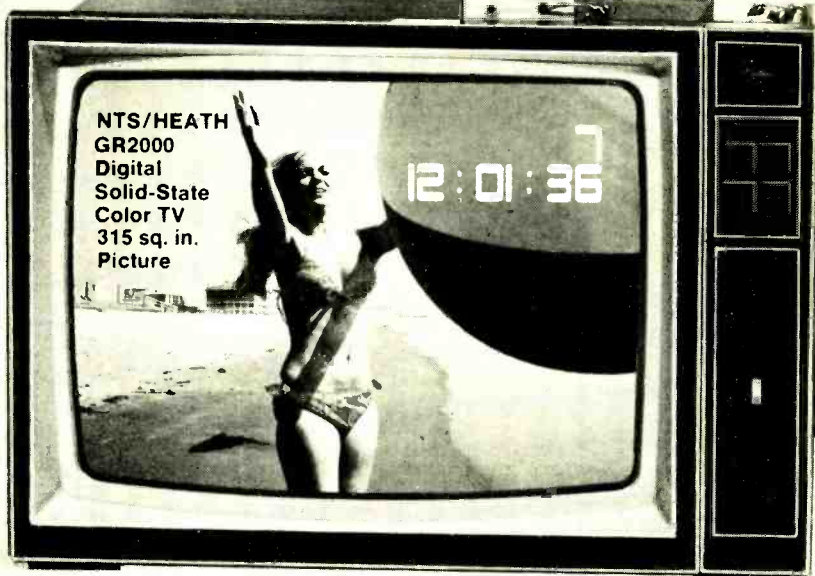

(Simulated TV Reception)

As an NTS student you'll acquire the know-how that comes with first-hand training on NTS professional equipment. **Equipment you'll build and keep.** Our courses include equipment like the **NTS/Heath Digital GR-2000 Solid State color TV** with first-ever features like silent varactor diode tuning; digital channel selection, (with optional digital clock), and big 315 sq. in. ultra-rectangular screen.

Also pictured above are other units — 5" solid state oscilloscope, vector monitor scope, solid-state stereo AM-FM receiver with twin speakers, digital multimeter, and more. It's the kind of better equipment that gets you better equipped for the electronics industry.

This electronic gear is not only designed for training; it's field-type — like you'll meet on the job, or when you're making service calls. And with NTS easy-to-read, profusely illustrated lessons you learn the theory behind these tools of the trade.

**Choose from 12 NTS courses** covering a wide range of fields in electronics, each complete with equipment, lessons, and manuals to make your training more practical and interesting.

**Compare our training; compare our lower tuition.** We employ no salesmen, pay no commissions. You receive all home-study information by mail only. All Kits, lessons, and experiments are described in full color. Most liberal refund policy and cancella-

POPULAR ELECTRONICS

# and the equipment be equipped.

**COMPARE OUR  
KITS AND LESSONS.  
COMPARE OUR  
TUITION.**

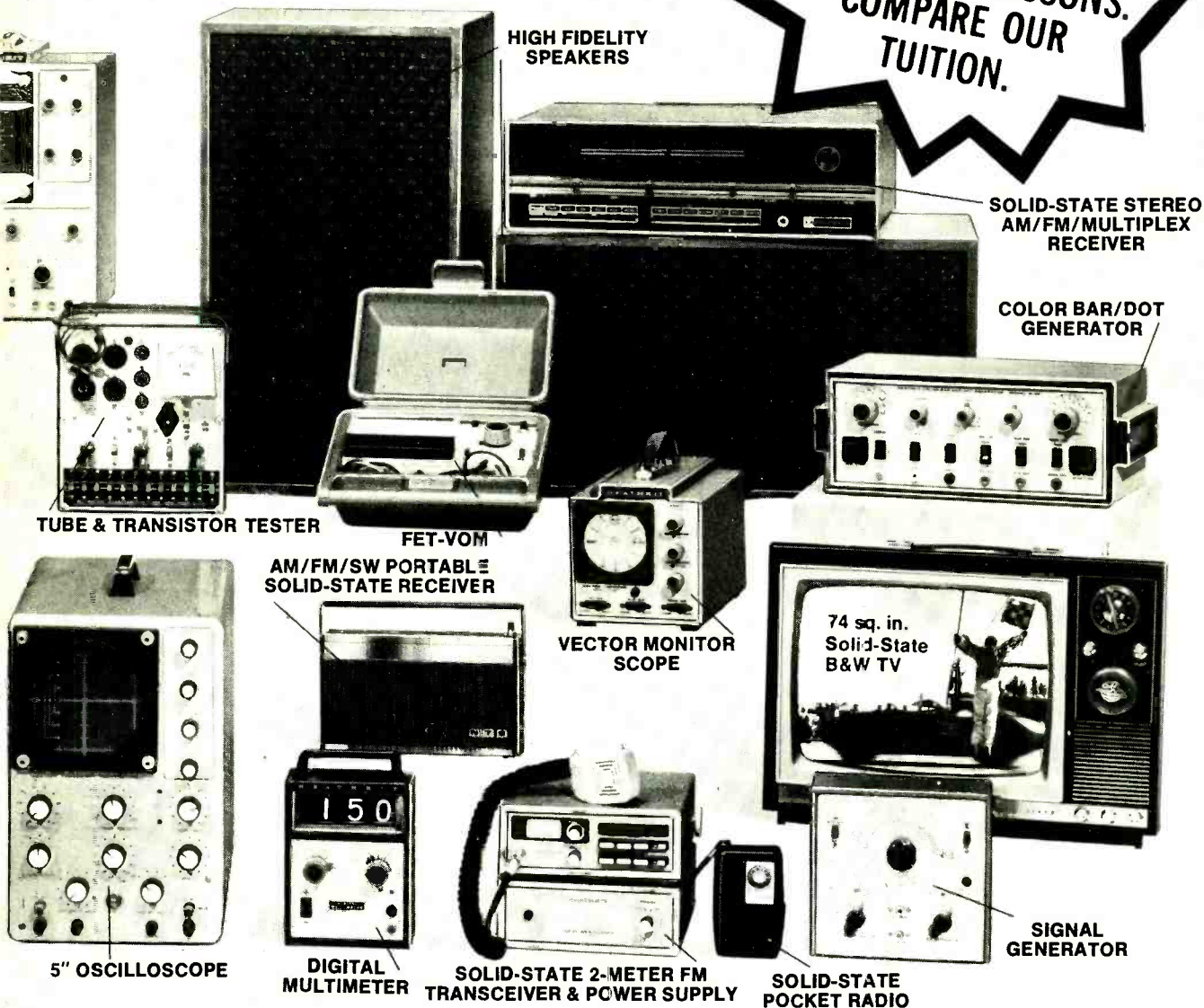

HIGH FIDELITY  
SPEAKERS

SOLID-STATE STEREO  
AM/FM/MULTIPLY  
RECEIVER

COLOR BAR/DOT  
GENERATOR

TUBE & TRANSISTOR TESTER

FET-VOM

AM/FM/SW PORTABLE  
SOLID-STATE RECEIVER

VECTOR MONITOR  
SCOPE

SIGNAL  
GENERATOR

5" OSCILLOSCOPE

DIGITAL  
MULTIMETER

SOLID-STATE 2-METER FM  
TRANSCIVER & POWER SUPPLY

SOLID-STATE  
POCKET RADIO

tion privileges spelled out. Make your own comparisons, your own decision. Mail card today, or clip coupon if card is missing.

**NO OBLIGATION. NO SALESMAN WILL CALL**

**APPROVED FOR VETERAN TRAINING**

Get facts on new 2-year extension

## NATIONAL TECHNICAL SCHOOLS

TECHNICAL-TRADE TRAINING SINCE 1905  
Resident and Home-Study Schools  
4000 So. Figueroa St., Los Angeles, Calif. 90037

**NATIONAL TECHNICAL SCHOOLS** Dept. 205-055  
4000 South Figueroa St., Los Angeles, Calif. 90037  
Please send FREE Color Catalog and Sample Lesson.  
NO OBLIGATION. NO SALESMAN WILL CALL.

<input type="checkbox"/> Color TV Servicing	<input type="checkbox"/> Electronics Technology
<input type="checkbox"/> B & W TV and Radio Servicing	<input type="checkbox"/> Computer Electronics
<input type="checkbox"/> Electronic Communications	<input type="checkbox"/> Basic Electronics
<input type="checkbox"/> FCC License Course	<input type="checkbox"/> Audio Electronics Servicing

NAME \_\_\_\_\_ AGE \_\_\_\_\_  
ADDRESS \_\_\_\_\_ APT # \_\_\_\_\_  
CITY \_\_\_\_\_ STATE \_\_\_\_\_

Please fill in Zip Code for fast service \_\_\_\_\_  
 Check if interested in G.I. Bill information.  
 Check if interested ONLY in classroom training in Los Angeles.

# EXAR

## IC'S AND KITS

NOW AVAILABLE FROM:  
JAMES ELECTRONICS

### FUNCTION GENERATOR KIT

Introductory Offer

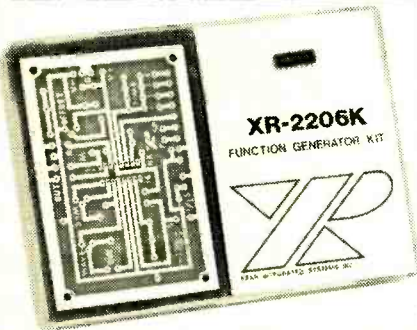

The Function Generator Kit features sine, triangle and square wave; THD 0.5% typ.; AM/FM capability.

#### XR-2206KA

Includes monolithic function generator IC, PC board, and assembly instruction manual.

**\$19.95**

#### XR-2206KB

Same as XR-2206KA above and includes external components for PC board.

**\$29.95**

#### MONOLITHIC IC'S

##### TIMERS

XR-555CP	Monolithic Timer	\$1.10
XR-320P	Precision Timer	1.55
XR-556CP	Dual-555 Timer	1.85
XR-2556CP	Dual Timing Circuit	3.20
XR-2240CP	Programmable Counter/Timer	4.80

##### PHASE LOCKED LOOPS

XR-210	FSK Demodulator	5.20
XR-215	High Frequency PLL	6.60
XR-567CP	Tone Decoder (mini DIP)	1.95
XR-567CT	Tone Decoder (TO-5)	1.70

##### STEREO DECODERS

XR-1310P	PLL Stereo Decoder	3.20
XR-1310EP	PLL Stereo Decoder	3.20
XR-1800P	PLL Stereo Decoder	3.20

##### WAVEFORM GENERATORS

XR-205	Waveform Generator	8.40
XR-2206CP	Monolithic Function Generator	5.50
XR-2207CP	Voltage-Controlled Oscillator	3.85

##### OTHER EXAR IC'S

XR-1468CN	Dual ±15V Tracking Regulator	3.85
XR-1488N	Quad Line Driver	5.80
XR-1489AN	Quad Line Receiver	4.80
XR-2208CP	Operational Multiplier	5.20

Satisfaction Guaranteed. \$5.00 Min.  
Order—1st Class Mail No Charge/  
California Residents Add 6% Sales Tax

# JAMES

P.O. BOX 822, BELMONT, CA. 94002  
PHONE ORDERS — (415) 592-8097

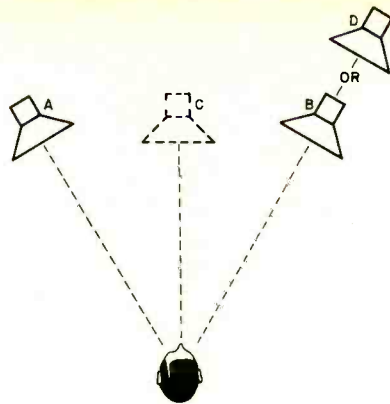

Fig. 2. Loudspeaker arrangement shows effect of relative arrival time.

tant from the listener. If driven with identical signals at identical levels, their outputs should fuse in the listener's ear-brain to produce a "phantom" sound source at position C. (This is how we hear a mono recording through a stereo system.) However, if speaker B is moved a foot farther away from the listener (to position D) the arrival time of its output is delayed by about a millisecond and the phantom source will move over to coincide with speaker A. Thus a very small shift in the speaker listener distance will practically eliminate speaker B's influence on sound localization.

There's more to the story. If we drive speaker B, now at position D, to a level of 5 dB higher than speaker A, we find that we can bring the phantom sound source back to position C. In other words, we can cause amplitude differences to offset time differences, although, in practice, the amplitude difference required is often not the same for all frequencies.

When you think about it, 5 dB is a very high price to pay in terms of power output for a shift in relative distance of one foot. Furthermore, it has been found that even inches and fractions thereof will have a significant effect in ITD's. This is a problem for the listener at home. He must choose his seating position carefully and keep his head very still if he wants to realize the optimum stereo effect. But it would be even more of a problem, I believe, if it didn't drive recording engineers so crazy that they tend to make certain adjustments in advance.

Figure 3 illustrates what appears to be a logical microphone layout for the most basic type of stereo recording. I have used this configuration and vari-

ous modifications of it myself, for reasons that will become clear later on. But it has a great fault: it is irretrievably prone to a "hole-in-the-middle" effect. A listener present at the live performance would hear (with his two ears) the trumpet as shown by the solid lines. They are practically identical in length, meaning that there's virtually no ITD, and the listener would have little difficulty locating the trumpet as *near* but not quite at front center. The home listener, with his two speakers placed to correspond to the microphone locations, has to depend on the relative outputs of those speakers to position the trumpet accurately. And the contribution of the right speaker is hopelessly late due to the additional distance (dashed lines) the trumpet sound has to transverse to get to the stage-right microphone. No reasonable level modification could compensate for this, so the trumpet's location is yanked right into the left speaker, leaving the center of the stereo stage void. (Actually, direct center sources will be accurately located, being equidistant from the microphones. Hole-in-the-middle stereo might more properly be called three-point stereo—left, right, and center.) Solution? Well, some recording companies particularly those in the U.S., started using more microphones (with their outputs subsequently mixed) so that at least two mikes always pick up the same instrument without excessive time differences. Ultimately, even more mikes were used, finally leaving the stage apron and invading the orchestra for the multi-track extravaganzas we now enjoy.

In Europe, coincident directional microphones began to be favored with

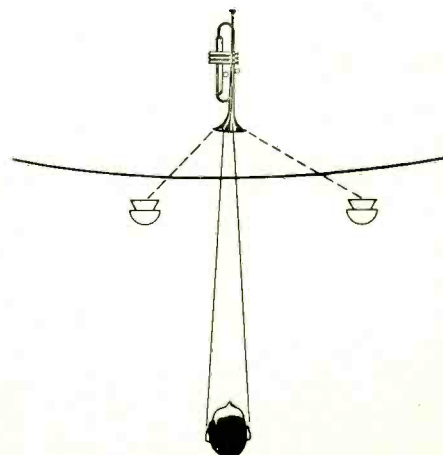

Fig. 3. Popular stereo miking setup has hole-in-middle fault.

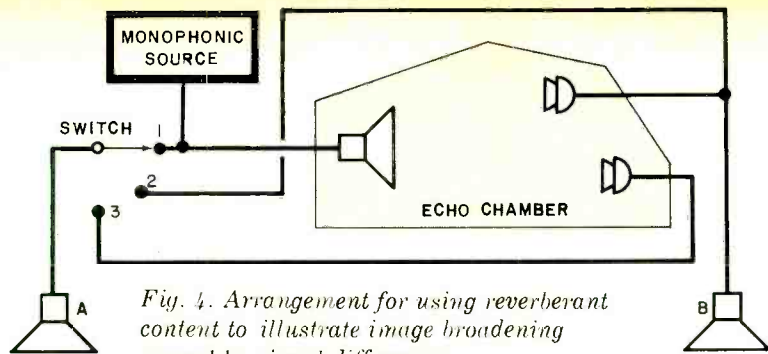

Fig. 4. Arrangement for using reverberant content to illustrate image broadening caused by signal differences.

their capsules placed as close together as possible and simply aimed at different parts of the orchestra. Both of these approaches were, in part, attempts to dominate ITD's with IAD's. The multi-mike technique afforded such intimate control over levels of various instruments that they didn't have to worry too much about ITD's. Coincident mikes were spaced so close that there were no ITD's to speak of! Both techniques improved localization, each in its own fashion.

#### Nondirectionality And The Ear.

Now that we've triumphed (sort of) over the problem of getting good stereo localization, what do we do

about good stereo nonlocalization? The only practical way to produce a diffuse sound appears to be through ITD's or interaural phase differences, which amounts pretty much to the same thing.

Addressing the Audio Engineering Society in 1972, Mark B. Gardner of Bell Telephone Labs probed deeply into phase and sound directionality. This included the phenomenon of stereo "image broadening," which is achieved through small time delays and other mechanisms, and the localization of phantom sources outside the stereo speaker array due to phase shifts between channels.

For example, in the experimental

setup of Fig. 4, speakers A and B are driven either by the mono signal source shown or by a version of that sound with reverberation added in an echo chamber. With the switch in position 1, speaker A gets the mono signal directly, while speaker B reproduces the "reverberated" version. Because of the delay and phase randomness introduced into one of the channels (channel B) the perceived effect is that of a diffused sound that seems to encompass space. With the switch in position two, both speakers are driven by signals from the same echo-chamber microphone. In this case, according to Gardner, the signals are identical, and the listener perceives the sound (rich in reverberation though it is) emanating from a point directly between the two speakers. There is no spatial sensation. Position 3, driving the speakers from two different echo-chamber microphones, restores the "space," since phase/time relationships are again random between the two channels described.

Five Japanese researchers writing in the *Journal of the Audio Engineering Society* (October 1971) about the subjective effect of multi-channel reproduction described much the same

## You don't have to buy a new car to get an electronic ignition.



Most of you know the evaluation of automotive electrical systems . . . an evaluation characterized only occasionally by efficiency and performance. I know that, and that's why I use the Delta Mark Ten B CDI on all my cars, new and old. And believe me, you don't have to have a new car to appreciate the best electronic ignition available today. Study these features and you'll know what I mean.

1. Mark Ten and Mark Ten B Capacitive Discharge Ignition Systems are manufactured by Delta Products, Inc., a company with a conscience, and with a proven record of reliability both in product and in customer relations.
2. The Mark Ten CDI's really do save money by eliminating the need for 2 out of 3 tune-ups. Figure it out for yourself. The first tune-up or two saved pays for the unit, the rest is money in your pocket. No bunk!
3. Because the Mark Ten CDI's keep your car in better tune, you actually can save on expensive gasoline.
4. With a Mark Ten, spark plugs stay clean and last longer . . . fouling is virtually eliminated.



No matter what kind of car you drive, it too can use a Delta quality lift.

I want to know more about Mark Ten B CDI's. Send me complete no-nonsense information on how they can improve the performance of my car.

Name \_\_\_\_\_  
 Address \_\_\_\_\_  
 City \_\_\_\_\_ State \_\_\_\_\_ Zip \_\_\_\_\_



**DELTA PRODUCTS, INC.**

P.O. Box 1147, Dept. PE, Grand Junction, Colo. 81501  
 303-242-9000

Mark Ten B, assembled	\$64.95 ppd	Standard Mark Ten, assembled	\$49.95 ppd
Mark Ten B, kit	\$49.95 ppd	DeltaKit®	\$34.95 ppd

CIRCLE NO. 15 ON READER SERVICE CARD

... here Today!

# "IGNITION OF THE FUTURE" ALLISON "OPTO-ELECTRIC"

☆ The BEST...the ULTIMATE...  
of ALL the Ignition Systems!

● (We challenge ANYONE  
to dispute this Fact.)

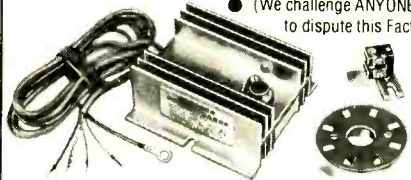

● Never wears out or needs any Maintenance!



● Does more than Pay for itself in  
GAS SAVINGS

... it gives you Maximum Power  
with continuous PEAK PERFORMANCE

... while reducing Maintenance  
and Operating Costs!



● The Allison OPTO-ELECTRIC System eliminates the Points and Condenser, replacing them with an OPTO-ELECTRONIC TRIGGER, using a Light-Emitting Diode and Photo transistor. As there are NO moving parts in rubbing contact... Timing adjustments are PERMANENT. The only "TRUE" Electronic Ignition... that you can buy for under \$100.

● Gives 40-Times more Timing Accuracy than ANY system using "Mechanical" Breaker-Points! UNLIMITED RPM! "Electronically-Controlled" DWELL automatically supplies HIGHEST Performance at both Low and High speeds. Spark strength does not fall off at high RPM POSITIVE SPARK helps eliminate "Misfire" for faster acceleration and improved Engine Performance! Smoother running (No timing fluctuation as with Magnetic Units). Easier Starting under any condition! Sparkplugs LAST 3 to 10-Times LONGER.

All SOLID-STATE Components. UNAFFECTED By Temperature, Moisture, or Vibration! Highest grade materials Guarantee you solid, Dependable Performance.

★ Perfect Timing and Dwell never change.

Pays for itself! Eliminates ignition Tune-Ups forever!  
"INFINITE LIFE"...Once installed...Never needs replacing.

● PERFECT TIMING INCREASES Engine Efficiency and Gas Mileage. SAVES Precious Fuel! Allison gives you MAXIMUM Engine Efficiency 100% of the time...and that's the name of the game for BETTER Gas Mileage and Economy



★ PROVEN RELIABILITY!

Dyno Tested up to 15,000 RPM.  
Road and Race Proven.

(Opto-Electric Systems won at  
INDY Two years in a row!)

● QUICK AND EASY INSTALLATION

★ If you want the BEST, and SAVE! This is IT!

● ORDER with CONFIDENCE...

SATISFACTION GUARANTEED!

Only \$49.95  
COMPLETE.

1-YEAR FACTORY WARRANTY!

● As you can see, you're not taking any  
chances at all... Send your Order Today

State Make, Year, Engine Size. (Calif. Res. add Tax).

● (So New...it's Sold ONLY FROM FACTORY DIRECT).

You may use your MASTER CHARGE or BANKAMERICARD.

Send us (1) Your Number, (2) Interbank No., (3) Exp. Date.

● Before buying any other Type ignition system...

Send Postcard for our FREE BROCHURE.

★ If you have already installed a C-D ignition system,  
Modernize and Increase its Efficiency...

CONVERT YOUR "C-D" UNIT TO BREAKERLESS!

Opto-Electric "TRIGGER UNIT"...Only \$34.95



● Our BEST Salesmen are the owners  
and users of our ALLISON System!

**ALLISON**  
AUTOMOTIVE COMPANY

1269 - P, East EDNA PL., COVINA, CAL. 91722

CIRCLE NO. 2 ON READER SERVICE CARD

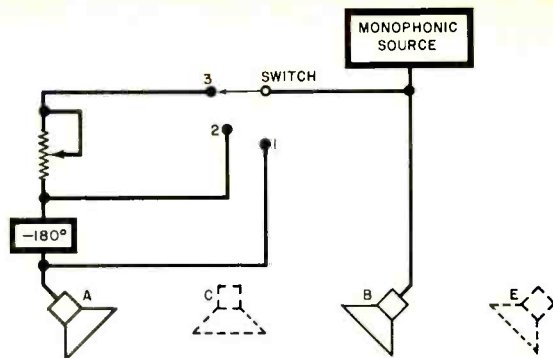

Fig. 5. Influence of phase reversal and level difference on fused-image location is shown.



thing. In fact, their results indicated a close correlation between phase/time incoherence at a listener's ears and sensation of space.

Another experiment cited by Gardner shows to what extent phase differences can extend the range of sound-source localizations provided by a conventional stereo system. In the setup shown in Fig. 5, the phase of the signal going to speaker A can be reversed, in which case the phantom sound source (assuming the listener is positioned equidistant from the two speakers) shifts from a point directly ahead (C) to one directly behind (D). Switch position 3, which introduces some variable attenuation into channel A, enables one to achieve intermediate effects; locating the phantom source at E, for example. It would appear that, if you are willing to sit in the right spot and keep your head perfectly still, you can have "surround sound" from just two speakers. Again, this was confirmed by studies in Japan (Matsudaira and Fukami, in *JAES*, December 1973), although the researchers were inclined to attribute the rear localizations to contributions of the listening room.

Matsudaira and Fukami, writing specifically about the effects of phase differences on sound localization, presented further findings. For a representative sample of listeners, they observed that localization was ambiguous when interchannel phase differences approached 180 degrees (completely out of phase), but became less so as phase differences were increased toward 360 degrees. This

would suggest that it is phase rather than time differences to which we respond most readily, although time apparently becomes a factor when delays are increased.

**Making Records.** From all of this, it's hard to avoid the conclusion that there should be a well-organized division of labor applied to stereo recording. IAD's, which seem easier to manipulate, should be assigned the task of sharply localizing instruments and performers. ITD's can then create the diffuse sonic environment of the performance. This, in effect, is what appears to happen in many good stereo recordings, although it may not be systematically sought. Recordings made exclusively with closely coincident microphones will lack a significant amount of ITD's, although IAD's may be naturally rendered. Widely spaced microphones provide a wealth of ITD's that are sometimes so great in magnitude that localization can't be controlled. Certain special mike setups (such as the midside technique pioneered in Germany) can be made to work pretty flexibly in terms of the balance of ITD's to IAD's.

The multi-mike/multi-track approach, which is becoming popular world-wide, potentially offers the greatest flexibility of all, since signal processing can be made very selectively on small segments of the total performance. Unfortunately, multi-tracking results in an embarrassment of riches. It seems there are so many adjustments that could be made, and never enough time to explore them. ♦



**"CLEAR" "Solid"...**  
**"POWERFUL"...**  
**"Crisp" "PENETRATING"...**

Speech Compression is built-in every Johnson CB radio. State-of-the-art circuitry electronically selects voice frequencies that penetrate noise and interference . . . then boosts the level of modulation to give your signal that powerful "Johnson sound." It's one of many engineering advances — like receiver "steep skirt" filtering to cut interference and automatic threshold limiting to slice out noise — that gives U.S.-made Johnson CB that extra edge of performance. Performance that's backed by a full 1-year parts and labor warranty with over 700 authorized service centers nationwide.

**Messenger 250**  
 100% solid-state base station



**Messenger 123B** 23-channel mobile with +/- ground switch



**Messenger 130 and 132**  
 "The radiotelephone CB System"  
 with private listening option



write for free catalog

**E.F. Johnson Co.**

Waseca, Minnesota 56093 • In Canada: A. C. Simmonds & Sons, Ltd.

# Look for the PTC Semiconductor Mart at your Mallory Distributor's.

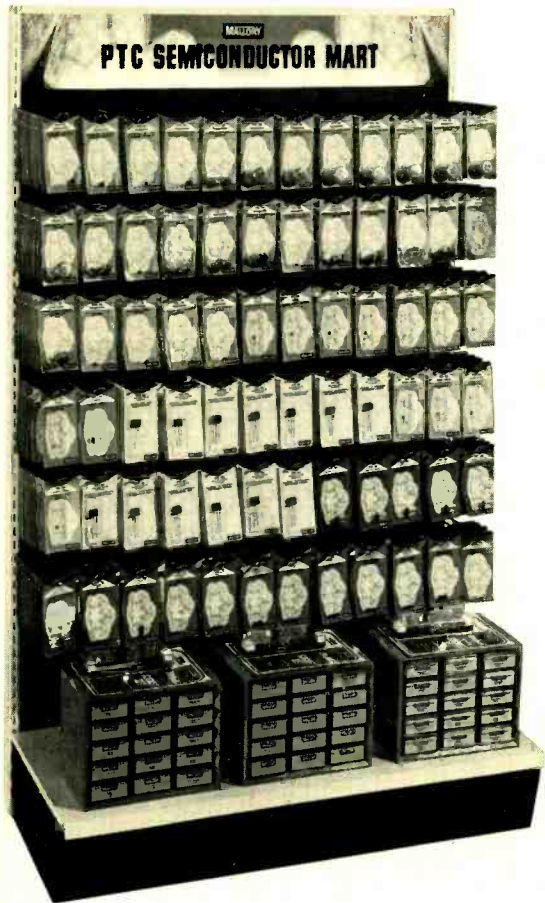

**THE SEMICONDUCTOR MART.** Here's the quick, easy way to get the replacements you need. It's the best assortment of the hottest semiconductors around. Transistors, diodes, multiple diode packages, zener diodes and integrated circuits included.

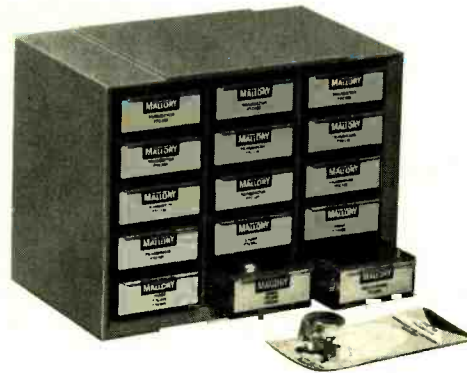

**THE FAMOUS MALLOBIN® WAREHOUSE.**  
With the semiconductors most needed by service technicians.



**FREE** copies of the very latest cross-referenced Semiconductor Product Guide.

**Clear, concise product data on the packages makes your choice easy. And Mallory quality, versatility, and dependability make every choice a good one.**

## You know what you need. Now you know where to find it.

**MALLORY**

**MALLORY DISTRIBUTOR PRODUCTS COMPANY**  
a division of P. R. MALLORY & CO. INC.  
Box 1284, Indianapolis, Indiana 46206; Telephone: 317-856-3731

Batteries • Capacitors • Controls • Security Products • DURATAPE® • Resistors • Semiconductors • SONALERT® • Switches • Timing Devices and Motors  
MALLOBIN® is a registered trademark of P. R. Mallory & Co. Inc.



# CONVERTER TURNS COUNTER INTO A DIGITAL VOM



*Your frequency counter  
can double as a  
highly accurate  
3 3/4-digit DVOM without  
modifying the counter.*

BY ROBERT S. STEIN

**F**OR MANY years, the electronic volt-ohmmeter has been a standard instrument in the service shop, hobby lab, and ham shack. In recent times, this instrument has often been joined by the electronic frequency

counter, whose size and cost have been drastically reduced by integrated circuits. The next acquisition might well be the popular digital multimeter.

For those nonprofessionals who may not always be able to justify the

expense of a DMM (since it duplicates, functionally, his analog VOM), here is a relatively inexpensive (under \$75) conversion unit which allows a frequency counter to be used as an especially accurate 3 3/4-digit DVOM

### DVOM SPECIFICATIONS

#### AC and DC Volts

**Ranges:** 5, 50, 500, 1000

**Resolution:** 1 mV on 5-V range

**Accuracy:** Better than 1% of reading  
±1 digit (above 15 mV on ac)

**Input Resistance:** 11.1 megohms on dc, 1.1 megohms on ac

**AC Frequency Response:** ±0.5 dB from 20 Hz to 25 kHz; -3 dB at 125 kHz

#### Resistance

**Ranges:** 500 ohms; 5, 50, 500 kilohms; 5 megohms

**Resolution:** 0.1 ohm on 500-ohm range

**Accuracy:** Better than 1% of reading  
±1 digit when calibrated against 0.1% standards

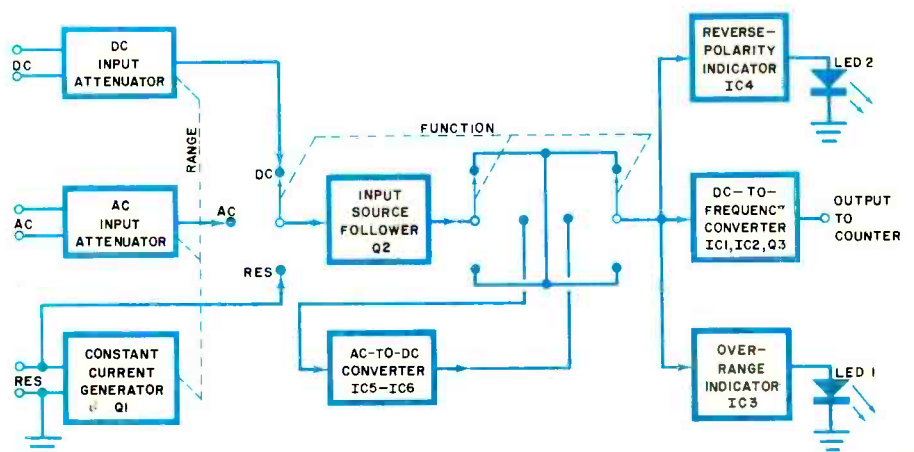

Fig. 1. Block diagram showing basic system operation.

without any changing of the counter.

The DVOM converter is used in conjunction with an electronic frequency counter capable of measuring 9999 Hz with 1-Hz resolution. Thus, a four-digit readout is presented (considered to be 3¾ digits since the most significant

digit goes from zero to five instead of nine). Four ranges of voltage readings (ac and dc) and five ranges of resistance readings are controlled by two front-panel switches.

Calibration of the dc ranges of a DVOM is easy, using standard refer-

ence mercury cells. In most cases, a reference for calibrating the ac ranges is not so easily obtainable for an instrument whose accuracy is better than 5%. Calibrating the ac voltage ranges of this DVOM converter, however, is accomplished by using the

## PARTS LIST

- C1—Four 0.01- $\mu$ F, 1.5-kV ceramic capacitors in parallel
- C2,C3,C4—0.01- $\mu$ F, 1-kV ceramic capacitor
- C5,C6,C9,C10,C18,C21,C22—0.01- $\mu$ F, 50-V ceramic capacitor
- C7,C17—150-pF, 50-V ceramic capacitor
- C8—0.001- $\mu$ F, 5%, silver-mica or Mylar capacitor
- C11—18-pF, 50-V ceramic capacitor
- C12,C13—0.003- $\mu$ F, 3-kV ceramic capacitor
- C14,C15—0.47- $\mu$ F, 25-V ceramic capacitor
- C16—10-pF, 50-V ceramic capacitor
- C19—1- $\mu$ F, 25-V electrolytic capacitor
- C20—33-pF, 50-V ceramic capacitor
- C23,C24—1000- $\mu$ F, 25-V electrolytic capacitor
- C25—50- $\mu$ F, 25-V electrolytic capacitor
- C26—4.7- $\mu$ F, 25-V tantalum (or 25- $\mu$ F, 25-V aluminum) capacitor
- D1,D2,D4 to D10—1N914 or 1N4148 diode
- D3—1N5228 or HEPZ0208 diode
- D11 to D14—1N4002 or HEP0156 diode
- D15—1N4744 or HEPZ0418 diode
- IC1—LM301AN op amp
- IC2—555 timer
- IC3,IC4—741C op amp
- IC5,IC6—LM308H op amp
- IC7—LM320H-15, LM320K-15,LM320-K-5.2 regulator (see text)
- I1—117-V pilot lamp assembly (Radio Shack 272-328 or similar)
- J1,J2—5-way binding post (one red, one black)
- J3—UG-1094/U BNC connector
- J4—22-contact pc board edge connector (Amphenol 143-022-01 or similar)
- LED1,LED2—Light-emitting diode (MLED 655, Radio Shack 276-041 or similar)
- Q1—2N3638, 2N3638A, or HEP716 transistor
- Q2—2N5199 transistor
- Q3—E300, 2N5245, HEP802 transistor
- R1—10-megohm, 0.1%, 1-watt metal film resistor\*
- R2—1-megohm, 0.1%, metal-film resistor\*
- R3,R6—100,000-ohm, 0.1%, metal-film resistor\*
- R4—11,110-ohm, 0.1%, metal-film resistor\*
- R5—1-megohm, 0.1%, 1-watt, metal-film resistor\*
- R7—10,000-ohm, 0.1%, metal-film resistor\*
- R8—1111-ohm, 0.1%, metal-film resistor\*
- R9—2.7-megohm, 10% resistor
- R10—3.9-megohm, 10% resistor
- R11—47-ohm, 10% resistor
- R12—3.3-megohm, 5% resistor
- R13—500,000-ohm trimmer potentiometer (Mallory MTC55L1, CTS X-201-R504B, Radio Shack 271-221)
- R14—330,000-ohm, 5% resistor
- R15—50,000-ohm trimmer potentiometer (Mallory MTC54L1, CTS X-201-R503B, Radio Shack 271-219)
- R16—33,000-ohm, 5% resistor
- R17—5000-ohm trimmer potentiometer (Mallory MTC53L1, CTS X-201-R502B, Radio Shack 271-217)
- R18—3300-ohm, 5% resistor
- R19—500-ohm trimmer potentiometer (Mallory MTC52L1, CTS X-201-R501B, Radio Shack 271-226)
- R20—330-ohm, 5% resistor
- R21—100-ohm trimmer potentiometer (Mallory MTC12L1, CTS X-201-R101B)
- R22—100-ohm, ½-W, 10% resistor
- R23—1500-ohm, 10% resistor
- R24—100,000-ohm, ½-W, 10% resistor
- R25—6800-ohm, 5% resistor
- R26—6200-ohm, 5% resistor
- R27—1000-ohm trimmer potentiometer (Mallory MTC13L1, CTS X-201-R102B, Radio Shack 271-227)
- R28,R44,R51—10,000-ohm trimmer potentiometer (Mallory MTC14L1, CTS X-201-R103B, Radio Shack 271-218)
- R29,R50—93, 100-ohm, 1% metal-film resistor
- R30,R32—1-megohm, 10% resistor
- R31,R40 to R43—100,000-ohm, 10% resistor
- R33—3.0- or 3.5-megohm trimmer potentiometer (Mallory MTC355L1, Centralab TSV-3M)
- R34—5.1-megohm, 5% resistor
- R35,R56—10,000-ohm, 10% resistor
- R36—270-ohm, 10% resistor
- R37—2200-ohm, 10% resistor
- R38—16,000-ohm, 5% resistor
- R39—33,000-ohm, 5% resistor
- R45,R47,R49—82,500-ohm, 1% metal-film resistor
- R46—68,000-ohm, 10% resistor
- R48—41,200-ohm, 1% metal-film resistor
- R52—33,000-ohm, 10% resistor
- R53—150-ohm, ½-W, 5% resistor
- R54—300-ohm, 5% resistor
- R55—560-ohm, 5% resistor

- S1—3-pole, 5-position rotary switch (Mallory 4M2225, Centralab PA-1013)
- S2—6-pole, 5-position rotary switch (Mallory 4M2235, Centralab PA-1021)
- T1—32-V, 100-mA center-tapped transformer (Triad F-90X)
- Misc.—Cabinet (LMB W-1C or similar), knobs (2), terminal strips, grommet line cord strain relief, angle brackets, rubber feet (4), test leads, mounting hardware.

Note—An etched and drilled printed circuit board is available at \$9.50 (post-paid in U.S.A.) from R.S. Stein, 1849 Middleton Ave., Los Altos, CA 94022.

\* 1% resistors may be used in place of 0.1% resistors specified, but with reduction of accuracy to approximately 3% on the 50-, 500-, and 1-kV ranges. If 1% values are selected, use an 11,000-ohm resistor in series with a 110-ohm type for R4, and a 1000-ohm resistor in series with a 110-ohm type for R8.

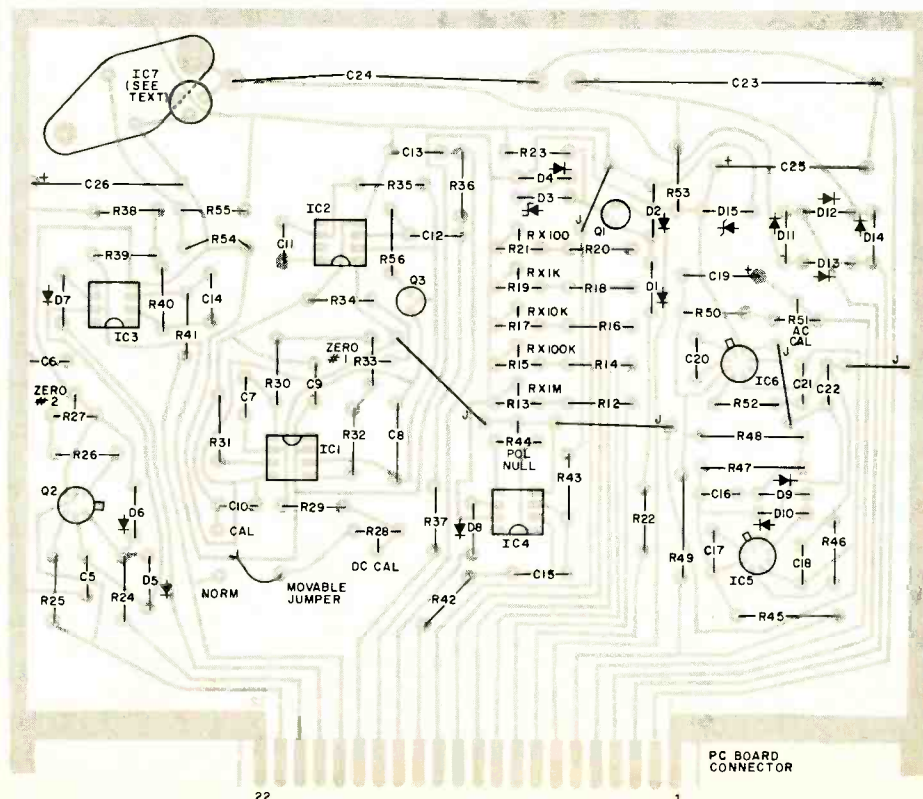

same mercury cells employed for the dc calibration.

The DVOM converter actually measures the average value of the applied ac voltage, but the readout is the equivalent rms voltage of a sine wave. This results in a measurement that is far more accurate than that provided by the usual electronic multimeter. They usually respond to the ac peak voltage and are calibrated to read out 0.707 times the peak. (The advantages of an average-responding voltmeter over a peak-responding meter are beyond the scope of this article.)

Another advantage of the DVOM converter is that it provides complete isolation (up to 1000 V) between the case and the equipment being tested, as opposed to the usual electronic voltmeter which has the negative lead grounded to the case. The safety factor permits making measurements on

circuits directly connected to the ac line without a common ground.

**Measurement Functions.** As shown in Fig. 1, the dc voltage to be measured is applied to an attenuator (controlled by the range switch) which reduces the input to a nominal maximum of 5 V. The input source follower provides a high input impedance for the attenuator and a low-impedance current source for the frequency converter. The latter changes the dc to a pulse train whose frequency is proportional to the input (1 volt = 1000 Hz). The pulse train is then supplied to the frequency counter for digital readout.

For ac measurements, an ac-to-dc converter is added to provide a dc signal to the frequency converter. The average value of the ac voltage is increased by a factor of 1.111 (the ratio of rms to average voltage for a sine

wave) so that the counter indicates the equivalent rms voltage.

To measure ohms, the range switch selects a current value from the constant-current generator and this current is applied to the resistance. The resulting voltage drop is then treated as a dc voltage input. On the 500-ohm range, for example, the constant current is 10 mA. Applied to a 500-ohm resistor this would give a voltage drop of 5 V. Each successive position of the range switch increases the multiplication factor by ten and reduces the current by the same factor so that the nominal full-range voltage across the unknown is always 5 V.

Although automatic polarity switching could have been included in the DVOM converter, it would have increased the complexity of the circuits and the polarity indicator would not  
(Continued on page 32)

Fig. 2. Actual-size foil pattern for pc board is below, component layout on opposite page.

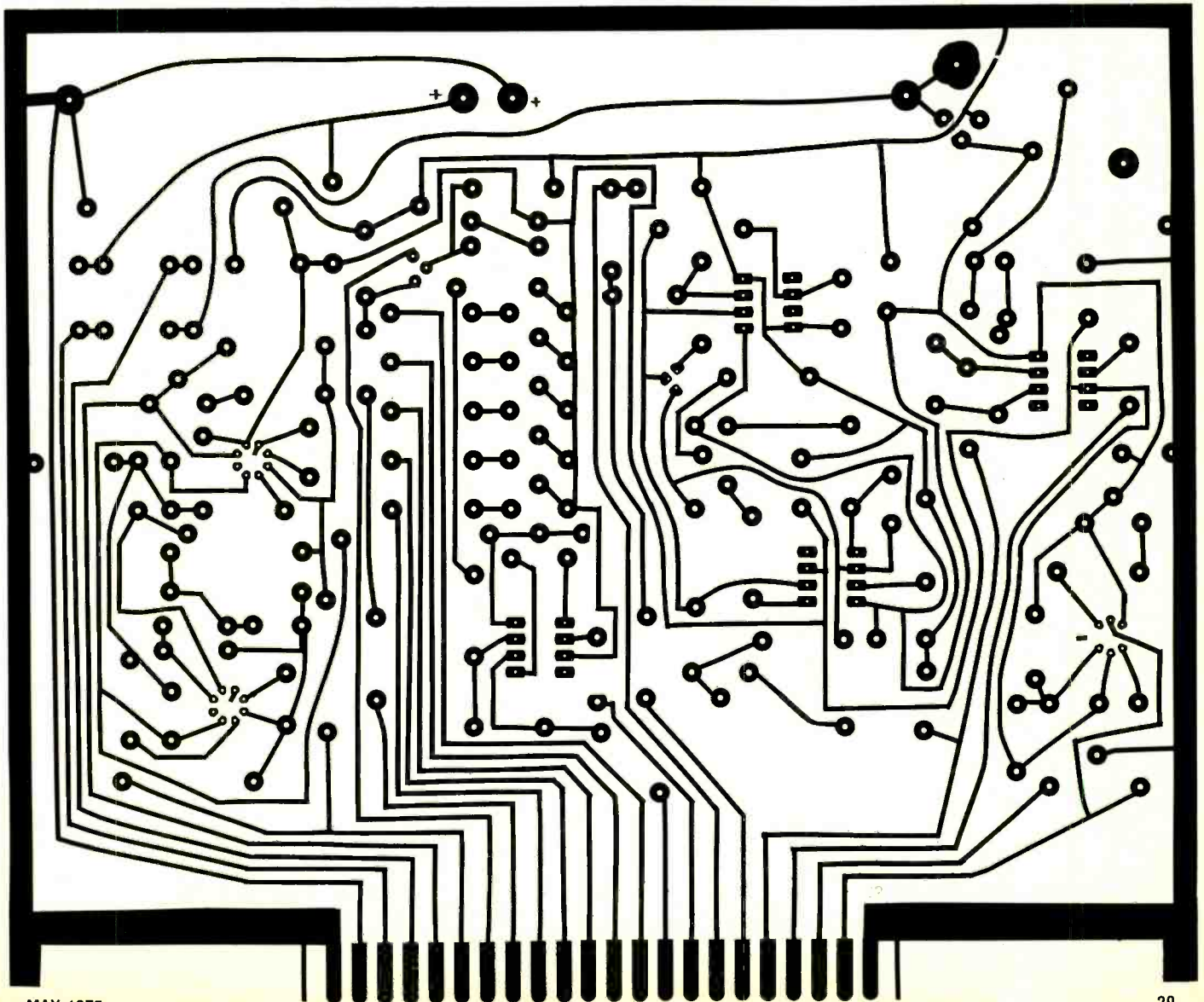



The positive supply is regulated by *D15*, while the negative supply is regulated by *IC7*. The latter can be either an LM320H-15 or LM320K-15, which are identical electrically but have different case configurations. It is also possible to use a 5.2-volt regulator (LM320K-5.2) which may be less expensive. The output is raised to 15 volts by referencing the regulator through *R54* and *R55*. It is important that the negative supply be well regulated—within a few tenths of a volt—if the dc-to-frequency converter is to be calibrated by *R28* and *R29*. Regulation of the positive supply is not as important.

The constant-current generator for resistance measurements (Fig. G) uses *Q1* to generate the current. The emitter is connected to the +15-volt supply through *S1* (Fig. A) to one of the five series resistor networks. Diodes *D3* and *D4* provide forward bias for the base of *Q1*. When the collector is returned to ground through the unknown resistance, collector current flows and the voltage across the unknown is applied to the input source follower. Resistor *R22* and diodes *D1* and *D2* protect the circuit against the accidental application of low voltage when the FUNCTION switch is set to measure resistance. A negative voltage will be clamped by *D2*, while a positive voltage will be blocked by *D1*.

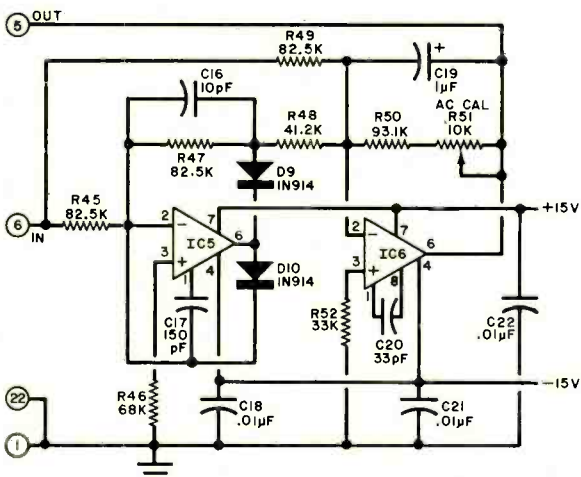

Fig. D. Ac-to-dc converter is a rectifier.

Fig. E. Reverse-polarity indicator.

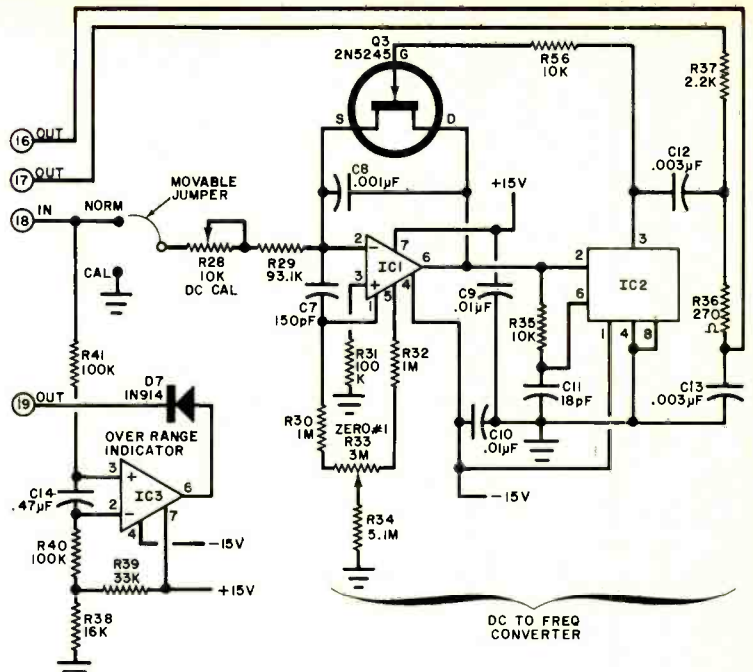
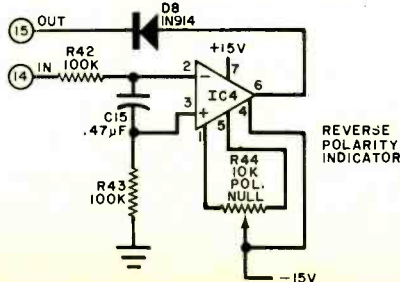

Fig. C. Over-range indicator circuit drives LED1.

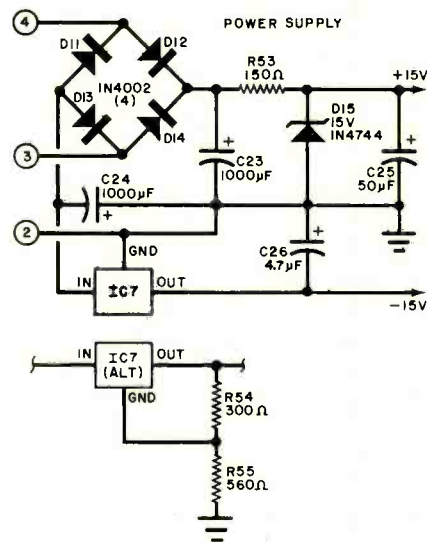
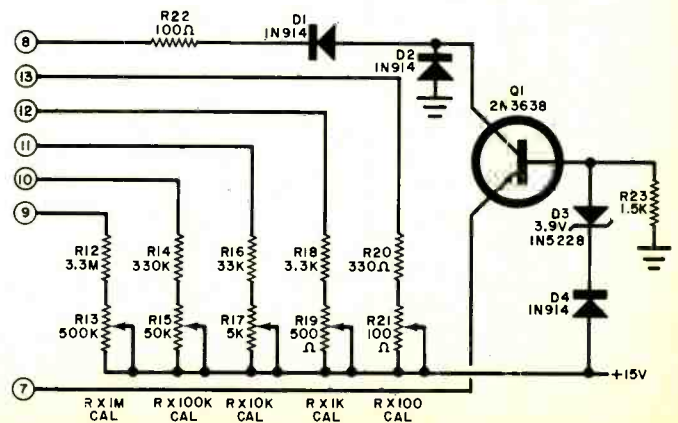

Fig. F. Power-supply circuit.

Fig. G. Constant-current generator for resistance tests.



continued from page 29

have been next to the readout unless the counter were modified. Consequently, the converter has a REVERSE POLARITY indicator (*LED2*) which goes on when the polarity is the reverse of the position selected by the FUNCTION switch. Then, it is only necessary to change the switch position; the leads do not have to be reversed.

The OVER RANGE indicator (*LED1*) goes on when the selected range of any function is being exceeded. Nominally, the range maximum is 5, or a decade multiple thereof, though the DVOM will over-range by nearly 100%. Above 5 or 6 volts, however, accuracy is reduced so that *LED1* shows when to switch to another range.

**Construction.** Most of the components in the converter are mounted on the printed circuit board (Fig. 2). In the prototype (see photo), the board was mounted at a 45° angle to make room for the transformer at the back and the switches at the front. (This approach reduces the total amount of room needed.) In assembling the board, be sure to observe the polarities of the semiconductors and capacitors. Install the five jumpers shown in Fig. 2. Identify the trimmer potentiometers to make calibration easier.

On the pc board, below *IC1*, there

are two terminals marked NORM and CAL. These are made by soldering half-inch lengths of #18 bare wire to the pads and sticking them through to the component side of the board. The associated movable jumper is made of a 1½" length of flexible, insulated wire. Solder one end to the pad on the board and terminate the other end with a contact removed from a 7- or 9-pin miniature tube socket.

The board is designed for one of three different negative voltage regulators at *IC7*. If an LM320H-15 (TO-5 case) is used, resistors *R54* and *R55* are not required. If an LM320K-15 (TO-3 case) is used, resistors *R54* and *R55* are not used but a jumper is connected where *R55* would be. If an LM320K-5.2 is used, both *R54* and *R55* are required.

The leads of zener diode *D15* should be bent so that the diode stands about ½ inch above the board to increase its power dissipation.

In the prototype, the LMB W-1C chassis was inverted, with new mounting holes and four rubber feet on the bottom. A small right-angle bracket was mounted at the center of the front panel so that the cover could be clamped to the cabinet.

Install the front-panel components as shown in the photograph, using

grommets to hold the LED's. Indicator *I1* has its own mounting collar. Use press-on type to identify the components and switch positions.

Using small lengths of metal bent at a 45° angle, mount *J4* so that the top of the board is almost at the top of the back of the cabinet. A small plastic retainer can be made to hold the top of the board. Contact 1 of *J4* is at the RANGE switch side of the cabinet.

All components on *S1* are wired point-to-point, using insulation where necessary. The power cord can be brought out through the rear of the cabinet, using a rubber grommet.

**Calibration.** The following are needed for calibration: two 1.35-V mercury cells (Mallory RM401R, RM450R, RM625R or similar); a test jumper approximately 4" long with a miniature alligator clip on each end; five 0.1% (or better) resistors, one in each of the following ranges: 200 to 400 ohms, 2k to 4k, 20k to 40k, 200k to 400k and 2M to 4M; one 10k, ten-turn potentiometer. The accuracy of the ohmmeter calibration depends on the accuracy of the 5 precision resistors.

Connect a coax cable between *J3* on the DVOM converter and the input to the frequency counter. Set the counter so that it will read with a resolution of 1 Hz. Since the location of the decimal point on the counter display depends on the type of counter being used, all data can now be given in hertz.

Perform the calibration steps as numbered below. Adjustments are made in steps 3 and 4 which require a 1-Hz count to be displayed on the counter no more than once every five seconds. This observation is simplified if an oscilloscope having a driven or triggered sweep is available. The scope vertical input should be connected in parallel with the input to the counter. Set the controls on the scope for triggered sweep, which will be initiated each time the DVOM converter generates an output pulse. Adjust the calibration control in each step so that the sweep is triggered no more than once every five seconds.

1. With the FUNCTION switch (*S2*) OFF, connect the movable jumper on the pc board to the CAL terminal. Temporarily short *C1*, using the test jumper.

2. Set the FUNCTION switch to +DC and the RANGE switch to 5V/RX1K. Short the input terminals of the DVOM and allow the unit to warm up for 15 minutes.

Photo shows assembly of board in chassis with points labelled.

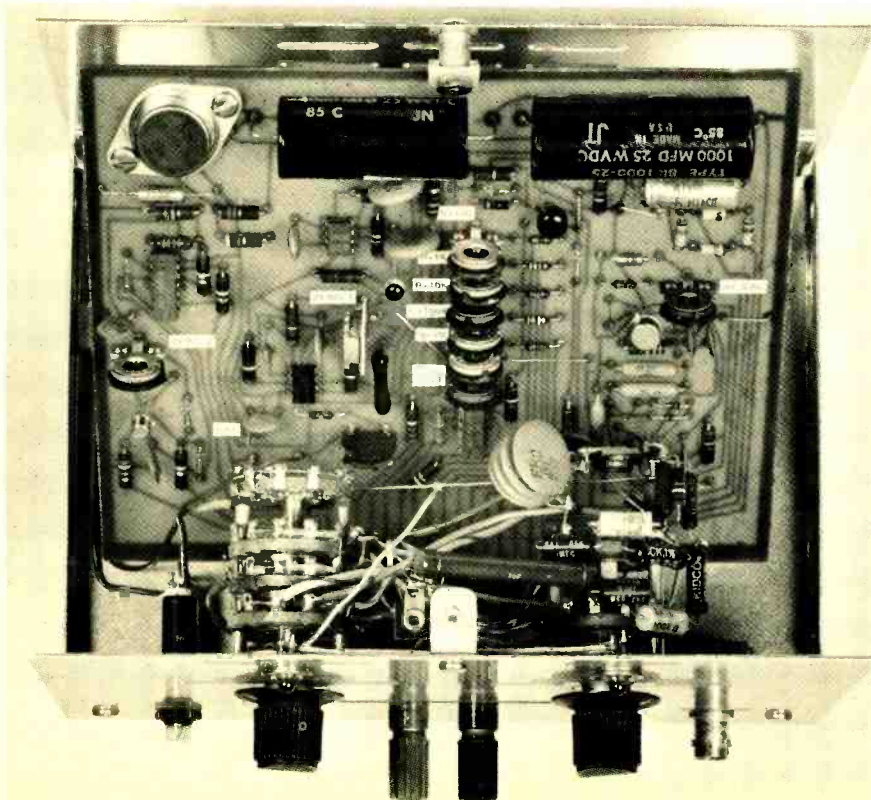



3. Rotate *R33* to the end which results in a display on the counter. Then readjust it to the point where the counter displays 1 Hz no more than once every five seconds. This is *critical*; do not set the control past this point if accuracy of calibration is to be obtained.

4. Connect the movable jumper on the pc board to the NORM terminal. Adjust *R27* the same as *R33* in step 3.

5. Adjust *R44* to the point where *LED2* just goes off. This is refined in step 14.

6. Remove the short from the input terminals and connect the two 1.35-V mercury cells in series across the terminals. Adjust *R28* to get a counter display of 2708.

7. Set the FUNCTION switch to AC and adjust *R51* for a counter display of 3009. Disconnect the mercury cells.

8. Set the FUNCTION switch to RES and the RANGE switch to RX100. Connect a precision resistor having a value between 200 and 400 ohms to the input terminals. Adjust *R21* for a display equal to the first four significant figures of the resistor value.

9. Set the RANGE switch to 5V/RX1K. Connect a precision resistor between

2000 and 4000 ohms to the input. Adjust *R19* for a display equal to the first four significant figures.

10. With the RANGE switch on 50V/RX10K, and an input between 20,000 and 40,000 ohms, adjust *R17* to get the proper display.

11. With the RANGE switch on 500V/RX100K, and an input between 200,000 and 400,000 ohms, adjust *R15* to get the proper display.

12. With the RANGE switch on 1000V/RX1M, and an input between 2 and 4 megohms, adjust *R13* to get the proper display.

13. Set the FUNCTION switch to +DC and the RANGE switch to 5V/RX1K. Check the OVER RANGE indicator by applying a dc voltage variable from 1 to 7 volts to the input. The indicator should come on when the applied voltage is between 5 and 6 volts.

14. Connect a 10-kilohm potentiometer across a mercury cell to apply 1 millivolt to the input and check that the counter reads 0001. Set the FUNCTION switch to -DC to see if the REVERSE POLARITY indicator comes on. If it does not, adjust *R44* so that the indicator glows or blinks at a reverse voltage of 1 to 3 mV and is off when the

DVOM leads are shorted in all voltage positions of the RANGE switch.

15. Remove the test jumper which was installed across *C1*.

**Operation.** In using the converter, there are a few points to keep in mind. First, the counter display is not related to the DVOM range. You must determine mentally where the decimal point should be located. Probably the most convenient display is one which reads out in kilohertz with three digits to the right of the decimal point. This provides a basic 5-volt range and is easily scaled by factors of ten each time the RANGE switch is changed. This is also the basis for the resistance range designations.

Note that the OVER RANGE indicator will always be on when the FUNCTION switch is set to RES and the input terminals are open since infinite resistance is obviously over range.

When the FUNCTION switch is set to AC, there will be a residual reading on the counter even with the input terminals shorted. The reading will be between 5 and 10 millivolts, which limits the lowest meaningful ac reading to about 15 mV. ♦

## UNIQUE CONTINUITY TESTER

*Two-transistor VCO generates only 50 microamperes.*

BY J. von MUECKE, Motorola Applications Lab

**C**HECKING an electronic circuit for continuity would appear to be a very simple job—just use a VOM, VTVM, or other type of resistance measuring instrument. Unfortunately, the use of such instruments in a solid-state circuit is not a good idea since the current they put out for resistance measurements can damage semiconductor junctions.

The easy-to-build continuity tester described here has only 50 microamperes between the test probes in a short-circuit condition. This permits its use on most common IC's and discrete semiconductors, including MOS devices.

The "readout" on the continuity tester is audible so that there is no need to keep one eye on a meter when probing around in a circuit. Many a semiconductor junction has been damaged when a probe slipped from a certain point as the operator looked

up to read a meter. With this tester, a good diode junction will "sound" good when forward biased.

**Circuit Operation.** Transistors *Q1* and *Q2* form a simple voltage-controlled audio oscillator, using a speaker as the output. The oscillation frequency is determined by *R1*, *C1*, *R4*,

and the resistance between the test probes. Resistor *R3* provides the collector load for *Q2* and capacitor *C2* is used for audio bypass.

With the test probes open (unshorted), battery life is approximately the same as shelf life since no power is consumed when there is no continuity between the probes.

**Construction.** The continuity tester can be assembled on a small piece of perforated board and mounted, with the battery, in an appropriate enclosure. A small speaker can be cemented to the top cover of the enclosure with holes drilled in the cover for the sound to escape.

Bring the test leads out through grommets and terminate them with conventional metal tips with plastic sleeves. Color-code the probes with red for the positive side of the battery and black for the other side. ♦

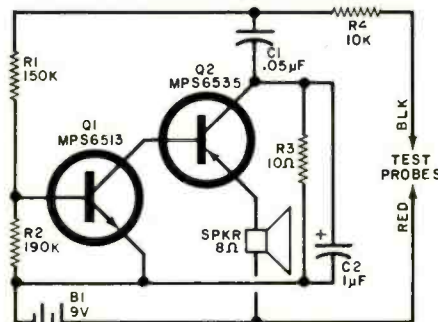

*Schematic of easy-to-build tester.*

**T**HERE'S a host of magnetic tape types available to recordists, from low-noise to ferrichrome formulations. To achieve the most fidelity from each tape, a tape recorder must have its bias level and, sometimes, record/playback equalization properly set for each type.

Some tape machines offer multiposition switches to make automatic internal adjustments for popular tape classifications—standard, high-output, chromium-dioxide, etc. Most, however, do not cover all tapes, especially the newer ones. Moreover, formulations of the same type of tape often differ from brand to brand, necessitating bias-level modifications to take full advantage of their potential.

Many tape enthusiasts think they are stuck with a built-in bias and equalization settings of their machines. Not true! If you own a VTVM and an audio oscillator, you can "tune" your tape recorder to optimize performance for your preferred type and brand of tape. Here's why and how.

**Tape Bias.** Three variables in a tape deck's electronics determine overall performance: bias current applied to the record head, record equalization and playback equalization. Each affects frequency response, distortion and signal-to-noise ratio. They also interact. Let's consider tape bias first.

To illustrate some of the effects of bias on tape deck performance we experimented with a Model 7 Ferrograph recorder. This unit has continuously variable bias settings for each channel—a feature almost invariably found on professional tape equipment. Utilizing virgin BASF type LP35LH (high-output, low-noise) tape, we turned the bias current as far down as possible (about 10 dB below the figure recommended by Ferrograph). Several test recordings were made with a 1000-Hz tone at the 0-VU level. Each successive test was made with more record bias applied. The results are plotted as a continuous graph in Fig. 1, in which output level and harmonic distortion are both plotted against bias current level (expressed in dB).

The curves indicate that, as bias increases, output level rises and distortion decreases, remaining at or near its minimum over a fairly broad range of adjustment. This would suggest that it might be a good idea to set the

# Matching Tape Decks

*Here's how to obtain optimum performance from tape formulations that don't*

bias at a somewhat lower point than the "0-dB" point recommended by the manufacturer. To do so, however, would cause another problem, as indicated in the curves of Fig. 2. We repeated the experiment except that this time we used a 10,000-Hz signal. To prevent "tape saturation" at this high frequency (which might occur due to the high-frequency boost of the record equalization), we backed down the recording level to 10 dB below the 0-VU point. The results differ markedly from those observed in Fig. 1. If, for example we had first decided to "back-off" to a -3-dB level of bias, we would have gained about 3 dB in output level

without a significant jump in harmonic distortion level at mid-frequencies. The same adjustment for a 10,000-Hz signal, however, would have resulted in a rise in output level of some 7 dB (relative to our -10-dB input reference); and distortion would have risen from 3% to just over 4%. The rise in output level is the result (among other things) of the high-frequency record preemphasis which is normally built-in to overcome the tendency of higher bias current to reduce high-frequency output.

To further illustrate this point, we applied a frequency-swept (1000-to-20,000-Hz) signal to the high-level

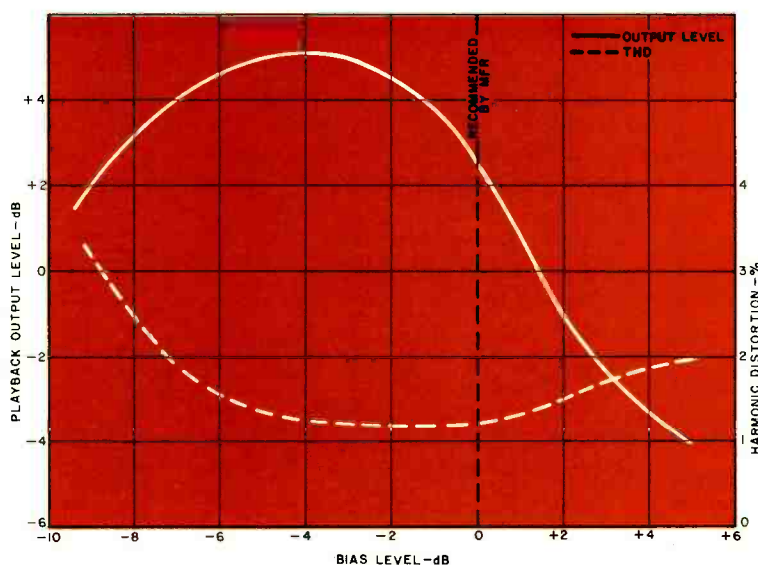

Fig. 1. How bias current affects performance. A 1000-Hz signal was recorded at 0 VU and 7½ ips.

# to Magnetic Tape

match a tape machine's  
factory-set bias and  
equalization characteristics.

inputs of the recorder. Figure 3 shows a display of two full sweeps. The upper trace represents the left channel, whose record bias was adjusted for optimum, in accordance with manufacturer's instructions. The lower trace shows recorded output from the right channel, whose record bias was "under-adjusted" as described. The undesired rise in response (peaking at about 10,000-Hz) is clearly visible in the lower trace. The 3-dB increase in output that we might have achieved in the midrange is hardly worth it in view of the nonuniform response and increased distortion at high frequencies.

So far, we have discussed the importance of proper bias adjustment when using high-quality tape. The most startling revelation came when we substituted a poorer quality "white box" or private label brand from a well-known distributor. Having left all our bias adjustments in their "optimum" positions (as recommended by the manufacturer), we simply substituted the sweep-frequency experiment. Scope gain settings remained the same. The results for both channels are shown in Fig. 4. Output level has dropped significantly (more than 6 dB at midfrequencies) and high-end response has fallen off more rapidly.

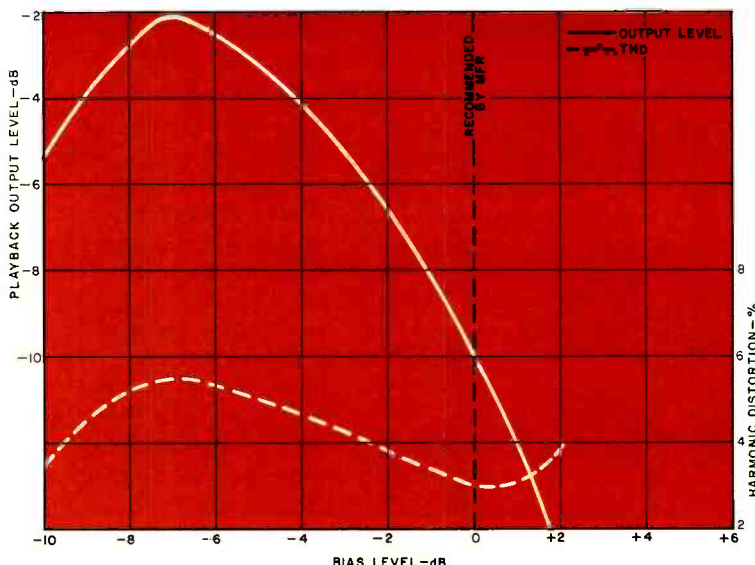

Fig. 2. Effects of bias current on high-frequency performance. Signal was 10,000 Hz at -10 VU.

Obviously, here is a case where "backing off" on the bias adjustment would improve both output level and high-frequency response, without having it alter any of the equalization characteristics.

**Adjusting Bias On Your Tape Deck.** If you had the time, money, and patience to try every type of high-quality tape available, you could probably find the exact brand and type of tape for which your machine is optimized. Often, the manufacturer will tell you the specific tape he used in setting the bias of your deck. If, on the other hand, you own a less sophisticated machine, the manufacturer may have set the bias at a compromise value for many brands of tape. This is true, even if your machine is equipped with two or more bias settings. Considering the great variety of tapes available, it would take a dozen or more positions to take care of them all ideally. If you have selected a given brand and type of tape, it is fairly easy to trim the bias current level to suit that tape. You will need an audio oscillator (with variable frequency output) and a VTVM. If your tape deck has separate playback and record heads (and separate preamps) the adjustment can be made in a single step, since you can monitor playback results as you vary bias current. If your machine combines record and playback in a single head, you will have to make the bias adjustment in a series of discrete small steps, playing back the results of each short recording strip to overcome this drawback.

Typically, the output of the high-frequency erase/bias oscillator in your tape deck is fed through potentiometers or trimmer capacitors to one side of the record head coil for each channel, as shown in Fig. 5. A suitable test set-up for making the adjustment is shown in Fig. 6. Record a 1000-Hz signal at a level of about 5 dB below 0 VU. Starting with a minimum bias level, increase the bias current while observing the playback output level on the VTVM, which is connected to the playback or line outputs of the deck. As you increase bias, output level will increase—rapidly at first and then more slowly. Eventually, you will observe maximum output. Increase the bias a bit further, until the observed output drops off approximately 0.5 dB. Repeat the procedure for the alternate channel.

The slight amount of excess bias

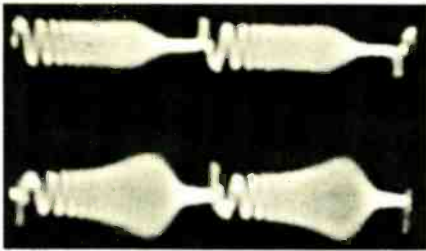

Fig. 3. Upper trace shows good response of properly biased channel. Under biasing (below) causes peaking.

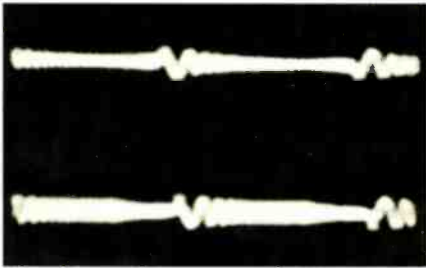

Fig. 4. With same bias setting as in Fig. 3, substitution of inferior tape gives lower output and poor response.

has several benefits. For example, it can help to reduce the amount of recording "drop outs" that occur because of poor dispersion of particles in the tape.

After you have optimized bias for each channel, it is a good idea to check overall frequency response from record-through-play cycle. We find it most convenient to check each channel individually. Connect the audio oscillator to one line input and connect a microphone to the alternate channel microphone input. Start at the low-frequency end, setting the record level for the audio oscillator channel at  $-10$  dB (at 1000 Hz) for an open reel deck, or  $-20$  dB if you are checking a cassette machine. (High-

frequency equalization at slow speeds of cassette decks is greater, and attempting to plot response levels above  $-20$  dB will result in tape saturation at high-frequencies) Use a series of short frequency spot-checks, announcing each frequency on the alternate channel as you proceed. In that way, you won't have to keep track of all the frequencies you use. Monitor the output and plot the results on suitable graph paper. If you find there is a rise in high-frequency response, increase the bias setting slightly until flat response is restored. If treble roll-off seems excessive, decrease the bias slightly.

While frequency response at the high end is related to bias settings, it is also determined by the combination of record and playback equalization. If optimum bias has been achieved and you find that record/playback frequency response is still poor, it might be better to attempt to optimize equalization rather than altering the bias level. An extreme change in bias level might cause harmonic and intermodulation distortion to rise significantly.

**Tape Equalization.** Unlike phonograph discs, there is no such thing as a "standard" record equalization curve for tapes. There are, however, standards for playback equalization. The most popular are the NAB and the CCIR (DIN) standards. The object of all tape equalization is, of course, to reproduce all frequencies at their original volume levels. Figure 7 illustrates the output that will be produced by a playback head having a 4-micron gap at various tape speeds. Since tape heads respond to velocity of changing magnetization pattern, the output

rises with frequency until the wavelength of the desired frequency approaches the gap length of the head, at which point, output level begins to drop rapidly. The tape recorder has two chances to "flatten" the overall record/play response curve. During the record process, treble boost can be applied to compensate for the high-frequency roll-off. If too much preemphasis is used, however, tape saturation will occur, distortion will increase, and treble response will roll off. Equalization deemphasis is also applied during playback. The almost linearly descending curves of Fig. 8 compensate for the rising output characteristic of the playback head, while the slight rise of the high end of the curve compensates for the roll-off in head response. If not enough deemphasis is designed into the playback preamplifiers, improved high-frequency response will be offset by increased tape hiss. Therefore, a balance which takes into account both frequency response and S/N must be maintained between the record and playback equalization.

Figure 9 shows typical (but by no means standard) record equalization curves used as complements to the previously shown NAB and CCIR curves. Since most audiophiles tend to look upon high-frequency response as the single most important tape deck specification, some manufacturers use a bit less record equalization and considerably more playback equalization, to claim better high-frequency response even if it means more tape hiss. This is particularly true in cassette decks.

Now, add to all this the fact that certain types of tapes (notably  $\text{CrO}_2$ ) offer inherently better high-frequency response to begin with than others. You can see that no one set of record and playback equalization curves will really be best for all types of tape. It is for this reason that equalization switches have found their way onto the front panels of both open-reel and cassette machines.

To customize your deck's response for your preferred tape, you can change its playback equalization. While it is also possible to alter the record equalization curve, we would not recommend doing so. A change in record equalization might affect headroom, tape saturation level and distortion. It would also be difficult to use the built-in record level meters which have been designed with all these fac-

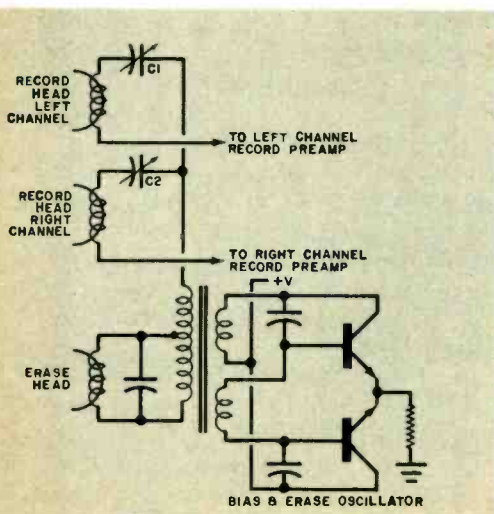
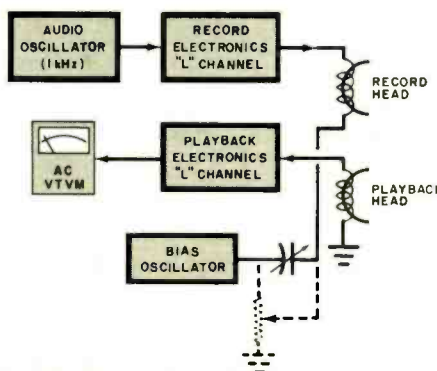

Fig. 5. Partial schematic shows how bias is adjusted by trimming  $C1$  and  $C2$ .

Fig. 6. Setup for adjusting record bias while observing playback level.



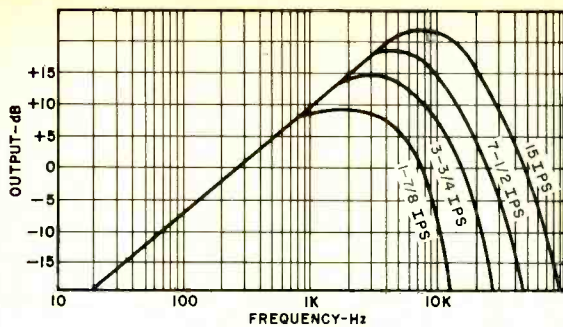

Fig. 7. Typical playback head output vs frequency for popular tape speeds.

Fig. 8. Two standard tape playback equalization curves for open-reel decks.

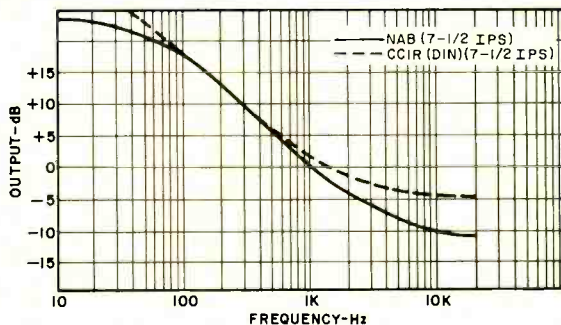
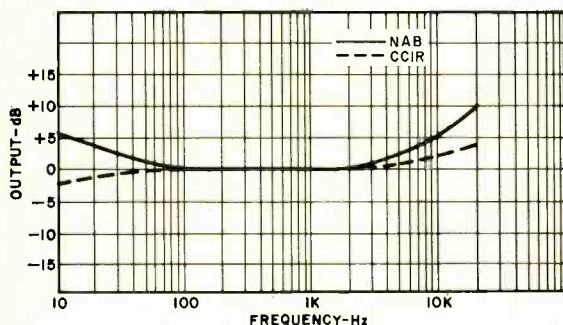

Fig. 9. Typical record equalization curves which complement NAB and CCIR.



tors in mind. If, however, you find that, with a given tape, your S/N is more than satisfactory but your high-frequency response leaves something to be desired, there's nothing to prevent you from experimenting with and altering the time constants of the playback equalization circuit. Some machines, in fact, have internal calibration potentiometers for this purpose.

A partial schematic of the playback circuit of a cassette deck is shown in Fig. 10. Potentiometer *R1* determines the overall time constant of the feedback network and therefore the frequency at which the curve "flattens out." Rotating the potentiometer so that it shorts out the 0.0022- $\mu$ F capacitor will lower high-frequency output, while rotation in the opposite direction (so that the full resistance is across the capacitor) increases output level for higher frequencies. If you are daring enough, you can even change fixed values of capacitors and resistors if your machine has no variable elements in its equalization circuit. Before attempting to do this in a haphazard way, you should write to

the manufacturer and outline your objectives. For example, there is a new type of chromium-dioxide tape which works best with an equalization time constant of 70 microseconds. The cassette case in which the tape is packaged has a special notch molded into the housing. Some of the newest cassette machines incorporate a switch which is activated by the insertion of

these cassettes. The switch alters the equalization time constant from 120 microseconds to 70 microseconds. But if your cassette deck is not equipped with this automatic switching and you want to convert the equalization for this new tape, what can you do? If you have a schematic of the machine, you may be able to find the pair of components (usually a resistor and a capacitor in parallel) which determine the 120- $\mu$ s time constant. The time constant equals *R* times *C*. If a 12-kilohm resistor and 0.01- $\mu$ F capacitor are combined, the time constant is  $10^{-8} \times 12 \times 10^3$ , which equals  $120 \times 10^{-6}$  or 120  $\mu$ s. Changing the resistance value to 6.8k will bring the time constant close to 70  $\mu$ s. Of course, you would then be restricted to that type of tape exclusively, unless you can rig up a suitable switch that would restore the old time constant when you wish to use the standard tape. Again, we recommend that you consult the manufacturer before you arbitrarily start substituting circuit components, since each manufacturer uses his own approach to equalization.

Since tape manufacturers are constantly introducing newer and better tapes, it is impossible for tape deck designers to provide optimum settings of bias and equalization for all present and future varieties. If you are willing to invest the time and effort, however, these improved tapes need not render your tape deck obsolete. A slight adjustment of bias and perhaps a modification of playback equalization, if performed with care, can update your favorite tape recorder. You will then be able to use the latest and best tape you can find.  $\diamond$

Fig. 10. Playback preamplifier section of cassette deck. Components in dotted area determine playback equalization curve.

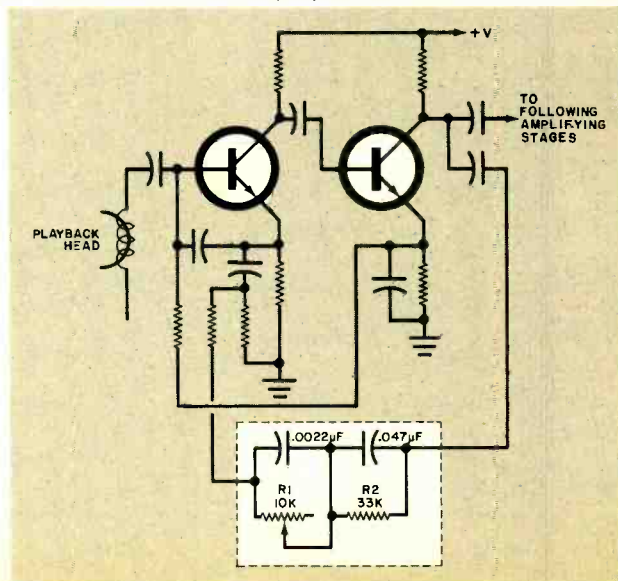

# HOW ACCURATE

## IS YOUR AC

### DIGITAL CLOCK?

BY R. L. CONHAIM

**W**HICH is more accurate for a digital clock, a crystal-controlled time base or a line-frequency time base? If you vote for the crystal time base, you are partially correct. It is more accurate over short periods of time when compared to line-operated time bases. The specified accuracy for a crystal time base can be as good as  $\pm 0.0005$  percent, while the line-frequency accuracy is stated at only  $\pm 0.033$  percent.

At first glance, the accuracy of the line-frequency time base appears to be woefully inaccurate for good timekeeping purposes. But the line-frequency accuracy is stated for only the short haul. In reality, it is much more precise.

Let us consider two digital clocks, one with a crystal time base and the other with a line-frequency time base. Set the times of both with WWV (or CHU) radio signals and leave them for a year. For this experiment, make two assumptions: (1) that there are no power outages during the test period, and (2) that the crystal errors are all in the same direction. At the end of the test period, our crystal-controlled clock might be off by about 158 seconds. But the line-driven clock might be off by only 3 seconds! As you can see, the dismally poor 0.033-percent accuracy of the line-frequency time base is really closer to 0.0000095 percent over the long haul, which far exceeds the 0.0005-percent accuracies of even the best crystal time bases.

The reason for the apparent discrepancy lies in the way the powerline frequency is controlled and corrected. While it is true that power companies monitor frequency and correct it periodically, the corrections are made against time so the average frequency remains almost exactly at 60 Hz.

All power companies in the continental U.S. (except in Texas) are tied together in a power "grid." So, all interconnected power systems are operating at the same nominal fre-

quency, usually maintained at 59.98 to 60.02 Hz. The grid frequency is monitored against a time standard that is kept exactly in step with WWV. When

the grid time deviates from the master clock by 3 seconds, factors are introduced to bring the grid back to the correct time. ♦

## HI-LO PASS FILTER

BY RAYMOND GEORGE ROSS

**T**WO fairly common problems plague CB'ers: The first is to have damage occur to the front-end circuit of the receiver due to static charge built up on the antenna. The second is difficulty with neighbors due to causing TV interference. It might seem that a single, simple solution to both of these problems is impossible since they concern different portions of the transceiver and they involve signals widely separated in the frequency spectrum.

Obviously, a high-pass filter is needed to drain off the dc or low-frequency signal caused by static charges, and a low-pass filter is required to block the harmonic signals in the transmission. Actually, the two filters can be combined—which is what we have done in the device described here. It is simple to build and easily used with a transceiver.

**Circuit Description.** As shown in the schematic, the r-f output from the transceiver enters the filter through *J1*. A series-resonant circuit consisting of *C1* and *L2* provides a low-impedance path (about 10 ohms) for the 27-MHz signal; but at 54 MHz (a main source of TVI), the impedance is 80 ohms, and it gets progressively higher as the frequency increases. Thus, the harmonics are blocked and shunted off through *C2*.

In the high-pass part of the filter, *L1* presents a high impedance to the 27-MHz signals, so very little of that energy is lost. However, the impedance for low-frequency signals is very low so these signals from the antenna are shunted off.

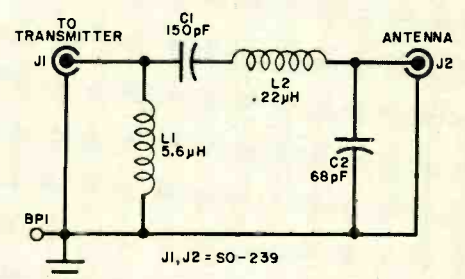

**Assembly & Use.** Conventional assembly techniques can be employed when building the filter. Just make sure you house the circuit inside a metal box to provide good shielding, place *J1* and *J2* on opposite ends of the box and keep component leads as short as possible.

Connect a short length of coaxial cable (1 to 2 ft) from the transceiver's r-f output to *J1*. Attach the antenna feedline to *J2* and a wire (at least #14) from *BP1* to a good earth ground—a cold-water pipe will do nicely. A good ground is important to bleed off static charges quickly and provide shielding. ♦

**U**NNECESSARY muscular tension is known to be one of the contributing factors to psychosomatic illness. Unfortunately, much of this muscular tension is subconscious so many people can't relax because they aren't aware of the tension. Consequently, many methods have been devised to provide recognition of tension and encourage relaxation—including yoga and "autogenic training" (biofeedback techniques).

To detect muscular tension scientifically it is only necessary to measure the minute electrical signals generated by a muscle when it is working. This is done by an electromyograph (EMG). The EMG has electrodes which are placed in intimate contact with the skin over a given muscle. When the muscle is under tension, the EMG provides either a visual (meter) or audible indication of the muscle tension. The person to whom the electrodes are attached then becomes part of the feedback loop through his eyes or ears and can try to reduce the tension by mental or physical means. With this electronic aid, a person can learn to eliminate or greatly reduce the tension, thereby bringing about changes in general well-being.

Relaxation is not achieved instantaneously, and many training sessions may be required in difficult cases. Since emotions play a large role in the production of tension, unexpected feelings may be experienced when one becomes familiar with "letting go." The simple EMG feedback monitor described here can be used to practice muscle relaxation and also to explore the building up of muscles.

A block diagram of the monitor is shown in Fig. 1. The minute (microvolts) muscle signals detected by the skin electrodes are amplified and then applied to a rectifier/integrator stage. The pulses are averaged and either displayed on a meter or used to drive a voltage-controlled oscillator that generates a series of clicks for the audible signal. The amount of muscular tension—and the magnitude of the

## BUILD A **MUSCLE FEEDBACK MONITOR**

*New biofeedback  
technique helps  
to reduce tensions.*

BY MITCHELL WAITE



### EDITOR'S NOTE

This muscle monitor is intended for experimentation and entertainment only. It is not to be used as a substitute for professional clinical therapy. Persons with heart disease, high blood pressure, or any other tension-related illness should consult a physician. The monitor is *not* to be considered a home remedy for any illness.

voltage picked up by the electrodes—varies the reading on the meter and the frequency of the clicking sound.

**How It Works.** In a device of this type, the differential input preamplifier is the most important stage (*Q1*, *Q2*, and *IC1* in Fig. 2). This is because common-mode signals such as stray 60-Hz fields and associated line noises, put a limit on the signal resolution. The circuit's common-mode input impedance is compared to the source unbalance to determine the maximum common-mode rejection ratio.

In the circuit, op amp *IC1* is used as a bootstrap element. The common-mode signal on the collector of current source *Q3* is fed back to the input through *R3*, *R4*, and *R5* so that the common-mode signal actually "sees" an impedance much higher than the values of these resistors. With this circuit, the balance between *C1-R1* and *C2-R2* and the impedance of the electrode determines the overall common-mode rejection. Making *C1* and *C2* larger in value improves common-mode rejection but also increases the recovery time due to transients at the electrodes. Input noise in the circuit is minimized by using low-noise transistors and designing the collector currents for low noise. R-f interference is drained off by capacitors *C3* and *C4*.

The output of the preamplifier is applied to *IC2*, a high-gain, noninverting amplifier. Associated with the amplifier are a low-pass filter (-3 dB at 1 kHz) made up of *C6* and *R11* and a high-pass filter (-3 dB at 200 Hz) made up of *C7* and *R12*. A second high-pass filter (*Q4*) further reduces low-frequency components. Sensitivity is set by *R25* and the signal is applied to a gain-of-30 noninverting amplifier (*IC3*), which also acts as a rectifier, integrator, and meter amplifier. Rectifier *D1* is located in the feedback circuit to reduce the effects of the diode voltage drop to a few millivolts. Transistor *Q5* acts as a buffer between the integrator and the meter.

Overall muscle activity can be averaged between 5 ms and 0.5 s, depending on the setting of *R26*. The sensitivity control, *R25*, is calibrated when integration is set at maximum.

The output frequency of the voltage-controlled oscillator (*IC4*) is a function of the voltage level applied to its input through *R22*. The timer is biased so that, at a certain low-voltage thresh-

## MUSCLE BIOFEEDBACK APPLICATIONS

**Feedback Technique for Deep Muscle Relaxation.** Experiments have shown that zero-firing of single motor units with EMG BFT can be achieved in less than twenty minutes. Most subjects report changes in body image. Further, work reveals that people can subjectively turn on and off, selected single-muscle motor units, even delicately controlling their firing patterns.

**Paralyzed Muscles Retrained at Home.** People recovering from cardiovascular accidents are often faced with the retraining of paralyzed limbs—a long and tedious job. Experiments are revealing now that much of the work load can be taken off the patient and also speeded up if biofeedback techniques are applied. An EMG monitor can sense minute muscle activity and inform the patient of the activities instantly.

**"Talking" Muscles Help Scientists Design for Maximum Efficiency.** A group of researchers at Eastman Kodak Co., known as the Human Factors Group, is looking into the activity of muscles in industry. Using the results of EMG data and performance tasks, they are able to design steps for a job to provide the least muscle discomfort, while obtaining maximum productivity of body movements.

**EMG Signals Give Hams a Third Hand.** Many who are physically handicapped are interested in amateur radio as a hobby. In a series of unique experiments, doctors have used the still-good EMG signals going to an amputee's missing limb to control a Morse code relay. Patients have, after brief training, learned to send up to 15 words per minute! By using a rectified EMG signal, 360-degree servo control for an antenna and tuning coils was achieved.

**Learning to Control Tension Headaches.** Experiments have shown that, by monitoring the "frontalis" or forehead muscle and using feedback, people can learn to reduce the occurrence of tension headaches. When presented this information, in a comfortable manner, patients have learned to abort the headaches without the biofeedback equipment.

**Lowering Anxiety.** EMG biofeedback has perhaps its greatest potential as an aid to anxiety reduction. By helping psychologists show their patients how to initiate self-induced calm and real relaxation, EMG monitors would be useful. Though still in its infancy, this application has vast potential and is the area of most interest for EMG at this time.

old, the oscillator automatically shuts off. The threshold is determined by the gain of the circuit and the value of *R24*. The turn-on threshold is approximately 2.5 microvolts at the skin electrodes with the sensitivity control set to maximum. Reducing the sensitivity raises the threshold point. The threshold was selected to make changes in muscle tension more ap-

parent. The frequency range of the vco is approximately 5 to 30 pps.

Power for the circuit is provided by two 9-volt batteries. The power for the input stage is decoupled by *R20* and *C12* for the positive side and *R21* and *C13* for the negative.

**Construction.** Due to the high gain and complexity of the circuit, a pc board should be used. An actual-size foil pattern and component placement are shown in Fig. 3. When installing the components, be sure they are properly oriented with regard to terminals and polarities. Don't forget the single jumper on the component side. Note that some pads on the foil pattern have numbers corresponding to those on the schematic.

The pc board and the two batteries (preferably alkaline) are installed in a suitable metal enclosure. Metal is used to keep 60-Hz interference to a minimum. Mount the components on the front panel as shown in the photograph. The audio output jack is mounted on one side of the enclosure.

The SENSITIVITY control is marked for 10<sup>3</sup> μV in the full counterclockwise position, 500 μV at the center and 10 μV at the other end. Mark the

Fig. 1. The EMG feedback loop.

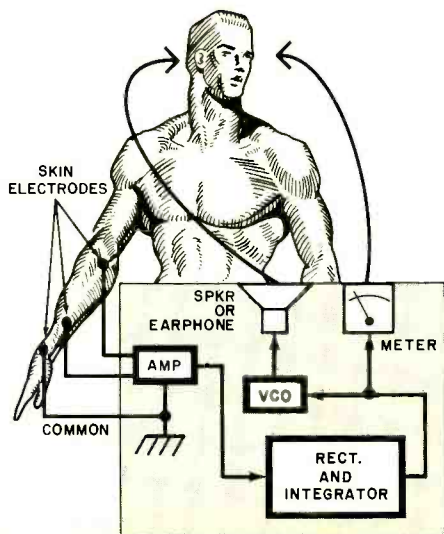



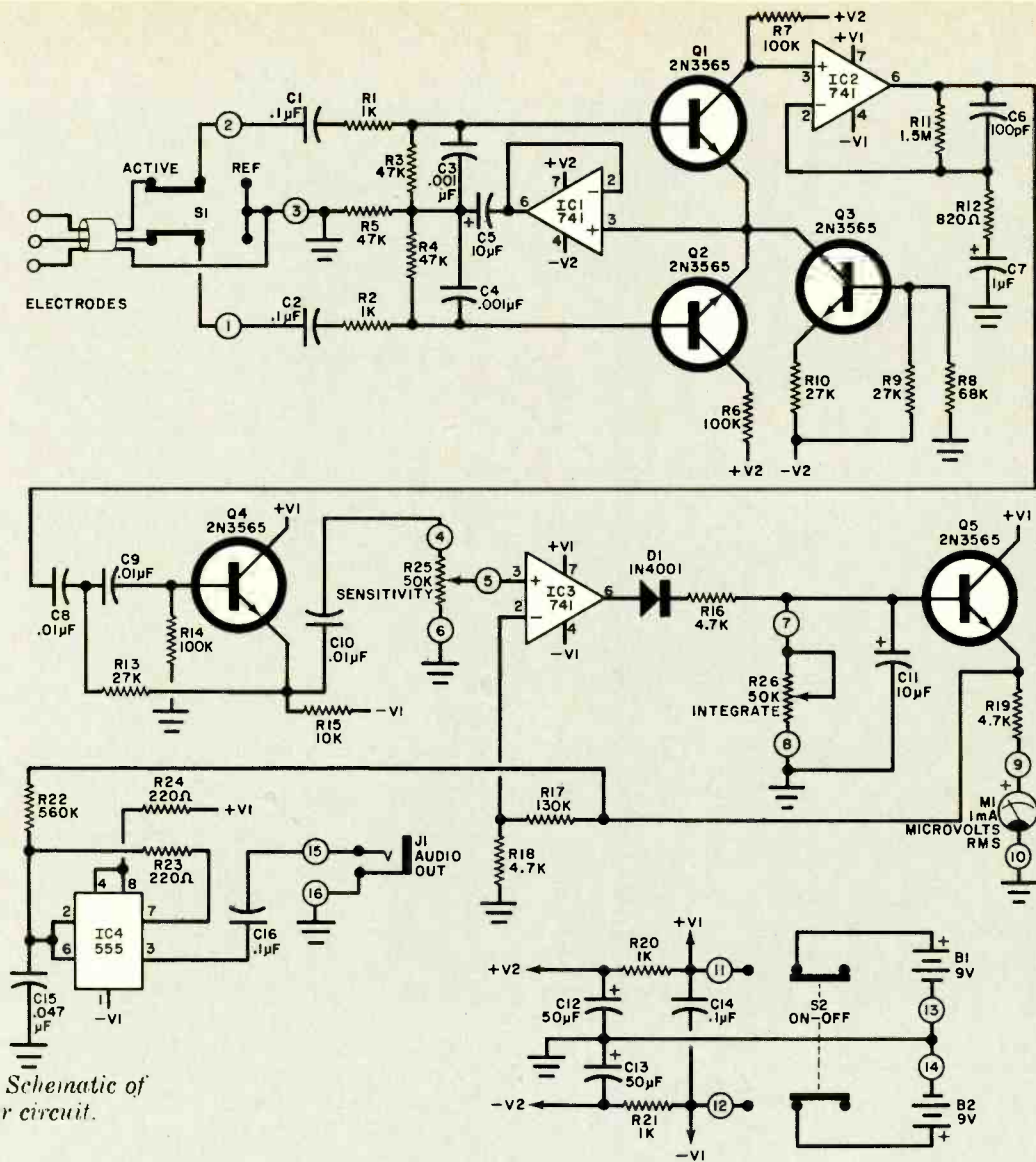

Fig. 2. Schematic of monitor circuit.

### PARTS LIST

- B1, B2—9-volt battery
  - C1, C2—0.1- $\mu$ F, 10% Mylar capacitor
  - C3, C4—0.001- $\mu$ F, 10% Mylar capacitor
  - C5, C11—10- $\mu$ F, 10-V electrolytic capacitor
  - C6—100-pF, 10% silver-mica capacitor
  - C7—1- $\mu$ F, 10-V electrolytic capacitor
  - C8 to C10—0.01- $\mu$ F, 10% Mylar capacitor
  - C12, C13—50- $\mu$ F, 10-V electrolytic capacitor
  - C14, C16—0.1- $\mu$ F, 10% Mylar capacitor
  - C15—.047  $\mu$ F 10% Mylar capacitor
  - D1—1N4001 diode
  - IC1 to IC3—741 op amp
  - IC4—555 timer
  - J1—Miniature earphone jack
  - M1—1-mA meter (Radio Shack 22-037 or similar)
  - Q1 to Q5—2N3565 transistor
- Following resistors are  $\frac{1}{4}$ -watt, 5%:
- R1, R2, R20, R21—1000 ohms
  - R3 to R5—47,000 ohms
  - R6, R7, R14—100,000 ohms
  - R8—68,000 ohms

- R9, R10, R13—27,000 ohms
  - R11—1.5 megohms
  - R12—820 ohms
  - R15—10,000 ohms
  - R16, R18, R19—4700 ohms
  - R17—130,000 ohms
  - R22—560,000 ohms
  - R23, R24—220 ohms
  - R25, R26—50,000-ohm linear potentiometer
  - S1, S2—Dpdt subminiature switch
- Misc.—Miniature crystal or magnetic earphone and plug; set of electrodes ( $\frac{1}{2}$ " stainless steel discs and electrode paste) or disposable Ag/Ag-C1 types; enclosure (LMB-778 or similar); knobs (2); two-conductor shielded cable (5 ft); miniature alligator clips (3); rubber grommet; mounting hardware. Disposable Ag/Ag-C1 electrodes are available from medical supply houses. Permanent Ag/Ag-C1 electrodes are preferred for ease of use. Small plastic containers of electrode cream are also available from medical supply houses.

Note—The following are available from EDC, P.O. Box 9161, Berkeley, CA 94709; complete kit of parts including two disposable Ag/Ag-C1 electrodes, stainless steel reference electrode, drilled and solder-plated pc board, drilled and painted enclosure, and 1-oz container of electrode gel (kit PE-22) at \$54.50; separate drilled and solder-plated pc board (PE-23) at \$3.98; drilled and painted enclosure (PE-24) at \$4.50; set of three disposable Ag/Ag-C1 electrodes (PE-25) at \$3.98; pair of permanent Ag/Ag-C1 electrodes (PE-26) at \$15.95; 1-oz container of electrode gel (PE-9) at \$0.75; 4-oz container of electrode gel (PE-9X) at \$2.50. Orders for complete kits shipped postpaid and insured. Orders for components and accessories shipped postpaid, insurance extra. Add \$1.00 for handling on orders less than \$5.00. California residents, please add 6% sales tax (6 $\frac{1}{2}$ % for BART counties).

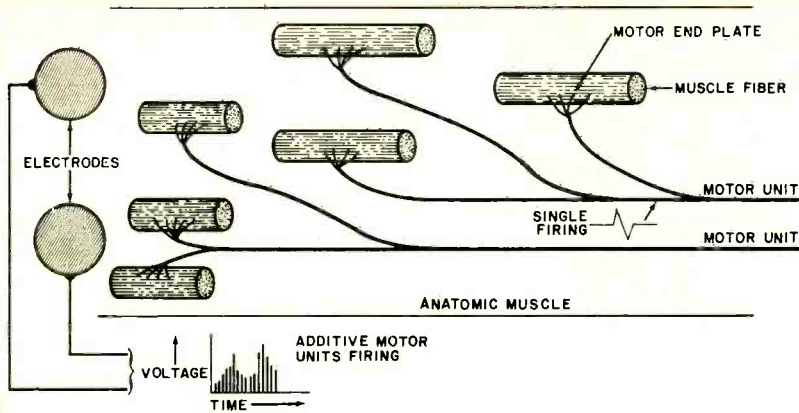

### THE SOURCE OF MUSCLE SIGNALS

The signals picked up by the muscle monitor originate in large motor nerves, each of which supplies pulses to any of 25 to 2000 motor end plates. (Only three end plates are shown in the diagram for simplicity.) Each set of end plates makes up a "motor unit." The motor units are not clumped together, but are interlaced to give the muscle its smoothness in movement. The electrical signal associated with the tensing of a muscle is made up of thousands of randomly additive microvolt pulses. Each pulse is associated with a motor

unit, and each motor unit may drive many hundreds of muscle cells.

For medium tension (with Ag/Ag-Cl skin electrodes), the EMG energy is at a frequency between 200 and 2000 Hz and an amplitude between 500  $\mu$ V and 1 mV. It is noise-like in appearance. However, at low tension levels, individual motor units may be differentiated with pulse rates of 25 to 100 pps. Amplitudes are between 5 and 25  $\mu$ V, depending on the physical distance between the motor units and the skin electrode.

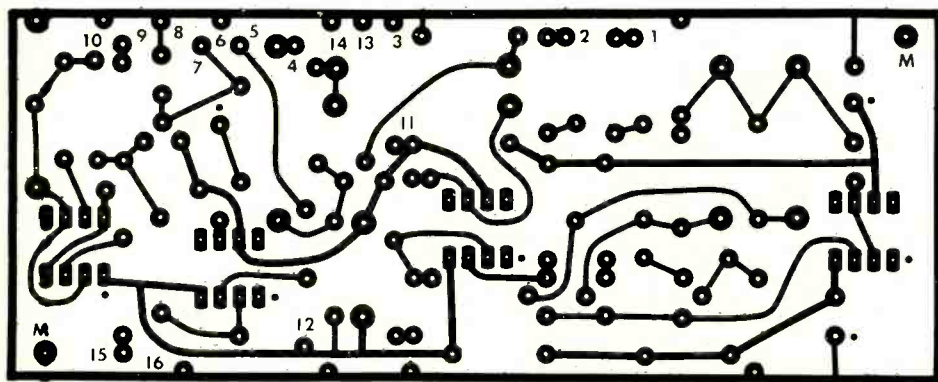
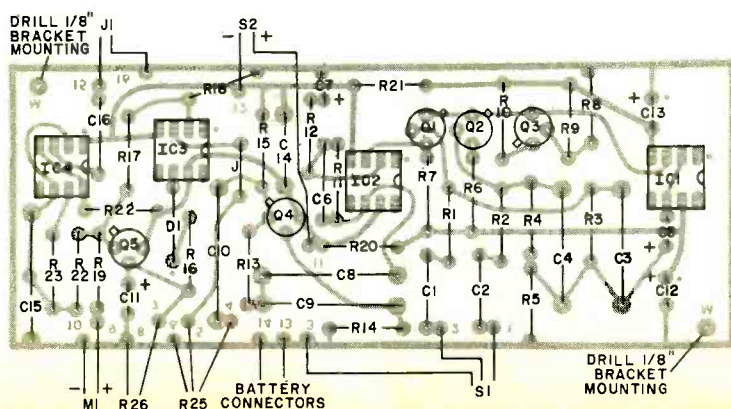

Fig. 3. Etching and drilling guide (above) and component layout.



INTEGRATION control 5 ms on full CCW, 250 ms at the center, and 0.5 s for full CW.

**Circuit Checkout and Use.** With fresh batteries installed, connect both "live" inputs across a resistance of 1000 to 5000 ohms and insert an earphone in J1. With the MODE switch ON REF, and SENSITIVITY and INTEGRATION controls maximum clockwise, turn on the monitor. The meter indication should be between 1/5 and 1/4 of full scale, indicating the maximum noise being generated in the circuit. There may be a slight delay (about half a second) before the meter deflects, as the input stage stabilizes.

Put the MODE switch on ACTIVE and note that the meter indication rises as the added noise of the resistor comes into play. Note also that the vco rate increases (through the earphone).

When you are sure that the circuit is operating properly, attach the two active leads to an area over a forearm muscle and attach the shield lead (with its electrode) to an area (such as the wrist) where there is little muscle activity. The two active leads should be attached to high-quality, low-noise electrodes such as a disposable or permanent silver/silver-chloride type. The shield of the electrode cable is the reference lead and should be connected to a low-cost electrode (such as stainless steel). The electrodes are held in position with tape or some other type of adhesive.

With the MODE switch on ACTIVE, adjust the INTEGRATION control to 0.5 s and set the SENSITIVITY control to its minimum. Slowly increase the latter while flexing the forearm muscles. Observe the change in indication on the meter and in the frequency of the audible signal. Make a note of the SENSITIVITY setting when the arm is relaxed. Try the approach once more, this time trying for a lower relaxed reading by changing your thoughts and mental attitude.

Move the SENSITIVITY control up slightly and try again to relax the forearm to reduce the indications to zero. Repeat this operation with the SENSITIVITY increased again. A regular daily routine works best, practicing between 15 and 30 minutes a day on muscle areas that give you a particular problem—such as the forehead if you have tension headaches. Keep a record of sensitivity readings, and in a period of a week you should see some sign of improvement.

**C**RYSTAL-CONTROLLED oscillators have long been used where extremely accurate frequency with excellent long-term stability is required. Until fairly recently, however, such signals were available at only a single fundamental frequency (and perhaps its whole-number harmonics) from any given crystal oscillator. Now, a new type of instrument, known as a frequency synthesizer, has been developed that makes crystal-controlled signal quality available at thousands of discrete frequencies—in most cases, all with a single crystal.

The frequency synthesizer provides laboratory-quality periodic functions at reasonably low cost. The instrument is easy to operate, has state-of-the-art accuracy, exceptional stability, a frequency range that can go as high as several tens of gigahertz, etc.

**Basic Frequency Synthesizer.** A frequency synthesizer is simply a collection of frequency dividers, spectrum generators, mixers, and other types of circuits commonly used in electronics. In the frequency synthesizer, their sole purpose is to generate a single sinusoidal frequency from a highly stable crystal-controlled fixed-frequency master reference oscillator. In some cases, several master reference oscillators are used in a given instrument, but the method used to obtain the final output frequency remains the same. In all cases, the number of possible output frequencies always greatly exceeds the number of reference oscillators.

The high stability and accuracy of the master reference oscillators accounts for the accuracy and stability of every signal generated by a frequency synthesizer. The basic accuracy, resolution, long-term stability, and repeatability of the frequency synthesizer's output signal are all directly dependent upon the characteristics of the reference oscillator. Hence, frequency parameters on the order of 1 part per billion ( $10^9$ ) are common when dealing with frequency synthesizers.

To synthesize is to form by combining separate parts. In a frequency synthesizer, the parts combined are harmonics and subharmonics of the master reference oscillator's output frequency. So, any frequency generated by the synthesizer must be harmonically related to the crystal frequency. Consequently, all of the signals that are brought together to form

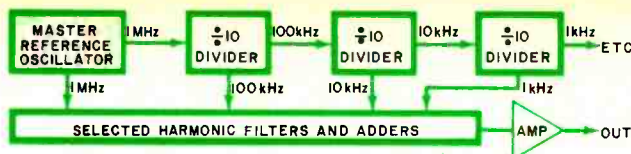

Fig. 1. Basic process of frequency synthesis.

# HOW FREQUENCY SYNTHESIZERS WORK

*A myriad of highly accurate frequencies  
can be generated from a single crystal.*

BY THOMAS R. SEAR

the final output frequency are phase-locked because of their common origin. This simplifies the combining of several frequencies to obtain a single frequency.

The master reference oscillator's output signal frequency is digitally divided to obtain many of the "parts" that are used to form the desired output frequency. Since signals that are known to the tenth, hundredth, or thousandth of a cycle can be synthesized, many degrees of frequency division or harmonic generation might be used in some instruments. Also, extreme accuracy during synthesis involves highly complex circuit functions. But once a signal enters a divider chain, the dividers have no influ-

ence on its basic accuracy upon exiting the chain.

The basic process of frequency synthesis is illustrated in Fig. 1. The output of the master reference oscillator is divided in several steps into precise subharmonics that are then recombined as needed to synthesize the desired frequency. For example, the master reference oscillator might generate a 1-MHz signal and each divider might subdivide the frequency of the signal fed to its input by a factor of 10. In this manner, the output of the first divider is 100 kHz, the second divider is 10 kHz, and the third divider 1 kHz. And so on down the line to possibly a 1-Hz division. (Each divider also provides harmonics of its own output

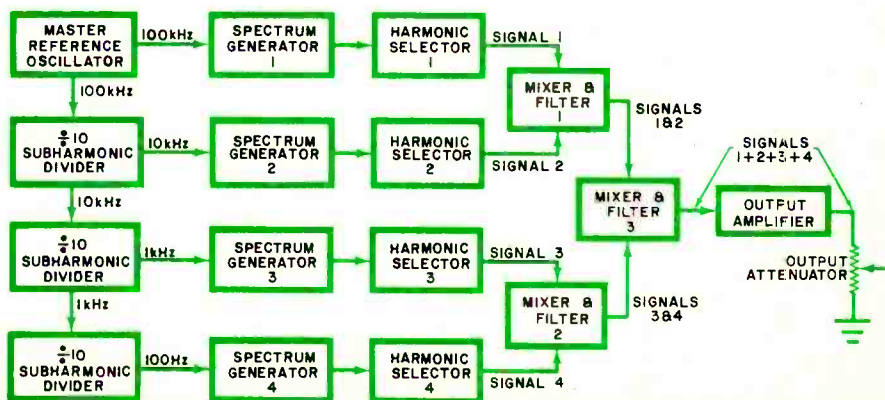

Fig. 2. A semi-complete setup for a frequency synthesizer.

frequency, but more about this later.) A switched filter arrangement then passes the proper harmonics to a series of mixers and filters that ultimately pass only the single desired frequency.

Most of the signals that exist between the master reference oscillator of a frequency synthesizer and the harmonic-selecting circuitry consist of rectangular-wave pulses. This simplifies frequency division through digital multivibrators that require fast rise and fall times for proper switching.

**Practical Synthesizer.** So far, we have been discussing the theoretical frequency synthesizing system. The setup shown in Fig. 2 represents a more practical but still far from complete frequency synthesizing system. As is the case in Fig. 1, the master reference oscillator in Fig. 2 has the two output lines common to such oscillators in synthesizers.

Let us assume a 100-kHz output signal frequency from the master reference oscillator. Without prior frequency division, this signal goes directly into SPECTRUM GENERATOR 1 to obtain higher-order harmonics of the

oscillator's fundamental frequency. (See box.)

The output of the master reference oscillator is also applied to a string of subharmonic frequency dividers, each of which reduces the frequency applied to it by a factor of 10. The divider section in an actual frequency synthesizer will contain as many stages as needed to provide the incremental frequency control desired, but for simplicity in our example, there are only three dividers shown, providing the tenth, hundredth, and thousandth subharmonics.

We now have four frequencies available: the 100-kHz master reference oscillator, 10-kHz tenth subharmonic, 1-kHz hundredth subharmonic, and 100-Hz thousandth subharmonic frequencies. Each of these frequencies, in turn, is fed to a highly nonlinear device (spectrum generator) so that a spectrum of harmonic frequencies is generated, starting with the input frequency to each generator and continuing with the second, third, fourth, and up to the tenth and beyond. This means that frequencies of 100 kHz, 200 kHz, 300 kHz, etc., are present at the output of SPECTRUM GENERATOR 2; 1 kHz, 2 kHz,

3 kHz, etc., at the output of SPECTRUM GENERATOR 3; and 100 Hz, 200 Hz, 300 Hz., etc., at the output of SPECTRUM GENERATOR 4.

The term "spectrum generator" is a fancy way of saying that the signal has been processed into a waveform that has very fast rise and fall times. The reason for this is that signals with pulse-like features are made up of a vast number of harmonically related sinusoidal signal frequencies. The output from the spectrum generator is a rectangular waveform containing all of the harmonics needed to form desired frequencies. All that is necessary now is to adjust the applicable frequency controls on the frequency synthesizer so that the required harmonics are passed on to the mixer

Depending on the specific settings of the various frequency-selection controls, the desired harmonic from each spectrum generator is applied to the applicable mixer. The selected harmonics are then applied in pairs to the appropriate mixing and filter circuits. In these circuits, two frequencies are combined through a heterodyning mixing process that results in the generation of the original frequencies and their sum and difference

### SPECTRUM GENERATION AND FREQUENCY SYNTHESIS

Spectrum generators used in frequency synthesizers are typically comb-type generators. These are comprised of step-recovery diodes (variable-capacitance or Varactor<sup>®</sup> diodes) and a group of filters. The filters are used for selecting outputs at specific frequencies harmonically related to the input signal's frequency.

The diode's resistance and capacitance vary with the instantaneous value of the input signal level. This leaves no possibility that the output signal will even remotely resemble the input signal. As shown in A, a sinusoidal input to the

spectrum generator is transformed into an equal number of harmonic-rich, extremely fast risetime pulses. By applying this signal to the appropriate filters, harmonics of a very high order can be obtained for use in synthesizing other frequencies.

The harmonics obtained from the spectrum generator are usually fed into a diode switch matrix. The matrix is controlled by dc potentials applied by working the frequency control switches on the synthesizer's front panel. Diagram B is a simplified schematic of a common diode switch arrangement.

The dc control voltage for the diode switch typically comes from switches, but it can also be keyed in remotely through connectors located on the rear apron of the synthesizer. Some sophisticated synthesizers can literally be programmed for desired signal parameters via internal read-only memories (ROM's).

In diagram C, each of the eight 10-position switches can be used to select any one of the nine 100-kHz harmonics being applied to the diode switch matrix. The harmonics selected are applied to a combination of balanced mixers and decade dividers that process the signals to provide a synthesized output frequency. A setting of 0 indicates that no harmonic is selected.

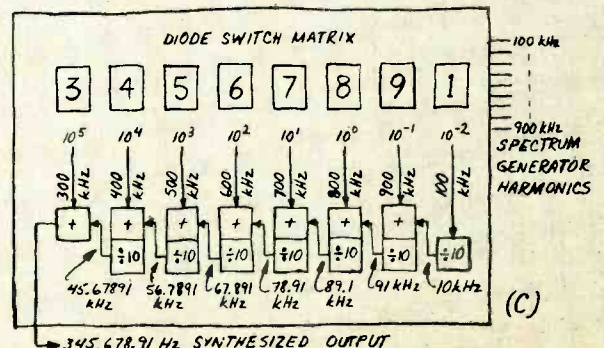
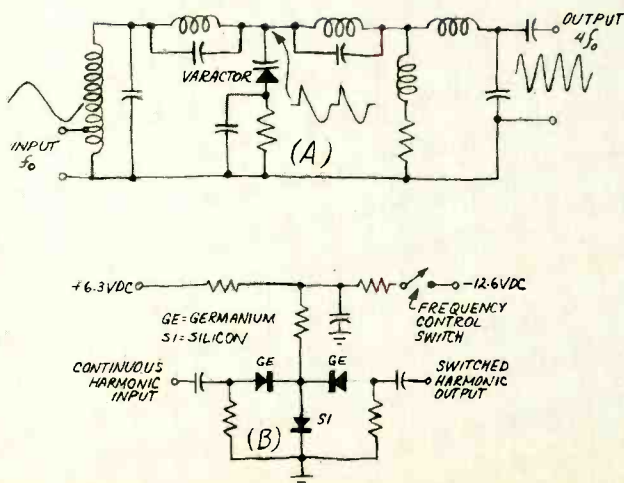



*Fig. 3. Rockland Systems Model 5500 synthesizer has frequency range of 10 Hz to 40 MHz in 1-Hz steps.*

frequencies. The filtering action in each mixer insures that only the sum frequency of the two input frequencies appears at the output of each mixer and filter circuit. The original frequencies and their difference frequencies are attenuated some 70 to 90 dB below the main signal frequency from the master reference oscillator.

The synthesized signal emerging from the final mixer and filter circuit constitutes the desired signal frequency. From this point onward, the signal is processed through conventional amplifiers and/or attenuators so that the output characteristics can be controlled as in a conventional signal generator.

**Categories.** Basically, there are two main categories of frequency synthesizers: those used as subsystems in other gear (such as the synthesizers found in CB transceivers) and those used as separate test equipment. The first type requires that the equipment's switching arrangement be wired to produce only those frequencies required for the application and no others when the switches are operated. The latter category is many magnitudes more flexible, permitting a virtually unlimited number of frequencies to be dialed in for delivery at the output.

Setting up a test-equipment-type frequency synthesizer to deliver at its output a signal of a given frequency is quite simple. Depending on the manufacturer and/or the model number, the synthesizer will have a battery of 10-position rotary switches or a matrix of pushbutton switches assigned the function of providing a means of selecting harmonics. The number of rotary switchers (and in some cases pushbutton switches) provided depends on how many decades of control are required in the instrument, as in the Rockland Systems Corp. instruments (Fig. 3). Where pushbutton switches are provided for selecting

harmonics, the number usually remains constant, as in the Hewlett-Packard instruments (Fig. 4). In addition to providing harmonic selector switches, synthesizers also feature decimal readouts of the exact frequency selected.

Now, let us assume that we want an output signal whose frequency is 347.1 kHz (347,100 Hz). Remember that the output frequency is the sum of the harmonics selected. Returning to Fig. 2, we would set HARMONIC SELECTOR switches 1 through 4 to positions 3, 4, 7, and 1, respectively. This would provide harmonic selector outputs of 300 kHz, 40 kHz, 7 kHz, and 100 Hz which, when summed, yields an output frequency of 347.1 kHz. (If you were operating the pushbutton-type instruments, like those made by Hewlett-Packard, you would press buttons 3, 4, 7, decimal point, 1 and kHz or 3, 4, 7, 1, 0, 0, and Hz.)

Notice that the total number of harmonics present at the output of each spectrum generator is constant. The same is true of the outputs from the master reference oscillator and the frequency dividers. The only variables in the entire circuit are the frequencies of the signals that the various harmonic selectors pass on to their associated mixer and filter circuits.

**Where They Are Used.** The frequency synthesizer provides an easy means for generating any frequency desired from a band of frequencies that often covers many decades. Consequently, the synthesizer combines the convenience of a continuously ad-

justable wideband oscillator that has the frequency precision, at any setting, of a crystal-controlled single-frequency oscillator or frequency standard. Obviously, such features are of great value to the technician. To prove the point, frequency synthesizers are now appearing in a wide range of instrumentation.

Sophisticated radio transmitters, receivers, and transceivers are currently using the principle of frequency synthesis to permit rapid and exact frequency selection. In the workshop and laboratory, frequency synthesizers are being utilized in lieu of older, more traditional types of signal sources not only because they provide an order of magnitude improvement in accuracy, but also because required frequencies can be quickly selected by setting a few switches. This eliminates the time-consuming procedure of setting a graduated-frequency dial and verifying the frequency with a separate frequency counter.

Frequency synthesizers are so accurate that relays can be used in place of switches for frequency selection. This means that the checking and testing of equipment can be accomplished under the control of a computer.

The digital nature of frequency synthesizers means that oscillators at widely separated locations can be locked together in both frequency and phase under digital control. This procedure is difficult at best with standard frequency sources but is a fairly simple technique with digital electronics. ♦

*Fig. 4. Hewlett-Packard Model 3330B uses pushbutton switches for selecting desired harmonics automatically.*

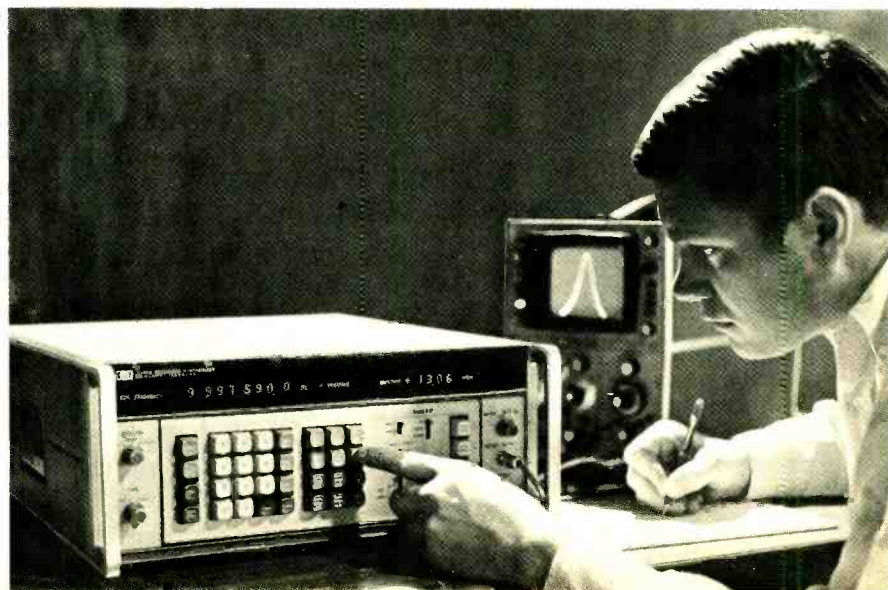

# Low-Cost Remote Control of Appliances & Lights

BY GEORGE A. ELLSON

*Circuit is triggered on and off by a flashlight's beam*

**R**EMOTE control systems have always been popular as step, energy, and time savers. Invalids find them eminently practical for controlling electrical appliances, lights, and radio and TV receivers.

Depending on the specific application and the degree of control desired, a remote-control system can be expensively elaborate or very simple in design. Perhaps the most practical in economy and design is the simple light-activated system of the type described in this article. This system should cost roughly \$19 for all parts. It is virtually foolproof to operate, requir-

ing only an ordinary flashlight to trigger it on and off. The system will control virtually any load rated at up to 4 amperes or 450 watts.

**About the Circuit.** Transistors *Q1* and *Q2* in Fig. 1 form a regenerative bistable switch, using *Q3* as the collector load for *Q2*. The voltage across *R8* is high when *Q3* is cut off and low when *Q3* is saturated. The condition of *Q3* depends on the voltage at the base of *Q1*, which is in turn dependent on the resistance of the *LDR1/LDR2* voltage divider. Light-dependent resistors *LDR1* and *LDR2* are photosensitive

devices. When their active surfaces are dark, their resistance is at maximum. However, when the surfaces are illuminated, the resistance decreases, the amount of decrease governed by the intensity of the light.

If both *LDR*'s receive the same amount of light, the base bias of *Q1* remains the same. Now, if only *LDR1* is illuminated, its resistance drops and causes *Q1* to go into cutoff. But if only *LDR2* were to be illuminated, its change in resistance would cause *Q1* to go into saturation. The fast regenerative action of the circuit will then cause *Q3* to go into saturation or

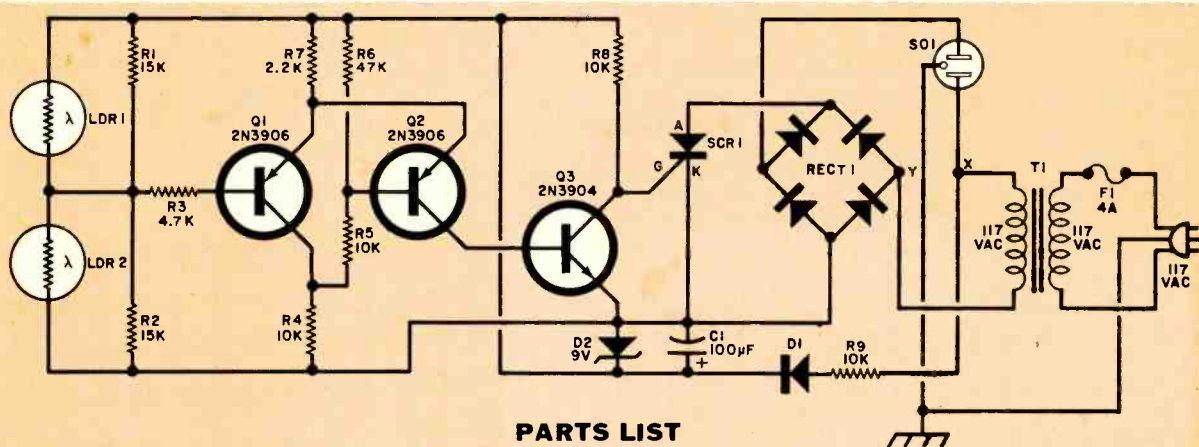

## PARTS LIST

C1—100- $\mu$ F, 15-volt electrolytic capacitor  
 D1—200-PIV, 500-mA silicon rectifier (1N647 or similar)  
 D2—9-volt, 1/2-watt zener diode (1N960 or similar)  
 F1—4-ampere fuse  
 LDR1, LDR2—Cadmium-sulfide light-dependent resistor (Radio Shack No. 276-677 or similar)  
 Q1, Q2—2N3906 transistor

Q3—2N3904 transistor  
 R1, R2—15,000-ohm, 1/2-watt resistor  
 R3—4700-ohm, 1/2-watt resistor  
 R4, R5, R8—10,000-ohm, 1/2-watt resistor  
 R6—47,000-ohm, 1/2-watt resistor  
 R7—2200-ohm, 1/2-watt resistor  
 R9—10,000-ohm, 1-watt resistor  
 RECT1—200-PIV, 4-ampere (minimum) rectifier bridge assembly  
 SCR1—200-PIV, 4-ampere silicon con-

trolled rectifier (General Electric No. 106B or similar)  
 SO1—Three-wire chassis-mounting ac receptacle  
 T1—117-volt isolation transformer  
 Misc.—Three-wire line cord with plug (16 or 14 gauge); aluminum utility box; printed circuit board or perforated board and solder clips; spacers; hookup wire; fuse socket; machine hardware; solder; etc.

Fig. 1. Relative resistances of *LDR1* and *LDR2* determine operation of bistable switch made up of *Q1* and *Q2*.

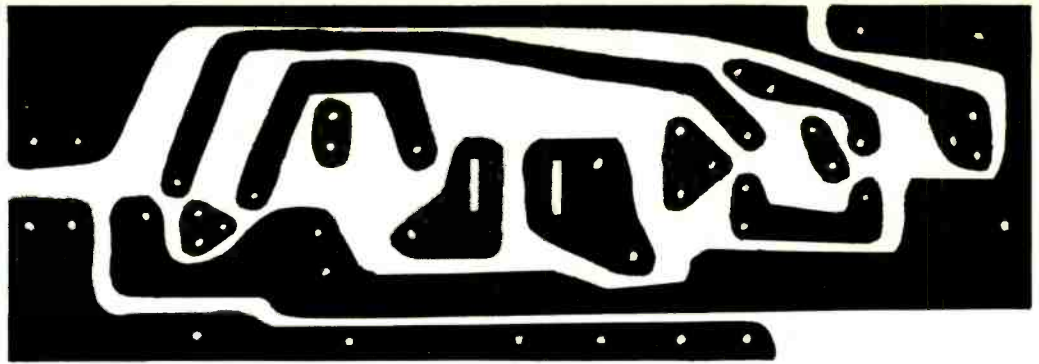
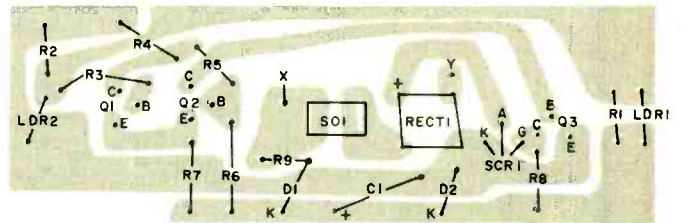

Fig. 2. Actual-size foil pattern for the printed circuit board is shown above. The component placement diagram is at right.



become cut off according to which of the LDR's receives the light.

Once the bistable switch goes into a given state, it will remain in that state (as long as power is applied to the circuit) until the opposite LDR is illuminated.

Resistor *R8* determines the level of the gate voltage applied to *SCR1*. When *Q3* is saturated, this gate voltage is minimum. Conversely, when *Q3* is cut off, the gate voltage is at maximum.

The SCR is connected in series with rectifier assembly *RECT1* and control socket *SO1* across the power line. With no filter capacitor in the circuit, the negative-going ac line alternations are "folded up" to produce 120 positive-going half cycles/second on the anode of *SCR1*. The SCR will not conduct until its gate is made positive with respect to the voltage on the cathode. When this occurs (*Q3* will be cut off), the SCR conducts and powers the electrical device plugged into *SO1*. The SCR will remain conducting for as long as the gate voltage is applied to it. When *Q3* is triggered into saturation, the SCR automatically turns off when the voltage applied to its anode reaches the zero point. Then the device plugged into *SO1* has its power cut off.

Resistor *R9*, diode *D1*, capacitor *C1*, and zener diode *D2* form the low-voltage supply for the transistor circuit.

**Construction.** Building the light-activated remote control system is best accomplished with the aid of a printed circuit board, the actual-size

etching and drilling guide and components placement diagram for which are shown in Fig. 2. Note that all components, with the exception of *LDR1* and *LDR2* and *SO1*, mount on the component side of the board. The isolation transformer, *T1*, and the fuse, *F1*, can be mounted at any convenient point within the enclosure.

Start construction by mounting the components on the top side of the board, putting in *SO1* last. Pay particular attention to the polarities of the diodes, rectifier assembly and electrolytic capacitor *C1* and the lead orientations of the transistors and SCR. Resistor *R9* and diode *D1* mount to the board by only one lead each. (The lead that goes to the board connection for *D1* is the cathode.) The anode of *D1* and the free lead from *R9* get soldered together to complete the circuit. Trim off excess lead lengths on the foil side of the board.

Trim the leads of the photocells to  $\frac{3}{8}$  in. (9.53 mm). Solder the leads of *LDR1* and *LDR2* to the board's conductors in the appropriate locations. Let the photocells extend as far from the surface of the board as their trimmed leads will allow.

Fashion a pair of flat black tubes, each about an inch long and just large enough in diameter to fit over the cases of the photocells. These tubes (they can be made from heavy construction paper but *not* metal) serve as light shields to prevent erratic operation of the system where ambient lighting is variable.

Select an enclosure that will comfortably accommodate the circuit board assembly. The pc board layout

shown in Fig. 2 is designed for a two-wire power system. Hence, the case should be all-plastic or all-Bakelite. If you elect to go to a safer three-wire system, you can use a metal case; but make absolutely certain that all three wires from the power cord, socket, and *T1* (the latter mounted on the case instead of the board assembly) are properly connected to avoid shock hazard.

Before mounting the circuit board assembly in place, drill holes through the case directly in line with the photocells. Slide the light shields over the photocells, and mount the board in place.

**Operation.** The only device needed to trigger the remote control system is an ordinary flashlight. Use a table lamp to check out the system. While it is still plugged into the wall outlet, turn on the lamp. Then, without switching it off, unplug the lamp's cord from the outlet and plug it into *SO1*. Plug the line cord from the remote control system into the wall outlet.

Shine the beam of the flashlight into first one, then the other photocell hole. The lamp should come on and extinguish in step with the movement of the beam from one hole to the other.

The range of the remote control system is directly related to the distance between the photocells. The flashlight beam must be able to illuminate only one photocell at a time. If you desire greater range than the pc assembly setup allows, you can separate the photocells even more. In this case, use shielded cable between them and the circuit board.

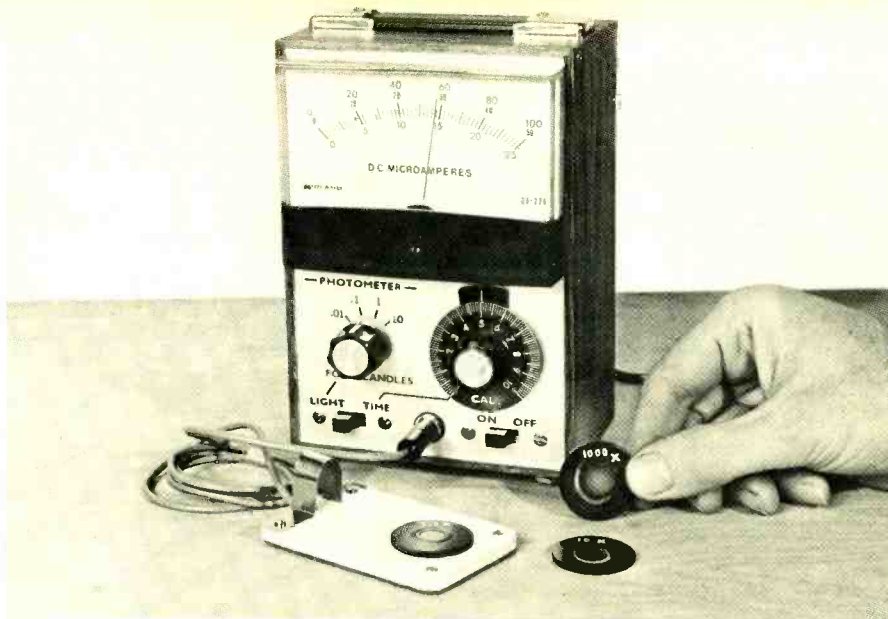

BUILD A

# Wide-Range Photometer/Enlarger and Exposure Meter

BY A. A. MANGIERI

*Valuable darkroom accessory covers broad spectrum of light intensities and exposure time ranges*

**I**F YOU do any type of photographic enlarging, contact printing, light-intensity measuring, etc., you need a photometer/exposure-time meter. Here is a high-resolution instrument with 0.01-, 0.1-, 1.0 and 10-foot-candle (ft-c) ranges that are usable down to 0.0005 ft-c. Neutral-density filters can be used to extend the upper range to 10,000 ft-c.

Exposure-time ranges include 0 to 25, 50, and 100 seconds at any multiple or intermediate range desired. A calibration control accounts for differences in paper speed and other factors. And a number of contrast ranges assist in paper grade selection.

The assembled instrument features an illuminated meter scale, and a high-stability operational amplifier IC that has instant-on, zero drift, and immunity from line-voltage variations. A high-speed linear cadmium-sulfide photocell is used to sense the measured light.

**About the Circuit.** In the simplified light-measuring circuit shown in Fig. 1A, as the light intensity on PC1 increases, the photocell's resistance decreases. This causes an increase in the input current,  $I_{IN}$ . The feedback

current in light-range resistor  $R$  produces a voltage,  $V_F$ , across this resistor which is the same as  $V_{OUT}$ . Consequently, M1 indicates in direct proportion to the intensity of the light.

In the basic time-measuring circuit

*Fig. 1. Simplified op amp circuit for measuring light level (A) and exposure time (B).*

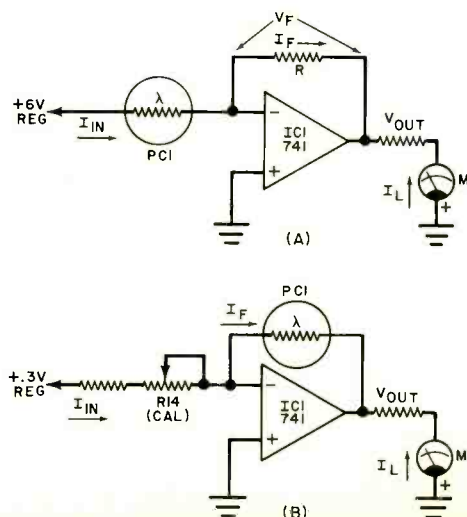



shown in Fig. 1B, PC1 is placed in the op amp's feedback circuit. Calibration potentiometer R14 presets the input current—and feedback current—to a fixed level. With a decrease in light intensity striking PC1, the resistance of the photocell increases and the input and feedback currents remain equal and unchanged, but the feedback and output voltages increase. Thus, the meter indications are inversely proportional to the intensity of the light falling on PC1. An appropriate setting of R14 provides a direct reading in seconds on M1.

The complete schematic diagram of the photometer/timer is shown in Fig. 2. Switch S2 provides either light-level or time modes, while S1 is used to select the light range. A split zener diode power supply (D1 and D2) provides the regulated voltages for IC1. Potentiometer R16 sets the op amp's input bias, while R15 is the offset-voltage null adjustment.

Meter movement protection is pro-

vided by the limiting (saturating) action of the op amp, while C5 prevents rapid pegging of the meter's pointer. Capacitors C1 and C3 minimize the amplifier response to any ac present on the signal leads.

**Construction.** Except for S1, S2, S3, R14, M1, and T1, all components can be mounted on perforated board with push-in solder clips. Use a socket for IC1. Install C1 and C2 close to the IC socket. (A completely wired board assembly is shown in Fig. 3.)

Select an enclosure that is large enough to accommodate the meter and other front-panel controls, with enough depth to permit mounting the board assembly and T1. Start assembling the system by machining the enclosure's front panel to accept the controls and meter movement, and mount the parts in their respective holes. Do not forget to install phone jack J1 on the front panel. Note that a two-circuit phone jack and plug are

used. Only the tip and ring contacts of the plug (and their respective jack contacts) are used for the PC1 lead connections. This is necessary because the photocell's leads must not be connected to ground. If you wish, use two-conductor shielded cable between P1 and PC1, leaving the shield "floating" at the PC1 end and connecting to the barrel contact on P1.

The meter scales (0-25 and 0-100) must be properly labeled to provide the appropriate meter readings. This can be accomplished with the aid of a dry-transfer lettering set. Carefully remove the snap-on cover from the meter movement and label the scales as shown in the lead photo. While the cover is off the movement, you can install the optional illumination lamps (I1 and I2). Uniform scale illumination can be obtained by installing a bright reflective metal strip above the meter scales.

Use a well-subdivided scale for calibration potentiometer P14. Either

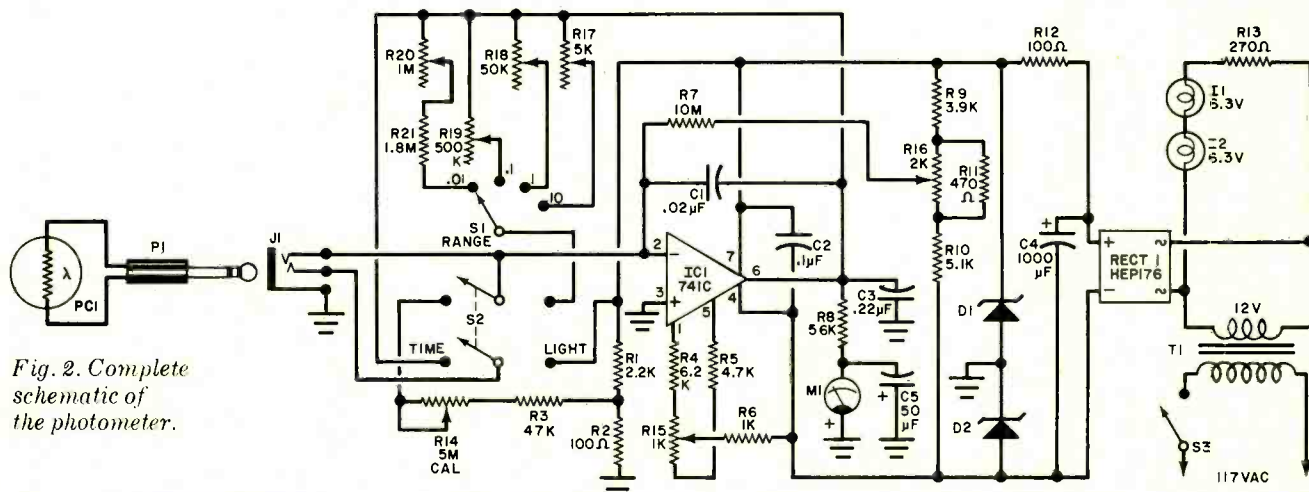

Fig. 2. Complete schematic of the photometer.

**PARTS LIST**

- C1—0.02- $\mu$ F, 25-V disc capacitor
- C2—0.1- $\mu$ F, 25-V disc capacitor
- C3—0.22- $\mu$ F, 25-V disc capacitor
- C4—1000- $\mu$ F, 35-V electrolytic capacitor
- C5—50- $\mu$ F, 15-V electrolytic capacitor
- D1, D2—6.2-V, 1-W zener diode (HEP103 or similar)
- I1, I2—Meter illumination lamp kit (Midland F71)\*
- IC1—741C operational amplifier
- J1—Miniature phone jack
- M1—0-50-microampere, 4-in. dc meter (Midland F64)\*
- PC1—Linear high-speed photocell (Clairrex CL705HL) (Do not substitute)
- P1—Miniature phone plug
- R1—2200-ohm, 1/2-W, 10% resistor
- R2—100-ohm, 1/2-W, 10% resistor
- R3—47,000-ohm, 1/2-W, 10% resistor
- R4—6200-ohm, 1/2-W, 5% resistor
- R5—4700-ohm, 1/2-W, 5% resistor

- R6—1000-ohm, 1/2-W, 10% resistor
- R7—10-megohm, 1/2-W, 10% resistor
- R8—56,000-ohm, 1/2-W, 5% resistor
- R9—3900-ohm, 1/2-W, 5% resistor
- R10—5100-ohm, 1/2-W, 5% resistor
- R11—470-ohm, 1/2-W, 10% resistor
- R12—100-ohm, 1-W resistor (see text)
- R13—270-ohm, 2-W resistor (see text)
- R14—5-megohm, audio-taper potentiometer (Mallory U65 or similar)
- R15—1000-ohm wirewound pc-type potentiometer (Centralab V-1000 or similar)
- R16—2000-ohm wirewound pc-type potentiometer (Centralab V-2000 or similar)
- R17—5000-ohm carbon pc-type potentiometer
- R18—50,000-ohm carbon pc-type potentiometer
- R19—500,000-ohm carbon pc-type potentiometer

- R20—1-megohm carbon pc-type potentiometer
- R21—1.8-megohm, 1/2-W resistor
- RECT1—1-A, 200-V PIV bridge rectifier (HEP176 or similar)
- S1—Single-pole, four-position, shorting-type rotary switch
- S2—Dpdt slide switch
- S3—Spst slide switch
- T1—12-V, 0.3-A filament transformer (Radio Shack 273-1385 or similar)
- Misc.—Perforated board; flea clips; case 3" x 4 1/2" x 6 1/2" (Vector W30-66-46); miniature shielded cable; line cord; dial plate; knobs; IC socket; 1/16" phenolic sheet; 22-megohm carbon resistors (2); 15,000-ohm carbon resistor; etc.

\* The following are available from Electronics Distributors, Inc., 4900 N. Elston Ave., Chicago, IL 60630; meter (F64 less lamps), meter scale illumination kit (F71).

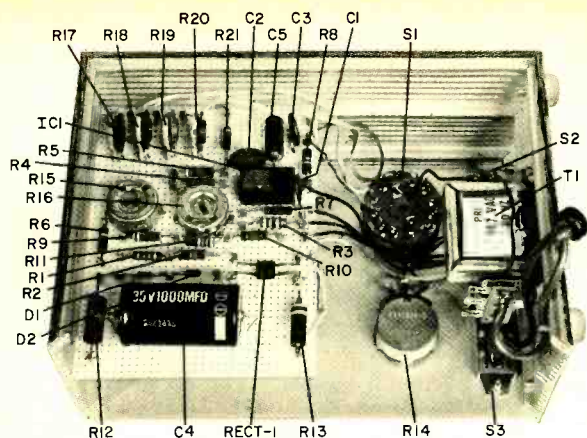

Fig. 3. Interior view of prototype showing placement of all parts.

a panel-mounted dial plate or a rotating dial flange can be used. Identify the front-panel controls with dry-transfer lettering.

Mount *PC1* between two pieces of thin phenolic board, allowing the sensitive surface of the cell to protrude through a hole in the upper board. The protrusion should be about  $\frac{1}{16}$  in. (1.59 mm) above the board's surface. After properly mating the boards, remove *PC1* and spray the outer surfaces a flat (matte) white paint.

Connect and solder the two inner conductors of a thin two-conductor shield cable to the leads of *PC1*. (Do not connect the shield to the photocell.) Insulate the solder joints with electrical tape. Place *PC1* in position and secure the two pieces of board together, with the cable sandwiched between them. A metal finger loop can be mounted on one end of the assembly for ease in positioning the sensor.

Connect the free end of the microphone cable to *P1*. The shield goes to the barrel contact, while the inner conductors go to the ring and tip contacts.

Power transformer *T1* can be mounted to the bottom or one wall of the enclosure with machine hardware. Connect its primary leads to a two-lug, non-grounding type terminal strip. Route the line cord through a rubber-grommet-lined hole drilled through the rear wall of the enclosure. Connect it to *S3* and *T1* as shown in Fig. 2.

### Adjustment and Calibration.

Using clip leads, connect a milliammeter in series with *R12*. If necessary, adjust the value of *R12* for an indicated current of approximately 70 mA. Install *R13* and measure the voltage drop at the meter lamp terminals; it should be 6.3 volts across both lamps. If not, adjust the value of *R13*. Check that there are about 20 volts dc across

*C4*, and about 6 volts across *D1* and across *D2*.

To adjust the bias current of *IC1*, set *S2* to TIME, *R14* to maximum resistance, and remove *R1* from the circuit. Connect about 44 megohms of resistance (two 22-megohm carbon resistors in series) to a phone plug and insert it into *J1*. Then, adjust *R16* until *M1* indicates zero. If this cannot be accomplished, replace *R10* with a resistance between 3900 and 7500 ohms. Alternatively, you can increase (or omit) *R11* for a broader range.

The next adjustment compensates *IC1*'s input offset voltage. With 44 megohms plugged into *J1* and all other conditions as above, connect a 15,000-ohm, 10-percent resistor across pin 2 (input) and pin 3 (ground) of *IC1*. Adjust *R15* for a zero indication on *M1*. If this is not possible, slightly increase the value of *R5* and decrease *R4*, or vice versa. Maintain the sum of *R4* plus *R5*, at 8000 ohms or more.

Upon removing the 15,000-ohm resistor, *M1* should remain at zero. If not, repeat the input bias and offset adjustments. Install *R1* and check to see that there is a 0.3-volt dc drop across *R2*. Adjust *R1* or *R2* if necessary.

The final adjustments are made to calibrate the foot-candle ranges. The nominal resistance of *PC1* is 28,000 ohms at 2 ft-c and 56,000 ohms at 1 ft-c. Set range potentiometers *R17* through *R20* about halfway through their travels and set *S2* to LIGHT. Connect a 5600-ohm resistor to a phone plug and insert it in *J1*. This simulates the ideal resistance of *PC1* at 10 ft-c.

Set *S1* to the 10-ft-c range and adjust *R17* until *M1* indicates full-scale. Similarly, use a 56,000-ohm, a 560,000-ohm, and a 5.6-megohm resistor, respectively, to calibrate the 1-, 0.1-, and 0.01-ft-c ranges while adjusting the corresponding potentiometers. The simulating resistors used

should have 5-percent or better tolerances. If an accurate photometer is available, you can use it to calibrate the light ranges.

Although neutral-density filters can be used to extend the light ranges, filters using film negatives are satisfactory for non-critical use. Using the enlarger as a light source, focus it and remove the film from the carrier. Place *PC1* on the enlarger easel and set *S1* to the 1-ft-c range. Stop down the lens until *M1* indicates 1 ft-c. For the X10 multiplier, select a portion of unwanted negative that, when placed over the sensor, causes the meter to indicate 0.1 ft-c. Affix the film to a thin blackened washer or disc that fits over the top of the photocell. Place the glossy side up to protect the emulsion from scratches. Selected film bits should be uniform and without detail.

**Application.** Measure light with *S2* set to LIGHT and *S1* set to the desired range. Measure time with *S2* set to TIME and *R14* set to a previously determined calibration setting for the particular application. The calibrating procedure for *R14* accounts for paper speeds, mode of operation, time scale in use, and processing factors. This is performed once for each set of conditions and recorded for future use. When calibrating or using the instrument, all darkroom lights must be off. Avoid directly illuminating *PC1* by the meter's lights.

Select an average negative and make the best possible print in the conventional manner using test strips. As an example, let us assume the best print required 15 seconds of exposure time at f/8 aperture. For the integrated light method, you will need a 2½-in. (6.35-cm) square piece of ground glass as a light scatterer. With the enlarger undisturbed, place *PC1* at the center of the projected image and set *S2* to TIME. Hold the light scatterer up to the enlarger's lens. Then adjust and record the settings of *R14* that result in 15 seconds indication on the 25-, 50-, and 100-second scales where possible. Also, record the data on the projection paper in use.

To use the exposure meter at a later date, set *R14* to the recorded setting for the particular paper and time scale. At almost any lens aperture and print magnification, use the light scatterer and observe the required exposure time. You can select the exposure time desired by varying lens aperture (or vice versa). A blackened paper tube

from a 35-mm film carton positioned over the sensor checks or eliminates the effect of stray light. During exposure, S3 can be switched off.

Calibrate R14 with the lens aperture set to one or two stops larger than the exposing aperture of the test print when using the instrument with small lamp enlargers. In the example, open the lens one full stop to f/5.6. Calibrate R14 for 15 seconds indication on each time scale where possible. Using this mode of measurement, observe exposure time at any selected aperture and close down one stop before exposing. Alternatively, you can halve the indicated exposure and expose at the measuring aperture.

The spot method determines exposure time at print shadows without the use of a light scatterer. To calibrate, place PC1 at important print shadows (bright portion of the projected image) and adjust R14 until the meter indicates 15 seconds on each time scale. To use this mode, set R14 as recorded for the paper and time scale, place PC1 at the print shadows, and observe the required exposure time.

Contrast measurements use the light scales to determine the ratio of

light levels at the bright and dark portions of the image. The table gives various contrast ranges with the setup

S1 Range (initial)	M1 (%) (preset)	S1 Range (final)	Contrast Range
0.01	100	0.1	10
0.01	100	1	100
0.01	100	10	1000
0.1	40	0.1	2.5
0.1	40	1	25
0.1	40	10	250
0.1	20	0.1	5
0.1	20	1	50
0.1	20	10	500

requirements. Because it is used most frequently, set up the 0-to-25 range with S2 on LIGHT and S1 on the 0.1-ft-c range. Place PC1 at the darkest area of the image and adjust the lens aperture until M1 indicates 40 percent of full-scale. Advance S1 one decade to the 1-ft-c range. Note that M1 now indicates 1 on the 0-to-25 scale.

Move PC1 to the brightest area of the image and read image contrast directly on M1. Middle contrasts of 8 to 15 indicate the use of normal-contrast paper. By keeping notes, relate contrast measurements with the required paper grade.

The integrated light method, preferably used with negatives of average balance, requires either a correction or recalibration of R14 for negatives of predominantly light or dark scenes. The spot method, capable of handling almost any negative, assumes that projected print shadow areas are larger than the photocell's diameter.

By installing a photocell in the tip of a probe, you can take measurements on contact print boxes, viewing screens, etc. For camera applications, choose between the LIGHT and TIME scales. The TIME scales can be interpreted in any convenient manner, such as 0 to 2.5, 5, and 10 seconds or 0 to 250, 500, and 1000 milliseconds, and easily converted to fractional shutter speed if desired.

Bear in mind that CdS cells exhibit a memory effect related to previous light history. Therefore, avoid exposing PC1 to sunlight or bright room lights prior to use. Also, response time increases with decreasing light levels. So, allow time for the meter indication to settle at very low light levels. Long-term meter drift proved to be nonexistent in use, but you can check meter zero by setting S2 to LIGHT and removing P1. ♦

## WHAT DO YOU KNOW ABOUT TRANSFORMERS?

BY ROBERT P. BALIN

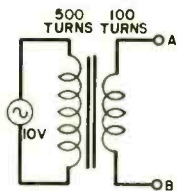

1. Assuming no losses, the output voltage between A and B is \_\_\_\_ volts.

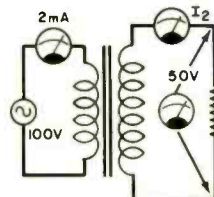

2. Assuming no losses, secondary current  $I_2$  is \_\_\_\_ mA.

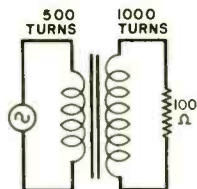

3. The 100-ohm secondary load will look like \_\_\_\_ ohms to the primary voltage supply.

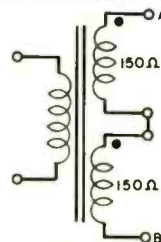

4. If the two 150-ohm windings are connected as shown, the output impedance between A and B will be \_\_\_\_ ohms.

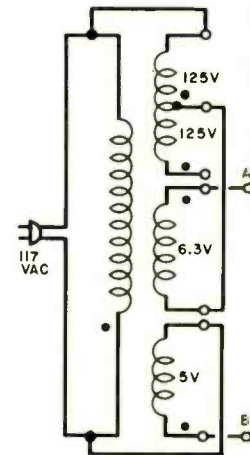

5. Taking into account the way the windings are connected and their polarity markings, the output voltage between A and B will be \_\_\_\_ volts.

Answers: 1. 2 volts; 2. 4 mA; 3. 25 ohms; 4. 600 ohms; 5. 9.3 volts.

IF YOU ARE READY FOR SERIOUS CAREER

# Learn College-Level



ADVANCEMENT NOW—

# Electronics at Home

## With CREI's unique Electronic Design Laboratory Program

There is only one way to a career in advanced electronics—through advanced training. You can get such training through a resident engineering college or you can take a CREI specialized college level electronics program at home.

**Wide Choice of Programs.** CREI offers you program arrangements with *fourteen* areas of specialization in advanced electronics. You can select exactly the area of specialization for the career you want.

CREI also offers program arrangements *both* for those with extensive experience in electronics *and* for those with only limited experience. All programs are college-level, except for a brief introductory level course, which is optional.

**Unique Laboratory Program.** CREI now offers a unique *Electronic Design Laboratory Program* to train you in the actual design of electronic circuits. You also get extensive experience in tests and measurements, breadboarding, prototype building and in other areas important to your career. The Lab Program makes it easier for you to understand the principles of advanced electronics. Only CREI offers this complete college type laboratory program.

The Lab Program includes professional equipment which becomes yours to keep. You will especially appreciate the Electronic Circuit Designer, which is available only through this program and which you will find extremely valuable throughout your professional career.

**College Credit.** You can actually earn college credit through CREI programs, which you can use at recognized colleges for an engineering degree. CREI maintains specific credit transfer arrangements with selected colleges in the U. S.

**Industry Recognized Training.** For nearly 50 years CREI programs have been recognized throughout the field of electronics. CREI students and graduates hold responsible positions in every area of electronics and are employed by more than 1,700 leading organizations in industry and government.

**Qualifications to Enroll.** To qualify for enrollment, you should be employed in electronics or have previous experience or practical training in the use of electronic equipment. You must also be a high school graduate or true equivalent.

**All CREI Programs are available under the G.I. Bill**

**Send for FREE Book.** If you are qualified, send for CREI's full color catalog describing these college-level programs and your career opportunities in advanced electronics. Mail card or write for your copy of this book.



**CREI** CAPITOL  
RADIO  
ENGINEERING  
INSTITUTE

McGraw-Hill Continuing Education Center  
3939 Wisconsin Avenue Northwest  
Washington, D. C. 20016



Accredited Member, National Home Study Council



# Product Test Reports

## ABOUT THIS MONTH'S HI-FI REPORTS

Sansui's Model 771 stereo receiver is a fine example of the caliber of performance offered by some of today's medium-priced receivers. Even at its conservative power rating of 32 watts, it can drive low-efficiency acoustic-suspension speakers to room-filling volume, with totally inaudible distortion. Its FM tuner section is of comparable quality.

A very different component is the deluxe Mark IVDM power amplifier from SAE. It is expensive, but it has performance to match. Although its 100-watt/channel rating may not seem to qualify it for the "super" amplifier category, it is actually able to deliver nearly twice that power without strain. As one would expect from an amplifier in its price range, the SAE Mark IVDM has almost unmeasurable distortion, so that the most advanced test equipment actually reads its own internal distortion, rather than that of the amplifier.

Somewhat of a "noverick" among cassette recorders, the new Nakamichi 500 is a plain, almost starkly styled machine, without some of the operating "features" of many modern deluxe cassette machines. Its forte is high performance, with as faithful a job of recording and playback as one could hope for in a cassette system. Further, the superior "headroom" afforded by Nakamichi's special design and the unique peak reading meters remove most of the "guesswork" from making good recordings and simplifying the whole operation.

—Julian D. Hirsch

## SANSUI MODEL 771 AM/STEREO FM RECEIVER

Medium-priced unit surpasses manufacturer's claims.



Retailing for \$379.95, the Sansui Model 771 AM/stereo FM receiver is in the

medium-price category. It carries a power output rating specified at 32 watts/channel into 8-ohm loads with both channels driven simultaneously over a frequency range of 20 to 20,000

Hz at less than 0.5% distortion. The FM tuner section has a rated IHF usable sensitivity of 2.0  $\mu$ V and less than 0.4% harmonic distortion in mono and 0.6% in stereo.

**General Description.** The control panel of the receiver occupies the entire lower half and part of the upper half of the front panel. The receiver's

output can be switched by the SPEAKERS switch to any of three pairs of speaker systems, to two combinations of two pairs of speaker systems, or to all speakers off to permit private listening via a pair of headphones plugged into the PHONES jack on the front panel.

The separate BASS and TREBLE controls have 11 detented positions with zero at the top and 5 plus and minus positions on either side. The BALANCE control is also detented at its center position.

Pushbutton switches on the front panel provide control of POWER, AUDIO MUTING (provides a volume drop of 20 dB for temporary interruptions in listening), and the LOW and HIGH filters. Other pushbutton switches can be used to switch in and out of the circuit: LOUDNESS compensation, MONO mode, FM MUTING, and separate TAPE MONITOR functions for two tape decks.

A MIC jack is also provided on the control panel. When a microphone is plugged into it, its signal takes precedence, regardless of the source to which the receiver is switched.

The upper portion of the front panel is dominated by a "blackout" window, behind which is the AM/FM tuning dial, an FM STEREO legend that lights up in red when a stereo signal is received, and a single meter that indicates both AM and FM signal strengths. The TUNING knob and source SELECTOR that complete the front-panel controls are also located on the upper half of the front panel, to the right of the window. The source SELECTOR has positions for PHONO, FM AUTO, FM, AUX 1, and AUX 2.

On the rear apron are the receiver's inputs and outputs, including insulated spring-loaded terminals for the speaker hookups. An extendible AM ferrite rod antenna and terminals for both 300-ohm and 75-ohm FM antennas and a wire AM antenna are also provided. A DIN socket duplicates the functions of the TAPE 1 inputs and outputs. Finally, there are two accessory ac outlets, one of which is switched.

The receiver measures 18 $\frac{1}{8}$ " W  $\times$  11 $\frac{3}{4}$ " D  $\times$  5 $\frac{3}{4}$ " H (48  $\times$  30  $\times$  13.6 cm) and weighs 26.4 pounds (12 kg). The receiver is supplied in a walnut-finished wood cabinet.

**Laboratory Measurements.** The receiver's audio amplifiers proved to be rated most conservatively. At 1000 Hz, the output waveform clipped at 53 watts/channel into 8 ohms, 71.5 watts

into 4 ohms, and 33 watts into 16 ohms. At the rated 32 watts/channel into 8 ohms and at half and one-tenth rated power, the harmonic distortion was typically about 0.1% and never exceeded 0.27% from 20 to 20,000 Hz.

The 1000-Hz THD decreased smoothly from 0.25% at 0.1 watt to about 0.07% at 40 watts/channel output. The IM distortion had a similar characteristic, falling from 0.56% at 0.1 watt to 0.3% at 40 watts. At very low power levels, between 100 mW and 1 mW output, the IM distortion was as high as 1%, indicative of a slight amount of crossover distortion. This distortion was not audibly significant at these power levels.

A 43-mV signal at the AUX inputs or a 1.1-mV signal at the PHONE inputs drove the amplifiers to a 10-watt/channel reference power level. The noise level through either input was a very low -71 dB referred to 10 watts. The phono preamplifier had an exceptional dynamic range, overloading at 225 mV at its input.

The tone control and LOUDNESS compensation systems had conventional characteristics, with the latter boosting both low and high frequencies at reduced volume settings. The filters had gradual 6-dB/octave slopes, with the -3-dB frequencies at 110 Hz and 3600 Hz. The RIAA equalization error was less than 0.5 dB from 60 to 20,000 Hz, increasing to -2.5 dB of error at 30 Hz. The equalization at high frequencies was affected slightly by the cartridge inductance (about average for the amplifiers we have tested in recent years). The loss amounted to 2 to 5 dB at frequencies beyond 15,000 Hz, depending on the cartridge used.

In the FM tuner section, we measured a 2.1- $\mu$ V IHF usable sensitivity. The very steep limiting curve resulted in a 50-dB quieting sensitivity of 2.5  $\mu$ V

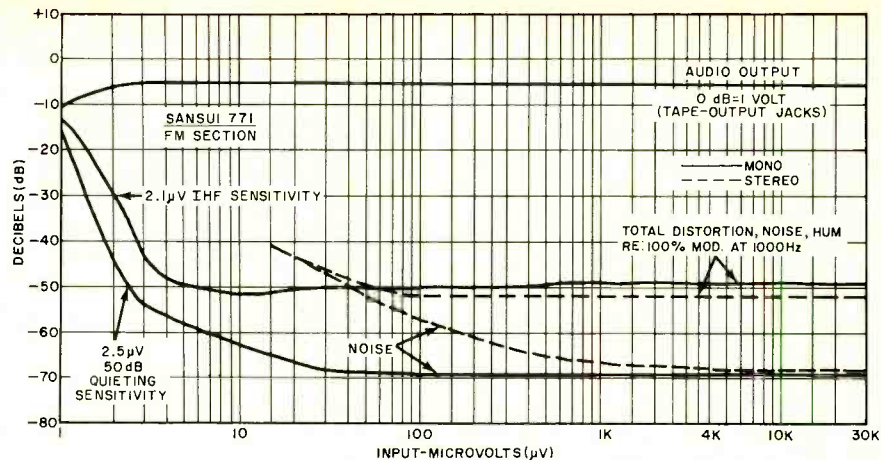

in mono and 40  $\mu$ V in stereo. The ultimate S/N was 69 dB in mono and 66 dB in stereo. The ultimate distortion was 0.37% in mono and, at 0.28%, even less in stereo.

The capture ratio of the tuner was 1.4 dB at 1000  $\mu$ V, and its AM rejection was a very good 63 dB. Image rejection and alternate-channel selectivity were also exceptionally good for a receiver in the Model 771's price range, measuring 80 dB and 84 dB, respectively. The signal thresholds for muting and automatic stereo switching were both 15  $\mu$ V.

In stereo, the FM frequency response was almost perfectly flat over most of the audio range. It was within  $\pm 0.5$  dB from 30 Hz to 11,000 Hz and

down 3 dB at 15,000 Hz. The 19-kHz pilot carrier in the audio outputs was 70 dB below full modulation. Stereo channel separation was very uniform at about 30 dB from 30 to 2000 Hz. It reduced smoothly to 18.5 dB at 10,000 Hz and 15 dB at 15,000 Hz.

The AM frequency response was down 6 dB at 170 Hz and 3300 Hz.

**User Comment.** Judged by its features and performance specifications, the Sansui Model 771 stereo receiver would appear to be quite similar to most competitively priced receivers. However, when we examine its actual measured performance, we find that in many respects the Model 771 invites comparison with some much more expensive receivers.

In every significant aspect of its FM and audio performance, the Model 771 not only surpasses its advertised ratings, but it does so by a comfortable margin. In addition, there were no "bugs" in its operation, which was exceptionally smooth. This would be an excellent choice of receivers for anyone who is looking for a bit more power and overall performance than is available in low-priced receivers.

CIRCLE NO. 66 ON READER SERVICE CARD

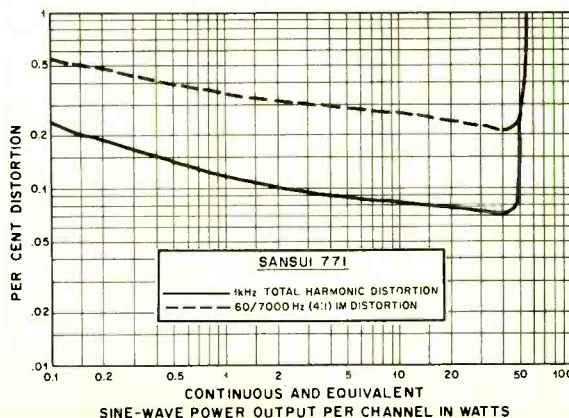
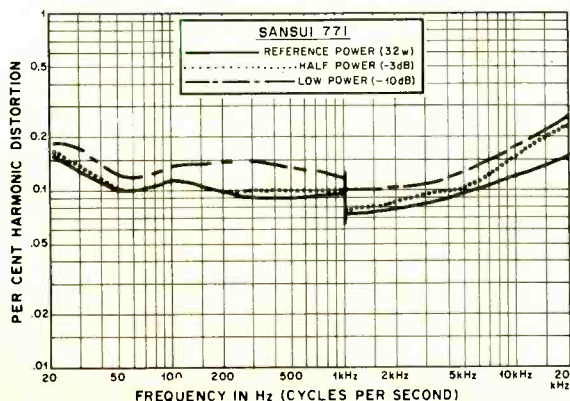
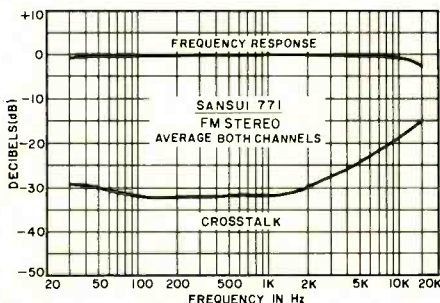

## SAE MARK IVDM BASIC POWER AMPLIFIER

*State-of-the-art performance, ultra conservatively rated.*



The SAE Mark IVDM deluxe basic stereo power amplifier has a continuous output power rating of 100 watts/channel into 8 ohms, 200 watts into 4 ohms, and 50 watts into 16 ohms. These basic power levels are specified at less than 0.1% THD. The amplifier features differential (push-pull) circuitry from its inputs to its speaker outputs. Except for the input blocking capacitors, all stages are direct coupled.

SAE has developed an IC-controlled biasing system for the amplifier's output stages. It eliminates any tendency for the amplifier to go into thermal runaway. It also appears that the company has directed special efforts toward eliminating the crossover-notch effect that causes the distortion levels of most amplifiers to rise appreciably at very-low-power outputs. Heavy-duty regulated power supplies, a large heat sink area, and adequate thermal circuit breakers insure safe operation of the amplifier under any normal operating conditions.

The amplifier has no external operating controls, not even a power switch. (It is meant to be entirely controlled from a preamplifier.) Its inputs,

speaker outputs, and power-line fuse are located on the rear apron. Internal power supply fuses are not ordinarily user-replaceable.

The Mark IVDM, comes with two large illuminated output-power meters on its front panel. (The amplifier, minus the meters, is available as the Mark IVD.) Pushbutton switches are provided for increasing the meter sensitivity by 6, 12, and 18 dB so that useful indications can be obtained with the amplifier delivering from a fraction of a watt to its full rated power to the loads. Alternatively, the meters can be switched out of the circuits altogether.

The amplifier measures 17" W x 13" D x 5 3/4" H (43.2 x 33 x 14 cm) and weighs about 35 pounds (16 kg).

The SAE Mark IVDM amplifier retails for \$600. Without the meters, the Mark IVD sells for \$500. An optional walnut cabinet is available for \$44.

**Laboratory Measurements.** Inputs of 0.4 volt into each channel drove the amplifier to a reference output power of 10 watts/channel, with the noise 94 dB below that level. When we drove both channels simultaneously into 8-ohm loads at 1000 Hz, the output waveform clipped at 200 watts/channel, which is twice the rated output power. Into 4 ohms, the clipping level was at 280 watts/channel, while into 16 ohms, it was at 115 watts/channel. The internal power supply fuses blew when we drove the amplifier into clipping with 4-ohm loads, a condition we cannot imagine anyone ever approaching.

The harmonic distortion did not vary significantly between the rated power

output levels. From a maximum of about 0.05% at 20 Hz, the distortion dropped to between 0.005% and 0.008% at 1000 Hz. It rose to 0.025% at 20,000 Hz.

The 1000-Hz THD was less than 0.01% up to 180 watts/channel output and was typically 0.005% or less. The IM distortion rose from 0.002%, the residual of our test equipment, at 0.1 watt, to 0.005% at the rated 100 watts, and to 0.1% at 190 watts. Even at the extremely low output of 2 to 3 mW, the IM was a mere 0.014%.

The amplifier's frequency response was about as flat as our test equipment over the audio range and considerably beyond. It varied by less than 0.1 dB from 5 to 20,000 Hz (which is why we don't show the curve here) and was down 3 dB at 140,000 Hz. The square-wave rise time was 2.0 to 2.5  $\mu$ s, depending on the power level.

The calibration of the meters was reasonably accurate. A 0-dB indication corresponded to about 90 watts/channel output into 8-ohm loads. The attenuator steps of 6, 12, and 18 dB were accurate to within 0.2 dB.

During our tests and subsequent use of the amplifier, which included considerable time at or near full power, it did not suffer any deterioration of its characteristics, although the thermal cut-out tripped several times.

**User Comment.** As our measurements reveal, the SAE Mark IVDM amplifier delivers true state-of-the-art performance with distortion levels that cannot be measured with any but the most advanced laboratory instruments. In use, the amplifier contributes no sound of its own to what is heard, which is a hallmark of the very best of amplifiers. For all purposes, the Mark IVDM is a distortionless am-

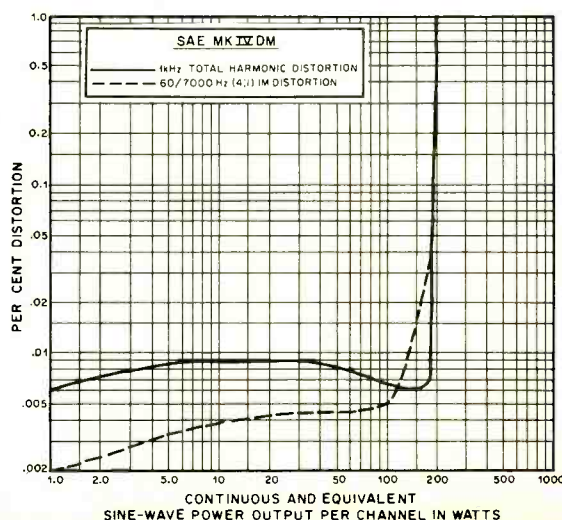
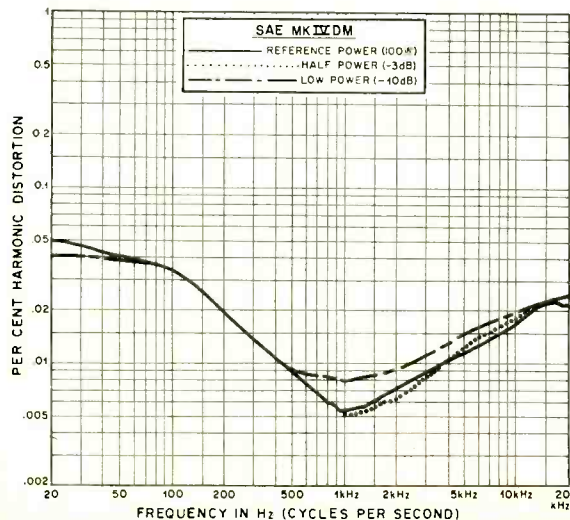



plifier. The quality of the music you hear will depend on the quality of the music signal fed into the amplifier.

For a 100-watt/channel basic power

amplifier, a \$500 price tag would be rather expensive. However, in view of the fact that the amplifier is almost unreasonably conservatively rated at

about half the power it is capable of delivering, the high price is not so very high.

CIRCLE NO. 67 ON READER SERVICE CARD

## NAKAMICHI MODEL 500 CASSETTE DECK

*Top record/playback performance.*



Having first become known in the U.S. for very expensive three-head cassette

recorders, Nakamichi Research Inc. has now introduced a moderately priced (\$399) two-head deck, the new Model 500. It boasts a host of features one expects to find in a top-quality deck, plus some noteworthy extras. A special focused-gap record/playback head, for example, provides extended high-frequency response, and a peak-level meter offers a professional 45-dB range.

Among the other attributes of this deck are: bias and equalization can be switched for the three major cassette tape formulations; a Dolby system helps to keep down noise; a servo-controlled dc motor maintains constant speed; and a resettable tape counter has a memory function that stops tape motion in rewind at any preset position.

**General Description.** The Model 500's transport is controlled by the common piano-key system. The keys are assigned the usual record (REC), rewind (REW), play/record (PLAY/REC), fast-forward (FORWARD), PAUSE, and STOP/EJECT functions. The STOP/EJECT key must be operated before going from one operating mode to any other. Slight pressure on the key stops tape motion, while greater pressure ejects the cassette.

Four slide-type controls are provided for adjusting the record level for the LINE and MIC inputs. A BLEND MIC input, with its own control, supplies a third microphone signal to both channels. All inputs can be mixed. A single

slide-type control permits simultaneous adjustment of the playback level for both channels.

At the top rear of the deck are the two meters. (They are not affected by the setting of the playback level control.) They have logarithmic scales to cover the 45-dB range and can display almost the full dynamic range of any program being recorded or played. The response time is 150 ms and the decay time is 2 seconds. The 0-dB mark on the scale corresponds to the standard 200-mW/m Dolby level.

Two control panel toggle switches set the bias and record/playback equalization for standard (NORMAL), high-performance ferric-oxide and CrO<sub>2</sub> tape formulations. A third switch is for the Dolby system; it has a separate position to calibrate the Dolby system for any type of tape. Controls for making the adjustment are at the rear of the deck. A fourth switch permits the LIMITER to be switched in to prevent distortion if recording levels exceed 0 dB, or out of the circuit when not needed.

Along the front are the PHONES jack for 8-ohm headphones and three microphone jacks. The L and R MIC jacks deliver signals to the respective channels, while a BLEND MIC jack delivers a signal to both channels simultaneously.

On the rear apron are the LINE inputs and outputs and a DIN connector and slide switch for the MPX filter used when making FM Dolby recordings.

The deck measures 15" W x 10" D x 4½" H (38 x 25 x 11 cm) and weighs 15½ pounds (7 kg).

**Laboratory Measurements.** We measured the deck's playback response with a Philips TC-FR tape for the standard (120-μs) and a Teac MTT-116SP tape for the CrO<sub>2</sub> (70-μs) equalization. Over the tapes' 40-Hz to 10,000-Hz range, the 120-μs response varied ±2 dB and the 70-μs response varied ±1.2 dB.

A TDK SD tape was used for NORMAL (the deck had been adjusted for this tape), Nakamichi EX for EX, and Nakamichi Chrome for CrO<sub>2</sub>. At a -20-dB level, the differences in re-

sponse were very small between tapes. The overall response of ±2 dB from 25 Hz to between 17,000 and 18,000 Hz is one of the better figures we have measured in cassette recorders.

We also measured the response at a 0-dB level to judge the degree of tape

The great new  
**Super Scanner**

The only "two-antennas" antenna. It scans 360 in milliseconds with 5.75 dB gain. Or beams an 8.75 dB gain signal where and when you want it—instantaneously. (And you'll wish you had a radio as handsome as the control box!)

- New contemporary control console with blackout panel, simulated leather end panels.
- Compact size — radius just 3 feet. Wind rated in excess of 100 mph.
- Ideal for emergency teams — zero in on trouble spots instantly.



MODEL MS 119 Super Scanner electronic beam antenna with control console.



**the antenna specialists co.**

Division of ORION INDUSTRIES, INC.  
12435 Euclid Ave., Cleveland, Ohio 44106  
Export: 2200 Shames Dr.,  
Westbury, L.I., New York 11590  
Canada: A. C. Simmonds & Sons, Ltd.

CIRCLE NO. 6 ON READER SERVICE CARD

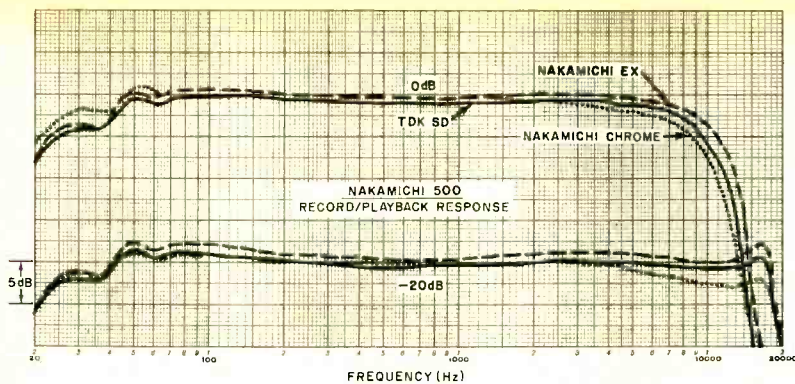

saturation at high frequencies, which causes an early rolloff of highs on any cassette deck. The intersection of the 0- and -20-dB curves in each case was between 14,000 and 15,000 Hz—typical of the better cassette machines and tapes we have tested.

The "tracking" of the Dolby circuits was very close. The frequency-response curves measured with and without the Dolby system differed by less than 1.5 dB at any point with -20-dB and -30-dB recording levels. The MPX filter introduced a slight (2-dB) peak at 15,000 Hz. It cut off rapidly above 16,000 Hz to attenuate by about 30 dB any 19-kHz pilot carrier signal that could interfere with proper operation of the Dolby system.

The 60-mV LINE or a 0.18-mV MIC input produced a 0-dB recording level. The mic inputs began to overload with signals exceeding 17 mV. (Anyone making live recordings with high-output mikes or of very loud program sources is advised to use an external attenuator.) The playback level from a 0-dB signal was 0.9 V at maximum playback-level control setting.

Playback distortion at a 0-dB recording level was between 2.2% and 2.5%, depending on the type of tape used. The reference recording level that produced a 3% playback distortion was +1.5 dB with CrO<sub>2</sub> tape and +1 dB with SD and EX tapes. The unweighted S/N ratio, referred to this level, was 49.5 dB with SD, 48.3 dB with EX, and 54 dB with CrO<sub>2</sub> tape.

The lower noise of the CrO<sub>2</sub> tape is due to the 70- $\mu$ s playback equalization. With IEC "A" weighting to correlate with the audibility of the noise, these figures became 52.2, 50.8, and

57 dB. With the Dolby system in, they became 63, 59, and 63.3 dB.

The microphone inputs were exceptionally quiet. They added only 3 dB to the recorded noise at maximum gain.

The unweighted wow and flutter measured 0.13% on playback and 0.12% in a combined record/playback measurement. It consisted almost entirely of flutter, with the wow being at the 0.02% residual of the test tape. Tape speed was fast by a slight 0.75%, but well within the 1.0% tolerance considered normal for cassette machines. The transport required relatively slow times of 130 and 120 seconds to handle a C-60 cassette in fast forward and rewind, respectively.

The meters were accurately calibrated, exhibiting an error of less than 1 dB down to -25 dB, and 2 dB at -40 dB. Using tone-burst signals, they indicated only 1 dB lower than their steady-state values with a 0.5-s burst, 2.5 dB lower with 0.1-s burst, and 3.5 dB lower with a 50-ms burst. All had a 1-s "off" time. The headphone volume level was satisfactory with 8-ohm phones (the type most popular), but not 200 ohms or higher.

**User Comment.** With respect to frequency response and noise, the Model 500 is one of the finest two-head cassette recorders we have tested. When listening to off-the-air, recorded, and commercially duplicated tapes, we were unable to detect any degradation in quality. This was true even in A-B comparisons against the original programs.

We were also impressed by the deck's ability to record interstation hiss from an FM tuner at -10 dB and

play it back with such fidelity that a close comparison with the original revealed only a trace of "dulling" of the highest frequencies in the hiss. This is a test that most cassette and a number of open-reel recorders fall far short of passing. It says a lot for the efficacy of Nakamichi's head design in recording and retrieving very high frequencies from the slow-moving cassette tape. The transport was exceptionally quiet, electrically and mechanically.

The meters were easily the best we have seen on a tape recorder. By accurately indicating the momentary peak levels, they allowed us to record at the highest possible level with virtually no risk of overload or distortion. The limiter was also useful since it had no effect until the program level exceeded 0 dB. It should be used with discretion, however, because even if it does not distort in the usual sense, a severe overload still sounds unnatural.

Clearly, when it comes to record/playback results, the Nakamichi Model 500 cassette deck is hard to beat, especially at its price. The transport system is somewhat clumsier to operate than a solenoid-operated system might be, but Nakamichi may have chosen to do this to give preference to special tape heads and accurate wide-range meters, among other features, still keeping the price down. If all of this plus solenoid control were incorporated into the Model 500, its price would have been much higher.

The transport control buttons could benefit from color coding or some other means of easy identification, but this is a minor comment. The STOP/EJECT button has only slight difference in pressure requirements between its dual functions. These, however, are things that can be compensated for with increased familiarity. And the rewind and fast forward speeds are a bit slow for our tastes.

What we have in the Model 500 is a cassette deck for enthusiasts who will trade the equivalent of an automobile's automatic transmission and power steering for superperformance. Doubtlessly, there are many quality-conscious people who will happily opt for this.

CIRCLE NO. 68 ON READER SERVICE CARD

## PEARCE-SIMPSON BENGAL AM/SSB CB TRANSCEIVER

*Base station features unique metering system.*

**C**OMBINED into Pearce-Simpson's "Bengal" base-station

transceiver are both AM and SSB operating modes to provide maximum

CB communicating capability. Designed primarily as a base station, the

POPULAR ELECTRONICS



transceiver's ac power supply is fully electronically regulated. If desired, the rig can also be used in a mobile environment (a mounting bracket is supplied for this purpose) that has a 12-volt dc negative-ground electrical system.

All 23 AM and 46 SSB transmit and receive channels are made available by means of a crystal frequency synthesizer system. In the SSB mode, the user has the choice of USB or LSB operation. Among the various features offered in the transceiver are a switchable noise blanker, meter, clarifier controls, separate RF and MIKE GAIN and VOLUME controls, adjustable SQUELCH control, and PA/CB selector switch. Add to these, external speaker jacks on the rig's rear apron for PA and receiver service and a push-to-talk microphone with attached coiled cord.

The metering system in this transceiver is rather unique. It has separate scales and functions for indicating SSB receive in S units, AM receive in S units, AM carrier output in watts, SSB PEP output in watts, and AM modulation in percentage. Another unusual feature is the inclusion of a headphone jack on the transceiver that permits private listening to incoming transmissions.

The Bengal transceiver measures 12 $\frac{7}{8}$ " W x 9 $\frac{7}{8}$ " D x 5" H (32.7 x 25.1 x 12.7 cm). It retails for \$399.95.

**Receiver Details.** The frequency-synthesis system employs what Pearce-Simpson refers to as a Hetro Sync™ circuit. This is essentially a conventional setup in which various crystal combinations are used to provide the heterodyning signals needed for deriving the desired i-f. The synthesizer is followed by a four-diode balanced mixer and bandpass circuits that minimize spurious responses.

The receiver employs a low-noise FET r-f stage and single conversion to a 7.8-MHz i-f on SSB and a second conversion to 455 kHz on AM. A

7.8-MHz crystal filter is used for obtaining SSB selectivity, while a single i-f stage is used with a diode ring demodulator (detector). For AM, a ceramic filter precedes two 455-kHz i-f stages, which are followed by the usual envelope detector and a full-time automatic noise limiter (anl). Separate amplified agc systems and S-meter circuits are engaged for the AM and SSB modes.

The a-f system consists of three stages that drive a push-pull output amplifier. The output amplifier is also used for modulating the AM carrier during AM transmit. The noise blanker utilizes diode detection and a FET pulse amplifier, which operates a series gate following the first mixer.

**Transmitter Details.** The SSB signal is generated via the usual filter method, with the 7.8-MHz signal combined with the synthesizer signal at an IC balanced mixer. Two r-f stages provide amplification for driving the r-f output power amplifier. A three-section filter permits matching the output stage to a 50-ohm load. A TVI trap and an automatic level control (alc) setup are also included in the output stage.

For AM, the 7.8-MHz crystal-oscillator signal is similarly combined with the synthesizer signal to provide the on-channel carrier. The carrier then goes to the r-f amplifiers, where the driver and power amplifier are collector modulated. The voltage is then reduced by an electronic power-control circuit that maintains the input power within the legal limits. Automatic modulation control (amc), a pre-amplifier that switches in for all transmissions, and a transmit/receive transfer relay round out the transmitter's features.

**Test Results.** On our test bench, the transceiver's receiver measured 0.14  $\mu$ V on SSB and 0.8  $\mu$ V on AM for 10 dB (S + N)/N. Image, i-f, and spurious-signal rejection were 95, 105, and 60 dB, except that at 30.7 MHz the spurious-signal rejection measured 45 dB. Adjacent-channel rejection was nominally 50 dB, while unwanted-sideband suppression measured 65 dB at 1000 Hz.

The squelch system had a range from 0.15  $\mu$ V on SSB and 0.7  $\mu$ V on AM to 1000  $\mu$ V. The agc system had a 9-dB a-f output change for a 20-dB r-f input change (at 1 to 10  $\mu$ V) and 7 dB with a 60-dB input change (at 10 to 10,000

$\mu$ V). A 100- $\mu$ V input signal was required for the meter to give an S9 indication. The overall response on SSB was 550 to 2750 Hz, while on AM it was 325 to 2500 Hz. The audio output power delivered to an 8-ohm load was 3.5 watts at 3% distortion at the start of clipping with a 1000-Hz test signal.

In the transmitter section, the output power measured 12 watts PEP on SSB and 4 watts on AM. Third-order distortion at the rated PEP on SSB was 22 dB below a two-tone test or 28 dB below a single-tone test. Carrier and sideband suppression measured 60 and 65 dB, respectively. The a-f response of the transmitting system was nominally 200 to 2800 Hz. On AM, 100% modulation produced 6% distortion (10% with 6 dB of clipping). Splatter was down 40 dB. The frequency response was nominally 350 to 3800 Hz, while the frequency tolerance at the extremes of the CLARIFIER control was within  $\pm$ 600 Hz.

**User Comment.** We found that, by limiting the meter pointer's swing to about the 10-watt PEP position on SSB or for AM between the 80% and 90% marks on the scale, excessive SSB "flattopping" and AM clipping could be held down. In operation, if the transmitter is operated beyond these points, splatter could be created in spite of the transceiver's amc and alc.

Signal quality was excellent, enhanced by a front-facing speaker in the transceiver. There was no significant difference in the audio output level between the AM and SSB modes of operation. This is not always the case with combination AM/SSB transceivers where less care is taken to match the gains of the AM and SSB sections in the receiver.

The Bengal's fine unwanted-sideband suppression made it possible to listen to SSB signals simultaneously using opposite sidebands on a channel without interfering with one another. Good overload characteristics made reduction of the r-f gain seldom necessary with strong signals. The noise blanker had little effect on low-level noise, but pulses stronger than 40 dB above 1  $\mu$ V were attenuated by about 35 dB.

Not mentioned in the operator's manual is that the microphone gain control functions only on CB transmit. For PA operation, the a-f volume control serves as the mike gain control.

CIRCLE NO. 69 ON READER SERVICE CARD

# NEW KITS, NEW VALUES IN

## NEW Digital & Analog Power Supplies



Kit or Assembled,  
they out-feature  
any others  
for the price.

Analog models  
from **\$169.95**

Digital models  
from **\$219.95**

Heath sets a new benchmark for lab-grade power supplies with the new "2700" series. Their precision, stability, and ease of operation make them ideal for laboratories, yet their prices put them in reach of hobbyists and technicians alike.

**Wide model choice.** Choose from 4 DC voltage ranges; 0-7.5V. @ 10A., 0-15V. @ 5A., 0-30V. @ 3A., 0-60V. @ 1.5A. Choose 3½ digit readout or 3½" analog meter readout. Choose kit or assembled models. All kit analog models are 169.95; kit digital models 219.95; assembled analog models 255.00; assembled digital models 340.00.

**More features, more versatility.** Constant voltage and constant current (not simple current limiting, but fully specified constant current operation), each independent of the other. Complete voltage and current programmability with rear panel connec-

tors for external control. Remote sensing at the load compensates for lead and connector voltage drop. Any of the supplies can be connected in auto-series or auto-parallel to deliver specific voltages or currents beyond that of single units. When two supplies of the same rating are connected in series, internal circuitry insures proper voltage sharing to maintain regulation. Supplies of different ratings can be connected in series with external circuitry. Units operate in master-slave configuration. Two or more supplies can be connected in parallel for greater current capacity. They will deliver 80% of current rating with no loss of regulation, regardless of load. Full protection against indefinite short-circuit operation, accidentally applied voltages, and open remote-sensing leads. For full information including the superb specifications of this new series, see the new Heathkit catalog.



GR-500

GR-400

GR-300

Simulated TV pictures

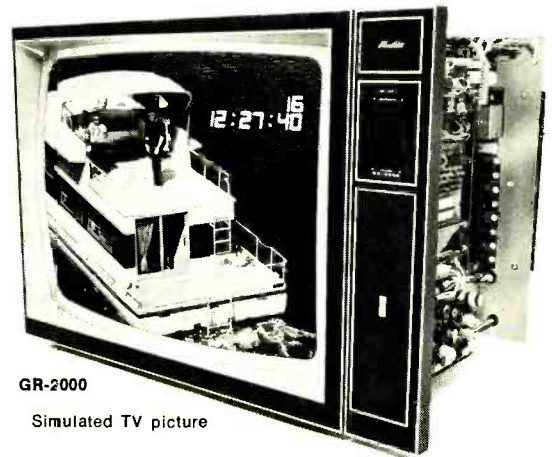

GR-2000

Simulated TV picture

### 15, 17 & 19" (diagonal) Color TVs with On-Screen Digital Readout

Advanced Heath engineering and outstanding picture quality. All feature on-screen channel readout & optional plug-in clock modules. In-line picture tubes with slotted shadow masks provide exceptionally bright, sharp pictures. In the GR-400 and 500, black matrix tubes improve contrast. And here's something new — static toroid yoke & magnet assemblies never require convergence & fixed LC filters eliminate instrument IF alignment. GR-300 & 400 come with walnut veneer cabinets; cabinets for the GR-500 start at \$39.95.\*

Kit GR-300 (15" diag.), with cabinet	449.95*
Kit GR-400 (17" diag.), with cabinet	489.95*
Kit GR-500 (19" diag.), less cabinet	499.95*
Kit GRA-2000-1, Digital Clock Module	29.95*

### Highly Acclaimed GR-2000 Digital-Design Color TV

The set that brought TV into the digital age — and still one of the finest made. Tuning is totally digital solid-state & the channel number appears right on the big, 25" (diagonal) screen. The optional clock module also displays the time on the screen. For the ultimate in convenience, add the optional wireless remote control. Can be custom mounted; optional cabinets start at \$119.95\*.

Kit GR-2000, less cabinet	669.95*
Kit GRA-2000-1, Digital Clock Module	29.95*

# YOUR FREE HEATHKIT CATALOG



## NEW Heathkit Stereo "Super-Amp"

200 watts, minimum RMS, per channel into 8 ohms with less than 0.1% total harmonic distortion from 20-20,000 Hz.

AA-1640 \$439.95, less meters

Specifications don't say it all, but they do indicate the quality of this exceptional amplifier. Take the power statement above, for example; if you are familiar with Heath's conservative stance in specifications, you will know that there's no question that this amplifier will do at least that well. The same holds true for the exceptionally low distortion figures. Other impressive figures are: hum and noise 100 dB below full output; damping factor greater than 50; channel separation 50 dB minimum.

**The features behind the specifications.** The super power comes from the super power supply... a 25 lb. transformer that will maintain full output under the most demanding program material. Two 6 lb. die-cast heatsinks cool the 16 output transistors... no noisy fans are needed. Even when used as a PA amplifier, it needs only normal ventilation. Automatic circuitry helps protect your speakers; a 10-second delay protects your speakers from turn-on "thumps" and disconnects them instantly when power is turned off. The delay circuit also disconnects the speakers if it detects DC or extremely low-frequency AC at the outputs. Automatic thermal shut-down helps prevent damage from overheating. And speaker fuses are located within the

primary feedback loop... an exclusive Heath design which maintains a high damping factor for high-definition bass response.

**Optional peak-responding meters** continuously monitor the output. The back-lighted meters have linear calibrations from -30 to +3 dB and can also be read directly in watts from 0.2 to 200 watts into 8 ohms. So fast they even respond to record "clicks", they are useful as overload indicators. And if you buy the meters at the same time as the amp., you save \$20.

**Front panel controls** include pushbutton on/off, left and right channel gain controls, and LED power and high temperature indicators.

**To hear music as you've never heard it before...** build the AA-1640. For sheer power and exceptionally low distortion, we believe it is one of the finest amplifiers ever made. Super-amp... super-sound.

- Kit AA-1640, less meters, 69 lbs., Exp/Frt ..... 439.95
- Kit AAA-1640-1, meters only, 4 lbs., mailable ..... 69.95
- Kit AA-1640 & Kit AAA-1640-1, 73 lbs., Exp/Frt ..... 489.95



**NEW**

## Heathkit Stereo Microphone Mixer ... 129.95

For fine home recording facilities and elaborate PA and sound reinforcement systems. Wide response (40-20,000 Hz, +1 dB) and low distortion (0.5%) with unusual versatility. Each of the two outputs has its own master control and meter and switchable for stereo or mono modes. Six inputs: two high-level for disc or tape, four low-level for microphones (switchable to high impedance, unbalanced, or low impedance, balanced). The fourth mic. input has a "pan" control to adjust its apparent location anywhere from left to right. All inputs can be individually switched to left, off, or right channel. Mixing bus access permits paralleling added mixers for extra inputs and outputs. Two lighted dual-range meters plus adjustable LED peak indicators. Slider controls and switches.

Kit TM-1626, 12 lbs., mailable ..... 129.95



**NEW**

## AM/FM Stereo Receiver... 139.95

Proof that good sound can cost less. The preassembled AM/FM tuner section has 5  $\mu$ v sensitivity for distant station reception. Ceramic filters offer 60 dB selectivity to remove alternate channel interference. AFC. Integrated circuit FM IF. Phase-locked loop integrated circuit multiplex. Direct-coupled amplifier design with an honest 4.5 watts, min. RMS, per channel into 8 ohms from 50-15,000 Hz with less than 1% total harmonic distortion. Slider vol. and balance controls; ganged rotary bass and treble controls. Inputs for ceramic cart. changer and tape. Handsome walnut-grained vinyl-clad plastic and metal enclosure included. It's one of Heath's new Valu-Component line; see them all in the Heathkit catalog.

- Kit AC-1118, receiver, 15 lbs., mailable ..... 139.95
  - Kit AS-1140, pair of speakers, 15 lbs. .... 34.95
- Order with speakers and save 5%.

**HEATHKIT ELECTRONIC CENTERS** —  
Units of Schlumberger Products Corporation  
Retail prices slightly higher.

ARIZ.: Phoenix; CALIF.: Anaheim, El Cerrito, Los Angeles, Pomona, Redwood City, San Diego (La Mesa), Woodland Hills; COLO.: Denver; CONN.: Hartford (Avon); FLA.: Miami (Hialeah), Tampa; GA.: Atlanta; ILL.: Chicago, Downers Grove; IND.: Indianapolis; KANSAS: Kansas City (Mission); KY.: Louisville; LA.: New Orleans (Kenner); MD.: Baltimore, Rockville; MASS.: Boston (Wellesley); MICH.: Detroit; MINN.: Minneapolis (Hopkins); MO.: St. Louis (Bridgeton); NEB.: Omaha, N.J.: Fair Lawn; N.Y.: Buffalo (Amherst), New York City, Jericho (L.I.), Rochester, White Plains; OHIO: Cincinnati (Woodlawn), Cleveland, Columbus, Toledo; PA.: Philadelphia, Pittsburgh; R.I.: Providence (Warwick); TEXAS: Dallas, Houston; VA.: Norfolk (Va. Beach); WASH.: Seattle; WIS.: Milwaukee.



New Heathkit Catalog shows these and 350 other easy-to-build kits including Color TV, Stereo, Test, Marine, Amateur Radio, etc. Send today.

## Send for FREE Catalog

Heath Company, Dept. 10-05 Benton Harbor, MI 49022		HEATH Schlumberger
<input type="checkbox"/> Please send Free Heathkit Catalog. <input type="checkbox"/> Enclosed is \$ _____; please ship models _____		
NAME _____		
ADDRESS _____		
CITY _____	STATE _____	ZIP _____
<small>PRICES &amp; SPECIFICATIONS SUBJECT TO CHANGE WITHOUT NOTICE. ALL PRICES ARE FACTORY MAIL ORDER, F.O.B. FACTORY.</small>		
		CL-564

## HEATH/SCHLUMBERGER MODEL SG-1271 FUNCTION GENERATOR

Wide-band generator available as kit or assembled.



**T**EST equipment is getting better and more sophisticated, without becoming astronomically expensive. An excellent example of this is the new breed of function generators that is rapidly overtaking in popularity the traditional audio signal generator. What the function generator has is an extremely wide bandwidth (usually from less than 10 Hz to 1 MHz and beyond), coupled with three waveforms—sine, square, and triangle—from which to choose. Cost is about 50% more than a standard signal generator.

Among the new function generators on the market is the Heath/Schlumberger Model 1271, that comes factory wired for \$140. The same instrument is available as the Heathkit Model IG-1271 in kit form for \$99.95. In either version, it covers a range of 0.1 Hz to 1 MHz, dialed in by a FREQUENCY MULTIPLIER switch, with six decade ranges, and a variable FREQUENCY control for fine adjustments within the range selected. The output circuit that delivers the sine, square, and triangle waveforms for test purposes is short-circuit proof. This stage has an output impedance of 50 ohms and can deliver up to 10 volts peak-to-peak signal level.

The frequency accuracy of the instrument is 13% of the FREQUENCY dial setting, while the output is flat within  $\pm 1.5$  dB over the instrument's entire frequency range. The output signal ATTENUATOR is a two-control system. A six-position rotary switch provides a 50-dB attenuation range, ticked off at 10-dB intervals. Concentric with this switch is a potentiometer control that serves as a 20-dB vernier for fine control of the attenuation. Summing the attenuation of both controls, the function generator has a very wide 70-dB attenuation range.

The sine-wave output has a 3% max-

imum harmonic distortion over a 5-to-100,000-Hz frequency range. The rise and fall times on the square-wave function are both 100 ns, while the symmetry on the triangle-wave function is 10% of the 50% duty cycle. Finally, the power demand of the instrument is only about 15 watts from the ac line.

The function generator measures  $8\frac{7}{8}$ " D  $\times$   $7\frac{1}{4}$ " W  $\times$  3" H (22.5  $\times$  18.4  $\times$  7.6 cm). It weighs 4.2 pounds (about 2 kg). The dimension figures are given for the instrument minus its carrying handle/tilt stand.

The instrument we received for testing was the factory-wired Model SG-1271. We have no first-hand assembly comments we can make about the kit instrument. However, thumbing through the assembly/operating manual provided with the instrument and a look inside the case permit us to make a couple of educated guesses. The kit should present no problems during assembly even for a neophyte. We estimate that three to four evenings spent at assembly, depending on how much time you are willing to spend at a sitting, will suffice to have the kit completely wired and ready to go.

**User Comment.** The very wide frequency range of the function generator might at first appear to be overly generous. It isn't. Today's broadband circuits require an extremely wide frequency range for adequate testing and troubleshooting. Tests on such circuits should also routinely include checking to see what happens when input signal frequencies are outside of the circuits' ranges.

Most of us know what to do with sine and square waves. But the inclusion of the triangle-wave function in these generators presents a puzzle. Just what do you do with a triangle wave? The answer is a great many things. For one thing, it is a natural for visually checking the distortion in audio equipment. Unlike sine waves that begin to show definite visible distortion at levels exceeding 7% or 8%, the triangle wave points up the existence of much lower distortion levels.

Waveform A in the drawings is a clean, straight-edged triangle, free of bends, kinks, bumps, and dips. If you put this signal into an amplifier and boost the generator's output level to and beyond the clipping point, the

clipping condition will be readily apparent when the sharp points on the waveform flatten out, as shown in waveform B. The further into clipping the amplifier is driven, the greater the flattening effect. Crossover distortion, as illustrated by waveform C, is also very apparent as the ideally straight line shifts around the center axis. Variations in amplifier gain are similarly easy to discern in the waveform. Many of these gain variations manifest themselves as shown in waveform D. A single-frequency triangle wave can take the place of several octaves of sine waves when checking out the action of bass and treble controls. A high-frequency roll-off will look like waveform E, while a low-frequency rolloff will look like waveform F.

Another place where triangle waves come in handy is in servo systems. If you do any work with servo loops, the very-low-frequency triangle waves should prove of great interest.

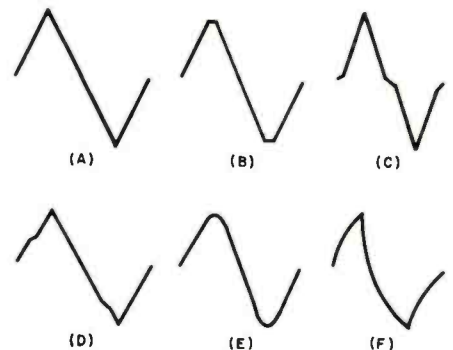

**Bench and Field Tests.** We tested the function generator using a laboratory-quality oscilloscope and a distortion analyzer. Taken right from its shipping carton, the instrument's test performance complied with the published specifications. After making a few minor adjustments, in accordance with the procedure outlined in the manual, we were able to better the published specifications.

Then, for the next few weeks, we put the function generator to work on our service bench. We used it to check out and troubleshoot a variety of circuits ranging from high-quality audio components to digital systems, ham gear, and a number of the experimental projects. Needless to say, the function generator performed flawlessly.  $\blacklozenge$

CIRCLE NO. 5 ON READER SERVICE CARD

POPULAR ELECTRONICS

ENGLISH-LANGUAGE SHORTWAVE BROADCASTS FOR MAY-AUGUST 1975 By Roger Legge

TO EASTERN NORTH AMERICA

TIME-EDT	TIME-GMT	STATION	QUAL*	FREQUENCIES, MHz
7:00-9:00 a.m.	1100-1300	**VOA, Washington, U.S.A.	G	6.185, 9.565
7:00-10:30 a.m.	1100-1430	London, England	G	11.905 (to 8:15 a.m.), 15.365 (via Canada)
7:15-8:15 a.m.	1115-1215	Montreal, Canada	G	9.58
7:15-8:45 a.m.	1115-1245	Melbourne, Australia	G	15.13, 17.69
7:30-8:00 a.m.	1130-1200	Jerusalem, Israel	F	11.685
8:00-8:55 a.m.	1200-1255	Peking, China	F	11.74, 15.115, 17.88
8:15 a.m.-12:30 p.m.	1215-1630	HCJB, Quito, Ecuador	G	15.14
9:15-9:45 a.m.	1315-1345	Berne, Switzerland	F	15.185
10:00-10:30 a.m.	1400-1430	Helsinki, Finland	F	15.24, 17.71
10:30 a.m.-12:15 p.m.	1430-1615	Stockholm, Sweden	G	15.365 (via Canada)
1:00-1:30 p.m.	1700-1730	London, England	G	17.84 (via Ascension Is.)
4:00-4:55 p.m.	2000-2055	**Paris, France	F	15.12, 17.755
5:15-7:00 p.m.	2115-2300	Jerusalem, Israel	F	7.395, 9.815, 12.025, 15.10
5:30-6:50 p.m.	2130-2250	London, England	G	9.51, 9.58 (via Ascension Is.) 11.78
6:30-7:00 p.m.	2230-2300	Hilversum, Holland	G	9.715, 11.73 (Sun., Dutch)
6:30-7:20 p.m.	2230-2320	Vilnius, U.S.S.R.	G	9.665, 11.77 (Sat/Sun)
6:55-7:15 p.m.	2255-2315	Johannesburg, S. Africa	F	5.98, 6.035, 9.525, 9.695
7:00-7:30 p.m.	2300-2330	Brussels, Belgium	F	9.73
7:00-8:30 p.m.	2300-0030	Helsinki, Finland	F	15.185
7:00-8:00 p.m.	2300-0100	Moscow, U.S.S.R.	G	9.53, 9.655, 11.735, 11.77
7:45-8:45 p.m.	2345-0045	London, England	G	6.175, 9.51, 9.58, 11.78
8:00-8:30 p.m.	0000-0030	Tokyo, Japan	F	15.27, 15.445
8:00-9:00 p.m.	0000-0100	Tirana, Albania	G	7.065, 9.78
8:30-9:00 p.m.	0000-0100	Peking, China	F	15.06, 15.52, 17.672
8:30-9:00 p.m.	0030-0100	Sofia, Bulgaria	F	9.70
8:30-9:00 p.m.	0030-0100	**VOA, Washington, U.S.A.	G	6.19, 9.67, 11.83, 11.89, 15.40
8:30 p.m.-3:00 a.m.	0030-0700	Stockholm, Sweden	F	11.755, 11.955
8:40-9:00 p.m.	0040-0100	Kiev, U.S.S.R.	G	9.53, 11.735 (Mo/Th/Sat)
9:00-9:15 p.m.	0100-0115	HCJB, Quito, Ecuador	G	5.97, 9.56, 11.915
9:00-9:20 p.m.	0100-0120	Brussels, Belgium	F	6.055
9:00-9:30 p.m.	0100-0130	Vatican City	G	5.995, 6.165, 9.605, 11.845
9:00-9:45 p.m.	0100-0145	Rome, Italy	G	9.575, 11.81
9:00-10:00 p.m.	0100-0200	Budapest, Hungary	G	6.00, 7.25, 9.833, 11.91
9:00-10:05 p.m.	0100-0205	Madrid, Spain	G	6.065, 11.925
9:00-10:05 p.m.	0100-0205	Berlin, DDR	F	6.085, 9.655
9:00-10:05 p.m.	0100-0205	Montreal, Canada	G	7.12, 9.78 (via Tirana), 15.06, 17.855
9:00-10:05 p.m.	0100-0205	Peking, China	G	5.93, 7.345, 9.54, 11.99
9:00-10:05 p.m.	0100-0205	Prague, Czechoslovakia	G	6.04, 9.565
9:00-10:05 p.m.	0100-0205	Cologne, Germany	G	6.10, 9.745, 11.865 (via Malta)
9:00-11:00 p.m.	0100-0300	Melbourne, Australia	G	15.32, 17.795
9:00-11:30 p.m.	0100-0330	London, England	G	5.975, 6.175, 7.325, 9.51, 9.58
9:00 p.m.-1:00 a.m.	0100-0500	Havana, Cuba	G	11.93
9:30-9:55 p.m.	0130-0155	Moscow, U.S.S.R.	G	9.53, 9.665, 9.685, 11.735
9:30-10:30 p.m.	0130-0230	Tirana, Albania	G	6.20, 7.30
9:30-10:30 p.m.	0130-0230	Vienna, Austria	F	6.155, 9.77
9:45-10:15 p.m.	0145-0215	Bucharest, Romania	F	5.99, 9.57, 11.94
10:00-10:30 p.m.	0200-0230	Berne, Switzerland	G	5.965, 6.12, 9.535, 11.715
10:00-10:45 p.m.	0200-0245	Lisbon, Portugal	G	6.025, 11.935
10:00-11:20 p.m.	0200-0320	Madrid, Spain	G	6.065, 11.925
10:00-11:20 p.m.	0200-0320	Hilversum, Holland	G	6.165 (via Bonaire)

TO WESTERN NORTH AMERICA

TIME-PDT	TIME-GMT	STATION	QUAL*	FREQUENCIES, MHz
7:00-7:15 a.m.	1400-1415	Tokyo, Japan	G	9.505
7:00-9:00 a.m.	1400-1600	**VOA, Washington, U.S.A.	G	6.185, 9.565
4:00-5:30 p.m.	2300-0030	London, England	G	6.175, 9.74 (via Canada)
5:30-9:30 p.m.	0030-0430	Moscow, USSR	G	12.05, 15.21, 17.72, 17.775 (via Khabarovsk)
5:30 p.m.-12:00 a.m.	0030-0700	London, England	G	6.175, 9.51, 9.58
6:00-8:00 p.m.	0100-0300	HCJB, Quito, Ecuador	G	5.97, 9.56, 11.915
6:30-7:30 p.m.	0130-0230	Melbourne, Australia	G	11.97, 15.32, 17.795
7:00-8:50 p.m.	0200-0350	Moscow, U.S.S.R.	G	12.05, 15.21, 17.775, (via Khabarovsk)
7:30-8:00 p.m.	0230-0300	Peking, China	G	15.06, 15.35, 17.855
8:00-8:30 p.m.	0300-0330	Tokyo, Japan	G	15.195, 15.235, 17.825
8:00-8:45 p.m.	0300-0345	Taipei, Taiwan	G	9.685, 11.86, 17.89
8:00-8:50 p.m.	0300-0350	Stockholm, Sweden	F	11.955
8:00-9:00 p.m.	0300-0400	Kiev, USSR	F	12.05, 15.21, 17.90 (via Khabarovsk)
8:00-9:00 p.m.	0300-0400	(Mon/Th/Sat) Madrid, Spain	F	6.065, 11.925
8:00-10:00 p.m.	0300-0500	Cologne, Germany	F	6.075, 6.185, 9.745 (via Malta)
8:00-10:00 p.m.	0300-0500	Buenos Aires, Argentina	F	9.69 (Mon-Fri)
8:00-10:00 p.m.	0300-0500	Prague, Czechoslovakia	F	7.345, 9.54, 11.99
8:00-10:00 p.m.	0300-0500	Peking, China	G	15.06, 15.385, 17.735, 17.855
8:30-9:00 p.m.	0330-0400	Lisbon, Portugal	F	6.025, 11.935
8:30-9:15 p.m.	0330-0415	Berlin, DDR	F	9.73, 11.825, 11.84
8:30-9:15 p.m.	0330-0415	Moscow, U.S.S.R.	G	12.05, 15.16, 15.21, 17.88 (via Khabarovsk)
8:30-9:15 p.m.	0400-0415	Tokyo, Japan	G	15.105
9:00-9:30 p.m.	0400-0430	Sofia, Bulgaria	F	9.70
9:00-10:55 p.m.	0400-0555	Montreal, Canada	G	6.135, 9.755
9:15-9:45 p.m.	0415-0445	Budapest, Hungary	F	7.25, 9.833, 11.91
9:30-10:00 p.m.	0430-0500	Berne, Switzerland	F	9.725, 11.715
9:45-10:50 p.m.	0445-0550	Cologne, Germany	G	6.075, 6.185, 9.545, 6.085, 9.605 (via Canada)
10:00-10:30 p.m.	0500-0530	Seoul, Korea	G	11.925
10:00-11:20 p.m.	0500-0620	Hilversum, Holland	G	6.165, 9.715 (via Bonaire)
11:00-11:15 p.m.	0600-0615	Tokyo, Japan	G	15.105
11:00 p.m.-12:00 mdt	0600-0700	Buenos Aires, Argentina	G	9.69 (Mon.-Fri.)
11:30 p.m.-1:00 a.m.	0630-0800	Havana, Cuba	G	9.525

\*Reception quality (Virginia location, Collins Communications Receiver, L antenna): G-good, F-fair, P-poor  
 Reception quality of Western North America broadcasts is expected reception in California.  
 \*\* Not intended for North America, but receivable satisfactorily.  
 Note: Frequencies and times may change. Those given here were available at time of writing.

Are you,  
of all people,  
still opening  
your garage

the  
hard  
way?

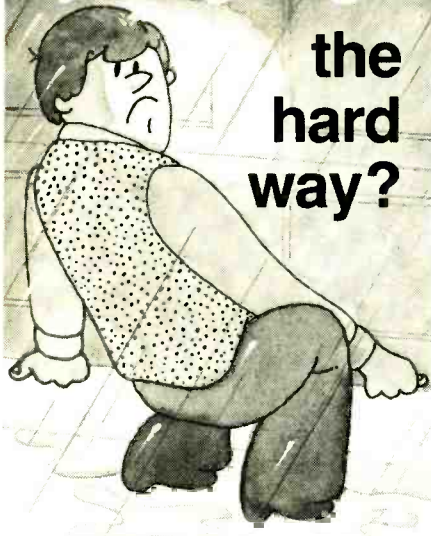

## Anybody who's into electronics

certainly should be getting the everyday convenience and family security of automatic garage door operation... especially now, with Perma Power's great Electro Lift opener... made to fit in the trunk of your car, designed for easy handling and simple do-it-yourself installation. Available now at a surprisingly low price from your distributor.



**P.S.** Show off your opener to your friends and neighbors. You'll probably be able to pay for yours with what you make installing openers for them.

**Perma Power®**

Chamberlain Manufacturing Corporation  
Perma Power Division  
5740 North Tripp Avenue, Chicago, Illinois 60646  
Telephone (312) 539-7171

CIRCLE NO. 35 ON READER SERVICE CARD

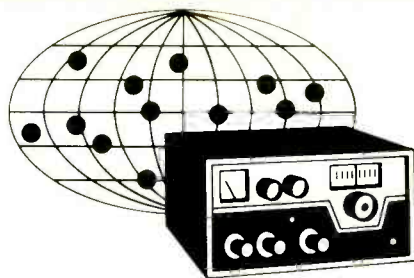

# DX Listening

By Glenn Hauser

## THE HAPPY STATION

**R**ADIO NEDERLAND holds a dominant position among European broadcasters heard in North America. Besides being a very friendly station, RN is the only one to have a relay in the Caribbean. Of course, RN still uses the direct Europe-North America path, but transmissions on this route are among the worst in the world (especially when sunspots are scarce) since so much of it passes through the auroral blanketing zone. In fact, RN is often heard better from its other relay in Madagascar than over the direct path.

"The Happy Station Show" fills each 80-minute Sunday transmission. Devoted to promoting international friendship, it's one of the oldest international broadcasts. "News and Spotlight" begin all other transmissions—except the final repeat at 0500 GMT. Despite previous erroneous listings, features start immediately, and the news is delayed until about 0605. This allows the staff in Holland an extra hour of sleep in the morning!

The Monday feature program covers items of cultural interest. These include, a classical music selection especially chosen for its compatibility to SW transmission. On Tuesday and Thursday, the features begin with press reviews. Wednesday brings a variety of short shows, such as Dutch language lessons, Letterbox, "Holland Makes It," and "Parsons' Penthouse"—a phone-out show interviewing celebrities. There is more serious fare on Thursday: DX Juke Box, Focus on Science and Your Health; and on Friday the program opens with jazz, followed by alternating specialty programs for tourists, women, and philatelists. Several programming changes are expected as of May 5.

DX Juke Box runs informal correspondence courses each year from March through August. This year the course deals with the radio spectrum. If you've missed the first few lessons,

it's not too late to enroll. Just ask for printed texts of the lessons, from DX Jukebox, Radio Nederland, Box 222, Hilversum, Holland. While you're at it, be sure to request the DX Information Service Catalog, wherein other RN "freebies" are listed, including several previously aired radio courses—on propagation, television DX, and "all-round" DX'ing.

Radio Nederland also enjoys the distinction of being the only European station to broadcast to North America on mediumwave—via Bonaire, of course. The English program is a bit too early in the evening (2335-0010 GMT Mon. to Fri.; 2300-0010 weekends) to penetrate much beyond the southeastern states, especially in the summer. But the 500-kW PJB transmitter is a good match for 50-kW CKLW and 150-kW XEROK, the main competitors on 800 kHz. RN's mediumwave programming is different from that on shortwave, so it's worth a little extra effort to hear.

**Polish Radio Warsaw.** Despite their omission in most listings, Polskie Radio broadcasts in English to North America. It's a difficult DX because the English is mixed in with Polish, and pulling them in takes a lot more than a ten-foot antenna pole. PR's spring schedule shows the bilingual broadcast at 0200-0355 GMT on 15.120, 11.815, 11.810, 9.675, 7.270, 6.135, and 6.095 MHz. Even if you can't pick them up you can still participate in a Polish Radio Contest! The big prize is a ten-day, all-expense-paid trip to Poland. Write an *interesting* letter expressing your reflections on the thirtieth anniversary of the victory over fascism, to Polskie Radio, P.O. Box 46, 00-950 Warsaw, Poland. Postmark deadline is May 9.

DX listeners were expecting the worst from France, as rumors circulated that ORTF would cease all shortwave broadcasting this year. Instead, under the new name Radio

POPULAR ELECTRONICS



France International, an hour-long English broadcast was added at 1700 GMT, on practically every band! Though it is aimed at Africa, we've had good reception in Oklahoma. The English broadcasts of Radio Deutsche Welle to North America seemed destined for extinction, too—but survived past the December 31 cutoff date. DW continues to expand its operations elsewhere, with relays from Sierra Leone on 5.98 to 9.63 MHz.

The Israel Broadcasting Authority has completed antenna adjustments, allowing direct beams to North America, with 300-kW power. The afternoon and late-evening English programs have become easier to hear, but if you'd like them in prime evening time, write Mr. Yigal Allon, Foreign Minister, Jerusalem, Israel, suggesting this addition. The existing programs jump an hour forward and back as DST comes and goes in Israel.

### Keeping Busy This Summer.

Casual mediumwave DX'ers take the summer off, figuring the static is too much to fight. But certain parts of the world are heard best on some quiet summer nights. If there are thunderstorms to the east of you, by 4 or 5 a.m. your time, that area may be daylight, preventing the static crashes from propagating and blotting out exotic stations to the west. In the western half of North America, deep South Americans come through best in midsummer. Try for Chile on 760, 1060, 1140 or 1180 kHz just before sunrise—or before nearby stations sign on. Mediumwave reception from Africa, Australia and New Zealand also peaks in the summer.

May, June and July are the big months for sporadic-E DX on FM and



Test pattern of XEFE-TV. This channel-2 signal was picked up via E-skip during June of 1974.

TV. One station to look for, if you're between 1000 and 2000 km (620 to 1240 miles) from Nuevo Laredo is XEFE-TV, channel 2. We snapped their distinctive custom test pattern at 6:23 p.m. CST on Thursday, June 6, 1974.

MAY 1975

**DX Conventions.** There will be conventions scattered throughout June, July and August, sponsored by several major clubs. All of them welcome nonmembers who'd like to get acquainted with other DX listeners. Among those scheduled far in advance is National Radio Club, Aug. 15-17 in Hartford, Conn. (information from NRC, Box 127, Boonton, NJ 07005). NRC also holds area DX meetings during several major holiday breaks. The Worldwide TV-FM DX Association meets this year in Fort Lauderdale, Fla., Aug. 1-3. Contact co-host Ken Simon, 528 Pilgrim Road, West Palm Beach, FL 33405.

For information on other DX conventions, contact ANARC Executive Secretary Dave Browne, 557 N. Madison Ave., Pasadena, CA 91101. You can also subscribe to the monthly Association of North American Radio Clubs Newsletter, at \$2.50 per year. ANARC is not a club, but a confederation of clubs; its newsletter summarizes member club activities.

Some regional DX groups, concentrating on local gatherings are: Metro-Atlanta DX-ing Association, c/o Brian Levy, 600 Dalrymple Rd., Apt. 8A, Atlanta, GA 30328; University of Manitoba DX/SWL Club, Room 515, Box 131, University Centre, Winnipeg, Manitoba R3T 2N2 Canada; Suburban Philadelphia Area DX'ers (SPADES), c/o M. Harlan Bye, Apt. 917, Wildman Arms, Swarthmore, PA 19081; Northern California DX'ers, c/o Rick Heald, 17412 Rolando Ave., Castro Valley, CA 94546; Southern California Area DX'ers (SCADS) with two-day meetings rivalling major DX conventions, c/o Don Johnson, P.O. Box E, Elsinore, CA 92330. Also Minnesota DX Club c/o Tom Gavaras, 16920 Seventeenth Ave., No., Wayzata, MN 55391.

**Publications.** The International Radio Club of America has published its third yearly "Foreign Log," a by-frequency compilation of most MW-DX items reported to the club through last August. Cost is \$3.75 for Vol. III; if you'd like Vols. I and II as well, all three can be ordered for \$7.00—or, just II and III for \$5.50. Send a check or money order payable to IRCA, 12536 Arabian Way, Poway, CA 92064.

The National Radio Club has just published its "Receivers Manual," a 72-page collection of articles reviewing receivers suitable for MW DX'ing. It covers modifications and accessories. Cost is \$2.50 from NRC, Box 127, Boonton, NJ 07005.

# free

## The "NEW LOOK" 1975 LAFAYETTE Radio Electronics CATALOG

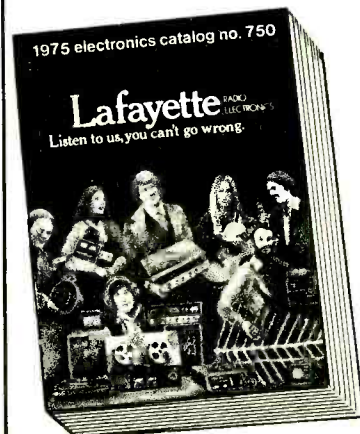

The ONLY Nationally Distributed Full-line Catalog with a Major Showing of the Newest NAME-BRAND electronics products for 1975.

**FREE  
SEND TODAY**

**SAVE on exclusive Lafayette Products plus MAJOR BRANDS**

• Stereo and 4-Channel Systems • Tape Equipment • Car Stereo • CB and Ham Gear • Police/Public Service Receivers • Antennas • Cameras • TV • PA and Test Equipment • Musical Instruments and Amplifiers • Books • Electronic Calculators • Security Systems • PLUS PARTS, TUBES, BATTERIES, HARDWARE, MORE!

## Lafayette

Listen to us, you can't go wrong.

Dept. 35055

Lafayette Radio Electronics

111 Jericho Tpke., Syosset, L.I., N.Y. 11791

Send me your FREE 1975 Catalog

Name ..... Apt. ....

Street .....

City ..... State .....

Zip .....

Send a 1975 Catalog to my friend

Name ..... Apt. ....

Street .....

City ..... State .....

Zip .....

CIRCLE NO. 27 ON READER SERVICE CARD

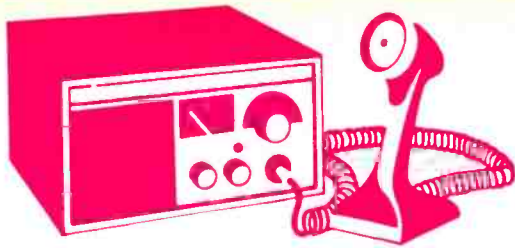

# CB Scene

By Len Buckwalter, K10DH

## MICROPHONE TECHNIQUES

**T**HE WAY a CB operator talks into his mike is probably as unique as his fingerprints. No authority has yet handed down the specs on talking techniques, so they tend to fall into random categories. Pick the right approach and your range and intelligibility may well be doubled. Among the types I've heard are:

*The Muncher.* He talks so close to the mike that he'll rust out the case. You'll recognize him when you pull up next to his mobile at a stop light. From the side, he resembles a kid mouthing a giant lollipop.

*The Movie Star.* I saw Karen Black pull this one off in "Airport 75". She's the stewardess who gets on the radio and saves a crippled jumbo jet and its passengers. Despite a 200-mph wind roaring through a hole in the cockpit, she spaces the mike far enough away so it won't hide her face, hairdo or lovely dimples.

*The Cross-Talker.* This fellow's been told that, if you speak directly into a mike and utter words that begin with P or B (what speech analysts call "plosives"), you'll rattle the listener's eardrums. The cure, he's heard, is to rotate the mike away from the mouth so the voice is not directed at the grille, but *across* it.

*My Aunt Tillie.* She's a very modern lady, but doesn't trust the principle of electronic amplification. Because she can't see the listener, she shouts into the mike. She's hilarious to watch on a long-distance phone call—the further away the party, the louder she screams. She once called her daughter in Anchorage and couldn't speak for a week afterward.

*Marvin Marconi.* This man's so good on a mike he can raise the Coast Guard 50 miles away during a lightning storm while hail is hitting the deck. That's impressive—considering the Guard doesn't even monitor CB.

Which of these five types has the correct mike technique? As you may suspect, it's a trick question because

any one could be correct. The trouble is, a huge number of variables—mike sensitivity, gain, ambient noise, preamp or modulator circuitry, voice timbre and supply voltage, to name some—muddy the answer.

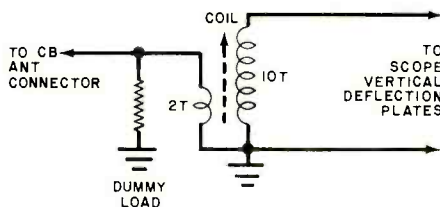

*Fig. 1. CB-to-scope coupler. The resistive dummy load and adjustable r-f transformer are easily made from "junk-box" parts.*

### Built-in Circuits.

Another complication is the compressor or limiter that may have been built into the rig. Although the FCC forbids modulation levels over 100 percent, keeping the average between 85 and 100 is one of the best ways to cut through ignition noise, distance and other range-robbers. Talk-boosting circuits are fine, but they can't be expected to work over a broad range of conditions. Some circuits selectively peak on certain voice frequencies (not necessarily tones which improve comprehension) and, when driven too hard, overmodulate the transmitter. Even if the FCC had no rule about overmodulation, it's a condition to be shunned. Modulation levels greater

than 100 percent interrupt the carrier for brief periods, generating splatter and distortion across many channels.

Flirting near that 100% limit, though, is good technique for the simple reason that the r-f signal power varies as the square of current and voltage in the modulating envelope. When a carrier is fully modulated, a third of the output is useful "talk" power. At low levels (20%) of modulation, talk power is only 2% of the total output. That's why it is essential to choose the mike technique that delivers high average levels.

### Some Simple Tests.

There are several ways to determine the proper technique. With a few inexpensive gimmicks, you can conduct some revealing tests in just a few minutes. For example, if you have a scope, even a cheap one, you can see a revealing picture of the modulated carrier by sampling the r-f output and applying it directly to the scope's vertical axis. A simple coupler for this test is shown in Fig. 1. It consists of a dummy load and an impedance transformer that could be wound on any slug-tuned coil form about a half inch in diameter. The transformer steps up the output impedance from 50 ohms to several thousands ohms, which also raises the r-f voltage. This assures a good display on the scope.

Use #18 insulated wire to wind the turns on the transformer and connect the ends of the secondary directly to the scope's vertical deflection plates. The secondary cannot be connected to the vertical amplifier. The 2-turn primary can be wound of the same wire at one end of the secondary, with the leads connected to the dummy load. The latter can be a 50-ohm, 5-watt noninductive (not wirewound) resistor or four 220-ohm, 1-watt carbon resistors in parallel. With the circuit complete and the transceiver turned on, you will probably see only a

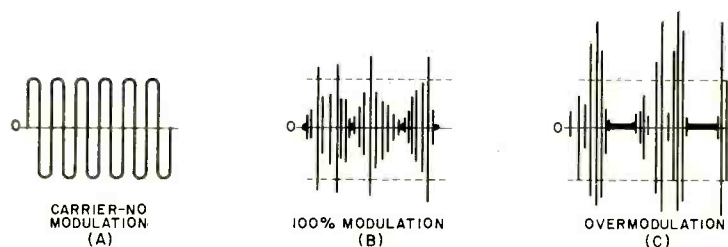

*Fig. 2. Scope traces for various modulation levels. The solid dashes shown in (C) indicate that severe splatter is being generated.*

thin line on the scope because the coupler is far from resonance. Adjust the coil slug to make the trace as thick as possible. Try for a height of about two inches. Adjust the spacing of the secondary winding turns if necessary. Once you have a good display, hum into the mike and adjust the scope's horizontal sweep to get two or three cycles of the modulated envelope across the screen.

Figure 2 shows the various scope patterns that can be seen. With 100% modulation, bright green dots will flash between the cycles of the envelope. With overmodulation, these dots elongate into dashes—a warning that the carrier is being cut off and is causing splatter. Unlike VU or modulation-level meters, the scope trace has no inertia and provides an instantaneous, highly accurate reading of the modulation. The trace also shows you how to refine your mike technique. While watching the scope, determine the best mike distance and position and the best speech level to obtain 100% modulation.

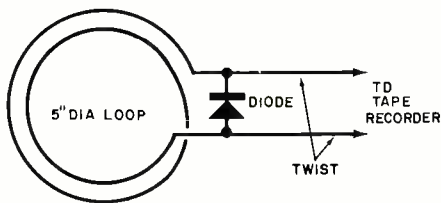

Fig. 3. Pickup loop for tape recorders. R-f output is sampled, rectified, and coupled to the recorder's microphone input.

#### An Audio Test.

This procedure alone may not tell the whole story. It is as important to hear how your mike technique sounds as it is to see how it looks on the scope. To do this, use a length of hookup wire to make a loop 5 in. in diameter as shown in Fig. 3. Connect a small-signal diode (1N60 or similar) across the loop. Couple the loop and diode to a tape recorder with a length (probably about 2 feet) of twisted-pair cable terminated in a standard microphone plug.

To record your signal as it is actually transmitted, maneuver the loop around the air vents of your CB rig (which is connected to a dummy load) until a strong signal is indicated on the recording level monitor. Now you can experiment with your mike technique and verify the results on the tape playback. Listen for the strongest, cleanest audio. ♦

MAY 1975

# GOOD OLD U.S. KNOWHOW

## 23 CHANNEL U.S. MADE CB FOR LESS THAN \$8.00/CHANNEL



**Feature-packed CB radio: 23 channels, S meter, local/distance control, PA function, locking mounting bracket, high-performance mic.**  
**Only \$169.95.**

*See your dealer today for this high quality, low-priced U.S. made transceiver. Or write for full details.*

62

**((P))Pace Communications, Div. of Pathcom Inc. 24049 S. Frampton Ave., Harbor City, Ca. 90710. Available in Canada from Superior Electronics Ind.**

CIRCLE NO. 34 ON READER SERVICE CARD

## FREE McIntosh CATALOG and FM DIRECTORY

Get all the newest and latest information on the new McIntosh Solid State equipment in the McIntosh catalog. In addition you will receive an FM station directory that covers all of North America.



### MX 113

FM/FM STEREO - AM TUNER AND PREAMPLIFIER

**SEND  
TODAY!**

McIntosh Laboratory, Inc.  
East Side Station P.O. Box 96  
Binghamton, N.Y. 13904  
Dept. PE

NAME \_\_\_\_\_

ADDRESS \_\_\_\_\_

CITY \_\_\_\_\_ STATE \_\_\_\_\_ ZIP \_\_\_\_\_

If you are in a hurry for your catalog please send the coupon to McIntosh.  
For non rush service send the *Reader Service Card* to the magazine.

CIRCLE NO. 28 ON READER SERVICE CARD

71

Hunting for  
a better job?

CIE will  
help you get  
the license  
you need



**A Government FCC License can help you qualify for an exciting, rewarding career in ELECTRONICS, the Science of the Seventies. Read how you can prepare at home in your spare time to pass the FCC Licensing examination.**

If you're out to bag a better job in Electronics, a Government FCC License can give you a shot at job opportunities with *real* futures.

According to the U.S. Office of Education Bulletin (4th Edition): "The demand for people with technical skills is growing twice as fast as for any other group, while jobs for the untrained are rapidly disappearing." There are new openings every year in many different industries for electronics specialists. And you don't need a college education to qualify.

But you *do* need knowledge . . . knowledge of electronics fundamentals. And one of the nationally accepted methods of measuring this knowledge . . . is the licensing program of the FCC (Federal Communications Commission).

**Importance of an FCC License and CIE's Warranty of Success**

If you want to work in commercial broadcasting . . . television or AM or FM broadcasting . . . as a broadcast engineer, federal law requires you to have a First Class Radiotelephone License. Or if you plan to operate or to maintain mobile two-way communications systems, microwave relay stations or radar and signaling devices, a Second Class FCC License is required.

But even if you aren't planning a career which involves radio transmission of any kind, an FCC "ticket" is valuable to have as Government certification of certain technical skills. It's a job credential recognized by some employers as evidence that you really know your stuff.

So why doesn't everyone who wants a good job in Electronics get an FCC License?

It's not that simple. To get an FCC License, you must pass a Government licensing exam.

A good way to prepare for your FCC License exam is to take one of the CIE career courses which include FCC License preparation. We are confident you can successfully earn your license, if you're willing to put forth an effort, because the vast majority of CIE students have. In fact, based on continuing surveys, close to 9 out of 10 CIE graduates have passed their FCC exams!

That's why we can offer this time-tested Warranty of Success: when you successfully complete any CIE career course which includes FCC License preparation, you will be able to pass the Government FCC Examination for the License for which the course prepared you or you will be entitled to a full refund of an amount equal to the cash price of tuition for CIE's Course No. 3, "First Class FCC License," in effect at the time you enrolled. This warranty is good from the date you enroll until the last date allowed for completion of your course.

**CIE HAS CAREER COURSES THAT INCLUDE "HANDS ON" TRAINING**

**ELECTRONICS TECHNOLOGY with LABORATORY Courses** . . . takes beginner from fundamentals to skills required of technician or engineering assistant. Includes Experimental Electronics Laboratory for "hands on" training.

**COLOR TV MAINTENANCE and REPAIR** . . . several CIE courses combine electronics theory with the actual construction, testing and troubleshooting a big screen, stolid state color TV.

**With CIE you learn at home**

With CIE, you learn in your spare time at home . . . or wherever else is convenient. No classroom time, ever. No one to make you go too fast . . . or too slow. With CIE's Auto-Programmed® Lessons you'll pick up facts, figures, and electronics theories you may have considered "complicated" . . . even if you've had trouble studying before.

**You can have attractive job opportunities**

There have already been many exciting developments and breakthroughs in Electronics and some people might assume there will be no new frontiers . . . no new worlds to conquer. Not so.

Electronics is still growing. In nearly every one of the new and exciting fields of the Seventies you find electronics skills and knowledge in demand. Computers and data processing. Air traffic control. Medical technology. Pollution control. Broadcasting and communications. Once you have the solid technical background you need, you can practically choose the career field you want . . . work for a big corporation, a small company or even go into business for yourself.

Yes, Electronics can be the door to a whole new world of career opportunities for you. And CIE training can be your key.

**Send for FREE school catalog**

Discover the opportunities open to people with electronics training. *Learn* how CIE career courses can help you build new skills and knowledge and prepare you for a meaningful, rewarding career. We have courses for the beginner, for the hobbyist, for the electronics technician, and for the electronics engineer. Whether you are just starting out in Electronics or are a college-trained engineer in need of updating (or anywhere in between), CIE has a course designed for *you*.

Send today for our FREE school catalog and complete package of career information. For your convenience, we will try to have a representative call to assist in course selection. Mail reply card or coupon to CIE . . . or write: Cleveland Institute of Electronics, Inc., 1776 East 17th Street, Cleveland, Ohio 44114. Do it TODAY.

**APPROVED UNDER G. I. BILL**

All CIE *career* courses are approved for educational benefits under the G.I. Bill. If you are a Veteran or in service now, check box for G.I. Bill information.

**CIE Cleveland Institute of Electronics, Inc.**

1776 East 17th Street, Cleveland, Ohio 44114  
Accredited Member National Home Study Council

**Cleveland Institute of Electronics, Inc.**

1776 East 17th Street, Cleveland, Ohio 44114

Please send me your FREE school catalog and career information package today.

I am especially interested in:

- Electronics Technician
- FCC License Preparation
- Color TV Maintenance
- Mobile Communications
- Industrial Electronics
- Electronics Engineering
- Other \_\_\_\_\_

Print Name \_\_\_\_\_

Address \_\_\_\_\_ Apt. \_\_\_\_\_

City \_\_\_\_\_

State \_\_\_\_\_ Zip \_\_\_\_\_ Age \_\_\_\_\_

Check box for G.I. Bill information.

Veteran  On Active Duty PE-82

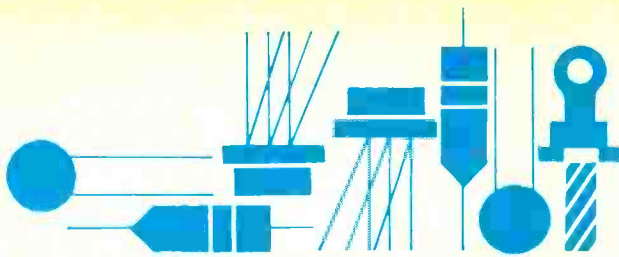

# Solid State

By Lou Garner

## A LOOK AT DC CONVERTERS

**B**ACK in the ancient days B.T. (Before Transistors), senior electronics technicians sometimes initiated their apprentices by sending them to pick up either "a dc step-up transformer" or "a grid leak drip pan." Either task was equivalent to sending an apprentice machinist to pick up a "left-handed monkey wrench," for neither component existed except in fancy. (Although pranksters occasionally would label ash trays as "drip pans.")

Had it existed, the dc transformer would have greatly simplified the design and construction of battery-powered vacuum-tube circuits as well as special-purpose controls, lighting and test instruments.

Today, however, an apprentice sent for a dc transformer might well return with one—not a single component, to be sure, but a module which performs all the functions of the imaginary device, converting one dc voltage to a much higher one.

Made possible through solid-state circuitry and better known as *dc/dc converters*, modern "dc transformers" comprise three basic circuit elements: an oscillator or semiconductor switch, a transformer or tapped coil, and a rectifier/filter network. They are used extensively in equipment designs requiring high as well as standard battery voltages, such as port-

able oscilloscopes, battery-powered TV sets, Geiger counters, megohmmeters, and digital equipment featuring gas-discharge displays.

Solid-state dc/dc converters, while extremely useful, do have certain limitations. Their efficiencies can range from less than 10% to 80%, or more, approaching the efficiencies of conventional ac transformers. It depends on their design and on how well their components are matched. While they can be designed and built to handle substantial amounts of power, the battery drain may be horrendous.

Consider, for example, a dc/dc converter with, say, 50% efficiency, and delivering 400 volts at 150 mA. The output is 60 watts. With 50% efficiency, the required dc input would be 120 watts. If a standard 6-volt battery were used as the prime power source, the current drain would be 20 amperes! Except for a few special-purpose applications, then, dc/dc converters generally are used where the high-voltage current requirements are relatively small.

Two basic dc/dc converter circuits are illustrated in Fig. 1. Both require a minimum of components and are suitable for low-power experimental applications. Both can be duplicated quite easily in the home laboratory or workshop.

Referring, first, to Fig. 1A, transistor

*Q1* is used as a simple oscillator, with its base bias established by series resistor *R1*, bypassed by capacitor *C1*. Transformer *T1*'s tapped primary winding provides the in-phase feedback needed to start and maintain oscillation, while its secondary winding steps up the resulting ac signal (actually, pulsating dc) to a higher voltage. The transformer's output is rectified by *D1* and smoothed by *C2*, developing the dc output voltage. The output capacitor also serves as an initial ripple filter, but an additional filter network may be required in some applications. Operating power, obtained from a low-voltage dc source such as conventional batteries, is applied to the circuit's input terminals. Although a pnp device is indicated in the diagram, an npn type may be used simply by reversing the dc supply polarity.

The dc/dc converter's output voltage depends upon the input voltage, the turns ratio of *T1*, the value of *C2*, and the load. For a given input voltage, the greater the transformer's turns ratio and the lighter the loading, the higher the output voltage. In practice, a low-power transistor and miniature transformer can deliver relatively high voltages if the load requirements are in the low milliwatt range.

The circuit's power handling capability, on the other hand, depends upon ratings of *Q1* and *T1* and, to some extent, on *C2*'s value. If substantial output power is required—in the multiwatt range, for example—a comparatively heavy transformer may be needed, while *Q1* will have to be a high-power device.

A somewhat different approach is used in the dc/dc converter circuit shown in Fig. 1B. Here, a unijunction transistor relaxation oscillator delivers sharp current pulses to a tapped ferrite-core induction coil, *L1*, which, in turn, develops high-voltage pulses

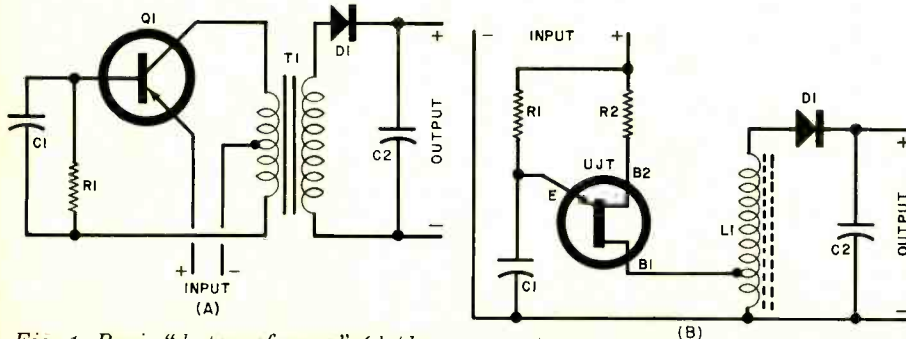

Fig. 1. Basic "dc transformer" (dc/dc converter) circuits using a transistor (A) and a UJT (B).

which are rectified by diode *D1*, charging output capacitor *C2*. Capacitor *C1* is charged by the low-voltage power source through series resistor *R1* and discharged periodically by the UJT through the lower section of *L1*. The frequency is determined primarily by the *R1-C1* time constant, assuming a fixed supply voltage.

The UJT circuit can develop comparatively high output voltages if a suitable coil is used, but has a limited power handling capability. If somewhat greater power is needed, the UJT can be used to trigger an SCR, which, in turn, discharges a second capacitor through the induction coil.

Although either of the basic circuits given in Fig. 1 can be used as dc/dc converters, both are relatively inefficient. Of the two, the circuit shown in Fig. 1A is preferred for medium-to-moderately-high dc voltages at power levels up to, say, a few watts, while the UJT circuit is preferred for very high voltages at the lower milliwatt or microwatt level.

Where substantial power and higher efficiencies are needed, a push-pull oscillator is preferred over the single-ended design shown in Fig. 1A. A suitable circuit is illustrated in Fig. 2. Although transistors *Q1* and *Q2* are wired in a push-pull configuration, they actually serve as switching elements, being driven either to saturation or cut-off alternately. A full-wave bridge rectifier, *D1* through *D4*, is used in place of the half-wave type shown in the earlier circuits. Series resistors *R1* and *R2* establish the transistor's base biases and also limit the drive signal delivered by *T1*. A small load resistor, *R3*, across *C1* stabilizes circuit operation.

For experimental purposes, either of the circuits given in Figs. 1A or 2 may be duplicated using components found in the average home electronics

workshop. Transformer *T1* can be almost any two-winding iron-core unit with a tapped step-down winding, although a center-tapped winding is required for the "push-pull" circuit. Typically, you could use tube-type audio output transformers or surplus filament transformers. The transistors can be medium- to high-power types similar to the HEP234, 235, or 244 (npn) or Sylvania's types ECG124 (npn), ECG127, or ECG162 (npn). Bias resistor values may range from a few hundred to several thousand ohms, depending on the characteristics of the transistors and transformer used. Type 1N4000 series output rectifiers are suitable for most applications, while the output capacitor can be a 10- $\mu$ F electrolytic with a suitable voltage rating. Bypass capacitor *C1*, Fig. 1A, is optional and may not be needed; if used, its value will range between 0.5 and 5  $\mu$ F, in most cases. Stabilizing output load resistor *R3*, Fig. 2, generally will be a 1-to-2-megohm, 1-watt type.

Although the dc/dc converter circuits are not overly critical, some care must be taken to avoid component damage. First, do not try to "push" for excessively high output voltages by increasing the input voltage. Doing so may cause either transistor breakdown or a breakdown in the transformer's insulation. Second, if the transistor(s) become warm in use, provide adequate heat-sinking. Third, don't overload or you may burn out either the transistor(s) or the transformer windings.

Another dc/dc converter circuit which may be of interest to more advanced hobbyists is illustrated in Fig. 3. Suggested by the Ferroxcube Corporation (Saugerties, NY 12477), this design features a special hand-wound transformer (*T1*), a full-wave bridge rectifier, and high-frequency (20-kHz) operation. According to Ferroxcube,

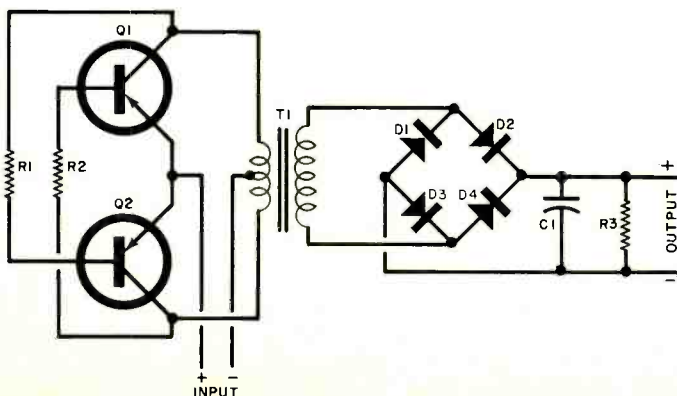

Fig. 2. Practical dc/dc converter featuring "push-pull" transistors.

# Incredible.

How else would you describe a preamplifier with:

- A **Peak Unlimiter** that restores dynamics lost in recording to closely approximate the original.
- A **Downward Expander** that reads "gain riding" and expands dynamics down to precisely the intended level.
- An **AutoCorrelator** that makes record/tape hiss and FM broadcast noise virtually vanish without affecting musical content.
- **Plus** an Active Equalizer that gives you flat energy distribution over the full audio spectrum, Joystick Balance and Step Tone Controls that allow precise music tailoring to your listening environment and SQ\* and Phase Linear differential logic for Quad Sound.



The 4000 is an advanced stereo preamp that actually puts back in what recording studios take out . . . lets your music (at last) reach life-like levels without distortion . . . lets you (for the first time) hear your music from a silent background. It is, in a word, incredible. Ask your dealer for an audition.

**Warranty:** 3 years, parts & labor.

## Phase Linear 4000

THE POWERFUL DIFFERENCE

PHASE LINEAR CORPORATION  
P.O. Box 1335 • Lynnwood, Wash. • 98036

\*SQ is a trademark of CBS, Inc.  
CIRCLE NO. 36 ON READER SERVICE CARD

this circuit will deliver 150-volt dc when powered by a 12-volt dc source. It has an efficiency rating over 80% and a power handling capability of over 4 watts. Except for T1, standard components are used. The transformer is wound on a type 3C8 (768T188) toroid core, using the number of turns and sizes of enamelled copper wire indicated on the diagram.

With the extremely small transformer made possible by high-frequency operation—the toroid core is only 1/2" diameter—the Ferroxcube circuit is ideally suited for use in portable and miniaturized equipment. With care, the entire circuit could be assembled on a pc or perf board no larger than a package of cigarettes.

**Circuits Revisited.** Perhaps the most difficult task facing me in preparing this column is choosing, from the hundreds of available circuits, the ones to feature in the magazine. While I try for variety, I also attempt to pick those which, I feel, have maximum potential reader interest. Unfortunately, I can't reply to all of the mail received—not even to those writers whose circuits I hope to publish. (As mentioned before, there is no payment for ideas published. Just personal satisfaction.)

Right now, I would like to look at some of the circuits we have published in the past and pass on some comments we have received about them.

Last October, I discussed two simple LED flasher circuits, repeating a dual flasher in my December column. Although both circuits are reasonably foolproof when powered by a 9-volt transistor battery, as suggested in the column, and although there have been no complaints from readers, one of our editors has pointed out that either a transistor or an LED might be damaged under some conditions if the circuits are powered by a heavy-duty power supply. If you plan to use these circuits with such power sources, then, you'll find it worthwhile to add a current-limiting resistor in series with each LED. The proper values for the resistors can be determined for the specific LED's used by applying

Ohm's Law, as suggested in Walter G. Jung's article *Light Up Your Circuits With LED's* (October 1974).

An interesting application for the dual flasher has been submitted by reader Lee Lanterman, K5IKE (201 S. 19th, Frederick, OK 73542). He suggests using a pair for a bicycle, with each having a red (rear) and an amber (front) LED. A center-off spdt lever or toggle switch would be used to operate the flashers.

Although Bill Roberts (Rt. 3, Hghwy 81, Winder, GA 30680) reports a good response to his preamp circuit, featured in my December column, several readers have written of problems with his design, including Hubert W. Brown (Rt. 13, Box 200, Nunn Road, Brooks-

*Fig. 3. High-frequency, high-efficiency dc/dc converter circuit suitable for compact equipment applications.*

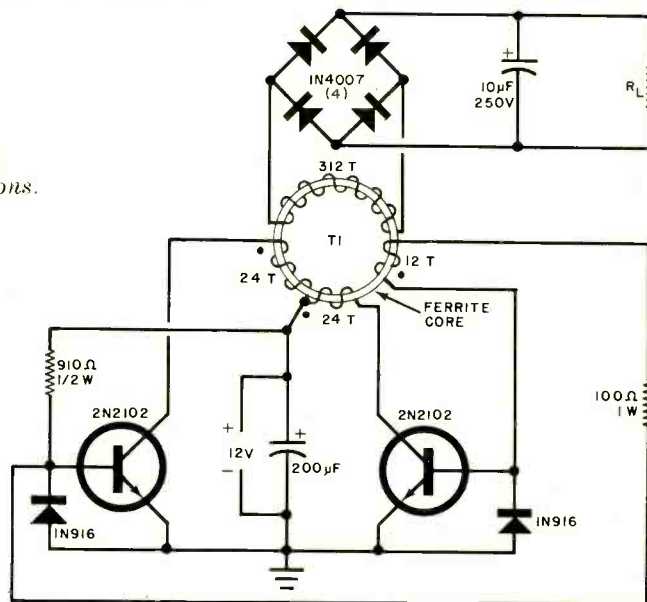

ville, FL 33512) and Ben Smith of Mat-tel, Inc. (Hawthorne, CA 90250). Ben suggests that Bill may have "tailored" his design empirically for his specific IC and that other IC's of the same type, but with lower gain, might not work very well in the circuit.

If you're among those having trouble with Bill's preamp, you might wish to try Fairchild's original circuit, illustrated in Fig. 4. As in Bill's design, the IC is a  $\mu$ A739, the resistors are 1/4- or 1/2-watt types, and the capacitors are either small ceramics or electrolytics (where polarity is indicated). For stereo applications, both halves of the IC are used, with all circuit components duplicated except for the input bias voltage-divider, R1-R2-C2, which is common to both sections.

Intrigued by M.J. Guenther's linear-scale ohmmeter (January), reader William D. Holland (Page House 1-53, Caltech, Pasadena, CA

## Sun, Fun, Surf, & Circuits

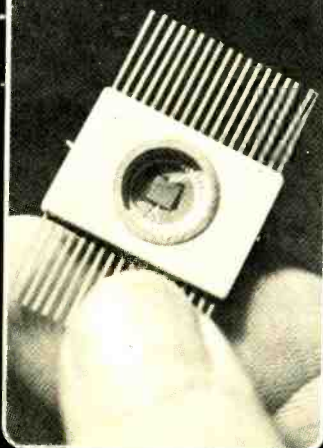

Imagine a curriculum in Electronics Technology that includes field trips to the Bahamas and the Florida Keys. Florida Institute of Technology offers you this and more. Our fully-accredited two year Associate of Science degree program in Electronics Technology provides a unique balance between the academic and the practical. This course offers specialization options in Marine, Communications, or Industrial technology. Our coeducational campus is set in 84 acres of tropical palms bordering the Indian River at Jensen Beach, Florida.

For further information return coupon to:

**Florida Institute of Technology**  
720 S. Indian River Drive, Jensen Beach, Fla. 33457

Name \_\_\_\_\_  
Street \_\_\_\_\_  
City \_\_\_\_\_ Zip \_\_\_\_\_ Age \_\_\_\_\_  
Veteran  PE 5/75



91126) has suggested a number of modifications which simplify construction and operation. One of the two circuits Bill submitted is given in Fig. 5. He has replaced the IC voltage reference source used in the original circuit with a 6.8-volt zener diode, *D1*, and buffer amplifier, *Q1*. He has modified the output circuit to permit voltmeter measurement to ground rather than to a "floating" point and has suggested the addition of a protective zener diode (*D2*) across the test terminals, *BP1* and *BP2*, to prevent off-scale voltmeter readings when the unknown resistor is removed. The zener's value is determined by the meter's full-scale reading.

A number of readers have commented on the FET phase shifter circuit discussed in November, 1974. Richard Bozek (12907 Shady Oak Blvd., Garfield Hts, OH 44125) and D.G. Lee (7749 Iberville St., Montreal, Quebec H2E-2Z3, Canada), among others, complained they were unable to locate the type 2N2609 FET's specified for the circuit, while readers Gary L. Fesler (2024 S. Wichita, Wichita, KS 67213) and Richard Gicewicz (16 Cottonwood Place, Albany, NY 12205) complained of poor results.

Inasmuch as the original phase shifter circuit was one suggested by a major semiconductor manufacturer, I assumed it to be a foolproof design. After receiving these letters, however, I personally bench-checked the circuit using a variety of FET's, including TI's TIS58 and TIS73 and the HEP 802, adjusting dc polarities as required for the n-channel and p-channel types.

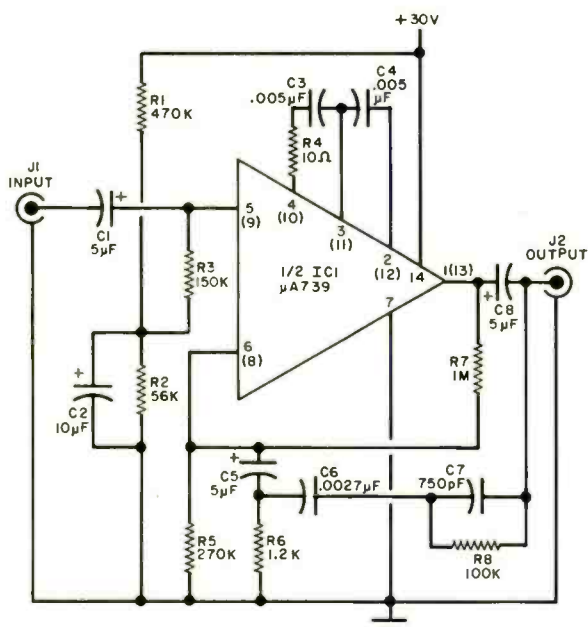

Fig. 4. Fairchild's preamplifier circuit.

I found that the circuit failed to work on occasion, but discovered this was due to my using the wrong pin connections for the FET electrodes. (Not all FETs have the same terminal arrangement.) I also discovered that the phase shifter has some interesting operating characteristics. The amount of phase shift varies with frequency and a readjustment of the control is necessary as different frequencies are checked. Apparently the coupling capacitors introduce an added shift at low frequencies, while distributed wiring capacitances play an important role at high frequencies.

In any case, I found that the circuit *did* work with a

# Autoranging multi-function counter

\$349

1900A



- Traditional Fluke quality
- Autoranging in both frequency and period measurements
- 5 Hz to 80 MHz, high sensitivity — 25 mV
- Event counting to 10<sup>6</sup> events, automatic overflow
- Six digit LED display with automatic annunciation
- Optional battery operation and data output
- Full 12-month guarantee
- Service centers coast to coast
- Available from stock

**FLUKE**  
COUNTER DIVISION

John Fluke Mfg. Co., Ltd.  
P.O. Box 1094, Station "D"  
Buffalo, N.Y. 14210  
Phone (716) 842-0311  
TWX 610-492-3214

CIRCLE NO. 19 ON READER SERVICE CARD

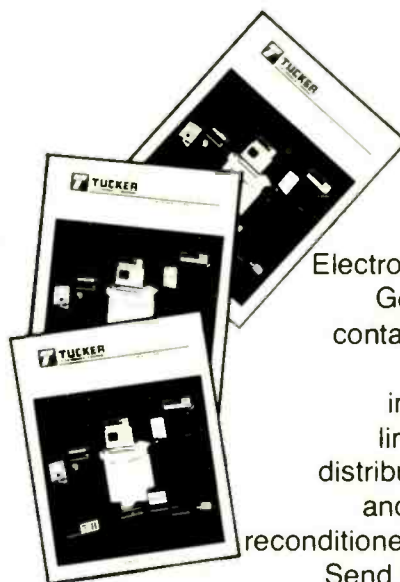

**FREE**

The Tucker Electronics Company General Catalog contains 160 pages of electronic instruments, 16 lines of low cost distribution products, and thousands of reconditioned instruments. Send for yours now.



**TUCKER**  
ELECTRONICS • COMPANY

P. O. Box 1050 • Garland, Texas 75040

CIRCLE NO. 48 ON READER SERVICE CARD

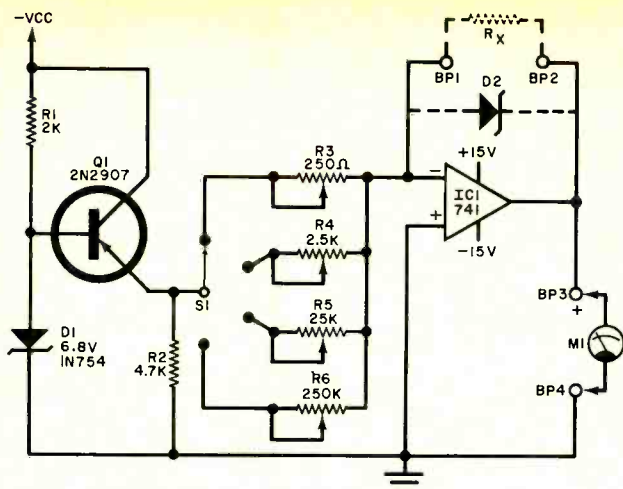

Fig. 5. Bill Holland's modified version of M.J. Guenther's linear-scale ohmmeter.

number of different FET's when properly wired, with correct dc polarities applied, and with some adjustment of component values for optimum performance. Problems were encountered with very high and very low frequencies, however, or when the circuit was overloaded.

If you're working with a phase shifter and encounter problems, you can use the test arrangement illustrated in Fig. 6A to check circuit performance. The original (input) signal is applied to an oscilloscope's vertical terminals, the phase-shifted signal to the horizontal terminals. The scope's internal linear sweep is not used. With the instrument's vertical and horizontal amplifiers adjusted for comparable deflection, one can obtain a variety of patterns as the relative phase of the two signals is shifted, ranging from a straight line at a 45° angle through varying ellipses to a full circle, as illustrated in Fig. 6B. A tilted straight line indicates a phase difference of either 0° or 180°, depending

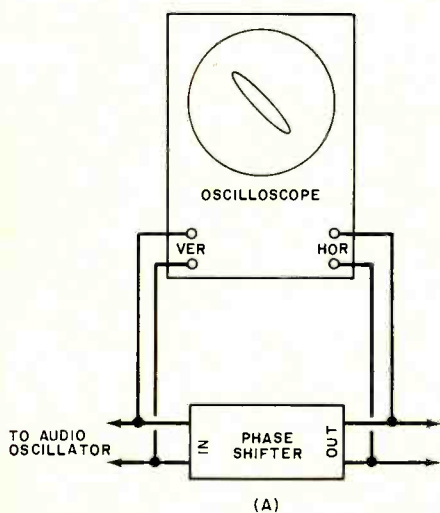

Fig. 6A. Checking phase shift: The basic test arrangement.

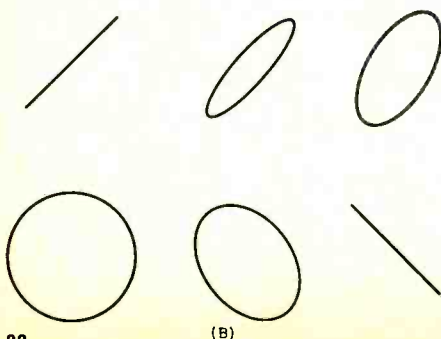

Fig. 6B. Typical phase-shifted patterns.

on its slope and the scope's internal connections. A circle is formed when the phase difference is 90° or a multiple thereof. Ellipses represent phase differences between 0° and 90° or between 90° and 180°, depending on their direction of slope.

**Device/Product News.** Despite the poor shape of the nation's economy, semiconductor manufacturers across the U.S. have continued to introduce exciting new devices with potential applications in hobbyist and experimenter projects.

National Semiconductor Corporation (2900 Semiconductor Drive, Santa Clara, CA 95051) has introduced a new low-cost instrumentation amplifier and three new series of voltage regulators. The amplifier, type LH0037, features a 300-megohm input impedance and a common-mode rejection ratio of 100 dB. Comprising three operational amplifiers and a precision, laser-trimmed thin-film network, the new IC is suitable for a variety of amplifier and instrumentation applications. Only a single resistor is needed to set the unit's gain to any value between one and 1000. Supplied in a 12-pin TO-8 hermetic case, the LH0037 can be operated on dual power sources of five to twenty-two volts.

Featuring a three-terminal design (in, out, and ground), National's new IC voltage regulators are identified as LM341, LM342, and LM78L. The LM341 and LM342 series are supplied in plastic TO-202 packages and are available in ratings of 5, 6, 8, 12, 15, 18 and 24 volts. The LM341 is rated for 500-mA currents with a suitable heat sink, the LM342 at 200 mA. The LM78L is offered in both TO-5 and TO-92 packages and with ratings of 5, 8, 12, 15, 18 and 24 volts at a maximum current of 100 mA. All three series of regulators feature internal current limiting.

International Rectifier Corporation (233 Kansas Street, El Segundo, CA 90245) is now offering a new 2-ampere, 1000-volt "universal" rectifier designed specifically for experimenter, hobbyist and replacement applications. With a 60-A surge rating, the device, type R210, should be ideal for the dc/dc converter circuits discussed earlier.

Motorola's Semiconductor Products Division (P.O. Box 20924, Phoenix, AZ 85036) has a new IC which is the equivalent of four improved 741 op amps in a single dual-inline package. Except for a common bias circuit, each amplifier in the package is completely independent. Designated type MC3403, the IC features class AB output stages in each amplifier which allows the output to swing to ground in single-supply operation and, in addition, permits split-supply operation without crossover distortion.

RCA's Solid State Division (Box 3200, Somerville, NJ 08876) has introduced two new TV sound i-f and audio output IC subsystems. The CA3134EM and CA3134E combine sound i-f and audio output functions to provide complete sound systems for both color and black-and-white receivers. The circuit functions include a multistage i-f amplifier-limiter, an FM detector, an electronic attenuator, and an audio power amplifier designed to drive an 8-, 16-, or 32-ohm loudspeaker. The CA3134EM is similar to the CA3134E except that it incorporates a tin-plated copper-strap heat sink for directly mounting the device on a pc board. Both devices, with suitable heat sinks, can supply a nominal power output of 3 watts. Featuring a differential peak detector requiring but a single tuned coil, 200-μV limiting, internal current limiting and thermal shutdown, and a wide power supply range (12 to 33 volts), the devices are supplied in 16-lead "power stud" DIP's.

# MITTS

## BUILDING YOUR OWN COMPUTER WON'T BE A PIECE OF CAKE.

(But, we'll make it a rewarding experience.)

Chances are you won't be able to assemble the *Altair 8800 Computer* in an hour or two. But, that's only because the *Altair* is a real, full-blown computer. It's not a demonstration kit.

The *Altair Computer* is fast, powerful, and flexible. Its basic instruction cycle time is 2 microseconds. It can directly address 256 input and 256 output devices and up to 65,000 words of memory.

Thanks to buss orientation and wide selection of interface cards the *Altair 8800* requires almost no design changes to connect with most external devices. Up to 15 additional cards can be added inside the main case.

The *Altair Computer* kit is about as difficult to assemble as a desktop calculator. If you can handle a soldering iron and follow simple instructions, you can build a computer.

You see, at *MITTS*, we want your experience with our kits to be rewarding. That's why we take such pains to write an accurate, straight-forward assembly manual. One that you follow step-by-step. (We leave nothing to the imagination.)

Some electronic kit companies are experts at cutting the corners. They promise you the sky and deliver a box full of surplus parts and a few pages of faded instructions run off on their copying machine.

We're experts at **not** cutting the corners. Our *Altair Computer* has been designed for both the hobby and the industrial market. It has to be constructed of the finest, quality parts. And it is.

That's why we give you double-sided boards, gold-plated connectors, a 10 Amp power supply (enough to power 15 additional cards), toggle switches and an all aluminum case complete with sub-panel and detachable dress panel.

That's why we give you three manuals (Assembly, Operator's and Trouble-shooting) in a hard-cover, 3 ring binder plus an Assembly Hints manual.

Buy our computer and we'll automatically make you a member of the *Altair User's Group*. You'll have access to a whole range of custom software designed exclusively for the *Altair 8800*.

We're quite serious about making computer power available to you at a price you can afford.

### BASIC ALTAIR AND OPTIONS

The basic *Altair 8800 Computer* includes the CPU, front panel control board, front panel lights and switches, power supply and expander board (with room for 3 extra cards) all enclosed in a handsome, aluminum case.

Options now available include 4K dynamic memory cards, 1K static memory cards, parallel I/O cards, three serial I/O cards (TTL, RS232, and TTY), octal to binary computer terminal, 32 character alpha-numeric display terminal, ASCII keyboard, audio tape interface, floppy disc system, and expander cards.

Software now available includes an assembler, text editor and system monitor.

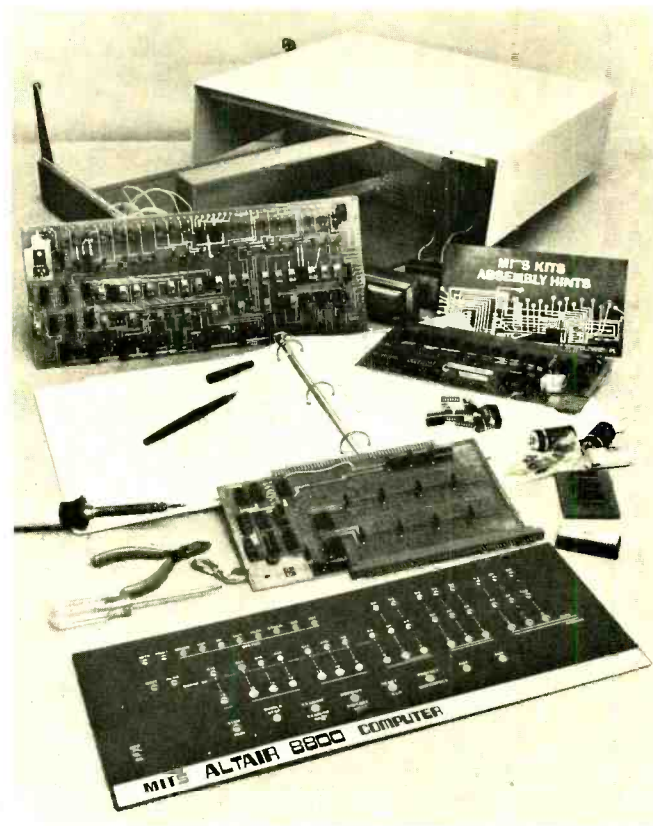

### PRICE

Altair 8800 Computer: \$439.00 kit  
\$621.00 assembled

### SAVE \$45.00!

For P.E. readers only! The Basic *Altair 8800 Computer* plus 256 words of static memory. \$542.00 value. Now only \$497.00. Check the appropriate box in the coupon below. \*

Warranty: 90 days on parts and labor for assembled units.  
90 days on parts for kits.  
prices and specifications subject to change without notice

MITTS/6328 Linn N.E., Albuquerque, N.M., 87108, 505/265-7553

MAIL THIS COUPON TODAY!

Enclosed is a Check for \$ \_\_\_\_\_

or Bank Americard # \_\_\_\_\_

or Master Charge # \_\_\_\_\_

Credit Card Expiration Date \_\_\_\_\_ \* *Special*

ALTAIR 8800  Kit  Assembled  P.E. Kit

Include \$8.00 for Postage and Handling

Please send free Altair System Catalogue

NAME \_\_\_\_\_

ADDRESS \_\_\_\_\_

City \_\_\_\_\_ State & Zip \_\_\_\_\_

MITTS/6328 Linn, N.E., Albuquerque, New Mexico 87108  
505/265-7553

# It takes more learn about

**Bell & Howell Schools introduces three fascinating learn-at-home programs featuring some of the finest equipment available as your "teachers." Choose the program you prefer—then mail card for more details today!**

Experience is the best teacher, without a doubt. And when it comes to learning electronics, we feel it's hands-on experience with state-of-the-art equipment that counts the most. That's why with Bell & Howell Schools' learn-at-home programs you work with some of the most up-to-date equipment. Equipment that's being used today—and will be used tomorrow. So the skills and knowledge you acquire will be useful for years to come.

Of course, with all our learn-at-home programs you'll have plenty of lab manuals and basic principles to work with. And you'll also get exciting "teachers" to help make electronics come alive...

**Lab Starter Kit gives you hands-on experience with the very first lesson.**

We get you started with the basics in an exciting way! At the very beginning you get a fully-assembled volt-ohm meter as well as design panels, modular connectors, experimental parts and battery. So you don't just read about electronics principles, you actually see them at work!

**You build your own Electro-Lab® electronics training system.**

Whatever program you choose, you get your own home laboratory including oscilloscope, digital multimeter and design console to give you actual experience in wiring, soldering, assembling, testing, trouble-shooting and circuit analyzing.

## **I. Learn new skills in the field of Home Entertainment Electronics including building the new generation color TV.**

What better or more exciting way to learn digital electronics! Once you have the basics under your belt and get into color theory and service, you'll build a 25" diagonal color TV and probe into the digital technology behind digital channel numbers that flash on the screen... a digital clock that flashes the time to the second and an automatic channel selector.

As you put the set together, you'll discover how advanced integrated circuitry works, how to trouble-shoot it and much more. Upon completion of the program you'll have gained the specialized occupational skills to service color TV's plus the principles that you can apply to repair a variety of home electronic equipment. And you'll have the foundation to understand and work with new product applications as they're developed, too!

## **II. Use professional communications equipment as you delve into Communication Electronics .**

Here's how to pick up skills in the vital field of two-way radio, widely used in public safety, marine, industrial and transportation areas. Bell & Howell Schools Communication Electronics Program can help prepare you for the FCC licensing exam, right through to 1st class radiotelephone operator. And teach you skills in two-way radio, radar or commercial broadcasting.

For a refundable deposit, you get to use the special two-way radio equipment lab featuring an FM transceiver, frequency meter, and modulation meter. All regular, first-rate commercial grade test equipment.



"Electro-Lab®" is a registered trademark of the Bell & Howell Company.

Simulated TV Picture/Test Pattern

# than books to electronics.

### III. Digital Trainer helps you learn the latest in Industrial Digital Electronics.

Digital technology is setting new standards of accuracy and beginning a revolution in industry. For example, more precise control in refining, manufacturing plants, food processing and transportation.

And now you can learn about this technology with Bell & Howell Schools' unique Digital Trainer. You'll analyze and experiment with various types of

integrated circuits so you'll have a solid background in modern digital electronics and its applications to industry.

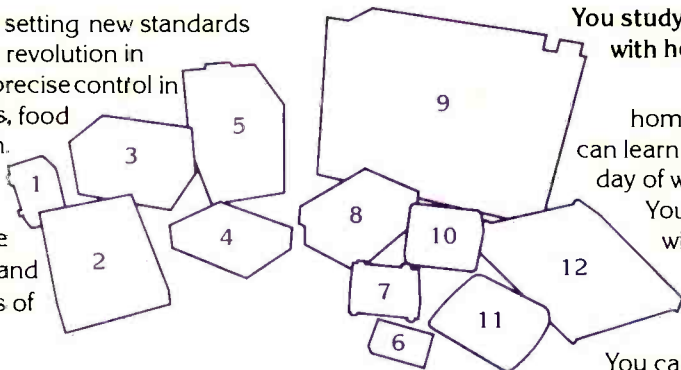

**You study at home in your spare time . . . with help as close as the telephone.**

Because these are home study programs, you can learn electronics without missing a day of work or a single paycheck.

You study at your convenience—without being a classroom captive. If you ever have any questions, you can call our toll-free number for help.

You can also meet and talk shop with fellow students and instructors at "help sessions" held in 50 cities at various times throughout the year. Bell & Howell Schools tries to give you more personal attention than any other learn-at-home program.

**Decide which exciting program you're interested in...you can check more than one. Then mail postage-paid card today for full information!**

Taken for vocational purposes, these courses are approved by the state approval agency for Veterans' Benefits. Please check box on card for more information. Naturally, we cannot offer assurance of income opportunities.

1. Power Output Meter
2. Design Console
3. Modulation Meter
4. Digital Multimeter
5. Triggered Sweep Oscilloscope
6. Lab Starter Kit
7. Frequency Meter
8. FM Transceiver
9. 25" Diagonal Color-TV
10. Alignment Generator
11. Lesson Tape Player
12. Digital Trainer



724R3

If card has been removed, please write to:

An Electronics Home Study School  
DeVRY INSTITUTE OF TECHNOLOGY

ONE OF THE  
**BELL & HOWELL SCHOOLS**  
4141 Belmont, Chicago, Illinois 60641

# LARGE-LARGE DISCOUNTS LOW - LOW PRICES

NATIONALLY  
ADVERTISED STEREO EQUIPMENT  
AT LOWEST PRICES!

TURNABLES \* SPEAKERS \* RECEIVERS  
AMPLIFIERS \* TAPE RECORDERS

WRITE FOR QUOTE ON  
NATIONALLY ADVERTISED BRANDS OF STEREO  
COMPONENTS. SATISFACTION  
GUARANTEED!

*Clifford's*

**HI-FI WHOLESALERS**  
P. O. Box 809  
Kankakee, Illinois 60901  
(815)-939-7868

CIRCLE NO. 10 ON READER SERVICE CARD

## DIXIE SAVE ON Brand Name Audio Components

**BY MAIL**

### Write Today for Our FREE Audio Catalog

DIXIE is one of the oldest and largest audio component mail order houses in the country. Our prices on brand name components are actually LOWER than "Discounters". See our new catalog or call us for a price quote. Everything shipped factory-sealed with full manufacturer's warranty.

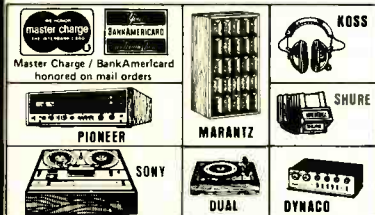

#### DIXIE HI-FIDELITY

5600 Second St., N. E., Washington, D. C. 20011  
Phone: 1-202-635-4900

Please rush me your FREE Audio Catalog and complete information. I understand there is no obligation.

Name \_\_\_\_\_  
Address \_\_\_\_\_  
City \_\_\_\_\_  
State \_\_\_\_\_ Zip \_\_\_\_\_ PE 5

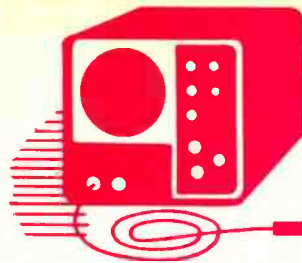

# Test Equipment Scene

By Leslie Solomon

## TUNING THE VITS

**P**EOPLE in the TV servicing business as well as many interested hobbyists, take pride in knowing what makes up the standard TV signal because this knowledge, coupled with some decent test equipment, enables them to keep their receivers working properly. Until recently (the last few years, actually) one of the best pieces of service information was the test pattern that TV stations transmitted at odd times. These were the "real" signals that permitted checking the working order of a receiver and its antenna system. Watching the "wedge" come down to the center of the bullseye was a sure test of frequency response that left no doubt as to the picture quality that could be expected with the regular television transmissions.

Unfortunately, test patterns are a thing of the past in most localities—though occasionally you will find a station that uses one. However, all is not lost. Unknown to most people there is a test pattern being transmitted—along with the regular TV picture—all the time! But, where is this test pattern? Why doesn't it interfere with the conventional programming?

The TV picture as seen on a standard receiver covers the area between

the horizontal and vertical sync pulses. If you roll down the vertical control so that the thick black (horizontal) bar comes into view, you will note that there are a number of unused horizontal lines. Then, if you look closely at those couple of lines just above the actual video, you will see some white dots and bars. These carry what is known as the vertical interval test signal (VITS) transmitted by the TV station.

The circuit, as shown, is not really a construction project. It is meant to be of educational benefit to anyone interested—and we think a number of people will be when they realize what it will do. They will be able to examine the structure of the TV signal in either of the two interlaced fields, from the equalizing pulses that follow the vertical sync, through the VITS, the "half-line" in field 1, to the video within the picture.

**About the Circuit.** The NAND gates can be any type of TTL device (such as the 7400). The flip-flop can also be any TTL unit. (We used a 7473 because it was handy.) The two 555 timers could be replaced with a dual unit.

The purpose of the circuit is to produce a 65-microsecond (one horizontal line) "window" that can be "tuned"

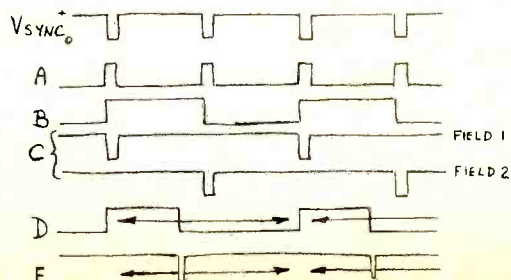
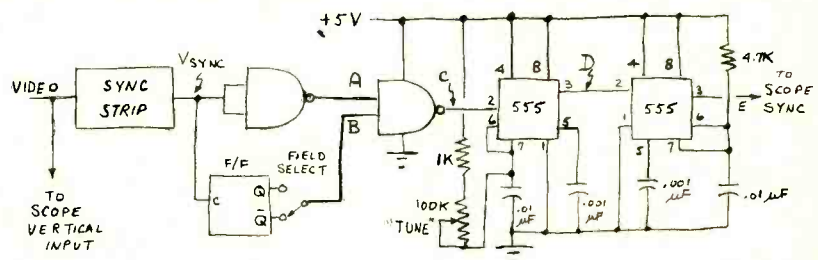

to any line on either field within the range of the circuit. The result is displayed on an oscilloscope. The video signal from a receiver is applied to the vertical input of the scope, while a sync stripper removes the vertical pulse, from which all timing derives. You can extract the vertical pulse from the receiver if desired.

The vertical sync pulse is applied to the A input of the two-input NAND gate, with the other input supplied by signal B from a flip-flop triggered by the vertical sync pulse. By selecting either the Q or not-Q output of the flip-flop, you can choose either field for examination. A 0.22- $\mu$ F capacitor connected from point A to ground clears up the fine extraneous pulses that may be present on the line.

The sync pulse from the selected field (waveform C) is used to trigger a variable-delay monostable using a 555 timer. As shown in waveform D, the trailing edge can be positioned anywhere between two successive vertical sync pulses of the same field. This is accomplished by varying the time constant with the 100,000-ohm potentiometer. This signal is then used to drive another 555 acting as a 65-microsecond monostable. The output of this circuit is then used as the scope trigger pulse.

**System Setup.** To set the system up, the composite video from the receiver is applied to the scope's vertical input and the scope's vertical gain is adjusted for the desired viewing height. Set the scope sweep for external triggering, and set the sweep time for one or two horizontal lines (65 microseconds per line). It is best to use a triggered sweep scope. Because of the high writing speeds involved, it will be necessary to increase the beam brightness on the scope.

If everything is working properly, you will see a couple of lines of video, including the horizontal sync pulses. By adjusting the 100,000-ohm potentiometer, you should be able to "tune" the scope up and down the horizontal lines from the equalizing pulses near the vertical sync, down past the empty lines with just the horizontal sync displayed, through the VITS and the half-line used for interlace, down into the picture video. You can now tune the scope until the VITS is displayed; and by flipping the field-selector switch, you can check on either field. Without the flip-flop, you will see the TV signal go into interlace.

# PLUG-IN WIRE BUILD TEST MODIFY

without soldering for as little as

**\$ 3**

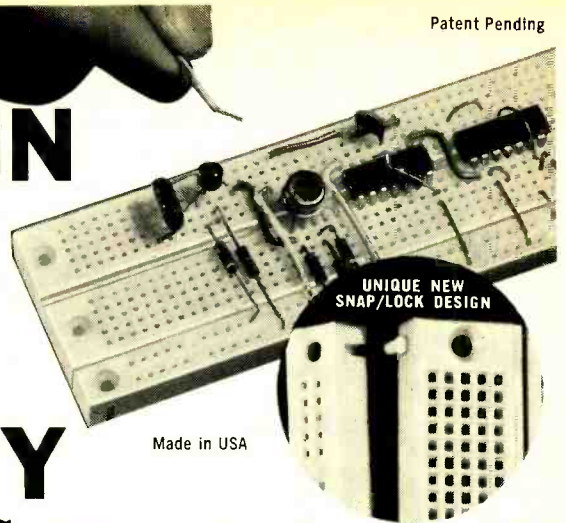

Made in USA

Continental Specialties' QT (Quick Test) Sockets and Bus Strips expand breadboarding without shorts or burnt fingers. Just Snap/Lock together as many QTs as you need and test ICs, transistors, resistors, capacitors and more. Plug-in and connect with #22 AWG solid hook-up wire without soldering or patch cords. QTs are totally reusable. 10 different sizes. Order today off-the-shelf from CSC or local distributor. Charge: BAC, MC, AX. Write for free catalog. Free English/Metric Slide Rule with each order. Dealer inquiries invited.

Item No.	IC Capacity in 14 pin DIPs	Unit Price (US only)
QT-59S	8	\$12.50
QT-59B	-	2.50
QT-47S	6	10.00
QT-47B	-	2.25
QT-35S	5	8.50
QT-35B	-	2.00
QT-18S	2	4.75
QT-12S	1	3.75
QT- 8S	1	3.25
QT- 7S	1	3.00

Add \$1.50 shipping/handling. Foreign orders add 15%.



CONTINENTAL SPECIALTIES CORPORATION

Box 1942, New Haven, CT 06509. phone 203/624-3103

W. Coast Office: Box 7809, S. Francisco, CA 94119 415/383-6207

Canada: Available thru Len Finkler Ltd., Ontario

CIRCLE NO. 11 ON READER SERVICE CARD

Prices subject to change

## TOP Discount AUDIO

*Your* **NATIONAL HEADQUARTERS**

**For Famous Brand Electronics By Mail**

333 N. Michigan Ave. • Suite 2025  
Chicago, IL 60601 • (312) 293-1825

*All Orders Shipped In  
Factory-Sealed Cartons*

**Write Or Call For  
The Lowest Prices  
Anywhere!**

**MILLION \$\$\$ INVENTORY**

**LOWEST PRICES ON**

RECEIVERS	TURNABLES	TUNERS
SPEAKERS	CHANGERS	CARTRIDGES
TAPE DECKS	AMPLIFIERS	HEADPHONES
CALCULATORS	COMPACTS	CAR AUDIO

Top Discount Audio 333 N. Michigan Avenue  
Suite 2025, Chicago, IL 60601  
(312) 293-1825

Date \_\_\_\_\_

Please send me a quote on \_\_\_\_\_

MR.  MS.

(First) (Initial) (Last)

(Number And Street)

(City) (State) (Zip Code) PE-5

CIRCLE NO. 46 ON READER SERVICE CARD

# CAR STEREO ETC.

Great savings on Blaupunkt, Pioneer, Sanyo, Craig, J.I.L., Jensen, Sparkomatic, Royce, Delta and more! These fine AM-FM radio, tape, speaker, CB radio and electronic ignition systems are all illustrated in our value packed Spring catalog along with some very informative articles on car stereo including complete installation instructions. So, rush us your name and we'll rush you our FREE catalog.

CRUTCHFIELD  
P.O. Box 888, DEPT. E  
Charlottesville, Va.  
22902

(804) 977-0121

P.S. On all purchases, we pay the freight, give same day service and guarantee your complete satisfaction.

CIRCLE NO. 13 ON READER SERVICE CARD

# SAVE!

MONEY • TIME • FREIGHT

QUALITY STEREO EQUIPMENT AT LOWEST PRICES.

YOUR REQUEST FOR QUOTATION RETURNED SAME DAY.

FACTORY SEALED CARTONS—GUARANTEED AND INSURED.

SAVE ON NAME BRANDS LIKE:  
 A.D.C. KLH  
 A.R. SHURE  
 DYNACO KOSS  
 SONY FISHER

AND MORE THAN 50 OTHERS

BUY THE MODERN WAY  
 BY MAIL—FROM

## illinois audio

Department 217S  
 12 East Delaware  
 Chicago, Illinois 60611  
 312-664-0020

CIRCLE NO. 22 ON READER SERVICE CARD

now available for the telephone experimenter

### COMPLETE CONSTRUCTION PLANS

TELEPHONE PLANS: \$3.00 each.  
 Answering Device, Automatic Dialer, "Black Box", Call Diverter, Call Limiter, Conference Bridge, Central Dial Exchange, Melodic Ringing Generator, Recorder, Actuator, Remote Control, Schematics, Speakerphone, Telexlink Burglar Alarm, Voice Scrambler, Dial/Tone Converter, Tone/Dial Converter.  
 MISC. PLANS: \$6.00 each.  
 Bifedback Conditioner, Multifrequency Encoder Network, Horizontally Stimulator, Dodecahedron Speaker Enclosure, Photographic Pinhole Camera.

ALL OF THE CONSTRUCTION PLANS ABOVE: \$24.95 AIRMAILED.

LEARN THE SECRETS OF YOUR TELEPHONE



Have you ever wondered what lies behind that telephone dial? Now you can learn the tricks of the telephone trade. Get the inside story of telephone systems—their quirks and flaws, and remain up to date on vital occurrences within the telephone industry. TELEPHONE ELECTRONICS LINE is a publication designed for the telephone enthusiast, Phone Phreak, and experimenter, containing interesting articles which offer a wealth of hard to find information. Technical theory is also discussed among the following items:  
 Current News Items • Code Numbers  
 Illustrations • Games • Facts • Plans  
 Projects • History • Comics • Stories  
 Facts previously Tel. Co. confidential is now published in TEL!  
 One year subscription rate: United States \$6.00, Canadian & foreign \$8.00.

ALL OF THE CONSTRUCTION PLANS ABOVE PLUS A ONE YEAR SUBSCRIPTION TO TELEPHONE ELECTRONICS LINE: \$29.95 AIRMAILED.

### THE LEGAL ASPECTS OF INTERCONNECTION

The complete reference book to your LEGAL RIGHTS as a telephone subscriber. Study toll evasion, tariffs, wiretapping, customer provided equipment, and many more!

ALL OF THE CONSTRUCTION PLANS ABOVE AND A ONE YEAR SUBSCRIPTION TO TEL PLUS "THE LEGAL ASPECTS OF INTERCONNECTION": \$49.00 AIRMAILED.

TELETRONICS COMPANY OF AMERICA  
 22035 BURBANK BLVD., WOODLAND HILLS CA 91384 USA

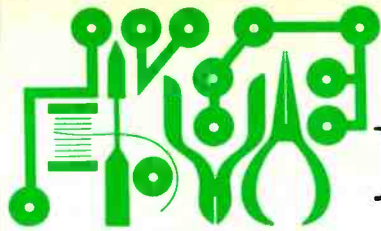

# Hobby Scene

## 60-HZ FILTER FOR HEADPHONES

**Q.** I like to use hi-fi headphones with my shortwave receiver, but am bothered by 60-Hz hum. Can you provide a circuit which will filter out the hum?—M.K. Jeeves, Saskatoon, Saskatchewan.

**A.** The circuit shown below is a 60-Hz adjustable-Q notch filter. Adjusting the 50,000-ohm potentiometer at the

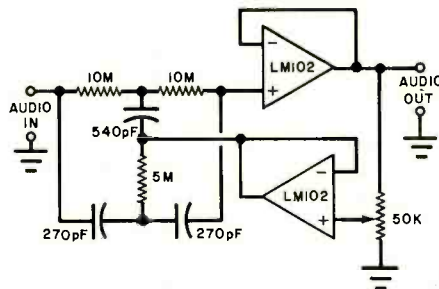

output of the second voltage follower for the twin-T R-C filter permits varying Q from 0.3 to 50. This varies the width of the 60-Hz notch. The notch depth depends on component matching. Using 1% resistors and 1% capacitors should give good results.

## DIGITAL CLOCK BEEPER

**Q.** I have installed an alarm in my digital clock and would like to have an audible beeper. I was trying to create a circuit that would produce a half-second pulse, then pause for a half-second, and pulse again, continuing this cycle until the power is turned off. I was using 555 timers but couldn't make a workable circuit. Any ideas?—D. Blumenfeld, Millburn, NJ.

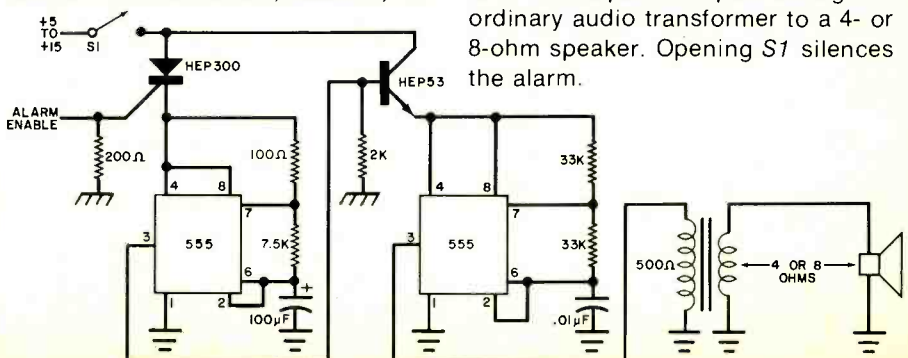

## CAPACITOR TYPES AND USES

**Q.** I would like to know the difference between polystyrene, mica, ceramic, and paper capacitors. For what applications is each type used?—Roger Simoneau, Montreal, Canada.

**A.** The difference between the types is in the material that makes up the dielectric (the insulating material between the two metal plates of the capacitor). The thinner the dielectric, the higher the capacitance because the plates are closer together. (This is assuming a constant plate area. Plate area can also be increased to increase the capacitance, which is the thing to do for high voltages.) Ceramic capacitors can be used for coupling and bypassing applications or in tuned circuits at frequencies up to 100 MHz (if care is taken in sizing and dressing leads). Most mica capacitors can be used at frequencies up to a few hundred MHz. Polystyrene capacitors exhibit properties similar to those of good mica capacitors, while Mylar units suffer from inductive reactance problems similar to those of paper capacitors.

**A.** The circuit shown should work. The alarm enable pulse from the clock will turn the SCR on (assuming S1 is closed), which provides power for the first 555. This timer runs in the astable mode with a 50% duty cycle and a rate of 1 Hz. Timer output turns the transistor on and off, which controls power for the second 555. This timer is also free-running, but at a frequency of 1.5 kHz. The output is coupled through an ordinary audio transformer to a 4- or 8-ohm speaker. Opening S1 silences the alarm.



# BIG DISCOUNTS

## STEREO COMPONENTS

Largest selection of top name brands... try us and see

It's worth a call  
**(301) 488-9600**



DEPT. D  
6330 Frankford Ave.  
Baltimore, Md. 21206

All mail answered within 24 hours

Phone Daily 9 AM to 9 PM  
Saturday 9 AM to 4 PM  
Phone (301) 488-9600

CIRCLE NO. 24 ON READER SERVICE CARD

## MiniMicroMart

### Lowest Memory Prices

1101A	256 x 1		\$2.00
2102-3	1024 x 1	1500 ns	\$7.00
2102	1024 x 1	1000 ns	\$7.50
2102-2	1024 x 1	650 ns	\$8.00
2102-1	1024 x 1	500 ns	\$9.00
1103	1024	Dynamic	\$3.00
8101	256 x 4		\$12.00

Write for quant. quotes.

### Famous 1702A PROM, 256 x 8

Programmable & erasable ROM memory. Perfect for mini-computer software applications. Now only \$27.50. (Programming service available at nominal price.)

### A.S.C.I.I. Computer Keyboard \$40.

### Universal Asynchronous Receiver/Transmitter \$9.95\*

TV Typewriter II, Feb. R-E, all IC's w/memories, \$79.95.

### Microprocessor Circuits

8008 CPU-IC	\$120 value	\$47.50
	w/8-1101A's	\$60.95
	w/8-2102's	\$103.95
8080 CPU-IC	\$320 value	\$169.95
	w/8-1101A's	\$179.95
	w/8-2102's	\$209.95

### Mini Computer Kits

Basic Kits starting at \$179. w/PC boards, CPU, memory Mark 8 IC's \$72., not including CPU and memory. IC's for MOD 8 and Scelbi available. Altair 8800 IC's w/8080 and memories \$199.50. Popular Altair interface boards available—write for details.

### Power Supply Kits

Components for any required supply.

Send stamped, self addressed envelope for details on all of above and on many other items of interest.

Mini Micro Mart  
1618 James Street  
Syracuse, New York 13203  
(315) 422-4467

CIRCLE NO. 50 ON READER SERVICE CARD

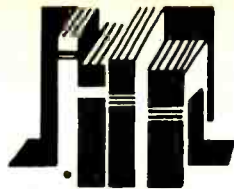

## Electronics Library

### ELECTRONIC EXPERIMENTER'S GUIDEBOOK

by Don Tuite

In a straightforward presentation, this guide to electronic home-brewing shows hobbyists how to select and use tools, solder, and fabricate circuits. The common construction techniques are explained—wired breadboards, stick-on circuits, printed circuits, and metal chassis construction. Procedures are given for the three conventional means for making etched pc boards—direct application of resist, sensitized board and photo negative, and sensitized board and mechanical negative. Eight useful and instructive projects, including a strobe light, dc-to-ac inverter, and a FET shortwave receiver, are described.

Published by Tab Books, Blue Ridge Summit, PA 17214. 182 pages. \$7.95 hardbound, \$4.95 paperback.

### ELECTRONIC CALCULATORS

by H. Edward Roberts

Written by the president of MITS, Inc., a major manufacturer of calculators and electronic kits, this book presents historical development and general design information of electronic calculators. The abacus, mechanical arithmetic, the analytical engine, electronic computers, and programmable calculators are some of the topics covered. In an easy, lucid style, the author describes calculator memories, displays, design, fabrication, component selection, interface with hard-copy equipment, and servicing. Photographs and drawings supplement the text.

Published by Howard W. Sams and Co., 4300 W. 62nd Street, Indianapolis, IN 46206. 176 pages. \$5.95 softbound.

### INTRODUCTION TO ELECTRONIC TECHNOLOGY

by R. J. Romanek

Emphasizing the basic concepts of electronics, this book was written as a textbook for introductory electronics courses. Additionally, it can serve as a review of fundamentals for technicians and others. Among the topics covered are the electron, measurements, voltage, current, power, impedance, series circuits, parallel and series/parallel circuits, network analysis, time constants, and resonance. Math is held to simple algebra, right-triangle trigonometry, vector algebra, and simple exponentials.

Published by Prentice-Hall, Inc. Englewood Cliffs, NJ 07632. 355 pages. \$14.50 clothbound.

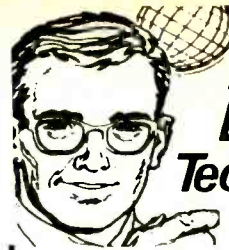

## Attention Electronic Technicians!

### SCHOOLING OF EXCELLENCE in ELECTRONICS ENGINEERING

If you have adequate schooling and experience at the technician level you may be able to qualify to enter our college-level Home Study Program in Electronics Engineering. The CIEE Program is OUTSTANDING, and up-to-date in every respect. CIEE is a forward-looking school, and Engineering is taught on the basis of application and understanding rather than on the basis of memorization. All lesson material and texts are thorough and easy-to-understand. Through this Highly Effective Home Study Program in Electronics Engineering you can raise your status and pay to the Engineering level. No residence classes required for those who qualify. If you are an electronics technician with above-average ambition, and not willing to settle for anything less than the best home study Engineering Schooling available anywhere, then you should write TODAY for our free revealing descriptive literature. There is no obligation, and no salesman will call on you.

### COOK'S INSTITUTE

of Electronics Engineering

Raymond Road  
P. O. Box 10634  
Jackson, Miss. 39209



Established 1945  
Formerly Cook's School of Electronics

CIRCLE NO. 12 ON READER SERVICE CARD

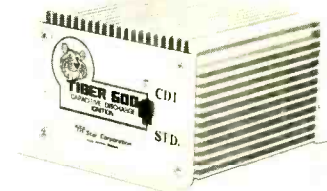

## 12 REASONS YOUR CAR NEEDS TIGER CDI

Instant starting in any weather - Eliminates tune-ups - Increases gas mileage - Increases horsepower 15% - Improves acceleration and performance - Spark plugs last up to 70,000 miles - Reduces engine maintenance expense - Amplifies spark plug voltage to 45,000 volts - Maintains spark plug voltage to 10,000 RPM - Reduces exhaust emissions - Dual ignition switch - An Unconditional LIFETIME GUARANTEE Installs in 10 minutes on any car with 12 volt negative ground - No rewiring - Most powerful, efficient and reliable Solid State Ignition made.

SATISFACTION GUARANTEED or money back

TIGER 500 assembled . . . . . \$53.95  
TIGER SST assembled . . . . . \$42.95

Post Paid in U.S.A.

Send check or money order with order to:

**Tri-Star Corporation**

P. O. Box 1727 C  
Grand Junction, Colorado 81501

DEALER INQUIRIES INVITED

CIRCLE NO. 47 ON READER SERVICE CARD

# ELECTRONICS MARKET PLACE

**NON-DISPLAY CLASSIFIED: COMMERCIAL RATE:** For firms or individuals offering commercial products or services, \$1.80 per word (including name and address). Minimum order \$27.00. Payment must accompany copy except when ads are placed by accredited advertising agencies. Frequency discount, 5% for 6 months; 10% for 12 months paid in advance. **READER RATE:** For individuals with a personal item to buy or sell, \$1.10 per word (including name and address.) No minimum! Payment must accompany copy. **DISPLAY CLASSIFIED:** 1" by 1 column (2-1/4" wide), \$215.00. 2" by 1 column, \$430.00. 3" by 1 column, \$645.00. Advertiser to supply cuts. For frequency rates, please inquire.

**GENERAL INFORMATION:** First word in all ads set in bold caps at no extra charge. All copy subject to publisher's approval. All advertisers using Post Office Boxes in their addresses **MUST** supply publisher with permanent address and telephone number before ad can be run. Advertisements will not be published which advertise or promote the use of devices for the surreptitious interception of communications. Closing Date: 1st of the 2nd month preceding cover date (for example, March issue closes January 1st. Send order and remittance to **POPULAR ELECTRONICS**, One Park Avenue, New York, New York 10016, Attention: Hal Cymes.

**FOR SALE**

**RADIO—T.V. Tubes—**36 cents each. Send for free catalog. Cornell, 4213 University, San Diego, Calif 92105.

**SOUND SYNTHESIZER KITS—**Surf \$12.95, Wind \$12.95, Wind Chimes \$17.95, Electronic Songbird \$6.95, Musical Accessories, many more. Catalog free. PAIA Electronics, Box J14359, Oklahoma City, OK 73114.

**GOVERNMENT Surplus Receivers, Transmitters, Snooper scopes, Radios, Parts.** Picture Catalog 25 cents. Meshna, Nahant, Mass. 01908.

**LOWEST Prices Electronic Parts Confidential Catalog Free.** KNAPP, 3174 8th Ave. S.W., Largo, Fla. 33540.

**ELECTRONIC PARTS, semiconductors, kits. FREE FLYER.** Large catalog \$1.00 deposit. BIGELOW ELECTRONICS, Bluffton, Ohio 45817.

**AMATEUR SCIENTISTS, Electronics Experimenters, Science Fair Students, Construction plans—**Complete, including drawings, schematics, parts list with prices and sources. Robot Man — Psychedelic shows — Lasers — Emotion/Lie Detector — Touch Tone Dial — Quadraphonic Adapter — Transistorized Ignition — Burglar Alarm — Sound Meter... over 60 items. Send 25 cents coin (no stamps) for complete catalog. Technical Writers Group, Box 5994, University Station, Raleigh, N.C. 27607.

**METERS—**Surplus, new used, panel or portable. Send for list. Hanchett, Box 5577, Riverside, CA 92507.

**WE SELL CONSTRUCTION PLANS. TELEPHONE Answering Machine, Speakerphone, Carphone, Phonevision, Auto Dialer, Touch Button Dialer, Central Dial System, TELEVISION: \$35.00 Color Converter, Video Tape Recorder, \$25.00 Camera. HOBBYIST: Electron Microscope, 96 Hour Tape Music System, Ultrasonic Dish-washer, Radar-Oven, Plans \$4.95 each. NEW ITEM: \$75 Electronic Pocket Calculator, \$7.50. COURSES: Telephone Engineering \$39.50, Detective Electronics \$22.50, Integrated Circuit Engineering, \$49.50. NEW SUPER HOBBY CATALOG plus year's subscription to Electronic News Letter AIRMAILED \$1.00. Don Britton Enterprises, 6200 Wilshire Blvd., Los Angeles, Calif. 90048.**

**MECHANICAL, ELECTRONIC devices catalog 10 cents, Greatest Values — Lowest Prices. Fertik's, 5249 "D", Philadelphia, Pa. 19120.**

**FREE! Bargain Catalog—I.C.'s, LED's, readouts, fiber optics, calculators parts & kits, semiconductor parts. Poly Paks, Box 942PE, Lynnfield, Mass. 01940.**

**BUGGED???** New locator finds them fast. Write, Clifton, 11500-L N.W. 7th Avenue, Miami, Florida 33168.

## DISCOUNT PRICES

**B & K, SENCORE, LEADER and RCA**  
Test Equipment  
RAYTHEON, ICC/MULLARD Tubes  
TELEMATIC Test Jigs  
Free Catalog

**FORDHAM RADIO SUPPLY CO., INC.**  
558 Morris Ave. • Bronx, N.Y. 10451

**FREE CATALOG.** Parts, circuit boards for POPULAR ELECTRONICS projects. PAIA Electronics, Box C14359, Oklahoma City, OK 73114.

**YOU WILL SAVE BIG MONEY!** Surplus, Clearouts, Bankruptcy, Inventory, Deals. Catalog \$1 (redeemable), ETCOA Electronics, Box 741, Montreal, H3C 2V2, U.S. Inquiries.

**BURGLAR-FIRE alarm supplies and information.** Free catalog, Protecto Alarm Sales, Box 357-G, Birch Run, Michigan 48415.

**TELEPHONE "BUGGED"?** Countermeasures Brochure \$1.00, Negeye, Drawer 547, Pennsboro, VA 22645.

**HEAR POLICE/FIRE Dispatchers!** Catalog shows exclusive directories of "confidential" channels, receivers. Send 10 cent stamp, Communications, Box 56-PE, Commack, N.Y. 11725.

**CONVERT any television to sensitive, big-screen oscilloscope.** Only minor changes required. No electronic experience necessary. Illustrated plans, \$2.00, Sanders, Dept A-33, Box 92102, Houston, Texas 77010.

**CD IGNITIONS, VHF/UHF monitors, crystals, CB radios,** Southland, Box 3591-B, Baytown, Texas 77520.

**CRYSTALS, Scanners, \$3.88, include make and frequency.** G Enterprises, P.O. Box 461PC, Clearfield, UT 84105.

**ALPHA/THETA BRAINWAVE biofeedback instruments.** Analog instruments from \$125; digital processing systems from \$225, BioScan, Box 14168-E, Houston, Texas 77021.

## INTERNATIONAL ELECTRONICS UNLIMITED

### POCKET CALCULATOR KIT

5 function plus constant — addressable memory with individual recall — 8 digit display plus overflow — battery saver — uses standard or rechargeable batteries — all necessary parts in ready to assemble form — instructions included, 3" x 5 1/2"



**\$24.95**

### MAY SPECIALS

7441	.69	8008	CPU	\$59.50
7445	.79	2102	1024 bit	6.95
7475	.49	1702A	2048 bit	21.95
7490	.59	5203	UV eras.	17.95
74123	.59	5261	1024 bit	2.95
340T 5v (7805)	1.35	5262	2048 bit	7.95
340T 15V	1.35	5316	alarm clock	4.95
		7001	alarm clock	7.95
		8038	V. cont. osc.	5.95
		MAN 1		1.50
		MAN 5		1.95
		MAN 6		3.95
		MAN 8		1.95
		MAN 66		2.95
		HP 5082		
		7414 (4 DIG)		2.75
		HP 5082		
		7405 (5 DIG)		2.95
		5020 RED LED		5/\$1.00
		MCT 2		.59

### TTL

7400	S .19	7485	\$1.39
7401	.19	7486	.44
7402	.19	7489	2.75
7403	.19	7490	.76
7404	.22	7491	1.29
7405	.22	7492	.79
7406	.39	7493	.79
7407	.39	7494	.89
7408	.25	7495	.89
7409	.25	7496	.89
7410	.19	74105	.49
7411	.29	74107	.49
7413	.79	74121	.57
7415	.39	74122	.53
7416	.39	74123	.99
7417	.39	74125	.69
7420	.19	74126	.79
7422	.29	74141	1.23
7423	.35	74145	1.15
7425	.39	74150	1.09
7426	.29	74151	.89
7427	.35	74153	1.29
7430	.22	74154	1.59
7432	.29	74155	1.19
7437	.45	74156	1.29
7438	.39	74157	1.29
7440	.19	74161	1.39
7441	1.09	74163	1.59
7442	.99	74164	1.89
7443	.99	74165	1.89
7444	1.10	74166	1.65
7445	1.10	74173	1.65
7446	1.15	74175	1.89
7447	1.15	74176	1.65
7448	1.15	74177	.99
7450	.24	74180	1.09
7453	.27	74181	3.65
7454	.39	74182	.89
7460	.19	74190	1.59
7464	.39	74192	1.49
7465	.39	74193	1.39
7472	.36	74194	1.39
7473	.43	74195	.99
7474	.43	74196	1.85
7475	.75	74197	1.15
7476	.47	74198	2.19
7483	1.11	74199	2.19

Data sheets supplied on request. Add \$3.50 for items less than \$1.00.

### CMOS

74C00	S .39	74C154	3.50
74C02	.55	74C157	2.19
74C04	.75	74C180	3.25
74C08	.75	74C161	3.25
74C10	.65	74C163	3.25
74C12	.65	74C164	3.50
74C20	.85	74C173	2.90
74C73	1.55	74C195	3.00
74C74	1.15	80C95	1.50
74C76	1.70	80C97	1.50

### 4000 SERIES RCA-EQUIV.

CD4001	S .55	CD4017	2.95
CD4009	.85	CD4019	1.35
CD4010	.85	CD4022	2.75
CD4011	.55	CD4023	.55
CD4012	.55	CD4025	.55
CD4013	1.20	CD4027	1.35
CD4016	1.25	CD4035	2.85

### LINEAR CIRCUITS

301	Hi perf. op amp	mDIP	\$ .32
307	Op amp	mDIP	.29
308	Micro-pwr op amp	mDIP	.99
309K	5V reg 1A	TO-3	1.50
310	V tolr. Op Amp	mDIP	1.19
311	Hi perf. V comp	mDIP	1.05
319	Hi-speed dual comp	DIP	1.29
320	Reg regulator (5V, 5.2V, 12V, 15V)	TO3	1.25
324	Quad op amp	DIP	1.89
339	Quad comp	DIP	1.69
340T	Pos V reg (5V, 6V, 8V, 12V, 15V, 18V, 24V)	TO-220	1.75
372	AG-IF strip det	DIP	.79
376	Pos V reg	mDIP	.59
377	2 w stereo amp	DIP	2.69
380	2w audio amp	DIP	1.29
380.8	.6w audio amp	mDIP	.89
381	Lo noise dual preamp	DIP	1.69
550	Prec. V reg	DIP	.79
555	Timer	mDIP	.99
560	Phase locked loop	DIP	2.75
562	Phase locked loop	DIP	2.65
565	Phase locked loop	DIP	2.65
566	Function gen	mDIP	2.50
567	Tone Decoder	mDIP	2.95
709	Op amp	DIP	.29
710	Hi speed V comp	DIP	.39
723	Volt reg.	DIP	.69
739	Dual hi perf amp	DIP	1.19
741	Comp. op amp	mDIP	.35
747	Dual 741	DIP	.79
748	Freq adj 741	mDIP	.39
1304	FM mux st demod	DIP	1.19
1307	FM mux st demod	DIP	.82
1458	Dual Comp op amp	mDIP	.69
1800	Stereo Multiplexer	DIP	2.75
3900	Quad amp	DIP	.39
7524	Core mem sense amp	DIP	.79
7525	Core mem sense amp	DIP	.95
75451	Dual prl. driver	mDIP	.39
75452	Dual prl. driver	mDIP	.39
75453	Dual prl. driver	mDIP	.39
75491	Quad seq driver	DIP	.79
75492	Hex dig. driver	DIP	.89

Data sheets supplied on request. Add \$3.50 for items less than \$1.00.

### CALCULATOR & CLOCK CHIPS w/data

5001	12 DIG 4 funct fix dec	3.95
5002	Same as 5001 exc btry pwr	7.95
5005	12 DIG 4 funct w/mem	8.45
MM5725	8 DIG 4 funct chain & dec	2.79
MM5736	18 pin 6 DIG 4 funct	4.95
MM5738	8 DIG 5 funct K & Mem	7.95
MM5739	9 DIG 4 funct (btry sur)	6.95
MM 5311	28 pin BCD 6 dig mux	6.95
MM 5312	24 pin 1 pps BCD 4 dig mux	6.95
MM 5313	28 pin 1 pps BCD 6 dig mux	7.95
MM 5314	24 pin 6 dig mux	8.95
MM 5316	40 pin alarm 4 dig	8.95

### COSMETIC REJECTS

FUNCTIONALLY PERFECT		
5001		\$1.95
5002		2.50

### SHIFT REGISTERS

MM 5013	1024 bit accum, dynamic	mDIP	\$1.95
MM 5016	500/512 bit dynamic	mDIP	1.75
MM 5058	1024 bit static	DIP	3.95
SL-5-4025	Dual 64 bit static	DIP	1.50

### MEMORIES

1101	256 bit RAM MOS	\$1.75
1103	1024 bit RAM MOS	4.95
5203	2048 bit eras. PROM	24.95
5260	1024 bit RAM low power	3.95
7489	64 bit RAM TTL	2.75
8223	Programmable ROM	4.95
74200	256 bit Ram-tri-state	7.95

### LED'S AND OPTO ISOLATORS

MV10B	Red TO 18	\$ 2.50 ea.
MV50	Axial leads	.25
MV5020	Jumbo visible red	.25
ME4	Infra red diff. dome	.60
MAN1	Red 7 seg. .270"	2.50
MAN2	Red alpha num .32"	4.95
MAN4	Red 7 seg. .190"	2.15
MAN5	Green 7 seg. .270"	2.95
MAN7	Red 7 seg. .270"	1.35
MAN8	Yellow 7 seg. .270"	3.95
MAN66	60" high dir. view	4.65
DL707	Red 7 seg. .3"	2.15
MCT2	Opto-iso transistor	.69

### ON ORDERS OVER \$25.00 DEDUCT 10%

Satisfaction is guaranteed. Shipment will be made via first class mail — postage paid — in U.S., Canada and Mexico within three days from receipt of order. Minimum order — \$5.00. California residents add sales tax



(408) 659-3171

**INTERNATIONAL ELECTRONICS UNLIMITED**  
P.O. BOX 1708 MONTEREY, CALIF. 93940 USA

**C-MOS**

4000AE	.45	39
4001AE	.45	39
4002AE	.45	39
4004AE	5.85	5.85
4005AE	3.50	3.90
4007AE	.45	39
4008AE	2.90	2.70
4009AE	.45	39
4010AE	.55	54
4011AE	.48	45
4012AE	.45	39
4013AE	.45	39
4014AE	2.80	2.50
4015AE	2.80	2.50
4016AE	.90	75
4017AE	1.80	1.70
4018AE	2.80	2.60
4019AE	.85	60
4020AE	2.80	2.60
4021AE	2.20	1.90
4022AE	1.80	1.60
4023AE	.48	45
4024AE	1.60	1.40
4025AE	.45	32
4026AE	8.40	7.90
4027AE	.90	80
4028AE	1.70	1.50
4029AE	2.20	2.00
4030AE	.80	60
4033AE	3.40	2.90
4035AE	2.00	1.80
4040AE	2.20	2.00
4041AE	1.20	.90
4042AE	1.20	1.00
4043AE	1.20	1.00
4044AE	1.20	1.00
4047AE	3.10	3.00
4048AE	1.45	1.35
4049AE	1.00	.80
4050AE	1.00	.80
4051AE	3.35	2.90
4052AE	2.15	2.05
4053AE	2.90	2.80
4054AE	2.70	2.60
4055AE	3.45	3.41
4060AE	3.30	3.00
4066AE	1.20	1.00
4069AE	.80	.70
4071AE	.45	.38
4076AE	1.70	1.50
4081AE	.45	.39
4510AE	2.00	1.80
4516AE	2.90	2.80
4518AE	3.30	3.00
4520AE	1.90	1.70
4901AE	.45	.38
4911AE	.45	.38



**WAVEFORM GENERATOR**  
**XR205K KIT** Only \$28.00  
 Here's a highly versatile lab instrument at a fraction of the cost of conventional unit. Kit includes two XR205 IC's, data & applications, PC board (etched & drilled, ready for assembly) and detailed instructions.

**DUAL LOW NOISE OP AMP**  
 LM3331V  
 V<sub>io</sub> = 6mV  
 V<sub>ic</sub> = 1000 nA  
 I<sub>io</sub> = 2000 nA  
 Noise = 1.5dB  
 \$2.20

**DISPLAYS**  
 OPCA  
 SLA1 Red 2.25  
 SLA11 Green 3.50  
 SLA21 Yellow 3.50  
 SLA7 Red 1.60  
 LITRONIX  
 DL80 Red 6.00  
 DL81 Red 6.00  
 DL10 Red 6.00  
 DL10A Red 4.00  
 DL10B Red 4.90  
 DL57 Red 9.90  
 DL61 Red 12.00  
 DL33 Red 4.00  
 DL44 Red 6.00  
 DL402 Red 4.00  
 DL701 Red 3.40  
 DL701 Red 2.25  
 DL702 Red 2.35  
 DL747 Red 2.50  
 XCITON  
 XAN72 Red 2.00  
 XAN52 Green 2.00

**LEDs**  
 .125" dia.  
 209 Red \$.25  
 209 Yellow \$.35  
 209 Green \$.35  
 .160" dia.  
 216 Red .25  
 216 Yellow .30  
 216 Green .30  
 .200" dia.  
 220 Red .25  
 220 Yellow .30  
 220 Green .30  
**LOW PROFILE**  
 226 Red \$.25  
 226 Yellow .30  
 226 Green .30  
 226 Orange .30  
 5053 Red .35  
 5053 Yellow .40  
 5053 Green .40  
 5053 Orange .40  
 216 = MV5024  
 5053 = MV5053  
 MV50 Red \$3.00

**7400N TTL**

7400N	\$14.00	7444N	\$1.05	7496N	\$8.85	74161N	1.28
7401N	.17	7445N	1.04	74100N	1.30	74162N	1.50
7402N	.14	7446N	1.10	74104N	1.25	74163N	1.48
7403N	.17	7447N	1.00	74105N	.45	74164N	1.70
7404N	.21	7448N	1.00	74107N	.40	74165N	1.78
7405N	.20	7450N	.15	74109N	.92	74166N	1.50
7406N	.35	7451N	.23	74110N	.72	74170N	2.60
7407N	.27	7453N	.28	74111N	.92	74181N	1.40
7408N	.18	7454N	.26	74114N	.92	74174N	1.20
7409N	.23	7455N	.37	74115N	.92	74175N	1.60
7410N	.14	7460N	.25	74118N	1.51	74176N	1.30
7411N	.27	7462N	.37	74121N	.50	74177N	1.50
7412N	.52	7464N	.37	74122N	.50	74180N	1.05
7413N	.72	7465N	.37	74123N	.90	74181N	3.20
7414N	2.25	7470N	.20	74125N	.60	74182N	.75
7415N	.37	7471N	.49	74126N	.64	74184N	2.90
7416N	.37	7472N	.33	74128N	1.32	74188N	2.29
7417N	.37	7473N	.38	74132N	2.06	74188N	4.90
7420N	.17	7474N	.35	74136N	.92	74190N	1.49
7421N	.60	7475N	.60	74140N	2.50	74191N	1.49
7422N	.27	7476N	.45	74141N	1.19	74192N	1.40
7423N	.48	7478N	.55	74145N	1.08	74193N	1.29
7424N	.36	7480N	.60	74147N	2.90	74194N	1.35
7426N	.27	7481N	1.19	74148N	2.20	74195N	.80
7427N	.31	7482N	.90	74150N	.99	74196N	1.90
7428N	.52	7483N	.80	74151N	.84	74197N	.80
7430N	.20	7484N	3.02	74152N	1.50	74198N	2.00
7431N	.29	7485N	2.50	74153N	1.05	74199N	2.09
7432N	.62	7486N	.40	74154N	1.48	74200N	4.90
7437N	.36	7489N	2.40	74155N	1.08	74221N	1.75
7438N	.35	7490N	.60	74156N	1.18	74251N	1.75
7439N	1.05	7491N	1.00	74157N	1.18	74278N	2.95
7440N	.16	7492N	.84	74158N	1.44	74279N	1.10
7441N	.29	7493N	1.60	74160N	1.50	74293N	.95
7442N	.90	7494N	1.20			74298N	2.55
7443N	.95	7495N	.80				

7400N	\$14.00	7444N	\$1.05	7496N	\$8.85	74161N	1.28
7401N	.17	7445N	1.04	74100N	1.30	74162N	1.50
7402N	.14	7446N	1.10	74104N	1.25	74163N	1.48
7403N	.17	7447N	1.00	74105N	.45	74164N	1.70
7404N	.21	7448N	1.00	74107N	.40	74165N	1.78
7405N	.20	7450N	.15	74109N	.92	74166N	1.50
7406N	.35	7451N	.23	74110N	.72	74170N	2.60
7407N	.27	7453N	.28	74111N	.92	74181N	1.40
7408N	.18	7454N	.26	74114N	.92	74174N	1.20
7409N	.23	7455N	.37	74115N	.92	74175N	1.60
7410N	.14	7460N	.25	74118N	1.51	74176N	1.30
7411N	.27	7462N	.37	74121N	.50	74177N	1.50
7412N	.52	7464N	.37	74122N	.50	74180N	1.05
7413N	.72	7465N	.37	74123N	.90	74181N	3.20
7414N	2.25	7470N	.20	74125N	.60	74182N	.75
7415N	.37	7471N	.49	74126N	.64	74184N	2.90
7416N	.37	7472N	.33	74128N	1.32	74188N	2.29
7417N	.37	7473N	.38	74132N	2.06	74188N	4.90
7420N	.17	7474N	.35	74136N	.92	74190N	1.49
7421N	.60	7475N	.60	74140N	2.50	74191N	1.49
7422N	.27	7476N	.45	74141N	1.19	74192N	1.40
7423N	.48	7478N	.55	74145N	1.08	74193N	1.29
7424N	.36	7480N	.60	74147N	2.90	74194N	1.35
7426N	.27	7481N	1.19	74148N	2.20	74195N	.80
7427N	.31	7482N	.90	74150N	.99	74196N	1.90
7428N	.52	7483N	.80	74151N	.84	74197N	.80
7430N	.20	7484N	3.02	74152N	1.50	74198N	2.00
7431N	.29	7485N	2.50	74153N	1.05	74199N	2.09
7432N	.62	7486N	.40	74154N	1.48	74200N	4.90
7437N	.36	7489N	2.40	74155N	1.08	74221N	1.75
7438N	.35	7490N	.60	74156N	1.18	74251N	1.75
7439N	1.05	7491N	1.00	74157N	1.18	74278N	2.95
7440N	.16	7492N	.84	74158N	1.44	74279N	1.10
7441N	.29	7493N	1.60	74160N	1.50	74293N	.95
7442N	.90	7494N	1.20			74298N	2.55
7443N	.95	7495N	.80				

**LOW POWER TTL**

74L00N	.45	74S74N	1.30	74S158N	2.40
74L02N	.45	74S85N	1.10	74S160N	4.70
74L03N	.75	74S86N	2.70	74S174N	3.30
74L04N	.75	74S112N	2.20	74S181N	10.20
74L08N	.80	74S113N	1.50	74S189N	5.10
74L10N	.75	74S132N	3.60	74S194N	3.30
74L11N	.65	74S133N	.90	74S195N	3.30
74L20N	.80	74S138N	2.40	74S225N	2.40
74L30N	.80	74S139N	2.40	74S253N	2.40
74S32N	.80	74S140N	.90	74S257N	2.40
74S40N	.80	74S151N	2.40	74S258N	2.40
74S51N	.80	74S153N	2.40	74S260N	.90
74S64N	.80	74S157N	2.40	74S280N	5.70

**HIGH SPEED TTL**

74H00N	.34	74H53N	.36		
74H02N	.34	74H54N	.36		
74H03N	.39	74H55N	.36		
74H04N	.39	74H56N	.36		
74H10N	.34	74H61N	.36		
74H20N	.39	74H62N	.36		
74H42N	1.62	74H71N	.80		
74H51N	.34	74H72N	.74		
74H73N	.74	74H73N	.90		
74H74N	.89	74H74N	.87		
74H90N	1.62	74H76N	.90		
74H93N	1.74	74H101N	.80		
74H95N	1.62	74H102N	.80		
93L01	1.50	74H103N	1.10		
93L08	3.20	74H52N	.36	74H106N	1.35

**DECODED READ/WRITE RAM**

P1103 \$6.20

**LOW POWER TTL**

74L00N	.34	74H00N	.34	74H53N	.36
74L02N	.34	74H01N	.34	74H54N	.36
74L03N	.39	74H04N	.38	74H55N	.36
74L04N	.39	74H05N	.37	74H60N	.36
74L10N	.34	74H08N	.40	74H61N	.36
74L20N	.39	74H10N	.36	74H62N	.36
74L42N	1.62	74H11N	.36	74H71N	.80
74L51N	.34	74H20N	.36	74H72N	.74
74L73N	.74	74H21N	.36	74H73N	.90
74L74N	.89	74H22N	.36	74H74N	.87
74L90N	1.62	74H30N	.36	74H76N	.90
74L93N	1.74				

## MAJOR MAGNUS ORGAN ASSEMBLY



This is the major assembly in many models of MAGNUS ORGANS. It consists of the treble board, which is the source of 3 octaves (37 notes), and several chords. It includes the 3 octave keyboard, power transformer, headphone jack and cable to speaker and volume control. The whole unit is sturdily mounted on a 13 1/2" x 31 1/2" plywood board, and weighs about 14 lbs. Each unit tested and guaranteed. Very easy to complete your organ with this unit as a foundation. Data supplied.

STOCK NO.P5254 \$47.50 ea. 2/90.00

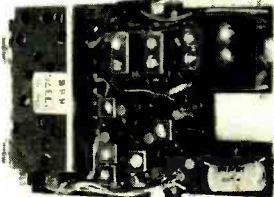

### 13 TRANSISTOR AM-FM TUNER & IF STRIP

Complete AM-FM tuners and IF strips. Needs only an audio amplifier and 12 volts DC to make a fine, highly selective set. Originally made for trucks and busses, very ruggedly built. We provide data and circuit diagram.

3 1/2"x5 1/2" STOCK NO.P5255 7.95 ea. 2/15.00

### COMPUTER GRADE CAPACITORS

6000 MFD. 75 volts STOCK NO.P2450 3.50 ea. 4/12.00  
 39,000 MFD. 75 volts STOCK NO.P2449 4.75 ea. 4/17.00

Please include sufficient postage; excess will be refunded. Send for new catalog 14. 64 pages of electronic bargains.



# DELTA ELECTRONICS CO.

BOX 1, LYNN, MASSACHUSETTS 01903  
 Phone (617) 388-4705

CIRCLE NO. 14 ON READER SERVICE CARD

For faster service

USE ZIP CODE

on all mail

SURPRISE! Build inexpensively, the most Unusual Test Instruments, Futuristic Gadgets using Numerical Readouts! Catalogue Free! GBS, Box 100A, Green Bank, West Virginia 24944.

ELECTRONIC IGNITION: Capacitor, transistor, pointless. Auburn sparkplugs. Information 10 cents. Anderson Engineering, Epsom, N.H. 03234.

WHOLESALE Scanners, CB, Crystals, Directories, SSB/AM. Catalog 25 cents. G—Enterprises, Box 461P, Clearfield, Utah 84105.

7,000 SEMICONDUCTORS, 100's Electronic Circuit Kits, Technical Reports, Energy Conservation, Computers. Cat. 50 cents. E/S Lab, Box 738, College Park, MD 20740.

LEARN DESIGN TECHNIQUES. Electronics Monthly Newsletter. Digital, linear construction projects, design theory and procedures. Sample copy \$1.00. Valley West, Box 2119-B, Sunnyvale, California 94087.

TELEPHONES UNLIMITED, equipment, supplies. Catalog 50 cents. Box 1654E, Costa Mesa, Calif. 92626

WE SELL MONEY MAKING CONSTRUCTION MANUALS!!! — Reclaim GOLD, SILVER for EXCELLENT full or part time money!!! — PLUS, we buy scrap gold & silver — ALSO, we sell 99.999% pure SILVER BARS!!! — Color Catalog 25 cents — Airmailed 50 cents — Creative Products, Dept. PE-575, 4913 Northridge NE, Albuquerque, New Mexico 87111.

DIGITAL IC Manual-Latest Edition—1500 types by types/diagram number \$3.95. 32—function digital computer kit—IC, transistors, instructions, \$14.00. IC applications manual—numerous circuits—Analog/Digital, \$3.95. Electronics, P. O. Box 127, Hopedale, Mass. 01747.

ELECTRONIC COMPONENTS—all kinds, send for free catalog. Epic, Box 20152A, Minneapolis, Minn. 55420.

FOR A New Electronic Experience, learn to control your brainwaves. Aquarius Electronics, Box 962E, Albion, CA 95410.

COMPUTER SCHEMATICS 256 bits, expandable to several K. Many other schematics available. SP Electronics, Box 5E, Prospect Heights, Illinois 60070.

AUTHENTIC, INSTRUMENTED, FLYING ROCKETS for casual or serious experimenters. Over 80 scale original, multi-stage or ready-to-fly models. Solid-propellant engines for safe, electric launch system liftoffs up to 2,500 feet. Measure altitude, temp, inversions, more. Real telemetry, electronic tracking, aerial still and movie photography with super-miniaturized equipment. New, detailed tech manual and full-color catalog, 25 cents from ESTES INDUSTRIES Dept. 18J, Penrose, Colo. 81240.

## MAY INVENTORY SPECIAL!

### Replacement Semiconductors

MOTOROLA

HEP No.	HEP No.	HEP No.	HEP No.
1	89	233	4.20
2	1.25	234	3.25
3	1.25	235	4.50
50	79	236	5.70
51	1.29	237	9.75
52	95	238	4.70
53	1.15	239	6.50
54	1.08	244	2.15
55	1.20	248	6.49
56	1.44	250	.79
57	1.20	253	1.20
75	2.95	553	4.10
76	4.95	556	2.70
101	95	558	3.87
102	1.20	558	4.39
103	1.20	570	2.10
104	1.20	571	2.10
105	1.20	600	1.11
134	.26	601	1.11
151	1.90	602	1.84
156	.41	603	1.84
160	.75	604	1.84
165	.62	605	1.84
166	.60	606	1.84
170	.82	607	1.84
176	2.05	608	1.84
177	2.25	609	2.49
178	3.05	610	2.49
231	1.99	611	2.49
232	2.34	623	2.20

GENERAL ELECTRIC	G. E. No.	TR59-C	3.35
54	3.00	TR65-C	4.00
55	3.05	TR67-C	11.30
56	4.25	Z1012-C	.50
57	1.95	Z1106-C	.85
58	2.20	Z1306-C	2.05
59	1.26	Z1312-C	2.05
60	1.20	Z1314-C	2.05
61	1.32	Z1318-C	2.05
62	.81	Z1322-C	2.05
63	1.80	Z1328-C	2.05
64	.96	Z1334-C	2.05
66	2.49	Z3305-C	3.50
67	1.80	Z3314-C	3.50
69	2.76	Z3320-C	3.50
72	4.15	Z3325-C	3.50
73	11.00		
74	8.10		
75	7.20		

RCA

International Rectifier	SK3003	99
CD05F	SK3004	1.14
CD07F	SK3005	1.17
CD09F	SK3006	1.41
CY-1F	SK3007	1.26
CY-2F	SK3008	1.23
E-075L-C	SK3009	2.34
E-150L-C	SK3010	1.26
E-150L-F	SK3012	2.88
E-500L-F	SK3015	6.30
EX39-X	SK3019	1.47
EX42-X	SK3020	1.32
EX46-X	SK3021	1.95
EX62-X	SK3025	2.70
EX76-X	SK3026	1.80
EX85B-X	SK3027	3.15
EX89-X	SK3050	3.78
EX215-X	SK3052	2.35
EX499-X	SK3053	4.68
EX215-X	SK3067	3.15
TR23-C	SK3078	7.00
TR30-C	SK3079	4.95
TR53-C	SK3082	2.34
TR57-C	SK3083	2.52
	SK3084	2.88

### OEM SPECIALS

TRANSISTOR SPECIALS Power Units Similar to Jeduc Nos. Hardware Included.	METAL	EPOXY	METAL	EPOXY	
2N441	To-36	2.100	2N2722A	35	22
2N458A	To-3	4.100	2N2369	18	13
2N538	Mt-36	3.100	2N2484	75	35
2N1015	Mt-1	1.000	2N2904	50	20
2N1725	To-61	2.150	2N2905	50	20
2N2288	To-3	2.100	2N2905A	85	35
2N3054	To-66	5.100	2N2906	40	20
2N3055	To-3	4.100	2N2907	40	20
2N5002	To-59	3.200	2N3053	20	16
2N5296 Tip31	To-220	7.100	2N3251	75	35
			2N4036	75	35

### Motorola MK-20 Power Transistor Mounting Kit .75

Integrated Circuits	World's Smallest Transistor! Now Available! Limited Time Only!
UA703C	40
CA3066	4.00
CA3068	6.50
MC1305	1.50
Replacement for Zenith 221-36 221-37 221-39 3.50	

Case Size .04 x .04 x .03 in PNP 3 00 NPN 3 00

Transistor Grab Bag - Germanium and Silicon small sigs and power transistors. 95% yield. 30 1 00

Prime 10 watt Zeniths, anode and cathode case, up to 180 volts. Do 4. 1.75

CITIZEN BAND APPLICATION	POWER TRANSISTORS	RECTIFIERS		
NPN Silicon 27 MH Band RF Power Transistors	High Voltage TV Transistors	10 100		
2SC781	BU204	1N4001	90	7.00
2SC799	BU205	1N4002	1.00	8.00
2SC1306	BU206	1N4003	1.10	9.00
2SC1307	BU207	1N4004	1.20	10.00
2SC517	BU208	1N4005	1.30	11.00
MR8F004	BU209	1N4006	1.40	12.00
	2SC1170	1N4007	1.50	13.00
	2SC1172B			
	2SC1308			
	2SD380			

Experimenter-Hobbyist Parts	SILICON UNIUNCTIONS	CMOS			
GE-X1	2N2646	SS4001AE	55	SS4025AE	55
GE-X2A	2N2647	SS4002AE	65	SS4027AE	1.35
GE-X3	2N6027 PUT	SS4011AE	55	SS4028AE	2.80
GE-X4	2N6028 PUT	SS4012AE	55	SS4030AE	65
GE-X5	2N1671	SS4013AE	1.30	SS4049AE	1.35
GE-X6	D5E37	SS4015AE	3.00	SS4050AE	1.35
GE-X8					
GE-X9					
GE-X10					

20% off on Replacement orders of 25.00 or more. Above is partial list of current stock available at drastic reductions. Send for complete list!

ALL PARTS GUARANTEED AND TESTED ON PREMISES. WRITE FOR FREE CATALOG AND LG. QUANTITY DISCOUNTS.



New-Tone Electronics

P.O. BOX 1738 A  
 BLOOMFIELD, N.J. 07003 • 201-762-9020

CIRCLE NO. 31 ON READER SERVICE CARD

# AM TUNER TORNADO

WITH BUILT-IN AMP

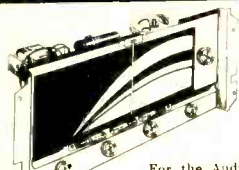

**\$9.95**

- Slide-Rule Dial Covers
- (10-watts Peak Power)
- ALL SOLID STATE!!!

For the Audiophiles who are seeking an economy hi-fi AM only at our give-away price! Never advertised before. Same quality and construction as our 20W to 60W units. Features: 4 controls; Tuning, Tone, ON/OFF Volume, Circuit Switch (AM-Phono), 2-Speaker stereo effect system, 6-ft. power cord, Phono cables, with hookups, 115 VAC, 60 cycles. No escutcheon. Size: 10 7/8 x 5 3/8 x 3 1/2" deep, Wt. 3 lbs.

**AM FM \$19.95**

Never before have we ever seen such a combination of AM and FM with built-in high quality at such a low price. A "natural" for the economy-minded Audiophile. Features: Tuning, Tone, ON/OFF Volume, Balance, Circuit Switch (AM, FM, FM-AFC, Phono), 2-Speaker stereo effect system, 6-ft. power cord, Phono cables, with hook-ups, 115 VAC, 60 cycles. No escutcheon. Size: 13 x 7 x 3 1/2" deep, Wt. 3 lbs.

## "PROFESSIONAL" 60 WATT AM-FM MUX TUNER AMP



**\$69.95**

The finest built 60 watt tuner amp we've had for years. We call it THE AUDIOPHILE BUY OF THE YEAR! It compares to Fisher and Hi Fi Scout quality. Crisp hi-fi, organ type quality for the lows. Fine linear response using a pair of 45 watt style matched power tube transistors for each channel. Built-in preamp for using magnetic cartridges, black and chrome-silver look molded panel with glass already attached to tuner. It's made to JUST SLIDE INTO CABINET! Push-button features for phono, am, fm, stereo, tape. Red "FM and TAPE" show on glass. You can't see dial plate behind glass til you press any of the above push buttons, and then the scale illuminates. Two separate rocker switches for POWER (ON-OFF) and AFC Controls. Modern slide volume, balancer, bass and treble controls. With knobs for these and a black chrome trimmed 2" round for tuning. Balance controls indicate left and right speakers. Jack on panel for standard stereo head-phones. Built-in AM and FM antennas. REAR CONNECTIONS: has two separate cables to plug into stereo-phonosystem, AC cable for interconnect power to turn-table, cable to connect to phono system for automatic shut-off. Separate bakelite panel that you can add an additional FM antenna for "coming up" stations. Has two separate cables to plug into stereo-phonosystem, AC cable for interconnect power to turn-table, cable to connect to phono system for automatic shut-off. Separate bakelite panel that you can add an additional FM antenna for "coming up" stations. Has two separate cables to plug into stereo-phonosystem, AC cable for interconnect power to turn-table, cable to connect to phono system for automatic shut-off. Separate bakelite panel that you can add an additional FM antenna for "coming up" stations.

## BIGGEST MAN-7 SALE \$1

THAT'S RIGHT! MAN-7's at the readout sale of the century! The MAN-7 is a 7-segment "reflective bar" version of the famous MAN-1. The optimum in light efficiency and construction. Looks like a signal, the MAN-1. Pin connections same. Wide angle viewing. 0.27" character height, color red.

- MAN-5 as MAN-7 except green **\$1.49**
- MAN-8 as MAN-7 except yellow **\$1.49**

- XENON FLASH STROBE TUBE **\$1.95**
- 555 Timer OR 558 Dual 741 **2 for \$1**

- 7-SEGMENT 3 for \$6.
- OPCOA SLA-1 **\$2.50**
- REFLECTIVE LED READOUT
- Litron 704 Red **\$2.50**
- Litron 707 Red **\$2.50**

- CLOCK CHIPS as low as **\$3.95** ON A "DIP"
- WITH DATA SHEETS
- MM5311 6-digit 28-Pin **\$6.99**
- MM5312 4-digit 24-Pin **6.99**
- MM5313 6-digit 28-Pin **6.99**
- MM5314 6-digit 24-Pin **6.99**
- MM5316 4-digit 40-Pin, alarm **6.99**
- MM5316-A no alarm **3.95**
- 50250 6-digit LED\* 28 pin **\$8.50**
- 7001 6-digit LED\*\* 28 pin **7.95**

## "ALL LED" MONSANTO READOUTS

MONSANTO TYPE	CHAR. HT.	SALE EACH	Quantity Discounts
MAN-1	.27	\$3.50	3 for \$ 9.
MAN-2	.32*	4.95	3 for \$12.
MAN-3	.12	1.00	3 for \$2.50



## IT'S NEW! NEVER OFFERED BEFORE! 9-FUNCTION, 8-DIGIT MEMORY CALCULATOR KIT

It's the easiest multi-function kit today!

- \* DOUBLE MEMORY
- \* Percent, Constant, Display Restore
- \* 4-Function Arithmetic
- \* 22 KEYS!

Only **\$29.95**

EASY TO PUT TOGETHER! You bet it is... imagine no resistors, capacitors, but it ONLY REQUIRES 2 CHIPS and a READOUT! How's that for simplicity? The 2 Memory keys are MS (Memory Storage) and MR (Memory Recall) (requires very little soldering). The display restore key is to conserve battery life. Your display on panel shuts off 25 seconds after the last operation. By depressing "D" key, the display is restored! Uses 6 N cell batteries. Red decimal appears on left to show when batteries need replacement or charging. Has Decimal, Clear, Constant, Percent, and arithmetic key, red, white and blue colors. Lightweight, pocket size 5 1/4 x 3 x 2" at back, side x 1 1/2" front side of angular display panel black case. Nifty unit for business, school, home, and for the youngsters. Slips into any pocket, briefcase with ease. Easy-to-understand pictorial instruction booklet and how-to-use-book.

- KIT INCLUDES: case, 22-key keyboard kit, ON-OFF switch (part of keyboard) PC board, driver and memory calculator chips, 9-digit "bubble" magnifier LED array, array cable, AC adapter jack & wires, battery case, 6 battery card display, instruction and pictorial step-by-step construction booklet.
- \* AC ADAPTER FOR ABOVE ..... \$3.50

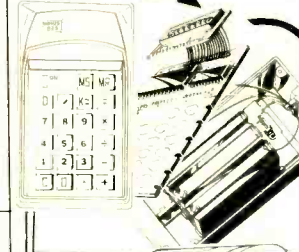

## THE SIMPLEST! FINEST! SMALLEST! 6-FUNCTION AC-DC CALCULATOR KIT! \$22.95

- \* Lightweight, pocket size
- \* Extra large display
- \* 6 functions plus, minus, times, percentage, constant, floating decimal
- \* Chain and Mix calculations
- \* Simplified indexing
- \* Mark up and Mark down
- \* Constant multiplication and division
- \* AC adaptor jack

Designed specifically for Poly Paks under the Dalton 80 brand. IMAGINE! Only 2 1/2 x 1 x 1/2" Slides easily into your vest pocket, brief case, or lunchbox. We hunted everywhere to find a calculator kit that can be small, do the many functions, with fine engineering design and SIMPLE TO BUILD! WHY? Because it has the fewest parts in a kit. Imagine the pc board only has the chip, 1 resistor, two transistors, two drivers with the 9 digit readout. SIMPLE! You bet it is. It's even packed in a multicolor attractive story. Kit includes: attractive black case with red filter; Flex Key (type 205K-66) 18 key keyboard that measures only 2 1/2 x 2" with 2 switches, one for ON-OFF, one for K constant; MAIN pc board; readout two 75491 ic drivers; Hewlett Packard 9 digit array cable; 9 Volt battery connector resistors; two transistors; back protective plate; necessary wire plugs; easy instructions. (Less 9 volt silicon battery and AC adapter) **EASIEST KIT TO BUILD**

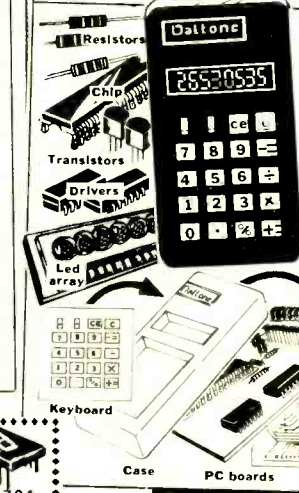

## Inflation-Fighting ECONOMY IC PRICES

Type	Sale	Order by type number! Spec sheets on request ONLY	Factory Marked
SN7400	\$.22	SN7438	.49
SN7401	.22	SN7440	.19
SN7402	.22	SN7441	1.00
SN7403	.22	SN7442	1.00
SN7404	.27	SN7443	1.00
SN7405	.24	SN7444	1.00
SN7406	.79	SN7445	1.00
SN7408	.27	SN7446	1.10
SN7409	.27	SN7447	1.10
SN7410	.19	SN7448	1.45
SN7411	.31	SN7450	.27
SN7413	.89	SN7451	.28
SN7414	2.25	SN7453	.28
SN7415	.45	SN7455	.28
SN7416	.45	SN7462	.39
SN7417	.50	SN7464	.39
SN7420	.22	SN7465	.39
SN7422	.29	SN7471	.55
SN7423	.32	SN7472	.42
SN7425	.35	SN7473	.52
SN7426	.31	SN7474	.39
SN7427	.35	SN7475	.91
SN7430	.24	SN7476	.52
SN7432	.28	SN7478	.79
SN7437	.45	SN7480	.59
SN7481	1.25	SN74141	1.19
SN7482	.99	SN74145	1.19
SN7483	.99	SN74148	2.95
SN7484	.49	SN74150	1.19
SN7489	2.95	SN74151	.99
SN7490	1.81	SN74153	1.39
SN7491	1.35	SN74154	1.69
SN7493	.99	SN74155	1.29
SN7496	.99	SN74156	1.15
SN7499	.99	SN74157	1.45
SN74100	1.55	SN74158	1.45
SN74104	1.25	SN74161	1.59
SN74105	.95	SN74163	1.75
SN74106	.95	SN74164	2.95
SN74107	.95	SN74165	2.85
SN74108	.95	SN74166	1.85
SN74112	.95	SN74173	1.85
SN74113	.95	SN74174	2.25
SN74114	.95	SN74175	1.99
SN74121	.49	SN74176	1.25
SN74122	.55	SN74177	1.25
SN74123	1.09	SN74180	1.10
SN74125	.65	SN74181	3.95
SN74126	.89	SN74182	1.05
SN74140	2.50	SN74190	1.49

BRAND NEW LOWEST PRICES GENERAL ELECTRIC 3-WATT AUDIO AMP \$2.50 Delivers 3.5 watts continuous, 6 watts peak. With heat sinks; micro-mini size; 3/4 x 1/2" x 9 to 30V supply. High sensitivity. 8 to 16 ohms.

## "BEEPER" AND "DATER" MK50250 CLOCK ON THE CHIPS BEEPER 8.50

Imagine a chip (MK50250) "Beeping" and audible alarm! All others are external. It also features internal brightness control. The CT7001 requires external triggering of alarm date of the month and direct drive to LED readouts. Both require minimum current drain and voltages, for either 3 to 6 LED readouts, 12 or 24 hours, AM and PM.

Terms: add postage. Rated: net 30 Phone Orders: Wakefield, Mass. (617) 245-3829 Retail: 16-18 Del Carmine St., Wakefield, Mass. (off Water Street) C.O.D.'s MAY BE HONORED

20c CATALOG on Fiber Optics, 'ICs, Semi's, Parts MINIMUM ORDER - \$4.00

**POLY PAKS**  
P.O. BOX 942E, LYNNFIELD, MASS. 01940

# MICROPROCESSORS

**MINI COMPUTER ERASEABLE PROM \$24.50**

MM5203 Erasable ultraviolet PROMS: Quartz lid, 2048 static, Specs.....

MM5202 (1702) like above - \$24.50

**8008 "THE COMPUTER ON THE CHIP" Only \$59.95**

Usually called "Microprocessor" — it is a p Channel Si gate MOS 8-bit Parallel Central Processor. A CPU Central Processing Unit on a chip. Features complete instruction decoding and control. Capability to address 16K x 8 bits of memory (RAM, ROM, SR). Build a micro-computer system when interfacing with other chips, such as 1101, 1103, 2102 (RAMS), etc. With spec sheets. 16-pin dip package. **\$59.95**

2102 1000-bit "static" Ram for above. .... \$6.95

PYROTECHNICAL chemicals, casings, fuse, tools, literature, supplies. Listing-50 cents, with samples — \$1.00. Westech, Logan, Utah 84321.

READ AND USE MICROCOMPUTER Hardware/Software ideas in ECS monthly. Write for free catalog and subscription inf. MP Publishing Co. Box 378P, Belmont, Massachusetts 02178.

RECONDITIONED Test Equipment. \$0.50 for catalog. Walter, 2697 Nickel, San Pablo, CA 94806.

BURGLAR-FIRE ALARM components, hardware. Free catalog. Information. Silmar, 133 S.W. 57 Ave., Miami, Florida 33144.

COMPUTER countless uses. 8 bit word, powerful instruction set. Complete \$225. Brochure 10 cents. RAECO, Box 14, Readville, Mass. 02137.

COMPUTER TESTED ICs. 7493 .60, 7420 .17, 7430 .16, 74107 41. Low prices while quantities last. Add 50 cents for handling. URL, 2501 United, Elk Grove, Ill. 60007.

THERMISTORS—Ultra high sensitivity thermal sensors. Send \$10 for new product sample or write for free specs. Dombor Associates, 11920 Beltsville Rd., Suite 31, Beltsville, MD 20705.

COLOR SOUND PROJECTOR, R.C.A. 16mm Studio Model TP6CC. Hardly used—offers, Miller, 507 Monroe St., Boonton, NJ 07005.

GROUND FAULT DETECTORS, TESTERS. Audible and Visual Continuity testers, Tone Generators, Music tone synthesizers. Direct Manufacturer Sales. Write for Brochures. Kabo Electronics, Box 477, Natick, Mass 01760.

HP 45 OWNERS—Your calculator has built-in timer. Details write Calculator, Box 862, Pacifica, CA 94044.

ALTAIR 8800 components, memories, interfaces. substantial savings. Other microprocessor component kits available including Mark 8, 2111 memories, \$12.50; 1702A, \$27.50; 8008, \$47.50; 8080, \$179.95; UART, \$9.95. ASCII keyboard, \$40.00. Lowest prices 2102 memories. Mini Micro Mart, 1618 James, Syracuse, NY 13203.

MONITOR RECEIVER, Preamp, Scanner. UHF Converter kits. Hamtronics, 182 Belmont, Rochester, NY 14612.

FREE giant bargain electronic catalog listing thousands of components, tubes, transistors. IC's kits, test equipment. EDLIE'S, 2700-PC Hempstead Tpke., Levittown, N.Y., 11756.

CONSTRUCTION PROJECTS: Laser, \$2.00. TV Camera, \$3.95. Catalog, Technologic, Box 5262, Orchard Lake, Michigan 48033.

COMPLETE CONSTRUCTION PLANS. Many low-cost, solid state projects. Free catalog, Robert Delp, Box 1026F, Fremont, CA 94538.

FREE Bargain Catalog. Ultrasonic devices, LEDs, transistors, IC's, keyboards, Xtals, unique components. Chaney's, Box 15431, Lakewood, CO 80215.

OOPS! Resistors, 1/4 W, 5%. Full lead, new. 3.3, 390, 470, 1k, 2.2k, 3.9k. Guaranteed. For use in TTL circuitry (Examples Supplied). Any 30/1.00. Hersch, Box 17704, San Diego, Calif., 92117.

BRAND NEW! Six digit alarm clock IC—Mostek MK50250—Full feature, snooze, dimming, with schematic plus data sheets. \$4.95—Kit of six 0.6" LED's, like DL-747 \$11.70! All new, guaranteed parts. Catalog 25 cents, redeemable. Diamondback Engineering, P.O. Box 194, Spring Valley, Ill. 61362.

NEW COLOR TELEPHONES, booklets about connecting telephones, and accessories. Details 25 cents. Queens Village Telephone Supply, Box 29002-M, Queens Village, NY 11429.



Model 43a **TV Dot C.H. Gen.**  
low cost Complete 4-wire module with instr. Nothing else to buy.  
4.5v in. RF out  
9 x 9 display. Size 4" x 4"  
Output tunes chan 2 thru 4.  
Only **29.95**PP (w/1 yr guar)

Litek Inc. 2143-1 Wyandotte Me View CA 94043

CARBON FILM RESISTORS. Brand new as low as 2-1/4 cents. FREE samples and specifications. COMPONENTS CENTER—PE, Box 134, New York, NY 10038.

4 CHANNEL DIGITAL OSCILLOSCOPE. Sixteen LEDs per channel display. Externally triggered sweep and storage modes. 1Hz to 3 MHz sweep rate. Unbeatable for TTL troubleshooting. Plans \$4.50. ARS SYSTEMS, Box 1922D, Sunnyvale, CA 94088.

MEASURE AC current using your VOM. \$5.95 adapter plugs into VOM receptacles. Also available: Power Factor Adapter—\$11.95. Send for details. I.R.C., Box 262, Massapequa, New York 11758.

UNPRINTED circuit board. Save time. Save dollars. No messy chemicals. New, original circuit board technique. Send \$3.00. Satisfaction or money back. Jhcompany, P.O. Box 1, Lee's Summit, Mo. 64063.

POWER SEMICONDUCTORS 1-35 Amp Rectifiers, SCR's, Bridges. Free Catalog, including Test Specifications. Middleton Electronics, P.O. Box 253, Middleton, Mass. 01949.

MONITOR RECEIVER CRYSTAL CERTIFICATES, \$3.50 each. 10 for \$32.00. Randall, Box 23174, Milwaukee, Wis. 53223. Catalog Police Receivers, C.B., etc. 50 cents. We accept Master Charge, BankAmericard.

LIQUID CRYSTAL. 3-1/2 digit wristwatch display. New, with instructions for building wristwatch. Final closeout. Less than original, factory wholesale price. \$5.00 each. Two for \$10. Tricooney Winflow, Inc. Box 5885, Grand Central Station, New York, N.Y. 10017.

EAVESDROPPERS Got You BUGGED???...Protect Your Privacy. Countermeasure Equipment Catalog—\$1.00. CALTRONIX, 1102 College, Santa Rosa, California 95404.

CONVERT any transistorized T.V. Tuner to a Tuner Substituter. Plans \$2.00. \$35.00 for completed and tested Super Substituter. Radio Television Training, Box 279, P-35, Syracuse, N.Y. 13206.

MULTIPLE RESTRIKE IGNITION. Repetitive Spark Improves Combustion Efficiency. Free Brochure. Labtronics, 3635-P Hillside, Ypsilanti, Michigan 48197.

ALPHA BRAINWAVE MONITOR—New from EICO. Model BW300 Kit, \$34.95. Wired, \$59.95 Postpaid. Send check or money order. M&K Electronic Corp., 135-33 Northern Blvd., Flushing, N.Y. 11354.

TEST EQUIPMENT—DISCOUNT PRICES: B&K, Sencore, Leader, EICO, Lectorch, M&K Electronic Corp., 135-33 Northern Blvd., Flushing, N.Y. 11354.

FIREWORKS, over 100 items. lowest prices, top quality, catalogue 50 cents. Pyro-Sonic Devices, PE, Box 711, Grand Haven, Michigan 49417.

WANTED

QUICKSILVER, Platinum, Silver, Gold, Ores Analyzed. Free Circular. Mercury Terminal, Norwood, Mass. 02062.

TTL		CMOS	
7400*	\$1.00	7488	4.00
7401	.23	7489*	2.25 <sup>ea</sup>
7402	.23	7490*	69 <sup>ea</sup>
7403	6/1.00	7491*	1.00
7404	.25	7492	.95
7405	.24	7493	.95
7406	.50	7494	.97
7407	.50	7495	.95
7408	.25	7496	.95
7409	.25	74100	1.50
7410*	6/1.00	74107	.47
7411	.30	74121	.55
7412	.40	74122	.47
7413*	.75	74123	1.05
7416	.45	74125	.60
7417	.45	74126	.80
7418	.25	74141	1.15
7420	.23	74145	1.15
7421	.27	74150	.95
7423	.32	75151	1.20
7425	.27	74153	1.50
7426	.31	74154	1.25
7427	.32	74155	1.30
7429	.40	74156	1.30
7430	.33	74157	1.55
7432	.26	74160	1.65
7437	.45	74161	1.65
7438	.50	74163	2.50
7439	.50	74164	2.50
7440	.23	74165	2.50
7441	1.10	74166	1.75
7442	1.05	74170	3.00
7443	1.10	74173	1.75
7444	1.15	74174	1.85
7445	1.10	74175	1.85
7446	1.25	74176	.85
7447*	.89	74177	.85
7448	1.25	74180*	1.00
7450	.25	74181	3.75
7451	.27	74182	1.00
7453	.27	74184	2.30
7454	.40	74185	2.30
7459	.25	74187	7.00
7460	.25	74190	1.50
7470	.45	74191	1.50
7472	.41	74192*	1.25
7473*	.39	74193*	1.25
7474	.47	74194	1.50
7475*	.75	74195	1.05
7476*	.40	74196	1.25
7480	.50	74197	1.05
7482	1.75	74198	2.25
7483	1.15	74199	2.75
7485*	1.10	74200	7.00
7486	.47	74250	5.00

(Zener) DIODES (Rectifier)	
IN456	6/\$1
IN458	6/\$1
IN485A	5/\$1
IN746	4/\$1
IN752	4/\$1
IN1183	1.60
IN1184	1.70
IN1186	1.80
IN3600	6/\$1
IN4001	.09
IN4002	.10
IN4004	.10
IN4148	15/\$1
IN4154	12/\$1
IN4734	.28c
IN4735	.28c
IN5232	.28c
IN5234	.28c
IN5243	.28c
IN5282	5/\$1

**\* MAY SPECIALS \***

8008 Processor	\$49.95	AY5-1013 UART	\$9.95
1101 256 x 1 RAM	2.25	RC4194 TK	5.95
2102 1024 x 1 RAM	7.25	RC4195 TK	3.25

**50 VOLT CERAMIC DISC CAPACITORS**

1-9 10-49 50-100		1-9 10-49 50-100	
.001mf, 5c	3.5c	.033mf, 6c	4c 3.5c
.0047mf, 6c	4c 3.5c	.047mf, 6c	4c 3.5c
.01mf, 5c	3.5c 3c	.1mf, 12c	10c 7.5c
.022mf, 6c	4c 3.5c	100pf, 6c	4c 3.5c

**100 Volt Mylar Film Capacitors**

.001UFD	.09 .07 .05	.022UFD	.10 .08 .06
.0022UFD	.09 .07 .05	.047UFD	.12 .09 .07
.0047UFD	.09 .07 .05	.1UFD	.15 .12 .10
.01UFD	.10 .08 .06	.22UFD	.21 .18 .15

**Miniature Aluminum Electrolytic Capacitors**

.47UFD/50V		.14 .12 .11		47UFD/25V		.19 .15 .14	
1UFD/16V	.14 .12 .11	100UFD/16V	.19 .15 .14	1UFD/50V	.15 .12 .11	100UFD/25V	.24 .18 .17
2.2UFD/50V	.14 .12 .11	100UFD/50V	.24 .18 .17	3.3UFD/25V	.14 .12 .11	220UFD/16V	.24 .18 .17
4.7UFD/25V	.14 .12 .11	220UFD/25V	.35 .25 .24	10UFD/16V	.14 .12 .11	470UFD/16V	.37 .30 .27
10UFD/25V	.14 .12 .11	470UFD/25V	.49 .39 .35	10UFD/50V	.14 .12 .11	1000UFD/16V	.49 .39 .35
10UFD/50V	.14 .12 .11	1000UFD/25V	.75 .60 .55	22UFD/16V	.14 .12 .11	1000UFD/25V	.75 .60 .55
22UFD/16V	.14 .12 .11	2200UFD/16V	.75 .60 .55	47UFD/16V	.17 .14 .13	Axial or Radial Lead Type	

**MPS-A05 5/\$1 TRANSISTORS**

2N918	.25	2N2906A	4/\$1	2N3906	4/\$1
2N2219A	3/\$1	2N2907A	5/\$1	PN4249	4/\$1
2N2221	4/\$1	2N3053	2/\$1	PN4250	4/\$1
2N2222A	5/\$1	2N3055	.95	2N4409	5/\$1
2N2369	5/\$1	2N3725A	2/\$1	2N5129	.19
2N2369A	4/\$1	2N3903	5/\$1	2N5139	.19
2N2484	4/\$1	2N3904	4/\$1	C106B1-SCR-2	\$1

**Cal. & Ck. Chips**

5001	\$3.95	25' VIEWING DISTANCE	8 P \$ .22
5005	5.95	Walnut Case-6"x3"x1"	14 P .26
5030	7.95	6r. & Min.-.6r" High	16 P .29
MM5311	4.95	Seconds-.3r" High	18 P .46
MM5312	4.95	KIT - All Comp. & Case	24 P .68
MM5313	4.95	Wired & Assembled	28 P .89
MM5314	4.95		36 P 1.10
MM5316	6.95		40 P 1.25

Satisfaction Guaranteed. \$5.00 Min. Order. U.S. Funds. California Residents - Add 6% Sales Tax. Write for FREE 1975 Catalog - Data Sheets .25c each

**JAMES**  
P.O. BOX 822, BELMONT, CA. 94002  
PHONE ORDERS - (415) 592-8097

LINEAR			
LM300H	\$.69	LM741H/N	\$.31*
LM301H/N	.29*	LM747N	.69
LM302H	.69	LM748N	.35
LM304H	.79	LM1303N	.79
LM305H/N	.89	LM1304N	1.00
LM307H/N	.35	LM1307N	.79
LM308H/N	1.05	LM1310P	3.25*
LM309K	1.25*	LM1458N	.69
LM310H/N	1.19	LM1469N	.99
LM311H/N	.95	LM1556V	1.85
LM318N	1.69	CA3013	1.70
LM319	1.19	CA3023	2.15
LM320K*	1.50	CA3035	2.25
LM324	1.85	CA3039	1.35
LM339N	1.95	CA3046	1.15
LM340K	1.89	CA3059	2.46
LM340T	1.75	CA3060	2.80
LM370N	1.05	CA3065N	.75
LM373N	2.05	CA3080	.85
LM380-8	1.00	CA3083	1.60
LM380N	1.25*	CA3086	.70
NE531T	3.00	CA3089	3.25
NE536T	3.00	CA3091	8.25
NE550N	.79	CA3123	1.85
NE555N	69*	CA3600	1.75
NE556N	1.85	LM3900	.55
NE560	2.50	LM3905	.55*
NE561	2.50	LM7805	1.75
NE562	2.50	8038B	3.95*
NE565H/N	2.00*	LM9601	.55
NE566	2.00*	LM9602	.75
NE567H/N	2.00*	75450	.49
LM703H/N	.43	75451	.39
LM709H/N	.29	75452	.39
LM710H/N	.29	75453	.39
LM711H/N	.29	75491	.79
LM723H/N	.55	75492	.89
LM733H/N	1.75	75494	.89
LM739N	1.29	75324N	1.75*
LM565H	1.50*	LM567H	1.50*

**1/4 W 5% CARBON COMP RESISTORS**  
5-25 30-95 100-495 500-995 1000 UP  
.05 .04 .03 .0275 .025

All Std. Values — 5 Ea. Min.  
Add 5¢ per value if sorting is required

PROJECTS	LEDS	8000 Series
82G3	\$ 7.00	MV 10 5/1 8090-98 .55
8267	4.00	MV 50 6/1 8123 1.50
2513*	11.00	MV 50245/1 8223* 3.00
2518	7.00	MAN-1 1.95 8263 7.00
2519	4.00	MAN-3 .95 8267 4.00
2524*	3.95	MAN-4 1.95 8280 .75
2525	7.00	MAN-7 1.50 8281 .85
2529*	4.00	DL 33 1.95 8288 1.15
4024P*	2.25	DL747 2.50 8880 1.35

**PLANS AND KITS**

**ATTENTION AUDIO FREAKS!!** ... Audio Processing Circuits ... designs, kits, units. Laboratory tested designs for hobbyist through professional use—limiters, compressors, equalizers, phasers, mixers and more! Send now—\$1.00 (refundable) for complete catalog—CIRCUIT RESEARCH LABS, 3920 E. Indian School, Phoenix, AZ 85018.

**FREE CATALOG.** 200+ unique electronic projects. Biofeedback, acupuncture, more! Cimarron Labs, 4183A Springfield St., Burton, Michigan 48509.

**AMAZING ELECTRONIC PRODUCTS**—Pocket Laser, See-In-The-Dark, Scramblers, Penlight Strobe, Energy Devices, TV Disruptor, Many More. All New. Catalog \$1.00, INFORMATION UNLTD., West St., Milford, N.H. 03055.

**EM Synthesizer Studio/lab quality.** Send SASE or 25 cents. CFR ASSOCIATES, POB F, Newton, NH 03858.

**NEW ORGAN KIT BUILDERS MANUAL \$3.00.** Circuits, block diagrams, details on diode keyed IC divider and independent oscillator designs. Many new kits and models. Keyboards also for synthesizers. Manual cost refundable with purchase. DEVTRONIX ORGAN PRODUCTS, Dept. C, 5872 Amapola Dr., San Jose, CA 95129.

**FREQUENCY counter.** Digital Clock, Logic Probe and more to come. Complete kits or PC Boards, reasonable priced full details \$3.00 Refundable. East Coast Electronics, 50 Scott, Hamburg, New York 14075.

**SEE music.** Connect any television to stereo. Displays pulsating Lissajous patterns. Booklet \$2.00. MusicVision, 324 Stanton, Ames, Iowa 50010.

**SOUND EFFECTS Solid State Electronic Kits available.** Gunfire, Explosions, others. Write: URL, 2501 United, Elk Grove, IL 60007.

**DIGITAL CIRCUIT plans** are available for: Automatic 125 meg. freq. counter with many features. Deflux Logic Probe with pulse indicator. Digital Clock 6 digit read-out. 60 Hz. time base for all digital clocks. Digital tachometer. Plans \$2.50 each. Boards available for all plans, drilled, etched and plated. Com-Tronics, 144 Cloverside Ct., Buffalo, N.Y. 14224.

**DIGITAL ALARM CLOCK KITS.** Complete kit of electronic parts for four digit. LED display alarm clock—\$22.30 post paid. Send for free flyer, bargain kits, components. Digitex, Box 4731, Dallas, Texas 75247.

**SPECTACULAR Music Patterns** on Color Television from your amplifier. Easy. Won't affect TV. "TV Color Organ" Plans \$5. Malvern Electronics, Box 338P, Malvern, Ohio 44644.

**DUAL TRACKING .75 VDC, 100 ma power supply kit.** Complete with line cord, solder, everything—only \$14.95. Deluxe case add \$4.80. Satisfaction guaranteed. Include \$1.00 shipping and handling. Californians add sales tax. Other kits available. Send for free brochure. Dage Scientific Instruments, 1931 Tobruk, Livermore, CA 94550.

**TESLA COIL—40" SPARKS!** Plans \$7.50. Information 75 cents. Huntington Electronics, Box 2009-P, Huntington, Conn. 06484.

**CALCULATOR KIT.** 8 digit four function \$19.95. Six digit readout Electronic clock less case and cord \$19.95. SASE for flyer. HAL-TRONIX, Box 1101, Southgate, Mich. 48195.

**NEW FROM EICO—**Listen to official FCC-Licensed background music (SCA) on your FM radio without commercials. EC5000 Kit, \$12.95 Postpaid. M&K Electronic Corp., 135-33 Northern Blvd., Flushing, N.Y. 11354.

**HIGH FIDELITY**

**DIAMOND NEEDLES and Stereo Cartridges** at Discount prices for Shure, Pickering, Stanton, Empire, Grado and ADC. Send for free catalog. LYLE CARTRIDGES, Dept. P, Box 69, Kensington Station, Brooklyn, New York 11218.

**LISTEN TO SPECTACULAR 4-CHANNEL SOUND!**

Expand your stereo to quadrasonic Hi-Fi.

Build the VISTA Full Logic "SQ" Decoder.

Latest CBS licensed circuitry using 3 IC's to provide Full Logic and Wave Matching.

Exclusively ours. Kit SQ-1 \$37.50. Shipped prepaid in USA & CANADA.

Send for information.

**PHOTOLUME CORPORATION**  
118 East 28th Street, New York, N.Y. 10016

**MOVIE FILMS**

**8MM-SUPER 8-16MM MOVIES!** Biggest Selection! Lowest Prices! Free Catalog! Cinema Eight, Box PE, Chester, Connecticut 06412.

**MAY 1975**

**ELECTRICAL SUPPLIES & EQUIPMENT**

**PLATING Equipment.** Portable Platers. Supplies and "Know-How." Build your own tanks for nickel, chrome, etc. Easy-to-install PVC liners. Rectifier components—all sizes. Schematics, parts lists, formulas, operating instructions for all plating. Guaranteed to save you 25%-75%. Some good units for sale. Write for details. Platers Service Company, 1511-PE Esperanza, Los Angeles, Calif. 90023.

**TUBES**

**RADIO & T.V. Tubes—**36 cents each. Send for free Catalog. Correll, 4213 University, San Diego, Calif. 92105.

**RECEIVING & INDUSTRIAL TUBES, TRANSISTORS. All Brands —**Biggest Discounts. Technicians, Hobbyists, Experimenters — Request FREE Giant Catalog and SAVE! ZALYTRON, 469 Jericho Turnpike, Mineola, N.Y. 11501.

**TUBES "Oldies",** latest. Lists free. Steinmetz, 7519 Maplewood, Hammond, Indiana 46324.

**CASH PAID FOR OBSOLETE RECEIVING TUBES** WE300B, WE300A, WE350B, WE252A, WE274A/B, WE284D, RCA45, RCA50. Small and large quantities, and movie theatre equipment, amplifier WE86A, WE59A, WE30A, WE91A/B, pick-up WE9A, WE10A, etc. Contact M. Takabe, 303 Fifth Ave., N.Y.C. 10016. Tel: (212) 679-1970.

**COLOR Picture Tubes,** wholesale prices. Free price list. Spectrum Enterprises, 520 Heather, Va. Beach, VA 23462.

**TUBES receiving, factory boxed, low prices, free price list.** Transletronic, Inc., 1306 40th Street, Brooklyn, N.Y. 11218A. Telephone: 212-633-2800.

**MUSICAL INSTRUMENTS**

**UP TO 60% DISCOUNT.** Name brand instruments catalog. Freepost Music, 455N Route 110, Melville, N.Y. 11746.

**WHOLESALE! Professional Guitars, PA Systems, All-Cell Speakers, 240W RMS Amplifiers.** Free Catalog, Carvin, Escondido, Calif. 92028.

**EMS Synthesizers, Sequencers, Keyboards and Modules** are now offered direct to you. We've eliminated the middleman. Drastic savings! Write: EMS (P.E.), 460 West St., Amherst, Mass. 01002.

<p><b>INTEL 8008</b> 4 BIT MICROPROCESSING CHIP (WITH DATA BOOK) <b>\$64.50</b> 2102A-1024 BIT RAM <b>\$6.95</b> 1702A UV PROM <b>\$24.00</b></p>		<p><b>TRANSISTOR SPECIALS</b> 2N256 PNP GE TO-3 ..... \$ 50 2N404 PNP GE TO-5 ..... 4/\$1.00 2N3866 NPN Si TO-5 RF ..... \$ .75 2N1016A NPN Si TO-82 ..... \$1.95 2N3904 NPN Si TO-92 ..... 4/\$1.00 MPS3393 NPN Si TO-92 ..... 4/\$1.00 2N3906 PNP Si TO-92 ..... 4/\$1.00 MPS A13 NPN Si TO-92 ..... 3/\$1.00 2N3757 NPN Si TO-66 ..... \$ .70 2N2222 NPN Si TO-18 ..... 5/\$1.00 2N3055 NPN Si TO-3 ..... \$1.00 2N5296 NPN Si TO-220 ..... \$ .50 2N6109 PNP Si TO-220 ..... \$ .55 2N4898 PNP Si TO-66 ..... \$ .60 2N3919 NPN Si TO-3 RF ..... \$1.50 2N3638 PNP Si TO-5 ..... 5/\$1.00 2N2218A NPN Si TO-5 ..... 4/\$1.00</p>		<p><b>C/MOS (DIODE CLAMPED)</b> 74C 02 — \$ .55 CD 4019 — \$1.20 74C 10 — \$ .60 CD 4022 — \$2.10 74C 157 — \$2.15 CD 4023 — \$ .53 74C 165 — \$3.50 CD 4024 — \$2.15 CD 4001 — \$ .53 CD 4025 — \$ .50 CD 4002 — \$ .53 CD 4026 — \$5.00 CD 4006 — \$3.60 CD 4027 — \$1.20 CD 4007 — \$ .60 CD 4028 — \$2.75 CD 4009 — \$ .80 CD 4029 — \$4.80 CD 4010 — \$ .65 CD 4030 — \$ .53 CD 4011 — \$ .53 CD 4035 — \$2.30 CD 4012 — \$ .53 CD 4042 — \$2.75 CD 4013 — \$1.00 CD 4046 — \$3.75 CD 4015 — \$3.25 CD 4047 — \$3.60 CD 4016 — \$1.05 CD 4050 — \$1.05 CD 4017 — \$2.70 CD 4055 — \$3.20</p>			
<p><b>MINIATURE TRIM POTS</b> 5K, 10K, 25K, 50K, 100K. <b>\$7.5 EA. 3/\$2.00</b></p>		<p><b>CAPACITORS</b> 6V 30UF TANT .5/\$1.00 12V 200UF ELECT . \$ .30 200V 4.7UF ELECT . \$ .30 10UF 12V ELECT .5/\$1.00</p>		<p><b>Full Wave Bridges</b> PRV. 2A 6A 15A 200 95 1.25 \$3.00 400 1.15 1.50 \$4.00 600 1.35 1.75 \$5.00</p>			
<p><b>MULTI-TURN TRIM POTS</b> Similar to Bourns 3010 style 3/16" x 3/8" x 1 1/4" 50, 100, 500, 2000, 5000, 10,000 ohms <b>\$1.50</b></p>		<p><b>MAN-1, Red or Yellow</b> LED READOUT <b>\$2.50</b> MAN-3 READOUT <b>\$1.75</b></p>		<p>5311—CLOCK CHIP 6 DIGIT BCD HOLD COUNT, OUTPUT STROBE <b>\$6.75</b> 5314—CLOCK CHIP 6 DIGIT HOLD COUNT OUTPUT STROBE <b>\$6.75</b> 5316—ALARM CLOCK CHIP <b>\$6.75</b></p>			
<p><b>LIGHT ACTIVATED SCR'S</b> TO-18 200V 1A <b>\$1.75</b></p>		<p><b>MAN-1, Red or Yellow</b> LED READOUT <b>\$2.50</b> MAN-3 READOUT <b>\$1.75</b></p>		<p>2513-64x7x5 CHARACTER GEN. .... \$9.95 2516-64x6x8 STATIC CHARACTER GEN. .... \$9.95</p>			
<p><b>PRINTED CIRCUIT BOARD</b> 4 1/2"x6 1/2" single sided epoxy board, 1/16" thick, unetched. <b>\$5.00 ea. 5/\$2.20</b></p>		<p>1103 1024 bit RAM <b>\$4.75</b> NEC 6003 2048 bit RAM <b>\$9.50</b> 1101 256 bit RAM <b>\$1.75</b> 8225 64 bit-write RAM <b>\$2.75</b> 8223-PROM <b>\$4.75</b></p>		<p><b>SANKEN AUDIO POWER AMPS</b> Si 1010 G 10 WATTS <b>\$ 6.40</b> Si 1025 E 25 WATTS <b>\$17.95</b> Si 1050 E 50 WATTS <b>\$24.95</b></p>			
<p><b>MC14435 &amp; MC1405L. A TWOPIECE 8 1/2 DIGIT A/D CONVERTER SYSTEM FOR PANEL METERS AND DUM'S</b> <b>\$39.95</b></p>		<p>MM5203-2048 BIT ERASABLE PROM <b>\$24.00</b></p>		<p><b>LINEAR CIRCUITS</b> LM 309K 5V 1A REGULATOR <b>\$1.50</b> 723 -40 +40V REGULATOR <b>\$ .58</b> 301/748 Hi Per. Op. Amp. <b>\$ .30</b> LM 320 -5 or -15V REGULATOR <b>\$1.75</b> LM 376 V to 37V POS. REG. <b>\$ .58</b> 7414 or 741C OP. AMP. <b>\$ .31</b> 709C OPER AMP. <b>\$ .25</b> 340T-5, 12, 15, 18, 24V POS. REG TO-220 <b>\$1.75</b> 101 OPER AMP. HI PERFORM. <b>\$ .75</b> LM 308 Oper. Amp., Low Power <b>\$1.05</b> 747 -DUAL 741 <b>\$ .75</b> 711 COMPARTOR <b>\$ .31</b> 537 -PRECISION OP. AMP. <b>\$2.60</b> LM 3900 -QUAD OP. AMP. <b>\$ .49</b> LM 324 -QUAD 741 <b>\$2.20</b> 560 -PHASE LOCK LOOP <b>\$2.50</b> 561 -PHASE LOCK LOOP <b>\$2.50</b> 565 -PHASE LOCK LOOP <b>\$2.50</b> 567 -TONE DECODER <b>\$2.85</b> 703 -RF-IF AMP. <b>\$1.15</b> LM 370 -AGC SQUELCH AMP <b>\$1.45</b> 555 -2 us - 2 HR. TIMER <b>\$ .88</b> 1456 OP. AMP. <b>\$ .95</b> CA 3054 TRANSISTOR ARRAY <b>\$1.75</b> LM 380 -2W AUDIO AMP. <b>\$1.39</b> LM 377 -2W STEREO AUDIO AMP. <b>\$2.60</b> LM 381 -STEREO PREAMP. <b>\$1.69</b> LM 382 -DUAL AUDIO PREAMP. <b>\$1.69</b> LM 311 -HI PER. COMPARTOR <b>\$ .95</b> LM 319 -DUAL HI SPEED COMP. <b>\$1.15</b> LM 339 -QUAD COMPARTOR <b>\$1.45</b></p>			
<p>TIS 73 N FET ..... <b>\$ .50</b> 2N4891 UJT ..... <b>\$ .50</b> ER900 TRIGGER DIODES <b>4/\$1.00</b> 2N6028 PROG. UJT ..... <b>\$ .75</b></p>		<p>Conductive Elastometer low profile calculator keyboard. A 2 3/4" x 3 1/4" x 1/2" flex key. 19SK-6 keyboard having 0-9, +, -, x, =, K+C buttons with off, on switch. <b>\$6.00</b></p>		<p><b>TRIACS</b> PRV. 1A 10A 100 40 70 1.30 40 50 1.20 200 70 1.10 1.75 60 70 1.60 400 1.00 1.60 2.60 1.00 1.20 2.20 600 1.70 2.30 3.00</p>			
<p><b>VERIPAX PC BOARD</b> This board is a 1/16" single sided paper epoxy board, 4 1/2"x6 1/2" DRILLED and ETCHED which will hold up to 21 single 14 pin IC's or 8, 16 or LSI DIP IC's with busses for power supply connections. Is also etched for 22 pin connector <b>\$5.25</b></p>		<p>100x100 IMAGE SENSOR CHARGED COUPLED DEVICES USED IN SOLID STATE CAMERAS WITH APPLICATIONS <b>198.00</b></p>		<p><b>SCR'S</b> PRV. 1A 10A 100 40 70 1.30 40 50 1.20 200 70 1.10 1.75 60 70 1.60 400 1.00 1.60 2.60 1.00 1.20 2.20 600 1.70 2.30 3.00</p>			
<p>ME-4 IR LED <b>\$ .40</b> MT-2 PHOT TRANSISTOR <b>\$ .60</b> GREEN GAP OSL-16 LED <b>\$ .40</b> RED GAP OSL-3 LED <b>\$ .30</b> 16 PIN DIP SOCKETS <b>\$ .40</b> 14 PIN DIP SOCKETS <b>\$ .50</b></p>		<p><b>TTL IC SERIES</b> 74100 - 30 7476 - 45 7400 - 17 7480 - 61 7401 - 17 7483 - 99 7402 - 17 7485 - 130 7403 - 17 7486 - 48 7404 - 21 7490 - 71 7405 - 21 7491 - 110 7406 - 37 7492 - 75 7407 - 37 7493 - 71 7408 - 23 7495 - 85 7410 - 17 7496 - 85 7411 - 27 8267 - 195 7412 - 45 74107 - 45 7413 - 73 74121 - 55 7416 - 37 74123 - 91 7417 - 37 74125 - 65 7420 - 17 74126 - 70 7425 - 37 74150 - 99 7426 - 27 74151 - 85 7427 - 31 74153 - 105 7430 - 17 74154 - 149 7432 - 27 74155 - 105 7437 - 41 74157 - 119 7438 - 35 74163 - 149 7440 - 17 74164 - 179 7441 - 95 74165 - 179 7442 - 95 74173 - 155 7445 - 105 74175 - 180 7446 - 110 74177 - 150 7447 - 110 74181 - 350 7448 - 110 74192 - 145 7472 - 33 74193 - 130 7473 - 41 74195 - 89 7474 - 41 75324 - 175 7475 - 71 75491 - 110</p>		<p><b>REGULATED MODULAR POWER SUPPLIES</b> + 15VDC AT 100 ma, 115VAC INPUT ..... <b>\$24.95</b> 5VDC AT 1A, 115VAC INPUT ..... <b>\$19.95</b> 12V 6A ..... <b>\$24.95</b></p>		<p>8038C IC VOLTAGE CONTROLLED OSCILLATOR <b>\$4.95</b></p>	
<p>NEW FROM EICO—Listen to official FCC-Licensed background music (SCA) on your FM radio without commercials. EC5000 Kit, \$12.95 Postpaid. M&amp;K Electronic Corp., 135-33 Northern Blvd., Flushing, N.Y. 11354.</p>		<p>Terms: FOB Cambridge Mass. Send check or Money Order. Include Postage. Minimum Order \$5.00</p>		<p>8038C IC VOLTAGE CONTROLLED OSCILLATOR <b>\$4.95</b></p>			

Send 20c for our catalog featuring Transistors and Rectifiers; 145 HAMPSHIRE ST. Cambridge, Mass.



**SOLID STATE SALES**  
P.O. BOX 74A  
SOMERVILLE, MASS. 02143 TEL. (617) 547-4005

**WE SHIP OVER 95% OF OUR ORDERS THE DAY WE RECEIVE THEM**

CIRCLE NO. 42 ON READER SERVICE CARD

# Quality Electronic Components

SPECIAL SAVINGS DISCOUNT ON LINEAR AND DIGITAL INTEGRATED CIRCUITS

10% off from the retail of your I.C. order if a minimum \$25.00 based on single lot prices. 7% off for \$50.00 or more, 10% for \$100.00 or more. Additional large quantity discounts offered.

## TTL & CMOS INTEGRATED CIRCUITS

7400N	25c	7445N	.81c	7459N	.90c	74193N	\$1.17	4027AE	.67c
7401N	25c	7446N	.81c	7458N	.81c	74193N	\$2.75	4028AE	\$1.09
7402N	25c	7447N	.81c	74107N	.32c	74199N	\$2.75	4029AE	\$1.42
7403N	25c	7448N	.90c	74121N	.38c	4000AE	.30c	4030AE	.50c
7404N	25c	7450N	.23c	74122N	.45c	4001AE	.30c	4033AE	\$1.67
7405N	25c	7451N	.23c	74123N	1.08	4002AE	.30c	4034AE	\$3.34
7406N	25c	7453N	.23c	74141N	.99c	4036AE	\$1.50	4035AE	\$1.42
7407N	25c	7454N	.23c	74150N	\$1.44	4008AE	.30c	4040AE	\$1.67
7408N	25c	7459N	.25c	74151N	.90c	4008AE	\$1.17	4041AE	.92c
7409N	25c	7460N	.23c	74153N	.81c	4009AE	.67c	4042AE	.84c
7410N	25c	7472N	.36c	74155N	.81c	4010AE	.67c	4043AE	.67c
7411N	25c	7473N	.32c	74156N	.81c	4011AE	.30c	4044AE	.67c
7412N	25c	7474N	.32c	74157N	.72c	4012AE	.30c	4046AE	\$2.51
7413N	25c	7475N	.36c	74158N	\$1.53	4013AE	\$1.67	4050AE	.58c
7414N	25c	7476N	.36c	74160N	\$1.26	4015AE	\$1.17	4051AE	\$1.50
7415N	25c	7480N	.72c	74161N	\$1.17	4016AE	.63c	4052AE	\$1.50
7416N	25c	7482N	.72c	74162N	\$1.26	4017AE	\$1.17	4053AE	\$1.50
7417N	25c	7484N	.72c	74163N	\$1.26	4018AE	\$1.67	4060AE	\$1.67
7418N	25c	7485N	\$1.40	74164N	\$1.35	4019AE	.58c	4066AE	\$1.00
7419N	25c	7486N	.32c	74165N	\$2.45	4020AE	\$1.67	4071AE	.30c
7420N	25c	7489N	\$4.47	74166N	\$2.00	4021AE	\$1.50	4072AE	.30c
7421N	25c	7490N	.50c	74167N	\$1.00	4022AE	\$1.25	4073AE	.30c
7422N	25c	7491N	.81c	74168N	.81c	4023AE	.30c	4075AE	.30c
7423N	25c	7492N	.50c	74181N	\$2.25	4024AE	\$1.00	4081AE	.30c
7424N	25c	7493N	.50c	74192N	.90c	4025AE	.30c	4082AE	.30c
7425N	25c	7494N	.81c	74193N	\$1.26	4026AE	.67c		

## LINEAR INTEGRATED CIRCUITS

555V MINIDIP TIMER	82.5c	558V MINIDIP DUAL AMP	75.0c
565A DIP PLL	\$3.38	567V MINIDIP DECODER	\$3.38
741V MINIDIP OP AMP	50.0c	723A DIP VOLTAGE REG.	82.5c
748V MINIDIP OP AMP	42.0c	747A DIP DUAL AMP	97.5c
LM129 5 VOLT REG	\$1.80	LM3900 DIP QUAD AMP	60.0c
LM135 15 VOLT REG	\$1.80	LM309K 5 VOLT REG	\$1.75

## MINIATURE ALUMINUM ELECTROLYTIC CAPACITORS

— AXIAL LEAD TYPE —

100 ±10%	10 ±5%	50 ±10%	100 ±5%	1000 ±10%	5000 ±10%
1 uFD/50V	.14c	.12c	.11c	.10c	.09c
2.2 uFD/50V	.14c	.12c	.11c	.10c	.09c
3.3 uFD/50V	.14c	.12c	.11c	.10c	.09c
4.7 uFD/50V	.14c	.12c	.11c	.10c	.09c
10 uFD/50V	.14c	.12c	.11c	.10c	.09c
22 uFD/50V	.14c	.12c	.11c	.10c	.09c

## 1 AMP SILICON RECTIFIERS

1N4001 50 PIV 1/2" S1	100/56	1N4005 600 PIV 8/51	100/59
1N4007 1000 PIV 6/51	100/51	100/588	

## SILICON SIGNAL & SWITCHING DIODE

1N4148 (1N914 equiv.)	12/51	100/57	1M/550	5M/520
-----------------------	-------	--------	--------	--------

## MOLEX SOLDERCON IC TERMINALS

100/S1	500/34.20	1000/38.20	5000/38.20	50,000/52/75
--------	-----------	------------	------------	--------------

## LED 7 SEGMENT DISPLAYS

DATALIT-704	\$1.00	DATALIT-707	\$1.50
-------------	--------	-------------	--------

## MACHINE SCREWS, NUTS & LOCKWASHERS

2-56 1/8" Screw	.90c/c	2-56 1/8" Screw	.98c/c	6 AMP SPST N.O. CONTACTS
4-40 1/8" Screw	.96c/c	4-40 1/8" Screw	.96c/c	
6-32 1/4" Screw	.92c/c	6-32 1/4" Screw	.86c/c	
8-32 3/8" Screw	\$1.05/c	8-32 5/8" Screw	\$1.35/c	
2-56 Hex Nut	.51/35c	2 Lock Washer	45c/c	Call Voltage 1 10
4-40 Hex Nut	.51/45c	4 Lock Washer	45c/c	5V \$2.00 \$1.50
6-32 Hex Nut	.51/45c	6 Lock Washer	45c/c	6V \$2.00 \$1.50
8-32 Hex Nut	.51/50c	8 Lock Washer	45c/c	12V \$2.00 \$1.50
				24V \$2.00 \$1.50

## DISC CAPACITORS

100 pF/500V	.7c	5.5c	4.5c	3.6c	8 pin Solder	27c	21c
220 pF/500V	.7c	5.5c	4.5c	3.6c	14 pin Solder	29c	23c
470 pF/500V	.7c	5.5c	4.5c	3.6c	16 pin Solder	32c	25c
1001/500V	.7c	5.5c	4.5c	3.6c	18 pin Solder	34c	26c
0022/500V	.7c	5.5c	4.5c	3.6c	24 pin Solder	54c	42c
0047/500V	.7c	5.5c	4.5c	3.6c			
01/500V	10c	7.5c	6.3c	5.0c	8 pin W.W.	38c	30c
01/25V	5c	6.0c	5.3c	4.2c	14 pin W.W.	50c	39c
022/25V	6c	4.0c	3.5c	2.7c	16 pin W.W.	54c	42c
047/25V	9c	6.0c	5.3c	4.2c	18 pin W.W.	88c	68c
1/25V	12c	9.0c	7.5c	6.0c	24 pin W.W.	.99c	80c

## 1/2 & 1/4 WATT CARBON COMP. RESISTORS

5 each of the 85 standard 10% values (2.2-22M) 1/2 W Resistors (425 pcs.)	Sorted by value \$12/set 2-4 are \$11/set 5-9 are \$10/set.
5 each of the 70 standard 10% values (10.5-56M) 1/4 W Resistors (350 pcs.)	Sorted by value \$12/set 2-4 are \$11/set 5-9 are \$10/set.

## SILICON TRANSISTORS

EN18	10-106	21c	18.5c	16.5c	2N3645	10-105	20c	17.5c	16.0c
EN30	10-106	21c	18.5c	16.5c	2N3646	10-106	22c	19.0c	17.5c
EN22	10-106	21c	18.5c	16.5c	2N3904	10-92	22c	19.0c	17.5c
EN2369A	10-106	21c	18.5c	16.5c	2N3956	10-92	22c	19.0c	17.5c
EN2907	10-106	21c	18.5c	16.5c	2N4174	10-92	22c	19.0c	17.5c
2N717	10-98	18c	16.0c	14.5c	2N4126	10-92	22c	19.0c	17.5c
2N391A	10-98	22c	19.0c	17.5c	2N4401	10-92	22c	19.0c	17.5c
2N392	10-98	22c	19.0c	17.5c	2N4403	10-92	22c	19.0c	17.5c
2N393	10-98	22c	19.0c	17.5c	2N5587	10-92	22c	19.0c	17.5c
2N394	10-98	22c	19.0c	17.5c	2N5589	10-92	22c	19.0c	17.5c
2N3563	10-106	20c	17.5c	17.5c	2N5129	10-106	19c	17.0c	15.0c
2N3565	10-106	20c	17.5c	16.0c	2N5133	10-106	19c	17.0c	15.0c
2N3638	10-105	20c	17.5c	16.0c	2N5134	10-106	19c	17.0c	15.0c
2N3682A	10-105	20c	17.5c	16.0c	2N5137	10-106	19c	17.0c	15.0c
2N3647	10-106	20c	17.5c	16.0c	2N5138	10-106	19c	17.0c	15.0c
2N3641	10-105	20c	17.5c	17.5c	2N5139	10-106	19c	17.0c	15.0c
2N3643	10-105	20c	17.5c	16.0c	2N3055	10-3	\$1.00	95.0c	65.0c

## FIELD EFFECT TRANSISTORS

MPT102	10-92	14	380	350	2N5457	10-92	47	420	375
--------	-------	----	-----	-----	--------	-------	----	-----	-----

## NPN DARLINGTON TRANSISTOR

MPS-A13	10-92	Min DC Current Gain of 5000 at 10mA.	.38	.320	.290
---------	-------	--------------------------------------	-----	------	------

Send for Free Catalog or Mail Readers Service Card  
COD ORDERS ACCEPTED FOR SAME DAY SHIPMENT  
CALL 218-681-6674

## DIGI-KEY CORPORATION

P.O. Box 126 Thief River Falls, MN 56701

CIRCLE NO. 16 IN READER SERVICE CARD

## TAPE AND RECORDERS

RENT 4-Track open reel tapes—all major labels—3,000 different — free brochure. Stereo-Parti. 55 St. James Drive, Santa Rosa, Ca. 95401.

1930-1962 Radio Programs. Reels. \$1.00 Hour! Cassettes. \$2.00 Hour! Mammoth Catalog. \$1.25 AM Treasures. Box 192F. Babylon, N.Y. 11702.

## CASSETTE LABELS

Plain white cassette labels, Norelco cassette cleaners, famous brand cassettes				10M
10 reels	Send for open reel and cassette discount catalog			
Cassette Labels (Multiples of 10)	10-99	100	1000	10M
Norelco Cassette Cleaner	.02	.015	.01	.006
F Scotch Cassette SC90HE	.60	.55	.50	.45
10 1/2" Metal, MAB Reel, Used	3.75	3.10	2.95	2.80
*Buy 10 SC90HE Get 5 Free	1.00	.90	.80	.75

Minimum Order: \$5.00  
1776 COLUMBIA ROAD, N.W. WASHINGTON, D.C. 20009

## SAXITONE TAPE SALES

RECEIVE TEN Half-Hour 7-1/2 IPS four track tapes. New live recordings plus year's club membership. Send \$10.00 to: Amatapex, 5411 Bocage St., Montreal, P Q H4J 1A2. U.S. Inquiries.

OLD Radio on cassettes. \$1.50 per show. Catalog 25 cents Refundable. Radio Classics, Box 804A, Mattituck, N.Y. 11952.

## GOVERNMENT SURPLUS

GOVERNMENT Surplus. How and Where to Buy in Your Area. Send \$2.00. Surplus 30177-PE Headquarters Bldg., Washington, D.C. 20014.

MANUALS for Govt Surplus radios, test sets, scopes. List 50 cents (coin). Books. 7218 Roanne Drive, Washington, D.C. 20021.

## PERSONALS

MAKE FRIENDS WORLDWIDE through international correspondence. Illustrated brochure free. Hermes, Berlin 11, Box 110660-ZD, Germany.

## INSTRUCTION

LEARN ELECTRONIC ORGAN SERVICING at home all makes including transistor. Experimental kit—troubleshooting. Accredited NHCSC. Free Booklet. NILES BRYANT SCHOOL. 3631 Stockton, Dept. A, Sacramento, Calif. 95820.

LEARN WHILE ASLEEP. Hypnotize! Strange catalog free. Auto-suggestion. Box 24-ZD, Olympia, Washington 98501.

DEGREE IN ELECTRONICS through correspondence. Free catalog. Grantham, 2000 Stoner Avenue, Los Angeles, California 90025.

INTENSIVE 5 week course for Broadcast Engineers. F.C.C. First Class license. Radio Engineering Incorporated, 61 N. Pineapple Ave., Sarasota, Florida 33577 and 2402 Tide-water Trail, Fredericksburg, VA 22401.

### F.C.C. EXAM MANUAL

PASS FCC EXAMS! Memorize, study — "Test Answers" for FCC 1st and 2nd class Radio-Telephone licenses. Newly revised multiple choice questions and diagrams cover all areas tested in FCC exams plus "Self-Study Ability Test." \$8.95 postpaid. Moneyback Guarantee.

COMMAND PRODUCTIONS P.O. BOX 26348-P  
RADIO ENGINEERING DIVISION SAN FRANCISCO, CALIF. 94126

SCORE high on F.C.C. Exams... Over 300 questions and answers. Covers 3rd, 2nd, 1st and even Radar. Third and Second Test. \$14.50. First Class Test, \$15.00. All tests. \$26.50. R.E.I., Inc., Box 806, Sarasota, Fla. 33577.

FCC License, electronics design, satellite communications, through correspondence. Free catalog. Genn Tech, 5540 Hollywood Blvd., Los Angeles, Ca 90028.

UNIVERSITY DEGREES BY MAIL! Bachelors, Masters, Ph.D's. Free revealing details. Counseling, Box 1162-PE5, Tustin, California 92680.

## INVENTIONS WANTED

CASH-ROYALTIES for patented, unpatented Inventions. Global Marketing Service, 139-P Lake Mercet Hill South, San Francisco, California 94132.

INVENTORS: Protect your ideas! Free "Recommended Procedure", Washington Inventors Service, 422T Washington Building, Washington, D.C. 20005.

FREE PAMPHLET: "Tips on Safeguarding Your Invention." Write: United States Inventors Service Company, 708-T Carry Building, Washington, D.C. 20005.

# inventors

## ...Manufacturers Need New Products

If you have an idea for a new product, or a way to make an old product better, contact us, "the idea people." We'll develop your idea, introduce it to industry, negotiate for cash sale or licensing.

Send for our FREE "Invention Kit." It has a special "Invention Record Form," an important brochure, "Your Invention - Its Development, Protection & Marketing," and a Directory of 500 Corporations Seeking New Products. You'll learn how ideas become a reality!

**RAYMOND LEE ORGANIZATION**  
230 Park Avenue, New York, N.Y. 10017

I'd like to find out how to take action on my idea. Send Free "Invention Kit No. A-112"

Name \_\_\_\_\_ Please Print  
Address \_\_\_\_\_  
City \_\_\_\_\_ State \_\_\_\_\_ Zip \_\_\_\_\_

SAN FRANCISCO LOS ANGELES TORONTO VANCOUVER DENVER CHICAGO

## INVENTIONS IDEAS WANTED

Manufacturers Need New Products. Your invention, new product or idea developed for cash / royalty sales by Professional Organization.

"No Idea Is Too Small"★  
Free Booklet: "How to Safeguard, Develop and Market Your Ideas to Industry"

**LAWRENCE PESKA ASSOCIATES**  
500 Fifth Ave., Dept. MM, N.Y.C. 10036  
Phone (212) 354-9696

A trademark of Lawrence Peska Associates, Inc.

## BUSINESS OPPORTUNITIES

I MADE \$40,000.00 Year by Mailorder! Helped others make money! Free Proof. Torrey, Box 318-NN, Ypsilanti, Michigan 48197.

FREE CATALOGS. Repair air conditioning, refrigeration. Tools, supplies, full instructions. Doolin, 2016 Canton, Dallas, Texas 75201.

MAILORDER MILLIONAIRE helps beginners make \$500 weekly. Free report reveals secret plan! Executive (1K\$), 333 North Michigan, Chicago 60601.

PIANO TUNING LEARNED QUICKLY AT HOME! Tremendous field! Musical knowledge unnecessary. GI approved. Information free. Empire School, Box 450327, Miami 33145.

\$200.00 DAILY in Your Mailbox! Your opportunity to do what mail-order experts do. Free details. Associates, Box 136-J, Holland, Michigan 49423.

FREE BOOK "2042 unique proven enterprises." Work home! Hayling-B, Carlsbad, CA 92008.

## REMAILS

LETTERS FORWARDED. Will Stamp and Zip. Max. 2. 50 cents. Malo, P. O. Box 1597, Boston, MA 02104.

## PRINTING

PRINTING Presses, Type, Supplies. Lists 10 cents. Turnbaugh Service, Mechanicsburg, PA 17055.

## EMPLOYMENT OPPORTUNIT



## ADVERTISERS INDEX

READER SERVICE NO.	ADVERTISER	PAGE NUMBER
1	Adva Electronics	96
2	Allison Automotive Company	24
3	Altaj Electronics	95
20	Ancrona Corp	91
6	Antenna Specialists Co., The	59
7	B & K Precision, Products of Dynascan	13
8	Babylon Electronics	101
	Bell & Howell Schools	82, 83, 84, 85
	CREI Capitol Radio Engineering Institute	52, 53, 54, 55
9	Cleveland Institute of Electronics	72, 73, 74, 75
10	Clifford's Hi-Fi Wholesalers	86
11	Continental Specialties Corporation	87
12	Cook's Institute of Electronics Engineering	89
13	Crutchfield	87
14	Delta Electronics Co	92
15	Delta Products, Inc	23
16	Digi-Key Corporation	100
	Dixie Hi-Fidelity	86
17	EICO	6
18	Edmund Scientific Co	102
25	Exar Integrated Systems, Inc	22
	Florida Institute of Technology	78
19	Fluke Mfg. Co., Ltd., John	79
5	Heath Company	62, 63, 64, 65
21	Hickok Electrical Instrument Co., The	14
22	Illinois Audio	88
23	International Electronics Unlimited	90
24	International Hi-Fi Distributors	89
26	James	98
33	Johnson Co., E.F.	25
27	Lafayette Radio Electronics	69
28	McIntosh Laboratory, Inc	71
29	MTS	81
30	Mallory & Co., P.R.	26
50	Mini-Micro Mart	89
	NRI Schools	8, 9, 10, 11
	National Technical Schools	18, 19, 20, 21
40	New Electronics	96
31	New-Tone Electronics	92
32	OEMorsco	96
34	Pace Communications	71
35	Perma-Power	68
36	Phase Linear Corporation	77
37	Poly Paks	97
38	RCA	7
39	Radio Shack	2
41	Sansui Electronics Corp	16, 17
42	Solid State Sales	99
43	Southwest Technical Products Corp	5
44	Stanton Magnetics, Inc.	THIRD COVER
46	Tap Discount Audio	87
45	Teletronics Company of America	88
47	Tri-Star Corporation	89
48	Tucker Corporation	79
49	U.S. Pioneer Electronics Corp	SECOND COVER, 1
4	United Audio Products, Inc	FOURTH COVER

CLASSIFIED ADVERTISING 90, 92, 96, 98, 99, 100, 101

## HOME ENTERTAINMENT FILMS

SAVE A BUCK IN '75! HORROR FILM SPECIALS: Adventures of Batman (Electrical Brain, Poison Peril, Executioner Strikes); or Dracula, Son of Frankenstein, Bride of Frankenstein, Mummy's Ghost—Your Choice Super 8, B&W, 200' reels. \$7.95 each delivered while they last. Ali-Foreman Championship Fight—Super 8, Color, 200' reel, \$18.95 PPD (Regular \$19.95) Send for revised Castle, Columbia or Sportlite Catalogs, 30 cents each (coins or stamps, please). SPORTLITE, Elect. Dept.-5, Box 24-500, Speedway, Indiana 46224.

## TREASURE FINDERS

FREE FACT-FILLED CATALOG! World's largest selection! Metal detectors starting at \$79.50. Two year guarantee! Three factories. U.S.-Canada, 1,200 dealers - Service Centers nationwide. Finest instruments at any price! Budget Terms. Dealer inquiries invited. Write: White's Electronics, Inc. Dept. PD55, 1011 Pleasant Valley Road, Sweet Home, Oregon 97386.

TREASURE FINDER locates buried gold, silver, coins, treasures. 6 powerful models. Instant financing available. Write or call for free catalog. Phone (713) 682-2728 day or night. Dealer inquiries invited. Relco, Dept. AA20, Box 10839, Houston, Texas 77018.

## REAL ESTATE

FREE SUMMER CATALOG! Over 2,500 top values in 40 states coast to coast! UNITED FARM AGENCY, 612-EP West 47th St., Kansas City, Mo. 64112.

## MINICOMPUTERS

WILL Buy, Sell or Trade homemade and other peripheral devices, software programs, etc. AL COVE, 230 Main, North Reading, Mass. 01864.

## MAGNETS

MAGNETS. All types. Specials-20 disc, or 10 bar, or 2 stick, or 8 assorted magnets. \$1.00. Magnets, Box 192-H, Randallstown, Maryland 21133.

## RECORDS

OLDIES. 45rpm. Free Catalog. Corny's Record Shop, Box 166TG, Mason, Ohio 45040.

## RUBBER STAMPS

RUBBER address stamps. Free catalog, 45 type styles. Jackson's, Box 443G, Franklin Park, Ill. 60131.

## BOOKS AND MAGAZINES

FREE catalog aviation/electronic/space books Aero Publishers, 329PE Aviation Road, Fallbrook, California 92028.

FREE book prophet Elijah coming before Christ. Wonderful bible evidence. Megiddo Mission, Dept. 64, 481 Thurston Rd., Rochester, N.Y. 14619.

BOOKS—thousands titles, bargains. Catalog Free. Cassiano, 92-27 New York Blvd., Jamaica, New York 11433.

POPULAR ELECTRONICS INDEXES. Detailed and complete subject indexes now available to both 1972 and 1973 magazines. Hundreds of subject references to help you quickly find that special project, article, or product test. 1972 and 1973 editions \$1.00 each. INDEX box 2228, Falls Church, Va. 22042.

"LEARNING ABOUT SYNTHESIZERS." A must for anyone interested in electronic music. Write: Music Studios, South Village Square, Amherst, Mass. 01002. \$5 plus 50 cents handling.

## PLASTICS

CASTOLITE pours like water, hardens like glass without heat. Crystal clear, colors. Embed flowers, seashells, mementos, anything. Make fine gifts. Form flexible molds over patterns of any shape, size. Reproduce your own designs in plastics, candlewax, metal, plaster, cement. Free Brochure. Or send \$1.00 for illustrated Manual Catalog. Profitable. CASTOLITE, Dept. 75E/PE, Woodstock, Ill. 60098.

## DIP SOCKETS

8 PIN PCB 9-22 24 PIN PCB 4-75  
14 PIN PCB -26 40 PIN PCB 1-25  
16 PIN PCB -30 14 PIN WIRE WRAP -35

## POTTER & BRUMFIELD



Type KHP Relay 4 PDT 3A Contacts  
24 VDC (650 coil) ea. \$1.50 10/\$14.00  
120 VAC (10.5 MA coil) ea. \$1.75 10/\$15.75

## CARBON RESISTORS

Carbon Resistors 1/4 Watt 5% full prime, all values in stock. 10 per value (minimum quantity). . . . . ten for \$4.45

## FAIRCHILD "TRIMPOTS"



ea. only \$1.89 10 for \$7.50  
Brand new 20 turn precision trimmers. These are prime parts mostly individually packed in sealed envelopes. These values in stock:  
50 OHM 1 K 5 K 25 K  
500 OHM 2 K 10 K

## DIODE ARRAY



10 1N914 Silicon Signal Diodes in one package. 20 leads spaced .1"; no common connections. ea. \$3.25 10 for \$2.25

## 8270 DIP 4-BIT SHIFT REGISTER

4-Bit Shift Register—parallel and serial input and output; data entry is synchronized with clock pulse.  
ea. \$3.50 10 for \$3.95

## 2N3055 NPN TRANSISTOR

2N3055 Transistor (power) PD-1154;  
VCE-60V; HFE-50; FT-30K; Case-TO-3  
ea. \$1.15 10 for \$6.95

## 2102-2 MOS 1024 BIT MEMORY

FULLY DECODED STATIC RANDOM ACCESS MEMORY DIRECTLY TTL COMPATIBLE INPUTS AND OUTPUT SINGLE 5V SUPPLY - - NO CLOCKS OR REFRESH  
\$6.95 EA. (DIP) 8 FOR \$49.95

## 7400 DIP TTL SPECIAL

7400 DIP TTL Special Signetic/House Numbered. ea. \$3.17 10 for \$1.50

## 7404 DIP TTL

7404 DIP TTL Special Hex Inverter, Signetic/House Numbered.  
ea. \$3.17 10 for \$1.50

## SEND FOR FREE FLYER!

C.O.D. PHONE ORDERS ACCEPTED—\$10 MINIMUM

All parts surplus and tested; leads plated with gold or solder. Orders for \$5 or more are shipped prepaid; smaller orders add 5% California residents add Sales Tax. 10% shipped within 24 hours. p. O. Box 41727 Sacramento, Ca. 95841

## BABYLON ELECTRONICS

(916) 334-2161

CIRCLE NO. 8 ON READER SERVICE CARD

## HYPNOTISM

SLEEP learning. Hypnotic method. 92% effective. Details free. ASR Foundation, Box 23429EG, Fort Lauderdale, Florida 33307.

FREE Hypnotism. Self-Hypnosis. Sleep Learning Catalog! Drawer H400, Ruidoso, New Mexico 88345.

AMAZING self-hypnosis record releases fantastic mental power. Instant results! Free trial. Write: Forum (AA5), 333 North Michigan, Chicago 60601.

## MISCELLANEOUS

WINEMAKERS: Free illustrated catalog yeasts, equipment. Semplex, Box 12276P, Minneapolis, Minn. 55412

LOVELY DRESSED DOLL. 7-1/2"; hides the toilet paper. Blue, Pink. \$4.00—NELHEK, 150-50 35th Ave. 45D, Flushing, N. Y. 11354.

SENSATIONAL conversation piece! Computer-created "Mona Lisa." 16" by 12" suitable for framing. \$4.00. Sigma Services, 6913 Furman Parkway, Riverdale, Maryland 20840.

# LIVE IN THE WORLD OF TOMORROW... TODAY!

And our FREE 180 PAGE CATALOG is packed with exciting and unusual values in electronic, hobby and science items — plus 4,500 finds for fun, study or profit... for every member of the family.

**A BETTER LIFE STARTS HERE**

## LOW-COST ULTRASONIC CLEANER

Full pint capacity at price of old 1/3 pt. model. For home, industry! Makes grimy, small delicate parts & objects sparkle — from diamonds to dentures, electronic items to coins & combs. Fully transistorized metal & stainless steel cabinet (6 x 4 x 4") with built-in tank has frequency control, item platform. Incls. cleaning powder, mfrs. 1-yr guar. 110-120v AC.



Stock No. 71,003AV ..... \$65.95 Ppd.  
 No. 71, 198AV ..... 1/4 Qt. Sz. \$115.00 Ppd.  
 #85, 128AV (33 lb.) ..... 1/2 Gal. Sz. \$299.50 FOB

## Re-Ne LASERS FROM \$115.00

Edmund quality, TEM<sub>00</sub> mode, cold cathode for long life. Completely self-contained units: solid state power supply; 110v AC. 0.3mW min — GREAT GENERAL PURPOSE LASER: 1.2mm beam dia., 2.0mRad beam Diverg.



Stock No. 79,061AV ..... \$115.00 Ppd.  
 1.0mW min — HI-PERFORMANCE LAB LASER: 1.2mm beam dia., 1.0mRad beam Diverg.  
 Stock No. 79,050AV ..... \$180.00 Ppd.  
 3.0mW min — DEPENDABLE HI-POWERED LASER: 1.0mm beam dia., 0.8mRad beam Diverg.  
 Stock No. 79,052AV ..... \$350.00 Ppd.

## NEW! KIRLIAN PHOTOGRAPHY KIT!

Experiment in the fascinating new field of "Kirlian electrophotography"— images obtained on film without camera or lens by direct recording of electric charge transmitted by animate & inanimate objects. Each "aura" differs—animate aura said to change corresponding to physical changes. Kit incls. portable darkroom, double transformer isolated from power source; instrs.



Stock No. 71,938AV ..... \$49.95 Ppd.  
 "HIGH VOLTAGE PHOTOGRAPHY" by H.S. Dakin  
 No. 9129AV (60-PG. PAPERBACK BDOK) ..... \$5.00 Ppd.  
 DELUXE KIRLIAN PHOTOGRAPHY SET  
 No. 72,053AV ..... \$399.00 Ppd.

## LOW COST 7X INFRA-RED VIEWER

For infra-red crime detection surveillance, security system alignment, I.R. detection, laser checking, nite wildlife stucy, any work req. I.R. detection & conv. to visible spectrum. Self cont. scope w/everything incl I.R. light source, 6v or 12v power, 6032 I.R. converter tube, f/4.5 objective lens, adjust. triplet eyepiece. Focuses from 10' to infinity.



No. 1659AV (11 x 14 1/4 x 3") ..... \$275.00 Ppd.  
 WITHOUT LIGHT SOURCE  
 No. 1648AV ..... \$225.00 Ppd.

## MAIL COUPON FOR GIANT FREE CATALOG!

180 PAGES • MORE THAN **4500 UNUSUAL BARGAINS**

Completely new 1975 edition. New items, categories, illustrations. Dozens of electrical and electromagnetic parts, accessories. Enormous selection of Astronomical Telescopes. Unique lighting and ecological items. Microscopes, Binoculars, Magnifiers, Magnets, Lenses, Prisms. Hard-to-get surplus bargains. Ingenious scientific tools. 1000's of components.

**EDMUND SCIENTIFIC CO.**  
 300 Edscorp Building, Barrington, N. J. 08007  
 Please rush Free Giant Catalog "AV"

Name \_\_\_\_\_  
 Address \_\_\_\_\_  
 City \_\_\_\_\_ State \_\_\_\_\_ Zip \_\_\_\_\_

## COMPLETE & MAIL WITH CHECK OR M.O.

**EDMUND SCIENTIFIC CO.** 300 Edscorp Building, Barrington, N.J. 08007

How Many	Stock No.	Description	Price Each	Total
<input type="checkbox"/>	PLEASE SEND GIANT FREE CATALOG "AV"			
<input type="checkbox"/>	Charge my BankAmericard			
<input type="checkbox"/>	Charge my Master Charge			
Add Handling Chg.: \$1.00, Orders Under \$5.00, 50¢, Orders Ovr \$5.00				
Interbank No. _____				
My Card No. Is _____				
Card Expiration Date _____				
30-DAY MONEY-BACK GUARANTEE. Name _____				
You must be satisfied or return any purchase in 30 days for full refund. *\$15.00 minimum Address _____				
City _____ State _____ Zip _____				

## 3-CHANNEL COLOR ORGAN KIT



own channel (max. 300w ea.). Kit features 3 neon indicators, color intensity controls, controlled individ SCR circuits; isolation transformer; custom plastic housing; instr.

Stock No. 41,831AV ..... \$18.95 Ppd

## AM RADIO FITS IN/ON YOUR EAR!



Wear it inconspicuously *everywhere*, listen as you work (lawn, yard, office), watch (game, beach) or wait. Instant music, news, sports. No gimmick, our 6/10-oz. technological wonder has integrated circuit, 11 transistors, patented ferrite antenna/tuner/volume dial. Uses normal silver oxide hearing aid batt. (incl) for approx. 100 hrs. playing. New batt. to slip in avail. at drug stores (about 50c). No lengthy wires, bulky cases, or power-packs!

Stock No. 42,275AV ..... \$14.95 Ppd.

## KNOW YOUR ALPHA FROM THETA!



For greater relaxation, concentration, listen to your Alpha-Theta brainwaves. Ultra-sensitive electrode headband slips on/off in seconds—eliminates need for messy creams, etc. Atch'd to amplifier, filters brainwaves, signals beep for ea. Alpha or Theta wave passed. Monitoring button stimulates Alpha sound; audio & visual (L. E. D.) feedback. Reliable, easy-to-use unit comparable to costlier models. Completely safe. Comprehensive instruction booklet.

No. 1635AV (8 x 3 x 4"; 24 oz.) ..... \$134.50 Ppd.  
 DELUXE "ON" TIME MONITOR—Measures and records % LOW COST "STARTER" UNIT  
 No. 1652AV ..... (15 x 10 x 6") ..... \$349.50 Ppd.  
 No. 71809AV ..... \$55.00 Ppd.  
 DO-IT-YOURSELF KIT ..... No. 61,069AV ..... \$34.95 Ppd.

## QUALITY DETECTOR UNDER \$40



New Edmund-developed, fully transistorized BFO unit capable of locating quarter at 18" — powerful 6-trans. oscillator-amplifier circuit. Easily compares to others priced 50% higher! Aluminum pole and housing—not plastic! 6" waterproof search coil (Faraday shielded to elim. outside interference); long 50-hr. battery

(9V) life; powerful 2" speaker; 1-knob on-off tune control. Perfect balance; lightweight (2 lbs.). Great buy!  
 Stock No. 80,222 AV ..... \$39.95 Ppd.

## 4 1/4" ASTRONOMICAL TELESCOPE

See moon craters, rings of Saturn, double stars. New equatorial mount; f/10, 1/4 wave mirror (Pyrex). Gives theoretical limit of resolution. Rack & pinion focusing. Aluminum tube. 6X finder. 1" F.L. 45X Kellner achromatic eyepiece and Barlow lens to double & triple power up to 135X. Free Star Chart plus 2 Books.

Stock No. 85,105AV (Shipping Wt. 42 lbs.) ..... \$149.50 FOB  
 4 1/4" WITH CLOCK DRIVE ..... No. 85,107AV ..... \$189.50 FOB  
 6" REFLECTOR TELESCOPE (48X to 360X) ..... No. 85,187AV ..... \$249.50 FOB  
 6" WITH CLOCK DRIVE ..... No. 85,086AV ..... \$285.00 FOB  
 3" DELUXE REFLECTOR (30X to 90X) ..... No. 80,162AV ..... \$79.95 Ppd.  
 STANDARD 3" REFLECTOR ..... No. 85,240AV ..... \$49.95 Ppd.

# Altaj Electronic Bargains

PRICES SLASHED! WE WANT YOUR BUSINESS. SATISFACTION GUARANTEED ON EVERY ITEM



**CALCULATOR BASIC KIT WITH TI CHIP**  
Includes case with matching all function keyboard, and 9 digits of LED readouts plus a Texas Instruments TMS 103 NC calculator chip. (Same style chip as in TI Datamath calculator). All the basics for building your own hand held calculator. Special — \$9.95 Quantity Limited.

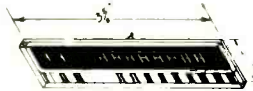

**BURROUGHS PANAPLEX II  
12 DIGIT READOUT**

#BR13251 Neon 7 segment readout. Latest design for calculators, etc. Requires 160 VDC. Right hand decimals. Brand new, factory fresh. We include mating socket FREE \$4.95  
NOTE: With purchase of above readout array we offer motorola 2N5401 PNP High Voltage driver transistor for 10¢ each.



**LM308K**  
TO-3 Case, 1 AMP 5 VDC Voltage Regulator. Brand New By National \$1.19

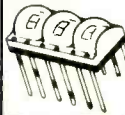

**3 DIGIT LED READOUT ARRAY**  
Like Litronix DL-33. 3 MAN-3 style readouts in one package. Factory new units Designed for calculators. Special — \$1.39 (3 Digits)



**OPCOA SLA-1 LED READOUT**  
.33 in. character. Left decimal pt. Uses 7447 driver. Easier to read than MAN-1. Factory prime units. Best Price in USA! \$1.19



**MAN-3 LED READOUTS**  
Brand new, factory prime units. .12 in. character. Common cathode. Perfect for calculators. 39¢ ea. Best Price Anywhere!

## CALCULATOR CHIP BONANZA PRICES SLASHED!

The newest and easiest to use chips available today. Made by famous US mfg. All are 28 pin DIP. Features: direct LED segment drive, low power consumption, internal keyboard debounce, internal clock oscillator, single supply voltage, internal keyboard encoding, and floating decimal point. Does not require many external components as do older types like CT5001, 5002, 5005, etc. We offer the most sophisticated functions for the lowest price anywhere.

Chip #1 — 8 Digit, Constant, Six Function (+, -, x, +, %, √) — \$3.95  
Chip #2 — 8 Digit, Memory, Six Function (+, -, x, +, √, M) — \$4.95  
Chip #3 — 8 Digit, Memory, Six Function (+, -, x, +, %, 1/x) — \$4.95

## DIGITAL ALARM CLOCK IC

The newest and easiest to use alarm chip on the market today. Features:

1. Single supply voltage.
2. LED intensity control
3. Simple time set.
4. 4 or 6 Digit LED Display
5. AM-PM indication
6. 24 Hr. Alarm.
7. 10 minute snooze.
8. Outperforms MM5316

Order #70250 — \$6.95 (2 FOR \$12)



## MM5314 NATIONAL CLOCK CHIP

The most popular clock chip around. We made a huge special purchase of factory fresh, prime units. Lowest price in USA. 24 Pin DIP. 4 or 6 Digits. With Specs. \$4.95

## MINI CORE MEMORY SPECIAL

Mfg. by DATARAM. Stores 180 words of 18 bits each. With sense amps and associated drive circuits. A complete memory system. We include 50 pages of data and schematics. Data only \$2.50 Brand New. Special \$24.95



## DIGITAL WRIST WATCH CRYSTAL

Brand new, mfg. by CTS-KNIGHT. 32.768 KHZ. Standard, most popular type. Special \$1.95

**COLOR ORGAN CONTROL MODULE**  
Completely self-contained. Has SCR circuitry. AC line cord, etc. From a close out by a mfg of color organs. New, unused \$1.95

## GE POWER TRANSISTOR ASSORTMENT

Plastic power devices. Includes NPN and PNP, darlington, high voltage, high current, and various other types. Cases are color coded for easy sorting. Untested but includes many useable units. SPECIAL — 20 FOR \$1

## 1024 BIT SIGNETICS P-ROM

82S1291-256X4 bipolar, field programmable ROM. Fully TTL compatible. 50 ns. max address access time. Much faster than MOS type units. Perfect for code conversions, microprogrammers, hand-wired algorithms, controllers, etc. With specs. Regular \$35 ea. SPECIAL — \$6.95  
BEST MEMORY BUY IN USA!

## SOLID STATE MEMORY ARRAY

Brand new, MFG. by Monolithic Systems Corp. Consists of 16-1101 (256 Bit Ram) and associated drive circuits. Drive circuits include 24 assorted 7400 series devices and various transistors, diodes, etc. Array is mounted on two stacked 6 x 8 in. PC boards. Original cost \$300 ea. With schematic. These are recommended for experienced hobbyists only. Limited quantity — \$29.95 ea.

## \$1 VALUE-FREE BONUS

Free 28 Pin Socket with purchase of any clock or calculator chip.

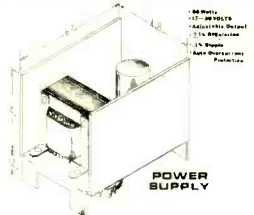

## REGULATED DC POWER SUPPLY

Brand new by wattless. DC output 17 to 30 V. Rated 60 WATTS out. Our tests show these units will put out 12 VDC by changing one resistor. #OEM 60-3. Original cost \$57.50. In original factory boxes, with specs. Special \$14.95

## 7805 STYLE REGULATORS

TO-220 Plastic Case 5VDC Regulator. Brand New by National — 99¢

## FACTORY NEW LED'S

Jumbo Red-Like MV5024-8/\$1  
Jumbo Green-Like MV5222-5/\$1  
Jumbo Yellow-5/\$1  
Mini Red-Like MV50-10/\$1

## MOS 4 DIGIT COUNTER IC

An ALTAJ exclusive. These are the latest, state of the art, MOS chips. By a famous US mfg. Contains a complete 4 digit counter, including 4 decade counters, latches, multiplexing circuits, display decoders, etc. Features 5 VDC operation, 25 MW power consumption, both 7 segment and BCD outputs. Perfect for making DVM's, frequency meters, tachometers, stopwatches, or any other device requiring 4 or more digits. Complete with specs. 28 Pin DIP. QTY Limited. Special — \$12.50

## CT7001 BY CAL-TEX

Digital alarm clock chip with calender feature. 4 or 6 digits. Also has timing circuitry for radio ON-OFF control factory fresh. \$6.95

## JUMBO LED READOUT

Twice the size of regular readouts. .65 inches. Like Litronix DL747. Outperforms and easier to read than SLA-3, only 20 MA per segment. Our best readout for digital clocks. \$2.95 ea (6 FOR \$15) Common Anode

## LINEAR IC SPECIALS

555V-75c 567V-\$1.95 723CH-59c 741CV-39c  
LM324 by National — Quad 741C in one DIP — \$1.79

**ELECTROLYTIC CAPACITOR SPECIAL**  
220 MFD at 25 WVDC. AXIAL Leads by GI. Brand New 6 for \$1

## MINIATURE SWITCH

Rocker style. Small size. SPDT. Perfect for use on digital clocks. 4 FOR \$1

## PRIME TTL DIP IC'S

7400-16c	7448-89c	74151-75c
7402-16c	7453-16c	74153-89c
7404-16c	7473-37c	74154-95c
7406-24c	7474-37c	74157-99c
7408-16c	7475-65c	74161-99c
7410-16c	7476-39c	74163-1.19
7413-49c	7483-85c	74164-1.29
7420-16c	7490-69c	74165-1.49
7427-24c	7492-75c	74174-1.29
7430-16c	7493-75c	74175-1.39
7437-39c	7495-75c	74181-2.75
7438-35c	7496-75c	74192-1.25
7440-16c	74121-38c	74193-1.25
7442-69c	74123-75c	74195-79c
7447-89c	74150-70c	74197-79c

## 8038 FUNCTION GENERATOR

Brand new Voltage controlled oscillator. Has sine, square wave, and triangular outputs. \$4.50 each.

## IN4148 DIODES

High speed switching diodes. Brand new units, however, leads are cut and bent for PC board insertion, still plenty long. 30 For \$1

## POLAROID FILTERS

The real thing by Polaroid Corp. Pale green in color. 2.3 x 12 inches. Use with various readouts or for optical experiments, limited Qty. 2 For \$1.

## PHASE LOCKED LOOP

565A by Signetics. Extremely stable. High linearity, wide frequency range. TTL compatible. Perfect for tone decoders, FSK, SCA receivers, frequency multiplication and division — \$1.75. WITH SPECS

## MOTOROLA POWER TRANSISTOR

MJ3029 — TO3 Case — NPN Silicon High Voltage — VCEO — 250V Used in horiz. and vert. TV Circuits. Regular Price \$4. Our Price 95c

## ELECTROLYTIC CAPACITORS

10MFD 25WVDC — Upright — 7c  
50MFD 15WVDC — Upright — 10c  
50MFD 15WVDC — Axial — 10c  
100MFD 15WVDC — Upright — 14c

## PLASTIC SILICON TRANSISTORS

Use for drivers in clock or calculators.  
MPS222A — NPN  
MPS2714 — NPN  
MPS3704 — NPN  
2N 3904 — NPN  
2N 3906 — PNP  
2N 4249 — PNP

**YOUR CHOICE 6 FOR \$1 ALL NEW UNITS**

## ZENERS

IN746 — 400MW — 3.3V  
IN752 — 400MW — 5.6V  
YOUR CHOICE 8 FOR \$1

## TTL IC ASSORTMENT

Various types. Most are marked. Our best selling assortment. Untested but includes many useable devices. 200 PCS FOR \$3.95

Our lower prices and superior quality have made ALTAJ one of the fastest growing electronic suppliers in the USA. Put your trust in our unconditional money back guarantee.

**ALTAJ ELECTRONICS**  
P.O. BOX 38544  
DALLAS, TEXAS 75238

TERMS: Check or money order. No COD. Add 10% Pstg. and Hd'g. Tex. Res. add 5%.



# Introducing the NEW Stanton Gyropoise® turntable

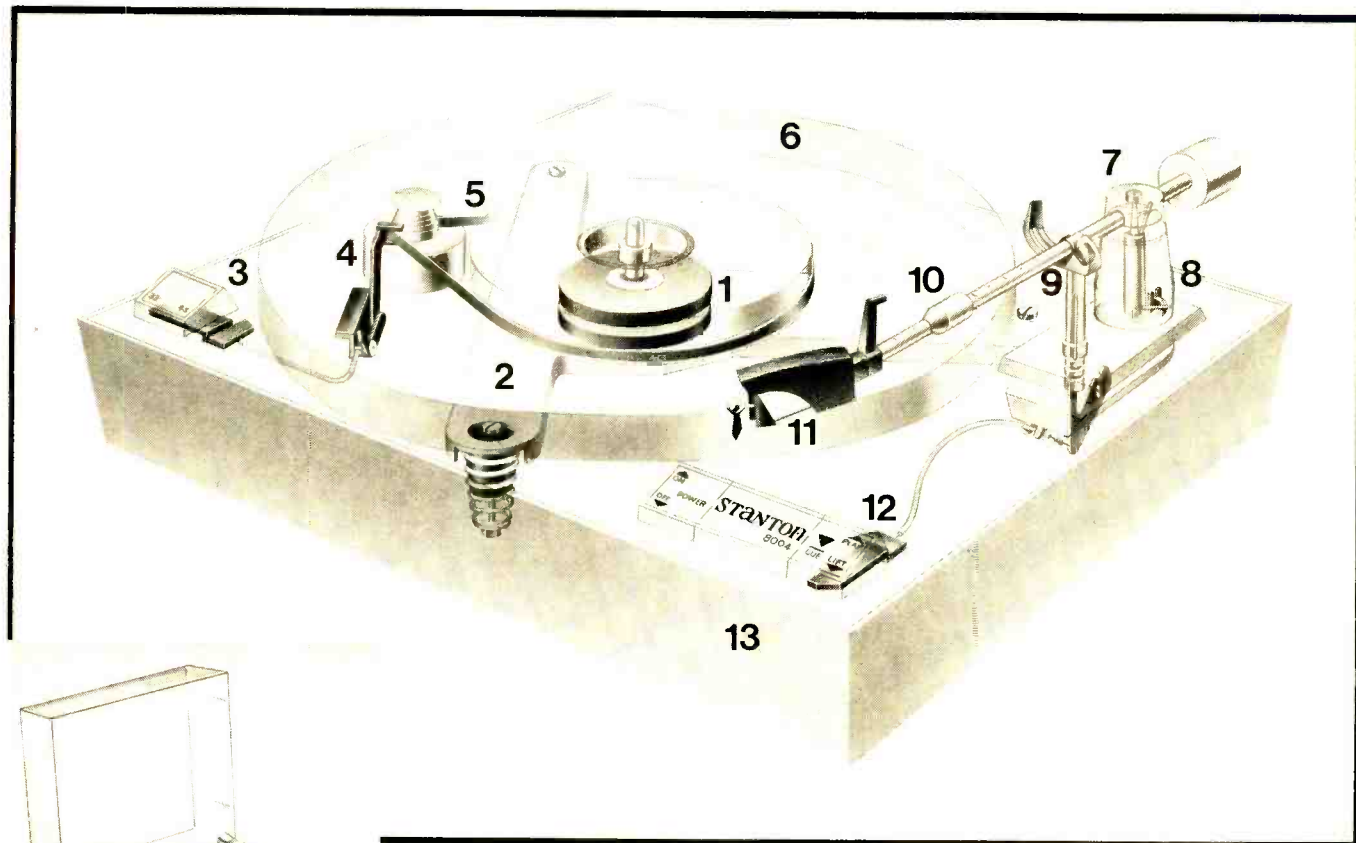

**Look at all these quality features,  
many of them exclusively ours!**

1. Gyropoise® —frictionless magnetic suspension of the platter.
2. Die cast aluminum T-Bar for sturdy structure.
3. 2-Speed changer for 33 rpm and 45 rpm playback.
4. 24-Pole synchronous high torque motor.
5. Belt drive for noiseless operation.
6. 12" die cast machined high polish aluminum platter.
7. Unipoise® —single point tone arm suspension.
8. Anti-skate control adaptable to all types of styli.
9. Magnetic hold bar for tone arm convenience.
10. Stylus force slide (range 0 - 4 grams).
11. Stanton state-of-the-art stereo or discrete cartridge.
12. Viscous damped cueing control for featherlight lowering of stylus.
13. Handsome walnut veneer base (comes complete with dust cover).

**ADDITIONAL FEATURES:**

- (a) Comes equipped with low capacitance cables
- (b) Wow and Flutter— $\leq .07\%$  din 45507 weighted
- (c) Rumble— $\leq -60$  dB din 45539 weighted

It's the important exclusive features that make the difference. Only Stanton Turntables have Gyropoise®, the patented frictionless magnetic suspension bearing—thus the platter makes no vertical contact with the body of the structure. This isolation eliminates vertical rumble.

Only Stanton Turntables have Unipoise®, the patented single point tone arm suspension. The arm is supported by a single pivot for both lateral and vertical movement.

Only Stanton Turntables come equipped with a state-of-the-art Stanton cartridge, either the 681 Triple-E calibrated to the tone arm for stereo playback, or the magnificent 780/4DQ for discrete.

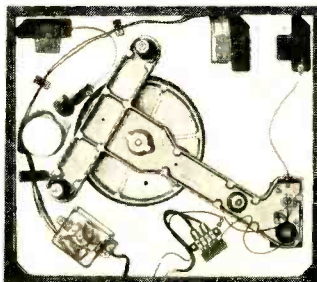

Bottom view shows simplicity of design.

See your franchised Stanton dealer for a demonstration of this great new product.



For further information, write: Stanton Magnetics, Inc., Terminal Drive, Plainview, N.Y. 11803

CIRCLE NO. 44 ON READER SERVICE CARD

www.americanradiohistory.com

# Before you buy a manual turntable, consider what "manual" really means.

"Manual" means more than just "single play." Every time you play a record, you must pick up the tonearm and move it to the record. And at the end of play, you must stop whatever you're doing, go to the turntable and return the tonearm to its resting post. All by hand.

Not only is this inconvenient, it's also risky, because the business end of a tonearm is virtually weightless. Handling it without damage to the delicate stylus and your fragile records takes a very steady hand.

## What about the automatic's extra moving parts?

An advantage often assumed for the manual turntable is simplicity: few moving parts. The automatic turntable does have additional parts, but they serve only to move the tonearm to and from the record when cycling. During play, a fully automatic Dual turntable has no more moving parts than a manual: motor, platter and drive system.

What's more, every manual turntable requires one additional moving part that no Dual ever requires: you.

## Why many manual turntable owners switched to Dual.

From warranty cards, we know that many Dual owners formerly owned manual turntables and switched to enjoy Dual's quality performance plus fully-automatic convenience and safety.

For many years, more audio experts—hifi editors, engineers and record reviewers—have

owned Duals than any other make of quality turntable. So have the readers of the leading music/equipment magazines. Certainly no group is more concerned about record protection and the quality of music than these people.

Even the lowest priced Dual, model 1225, at \$139.95 has more precision than you are ever likely to need. As for the highest-priced Dual, the \$400 electronic, direct-drive model 701, test reports have been extraordinary. Most independent test labs acknowledge that its rumble, wow and flutter are below the measuring capability of their test equipment.

## A word for those who still think they want to play manually.

Despite all the above, you may still prefer to play your records manually.

The Dual tonearm gives you

this option, because it is as free-floating during play as any manual-only tonearm. Thus you can always place it on the record or lift it off—manually.

However, we predict that you will soon take full advantage of the convenience and security of Dual's full automation. Which is what most Dual owners prefer.

And considering what kind of people own Duals, that's something you really should consider.



## United Audio Products

120 So. Columbus Ave.,  
Mt. Vernon, N.Y. 10553

Exclusive U.S. Distribution Agency for Dual



The multi-play automatic Dual 1229Q, \$269.95. Other multi-play automatics from \$139.95. All less base and dust cover. Single-play automatics are the Dual 601, \$295, and the electronic direct-drive Dual 701, \$400. Both include base and dust cover.

CIRCLE NO. 4 ON READER SERVICE CARD