

# Popular Electronics®

WORLD'S LARGEST-SELLING ELECTRONICS MAGAZINE

APRIL 1975/75c

**HOW TO LISTEN TO OUT-OF-STATE AM BROADCASTS**

**A LOW-COST COMPANDER FOR HI-FI**

**CAREER GUIDE: FAA ELECTRONICS TECHNICIAN**

**MINIVOLTER**

**WITH 500 $\mu$ V  
FULL-SCALE**

**LAB TEST REPORTS**

**Realistic STA-250  
Stereo Receiver**

**Kenonic C-200  
Stereo Preamplifier**

**Stanton 681EEE  
Stereo Phono Cartridge**

**Hy-Gain 623 AM/SSB  
CB Base Station**

**EL Instruments PG-2  
Pulse Generator**

## PORTABLE Analog/Digital Memory Translator



USE WITH  
ANY  
TAPE  
RECORDER



490684 LNE 10882099 JAN79 0410  
KENNETH J LYNES  
1088 22ND AV SE  
MINNEAPOLIS MN 55414



# At Pioneer, we listen.

Bobby Colomby of Blood, Sweat & Tears is a musician's musician. So when he told Pioneer what he was looking for in the way of features in a tape deck, we listened. And our engineers came up with the new RT-102CL stereo tape deck.

This 3-motor, 3-head unit has virtually every feature a professional like Bobby looks for, yet it's completely simple to use for home recording.

Take the pushbutton control system. It's solid state electronics with full logic. This means you can

switch from Record to Fast Rewind, for instance, without using the Stop button. Bobby appreciates it because there's no clicking or popping noises. And it's completely jam-proof; it will never spill tape.

Bobby especially wanted long range record playback capability. The RT-102CL provides 12 hours on a single 10½-inch reel.

"With so many types of tape on the market," said Bobby, "it's a drag when you have to look for one special tape. The RT-102CL plays every tape with optimum sound reproduction." (That's because it has a 3-step tape bias selector.)

And if you're recording from old records, the equalizer selector helps to revitalize their highs. The improved sound will amaze you.

The RT-102CL has the widest array of features ever built into a tape deck — 2 & 4-channel playback, pause control, sound-on-sound, mence mixing, plus

much more. At nine hundred dollars it would be a great value. At \$649.95, it's unbeatable.

Pioneer thanks Bobby. And so will you. At Pioneer, we listen.

U. S. Pioneer Electronics Corp.  
75 Oxford Drive, Moonachie,  
New Jersey 07074.  
West: 13300 S. Estrella, Los Angeles,  
Cal. 90248 / Midwest: 1500  
Greenleaf, Elk Grove Village, Ill.  
60007 / Canada: S. H. Parker Co.

 **PIONEER**  
when you want something better



CIRCLE NO. 49 ON READER SERVICE CARD

[www.americanradiohistory.com](http://www.americanradiohistory.com)

# MITTS

## BUILDING YOUR OWN COMPUTER WON'T BE A PIECE OF CAKE.

(But, we'll make it a rewarding experience.)

Chances are you won't be able to assemble the *Altair 8800 Computer* in an hour or two. But, that's only because the *Altair* is a real, full-blown computer. It's not a demonstration kit.

The *Altair Computer* is fast, powerful, and flexible. Its basic instruction cycle time is 2 microseconds. It can directly address 256 input and 256 output devices and up to 65,000 words of memory.

Thanks to buss orientation and wide selection of interface cards the *Altair 8800* requires almost no design changes to connect with most external devices. Up to 15 additional cards can be added inside the main case.

The *Altair Computer* kit is about as difficult to assemble as a desktop calculator. If you can handle a soldering iron and follow simple instructions, you can build a computer.

You see, at *MITTS*, we want your experience with our kits to be rewarding. That's why we take such pains to write an accurate, straight-forward assembly manual. One that you follow step-by-step. (We leave nothing to the imagination.)

Some electronic kit companies are experts at cutting the corners. They promise you the sky and deliver a box full of surplus parts and a few pages of faded instructions run off on their copying machine.

We're experts at **not** cutting the corners. Our *Altair Computer* has been designed for both the hobby and the industrial market. It has to be constructed of the finest, quality parts. And it is.

That's why we give you double-sided boards, gold-plated connectors, a 10 Amp power supply (enough to power 15 additional cards), toggle switches and an all aluminum case complete with sub-panel and detachable dress panel.

That's why we give you three manuals (Assembly, Operator's and Trouble-shooting) in a hard-cover, 3 ring binder plus an Assembly Hints manual.

Buy our computer and we'll automatically make you a member of the *Altair User's Group*. You'll have access to a whole range of custom software designed exclusively for the *Altair 8800*.

We're quite serious about making computer power available to you at a price you can afford.

## BASIC ALTAIR AND OPTIONS

The basic *Altair 8800 Computer* includes the CPU, front panel control board, front panel lights and switches, power supply and expander board (with room for 3 extra cards) all enclosed in a handsome, aluminum case.

Options now available include 4K dynamic memory cards, 1K static memory cards, parallel I/O cards, three serial I/O cards (TTL, RS232, and TTY), octal to binary computer terminal, 32 character alpha-numeric display terminal, ASCII keyboard, audio tape interface, floppy disc system, and expander cards.

Software now available includes an assembler, text editor and system monitor.

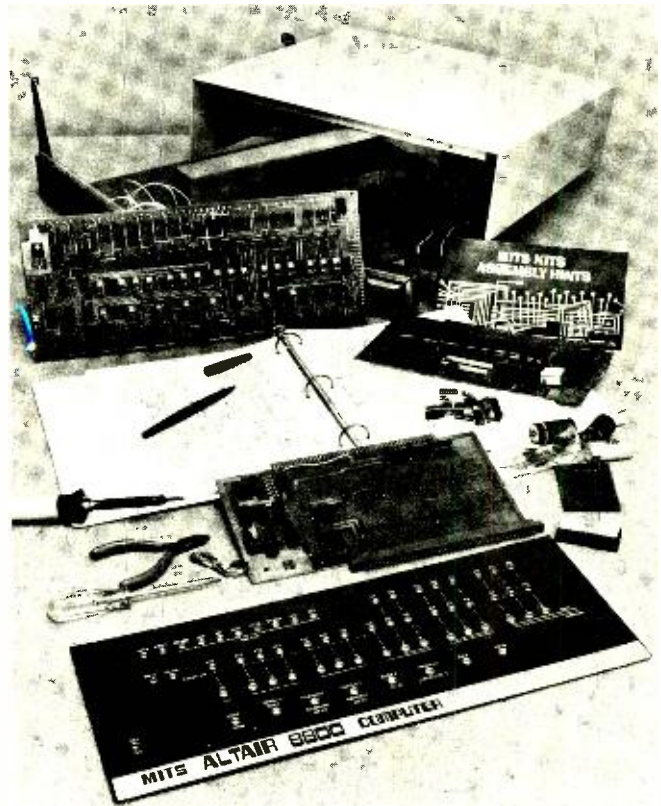

## PRICE

Altair 8800 Computer: \$439.00 kit  
\$621.00 assembled

## SAVE \$45.00!

For P.E. readers only! The Basic *Altair 8800 Computer* plus 256 words of static memory. \$542.00 value. Now, only \$497.00. Check the appropriate box in the coupon below.\*

Warranty: 90 days on parts and labor for assembled units  
90 days on parts for kits  
prices and specifications subject to change without notice

MITTS/6328 Linn N.E., Albuquerque, N.M., 87108, 505/265-7553

MAIL THIS COUPON TODAY!-----

Enclosed is a Check for \$ \_\_\_\_\_

or Bank Americard # \_\_\_\_\_

or Master Charge # \_\_\_\_\_

Credit Card Expiration Date \_\_\_\_\_ \* *Special*

ALTAIR 8800  Kit  Assembled  P.E. Kit

Include \$8.00 for Postage and Handling

Please send free Altair System Catalogue

NAME \_\_\_\_\_

ADDRESS \_\_\_\_\_

City \_\_\_\_\_ State & Zip \_\_\_\_\_

MITTS/6328 Linn, N.E., Albuquerque, New Mexico 87108  
505/265-7553



# Look for the PTC Semiconductor Mart at your Mallory Distributor's.

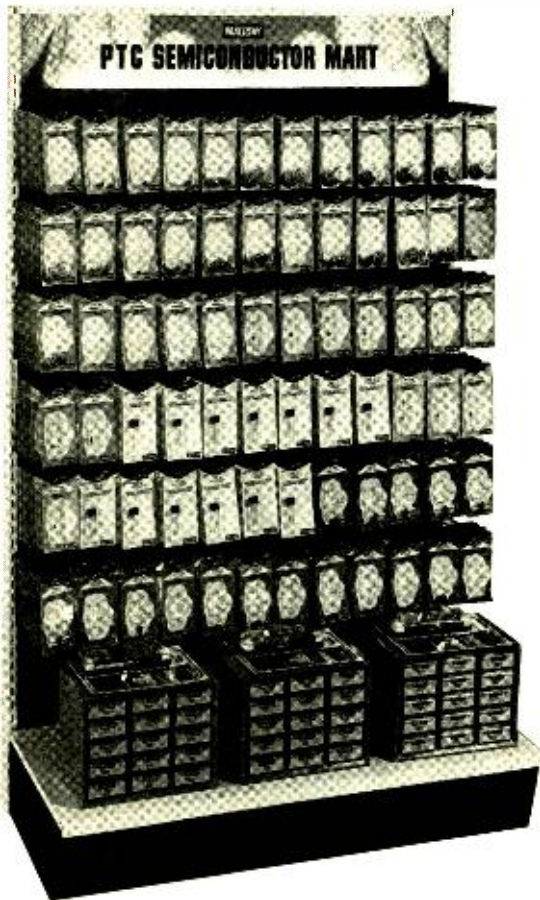

**THE FAMOUS MALLOBIN<sup>®</sup> WAREHOUSE.**  
With the semiconductors most needed by service technicians.

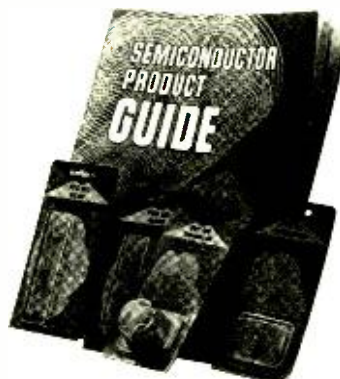

**THE SEMICONDUCTOR MART.** Here's the quick, easy way to get the replacements you need. It's the best assortment of the hottest semiconductors around. Transistors, diodes, multiple diode packages, zener diodes and integrated circuits included.

**FREE** copies of the very latest cross-referenced Semiconductor Product Guide.

**Clear, concise product data on the packages makes your choice easy. And Mallory quality, versatility, and dependability make every choice a good one.**

## You know what you need. Now you know where to find it.

**MALLORY**

**MALLORY DISTRIBUTOR PRODUCTS COMPANY**

a division of P. R. MALLORY & CO. INC.

Box 1284, Indianapolis, Indiana 46206; Telephone: 317-856-3731

Batteries • Capacitors • Controls • Security Products • DURATAPE<sup>®</sup> • Resistors • Semiconductors • SONALERT<sup>™</sup> • Switches • Timing Devices and Motors

MALLOBIN<sup>®</sup> is a registered trademark of P. R. Mallory & Co. Inc.

**CIRCLE NO. 28 ON READER SERVICE CARD**

# Popular Electronics®

WORLD'S LARGEST SELLING ELECTRONICS MAGAZINE

## FEATURE ARTICLES

<b>HOW TO LISTEN TO OUT-OF STATE AM BROADCASTS</b> .....	Thomas R. Sundstrom	31
<i>DX'ing the medium-wave band is an inexpensive, fascinating hobby.</i>		
<b>EXPERIMENTING WITH LIGHT-BEAM COMMUNICATIONS</b> .....	Forrest M. Mims	40
<i>What you need to get started in a rapidly growing type of communication.</i>		
<b>GETTING TO KNOW THE LIQUID CRYSTAL DISPLAY</b> .....	Gary McClellan	43
<b>HOW TO BECOME AN FAA ELECTRONICS TECHNICIAN</b> .....	Thomas R. Sear	48
<i>Now is an opportune time to get into this rewarding electronics career.</i>		

## CONSTRUCTION ARTICLES

<b>BUILD A PORTABLE ANALOG/DIGITAL MEMORY TRANSLATOR</b> .....	Joe Sulmar & Jay Eisenberg	27
<i>Record dc and digital information on tape.</i>		
<b>BUILD A BLACKLIGHT LANTERN</b> .....	W. E. McCormick	35
<i>Battery-powered, ultraviolet lamp for experimenting and lighting.</i>		
<b>LOW-COST COMPANDER ENHANCES HI-FI RECORDINGS</b> .....	Craig Anderton	38
<i>Expands or compresses playback's dynamic range.</i>		
<b>BUILD THE MINIVOLTER</b> .....	John F. Hollabaugh	46
<i>Measures from 500 microvolts to 100 volts full-scale.</i>		

## COLUMNS

<b>STEREO SCENE</b> .....	Ralph Hodges	17
<i>A short history of four-channel.</i>		
<b>SOLID STATE</b> .....	Lou Garner	66
<i>The photo detector/power amplifier I.C.</i>		
<b>CB SCENE</b> .....	Len Buckwalter	70
<i>How to mount mobile antennas.</i>		
<b>AMATEUR RADIO</b> .....	Herbert S. Brier	76
<i>Restructuring the amateur service.</i>		
<b>TEST EQUIPMENT SCENE</b> .....	Leslie Solomon	78
<i>Some rules for using equipment.</i>		
<b>ART'S TV SHOP</b> .....	Art Margolis	80
<i>The missing burst.</i>		
<b>HOBBY SCENE</b> .....	Editorial Staff	86

## PRODUCT TEST REPORTS

<b>REALISTIC MODEL STA-250 AM/STEREO FM RECEIVER</b> .....	51
<b>KENSONIC MODEL C-200 PREAMPLIFIER</b> .....	57
<b>STANTON MODEL 681EEE STEREO PHONO CARTRIDGE</b> .....	58
<b>HY-GAIN MODEL 623A AM/SSB BASE STATION CB TRANSCEIVER</b> .....	59
<b>EL INSTRUMENTS MODEL PG-2 PULSE GENERATOR KIT</b> .....	60

## DEPARTMENTS

<b>EDITORIAL</b> .....	Art Salsberg	4
<i>Chicago in the winter.</i>		
<b>LETTERS</b> .....		6
<b>NEW PRODUCTS</b> .....		12
<b>NEW LITERATURE</b> .....		16
<b>ELECTRONICS LIBRARY</b> .....		88

POPULAR ELECTRONICS, April 1975, Volume 7, Number 4, Published monthly at One Park Avenue, New York, NY 10016. One year subscription rate for U.S., Possessions and Canada, \$7.98; all other countries, \$8.98. Second class Postage paid at New York, NY and at additional mailing offices. Authorized as second class mail by the Post Office Department, Ottawa, Canada and for payment of postage in cash. Subscription service and Forms 3579, P.O. Box 2774, Boulder, CO 80302.

POPULAR ELECTRONICS including ELECTRONICS WORLD, Trade Mark Registered, Indexed in the Reader's Guide to Periodical Literature. COPYRIGHT © 1975 BY ZIFF-DAVIS PUBLISHING COMPANY. ALL RIGHTS RESERVED

Ziff-Davis also publishes Boating, Car and Driver, Cycle, Flying, Modern Bride, Popular Photography, Skiing and Stereo Review.

Forms 3579 and all subscription correspondence should be addressed to POPULAR ELECTRONICS, Circulation Dept., P.O. Box 2774, Boulder, CO 80302. Please allow at least eight weeks for change of address. Include your old address, as well as new—enclosing, if possible, an address label from a recent issue. Send editorial correspondence to POPULAR ELECTRONICS, 1 Park Ave., New York, NY 10016. Editorial contributions must be accompanied by return postage and will be handled with reasonable care; however, publisher assumes no responsibility for return or safety of manuscripts, art work, or models.

**EDGAR W. HOPPER**  
Publisher

**ARTHUR P. SALSBERG**  
Editorial Director

**LESLIE SOLOMON**  
Technical Editor

**JOHN R. RIGGS**  
Managing Editor

**ALEXANDER W. BURAWA**  
Feature Editor

**EDWARD I. BUXBAUM**  
Art Director

**JOHN McVEIGH**  
Assistant Editor

**ANDRE DUZANT**  
Technical Illustrator

**HERBERT S. BRIER**  
**LEN BUCKWALTER**  
**LOU GARNER**  
**GLENN HAUSER**  
**JULIAN D. HIRSCH**  
**RALPH HODGES**  
**ART MARGOLIS**  
Contributing Editors

**JOSEPH E. HALLORAN**  
Advertising Director

**JOHN J. CORTON**  
Advertising Sales

**LINDA BLUM**  
Advertising Service Manager

**PEGI McENEANEY**  
Executive Assistant

**STANLEY NEUFELD**  
Associate Publisher

**FURMAN H. HEBB**  
Group VP, Electronics & Photo

ZIFF-DAVIS PUBLISHING COMPANY  
Popular Electronics  
Editorial and Executive Offices  
One Park Avenue New York, New York 10016  
212-725-3500  
Hershel B. Sarbin, President  
Furman Hebb, Executive Vice President and Treasurer  
Phillip T. Heffernan, Senior Vice President, Marketing  
Edward D. Muhfeld, Senior Vice President, Sports Division  
Philip Sine, Senior Vice President  
Frank Pomerantz, Vice President, Creative Services  
Arthur W. Butzow, Vice President, Production  
Lawrence Sporn, Vice President, Circulation  
George Morrissey, Vice President  
Sydney H. Rogers, Vice President  
Sidney Holtz, Vice President  
Charles B. Seton, Secretary  
Edgar W. Hopper, Vice President, Electronics Div.  
  
William Ziff, Chairman  
W. Bradford Briggs, Vice Chairman

Midwestern Office  
The Pattis Group, 4761 West Touhy Ave.,  
Lincolnwood, Illinois 60644, 312 679-1100  
GERALD E. WOLFE, GEORGE B. MANNION  
THOMAS HOCKNEY

Western Office  
9025 Wilshire Boulevard, Beverly Hills, CA 90211  
213 273-8050; BRadshaw 2-1161  
Western Advertising Manager, BUD DEAN

Japan: James Yagi  
Oji Palace Aoyama, 6-25, Minami Aoyama  
6 Chome, Minato-Ku, Tokyo 407-1930/6821,  
582-2851



The publisher has no knowledge of any proprietary rights which will be violated by the making or using of any items disclosed in this issue.



## Editorial

### CHICAGO IN THE WINTER

During a jet flight home from the 1975 Winter Consumer Electronics Show in Chicago, I reflected on what I had seen and heard. This bi-annual major exhibit could, perhaps, be summed up: few new product introductions, domination by calculator manufacturers and a general economic outlook that's best described as hopeful.

A handful of new product entries caught my attention, some of which were prototypes that may never reach the marketplace. • Panasonic, for example, displayed a military-styled, portable FM/AM radio (Model RF-1300) with an integrated rhythm maker that features eight rhythms from waltz to rock; drums, cymbals, etc., combined with two microphone/guitar mixing inputs. • Toshiba revealed its \$1800 ST-910 digital frequency synthesizer FM stereo tuner, which includes muting-level and signal-level indicators, seven memory stations and automatic/manual scanning. Of special interest to PE readers is the tuner's electronic component makeup—32 transistors, 9 FET's, 100 diodes, 96 IC's and 24 LED's. • A British manufacturer, Lecson, hoping to enter the hi-fi market here, introduced a novel (to look at) basic power amplifier that's encased in a heat-dissipating, fluted, die-cast cylinder. (Thought it was a high-intensity lamp base when I first saw it.) • Rhoades showed a TV audio tuner, a \$169 unit that plugs into a stereo system's AUX input for better TV sound. • A new turntable—in a microwave oven—from Sharp attracted hungry onlookers. It revolves during the cooking cycle to assure even cooking.

A host of electronic digital clocks and watches were displayed, including large wall clocks. Outstanding were a thin (1½-inch) 10¼-inch square wall clock with a choice of red LED or orange gaseous displays from Infinity, and Ashley-Butler's clocks with LCD digits almost two inches high, housed in a variety of decorator cases. From ADD-A-Sound was an audio-frequency transmitter/portable speaker system that employs two different carriers for remote stereo use without running wires around the house. And Quantum displayed speaker systems expressly designed for four-channel use. Control panels on each speaker regulate sound projection path, with up to 20 settings possible. The FCC's office of Chief Engineer was represented at the Show, too, urging home entertainment manufacturers to incorporate protective measures in designs to avoid audio equipment pickup of radio signals. The EIA Consumer Electronics Group has already recognized the problem and describes some preventive methods in its November 1974 Engineering Bulletin No. 7, "Audio Rectification."

Hi-fi equipment was not heavily represented at the Show, which wasn't surprising since it's the Summer CES Show that traditionally serves as the big springboard for the new model introductions. It was at the 1971 SCES, in fact, that four-channel equipment was first introduced. With over 300 FM stations transmitting some form of 4-channel broadcast and nearly 700 quadrasonic discs available as software right now, plus advances in equipment design, the second half of 1975 is expected to show an upswing of public interest in the four-year-old four-channel format.

Hi-fi notwithstanding, the array of varied electronic equipment shown at WCES, which also included TV, auto radio, CB, and even a home video game at \$299, proved that electronics continues to invade more and more avenues of our daily life.

*Art Salsberg*



# Now there's a CB radio with too much talk power.



Put punch in your voice, from a block away to the fringes of your range. New Dyna-Mike gain control puts out absolute modulation. So much talk power you'll have to turn it down.

An important feature, but only one that makes this fantastically low-priced CB radio the best CB value on today's market.

The Cobra 21 with crystal filter, dual conversion receiver, transmits and receives on all 23 AM channels.

Features 60 dB adjacent channel rejection that completely eliminates bleedover.

Extra large Power S Meter lets you monitor your set's performance easily even when it's tucked under the dashboard.

And you get switchable automatic noise limiter, P.A./external speaker jack, large built-in speaker and detachable mike.

It's all wrapped up in a beautiful, compact cabinet only 6" wide x 2½" wide x 7½" deep. Meets FCC requirements.

Ask your CB Dealer for the Cobra 21. The radio with too much talk power for not much money.



**COBRA 21**  
WITH EXCLUSIVE DYNA MIKE

Product of DYNASCAN CORPORATION • 1801 W. Belle Plaine • Chicago, Illinois 60613

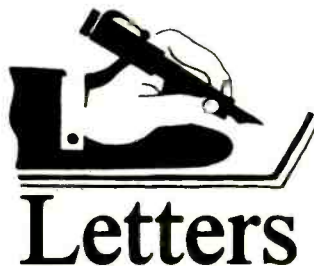

# Letters

## STATUS OF PAY TV

Shel Kagan's "Pay TV Status Report" (December 1974) was well researched and well written. It represents a most impressive summary of the state of the art.

Incidentally, your readers might be interested to know that the Federal Communications Commission has adopted new regulations that will continue to hold back the full potential of pay TV. The FCC has not listened to the CATV industry's arguments for more than two years. Apparently, the only step remaining is for the public to express its opinions about marketplace development of pay TV to the FCC Commissioners and to the members of Congress.

GARY H. ARLEN  
Public Information Manager  
National Cable Television Association  
Washington, D.C.

## NOD OF APPROVAL

Congratulations on the content of "Blazing Speakers" ("Stereo Scene," November 1974). The article is a clear, no-nonsense treatment of a subject that has been poorly handled in the past and about which serious misunderstandings have existed for a long time.

JIM LONG  
Marketing Manager  
Electro-Voice, Inc.  
Buchanan, Mich.

## MINICOMPUTER MAKES MAXISPLASH

As a result of the Altair 8800 minicomputer article in the January issue, I have decided to subscribe to PE. Now, I'm looking forward to an article on building a CRT terminal and would like to see another article about using a cassette deck with the mini for additional memory.

DAVID WILSON  
Highland Park, Mich.

The world's largest-selling electronics magazine has outdone even itself this time with simultaneously publishing construction plans for both the Altair 8800 minicomputer and "An Under-\$90 Scientific Calculator" (January 1975).

LOUIS H. LENERT  
Educational Technologies  
Reynoldsburg, Ohio

Congratulations on being the first magazine to present a truly advanced minicomputer construction project. However, I must point out that the text contains several errors:

First, the price of the complete Altair 8800 will be about \$760 when one adds the needed Intel 8080 IC to the basic \$400 price. Secondly, the number of sub-routines available could not possibly be 65,000 when there are only 65k words of memory. Third, a minicomputer cannot handle more than one program at a time. If a second program is to be executed, the current program must be interrupted. Fourth, the Intel 8008 chip is not "designed for use as a buffer." Finally, for anything more than very simple programs, an assembler is required for programming the computer.

In spite of the errors cited, I am very pleased that POPULAR ELECTRONICS has chosen a truly state-of-the-art minicomputer for a construction article.

ROBERT BROWN  
Livonia, Mich.

*The cost of the entire kit (with 256 words) included the Intel 8080 IC. When the article was published, this price was \$397. It is now \$495 (as of March 1, 1975). (The supplier informs us that the increase was necessitated by production-model improvements such as increased power supply, synchronization, and edge-connection*

# CMOS MICROLAB

- \* LEARN HOW DIGITAL CIRCUITS WORK
- \* VERIFY DESIGNS QUICKLY
- \* IDEAL TEACHING AID

The CMOS Microlab makes it possible to quickly check, or understand a variety of digital circuits. Battery operation makes the Microlab super convenient. Use it anywhere. Indicator lamps are all LED types that are rugged and will never burn out. Included in the Microlab are four (4) flip-flops, four (4) dual input NOR gates, four (4) dual input NAND gates, two (2) four input NAND gate and an inverter. No external signal sources are needed in most cases. Connections are made with reliable, easy to use push-on type connectors on the jumper wires. The entire instrument is "goof-proof". No possible combination of connections, no matter how wrong, can damage the circuit.

The kit is housed in a 5 x 7 x 3 break resistant impact plastic case. Powered by four (4) standard "D" cells. (Not included in kit)

#CMOS Complete Microlab Kit.....\$34.50 PPd

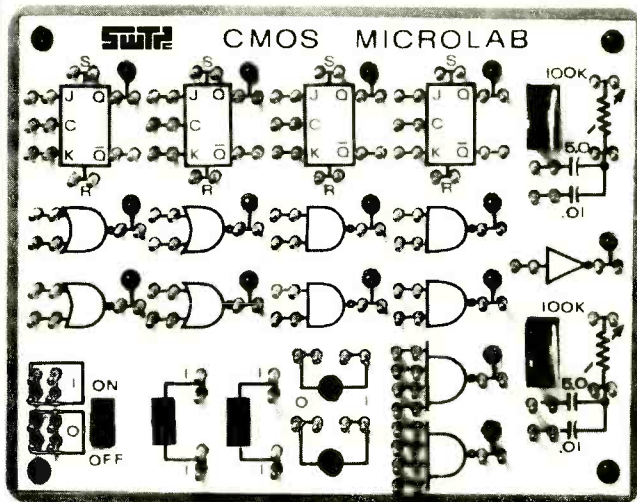

Southwest Technical Products Corp.  
219 W. Rhapsody  
San Antonio, Texas 78216



boards. These improvements were included at the old price until March 1.) A basic processor without memory is also available for \$439.

The maximum number of two-word sub-routines is 32k. But subroutine nesting is almost unlimited; and is certainly more than sufficient, since how many times are you going to want to do more than a 10-level program? Although the computer cannot work two programs simultaneously (as you said), it works so fast that it appears to be doing so. The 8008 is described as a "communication processor," which is a fancy name for "buffer." It has, of course, been used as a CPU; but it is not a powerful one, exhibiting slow speed and interrupt handling problems, among other shortcomings. Finally, part two of the article (in the February 1975 issue) explained the need for an assembler during programming.

The Altair 8800 computer project has really pleased me. It certainly beats some of the competition. But a minicomputer with only 256 steps is only a toy with lots of potential. How much will each memory block of 4k words cost?

EDWARD LORING TOTTLE  
Baltimore, Md.

Each kit of 4k memory costs \$264. Before March 1, the price was \$198.

#### THE CALCULATOR EXPLOSION

The "Under-\$90 Scientific Calculator" in the January 1975 issue is outdated before anyone can even build it. Right now, assembled calculators with identical capability are being sold for \$90. Your construction articles should be ahead of the pack if they are to be of any use to your readers. The timeliness of the Altair 8800 minicomputer is more like what I mean.

S. LIEBERMAN  
Los Angeles, Calif.

The material that appears in POPULAR ELECTRONICS must be planned several months in advance of its publication date. Ordinarily, the timeliness of our articles goes unaffected as a result of our keeping on top of the latest developments in electronics. On rare occasions, events occur so quickly (as they have in the calculator field in the last few months) that we are caught unawares. This is what happened with our calculator article. However, even when compared to competitively priced assembled calculators, ours is still a good buy, especially for those people who like to build their own electronic devices.

#### DIRECT CONVERSION

Many thanks for publishing construction plans for "A Direct-Conversion AM/SSB Project" (November 1974). I should have had a receiver like this a number of years ago when teaching amateur radio novices.

DAVID WELTY  
Monterey, Calif.

# BUILD & TEST CIRCUITS AS FAST AS YOU THINK!

- POWER FOR THE PROFESSIONAL
- ECONOMY KITS FOR THE HOBBYIST
- A MODEL AND A PRICE FOR EVERYONE



## PROTO BOARD 203

Breadboard Prototyping with 5 Volt, 1 AMP Regulated Power Supply included! A total ready-to-use power breadboard prototest device with a built-in regulated, short-proof power supply. Just plug-in and start building! 2 extra floating 5-way binding posts for external signals. Self-contained with power switch indicator lamp and power fuse. 24-14 pin DIP capacity. Attractive two-tone quality case. All metal construction. 9 $\frac{3}{4}$ " L x 6 $\frac{1}{2}$ " W x 2 $\frac{3}{4}$ " H. 5 lbs. Order today!

**\$75**

Add \$2.50 shipping/handling

A modestly priced kit for the economy-minded experimenter . . .

## PROTO BOARD 100

A low cost, big 10 IC capacity breadboard kit with all the quality of QT sockets and the best of the Proto Board series . . . complete down to the last nut, bolt and screw. Includes 2 QT-35S Sockets; 1 QT-35B Bus Strip; 2 5-way binding posts; 4 rubber feet; screws, nuts, bolts; and easy assembly instructions.

**19<sup>95</sup>**

Add \$1.50 shipping/handling.

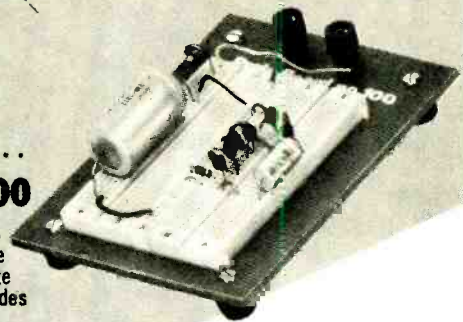

**PROTO-CLIP**  
for Power-On,  
Hands-Off Signal  
Tracing. No more  
shorting leads.  
Costs less than . . .

**\$5**

Bring IC leads from pc board for fast signal tracing and troubleshooting. Inject signals. Wire unused circuits into boards. Scope probes and test leads lock onto Dynagrip inset (see circle) for hands-off testing. Plastic construction eliminates springs, pivots. Non-corrosive nickel/silver contacts for simultaneous low resistance connections.

PC-14, 14-pin Proto Clip, \$4.50 ea.  
PC-16, 16-pin Proto Clip, \$4.75 ea.

Add 75¢ shipping/handling.

Order today off-the-shelf from CSC or local distributor. Charge: BAC, MC, AX. Write for free catalog. Free English/Metric Slide Rule with each order. Dealer inquiries invited.

Foreign orders add 15%.

**CSC** Continental Specialties Corp.

Box 1942, New Haven, CT 06509 • 203/624-3103

Patents Pending Made in USA  
Prices subject to change

W. Coast Off.: Box 7809, S. Francisco, CA 94119 • 415/383-4207  
Canada: Available thru Len Finkler Ltd., Ontario

CIRCLE NO. 12 ON READER SERVICE CARD

# Where do the pros get their training?



**Almost half of the successful TV servicemen have home study training and with them, it's NRI 2 to 1.** It's a fact! Among men actually making their living repairing TV and audio equipment, more have taken training from NRI than any other home study school. More than twice as many!



Not only that, but a national survey,\* performed by an independent research organization, showed that the pros named NRI most often as a recommended school and as the first choice by far among those who had taken home study courses from *any* school. Why? Perhaps NRI's 60-year record with over a million students...the solid training and value built into every NRI course...and the designed-for-learning equipment originated by NRI provide the answer. But send for your free NRI catalog and decide for yourself.



### Two Famous Educators... NRI and McGraw-Hill.

NRI is a part of McGraw-Hill, world's largest publishers of educational material. Together, they give you the kind of training that's geared for success...practical know-how aimed at giving you a real shot at a better job or a business of your own. You learn at home at your convenience, with "bite-size" lessons that ease learning and speed comprehension. Kits designed to give you practical bench experience also become first-class professional instruments you'll use in your work.

*\*Summary of survey results upon request.*

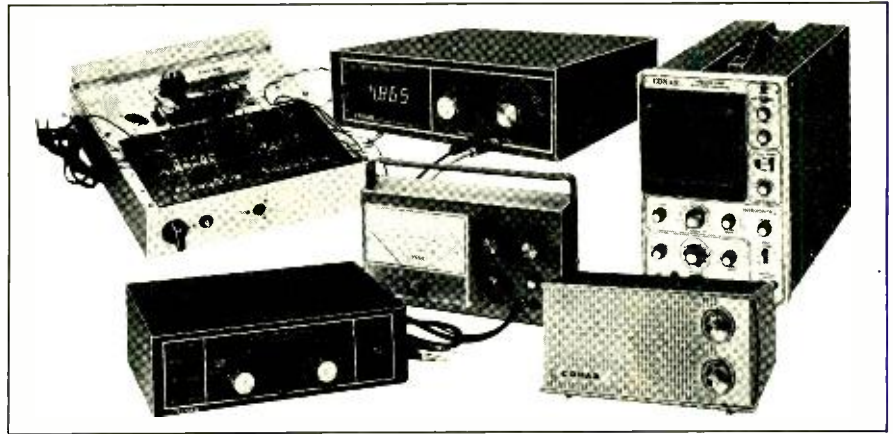

### 25" Diagonal Color TV... Professional Instruments

As a part of NRI's Master Course in TV/Audio servicing, you build a big-screen solid state color TV with every modern feature for great reception and performance. As you build it, you perform stage-by-stage experiments designed to give you actual bench experience while demonstrating the interaction of various stages of the circuitry. And your TV comes complete with console cabinet, an optional extra with other schools. Likewise, NRI's

instruments are a cut above the average, including a 3½ digit precision digital multimeter, triggered sweep 5" oscilloscope, and integrated circuit TV pattern generator. They're top professional quality, designed to give you years of reliable service. You can pay hundreds of dollars more for a similar course and not get a nickel's worth extra in training and equipment.

### Widest Choice of Courses and Careers.

NRI doesn't stop with just one course in TV/Audio servicing. You can pick from five different courses (including an advanced color course for practicing technicians) so you can fit your training to your needs and your budget. Or, you can go into Computer Technology, learning on a real, digital computer you build yourself. Communications with famous Johnson transceiver. Aircraft or Marine Electronics. Mobile radio, and more.

### Free Catalog... No Salesman Will Call.

Send the postage-paid card for our free color catalog showing details on all NRI electronics courses. Lesson plans, equipment, and career opportunities are fully described. Check card for information on G.I. benefits. No obligation, no salesman will call. Mail today and see for yourself why the pros select NRI two to one!

If card is missing, write to:



### NRI SCHOOLS

McGraw-Hill Continuing Education Center  
3939 Wisconsin Avenue,  
Washington, D.C. 20016

# EXAR

IC'S AND KITS  
NOW AVAILABLE FROM:  
JAMES ELECTRONICS

## FUNCTION GENERATOR KIT

Introductory Offer

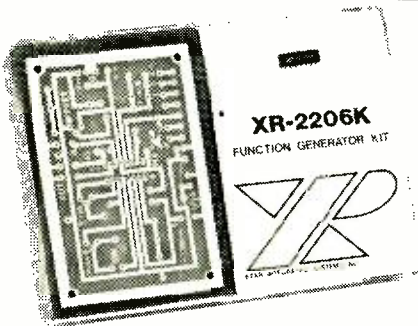

The Function Generator Kit features sine, triangle and square wave; THD 0.5% typ.; AM/FM capability.

### XR-2206KA

Includes monolithic function generator IC, PC board, and assembly instruction manual.

**\$19.95**

### XR-2206KB

Same as XR-2206KA above and includes external components for PC board.

**\$29.95**

## MONOLITHIC IC'S

### TIMERS

XR-555CP Monolithic Timer	\$1.10
XR-320P Precision Timer	1.55
XR-556CP Dual-555 Timer	1.85
XR-2556CP Dual Timing Circuit	3.20
XR-2240CP Programmable Counter/Timer	4.80

### PHASE LOCKED LOOPS

XR-210 FSK Demodulator	5.20
XR-215 High Frequency PLL	6.60
XR-567CP Tone Decoder (mini DIP)	1.95
XR-567CT Tone Decoder (TO-5)	1.70

### STEREO DECODERS

XR-1310P PLL Stereo Decoder	3.20
XR-1310EP PLL Stereo Decoder	3.20
XR-1800P PLL Stereo Decoder	3.20

### WAVEFORM GENERATORS

XR-205 Waveform Generator	8.40
XR-2206CP Monolithic Function Generator	5.50
XR-2207CP Voltage-Controlled Oscillator	3.85

### OTHER EXAR IC'S

XR-1468CN Dual $\pm 15V$ Tracking Regulator	3.85
XR-1488N Quad Line Driver	5.80
XR-1489AN Quad Line Receiver	4.80
XR-2208CP Operational Multiplier	5.20

Satisfaction Guaranteed. \$5.00 Min.  
Order—1st Class Mail No Charge/  
California Residents Add 6% Sales Tax

# JAMES

P.O. BOX 822, BELMONT, CA. 94002  
PHONE ORDERS — (415) 592-8097

CIRCLE NO. 47 ON READER SERVICE CARD



## New Products

Additional information on new products covered in this section is available from the manufacturers. Either circle the item's code number on the Reader Service Card inside the back cover or write to the manufacturer at the address given.

### COURIER 4-CHANNEL PORTABLE SCANNER

The Cop-Scan uhf scanning monitor is a 4-channel portable unit covering the 450-to-475-MHz band. It features a flexible antenna, dual-conversion superhet circuitry, ceramic and crystal filters, LED displays, adjustable squelch and volume. Automatic or manual scanning is switch-selected. Jacks are provided for an earphone, power supply and recharger for optional NiCd battery back. The receiver is housed in a high-impact plastic case.

CIRCLE NO. 70 ON READER SERVICE CARD

### PEARCE-SIMPSON DEPTH SOUNDER

The Dolphin 360 depth sounder by Pearce-Simpson is a solid-state unit with a claimed range of 60 feet/60 fathoms (selectable). Operating frequency is 200



kHz; beam width, approximately 15 degrees. It includes a sunshield for easy viewing, a transducer for transom mounting, power leads, and a stainless steel transom mounting bracket. For through-hull installations, a bronze transducer is available as an option. Requires supply voltage of 12.6 V dc, 0.5 A. The Dolphin 360 measures 7 2/3" x 4 7/12" x 8 1/3" (19.3 x 11.5 x 20.9 cm) and weighs 3 lb (1.4 kg).

CIRCLE NO. 71 ON READER SERVICE CARD

### MARANTZ ELECTROSTATIC HEADPHONES

The Marantz Model SE-1S headphones use electrostatic transducers, have a claimed frequency response of 20 to 20,000 Hz, and a weight of 14 oz. (397 g). Distortion at

100-dB SPL is said to be less than 0.5% from 40 to 20,000 Hz, and 1.5% at 20 Hz. Impedance is 30 ohms, and required power is 3 watts rms/channel. Included with the SE-1S headphones is the EE-1 Energizer with built-in headphone/speaker switching. It also features protective circuitry for drive levels, and facilities for an additional set of headphones. \$129.95.

CIRCLE NO. 72 ON READER SERVICE CARD

### PIONEER ELECTRONIC CROSSOVER NETWORK

Pioneer's new Model SF-850 Electronic Crossover Network provides variable passbands for the bass, midrange, and treble regions. As many as ten different



crossover points are possible (125, 250, 500, 700, and 1000 Hz for low-mid ranges; 1000, 2000, 4000, 6000 and 8000 Hz for mid-high ranges). Independent selection of crossover points is provided for low, mid, and high channels. The Pioneer SF-850 also allows selection of three different slope characteristics—6, 12, and 18 dB/octave. The mid slope selectors provide flat positions to facilitate 2-way/multi-way amplifier configurations. Independent channel level controls are coaxial, allowing separate adjustments for left and right signals. The SF-850 measures 13-25/32 in. by 5-15/32 in. by 12-31/32 in. (35 by 13.8 by 32.9 cm) and weighs 12.3 lb (5.6 kg). \$199.95.

CIRCLE NO. 73 ON READER SERVICE CARD

### WAHL THERMAL-SPOT TESTER

The Thermal-Spot Tester by the Wahl Clipper Corp. provides a concentrated jet of hot air that can be directed to a specific component without physical contact. Many components will not malfunction until they reach operating temperature. The Thermal-Spot will allow examination of individual parts without waiting for the entire circuit to warm up. The compact Thermal-Spot heats the jet of air to about 125°C (260°F). It can also be used with heat-shrink tubing, for drying epoxies and cements, and to quickly dry out tuners after spray cleaning.

CIRCLE NO. 74 ON READER SERVICE CARD

### SANSUI LOW-COST RECEIVER

Making heavy use of ICs, the Model 441 AM/FM stereo receiver's tuner front end has a low-noise, dual-gate MOSFET to improve sensitivity and S/N ratio. Other tuner features include two ceramic filters, high-density ICs in the i-f and FM demodulator sections, and a tuning meter. The amplifier

POPULAR ELECTRONICS



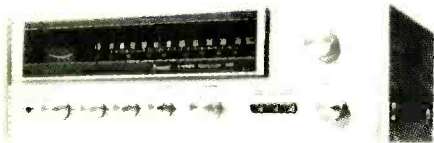

section uses a direct-coupled hybrid IC final amp delivering 11 W rms/channel into 8 ohms over a bandwidth of 40 to 18,000 Hz. THD is less than 1% and IM less than 0.8%, at rated power. Frequency response is 30 to 15,000 Hz, i-f rejection better than 75 dB at 98 MHz, and S/N is better than 65 dB. Stereo separation is better than 40 dB at 1000 Hz. Two pairs of speaker outputs are provided, as well as antenna inputs for 75- and 300-ohm transmission lines. \$219.95.

CIRCLE NO. 75 ON READER SERVICE CARD

### ACOUSTIC RESEARCH AR-10π

The AR-10π is a three-way system employing a "woofer environmental control" for proper bass response, according to Acoustic Research. The woofer control is said to compensate for the effects of speaker placement on bass radiation. A three-position switch tailors woofer action for 1π (in front of a wall on the floor), 2π (wall-mounted) and 4π (in the middle of a room) speaker positions. All controls of the AR-10π are located behind a front panel, above the foam grille. A 12-inch (30.1-cm)

woofer, 1½-inch (3.8-cm) dome midrange, and ¾-inch (1.9-cm) dome tweeter are used. Nominal impedance is 8 ohms, and minimum power requirement is 25 W. Crossover frequencies are 525 Hz and 5000 Hz. System resonance is 42 Hz. The AR 10π weighs 55 lb (25 kg) and measures 25" x 14" x 10¼" (62.8 x 35.1 x 25.7 cm). \$350.00.

CIRCLE NO. 76 ON READER SERVICE CARD

### E.F. JOHNSON HANDSET BASE STATION

The Messenger 132, a 23-channel CB base-station transceiver, incorporates a handset in its "radiotelephone" design.



This feature permits private listening, and, Johnson claims, increased clarity of transmissions in noisy environments. Received signals can also be heard through a built-in or external speaker. An illuminated meter doubles as a received signal-strength and relative r-f output indicator. Squelch and volume controls are included.

A PA function allows paging through an external speaker. A back-lighted channel selector changes from white to red when the Messenger 132 is in the transmit mode.

CIRCLE NO. 77 ON READER SERVICE CARD

### HICKOK PORTABLE SEMICONDUCTOR TESTER

Hickok's new Model 215 Semiconductor Tester is a pocket-size, self-contained test instrument capable of checking npn's, pnp's, FET's, diodes, SCR's and UJT's in or out of circuit. The Model 215 automatically determines proper lead configuration, and indicates by LED displays if the device is GOOD or BAD. If GOOD, it further identifies which lead is the base (gate for FET's) and whether npn or pnp. The CMOS circuitry improves reliability and provides long life for the two 9-volt batteries.

CIRCLE NO. 78 ON READER SERVICE CARD

### ASCOM FIELD STRENGTH METER

A very compact field strength meter, the Model ASM-105, has been introduced by Ascom Electronic Products. The field strength meter can be put to many uses: field checks of antenna radiation, antenna tuning, and comparative tests of various transmitters and antennas. The Model ASM-105 requires no internal power, and covers the frequency range of 27 MHz to 225 MHz. \$15.95.

CIRCLE NO. 79 ON READER SERVICE CARD

## You don't have to buy a new car to get an electronic ignition.



Let's face it. After 37 years, even a Phantom III can use a lift. That's why I put a Delta Mark Ten B Capacitive Discharge Ignition on my Phantom . . . to give her a spark I'd pit against any '75 model car. I went to Delta because they aren't Johnny-come-latelys. Delta's been making electronic ignition systems for over a decade.

Whatever kind of car you drive, you can give it the same great Delta performance I gave mine.

- Mark Ten B Capacitive Discharge Ignition Systems are manufactured by Delta Products, Inc., a company with a conscience, and with a proven record of reliability both in product and in customer relations.

- The Mark Ten B really does save money by eliminating the need for 2 out of 3 tune-ups. Figure it out for yourself. The first tune-up or two saved pays for the unit, the rest is money in your pocket. No bunk!

- Because the Mark Ten B keeps your car in better tune, you actually can save on expensive gasoline.

- With a Mark Ten B, spark plugs stay clean and last longer . . . fouling is virtually eliminated.



I want to know more about Mark Ten B CDI's. Send me complete no-nonsense information on how they can improve the performance of my car.

Name \_\_\_\_\_

Address \_\_\_\_\_

City \_\_\_\_\_ State \_\_\_\_\_ Zip \_\_\_\_\_



**DELTA PRODUCTS, INC.**

P. O. Box 1147, Dept. PE, Grand Junction, Colo. 81501  
303-242-9000

Mark Ten B, assembled	\$64.95 ppd	Standard Mark Ten, assembled	\$49.95 ppd
Mark Ten B, kit	\$49.95 ppd	Δeltakit®	\$34.95 ppd

www.americanradiohistory.com CIRCLE NO. 14 ON READER SERVICE CARD

# Hewlett-Packard introduces a smaller uncompromising calculator,

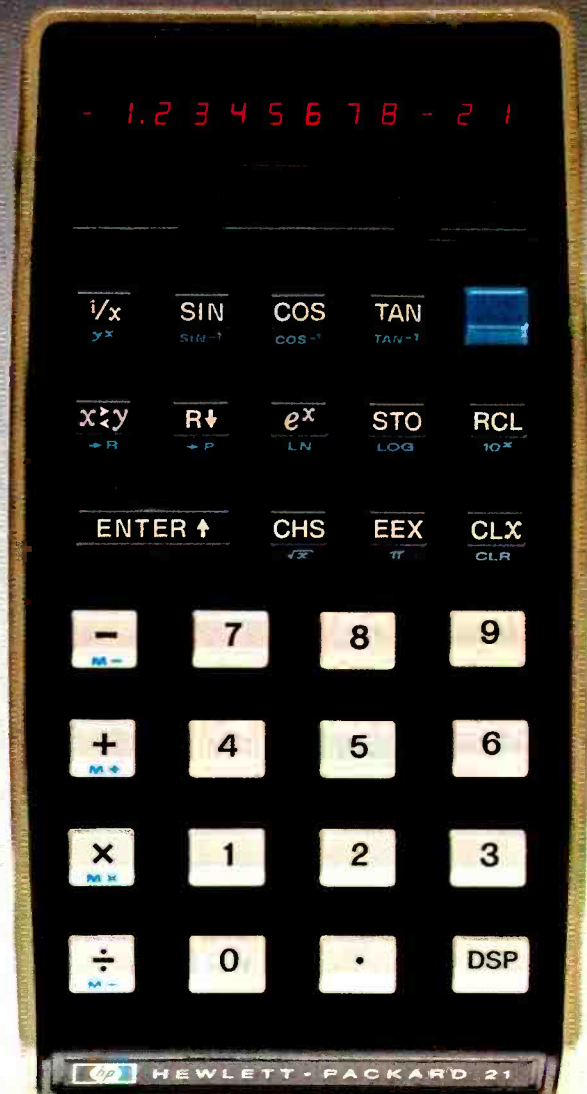
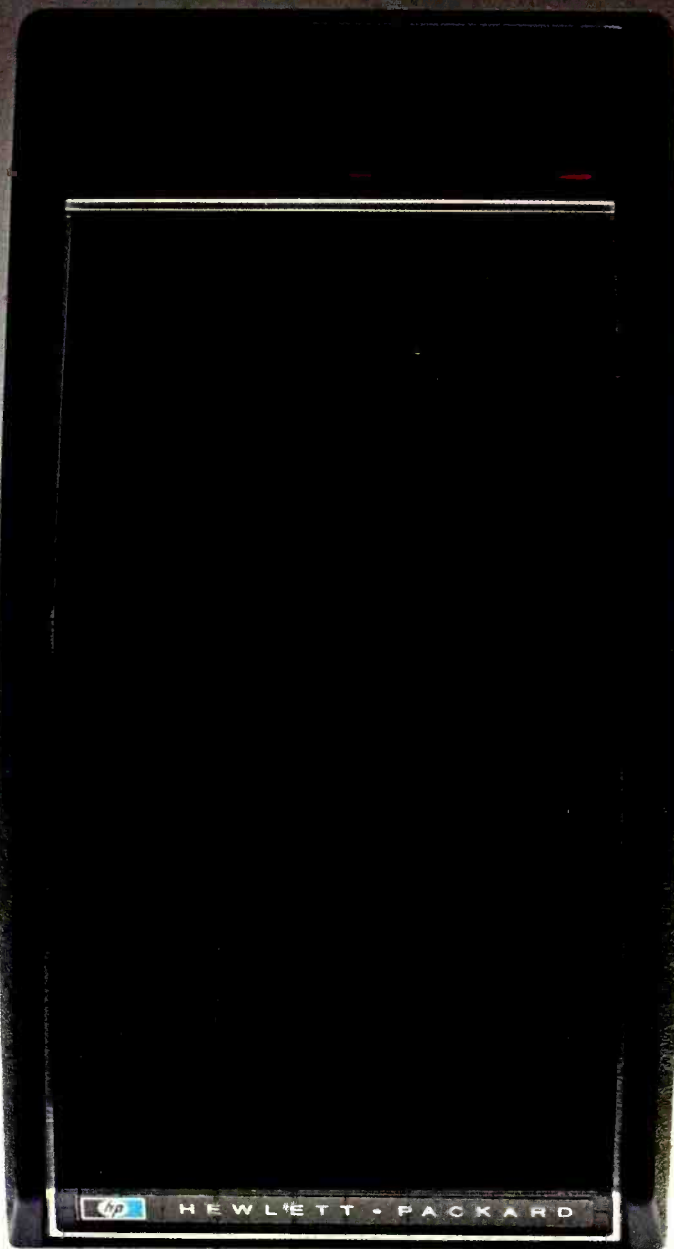



# the new HP-21 Scientific. \$125.00\*

Now \$125.00 buys:

- **More power than our HP-35.** 32 pre-programmed functions and operations, including rectangular/polar conversion, register arithmetic and common log evaluation.
- **Smaller size.** 6 ounces vs. 9 ounces for our HP-35.
- **Display formatting.**
- **H-P's unique and efficient RPN logic system.**
- **H-P's quality craftsmanship.**
- **An unbeatable price:performance ratio.**

Here are the details:

**32 pre-programmed functions and operations.** The HP-21 performs all log and trig functions, the latter in radians or degrees. It's our only calculator short of the HP-45 that lets you:

- convert polar to rectangular coordinates, and back again ( $\rightarrow P, \rightarrow R$ );
- do full register arithmetic ( $M+$ ,  $M-$ ,  $M\times$ ,  $M\div$ );
- calculate a common antilog ( $10^x$ ) with a single keystroke.

The HP-21 also performs all basic data manipulations ( $1/x$ ,  $y^x$ ,  $\sqrt{x}$ ,  $\pi$ ) and executes all pre-programmed functions in *one second or less*.

**Full display formatting.** The Display key (DSP) allows you to choose between fixed decimal and scientific notation and lets you control the number of places displayed. (The HP-21 always uses all 10 digits internally.)

When a number is too large or small for fixed decimal display, the HP-21 switches automatically to scientific, so you never have to worry that the calculator will confuse a smaller number with zero.

Finally, if you give the HP-21 an impossible instruction, the Display spells E-r-r-o-r.

**RPN logic system.** Here's what this unique time-and-error-saving logic system means for you:

- You can evaluate *any* expression without copying parentheses, worrying about hierarchies or re-structuring beforehand. Your calculator remembers what's where—automatically.
- You can solve *all* problems your way—the way you first learned in beginning algebra, the way you now use when you use a slide rule.

- You solve *all* problems—no matter how complex—one step at a time. You *never* work with more than two numbers at once.
- You get continuous and immediate feedback. You see *all* intermediate answers *immediately*, because your calculator executes each function immediately after you press the function key. *You watch it happen.*
- You can easily recover from errors. You can back-track when you err, because your calculator performs all operations sequentially.
- You can re-use numbers without re-entering them. Your calculator becomes your scratch pad.

**H-P quality craftsmanship.** One reason Nobel Prize winners, astronauts, conquerors of Everest, America's Cup navigators and over 500,000 other professionals own H-P calculators. Here are four examples of it:

- Every key on every calculator is double injection molded, so the symbol it carries won't wear off. Every function key has a positive click action, so you know for sure the function has registered when you press one.
- There's a moisture barrier under the keyboard to protect the calculator's innards from coffee, tea, milk, what-have-you.
- It's no accident that the OFF-ON switch operates as smoothly as it does. We greased it with silicon when we installed it. It's also no accident that it moves in a horizontal plane. That's to prevent it from moving when you put the calculator into its carrying case or your shirt pocket.
- The heavy gauge plastic case is designed to withstand a long tumble to a hard floor. Incredibly, one H-P pocket calculator once withstood a trip through a snow-blowing machine. The case cracked, but the machine worked.

800-538-7922 (in Calif. 800-662-9862). The numbers to call for a "hands-on" demonstration. We'll give you the name of a dealer near you, and we'll send you detailed specifications of our new HP-21. Challenge it with your problems. See for yourself how much performance \$125.00\* can buy.



Sales and service from 172 offices in 65 countries.  
Dept. 254A, 19310 Pruneridge Avenue, Cupertino, CA 95014



## New Literature

### CROWN HIGH-FIDELITY BROCHURE

Crown International offers a new four-color brochure describing the company's complete line of hi-fi amplifiers, preamplifier, speaker system, control centers and tape recorders. The brochure quotes some specifications, but up-to-date spec sheets and laboratory test reports are also available upon request. Address: Crown International, 1718 W. Mishawaka Road, Elkhart, IN 46514.

### RCA PICTURE TUBE PRODUCT GUIDE

A revised product guide describing RCA picture tubes for the renewal market has been announced by RCA Electronic Components. The guide includes an interchangeability directory that lists RCA replacements for 975 (including 85 foreign) industry types. Its characteristics charts contain data on all types for which RCA has

a replacement. The product guide also includes basing diagrams, pictorial views, and keys to tube sizes in the old, new, and foreign designation systems. Address: RCA Electronic Components, Commercial Engineering, Harrison, NJ 07029.

### MULTIMETER BROCHURE

A 6-page brochure describing a 4½-digit Multimeter is available from Data Precision Corporation. The publication describes the Model 1450 which utilizes Data Precision's Tri-Phasic™ A/D conversion technique, Isopolar reference system and Ratiohm™ resistance measuring system. Address: Data Precision Corporation, Audubon Road, Wakefield, MA 01880.

### EDMUND ENERGY-SAVING BULLETIN

"Tips and Things for Beating the Energy Crisis" is an informative 8-page bulletin offered free by the Edmund Scientific Company. It shows how to save on heating and air conditioning both in the home and plant. Hints are given for making the best use of energy in the kitchen—on and in the stove, refrigerator/freezer, and other electrical appliances. Also included is information on energy-saving devices such as a windmill generator, solar cells, and plans for a Solar House. Address: Edmund Scientific Co., 555 Edscorp Bldg., Barrington, NJ 08007.

### KURZ-KASCH KNOB CATALOG

A two-color, 20-page catalog of knobs and equipment enclosures is offered free by Kurz-Kasch, Inc. Many varieties of knobs are illustrated, including spinner knobs and pointer, dual-control, and skirted models. Address: Kurz-Kasch, Inc., Dayton, OH 45401.

### KESTER SOLDER SLIDE RULE

A handy slide rule published by Kester Solder provides flux selector data and solder alloys guides on flip sides. The pocket-size slide rule gives flux choices for 22 metals; and 36 solder alloys and their melting points are listed. Address: Kester Solder, 4201 Wrightwood Ave., Chicago, IL 60639.

### NATIONAL SPECIAL FUNCTION CATALOG

A new 200-page Analog and Digital Special Function Catalog is now available from National Semiconductor Corp. The new catalog contains design and application information on amplifiers, comparators, analog switches, MOS clocks and digital drivers, and power supply modules. The catalog contains a cross reference guide, product selection guides, and detailed technical information on National's special function IC's. Address: National Semiconductor Corp., Marketing Services Dept., 2900 Semiconductor Dr., Santa Clara, CA 95051.



## Clear, powerful signals with get-through punch

- SBE "SSB" equipment—the finest—operates at highest legal talk power limits—25W input, 12W out, p.e.p.
- Bang through! Using SSB is like adding a good 3-element beam to the best AM set. Also enjoy 46 channel SSB operation w/LSB/USB.



SIDEBANDER II, SSB/AM

SIDEBANDER III, SSB



Choose from among three, performance-proved SSB transceivers. For **mobile**, two exceptional sets: **SIDEBANDER II** has SSB and AM with hi-level modulation or **SIDEBANDER III** with SSB only. Both operate at 25W peak power on SSB with USB and LSB—"Clarifier"—Squelch—Noise limiter—RF gain control—Panel monitor meter—PA/Hailer provisions. **CONSOLE II** is a top quality base station transceiver of highest utility—provides both full power SSB and AM—has built-in AC power supply, will switch automatically to external DC battery if power fails—a highly desirable emergency function. Has all features of mobile sets, adds, ON THE AIR indicator and meter monitoring for Power out, "S" units and VSWR. Also accepts VOX accessory for voice controlled S/R switching. Slip-on outer cabinet of beautiful grained wood is an accessory.



CONSOLE II, SSB/AM

### LINEAR SYSTEMS, INC.

220 Airport Blvd., Watsonville, CA 95076

WRITE FOR  
DESCRIPTIVE BROCHURE

CIRCLE NO. 25 ON READER SERVICE CARD

[www.americanradiohistory.com](http://www.americanradiohistory.com)

POPULAR ELECTRONICS





# Stereo Scene

By Ralph Hodges

## A SHORT HISTORY OF FOUR CHANNEL

**A**n engineering chief from GE had asserted that, on a dollar-for-dollar basis, more satisfactory performance could be obtained from four channels than from two.

I listened very carefully then to the GE spokesman's reasoning, but didn't understand a great deal of it, I'm afraid. When the press briefing ended, I was left with the impression he had said something about four channels not having to "work" as hard (per channel) as two for equivalent loudness levels, and that a four-channel system's greater distribution of actual sound sources produces a greater (better) distribution of room-mode effects.

That was almost two years ago. Since then, if the audiophile community has come to believe that an \$800 four-channel system is better than an \$800 stereo (two-channel) system, there is precious little sign of it. Sales of four-channel equipment, while not as lackluster as they are sometimes reported, have been a disappointment to some of those companies who thought they sniffed a major revolution in the wind during the early

Seventies. The promise based on the 4-channel premise is still there, although the word "quadraphonic" is not yet on the lips of the man on the street. What is to blame? Ineffective demonstrations, of course; and there is also the confusing multitude of available or proposed systems. Extravagant claims made for systems still very much in the development stage greatly contributed, I believe. Finally there is the view—an astute one, perhaps—of Andy Petite of the Advent Corp., once seriously involved with four channel: four channel, even more than stereo, has never been successfully defined or described itself. Does it surround you with sound like some unfortunate caught between the artillery barrages of opposing armies? Is it a world apart, where you float in a sensation never before experienced by mortal man? Or does it bring you correctly reproduced, reflected sound?

Much of this confusion is expected to be eliminated in the future. The IHF has observed that only 1% of the market has ever heard of 4-channel sound. And most of this minuscule group

have not been properly exposed to the format. Manufacturers recognize that they face a public education challenge to bring the concept of quadraphonic sound to the fore, illustrating the enormous improvement of sound reproduction achieved with the latest systems (rather than fighting each other over who has the best system).

**The Beginnings.** Multi-channel (more than two) stereo is not particularly new. In the 1950's, Marvin Camras conducted one of the earlier and more famous experiments by ringing a room-size area of various acoustic environments with outward-facing microphones and recording acoustic events on twelve tracks. For playback, twelve speakers replaced the microphones and the listener(s) was put in the middle. No one I have talked to who attended the (much later) demonstration of these experiments was disappointed, but neither was anyone ecstatic. Perhaps they never imagined they were hearing more than a laboratory curiosity.

However, by the time of the late 1960's, Acoustic Research had begun its portentous investigations into multi-channel sound. AR used artificial reverberation devices, as well as live recordings. For the latter, four microphones (or the equivalent) and four playback loudspeakers were used, placed in the now-traditional rectangular pattern of front and rear pairs. The choice of four was mostly an arbitrary one. Otherwise, the technique did not differ much from the one Camras had used.

Several of the tapes AR made and later demonstrated sounded spectacular to the ears of audiophile listeners. They also served to arouse speculation as to the viability of four channel as a consumer medium.

**Creation of Space.** By and large these first forays into quadraphonics were pragmatic rather than theoretical; in other words, they proceeded from the notion that if it were possible to set up one credible stereo "stage" in front, it should be possible to add three more to encompass the listener. Not much thought was given to what was necessary and what irrelevant to produce the desired aural illusion, especially since so little was known about the requirements for "fooling" the ear-brain mechanism in this way. But in almost every case, the illusion these early experimenters were after



# Doing anything interesting after work?

If you're spending more time at home these days, why not use some of it constructively—to continue your education? Send for details about this fascinating learn-at-home program from Bell & Howell Schools. Find out how interesting it can be to build new occupational skills in electronics— at home, after work.

Look into it. Mail the card now.





## Let Bell & Howell Schools help you discover electronics at home.

These days, it seems like almost everything is "going electronic." If you've got time after work, spend some of it learning electronics.

Mail the card for details about this fascinating learn-at-home program from Bell & Howell Schools.

### Why this program is designed to make learning electronics especially interesting.

Electronics is a fascinating subject! But, let's face it, learning at home means you're on your own a good part of the time. There's no teacher to prod and coax you.

That's why we planned this learn-at-home program to hold your attention and make each principle you learn more vivid... easier to remember!

We'd like to think you'll rush home from work each evening— anxious to haul out your course materials and get down to business!

Let's talk about what we do to keep you interested.

### For one thing, we don't just send you books.

Oh, books are important. In fact, this program includes a complete set of carefully prepared texts. And there's no way you can get along without them.

But if you decide to spend some of your time learning electronics at home, you're going to get a lot more than books. You're going to take your jacket off, roll up your sleeves and actually get your hands on modern electronic equipment. You're going to explore it... experiment with it... put it together yourself!

If that doesn't *already* sound like something pretty interesting to do after a day at work, take a closer look.

### With the very first lesson, you get a Lab Starter Kit to help you grasp the basics.

If you're a complete beginner at electronics, this Kit will help you make a good start.

It's not complicated. Just a simple voltmeter and "breadboard" you use for basic experiments that help you understand the fundamentals. Now, you're ready to move on to something more advanced.

(By the way, if you're *not* a beginner, we'll arrange advanced standing in the program so you start at the point that's right for you.)

## You actually build your own Electro Lab<sup>®</sup> electronics training system.

One evening, when you get home from work, you'll find a large package waiting for you. When you open it, you'll find a set of electronic components.

Probably that same evening, you'll want



to start working with these components. Following the instruction manuals and course materials—and using the principles you've learned—you'll actually begin to build three modern test instruments. Once assembled, they make up a complete home electronics laboratory you'll use for testing, troubleshooting and circuit analyzing.

**Use the design console**... to set up and examine circuits. It's completely modular... no soldering!

**Use the digital multimeter**... to measure voltage, current and resistance. Read data in big, clear numbers—just like on a digital clock!

**Use the solid-state "triggered sweep" oscilloscope**... to analyze modern, "state-of-the-art" integrated circuits. Triggered sweep feature locks in signals for easier observation!

By now, you've spent many fascinating evenings at home learning electronics. And you're really making progress. In fact, you're ready to get into "state-of-the-art" integrated circuitry—even some applications of *digital* circuitry!

### At this point, you start building a remarkable color TV.

As you build this 25" diagonal color TV, you investigate the digital circuitry that allows the automatic channel selector to go directly to preselected channels—as well as discovering the circuitry behind channel numbers and a digital clock that appear on the screen. You find out why the Black Matrix picture tube makes for such exceptional color clarity. You explore "state-of-the-art" integrated circuitry and

the 100 percent solid-state chassis.

Once you've built this TV, you've rounded out your electronic training and gained new occupational skills.

### Bell & Howell Schools' step-by-step methods smooth your progress.

Since you're learning at home, on your own, we do everything possible to keep your progress trouble-free

For example, since it's easier to grasp new ideas one at a time, we send you texts that break the subject of electronics into small segments. You can take your time to master each one before moving on to the next.

### Special learning opportunities give you extra help and attention.

In case you do run into a problem or two, we're ready to give you more help and personal attention than you'd expect from most learn-at-home programs.

For example, many home study schools ask you to mail in your questions. Bell & Howell Schools gives you a toll-free number to call for answers you need right away.

Few home study schools offer personal contact with instructors. Bell & Howell Schools organizes "help sessions" in 50 major cities at various times during the year—where you can discuss problems with fellow students and instructors in person.

### The skills you develop could lead you in exciting new directions.

No school can promise you a job or income opportunity. But the skills you learn from this Bell & Howell Schools' program could help you look for a job in the electronics industry... or upgrade your present job... or use these skills as a base for continuing your education in electronics programs.

Taken for vocational purposes, this program is approved by the state approval agency for Veterans' Benefits.

### Send for details today.

Why not find out how constructive and interesting it can be to spend time learning electronics. Mail the card now.

### For more details, mail the postage-paid card today!

"Electro-Lab<sup>®</sup>" is a registered trademark of the Bell & Howell Company.  
Simulated TV test pattern.

If card has been removed, write:

An Electronics Home Study School  
DEVRY INSTITUTE OF TECHNOLOGY

ONE OF THE  
**BELL & HOWELL SCHOOLS**  
4141 Belmont Chicago, Illinois 60641

# TAKE YOUR CHOICE

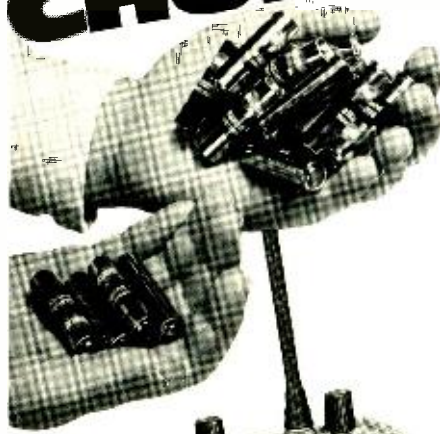

**Mini-Scan™**  
is the pocket scanner that works a week on just 4 penlight cells.

A breakthrough we call "mini-miser circuitry" makes it possible ... and it's actually 2½ to 5 times more efficient than any other pocket scanner we tested!\* Just 4 alkaline penlight cells power it for a full week, 8 hours a day, on a tough 50-50 duty cycle (50% full volume, 50% squelched). And its performance is bred from our experience in public safety two-way radio ... so it also gives you the crispest, clearest messages possible. Just \$119.95 with built-in ferrite antenna (batteries, crystals and optional flexible antenna extra.)

\*Test results gladly supplied on request.



**Johnson**  
MINI-SCAN™

... the professional pocket scanner

E. F. JOHNSON CO., WASECA, MINNESOTA 56093  
IN CANADA: A. C. SIMMONDS & SONS, LTD.  
CIRCLE NO. 33 ON READER SERVICE CARD



was the same: they wanted to create a pseudo concert hall—the impression of a large enclosed space in which the music from recordings could exist and "breathe."

Anyone can roughly judge the size of a room, even in pitch darkness, by simply making some kind of noise in it. The sound reflections (reverberation) then give it away. The reverberation patterns of large rooms (halls and auditoriums) and small, illustrated in Fig. 1, are characteristic. In a small room, sound coming directly from the source is followed almost instantaneously by rather strong reflections from nearby surfaces. This sonic bombardment continues until the sound energy escapes or is absorbed, mostly by collision with those same surfaces that reflect part of it. In a confined space the collision rate is high, so absorption takes over rather quickly.

In a large room, the first reflections are later in arriving, having had to traverse greater distances. They are also somewhat weaker. However, the sound may "hang on" considerably longer since collisions with walls and ceiling are less frequent, and this accounts for the concert-hall "bloom" that is so flattering to certain types of music.

Two-channel stereo had proved itself less than completely effective in portraying this rich reverberant field; the reverberation was audible on many recordings, but it rarely gave the listener the feeling that he was *in* it. The four-channel solution was to add rear speakers so that reverberation could come at him from all directions. Furthermore, during recording, this reverberation would be miked just as if it were the direct sound from the musicians. Stereo microphone arrays were aimed at the sides and back of the concert hall, as well as at the stage. All this sonic information was assigned to appropriate tracks on the tape, and rendered back through four encompassing speaker channels. One

thing that was not really considered—or perhaps it was beyond considering—was the effect that the acoustics of the *listening* room would have on all this. By superimposing the curves of Fig. 1 to produce Fig. 2, we can see that, for a brief time after the cessation of the direct sound, the reverberant field of a small room is considerably stronger than that of a large hall. The result, theoretically, would be a momentary masking of the hall reverberation (on the record) by the listening room acoustics. You can get an idea of what this sounds like, I believe, by playing the final note of any loud symphonic or organ passage on a conventional stereo system. As the note ends, there is the briefest instant of disorientation before the reverberant tail of the sound (from the record) is heard through the speakers. How much this phenomenon would affect the four-channel illusion was, and still is to a large extent, an open question.

**Moving On.** The idea of four-channel reproduction had by now reached the outside world, and there was widespread interest in how the technique could be adapted to the phonograph disc, or even stereo FM. Then up popped Peter Scheiber of Audiodata with an answer of sorts. Scheiber's answer was complex and became more so as time went on. At the heart of it was the relatively simple concept of matrixing, which rapidly became almost a household word, as did the term "separation," since that was where matrix systems had their problems. Conventional matrix techniques applied to a two-channel medium (with no increase in frequency bandwidth allowed) provided only very limited separation between four channels; if you distributed the available separation equally you got 3 dB between each speaker pair. Not excitingly good! Scheiber knew this and concentrated on sophisticated subsequent signal processing to improve

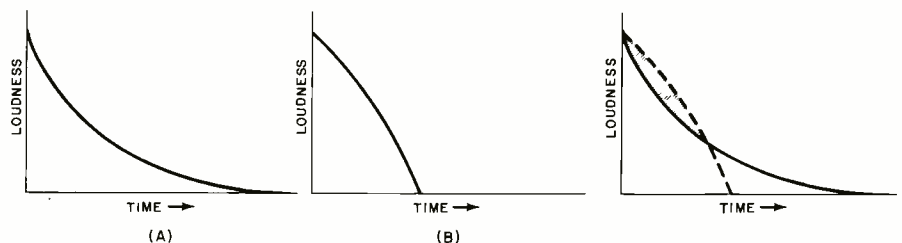

Fig. 1. Curve (A), left, shows reverb characteristics of a large hall; (B) is for small listening room. Fig. 2, right, combines them to show how time curve (B)'s acoustics dominate recorded ambience.



matters, as did others shortly after. He had a fair measure of success, but the economic realities of the equipment grew unmanageable (and still were when Scheiber was last spoken to).

The matrix concept promptly engendered what seemed like a thousand variations: Dynaquad, Electro-Voice, Sansui, (the latter marketing a device that also phase-shifted and equalized channels), and many others more obscure. About all you could say for them was that the cheapest (Dynaquad) was capable of sounding as good as the costliest. And most of them emphasized the effect that could be obtained from synthesizing four channels from two-channel material. This was astonishingly good with some recordings, but it also laid bare the fact that software for any of the systems was virtually nonexistent. Then CBS demonstrated a somewhat more complicated matrix system with subsequent signal processing that the company called "logic." It worked very well if all you asked of it was the silencing of three channels when only the fourth was supposed to be playing. More than a year would pass before "full-logic" decoders for the system became generally available, but at least Columbia's entry meant that four-channel recordings (intended for SQ decoding) would be widely obtainable. To top this, a short time later RCA announced that it would go with the technologically difficult technique developed by JVC: an ultrasonic carrier on the disc to contain the needed extra information.

**Echo Chambers.** Throughout this period there were those who held that if you wanted reverberation, you might as well get it the way the recording studios often do: by using delay lines. The only device of this type intended for "four-channel" applications that ever came close to being marketed was a device sponsored by Harman-Kardon. It employed mechanical springs that were carefully equalized to subdue their various resonant nastinesses. Others experimented with tape loops and even acoustic delay lines. A number of these systems fed reverberation only to the rear channels—theoretically unacceptable, although the effect didn't always sound that bad.

The king of the delay-line systems was built by Horrall and Watters at Bolt Beranek and Newman for the purpose of studying auditorium acoustics. The



*Fig. 3. BB&N simulator has AR amps, 4x speakers and AKG reverb unit.*

artificial reverberation is generated by a high-speed tape loop with eight stereo playback heads (16 tracks), as well as a real room-type echo chamber. At the time I visited, the system, called the "Auditorium Acoustics Simulator," was in temporary quarters at the firm's Waltham, Mass., offices, and a high-quality spring-type delay line had been substituted for the echo room. Otherwise the operation was unmodified. It works as follows.

A 1/24-scale model of the auditorium is constructed and measurements are made in it of impulse sound with a small microphone capsule pointed in various directions. After the results have been adjusted for frequency/wavelength effects (due to the model's smaller scale), computer programs are written for twelve channels, corresponding to twelve microphone directions. The contents of the channels are assembled, according to the programs, by mixing, in various proportions, the outputs of a (virtually) reverberationless recording of a symphony orchestra and the various delay mechanisms. The channels are then fed to twelve speaker systems carefully positioned about an acoustically dead listening room of average size (see Fig. 3). The way the bass is handled is especially interesting. Below 150 Hz it is all fed to two 12-inch acoustic-suspension woofers. The woofers are then placed so that the room modes activated by one are not activated by the other. And finally, each woofer is limited in bandwidth to the range over which its response is essentially flat. The frequencies that one woofer cannot reproduce uniformly are handled by the other. This works because low frequencies are presumably nondirectional; the woofers could theoretically be anywhere in the room (during my visit they were

# Crown POWER

## reveals a new level of listening

Discover the five elements of Crown power that make hearing the DC300A such a unique listening experience.

### Extreme low distortion:

Maximum total harmonic and intermodulation distortion of 0.05% over a bandwidth of 1-20,000 Hz. Such minute levels made it necessary for Crown to design its own intermodulation distortion analyser, now in use industry wide.

### Continuous power:

155 watts/channel minimum RMS into 8 ohms stereo, 310 watts minimum RMS into 16 ohms mono, over a bandwidth of 1-20,000 Hz.

### Complete protection:

The DC300A is fully protected against shorted loads, mismatched connections, overheating and excessive line voltage, input overload as well as RF burnout. And this amp will drive any type load, resistive or reactive.

### Uncommon reliability:

The DC300A's reliability is legendary. Leading big name rock groups demand DC300A's because of their rugged ability to withstand tour-long punishment and still produce flawless sound. And major recording studios insist on Crown to keep time losses at a minimum. The professionals know from experience Crown's unqualified dependability.

### Exclusive warranty:

Crown's unique warranty covers not only parts and labor but **round-trip shipping** for three years. These shipping costs are an important factor in our warranty, and it is not surprising that no other amplifier manufacturer offers this service.



For color brochure, write Crown, Box 1000, Elkhart, IN 46514. For the most sensational sound demo of your life, take your best material to the nearest Crown dealer.



# Crown

WHEN LISTENING BECOMES AN ART  
CIRCLE NO. 43 ON READER SERVICE CARD

# unique ballpoint

BY Xcelite®

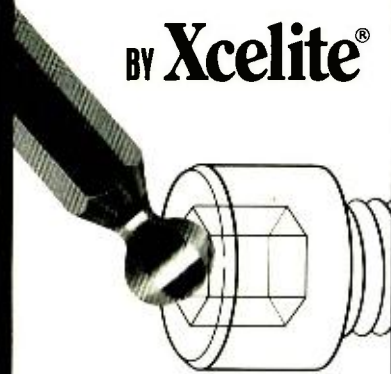

## DRIVES HEX SOCKET SCREWS FROM ANY ANGLE

Ever try to drive hex socket screws from an odd angle? Want an easier, faster way to drive 'em under any conditions?

HERE'S YOUR ANSWER: With unique "ballpoint," you can slip these Xcelite screwdrivers into hex sockets... slick as a whistle and secure as a vise... straight-on or from any angle... to drive 'em home in a flash! 9 sizes: .050"-3/16." With fixed handles, singly or complete set in roll up kit, and as interchangeable Series 99 blades, singly or with handle and extension in compact case. Metrics, too.



Ask your local distributor or write...

**Weller-Xcelite  
Electronics Division**



**The Cooper Group**

ORCHARD PARK, N. Y. 14127

CIRCLE NO. 41 ON READER SERVICE CARD

close together and off to one side) and still sound right stereophonically.

When I heard it, the BB&N system performed magnificently, providing an uncanny sense of hall sound and a somewhat remote orchestra. Unfortunately, the simulator is not and was never intended to be a consumer product.

**The Present.** In the ensuing several years, all four-channel systems either became technically better or disappeared. CBS went beyond its full-logic decoder to add "variable blend," an electronic cancellation technique that can work when all four channels are supposed to be "on." RCA grappled with a myriad of hardware and software problems, at least holding its ground and, sporadically, even seeming to move ahead. And Sansui essentially dropped its rather weird Quadraphonic Synthesizer somewhere along the way and came up with Vario-Matrix, perhaps the most refreshing solution to matrix separation shortcomings that has been seen to date.

Unfortunately, much of this progress fell on deaf or jaded ears. The carefully nurtured expectations of consumers had been disappointed too often already, and much of the available software was still bland, engineered for quadraphonic effects with a frequently lead-heavy hand.

At present, RCA is finding out that today's prevailing standards of disc-record manufacture are not quite up to the technical demands of its CD-4 systems, theoretically flawless though the system is. CBS continues to hold the upper hand with the SQ matrix, which enjoys the greatest degree of acceptance from record and equipment manufacturers. Ironically, however, the great progress being made in SQ decoders might even be a drag on sales; some prospective buyers seem to be holding off until the system is "finished." For example, the Tate SQ separation enhancer, demonstrated to high acclaim at last summer's Consumer Electronics Show (and not really seen since), has whetted the appetites of many for still better SQ performance than is available now.

Running gamely in third place is Sansui, which has lately adopted a somewhat different strategy: aggressively selling its QS matrix system to FM broadcasters. There is actually some method in this madness, since the Sansui equipment's capability for

synthesizing a four-channel effect from stereo material enables FM stations to maintain a consistent format. They simply "presynthesize" everything they play and throw it on the air—full-time "four-channel" broadcasting. QS-processed material of any kind is generally compatible, giving results on two-channel systems that are as good as stereo material yields. (Often better. As Peter Scheiber claimed some years ago, the abundant random-phase—and even anti-phase—content of four-channel matrix recordings tends to produce a "spacier" stereo image on two-channel equipment, often seeming to extend beyond the two speakers).

Fortunately, nobody is fussing too much about the compromised mono compatibility, which probably isn't that problematic in most cases anyway. But unfortunately, Sansui still refuses to sell a separate QS decoder. So anyone who wants QS Vario-Matrix but doesn't want a Sansui four-channel amplifier for whatever reason, will have to wait until the QS licensees, of which there are a good many by now, fill the gap in some way.

Informed reports indicate that there is still a serious limitation to the best configurations of the current matrix systems. As good as they can be for surround-type four channel, for subtler effects like rear-channel ambience there is still a tendency for instruments to sneak back behind the listener. This seems to be an artifact of the old separation problem again. I would suspect that a major factor responsible is confusion of arrival times for what is supposed to be the direct sound source.

In a reverberant environment the ear depends heavily on the earliest impinging sound to judge the direction of the source; the later sonic arrivals will presumably all be reflections. In a properly made *discrete* four-channel recording these ambient reflections will be appropriately delayed; and, of course, any system using artificial reverberation will involve delays. But when leakage between channels occurs in a matrix system there is no delay, so the sound of the instrument arrives simultaneously from several directions.

It appears just as certain as ever that we are ultimately destined to have a four-channel system or systems. And as for those views that four channel will soon disappear without trace—not very likely. ♦



# Radio Shack Wants You to Switch to New Supertape®

Join the big switch to Supertape and save a neat 50% on your trial order at any participating Radio Shack store or Dealer. It's made in our factory on the newest equipment and to the

highest standard we could set. It's internationally sold and acclaimed. Let your recorder and your ears be the judge. Not our advertising. Not theirs, either! Try Supertape today.

**3 VALUABLE BONUS COUPONS**

**TRY RADIO SHACK SUPERTAPE**

**OUR BEST AT 50% OFF**

**BRING INTO ANY OF OUR STORES\***

\*Participating Stores.



Radio Shack's own tape factory in Fort Worth, Texas.



**ASK FOR FREE CATALOG!**  
See what's really new in electronics. 164 pages of exclusive bargains in audio, CB, kits, parts, more!

**GET ONE SUPERTAPE CASSETTE**

**AT NO EXTRA COST**

when you buy the same cassette at the regular price at any participating Radio Shack store or Dealer. Limit one. This coupon must accompany your in-person order. None sent by mail.



STORE # \_\_\_\_\_ 502

**GET ONE SUPERTAPE OPEN REEL**

**AT NO EXTRA COST**

when you buy the same reel at the regular price at any participating Radio Shack store or Dealer. Limit one. This coupon must accompany your in-person order. None sent by mail.



STORE # \_\_\_\_\_ 502

**GET ONE SUPERTAPE CARTRIDGE**

**AT NO EXTRA COST**

when you buy the same cartridge at the regular price at any participating Radio Shack store or Dealer. Limit one. This coupon must accompany your in-person order. None sent by mail.



STORE # \_\_\_\_\_ 502

**Radio Shack®**

A TANDY CORPORATION COMPANY

P. O. Box 1052, Fort Worth, Texas 76101

OVER 3000 STORES • 50 STATES • 7 COUNTRIES

# Heavyweight performance in the lightweight class!



**3 great new  
hand-held  
transceivers--  
from Royce.**

**New, lightweight construction!**

**Model 1-408** is light in weight, with power to spare. Choice of 5-watt or 2-watt power input—use only the power you need and increase battery life. 3-way meter monitors battery level, power output, incoming signal strength. P.A. switch. 6-channel versatility (Channel 11 crystals supplied). Heavy-duty carrying case. Plus so much more.

Model 1-408  
Suggested Retail Price  
**\$109.95**

**Full, 2-watt transmitter input!**

**Model 1-402** weighs less than 2 pounds, yet has 3-channel versatility. Fully variable squelch control. Accessory jacks for earphone, external speaker, AC adaptor, battery charger, or external power. Built-in noise limiter. Heavy-duty telescopic antenna. *See the 1-402 before you buy!*

Model 1-402  
Suggested Retail Price  
**\$56.95**

**1-watt, 3-stage!**

**Model 1-400** features full 1-watt input power in a 3-stage transmitter. Plus high performance receiver chassis with tuned RF stage, and 2-channel versatility. Automatic noise limiter. Jacks for earphone, external speaker, AC adaptor, battery charger, external power. *Truly a deluxe hand-held transceiver!*

Model 1-400  
Suggested Retail Price  
**\$43.95**

Be sure to see us at the CONSUMER ELECTRONICS SHOW, June 9-12,  
McCORMICK PLACE, Booth # 9842

**Royce**  **electronics  
corporation**

**DISTRIBUTORS: WRITE FOR COMPLETE INFORMATION!** Get all the facts about new products from Royce—the pacesetter in the CB field! Call or telex for complete information on our entire line of CB transceivers.

1142 Clay Street, North Kansas City, Missouri 64116  
CALL: (816) 842-0252 • TELEX: 426-145  
CIRCLE NO. 53 ON READER SERVICE CARD





## BUILD A PORTABLE Analog/Digital Memory Translator

- Record analog data from dc to 250 Hz.
- Record digital data to 500 bits/second.
- Transmit data over conventional communication lines.
- Scramble speech.
- Record computer/calculator programs.
- Program lamps, speakers, ovens, etc.



BY JOE SULMAR AND JAY EISENBERG

**T**HE portable Memory Translator described here is designed to convert dc and low-frequency information to a signal that can be recorded on almost any low-cost cassette. This permits the storage of data (including digital) of a number of different types for future use and reference. (An alternative is the use of a chart recorder—which is not usually portable and is relatively expensive.)

The Memory Translator can handle signals between dc and about 250 Hz and digital data up to about 500 bits per second. The recorded tapes can be played back through the Translator at any time to reproduce the original signal. A simple additional circuit can be used to make the digital output compatible with TTL. In addition, two Memory Translators can be used to transmit data on a standard communication link.

A "marker" pulse can be injected on the tape to identify any particular

portion. When the marker is inserted (by means of a pushbutton switch) and when it recurs on playback, a

indicator light on the Translator is lit. This feature is especially useful for data alignment and synchronization.

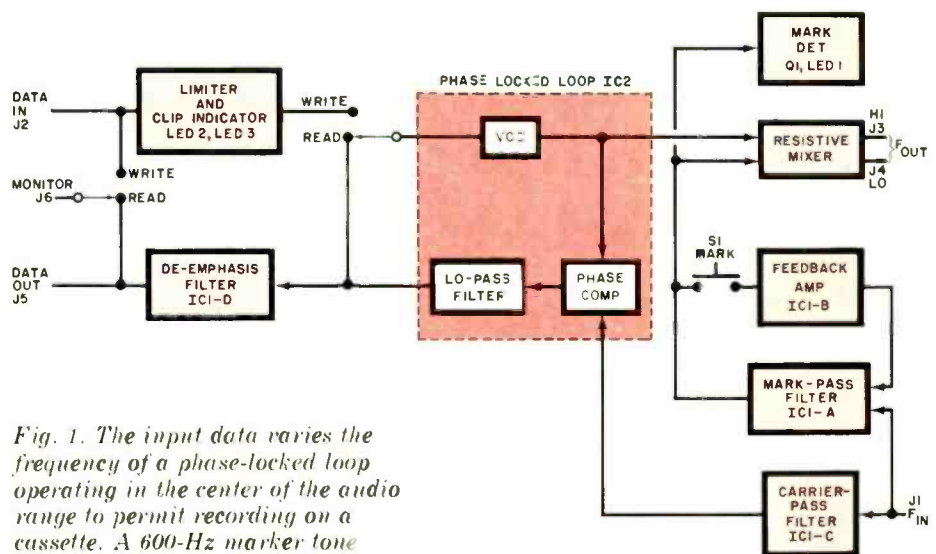

Fig. 1. The input data varies the frequency of a phase-locked loop operating in the center of the audio range to permit recording on a cassette. A 600-Hz marker tone can be inserted at any point.

## PARTS LIST

- B1, B2—9-volt battery  
 C1, C2—6800-pF 5% capacitor  
 C3, C6, C8, C12, C17, C19—0.1- $\mu$ F capacitor  
 C4—1.5- $\mu$ F capacitor  
 C5—0.01- $\mu$ F capacitor  
 C7—1800-pF, 5%, polystyrene capacitor (see text)  
 C9, C11—430-pF, 5% capacitor (see text)  
 C10—1500-pF, 5% capacitor (see text)  
 C13—1000-pF capacitor  
 C14, C16—5700-pF capacitor (see text)  
 C15—500-pF capacitor  
 C18, C20—300- $\mu$ F, 10-V electrolytic capacitor  
 D1 to D4—1N4148 diode  
 D5, D6—5.6-V zener diode  
 IC1—Quad op amp (National LM324N)  
 IC2—Phase-locked loop (RCA CD4046)  
 J1 to J6—Phono connectors  
 LED1 to LED3—Red light emitting diode  
 Q1, Q2—Transistor (Motorola MPSA05)  
 Q3—Transistor (Motorola MPSA70)  
 Following resistors are all  $\frac{1}{4}$ -watt, 10%:  
 R1, R10, R15, R21, R23—47,000 ohms  
 R2—680,000 ohms  
 R3—2000 ohms  
 R4—1000 ohms  
 R5, R8, R9, R19—10,000 ohms  
 R6, R7—200,000 ohms  
 R11—100,000 ohms  
 R12—39,000 ohms  
 R13, R16—82,000 ohms  
 R14—510 ohms  
 R17—330,000 ohms  
 R18—300 ohms  
 R20—1 megohm  
 R22, R28, R29—24,000 ohms  
 R24—22 ohms  
 R25—240,000 ohms  
 R26—150,000 ohms  
 R27—33,000 ohms  
 S1—Spst normally open pushbutton switch (Alco MSPS-103C or similar)  
 S2—4pdt, on-none-on subminiature toggle switch (Alco MST405N or similar)  
 S3—Dpst miniature toggle switch (Alco MST-205N or similar)  
 Misc.—Suitable chassis, battery holders, rubber feet (4), mounting hardware, wire, solder, etc.

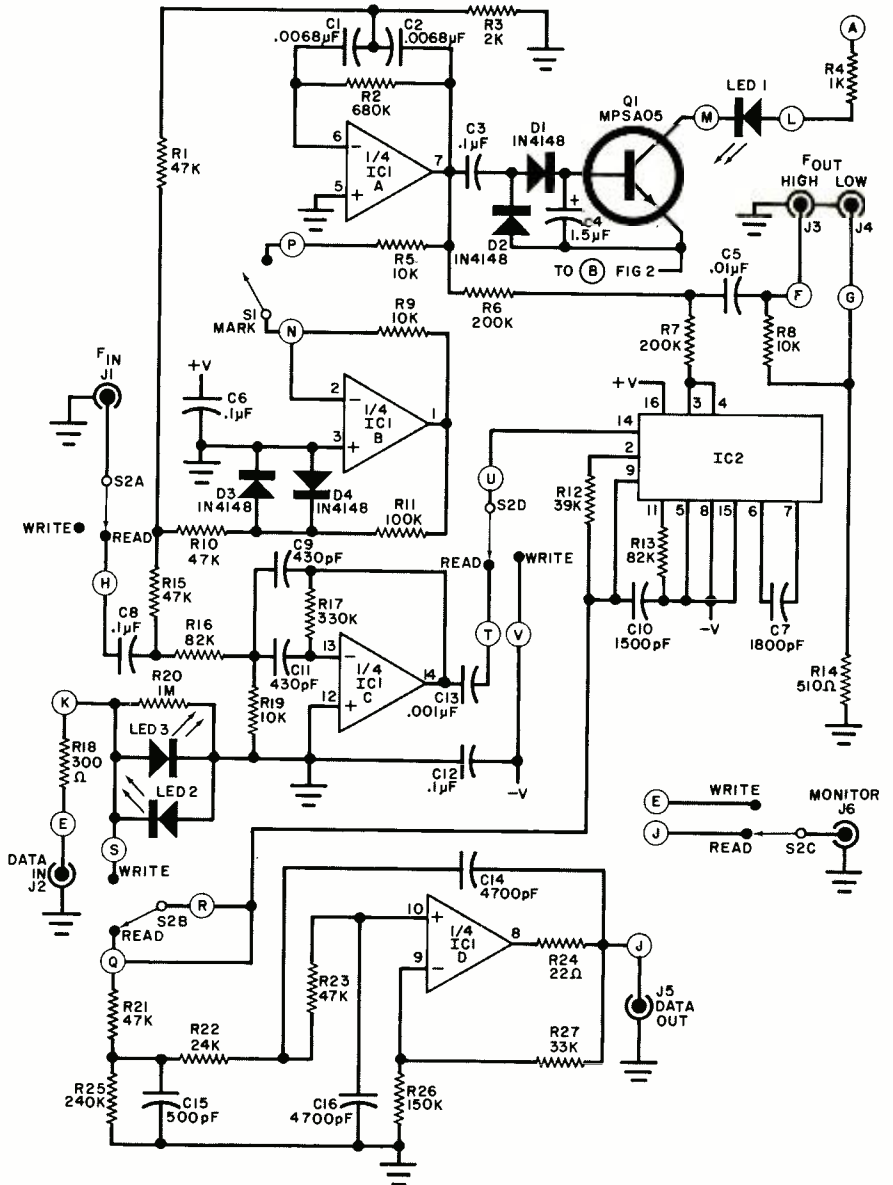

Fig. 2. Schematic of the translator. Letters in circles indicate connections between board and other components.

Note—The following are available from Electronics Research Group, 22 Mill St., Arlington, MA 02174: complete kit of all parts including case, excluding batteries

(ER-MT-1) at \$69.95 plus \$2 shipping and handling; pc board alone (MTPC-1) at \$7.50 postpaid; chassis, front panel and hardware (CP1) at \$15.00 postpaid.

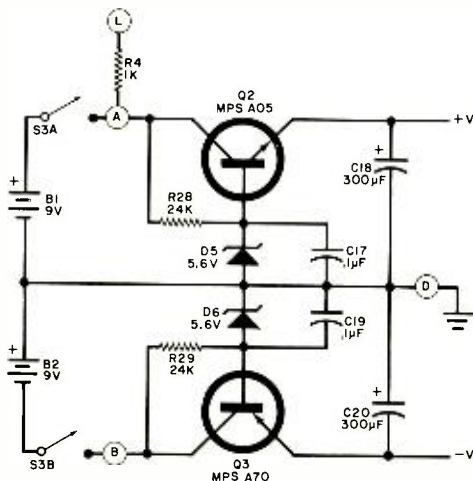

Fig. 3. Power supply can be mounted on pc board with the exception of batteries.

**How It Works.** Since tape recorders are relatively insensitive to low-frequency audio inputs, it is necessary to convert the data into high-frequency tones. The block diagram in Fig. 1 shows how this is done.

The data input at J2 is first applied to a level limiter and clip indicator. Light emitting diodes LED2 and LED3 are illuminated when negative and positive (respectively) peaks exceed the diode breakdown (1.5 V). With the system in the WRITE mode, the input is then applied to a phased-locked loop



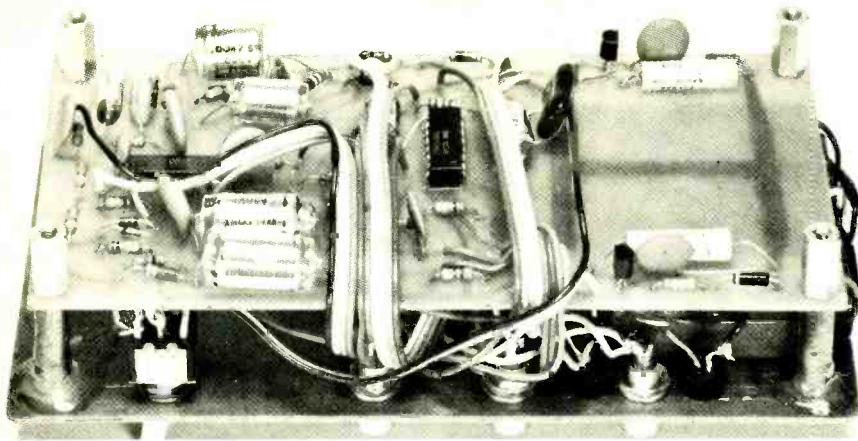

Photo of the prototype shows the pc board connected to the front panel with spacers. Batteries are located between board and panel.

(IC2). The frequency of the internal vco is about 7 kHz when the input signal is zero. Positive and negative variations of the input cause instantaneous frequency deviations of the vco output. The latter is applied to the tape recorder through the output terminals J3 and J4. Connector J3 is a 400-mV rms output for the tape recorder's line input, while J4 delivers a 30-mV rms signal for the recorder's microphone input. The FM output swings between 5000 and 9000 Hz so it is suitable for low-cost recorders.

With the system in the READ mode, the input (J1) from the recorder goes through a carrier-pass filter (IC1C) that protects the phase-locked loop from unnecessary noise (especially the 600-Hz marker). The signal from the recorder varies the frequency of

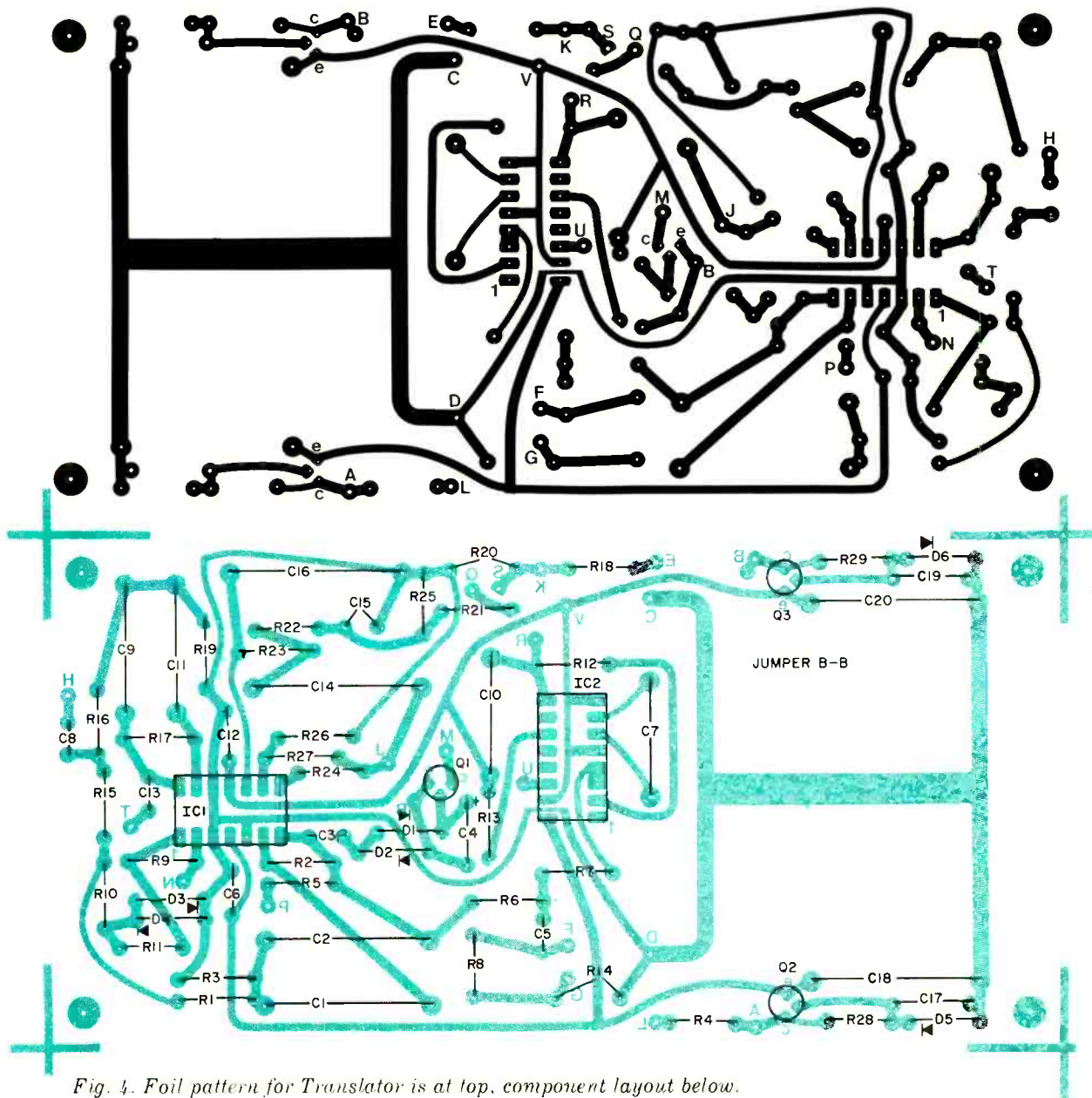

Fig. 4. Foil pattern for Translator is at top, component layout below.

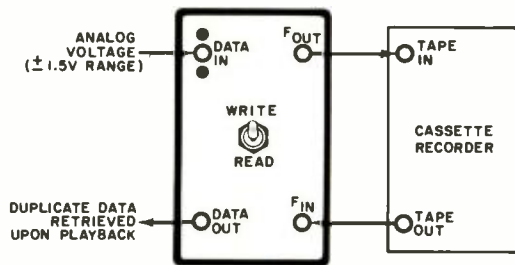

Fig. 5. Use this setup to connect Translator to a tape recorder.

the PLL and the de-emphasis filter (IC1D) removes the carrier from the signal. The input from the tape recorder should be about 100 mV rms for dependable data reading.

The mark-pass filter (IC1A) is an active, high-Q, 600-Hz bandpass filter. In the WRITE mode, depressing S1 introduces the filter into the feedback circuit of amplifier IC1B, causing it to oscillate at 600 Hz. This tone is resistively added to the main signal output for modulation on the tape. At the same time, the marker is indicated by the lighting of LED1 through Q1.

In the READ mode, the 600-Hz marker pulse recorded on the tape is detected by the mark-pass filter to energize Q1 and light LED1.

The complete schematic of the Translator is shown in Fig. 2 and the power supply circuit is shown in Fig. 3. Note that connections to components not located on the pc board

are made to points identified by letters on the schematic.

**Construction.** The foil pattern for the pc board and component layout are shown in Fig. 4. Be sure to use precision capacitors for C1, C2, C7, C9, C10, C11, and C14. Also, C7 must be a polystyrene type to assure temperature and humidity stability. The insulated jumper must be installed between the two points marked B in Fig. 4. Observe the polarities of the electrolytic capacitors and semiconductors and the notch-and-dot codes of the IC's. Use a low-power soldering iron and fine solder.

The case used in the prototype was 6½" by 3½" by 1¾" (16.5 x 8.9 x 4.5 cm). The cover should be metal. Using the front-panel photograph as a model, drill twelve ¼-in. holes to mount the front-panel components. Note that these are laid out in logical order. That

is, the two LED's used to indicate clipping are mounted next to the input connector; LED1 is adjacent to S1, etc.

Use spacers in attaching the pc board to the front panel, leaving enough room to accommodate the two 9-V batteries.

**Operation.** A typical arrangement for low-frequency analog recording is shown in Fig. 5. To record data, place the MODE switch in WRITE, turn on the tape recorder and the Translator. Operate the MARK pushbutton to denote any desired special point in the recording. Use the same interconnection to read the data back, but with the MODE switch on READ.

The system is linear with unity gain for input levels of  $\pm 1.5$  volts.

Fluctuating voltage for the purpose of programming electronic equipment can be stored for later use. For example, the sound level of a speaker or the intensity of a light can be pre-programmed for displays or demonstrations. The absolute temperature of an oven can be controlled as long as the tape runs. The operation of servo motors and solenoids can also be programmed.

Two Memory Translators can be used to form a voice scrambling link. The output of the transmitting Translator will be a modulated 7-kHz tone which can be transmitted by radio or telephone to the second Translator which unscrambles the tone into an intelligible voice. In addition, cassettes containing confidential information can be filed and stored, to be decoded only by another Translator.

Two Translators can also be coupled to provide remote data communication. In this case, the Translators are acoustically coupled to telephone handsets and data is transmitted through the line. In this type of operation, it is better to change the carrier frequency from 7 kHz to about 2 kHz. To do this, change C2 and C7 to 1500 pF, C9 to 4700 pF, C10 to 5000 pF (polystyrene) and C12 and C14 to 0.02  $\mu$ F.

To interface TTL with the tape recorder, use the arrangement shown in Fig. 6. A dual 741 op amp can be used. The circuit consists of a level translator for the TTL input and a Schmitt trigger to provide clean logic edges on the playback. Since the maximum recording rate is 500 bits per second, 600,000 bits can be recorded on a 20-minute tape, 900,000 bits on a 30-minute tape, etc.

### CHART RECORDINGS BY MAIL

If you need a chart recording, but the cost of a high-quality pen recording machine is too high, the Memory Translator provides an easy solution.

Record the data on a conventional tape cassette. Mail the cassette to R.I.E.P. Inc., 29 Ware St., Cambridge, MA 02139 and you will get a professional 100-Hz bandwidth chart recording. (Cassette will also be returned.)

The charge is \$3.50 per cassette side, plus 10¢ per minute of recorder time.

In making the cassette tape, observe the following guidelines: begin with an initial marker, followed by 15 seconds of grounded data input. Then put in another marker before the beginning of the data. This will allow voltage offset compensation for the difference between your Memory Translator and the master Memory Translator at the chart recorder. Insert six markers to indicate the end of the data.

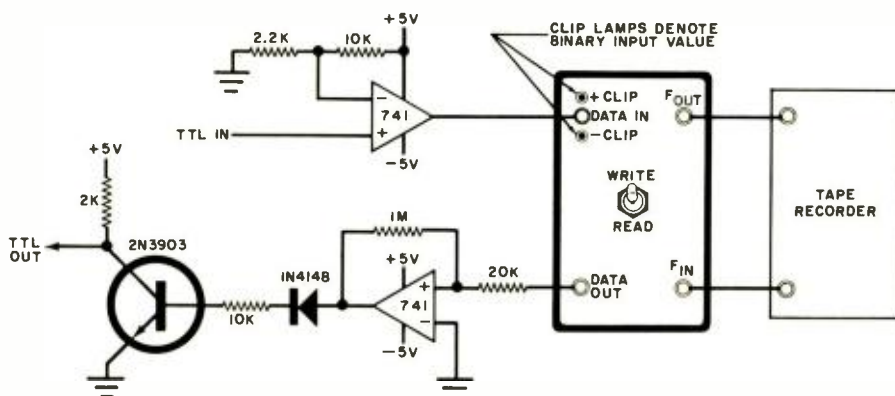

Fig. 6. Two op amps can be used in an external circuit to make the Translator compatible with TTL.



# How to Listen to Out-of-State AM Broadcasts

*DX'ing the medium-wave band is a fascinating hobby that can be pursued with a minimum of equipment.*

BY THOMAS R. SUNDBLUM

**L**ISTENING to distant, or out-of-state, stations in the medium-wave band (DX'ing the medium waves) is an excellent hobby which requires a minimum of radio equipment and is a good springboard to the more sophisticated shortwave DX'ing. Listening to stations a thousand or more miles away may be done with only a small portable AM radio or the nearest table radio. Therefore, one can DX the medium-wave band (535 to 1605 kHz) even on a very limited budget.

At the other end of the equipment spectrum, several hundred MW DX'ers in two MW-oriented listener clubs use sophisticated receivers, frequency calibrators, tape recorders, and a variety of specialized equipment to extract intelligence from the ether.

There's more to MW DX'ing than just trying to see how many stations can be heard or how far away a station might be heard. For example, my wife and I are avid National Hockey League fans and particular games, occurring elsewhere in the country, often have a bearing on the standing of our local favorite. So our enjoyment of this spectator sport is enhanced by our being able to listen (with top-notch equipment) to all but three or four of the stations that broadcast games of other teams in the league. With use of a medium-grade portable, that number increases to only six or so that

can't be heard. For sports enthusiasts, we've listed here the prime or feed (if a network) station carrying broadcasts of the four major sports.

By international agreement, the broadcast band (BCB) in North America consists of 107 frequency allocations between 540 kHz and 1600 kHz. There are three major types: clear, regional, and graveyard.

*Clear channels* are the easiest on which to hear distant stations. The clears are assigned to 540, 640-780, 800-900, 940, 990-1140, 1160-1220, and 1500-1580 kHz. Although there may be many daytime-only stations operating on clear channels between sunrise and sunset, at night there are only one (class I-A) or two (class I-B) stations operating, usually with a maximum power of 50,000 watts. Forty-one states and the District of Columbia have at least one station operating on a clear channel. There are some exceptions to the only-station-on-the-frequency-at-night concept, identified in the FCC rules as class II stations, and these may operate on the clears at night but usually with lower power and restricted directional antenna patterns in order to protect the class I operations.

*Regional channels* have class III stations operating daytime-only or unlimited (day and night) with a maximum power of 5 kW, intended to serve a major population center and the rural area adjacent thereto. Power at night may be as little as 500 watts, and directional antenna patterns may be employed during the day or the night, or both, in such a manner as to minimize interference on the same or adjacent frequencies. The regional channels

are 550-630, 790, 910-980, 1150, 1250-1330, 1350-1390, 1410-1440, 1460-1480, 1590, and 1600 kHz.

*Graveyard channels*, the third category of frequencies, is the smallest in number of channels, but the largest in terms of number of stations per frequency. Accordingly, with upwards of 150 stations each, all low-power and local service, these probably provide the greatest challenge to listeners specializing in domestic (U.S. and Canadian) DX'ing. The class IV stations have virtually unlimited hours, running 1 kW during the day and 250 watts at night, with a non-directional antenna pattern. There are six graveyard, so named because of the congestion, channels: 1230, 1240, 1340, 1400, 1450, and 1490 kHz.

**Listening Tips.** When to listen? The old axiom of "the best time to listen is when you have the time" is most appropriate here. Actually, there are three variables to consider: daily, yearly, and the sunspot 11-year cycle.

The nighttime hours, as I'm sure you have already noted through casual listening, provide the best long-range reception. This is due to skywave reception; off the E-layer in the ionosphere, the best signals are from about 1000 miles distant. In New Jersey, for instance, stations in Chicago, St. Louis, and Cuba dominate the clear channels at night. Groundwave reception (that is, signals traveling along the surface of the earth) is enhanced, too, increasing from an average 100 miles during the day to 500 or so at night.

The transitional hours of sunrise and sunset also provide enhanced reception. Daytime-only stations offer an excellent source of good DX catches and, depending on the frequency, daytimers can be heard up to a 1000 miles away during these twilight hours.

As it gets dark first in the East, daytimers on the East Coast are the first to go off the air each day. As the sun-

set zone moves west, stations to the west sign off at 15-minute intervals, removing more and more *interfering* stations. For example, 1580 and 1550 kHz are two excellent sunset frequencies. With only one Canadian clear on each to cope with, daytimers can be heard signing off up to two hours beyond my local sunset time; by this time, daytimers in the Midwest and South-central states are the ones being heard, playing "The Star Spangled Banner." DX'ing the regional frequencies at sunset does not provide much range, as there are a greater number of unlimited-hour stations remaining on the air, but a range of 400 miles (in New Jersey) is not an unreasonable expectation. Stations in the South Atlantic and Gulf states dominate sunset DX-ing on the regional channels here.

Sunrise DX'ing provides an equally good opportunity to log daytimers to the east of the listener. With the receiving point in darkness, daytimers will sign-on to the east and, as the sun rises, fade into the noise level as closer stations encounter their local sunrise and proceed to sign on. These, too, are at 15-minute intervals. DX'ers in the Midwest are almost ideally situated for sunrise and sunset DX'ing since they can cover the entire continent.

DX'ers on the West Coast usually have to limit twilight DX'ing to the sunrise period and, accordingly, have to be early risers. Six a.m. EDT, of course, means a 3 a.m. PDT session at the dials.

Sometimes it is possible to succeed at sunrise and sunset DX'ing even though you're in the "wrong" part of the continent. For example, WQXR on 1560 kHz in New York City normally signs on at 6 a.m. Eastern time, but on Sundays the station is quiet until 7 a.m. Accordingly, with the late winter sunrise, DX'ers on the East Coast have 30 to 45 minutes of sunrise DX'ing in the twilight hours without interference.

Determining operating schedules of local stations is a useful exercise and often good DX can be found on clear or regional channels when the local is silent. An example is the unlimited-hour WBUD-1260 Trenton, New Jersey, that dominates the daytime dial . . . except on Sundays when sign-on time is 7:30 a.m. Several other daytimers have been added to the log of "heard" stations by listening between 6 and 7:30 a.m.

## STATIONS FOR SPORTS BROADCASTS

### HOCKEY STATIONS (National Hockey League)

Atlanta Flames	WGST-920	Montreal Canadiens	CFCF-600 (English)
Boston Bruins	WBZ-1030		CBF-690 (French)
Buffalo Sabres	WGR-550	New York Islanders	WMCA-570
California Seals	KEEN-1370	New York Rangers	WNEW-1130
Chicago Black Hawks	WMAQ-670	Philadelphia Flyers	WCAU-1210
Detroit Redwings	WJR-760	Pittsburgh Penguins	KDKA-1020
Kansas City Scouts	WDAF-610	St. Louis Blues	KMOX-1120
Los Angeles Kings	KFI-640	Toronto Mapleleafs	CKFH-1430
Minnesota North Stars	WCCO-830	Vancouver Canucks	CKNW-980
		Washington Capitals	WTOP-1500

### FOOTBALL STATIONS (National Football League)

Atlanta Falcons	WQXI-790	Miami Dolphins	WIOD-610
Baltimore Colts	WCBM-680	Minnesota Vikings	KSTP-1500
Buffalo Bills	WKBW-1520	New England Patriots	WBZ-1030
Chicago Bears	WGN-720	New Orleans Saints	WWL-870
Cincinnati Bengals	WLW-700	New York Giants	WNEW-1130
Cleveland Browns	WHK-1420	New York Jets	WOR-710
Dallas Cowboys	KRLD-1080	Oakland Raiders	KNBR-680
Denver Broncos	KOA-850	Philadelphia Eagles	WIP-610
Detroit Lions	WJR-760	Pittsburgh Steelers	WTAE-1250
Green Bay Packers	WTMJ-620	St. Louis Cardinals	KMOX-1120
Houston Oilers	KILT-610	San Diego Raiders	KDEO-910
Kansas City Chiefs	KCMO-810	San Francisco 49'ers	KSFO-560
Los Angeles Rams	KMPC-710	Washington Redskins	WMAL-630

### BASEBALL STATIONS

American League		National League	
California Angels	KMPC-710	Atlanta Braves	WSB-750
Baltimore Orioles	WBAL-1090	Chicago Cubs	WGN-720
Boston Red Sox	WHDH-850	Cincinnati Reds	WLW-700
Chicago White Sox	WMAQ-670	Houston Astros	KPRC-950
Cleveland Indians	WWWE-1100	Los Angeles Dodgers	KABC-790
Detroit Tigers	WJR-760	Montreal Expos	CFCF-600 (English)
Kansas City Royals	KMBZ-980		CKAC-730 (French)
Milwaukee Brewers	WTMJ-620	New York Mets	WHN-1050
Minnesota Twins	WCCO-830	Philadelphia Phillies	WCAU-1210
New York Yankees	WMCA-570	Pittsburgh Pirates	KDKA-1020
Oakland Athletics	KEEN-1370	St. Louis Cardinals	KMOX-1120
Texas Rangers	WBAP-820	San Diego Padres	KOGO-600
		San Francisco Giants	KSFO-560

### BASKETBALL STATIONS (National Basketball Association)

Atlanta Hawks	WSB-750	Kansas City-Omaha Kings	KMBA-980/ KLNG-1490
Boston Celtics	WBZ-1030		
Buffalo Braves	WBEN-930	Los Angeles Lakers	KFI-640
Capital Bullets	WWDC-1260	Milwaukee Bucks	WTMJ-620
Chicago Bulls	WIND-560	New York Knicks	WNEW-1130
Cleveland Cavaliers	WERE-1300	Philadelphia 76'ers	WCAU-1210
Detroit Pistons	WJR-760	Phoenix Suns	KTAR-620
Golden State Warriors	KEEN-1370	Portland Trail Blazers	KOIN-970
Houston Rockets	KPRC-950	Seattle Supersonics	KOMO-1000



Daytime DX'ing is useful to the beginning DX'er. It is important to know what stations are regularly heard, and which are daytime-only and which are operating on unlimited hours. Daytime DX'ing is usually defined as that which occurs between two hours after sunrise and two hours before sunset when reception is 99% limited to groundwave only. (Note, however, there can be some weak skywave reception during the daylight hours . . . given a quiet frequency. Most daytime skywave reception is noted during the short winter days and on the clear channels.)

With a directional receiving antenna (notice the directional effects of the ferrite loop antenna in your AM portable radio), it is possible to dig "behind" your locals and find secondary stations. A marginally dominant graveyard local can be eliminated, and several other stations can be heard. Often, such "nulling" of the dominant station on a regional channel will also yield one or two others during the daylight hours and sometimes at a considerable distance.

The second variable factor that BCB DX'ers have to consider is the annual variation of reception conditions. We all know that summertime means high noise levels and thunderstorms. Further, the increased daylight hours cause changes in the several ion layers in the ionosphere which tend to inhibit skywave propagation. The atmospheric crescendos are deafening and, as a result, many BCB DX'ers forego the hobby from May to September. However, there are some noise-limiting circuits around that help the persistent DX'er through all but the most severe problems.

The summertime conditions of noise and lack of long-range skip is a blessing in disguise for the enthusiast pursuing graveyard DX. There is a definite lack of clutter from inaudible class IV's. During the winter they "skip" in and add to the clutter, but during the summer are "masked" out. For those with patience and the willingness to monitor a graveyard frequency for an hour or two at a sitting, you may be rewarded with an exceptional catch. Most of the time, all that will be heard is a jumble of unintelligible audio. But on the average, during each hour something will float to the top for a few seconds or a few minutes, and you might be lucky enough to have an identification included. The most productive hours seem to be in

the midnight to 2 a.m. block of time when sign-offs are most frequent. If you have a communications-type receiver that lets you switch off the AVC (automatic volume control) do so and use the sensitivity control to adjust the audio level. The AVC cannot follow, without introducing distortion, the rapid changes in signal level which can be on the order of 20, 30, or 40 dB.

And, finally, the third variable in our scheme of things is the sunspot cycle which varies over an 11-year period. At the minimums, one of which we are in now, the various ion layers increase in density. This includes the F-layer, which is about 120 miles up and normally comes into play in a discussion of shortwave propagation. A single hop via the F-layer is good for about 3000 miles and multiple hops off the F-layer can, and do, bounce BCB signals around the world. (BCB DX'ers who specialize in pursuing reception of signals from outside the North American continent have upwards of 100 different countries to their credit—from as far distant as Australia and New Zealand, South Africa, and the Middle East.)

Thus far we've dealt with natural variables, but there are several man-made factors, too. FCC rules allot the hours from midnight to 6 a.m. local time for experiments and both daytimers and unlimited-hour stations are authorized to conduct tests within those hours. There are two kinds of tests: frequency checks and equipment tests. Sometimes it is a bit hard to tell the difference due to the station's method of performing each, but the frequency check (FC) is usually of 15-minute duration with a 1000 or 800 Hz tone and one or two identifications. A few FC's use music and a few, especially in the south, use the telephone dial tone as modulation. The vast majority of FC's are run on a monthly basis on a fixed day-of-the-week schedule. For example, Montana can be heard on a FC each first Monday of the month at 2:45-3:00 a.m. EDT on KGHL-790 Billings, using a 1000-Hz tone. The purpose of a frequency check is to have an outside engineering firm check (to the nearest hertz) the precise transmitting frequency to insure its stability, as required by the FCC.

Equipment tests usually run longer than 15 minutes and, if major equipment and antenna changes are being made, such testing could run for the full time of the experimental period.

## DX REFERENCE MATERIAL

**National Radio Club Domestic Log.** Price, about \$7.00; its prime listing is by frequency with a secondary cross-index by call. Additional data includes mailing address, antenna pattern notes, PSA powers, and operating schedules of unlimited-hour stations. Accuracy, with updaters, is excellent. National Radio Club, Box 127, Boonton, New Jersey 07005.

**Broadcasting Yearbook**, published as the first issue of the year (albeit not available until late March) of the trade journal "Broadcasting". The 1975 annual is priced at \$15 ppd. Before spending this kind of money, the beginning DX'er may wish to look at a copy at a local radio or TV station, or local library. Broadcasting Publications, Inc., 1735 DeSales St., N.W., Washington, D.C. 20036.

**World Radio TV Handbook (WRTH).** The BCB and SW DX'er alike should have this standard reference in his or her personal library; a new edition is available early in January each year at the approximate price of \$9.00. Gilfer Associates, Box 239, Park Ridge, New Jersey 07656.

Sometimes tones are used and sometimes records are played. Some stations make an equipment test sound like "regular schedule" without commercials and shout the identification loud and clear, soliciting phone calls from far-distant listeners. In any case, equipment tests (ET's) also provide a chance to log otherwise impossible-to-hear daytimers and unlimited-hour stations that do not otherwise operate beyond midnight local time. The only trouble is that ET's are not scheduled on a regular basis and the DX'er has to hunt them on a random basis.

However, a man-made convention helps the DX'er in this regard. The bulk of the 24-hour non-stop operations do come to a halt once a week on Monday mornings. Fortunately, this includes the giant 50,000-watt stations on the clear channels and some good DX can be found. Daytimers operating on the clears often test during the silent period (SP) of the class I, and with the open frequency span the continent. While FC's and ET's are found on any and all mornings, many do take place on Monday mornings. Saturday mornings seem to be a second favorite choice of engineers for ET's, and Sunday mornings seems to be the low-water mark for experimental period operations.

**How To Get Started.** With a little planning the beginning DX'er should be able to log 400 or 500 stations in his or her first year of listening.

The first step is to take an inventory of the local stations operating during the day and evening hours. Make note of the operating schedules, if possible, because later on you'll want to listen during the dominant local's silent period. A methodical approach to this study should take one or two months and account for 150 to 200 stations that can be classified as "regulars."

Step two should be an effort to listen "behind" the dominant local, again both during the daylight and evening hours. One or two more stations will probably be added per regional and graveyard channel, depending upon the area of the country you are in. Probably a minimum of 50 stations can be added in this way, and now the total "heard" should be in the neighborhood of 250 stations.

Step three should be a study of the clear channels at night, and a minimum of 50 stations should be counted upon completion of this study, which should take two to four weeks. Your

total stations heard should now be around 300.

These steps should result in a total population of stations that will regularly be present when looking for the new and unusual loggings. Your knowledge of what is "normal" is a key to spotting band openings and stations not normally heard. These 300 or so stations will become "pests" over the long run and it is best to get a fix on operating schedules so that you can listen during the silent periods of the various stations.

Step four is to begin scanning the bands on Monday mornings, and check out each FC or ET that you find. The test tone is characteristic and it is best to stop at each one when it obviously is not a local. ID's come at the strangest times, so pay attention.

It is impossible to predict the completeness of the ID in the ET or FC as it varies from just one set of call letters to a complete ID including frequency, power, address, telephone number, and ownership. For this reason it is often useful to have a tape recorder running whenever DX'ing, as a missed ID can be replayed and deciphered, if necessary, until understood.

Step five is to get your feet wet in sunset and sunrise DX'ing. The easiest way to get into this is to DX the regular clear-channel daytimers to get their locations. Follow the same pattern on the regionals to get you a clue as to where the garbled ID in the jumble on the regional channel came from. Virtually every daytimer who wants one now has a PSA (pre-sunrise authority). This allows him to operate at a specified low-power level (no more than 500 watts), sometimes with a directional antenna system, between 6 a.m. local time and sunrise. Accordingly, 6 a.m. local time is a key to hearing the sign-ons of many stations on both regional and clear channels.

Steps four and five can be implemented simultaneously. Over the remaining six to eight months of our mock one-year time-table, an average of four new stations per Monday morning and two new stations per day (one each from sunrise and sunset) for 20 days per month should work out to about 50 stations per month. Six months would account for 300 new stations, added to our base of 300 "regulars," yields over 600 stations for the first year of effort. Not bad, eh?

In this effort, you'll probably find the count of states heard to be around 40 or so without any special difficulty.

The last ten will be the hardest. For those on the East Coast, Oregon, Idaho, Wyoming, and Alaska will be the most difficult. For those out West, the New England states of Maine, New Hampshire, and Vermont, plus Delaware and New Jersey will be a challenge.

In all of this, you are probably going to run across some French and Spanish speakers in the dark hours. Excepting 840 kHz, which is either Haiti or St. Lucia (both in the Caribbean), it is almost a certainty that the French-speaking stations logged will be from Canada. Spanish-speaking stations can be from anywhere in Latin America, but for the beginning DX'er noting those with the strongest signals, it would be reasonably safe to say that the East and Midwest DX'ers are dealing with the high-powered Cubans, and the West Coast DX'ers are contending with the Mexicans. Very little English is spoken south of the border in Latin America, but that which is most often heard is 4VEH 1035 Cap Haitien, Haiti; Radio Paradise-1265 St. Kitts; and XERF-1570 Villa Acuna, Mexico. Note that some stations (exemplified by Haiti and St. Kitts) do operate on "split" frequencies, i.e., between the nominal even-10 kHz assignments.

Also observe that East Coast listeners have Europeans to contend with during the winter months, and these operate on 9-kHz spacings. Accordingly, many are on "split" frequencies and can be heard regularly. Perhaps one of the easiest for even a beginning DX'er is the BBC outlet on 1088 after WBAL-1090 Baltimore goes off the air at 1 a.m. on a Monday morning. Equally, West Coast DX'ers have to contend with myriads of Japanese, Korean, and mainland Chinese stations, but the bulk of these operate on the even-10 kHz spacings.

The subject of foreign DX'ing is a world unto itself and, given the proper equipment, it is more challenging than DX'ing the shortwave bands.

To DX the BCB effectively, it is important that you have some reference material handy. Of greatest importance is a log of domestic U.S. and Canadian stations (see box). Joining a medium-wave DX Club is another worthwhile move.

As you can imagine, medium-wave DX'ing is a fun hobby. And since you don't need fancy equipment, it's easy to get started. So join us down here in the BCB; you'll like the "waves." ♦



**T**HERE are many things in nature that, in natural light, look pretty dull. When illuminated by ultraviolet light, however, they take on the appearance of colorful gems. The minerals in rocks, sand, even dirt and some insects fluoresce with beautiful colors under UV light. You can see it all with the aid of the portable black-light lantern described here.

The ultraviolet fluorescent lamp can also be replaced by a 6-watt daylight fluorescent lamp to provide normal light if desired. If you have a source of 117-volt ac, a simple connector change permits the lantern to be used as a light source, while the batteries are being recharged. The lantern uses a 6-volt rechargeable wet-cell; and, since the drain is only about 1.75 amperes, quite a few hours of operation can be obtained from a single charge.

**Circuit Operation.** As shown in Fig. 1, transistors *Q1* and *Q2* are arranged as a power oscillator. Resistor *R1* determines the turn-on voltage and *R2* determines the frequency of oscillation. With the components specified, the frequency is in the low audio range, but high enough to minimize lamp flicker. Resistors *R1* and *R2* actually form a voltage divider to bias the transistors into conduction before oscillation starts.

The alternating currents in the two halves of the collector winding induce a voltage in the secondary of *T1*. Capacitor *C1* reduces voltage spikes that might damage the transistors. With no load, the voltage is 135 V, which drops to about 110 V (a square wave) with a 6-watt load.



## BUILD A BLACKLIGHT LANTERN

*Battery-powered, long-wave ultraviolet lamp  
reveals color patterns of many substances.*

*Doubles as camp lantern.*

BY W.E. McCORMICK

With *S1* in the BATTERY position, the ac voltage lights indicator lamp *I2* and is applied to *I1* through a ballast. Closing switch *S2* completes the lamp filament circuit to heat up the filament. When *S2* is released, the ballast generates an inductive kick to strike an arc in the lamp. This method of lamp starting is used for two reasons: glow-type starters do not work well with the square wave involved here,

and such starters may be unreliable at low temperatures.

With *S1* in the ac position, the oscillator is disabled and conventional 117-volt ac can be applied to *J1* through *P2*.

**Construction.** The transformer used for *T1* must be modified for this application. Begin by removing the metal mounting-binding strap from around

### ULTRAVIOLET LIGHT AND FLUORESCENCE

There are hundreds of relatively common substances that are usually quite drab under conventional visible light, but are quite brilliantly colored when illuminated by ultraviolet light. For example, when illuminated with ultraviolet at 3560 Angstroms (as provided by this project), a common, dirty-white mothball becomes a vibrant purple.

Roughly half of the substances that fluoresce strongly enough to be seen by the unaided eye, react to longwave (3560 Å) ultraviolet. The remainder react to shortwave (2535 Å) ultraviolet, while some react to both wavelengths. Some exhibit a color shift when the wavelength is changed, and others undergo a complete color reversal.

Many substances have a pronounced phosphorescence and continue to glow either the same color or a different one, after the excitation is re-

moved. This can make it possible to differentiate between many materials that have the same fluorescence.

Shortwave ultraviolet lamps can produce sunburn and are dangerous to the eyes. When using an instrument of this type, goggles should be worn at all times. (Window glass or clear acrylic plastic, which are opaque to the wavelength, will suffice.) Longwave lamps provide no sunburn hazard and are optically safe.

Geologists are now using ultraviolet light in oil prospecting. They lay out a grid covering the area under investigation and take core samples at various points from a depth of about six inches. The oil does not have to be near the surface since the hydrocarbons brought up by leaching, capillary action, and evaporation promote the growth of micro-organisms (*bacillus methanicus* and *bacillus ethanicus*)

which fluoresce blue under longwave ultraviolet.

This method not only locates oil. It produces an outline of the underground pool on the grid. With a little knowledge of the local shale strata and oil sand, the pool's depth can be determined; and the amount of oil to be expected can be determined from the size of the area that fluoresces. The quality of the oil is indicated by color saturation—high sulfur content shifts the color toward yellow and paraffin content shifts it toward pale blue. Other minerals, in suspension, can also be detected. By color matching, it is possible to tell if the pool is a new strike or leakage from an adjacent field.

Longwave ultraviolet is widely used in criminology to detect forged paintings, altered documents, and the authenticity of antique glass and china.

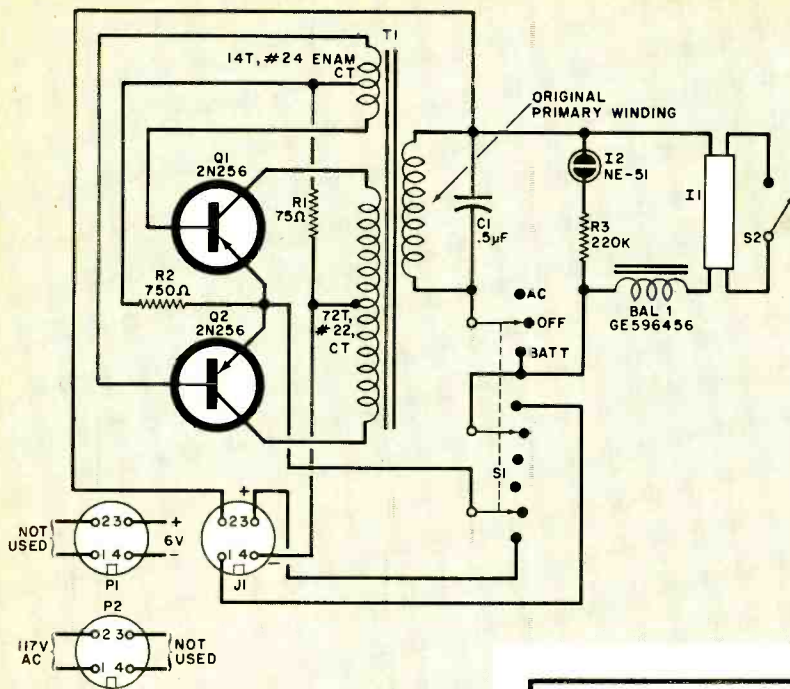

Fig. 1. Two-transistor power oscillator generates approximately 110 volts for ultraviolet lamp.

### PARTS LIST

- BAL1—Ballast inductor (GE 596456 or similar, available through electrical supply houses)  
 C1—0.5- $\mu$ F, 400-volt capacitor  
 I1—Fluorescent lamp (6 watts): either ultraviolet (GE F6T4/BLB or similar, available from Edmund Scientific, 300 Edscorp Bldg., Barrington, NJ 08007, Cat. No. 60,124, \$4.75.) or standard daylight (GE F6T5/CW, available through electrical supply houses)  
 I2—NE-51 neon lamp  
 J1—4-pin male plug (H.H. Smith 86CP4 with 12-001-003 adapter plate)  
 P1, P2—4-pin female connector (Amphenol Series 86-PF4)  
 Q1, Q2—2N256 power transistor  
 R1—75-ohm, 10-watt, 10% resistor  
 R2—750-ohm, 1/2-watt resistor  
 S1—4pdt, 3-locking position anti-capacitance switch (Radio Shack 275-600 or similar)  
 S2—Spst normally open pushbutton switch  
 T1—117-volt primary; 12.6-volt, 1.2-A secondary filament transformer (Radio Shack 273-1505, modified as per text. Do not substitute.)  
 Misc.—Plastic case (Bud AC403); metal plate (Bud BPA1590), fluorescent lamp holder (one pair, miniature flush mount, GE 78-X715 or similar); power transistor mounting kit (two, HEI450 or similar); six-foot line cord with plug; three-foot battery cable (#18 stranded); 6-V, 6-A battery (Olson BA-200, \$3.49, or PolyPaks, P.O. 942, S. Lynnfield, MA 61940, Cat. No. 92CU1516, \$4.95); grommets; decals; mounting hardware; etc.

the core. Then use a thin-bladed knife to loosen the individual laminations and remove them. Be careful not to cut any wires.

Peel the insulating tape from the coil and set it aside for later use. Carefully strip off the secondary (green leads with yellow center tap) and save the wire. Leave the existing primary (black leads) and cover it with a single layer of the insulating tape.

In winding new turns, be sure all winding is made in the same direction. You can wind either way around the core; but once started, everything must be in that direction.

Put the winding (#22 wire) for the collector circuit on first. Color code the start of the winding using a 4" length of spaghetti. Anchor the winding under one of the bobbin flanges by using a small piece of tape. Start wind-

### COLOR AND LOCATION OF MINERALS

Minerals	Color under visible light	Color under longwave UV	Where commonly found
Adamite (basic arsenate of zinc)	Pale green	Green	Southwestern U.S. and Mexico
Amber (a hydrocarbon)	Usually yellow, sometimes brown or white	Blue-white	Widely distributed U.S.
Argonite (calcium carbonate)	Indiscernable in mineral mass	Green Orange Brilliant red	New Mexico Sicily Australia
Barite (barium sulphate)	Gray	White, cream or yellow Bright golden Orange	Widely distributed U.S. N. Carolina only
Calcite (calcium carbonate)	White coating in rock seams	Blue Pale yellow Bright Orange in association with red	Widely distributed U.S. N. Jersey, Texas California
Celestite	Colorless crystals Blue crystals	White, blue-white White with green after-glow	Ohio, Midwestern U.S. Ohio only
Cerussite (lead carbonate)	Yellowish gray Dull gray	Yellow	Lead mining regions
Corundum (aluminum oxide)	Red	Deep red	N. Carolina, N. Jersey
Deweylite (magnesium silicate)	Mottled dull green usually in serpentine formation	White	Maryland, Pennsylvania
Diamond	Clear or faintly tinted (any color)	Most commonly blue, but can be almost any color	Africa, Arkansas, U.S.



ing adjacent turns across the bobbin, keeping the turns snugly against each other. At 36 turns, make a 4"-long twisted loop and use a piece of colored spaghetti to insulate and identify it. Bring this out to one side. Wind another 36 turns, fasten it down with tape, and bring out a 4" end identified with colored spaghetti. Place a single layer of tape over the completed winding.

For the base circuit winding, use the #24 wire saved from the original secondary. Use a 4" length of colored spaghetti to identify the start. Wind seven turns, make a center tap as before, and add seven more turns. After all winding is complete, place a layer of tape over the assembly.

Before trying to reassemble the core (laminations), scrape any excess varnish off them. Otherwise, it may be

difficult to fit them back on the bobbin. With laminations reassembled, replace the mounting strap, being careful not to pinch the lead ends.

In the prototype, a 5" by 9½" by 2½" (12.7 x 24.1 x 6.4 cm) plastic box with a metal cover was used. The two transformers are mounted on the outside of the cover using a kit (socket, mica insulator, and insulating hardware) so that the cover provides a heat sink. Be sure the collectors are not making electrical contact with the cover. Switch *S1* and *I2* are mounted on the same cover.

The transformer is mounted in the enclosure, while *S2* and *J1* are on one of the sides. Drill a small hole for the four leads to the fluorescent lamp. The lamp reflector can be made of sheet aluminum with wooden end pieces. The lamp holders are attached to the



Batteries can be carried in cassette or binocular case with shoulder strap.

Diopside (silicate of calcium and magnesium)	Masked by pyroxene mass	White, blue-white	N.Y., N. Jersey
Fluorite (calcium fluoride)	Purple, green or yellow. Occasionally, blue	Blue, dark red	Widely distributed U.S.
Opal (hydrous silica)	Variegated	Green	Western U.S.
Scapolite (complex silicate of calcium, sodium and aluminum)	White, greenish yellow	Brilliant yellow, red	Quebec, Canada
Sodalite (a silicate of sodium containing aluminum and chlorine)	Usually nondescript	Golden brown	N. Hampshire, N. Jersey
Sphalerite (zinc sulphide)	Often indiscernable in mass	Golden orange, blue	N. Jersey, Colorado, Arizona
Tremolite (calcium magnesium silicate)	Colorless crystals or a dull talc	Pink, red, fire-red, orange, gray-green or cream	New York  Ontario, Canada only
Willemite (zinc silicate)	Usually indistinguishable, sometimes apple-green, dark brown or red	Yellow-green Blue-white	Arizona, N. Jersey
Wollastonite (calcium metasilicate)	Gray or white	Weak orange or yellow (Blue-white if associated with barite or green with Willemite)	N. Jersey, Arizona
Zircon (zirconium silicate)	Clear, blue Red	Dirty yellow Dirty red	California, N. Carolina

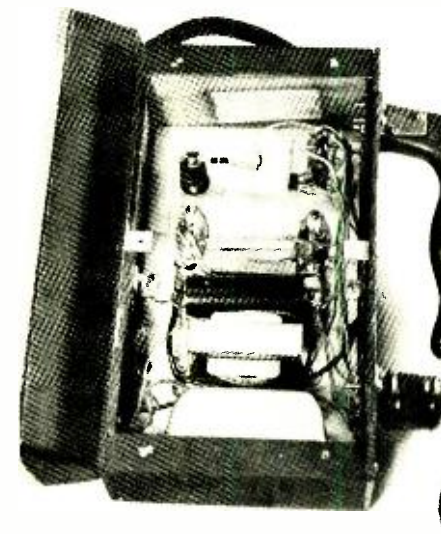

Internal layout of prototype.

end pieces. The reflector can then be attached to one long side of the case. A pistol-grip handle can be attached to the case if desired.

The 6-volt battery can be carried in a shoulder holder (cassette case, binocular case, etc.) with a two-lead cable to plug *P1*. A conventional 117-volt lamp cord can be connected to *P2*. ♦

#### BIBLIOGRAPHY

- Fluorescent Light and Its Applications*, by H.C. Dake and J. DeMent, Chemical Publishing Co., Inc., 1941.
- Fluorochemistry*, by J. DeMent, Chemical Publishing Co., Inc., 1945.
- Ultraviolet Guide to Minerals*, S. Gleason, Van Nostrand, 1960.
- Fluorescence Analysis in Ultraviolet Light*, by J.A. Radley and J. Grant, Chapman and Hall, Ltd., 1959.
- Blacklight Fixture Facts*, Edmund Scientific Co., 300 Edscorp Bldg., Barrington, NJ 08007.
- Earth Science Magazine*, Chicago, Ill.
- Rocks and Minerals Magazine*, Peekskill, N.Y.





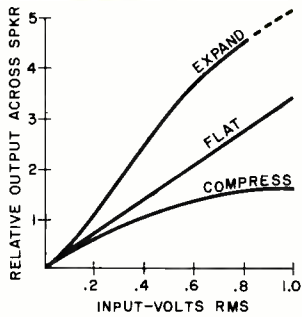

Fig. 2. Graph shows how compander expands or compresses the relative output across speaker.

hooked up between your preamp and power amp or through the tape monitoring circuit. (A compander is not to be confused with devices such as tone controls and equalizers, which alter the frequency response of a system.)

**Circuit Operation.** The heart of the compander circuit (Fig. 1) is an optoisolator (O1), which contains a light emitting diode and a low-distortion photocell in a light-tight plastic enclosure. This unit has much faster response time than devices using an incandescent lamp (often used in compressors). It also introduces less distortion and has the advantage of providing a slight "slow release" action to enhance the expansion effect.

The audio signal at the speaker terminals of the amplifier is applied to connector J1. The level is controlled and reduced by R1, R2, and R3, with diodes D1 to D3 acting as voltage limiters to protect the LED's. The signal level is monitored by LED1. The brightness of the LED in O1 varies with the signal causing the resistance of the photocell to vary.

The power supply provides a small dc voltage (adjusted by R10) to keep the two LED's within their conduction range. This prevents a sudden snap in the volume when a signal is applied.

With S1 in the OFF position and S2 on OUT, the input signal at J3 is applied to R7 and R8 and the output at J5 is half of the input. This insertion loss is required to create the "headroom" needed for expansion.

When S1 is in the EXPAND position, the photocell in O1 is connected across R7 to vary the resistance of the upper half of the voltage divider. This changes the output on J5. Potentiometer R6 acts as a "depth" control to determine how much the variations in the photocell resistance affect the voltage divider.

As the sampled signal increases, resistance of the photocell decreases, increasing the output at J5. This provides the desired expansion.

When S1 is in the COMPRESS position, the photocell is connected across R8 so that, as the sampled signal increases, the output at J5 decreases.

The curves in Fig. 2 are typical of the expansion compression effects.

**Construction.** The complete circuit, with the exception of transformer T1, can be assembled on perforated board. The transformer should be located as far as possible from the signal leads to avoid pickup.

The circuit shown in Fig. 1 is for one channel, except that the power supply can handle two channels for stereo. Mount the various phono jacks and the two calibrate controls (R10 and R11) on the rear apron (suitably identified) and the switches and depth potentiometers on the front panel. The two monitoring LED's can also be mounted in rubber grommets on the front panel. An on/off switch can be used in the primary of T1 or the compander power supply can be plugged into a switched receptacle on the preamplifier.

**System Hookup.** The compander will work with any amplifier that delivers two watts or more of output. If you have a separate preamplifier/power-amplifier setup, use the hookup shown in Fig. 3A. Use shielded audio cables to interconnect the three devices. Be sure the "hot" side of the amplifier output is fed back to the compander.

If you have an integrated unit, use the hookup shown in Fig. 3B. Connect a shielded audio cable from the tape-output jack of the amplifier to J5 of the compander and another shielded cable from J2 on the compander to

the tape-monitor jack on the amplifier. By switching the amplifier's tape monitor to "in," the compander will be put into the circuit.

**Checkout.** With the system properly connected (be sure not to confuse the channels) and operating, adjust each channel's calibrate control (R10 and R11) until the front-panel monitor is just illuminated. Proper adjustment here provides the best linearity and channel balance.

Working with one channel at a time, place S1 in the EXPAND position, the sensitivity control (R1) at minimum, and the depth control (R6) at maximum. Turn up the volume on your system to the most comfortable listening level. Then advance the sensitivity control until LED1 starts to flicker. Avoid bright peaks on the LED. The music should sound more accented, with a greater dynamic range. Operate the depth control to obtain the desired amount of expansion. To be sure everything is working, turn off the compander and note how much flatter the music sounds.

To check compression, place S1 on COMPRESS and the sensitivity and depth controls to maximum. Turn up the volume. You should note that the audio output does not rise above the preset level. Adjust both controls to obtain the best output.

At some low listening levels, there may not be quite enough signal to drive the compander properly. This produces a "breathing" effect which can be remedied by turning up the listening level or turning down the depth control. This effect may also occur if the calibration controls are not set high enough.

There is no such thing as the optimum amount of expansion. Some recordings require less than others. However, most will benefit from the extended dynamic range. ♦

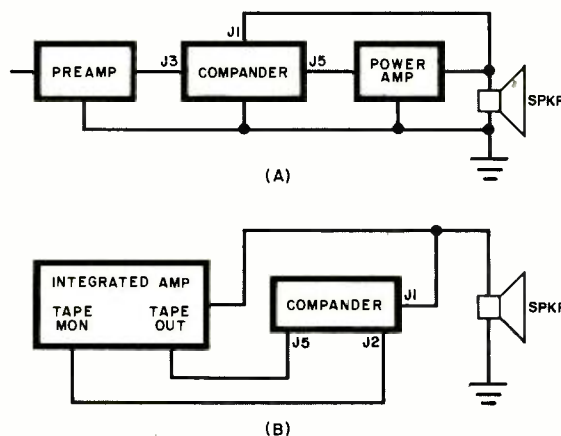

Fig. 3. If you have separate preamp and power amplifier, use hookup at (A). For integrated amplifier, use (B). Both are for one channel only.

# EXPERIMENTING WITH LIGHT-BEAM COMMUNICATIONS

*Only a few simple  
components are needed  
to get started in  
this fascinating type of communication.*

BY FORREST M. MIMS

**G**etting on the air with a light-beam communicator requires a bare minimum of parts and only a fraction of the money you would have to lay out for radio gear. You don't even need an FCC radio operator's license to get on the air. And with light-beam communication, you get the added bonus of interference-free, jam-proof, and private transmissions. It is no wonder, then, that thousands of experimenters are turning to this communicating medium that is currently enjoying new popularity after an almost century-long hiatus.

Light-beam communication is subject to the laws of optics, just as radio communication is subject to the laws of electronics. In most respects, the two types of communication behave basically the same in their respective media. So, you do not have to learn a whole new discipline to get into light-beam communication.

**Optical Considerations.** Little or no electronics knowledge is required for the simplest of light links but a few basic guidelines in optics can enhance even the most sophisticated light communication system. Let us start with the basic principles.

The first rule to remember is that a diverging beam of light follows the *inverse square law*, in which the intensity of the diverging beam decreases in direct proportion to the square of the distance. The implication is obvious: use a very narrow beam for long-distance transmission. This is easily said, but a narrow beam is more difficult to align with a receiver than is a broader beam.

The second rule to remember is that the divergence (spread) of a light source paired with a simple lens is given by the formula  $\theta = d/f$ , where  $\theta$  is the beam's divergence in radians,  $d$  is the diameter of the light source, and  $f$

is the focal length of the lens. (Don't be intimidated by radians. They are really a simple tool that can save you a lot of time when working with problems in optical communications.)

Remember that all numerical values must be stated in the same measurement system. In the case of optics, it is generally more convenient to use the metric system instead of the traditional "British" system of inches, feet, etc. So, let us assume that we have a 2-in. focal-length lens. Converting to the metric system (multiplying by 25.4 to obtain millimeters), the focal length can now be expressed as 50.8 mm. Now, assuming the light source to be a LED with a square chip measuring 0.5 mm on each side. Plugging these values into the above equation, we get a divergence figure of  $0.5/50.8$ , or 0.0098 radian. Converting this answer to degrees ( $0.0098 \times 57.3$ ), we get 0.56° divergence.



Rule number three is: as the focal length of a lens is increased without a similar increase in lens diameter, the energy intercepted by the lense decreases. This is a particularly important rule because a long focal length gives a small beam spread. But since there is little advantage in reducing beam spread at the expense of the power contained within the beam, a compromise must be struck. The best approach is to use a "fast" lens (one with a diameter roughly equal to its focal length) to achieve small beam spread with high collection efficiency. The term "f/number" is used to define the ratio of lens diameter to focal length and is expressed as  $f/No = d/fl$  where  $d$  is the lens diameter and  $fl$  is the focal length. A lens whose focal length and diameter are equal has an  $f/No$  of 1, expressed as  $f/1$ .

The final rule to remember is that one radian corresponds to an angle which, when placed with its vertex at the center of a circle intercepts an arc whose length equals the radius of the circle. As we have already seen, one radian is equal to  $57.3^\circ$ . Therefore, it is approximately correct to say that the diameter of the field of view of an optical system is equal to the angle in radians times the distance or  $d_{fov} = \theta R$  where  $\theta$  is the divergence in radians and  $R$  is the distance.

This relationship is very useful. For example, suppose you wish to know the diameter of the beam from an optical communicator at a receiver located 2 km down-range. Assuming a beam divergence of 0.001 radian ( $10^{-3}$  radian or 1 milliradian), we can plug

*According to the inverse square law, the total intensities at points 2 and 4 are equal; but the intensity per unit area at 4 is  $\frac{1}{4}$  that at point 2.*

LIGHT SOURCE

the two numbers into the equation to obtain  $2000 \text{ meters} \times 0.001 = 2 \text{ meters}$  (roughly 6.56 ft). This is much faster and simpler than using trigonometry; it even eliminates the need for trig tables. In fact, simple radian calculations can be done in your head.

The basic rules cited above must be used properly for accurate results. For example, an internally lensed LED has a light source equal to the diameter of the lens—not the LED chip. Such a LED will give a broader beam-spread when used with an external lens than would a LED with a flat cap. Similarly, the LED with the flat cap permits less power to be captured by the external lens due to its wider emission angle. Nevertheless, it is usually best to use LED's with flat glass caps and sacrifice the power loss for the divergence improvement.

**Light Sources.** Very simple, low-cost light-beam communicators can be made using sunlight, an incandescent lamp, or a LED as the light source. Using the sun, of course, limits the useful operation period to times when the sun is at an appropriate angle in the sky. Consequently, incandescent lamps and LED's are better for general-purpose communication.

Given a choice between an incandescent lamp or a LED as the light source in a light communicator, the latter has several advantages to recommend it. LED's can be modulated at megahertz rates as opposed to the few thousand hertz rate of an incandescent lamp, the result of thermal lag in the filament. Also, LED's emit a relatively narrow spectrum of light so that a narrow bandpass optical filter can be used over the receiver to permit operation in full daylight. Then, too,

LED's are highly compatible with solid-state driving circuitry.

Infrared LED's are almost always used in light-beam communicators because of their greater efficiency when compared with other LED types. The two major types of IR LED's are plain gallium arsenide (GaAs) and silicon-doped gallium arsenide. Plain GaAs diodes are best where modulation rates exceed 500,000 Hz, while doped GaAs diodes are better for

slower modulation rates, where they operate more efficiently than do straight GaAs LED's. (Manufacturers do not always reveal the composition of their diodes; so, check the wavelength. Straight GaAs diodes emit light at about 900 nanometers, or 9000 Angstroms, while silicon-doped GaAs diodes emit at about 940 nm.)

Amateur experimenters can communicate over long distances—more than a mile—with a well-designed LED system. Still greater distances can be obtained by going to one of the various types of lasers as the light source.

**Light Detectors.** An ordinary silicon solar cell is an excellent detector for many simple light-beam communicators. Their large active areas reduce the need for a collector lens over moderate communication ranges, a feature that greatly simplifies signal detection. Even when a collector lens or reflector is used, the cell's large detection area means that alignment is not critical as long as the focused light from the transmitter strikes some part of the active area.

Phototransistors and light-sensitive FET's have greater sensitivity and faster frequency responses than solar

cells. It is best to use phototransistors with external base leads since operation in the dark reduces their sensitivity and some bias will be needed to bring the sensitivity back up to normal. Phototransistors saturate in bright sunlight; so, daylight operation requires shielding from ambient light and, ideally, an optical filter designed to pass only a narrow band of light peaked at the transmitter's wavelength.

Best operation of most light-beam communicators is obtained with a PIN photodiode. When operated in the reverse-biased mode, the PIN photodiode exhibits a linear response to light over at least seven decades of intensity. The diode can be used in

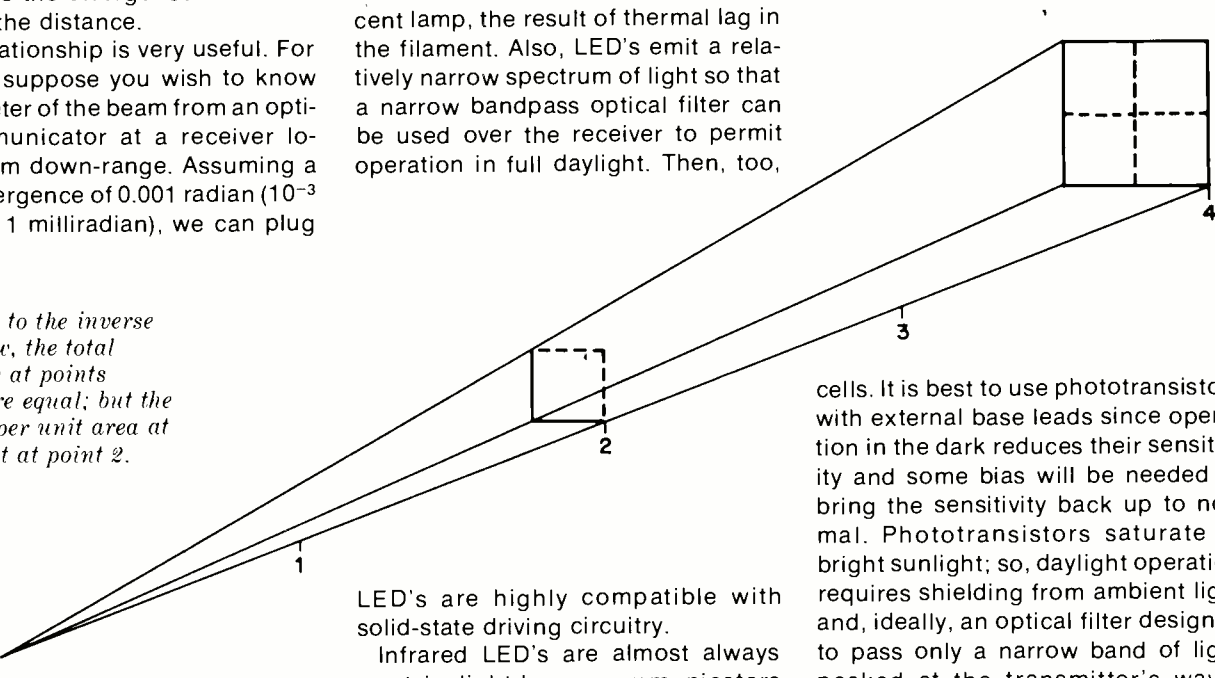

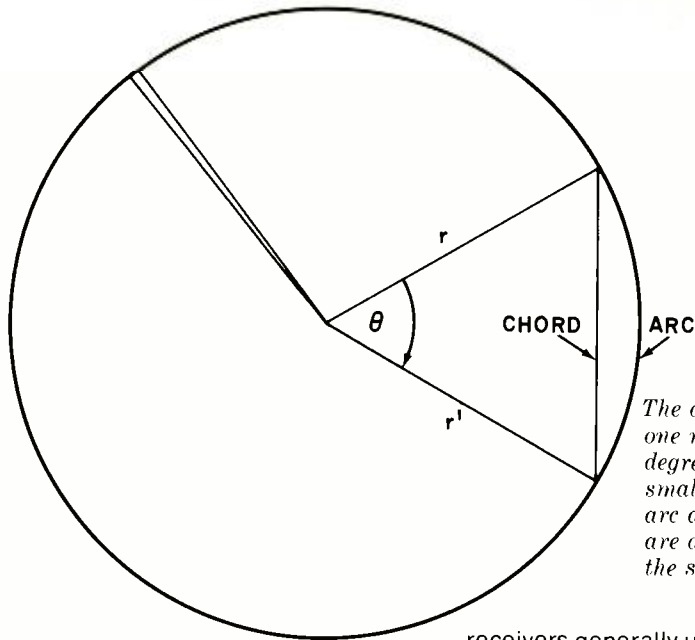

*The angle, theta, is one radian or 57.3 degrees. For very small angles, the arc and the chord are approximately the same length.*

daylight to detect a modulated light signal by using a capacitor to block the unwanted dc signal caused by ambient light. PIN photodiodes are also very good for detecting fast light pulses.

Don't buy just any PIN photodiode offered to you. The one you settle on should have a sensitivity of at least 0.35 mA/mW. Spend the \$10 or \$15 asked for a good diode and be sure of getting good results. (Less sensitive diodes are available for "bargain" prices, but they are not worth the investment.) You can always use the relatively expensive diode in more than one system. Simply use transistor sockets to permit quick insertion and removal.

Two very sophisticated light sensors are the avalanche photodiode and the photomultiplier tube. Both are very expensive for the average experimenter and each requires a fairly complex power supply and operating circuitry.

**Optical Devices.** Most light-beam communication systems can be built with a single optical element at the transmitter and receiver ends. Simple lenses are fine for LED systems, but color-corrected achromatic lenses should be used in multi-wavelength systems. Always use a convex lens to project light into a beam or to focus it into a point. And remember that plastic lenses can often be used but that they also absorb more light than do glass lenses.

Most transmitters will operate well with a single transmitting lens, while

receivers generally use either a lens or a parabolic reflector. Another possibility for receivers is a large Fresnel lens.

For more on optical components, refer to any fairly detailed book devoted to light and optics.

**Where to Get Supplies.** The electronic portions of a light-beam communication system are generally straightforward and can be obtained from most local parts stores or mail-order houses. Good-quality LED's that are ideal for light-beam communicators are made by General Electric, RCA, Texas Instruments, Monsanto, Spectronics, and other semiconductor manufacturers. Check your local authorized dealers. Also, keep an eye out for special LED buys featured in the ads at the back of POPULAR ELECTRONICS. However, remember that surplus LED's may not have the output power capability of some of the newer LED's available from authorized manufacturer distributors.

PIN photodiodes are somewhat more difficult to come by than are LED's, but they are available. Most of this author's experiments are performed with PIN photodiodes made by EG&G, a major manufacturer of light-detection apparatus. The EG&G No. SGD-040B is a good economical diode that sells for \$15 from Cramer Electronics, Inc., 85 Wells Ave., Newton, MA 02159. It has a typical sensitivity of 0.5 mA/mW at 900 nm.

Optics for light-beam communicators are available from a long list of sources. Fiber optics, for example, can be obtained from most electronic parts dealers, locally or by mail

order. (Glass or low-loss plastic fibers must be used with infrared LED's, while ordinary plastic fibers can be used with most visible-light sources.)

The biggest supplier of optics for the experimenter is Edmund Scientific Co. (150 Edscorp Bldg., Barrington, NJ 08007). A free copy of the latest Edmund catalog is an essential part of the light-beam communicator's supplies. The catalog lists hundreds of lenses, parabolic reflectors, filters, and other optical components suitable for light-beam communication work.

Closer to home, you will find that an ordinary flashlight can make an excellent light-beam receiver. Simply remove the lamp and install in its place a pair of solar cells, back to back, and install an amplifier module in the place formerly occupied by the batteries. A lantern-type flashlight is best for this application because it has an internal volume large enough to accommodate the circuitry required for the receiver, including batteries, and its large reflector will easily pick up a voice-modulated beam at a half mile or more distance.

For really sensitive receivers and correspondingly greater reception ranges, try cutting off the cover lens of a sealed-beam automobile headlight with a glass saw. This is a job that requires a lot of patience and care. Wear heavy work gloves throughout the operation to the point where you remove the dangerously sharp edges of the glass with a carborundum stone, after which you can remove the gloves. Remove the filament and install the detector on the two posts, active area facing the mirrored surface of the reflector.

Even better systems can be made with the large Fresnel lenses sold by Edmund Scientific Co.

**More Information.** It is impossible to list and describe everything you need to know about light-beam communication equipment in a brief article. So, for more information on the topic, try any good library. Detailed information on laser diodes can be found in *Semiconductor Diode Lasers* by R. W. Campbell and F. M. Mims, while LED's and LED communicators are dealt with in detail in *Light Emitting Diodes and LED Circuits and Projects*, both by F. M. Mims. All three books are available from Howard W. Sams & Co., Inc., Indianapolis, IN 46268.



**A** DISPLAY for modern digital electronic equipment would ideally have an extremely low current demand, almost infinite life, and a low price tag. While no present display design can be considered to be "ideal," the liquid crystal display, or LCD, comes a great deal closer to the mark than any of the other available types.

The latest LCD's draw only nanoamperes, as contrasted to the milliamperes and even amperes required for driving other types of displays. This current demand is a critical factor in battery-powered wristwatches, multimeters, etc. The new LCD's theoretically have infinite life, and they are relatively inexpensive when purchased in quantity.

The LCD is unique in at least one respect other than its minuscule current demand: It is *not* a light-generating device as are all the other types of displays. Instead, it uses (and requires) an independent source of light—usually ambient light—to make its activated segments visible. In the dark and under dim lighting conditions, the segments are not visible, which means that back-lighting or some other non-ambient light source must be provided. Conversely, the modern LCD becomes increasingly more legible as the ambient light level increases. (Light-generating displays operate in the opposite manner, washing out in bright ambient light but becoming more legible as the light level is decreased.)

**Types of LCD's.** There are two basic types of liquid crystal displays. The first to make its appearance was the dynamic-scatter LCD. It was later followed and has now been generally superseded by the field-effect LCD. Because of its growing popularity and the advantages it has to offer, our concentration here is on the field-effect LCD.

The field-effect LCD has risen in popularity because it requires only about 20% of the current demanded by the dynamic-scatter LCD. Furthermore, its display is a great deal more legible under a wider range of ambient lighting conditions. A display with either feature would have been instantly popular. That the field-effect LCD offers both in the same package is a welcome bonus.

The physical makeup of a field-effect LCD is shown in Fig. 1. In the most basic terms, it consists of two pieces of glass separated by a nematic



Siemens AG Field-Effect LCD

## Getting To Know The Liquid Crystal Display

*When properly applied, the LCD offers many advantages over other displays.*

BY GARY McCLELLAN

liquid (the name used for the liquid crystal material). The facing sides of the glass are coated with a microscopically thin layer of metal, so thin that it appears to be transparent. The metallization layer covers the entire active area on one piece of glass and is broken up into individually addressable, electrically isolated segment "islands" on the other piece of glass. The

metallization continues from the single large area and segment islands, through the separator/seal, to the edges of the display package to provide electrical connection points for the driving circuitry.

The key to the electrical operation of the field-effect LCD is the *twisted nematic fluid* that fills the entire volume of space provided by the separa-

tor/seal between the pieces of glass. Just as important from an optical viewpoint are the polarizing filters bonded to the front and rear of the display package. The importance of the filters can be seen by powering a field-effect LCD with an ac voltage but leaving off the filters. Although the proper electrical activity would be taking place, a glance at the display would not reveal the fact. Add the filters, and the activated segments would show up sharply contrasted against the background of the display.

When the twisted nematic liquid is first placed in the cell between the two pieces of glass, its molecules arrange themselves parallel to the plane of the glass. When a voltage "field" is applied to the liquid, the molecules "twist" 90° to alter the light passing through it. (Hence the origin of the terms "field effect" and "twisted" nematic.)

The polarizing filters are equally important because they change ambient light that travels in all directions into polarized light in only one direction. This permits the nematic liquid to act like a shutter to control the light passing through the display by shifting the phase of the light. The light emerging from the nematic liquid is then converted back to its omnidirectional form to render it visible. (This sequence is shown in Fig. 2.)

It is possible to obtain either black or clear digits with a field-effect LCD. The only design change between the two types of numerals is a simple 90° rotation of one of the polarizing



*LSI Computer Systems Cl200 MOS Clock Circuit drives an LCD.*

filters. Users of LCD's generally select the type of digits best suited for their equipment application. Wristwatch manufacturers use displays with black digits because of the sharp contrast they give against the background. Clear digits are often preferred in digital panel meters where back-lighting (usually through a milky-white or colored filter) is practical and desirable.

An interesting phenomenon about field-effect LCD's is that they are less prone to washing out under strong ambient light than any other type of display. The digits of a field-effect LCD actually become deeper black or clearer as the intensity of the ambient light increases.

The dynamic-scatter LCD is similar in many ways to the field-effect LCD. It differs mainly in that it does not have polarizing filters and that its segments

are milky white when activated. Consequently, the construction of the dynamic-scatter LCD is the same as that of the field-effect LCD, minus the filters and with a different type of nematic liquid.

The dynamic-scatter LCD has a tendency to wash out under bright ambient lighting. So, some type of light shield is generally placed over the viewing side of the display.

All displays in the LCD lineup are available in either the reflective or the transmissive design, which means that a reflective surface, such as a mirror, may or may not be placed behind the display. Whether field-effect or dynamic-scatter LCD, the reflective display utilizes light striking its front to separate the activated segments from the background. Lacking a reflective surface, the transmissive display passes (transmits) light from the rear through the display itself.

**Driving the Display.** All LCD's require special drive voltages if they are to operate properly. Applying the improper voltages can drastically reduce the life of the display or cause the display not to operate at all. The proper driving voltage for any LCD is an ac voltage with no dc offset. Using a dc voltage or an ac voltage with a dc offset reduces the life of the display, often to only a few days, as opposed to several years with ac drive. The ac voltage applied to the display need not be sinusoidal. In fact, it is most often in the form of a square wave.

When an LCD is connected across an ac voltage source, it "looks" typically like a parallel RC circuit with resistance value ranging from 100 megohms to almost infinity and capacitance value ranging from 170 pF to 0.001  $\mu$ F. Powered by a dc source, the display also looks like a 100-megohm resistance, but this time without the capacitance.

Since the display has a high resistance (and correspondingly high ac impedance), which might typically be 1000 megohms, as in a digital wristwatch, leakage in the switch and display connector become critical factors. Even if switches and connectors rated as high as 100 megohms are used in an LCD circuit, chances are that, when the humidity is high, some voltage may reach the display regardless of the position of the switch between it and the power source.

One solution to the problem is shown in Fig. 3. This is the basic cir-

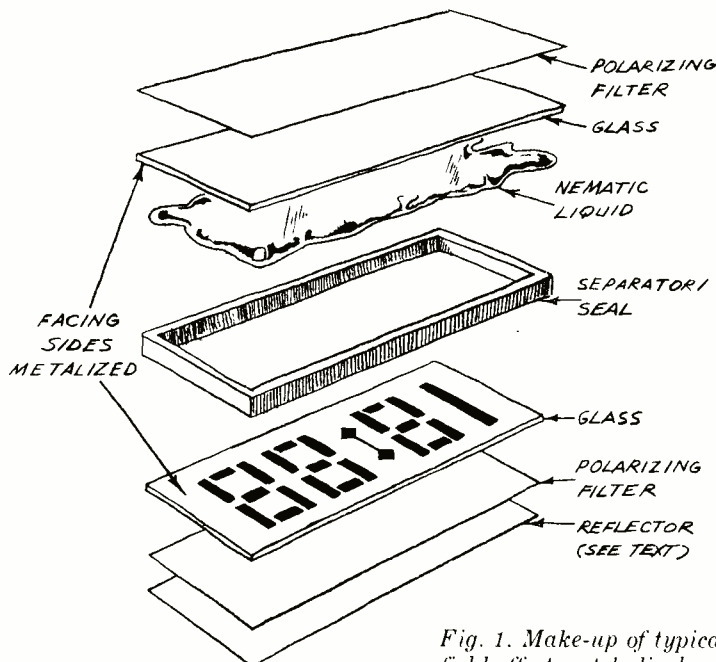

*Fig. 1. Make-up of typical field-effect watch display.*



cuit used to control liquid crystals. The backplane, common to all digit segments, receives a square wave signal. The segments are then either switched to the backplane or to the output of an inverter to turn them off and on, respectively. Switching the segment to the backplane shorts out the display. Switching to the output of the inverter applies to the display a 180° phase-shifted "on" signal. Admittedly, this is a brute-force approach, but it is very effective.

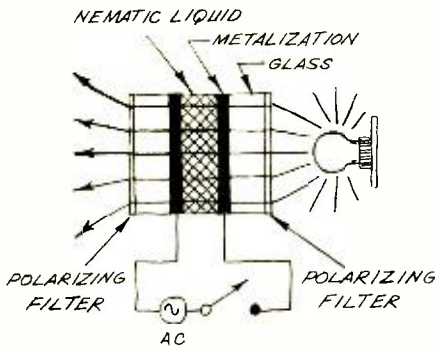

Fig. 2. Basic theory of how liquid crystal display works.

A driver for one segment of an LCD is shown in Fig. 4. Here, an exclusive-OR (XOR) gate takes the place of the switch in Fig. 3. It performs the same function, providing an in-phase signal to the segment when the gate input is low (off) and a 180° phase-shifted signal when the gate input is high (on). This circuit can be found almost anywhere liquid crystals are used.

The IC's used to drive LCD's are almost invariably CMOS devices. The reason for this is that, when a CMOS output stage goes low, the output looks like a resistor. (With TTL, DTL, and other IC families, the output looks like a diode that rectifies and puts dc on the display.) This is one of the reasons CMOS and LCD's are usually found together.

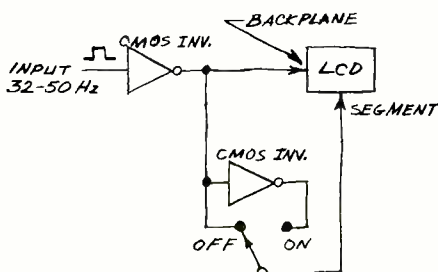
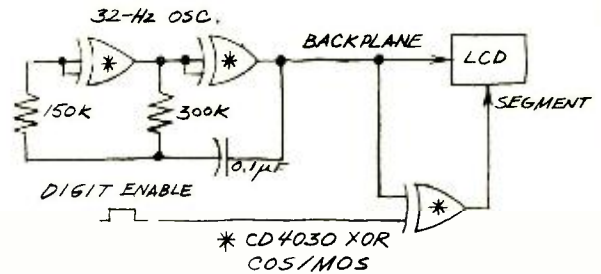

Fig. 3. Practical circuit for driving an LC display.

Fig. 4. Standard driver configuration for an LC display.



The drive voltage's amplitude in an LCD circuit is important. At least its rated voltage must be supplied to the display, which is the normal battery voltage in most CMOS systems. It is usually safe to exceed this voltage without harm, but the display segments might start to come on without being addressed as a result of internal display leakage if the voltage applied is too high.

The duty cycle and frequency of the drive voltage are equally important. The duty cycle must always be 50%, with equal on and off times. Anything other than a 50% duty cycle causes a dc offset that must be avoided. The frequency of the signal is usually about 32 Hz. Most displays have limited frequency responses, and 32 Hz is about optimum.

**Choosing a Display.** There are a number of things to consider and pitfalls to avoid when choosing an LCD. While it is true that you can use almost any LCD in almost any project, some preplanning can prevent your efforts from coming to grief at a later time.

First, consider the range of temperatures to which your project is likely to be subjected. Obviously, if it is to be operated reasonably near normal room temperature, you need not concern yourself with temperature problems. But if your project is going to be operating near 0° C (32° F), bear in mind that the display is going to respond very slowly, taking from several seconds to a few minutes for the digits to form and stabilize. On the other hand, where high operating temperatures are expected, consider putting the display in a cooler place, away from the instrument itself. Otherwise, the heat (up to 50° C in some environments) is likely to destroy the display.

Bear in mind that you must be able to provide the proper voltages and phases to the display. Use a 32-to-50-Hz, 50% duty-cycle square-wave driving signal, and make sure its amplitude is at least the rated (but not exceeding twice the rated) driving vol-

tage for the LCD. And do not forget to provide an XOR gate for each segment of the display as mentioned earlier.

Liquid-crystal displays are slower to respond than are other types of available displays. They are also more sensitive to the ambient temperatures at which they are operated. Consequently, an important factor to consider with your project is the speed at which the display must be able to respond. For digital clocks, watches, thermometers, multimeters, etc., the response of the typical LCD at normal room temperatures is sufficient. But where fast response is important, such as in frequency/events counters and computers, the response speed of the LCD, even under the best operating conditions, may prove too much for the display to handle. In such a case, you would be better off to consider an alternative display.

Now that they are becoming available through such outlets, you will in all likelihood be buying your LCD's from the surplus companies who advertise in the back of this and other magazines. But before you send in your order, carefully check the display descriptions in the ads to make sure that what you are ordering is what you want. If the description is incomplete, write to the dealer (or manufacturer if the company's name is given) for data on the display.

When you order, make certain that a connector is available for the display of your choice. In fact, take no chances; buy display and connector at the same time. Do not try to get along without a connector by soldering wires to the metallization layer along the display's edges. All you will accomplish is the destruction of the display.

The best way to become familiar with and find out the advantages of the liquid crystal display is to experiment. You can use an inexpensive display, even a "second" reject. Once you become familiar with them you are ready to incorporate LCD's in your digital projects.

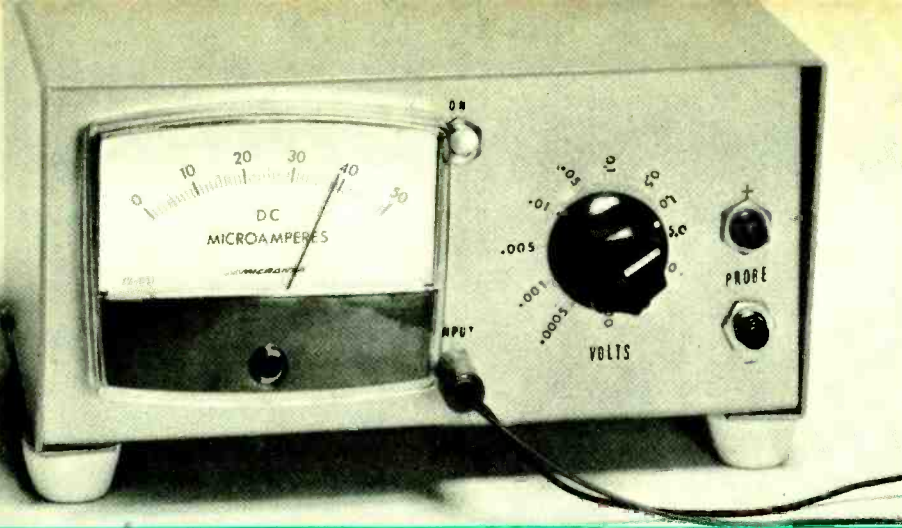

## BUILD THE MINIVOLTER



BY JOHN F. HOLLABAUGH

- Twelve ranges from 500  $\mu\text{V}$  to 100 volts full scale.
- Doubles as ohmmeter down to 0.02 ohm.
- Use to measure current down to 10 nA.
- Costs under \$20.

**N**OW you can have a voltmeter that measures from 500 microvolts to 100 volts full-scale, in 12 overlapping ranges, costing less than \$20. Designed for use on circuits where a little voltage makes a big difference, the sensitive Minivolter is ideal for use on solid-state equipment. In these low-voltage circuits, many conventional meters can't be used because of their relatively low input resistance. The input resistance of the Minivolter is one megohm per volt, drawing a current of one  $\mu\text{A}$ .

The Minivolter can also measure ac voltages if a 1.2 multiplier is used. And it will serve to indicate r-f levels in orienting TV antennas and to peak the low-level stages of transmitters.

**How It Works.** As shown in Fig. 1, op amp *IC1* is used as a voltage follower and *IC2* as a linear rectifier. Any voltage applied to the (-) input of *IC2* is multiplied by the gain of the op amp and inverted. The difference between the input (pin 2) and the output (pin 6) is high enough that the fixed voltage drop across *D1* and *D2* can be hidden by the drop across the series portion of *R15*. So the difference can be considered not to exist. Also, the diode barrier potential (0.7 volt) does not place a lower limit on the value being

measured since any practical value of voltage applied to the input causes some current to flow through the meter circuit.

If a positive voltage is applied to pin 2 of *IC2*, current flows through *D2*, controlled by *S3* (PROBE +), the meter, and part of *R15*. If a negative voltage is applied to pin 2 of *IC2*, the current flow is from the positive output and through *D1* back to the input. The current is actually from the input source since no current can be taken from the input terminal of the op amp. This current is between two and three times the meter rating for full-scale deflection. (In the prototype, the current was 2.8 times the 50- $\mu\text{A}$  meter current or 140  $\mu\text{A}$ .) The sensitivity of the meter has been reduced from 30,000 ohms/volt to 6800 ohms/volt, but we have gotten around the diode barrier drop. For a full-scale indication of 500 microvolts, the input resistance of *IC2* now looks like 3.6 ohms (500/140), which is not very good for a voltmeter. Thus it is necessary to use *IC1* as a voltage follower.

The voltage follower has a high input impedance and low output impedance due to the high open-loop gain of the 741 op amp. This makes it easy to match the high input impedance required of a voltmeter to the

low impedance required by the linear rectifier.

Some compromises have been made in the design of the range selection circuit due to the high offset current of the 741 op amp. A voltage-divider type of selection (as in conventional VTVM's) would be preferred because of the better input resistance on low ranges. However the voltage divider would have a value of shunting resistance across the input of the voltage follower which would require a rezeroing of the meter each time the range is switched. With the conventional 10-megohm resistance, the bias voltage generated across the input would be  $10 \times 10^6$  times 500 nA or 5 volts for the 500-microvolt range. Thus the conventional resistor approach was used instead of a voltage divider.

**Construction.** Most of the components can be wired point-to-point. A small board is required to mount the sockets for the IC's. Two 8-pin "mini-DIP's" can be accommodated in one 16-pin socket.

The potentiometers (except for *R17*) can be fastened with epoxy cement at convenient locations within the cabinet. Once they are adjusted, it is not necessary to have access to them. Install *R17* on the rear apron for easy access. Connect the range selector resistors to the appropriate terminals on *S1*. As noted in the Parts List, the high-value resistors can be made up of smaller units.

The 9-volt power supplies are made up of conventional AA cells in plastic holders.

**Calibration.** Before applying power to the Minivolter, connect a 10,000-ohm potentiometer across the meter and set the potentiometer to its minimum value. Adjust *R13* and *R14* to the far ends of their adjustments. Then back them off about 13 turns. Set *R17* to its midposition, and set *R16* to its maximum value.

Apply power to the Minivolter. Adjust the potentiometer across the meter until the meter gives an upscale reading. Then adjust *R13* and *R14* to make this reading a minimum. Progressively increase the value of the meter-shunting potentiometer and adjust the two trimmer potentiometers to obtain a zero until the shunting potentiometer can be removed from the circuit. Trim *R13* and *R14* a final time.



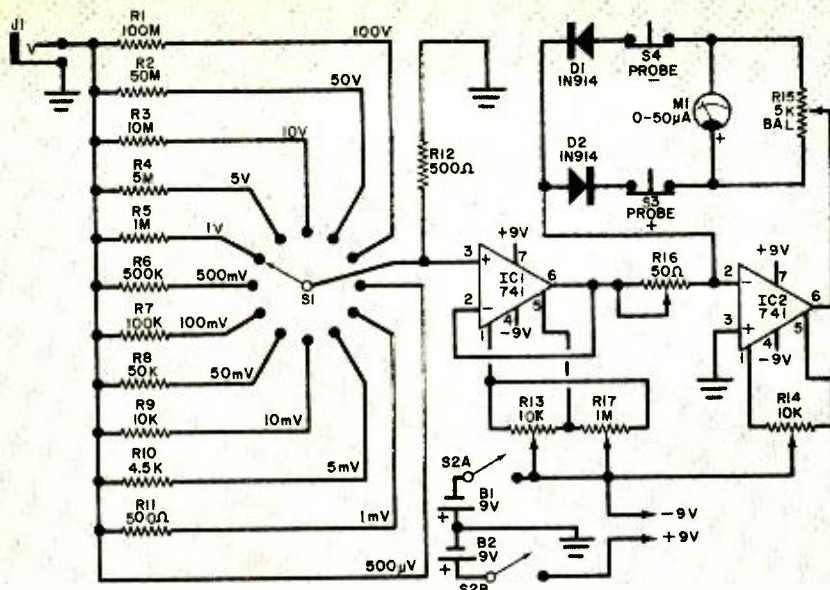

### PARTS LIST

- B1, B2—6 AA cells each  
 D1, D2—1N914 diode  
 IC1, IC2—741 op amp  
 J1—Phono jack  
 M1—0-50- $\mu$ A meter (Radio Shack No. 22-051 or similar)  
 Following resistors are  $\frac{1}{2}$ -watt, 5%:  
 R1—100 megohms (five 20 megohms in series)  
 R2—50 megohms (five 10 megohms in series)  
 R3—10 megohms  
 R4—5 megohms  
 R5—1 megohm  
 R6—500,000 ohms  
 R7—100,000 ohms  
 R8—50,000 ohms  
 R9—10,000 ohms

- R10—4500 ohms (two 9100 ohms in parallel)  
 R11, R12—500 ohms  
 R13, R14—10,000-ohm, miniature, multiturn trimming potentiometer  
 R15—5000-ohm, miniature multiturn trimming potentiometer  
 R16—50-ohm, miniature multiturn trimming potentiometer  
 R17—1-megohm potentiometer  
 S1—Single-pole, 12-position rotary switch (Radio Shack 275-1385 or similar)  
 S2—Dpst switch  
 S3, S4—Normally closed momentary-action pushbutton switch  
 Misc.—IC socket(s), battery holders (Radio Shack 270-384), battery clips, suitable enclosure (LMB No. N463), mounting hardware, rubber feet (4), wire, solder, etc.

Fig. 1. IC2 forms a linear rectifier for the meter, while IC1 is a voltage follower to give high input impedance.

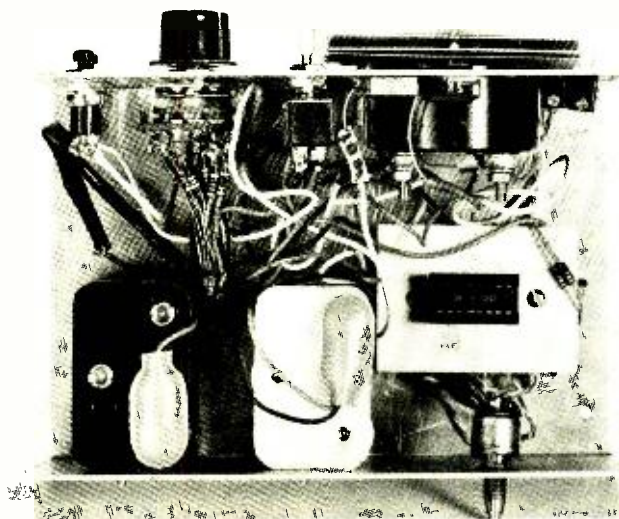

Photo shows how components were laid out in prototype.

Set S1 to a range suitable to measure a voltage known to be accurate (voltage reference or battery) and adjust R16 until the meter indicates the known voltage. Disconnect the reference and zero the meter with R13 and R14. Repeat these last two steps until calibration and meter zero are obtained.

The last part of calibration should be repeated if the meter tends to drift because of temperature effects on IC1. This drift will be about 1/50 of the meter range. After calibration, if the meter has been out of operation for some time, the drift will cause an up-scale deflection when the Minivoltmeter is first turned on. Do not re-adjust for this condition; it will disappear after a few minutes of warm-up.

To balance the polarity of indication, alternately apply the known dc voltage to the input and, operating the appropriate switch, adjust R15 to remove half of the difference of each reading. Do this until both readings are the same to insure the independence of polarity at the meter input.

**Use and Applications.** After turning on the Minivoltmeter, allow a couple of minutes for the IC's to warm up, noting that the meter goes to the zero mark. If it does not do so after a reasonable period, adjust R17 to obtain a zero. Make this adjustment with S1 in the 100-V position.

One can think of many unusual uses for the Minivoltmeter. Here are some examples:

- It can measure the voltage across a junction of dissimilar metals when heated (thermoelectric effect) or the voltage generated across a conventional glass-enclosed semiconductor diode when exposed to light.
- Voltages across a solder joint or connector can be measured for either an ac or dc drop with normal current flowing through the circuit.
- With a loop of wire connected across the input, the Minivoltmeter can be used to trace stray magnetic fields from power transformers, power lines hidden in walls, etc.
- By connecting the Minivoltmeter across an unknown resistor having a 1-mA current flowing through it, the instrument becomes an ohmmeter with readings down to 0.02 ohm.
- Switching to the 500- $\mu$ V range, the Minivoltmeter can be used as a 1- $\mu$ A meter having an internal resistance of 500 ohms. (It can measure currents down to 10 nanoamperes.)

# CAREER GUIDE: **HOW TO BECOME AN FAA ELECTRONICS TECHNICIAN**

BY THOMAS R. SEAR

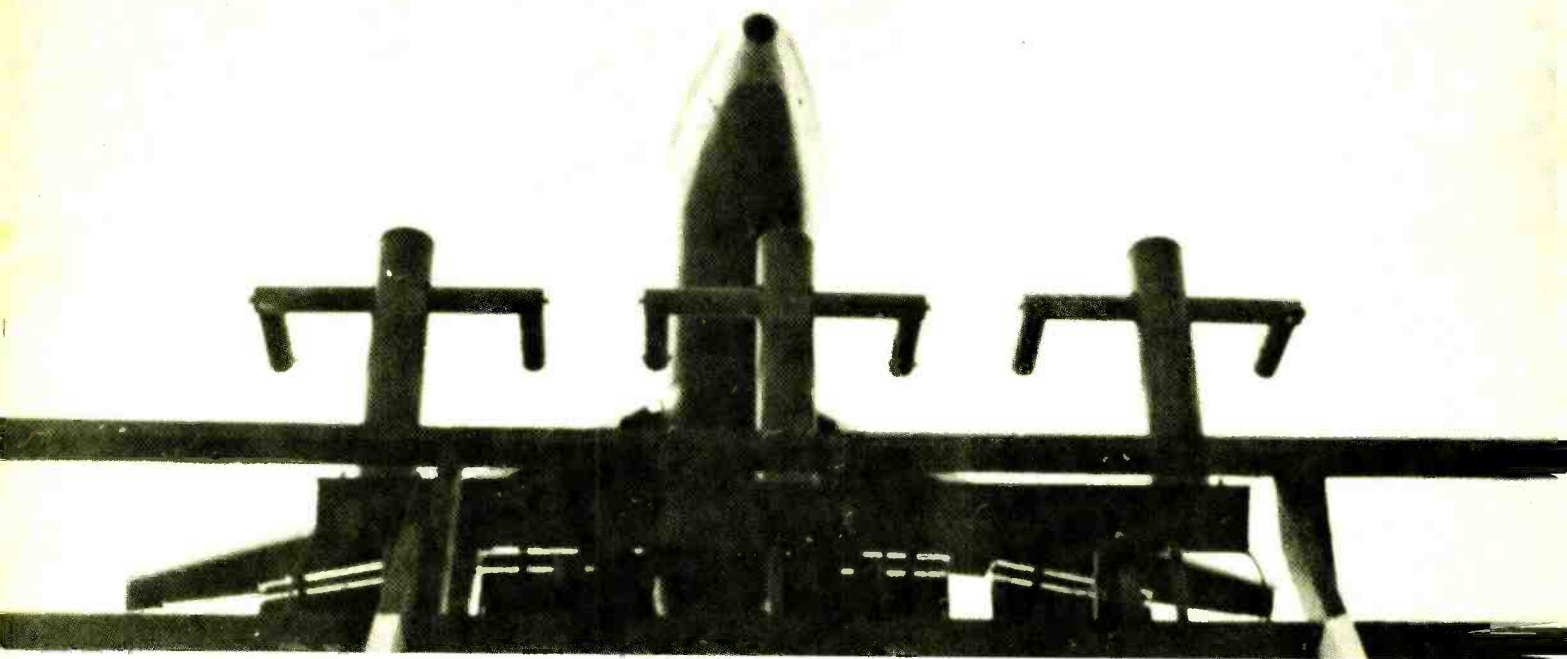

*Now is an opportune time to get started in  
one of the most rewarding careers in electronics.*

**T**HERE are many routes to career development in electronics, but few are more exciting and rewarding than becoming an electronics technician for the Federal Aviation Administration. Currently, there are approximately 9000 electronics technicians in the FAA who help the Air Traffic Control Specialists (ATCS's) to maintain an outstanding record of service and safety.

The electronics extensions of the ATCS—communication equipment, radar, teletype, etc.—offer excellent career opportunities for those people who can qualify for the various FAA electronics technician positions. And this is a particularly opportune time to seek those positions. Right now, and for the foreseeable future, openings will be available as technicians who

joined the FAA after World War II go into retirement.

Not everyone can get a job with the FAA. There are only 9000 positions in the entire country, and that number is not likely to change soon. So, what positions there are draw stiff competition. But an on-the-ball technician who lands one of the positions can look forward to a rewarding career where he can earn as much as \$20,000 a year in an interesting job.

**Type of Work.** As a prospective technician for the FAA, an applicant has six basic options, or career fields, in which he can choose to specialize. They include: navigational aids, communication equipment, systems installation, relief work, radar, and computers. Each option has strong

points, and which of them an individual works in depends on his goals, abilities, aptitudes, and the needs of the FAA. In general, and where possible, the interests of the individual are given primary consideration.

Whatever the option, the work of the technician is seldom boring or routine. Most technicians are certified to work on several types of equipment, which means that the day-to-day tasks they perform will usually be different on any two consecutive days.

There are also routine tests and measurements whose results must be evaluated and analyzed for trends that might lead to equipment failure. In addition, the technician is responsible for the repair and calibration of his test equipment, checking the operation and fuel level of his stand-by power



plant, measuring and analyzing VSWR, frequency, and power as required. He must also perform checks on electronic navigation signals generated by his system for use by aircraft. Testing antennas, transmission lines, and control lines and checking airport weather equipment are other duties of an FAA technician.

Measurements are a routine part of the technician's job, whether they be of bandwidth and sensitivity of his equipment, the specific gravity of a bank of storage batteries, or the depth of snow as he walks into a site in the mountains on snowshoes. Weather is not allowed to prevent the technician from performing his duties, not when lives are at stake.

When the technician is not actually testing or repairing the equipment for which he is responsible, he might be in the shop modifying equipment, the stockroom checking supply levels, or office making out reports. If things are really slow, he can take time to work on one of the many college-level correspondence courses offered personnel by the FAA. These are free of charge for use in career development.

**Who Can Qualify.** Although any normally healthy citizen of the U.S. is eligible to apply for a job with the FAA, not just anyone can become an FAA electronics technician. The nature of the work demands an individual who has had extensive technical training and who is able to accept the fact that lives depend on how well he performs his duties. By themselves, these two

factors narrow the field of applicants considerably.

The FAA, very selective in its hiring, further narrows the field. First, an applicant must pass a series of Civil Service tests to achieve status on the applicable register. (The register is a listing of interested people according to the scores achieved on the tests taken.) When an opening occurs, the person whose name heads the applicable list is called in for intensive interviewing. Only the best qualified person will get through this screening process.

The qualification process is based on two factors. First, all federal hiring is based on merit—the best qualified



*Difficult position is required of technician shown here working on the bearings of a TACAN rotating antenna assembly.*

are hired, promoted, etc. The second factor is that once an applicant is hired by the FAA, that is only the start of really extensive technical training. No matter how well-trained an applicant appears to be, he must prove to the FAA that he can perform his job according to specified standards. This means that he must pass a certification examination on every type of equipment upon which he might be required to work. (The certification procedure is roughly similar to the licensing program conducted by the Federal Communications Commission for commercial radio operators and repairmen.)

**Training Program.** The first step in training an FAA electronics technician may or may not be a period of on-the-job training to familiarize him with the

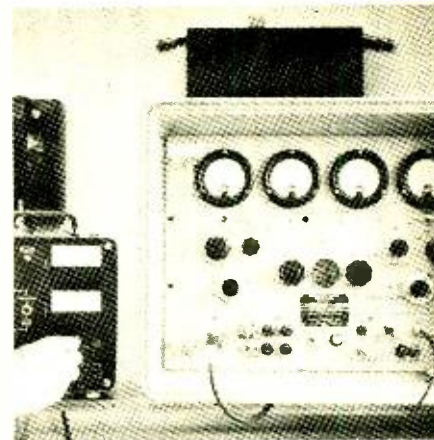

*Calibrating one of the many specialized test instruments—a portable instrument landing system field detector, at left.*

equipment upon which he or she (yes, the FAA offers equal employment opportunities to men and women) will be working. Then the technician is sent to Oklahoma City to attend the FAA Academy at Will Rogers Airport. Here, the new technician will spend from several days to 52 weeks, depending on the option involved, in intensive training to assimilate in-depth knowledge related to his new duties.

The time a technician is required to spend at the FAA Academy is a function of the equipment involved. Getting through the training at the Academy is no easy task. In addition to spending eight hours a day, five days a week, in classroom and laboratory work, the average technician might have to give up a good portion of each evening and weekends to study. No one is permitted to fall behind. And to make certain they do not, a written examination and/or performance test, based on the week's work, must be passed every week. Failure to maintain a grade average of at least 70% results in the technician's being shipped back to his duty station without being given the opportunity to finish the course. (Such a result is less than desirable on a technician's record because progress in the FAA is a function of displayed ability.)

When the technician returns from the Academy, having successfully completed the program of training, he is permitted a period of readjustment. Then he is scheduled to take the applicable certification exam. During the exam, the technician is required to demonstrate his ability to perform specified tests, measurements, adjustments, and usually repairs on the system.

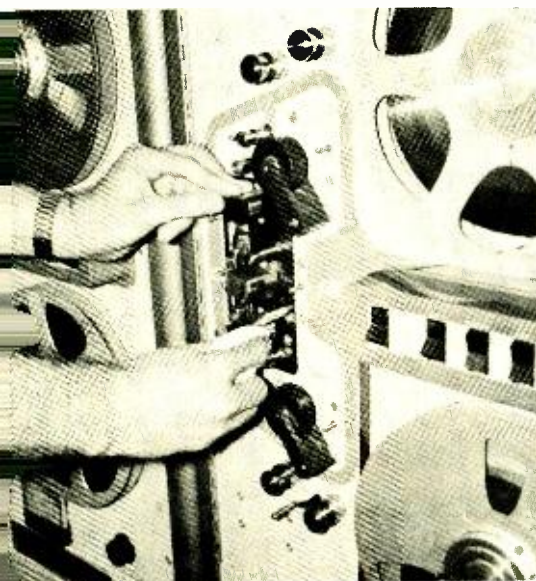

*Technician checks ten-channel tape recorder used to make semi-permanent record of communications between controllers and aircraft.*



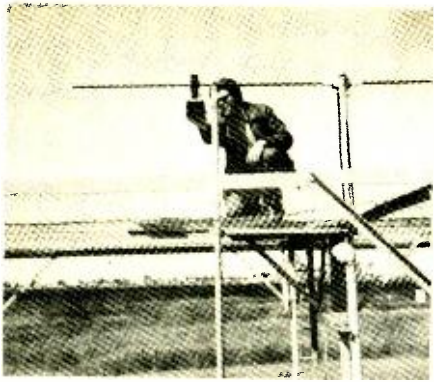

*Measuring critical antenna current on system which sends markers to an aircraft during final approach on instruments.*

The time needed to complete a certification varies from as short as 1 hour to as much as 40 hours, depending on the system involved. There are "lock-out" questions on the exam that can fail the technician if he cannot perform or answer them. Inability to satisfy a single lockout item, all of which are considered to be tests that are critical to the maintenance of the system, means that the technician must repeat part or all of the exam in not less than 30 days from the date of failure.

**Career Development.** The type of individual who makes it to the top in his particular area in the FAA is the creative person. Mindful of this, the FAA has developed a program that provides those people who wish to do so the opportunity to progress to positions of greater responsibility. For the technician, this means the opportunity to become an engineer if he wants to make the effort. Each year, all technicians are given the opportunity to apply for selection as an engineer development candidate.

From those people who apply for the positions, the best are selected and assigned to engineering-type positions at an FAA facility near a suitable college. Successful applicants generally have at least two years of college already; the FAA allows them up to two more years of study to achieve engineer status. This can be accomplished either by earning an engineering degree or by passing the Engineer-in-Training exam for the state in which the applicant is working.

During the two years allowed for completion of the program, the applicant works for the FAA, under the direction of a professional engineer, on engineering problems. Approx-

imately half of his normal work week is spent attending classes. Only technical courses are authorized by the FAA under the program, and nothing less than a C average is acceptable in a given course.

**Salaries and Benefits.** The pay that the FAA electronics technician receives is based on his skill, training, demonstrated ability, and time on the job. For an individual just entering FAA service, annual base pay might be on the order of \$5000 or so. For the "old timer" who has worked hard to get ahead and has 15 or more years with the FAA and has reached first level, base annual pay can reach \$20,000.

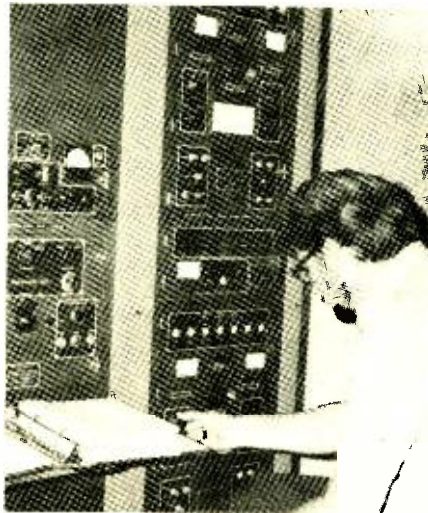

*Technician checks that radiation pattern of his VOR system is within tolerances required by the FAA for radio-navigation.*

The benefits the FAA technician receives include vacation and sick leave. Vacation time is accrued by the technician at a rate of 20 days per year during the first 15 years of Federal Service. Thereafter, vacation is accrued at a rate of 26 days per year. Sick leave is authorized at a rate of 13 days per year, regardless of rank or time in service. Unused sick leave can be saved until it is needed.

**How to Apply.** All in all, a career as an electronics technician with the FAA is hard to beat. If you are interested in pursuing a career as an FAA technician, the first step is to go to your local post office and ask for standard Federal Employment Application Form No. SF-171.

The form consists of at least four pages, each of which must be filled in with the information required. So, be

careful when you fill it out, and don't rush the job. Remember, this form is the only means the Civil Service Commission has of initially evaluating you.

When you have completed the form, mail it to the FAA Regional Office nearest you. (A complete list of Regional Office addresses can be obtained by writing to FAA Headquarters, 800 Independence Ave., S.W., Washington, DC 20591.) However, if you are seeking a position in another area of the country, send your application to the Regional Office that has responsibility for that area. The Regional Office will then process your application, after which it is only a matter of time before you are contacted. But do not be impatient. Contacts are made only when a position has been vacated and must be filled.

Ordinarily, FAA technician positions are not vacated all that often. But, as mentioned earlier, this is a particularly opportune time. The 30-year veterans of FAA service are now retiring, and others will be going into retirement during the next few years at a rate much greater than during any previous period.

If your luck holds, that first contact from the FAA will arrive soon. Meanwhile, bone up on your electronics theory and algebra because once you are contacted, you will not have time for studying. So, be prepared for the battery of tests you will be required to take. Your scores on them will decide whether or not you are going to make the FAA technician team. ♦

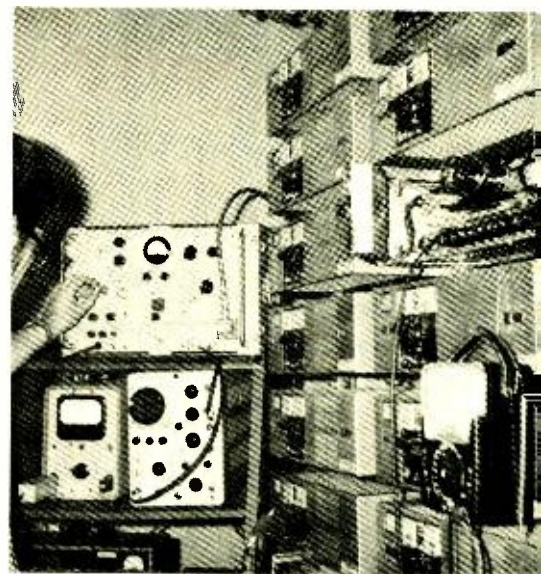

*Some of the test equipment used to check a 70-MHz i-f strip in a 6-channel radar information microwave link repeater site.*





# Product Test Reports

## ABOUT THIS MONTH'S HI-FI REPORTS

There seems to be a strong trend toward super-deluxe "high end" audio components coming from a number of manufacturers. The Kenosonic Ac-cuphase C-200 Preamplifier is an excellent example of what can be done when skilled design engineers are given free rein to develop the best possible product, free of the usual cost restrictions. In addition to a degree of flexibility and performance not likely to be approached by lower-priced components, the C-200 has an aura of precision and workmanship that go a long way toward justifying its considerable cost.

Near the other end of the price scale is a medium-power stereo receiver, the STA-250 by Realistic, that manages to combine much of the operating versatility and electrical performance of some far more expensive receivers. With a price tag only slightly above the lowest priced stereo receivers, it shows quite effectively that very satisfactory high-fidelity performance is possible at a surprisingly low price.

Some audio components manage to achieve such lasting and widespread acceptance that their manufacturers continue to produce them for years instead of replacing them annually with "new" or slightly face-lifted models. In phono cartridges, the Stanton 681EE has long been recognized for its unusually flat, uncolored response, combined with physical ruggedness. Stanton has made some further improvements, principally in reducing the moving mass, that result in a fine cartridge's becoming even finer. The result is the new 681EEE—basically almost identical to the "double-E" but nevertheless significantly improved.

—Julian D. Hirsch

## REALISTIC MODEL STA-250 AM/STEREO FM RECEIVER

Excellent FM tuner section and 44 watts/channel.

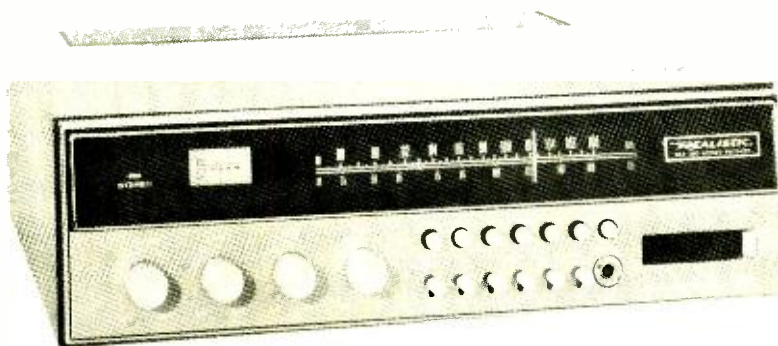

The Realistic Model STA-250 receiver, available from Radio Shack, offers an excellent

AM/stereo FM tuner and a relatively powerful audio amplifier at a price of only \$319.95. The 44-watt/channel rating (specified over a frequency range of 20 to 20,000 Hz into

8-ohm loads with both channels driven simultaneously) at less than 0.5% distortion is unique in the price range of this receiver. This power performance is rarely ever available in receivers that list for less than \$400. And that is not all, because the STA-250's tuner specifications are also comparable to those of many receivers that are costlier.

**General Description.** The fly-wheel-type tuning "knob" in this receiver is horizontal, accessible through a slot in the front panel. The receiver's TREBLE, BASS, BALANCE, and VOLUME controls are of more conventional design, employing traditional control knobs. The program source, mode of operation, tape monitoring, and power are selected by a system of pushbutton switches. Six lever switches are provided for switching in and out the LOUDNESS compensation, FM MUTE, HI and LO filters, and MAIN and REMOTE speaker outputs. A jack is also provided for stereo headphones.

Behind the receiver's black-out dial window are the logging scales and a single tuning meter that light up in a soft green color when power is turned on. The meter, a zero-center type, is for FM tuning and indicating relative signal strength on AM. The legend FM STEREO appears in white when a stereo broadcast is being received.

On the rear apron are located all inputs, outputs (except headphone), and a resettable circuit breaker for line power. Two unswitched ac accessory outlets are provided for convenience. There are two sets of PHONO inputs, either of which can be selected by setting a slide switch to the appropriate position. Another switch has positions for setting up the PHONO inputs for CERAMIC or MAGNETIC cartridges.

The receiver has three pairs of speaker outputs, all of which are available at phono jacks instead of the more usual screw- or clip-type terminals. Two outputs are for the MAIN and REMOTE speaker systems selected by the switch on the front panel, while the third is for rear speaker systems that can be driven with a derived L-R signal to produce a pseudo-quadraphonic or enhanced stereo effect from the receiver's "Quatravox" circuit. A slide switch activates the special rear outputs.

The Realistic Model STA-250 receiver is supplied with a wooden, walnut-finished cabinet. It measures 16 $\frac{7}{8}$  in. wide by 15 $\frac{1}{2}$  in. deep by 5 $\frac{1}{4}$  in. high (43×40×13.3 cm) and weighs roughly 23 lb (10.5 kg).

**Laboratory Measurements.** The receiver's FM tuner measured 2.0  $\mu$ V in mono and 6.5  $\mu$ V in stereo in the IHF usable sensitivity test, the latter also being the stereo switching threshold. The 50-dB quieting sensitivities in mono and stereo were both excellent at 2.7  $\mu$ V and 30  $\mu$ V, respectively. The

# The better the training the better you'll

Send for  
**FREE**  
illustrated  
career  
guide

NTS guide  
to careers in  
Electronics

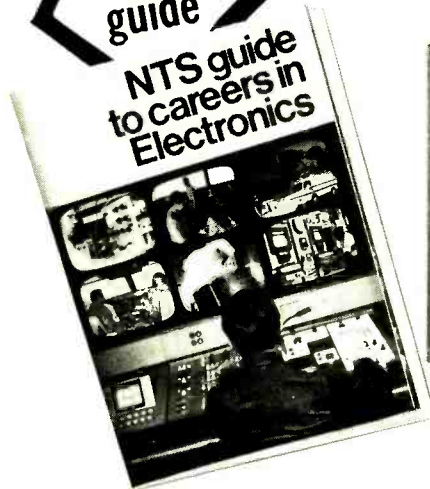

IN-CIRCUIT TRANSISTOR TESTER

COMPU-TRAINER

TROUBLESHOOTER  
VOM

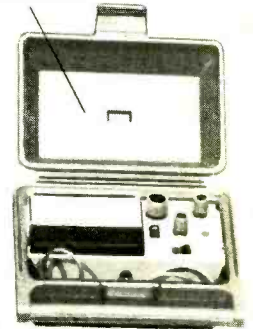
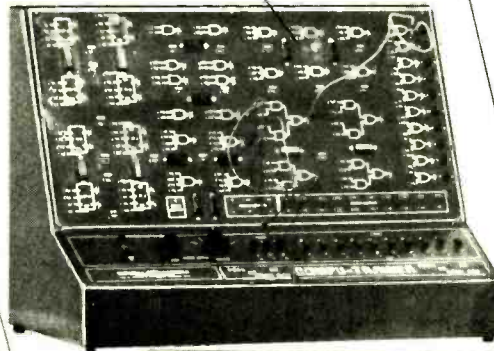

SOLID-STATE  
OSCILLOSCOPE

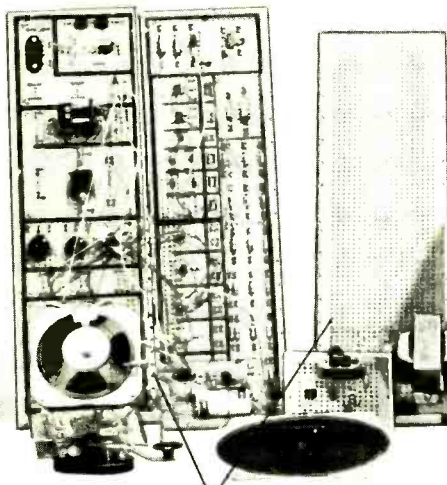

ELECTRO-LAB



(Simulated TV Reception)

As an NTS student you'll acquire the know-how that comes with first-hand training on NTS professional equipment. **Equipment you'll build and keep.** Our courses include equipment like the **NTS/Heath Digital GR-2000 Solid State color TV** with first-ever features like silent varactor diode tuning; digital channel selection, (with optional digital clock), and big 315 sq. in. ultra-rectangular screen.

Also pictured above are other units — 5" solid state oscilloscope, vector monitor scope, solid-state stereo AM-FM receiver with twin speakers, digital multimeter, and more. It's the kind of better equipment that gets you better equipped for the electronics industry.

This electronic gear is not only designed for training; it's field-type — like you'll meet on the job, or when you're making service calls. And with NTS easy-to-read, profusely illustrated lessons you learn the theory behind these tools of the trade.

**Choose from 12 NTS courses** covering a wide range of fields in electronics, each complete with equipment, lessons, and manuals to make your training more practical and interesting.

**Compare our training; compare our lower tuition.** We employ no salesmen, pay no commissions. You receive all home-study information by mail only. All Kits, lessons, and experiments are described in full color. Most liberal refund policy and cancella-



# and the equipment be equipped.

COMPARE OUR  
KITS AND LESSONS.  
COMPARE OUR  
TUITION.

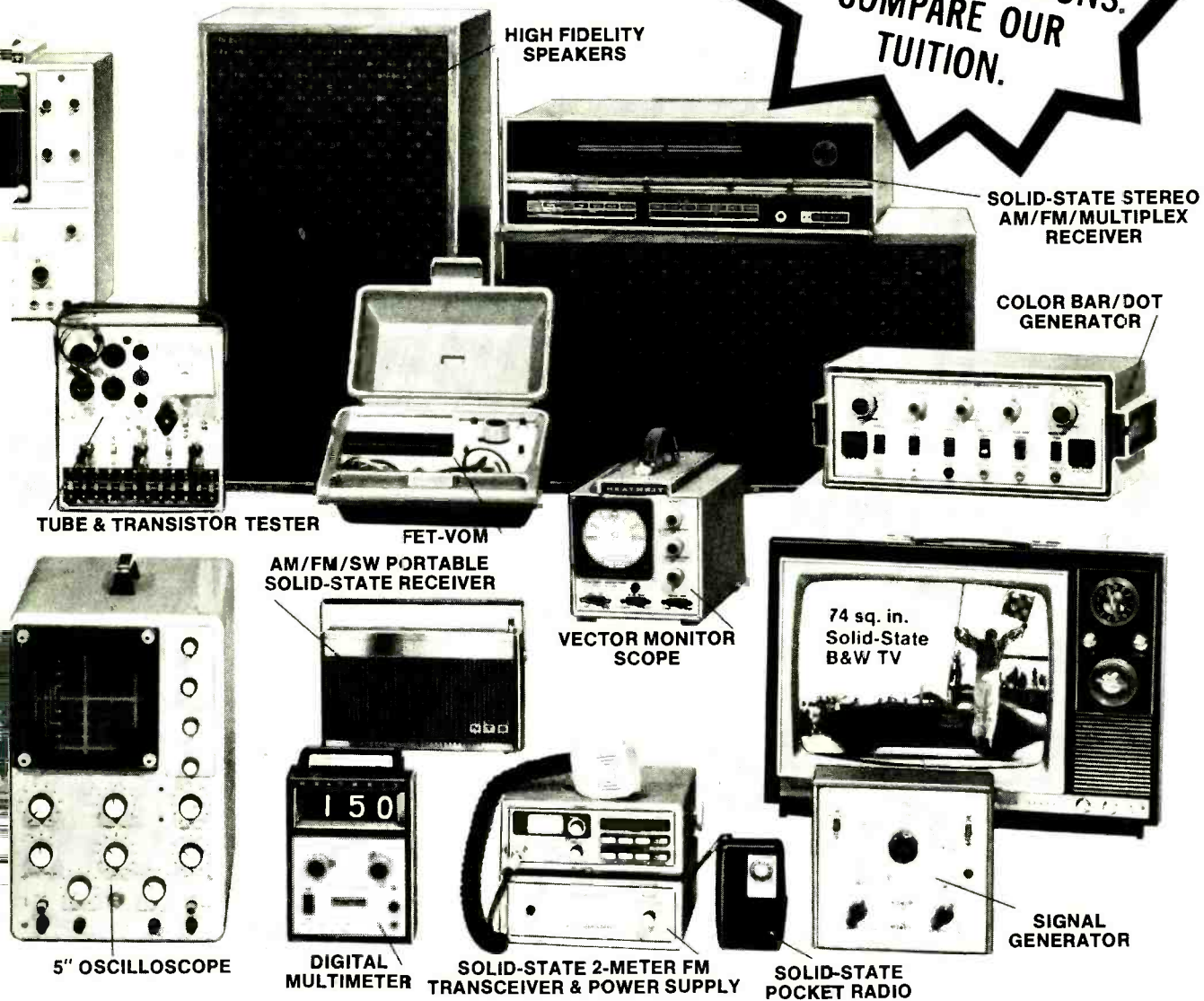

tion privileges spelled out. Make your own comparisons, your own decision. Mail card today, or clip coupon if card is missing.

**NO OBLIGATION. NO SALESMAN WILL CALL**

**APPROVED FOR VETERAN TRAINING**

Get facts on new 2-year extension

**NATIONAL TECHNICAL SCHOOLS**

TECHNICAL-TRADE TRAINING SINCE 1905  
Resident and Home-Study Schools  
4000 So. Figueroa St., Los Angeles, Calif. 90037

**NATIONAL TECHNICAL SCHOOLS** Dept. 205-045  
4000 South Figueroe St., Los Angeles, Calif. 90037  
Please send FREE Color Catalog and Sample Lesson.  
NO OBLIGATION. NO SALESMAN WILL CALL.

Color TV Servicing  
 B & W TV and Radio Servicing  
 Electronic Communications  
 FCC License Course
  Electronics Technology  
 Computer Electronics  
 Basic Electronics  
 Audio Electronics Servicing

NAME \_\_\_\_\_ AGE \_\_\_\_\_

ADDRESS \_\_\_\_\_ APT # \_\_\_\_\_

CITY \_\_\_\_\_ STATE \_\_\_\_\_

Please fill in Zip Code for fast service \_\_\_\_\_

Check if interested in G.I. Bill information.  
 Check if interested ONLY in classroom training in Los Angeles.

ultimate distortion, at a 1000- $\mu$ V input, was 0.3% in mono and 0.63% in stereo, while the ultimate S/N was 68 dB and 63 dB in mono and stereo. The FM muting threshold measured 4  $\mu$ V.

In stereo operation, the FM frequency response measured  $\pm 0.5$  dB from 30 to 12,000 Hz and was down 1.1 dB at 15,000 Hz. The stereo channel separation was very good, exceeding 36 dB from 60 to 15,000 Hz and was still 26.5 dB at 30,000 Hz.

The capture ratio was exceptionally good, measuring 0.7 dB at a 1000- $\mu$ V input and 1.6 dB at 10  $\mu$ V. The AM rejection was 37 dB, except at very high signal inputs, where it reached 48 dB at a 10,000- $\mu$ V input. Image rejection was 68.5 dB and alternate-channel selectivity was 65 dB, both good figures. The AM tuner's frequency-response characteristic caused the output to fall to -6 dB at 2500 Hz.

The conservatism of the audio power ratings of the receiver's amplifiers was demonstrated by the 1000-Hz clipping output power we measured at 56.5 watts/channel into 8 ohms, 75 watts into 4 ohms, and 36 watts into 16 ohms. At 1000 Hz, the THD was 0.16% at 0.1 watt and decreased smoothly to 0.07% at 1 watt and 0.025% between 20 and 50 watts, just before clipping. The IM distortion characteristic was somewhat similar, with the usual higher values of distortion: 0.4% at 0.1 watt, 0.26% at 1 watt, and a minimum of 0.12% in the

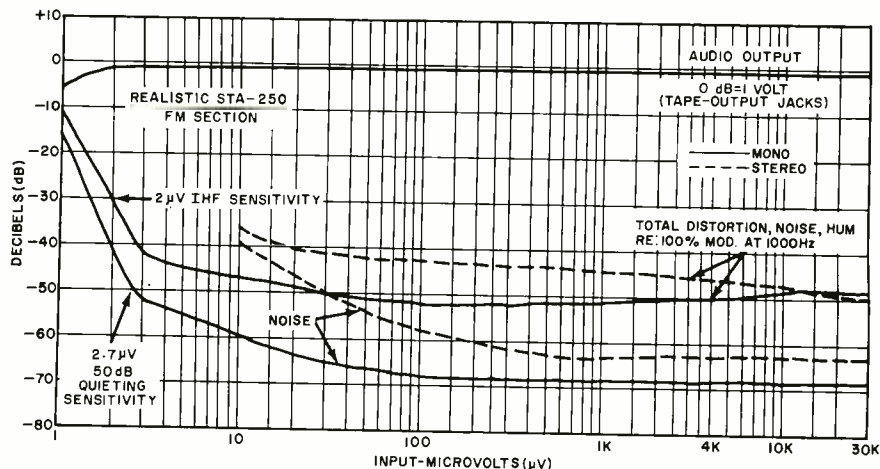

30-to-50-watt range. The distortion in the outputs was primarily due to "crossover" or notch distortion, which results in an increase in the measured value as the output power is reduced. The IM distortion rose to 1% at about 15 mW and to almost 4% at 1.5 mW, although at the usual listening levels of a few tenths of a watt or more, it was less than 0.25%.

At full rated power and half power, the distortion in the audio amplifiers was less than 0.1% over most of the audio-frequency range. It reached a maximum of about 0.2% at 20 Hz and 20,000 Hz. The measurements at frequencies below 1000 Hz included the residual hum level, which was generally greater than the actual distortion. When we were able to use the high-pass filter in our distortion analyzer for measurements beyond 1000 Hz, it was obvious that the distortion was between 0.025% and 0.05% at most audible frequencies.

To attain a reference output power of 10 watts, a signal of 36 mV was required at the AUX inputs or 0.75 mV at the PHONO (MAGNETIC) inputs. The respective S/N ratios were 63 dB and 57 dB, with the "noise" consisting mostly of hum. Phono overload occurred at a relatively low 38 mV input.

The tone controls had conventional characteristics, and the loudness compensation boosted only the low frequencies to a moderate extent. The RIAA equalization was accurate within  $\pm 0.5$  dB from 50 Hz to 20,000 Hz. However, the high-frequency phono response was influenced by cartridge inductance to a greater degree than is the case with many amplifiers, resulting in a drop of 2 to 5 dB in output at 15,000 Hz, depending on cartridge inductance. There was no effect on the response at frequencies of less than 10,000 Hz.

**User Comment.** The FM tuner section in the receiver was able to match—and occasionally surpass—the performance of some far more expensive tuners in receiving weak signals without excessive noise or distortion. With signals of normal strength, the tuner sounded exactly like "component" tuners costing a great deal more than the going cost of the entire Model STA-250 receiver.

We listened to the receiver at considerable length, using various types of speakers, and made A-B comparisons with other amplifiers whose measured distortions were far less. While we occasionally heard slight dif-

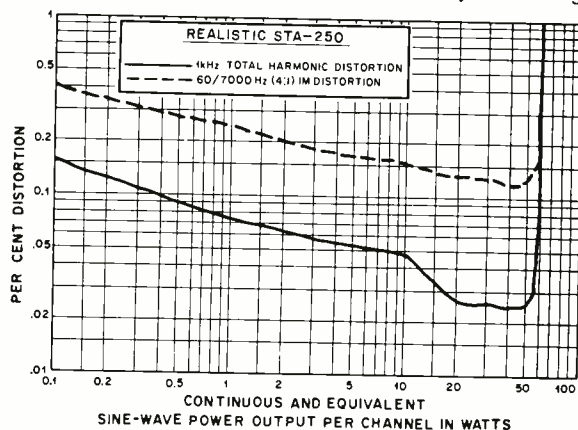
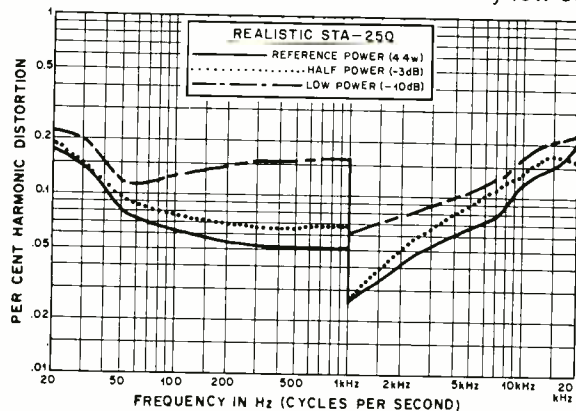
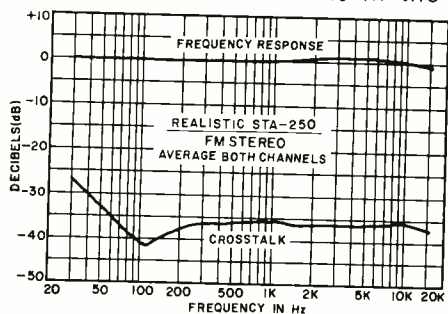



ferences between the Realistic and other receivers, they were merely differences, neither superior nor inferior sound characteristics. The Realistic receiver always sounded fine, and it was certainly better in quality than that inherent in the FM programs available to us.

It is manifestly unfair to compare the \$320 Realistic receiver with other re-

But we know of no other receiver at or even near its price that can match the combination of top-quality FM tuner performance and exceptional audio power capability of the Realistic Model STA-250 receiver. When used with good medium-priced speaker receivers selling for hundreds of dollars more, even though many aspects of its performance invite this comparison.

systems, record player and cartridge, and tape equipment, it could compete effectively in sound quality and overall user satisfaction with other receivers costing twice as much. To our way of thinking, this is a consideration that completely overshadows mere specifications or even laboratory bench performance figures.

CIRCLE NO. 65 ON READER SERVICE CARD

## KENSONIC MODEL C-200 PREAMPLIFIER

*Complementary-symmetry, push-pull design in every stage.*

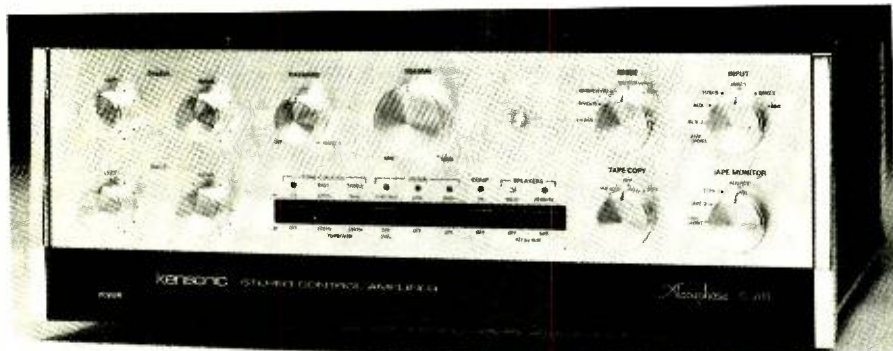

The Kenonic "Accuphase" Model C-200 is a high-grade hi-fi system control

preamplifier. Its performance specifications are exceptional, backed up by a high degree of operational flexibility and rugged quality construction. Manufactured in Japan by Kenonic Laboratories, Inc., and distributed in the U.S. by Teac Corp. of America, this preamp is rather unique in that it features a fully complementary-symmetry push-pull design in every stage from phono preamplifier to output stage.

**General Description.** The preamp has inputs for stereo microphones, two magnetic phono pickups, and four high-level sources. It can control two tape recorders from the front panel, with full monitoring capability. Additionally, the user has the option of copying from either recorder to the other while listening to a different program through the amplifier. There are also recording and playback connections for a third tape deck, but without the monitoring feature.

A MODE switch offers a choice of stereo programs with normal or reversed channel orientation, left-plus-right mono programs, or either left- or right-input mono through both channels.

The separate bass and treble controls for the two channels, each an 11-position switch, are teamed with conventional volume and balance controls. Pushbutton switches permit selection of different turnover frequencies for the tone-control setup (200 or 400 Hz for the bass and 2500 or 5000 Hz for the treble) or bypass the tone control circuits entirely.

A low-cut filter that operates below 30 Hz with an 18-dB/octave slope and a high-cut filter that operates above 5000 Hz with a 12-dB/octave slope can be switched in and out as desired. Also switchable is a subsonic filter that works with only the phono inputs, cutting off below 25 Hz at a 6-dB/octave rate when switched in.

Pushbutton switches are provided for loudness compensation and two pairs of speaker outputs from the power amplifier (in this case, the companion Kenonic Model P-300 amplifier). An optional remote switching relay accessory is available for the latter function.

The input and output jacks for the third tape deck, a headphone jack, the two auxiliary microphone jacks, a high-level source jack, and a second set of preamplifier outputs paralleling those on the rear apron are behind a section of the front panel where they are easily accessible. A switch provides a choice of 20,000-, 30,000-, or

47,000-ohm phono cartridge termination for the DISC 1 input, while the DISC 2 input is fixed at 47,000 ohms termination. Another switch adds either 0.5 or 1 dB to the low-frequency response through the phono inputs.

Another switch allows the power amplifier, when plugged into the appropriate outlet on the preamp's rear apron, to be switched on separately. The main power switch controls all preamplifier circuits and six switched outlets.

Located on the rear apron is a socket for plugging in the remote-control speaker switching accessory. Also on the rear panel are four gain controls for adjusting the gains of each channel for the phono inputs over a 10-dB range to match the signal levels of the high-level sources.

The preamp measures 17½ in. by 14 in. by 6 in. (44.5 × 35.6 × 15.2 cm) and weighs 30.8 pounds (14 kg). It retails for \$600.

**Laboratory Measurements.** The preamplifier has a rated maximum output of 10 volts. Up to that level, its output distortion did not exceed 0.01 percent, except at 20 Hz, where it measured 0.025 percent at 10 volts. (The output clipped at about 13 volts.) The 200-ohm output impedance is low enough to drive any power amplifier without difficulty.

For a 1-volt reference output, a 94-mV signal was required through the AUX input, while through the PHONO inputs only 0.94 mV was required. The preamp's noise level was very low, measuring 78 dB down on AUX and 74 dB down on the DISC inputs at the 1-volt output level.

This preamplifier has the widest dynamic range on PHONO of any preamplifier we have ever measured. It overloaded at 440 mV with maximum phono gain. However, by reducing the phono level controls on the rear apron

to minimum, the preamp overloaded at a remarkable 1.35 volts!

As might be expected from the choice of tone-control turnover frequencies and control settings, the range of available response curves was almost unlimited. The loudness compensation boosted to an 8-dB maximum only the low frequencies. The filters were among the most effective we have ever used from the standpoint of removing maximum noise with minimal effect on program material. For example, the low-frequency filter had no effect above 50 Hz; yet, it reduced the 20-Hz output by 10 dB. The high-frequency filter was down 3 dB at 5500 Hz and continued at a 12-dB/octave rate with increasing frequency.

The RIAA phono equalization was accurate to within  $\pm 0.5$  dB from 20 to 20,000 Hz. Due to the differential am-

plifier circuitry, the phono cartridge is effectively isolated from the equalization components. Hence, cartridge inductance had no effect on the accuracy of the high-frequency equalization. The subsonic filter began to take effect at about 1000 Hz and was down 3 dB at 35 Hz. To a great extent, it seemed to overlap the much more effective low-cut filter in its operating range. The low-frequency enhancement circuit increased the response by either 0.5 or 1 dB below 1000 Hz.

**User Comment.** A study of the circuits and internal construction of the preamp leaves no doubt that the designers have avoided just about every compromise usually made in the interests of economy. In its ruggedness and mechanical construction, the preamp resembles a laboratory instrument rather than a hi-fi product.

The operating controls have a smooth feel, combined with positive action, that is consistent with and complements the outstanding electrical performance of the preamp. It would be difficult to imagine a preamp with greater operating flexibility than the Model C-200 in terms of frequency response adjustment and available inputs and outputs.

As to listening quality, we can only say that this preamp will provide almost any frequency-response characteristics an audiophile could wish for, a dynamic range far greater than that of any program likely to be supplied to it, and distortion that is barely measurable, let alone being audible. With tone controls and filters bypassed, this preamp comes as close to the proverbial "straight wire with gain" as anything known to us.

CIRCLE NO. 66 ON READER SERVICE CARD

## STANTON MODEL 681EEE STEREO PHONO CARTRIDGE

*Reduced stylus mass makes fine performance even better.*



The Model 681-EEE is the successor to and supersedes Stanton's Model 681EE

stereo phono cartridge. In fact, the two models have identical external appearance, except for the difference in nomenclature marked on the removable stylus assemblies. The principal design difference between the two is that the EEE's stylus mass has been reduced by about one third.

The cartridge's stylus assembly has a removable "Longhair" brush that, when used, removes dust from the surface of the record. The use of this brush requires a slight modification in the usual method of setting up tracking force. The tonearm adjustment should be set 1 gram higher than the desired tracking force to compensate for the slight upward force exerted by the record's surface against the brush. This does not increase the force exerted by the stylus on the record

groove. Generally speaking, the anti-skating compensation should be increased by a like amount.

Called a "calibration standard" by Stanton, the Model 681EEE cartridge is notable for the flatness of its frequency response, which is tested and specified on a calibration card packed with each cartridge. The cartridge comes with mounting hardware and a small screwdriver.

Supplied standard with the cartridge is a 0.2- $\times$ 0.7-mil elliptical diamond stylus that is rated to track at between 0.75 and 1.5 grams. Available separately as options are a 1.0-mil conical-tip stylus designed for tracking at 2 to 5 grams for mono LP's and a 2.7-mil stylus designed for tracking at 3 to 7 grams for 78-rpm discs.

The retail price of the Stanton Model 681EEE stereo phono cartridge is \$82.

**Laboratory Measurements.** We installed the cartridge in the tonearm of a Dual Model 601 record player, set the tracking force to 1 gram, and used the recommended load of 47,000 ohms and 250 pF throughout our laboratory and listening tests. In preliminary tests, the cartridge tracked the highest levels of the Fairchild 101 and Cook Series 60 test records at the 1-gram tracking force.

The frequency response we obtained by using the CBS STR100 test record was exceptionally free from ir-

regularities. It had an almost perfectly linear, gentle slope downward from 500 Hz to 20,000 Hz, where the output was about 5 dB below the mid-frequency level. The only measurable departure from a smooth, straight line was a  $\pm 0.75$ -dB "blip" at about 17,000 Hz that was apparently due to a mechanical resonance. The response to a 1000-Hz square wave played from a CBS STR111 record revealed a moderately rounded convex top with no overshoot or other evidence of peaking or resonance.

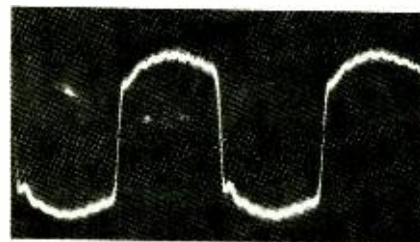

1000-Hz square wave.

The separation measured typically about 30 dB on one channel and 20 to 25 dB on the other channel at frequencies up to about 10,000 Hz. It was 10 to 20 dB between 10,000 and 20,000 Hz, with a "blip" in the crosstalk curve at the 17,000-Hz resonance point noted above. The low-frequency resonance was 7 Hz, at which point it produced a 10-dB rise on the response curve.

To evaluate the effect of higher load capacitance on the frequency re-



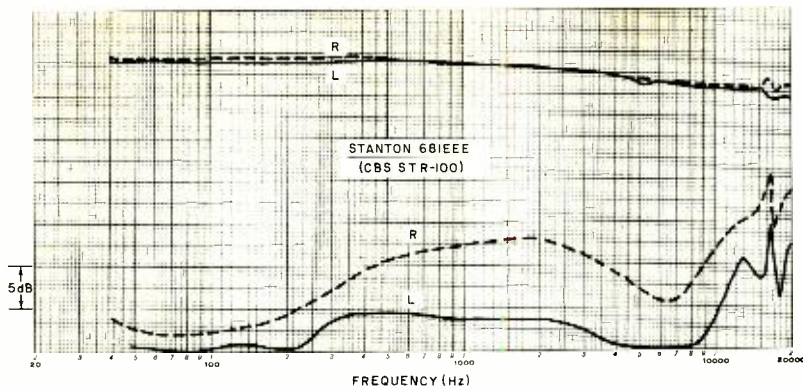

sponse, we temporarily increased the load to 480 pF, which is as high as will ever be encountered in practice. This increased the drop rate in the output curve at frequencies beyond 10,000 Hz, amounting at 20,000 Hz to an additional 5 dB. The Model 681EEE obviously does not require excessive circuit capacitance to equalize its frequency response as do some other cartridges. It should deliver optimum performance with almost any load.

The cartridge's output was almost perfectly matched between the channels at a 3.2-mV level at a velocity of 3.54 cm/s. We measured the IM distortion with the Shure TTR-102 record and discovered that it was low (about 1%) at the usual velocities. It did not begin to increase appreciably until the recorded velocity reached 18 cm/s, at which point it measured only 3.2%. At the maximum test velocity of 27.1 cm/s, the IM was 10%.

We checked the high-frequency tracking ability of the stylus with the shaped tone bursts of the Shure TTR-103 test record. The resulting intermodulation, which cannot be numerically compared to ordinary IM figures, was also very low. It just exceeded 1% at the maximum 30-cm/s velocity. For midrange tracking, we tested the cartridge with a German record favored by some European manufacturers. It has a 300-Hz signal recorded at different amplitudes. Distortion became audible at the "70- $\mu$ " level, corresponding to about 15 cm/s.

**User Comment.** A cartridge's basic sound character can often be inferred from its distortion and frequency-response measurements, more successfully than is possible with many other audio components. Therefore, we were not surprised to find that the Stanton cartridge was able to track

very-high-level musical recordings with ease, complementing the smoothest—if not the flattest—frequency response we have ever encountered in a phono cartridge.

These characteristics translate into a totally smooth, uncolored sound quality. When we used the cartridge to play the best records we had through the best speaker systems at our disposal, the results were spectacular. Even if the cartridge cannot receive the full credit for the total sound, it also cannot be charged with altering what was stored in the record.

The ability of the cartridge to track very-high-velocity music recordings without distortion was demonstrated by the manner in which it played the Shure "Audio Obstacle Course—Era III" disc. With the exception of the two highest levels of the sibilance test, which we have yet to hear played without a trace of "sandpaper" quality by any cartridge, the Model 681EEE revealed no signs of strain and was obviously not being pushed to its limits by this demanding record.

There are, quite literally, only a handful of cartridges that lead the field in every aspect of performance and that can fairly be said to surpass all lesser types, if not each other. The Stanton Model 681EEE cartridge is one of these.

CIRCLE NO. 67 ON READER SERVICE CARD

## HY-GAIN MODEL 623A AM/SSB BASE STATION CB TRANSCEIVER

*Digital frequency synthesizer eliminates multi-crystal need.*



**H**Y-GAIN'S Model 623A base station Citizens Band transceiver is designed for both AM and SSB operation. In some respects, it differs from other AM/SSB rigs. For example, the circuitry is all solid-state in design, except for the transmitter's power amplifier stage, which is a vacuum tube. This design departure greatly reduces the chance of damage to the power amplifier due to mismatched loads.

Another significant departure is that all 23 channel frequencies are derived from a phase-locked digital frequency synthesizer, rather than by the usual synthesis from a multi-crystal scheme. Adding to this list are a microphone gain control located on the rig's front panel, and an SWR indicator that is the directional wattmeter type and can be switched to indicate actual output power at all levels into a 50-ohm load.

Among the usual transceiver features you will find on and in the Model 623A are: r-f gain control; adjustable squelch; AM/USB/LSB Operating modes, switchable noise blanker; full-time AM ant; fine tuning (AM/SSB); alc for SSB transmit; and a meter that indicates S units on receive and SWR and output power on transmit. A built-in power supply permits the rig to be operated on 117-volt ac line power or from 12- to 14-volt dc sources.

The retail price of the Hy-Gain Model 623A CB transceiver is \$595.

**Receiver Details.** The receiver employs single conversion to a 7.825-MHz i-f. There are two r-f stages instead of the usual single stage. The r-f stages use dual-gate MOSFET's that are stagger tuned to provide a uniform bandpass for all channels and minimize unwanted signals while ensuring good sensitivity. We measured the sensitivity at 0.5  $\mu$ V for 10 dB (S+N)/N on AM with 30% modulation at 1000 Hz and 0.16  $\mu$ V with 10 dB (S+N)/N on SSB. A four-diode balanced mixer gives good signal-handling capabilities and minimized spurious responses. With respect to the latter, we measured a -60-dB figure. Image rejection was 80 dB, and i-f signal rejection was 78 dB.

Selectivity for both the AM and SSB modes of operation is obtained with a

six-pole crystal-lattice filter. The filter has a 3.5-kHz bandpass at the 6-dB points. The overall a-f response at the 6-dB points on SSB was 300 to 3750 Hz, while on AM it was 100 to 1750 Hz. (On AM, the signal frequency is centered in the filter's passband.) Unwanted SSB sideband suppression was 45 dB at 1000 Hz, while adjacent-channel rejection on AM was 60 dB.

Three cascaded dual-gate MOSFET stages make up the i-f section, which feeds the AM and SSB detectors and an amplified agc setup. The latter held the a-f output to within 7.5 dB on AM and 6 dB on SSB with an 80-dB (1 to 10,000  $\mu$ V) r-f input variation. The S meter registered S9 with a 30- $\mu$ V signal. The squelch threshold was adjustable for signals in the range of 0.8 to 10,000  $\mu$ V.

The a-f section has a complementary-pair transistor output stage that directly feeds a 3.2-ohm speaker built into the transceiver. We measured 5 watts of audio output power at 1000 Hz and 5.5% distortion.

The noise blanker operates through a balanced series gate. It attenuated noise peaks of 30 dB above a 0.3- $\mu$ V signal level to a tolerable level in the presence of this signal. The AM anl is an a-f series-gate setup.

**Frequency Synthesis.** The heterodyning signal needed for deriving the receiver's i-f is obtained from a self-excited voltage-controlled oscillator (vco). The vco produces frequencies between 19.150 and 19.430 MHz as needed for a 7.825-MHz i-f on a particular channel.

An 18.810-MHz signal from a crystal oscillator and the vco signal are applied to a mixer to generate a difference signal that ranges from 330 to 620 kHz, depending on the channel in use. The difference signal goes to a programmable divider, where it undergoes division by a factor of 33 to 62 (depending on the setting of the channel selector) to produce a 10-kHz signal. The resultant signal, in turn, is

compared by a phase detector against a 10-kHz reference signal derived from a separate crystal-oscillator-controlled circuit.

Any difference between the 10-kHz signals produces a voltage that is used to correct the frequency of the vco, locking both signals in phase with each other.

For SSB, the 18.810-MHz signal is shifted in either direction by 2050 Hz to shift the vco so that the i-f falls at the side of the filter required for accepting the desired sideband. Compensation is similarly made at a 7.825-MHz bfo for the overall frequency to remain on-channel.

**Transmitter Details.** On AM transmit, the 7.825-MHz bfo signal is routed to the receiver's mixer, which is used on both transmit and receive. Here, the on-channel carrier is produced in conjunction with the vco signal (19.140 to 19.430 MHz) using the sum frequency. This signal goes to two r-f stages that drive the power amplifier tube. The output of the latter employs a pi network that matches to a nominal 50-ohm load into which we measured a 3.5-watt carrier power level.

The output stage of the receiver's a-f system is transferred during transmit from the speaker to a transformer that provides the proper impedance match for plate-modulating the power amplifier stage. At 100% modulation, the distortion with a 1000-Hz test signal measured 5.5%. Adjacent-channel splatter, using a standard 2500-Hz test tone, was 50 dB down. With 6 dB of clipping, the distortion measured 17% and splatter was 40 dB down.

On SSB, the bfo and vco frequencies are shifted as noted above. SSB signal generation is accomplished with a balanced modulator and crystal filter. Once it is generated, the SSB signal goes to the mixer/transmitter system, which is set up for linear operation.

The PEP output was 8 watts with third-order distortion products 20 dB

below a 2-tone test (26 dB below single-tone output). Unwanted sideband suppression was as on receive and carrier suppression was 45 dB on USB and 35 dB on LSB. The overall response was 300 to 3750 Hz at 6 dB.

**User Comment.** Large, well-spaced control knobs and a king-size meter movement make the Hy-Gain Model 623A CB transceiver a breeze to use and operate. A two-speed tuning system, including a vernier-type FINE TUNE control that provides a  $\pm$ 950-Hz deviation from center frequency on transmit and receive, makes tuning SSB signals a snap. Also, the agc attack and slow-release times make copying SSB transmissions smooth and free of pops.

The peak-indicating output indicator (meter) provides a guide for the proper setting of the MIC GAIN control. We discovered with our test unit that during modulation the cleanest SSB signal resulted when the meter's pointer registered 2 to 3 watts (actual peak power was 8 watts), while on AM, a rise of 1 to 1.5 watts above the carrier level was about right for clean 100% modulation.

A microphone is not supplied with the transceiver, nor are there any provisions for public-address (PA) operation. A high-impedance, push-to-talk microphone equipped with a standard three-way phone plug is required. This, plus the fact that the transceiver measures 11  $\frac{7}{8}$  in. by 11  $\frac{1}{2}$  in. by 6  $\frac{1}{4}$  in. (30  $\times$  29  $\times$  16 cm), makes it basically a base station. But this does not preclude its use in mobile service, in which case, you might have to use an external speaker instead of the top-facing one built into the rig. Terminals are provided on the rear apron for hookup of the outboard speaker.

An excellent service manual for the transceiver is available as an extra-cost item from the manufacturer. It is well worth the extra money to get this manual when you buy the transceiver.

CIRCLE NO. 68 ON READER SERVICE CARD

## EL INSTRUMENTS MODEL PG-2 PULSE GENERATOR KIT

*Versatile test instrument at low cost.*

**U**NTIL fairly recently, the pulse generator was a little-used device, relegated to test equipment limbo. Most of the time, we were hard put to find a use for this strange instrument. Then, along came a tremendous swing to digital circuits and

products. Now a source of variable-frequency/variable-width pulses—a good definition of the pulse generator—has become a must-have test instrument.

When we first found ourselves in a situation that required the use of a

pulse generator, we looked for an instrument that would perform reliably without denting our budget too much. We found what we were looking for in the EL Instruments Model PG-2 basic pulse generator kit that retails for \$49.95.



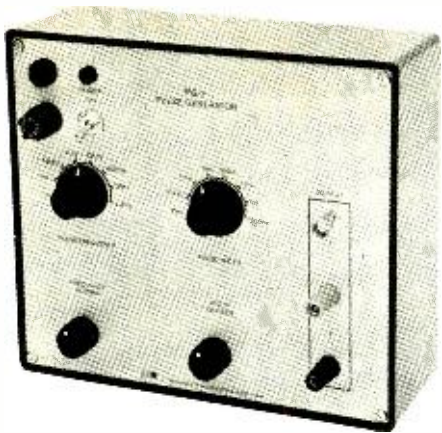

**Some Details.** Assembling the kit took us only an evening of unhurried work. No special tools were required, and we encountered no difficulties in putting the kit together. Everything mounts on the front panel, and even the line cord exits through a hole in the panel, held in place by a plastic strain relief. When we plugged the line cord into an ac outlet and turned on the power, the instrument worked properly the first time out.

The pulse generator contains two sets of controls, one for setting the output frequency and the other for setting the pulse width. The PULSE FREQUENCY switch is the coarse frequency control. It has seven positions in decade steps (except the last, or highest-frequency, position, which goes up a half decade from the previous position) for a 1-Hz to 5-MHz overall range. The FREQUENCY VERNIER provides a fine-tuning control for selecting discrete frequencies within the range selected.

The second set of controls works in a manner similar to those for the pulse frequency section. The PULSE WIDTH switch is a coarse control, with seven positions, six of which are labelled in decade steps from 1 s to 1  $\mu$ s and the seventh is labelled 200 ns. The WIDTH VERNIER selects the desired discrete

pulse width within the range selected.

Both the frequency and pulse-width switches, operating in conjunction with their respective vernier controls, have ranges that overlap each other for maximum flexibility. The output frequencies and pulse widths are more than adequate for almost any digital application you are likely to encounter.

The instrument has two output connectors. OUTPUT 1 is a BNC connector, while OUTPUT 2 is taken from across a pair of five-way binding posts. The two are in parallel with each other.

The rise time of the output signal is 15 ns, while the fall time is 10 ns, both with one TTL load connected to the instrument. A maximum of 10 TTL gates can be accommodated.

Aside from the frequency and pulse-width controls and the output connectors, the front panel has the power switch and lensed POWER ON lamp and the line fuse in bayonet-type holder.

**User Comment.** Since installing the pulse generator in our workbench, it has seen lots of service. Besides testing the many digital construction projects that come into the lab, the instrument has been used as a very-low-frequency clock generator for demonstrating calculator operation at a local school.

We have also used it as a horizontal sync simulator when troubleshooting a TV receiver and have used it as a trigger source for a dual-trace oscilloscope experiment. With the output frequency accurately set by a digital counter, we used the pulses as timing marks when injected into the Z (brightness) axis of a low-cost oscilloscope.

In all, the pulse generator has proven itself to be a very useful—and surprisingly versatile—instrument.

CIRCLE NO. 69 ON READER SERVICE CARD

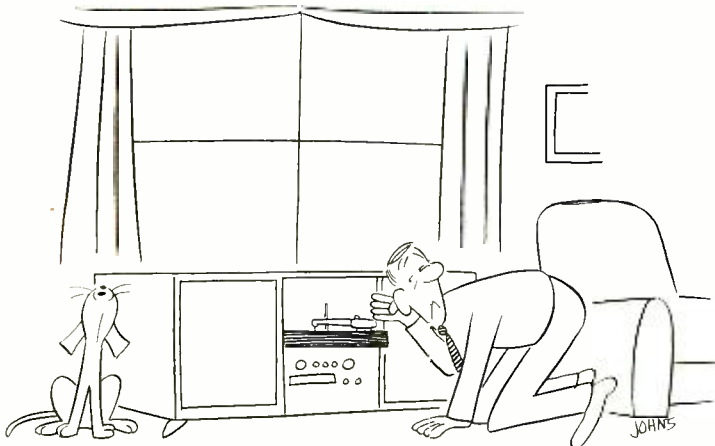

APRIL 1975

# free

The "NEW LOOK"

## 1975 LAFAYETTE Radio Electronics CATALOG

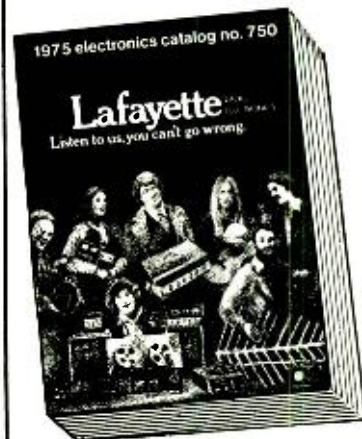

The ONLY Nationally Distributed Full-line Catalog with a Major Showing of the Newest NAME-BRAND electronics products for 1975.

FREE  
SEND TODAY

SAVE on exclusive Lafayette Products plus MAJOR BRANDS

- Stereo and 4-Channel Systems • Tape Equipment • Car Stereo • CB and Ham Gear • Police/Public Service Receivers
- Antennas • Cameras • TV • PA and Test Equipment • Musical Instruments and Amplifiers • Books • Electronic Calculators • Security Systems • PLUS PARTS, TUBES, BATTERIES, HARDWARE. MORE!

## Lafayette

Listen to us, you can't go wrong.

Dept. 35045

Lafayette Radio Electronics  
111 Jericho Tpke., Syosset, L.I., N.Y. 11791

Send me your FREE 1975 Catalog

Name ..... Apt. ....  
Street .....  
City ..... State .....  
Zip .....

Send a 1975 Catalog to my friend

Name ..... Apt. ....  
Street .....  
City ..... State .....  
Zip .....

CIRCLE NO. 24 ON READER SERVICE CARD



IF YOU ARE READY FOR SERIOUS CAREER

# Learn College-Level





ADVANCEMENT NOW—

# Electronics at Home

## With CREI's unique Electronic Design Laboratory Program

There is only one way to a career in advanced electronics—through advanced training. You can get such training through a resident engineering college or you can take a CREI specialized college level electronics program at home.

**Wide Choice of Programs.** CREI offers you program arrangements with *fourteen* areas of specialization in advanced electronics. You can select exactly the area of specialization for the career you want.

CREI also offers program arrangements *both* for those with extensive experience in electronics *and* for those with only limited experience. All programs are college-level, except for a brief introductory level course, which is optional.

**Unique Laboratory Program.** CREI now offers a unique *Electronic Design Laboratory Program* to train you in the actual design of electronic circuits. You also get extensive experience in tests and measurements, breadboarding, prototype building and in other areas important to your career. The Lab Program makes it easier for you to understand the principles of advanced electronics. Only CREI offers this complete college type laboratory program.

The Lab Program includes professional equipment which becomes yours to keep. You will especially appreciate the Electronic Circuit Designer, which is available only through this program and which you will find extremely valuable throughout your professional career.

**College Credit.** You can actually earn college credit through CREI programs, which you can use at recognized colleges for an engineering degree. CREI maintains specific credit transfer arrangements with selected colleges in the U. S.

**Industry Recognized Training.** For nearly 50 years CREI programs have been recognized throughout the field of electronics. CREI students and graduates hold responsible positions in every area of electronics and are employed by more than 1,700 leading organizations in industry and government.

**Qualifications to Enroll.** To qualify for enrollment, you should be employed in electronics or have previous experience or practical training in the use of electronic equipment. You must also be a high school graduate or true equivalent.

**All CREI Programs are available under the G.I. Bill**

**Send for FREE Book.** If you are qualified, send for CREI's full color catalog describing these college-level programs and your career opportunities in advanced electronics. Mail card or write for your copy of this book.



**CREI** CAPITOL  
RADIO  
ENGINEERING  
INSTITUTE

McGraw-Hill Continuing Education Center  
3939 Wisconsin Avenue Northwest  
Washington, D. C. 20016



Accredited Member, National Home Study Council

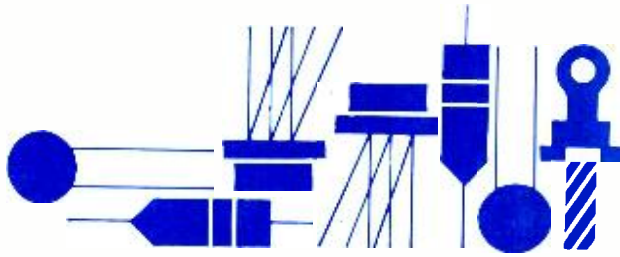

# Solid State

By Lou Garner

## THE PHOTO DETECTOR/POWER AMPLIFIER IC

**A**LTHOUGH hundreds of new IC's are introduced each year by semiconductor manufacturers, only a score or two ever "make it" as far as hobbyists and experimenters are concerned. A few—the ubiquitous 555 timer and the familiar 741 op amp are prime examples—become tremendously popular. Others achieve modest popularity and are used by most, if not all, hobbyists. A smaller number are used by a few experimenters here and there in special projects. But the overwhelming majority of new IC's seldom reach the home experimenter's workbench.

Often, the reasons for the lack of hobbyist interest in a new IC are obvious from its very nature. The device may be too expensive. It may be difficult to use, requiring extensive design calculations. It may have limited distribution, being offered only to the military and industrial markets. Its characteristics may be too specialized, limiting its area of application. Or it may require expensive external components.

On the other hand, there are a number of extremely versatile, modestly priced, and readily available devices which have remained in limbo from the average experimenter's viewpoint. After chatting with a number of hobbyist friends and corresponding with others, I've concluded that there are two major reasons why hobbyists ignore what, otherwise, seem to be extremely promising devices: (1) A general lack of knowledge about the device, despite the fact that it may have been described briefly in most popular publications; and (2) a lack of sufficient application data—i.e., practical circuits—to spark the potential user's imagination and start his/her creative juices flowing.

Consider, for instance, RCA's extremely versatile CA3062 Photo Detector and Power Amplifier. Introduced several years ago, the CA3062 is suitable for a wide variety of applications. It can be used in position sensors, intru-

sion alarms, level controls, counters, isolators, safety controls, light switches, edge monitors, and inspection equipment. The device is a monolithic IC comprising two independent sections on a single silicon chip—a photo-sensitive array and a differential power amplifier. Offered in a modified 12-lead TO-5 style package, the CA3062 is an extremely interesting device to study, even if never wired into a working circuit. The case top consists of a transparent lens, permitting ready observation of the entire chip and its connecting leads. By using a stylus microscope or powerful hand magnifier, one can examine the chip geometry in detail and gain a clear view of the working heart of an integrated circuit. Currently, the CA3062 nets for \$4.86 each in small quantities and is (or should be) available from all RCA franchised semiconductor distributors.

As illustrated schematically in Fig. 1, the CA3062's light-sensitive section consists of a photo-Darlington pair, Q1-Q9 and Q10-Q11, while the second section includes a differential amplifier, Q2-Q3-Q8, coupled through Q4 and Q5 to a pair of uncommitted-collector-and-emitter output transistors, Q6 and Q7. Each output transistor can handle currents of up to 100 mA, enough to provide direct drive to a relay or thyristor.

In practice, the photo-Darlington pair may be, at the user's option, either emitter or collector coupled to the differential amplifier, Q2-Q3 and its constant current sink, Q8. With emitter coupling, pin 11 is connected to pin 1 and pin 10 to a suitable voltage source. With collector coupling, pin 11 connects to circuit ground and pin 1 to pin 10 and thence to a voltage source through an appropriate load resistor. In most applications, the photo-Darlington's base terminals, pins 9 and 12, are tied together.

If the device is to be used primarily in switching applications, it can be wired for Schmitt trigger operation by

Fig. 1. The CA3062 photo detector and power amplifier consists of a photo-Darlington pair and a differential amplifier coupled to uncommitted output transistors.

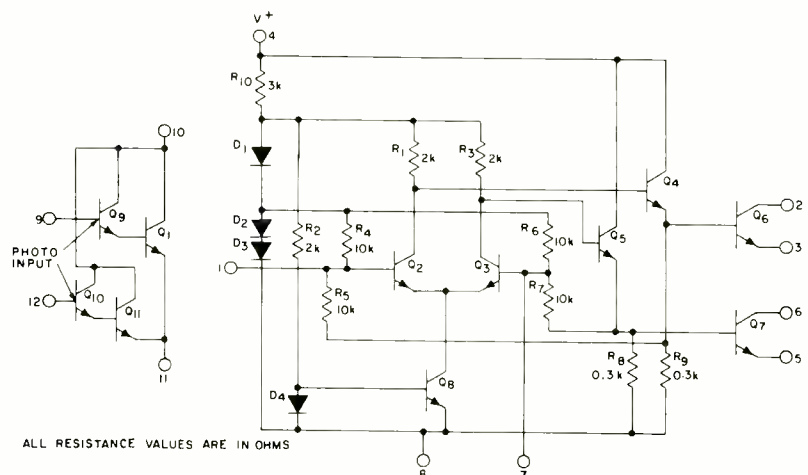
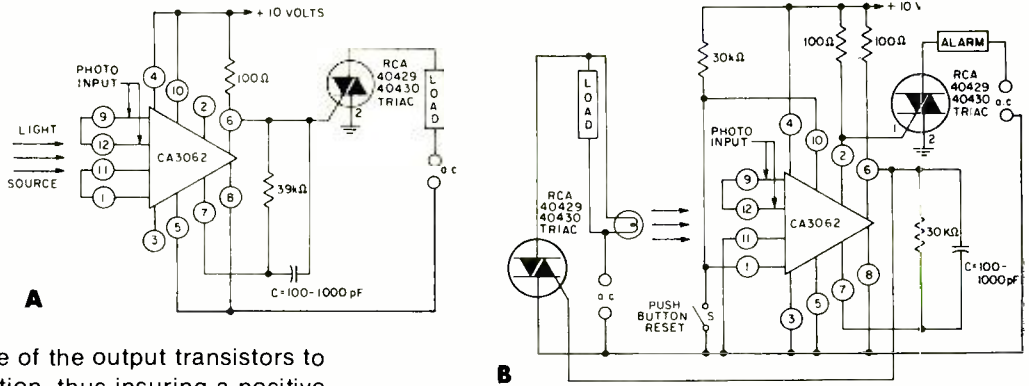



Fig. 2. Typical applications for the CA3062. (A) is a light-activated triac control; while (B) is triac control with automatic shutoff.



providing feedback from one of the output transistors to the differential amplifier section, thus insuring a positive and rapid transition from on to off conditions. When used as a switch, output transistor Q7 conducts as long as light falls on the photoarray, while Q6 remains in an off (non-conducting) state. When the light source fails or is interrupted, Q7 switches off and Q6 starts conducting. If desired, either, or both, of the output transistors may be used to achieve the required mode of operation.

RCA suggests that certain precautions be observed when using the CA3062 in practical circuits. First, because of the amplifier's high gain, all component and wiring lead lengths should be kept as short and direct as practicable. Second, applied light levels should be limited to below 60 lumens/ft<sup>2</sup> to avoid switching both output transistors on at the same time. Third, if an inductive output load is used, such as a relay or solenoid, a reverse-connected damping diode should be shunted across the coil to absorb transient voltage peaks during switching. Finally, all operating voltages and currents must be kept within maximum specified limits. The basic device is designed for operation on dc supplies of from 5 to 15 volts (between terminals 4 and 8) while the output transistors, Q6 and Q7, can handle up to 30 volts; however, the output current must be kept to within 100 mA. The signal voltages applied to the differential amplifier section (pins 1 and 7) must not exceed 3 volts.

Typical application circuits for the CA3062 are illustrated in Figs. 2 and 3. These were abstracted from both the specifications bulletin on the device and RCA's Application Note ICAN-6538, *Applications of the RCA-CA3062 IC Photo-Detector and Power Amplifier in Switching Circuits*, by J. D. Mazgy. All of the circuits feature standard, readily available components. All may be operated on batteries (except for the external load devices) or low-voltage, line-operated power supplies. The resistors are 1/4- or 1/2-watt types. The capacitors are either ceramic or electrolytics, as appropriate to their value, with working voltages suitable to the source voltages used for circuit operation.

The simple light-activated triac control circuit shown in Fig. 2A may be used in a number of remote control applications. It could be used, for example, to actuate an advertising display, to operate a garage door opener, or to provide remote switching of an electrical appliance. Here, feedback is provided between output transistor Q7 (pin 6) and one of the differential amplifier's inputs (pin 7) to achieve Schmitt trigger operation. The device's output transistor supplies a gate drive signal to a standard triac, controlling current through an external load powered by an ac line. The load's size is limited only by the triac's power-handling capability.

In operation, power is supplied to the load as long as light falls on the CA3062's photosensitive surface (through its transparent case top). If the light is removed, load current is switched off.

A modified circuit suitable for use as a safety control on industrial equipment is given in Fig. 2B. Here, an interruption in the light beam automatically shuts off power to an external load (such as a drill press), darkens the control light, and simultaneously sounds an external alarm. Operation can be restored and the alarm silenced only by removing the obstruction to the light beam and closing the momentary contact pushbutton reset switch.

As in the previous circuit, the IC is wired as a Schmitt trigger and the external ac load controlled by a triac which, in turn, receives its gate signal from the IC's output transistor, Q7. A conventional 117-volt ac incandescent lamp connected in parallel with the external load serves as a light source. The alarm feature is achieved by using the IC's normally off output transistor, Q6, to supply a gate drive signal to a second triac which, in turn, controls an external alarm signal. When Q7 switches off, cutting off load and lamp power, Q6 switches on, sounding the alarm.

Since the CA3062's output transistors can handle up to 100 mA, Q6's 100-ohm load resistor could be replaced by a Mallory SC628 *Sonalert*, with the second alarm triac and its external alarm device eliminated.

If the external Triac is used just to control a lamp, then a circuit modified as described above can serve as a reliable

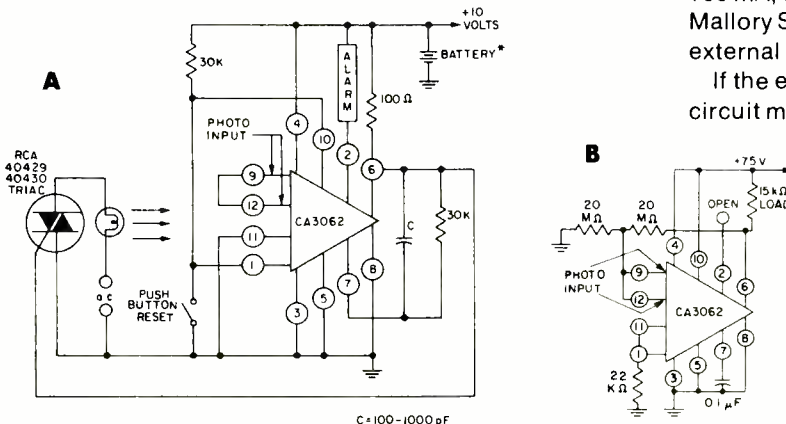

Fig. 3. Circuit shown at (A) is a modification of Fig. 2B to provide an intrusion alarm. A linear photoelectric amplifier can be built as shown at (B).

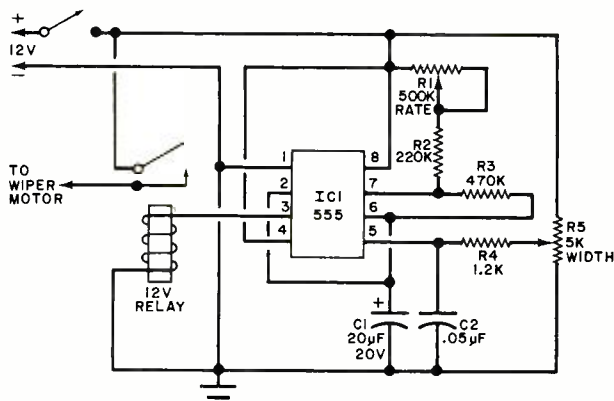

Fig. 4. Slow-sweep wiper control.

intrusion alarm. Such a modification is illustrated in Fig. 3A. Here, it is recommended that the circuit's power supply consist of a rechargeable battery *and* a line-operated trickle charger to insure continuous operation. As before, once the circuit has been "tripped" by an interruption of the light beam, it is necessary to actuate the reset switch to restore operation. In most installations, a key-operated lock switch would be used in place of the pushbutton switch so that an intruder could not reset the system, silencing the alarm.

Although the CA3062 is intended primarily for use as a control switch and is not ordinarily for linear operation, it can be used in such applications, as shown in Fig. 3B. When using the device as a linear photoelectric amplifier, the output load resistor should have a value greater than 1000 ohms to limit the unit's power dissipation and minimize thermal effects. Some experimentation with component values and initial light levels may be needed to achieve optimum performance.

**Readers Circuits.** Considering the time of year, it may not be surprising if raindrops keep falling on your head. While, according to tradition, April showers bring May flowers, there are days when there's just enough moisture in the air to smear a car's windshield, but not enough to lubricate the windshield wiper blades for continuous operation. When light rain and the foggy, foggy dew become a problem, an intermittently operating windshield wiper can offer real advantages. Of course, the basic concept is not new. Several intermittent windshield wiper control circuits have been published in the past and commercial

units are available from most auto accessory stores as well as new car dealers. But you can build your own unit at considerably less cost than commercial models using the simple circuit illustrated in Fig. 4. Featuring a standard 555 timer, the design was submitted by reader Craig S. Kellem (48 Briarwood Road, Wayne, NJ 07470).

Requiring relatively few components, Craig's circuit can be assembled in a single evening, even allowing time for a coffee break.

In operation, the relay is actuated at periodic intervals by the timer circuit, closing the wiper motor contacts. Potentiometer *R1* serves as the *pulse rate* control and potentiometer *R5* as the *pulse width* control. These two controls should be adjusted for optimum performance after the unit is installed in a car.

If impending storms are of more concern than gentle rain, you might want to try the storm forecaster circuit illustrated in Fig. 5. Unlike other "stormcaster" circuits we've featured in the past, all of which used type 555 IC's, this circuit employs discrete devices and, according to the contributor, Robert L. Phillips, FTM1 (FM Division, U.S.S. Oklahoma City, CLG-5, FPO San Francisco, CA 96601), offers distinct advantages over earlier versions. Bob's design does not require an unusually large input capacitor and does not lock-in on incoming signals, requiring manual reset. It does, however, feature both a visual and audible alarm.

In operation, noise signals obtained from a standard AM radio receiver are coupled through rectifier diode *D1* and used to charge input capacitor *C1* which, in turn, supplies a control bias to Darlington amplifier *Q1-Q2*. The Darlington stage is direct-coupled through current-limiting resistor *R3* to a two-stage complementary amplifier, *Q3-Q4*, with *Q4* serving to operate the visual alarm signal, incandescent lamp *I1*. At the same time, *Q4* supplies a control bias to a collector coupled multivibrator, *Q5-Q6*, which develops an audible alarm signal, reproduced by the PM loudspeaker serving as *Q5*'s emitter load. Circuit power is supplied by a six-volt battery, *B1*, controlled by spst power switch *S1*.

Bob indicates that the circuit will work well with almost any general-purpose, small-signal transistors, including those offered in bargain "surplus" assortments, provided the devices are not leaky. Input capacitor *C1* is a 1-µF high-quality electrolytic or metallized paper type, while *C2* and *C3* may be either paper or ceramic units. Indicator alarm lamp *I1* can be replaced by a LED with a suitable series resistor.

Fig. 5. Circuit to forecast storms uses discrete devices.

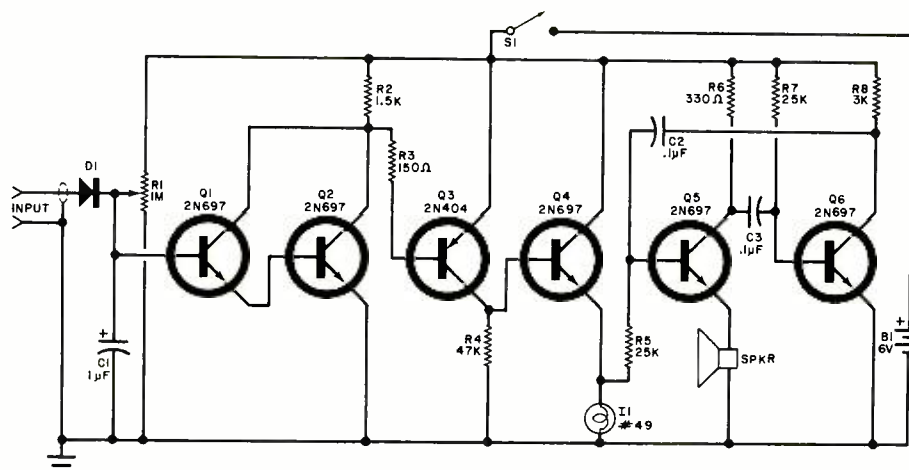



Neither layout nor lead dress should be overly critical although, because of the multiple stages involved, good wiring practices should be followed when duplicating the design. Signal-carrying leads should be kept short and direct and care should be taken not to overheat the semiconductor devices when soldering them in place. A pc board might be advisable.

Bob suggests the following adjustment procedure for his version of the "stormcaster": (1) Connect the input to the output (earphone) jack of a standard AM radio receiver tuned to a station-free area near the low end of the broadcast band. (2) With the receiver off and S1 closed, adjust R1 until I1 lights and a sound is heard from the loudspeaker. Back off R1's adjustment until the lamp goes dark and the sound stops. (3) With the receiver on, adjust the set's volume control for the desired level of sensitivity, readjusting R1 if necessary for optimum performance.

**Device/Product News.** Motorola Semiconductor Products, Inc. (P.O. Box 20924, Phoenix, AZ 85036) has introduced a number of new devices over the past few weeks, two of which should be of particular interest to experimenters and hobbyists: a new low-cost programmable operational amplifier and an inexpensive gas-discharge display driver.

Available in both round metal cases and plastic 8-lead DIP's, Motorola's operational amplifier is designed to permit the user to optimize (program) such dc characteristics as input current, power consumption and bias current, as well as ac characteristics such as open-loop voltage gain, slew rate and gain-bandwidth product, simply by choosing a suitable external resistor value or external current source. Designated type MC3476, the op amp can be used on supply voltages of  $\pm 6$  to  $\pm 15$  volts, and requires only 4.8-mW in typical applications. It features low input offset and bias currents and a high input resistance of 5 megohms, typical. Requiring no frequency compensation, the device has internal short-circuit protection. Programming is accomplished by varying the current supplied to a special terminal.

Intended for use with high-voltage gas-discharge displays of the types offered by Beckman and Burroughs, Motorola's new IC driver features eight separate channels, one for each of the seven display segments and another for the decimal point, and is directly compatible with the MOS outputs of electronic calculators due to its low 300- $\mu$ A input current requirement. Identified as type MC3491, it offers a minimum breakdown voltage of 80 V and is priced at only \$3.50 each in unit quantities.

RCA's Electronic Components group (415 South Fifth Street, Harrison, NJ 07029) has introduced a new series of eight GaAs laser arrays and a new IR emitting diode. Both the arrays and the diode are suitable for a variety of applications in industrial, military and commercial equipment, including intrusion alarms. The eight laser arrays, offered in RCA's OP-4A case, have minimum power outputs ranging from 25 to 300 watts at a drive current of 25 amperes at room temperature, but the devices, designated types C30002 through C30009, also may be operated at cryogenic temperatures ( $-196^{\circ}\text{C}$ ) if desired. The new IR LED, identified as type SG1009A, has a typical power output at 940 nanometers of 7.5 mW with a dc drive current of 100 mA. Priced at only \$3.50 each in small quantities, the SG1009A is supplied in a hermetically sealed two-lead type TO-18 case, with a glass lens top cover.  $\diamond$

**NOW AVAILABLE**

**A FLICK OF THE SWITCH**  
—your 1930-1950 book



Here's your time trip through the golden days of radio and into the dawn of television. Revisit old "cathedral" radios, Ham days and many more. Discover the fun of collecting. Over 1,000 pictures in 260 fascinating pages. Order now! \$9.95 Hard-cover, \$6.95 handbook.

Also order VINTAGE RADIO, 1887-1929, \$7.95 Hard-cover, \$5.95 handbook; RADIO COLLECTOR'S GUIDE, 1921-32, \$4.95; S. GERNSBACK'S 1927 RADIO ENCYCLOPEDIA \$12.95 Hard-cover, \$9.95 handbook; MOST OFTEN - NEEDED RADIO DIAGRAMS, \$7.00.

**ORDER NOW! —FREE AGE GUIDE!**

SEND CHECK TODAY to Vintage Radio, Dep't P, Box 2045, Palos Verdes Peninsula, CA., 90274  
Postage Paid. Ten Day Guarantee, Calif. add 6%.

_____	\$ _____
_____	\$ _____
_____	\$ _____
_____	\$ _____
_____	\$ _____
TOTAL	\$ _____

NAME \_\_\_\_\_  
STREET \_\_\_\_\_  
CITY \_\_\_\_\_ ST. \_\_\_\_\_ ZIP \_\_\_\_\_

**COLLECTORS!**

**FREE**

**1975**  
CATALOG  
OF  
CIRCUIT  
DESIGN  
AND  
BREADBOARDING  
EQUIPMENT

Send for your free copy of Circuit Design's new 1975 catalog. In it, you'll find lots of new ideas in solderless breadboarding aids and instrumentation (in kit form or assembled), as well as a host of hard to find components. If you are involved in any aspect of electronics, you can't do without it.

For your free copy, write to:

**CIRCUIT DESIGN, INC.**  
Div. of E&L Instruments  
P.O. Box 24 · Shelton, Connecticut 06484

CIRCLE NO. 8 ON READER SERVICE CARD



# CB Scene

By Len Buckwalter, K10DH

## HOW TO MOUNT MOBILE ANTENNAS

**A**N OFFICIAL of a CB antenna company told me recently that someone ought to write about the mobile antenna mount. That sounded about as exciting as watching your fingernails grow, but the man constructed his case. When a CB'er goes to a dealer, he argued, the man is rarely forewarned about all the antenna supports now on the market. Only after the CB'er has cut into his car, maybe drilled through the gas tank, does he wonder if there's a better way to do it. There probably is, considering there are now a dozen ways to loft a mobile antenna.

Before designers came out with today's array of clever fittings, choosing an antenna mount was mostly a matter of whether you wanted to drill a hole or not. Most people worry about decreasing their auto's resale value. One homebrew genius cooked up a scheme that would fool even a used-car dealer. He removed a taillight, then installed an antenna mount in the opening. When time came to sell the car—heh-heh—he screwed the tail light back on.

The fear of cutting a hole in the car is exaggerated; any careful worker can do the job. Just avoid the following pitfalls. The first happened to me when I climbed to the top of a shiny new Ford some years ago to mount a center-roof antenna. By concentrating too much weight on one foot, the roof sank into an ominous hollow the size of a soup bowl. Luckily, it rebounded like the bottom of an oil can. I quickly learned that an installer must

spread-eagle himself across the roof to avoid making a depression.

Another mishap occurred to a friend of mine when he was attempting to drill into the car's curving contour. He didn't hammer a starting dimple in the metal and the drill bit skittered off the mark and etched its way across the rooftop. The pattern in the paint resembled something I'd once seen on the side of a tepee.

But drilling the hole is often the easiest part of the job if you watch out for those hazards. One other precaution: place a block of wood next to the drill mark to act as a stop when the bit bursts through the metal. Otherwise, the bit continues to spin into an upholstered ceiling or, if you're making a trunk-deck installation, into your spare tire.

Now to deal with that question of a car's resale value. Time was when a body-and-fender shop would seal it up for five bucks. Today it probably costs as much as brain surgery! That antenna manufacturer mentioned earlier, though, said most dealers must do some work on a trade-in anyway, so you can argue against a deduction for a piddling hole. Another cure is to insert a rubber plug, especially sold for the purpose, into the hole to make a neat restoration. You might also leave the antenna mount in place and hope that it *increases* the car's value. If CB is Everyman's medium, the next owner may be grateful for your consideration. Just be sure he doesn't suspect the car was once a taxi or police car.

Before buying any mount or drilling holes, consider these questions. Will the antenna be located on a slanting surface? Must it be detachable or have a fold-down feature because of a low garage entrance? Will the antenna occasionally be transferred between vehicles? To see how these and other details affect the choice, let's consider each major mounting approach for what it has to offer:

**Bumper.** The attraction of a bumper mount is that you can go all

the way. It carries the 102-inch whip, biggest CB mobile antenna. A long whip produces a hearty signal for miles around, despite a bit of directionality because part of the whip is low. Installing a bumper mount is simple: clamp-on brackets fit almost any vehicle and permit the whip to be adjusted in a vertical position.

**Ball.** If your antenna will rest on a slanting surface (a curved fender, for example), you'll need a mount that can offset it. A ball is split and tilted to permit you to align the whip in the vertical plane. Although a ball can mount on a front cowl, it is usually placed on the rear deck. Excellent strength and durability make the ball mount the favorite type for commercial and public-safety radio services.



*New-Tronics standard ball mount (left). Antenna Specialists bumper mount (right).*

They almost always add an impact spring to absorb shock when the antenna strikes an obstruction. The various components—ball, spring and whip—generally terminate in a standard  $\frac{3}{8}$ "-24 thread. You can buy these items separately if you choose, or as a complete antenna system.

A ball mount requires a hole cut in the car body. But it's not difficult to make one at the rear deck because there's access to the underside of the hole through an open trunk.

**Cowl.** This mounting is much the same as the one supplied by auto makers for the standard car radio. Because it has a swivel arrangement similar to the ball mentioned before, but is not as rugged, the cowl mount may be considered a light-duty equivalent. It mounts at the front or rear deck, requiring a hole diameter that runs between 15/16-inch to 1 1/8-inch.



*New-Tronics TLM trunk lip mount.*



An advantage is that you can install a cowl mount in a "blind" hole; you don't have to get your fingers or a wrench inside the hole to tighten the nut. This is often a requirement when installing a cowl-mount on a front fender. You must also snake the coaxial cable inside the fender channel toward the CB set.

**Roof.** Placed near the center of the car roof, a roof mount also needs no wrench inside the hole for tightening. It has set screws which are accessible from the outside. The advantage of a roof mount is a lofty position on the car, which yields excellent range and uniform signal pattern. The most difficult part of a roof-mounting job is snaking the coaxial cable through the headliner to the window post. It calls for patience and a reasonably clear path between the headliner and metal roof.

The mounts mentioned so far are for permanent mounting. They offer the most flexibility in locating the antenna and add the advantage of placing the cable completely inside the car body. Now let's look at the newer series of mounts which solve special problems or ease the job of installation:

**Trunk Groove.** This mount requires two tiny drill holes, usually 7/32-inch diameter, in the trunk crack. But there's virtually no evidence left when the antenna is removed. The antenna can be placed at the sides or rear of the trunk, good locations for signal propagation.

**Body Mount.** Some manufacturers use "body" for what others call a "trunk" mount. It has the same mechanical arrangement—a versatile bracket held by two small screws and applied in difficult mounting situations: on farm tractors, construction machinery or a luggage rack. It can also adhere to a door edge or hood groove.

**Trunk Lip.** Another mount designed for the trunk, this one requires no holes. It has a clamp that curves around, and clamps to the trunk lip. It also prevents the cable from pinching when the trunk is closed. The bracket

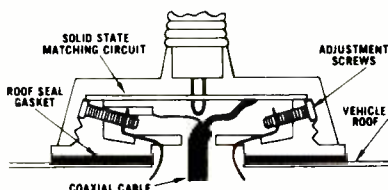

*Hy-Gain rooftop mounting system.*

APRIL 1975

installation needs little more than a screwdriver to tighten setscrews.

**Mirror.** This design came into vogue when truckers joined CB. No drilling is required to install a clamp-like arrangement which grips the side-view mirror bracket.

**Magnetic.** A powerful Alnico magnet in the base of this mount hugs the car's sheet metal in winds up to 100 mph. No clamping or drilling is needed. Just plunk the magnet anywhere there's flat steel and the installation is done. Remember, however, that the cable emerges from the side of the mount. Thus, it must be led into the vehicle through a partly open window, or a groove made in the molding. This mount is easily transferred between vehicles, a factor that may be important to your type of operation.

**Camper.** Conventional antenna mounts don't easily mount on a camper. Happily, engineers have developed a single, flexible bracket that attaches in a variety of ways to almost any surface. Sometimes it's not even necessary to drill holes because the bracket may match existing screws in the camper body.

An added problem in recreational vehicles is that there may not be sufficient metal surrounding the base of the antenna to create good ground-plane action. Accordingly, signal radiation suffers. One solution is the camber bracket, installed with a short, marine-type antenna. Because small boats are generally constructed of fiberglass, CB marine antennas are electrically constructed to operate with no ground plane.

**Motor-home.** The camber bracket described above also works on a motor home. If height limitations compel you to buy a short whip, you can mount it on the roof of a metal motor home with no electrical problem. Where the roof is fiberglass you'll have to provide an electrical ground plane. (Some manufacturers of motor homes embed a copper screen in the roof for this reason, so find out if one is provided.) At least one manufacturer overcomes the ground-plane problem in plastic roofs with a kit of aluminized tape. Self-sticking, it is placed in a cross-hatch pattern over the roof to simulate ground and should last several years.

There's more to mobile mounting than meets the eye, but there's enough hardware to prevent you from installing the right antenna the wrong way, or vice-versa. ♦

# SAVE!

**MONEY • TIME • FREIGHT**

♪ QUALITY STEREO EQUIPMENT AT LOWEST PRICES.

♪ YOUR REQUEST FOR QUOTATION RETURNED SAME DAY.

♪ FACTORY SEALED CARTONS—GUARANTEED AND INSURED.

♪ SAVE ON NAME BRANDS LIKE:  
A.D.C. KLH  
A.R. SHURE  
DYNACO KOSS  
SONY FISHER

AND MORE THAN 50 OTHERS

BUY THE MODERN WAY

BY MAIL—FROM

**illinois audio**

Department 217S

12 East Delaware

Chicago, Illinois 60611

312-664-0020

CIRCLE NO. 20 ON READER SERVICE CARD

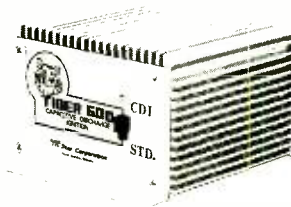

## 12 REASONS YOUR CAR NEEDS TIGER CDI

Instant starting in any weather - Eliminates tune-ups - Increases gas mileage - Increases horsepower 15% - Improves acceleration and performance - Spark plugs last up to 70,000 miles - Reduces engine maintenance expense - Amplifies spark plug voltage to 45,000 volts - Maintains spark plug voltage to 10,000 RPM - Reduces exhaust emissions - Dual ignition switch - An Unconditional LIFETIME GUARANTEE - Installs in 10 minutes on any car with 12 volt negative ground - No rewiring - Most powerful, efficient and reliable Solid State Ignition made.

SATISFACTION GUARANTEED or money back

TIGER 500 assembled . . . . . \$53.95

TIGER SST assembled . . . . . \$42.95

Post Paid in U.S.A.

Send check or money order with order to:

**Tri-Star Corporation**

P. O. Box 1727 C  
Grand Junction, Colorado 81501

DEALER INQUIRIES INVITED

CIRCLE NO. 39 ON READER SERVICE CARD

# exciting new projects for '75

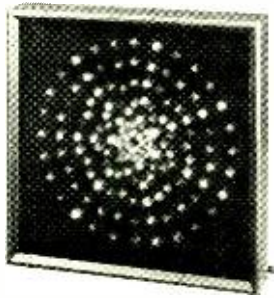

## NEW Heathkit Color Organ

"Kaleidoscopic" light show you hang on a wall. 4 filters separate sound into 4 bands; each controls 35 brilliantly colored lights — red for bass, blue for low midrange, green for upper midrange, amber for treble — 140 lights in all, pulsating in time to music of your hi-fi. Wide 25 db dynamic range; great for any type of music. Walnut-grain vinyl-clad case, 23" x 23" x 4 1/2". On/off/sensitivity control.

Kit TD-1006 ..... 79.95\*



## NEW Portable Digital Multimeter

Professional performance at a budget price. 26 ranges resolve voltages to 100  $\mu$ V, currents to 100 nA, measures AC & DC current up to 2 A, resistance from 100 to 1000K ohms. Big, bright 3 1/2-digit readout with automatic over-range & polarity indications. Built-in reference standards for easy field calibration. With rechargeable batteries & AC line cord.

Kit IM-2202 ..... 179.95\*



## NEW DC-10MHz Oscilloscope

A great scope—a great value! Perfect for TV servicing. 10 mV vertical input sensitivity, time bases from 200 ms/cm to 200 ns/cm, internal or external digital triggering, two input channels. Mu-metal shielded tube with 8x10 cm graticule.

Kit IO-4530 ..... 299.95\*



## NEW 40 kV Metered Probe

Ideal for high-voltage TV measurements—up to 40 kV with  $\pm$  3% accuracy. On/off switch.

Kit IM-5210 ..... 17.95\*  
Assembled SM-5210 ... 24.95\*



## NEW Emergency Car Strobe Light

Highly visible amber flash warns other drivers when your car stalls or breaks down. Non-marring magnetic base, 12' cord, plug fits cigarette lighter. For 12 VDC.

Kit GD-1026 ..... 29.95\*



## NEW Windshield Wiper Delay

Provides exactly the wiper speed you need for safe driving in any weather, from light mist to heavy rain. Works with most 12 VDC positive or negative ground cars.

Kit CH-1068 ..... 14.95\*



## NEW AM/FM Digital Clock Radio

Electronic digital clock with standby battery power to keep time (without display) during power interruptions, electronic "beep" alarm with adjustable volume, 5  $\mu$ V FM sensitivity, quality sound. Less batteries.

Kit GR-1075 ..... 129.95\*

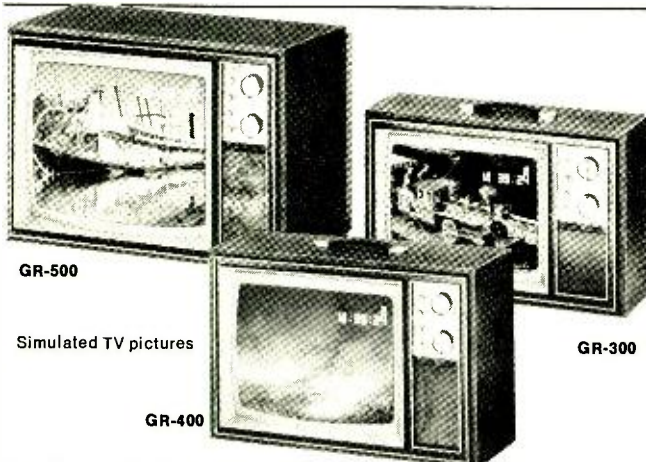

GR-500

Simulated TV pictures

GR-400

GR-300

## 15, 17 & 19" (diagonal) Color TVs with On-Screen Digital Readout

Advanced Heath engineering and outstanding picture quality. All feature on-screen channel readout & optional plug-in clock modules. In-line picture tubes with slotted shadow masks provide exceptionally bright, sharp pictures. In the GR-400 and 500, black matrix tubes improve contrast. And here's something new—static toroid yoke & magnet assemblies never require convergence & fixed LC filters eliminate instrument IF alignment. GR-300 & 400 come with walnut veneer cabinets; cabinets for the GR-500 start at \$39.95.\*

Kit GR-300 (15" diag.), with cabinet ..... 449.95\*  
Kit GR-400 (17" diag.), with cabinet ..... 489.95\*  
Kit GR-500 (19" diag.), less cabinet ..... 499.95\*  
Kit GRA-2000-1, Digital Clock Module ..... 29.95\*



GR-2000

Simulated TV picture

## Highly Acclaimed GR-2000 Digital-Design Color TV

The set that brought TV into the digital age—and still one of the finest made. Tuning is totally digital solid-state & the channel number appears right on the big, 25" (diagonal) screen. The optional clock module also displays the time on the screen. For the ultimate in convenience, add the optional wireless remote control. Can be custom mounted; optional cabinets start at \$119.95\*.

Kit GR-2000, less cabinet ..... 669.95\*  
Kit GRA-2000-1, Digital Clock Module ..... 29.95\*



# at traditional Heathkit savings

## There are 350 more in the new FREE Heathkit catalog!

### Who can build our kits? Anybody!

For over 27 years we've made superb electronic equipment that anyone can build—even with no prior knowledge of electronics or kit building. Famous Heathkit assembly manuals guide you step by step, showing you exactly what to do—even how to solder like a pro.

And we back every Heathkit purchase with people. Expert technical consultants at the factory and trained service personnel from coast to coast are ready to help every step of the way. Thousands of Heath customers will tell you—**we won't let you fail!**

When you're finished, you'll own one of the finest products available—kit or assembled. But don't take our word for it, independent reviewers consistently praise their quality.

You'll enjoy the satisfaction—and savings—of building a useful product with your own hands. And for years to come, you'll enjoy its unexcelled quality and performance. Build it yourself—with a little help from Heath.

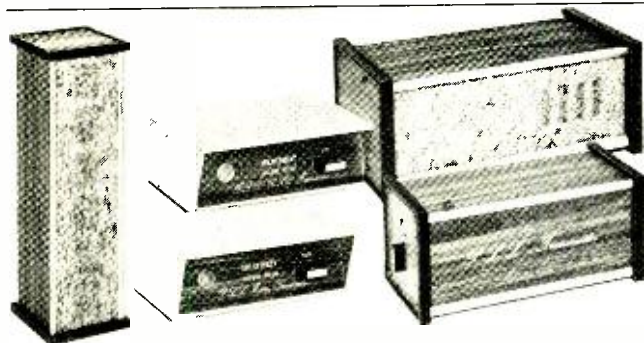
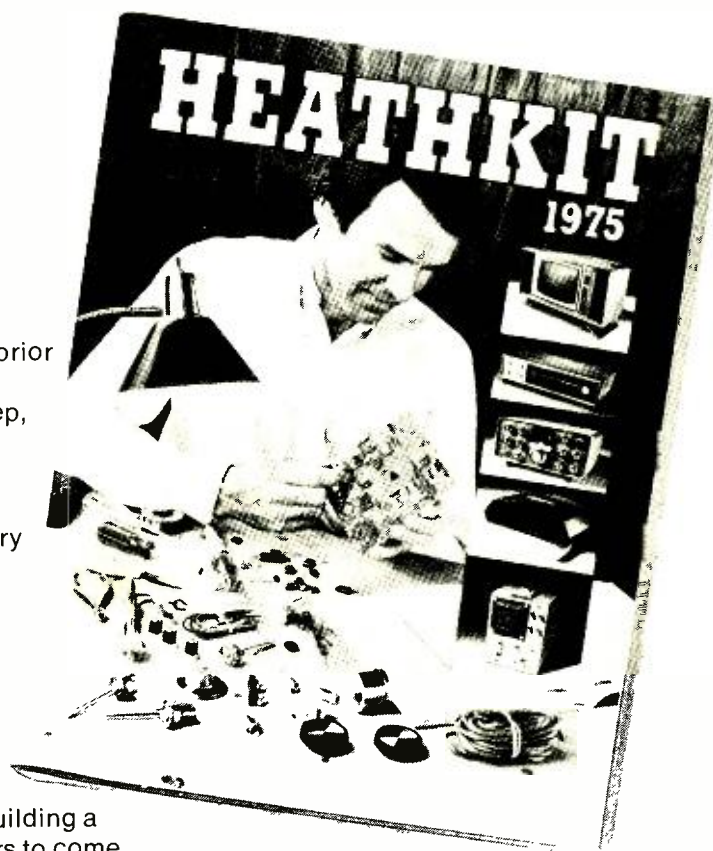

### NEW Heathkit/Delta Home Security System

Everything you need for a complete home security system. Remote detectors connect to Central Processor through your home's electrical wiring. Inputs for ultrasonic intrusion detector, heat & smoke detectors plus "panic button" & remote on/off switch. Central Processor features built-in speaker; output for an external speaker. Sounds alarm during power failure.



### NEW Valu-System Stereo & 4-Channel Components

Budget-priced systems with component-quality sound. Pick your own system—an AM/FM stereo receiver, \$139.95\*; an AM/FM stereo receiver with 8-track player, \$179.95\*; a 4-channel 8-track player, \$169.95\* or a 4-channel AM/FM receiver with 8-track player, \$239.95\*. Add speakers (just \$34.95\* per pair) and our \$44.95 ceramic changer, and you get our 5% system discount. A whole stereo system (shown above) starts at just \$208.86\*. See them in the new Heathkit Catalog.

### Send for your free 1975 Heathkit Catalog today!

Your free 1975 Heathkit Catalog describes the world's largest selection of electronic kits. You'll find kits for every interest, every age, every budget. Choose from digital-design color TVs, stereo and 4-channel hi-fi components, fishing and boating electronics, model radio-control equipment, amateur radio kits, digital clocks, weather instruments, shortwave and digital clock radios, treasure finders, automotive tune-up tools, service instruments, and educational kits. See why you get more for your money when you build it yourself—send for your free copy today.

HEATH		
Schlumberger		
Heath Company		
Dept. 10-04		
Benton Harbor, Michigan 49022		
Name _____		
Address _____		
City _____	State _____	Zip _____
PRICES & SPECIFICATIONS SUBJECT TO CHANGE WITHOUT NOTICE.		
*MAIL ORDER PRICES; F.O.B. FACTORY.		
		CL-560



# Amateur Radio

By Herbart S. Brier, W9EGQ

## RESTRUCTURING THE AMATEUR SERVICE

**O**n December 4, 1974, the Federal Communications Commission broke with tradition by proposing to issue a new code-free, amateur Communicator's license. The new license would authorize FM phone operation on the amateur frequencies above 144 MHz with a maximum transmitter power of 250 watts input. The new Communicator license would be one of two new licenses and many changes that will affect every amateur in the United States contained in FCC rule-making Docket 20282. Its major proposals, which are a distillation of 35 sometimes-contradictory petitions presented to the FCC over a period of several years, are summarized below. As you read the summary, remember that all the proposals are subject to revision. Any interested person has until June 16, 1975, to file original comments on them and until July 16, 1975, to file counter comments. The FCC specifically invites informed comments, which must be in the form of an original and 14 copies addressed to the Federal Communications Commission, Washington, D.C.

**The Proposals.** The proposals in FCC Docket 20282 divide the amateur spectrum into two parts at 29 MHz. Part A covers the high-frequency or shortwave spectrum below 29 MHz; part B covers the spectrum above 29 MHz. In general, seven separate licenses with their examinations tailored to the frequencies and the privileges they cover are available. All of them, including the new Communicator and the Novice class licenses, will be issued for a basic period of five years and will be renewable.

In addition to the Communicator license with its simple written examination, the big news in the series is a new *Experimenter* license, counterpart of the *Advanced* class license in the hf series. It authorizes all amateur privileges above 29 MHz using a maximum

transmitter power of 2000 watts, peak envelope power (PEP) output, which can translate to a dc power input up to 4,000 watts or so, depending on the mode and the efficiency of the transmitter used. Its examination consists of a 5-wpm code test and a written test covering amateur regulations and advanced amateur vhf/uhf theory and techniques. The *Technician* class license completes the vhf/uhf series. It will authorize code and phone operation on all frequencies above 50 MHz using a transmitter power of 500 watts PEP output. Its examination is a 5-wpm code test and a general written test on amateur regulations and vhf/uhf techniques and operation.

Below 29 MHz, the big changes in the *Novice* license are its expansion into a 5-year, renewable license with a maximum power input of 250 watts. Operating privileges, frequencies and examination remain unchanged. The *General* class license remains essentially unchanged below 29 MHz, except the privilege of using RTTY and other exotic modes of transmission are withdrawn. Also its new maximum transmitter power rating of 500 watts PEP output is somewhat below the old 1000-watt input limit. The *General* class examination will still include a 13-wpm code test, but the written test will have questions about vhf/uhf operations and specialized emissions eliminated. The new *Advanced* class license will authorize all amateur privileges below 29 MHz, except to operate CW in the restricted CW segments in the 3, 5, 7, 14, and 21-MHz bands. Maximum transmitter power of both the *Advanced* and *Extra* class licenses is 2000 watts PEP output. Under the new scheme of things, the present written part of the *Extra* examination is deleted and made a part of the *Advanced* and *Experimenter* examinations, eliminating uhf/vhf questions from the *Advanced* class version and hf questions from the *Ex-*

*perimenter* class version. Present *Extra* class licenses are to become life-time licenses authorizing all amateur privileges. The 20-wpm *Extra* class code test will be retained, and future holders of both *Advanced* and *Experimenter* class licenses who pass it will graduate to the life-time *Extra* license. They will still have to renew their station licenses every five years, however.

**Additional Details.** Present licensees will retain their present call letters, if they wish. New licensees will be issued call letters indicating their class of license. Details will be a subject of a future docket. Also, present *Advanced* class licensees will get *Experimenter* licenses and *General Technician* licenses by simple application. *Technicians* may obtain *Novice* class licenses via the same route. Future licensees will have to pass separate examinations to obtain privileges in both regions.

*Communicator* and *Novice* licenses will normally be issued and renewed by mail. Applicants for other classes of licenses who live over 175 miles from the nearest regular FCC examination point can also obtain them by mail but only for a maximum of five years. If they do not appear at an FCC office and pass the appropriate examination within that time, the license will not be renewed. In addition, if they move within 175 miles of an examination point or a new examination point is established within 175 miles of their locations, they will have a year to appear for the exam before their by-mail license will be cancelled. Physically disabled applicants may take the exams by mail, wherever they live, and the licenses may be renewed as long as the disability lasts.

Two volunteer examiners, over 21 and not related to the applicant, at least one of them having a license of a higher grade than the one being sought, are required to witness by-mail examinations. *Extra*-class licensees may be the principal examiners for any class of license examination, *Advanced* class licensees for *General* and *Novice* exams, *Experimenter* licensees for *Technician* and *Communicator* exams, and *Technicians* for *Communicator* exams, all assisted by another licensed amateur.

It has been predicted that the United States amateur population will be doubled within a few years after these proposals are enacted, possibly by the



end of the year. The possibility that a flood of new Communicator licensees will take over the frequencies above 144 MHz and disrupt forms of communication already established on these frequencies is a matter of deep concern to many uhf/vhf operators. The possibility might be minimized by allotting certain segments of these bands for weak-signal experiments especially susceptible to interference and amateur radio's long tradition of keeping its own house in order will also help.

**50-MHz "Short Skip".** Each year, as spring approaches, experienced 50-MHz operators anticipate the start of the annual spring-summer "short-skip" season. Its start is signalled by the band suddenly jumping with strong signals originating from distances up to 1200 miles and farther away. The signals may come from any direction and be heard for periods ranging from a few seconds to hours at a time before they disappear as suddenly as they appear, not to reappear for days at a time. Or the signals may pop in and out around the compass and around the clock for days at a time.

This form of "short-skip" or sporadic-E propagation is thought to be the result of high-velocity cross winds in the E layer of the ionosphere approximately 70 miles above the earth concentrating its ambient ions into super-ionized patches that bounce vhf signals striking the patches back to the earth. Any shift in the winds affects the strength, number and positions of the patches, which explains the variable nature of the propagation. The most likely times for vhf short skip in the United States are before noon and late in the afternoon during the warmer months of the year, but it can occur at any time. Its fascination is that it is practically the only avenue open to the low-power 50-MHz phone station, with a simple antenna, to work distances beyond a few hundred miles during most of a normal sunspot cycle. It is not unusual for a good operator to work well over 30 states, Canada, and possibly a couple of countries like Bermuda, Cuba, and Mexico between April and September. And it is downright habit forming to try to outguess the skip.

Short skip reaches as high as the 144-MHz band on rare occasions and with increasing frequency on the 28-, 21-, and 14-MHz bands.

**News Notes.** In the December, 1973, 10-meter contest, Jurgen, DJ6RD/W9, Valparaiso, Ind., was frustrated because none of the Novices he called could copy his call letters. In 1974, however, only one Novice he called had that difficulty. After several attempts to make a successful contact, Jurgen found the Novice in the Call Book, called him on the telephone, and said, "My call letters are D-J-6-R-D-Slant-band-W-9. Now, get on the air and have a contact. They made it! ... The Chicago FM Club worked with Project LEAP (Legal Elec-

tions in All Precincts) to provide communications for the representatives of the Attorney General, State's Attorney, and LEAP poll watchers during the last election in Chicago. Thirty-four amateurs were active from 6:00 a.m. to 6:00 p.m., relaying complaints ranging from illegal electioneering to a death threat to an election judge. The communications were relayed through the CFMC 2-meter repeater, WR9ABY, which covers Chicago like a blanket. Senator Charles Percy complimented the club and LEAP. The club will be back for the next elections. ♦

# DIGITAL MULTIMETER KIT

BATTERY OPERATED · AUTO POLARITY · AUTO ZERO

**AC VOLTS**  
1% 1MV TO 300 VOLTS

**DC VOLTS**  
1% 1MV TO 300 VOLTS

**OHMS**  
1% 1OHM TO 3 MEG

**CURRENT**  
1uA TO 300 MA

COMPLETE KIT  
LESS BATTERIES  
AND TEST LEADS  
FLORIDA SALES  
ADD 1% TAX

\$99.95

ALPHA ELECTRONICS

ALPHA ELECTRONICS 305 636 6951  
PO BOX 1005 MERRITT IS FLA. 32952

**for only \$19.95\* this ugly little space-age device makes your FM/AM mobile stereo sound like it's always parked near the radio station**

- 12 dB signal boost with channel capture, "pilot fencing" when far from station
- Works with all FM or AM/FM car stereo systems
- Installs easily in minutes.

**asc.com®**  
model ASC-100  
**stereo x-pander**

**ORDER TODAY!**  
money-back guarantee

**REEDER'S ELECTRONICS**  
3128 May Ave., Oklahoma City, OK 73112

Gentlemen: Please rush one ASC-100 Stereo X-pander. I understand I may return it for refund of full purchase price \$19.95\* within 10 days of receipt if I'm not completely satisfied. I enclose check \_\_\_\_\_ money order \_\_\_\_\_ or \$19.95\* plus \$1.00 for postage and handling. (Sorry - no COD's.)

NAME \_\_\_\_\_  
STREET \_\_\_\_\_  
CITY \_\_\_\_\_ STATE \_\_\_\_\_ ZIP \_\_\_\_\_

# BETTER THAN A THIRD HAND!



**PANAVISE TILTS, TURNS, AND ROTATES TO ANY POSITION. IT HOLDS YOUR WORK EXACTLY WHERE YOU WANT IT.**

**PanaVise has great strength yet is gentle enough to firmly hold delicate objects.**

Quite possibly the finest new tool you will buy this year, PanaVise is built to exacting professional standards. We guarantee it!

Illustrated is the Electronics Vise Model 396. Three other bases and a wide variety of heads are available. All interchangeable! Buy a basic unit, then add on to create your system.

Available through your dealer.  
Write for a free catalog.

**PANAVISE®** Dept. 22E  
10107 Adella Ave., South Gate, CA 90280  
In Canada: 25 Toro Rd., Downsview, Ont. M3J 2A6

 A Division of Colbert Industries

CIRCLE NO. 51 ON READER SERVICE CARD

## Coming Up In The May **Popular Electronics**

Convert Your Counter  
into a DVOM  
Biofeedback Muscle Monitor  
Matching Tape Decks to Tape  
Photometer & Exposure Meter



# Test Equipment Scene

By Leslie Solomon

## SOME RULES FOR USING EQUIPMENT

**M**OST test equipment, when properly used, will perform its natural function—make tests. Unfortunately, too many people treat their test equipment as if it were just another appliance, like a can opener. They jam the probes into the dark recesses of a chassis (which probably has power applied to it), twist some knobs, and hope that the results they get will tell them what they want to know. These are the same people who usually complain about the inaccuracy and short life of their test equipment and blame the manufacturer for their self-inflicted problems.

There are rules to be observed in using test equipment. They are simple to learn and they should be obeyed—starting now. The first rule is to read the manual that comes with the test gear. Too many times, a guy will unwrap a piece of new equipment, throw away the carton, glance briefly at the instruction manual, and then stow it away in the dark recesses of his work bench, never to consult it again unless something goes wrong with the equipment. This guy, if you pin him down, will usually say, "These things are all the same. Once you've used one VOM (or sweep generator or logic probe), you can use any other." Not once does he consider that, when a new model is designed, it may function differently from the old one. It may be capable of performing some sort of test that the old one couldn't. This is all spelled out in the manual, and it behooves the user to sit down and read it from cover to cover before he does anything else.

The next rule is to be fully aware of the capabilities, specifications, etc., of any piece of test equipment that you are using. For example, how much current does your ohmmeter deliver when the probe tips are shorted? You probably don't know; but you will apply it across a transistor or a low-power signal diode and then wonder why you keep having burned-out

components. By the same token, you should know what the voltage is at the tips of the ohmmeter. Also, are you sure which lead is the positive input and which is the negative. I happen to have two ohmmeters (nationally known brands) and the color coding on the inputs is different between the two.

In addition, you might try checking a conventional rectifier diode on the various ohmic ranges of your multimeter. Then ask yourself why the resistance values are different on the various ranges. You forget that your multimeter is not delivering a constant current so that you get different indications when the meter is switched between ranges. On the other hand, a digital multimeter uses a constant-current source for resistance readings so that it will show the same value on different ranges.

Still on the subject of meters, a number of readers have asked how they can determine the resistance of a meter that they want to use in building some test equipment. The circuit shown here is one way of doing it.

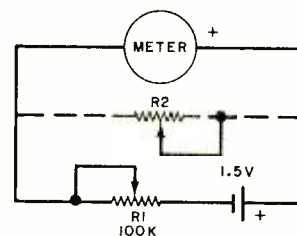

Using a 1.5-volt cell, the resistance of potentiometer  $R1$  should be high enough to limit the current to a safe value. (In this case, a value of 100 kilohms will limit the current to 15  $\mu\text{A}$ .) Do not connect  $R2$  at this time. With  $R1$  at full resistance, connect up the circuit. The meter may or may not move upscale. Carefully adjust  $R1$  until the meter goes to full scale. Using a potentiometer of several thousand ohms for  $R2$ , set it at full resistance and connect it across a full-scale-

POPULAR ELECTRONICS



reading meter. Then adjust  $R2$  until the meter indication drops to exactly half scale. Without disturbing the  $R2$  setting, remove it from the circuit and, using an accurate ohmmeter, carefully measure the resistance of  $R2$  between the open end and the wiper. This is the resistance of the meter. Depending on the meter, you may have to experiment with the value of  $R2$ —decreasing its end-to-end value as required.

There is one other area that should be considered. If you look at the manual for your meter, you will find the maximum voltage value that can be safely applied to the probe tips. This is usually called out as maximum dc and dc plus ac. When using the meter, particularly on vacuum-tube TV circuits, be sure not to exceed this value or you might ruin the meter.

Do you know what the input resistance of your old VOM is on the various voltage ranges? This is important when considering the loading effect of the VOM on a high-impedance circuit. The parallel combination of meter and circuit resistance can produce wrong indications. So, before making voltage measurements with a VOM, check the impedances so that you get a satisfactory voltage reading.

**How About Oscilloscopes?** The instruction manual for an oscilloscope tells you how to correct the various vertical amplifier attenuators for frequency to remove ringing and tilting. If you have a probe, it too must be compensated by trimming its built-in capacitor to prevent distorted waveforms. Since pulse shapes are important in many signal paths in TV receivers, this frequency compensation must be made if you are to get the right waveform. Also, if you use a square- triangle- or sawtooth-waveform generator in audio testing, the wrong waveform on your CRT will throw off your tests. Once again, consult the manual.

R-f signal generators present other problems. Many of them require a terminating resistor at the end of the output lead. Check the manual and be sure that, if needed, you have the necessary resistance.

If you do any work on digital circuits and have a digital multifrequency generator, keep in mind that many of these must also be driven into a certain load or the waveforms will not be correct. Check the manual to see if you need a 51-ohm terminator. ♦

APRIL 1975

## PACE CB 2-WAY RADIOS FOR RUGGED OUTDOOR USE

CB 133: IDEAL FOR RUGGED USE IN YOUR MOTORHOME,  
CAMPER OR TRAILER



CB 125: IDEAL TO STAY IN TOUCH  
WITH YOUR BASE CAMP



### ■ GREATER RECEIVING RANGE

- Sensitive dual conversion superheterodyne narrow band receiver for adjacent channel rejection.
- Staged audio response for more voice clarity.

### ■ MORE TALK POWER:

- Transmitter equipped with rugged silicon output and driver transistors for conservative delivery of maximum legal power output.
- 100% modulation to ensure full utilization of RF power and communications range.

### ■ EXTRA VALUE FEATURES:

- 25 channel synthesized design — no additional crystals to buy.
- Engineered for (+) or (-) ground vehicle applications.
- Mini-size — 1½" H x 5" W x 7" D
- 2-year U.S. factory service program.

ONLY \$119.95

### ■ WHEN GOING FISHING, OR HUNTING

- Squelch control for eliminating background noise.
- 3-position channel switch for channel selection.
- Remote speaker and earphone jacks (included).
- Optional battery charger AC adapter.
- Automatic gain control for listening convenience.
- High performance telescopic antenna.
- 2.5 watts RF power for increased range.
- Optional texon carrying case.

ONLY \$59.95

*Total convenience and safety while trailering and camping for only \$179.90 for the combination of the CB 133 and CB 125. PACE CB radios offer you dependability and reliability when needed.*

See your dealer today or write for further information. Please specify no. 62

((P))

Pace Communications, Div. of Pathcom Inc.  
24049 S. Frampion Ave., Harbor City, Ca. 90710 Available in Canada.  
CIRCLE NO. 31 ON READER SERVICE CARD

## FREE McIntosh CATALOG and FM DIRECTORY

Get all the newest and latest information on the new McIntosh Solid State equipment in the McIntosh catalog. In addition you will receive an FM station directory that covers all of North America.



### MX 113

FM/FM STEREO - AM TUNER AND PREAMPLIFIER

**SEND  
TODAY!**

McIntosh Laboratory, Inc.  
East Side Station P.O. Box 96  
Binghamton, N.Y. 13904  
Dept. PE

NAME \_\_\_\_\_

ADDRESS \_\_\_\_\_

CITY \_\_\_\_\_ STATE \_\_\_\_\_ ZIP \_\_\_\_\_

If you are in a hurry for your catalog please send the coupon to McIntosh.

For non rush service send the Reader Service Card to the magazine.

CIRCLE NO. 26 ON READER SERVICE CARD

**HUGE SAVINGS** ON FAMOUS BRAND STEREO COMPONENTS

**DISCOUNTS**  
ON NATIONALLY ADVERTISED  
TURNTABLES • CARTRIDGES  
COMPACTS • RECEIVERS  
AMPLIFIERS • TAPE RECORDERS

Wholesale Prices! Audio Warehouse Sales, One of the Capitols largest stereo whole salers will fill and deliver all your mail orders promptly in factory sealed cartons, at prices that will amaze you.

Write for quote on Famous Brand, Stereo Components. We guarantee satisfaction.

**AUDIO**  
**WAREHOUSE SALES**  
3310 NEW YORK AVE. N.E.  
WASHINGTON, D.C. 20002  
(202) 832-1616

CIRCLE NO. 49 ON READER SERVICE CARD

**BIG DISCOUNTS**

**STEREO COMPONENTS**

Largest selection of top name brands... try us and see...

It's worth a call  
**(301) 488-9600**

**INTERNATIONAL HI-FI DISTRIBUTORS**

DEPT. D  
6330 Frankford Ave.  
Baltimore, Md 21206

All mail answered within 24 hours

Phone Daily 9 AM to 9 PM  
Saturday 9 AM to 4 PM  
Phone (301) 488-9600

CIRCLE NO. 22 ON READER SERVICE CARD



# Art's TV Shop

By Art Margolis

## THE MISSING BURST

AS I walked into Peters' Electronic Parts a few days ago, old man Peters greeted me and said, "Art, I'm desperate—I need some help. Can you spare a few minutes?" I told him I could, and he led me to the back of the store. On a table I saw some factory-fresh test equipment, shiny hand tools and a chassis. "Going into the TV service business?" I asked. "Not by choice, my boy, not by choice," he muttered.

Then I noticed a tag on the receiver's line cord. It was from my crosstown competition, "Bob's TV." I smiled and asked, "Are you doing Bob's bench work now?"

"Not by choice," he said again, with more than a trace of disgust in his voice. I could see that the chassis was a GE CX model. There were a lot of them in the large motel on the highway near Bob's Shop. Bob had installed them quite a few years ago.

Peters moaned, "Bob's contracted to overhaul a lot of these old babies with new CRT's and flybacks. I ordered a hundred flybacks for him, but they don't work. He won't accept them. He's cancelling the order and is going directly to GE for good ones."

"What do you mean by that?" I asked. "How don't they work?"

"See for yourself," he said. I reached over and turned the receiver on. All the filaments lit up, and I heard a slight high-voltage crackling. The CRT lit up, and I examined the raster. It was full, straight, and bright. I attached an antenna and an excellent black and white picture appeared. I looked at Peters questioningly.

**No Color.** "It's supposed to be a color picture," he said sheepishly.

I reached for the color control and turned it. The black and white picture remained. Peters said, "There was good color before we changed the flyback."

I looked down. A new flyback trans-

former was soldered neatly in place. It wasn't a GE model, but one of the "exact replacement" types. I checked the installation against the wiring schematic. It was soldered according to the instructions.

Peters said, "I had only one GE unit, and it caused no problems. The color was perfect. But these..."

I creased my brow and wondered—what could the flyback do to kill the color? I sat down and examined the receiver. The picture showed no trace of color. I took a small screwdriver and rocked the COLOR KILLER control back and forth. Aha! Some color snapped in and out of the picture as I varied the control's setting. A closer look showed faint color running through the picture in narrow stripes, but it was way out of color sync. This helped me narrow down the problem to the circuitry associated with color sync.

The best way to diagnose this type of difficulty is to attempt an AFPC alignment and see how far you can get. I shorted out the control grid of the reactance tube. This removes the variable capacitance effect of the reactance circuit and allows the color oscillator to free-run. The colors stopped racing through the picture and began to just float by. That meant that the oscillator was performing well, and near the correct frequency,

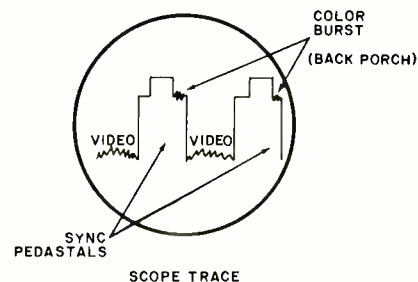

Color bursts are located on back porch of sync pedestal.



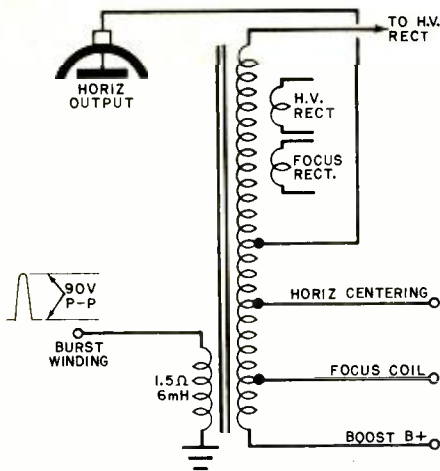

*Flyback transformer has special winding to generate spikes.*

since the colors were almost stationary. Removing the short caused the colors to start whirling by again. Trouble in the phase detector or burst circuit seemed likely.

I then shorted the input to the burst amplifier, preventing the burst signal from reaching the phase detector. The only signal reaching the phase detector is the sine-wave output of the 3.58-MHz oscillator. Voltages of equal magnitude but opposite polarity should appear at the twin diodes. If the voltages are not mirror images, the detector stage is the culprit. They did measure about  $\pm 12$  volts. The detector stage was OK, and trouble in the burst circuit was indicated.

The burst amplifier requires two inputs to function properly, the video signal and a horizontal pulse. The burst information is contained in the composite video signal, appearing as eight cycles on the back porch of the sync-and-blanking pedestal. The burst amplifier is biased into cutoff. If a video signal is applied to the input, no signal gets through. If a horizontal pulse and the video signal are applied simultaneously, the amplifier turns on, and the amplified burst appears at the burst output. The bursts then sync the color oscillator with the correct phase. The net result is a good picture with all the colors in place, not running through the picture like a moving rainbow.

"What effect would a new flyback have on the color sync?" I asked myself. Well, the flyback is the source of the horizontal pulse which turns on the burst amplifier. I picked up the probe of a transistorized multi-meter (TMM) and started to take dc voltage readings around the burst amplifier tube. All read near normal. I

switched the TMM to read peak-to-peak volts. Both the video signal and the flyback pulse appeared. I scratched my head and decided to check the flyback pulse again, since this was generated by the new flyback. The schematic called for 90 volts p-p, but the meter read 60 volts. This might not be indicative of a problem, since the meter's response drops off at high frequencies such as this (15,750 Hz). However, it did warrant further examination.

"I need a scope to see the pulse waveform," I told Peters. He went to a shelf and took down a new model.

Shortly, we had the scope displaying a bright green trace. I connected the scope's probe to the burst amplifier input to look at the horizontal pulse. A good spike was displayed on the CRT. I rechecked the schematic, and suddenly it struck me—the spike was a NEGATIVE (down-going) one! Instead of turning the amplifier on, as a positive spike would, it was driving the amplifier deeper into cutoff. The burst could not get through to sync the color.

It appeared that the leads on the flyback were reversed. I turned off the receiver and switched the leads. This wiring change should produce color sync. I turned on the set.

Peters was saying, "I hope it's just mislabelling and not . . .," as the picture came on with the colors correctly in place.

Peters laughed and slapped me on the back. "Good work, my boy! You've saved the day! Take what you need from my stock—it's on the house!" ♦

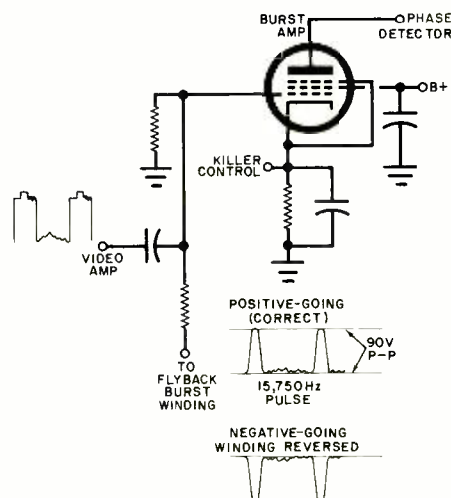

*Burst amplifier has video input plus spike from the flyback.*

# FREE EICO CATALOG

## 346 Ways To Save On Instruments, Burglar Alarms, Automotive & Hobby Electronics!

The more you know about electronics, the more you'll appreciate EICO. We have a wide range of products for you to choose from, each designed to provide you with the most pleasure and quality performance for your money. The fact that more than 3 million EICO products are in use attests to their quality and performance.

**"Build-it-Yourself" and save up to 50% with our famous electronic kits.**

For latest EICO Catalog on Test Instruments, Automotive and Hobby Electronics, Eicocraft Project kits, Burglar-Fire Alarm Systems and name of nearest EICO Distributor, check reader service card or send 50¢ for fast first class mail service.

**EICO—283 Malta Street,  
Brooklyn, N.Y. 11207**

*Leadership in creative electronics  
since 1945.*



**CIRCLE NO. 16 ON READER SERVICE CARD**

From CIE — Cleveland Institute of Electronics

# learn by doing!

Perform more than 200 exciting experiments with CIE's fascinating **ELECTRONICS LABORATORY PROGRAM!**

Put theory... into practice

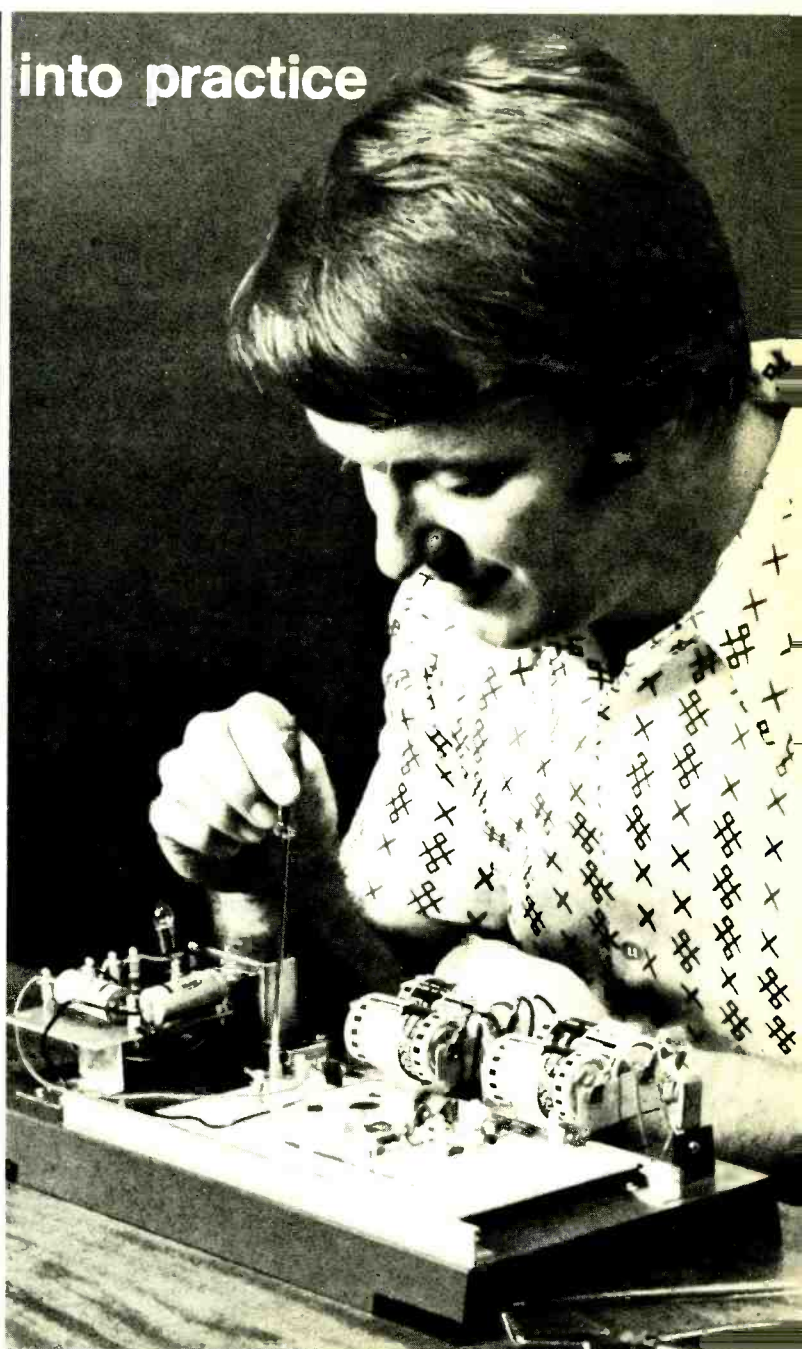



# You get your own Experimental Electronics Laboratory... work with components comparable to those used by industry!

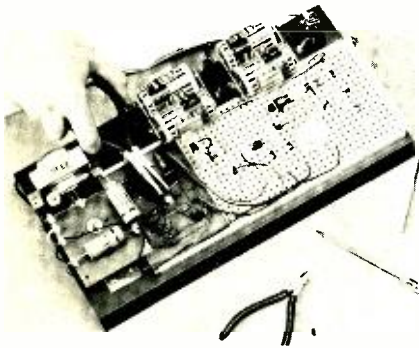

With CIE's Experimental Electronics Laboratory, you'll perform actual experiments and become adept at handling components. This valuable "hands on" experience helps you learn the "how" as well as the "why."

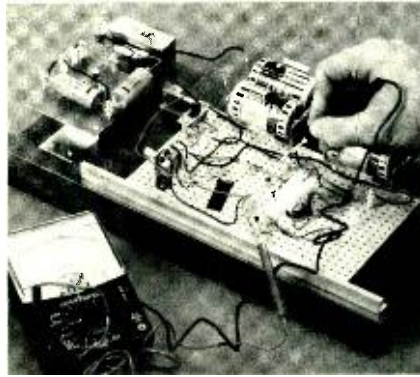

Testing and troubleshooting are an important part of your learning experience. Included in your laboratory is a precision "multimeter" to diagnose electrical and electronic troubles quickly and accurately.

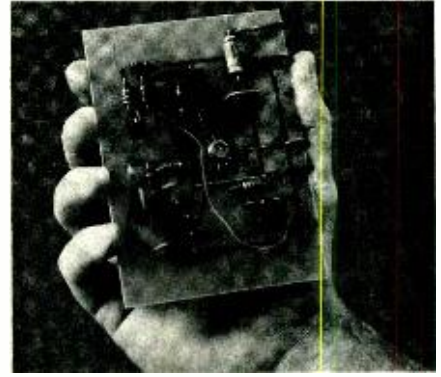

Modern space-age components like this IC (integrated circuit) are professional quality and can be used again and again in many of your projects. Lesson by lesson, piece by piece your knowledge grows!

## Prepare now for a rewarding career in Electronics . . . the Science of the Seventies.

Electronics miracles are changing today's world with breathtaking speed.

This growth in electronics technology has generated a need for electronics technicians trained in theory and practice to build the products, maintain them, and troubleshoot them during the Seventies and beyond.

Don't just wait for something to "happen" in your present job. Get ready now for a career you'll really enjoy . . . with the opportunity for a good income and the chance for advancement.

### Practical experience with experiments

"Hands on" experience helps to reinforce basic theory. When you learn by doing, you discover the "how" as well as the "why." You'll find out for yourself the right way as well as the wrong way to use electronic components. How to construct your own circuits, to discover trouble spots and learn how to fix them.

CIE offers a number of laboratory courses where you learn Electronics by "doing it yourself." You work with your own hands on electronics components and lab equipment. This combination of "head and hands" learning *locks in* your understanding of the crucial principles you'll use on the job in your new career.

And you do it all at home, in your spare time, at your best study pace. CIE's outstanding lessons allow you to progress step by step. An instructional technique time-tested for over 40 years of specialized electronics independent home-study training.

### Importance of an FCC License and our Warranty

If you want to work in commercial broadcasting . . . television or AM or FM broadcasting . . . as a broadcast engineer, federal law requires you to have a First Class Radiotelephone License. Or if you plan to operate or to maintain mobile two-way communications systems, microwave relay stations or radar and signaling devices, a Second Class FCC License is required.

Even if you aren't planning a career which involves radio transmission of any kind, an FCC License is valuable to have as Government certification of certain technical skills. It's a job credential recognized by some employers as *evidence* that you really know your stuff.

To get an FCC License, you must pass a licensing exam administered by the government. And we are confident you can successfully earn your license, if you're willing to put forth an effort, because the vast majority of CIE students have. In fact, based on continuing surveys, close to 9 out of 10 CIE graduates passed their FCC exams!

That's why we can offer this Warranty: when you successfully complete any CIE career course which includes FCC License preparation, you will be able to pass the Government FCC Examination for the License for which the course prepared you or you will be entitled to a full refund of an amount equal to the cash price of tuition for CIE's Course No. 3, "First Class FCC License," in effect at the time you enrolled. This warranty is good from the date you enroll until the last date allowed for completion of your course.

That's it! We *warrant* that you will get the License you trained for.

### You'll have attractive job opportunities

There have already been many exciting developments and breakthroughs in Electronics and some people might assume there will be no new frontiers . . . no new worlds to conquer. Not so.

Electronics is still growing. In nearly every one of the new and exciting fields of the Seventies you find electronics

skills and knowledge in demand. Computers and data processing. Air traffic control. Medical technology. Pollution control. Broadcasting and communications. Once you have the solid technical background you need, you can go after the career field you want . . . work for a big corporation, a small company, or even go into business for yourself.

Yes, Electronics can be the door to a whole new world of career opportunities for you. And CIE training can be your key.

### Send for FREE school catalog

Discover the opportunities open to people with electronics training. *Learn* how CIE career courses can help you build new skills and knowledge and prepare you for a meaningful, rewarding career. We have courses for the beginner, for the hobbyist, for the electronics technician, and for the electronics engineer. Whether you are just starting out in Electronics or are a college-trained engineer in need of updating (or anywhere in between), CIE has a course designed to fit your background, experience, and future goals.

Send today for our FREE school catalog and complete career information. For your convenience, we will try to have a representative call to assist in course selection. Mail reply card or coupon to CIE . . . or write: Cleveland Institute of Electronics, Inc., 1776 East 17th Street, Cleveland, Ohio 44114. Do it TODAY.



Approved  
Under  
G.I. Bill

All CIE career courses are approved for educational benefits under the G.I. Bill. If you are a veteran or in service now, check box for G.I. Bill information.

**CIE** Cleveland Institute of Electronics, Inc.  
1776 East 17th Street, Cleveland, Ohio 44114

Accredited Member National Home Study Council

Please send me your FREE school catalog and career information package.

I am especially interested in:

- |  |  |
|--|--|
| <input type="checkbox"/> Electronics Technician  | <input type="checkbox"/> Industrial Electronics  |
| <input type="checkbox"/> FCC License Preparation | <input type="checkbox"/> Electronics Engineering |
| <input type="checkbox"/> Color TV Maintenance    | <input type="checkbox"/> Other _____             |
| <input type="checkbox"/> Mobile Communications   |  |

Print Name \_\_\_\_\_

Address \_\_\_\_\_

Apt. \_\_\_\_\_

City \_\_\_\_\_

State \_\_\_\_\_

Zip \_\_\_\_\_

Check box for G.I. Bill information.  Veteran  On Active Duty

PE-81

... here Today!  
**"IGNITION OF THE FUTURE"**  
**ALLISON**  
**"OPTO-ELECTRIC"**

★ The BEST...the ULTIMATE...  
of ALL the Ignition Systems!

● (We challenge ANYONE  
to dispute this Fact.)

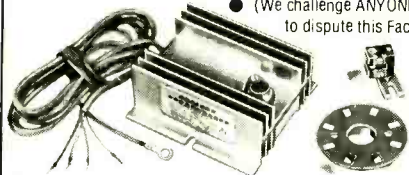

● Never wears out or needs any Maintenance!



● Does more than Pay for itself in  
**GAS SAVINGS**



...it gives you Maximum Power  
with continuous PEAK PERFORMANCE

...while reducing Maintenance  
and Operating Costs!



● The Allison OPTO-ELECTRIC System eliminates the Points and Condenser... replacing them with an OPTO-ELECTRONIC TRIGGER, using a Light-Emitting Diode and Phototransistor. As there are NO moving parts in rubbing contact... Timing adjustments are PERMANENT... The only "TRUE" Electronic Ignition... that you can buy for under \$100.

● Gives 40-Times more Timing Accuracy than ANY system using "Mechanical" Breaker-Points! UNLIMITED RPM! "Electronically-Controlled" DWELL automatically supplies HIGHEST Performance at both Low and High speeds... Spark strength does not fall off at high RPM... POSITIVE SPARK helps eliminate "Misfire" for faster acceleration and improved Engine Performance! Smoother running (No timing fluctuation as with Magnetic Units)... Easier Starting under any condition! Sparkplugs LAST 3 to 10-Times LONGER.

All SOLID-STATE Components... UNAFFECTED By Temperature, Moisture, or Vibration! Highest grade materials Guarantee you solid, Dependable Performance.

★ Perfect Timing and Dwell never change.

Pays for itself! Eliminates ignition Tune-Ups forever!  
"INFINITE LIFE"... Once installed... Never needs replacing.

● PERFECT TIMING INCREASES Engine Efficiency and Gas Mileage... SAVES Precious Fuel! Allison gives you MAXIMUM Engine Efficiency 100% of the time... and that's the name of the game for BETTER Gas Mileage and Economy.

★ **PROVEN RELIABILITY!**

Dyno Tested up to 15,000 RPM.

Road and Race Proven.

(Opto-Electric Systems won at  
INDY Two years in a row!)



● **QUICK AND EASY INSTALLATION**

★ If you want the BEST, and SAVE! This is IT!

● ORDER with CONFIDENCE...

**SATISFACTION GUARANTEED!**

Only \$49.95  
**COMPLETE.**

**1-YEAR FACTORY WARRANTY.**

● As you can see, you're not taking any  
chances at all... Send your Order Today

State Make, Year, Engine Size. (Calif. Res. add Tax).

● (So New...it's Sold ONLY FROM FACTORY DIRECT).

You may use your MASTER CHARGE or BANKAMERICARD.  
Send us (1) Your Number, (2) Interbank No., (3) Exp. Date.

● Before buying any other Type ignition system...

**Send Postcard for our FREE BROCHURE.**

★ If you have already installed a C-D ignition system,

Modernize and Increase its Efficiency...

**CONVERT YOUR "C-D" UNIT TO BREAKERLESS!**

Opto-Electric "TRIGGER UNIT"... Only \$34.95

● Our BEST Salesmen are the owners  
and users of our ALLISON System!



**ALLISON**  
**AUTOMOTIVE COMPANY**

1269-P, East EDNA PL., COVINA, CAL. 91722

CIRCLE NO. 2 ON READER SERVICE CARD  
86

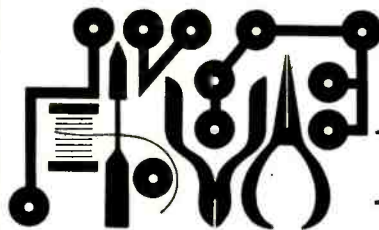

# Hobby Scene

## MOBILE CB POWER SUPPLY

**Q.** I'm a CB bug and I've been trying to build a power supply for my mobile rig (12-14.5 V, 1 A), but all the 6.3-volt transformers tried give me 8, 10, or 12 volts on my meter. Can you give me a circuit for such a supply, or give me the name and model of a transformer which will give an honest 6.3 volts?—R. Rodriguez, Bronx, N.Y.

**A.** We have always found trans-

former labelling to be accurate. Why not have your dealer check out the questionable component? In your case however, you may be reading peak-to-peak voltage, which is 1.414 times greater than the 6.3 V-rms output the transformer is rated for. Here's a power supply that will work with most transceivers and auto tape players. It uses a 6.3-volt transformer and a voltage doubler.

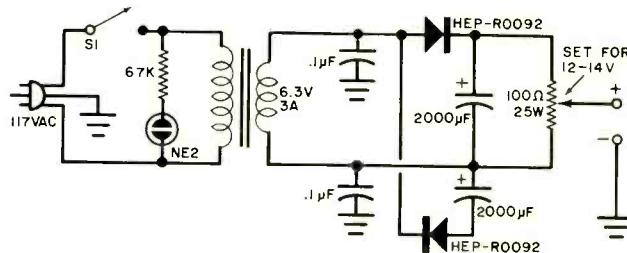

## A SUPPLY FOR TTL EXPERIMENTS

**Q.** I would like to experiment with TTL, but I don't know what 5-volt supply would be suitable. Can you help?—Chris Sommers, Oakland, Ca.

**A.** Sure! The circuit here uses a

6.3-volt filament transformer, a four-diode full-wave bridge (a one-package bridge module can be used), a large electrolytic, and a 5-volt regulator. Parts can be found in almost any electronics store, or by mail-order—check the back of this magazine!

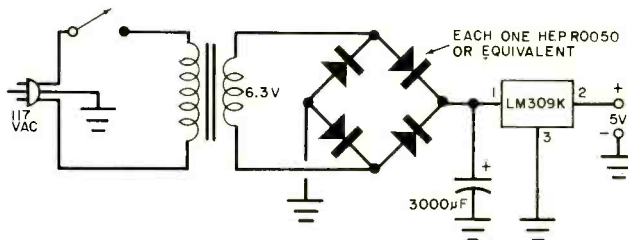

## WHAT ARE WHITE AND PINK NOISE?

**Q.** What are "white noise" and "pink noise"? Is there a simple circuit which will generate pink noise?—C. Spaulding, Fredonia, NY.

**A.** A concise and technically correct definition of white noise is: noise whose amplitude (strength) is a random (Gaussian) variable but which

has equal energy distribution over all frequencies of interest, regardless of the center frequency of the frequency range being considered. Pink noise is noise whose amplitude is inversely proportional to frequency over a specified range. Equal energy distribution occurs in any octave bandwidth within that range. Pink noise is very pleasing to the human ear, which is why many people feel relaxed listen-



ing to the patten of rain (a close approximation of pink noise). Other examples include the sound of surf and a shower stream. In the circuit below, a

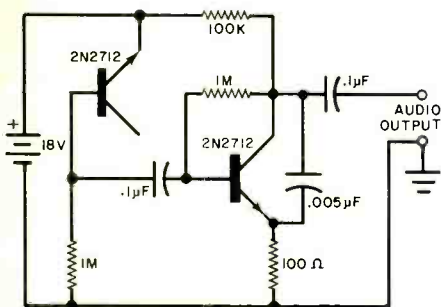

reverse-biased pn junction of a 2N2712 transistor is used as a noise generator. The second 2N2712 is an audio amplifier. The 0.005- $\mu$ F capacitor across the amplifier output removes some high-frequency components to simulate pink noise more closely. The audio output may be connected to high-impedance earphones or to a driver amplifier for speaker listening.

#### MOISTURE SENSOR

**Q.** Can you furnish me with a circuit for a moisture-sensing system which will turn on a pump when my basement gets flooded?—M.R. Cash, W. Palm Beach, Fla.

**A.** We have had several requests for similar applications, so the circuit shows a "black-box" load. The triac,

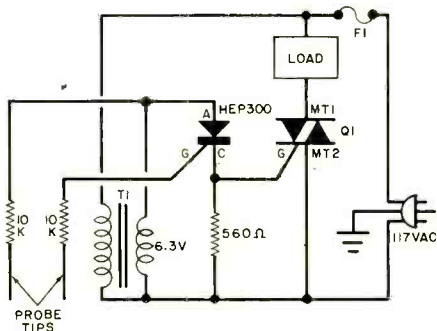

Q1, is not given a specific part number since various loads demand different currents. Check how much current your load demands and obtain a triac that can handle this amount. The triac should be well heat-sinked. Use the same current rating for F1 as Q1, and make it a quick-acting type fuse. The resistors may be mounted on a board, with leads in the clear used as probe tips.

APRIL 1975

## now available for the telephone experimenter

### COMPLETE CONSTRUCTION PLANS

TELEPHONE PLANS \$3.00 each.  
Answering Device, Automatic Dialer, "Black Box", Call Diverter, Call Limiter, Conference Bridge, Central Dial Exchange, Melodic Ringing Generator, Recorder - Actuator, Remote Control, Schematics, Speakerphone, Teletink, Burglar Alarm, Voice Scrambler, Dial/Tone Converter, Tone/Dial Converter.

MISC. PLANS \$6.00 each  
Biofeedback Conditioner, Multifrequency Encoder Network, Horticulture Simulator, Dodecahedron Speaker Enclosure, Photographic Pinhole Camera.

ALL OF THE CONSTRUCTION PLANS ABOVE: \$24.95 AIRMAILED.

### LEARN THE SECRETS OF YOUR TELEPHONE



Have you ever wondered what lies behind that telephone dial? Now you can learn the tricks of the telephone trade. Get the inside story of telephone systems—their quirks and flaws, and remain up to date on vital occurrences within the telephone industry. TELEPHONE ELECTRONICS LINE is a publication designed for the telephone enthusiast, Phone Phreak, and experimenter, containing interesting articles which offer a wealth of hard to find information. Technical theory is also discussed, among the following items:  
**Current News Items • Code Numbers Illustrations • Games • Facts • Plans Projects • History • Comics • Stories**  
Facts previously Tel. Co. confidential is now published in TEL!

One year subscription rate: United States \$6.00, Canadian & foreign \$8.00.

### THE LEGAL ASPECTS OF INTERCONNECTION

The complete reference book to your LEGAL RIGHTS as a telephone subscriber. Study toll evasion, tariffs, wiretapping, customer provided equipment, and many more!

ALL OF THE CONSTRUCTION PLANS ABOVE PLUS A ONE YEAR SUBSCRIPTION TO TEL PLUS "THE LEGAL ASPECTS OF INTERCONNECTION": \$40.00 AIRMAILED.

TELETRONICS COMPANY OF AMERICA  
22035 BURBANK BLVD., WOODLAND HILLS CA 91364 USA

CIRCLE NO. 44 ON READER SERVICE CARD

## Get this \$1100 cordless soldering iron for \$20



Model 7500 kit. Auto charger plug and extra tips optional.

Users tell us our Iso-Tip® Cordless Soldering Iron is worth its weight in gold. At writing, that's about \$1100 for a handy 5-oz. iron which lets you make up to 125 (or more) joints per charge . . . with cordless freedom of action!  
Snap on the standard fine tip or optional extra micro, general purpose, heavy duty or extension tips. Press a button and put 700° to work in 5 seconds . . . with a built-in spotlight on the action. Recharge overnight in the stand included.

This is the original cordless iron, with patented isolated tip design to eliminate electrical leakage.  
Yours for \$19.95. See your electronics parts dealer or order direct.

**WAHL CLIPPER CORPORATION**  
Department 2 • 2902 Locust Street  
Sterling, Illinois 61081 • (815) 625-6525  
Manufacturing excellence for over 50 years.  
CIRCLE NO. 42 ON READER SERVICE CARD

## fight birth defects

# Give MARCH OF DIMES

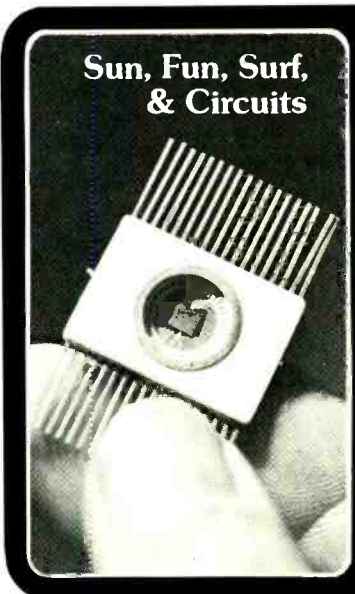

Imagine a curriculum in Electronics Technology that includes field trips to the Bahamas and the Florida Keys. Florida Institute of Technology offers you this and more. Our fully-accredited two year Associate of Science degree program in Electronics Technology provides a unique balance between the academic and the practical. This course offers specialization options in Marine, Communications, or Industrial technology. Our coeducational campus is set in 84 acres of tropical palms bordering the Indian River at Jensen Beach, Florida.  
For further information return coupon to:  
**Florida Institute of Technology**  
720 S. Indian River Drive, Jensen Beach, Fla. 33457

Name \_\_\_\_\_  
Street \_\_\_\_\_  
City \_\_\_\_\_ Zip \_\_\_\_\_ Age \_\_\_\_\_  
Veteran  PE 4/75

# Now...the most enjoyable, do-it-yourself project of your life—a Schober Electronic Organ!

You'll never reap greater reward, more fun and proud accomplishment, more benefit for the whole family, than by assembling your own Schober Electronic Organ.



You need no knowledge of electronics, woodwork or music. Schober's complete kits and crystal-clear instructions show you—whatever you are, whatever your skill (or lack of it)—how to turn the hundreds of quality parts into one of the world's most beautiful, most musical organs, worth up to twice the cost of the kit.

Five superb models, with kit prices from \$575 to around \$2,300, each an authentic musical instrument actually superior to most you see in stores.

Join the thousands of Schober Organ builders—owners who live in every state of the Union. Often starting without technical or music skills, they have the time of their lives—first assembling, then learning to play the modern King of Instruments through our superlative instructions and playing courses.

Get the full story FREE by mailing the coupon TODAY for the big Schober color catalog, with all the fascinating details!

The Schober Organ Corp., Dept. PE-59  
43 West 61st Street, New York, N. Y. 10023

- Please send me Schober Organ Catalog.  
 Enclosed please find \$1.00 for 12-inch L.P. record of Schober Organ music.

NAME \_\_\_\_\_  
ADDRESS \_\_\_\_\_  
CITY \_\_\_\_\_ STATE \_\_\_\_\_ ZIP \_\_\_\_\_

CIRCLE NO. 36 ON READER SERVICE CARD

## LARGE-LARGE DISCOUNTS LOW - LOW PRICES

NATIONALLY  
ADVERTISED STEREO EQUIPMENT  
AT LOWEST PRICES!

TURNABLES \* SPEAKERS \* RECEIVERS  
AMPLIFIERS \* TAPE RECORDERS

WRITE FOR QUOTE ON  
NATIONALLY ADVERTISED BRANDS OF STEREO  
COMPONENTS. SATISFACTION  
GUARANTEED!

*Clifford's*  
**HI-FI WHOLESALERS**  
P. O. Box 809  
Kankakee, Illinois 60901  
(815)-939-7868

CIRCLE NO. 10 ON READER SERVICE CARD

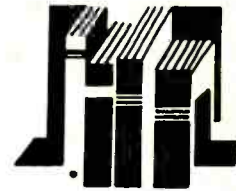

## Electronics Library

### COLOR TV TROUBLE FACTBOOK (2nd Edition)

This revised edition of the Factbook, by Editors of Electronic Technician/Dealer, includes an indexed reference guide to color TV problems and recommended solutions, manufacturers' service notes, and production change data. Service tips, troubleshooting data, and special problem-solving advice are given for many of the popular U.S. and Canadian color TV models. Each set is arranged alphabetically by manufacturer and model number. Partial schematics, location diagrams, chassis layouts, and sketches are included to make parts identification and replacement easier.

Published by Tab Books, Blue Ridge Summit, PA 17214. 348 pages. \$8.95, hard cover; \$4.95, paperback.

### SECOND-CLASS RADIOTELEPHONE LICENSE HANDBOOK (FIFTH EDITION)

by Edward Noll

The objective of this book is to prepare the reader for the required FCC examination, including the Elements I, II, and III tests. The first chapter provides a summation of operator and station licensing requirements. Operating frequencies, propagation characteristics, and emission types are described in Chapter Two. Later chapters concentrate on the responsibilities of the Second-Class licensee. Sample tests, rules and regulations, and progressive quizzes are included.

Published by Howard W. Sams & Co., Indianapolis, IN 46268. 448 pages. \$7.50 soft cover.

### THE VIDEO PRIMER

by Richard Robinson

This "how-to" book about the video media explains basic theory, hardware hookup and operating techniques for video cassette systems. Each chapter covers a specific topic, such as lighting, editing, and vidicons, to provide the user with as complete an exposure to video production as possible. The book is geared towards those who are disenchanted with network programming and who would like to produce their own material, whether for personal or community benefit.

Published by Links Books, 33 West 60th Street, New York, NY 10023. 380 pages. \$7.95 soft cover.

## OEMorsco

An OEM Distributor Of  
Certified Integrated Circuits

### A WARNING!!

DON'T READ THIS IF YOU DON'T VALUE YOUR TIME!  
Because of our large volume, and aggressive buying, our prices are lower than most manufacturer's 100 pc. OEM prices. If you wish to buy rejects, then buy the cheapest circuits you can find. This is sometimes OK for TTL circuits, but for MOS and CMOS, watch out! Our engineers like to have their projects work! We hope you feel the same way about yours. Is your time worth 20 cents/hour to troubleshoot marginal I.C.'s? If your time is worth more than that, then be advised that OEMorsco is the ONLY mail order supplier of certified and guaranteed I.C.'s and that our prices reflect the true costs of buying prime I.C.'s and testing every one to insure quality performance.

### MOS AND CMOS PRICES ARE COMING DOWN!

(TAKE A LOOK AT OUR DISCOUNT SCHEDULE BELOW)

#### USEFUL CMOS

The most useful logic family  
All 74C series are in our  
cross reference catalog

#### GATES

CD4001AE QUAD 2 NDR	.51
CD4002AE DUAL 4 NDR	.51
CD40011AE QUAD 2 NAND	.51
CD40012AE DUAL 2 NAND	.51
CD4023AE TRIP 3 NAND	.51
CD4025AE TRIP 3 NOR	.51
CD4071AE QUAD 2 EXOR	.51
CD4081AE QUAD 2 AND	.51

#### COUNTERS, DIVIDERS

CD4017AE DECADE	3.27
CD4018AE N. PRESETTABLE	3.86
CD4020AE 14 STAGE BINARY	3.39
CD4024AE 7 STAGE BINARY	1.90
CD4026AE DECADE WITH 7 SEC. DECODE.	6.25
CD4029AE UP, DDWN DRIVER	3.96
CD4029AE UP, DDWN PRESETTABLE	3.96

#### FLOPS

CD4013AE QUAD 0	1.98
CD4027AE DUAL JK	1.98

#### SHIFT REGISTERS

CD4006AE 18 BIT STATIC	2.93
------------------------	------

#### ADDERS

CD4008AE 4 BIT FULL	3.56
---------------------	------

#### DECODERS

CD4026AE DECADE TO 7	2.99
CD4033AE DECADE TO 7 W/RIPPLE BLANKING	3.85

#### MULTIPLEXERS

CD4016AE QUAD SWITCH	.99
CD4051AE DNE 8 CH	3.45
CD4053AE TRIP 2 CH	3.45
CD4066AE QUAD SWITCH	2.25

#### BUFFERS

CD4009AE HEX INV	1.30
CD4010AE HEX	1.30
CD4049AE HEX INV	1.30
CD4050AE HEX	1.30

#### MOS L.S.I.

MM5013N SINGLE 1024 BIT DYNAMIC SHIFT REGISTER	6.00
MM5016N SINGLE 512 BIT DYNAMIC SHIFT REGISTER	2.95
MM5017N DUAL 512 BIT DYNAMIC SHIFT REGISTER	5.80
MM5055N QUAD 128 BIT STATIC SHIFT REGISTER	4.50
MM5056N DUAL 256 BIT STATIC SHIFT REGISTER	4.25
MM5057N SINGLE 512 BIT STATIC SHIFT REGISTER	4.25
MM5058N SINGLE 1024 BIT STATIC SHIFT REGISTER	7.95
2502B QUAD 256 BIT DYNAMIC SHIFT REGISTER	6.10
2503V DUAL 512 BIT DYNAMIC SHIFT REGISTER	4.95
2504TA SINGLE 1024 BIT DYNAMIC SHIFT REGISTER	4.95
2504V SINGLE 1024 BIT DYNAMIC SHIFT REGISTER	4.75
2525V SINGLE 512 RECIRCULATING DYNAMIC	4.00
2509A DUAL 50 BIT STATIC SHIFT REGISTER	3.35
2510A DUAL 100 BIT STATIC SHIFT REGISTER	3.95
2521V DUAL 128 BIT STATIC SHIFT REGISTER	4.55
2527V DUAL 256 BIT STATIC SHIFT REGISTER	4.95
2533V SINGLE 1024 BIT STATIC SHIFT REGISTER	7.95
2602B 1024 STATIC RAM	13.85
C1103-1 1024 DYNAMIC RAM	5.50
P2102-2 1024 STATIC RAM	8.95

#### LINEAR

LM311N COMPARATOR 8 PIN DIP	1.25
LM311N-14 COMPARATOR 14 PIN DIP	1.78
LM311H COMPARATOR 8 PIN TO5	1.96
LM324N QUAD OP AMP 14 PIN DIP	1.99
LM380N AUDIO POWER 14 PIN DIP	1.15
LM3804N AUDIO POWER 8 PIN DIP	1.25
LM555N TIMER 8 PIN DIP	.76
LM741CH MOST POPULAR OP AMP	.60
LM320K-5, 5.5, 12, 15 TO3	3.10
LM308H HI Z INPUT OP AMP	1.50
LM308AH	4.95

Send \$2.00 for our unique limited edition catalog, industry-wide pin for pin cross reference functional guide and price list.

Please inquire about DM8090 through DM8880, F9300 series, Signetics 2500 and 9T series, and DTL, TTL. We also offer burn-in and custom testing (e.g., LM308AN-0.1mv) to OEM's.

#### OEMorsco

2403 Charleston Road  
Mountain View, CA 94043  
415-965-4446

DISCOUNTS: \$100—7%, \$350—14%, \$1000—22%, \$3500—30%, \$10K—36%.  
TERMS: Cash, check, \$1.00 packaging and postage for orders under \$20.00. California sales tax 6%.

CIRCLE NO. 30 ON READER SERVICE CARD



# ELECTRONICS MARKET PLACE

**NON-DISPLAY CLASSIFIED: COMMERCIAL RATE:** For firms or individuals offering commercial products or services, \$1.80 per word (including name and address). Minimum order \$27.00. Payment must accompany copy except when ads are placed by accredited advertising agencies. Frequency discount; 5% for 6 months; 10% for 12 months paid in advance. **READER RATE:** For individuals with a personal item to buy or sell, \$1.10 per word (including name and address.) No minimum! Payment must accompany copy. **DISPLAY CLASSIFIED:** 1" by 1 column (2-1/4" wide), \$215.00. 2" by 1 column, \$430.00. 3" by 1 column, \$645.00. Advertiser to supply cuts. For frequency rates, please inquire.

**GENERAL INFORMATION:** First word in all ads set in bold caps at no extra charge. All copy subject to publisher's approval. All advertisers using Post Office Boxes in their addresses **MUST** supply publisher with permanent address and telephone number before ad can be run. Advertisements will not be published which advertise or promote the use of devices for the surreptitious interception of communications. Closing Date: 1st of the 2nd month preceding cover date (for example, March issue closes January 1st. Send order and remittance to **POPULAR ELECTRONICS**, One Park Avenue, New York, New York 10016, Attention: Hal Cymes.

## FOR SALE

**FREE! Bargain Catalog—I.C.'s, LED's, readouts, fiber optics, calculators parts & kits, semiconductors, parts. Poly Paks, Box 942PE, Lynnfield, Mass. 01940.**

**GOVERNMENT Surplus Receivers, Transmitters, Sniperscopes, Radios, Parts, Picture Catalog 25 cents. Meshna, Nahant, Mass. 01908.**

**LOWEST Prices Electronic Parts. Confidential Catalog Free. KNAPP, 3174 8th Ave. S.W., Largo, Fla. 33540.**

**ELECTRONIC PARTS, semiconductors, kits, FREE FLYER. Large catalog \$1.00 deposit. BIGELOW ELECTRONICS, Bluffton, Ohio 45817.**

**RADIO—T.V. Tubes—36 cents each. Send for free catalog. Cornell, 4213 University, San Diego, Calif. 92105.**

**WE SELL CONSTRUCTION PLANS. TELEPHONE: Answering Machine, Speakerphone, Carphone, Phonevision, Auto Dialer, Touch Button Dialer, Central Dial System. TELEVISION: \$35.00 Color Converter, Video Tape Recorder, \$25.00 Camera. HOBBYIST: Electron Microscope, 96 Hour Tape Music System, Ultrasonic Dishwasher, Radar-Oven, Plans \$4.95 each. NEW ITEM: \$75. Electronic Pocket Calculator, \$7.50. COURSES: Telephone Engineering \$39.50, Detective Electronics \$22.50, Integrated Circuit Engineering, \$49.50. NEW SUPER HOBBY CATALOG plus year's subscription to Electronic News Letter AIRMAILED \$1.00. Don Britton Enterprises, 6200 Wilshire Blvd., Los Angeles, Calif. 90048.**

**AMATEUR SCIENTISTS, Electronics Experimenters, Science Fair Students... Construction plans—Complete, including drawings, schematics, parts list with prices and sources... Robot Man — Psychedelic shows — Lasers — Emotion/Lie Detector — Touch Tone Dial — Quadrasonic Adapter — Transistorized Ignition — Burglar Alarm — Sound Meter... over 60 items. Send 25 cents coin (no stamps) for complete catalog. Technical Writers Group, Box 5994, University Station, Raleigh, N.C. 27607.**

**METERS—Surplus, new used, panel or portable. Send for list. Hanchett, Box 5577, Riverside, CA 92507.**

**YOU WILL SAVE BIG MONEY! Surplus, Clearouts, Bankruptcy, Inventory, Deals, Catalog \$1 (redeemable). ETCOA Electronics, Box 741, Montreal, H3C 2V2. U.S. Inquiries.**

**BURGLAR-FIRE alarm supplies and information. Free catalog. Protecto Alarm Sales, Box 357-G, Birch Run, Michigan 48415.**

**BUGGED??? New locator finds them fast. Write, Clifton, 11500-L N.W. 7th Avenue, Miami, Florida 33168.**

**TELEPHONE "BUGGED"? Countermeasures Brochure \$1.00, Negeye, Drawer 547, Pennsboro, W. VA 26415.**

**HEAR POLICE/FIRE Dispatchers! Catalog shows exclusive directories of "confidential" channels, receivers. Send 10 cent stamp. Communications, Box 56-PE, Commack, N.Y. 11725.**

**CONVERT any television to sensitive, big-screen oscilloscope. Only minor changes required. No electronic experience necessary. Illustrated plans. \$2.00. Sanders, Dept. A-33, Box 92102, Houston, Texas 77010.**

**LOOKING FOR A NEW CHALLENGE?**  
... then build a TV camera!



ONLY SOLID STATE CAMERA AVAILABLE IN KIT FORM OR FACTORY ASSEMBLED. COMPLETE KIT WITH VIDEO TUBE ONLY \$169.95. POSTAL DELIVERY ANYWHERE IN U.S.A., CANADA and MEXICO. OPTIONAL AUDIO SUBCARRIER \$169.95. WRITE or PHONE NOW FOR COMPLETE CATALOG OF KIT PARTS and PLANS. (201) 432-397-3979.

1309 BROADWAY **ATV Research** DANOTA CITY, NEBR. 68721

**MECHANICAL, ELECTRONIC devices catalog 10 cents. Greatest Values — Lowest Prices. Fertik's, 5249 "D", Philadelphia, Pa. 19120.**

**SOUND SYNTHESIZER KITS—Surf \$12.95, Wind \$12.95, Wind Chimes \$17.95, Electronic Songbird \$6.95, Musical Accessories, many more. Catalog free. PAIA Electronics, Box J14359, Oklahoma City, OK 73114.**

**DISCOUNT PRICES**  
B & K, SENCORE, LEADER and RCA  
Test Equipment  
RAYTHEON, ICC/MULLARD Tubes  
TELEMATIC Test Jigs  
Free Catalog  
**FORDHAM RADIO SUPPLY CO., INC.**  
558 Morris Ave. • Bronx, N.Y. 10451

**CRYSTALS, Scanners, \$3.88, include make and frequency. G Enterprises, P.O. Box 461PC, Clearfield UT 84105.**

## SPRING CLEARANCE SALE!

### Japanese Transistors

2SA52	60	2SB463	1.65	2SC805	1.00	2SC1237	2.00
2SA101	.70	2SB471	1.75	2SC619	.70	2SC1239	2.80
2SA103	.70	2SB474	1.75	2SC620	.80	2SC1293	.85
2SA221	.60	2SB481	2.10	2SC627	1.75	2SC1317	.60
2SA473	.85	2SB492	1.25	2SC644	.70	2SC1347	.80
2SA495	.65	2SB495	.95	2SC645	.85	2SC1377	6.75
2SA497	.55	2SB605	2.00	2SC681	2.50	2SC1383	.75
2SA505	.65	2SB606	2.00	2SC684	2.10	2SC1393	.60
2SA562	.70	2SC15	.65	2SC687	2.50	2SC1409	2.75
2SA607	2.25	2SC24	.65	2SC696	2.35	2SC1410	2.75
2SA613	1.00	2SC32	.65	2SC710	.70	2SC1450	1.00
2SA643	.85	2SC33	.65	2SC711	.70	2SC1454	2.75
2SA647	2.75	2SC41	4.00	2SC712	.70	2SD300	.95
2SA673	.85	2SC49	.80	2SC713	.70	2SD45	2.00
2SA679	2.25	2SC56	.95	2SC732	.70	2SD64	.75
2SA682	.95	2SC143	3.50	2SC733	.70	2SD65	.75
2SA699	1.30	2SC154	3.75	2SC735	.70	2SD68	.70
2SA699A	2.00	2SC162	3.75	2SC739	.70	2SD72	1.00
2SA705	.55	2SC163	4.50	2SC756	1.50	2SD88	1.50
2SA714	2.50	2SC185	1.00	2SC774	1.75	2SD120	.85
2SA720	.70	2SC202	1.00	2SC775	2.00	2SD130	1.50
2SA733	.65	2SC206	1.00	2SC778	3.00	2SD141	2.25
2SB22	.65	2SC240	1.10	2SC783	1.00	2SD151	2.50
2SB54	.70	2SC261	.65	2SC784	.70	2SD170	2.00
2SB56	.70	2SC291	.65	2SC785	1.00	2SD180	3.00
2SB77	.70	2SC320	.75	2SC792	3.00	2SD198	2.50
2SB128	2.50	2SC352	.75	2SC793	2.50	2SD201	2.50
2SB135	.95	2SC353	.75	2SC828	.75	2SD218	5.00
2SB152	4.50	2SC371	.70	2SC829	.75	2SD235	1.00
2SB172	.55	2SC372	.70	2SC833	.70	2SD261	.80
2SB173	.55	2SC380	.70	2SC838	.70	2SD291	.85
2SB175	.55	2SC387	.70	2SC839	.85	2SD292	.85
2SB178	1.00	2SC394	.70	2SC930	.65	2SD300	2.50
2SB186	.60	2SC458	.70	2SC945	.65	2SD315	.75
2SB187	.60	2SC460	.70	2SC1010	.80	2SD318	.95
2SB235	1.95	2SC478	.80	2SC1012	.80	2SD341	.95
2SB303	.65	2SC482	1.75	2SC1013	1.50	2SD350	3.50
2SB324	1.00	2SC491	2.50	2SC1014	1.50	2SD352	.80
2SB337	2.10	2SC495	.70	2SC1018	1.50	2SD389	.95
2SB364	.65	2SC497	1.60	2SC1030	3.25	2SD390	.75
2SB365	.65	2SC515	.80	2SC1051	2.50	2SD437	6.00
2SB367	1.60	2SC535	.95	2SC1061	1.65	2SD458	.80
2SB370	1.10	2SC536	.65	2SC1096	1.20	2SD1111	3.50
2SB379	.65	2SC537	.70	2SC1098	1.15	2SD1115	3.75
2SB380	.70	2SC563	2.50	2SC1115	2.75	2SK19	2.25
2SB405	1.00	2SC564	.70	2SC1166	.70	2SK30	1.25
2SB407	2.10	2SC568	.70	2SC1173	1.25	2SK40	1.60
2SB415	1.05	2SC582	.85	2SC1213	.75		
2SB461	1.25	2SC591	2.50	2SC1226	1.25		

### OEM SPECIALS

**TRANSISTOR SPECIALS**  
Power Units Similar to Jeced Nos. Hardware Included.

2N441	To-36	2 1 00	2N718	27	15	2N2222A	35	22
2N458A	To-3	4 1 00	2N918	55	25	2N2369	18	13
2N538	Mt-36	3 1 00	2N930	25	18	2N2484	75	35
2N1015	Mt-1	1 00	2N1420	25	15	2N2904	50	20
2N1725	To-61	2 1 50	2N1613	.65	30	2N2905	50	20
2N2288	To-3	2 1 00	2N1711	.65	30	2N2905A	85	35
2N3054	To-66	5 1 00	2N2218	50	22	2N2906	40	20
2N3055	To-3	4 1 00	2N2219	50	22	2N2907	40	20
2N5002	To-59	3 2 00	2N2219A	75	30	2N3053	20	16
2N5296 Tip31	To-220	7 1 00	2N2221	25	17	2N3251	75	35
			2N2222	23	17	2N4036	75	35

**Motorola MK-20 Power Transistor Mounting Kit .75**

**Integrated Circuits**

UA703C	40
CA3086	4 00
CA3068	6 50
MC1305	1 50

Replacement for Zenith 221-36 221-37 221-39 3 50

**World's Smallest Transistor! Now Available! Limited Time Only!**  
Case Size .04 x .04 x .03 in PNP 3 00 NPN 3 00

**Transistor Grab Bag - Germanium and Silicon small sigs and power transistors 95% yield 30 1 00**

**Automotive Ignition Power IC Darlington 7 amp. BVCEO 500v. 8 95**

**CITIZEN BAND APPLICATION**  
NPN Silicon 27 MH Band RF Power Transistors

2SC781	3 25	2SC799	4 75	2SC1306	5 75	2SC1307	6 75	2SC517	4 75	MRF8004	3 00
--------	------	--------	------	---------	------	---------	------	--------	------	---------	------

**EXTRA VALUES!**

SCRs and Triacs To 39 To 18	5 1 00
To 64 To 48	50 1 00
Sil. glass rectifiers	50 1 00
German glass rect	50 1 00
1N914 sil. fast switch	10 90
1N2557 1N channel 10 32 plastic	4 1 00
NPN To 92 25v CEO HFE 25 100	10 1 00
100 300 and 300 500 @ 2MA	6 1 00
106y	10 1 00
Hobbyist's 16 pin Digital IC Guaranteed	10 1 00
709C Hi. Perf. op amp	4 1 00
IR 128 Heat Exchanger	50
IR Selenium Bridge Rectifier	50
IR Selenium Bridge Rectifier	50
IR Silicon Replacement Rectifier	50
IR Selenium 5 Pin. Convergence Rectifier	50
IR Universal Selenium Focus Rectifier	1 00
Omitate vitreous enameled Resistor	50
GE X6 Cadmium sulfide PhotoCell	50
GE 60D1 Dual Diode	35
GE 60X1 Dual Diode	40

**POWER TRANSISTORS**  
High Voltage TV Transistors

BU204	1300v	4 00	1N4001	90
BU205	1500v	4 75	1N4002	1 00
BU206	1700v	5 80	1N4003	1 10
BU207	1300v	5 50	1N4004	1 20
BU208	1500v	6 75	1N4005	1 30
BU209	1700v	8 25	1N4006	1 40
2SC1170	1100v	4 00	1N4007	1 50
2SC1172B	1100v	4 50		
2SC1308	1100v	5 00	12' Line Cords	
2SD380	1100v	6 00	.25 ea	

**SILICON UNIJUNCTIONS**

2N2646	To-18	50	SS4001AE	55	SS4025AE	55
2N2647	To-18	65	SS4002AE	65	SS4027AE	1 35
2N6027 PUT	To-92	55	SS4011AE	.55	SS4028AE	2 80
2N6028 PUT	To-92	75	SS4012AE	.55	SS4030AE	65
2N1671	To-5	1 00	SS4013AE	1 30	SS4049AE	1 35
D5E37	To-18	4 1 00	SS4015AE	3 00	SS4050AE	1 35
			SS4023AE	55		

**BRIDGES**  
PRV 2 AMP PRV 2 AMP

200	95	600	1 25
300	1 10	1000	1 75

**CMOS**

CHECK OR MONEY ORDER  
NO CODS. INCLUDE 10% FOR POSTAGE AND HANDLING  
MINIMUM ORDER \$ 5 00

**New-Tone Electronics**  
P.O. BOX 1738 A  
BLOOMFIELD, N.J. 07003



# CMOS



## IN PLASTIC DIP PACKAGES INPUTS PROTECTED AGAINST STATIC CHARGE

4000AE	DUAL 3 INPUT NOR PLUS INVERTER	30c
4001AE	QUAD 2 INPUT NOR	30c
4002AE	DUAL 4 INPUT NOR	30c
4006AE	18 STAGE STATIC SHIFT REGISTER	\$1.50
4007AE	DUAL COMPLEMENTARY PAIR PLUS INVERTER	30c
4008AE	FOUR BIT FULL ADDER	\$1.17
4009AE	HEX BUFFER/CONVERTER	67c
4010AE	HEX BUFFER/CONVERTER	67c
4011AE	QUAD 2 INPUT NAND	30c
4012AE	DUAL 4 INPUT NAND	30c
4013AE	DUAL D FLIP FLOP W/ SET/RESET	53c
4014AE	8 STAGE STATIC SHIFT REG. SYNCHRONOUS INPUT	\$1.67
4015AE	DUAL 4 STAGE STATIC SHIFT REGISTER	\$1.17
4016AE	QUAD BILATERAL SWITCH	63c
4017AE	DECADE COUNTER/DIVIDER W/ DECODED OUTPUTS	\$1.34
4018AE	PRESETTABLE DIVIDE BY N COUNTER	\$1.67
4019AE	QUAD AND-OR SELECT GATE	58c
4020AE	14 STAGE BINARY/RIPPLE COUNTER	\$1.67
4021AE	8 STAGE STATIC SHIFT REGISTER	\$1.50
4022AE	DIVIDE BY 8 COUNTER/DIVIDER	\$1.25
4023AE	TRIPLE 3 INPUT NAND	30c
4024AE	7 STAGE BINARY COUNTER	\$1.00
4025AE	TRIPLE 3 INPUT NOR GATE	30c
4026AE	DECADE COUNTER/DIVIDER W/ 7 SEG DISPLAY OUTPUT AND DISPLAY ENABLE	\$1.67
4027AE	DUAL J-K MASTER-SLAVE FLIP FLOP	67c
4028AE	BCD TO DECIMAL DECODER	\$1.09
4029AE	PRESETTABLE UP/DOWN COUNTER	\$1.42
4030AE	QUAD EXCLUSIVE OR GATE	50c
4033AE	DECADE COUNTER W/ 7-SEG DISPLAY OUTPUT AND RIPPLE BLANKING	\$1.67
4034AE	8 STAGE STATIC SHIFT REGISTER, BUSS ORIENTED	\$3.34
4035AE	4 STAGE PARALLEL IN/OUT SHIFT REGISTER	\$1.42
4040AE	12 STAGE RIPPLE CARRY BINARY COUNTER	\$1.67
4041AE	QUAD BUFFER-TRUE/COMPLEMENT	92c
4042AE	QUAD CLOCKED D LATCH	84c
4043AE	QUAD 3 STATE NOR R/S LATCH	67c
4044AE	QUAD 3 STATE NAND R/S LATCH	67c
4046AE	MICROPOWER PHASE LOCKED LOOP	\$2.51
4049AE	HEX BUFFER/CONVERTER-INVERTING	58c
4050AE	HEX BUFFER/CONVERTER-NON INVERTING	58c
4051AE	SINGLE 8 CHANNEL MULTIPLEXER	\$1.50
4052AE	DIFFERENTIAL 4 CHANNEL MULTIPLEXER	\$1.50
4053AE	TRIPLE 2 CHANNEL MULTIPLEXER	\$1.50
4060AE	14 STAGE RIPPLE-CARRY BINARY COUNTER/DIVIDER AND OSCILLATOR	\$1.67
4066AE	QUAD BILATERAL SWITCH	\$1.00
4071AE	QUAD 2 INPUT OR	30c
4072AE	DUAL 4 INPUT OR	30c
4073AE	3-3 INPUT AND	30c
4075AE	3-3 INPUT OR	30c
4081AE	QUAD 2 INPUT AND	30c
4082AE	DUAL 4 INPUT AND	30c

**DISCOUNTS:** CMOS can be included with TTL and Linear IC's. Deduct 4% from the total of your IC order if it exceeds \$25.00 based on single lot prices, 7% for \$50.00 or more, 10% for \$100.00 or more.

Send for Free Catalog or Mail Readers Service Card  
C.O.D. ORDERS ACCEPTED FOR SAME DAY SHIPMENT  
CALL 218-681-6674

Orders Less than \$10.00 add 50c Service Charge — Others Postpaid  
"Only Quality Components Sold!"

### DIGI-KEY CORPORATION

P.O. Box 126 Thief River Falls, MN 56701

CIRCLE NO. 15 ON READER SERVICE CARD

FREE CATALOG. Kits, Components, audio equipment. Electronic Supply Pacs, Box 175, Floral Park N.Y. 11001.

ALPHA/THETA BRAINWAVE biofeedback instruments. Analog instruments from \$125; digital processing systems from \$225. BioScan, Box 14168-E, Houston, Texas 77021.

SURPRISE! Build inexpensively, the most Unusual Test Instruments, Futuristic Gadgets using Numerical Readouts! Catalogue Free! GBS, Box 100A, Green Bank, West Virginia 24944.

ELECTRONIC IGNITION: Capacitor, transistor, pointless. Auburn sparkplugs. Information 10 cents. Anderson Engineering, Epsom, N.H. 03234.

WHOLESALE Scanners, CB, Crystals, Directories, SSB/AM, Catalog 25 cents. G—Enterprises, Box 461P, Clearfield, Utah 84105.

7,000 SEMICONDUCTORS, 100's Electronic Circuit Kits, Technical Reports, Energy Conservation, Computers, Cat. 50 cents. E/S Lab, Box 738, College Park, MD 20740.

LEARN DESIGN TECHNIQUES. Electronics Monthly Newsletter. Digital, linear construction projects, design theory and procedures. Sample copy \$1.00. Valley West, Box 2119-B, Sunnyvale, California 94087.

TELEPHONES UNLIMITED, equipment, supplies. Catalog 50 cents. Box 1654E, Costa Mesa, Calif. 92626.

WE SELL MONEY MAKING CONSTRUCTION MANUALS!!! — Reclaim GOLD, SILVER for EXCELLENT full or part time money!!! — PLUS, we buy scrap gold & silver — ALSO, we sell 99.999% pure SILVER BARS!!! — Color Catalog 25 cents — Airmailed 50 cents — Creative Products, Dept. PE-475, 4913 Northridge NE, Albuquerque, New Mexico 87111.

CD IGNITIONS, VHF/UHF monitors, crystals, CB radios, Southland, Box 3591-B, Baytown, Texas 77520.

FREE CATALOG. Parts, circuit boards for POPULAR ELECTRONICS projects. PAIA Electronics, Box C14359, Oklahoma City, OK 73114.

DIGITAL IC Manual-Latest Edition—1500 types by types/diagram number \$3.95. 32—function digital computer kit—IC, transistors, instructions, \$14.00. IC applications manual—numerous circuits—Analog/Digital, \$3.95. Electronics, P. O. Box 127, Hopedale, Mass. 01747.

ELECTRONIC COMPONENTS—all kinds, send for free catalog. Epic, Box 20152A, Minneapolis, Minn. 55420.

QUALITY military and industrial surplus electronics. Send 25 cents for last 3 of our monthly picture flyers. US only. Startronics, Box 17127, Portland, OR 97217.

COMPUTER SCHEMATICS. 256 bits, expandable to several K. Many other schematics available. SP Electronics, Box 5E, Prospect Heights, Illinois 60070.

AUTHENTIC, INSTRUMENTED, FLYING ROCKETS for casual or serious experimenters. Over 80 scale original, multi-stage or ready-to-fly models. Solid-propellant engines for safe, electric launch system liftoffs up to 2,500 feet. Measure altitude, temp, inversions, more. Real telemetry, electronic tracking, aerial still and movie photography with super-miniaturized equipment. New, detailed tech manual and full-color catalog, 25 cents from ESTES INDUSTRIAL Dept. 18H, Penrose, Colo. 81240.

LIFE-GUARD: The finest HEAT-SMOKE-GAS Alarm available, 100% solid state. COSMIC ELECTRONICS, Box 282, Lawrence, NY 11559.

DIGITAL ELECTRONICS! Highly effective course brings immediate results, \$10.00. Satisfaction or \$11.00 refunded! Plans, Projects, Free Literature. DYNASIGN, Box 60A7, Wayland, Mass. 01778.

ELECTRONIC COMPONENTS for the hobbyist. IC's, LED's, resistors, capacitors, etc. First quality and fast delivery. Send 25 cents for catalog. DIGI-CRAFT ELECTRONICS, P.O. Box 94, Brookline, MA 02146.

UNSCRAMBLERS: Fits any scanner or monitor, easily adjusts to all scrambled frequencies. Only 4" square \$29.95, fully guaranteed. Dealer inquiries welcomed. PDQ Electronics, Box 841, North Little Rock, Arkansas 72115.

BURGLAR ALARM dialing unit automatically calls police. \$29.95. Free literature. S&S Supply, Box 12375C, North Kansas City, MO 64116.

ELECTRONIC parts, low prices, free flyer: DARTEK ELECTRONICS, Box 2460, Dartmouth, Nova Scotia, Canada. U.S. Inquiries.

JAPANESE TRANSISTORS, Kit only \$23.44 including 14 powers, 10 others. Many types available, Free catalog. West Pacific Electronics, Box 25837, W. Los Angeles, Calif. 90025.

FREE! Diodes and catalog. BDJ Electronics; 11 Revere; Tappan, New York 10983.

HOLD-IT! A new precision electronics product. Details free. INNOVATIVE CONCEPTS, 4018 Clarke, Ft. Worth, Texas 76107.

ALPHA/THETA Biofeedback Instruments, \$29.95 hobbyist models to professional models with on time Digital Recorder ... DIGITAL: Heart Monitor, Thermometer, VOM, Frequency Counter, Function Generator, Logic Probe with readout, Tach and Dwell meter, etc. Free Catalog. COSMIC ELECTRONICS, Box 282, Lawrence, NY 11559.

LED Readouts — WOW! — Jumbo 0.6" digit, replaces Litronix DL-747, \$1.95 — 0.3", replaces DL-707, DL-704 (specify type) \$1.50 — Kit of 150 discrete LED's builds 3-1/2" 6 digit clock, \$25. — Digital Liquid Crystal wristwatch displays \$3.95! Want more? Bargain Catalog, 50 cents. Diamondback Engineering, P.O. Box 194, Spring Valley, Ill 61362.

INDIVIDUAL DIAGRAMS, servicing manuals, Radio-Television. Information. Supreme Publications, 1760 Balsam, Highland Park, Illinois 60035.

SURPRISE! SURPRISE! Digital Piano Tuning Device tunes musical instruments Accurately! Perfectly! Inexpensively! Construction-Instruction-Plans Complete \$12.95 Airmailed Postpaid! Moonlighting quickly repays \$40 electronics investment! GBS, Box 100P, Green Bank, West Virginia 24944.

USED Electronic Test Equipment. Mint Condition. Call evenings 212-648-8255.

"BASIC TELEPHONE WIRING" — Unique report gives complete details. \$3.50 postpaid. Queens Village Telephone Supply, Box 29002-L, Queens Village, NY 11429.

DIAGRAM MANUALS, Radio — Television, essential 14 volumes, normally \$44., only \$19.95, postpaid. Supreme Publications, 1760 Balsam, Highland Park, Illinois 60035.

FREE Bargain Catalog. Transistors, LED's, readouts, micro-miniature parts, unusual electronic components. CHANEY'S, Box 15431, Lakewood, CO 80215.

CALCULATOR MAGIC! Amaze and delight your family and friends with scores of fascinating pastimes, diversions, games, and magic tricks. Send today for our illustrated 189-page book "How To Entertain With Your Pocket Calculator." Paperback \$3.50, hardcover \$7.50, postpaid. Electret Scientific Company, Box 4132, Star City, West Virginia 26505.

PYROTECHNICAL chemicals, casings, fuse, tools, literature, supplies. Listing-50 cents, with samples — \$1.00. Westech, Logan, Utah 84321.

WEIRNU Special Sale					
LINEAR	1845N	.75	7445	.80	8090 1.50
					8811 .90
					8095 .40
					8812 .40
					8097 .40
					8830 .50
					8123 1.10
					8831 2.40
					8210 2.75
					8832 2.40
					8078 .25
					7413 .90
					8211 1.90
					8833 2.40
					8096 .85
					7414 1.10
					8212 1.75
					8834 or .80
					8098 .80
					7415 1.00
					8213 1.75
					8835 or .80
					8099 .25
					7416 1.25
					8214 2.00
					8836 1.25
					8097 .40
					7417 1.25
					8215 2.50
					8837 1.25
					8098 .40
					7418 .40
					8216 1.25
					8838 .75
					7419 .18
					8217 1.25
					8839 1.25
					7420/001 .18
					8218 .25
					8840 .25
					7421 .90
					8219 .90
					8841 .75
					7422 .18
					8220 2.75
					7423 .18
					8221 2.75
					7424 .18
					8222 2.75
					7425 .18
					8223 2.75
					7426 .18
					8224 2.75
					7427 .18
					8225 2.75
					7428 .18
					8226 2.75
					7429 .18
					8227 2.75
					7430 .18
					8228 2.75
					7431 .18
					8229 2.75
					7432 .18
					8230 2.75
					7433 .18
					8231 2.75
					7434 .18
					8232 2.75
					7435 .18
					8233 2.75
					7436 .18
					8234 2.75
					7437 .18
					8235 2.75
					7438 .18
					8236 2.75
					7439 .18
					8237 2.75
					7440 .18
					8238 2.75
					7441 .18
					8239 2.75
					7442 .18
					8240 2.75
					7443 .18
					8241 2.75
					7444 .18
					8242 2.75
					7445 .18
					8243 2.75
					7446 .18
					8244 2.75
					7447 .18
					8245 2.75
					7448 .18
					8246 2.75
					7449 .18
					8247 2.75
					7450 .18
					8248 2.75
					7451 .18
					8249 2.75
					7452 .18
					8250 2.75
					7453 .18
					8251 2.75
					7454 .18
					8252 2.75
					7455 .18
					8253 2.75
					7456 .18
					8254 2.75
					7457 .18
					8255 2.75
					7458 .18
					8256 2.75
					7459 .18
					8257 2.75
					7460 .18
					8258 2.75
					7461 .18
					8259 2.75
					7462 .18
					8260 2.75
					7463 .18
					8261 2.75
					7464 .18
					8262 2.75
					7465 .18
					8263 2.75
					7466 .18
					8264 2.75
					7467 .18
					8265 2.75
					7468 .18
					8266 2.75
					7469 .18
					8267 2.75
					7470 .18
					8268 2.75
					7471 .18
					8269 2.75
			</		



# Altaj Electronic Bargains

PRICES SLASHED! WE WANT YOUR BUSINESS. SATISFACTION GUARANTEED ON EVERY ITEM



**CALCULATOR BASIC KIT WITH TI CHIP**  
Includes case with matching all function keyboard, and 9 digits of LED readouts plus a Texas Instruments TMS 103 NC calculator chip. (Same style chip as in TI Datamath calculator). All the basics for building your own hand held calculator. Special — \$9.95 Quantity Limited.



**BURROUGHS PANAPLEX II  
12 DIGIT READOUT**

#BR13251 Neon 7 segment readout. Latest design for calculators, etc. Requires 160 VDC. Right hand decimals. Brand new, factory fresh. We include mating socket FREE \$4.95  
NOTE: With purchase of above readout array we offer motorola 2N5401 PNP High Voltage driver transistor for 10¢ each.



**LM309M**  
TO-3 Case, 1 AMP 5 VDC Voltage Regulator. Brand New By National \$1.19

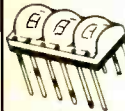

**3 DIGIT LED READOUT ARRAY**  
Like Litronix DL-33. 3 MAN-3 style readouts in one package. Factory new units Designed for calculators. Special — \$1.39 (3 Digits)



**OPCOA SLA-1 LED READOUT**  
.33 in. character. Left decimal pt. Uses 7447 driver. Easier to read than MAN-1. Factory prime units. Best Price in USA! \$1.19



**MAN-3 LED READOUTS**  
Brand new, factory prime units. .12 in. character. Common cathode. Perfect for calculators. 39c ea. Best Price Anywhere!

## CALCULATOR CHIP BONANZA PRICES SLASHED!

The newest and easiest to use chips available today. Made by famous US mfg. All are 28 pin DIP. Features: direct LED segment drive, low power consumption, internal keyboard debounce, internal clock oscillator, single supply voltage, internal keyboard encoding, and floating decimal point. Does not require many external components as do older types like CT5001, 5002, 5005, etc. We offer the most sophisticated functions for the lowest price anywhere.

Chip #1 — 8 Digit, Constant, Six Function (+, -, x, +, %, √) — \$3.95  
Chip #2 — 8 Digit, Memory, Six Function (+, -, x, +, %, √) — \$4.95  
Chip #3 — 8 Digit, Memory, Six Function (+, -, x, +, %, 1/x) — \$4.95

## DIGITAL ALARM CLOCK IC

The newest and easiest to use alarm chip on the market today. Features:

1. Single supply voltage.
2. LED Intensity control
3. Simple time set.
4. 4 or 6 Digit LED Display
5. AM-PM Indication
6. 24 Hr. Alarm.
7. 10 minute snooze.
8. Outperforms MM5316

Order #70250 — \$6.95 (2 FOR \$12)



## MM5314 NATIONAL CLOCK CHIP

The most popular clock chip around. We made a huge special purchase of factory fresh, prime units. Lowest price in USA. 24 Pin DIP. 4 or 6 Digits. With Specs. \$4.95

## MINI CORE MEMORY SPECIAL

Mfg. by DATARAM. Stores 180 words of 18 bits each. With sense amps and associated drive circuits. A complete memory system. We include 50 pages of data and schematics. Data only \$2.50 Brand New. Special \$24.95



## DIGITAL WRIST WATCH CRYSTAL

Brand new, mfg. by CTS-KNIGHT. 32.768 KHZ. Standard, most popular type. Special \$1.95

## COLOR ORGAN CONTROL MODULE

Completely self-contained. Has SCR circuitry. AC line cord, etc. From a close out by a mfg. of color organs. New, unused \$1.95

## GE POWER TRANSISTOR ASSORTMENT

Plastic power devices. Includes NPN and PNP, darlington, high voltage, high current, and various other types. Cases are color coded for easy sorting. Un-tested but includes many useable units. SPECIAL — 20 FOR \$1

## 1024 BIT SIGNETICS P-ROM

82S1291-256X4 bipolar, field programmable ROM. Fully TTL compatible. 50 ns. max address access time. Much faster than MOS type units. Perfect for code conversions, microprogrammers, hand-wired algorithms, controllers, etc. With specs. Regular \$35 ea. SPECIAL — \$6.95  
BEST MEMORY BUY IN USA!

## SOLID STATE MEMORY ARRAY

Brand new, factory prime units. .12 in. character. Common cathode. Perfect for calculators. 39c ea. Best Price Anywhere!

## NI-CAD BATTERY SPECIAL

Two cell battery packs 2.75 V capacity is 250 MA HRS. Two of these make a great power pack for TTL. Special 95c

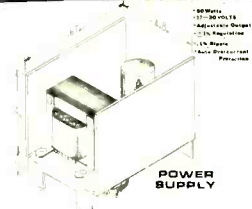

## REGULATED DC POWER SUPPLY

Brand new by waltass. DC output 17 to 30 V. Rated 60 WATTS out. Our tests show these units will put out 12 VDC by changing one resistor. #OEM 60-3. Original cost \$57.50. In original factory boxes, with specs. Special \$14.95

## 7805 STYLE REGULATORS

TO-220 Plastic Case 5VDC Regulator. Brand New by National — 99c

## FACTORY NEW LED'S

Jumbo Red-Like MV5024-B/\$1  
Jumbo Green-Like MV5222-5/\$1  
Jumbo Yellow-5/\$1  
Mini Red-Like MV50-10/\$1

## MOS 4 DIGIT COUNTER IC

An ALTAJ exclusive. These are the latest, state of the art. MOS chips. By a famous US mfg. Contains a complete 4 digit counter, including 4 decade counters, latches, multiplexing circuits, display decoders, etc. Features 5 VDC operation, 25 MW power consumption, both 7 segment and BCD outputs. Perfect for making DVM's, frequency meters, tachometers, stopwatches, or any other device requiring 4 or more digits. Complete with specs. 28 PIN DIP. QTY Limited. Special — \$12.50

## CT7001 BY CAL-TEX

Digital alarm clock chip with calendar feature. 4 or 6 digits. Also has timing circuitry for radio ON-OFF control factory fresh. \$6.95

## JUMBO LED READOUT

Twice the size of regular readouts. 65 inches. Like Litronix DL747. Outperforms and easier to read than SLA-3. only 20 MA per segment. Our best readout for digital clocks. \$2.95 ea (6 FOR \$15) Common Anode

## LINEAR IC SPECIALS

555V-75c 567V-\$1.95 723CH-59c 741CV-39c  
LM324 by National — Quad 741C in one DIP — \$1.79

## ELECTROLYTIC CAPACITOR SPECIAL

220 MFD at 25 WVDC. AXIAL Leads by GI. Brand New 6 for \$1

## MINIATURE SWITCH

Rocker style. Small size. SPDT. Perfect for use on digital clocks. 4 FOR \$1

## PRIME TTL DIP IC'S

7400-16c	7448-89c	74151-75c
7402-16c	7453-16c	74153-89c
7404-16c	7473-37c	74154-95c
7406-24c	7474-37c	74157-99c
7408-16c	7475-65c	74161-99c
7410-16c	7476-39c	74163-1.19
7413-49c	7483-85c	74164-1.29
7420-16c	7490-69c	74165-1.49
7427-24c	7492-75c	74174-1.29
7430-16c	7493-75c	74175-1.39
7437-39c	7495-75c	74181-2.75
7438-35c	7496-75c	74192-1.25
7440-16c	74121-38c	74193-1.25
7442-69c	74123-75c	74195-79c
7447-89c	74150-70c	74197-79c

## TIP-3055 BY TI

Plastic version of 2N3055. NPN Silicon 89¢

## 1 AMP SILICON RECTIFIERS

IN4002 — 100 PIV — 8¢  
IN4007 — 1000 PIV — 13¢

## 8038 FUNCTION GENERATOR

Brand new Voltage controlled oscillator. Has sine, square wave, and triangular outputs. \$4.50 each.

## IN4148 DIODES

High speed switching diodes. Brand new units, however, leads are cut and bent for PC board insertion, still plenty long. 30 For \$1

## POLAROID FILTERS

The real thing by Polaroid Corp. Pale green in color. 2.3 x 12 inches. Use with various readouts or for optical experiments. limited Qty 2 For \$1.

## PHASE LOCKED LOOP

565A by Signetics. Extremely stable. High linearity, wide frequency range. TTL compatible. Perfect for tone decoders, FSK, SCA receivers, frequency multiplication and division — \$1.75. WITH SPECS

## MOTOROLA POWER TRANSISTOR

MJ3029 — T03 Case — NPN Silicon High Voltage — VCEO — 250V Usec in horiz. and vert. TV Circuits. Regular Price \$4. Our Price 95c

## ELECTROLYTIC CAPACITORS

10MFD 25WVDC — Upright — 7c  
50MFD 15WVDC — Upright — 10c  
50MFD 15WVDC — Axial — 10c  
100MFD 15WVDC — Upright — 14c

## PLASTIC SILICON TRANSISTORS

Use for drivers in clock or calculators.  
MPS2222A — NPN  
MPS2714 — NPN  
MPS3704 — NPN  
2N 3904 — NPN  
2N 3906 — PNP  
2N 4249 — PNP

**YOUR  
CHOICE  
6 FOR \$1  
ALL NEW  
UNITS**

## ZENERS

IN746 — 400MW — 3.3V  
IN752 — 400MW — 5.6V  
YOUR CHOICE  
8 FOR \$1

## TTL IC ASSORTMENT

Various types. Most are marked. Our best selling assortment. Un-tested but includes many useable devices. 200 PCS FOR \$3.95

Our lower prices and superior quality have made ALTAJ one of the fastest growing electronic suppliers in the USA. Put your trust in our unconditional money back guarantee.

**ALTAJ ELECTRONICS**  
P.O. BOX 38544  
DALLAS, TEXAS 75238

TERMS. Check or money order. No COD. Add 10% Pstg. and Hdq. Tex Res. add 5%.





**SCOPE CALIBRATOR:** For Time Base cal: 2 Hz to 20 MHz (0.5 sec to 50 ns) in 2.5 sequence. For VERTICAL cal: continuously adjustable 0 to 1 V (0.2 mV resolution) or 0 to 10 V (2 mV resolution) AC or DC output (AC output freq. selectable 2 Hz to 500 kHz in 2.5 sequence); sync output:  $\pm 0.2\%$  abso. lute accuracy at 10 V,  $\pm 0.25\%$  linearity, all freqs.  $\pm 0.005\%$ , 3 digit voltage display; \$260 postpaid (Texas residents add 5% sales tax).

**INNOVATIVE ELECTRONIC TECHNOLOGY**  
112 Lochness Ln., Ft. Worth, TX 76126.

**MONITOR RECEIVER,** Preamp, Scanner, UHF Converter kits. Hamtronics, 182 Belmont, Rochester, NY 14612.

**FREE giant bargain electronic catalog** listing thousands of components, tubes, transistors, IC's kits, test equipment. EDLIE'S, 2700-PA Hempstead Tpke., Levittown, N.Y. 11756.

**TTL CLEARANCE** 7460 15 cents ea., 7475, 7490 55 cents ea., 7484 \$1.00 ea., 7491 75 cents ea., 74S03 50 cents ea., 74164 \$1.25 ea., IN4007 \$60/M, IN4148 \$22/M. Resistors, Capacitor, More. PRASAD ELECTRONICS, Box 32, Addison, Ill 60101.

**TELEPHONE TAPPED??? ... CAR FOLLOWED??? ... OFFICE BUGGED??? ...** Eavesdropping Countermeasure Equipment Catalog \$1.00. CAL-TRONIX, 1102 College, Santa Rosa, California 95404.

**SUPER SCIENTIFIC CALCULATOR DISCOUNTS:** Nationally famous brands — ideal for students, technicians, professionals. **EXCITING NEW FULLY PROGRAMMABLE MODELS** — all at unbeatable money-saving discounts. **WRITE for your FREE catalog now!** Rockland Marketing, Box 1823, Cedar Rapids, Iowa 52403.

**COMPONENTS.** 1013A UART \$13.95, MM5316 Clock \$8.00, 8038CC \$5.25 with specs. All postpaid. 10 cents stamp for latest flyer. TRI-TEK, Box 14206, Phoenix, Ariz. 85063.

**WHOLESALE ELECTRONICS** components. Catalog of bargains, 25 cents, refundable with order. ATLANTIS, P. O. Box 12654P, Tucson, AZ 85711.

**DESIGN, build, rewind any transformer.** Manual \$6.00 tells all. M.T.O., PO Box 468, Linden, CA 95236.

## MiniMicroMart

Supermarket of  
Microprocessor Values

**8008's - 8080's Memories**

Microprocessor Kits & IC's—also for Mark 8-A Altair 8800-Scelbi. Write for details.

1618 James St., Syracuse, N.Y. 13203  
315/422-4467

## WANTED

**QUICKSILVER, Platinum, Silver, Gold, Ores Analyzed.** Free Circular. Mercury Terminal, Norwood, Mass. 02062.

## TUBES

**RADIO & T.V. Tubes**—36 cents each. Send for free Catalog. Cornell, 4213 University, San Diego, Calif. 92105.

**RECEIVING & INDUSTRIAL TUBES, TRANSISTORS.** All Brands — Biggest Discounts. Technicians, Hobbyists, Experimenters — Request FREE Giant Catalog and SAVE! ZALYTRON, 469 Jericho Turnpike, Mineola, N.Y. 11501.

**TUBES receiving, factory boxed, low prices, free price list.** Translateronic, Inc., 1306 40th Street, Brooklyn, N.Y. 11218A, Telephone: 212-633-2800.

**TUBES "Oldies", latest.** Lists free. Steinmetz, 7519 Maplewood, Hammond, Indiana 46324.

**CASH PAID FOR OBSOLETE RECEIVING TUBES** WE300B, WE300A, WE350B, WE252A, WE274A/B, WE284D, RCA45, RCA50, Small and large quantities, and movie theatre equipment, amplifier WE86A, WE59A, WE30A, WE91A/B, pick-up WE9A, WE10A, etc. Contact: M. Takabe, 303 Fifth Ave., N.Y.C. 10016. Tel: (212) 679-1970.

## MOVIE FILMS

**BMM-SUPER 8-16MM MOVIES!** Biggest Selection! Lowest Prices! Free Catalog! Cinema Eight, Box PE, Chester, Connecticut 06412.

## ELECTRICAL SUPPLIES & EQUIPMENT

**PLATING Equipment.** Portable Platers, Supplies and "Know-How." Build your own tanks for nickel, chrome, etc. Easy-to-install PVC liners. Rectifier components—all sizes. Schematics, parts lists, formulas, operating instructions for all plating. Guaranteed to save you 25%-75%. Some good units for sale. Write for details. Platers Service Company, 1511-PE Esperanza, Los Angeles, Calif. 90023.

## TAPE AND RECORDERS

**RENT 4-Track open reel tapes**—all major labels—3,000 different — free brochure. Stereo-Parti, 55 St. James Drive, Santa Rosa, Ca. 95401.

**1930-1962 Radio Programs, Reels, \$1.00 Hour! Cassettes, \$2.00 Hour!** Mammoth Catalog, \$1.25. AM Treasures, Box 192F, Babylon, N.Y. 11702.

## CASSETTE LABELS

Plain white cassette labels. Norelco cassette cleaners, famous brand cassettes. "Like new" 10 1/2" metal reels. Send for open reel and cassette discount catalog.

10-99	100	1000	10M
02	015	01	007
60	55	50	45
3.25	3.10	2.95	2.80
1.00	.90	.80	.75

Plus Postage by Weight and Zone Minimum Order: \$5.00

**SAXITONE TAPE SALES**  
1775 COLUMBIA ROAD, N.W.  
WASHINGTON, D.C. 20009

**OLD Radio shows on cassettes.** \$1.50 per show. Catalog 25 cents. Radio Classics, Box 804, Mattituck, N.Y. 11952.

## SHORTWAVE LISTENING

**SWL'S QUARTERLY, 75 cents Books.** Efficient Antennas. SWL Guide. 414 Newcastel, Syracuse, NY 13219.

## GOVERNMENT SURPLUS

**GOVERNMENT Surplus.** How and Where to Buy in Your Area. Send \$2.00. Surplus 30177-PE Headquarters Bldg., Washington, D.C. 20014.

**MANUALS for Govt Surplus radios, test sets, scopes.** List 50 cents (coin). Books, 7218 Roanne Drive, Washington, D.C. 20021.

**GOVERNMENT SURPLUS.** How and Where to Buy. Save Hundreds. Earn Thousands. Details Dime. CHELER COMPANY, Dept. 25, Box 99157, Seattle, Wash. 98199.

## PERSONALS

**MAKE FRIENDS WORLDWIDE** through international correspondence. Illustrated brochure free. Hermes, Berlin 11, Box 110660/2D, Germany.

**INTEL 8008**  
8 BIT PROCESSING  
CHIP (with documentation) **\$79.50**

**MINIATURE TRIM POTS**  
5K, 10K, 25K, 50K, 100K,  
**\$7.5 EA. 3/\$2.00**

**MULTI-TURN TRIM POTS**  
Similar to Bourns 3010 style 3/16" x 3/8" x 1 1/4" 50, 100, 500, 2000, 5000, 10,000 ohms. **\$1.50 ea. 3/\$4.00**

**PRINTED CIRCUIT BOARD**  
4 1/2" x 6 1/2" single sided EPOXY board, 1/16" thick, unetched  
**\$5.0 ea. 5/\$2.20**

**LIGHT ACTIVATED SCR'S,**  
TO-18 200V 1A **\$1.75**

**NIXIE TUBES**  
MC14435 & MC1405L. A 2 piece 3 1/2 digit A/D Converter system for panel meters & DVMO. **\$39.95**

**4 WATT IR LASER**  
DIODES **\$7.95**

TIS 73 N FET **\$.50**  
2N4891 UJT **\$.50**  
ER900 TRIGGER DIODES 4/**\$1.00**  
2N6027 PROG. UJT **\$.75**

**VERIPAX PC BOARD**  
This board is a 1 1/8" single sided paper epoxy board, 4 1/2" x 6 1/2" (standard veripax). DRILLED and ETCHED which will hold up to 21 single 14 pin IC's or 8, 16 or LSI DIP IC's with busses for power supply connections. Is also etched for 22 pin connector **\$5.25**

FLV 100 VISIBLE LED **\$.50**  
ME-4 IR LED **\$.40**  
MT-2 PHOTO TRANSISTOR **\$.60**  
GREEN GAP OSL-16 LED **\$.60**  
RED GAP OSL-3 LED **\$.40**  
14 PIN DIP SOCKETS **\$.40**  
16 PIN DIP SOCKETS **\$.50**

10 WATT ZENERS  
3.9, 4.7 OR 5.6 V **\$.75 EA**  
4 WATT ZENERS  
3.9, 5.6, 6.8 OR 12 V **\$.30 EA**

PRV	1A	3A	12A	50A
100	.06	.14	.30	.80
200	.07	.20	.35	1.15
400	.09	.25	.50	1.40
600	.11	.30	.70	1.80
800	.15	.35	.90	2.20
1000	.20	.45	1.10	2.60

**REGULATED MODULAR POWER SUPPLIES**  
+15VDC AT 100 ma, 115VAC INPUT **\$24.95**  
5VDC AT 1A, 115VAC INPUT **\$19.95**  
12V, 6A **24.95**  
IN 4148 **14/\$1.00**

Terms: FOB Cambridge Mass. Send check or Money Order, include Postage. Minimum Order \$5.00

**TRANSISTOR SPECIALS**

2N256 PNP GE TO-3 **\$.50**  
2N404 PNP GE TO-5 **\$1.00**  
2N3866 NPN Si TO-5 RF **\$.75**  
2N1016A NPN Si TO-82 **\$.15**  
2N3904 NPN Si TO-92 **4/\$1.00**  
MPS3393 NPN Si TO-92 **4/\$1.00**  
2N3906 PNP Si TO-92 **4/\$1.00**  
MPS A13 NPN Si TO-92 **3/\$1.00**  
2N3767 NPN Si TO-66 **\$.70**  
2N2222 NPN Si TO-18 **5/\$1.00**  
2N3055 NPN Si TO-3 **\$.100**  
2N5296 NPN Si TO-220 **\$.50**  
2N6109 PNP Si TO-220 **\$.55**  
2N4898 PNP Si TO-66 **\$.60**  
2N3919 NPN Si TO-3 RF **\$.150**  
2N3638 PNP Si TO-5 **5/\$1.00**  
2N2218A NPN Si TO-5 **4/\$1.00**

**CAPACITORS**

6V 30 UF TANT 5/**\$1**  
20V 4.7UF TANT 5/**\$1**  
6.8UF 35V TANT 3/**\$1**  
50V 100UF ELECT **\$.40**  
10UF 12V ELECT 5/**\$1.00**

MAN-7 **\$1.00**  
MAN-1, RED OR YELLOW  
LED READOUT **\$2.50**  
MAN-3 READOUTS **\$1.75**  
MAN-4 READOUTS **\$2.00**

Full Wave Bridges  
PRV 2A 6A 25A  
200 95 1.25 \$3.00  
400 1.15 1.50 \$4.00  
600 1.35 1.75 \$5.00

1103 1024 bit RAM **\$.475**  
NEC 6003 2048 bit RAM **\$.950**  
1101 256 bit RAM **\$.175**  
1702A UV PROM **\$.2400**  
8223-PROGRAMMABLE **\$.475**  
MM5203-2048 BIT ERASABLE PROM **\$23.95**

Conductive Elastomer low profile calculator keyboard. A 2 3/4" x 3 1/4" x 1/2" flex key. 19SK-6 keyboard having 0-9, ., /, \*, -, =, K+C buttons with off-on switch. **\$6.00**

CT5005-12 DIGIT CALCULATOR CHIP **\$.795**

**TTL IC SERIES**

74100	—30		
7400	—17	7476	—45
7401	—17	7480	—61
7402	—17	7483	—90
7403	—17	7485	—130
7404	—21	7486	—48
7405	—21	7490	—71
7406	—37	7491	—110
7407	—37	7492	—75
7408	—23	7493	—71
7410	—17	7495	—85
7411	—27	7496	—85
7412	—45	8220	—150
7413	—73	74107	—45
7416	—37	74121	—55
7417	—37	74123	—91
7420	—17	74125	—65
7426	—27	74126	—70
7427	—31	74150	—99
7430	—17	74151	—85
7432	—27	74153	—105
7437	—41	74154	—149
7438	—35	74157	—119
7440	—17	74163	—149
7441	—95	74164	—179
7442	—95	74165	—179
7445	—105	74173	—155
7446	—110	74175	—180
7447	—110	74177	—150
7448	—110	74181	—350
7450	—17	74192	—145
7472	—33	74193	—130
7473	—41	74195	—89
7474	—41	75324	—175
7475	—71	75491	—110

8038C IC VOLTAGE CONTROLLED OSCILLATOR **\$.495**

**C/MOS (DIODE CLAMPED)**

74C 02 — \$.55 CD 4019 — \$1.20  
74C 10 — \$.60 CD 4022 — \$2.10  
74C 157 — \$2.15 CD 4023 — \$.53  
74C 165 — \$3.50 CD 4024 — \$2.15  
CD 4001 — \$.53 CD 4025 — \$.50  
CD 4002 — \$.53 CD 4026 — \$5.00  
CD 4006 — \$3.60 CD 4027 — \$1.20  
CD 4007 — \$.60 CD 4028 — \$2.75  
CD 4009 — \$.80 CD 4029 — \$4.80  
CD 4010 — \$.65 CD 4030 — \$.53  
CD 4011 — \$.53 CD 4035 — \$2.30  
CD 4012 — \$.53 CD 4042 — \$2.75  
CD 4013 — \$1.00 CD 4046 — \$3.75  
CD 4015 — \$3.25 CD 4047 — \$3.60  
CD 4016 — \$1.05 CD 4050 — \$1.05  
CD 4017 — \$2.70 CD 4055 — \$3.20

**5311—CLOCK CHIP 6 DIGIT BCD HOLD COUNT, OUTPUT STROBE** **\$.675**  
5314—CLOCK CHIP 6 DIGIT HOLD COUNT, OUTPUT STROBE **\$.675**  
5316—ALARM CLOCK CHIP **\$.675**

2513 64x7x5 CHARACTER GEN **\$.995**  
2516 64x6x8 STATIC CHARACTER GEN **\$.995**

**SANKEN AUDIO POWER AMPS**  
Si 1010 G 10 WATTS... **\$ 6.40**  
Si 1025 E 25 WATTS... **\$17.95**  
Si 1050 E 50 WATTS... **\$24.95**

**LINEAR CIRCUITS**

LM 309K 5V IA REGULATOR **\$1.50**  
723 40 — 40V REGULATOR **\$.58**  
301/748 — Hi Per Op. Amp **\$.30**  
LM 320 — 5 or 15V REGULATOR **\$1.75**  
LM 376 — V to 37V POS REG. **\$.58**  
741A or 741C OP. AMP. **\$.31**  
709C OPER AMP **\$.25**  
340T-5, 12, 15, 18, 24V POS. REG. TO-220 **\$1.75**  
101 OPER. AMP. HI PERFORM **\$.75**  
LM 308 OPER. AMP. LOW POWER **\$1.05**  
747—QUAL 741 **\$.75**  
711 COMPARATOR **\$.31**  
537—PRECISION OP AMP **\$2.60**  
LM 3900—QUAD OP AMP **\$.49**  
LM 324—QUAD 741 **\$2.20**  
560—PHASE LOCK LOOP **\$2.50**  
561—PHASE LOCK LOOP **\$2.50**  
565—PHASE LOCK LOOP **\$2.50**  
567—TONE DECOODER **\$2.85**  
703—RF-IF AMP **\$.41**  
LM 370—AGC SQUELCH AMP **\$1.15**  
555—2 us — 2 HR. TIMER **\$.88**  
1458 DUAL OP. AMP **\$.60**  
1456 OPER. AMP **\$.95**  
LM 380—2W AUDIO AMP **\$1.39**  
LM 377—2W STEREO AUDIO AMP **\$2.50**  
LM 381—STEREO PREAMP **\$1.69**  
LM 382—QUAD AUDIO PREAMP **\$1.69**  
LM 311—HI PER. COMPARTOR **\$.95**  
LM 319—DUAL HI SPEED COMP. **\$1.15**  
LM 339—QUAD COMPARTOR **\$1.45**

PRV	TRIACS			SCR'S		
	1A	10A	25A	1.5A	6A	35A
100	40	70	130	40	50	120
200	70	110	175	60	70	160
400	110	160	260	100	120	220
600	170	230	300			300



**SOLID STATE SALES**  
P.O. BOX 74A  
SOMERVILLE, MASS. 02143 TEL. (617) 547-4005

**WE SHIP OVER 95% OF OUR ORDERS THE DAY WE RECEIVE THEM**



# MICROPROCESSORS by Poly Paks

## 8008 "THE COMPUTER ON THE CHIP"

Usually called "Microprocessor" it is a p Channel Si gate MOS 8-bit Parallel Central Processor. A CPU Central Processing Unit on a chip. Features complete instruction decoding and control. Capability to address 16K x 8 bits of memory (RAM, ROM, SR). Build a micro-computer system when interfacing with other chips, such as 1101, 1103, 2102 (RAMS), etc. With spec sheets. 16-pin dip package. **\$59.95**

2102 1000-bit "static" Ram for above. . . . \$6.50



**\$59.95**



**POLY PAKS BLUE RIBBON Policy**

20-Years of Business INTEGRITY

20-Years of Money-Back GUARANTEES

20-Years of Economy! LOWEST PRICES!

## "ALL LED" MONSANTO READOUTS

MONSANTO TYPE	CHAR. HT.	SALE EACH	Quantity Discounts
MAN-1	.27	\$3.50	3 for \$ 9.
MAN-2	.32*	4.95	3 for \$14.
MAN-3	.12	1.00	3 for \$ 2.50
MAN-6	.60	4.50	3 for \$12.
MAN-64	.4	3.50	3 for \$ 9.
MAN-7	.27	1.50	3 for \$ 3.

\*.35 LED matrix

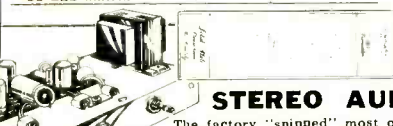

The factory "snipped" most of the cables to this compact 8 watt stereo unit with aluminum escutcheon on top. It's easy to use because we have all the cables marked ready to use. With power supply, 115vac, 3 controls, LEFT and RIGHT VOLUME controls for two speakers for balancing and center TONE control. With knobs. 7 x 3 1/2 x 3 1/2. Hookup spec sheets.

**5.95**

## BIGGEST MAN-7 SALE \$1

THAT'S RIGHT! MAN-7's at the readout sale of the century! The MAN-7 is a 7-segment "reflective" version of the famous MAN-1. The optimum in efficiency and construction. Looks like, acts like, the MAN-1. Wide angle viewing. 0.27" character height. color red.

**MAN-5 as MAN-7 except green 1.49**

## 35 WATT AUDIO AMPLIFIER BASIC

For Class AB use. Basic includes: Sigmatic 540 30 transistor high power driver TO-5 "IC", with a pair of complimentary 35-watt plastic transistors, i.e. 2N5296 pnp and 2N6109 pnp. With schematics, printed circuit and parts board layouts.

**CLOCK CHIPS as Low as ON A "DIP" \$3.95**

WITH DATA SHEETS

MM5311	6-digit 28-Pin	\$6.99
MM5312	4-digit 24-Pin	6.99
MM5313	6-digit 28-Pin	6.99
MM5314	6-digit 28-Pin	6.99
MM5316	4-digit 40-Pin, alarm	6.99
MM5316-A	no alarm	3.95

## 35 WATT AUDIO AMPLIFIER BASIC

For Class AB use. Basic includes: Sigmatic 540 30 transistor high power driver TO-5 "IC", with a pair of complimentary 35-watt plastic transistors, i.e. 2N5296 pnp and 2N6109 pnp. With schematics, printed circuit and parts board layouts.

**\$3.98 2 for \$7**

## "PROFESSIONAL" 60 WATT AM-FM MUX TUNER AMP

The finest built 60 watt tuner amp we've had for years. We call it THE AUDIOPHILE BUY OF THE YEAR! It compares to Fisher and Hi Scott quality. Crisp hi-fi, organ type quality for the lows. Fine linear response using a pair of 35 watt style matched power tube transistors for each channel. Built-in preamp for using magnetic cartridges, black and chrome-silver look molded panel with glass already attached to tuner. It's made to JUST SLIDE INTO CABINET! Push-button features for phono, am, fm, stereo, tape. Red "FM and TAPE" show on glass. You can't see dial plate behind glass till you press any of the above push buttons, and then the scale illuminates. Two separate rocker switches for POWER ON-OFF and AFC Controls. Modern slide volume, balance, bass and treble controls. With knobs for these and a black chrome trimmed 2 1/2" round for tuning. Balance controls indicate left and right speakers. Jack on panel for standard stereo headphones. Built-in AM and FM antennas. REAR CONNECTIONS: plus two separate cables to plug into stereo, phono system, AC cable for interconnect power to turn-table, cable to connect to phono system for automatic shut-off. Separate bakelite panel that you can add an additional FM antenna for "sounding up" signals, stereo jacks for playback and record for external tape decks, 4-WAY SPEAKER SYSTEM with switch to any channel individually for testing. Wt. 5 lbs.

**6995**

## AM-FM TUNER BUILT-IN AMPLIFIER \$19.95

• Slide-Rule Dial 2 Bands  
• (10-Watts Peak Power) Amp

Never before have we ever seen such a combination of AM and FM with built-in high quality such in low price. A "natural" for the economy-minded Audiophile. Features: Tuning Tone, ON/OFF Volume, Balance, Circuit Switch (AM, FM, FM-AM, phono), 2-Speaker stereo effect system, 6-ft. power cord, Phono cables, with hook-ups, 115 VAC, 60 cycles. No escutcheon. Size: 13 x 7 x 3 1/2" deep. Wt. 3 lbs.

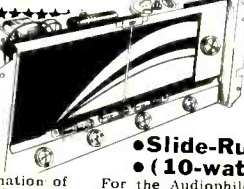

## AM TUNER BUILT-IN AMPLIFIER \$9.95

• Slide-Rule Dial Covers Broadcast  
• (10-watts Peak Power) Amplifier

For the Audiophiles who are seeking an economy hi-fi AM only at our give-away price! Never advertised before. Same quality and construction as our 20W to 90W units. Features: 4 controls; Tuning, Tone, ON/OFF Volume, Circuit Switch (AM-Phono), 2-Speaker stereo effect system, 6-ft. power cord, No escutcheon, with hookups, 115 VAC, 60 cycles. No escutcheon. Size: 10 1/2 x 5 1/2 x 3 1/2" deep. Wt. 3 lbs.

## THE SIMPLEST! FINEST! SMALLEST! 6-FUNCTION AC-DC CALCULATOR KIT! \$24.50

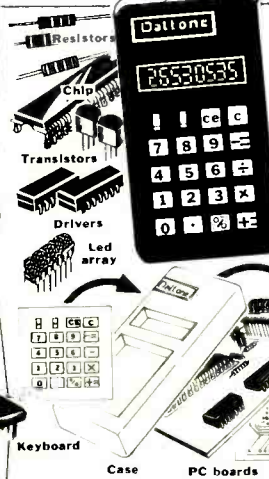

Lightweight, pocket size  
Extra large display  
6 functions plus, minus, times, percentage, constant  
Floating decimal  
Chain and Mix calculations  
AC adaptor jack

True credit balance  
Simplified indexing  
Mark up and Mark down  
Constant multiplication and division

Designed specifically for Poly Paks under the Dalton's NO BRAND IMAGINE! only 2 1/2 x 3 x 4 1/2". Slides easily into your vest pocket, brief case, or handbag. We hunted everywhere to find a calculator kit that can be small, do the many functions, with fine engineering design and SIMPLE TO BUILD! WHY? Because it has the fewest parts in a kit. Imagine the pc board only has the chip, 4 resistors, two transistors, two driver ic's with the 9 digit readout, SIMPLE! You bet it is. The entire kit is even packed in its own attractive, stylishly designed box that itself tells the mini calculator story. Kit includes: attractive black case with red filter; Flex Key (type 20SK-6) 18 key keyboard that measures only 2 1/2 x 2 1/2" with 2 switches, one for ON-OFF, one for K constant; MAIN pc board; readout board; famous Cal Tech 5030 26-pin calculator chip; two 75491 ic drivers; Hewlett Packard 9 digit array; ac jack; 9 Volt battery connector resistors; two transistors; back protective plate; necessary wire attachments. (Less 9 volt standard battery and AC adapter) **EASIEST KIT TO BUILD**

## GET KEY THE PARTS! Calculator Basics



12 DIGIT BASIC #4 — Key parts include: CT5001 chip, 4-3 digit readouts, factory etched PC board, case, carrying case, 2-resistor networks, decimal switch. Wild Rover Keyboard with ON-OFF switch diagrams. Sale \$19.95

8-DIGIT "TEXAS INSTRUMENT" BASIC KIT #7 — includes Texas-keyboard, 1K5149, standard 4-function. With 2 calculator chip TMS-0128, p.c. board, case, lens, Microswitch (on-off), 9-digit array; includes diagram. \$16.95

BASIC KIT #1 — includes case, all-function Flex Key Keyboard, Cal Tech CT5002 calculator chip, 9-digit LED display with built-on individual magnifiers. plus sheets. **\$16.95**

BASIC KIT #2 — same as Basic #1 except calculator chip is National 8-digit MM5725. **\$16.95**

BASIC KIT #3 — same as Basic #1 except calculator chip is National 6-digit MM5736 and 75492. **\$16.95**

12 DIGIT BASIC #4 — Key parts include: CT5001 chip, 4-3 digit readouts, factory etched PC board, case, carrying case, 2-resistor networks, decimal switch. Wild Rover Keyboard with ON-OFF switch diagrams. Sale \$19.95

8-DIGIT "TEXAS INSTRUMENT" BASIC KIT #7 — includes Texas-keyboard, 1K5149, standard 4-function. With 2 calculator chip TMS-0128, p.c. board, case, lens, Microswitch (on-off), 9-digit array; includes diagram. \$16.95

## 6 & 8 DIGIT MINI CALCULATOR BASICS

"The key parts kits"

\*So small fits in 'ur palm!  
\*Easier to assemble  
\*Requires approx. 6 more parts.

KIT NO. 5030 — 6 functions. Includes mini case, with lens, HP nine digit readouts with multiplex pc board, main pc board, keyboard (with two switches, percent and constant), ac adapter jack, 2- SN75491 drivers, CT5030 calculator chip with diagram. **\$16.95**

KIT NO. 5031 — 4 function, same as 5030 except uses CT503 chip. **\$16.95**

KIT NO. 5736 — 4 function, like 5031. Uses National MM5736 **\$12.95**

## Inflation-Fighting ECONOMY IC PRICES

Type	Sale	Order by type number! Spec sheets on request "ONLY"	Factory Marked
SN7400	\$ .19	SN7438	.49
SN7401	.19	SN7440	.19
SN7402	.24	SN7441	1.00
SN7404	.27	SN7442	.19
SN7405	.24	SN7443	1.00
SN7406	.79	SN7444	1.00
SN7408	.27	SN7445	1.00
SN7410	.19	SN7446	1.10
SN7411	.31	SN7447	1.10
SN7413	.89	SN7448	1.45
SN7414	2.25	SN7450	.27
SN7416	.45	SN7451	.28
SN7417	.45	SN7452	.28
SN7420	.22	SN7453	.28
SN7422	.29	SN7455	.28
SN7423	.32	SN7462	.39
SN7425	.35	SN7463	.39
SN7426	.31	SN7464	.39
SN7427	.35	SN7465	.39
SN7430	.24	SN7471	.55
SN7432	.28	SN7472	.42
SN7437	.45	SN7473	.42
SN7438	.49	SN7474	.39
SN7440	.19	SN7475	.91
SN7441	1.00	SN7476	.52
SN7442	.19	SN7478	.79
SN7443	1.00	SN7480	.59
SN7444	1.00	SN7481	1.25
SN7445	1.00	SN7482	.19
SN7446	1.10	SN7483	1.19
SN7447	1.10	SN7486	.49
SN7448	1.45	SN7489	2.95
SN7450	.27	SN7490	1.81
SN7451	.28	SN7491	1.81
SN7452	.28	SN7493	.99
SN7453	.28	SN7495	.99
SN7455	.28	SN7496	.99
SN7462	.39	SN74100	1.55
SN7463	.39	SN74104	1.25
SN7464	.39	SN74105	.95
SN7465	.39	SN74106	.95
SN7471	.55	SN74107	.49
SN7472	.42	SN74108	.95
SN7473	.42	SN74112	.95
SN7474	.39	SN74113	.95
SN7475	.91	SN74114	.95
SN7476	.52	SN74121	.49
SN7478	.79	SN74122	.55
SN7480	.59	SN74123	1.09
SN7481	1.25	SN74126	.89
SN7482	.19	SN74140	2.50
SN7483	1.19	SN74141	1.19
SN7486	.49	SN74142	1.95
SN7489	2.95	SN74143	1.95
SN7490	1.81	SN74150	1.19
SN7491	1.81	SN74151	.99
SN7493	.99	SN74153	1.39
SN7495	.99	SN74154	1.39
SN7496	.99	SN74155	1.29
SN74100	1.55	SN74156	1.45
SN74104	1.25	SN74157	1.45
SN74105	.95	SN74158	1.45
SN74106	.95	SN74161	1.19
SN74107	.49	SN74163	1.75
SN74108	.95	SN74164	2.85
SN74112	.95	SN74165	2.85
SN74113	.95	SN74166	1.85
SN74114	.95	SN74173	1.95
SN74121	.49	SN74174	2.25
SN74122	.55	SN74175	1.99
SN74123	1.09	SN74176	1.25
SN74126	.89	SN74177	1.25
SN74140	2.50	SN74180	1.10
SN74141	1.19	SN74181	3.95
SN74142	1.95	SN74182	1.05
SN74143	1.95	SN74190	1.49

## GENERAL ELECTRIC 3-WATT AUDIO AMP \$2.50

Delivers 3.5 watts continuous, 10 watts peak. With heat sinks; micro-mini size: 3/8 x 1/2 x 1/2. 9 to 30V supply. High sensitivity. 8 to 16 ohms.

## "BEEPER" AND "DATER" CLOCK ON THE CHIPS

Imagine a chip (MK50250) "Beepin" and audible alarm! All others are external. It features internal brightness control. The CT7001 requires external triggering of alarm, date of the month and direct drive to LED readouts. Both require minimum current drain and voltages, for either 4 to 6 LED readouts, 12 or 24 hours. AM and PM.

**8.50**

CT7001 Alarm and Date . 9.95

Terms: add postage. Rated: net 30  
Phone Orders: Wakefield, Mass. (617) 245-1829  
Retail: 16-18 Del Carmine St., Wakefield, Mass. (off Water Street) C.O.D.'S MAY BE PHONOED

20c CATALOG on Fiber Optics, '16's, Semi's Parts  
MINIMUM ORDER — \$4.00

**POLY PAKS**  
P.O. BOX 942E, LYNNFIELD, MASS. 01940



**INSTRUCTION**

LEARN ELECTRONIC ORGAN SERVICING at home all makes including transistor. Experimental kit—trouble-shooting. Accredited NHSC, Free Booklet. NILES BRYANT SCHOOL, 3631 Stockton, Dept. A, Sacramento, Calif. 95820.

LEARN WHILE ASLEEP, Hypnotize! Strange catalog free. Auto-suggestion, Box 24-ZD, Olympia, Washington 98501. DEGREE IN ELECTRONICS through correspondence. Free catalog. Grantham, 2000 Stoner Avenue, Los Angeles, California 90025.

INTENSIVE 5 week course for Broadcast Engineers. F.C.C. First Class license. Radio Engineering Incorporated, 61 N. Pineapple Ave., Sarasota, Florida 33577 and 2402 Tidewater Trail, Fredericksburg, VA 22401.

SCORE high on F.C.C. Exams... Over 300 questions and answers. Covers 3rd, 2nd, 1st and even Radar. Third and Second Test, \$14.50; First Class Test, \$15.00. All tests, \$26.50. R.E.I., Inc., Box 806, Sarasota, Fla. 33577.

FREE Home Study Electronics catalog. Home study courses. Write to Edu-Kits Workshop, Department 709D. Hewlett, N.Y. 11557.

**F.C.C. EXAM MANUAL**

PASS FCC EXAMS! Memorize, study... "Test Answers" for FCC 1st and 2nd class Radio Telephone licenses. Newly revised multiple-choice questions and diagrams cover all areas tested in FCC exams plus "Self Study Ability Test." \$8.95 postpaid. Moneyback Guarantee.

COMMAND PRODUCTIONS P.O. BOX 26348-P  
RADIO ENGINEERING DIVISION SAN FRANCISCO, CALIF. 94126

FCC License, electronics design, satellite communications, through correspondence. Free catalog. Genn Tech, 5540 Hollywood Blvd., Los Angeles, CA 90028.

FIRSTPHONE—4 Tests, formulas, aids, etc. Guaranteed! \$10. Engineer, DWR 570, Mars, PA 16046.

DESIGN your own power supply and regulator circuits. Twenty pages of circuit analyses and design examples, 8-1/2x11, \$2.00. Midwest Design, Box 163, Stevensville, Michigan 49127.

**Announcing the NEW STANDARD in Stereo Testing!**  
**The All-New Model SR12 STEREO TEST RECORD**

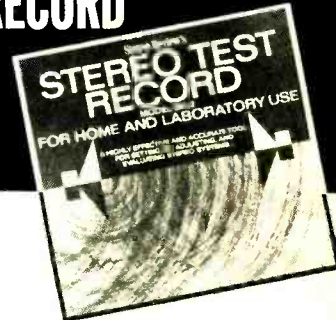

The most complete... most sophisticated... most versatile Test Disc available today...

For Just \$5.98!

Who needs the New Model SR12? You do. Whether you're an avid audiophile, a casual listener, or a professional technician... the new MODEL SR12 will be the most important disc in your entire collection. MODEL SR12 has been produced by Stereo Review Magazine for music lovers who want immediate answers to questions about the performance of their stereo systems and how to get the best possible sound reproduction. It is the most complete test record of its kind—containing the widest range of checks ever included on one test disc.

Make these important stereo checks BY EAR... (no test instruments required)  
• Frequency response • Separation • Cartridge tracking • Channel balance • Hum and rumble • Flutter • Cartridge and Speaker Phasing • Anti-Skating Adjustment • "Gun Shot Test" for Stereo Spread • Multi-purpose Musician's "A" • Equal-tempered Chromatic Octave • Guitar-tuning Tones.

Attention professionals: For the ultimate in stereo testing, 7 critical TEST EQUIPMENT checks...

- 1,000-Hz square waves to test transient and high-frequency response of phono pickups.
  - 500 to 20,000 Hz frequency-response sweep.
  - Sine-wave tone-bursts to test transient response of pickup.
  - Intermodulation test using simultaneous 400-Hz and 4,000-Hz signals.
  - Intermodulation sweep to show distortion caused by excessive resonances in tone arm and cartridge.
  - 1,000-Hz reference tones to determine groove velocity.
  - 3,000-Hz tone for flutter and speed test.
- Sample waveforms—illustrating both accurate and faulty responses are provided in the Instruction Manual for comparison with the patterns appearing on your own oscilloscope screen.

FREE Instruction Manual Includes Detailed Instructions, Charts, Tables and Diagrams

CHARGE YOUR ORDER TO YOUR AMERICAN EXPRESS, BANKAMERICARD, MASTER CHARGE OR DINERS CLUB ACCOUNT.



Ziff-Davis Service Division, Dept. R, 595 Broadway, New York, N.Y. 10012. PE-45

Please send the SR12 Stereo Test Record @ \$5.98. postpaid (\$8 outside U.S.A.).

Enclosed is \$\_\_\_\_\_ (Residents of Calif., Col., Fla., Ill., Mich., Mo., N.Y. State, D.C. and Tex. add applicable sales tax.)

CHARGE:  
 BankAmericard  Master Charge  
 American Express  Diners Club

Account # \_\_\_\_\_ Exp. Date \_\_\_\_\_  
Master Charge Interbank # \_\_\_\_\_  
(4 numbers over your name)

Signature \_\_\_\_\_  
Print Name \_\_\_\_\_

Address \_\_\_\_\_

City \_\_\_\_\_ State \_\_\_\_\_ Zip \_\_\_\_\_

**INTERNATIONAL ELECTRONICS UNLIMITED**

**APRIL SPECIALS**

74C00	\$ .29	\$25/100	74L00	\$ .25	\$20/100	7454	\$ .25	\$20/100
74C02	49	40/100	74L02	.25	20/100	7460	.15	10/100
74C04	53	50/100	74L03	.25	20/100	7490	.59	50/100
74C10	.59	50/100	74L04	.25	20/100	7493	.59	50/100
74C20	.59	50/100	74L06	.25	20/100	8836	.39	15/100
74C73	1.15	100/100	74L10	.25	20/100	380	1.19	100/100
74C107	1.25	110/100	74L51	.25	20/100	565	1.95	150/100
74C160	2.75	250/100	74L72	.35	30/100	2N3933	TO-72	1.29
74C164	2.95	260/100	74L73	.49	40/100	40636	TO-3	1.55
80C97	1.25	110/100	74L74	.39	30/100			

**TTL**

7400	\$ .19	7485	\$ 1.39
7401	.19	7486	.44
7402	.19	7489	2.75
7403	.19	7490	.76
7404	.22	7491	1.29
7405	.22	7492	.79
7406	.39	7493	.79
7407	.39	7494	.89
7408	.25	7495	.89
7409	.25	7496	.89
7410	.19	74105	.49
7411	.29	74107	.49
7413	.79	74121	.57
7415	.39	74122	.53
7416	.39	74123	.99
7417	.39	74125	.69
7420	.19	74126	.79
7422	.29	74141	1.23
7423	.35	74145	1.15
7425	.39	74150	1.09
7426	.29	74151	.89
7427	.35	74153	1.29
7430	.22	74154	1.59
7432	.29	74155	1.19
7437	.45	74156	1.29
7438	.39	74157	1.29
7440	.19	74161	1.39
7441	1.09	74163	1.59
7442	.99	74164	1.89
7443	.99	74165	1.89
7444	1.10	74166	1.65
7445	1.10	74173	1.65
7446	1.15	74175	1.89
7447	1.15	74176	1.85
7448	1.15	74177	.99
7450	.24	74180	.09
7453	.27	74181	3.65
7454	.39	74182	.89
7460	.19	74190	1.59
7464	.39	74192	1.49
7465	.39	74193	1.39
7472	.36	74194	1.39
7473	.43	74195	.99
7474	.43	74196	1.85
7475	.75	74197	1.15
7476	.47	74198	2.19
7483	1.11	74199	2.19

Data sheets supplied on request. Add \$.50 for items less than \$1.00

**LINEAR CIRCUITS**

301	Hi perf. op amp	mDIP	\$ .32
307	Op amp	mDIP	.35
308K	Micro-pwr op amp	mDIP	1.10
309K	5V reg 1A	TO-3	1.65
310	V follr. Op Amp	mDIP	1.19
311	Hi perf. V comp	mDIP	1.05
319	Hi-speed dual comp	DIP	1.29
320	Neg. regulator (5V, 5.2V, 12V, 15V)	TO3	1.35
324	Quad op amp	DIP	1.95
339	Quad comp	DIP	1.69
340T	Pos V reg (5V, 6V, 8V, 12V, 15V, 18V, 24V)	TO-220	1.95
372	AG-IF strip det	DIP	.79
376	Pos V reg	mDIP	.59
377	2 wv stereo amp	DIP	2.69
380	2w audio amp	DIP	1.49
380.8	6w audio amp	mDIP	.89
381	Lo noise dual preamp	DIP	1.79
550	Prec. V reg	DIP	.79
555	Timer	mDIP	.99
560	Phase locked loop	DIP	2.75
562	Phase locked loop	DIP	2.65
565	Phase locked loop	DIP	2.65
566	Function gen	mDIP	2.75
709	Op amp	DIP	.29
710	Hi speed V comp	DIP	.39
723	Volt reg	DIP	.69
739	Dual hi perf amp	mDIP	1.19
741	Comp. op amp	mDIP	.35
747	Dual 741	DIP	.79
748	Freq adj 741	mDIP	.39
1304	FM mux st demod	DIP	1.19
1307	FM mux st demod	DIP	.82
1458	Dual Comp op amp	mDIP	.69
1800	Stereo Multiplexer	DIP	2.75
3900	Quad amp	DIP	.65
7524	Core mem sense amp	DIP	1.89
7525	Core mem sense amp	DIP	.95
7535	Core mem sense amp	DIP	1.25
75451	Dual prl. driver	mDIP	.39
75452	Dual prl. driver	mDIP	.39
75453	Dual prl. driver	mDIP	.39
75491	Quad seq driver	DIP	.79
75492	Hex dig. driver	DIP	.89

Data sheets supplied on request. Add \$.50 for items less than \$1.00

**CALCULATOR & CLOCK CHIPS w/data**

5001	12 DIG 4 funct fix dec	3.95
5002	Same as 5001 exc btry pwr	7.95
5005	12 DIG 4 funct w/mem	8.45
MM5725	8 DIG 4 funct chain & dec	2.79
MM5736	18 pin 6 DIG 4 funct	4.95
MM5738	8 DIG 5 funct K & Mem	7.95
MM5739	9 DIG 4 funct (btry sur)	6.95
MM 5311	28 pin BCD 6 dig mux	6.95
MM 5312	24 pin 1 pps BCD 4 dig mux	6.95
MM 5313	28 pin 1 pps BCD 6 dig mux	7.95
MM 5314	24 pin 6 dig mux	8.95
MM 5316	40 pin alarm 4 dig	8.95

5001	12 DIG 4 funct fix dec	\$2.95
5002	Same as 5001 exc btry pwr	4.95
5005	12 DIG 4 funct w/mem	6.95
5725	8 DIG 4 funct chain & dec	2.25
5736	18 pin 6 DIG 4 funct	4.45
5738	8 DIG 5 funct K & Mem	4.95
5739	9 DIG 4 funct (btry sur)	4.95
5311	28 pin BCD 6 dig mux	4.95
5312	24 pin 1 pps BCD 4 dig mux	4.95
5313	28 pin 1 pps BCD 6 dig mux	4.95
5314	24 pin 6 dig mux	4.95
5316	40 pin alarm 4 dig	5.95
1103	256 bit RAM MOS	2.95
5260	1024 bit RAM	2.95
5261	1024 bit RAM	2.95
5262	2048 bit RAM	7.95
2102	1024 bit static RAM	6.95
5203	UV Eras.	19.85
HP508	4 digit common cathode	
27414	Fits 14 pin DIP - 11 lens	2.75
MAN 7	Red 7 seg 270"	.99
MAN 66	Red 6" spaced seg	3.50
MAN 6	Red 6" solid seg	3.95
8008	8 bit CPU prime quality	64.50

**SHIFT REGISTERS**

MM 5013	1024 bit accum dynamic	mDIP	\$1.95
MM 5016	500/512 bit dynamic	mDIP	1.75
MM 5058	1024 bit static	DIP	3.95
SL 54025	Quad 64 bit static	DIP	1.50

**MEMORIES**

1101	256 bit RAM MOS	\$1.75
1103	1024 bit RAM MOS	4.95
5203	2048 bit eras. PROM	24.95
5260	1024 bit RAM low power	3.95
7489	64 bit RAM TTL	2.75
8223	Programmable ROM	4.95
74200	256 bit Ram-tri-state	7.95

**LED'S AND OPTO ISOLATORS**

MV 10B	Red TO 18	\$ .25 ea.
MV50	Alx leadless	.20
MV5020	Jumbo visible red	.25
ME4	Infra red diff. dome	.60
MAN1	Red 7 seg .270"	2.50
MAN2	Red alpha num .32"	4.95
MAN4	Red 7 seg .190"	2.15
MAN5	Green 7 seg .270"	2.95
MAN7	Red 7 seg .270"	1.35
MAN8	Yellow 7 seg .270"	3.95
MAN66	6" high dir. view	4.65
DL707	Red 7 seg .3"	2.15
MCT2	Opto-iso transistor	.69

**ON ORDERS OVER \$25.00 DEDUCT 10%**

Satisfaction is guaranteed. Shipment will be made via first class mail - postage paid in U.S., Canada and Mexico within three days from receipt of order. Minimum order - \$5.00. California residents add sales tax.



INTERNATIONAL ELECTRONICS UNLIMITED  
P.O. BOX 1708 MONTEREY, CALIF. 93940 USA



**C-MOS**

1-9 10 up

4000AE	.48	.45
4001AE	.48	.45
4002AE	.48	.45
4004AE	5.85	5.85
4006AE	3.50	3.30
4007AE	.48	.42
4008AE	2.90	2.70
4009AE	.87	.86
4010AE	.55	.44
4011AE	.48	.45
4012AE	.48	.45
4013AE	.95	.85
4014AE	2.80	2.50
4015AE	2.80	2.50
4016AE	2.70	2.50
4017AE	2.60	2.50
4018AE	2.80	2.60
4019AE	.95	.85
4020AE	2.80	2.60
4021AE	2.70	2.50
4022AE	2.70	2.50
4023AE	.48	.45
4024AE	1.80	1.60
4025AE	.48	.45
4026AE	8.40	7.90
4027AE	1.20	1.00
4028AE	2.20	2.00
4029AE	4.00	2.90
4030AE	1.00	.90
4033AE	3.40	2.90
4035AE	2.80	2.70
4040AE	2.80	2.60
4041AE	1.20	.90
4042AE	2.80	2.60
4043AE	2.80	2.60
4044AE	3.10	3.00
4045AE	1.45	1.35
4047AE	1.10	.90
4049AE	1.10	.90
4050AE	1.10	.90
4051AE	3.35	2.90
4052AE	2.15	2.05
4053AE	2.90	2.80
4054AE	2.70	2.60
4056AE	3.45	3.41
4060AE	3.30	3.00
4066AE	1.80	1.60
4069AE	.80	.70
4071AE	.50	.45
4075AE	2.70	2.50
4081AE	.48	.42
4510AE	2.70	2.50
4516AE	2.90	2.80
4518AE	3.30	3.00
4520AE	3.30	3.00
4901AE	.48	.42



**WAVEFORM GENERATOR**

XR205K KIT Only \$28.00

Here's a highly versatile lab instrument at a fraction of the cost of conventional units. Kit includes two XR205 IC's, data & applications, PC board (etched & drilled, ready for assembly) and detailed instructions.

**7400N TTL**

7400N	.16	7444N	1.05
7401N	.23	7445N	1.04
7402N	.22	7446N	1.10
7403N	.22	7447N	1.10
7404N	.21	7448N	1.10
7405N	.21	7450N	.17
7406N	.36	7451N	.53
7407N	.45	7453N	.23
7408N	.23	7454N	.26
7409N	.23	7455N	.37
7410N	.18	7460N	.25
7411N	.27	7462N	.37
7412N	.52	7464N	.37
7413N	.72	7465N	.37
7414N	2.25	7470N	.30
7415N	.37	7471N	.49
7416N	.37	7472N	.33
7417N	.37	7473N	.41
7420N	.18	7474N	.40
7421N	.60	7475N	.70
7422N	.27	7476N	.45
7423N	.48	7478N	.55
7425N	.36	7480N	.60
7426N	.27	7481N	1.19
7427N	.31	7482N	.98
7428N	.52	7483N	.98
7430N	.20	7484N	3.02
7432N	.27	7485N	2.50
7433N	.62	7486N	.41
7434N	.41	7489N	2.50
7438N	.35	7490N	.70
7439N	1.05	7491N	1.15
7440N	.17	7492N	.84
7441N	.95	7493N	.71
7442N	.95	7494N	1.22
7443N	.95	7496N	.85

**DECODED READ/WRITE RAM**

P1103 \$6.20

**SCHOTTKY TTL**

74S00N	.45	74S74N	1.30
74S02N	.80	74S85N	6.10
74S03N	.75	74S86N	2.70
74S04N	.75	74S112N	2.20
74S08N	.80	74S113N	1.50
74S10N	.75	74S132N	3.60
74S11N	.80	74S133N	9.00
74S20N	.80	74S138N	2.40
74S30N	.80	74S139N	2.40
74S32N	.80	74S140N	.90
74S40N	.80	74S151N	2.40
74S51N	.80	74S153N	2.40
74S64N	.80	74S157N	2.40

**HIGH SPEED TTL**

74H00N	.34	74H53N	.36
74H02N	.34	74H54N	.36
74H03N	.39	74H58N	.36
74H04N	.39	74H60N	.36
74H10N	.34	74H68N	.36
74H20N	.39	74H10N	.36
74H42N	1.62	74H11N	.36
74H51N	.34	74H20N	.36
74H73N	.74	74H21N	.36
74H74N	.89	74H22N	.36
74L00N	1.62	74H30N	.36
74L03N	1.74	74H40N	.36
74L95N	1.62	74H50N	.36
93L01	1.50	74H51N	.36
93L01	1.60	74H52N	.36
93L08	2.30	74H106N	.95
93L09	1.80		
93L10	2.80		
93L11	4.20		
93L12	1.80		
93L14	1.70		
93L16	3.20		
93L18	3.50		
93L21	1.50		
93L22	1.80		
93L24	2.80		
93L28	3.70		
93L34	4.00		
93L38	4.20		
93L40	6.50		
93L41	6.50		
93L60	3.00		
93L66	2.70		

**COMPUTER INTERFACE**

DM8820N	2.40
DM8820AN	6.90
DM8830N	2.40
DM8831N	5.20
DM8832N	6.00
N8T26B	4.40
9600PC	3.30
9601PC	1.20
9602PC	2.10
9614PC	2.30
9615PC	2.40
9616DC	5.00
9617PC	4.50
9620PC	4.00
9621PC	4.00



PORTABLE 4 1/2 DIGIT MULTIMETER FOR \$299. A 10 MHz COUNTER OPTION FOR \$50.

**PULSE GENERATOR**

Interdesign 1101: 0.1Hz-2MHz. 0.5V Output, var. width, line or battery operation. \$159.00

**TWO-PHASE MOS CLOCK DRIVER**

MH0026CN \$5.50

**FM STEREO DEMODULATOR**

XR1310 \$3.90

MINIMUM ORDER: \$10.00. Add \$1.00 to cover postage and handling. SEND CHECK OR MONEY ORDER (NO C.O.D.) TO: California residents add 6% sales tax.



**ANATRON CORP.**

P.O. BOX 2208P, Culver City, CA 90230

CIRCLE NO. 46 ON READER SERVICE CARD

www.americanradiohistory.com

APRIL 1975

**DUAL LOW NOISE OP AMP**

LM331N: V<sub>io</sub> = 6mV I<sub>ie</sub> = 1000 nA I<sub>o</sub> = 2000 nA Noise = 1.5dB \$2.20



**CALCULATORS (Limited Qty.) \$19.00**

**1024-BIT N-Channel RAM**

2601-1	11.40
2601-21	11.40
2602B	8.00
2602-1B	8.00
2602-2B	8.00
MK4102P	11.40
7552-1CPE	8.00
7552-2CPE	8.00

**DISPLAYS**

OPCA SLA1	Red	2.25
SLA11	Green	3.50
SLA21	Yellow	3.50
SLA7	Red	1.60

**LITRONIX**

DL80	Red	6.00
DL81	Red	6.00
DL10	Red	6.00
DL10A	Red	4.00
DL1C1	Red	4.90
DL57	Red	9.90
DL61	Red	12.00
DL302	58	6.00
DL44	Red	6.00
DL402	Red	4.00
DL701	Red	3.40
DL702	Red	2.25
DL707	Red	2.35
DL747	Red	2.50

**XCI70N**

XAN72	Red	2.00
XAN52	Green	2.00

**74LS**

74LS00	58	74LS76	92
74LS01	58	74LS78	92
74LS02	58	74LS107	92
74LS03	58	74LS109	92
74LS04	63	74LS112	92
74LS05	63	74LS113	92
74LS08	58	74LS114	92
74LS09	58	74LS138	2.38
74LS10	58	74LS139	2.38
74LS11	58	74LS151	10
74LS15	58	74LS153	2.38
74LS21	58	74LS157	2.10
74LS22	58	74LS158	2.40
74LS25	58	74LS160	2.70
74LS27	64	74LS161	2.70
74LS30	58	74LS170	5.92
74LS32	64	74LS174	3.02
74LS51	58	74LS175	2.90
74LS54	58	74LS181	3.70
74LS55	58	74LS251	2.55
74LS57	92	74LS253	3.05
74LS74	92	74LS260	58

**LEDs**

.125" dia.	205 Red	\$ .25
	209 Yellow	.35
	209 Green	.35
.160" dia.	216 Red	.25
	216 Yellow	.30
	216 Green	.30
.200" dia.	220 Red	.25
	220 Yellow	.30
	220 Green	.30
LOW PROFILE	226 Red	\$ .25
	226 Yellow	.30
	226 Green	.30
	226 Orange	.30
	5053 Red	.35
	5053 Yellow	.40
	5033 Green	.40
	5033 Orange	.40
	216 = MV5024	
	5053 = MV5053	
	MV30 Red	\$ .30

**OPTOISOLATORS**

MONSANTD MCT2 1.35 LITRONIX IL1 1.30 IL12 1.40 CY74 1.35 ILD74 1.80 ILQ74 3.40

**9300 SERIES**

9300PC	1.00
9301PC	1.20
9304PC	1.60
9306PC	6.90
9308PC	2.50
9309PC	1.60
9310PC	1.50
9311PC	2.30
9312PC	1.20
9314PC	2.30
9316PC	1.50
9322PC	1.30
9324PC	2.50
9328PC	2.50
9334PC	2.95
9338PC	3.30
9340PC	5.00
9341PC	4.10
9342PC	1.15
9360PC	.75
9366PC	.75

**INTERFACE MODULES**

CY1010	Instr. Amp., Bipolar Input	29.00
CY1011A	Instr. Amp., Bipolar Input	49.00
CY1020	Instr. Amp., FET Input	34.00
CY1021A	Instr. Amp., FET Input	49.00
CY1021A	Instr. Amp., FET Input	59.00
CY1217	DAC, 10 Bit, Low Drift	39.00
CY2218	DAC, 12 Bit, 2 Quad Multiplying	149.00
CY2237	DAC, 12 Bit, Low Drift	69.00
CY2735	DAC, 4 Digit, Sect. Counting	79.00
CY3035	ADC, 8 Bit, Sect. Counting, Low Cost	89.00
CY3635	ADC, 3 Digit BCD, Sect. Counting, Low Cost	119.00

**LINEAR ICs**

H=TO5 N=DIP M=MINI-DIP D=CER-DIP K=TO3	LM114H	3.00	LM311H	1.70	LM711CN	9.30
	LM300H	1.20	LM311D	1.90	LM715CH	4.00
	LM300N	1.20	LM311M	1.75	LM715DC	4.60
	LM301AH	.90	LM311N	2.00	LM723CH	.90
	LM301AM	.80	LM312H	2.70	LM723CN	5.00
	LM301AN	1.10	LM318H	2.60	LM725CH	5.20
	LM301M	.80	LM301H	1.90	LM725CN	5.00
	LM302D	3.50	LM302N	1.30	LM733CH	1.40
	LM302N	1.30	LM320-5K	2.50	LM733CN	1.30
	LM302H	1.50	LM320-5T	2.50	LM741CH	.45
	LM304H	1.50	LM320-12K	2.90	LM741CN	.44
	LM305H	1.05	LM320-12K	2.90	LM741CN	.70
	LM305AH	.05	LM340-05K	2.60	LM741CN	1.00
	LM305N	1.00	LM340-06K	2.60	LM747CH	1.70
	LM305H	.95	LM340-08K	2.60	LM747CN	.90
	LM307H	.75	LM340-12K	2.60	LM748CN	.55
	LM307M	.95	LM340-15K	2.60		



### DIP SOCKETS

8 PIN PCB .22 24 PIN PCB .75  
 14 PIN PCB .26 40 PIN PCB 1.25  
 36 PIN PCB .30 24 PIN WIRE WRAP .35

### POTTER & BRUMFIELD



Type K1P Relay 4 PDT 3A Contacts  
 24 VDC (650 coil) ea. \$1.50 10/\$14.00  
 120 VAC (10.5 MA coil) ea. \$1.75 10/\$15.75

### CARBON RESISTORS

Carbon Resistors 1/4-watt 5% full prime, all values in stock 10 per value (minimum quantity). ten for \$4.5

### FAIRCHILD "TRIMPOTS"



ea. only \$3.89- 10 for \$7.50  
 Brand new 20 turn precision trimmers. These are prime parts mostly individually packed in sealed envelopes. These values in stock:  
 50 OHM 1 K 5 K 25 K  
 500 OHM 2 K 10 K

### DIODE ARRAY



10 IN914 Silicon Signal Diodes in one package, 20 leads spaced .1"; no common connections. ea. \$2.25 10 for \$2.25

### 8270 DIP 4-BIT SHIFT REGISTER

4-Bit Shift Register—parallel and serial input and output; data entry is synchronized with clock pulse. ea. \$3.50 10 for \$3.95

### 2N3055 NPN TRANSISTOR

2N3055 Transistor (power): PD-115W; VCE-60V; IHF-50; FT-30K; Case-TO-3 ea. \$1.15 10 for \$6.95

### 2102-2 MOS 1024 BIT MEMORY

FULLY DECODED STATIC RANDOM ACCESS MEMORY DIRECTLY TTL COMPATIBLE INPUTS AND OUTPUT SINGLE 5V SUPPLY — NO CLOCKS OR REFRESH

**\$6.95 EA. (DIP) 8 FOR \$49.95**

### 7400 DIP TTL SPECIAL

7400 DIP TTL Special Sensitive/House Numbered. ea. \$1.17 10 for \$1.50

### 7404 DIP TTL

7404 DIP TTL Special Hex Inverter, Sensitive/House Numbered. ea. \$1.17 10 for \$1.50

### SEND FOR FREE FLYER!

C.O.D. PHONE ORDERS ACCEPTED—\$10 MINIMUM

All parts surplus and tested; leads plated with gold or solder. Orders for \$5 or more are shipped prepaid; smaller orders add \$5c. California residents add Sales Tax. ICs shipped within 24 hours.

### BABYLON ELECTRONICS

P. O. Box 41277  
 Sacramento, Ca. 95841  
 (916) 334-2161

CIRCLE NO. 7 ON READER SERVICE CARD

### PLANS AND KITS

**ATTENTION AUDIO FREAKS!!** ... Audio Processing Circuits ... designs, kits, units. Laboratory tested designs for hobbyist through professional use—limiters, compressors, equalizers, phasers, mixers and more! Send now—\$1.00 (refundable) for complete catalog—CIRCUIT RESEARCH LABS, 3920 E. Indian School, Phoenix, AZ 85018.

**FREE CATALOG.** 200+ unique electronic projects. Bio-feedback, acupuncture, more! Cimarron Labs, 4183A Springfield St., Burton, Michigan 48509.

**AMAZING ELECTRONIC PRODUCTS**—Pocket Laser, See-In-The-Dark, Scramblers, Penlight Strobe, Energy Devices, TV Disruptor, Many More. All New. Catalog \$1.00. INFORMATION UNLTD., West St., Milford, N.H. 03055.

"BUILD eight digit wrist band calculator or submini pocket style for less than \$25.00. Pi, square roots, memory, chain, constant, powers, & reciprocals directly from read out. Kit includes data input board and plans, \$7.95. For advanced builders. KJ Electronics, P.O. Box 872, Mishawaka, Indiana 46544. Add 50 cents for postage and handling. Indiana Residents include 4% state tax. Patent applied for.

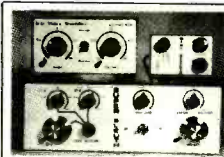

### DESCRAMBLERS

Several models to choose from... operates with all scanner and monitor receivers.

WRITE or CALL for Catalog  
 Phone (501) 273-5340

KRYSTAL KITS, Box 445, BENTONVILLE, ARK. 72712

**DIGITAL CLOCK** uses new computer compatible digits. Plans—\$1.28. Kit—\$25.00. Completed clock—\$32.00. Turner Electronics, New Ross, Indiana 47968.

**DIGITAL ALARM CLOCK KITS.** Complete kit of electronic parts for four digit. LED display alarm clock—\$22.30 post paid. Send for free flyer, bargain kits, components. Digitex, Box 47311, Dallas, Texas 75247

**POWER SUPPLY KIT +5 VDC at 1 AMP IC Regulated with -12 VDC bias supply.** Complete with chassis, power cord, solder, everything — only \$15.95. Deluxe case add \$3.80. Satisfaction guaranteed. Include \$1.25 shipping and handling. Californians add 6% sales tax. Free brochure on request. Dage Scientific Instruments, 1931 Tobruk, Livermore, CA 94550.

### LOGIC PROBE KIT



**\$14.95**

(plus shipping)

Now! A Digital Logic Probe kit at a realistic price. Red, Green, and Yellow light emitting diodes signal the presence of logic levels encountered in digital circuitry. Utilization of transistor and integrated circuit switching techniques permit the DIGAPEAKE-A to indicate logic 1, logic 0, and pulsing circuit conditions. Complete kit including easy instructions is available now from...

Chesapeake Digital Devices Inc.

P.O. BOX 341  
 Havre de Grace, MD 21078

EM Synthesizer Studio/lab quality. Send SASE or 25 cents. CFR ASSOCIATES, POB F, Newton, NH 03858.

**EXPLODING Wires!** Detonations, Ultra-speed Photography, Spectroscopy, Instructions, Charts. Spectacular Science Fair Project! Send \$1.00. United Science Center, 12146 Maple, Blue Island, Ill. 60406.



NEW for Engineers and Technicians. LED Digital wristwatch kits. hours, minutes, seconds. Month, day Perpetual calendar. Gold-plated case and band. Construction plans complete, including drawings, schematics, parts list. Send check of money order for kit \$99.95. Assembled \$149.50.

HAW-KITS, Box 1625,  
 GARLAND, TEX 75040

**TV PING PONG game.** Plays through your set's antenna terminals: Plans \$3.25. Four Channel DIGITAL OSCILLOSCOPE Plans \$4.50. ARS SYSTEMS, Box 1922B, Sunnyvale, CA 94088.

**NEW ORGAN KIT BUILDERS MANUAL \$3.00.** Circuits, block diagrams, details on diode keyed IC divider and independent oscillator designs. Many new kits and models. Keyboards also for synthesizers. Manual cost refundable with purchase. DEVTRONIX ORGAN PRODUCTS, Dept. C, 5872 Amapola Dr., San Jose, CA 95129.

**FREQUENCY counter, Digital Clock, Logic Probe** and more to come. Complete kits or PC Boards, reasonable priced full details \$3.00. Refundable. East Coast Electronics, 50 Scott, Hamburg, New York 14075.

### MUSICAL INSTRUMENTS

**UP TO 60% DISCOUNT.** Name brand instruments catalog. Freeport Music, 455N Route 110, Melville, N.Y. 11746.

**WHOLESALE!** Professional Guitars, PA Systems, Altec Speakers, 240W RMS Amplifiers. Free Catalog, Carvin, Escondido, Calif. 92028.

**STOP!** We want to answer all your questions about Synthesizers and Electronic Music. \$1 to Music Studios, 460 West St., Amherst, Mass. 01002.

### PRINTING

PRINTING Presses, Type, Supplies. Lists 10 cents. Turnbaugh Service, Mechanicsburg, PA 17055.

## ABOUT YOUR SUBSCRIPTION

Your subscription to POPULAR ELECTRONICS is maintained on one of the world's most modern, efficient computer systems, and if you're like 99% of our subscribers, you'll never have any reason to complain about your subscription service.

We have found that when complaints do arise, the majority of them occur because people have written their names or addresses differently at different times. For example, if your subscription were listed under "William Jones, Cedar Lane, Middletown, Arizona," and you were to renew it as "Bill Jones, Cedar Lane, Middletown, Arizona," our computer would think that two separate subscriptions were involved, and it would start sending you two copies of POPULAR ELECTRONICS each month. Other examples of combinations of names that would confuse the computer would include: John Henry Smith and Henry Smith; and Mrs. Joseph Jones and Mary Jones. Minor differences in addresses can also lead to difficulties. For example, to the computer, 100 Second St. is not the same as 100 2nd St.

So, please, when you write us about your subscription, be sure to enclose the mailing label from the cover of the magazine—or else copy your name and address exactly as they appear on the mailing label. This will greatly reduce any chance of error, and we will be able to service your request much more quickly.

## Planning to move?

Let us know **8 weeks in advance** so that you won't miss a single issue of POPULAR ELECTRONICS.

Attach old label where indicated and print new address in space provided. Also include your mailing label whenever you write concerning your subscription. It helps us serve you promptly.

Write to: P.O. Box 2774, Boulder, CO 80302, giving the following information:

- Change address only.
- Extend subscription.  Enter new subscription.
- 1 year \$6.98
- Payment enclosed (1 extra BONUS issue)
- Bill me later

**AFFIX LABEL**

If you have no label handy, print OLD address here.

name <small>please print</small>	address	city	state zip code

name      0171  
 address  
 city      state      zip code

Add'l postage: \$2 per year outside U.S., its poss. & Can.



# HONEYWELL COMPUTER BOARD

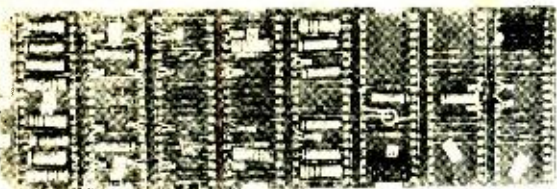

We thought this old favorite had disappeared, but we located one last lot, still at the old price. Loaded with discrete components, transistors, diodes, SCRs, precision resistors, capacitors etc. Board is 4"x12 1/2" Wt 1 Lb. ea.  
STOCK NO:P9121 3/2.00 9/5.00

# 1/4 WATT RESISTOR & DIODE BONANZA



PC boards, incomplete assemblies, loaded with 1/4 watt 5% & 10% resistors, 1N914 & 1N4148 high speed diodes, all unsoldered, easily removed with tweezers. Average 51 resistors & 35 diodes per board. About 10 different boards. 6"x3 1/2" ea. Wt 1/2 lb.  
STK. No.P9105, Av. 153 resistors & 105 diodes. 3boards, 2.00. 9 boards 5.00

**HIGH POWER TRANSFORMER**  
35 volts @ 6.0 amps. ct. and 10 volts @ 10 amps.  
STOCK NO.P9906 \$8.95 ea. 2/16.00

MINIMUM ORDER \$5.00. Include postage, excess refunded. New edition of our catalog now available.

**DELTA ELECTRONICS CO.**  
BOX 1, LYNN, MASSACHUSETTS 01903  
Phone (617) 388-4705

CIRCLE NO. 13 ON READER SERVICE CARD

**WOW! WHAT A LOAD OF BARGAINS!**  
only of TRACY DESIGN!

## DIGITAL INTEGRATED CIRCUITS

All are new and factory marked with type and date code

CATALOG NUMBER	DESCRIPTION	PRICE
7400	Quad 2 Input Pos. NAND Gate	34
7402	Quad 2 Input Pos. NOR Gate	34
7404	Hex. Inverter	34
7410	Triple 3 Input Pos. NAND Gate	34
7411	Triple 3 Input Pos. AND Gate	34
7413	Quad NAND Schmitt Trigger	42
7420	Quad 4 Input Pos. NAND Gate	42
7447	BCD to Seven Segment Decoder Driver	30
7473	Dual J-K Master-Slave Flip-Flop	62
7475	Quad Bistable Latch	62
7476	Quad J-K Master-Slave Flip-Flop with Preset and Clear	62
7490	Decade Counter	62
7492	Divide by Ten Counter	62
7493	4 Bit Binary Counter	92
74121	Monostable Multivibrator	19
74192	Presetable Synch. Decade Up-Down Counter	2.20

## LIGHT EMITTING DISPLAYS

### DIODES

Buy these Brand New HP and Motorola Displays at a Super Price for a Prime Display. ALL UNITS NEW AND GUARANTEED.

CATALOG NUMBER	COLOR	DESCRIPTION	PRICE
MAN51	Green	Common Anode, eight half decimal Common Anode, eight half decimal	1.10
MAN71	Red	Common Anode, eight half decimal	3.25
HP751	Red	*48" Display	4.50
MAN72	Red	Common Cathode, eight half decimal	3.25
MAN81	Yellow	Common Anode, eight half decimal	3.25
HP802	Red	Shorter Lead Letter	35

Headquarters For

- RESISTORS
- TRANSFORMERS
- CIRCUIT BOARDS
- POWER SUPPLIES
- EDGE CONNECTORS



TERMS: All orders require a Money Order or Bank Account Credit Card. Cash orders \$25.00 and \$100.00 in advance & handling.

## TRACY DESIGN CORP.

15870 SCHAEFER • DETROIT, MI 48227 • (313) 838-2501

CIRCLE NO. 45 ON READER SERVICE CARD

## MINIATURE FILM CAPACITORS

VALUE (uF)	PRICE TABLE	51 100
1.14	15.50	
001	10	09
004	10	09
01	10	09
05	15	17
2	21	20
28	26	25

## REGULATOR CIRCUITS

MC7805CP	5 volt regulator @ 1.5A max	1.75
MC7815CP	12 volt regulator @ 1.5A max	2.00
MC7815CP	15 volt regulator @ 1.5A max	2.00

## FIXED POWER SUPPLY KITS

Specifications	F950	11210	F1510
Input Voltage (50 500Hz)	105-125v	10-125v	110-125v
Output Voltage	5v - 5%	12v - 5%	15v - 5%
Output Current - I <sub>L</sub>	25 C 1.5A Max	1.6A Max	1.1A Max
PRICE	\$14.00	\$14.50	\$14.50

\*NO INFINITE SHORT CIRCUIT PROTECTION. Price includes Preformed G-10 Board, All Parts, and Transformer.

## DISPLAY BEZELS

CATALOG NUMBER	FILTER COLOR	PRICE	DIMENSION	These bezels are heat resistant plastic with a black matte finish. Filters are circular polarized type.
905 60	Red	2.50	1 3/4"	
910 60	Red	2.55	2 00"	
915 60	Red	2.65	3 00"	
920 60	Red	2.70	4 00"	
925 70	Amber	2.70	4 00"	



## SOCKETS

These sockets are from TI

NUMBER OF PINS	PRICE
8	21
14	25
16	28
24	1.00
28	1.20

## DIODES

1N4001	8¢/100
1N4002	8¢/100
1N4148	10¢/100
1N4501	5¢/200
13A 100PVP	

## TRIMMER POTENTIOMETERS

These are 5/16 diameter thumbwheel trimmer potentiometers

VALUES OHMS	PRICE TABLE
500 1K 5K 10K	
50K 100K 500K	
1.1H 1.39H 1.00	
1H 1.1H 1.25	

## VALUES OHMS

500 1K 5K 10K	
50K 100K 500K	
1.1H 1.39H 1.00	
1H 1.1H 1.25	

## TTL CMOS

7400	6/\$1.00	7488	4.00	CD4001	\$ .55
7401	.23	7489	*2.25ea	CD4002	.55
7402	.23	7490	*.69ea	CD4007	1.25
7403	6/1.00	7491	*1.00	CD4009	1.40
7404	.25	7492	.95	CD4010	.60
7405	.24	7493	.95	CD4011	.55
7406	.50	7494	.97	CD4012	.55
7407	.25	7495	.95	CD4013	1.50
7408	.25	7496	.95	CD4016	1.40
7409	.25	74100	1.50	CD4017	2.75
7410	6/1.00	74107	.47	CD4019	1.25
7411	.30	74121	.55	CD4020	1.50
7412	.40	74122	.47	CD4022	2.50
7413	.75	74123	1.05	CD4023	.55
7416	.45	74125	.60	CD4025	.55
7417	.45	74126	.80	CD4027	1.25
7418	.23	74141	1.15	CD4030	.60
7420	.23	74145	1.15	CD4035	2.75
7421	.27	74150	.95	CD4049	1.25
7423	.32	74151	1.20	CD4050	1.25
7425	.31	74153	1.50	74C00	.45
7426	.31	74154	1.25	74C02	.45
7427	.32	74155	1.30	74C04	.70
7429	.40	74156	1.30	74C20	.65
7430	.33	74157	1.55	74C74	1.15
7432	.26	74160	1.65	74C160	3.25
7437	.45	74181	1.65	74C161	3.25
7438	.50	74183	2.50	74C107	1.50
7439	.50	74164	2.50	74C151	2.90
7440	.23	74165	2.50	74C154	3.50
7441	1.10	74166	1.75	74C163	3.25
7442	1.05	74170	3.00	74C164	3.50
7443	1.10	74173	1.75	74C173	2.90
7444	1.15	74174	1.85	74C195	3.00
7445	1.10	74175	1.85		
7446	1.25	74176	.85		
7447	.89	74177	.85		
7448	1.25	74180	1.00		
7450	.25	74181	3.75	IN456	6/\$1
7451	.27	74182	1.00	IN458	6/\$1
7453	.27	74184	2.30	IN485A	5/\$1
7454	.40	74185	2.30	IN746	4/\$1
7459	.25	74187	7.00	IN752	4/\$1
7460	.25	74190	1.50	IN1183	1.60
7470	.45	74191	1.50	IN1184	1.70
7472	.41	74192	1.25	IN1186	1.80
7473	.39	74193	1.25	IN3600	6/\$1
7474	.47	74194	1.50	IN4001	.09
7475	.75	74195	1.05	IN4002	.10
7476	.40	74196	1.25	IN4004	.10
7480	.50	74197	1.05	IN4148	15/\$1
7482	1.75	74198	2.25	IN4154	12/\$1
7483	1.15	74199	2.75	IN4734	.28c
7485	1.10	74200	7.00	IN4735	.28c
7486	.47	74250	5.00	IN5232	.28c
				IN5234	.28c
				IN5243	.28c
				IN5282	5/\$1

20% Discount for 100 pcs. Combined 7400's (Except Specials)

## APRIL SPECIALS

8008 Processor	\$49.95	8080 Micro Processor	\$249.95
1101 256 x 1 RAM	2.25	N8T97 HEX Inverter	2.95
2102 1024 RAM	7.95	1702 2048 ROM	29.95
5203 2048 ROM	19.95	8111 256 x 4 N Channel	11.95

## Miniature Aluminum Electrolytic Capacitors

MFD-VOLTS	1-	9-	100	MFD-VOLTS	1-	9-	100
4.7UF/D/50V	.14	.12	.11	474UF/D/25V	.19	.15	.14
1UF/D/16V	.14	.12	.11	100UF/D/16V	.19	.15	.14
1UF/D/50V	.15	.12	.11	100UF/D/25V	.24	.18	.17
2.2UF/D/50V	.14	.12	.11	100UF/D/50V	.24	.18	.17
3.3UF/D/25V	.14	.12	.11	220UF/D/16V	.24	.18	.17
4.7UF/D/25V	.14	.12	.11	220UF/D/25V	.25	.25	.24
10UF/D/16V	.14	.12	.11	470UF/D/16V	.37	.30	.27
10UF/D/25V	.14	.12	.11	470UF/D/25V	.49	.39	.35
10UF/D/50V	.14	.12	.11	1000UF/D/16V	.49	.39	.35
22UF/D/16V	.14	.12	.11	1000UF/D/25V	.75	.60	.55
22UF/D/25V	.15	.13	.12	2200UF/D/16V	.75	.60	.55
47UF/D/16V	.17	.14	.13				

## 50 VOLT CERAMIC DISC CAPACITORS

.001 mf. 5c	3.5c	3c	.033 mf. 6c	4c	3.5c
.0047 mf. 6c	4c	3.5c	.047 mf. 6c	4c	3.5c
.01 mf. 5c	3.5c	3c	.1 mf. 12c		7.5c
.022 mf. 6c	4c	3.5c	100 pf. 6c	4c	3.5c

MPS-A05	5/\$1	TRANSISTORS	2N3905	4/\$1	
2N918	.25	2N2906A	4/\$1	2N3906	4/\$1
2N2219A	3/\$1	2N2907A	5/\$1	PN4249	4/\$1
2N2221A	4/\$1	2N3053	2/\$1	PN4250	4/\$1
2N2222A	5/\$1	2N3055	.95¢	2N4409	5/\$1
2N2369	5/\$1	2N3725A	2/\$1	2N5129	.19
2N2369A	4/\$1	2N3903	5/\$1	2N5139	.19
2N2484	4/\$1	2N3904	4/\$1	C106B1-SCR-2/\$1	

Cal. & Clk. Chips IC Skts  
5001 \$3.95 8 P \$ .22  
5005 5.95 14 P .26  
5030 7.95 16 P .29  
MM5311 5.95 18 P .46  
MM5312 5.95 24 P .68  
MM5313 5.95 28 P .89  
MM5314 5.95 36 P 1.10  
MM5316 6.95 40 P 1.25

WALL or T.V. DIGITAL CLOCK  
25" VIEWING DISTANCE  
Walnut Case-6 1/2"x3 1/2"x1 1/2"  
Hr. & Min.-6 1/2" High  
Seconds-3 1/2" High  
KIT - All Comp & Case \$39.95  
Wired & Assembled \$44.95

Satisfaction Guaranteed. All Items 100% Tested  
\$5.00 Min. Order - 1st Class Mail - No Charge  
California Residents - Add 6% Sales Tax  
Wholesale Outlets - Write for Special Discounts  
Write for FREE 1975 Catalog - Data Sheets 25¢ each

**JAMES**

P.O. BOX 822, BELMONT, CA. 94002  
PHONE ORDERS - (415) 592-8097  
CIRCLE NO. 23 ON READER SERVICE CARD

## LINEAR

LM300H	\$ .69	LM741H/N	\$ .31
LM301H/N	.29	LM747N	.69
LM302H	.69	LM748N	.35
LM304H	.79	LM1303N	.79
LM305H/N	.89	LM1304N	1.00
LM307H/N	.35	LM1307N	.79
LM308H/N	1.05	LM1310P	3.95
LM309K	1.25	LM1458N	.69
LM310H/N	1.19	LM1496N	.99
LM311H/N	.95	LM1556V	1.85
LM318N	1.69	CA3013	1.70
LM319N	1.19	CA3023	2.15
LM320K	1.50	CA3035	2.25
LM324N	1.85	CA3039	1.35
LM339N	1.95	CA3046	1.15
LM340K	1.89	CA3059	2.46
LM340T	1.75	CA3060	2.80
LM370N	1.05	CA3065N	.75
LM373N	2.05	CA3080	.85
LM380-8	1.00	CA3083	1.60
LM380N	1.25	CA3086	.70
NE531T	3.00	CA3089	3.25
NE536T	3.00	CA3091	8.25
NE550N	.79	CA3123	1.85
NE555N	.75	CA3600	1.75
NE556N	1.85	LM3900	.55
NE560	2.50	LM3905	.65
NE561	2.50	LM7805	1.75
NE562	2.50	80388	5.



# FREE

DATA SHEETS  
WITH EVERY ITEM  
739/749 IC WITH  
EVERY \$10 ORDER \*

- REDUCE YOUR PROJECT COSTS
  - MONEY-BACK GUARANTEE
  - 24-HOUR SHIPMENT
  - ALL TESTED AND GUARANTEED
- TRANSISTORS (NPN):
 

2N3563 TYPE RF Amp & Osc to 1 GHz (pl.2N918)	6/\$1.00
2N3565 TYPE Gen. Purpose High Gain (TO-92/106)	6/\$1.00
2N3567 TYPE High-Current Amplifier/500 mA	4/\$1.00
2N3866 TYPE RF Pwr Amp 1-2 W @ 100-600 MHz	\$1.50
2N3903 TYPE GP Amp & Sw to 100 mA and 30 MHz	6/\$1.00
2N3904 TYPE GP Amp & Sw to 100 mA (TO-92/106)	5/\$1.00
2N3919 TYPE RF Pwr Amp 3-5 W @ 3-30 MHz	\$3.00
2N4274 TYPE Ultra-High Speed Switch 12 ns	4/\$1.00
MP56515 TYPE High-Gain Amplifier h <sub>FE</sub> 250	3/\$1.00
Assort. NPN GP TYPES, 2N3565, 2N3641, etc. (15)	\$2.00
2N3638 TYPE (PNP) GP Amp & Sw to 300 mA	4/\$1.00
2N4249 TYPE (PNP) Low-Noise Amp 1 µA to 50 mA	4/\$1.00
  - FET'S:
 

N-CHANNEL (LOW-NOISE):	
2N4091 TYPE RF Amp & Switch (TO-18/106)	3/\$1.00
2N4416 TYPE RF Amplifier to 450 MHz (TO-72)	2/\$1.00
2N5163 TYPE Gen. Purpose Amp & Sw (TO-106)	3/\$1.00
2N5486 TYPE RF Amp to 450 MHz (plastic 2N4416)	3/\$1.00
E100 TYPE Low-Cost Audio Amplifier	4/\$1.00
ITE4868 TYPE Ultra-Low Noise Audio Amp.	2/\$1.00
TIS74 TYPE High-Speed Switch 40Ω	3/\$1.00
Assort. RF & GP FET'S, 2N5163, 2N5486, etc. (8)	\$2.00
P-CHANNEL:	
2N4360 TYPE Gen. Purpose Amp & Sw (TO-106)	3/\$1.00
E175 TYPE High-speed Switch 125Ω (TO-106)	3/\$1.00

APRIL SPECIALS:	
1N4154 DIODE 30 V/10mA-1N914 spec.	20/\$1.00
2N5108 RF TRANSISTOR 2W @ 450, 1W @ 1 GHz	\$2.50
749 Dual Audio Preamp/Op Amp (DIP)	\$ .80
340T 1A VOLT. REG. - Specify 6, 12 or 15 V	\$1.75
MM5316 Digital Alarm Clock-Snooze/Alarm/Timer	
Hrs, Mins, Secs, 4 or 6 Digit - with Specs/Schematics	\$7.95
MM5736 6-Digit 4-Function Calculator 18 PIN DIP	\$3.95

- LINEAR IC'S:
 

308 Micro-Power Op Amp (TO-5/MINI-DIP)	\$1.00
309K Voltage Regulator 5 V @ 1 A (TO-3)	\$1.50
324 Quad 741 Op Amp, Compensated (DIP)	\$1.90
380 2-5 Watt Audio Amplifier 34 dB (DIP)	\$1.29
555X Timer 1 µs-1 hr, Dif. pinout from 555 (DIP)	\$ .85
709 Popular Op Amp (DIP/TO-5)	\$ .29
723 Voltage Regulator 3-30 V @ 1-250mA (DIP/TO 5)	\$ .58
739 Dual Low-Noise Audio Preamp/Op Amp (DIP)	\$1.00
1458 Dual 741 Op Amp (MINI-DIP)	\$ .65
2556 Dual 555 Timer 1 µsec to 1 hour (DIP)	\$1.55

- DIODES:
 

1N3600 TYPE Hi-Speed Sw 75 V/200 mA	6/\$1.00
1N3893 TYPE RECTIFIER Stud Mount 400 V/12 A	2/\$1.00
1N914 or 1N4148 TYPE Gen. Purp. 100V/10mA	10/\$1.00
1N749 ZENER 4.3 Volt (±10%) 400 mW	4/\$1.00
1N753 ZENER 6.2 Volt (±10%) 400 mW	4/\$1.00
1N755 ZENER 7.5 Volt (±10%) 400 mW	4/\$1.00
1N757 ZENER 9.1 Volt (±10%) 400 mW	4/\$1.00
1N758 ZENER 10 Volt (±10%) 400 mW	4/\$1.00
1N965 ZENER 15 Volt (±10%) 400 mW	4/\$1.00
1N968 ZENER 20 Volt (±10%) 400 mW	4/\$1.00
D5 VARACTOR 5-50 W Output @ 30-250 MHz, 7-70 pF	\$5.00
F7 VARACTOR 1-3 W Output @ 100-500 MHz, 5-30 pF	\$1.00

\*MAIL NOW! FREE DATA SHEETS supplied with every item from this ad. FREE 739 or 749 Low-Noise Dual Op Amp included (\$1.00 value) with every order of \$10 or more, postmarked prior to 5/31/75

ORDER TODAY - All items subject to prior sale and prices subject to change without notice.

WRITE FOR FREE CATALOG offering hundreds of semiconductors not listed here. Send 10¢ stamp.

TERMS: All orders must be prepaid. We pay postage. \$1.00 handling charge on orders under \$10. Calif. residents add 6% sales tax.

## ADVA ELECTRONICS

BOX 4181-AA, WOODSIDE, CA 94062  
Tel. (415) 851-0455  
**CIRCLE NO. 1 ON READER SERVICE CARD**

### HIGH FIDELITY

DIAMOND NEEDLES and Stereo Cartridges at Discount prices for Shure, Pickering, Stanton, Empire, Grado and ADC. Send for free catalog. LYLE CARTRIDGES, Dept. P, Box 69, Kensington Station, Brooklyn, New York 11218.

SAVE 50%. Build your own speaker systems featuring Nor-elco, Eminence and CTS. Famous brands from world's largest speaker factories at lowest wholesale prices. Write for free catalog of speakers and electronic accessories. McGee Radio Company, 1901 McGee Street, Kansas City, Missouri 64108.

### LISTEN TO SPECTACULAR 4 CHANNEL SOUND!

Expand your stereo to quadraphonic Hi-Fi.  
Build the VISTA Full Logic "SQ" Decoder.

Latest CBS licensed circuitry using 3 IC's to provide Full Logic and Wave Matching.

Exclusively ours. Kit SQ-1 \$37.50. Shipped prepaid in USA & CANADA. Send for information.

**PHOTOLUME CORPORATION**  
118 East 28th Street, New York, N.Y. 10016



**CB-HAM-SWL...**  
they come through  
loud and clear in the  
all-new 1975  
**COMMUNICATIONS  
HANDBOOK**

Here's everything you want to know—need to know—about Citizens' Band, Amateur Radio, Shortwave Listening, Police-Fire Monitoring, Marine Radio. Whether you're an old hand or just getting started, this vital "How-To" guide will help you to get greater value, greater enjoyment out of every minute you spend with your equipment. CITIZENS' BAND—what it is, how it is used, how to get a license, how to set up your station, buying guidelines, single-sideband CB, PLUS 3 handy buyers' catalogs. AMATEUR RADIO—how to apply for a novice license, how to train and qualify, how to set up your rig, latest trends, including 2-meter FM—PLUS—illustrated HAM EQUIPMENT DIRECTORY, including slow-scan TV. SHORTWAVE LISTENING—how to choose and use SWL equipment, all the shortwave bands around the world PLUS a list of leading DX clubs and a complete BUYER'S GUIDE with full specs on all known general coverage SW receivers. SPECIAL BONUS—includes "TV DX'ing," "Medium Wave DX'ing," "Public Weather Broadcast Frequencies," Directory of all monitor receivers for picking up Police, Fire and Public Service broadcasts—and more.

ONLY \$1.25

Ziff-Davis Service Division, Dept. CH,  
595 Broadway, New York, N.Y. 10012 PE-45

Please send the 1975 COMMUNICATIONS HANDBOOK. I'm enclosing \$1.60 (\$1.25 plus 35¢ for postage and handling). Outside U.S.A. \$3.00, post-paid.

Residents of Calif., Col., Fla., Ill., Mich., Mo., N.Y. State, D.C. and Tex. add applicable sales tax (postage and handling charges non-taxable).

print name \_\_\_\_\_  
address \_\_\_\_\_  
city \_\_\_\_\_  
state \_\_\_\_\_ zip \_\_\_\_\_

### BUSINESS OPPORTUNITIES

I MADE \$40,000.00 Year by Mailorder! Helped others make money! Free Proof. Torrey, Box 318-NN, Ypsilanti, Michigan 48197.

FREE CATALOGS. Repair air conditioning, refrigeration. Tools, supplies, full instructions. Doolin, 2016 Canton, Dallas, Texas 75201.

MAILORDER MILLIONAIRE helps beginners make \$500 weekly. Free report reveals secret plan! Executive (1K4), 333 North Michigan, Chicago 60601.

*wanted* CITIZENS BAND  
**DEALER-DISTRIBUTORS**  
Send this Ad to:  
**PAL ELECTRONICS CO.**  
P. O. Box 778 • Westminster, Ca. 92683

PIANO TUNING LEARNED QUICKLY AT HOME! Tremendous field! Musical knowledge unnecessary. GI approved. Information free. Empire School, Box 450327, Miami 33145.

\$200.00 DAILY In Your Mailbox! Your opportunity to do what mail-order experts do. Free details. Associates, Box 136-J, Holland, Michigan 49423.

FREE BOOK "2042 unique proven enterprises." Work home! Hayling-B, Carlsbad, CA 92008.

**HIGHLY PROFITABLE ONE-MAN ELECTRONIC FACTORY**  
Investment unnecessary, knowledge not required. sales handled by professionals. Postcard brings facts about this unusual opportunity. Write today! Barta-DQ, Box 248, Walnut Creek, CA 94597.

CAPITAL CONTACTS. We reach underwriters who consider companies having net earnings to go public or private placement. Write for helpful information Confidential Consultant, 817 51st St., Brooklyn, N.Y. 11220.

UNIVERSITY DEGREES BY MAIL! Bachelors, Masters, Ph.D.s ... Free revealing details. Counseling, Box 1162-PE4, Tustin, California 92680.

GET AHEAD! Buy College Degrees...without studying! Free details. Counseling, Box 1162-PE3, Tustin, Calif. 92680.

MAIL OUR HIGH PROFIT paying circulars under your name! No postage or mailing envelopes to buy! Circulars furnished FREE! Send stamped addressed envelope. Wright, 949 Broadway, 602-PE, New York City 10010.

### INVENTIONS WANTED

CASH-ROYALTIES for patented, unpatented inventions. Global Marketing Service, 139-P Lake Merced Hill South, San Francisco, California 94132.

INVENTORS: Protect your ideas! Free "Recommended Procedure". Washington Inventors Service, 422T Washington Building, Washington, D.C. 20005.

FREE PAMPHLET: "Tips on Safeguarding Your Invention." Write: United States Inventors Service Company, 708-T Carry Building, Washington, D.C. 20005.

# inventors

...Manufacturers Need New Products

If you have an idea for a new product, or a way to make an old product better, contact us, "the idea people." We'll develop your idea, introduce it to industry, negotiate for cash sale or licensing. Send for our FREE "Invention Kit." It has a special "Invention Record Form," an important brochure, "Your Invention - Its Development, Protection & Marketing," and a Directory of 500 Corporations Seeking New Products. You'll learn how ideas become a reality!

**RAYMOND LEE ORGANIZATION**  
230 Park Avenue, New York, N.Y. 10017  
I'd like to find out how to take action on my idea. Send Free "Invention Kit No. A-112"

Name \_\_\_\_\_ Please Print  
Address \_\_\_\_\_  
City \_\_\_\_\_ State \_\_\_\_\_ Zip \_\_\_\_\_  
SAN FRANCISCO LOS ANGELES TORONTO VANCOUVER DENVER CHICAGO

### INVENTIONS IDEAS WANTED

Manufacturers Need New Products. Your invention, new product or idea developed for cash / royalty sales by Professional Organization.

"No Idea Is Too Small"★  
Free Booklet: "How to Safeguard, Develop and Market Your Ideas to Industry"  
**LAWRENCE PESKA ASSOCIATES**  
500 Fifth Ave., Dept. MM, N.Y.C. 10036  
Phone (212) 354-9696  
A trademark of Lawrence Peska Associates, Inc.

### BOOKS AND MAGAZINES

FREE catalog aviation/electronic/space books. Aero Publishers, 329PE Aviation Road, Fallbrook, California 92028.

FREE book prophet Elijah coming before Christ. Wonderful bible evidence. Megiddo Mission, Dept. 64, 481 Thurston Rd., Rochester, N.Y. 14619.

BOOKS—thousands titles, bargains. Catalog Free. Cassiano, 92-27 New York Blvd., Jamaica, New York 11433.

POPULAR ELECTRONICS INDEXES. Detailed and complete subject indexes now available to both 1972 and 1973 magazines. Hundreds of subject references to help you quickly find that special project, article, or product test. 1972 and 1973 editions \$1.00 each. INDEX, box 2228, Falls Church, Va. 22042.

INTERESTED in amateur TV, FM, RPT? Subscribe to A-5 Magazine, 1 YR \$4. Published bi-monthly since 1967. Box 128, Whitmore Lake, Mich. 48189.



# Popular Electronics

APRIL 1975

## ADVERTISERS INDEX

READER SERVICE NO.	ADVERTISER	PAGE NUMBER
1	Adva Electronics	100
2	Allison Automotive Company	86
3	Alpha Electronics	77
3	Altaj Electronics	91
46	Ancona Corp	97
49	Audio Warehouse Sales	80
7	Babylon Electronics	98
	Bell & Howell Schools	18, 19, 20, 21
	CREI Capitol Radio Engineering Institute	62, 63, 64, 65
8	Circuit Design, Inc	69
9	Cleveland Institute of Electronics	82, 83, 84, 85
10	Clifford's Hi-Fi Wholesalers	88
11	Cobra Division, Product of Dynascan	5
12	Continental Specialties Corp	7
43	Crown	23
13	Delta Electronics Co	99
14	Delta Products, Inc	13
15	Digi-Key Corporation	90, 101
16	EICO	81
17	Edmund Scientific Co	102
47	Exar Integrated Systems, Inc	12
	Florida Institute of Technology	87
5	Heath Company	72, 73, 74, 75
19	Hewlett Packard	14, 15
20	Illinois Auto	71
21	International Electronics Unlimited	96
22	International Hi-Fi Distributors	80
23	James	99
33	Johnson Co., E. F.	22
24	Lafayette Radio Electronics	61
25	Linear Systems, Inc	16
26	Mcintosh Laboratory, Inc	79
27	MITS	1
28	Mallory & Co., P. R.	2
	NRI Schools	8, 9, 10, 11
	National Technical Schools	52, 53, 54, 55
29	New-Tone Electronics	89
30	OEMorso	88
31	Pace Communications	79
51	Pana Vise	78
32	Poly Paks	95
34	Radio Shack	25
4	Reeder's Electronics	77
5	Royce Electronics	26
35	Sansui Electronics Corp	FOURTH COVER
36	Schober Organ Corp., The	88
37	Solid State Sales	92
38	Southwest Technical Products Corp	6
48	Stanton Magnetics, Inc.	THIRD COVER
44	Teletronics Company of America	87
45	Tracy Design Corp	99
39	Tri-Star Corporation	71
40	U.S. Pioneer Electronics Corp	SECOND COVER
	Vintage Radio	69
42	Wahi Clipper Corporation	87
41	Weller-Xcelite Electronics Division	24

CLASSIFIED ADVERTISING 89, 90, 92, 96, 98, 100, 101

## HOME ENTERTAINMENT FILMS

YOU CAN STILL SAVE A BUCK IN '75. The Marx Bros "The Incredible Jewel Robbery." Standard 8, B & W, \$6.95 PPD (you save 20% while they last). Joan Crawford in "Strait-Jacket" (horror film), Super 8, B & W, \$6.95 PPD. In color. Travel to Israel in Color. Popular Super 8 size, \$15.00 PPD (Price will be \$19.95 starting March 15). Or, choose from titles in Castle, Columbia or SportLite catalogs, 25 cents each (coins or stamps, please). SPORTLITE, Elect. Dept.-3, Box 24-500, Speedway, Indiana 46224.

## EMPLOYMENT OPPORTUNITIES

ELECTRONICS/AVIONICS EMPLOYMENT OPPORTUNITIES. Report on jobs now open. Details FREE. Aviation Employment Information Service, Box 240E, Northport, New York 11768.

## TREASURE FINDERS

FREE FACT-FILLED CATALOG! World's largest selection! Metal detectors starting at \$79.50. Two year guarantee! Three factories, U.S.-Canada, 1,200 dealers - Service Centers nationwide. Finest instruments at any price! Budget Terms. Dealer inquiries invited. Write: White's Electronics, Inc. Dept. PD5R, 1011 Pleasant Valley Road, Sweet Home, Oregon 97386.

TREASURE FINDER locates buried gold, silver, coins, treasures. 6 powerful models. Instant financing available. Write or call for free catalog. Phone (713) 682-2728 day or night. Dealer inquiries invited. Relco, Dept. AA20, Box 10839, Houston, Texas 77018.

## REAL ESTATE

NEW...FREE...SUMMER CATALOG! Over 2,500 top values in 40 states coast to coast! UNITED FARM AGENCY, 612-EP West 47th St., Kansas City, Mo. 64112.

## MINICOMPUTERS

WILL Buy, Sell or Trade homemade and other peripheral devices, software programs, etc. AL COVE, 230 Main, North Reading, Mass. 01864.

## RECORDS

OLDIES. 45rpm. Free Catalog. Corny's Record Shop, Box 166TE, Mason, Ohio 45040.

## RUBBER STAMPS

RUBBER address stamps. Free catalog, 45 type styles. Jackson's, Box 443G, Franklin Park, Ill. 60131.

MADE-TO-ORDER STAMPS. Low Prices. Free Catalog Allegheny, Box 14A, East McKeesport, PA 15035.

## PLASTICS

CASTOLITE pours like water, hardens like glass without heat. Crystal clear, colors. Embed flowers, seashells, mementos, anything. Make fine gifts. Form flexible molds over patterns of any shape, size. Reproduce your own designs in plastics, candlewax, metal, plaster, cement. Free Brochure. Or send \$1.00 for illustrated Manual Catalog. Profitable. CASTOLITE, Dept. 75D/PE, Woodstock, Ill. 60098.

## HYPNOTISM

SLEEP learning. Hypnotic method. 92% effective. Details free. ASR Foundation, Box 23429EG, Fort Lauderdale, Florida 33307.

FREE Hypnotism Self-Hypnosis. Sleep Learning Catalog! Drawer H400, Ruidoso, New Mexico 88345.

AMAZING self-hypnosis record releases fantastic mental power. Instant results! Free trial. Write: Forum (AA4), 333 North Michigan, Chicago 60601.

## MISCELLANEOUS

WINEMAKERS: Free illustrated catalog yeasts, equipment. Semplex, Box 12276P, Minneapolis, Minn. 55412.

BE READY. How to prepare and store for EMERGENCY. Free details. Lynn's, Box 1942E4, Minot, North Dakota 58701.

# Quality Electronic Components

SPECIAL SAVINGS DISCOUNT ON LINEAR AND DIGITAL INTEGRATED CIRCUITS  
Deduct 4% from the total of your I.C. order if it exceeds \$25.00 based on single list prices. 7% for \$50.00 or more, 10% for \$100.00 or more. Additional large quantity discounts offered.

TTL & CMOS INTEGRATED CIRCUITS	
7400N	25c 7445N .81c 7495N .90c 74193N \$1.17 4027AE .67c
7401N	25c 7446N .81c 7496N .81c 74198N \$2.75 4028AE \$1.09
7402N	25c 7447N .81c 74107N .32c 74199N \$2.75 4029AE \$1.42
7403N	25c 7448N .90c 74121N .38c 4000AE .30c 4030AE .50c
7404N	25c 7449N .23c 74122N .45c 4012AE .30c 4031AE \$1.67
7405N	25c 7451N .23c 74123N \$1.08 4022AE .30c 4032AE \$3.34
7406N	25c 7453N .23c 74141N .99c 4006AE \$1.50 4035AE \$1.42
7407N	25c 7454N .23c 74150N \$1.44 4007AE .30c 4040AE \$1.67
7408N	25c 7459N .25c 74151N .90c 4008AE \$1.17 4041AE .92c
7409N	25c 7468N .23c 74153N .81c 4009AE .67c 4042AE .64c
7410N	25c 7470N .36c 74154N \$1.44 4010AE .67c 4043AE .67c
7411N	25c 7472N .36c 74155N .81c 4011AE .30c 4044AE .67c
7413N	25c 7473N .32c 74156N .81c 4012AE .30c 4046AE \$2.51
7418N	25c 7478N .32c 74157N .72c 4013AE .30c 4049AE .58c
7417N	25c 7475N .54c 74158N \$1.53 4014AE \$1.67 4050AE .58c
7418N	25c 7476N .36c 74160N \$1.26 4015AE \$1.17 4051AE \$1.50
7420N	25c 7480N .72c 74161N \$1.17 4016AE .63c 4052AE \$1.50
7421N	25c 7482N .72c 74162N \$1.26 4017AE \$1.34 4053AE \$1.50
7422N	25c 7474N .72c 74163N \$1.26 4018AE \$1.67 4054AE \$1.67
7426N	25c 7485N \$1.40 74164N \$1.35 4019AE .58c 4066AE \$1.00
7430N	25c 7486N .32c 74165N \$2.45 4020AE \$1.67 4071AE .30c
7437N	25c 7489N .54c 74166N \$2.00 4021AE \$1.50 4072AE .30c
7438N	25c 7490N .50c 74175N \$1.00 4022AE \$1.25 4073AE .30c
7440N	25c 7491N .81c 74180N .81c 4023AE .67c 4074AE .30c
7441N	\$1.17 7492N .50c 74181N \$2.25 4024AE \$1.00 4081AE .30c
7442N	.65c 7493N .50c 74182N .90c 4025AE .30c 4082AE .30c
	7494N .81c 74192N \$1.26 4026AE \$1.67

LINEAR INTEGRATED CIRCUITS	
555V MINDIP TIMER	82.5c 558V MINDIP DUAL AMP .75c
565A DIP PLL	\$3.38 567V MINDIP DECODER .33c
741V MINDIP OP AMP	\$0.0c 723A DIP VOLTAGE REG. .82.5c
748V MINDIP OP AMP	\$2.0c 747A DIP DUAL AMP .97.5c
L129 5 VOLT REG	\$1.80 LM3900 DIP QUAD AMP .60c
L131 15 VOLT REG	\$1.80 L130 12 VOLT REG .81c
	LM309K 5 VOLT REG .51.75c

## MINIATURE ALUMINUM ELECTROLYTIC CAPACITORS

-AXIAL LEAD TYPE-	
100 pF 50V	14c 12c 11c 33 UFD/16V .15c 12c 11c 330 UFD/16V .35c 25c 24c
2.2 UFD/50V	14c 12c 11c 33 UFD/25V .17c 15c 14c 330 UFD/25V .44c 35c 32c
3.3 UFD/35V	14c 12c 11c 47 UFD/16V .17c 14c 13c 470 UFD/16V .37c 30c 27c
4.7 UFD/35V	14c 12c 11c 47 UFD/25V .19c 15c 14c 470 UFD/25V .44c 35c 32c
10 UFD/16V	14c 12c 11c 100 UFD/16V .19c 15c 14c 1000 UFD/16V .44c 35c 32c
10 UFD/25V	14c 12c 11c 100 UFD/25V .24c 18c 17c 1000 UFD/25V .54c 40c 35c
22 UFD/16V	14c 12c 11c 220 UFD/16V .24c 18c 17c 2200 UFD/16V .75c 60c 55c
22 UFD/25V	15c 13c 12c 220 UFD/25V .35c 25c 24c

## 1 AMP SILICON RECTIFIERS

1N4001 50 PIV 12/51 100/\$6 1000/\$48	1N4005 600 PIV 8/51 100/39 1000/\$70
1N4007 1000 PIV 6/51 100/31	1000/\$88

## SILICON SIGNAL & SWITCHING DIODE

IN4148 (IN914 equiv.)	12/51 100/57 1M/510 5M/5220
-----------------------	-----------------------------

## MOLEX SOLDERCON IC TERMINALS

100/51	500/\$4.20 1000/\$8.20 5000/\$38.20 50,000/\$275
--------	--

## LED 7 SEGMENT DISPLAYS

DATALIT-704	\$1.00 DATALIT-707	\$1.50
-------------	--------------------	--------

## MACHINE SCREWS, NUTS & LOCKWASHERS

MACHINE SCREWS, NUTS & LOCKWASHERS		REED RELAYS	
2-56 1/8 Screw	90c/c	2-56 1/8 Screw	98c/c
4-40 1/8 Screw	98c/c	4-40 1/8 Screw	98c/c
6-32 1/8 Screw	92c/c	6-32 1/8 Screw	86c/c
8-32 3/8 Screw	\$1.05/c	8-32 3/8 Screw	\$1.35/c
2-56 Hex Nut	\$1.45/c	2 Lock Washer	.45c/c
4-40 Hex Nut	\$1.45/c	4 Lock Washer	.45c/c
6-32 Hex Nut	\$1.45/c	6 Lock Washer	.45c/c
8-32 Hex Nut	\$1.50/c	8 Lock Washer	.45c/c

## DISC CAPACITORS

100 pF/500V	.7c	5c	5c	4.5c	3.6c	8 pin Solder	.27c	21c
220 pF/500V	.7c	5c	5c	4.5c	3.6c	14 pin Solder	.29c	23c
470 pF/500V	.7c	5c	5c	4.5c	3.6c	16 pin Solder	.32c	25c
001/500V	.7c	5c	5c	4.5c	3.6c	18 pin Solder	.34c	26c
.0022/500V	.7c	5c	5c	4.5c	3.6c	24 pin Solder	.54c	42c
.0047/500V	.7c	5c	5c	4.5c	3.6c			
.01/500V	.10c	7.5c	6.5c	5.0c	6.0c	8 pin W.W.	.38c	30c
.01/25V	.5c	3.5c	3.0c	2.4c	2.4c	14 pin W.W.	.50c	39c
.022/25V	.6c	4.0c	3.5c	2.7c	2.7c	16 pin W.W.	.54c	42c
.047/25V	.9c	6.0c	5.3c	4.2c	4.2c	18 pin W.W.	.88c	68c
.1/25V	.12c	9.0c	7.5c	6.0c	6.0c	24 pin W.W.	.99c	80c

## 1/2 & 1/4 WATT CARBON COMP. RESISTORS

5 each of the 85 standard 10% values (2.2-22k) 1/2 W Resistors (425 pcs.) Sorted by value \$12/set 2.4 ore \$11/set 5.9 ore \$10/set

5 each of the 70 standard 10% values (10-5.6M) 1/4 W Resistors (350 pcs.) Sorted by value \$12/set 2.4 ore \$11/set 5.9 ore \$10/set

## SILICON TRANSISTORS

EN918	10-106	1c	1c	10c	2N3645	10-105	20c	19c	99c	100
EN930	10-106	21c	18c	16c	2N3646	10-106	22c	19c	17c	17c
EN222	10-106	21c	18c	16c	2N3904	10-102	22c	19c	17c	17c
EN2369A	10-106	21c	18c	16c	2N3906	10-102	22c	19c	17c	17c
EN2907	10-106	21c	18c	16c	2N4124	10-102	22c	19c	17c	17c
2N2712	10-98	18c	16c	14c	2N4130	10-102	22c	19c	17c	17c
2N391A	10-98	22c	19c	17c	2N4401	10-102	22c	19c	17c	17c
2N3392	10-98	22c	19c	17c	2N4403	10-102	22c	19c	17c	17c
2N3393	10-98	22c	19c	17c	2N5087	10-102	22c	19c	17c	17c
2N3394	10-98	22c	19c	17c	2N5089	10-102	22c	19c	17c	17c
2N3563	10-106	20c	17c	15c	2N5159	10-106	19c	17c	15c	15c
2N3565	10-106	20c	17c	15c	2N5133	10-106	19c	17c	15c	15c
2N3638	10-105	20c	17c	15c	2N5134	10-106	19c	17c	15c	15c
2N3638A	10-105	20c	17c	15c	2N5137	10-106	19c	17c	15c	15c
2N3640	10-106	22c	19c	16c	2N5138	10-106	19c	17c	15c	15c
2N3641	10-105	20c	17c	15c	2N5139	10-106	19c	17c	15c	15c
2N3643	10-105	20c	17c	15c	2N3055	10-3	\$1.00	95c	85c	85c

## FIELD EFFECT TRANSISTORS

MPF102	10-92	44	380	350	2N5457	10-92	47	420	375
--------	-------	----	-----	-----	--------	-------	----	-----	-----

## NPN DARLINGTON TRANSISTOR

MP5-A13, 10-92 Min. DC Current

# LIVE IN THE WORLD OF TOMORROW... TODAY!

And our FREE 180 PAGE CATALOG is packed with exciting and unusual values in electronic, hobby and science items — plus 4,500 finds for fun, study or profit... for every member of the family.

## A BETTER LIFE STARTS HERE

### LOW-COST ULTRASONIC CLEANER

Full pint capacity at price of old 1.3 pt model. For home, industry! Makes grimy, small delicate parts & objects sparkle — from diamonds to dentures, electronic items to coins & combs. Fully transistorized metal & stainless steel cabinet (6 x 4 x 4") with built-in tank has frequency control, item platform. Incls. cleaning powder, mfrs. 1-yr guar. 110-120V AC.



Stock No. 71,003AV ..... \$65.95 Ppd.  
 No. 71,198AV ..... 1/4 Qt. Sz. \$115.00 Ppd.  
 #85, 128AV (33 lb.) ..... 1/2 Gal. Sz. \$299.50 FOB

### Re-Ne LASERS FROM \$115.00

Edmund quality, TEMoo mode, cold cathode for long life. Completely self-contained units; solid state power supply; 110v AC. 0.3mW min — GREAT GENERAL PURPOSE LASER: 1.2mm beam dia., 2.0mRad beam Diverg.



Stock No. 79,061AV ..... \$115.00 Ppd.  
 1.0mW min — HI-PERFORMANCE LAB LASER: 1.2mm beam dia., 1.0mRad beam Diverg.  
 Stock No. 79,050AV ..... \$180.00 Ppd.  
 3.0mW min — DEPENDABLE HI-POWERED LASER: 1.0mm beam dia., 0.8mRad beam Diverg.  
 Stock No. 79,052AV ..... \$350.00 Ppd.

### NEW! KIRLIAN PHOTOGRAPHY KIT!

Experiment in the fascinating new field of "Kirlian electrophotography"— images obtained on film without camera or lens by direct recording of electric charge transmitted by animate & inanimate objects. Each "aura" differs—animate aura said to change corresponding to physical changes. Kit incls. portable darkroom, double transformer isolated from power source, instrs.



Stock No. 71,938AV ..... \$49.95 Ppd.  
 "HIGH VOLTAGE PHOTOGRAPHY" by H.S. Dakin  
 No. 9129AV (60-PG. PAPERBACK BOOK) ..... \$5.00 Ppd.  
 DELUXE KIRLIAN PHOTOGRAPHY SET  
 No. 72,053AV ..... \$399.00 Ppd.

### LOW COST 7X INFRA-RED VIEWER

For infra-red crime detection surveillance, security system alignment, I.R. detection, laser checking, nite wild-life study, any work req. I.R. detection & conv. to visible spectrum. Self cont. scope w/ everything but I.R. light source wks in any I.R. lit area: 6v or 12v power, 6032 I.R. converter tube, f/4.5 objective lens, adjust. triplet eyepiece.



No. 1648AV ... (11x14 1/4x3") ..... \$225.00 Ppd.  
 DELUXE—WITH I.R. LIGHT SOURCE  
 No. 1659AV ..... \$275.00 Ppd.

### 3-CHANNEL COLOR ORGAN KIT



Easy to build low-cost kit needs no technical knowledge. Completed unit has 3 bands of audio frequencies to modulate 3 independent strings of colored lamps (i.e. "lows"-reds, "middles"-greens, "highs"-blues. Just connect hi-fi, radio, power lamp etc. & plug ea. lamp string into own channel (max. 300w ea.). Kit features 3 neon indicators, color intensity controls, controlled individ SCR circuits, isolation transformer, custom plastic housing; instr.

Stock No. 41,831AV ..... \$18.95 Ppd

### AM RADIO FITS IN/ON YOUR EAR!



Wear it inconspicuously *everywhere*, listen as you *work* (lawn, yard, office), *watch* (game, beach) or *wait*. Instant music, news, sports. No gimmick, our 6/10-oz. technological wonder has integrated circuit, 11 transistors, patented ferrite antenna/tuner/volume dial. Uses normal silver oxide hearing aid batt. (incl) for approx. 100 hrs. playing. New batt. to slip in avail. at drug stores (about 50c). No lengthy wires, bulky cases, or power-packs!

Stock No. 42,275AV ..... \$14.95 Ppd.

### KNOW YOUR ALPHA FROM THETA!



For greater relaxation, concentration, listen to your Alpha-Theta brainwaves. Ultra-sensitive electrode headband slips on/off in seconds—eliminates need for messy creams, etc. Attached to amplifier, filters brainwaves, signals beep for ea. Alpha or Theta wave passed. Monitoring button stimulates Alpha sound; audio & visual (L.E.D.) feedback. Reliable, easy-to-use unit comparable to costlier models. Completely safe. Comprehensive instruction booklet.

No. 1635AV (8x3x4"; 24. oz.) ..... \$134.50 Ppd.  
 LOW COST "STARTER" UNIT  
 No. 71809AV ..... \$55.00 Ppd.  
 DELUXE "ON" TIME MONITOR—Measures and records %  
 No. 1652AV ..... (15x10x6") ..... \$349.50 Ppd.

### QUALITY DETECTOR UNDER \$40



New Edmund-developed, fully transistorized BFO unit capable of locating quarter at 18" — powerful 6-trans. oscillator-amplifier circuit. Easily compares to others priced 50% higher! Aluminum pole and housing—not plastic! 6" waterproof search coil (Faraday shielded to elim. outside interference); long 50-hr. battery (9V) life; powerful 2" speaker; lightweight (2 lbs.). Great buy!

Stock No. 80,222 AV ..... \$39.95 Ppd.

### 3" ASTRONOMICAL REFLECTING TELESCOPE



See stars, moon, planets close-up! 30 to 90X. Famous Mt. Palomar Type. Aluminized & overcoated 3" diameter f/10 primary mirror, ventilated cell. Fork type equatorial mount. Durable PVC tube. Includes 1" F.L. 30X Ramsden. Barlow lens to triple power, 3X finder telescopes, hardwood tripod. FREE: "STAR CHART", "HOW TO USE" book.

Stock No. 85,240 AV ..... \$49.95 Ppd.  
 DELUXE 3" REFLECTOR TELESCOPE ..... #80,162AV ..... \$79.95 Ppd.  
 4 1/4" REFLECTOR (45X to 135X) ..... #85,105AV ..... \$149.50 FOB  
 4 1/4" REFLECTOR W/CLOCK DRIVE ..... #85,107AV ..... \$189.50 FOB  
 6" REFLECTOR (48X to 360X) ..... #85,187AV ..... \$249.50 FOB  
 6" REFLECTOR W/CLOCK DRIVE ..... #85,086AV ..... \$285.00 FOB



## MAIL COUPON FOR GIANT FREE CATALOG!

180 PAGES • MORE THAN 4500 UNUSUAL BARGAINS

Completely new 1975 edition. New items, categories, illustrations. Dozens of electrical and electromagnetic parts, accessories. Enormous selection of Astronomical Telescopes. Unique lighting and ecological items. Microscopes, Binoculars, Magnifiers, Magnets, Lenses, Prisms. Hard-to-get surplus bargains. Ingenious scientific tools. 1000's of components.

EDMUND SCIENTIFIC CO.  
 300 Edscorp Building, Barrington, N. J. 08007  
 Please rush Free Giant Catalog "AV"

Name \_\_\_\_\_  
 Address \_\_\_\_\_  
 City \_\_\_\_\_ State \_\_\_\_\_ Zip \_\_\_\_\_



## COMPLETE & MAIL WITH CHECK OR M.O.

EDMUND SCIENTIFIC CO. 300 Edscorp Building, Barrington, N.J. 08007

How Many	Stock No.	Description	Price Each	Total
<input type="checkbox"/>		PLEASE SEND GIANT FREE CATALOG "AV"		
<input type="checkbox"/>		Charge my BankAmericard *		
<input type="checkbox"/>		Charge my Master Charge *		
Interbank No. _____		Add Handling Chg.: \$1.00, Orders Under \$5.00, 50c. Orders Over \$5.00		
My Card No. Is _____		I enclose <input type="checkbox"/> check <input type="checkbox"/> money order for \$ _____		
Card Expiration Date _____		Signature _____		
30-DAY MONEY-BACK GUARANTEE.		NAME _____		
You must be satisfied or return any purchase in 30 days for full refund.		ADDRESS _____		
* \$15.00 minimum		CITY _____ STATE _____ ZIP _____		



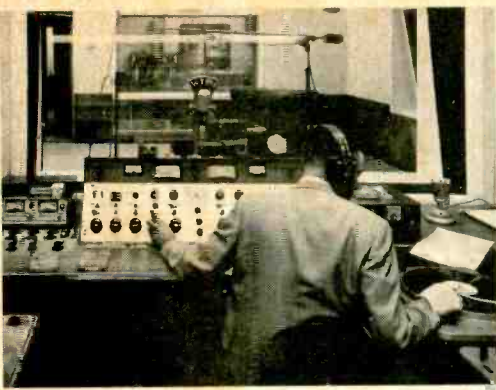

## In response to the needs of the recording and broadcast industries, Stanton creates the new calibration standard ...the 681 TRIPLE-E....

A definite need arose.

The recording industry has been cutting discs with higher accuracy to achieve greater definition and sound quality.

Naturally, the engineers turned to Stanton for a cartridge of excellence to serve as a primary calibration standard in recording system check-outs.

The result is a *new* calibration standard, the Stanton 681 TRIPLE-E. Perhaps, with this cartridge, the outer limits of excellence in stereo sound reproduction has been reached.

The Stanton 681 TRIPLE-E offers improved tracking at all frequencies. It achieves perfectly flat frequency response to beyond 20 kHz. It features a dramatically reduced tip mass. Actually, its

new ultra miniaturized stylus assembly represents an important advance in stereo cartridge design and construction, with substantially less mass than its predecessor. And this stylus assembly possesses even greater durability than had been previously thought possible to achieve.

The Stanton 681 TRIPLE-E features a new design of both cartridge body and stylus; it has been created for those for whom the best is none too good.

Each 681 TRIPLE-E is guaranteed to meet its specifications within exacting limits, and each one boasts the most meaningful warranty possible: an individual calibration test result is packed with each unit.

For further information write Stanton Magnetics, Inc., Terminal Drive, Plainview, N.Y. 11803.



CIRCLE NO. 48 ON READER SERVICE CARD



# Power-play-mates



## TU-7700 and AU-7700

SANSUI's power playmates – the TU-7700 tuner and the AU-7700 amplifier are made for each other – by design.

The TU-7700AM/FM stereo tuner, a breakthrough in tuner development, has far less distortion and wider stereo sound separation than comparable tuners.

Selectivity and sensitivity figures are so good as to be almost unbelievable. And this is a fitting component companion for SANSUI's AU-7700, a star at the top of the line of SANSUI's integrated amplifiers.

55 Watts per channel minimum RMS into 8 Ohm load from 20Hz to 20KHz with no more than 0.1% total harmonic distortion.

Separate or together-power houses both of them. Hear either the TU-7700 and/or the AU-7700 at your nearest SANSUI franchised dealer and be sure to pick up your free copy of "The Sounds of SANSUI" or write directly to us.

**SANSUI ELECTRONICS CORP.**  
Woodside, New York 11377 • Gardena, California 90247 • SANSUI ELECTRIC CO. LTD. Tokyo, Japan  
SANSUI AUDIO EUROPE S.A. Antwerp, Belgium • ELECTRONIC DISTRIBUTORS (Canada) B.C.  
CIRCLE NO. 35 ON READER SERVICE CARD

