

CB SPECIFICATIONS MADE EASY

Popular Electronics®

WORLD'S LARGEST-SELLING ELECTRONICS MAGAZINE

MARCH 1975 / 75¢

BUILD AN OMNI-DIRECTIONAL SPEAKER SYSTEM
NIGHT-LIGHT PROJECTS FOR CYCLISTS
THE NEW COLOR TV PICTURE TUBES

TESTED IN THIS ISSUE

Philips RH-532 Motional
Feedback Speaker System

Pioneer PL-71 Single-Play
Turntable

Regency ACT-C4H
Scanning Monitor

Heathkit TO-1260
Electronic Organ

How To Choose Electronic Organs

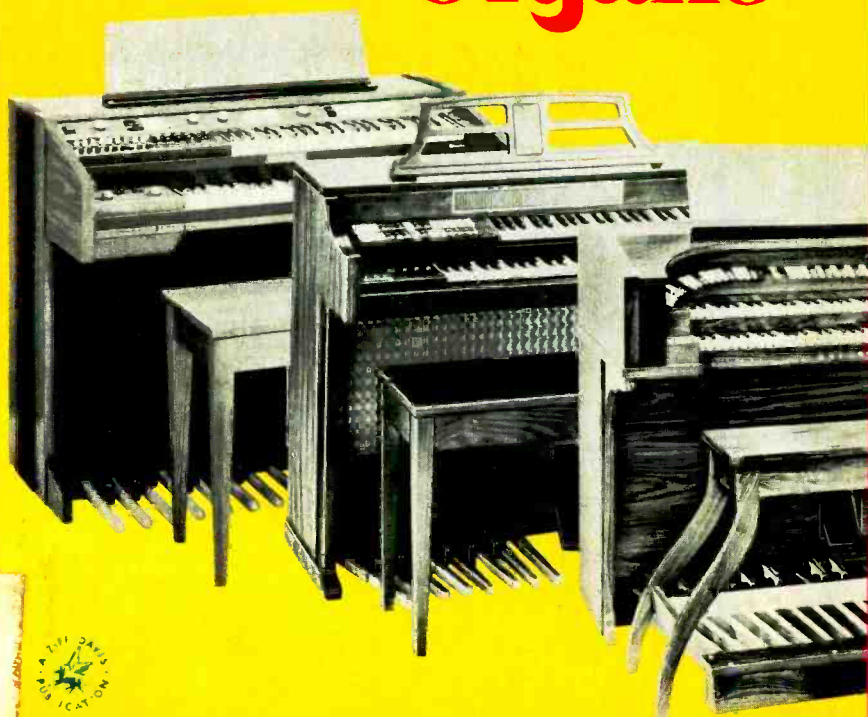

PE
TESTED!

**BUILD A
LADY'S LED
TIME/DATE
WRISTWATCH
...ONLY \$75**

Send not included

490684 LNE 10082099 JAN79 0410
KENNETH J LYNES
1088 22ND AV SE
MINNEAPOLIS MN 55414
03



For the best performance, get a manual turntable.

For the best manual turntable, get a Pioneer PL-71.

At Pioneer, we're convinced that a manual turntable is the best possible component for reproducing the sound of records. That's why we offer a complete line of manual turntables — topped by the truly superior direct-drive PL-71.



Strobe light to adjust and monitor for accurate speed.

Perfection in a turntable means just three things — (1) elimination of vibration or rumble, (2) accuracy of rotation, (3) unwavering consistency of speed, or elimination of wow and flutter. The PL-71 is magnificent in all three areas. Ultra-precise speed controls plus a built-in strobe help you adjust and monitor speed for absolute accuracy. The slow, stable direct-drive motor re-

duces vibration to the vanishing point and keeps wow and flutter well below an undetectable 0.05%.



Direct-drive for precision platter rotation.

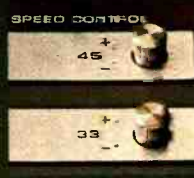

Electronic speed adjustment for each speed.

As for record groove tracking, our S-shaped tonearm is tops, too, with its adjustable anti-skating, viscous damped cueing and direct-reading tracking force calibration.



S-shaped tonearm for optimum groove tracking.

The Pioneer PL-71 is the best of the manual turntables. And a manual turntable is best for your listening needs. With its extraordinary performance, design and engineering, the PL-71 is only \$299.95. If you want the best of the best, you want the PL-71. Other Pioneer manual turntables are available from \$99.95.

U. S. Pioneer Electronics Corp.,
75 Oxford Drive, Morristown,
New Jersey 07074
West: 13300 S. Estrella, Los Angeles
90248 / Midwest: 1500 Greenleaf,
Elk Grove Village, Ill. 60007 /
Canada: S. H. Parker Co.

PIONEER
when you want something better



CIRCLE NO. 39 ON READER SERVICE CARD

www.americanradiohistory.com

mind-absorbing projects for electronic experimenters and hobbyists

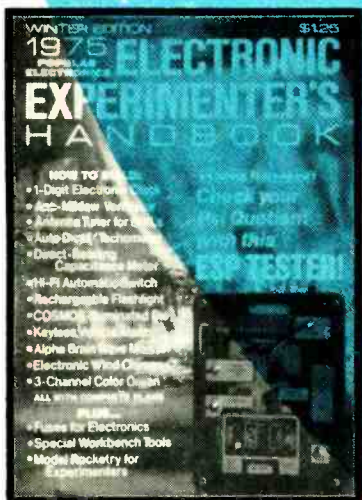

That's what you can count on
in the latest edition of

ELECTRONIC EXPERIMENTER'S HANDBOOK

It's by the editors of Popular Electronics — with features and articles and complete lab-tested instructions that guarantee successful hours and months of mind-absorbing projects for fun and practicality.

This latest 1975 Winter Edition helps you get it together . . . with a score of build-it-yourself projects.

Now you can confirm extra-sensory-perception (ESP) with THE ESP COMPUTER TESTER! It's a sophisticated random-number electronics project with digital readout . . . allows you to determine laws of probability . . . introduces you to digital electronics. And it can be a "fun" game or a serious investigatory instrument. Another random-generator project, BUILD A COSMOS DIE, can teach you how to use complementary - metal - oxide semiconductors, the hottest device today. The construction project's circuit forms the equivalent of a six-sided die by randomly displaying digits 1 to 6 on a small LED readout.

Can you relax completely whenever you want to? Here's an electronics approach — THE ALPHA BRAIN WAVE FEEDBACK MONITOR — that you can build for this purpose. By learning to produce 7.5 to 13 Hz, which is the brain-wave frequency band that researchers say is continuously created in meditative states of Yoga and Zen, you may be able to clear your mind of distracting thoughts and achieve calmness

quickly. Alternatively, if you want some excitement, read MODEL ROCKETRY FOR EXPERIMENTERS. Tells you all about a fascinating modern hobby and how to get into it.

Want to streamline your home lab? Consider building our DIRECT-READING CAPACITANCE METER. It will check values of capacitors directly on a meter scale. Or build the PRECISION LAB POWER SUPPLY, a regulated supply that delivers up to 30-volts and 1.2 amps. Or a PREAMPLIFIER FOR YOUR SCOPE. For the home, there's the DIFFERENTIAL-TEMPERATURE BASEMENT VENTILATOR that keeps out mildew and mold. It equalizes outside and inside temperature differences. Consider the MONODIGICHRON, a one-digit electronic clock that displays hours and minutes in sequential form. It's a great conversation piece, too. Try ELECTRONIC WIND CHIMES for the tinkling sounds of a breeze through your hi-fi amplifier. And how about an AUTOMATIC AMPLIFIER SWITCH for your hi-fi system?

The issue is filled with other exciting projects, in every area of electronics, including FUSES FOR ELECTRONICS, SMALL TOOLS FOR ELECTRONICS WORKBENCHES, AN ANTENNA TUNER FOR SWLers, A KEYLESS VEHICLE BURGLAR ALARM, RECHARGEABLE FLASHLIGHT, 3-CHANNEL COLOR ORGAN, and much more. All with complete construction plans, including parts lists and printed-circuit board patterns, for building stimulating and rewarding projects. Many products are unique designs, not available anywhere else. And in all cases, you save money by building your own!

Be sure you order
your copy today —
it's only \$1.25!



Ziff-Davis Service Division,
Dept. EE, 595 Broadway, PE-35
New York, N.Y. 10012

- Please send the 1975 ELECTRONIC EXPERIMENTER'S HANDBOOK—Winter Edition @ \$1.60 (\$1.25 plus 35c for postage and handling). Outside U.S.A. copies are \$3.00, postpaid.
- Also, I have circled the #'s below for the additional Annuals I wish to receive. Copies are \$2.25 each including postage and handling charges. Outside U.S.A. copies are \$3.00 each.

2 11 13 14 33 41
64 70 78 80 81 84

Enclosed is \$_____ for the Annuals ordered above.

Residents of Calif., Colo., Fla., Ill., Mich., Mo., N.Y. State, D.C. and Tex. add applicable sales tax (postage and handling charges non-taxable).

Print Name _____
Address _____
City _____
State _____ Zip _____

BRING YOUR REFERENCE LIBRARY UP-TO-DATE!

If you've missed any of the current and previously published Annuals, a wide selection is still available. To place your order, circle the corresponding numbers on the coupon on this page.

ELECTRONIC EXPERIMENTER'S HANDBOOK. Exciting electronics construction projects — all lab-tested by the editors, complete with parts list, easy "how-to-do-it, how-it-works" instructions, and many with actual PC foil patterns and I.C. diagrams!

1974 Spring — #41 • 1974 Winter — #64 • 1973 Spring — #2 • 1971 Winter — #33 • 1970 Spring — #14

COMMUNICATIONS HANDBOOK. Here in one single package, the combined knowledge and experience of the top men in each field, tunes you in on everything you need to know about CB, SWL and HAM.

1974 — #84 • 1973 — #80 • 1972 — #70

TAPE RECORDING & BUYING GUIDE. What's available — how to choose what's best for you and get the best use and pleasure from your tape player and recorder — reel-to-reel, cassette and 8-track cartridge. Complete directories and buying guides compare products feature by feature, cost by cost.

1974 — #11 • 1973 Summer — #13 • 1973 Winter — #78

STEREO DIRECTORY & BUYING GUIDE. The most complete consumer catalog of its kind available anywhere. Complete, accurate facts on more than 1500 products listing complete specs, model numbers, descriptions and prices. Plus a complete shop-at-home Buyers Guide loaded with expert information on what to look for, what to avoid, how to decide what's best for you at a price you can afford. 1974 — #81

Popular Electronics®

WORLD'S LARGEST-SELLING ELECTRONICS MAGAZINE

FEATURE ARTICLES

HOW TO CHOOSE AN ELECTRONIC ORGAN	Craig Anderton	27
CB SPECIFICATIONS MADE EASY	Wilfred M. Scherer	48
THE NEW COLOR TV PICTURE TUBES	Art Margolis	51
<i>How they will provide enhanced reception.</i>		
4-CHANNEL EQUIPMENT REPORT	Julian D. Hirsch	58
<i>What's new in tapes, discs, players, and recorders.</i>		
HOW TO SERVICE A CLOCK RADIO	John T. Frye	72
ENGLISH-LANGUAGE SHORTWAVE BROADCASTS FOR MARCH-APRIL 1975	Roger Legge	82

CONSTRUCTION ARTICLES

BUILD THE PLUS-4 OMNIDIRECTIONAL SPEAKER SYSTEM	David B. Weems	32
<i>Uses one woofer and four tweeters.</i>		
BUILD A LADY'S TIME/DATE WRISTWATCH—ONLY \$75	Bill Green	36
<i>Single IC provides hours, minutes/seconds/date.</i>		
TWO PROJECTS ADD SAFETY TO NIGHT BIKING		
ALTERNATELY FLASHING TAILLIGHTS	Terry Williamson	42
"ALWAYS-ON" BIKE LIGHTS	Charles Clinkenbeard	43

COLUMNS

STEREO SCENE	Ralph Hodges	16
<i>Tape bias and equalization.</i>		
SOLID STATE	Lou Garner	78
<i>Experimenting with LED's.</i>		
HOBBY SCENE	Editorial Staff	81
DX LISTENING	Glenn Hauser	83
<i>A world of news.</i>		
CB SCENE	Len Buckwalter	88
<i>The boom in CB channels.</i>		

PRODUCT TEST REPORTS

PIONEER MODEL PL-71 RECORD PLAYER	60
PHILLIPS MODEL RH-532 SPEAKER SYSTEM	61
REGENCY MODEL ACT-C4H SCANNING MONITOR RECEIVER	63
HEATHKIT/THOMAS MODEL TO-1260 ELECTRONIC ORGAN	68

DEPARTMENTS

EDITORIAL	Art Salsberg	4
<i>The root of it.</i>		
LETTERS		6
OUT OF TUNE		6
<i>"Build an Auto-Polarity, Auto-Zero Digital Multimeter" (Dec. 1974)</i>		
<i>"Update Your Digital Clocks" (Feb. 1975)</i>		
NEW PRODUCTS		12
NEW LITERATURE		15
NEWS HIGHLIGHTS		24
TIPS AND TECHNIQUES		90
ELECTRONICS LIBRARY		91

POPULAR ELECTRONICS, March 1975, Volume 7, Number 3. Published monthly at One Park Avenue, New York, NY 10016. One year subscription rate for U.S., Possessions and Canada, \$7.98; all other countries, \$8.98. Second class Postage paid at New York, NY and at additional mailing offices. Authorized as second class mail by the Post Office Department, Ottawa, Canada and for payment of postage in cash. Subscription service and Forms 3579, P. O. Box 2774, Boulder, CO 80302.

POPULAR ELECTRONICS Including ELECTRONICS WORLD, Trade Mark Registered. Indexed in the Reader's Guide to Periodical Literature. COPYRIGHT ©1975 BY ZIFF-DAVIS PUBLISHING COMPANY. ALL RIGHTS RESERVED.

Ziff-Davis also publishes Boating, Car and Driver, Cycle, Flying, Modern Bride, Popular Photography, Skiing and Stereo Review.

Forms 3579 and all subscription correspondence should be addressed to POPULAR ELECTRONICS, Circulation Dept., P. O. Box 2774, Boulder, CO 80302. Please allow at least eight weeks for change of address. Include your old address, as well as new—enclosing, if possible, an address label from a recent issue.

Editorial contributions must be accompanied by return postage and will be handled with reasonable care; however publisher assumes no responsibility for return or safety of art work, photographs, models, or manuscripts.

EDGAR W. HOPPER
Publisher

ARTHUR P. SALSBERG
Editorial Director

LESLIE SOLOMON
Technical Editor

JOHN R. RIGGS
Managing Editor

EDWARD I. BUXBAUM
Art Director

ALEXANDER W. BURAWA
Associate Editor

JOHN McVEIGH
Assistant Editor

ANDRE DUZANT
Technical Illustrator

**HERBERT S. BRIER
LEN BUCKWALTER
LOU GARNER
GLENN HAUSER
JULIAN D. HIRSCH
RALPH HODGES
WALTER G. JUNG
ART MARGOLIS**
Contributing Editors

JOSEPH E. HALLORAN
Advertising Director

JOHN J. CORTON
Advertising Sales

LINDA BLUM
Advertising Service Manager

PEGI McENEANEY
Executive Assistant

STANLEY NEUFELD
Associate Publisher

FURMAN H. HEBB
Group VP, Electronics & Photo

ZIFF-DAVIS PUBLISHING COMPANY
Popular Electronics

Editorial and Executive Offices
One Park Avenue New York, New York 10016
212-725-3500

Herchel B. Barbin, President

Furman Hebb, Executive Vice President and Treasurer
Phillip T. Heffernan, Senior Vice President, Marketing
Edward D. Muhlfeld, Senior Vice President, Sports Division
Philip Sine, Senior Vice President
Frank Pomerantz, Vice President, Creative Services
Arthur W. Butzow, Vice President, Production
Lawrence Sporn, Vice President, Circulation
George Morrissey, Vice President
Sydney H. Rogers, Vice President
Sidney Holtz, Vice President
Charles B. Seton, Secretary
Edgar W. Hopper, Vice President, Electronics Div.

William Ziff, Chairman
W. Bradford Briggs, Vice Chairman

Midwestern Office
The Pattis Group, 4761 West Touhy Ave.,
Lincolnwood, Illinois 60644, 312 679-1100
GERALD E. WOLFE, GEORGE B. MANNION,
DAVID ALLEN

Western Office
9025 Wilshire Boulevard, Beverly Hills, CA 90211
213 273-8050; BRadshaw 2-1161
Western Advertising Manager, BUD DEAN

Japan: James Yagi
Oji Palace Aoyama, 6-25, Minami Aoyama
6 Chome, Minato-Ku, Tokyo 407-1930/6821,
582-2851



Editorial

THE ROOT OF IT

Can one find Nth roots on a basic four-function calculator? We replied, "No," in the December 1974 "Letters" column, to the postman's regret as well as our own. The answer, as expressed in an avalanche of reader letters, should have been "Yes!"

We knew better, too, since we've long had an index card attached to the back of a "four-banger" outlining the procedure to be used. Further, John Frye described a square-root method in our May 1974 issue. For roots higher than the second or third, it can be a long, tedious process compared to punching just a few keys on a scientific calculator (which we now use for finding roots). Essentially, here's how it can be done with the ubiquitous four-function calculator.

To determine a square root, use the formula $(N/A + A)/2 = B$, where N is the number whose root is wanted, A is a rough estimate of the root, and B is the rough answer, which is then inserted into the formula as a second A to refine the answer. As an example, if the square root of 25 is desired, and we choose 4.5 for the first A (even though we know it's 5), the answer for B on the four-banger is 5.0277775. So we would use 5.03 for A in the next trial, and the answer would be 5.000089. This could be used as A for the next go-round — ad infinitum.

To find a cube root, the formula is $(N/A^2 + 2A)/3 = B$. It is not difficult to see, then, that any integral root can be found from $[N/A^{r-1} + A(r-1)]/r = B$, where r is the desired root. So, to our many readers who took the time and trouble to write to us on the subject (many offering variations on the formula), "Thanks!"

Another subject on which we have received many letters, stems from our November 1974 article on building a direct-conversion receiver. Our sketch of the Motorola MOSFET, HEP-F20007, agreed with the company's at the time, but it seems that they subsequently changed the packaging and used a different lead configuration. In that same issue, the pin connections for a quad NAND gate were omitted in the article on a digital LED thermometer. We did not number some connections because they differ from manufacturer to manufacturer. In cases such as these, the builder of a project will learn the proper pin connections when he buys the device.

January's "Altair 8800" computer project generated an immense reader response, which will be covered in a near-future issue. However, we did receive a single phone call and a reader letter charging us with claiming availability of a computer kit for \$397 when it is really \$397 plus \$360 for the Intel 8080 chip. No sir! Unbelievable as it sounds, kit price was \$397 including the \$360 Intel chip, as the parts list indicated. The IC is available separately, however, as noted at the bottom of the list, for those who wish to purchase only the device.

And, of course, we are still inundated by letters requesting information on where to obtain specific parts. Most of these queries are unnecessary if referral is made to just a handful of electronics parts catalogs—most of which are available free. To provide further assistance, we're just now finishing a study of industrial parts distributors. The results (to be published soon) will hopefully give readers some additional supply sources for components.

Art Salsberg



The publisher has no knowledge of any proprietary rights which will be violated by the making or using of any items disclosed in this issue.

Another introductory offer to new members of the ELECTRONICS AND CONTROL ENGINEERS' BOOK CLUB

	404/445 ELECTRONIC CIRCUITS MANUAL by J. Markus Pub. price, \$22.00 Club price, \$15.75		286/515 INTEGRATED CIRCUITS: A Basic Course for Engineers and Technicians by R. G. Hibberd Pub. price, \$10.25 Club price, \$8.45		
	637/458 DESIGNING WITH TTL INTEGRATED CIRCUITS by Texas Instruments Inc. Pub. price, \$19.50 Club price, \$13.50		100/810 MOS/LSI DESIGN AND APPLICATION by Carr & Mize Pub. price, \$18.50 Club price, \$13.50		
	404/437 SOURCEBOOK OF ELECTRONIC CIRCUITS by J. Markus Pub. price, \$21.50 Club price, \$17.50		388/458 MAGNETIC RECORDING by C. E. Lowman Pub. price, \$14.50 Club price, \$9.75		
	389/756 SEMI-CONDUCTORS MEMORY DESIGN AND APPLICATION by Texas Instruments Inc. Pub. price, \$18.50 Club price, \$13.75		287/341 STANDARD HANDBOOK OF ENGINEERING CALCULATIONS by T. G. Hicks Pub. price, \$19.50 Club price, \$14.25		
	491/364 THE DESIGN OF DIGITAL SYSTEMS by J. B. Peatman Pub. price, \$16.50 Club price, \$11.75		124/035 HANDBOOK OF PHYSICS, 2/e by Condon and Odishaw Pub. price, \$37.45 Club price, \$14.95		238/901 APPLICATIONS OF OPERATIONAL AMPLIFIERS by J. G. Graeme Pub. price, \$14.00 Club price, \$10.50
					649/170 OPERATIONAL AMPLIFIERS by Tobey, Graeme & Huelsman Pub. price, \$15.00 Club price, \$11.50
					353/387 MINICOMPUTERS FOR ENGINEERS & SCIENTISTS by G. Korn Pub. price, \$17.75 Club price, \$10.50
					209/731 STANDARD HANDBOOK FOR ELECTRICAL ENGINEERS, 10/e by Fink and Carroll Pub. price, \$34.85 Club price, \$24.95

Save time and money by joining the
Electronics and Control Engineers' Book Club



HERE is a professional club designed specifically to meet your day-to-day engineering needs by providing practical books in your field on a regular basis at below publisher prices.

How the Club operates: Basic to the Club's service is its publication, the *Electronics and Control Engineers' Book Club Bulletin*, which brings you news of books in your field. Sent to members without cost, it announces and describes in detail the Club's featured book of the month as well as alternate selections which are available at special members' prices.

When you want to examine the Club's feature of the month, you do nothing. The book will be mailed to you as a regular part of your Club service. If you prefer one of the alternate selections—or if you want no book at all for that month—you notify the Club by returning the convenient card enclosed with each *Bulletin*.

As a Club member, you agree only to the purchase of four books over a two-year period. Considering the many books published annually in your field, there will surely be at least four that you would want to own anyway. By joining the Club, you save both money and the trouble of searching for the best books.

MAIL THIS COUPON TODAY

ELECTRONICS AND CONTROL ENGINEERS' BOOK CLUB
582 Princeton Road, Hightstown, New Jersey 08520

Please enroll me as a member of the Electronics and Control Engineers' Book Club and send me the two books indicated below. I am to receive the higher priced of the two for just \$1, and my first selection at the special Club price. Actual postage, plus 25¢ handling charge will be added (sales tax, also, if applicable). These books are to be shipped on approval, and I may return them both without cost or further obligation. If I decide to keep the books, I agree to purchase as few as four additional books (including this first selection) during the next two years at special Club prices (guaranteed 15% discount, often more).

Write Code No. of
bonus book
here

Write Code No. of
first selection
here

Name _____

Address _____

City _____

State _____ Zip _____

E33270



In a class by itself.

The Phase Linear 400 Power Amplifier has only one serious competitor when it comes to advanced design, superior performance, made-one-at-a-time craftsmanship, proven reliability, elegant appearance . . . and incomparable value. And that's the Phase Linear 700B. Hear them both at your dealer soon.

Phase Linear 400

THE POWERFUL DIFFERENCE

201 watts per channel, min. RMS at 8 ohms from 20 Hz-20 kHz with no more than .25% total harmonic distortion.

PHASE LINEAR CORPORATION
20121 - 48th Avenue S.W.
Lynnwood, Washington 98036
CIRCLE NO. 30 ON READER SERVICE CARD

Letters

TO GROUND OR NOT TO GROUND

With regard to "Build an Under \$90 Calculator" (January 1975), I see danger ahead for those people who heed one of the suggestions presented in the "Safe Handling of MOS IC's." I refer specifically to the instruction to "ground yourself" by wrapping a length of meshed cable snugly around your wrist and connect the free end of the cable to a good ground. This is an open invitation to accidental electrocution.

A human body placed at ground potential offers an easy path for electrical conduction from any source of potential. Likely trouble spots in a hobbyist's work area include uninsulated drill handles, poorly grounded (or not grounded) line-powered equipment, etc.

The sane alternative to no grounding at all is to ground through at least 100,000 ohms of resistance in series with wrist and ground. A really safe value would be 1 megohm because at 117 volts ac, it would limit the current to a maximum of 100 μ A—which is considered a safe value for a normal adult—should an accidental contact be made with the ac line. The series resistor will not affect static charge elimination.

RICHARD GIRCYS
Worcester, Mass.

Your comments are well taken and there should indeed be a current-limiting resistor in series with the body and ground. But this is necessary only if you plan to remain grounded after handling the MOS device. Our instructions assumed the removal of the ground strap after the device was installed.

VOM VERSUS DMM ACCURACY

I recently discovered that the front-to-back resistance checks of diode and transistor junctions can be very different, depending on the instrument used for making the check. Using an ordinary VOM will give one set of readings, but the readings obtained when using a DMM are very different from what I had come to expect.

Checking into the phenomenon, I learned that the differences in readings arise from the different approaches used in the two instruments. The VOM applies a constant voltage to the junction, while DMM applies a constant current. In the first

case, the junction is biased into conduction, while in the latter it is not.

DAVE BENNET
Pacific Grove, Calif.

POLES, PROCEDURES, AND PENALTIES

The flagpole up which was run the Notice of Proposed Rule Making for a Class-1 TV device must have been awfully short from where I stand. (See page 36, November 1974.) I never even got a glimpse of it.

Could you tell me the price of obtaining type approval for a Class-1 TV device and what the penalty is for operating such a device without approval?

As an experimenter, I see this legislation on the part of the FCC as a means of forcing individuals out of experimentation.

ROLAND J. TEMPLE
Shelton, Wash.

The fee for type approving a Class-1 TV device is \$100. You'll get zapped to the tune of \$500 per day for every day you get caught using a non-approved device. Right now, the law includes everyone, but plans are afoot to amend it to exempt individual experimenters.

PE SOLVES TV TROUBLE

Talk about coincidence! I have had a TV receiver sitting in my basement for almost eight months, inoperable, of course. So, I was amazed when I saw the same symptoms of my receiver that Art Margolis described in his December 1974 "Art's TV Shop." Once I knew what to look for, it was a simple job of repair. Now I have all the color back in my receiver, for which I thank PE and Art Margolis.

SCOTT GILSON
Farmington, Mich.

Out of Tune

In "Build an Auto-Polarity, Auto-Zero Digital Multimeter" (December 1974) under Technical Specifications, the alternating current should read from 1 μ A to mA instead of 1 mA to 300 mA. Also, if you wish to increase the brightness of the decimal points in the display, you can change the value of R14 from 150 ohms to 100 ohms.

In the Hourly Chimer section of "Update Your Digital Clocks" (February 1975), the second line of the third paragraph should read "outputs" instead of "inputs."

POPULAR ELECTRONICS

MITS

THE ULTIMATE KIT IS FAST BECOMING THE ULTIMATE SYSTEM.

We introduced the *Altair 8800 Computer* on the cover of January's *Popular Electronics*. It was heralded by the editors of *PE* as "the first commercial type of mini-computer project ever published that's priced within reach of many households."

Since then, many exciting things have happened.

For one thing, business has boomed. We've had to hire extra people just to answer the phones. We've taken hundreds of orders. And we've mailed out thousands of our free *Altair 8800 Computer Systems* brochures.

But the best news is this: **WE'VE ADDED SOME GREAT OPTIONS.**

ITEM: 4,096 word *Dynamic Memory Card*. People tell us this is one of the best buys in the industry. Maximum access time is 420 nanoseconds. **PRICE:** \$264.00 kit, \$338.00 assembled.

ITEM: *Static Memory Card*. Comes with 256 words of memory and is expandable to 1024 words. Maximum access time is 850 nanoseconds. **PRICE:** \$103.00 kit, \$134.00 assembled.

ITEM: *Memory Modules*. Adds 256 words of memory to the *Static Memory Card*. **PRICE:** \$53.00 kit, \$61.00 assembled.

ITEM: Full 1024 word *Static Memory Card*. **PRICE:** \$176.00 kit, \$209.00 assembled.

ITEM: *Audio Cassette Record Interface*. Allows virtually unlimited memory storage for data or software. Operates by modulating audio frequencies in the record mode. Demodulates recorded data in playback mode. **PRICE:** \$128.00 kit, \$174.00 assembled.

ITEM: Full *Parallel Input/Output Card*. TTL compatible with necessary handshake flags for conventional parallel interface. Addressing circuitry allows each card to be addressed anywhere from location 0 to location 255. **PRICE:** \$92.00 kit, \$114.00 assembled.

ITEM: *Serial Input/Output Card RS232*. Full RS232 interface card uses a UART and has divider logic to allow for presettable baud rates from 110 to 19,200. **PRICE:** \$119.00 kit, \$138.00 assembled.

ITEM: *Serial Input/Output Card TTL*. Same as above except all signals are TTL level (both in and out). **PRICE:** \$124.00 kit, \$146.00 assembled.

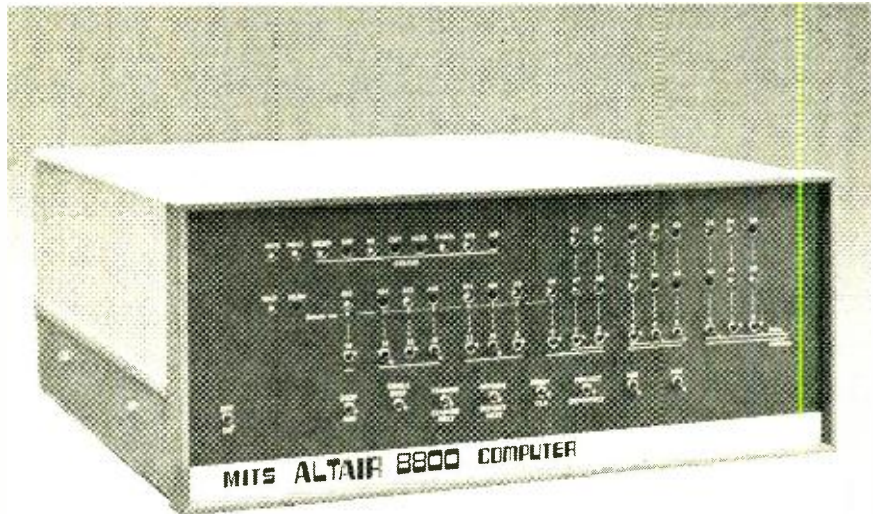

ITEM: *Serial Input/Output Card TTY*. Same as above except that it is for interfacing with conventional teletypes (current loop). **PRICE:** \$124.00 kit, \$146.00 assembled.

ITEM: *VLCI Computer Terminal*. This very low-cost terminal was originally featured in December's *PE* and it is now part of the *Altair System*. Allows user to convert from octal format to binary and back to octal, decimal, or hexadecimal. **PRICE:** \$129.00 kit, \$169.00 assembled.

ITEM: *C1256 Computer Terminal*. Basic memory of 256 characters with expandability to 1024 characters combines with a 32 character display to provide ease of operation. Special function keys for data retrieval and display format. ASCII coded keyboard and 110-300 baud rates. Auto-transmit and tape play record features. **PRICE:** \$595.00 kit, \$695.00 assembled.

ADD these items to the 15 other options currently under development (including a floppy disc system, a CRT terminal, 32 character display, line printer, etc.) and you can see why the **ULTIMATE KIT** is fast becoming the **ULTIMATE SYSTEM**.

ALTAIR 8800 PRICES

The *Altair 8800* is a full-blown, high-quality computer that sells for less than \$500.00 in kit form. Its parallel, 8-bit processor uses a 16-bit address. It has 78 basic machine instructions and it can directly address 256 input and 256 output devices. Basic instruction cycle time is 2 microseconds. **PRICE:** \$439.00 kit, \$621.00 assembled.

Warranty: 90 days on parts and labor for assembled units, 90 days on parts for kits.

Prices and specifications subject to change without notice.

MITS/6328 Linn, N.E., Albuquerque, New Mexico 87108, 505/265-7553.

MAIL THIS COUPON TODAY!

- Enclosed is a Check for \$ _____ or Master Charge # _____
 or Bank Americard # _____ Credit Card Expiration Date _____
 ALTAIR 8800 Kit Assembled Options (list on separate sheet)
 Include \$8.00 for Postage and Handling
 Please send free Altair System Catalogue

NAME _____

ADDRESS _____

City _____ State & Zip _____

MITS/6328 Linn, N.E., Albuquerque, New Mexico 87108, 505/265-7553

CIRCLE NO. 23 ON READER SERVICE CARD

Compare what you get training and you'll

Compare costs

Only NRI offers complete TV/ Audio Servicing Courses from \$312 to \$1,095 . . . with convenient, inexpensive time payment plans. In the Master Course in color TV servicing, with a 25" diagonal solid-state color TV, you save as much as \$650 under the next leading home study school.

NRI saves you money because our costs are lower. We pay no salesmen, and we design our own kits and equipment. We don't buy "hobby kits" from others. Nor do we penalize you with big interest charges for time payments. We pass the savings on to you.

Compare training

NRI is one of the few home study schools that maintains its own full-time staff of technical writers, editors, illustrators, development engineers and publications experts. The people who design the kits also design the lessons . . . so that theory and practice go hand in hand. The lessons aren't "retro-fitted" to an outside-source "hobby kit". The NRI set is designed exclusively for training. The fact that it is also a superb receiver for your personal use is an added plus.

Compare choices

Most schools offer one course in color TV servicing, period. Only NRI offers you five different courses to match your needs and budget. The 65-lesson basic course, complete with 7 kits, costs as little as \$312. Or you can step up to a \$425 course that includes a 12" diagonal black & white portable TV for hands-on experience. Then there's the 19" diagonal solid-state color TV course for \$695; the advanced color TV course for trained technicians with an 18" diagonal color TV for \$535; and finally, the magnificent 25" diagonal solid-state color TV course, complete with console cabinet, oscilloscope, TV pattern generator, and a 3½ digit digital multimeter, for \$1,095. Other schools charge you hundreds of dollars more for an equivalent course.



in TV/Audio home choose NRI.

Compare equipment Compare schools

NRI has engineered the widest variety of professional electronic lab equipment ever designed entirely for training at home. When you enroll in the Master Course in TV/Audio Servicing, for instance, you receive kits to build a wide band, solid-state, triggered sweep, service type 5" Oscilloscope; color pattern generator; solid-state radio; and a digital multimeter.

Before you settle on any home training course, compare the over-all program. See if you are getting kits engineered for experimentation and training . . . or merely "hobby kits". Count the experiments . . . compare the components. Don't just count kits. (Some schools even call a slide rule a kit.)

Home study isn't a sideline with NRI. We've been its innovating leader for 60 years. Ask any of the hundreds of thousands of NRI graduates. They'll tell you . . . you can pay more but you can't buy better training.

Along with each course, NRI provides bite-size, fully-illustrated lessons; personally graded tests; and the kind of person-to-person teaching that makes learning easier and faster.

Send for the free NRI full-color electronics catalog and discover why so many choose NRI. You'll find courses offered in TV/Audio Servicing, FCC License, Complete Communications Electronics, Digital Computer Electronics, Marine and Aircraft Electronics, Mobile Communications, etc.

**MAIL CARD
FOR YOUR
FREE NRI
CATALOG**

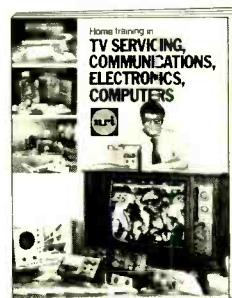

NO SALESMAN WILL CALL.

**AVAILABLE FOR CAREER
STUDY UNDER GI BILL**
Check box on card for information.



NRI SCHOOLS
McGraw-Hill Continuing Education Center
3939 Wisconsin Avenue,
Washington, D.C. 20016

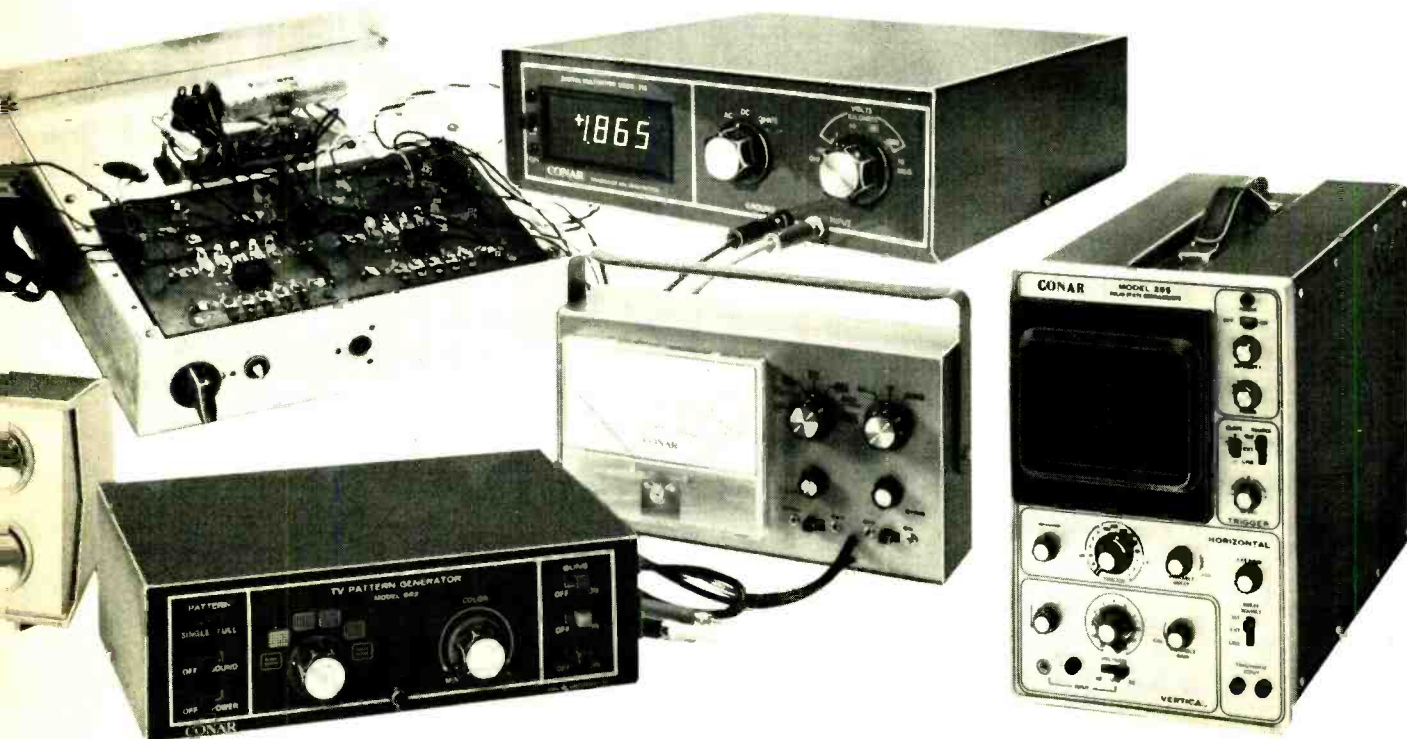

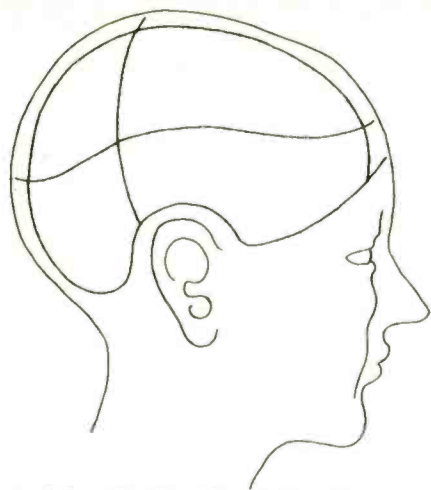

'GET INTO YOURSELF'

Discover your Alpha Brainwaves with this professional Biofeedback System.

Lowest Cost Brainwave Monitor

EICO introduces a price breakthrough in the fantastic new field of brainwave biofeedback... a completely safe, battery operated, biofeedback system that offers features and sensitivity comparable to professional models costing much more.

You Will Be Amazed At What You Hear

The BW-300 will detect your alpha brainwaves (which occur when you are totally relaxed) and produce a tone varying in frequency according to your mental state.

100% Solid State Circuitry

Reliable All Solid State IC Circuit Design features an active filter that isolates alpha brainwaves and a high-gain low-noise amplifier providing 5-microvolt sensitivity for easy alpha recognition. The BW-300 is supplied with stethoscopic earphones, electrodes headband, contact cream and instructions.

KIT 34⁹⁵

WIRED 59.95

FREE EICO CATALOG

For latest EICO Catalog on Test Instruments, Automotive and Hobby Electronics, Eicocraft Project kits, Burglar-Fire Alarm Systems and name of nearest EICO Distributor, check reader service card or send 50¢ for fast first class mail service.

EICO—283 Malta Street, Brooklyn, N.Y. 11207

Leadership in
creative electronics



CIRCLE NO. 14 ON READER SERVICE CARD
12

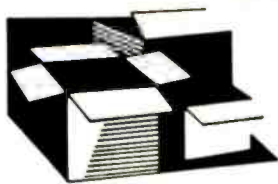

New Products

Additional information on new products covered in this section is available from the manufacturers. Either circle the item's code number on the Reader Service Card inside the back cover or write to the manufacturer at the address given.

SONY SIX-HEAD, AUTO-REVERSE TAPE DECK

The Sony TC-558 open-reel tape deck features three motors, continuous auto reverse, automatic shutoff, six ferrite heads,



servo-driven capstan, 7-inch reel capacity, and two operating speeds (3 $\frac{1}{2}$ and 7 $\frac{1}{2}$ ips). Frequency response is 30-20,000 Hz \pm 3 dB, S/N is 53 dB, rated by Sony using standard tape at 7 $\frac{1}{2}$ ips. Two line, mike, and phono inputs are provided, while outputs include two headphone, and line jacks. Two VU meters monitor input levels. There's an equalization switch for standard or low-noise tape, with appropriate bias for each. Price is \$769.95.

CIRCLE NO. 68 ON READER SERVICE CARD

RCA PERMACOLOR UHF/VHF/FM ANTENNA

RCA's new Permacolor Model 4BG48 uhf/vhf/FM outdoor antenna is designed for deep-fringe reception areas. The all-channel antenna has eight control elements and 48 perma-tuned circuits, each active on one or more TV frequency band. A bow-tie and corner reflector are used for uhf reception. Preassembled elements unfold and lock into place. Other features include break-off elements for FM broadcast reception control and V-shaped mast clamps. Overall measurements are 198 in. (497 cm) long by 108 in. (271 cm) wide with

a 115-in. (286-cm) turning radius. Uhf corner reflector dimensions are 38 in. by 23 in. (95.4 \times 57.7 cm). Price is \$99.95.

CIRCLE NO. 69 ON READER SERVICE CARD

BSR CD-4 AUTOMATIC TURNTABLE

A new automatic turntable by BSR, Model 4620W, is fully equipped for playing CD-4 discrete four-channel discs. A heavy-duty synchronous motor drives a 4-pound aluminum platter. Among other features are a variable-speed control to adjust pitch, a jam-proof counterweighted tonearm with calibrated stylus-force adjustment, dual-range anti-skate control, and a viscous-damped cue/pause control. The unit is equipped with an Audio Technica AT-12S CD-4 cartridge and comes complete with walnut-grained wood base and a tinted dust cover. \$139.95.

CIRCLE NO. 70 ON READER SERVICE CARD

MICRO-ACOUSTICS LOUSPEAKER

Micro-Acoustics' Model FRM-2 is an acoustic suspension, multitweeter speaker system. Priced at \$129.00 each, the FRM-2 uses three moving-coil tweeters mounted trihedrally. According to the manufacturer, this results in a 160-degree dispersion in horizontal and vertical planes. A 10-inch woofer with a narrow voice-coil gap is said to produce good bass response with a vented design's efficiency. System resonance is 50 Hz. Minimum drive requirement is 10 W rms.

CIRCLE NO. 71 ON READER SERVICE CARD

SENCORE AUTOMATIC TRANSISTOR ANALYZER

The TF30 Super Cricket by Sencore is a completely automatic bipolar and field effect transistor analyzer which requires no



set-up information. The Super Cricket will give an audible indication when one of six buttons, covering all possible basing configurations, and an npn-pnp switch are set

POPULAR ELECTRONICS

in proper position for the particular device being tested. A meter gives a visual good-bad indication. Also, the Super Cricket will distinguish a bipolar device from a FET, then determine the parameters beta, T_{ch} , G_m , I_{DSS} , I_{GSS} , lead identification and transistor polarity with the push of a button. All calibration is automatic, according to the manufacturer. A newly designed "touch-test" probe is included for in-circuit pc board troubleshooting. \$240.00

CIRCLE NO. 72 ON READER SERVICE CARD

SWITCHCRAFT DOLBY FM COMPENSATOR

Switchcraft, Inc. introduces its Model 621P1 two-channel de-emphasis compensator for use with FM receivers and Dolby B-Type noise reduction units. The compensator changes the de-emphasis

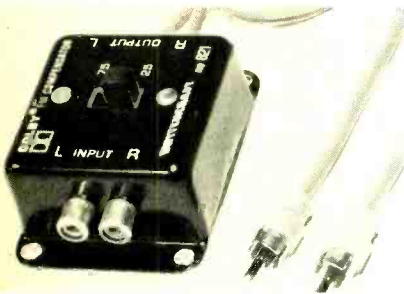

characteristic from the conventional 75- μ s to the recently approved 25- μ s figure that Dolbyized FM stations are using. A slide switch selects the appropriate characteristic. The 621P1 measures 2" x 2" x 1" (5 x 5 x 2.5 cm) and is priced at \$12.95. Address: Switchcraft, 5555 N. Elston Ave., Chicago, IL 60630.

SEMICONDUCTORS TEMPERATURE RECORDERS

An adhesive-back temperature recorder capable of detecting overheated TO-5 power components has been introduced by the Telatemp Corporation. The Model 505 "recorder" can be applied to the top of TO-5 power transistors and other small component packages. It contains five silver-colored windows which turn irreversibly black at a rated temperature, with a claimed 1% accuracy. Each window is calibrated at a specific increment between 65°C and 125°C. Other Telatemp component temperature recorders are available for use with TO-3, TO-66, LSI flatpacks and DIP packages. These recorders can be used to observe heat generation in prototypes, and the effectiveness of thermal cycling and burn-in tests. Available from Telatemp Corp., Box 5160, Fullerton, CA 92635.

DYNASCAN COBRA CAM-89 CB TRANSCEIVER

The Cobra CAM-89 by Dynascan is a solid-state, 23-channel AM base station transceiver, successor to the Cobra CAM-88. It offers full legal power output, delta tune, meters for signal-strength and modulation

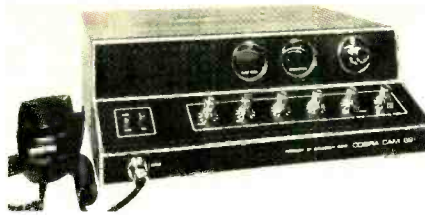

level, "DynaMike" gain control, and PA facilities. The receiving section is a dual-conversion superhet with r-f and tone controls and switchable ANL. A detachable microphone is included. The CAM-89 measures 5 $\frac{3}{4}$ " x 13 $\frac{3}{8}$ " x 12 $\frac{5}{8}$ " (14.4 x 33.6 x 31.7 cm). \$240.00.

CIRCLE NO. 73 ON READER SERVICE CARD

POWERCOM AUDIO CONTROL CENTER

Powercom's Program Control Center is a master control capable of switching stereo and mono audio components to a tape recorder and amplifier. The unit has ten switchable inputs and four output channels. A mono/stereo switch allows the use of mono components in two-channel systems. Available at \$14.95 from: Powercom Corp., Dept. 4, Box 454, Troy, NY 12181.

JVC NOISE REDUCTION UNIT

The JVC Model NR-1020 is an Automatic Noise Reduction System designed for tape applications. It is said to reduce tape hiss by 10 dB at 5000 Hz, and increase dynamic range. S/N ratio is 60 dB or more, according to JVC. The NR-1020 contains a built-in oscillator and comes with two calibration tapes. \$149.95.

CIRCLE NO. 74 ON READER SERVICE CARD

KEITHLEY AUTORANGING DMM

The Model 168 digital multimeter by Keithley Instruments is a portable five-function unit with autoranging. Ac/dc voltage and current, and resistance measurements can be made over a total of 24 ranges. LED displays are used and most of the digital circuitry is contained within one LSI chip. Basic dc accuracy is claimed to be $\pm 0.1\%$. The five functions span 100 μ V to 1000 V dc, 100 μ V to 500 V rms ac, 0.1 ohms to 20

kits

FOR THE HOBBYIST & PROFESSIONAL

FREE!
Printed Circuit Handbook
when you take this ad to
your electronic supplier.

GC ELECTRONICS
DIVISION OF HYDROMETALS, INC.
ROCKFORD, ILLINOIS 61101 U.S.A.

P.A.I.A.

ELECTRONICS, INC.

INTRODUCES THE **GNOME** MICRO-SYNTHESIZER KIT

#3740 GNOME KIT
\$48.95
plus shipping & insurance 4 lbs.

THE GNOME FILLS A VARIETY OF NEEDS!

- TO THE SEASONED PERFORMER... It's the extra voice that completes a composition while leaving expensive equipment free for more demanding tasks.
- TO THE BEGINNER... It's a low cost introduction to synthesizers that won't be obsolete when more expensive instruments are purchased.
- TO THOSE IN BETWEEN... the GNOME's portability and ease of operation make it great for "toy boxes," sound effects or just for fun.

P.A.I.A.'s FREE CATALOG features the GNOME and other electronic music kits. Check our Reader Service Number or Write: P.A.I.A. Electronics, Dept. P 1020 W. Wilshire Blvd., Okla. City, OK 73116

CIRCLE NO. 27 ON READER SERVICE CARD

free

The "NEW LOOK"
1975
LAFAYETTE
Radio Electronics
CATALOG

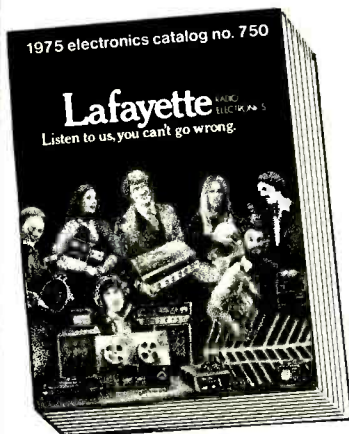

The ONLY Nationally Distributed Full-line Catalog with a Major Showing of the Newest NAME-BRAND electronics products for 1975.

FREE
SEND TODAY

SAVE on exclusive Lafayette Products plus MAJOR BRANDS

- Stereo and 4-Channel Systems • Tape Equipment • Car Stereo • CB and Ham Gear • Police/Public Service Receivers • Antennas • Cameras • TV • PA and Test Equipment • Musical Instruments and Amplifiers • Books • Electronic Calculators • Security Systems • PLUS PARTS, TUBES, BATTERIES, HARDWARE, MORE!

Lafayette

Listen to us, you can't go wrong.

Dept. 35035
Lafayette Radio Electronics
 111 Jericho Tpke., Syosset, L.I., N.Y. 11791

Send me your FREE 1975 Catalog

Name Apt.

Street

City State

Zip

Send a 1975 Catalog to my friend

Name Apt.

Street

City State

Zip

CIRCLE NO. 21 ON READER SERVICE CARD



megohms, and 100 nanoamperes to 1 A ac and dc. An optional shunt extends current capacities to 50 A. The Model 168 operates on 90-250 V ac and there's an optional rechargeable NiCd battery pack and an r-f probe. \$299.00.

CIRCLE NO. 75 ON READER SERVICE CARD

AM DX RECEIVING ANTENNA

Model DA-3, a compact, tuneable, shielded ferrite rod antenna for the AM broadcast band is offered by McKay Dymek. When connected to the antenna input of an AM radio, it's designed to pull in distant or low-power stations. The antenna can be rotated and tilted to null out undesirable signals. Features a built-in, FET two-stage preamplifier, and a 540-to-1600-kHz tuning range. Overall sensitivity is claimed to be 1 μ V. This antenna operates on 117 V ac or 6 V dc, weighs 6 1/2 lb (2.9 kg), and measures 13 3/8" W (34.9 cm) x 11"H (27.9 cm) x 9 7/16" D (23 cm). \$155.00

CIRCLE NO. 76 ON READER SERVICE CARD

HEATHKIT SOLID-STATE AMATEUR TRANSCEIVER

The Heath Model SB-104 transceiver is a totally solid-state unit covering the 80-through 10-meter bands. Digital frequency readout, broadbanded receiver input/transmitter output circuitry, and SWR-protected finals are among the rig's features. Transmitter power is switchable between two positions—QRP (1-watt output) and 100 watts output (CW and PEP). Receiver sensitivity is said to be less than 1 μ V. Re-

ceiving options available are a digital noise blanker, 400-Hz CW filter, and SB-styled speaker. The SB-104 requires a 12-volt power source, and is priced at \$699.95. Options include a remote vfo, \$119.95; fixed-station power supply, \$89.95; speaker, \$29.95; noise blanker, \$24.95; CW filter, \$34.95.

CIRCLE NO. 5 ON READER SERVICE CARD

YAMAHA MONITOR LOUDSPEAKER SYSTEM

The Model NS-1000M Monitor Loudspeaker System by Yamaha employs beryllium (a light, strong metal) dome 3/2-in (8.8-cm) mid- and 1-in (3-cm) high-frequency drivers, and a specially constructed 12-in (30-cm) woofer and cross-

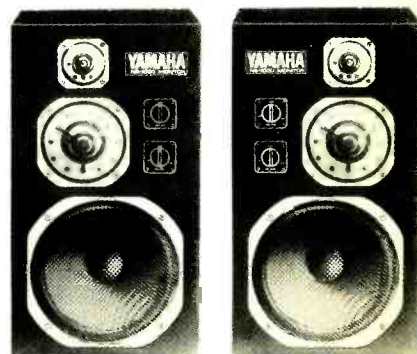

ceiving options available are a digital noise blanker, 400-Hz CW filter, and SB-styled speaker. The SB-104 requires a 12-volt power source, and is priced at \$699.95. Options include a remote vfo, \$119.95; fixed-station power supply, \$89.95; speaker, \$29.95; noise blanker, \$24.95; CW filter, \$34.95.

CIRCLE NO. 77 ON READER SERVICE CARD

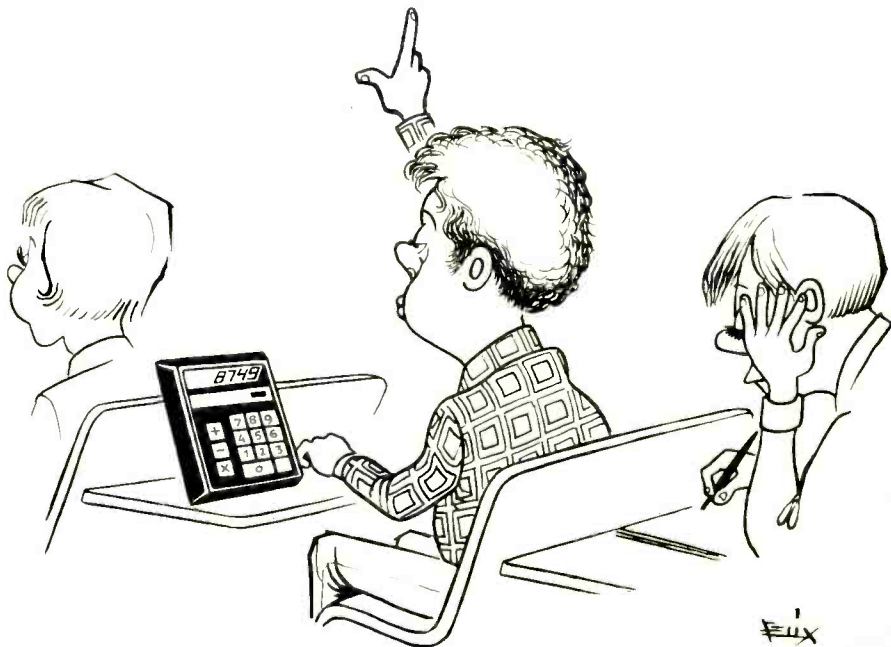

Flux

POPULAR ELECTRONICS

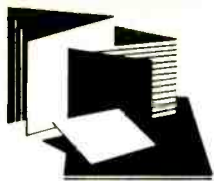

New Literature

7400 SERIES TTL PINOUT HANDBOOK

A handbook on circuit configurations of 7400/5400 series TTL IC's is available from IMS Associates. It contains pin connection diagrams, truth tables, a manufacturer cross reference of devices with the same pin configurations, and diagrams for one shots and drivers commonly used by experimenters. A summary of MIL spec logic drawing conventions is also included. Available for \$1.95 postpaid from: IMS Associates, Inc., 1298 E 14th St., San Leandro, CA 94577.

PILOT & INDICATOR LAMP CATALOG

Industrial Devices is offering a new 12-page catalog of pilot and indicator lights and accessories currently available. There are neon, incandescent, and solid-state versions in a variety of sizes, shapes, and configurations, and voltage ratings. Available from Industrial Devices, Inc., Edgewater, NJ 07020

TRACEWELL ENCLOSURE FACTSHEET

A factsheet illustrating Tracewell's line of molded enclosures is now available. The enclosures feature molded-in vertical slots and horizontal standoffs for easy mounting of pc boards. Non-skid rubber feet and ventilation slots are also provided. A carrying handle/tabletop support and mobile mounting bracket are optional accessories. Address: Tracewell Enclosures, 200 Montrose Way, Columbus, OH 43214.

ZENER DIODE CROSS REFERENCE

A cross-reference guide for zener voltage regulators is now available from the Semiconductor Division of International Rectifier. The 8-page application note (AN-105) lists over 1800 parts, giving competitive and IR part numbers. A chart of all available IR series shows power rating, zener voltage, and tolerance ranges. Other charts list voltage references, nominal temperature coefficients, case style, and MIL spec regulators. Address: International Rectifier Corp., Semiconductor Division, 233 Kansas St., El Segundo, CA 90245.

RCA SOLID-STATE PRODUCT GUIDE

An updated 36-page guide to RCA commercial solid-state products is available from the RCA Solid State Division. Designated SPG-201K, the guide lists IC's, power transistors, MOSFET's, r-f and microwave

power devices, power hybrid circuits, thyristors, and rectifiers currently available from RCA as standard commercial products. Significant ratings and characteristics are given for each type to aid in the selection of the optimum device for a particular application. Available from RCA Solid State Division, Box 3200, Somerville, NJ 08876.

PTS TAPE PLAYER PARTS CATALOG

A new 48-page catalog (No. 5) from PTS Electronics lists its line of tape player parts. An illustrated parts section enables fast selection of the required replacement. Catalog is \$2.00 from: PTS Electronics, Inc., Box 272, 5233 Hwy 37 S., Bloomington, IN 47401.

FANON SOUND CHARTS FOR INTERCOMS, PA

Intercom and PA system specification and selection is made easy with two wall reference charts by the Fanon/Courier Corporation. The Fanon Intercom System Selection Guide gives unit descriptions, block diagrams, and capabilities of various systems, including range, features, accessories and installation tips. The companion PA Amplifier System Selection Guide features indoor and outdoor public address system components for given area coverage and application requirements. Available from Fanon/Courier Corporation, 990 South Fair Oaks Ave., Pasadena, CA 91105.

You don't have to buy a new car to get an electronic ignition.



Most of you know the evaluation of automotive electrical systems . . . an evaluation characterized only occasionally by efficiency and performance. I know that, and that's why I use the Delta Mark Ten B CDI on all my cars, new and old. And believe me, you don't have to have a new car to appreciate the best electronic ignition available today. Study these features and you'll know what I mean.

1. Mark Ten and Mark Ten B Capacitive Discharge Ignition Systems are manufactured by Delta Products, Inc., a company with a conscience, and with a proven record of reliability both in product and in customer relations.
2. The Mark Ten CDI's really do save money by eliminating the need for 2 out of 3 tune-ups. Figure it out for yourself. The first tune-up or two saved pays for the unit, the rest is money in your pocket. No bunk!
3. Because the Mark Ten CDI's keep your car in better tune, you actually can save on expensive gasoline.
4. With a Mark Ten, spark plugs stay clean and last longer . . . fouling is virtually eliminated.



No matter what kind of car you drive, it too can use a Delta quality lift.

I want to know more about Mark Ten B CDI's. Send me complete no-nonsense information on how they can improve the performance of my car.

Name _____

Address _____

City _____ State _____ Zip _____

DELTA PRODUCTS, INC.
P.O. Box 1147, Dept. PE, Grand Junction, Colo. 81501
303-242-9000

Mark Ten B, assembled	\$64.95 ppd	Standard Mark Ten, assembled	\$49.95 ppd
Mark Ten B, kit	\$49.95 ppd	DeltaKit®	\$34.95 ppd

CIRCLE NO. 12 ON READER SERVICE CARD



Stereo Scene

By Ralph Hodges

TAPE BIAS AND EQUALIZATION

I RECEIVED a crestfallen note from a reader in Illinois recently. He was upset because his tape deck (an older model) lacked the bias and equalization switches that have proliferated over the past couple of years. Therefore, he felt, he wouldn't be able to experiment with the many new types of tape now available—tapes that inspired the switch facilities to begin with.

Fortunately he was wrong. The absence of the switches would mean a certain inconvenience, to be sure, but a tape recorder's *internal* bias and EQ adjustments are still the best way of matching a machine, as closely as possible, to the particular tape being used. I often wonder when I see the legends **NORMAL** and **SPECIAL** (or similar nomenclature) on these switches, just what kind of tape is being referred to. Presumably **SPECIAL** means the so-called low-noise/high-output formulations, but to suggest that all of them, from their numerous different manufacturers, perform identically is being optimistic.

True, chromium-dioxide cassettes tend to be very similar because, with few exceptions, the oxide material all comes from the same source. But the iron oxides applied to open-reel tapes

of the low-noise/high-output category are more diverse—so much so that there are evidently tape machines that *can't* be optimally set up for some of them. Not that there are a great many suppliers of such oxides. There aren't! But suppliers do exist in the U.S., Europe, and the Far East, all with products readily available in this country. So far as is possible they are secretive about their manufacturing processes, so differences in oxides and the tapes made with them frequently occur.

Hotter Tapes. Does this mean that when you put a reel of the latest (and "greatest") 1-mil polyester on your machine and casually flip the bias and EQ switches to **SPECIAL**, you are perhaps not getting the flattest possible frequency response and the lowest noise and distortion. Yes indeed!

The **SPECIAL** position can only refer to optimum conditions for one particular tape—or at best two or three tapes with highly similar characteristics. For any other tape, it's an approximation, which may or may not be audibly satisfactory. In recognition of this and additional factors, some tape-deck manufacturers still refrain from providing the almost ubiquitous

switches. The new \$1800 Revox with which I've been amusing myself for the past several weeks, for example, lacks them; but the continuously variable trimmers that can set the bias and EQ much more precisely are accessible (and clearly marked) with the removal of two back panels.

How did these better, "hotter" tapes come about? In general, they started to appear with the high-fidelity boom of the late sixties. The object was to provide tape with better frequency response, less noise and lower distortion. Simplistically put, the reason tape has distortion is that magnetic materials do not really behave linearly, and can be made to do so only with the exercise of considerable ingenuity, and even then with serious limitations. The reason tape has noise (the familiar tape hiss, as well as other noises) is that its surface (the oxide coating) is composed of ground-up bits of magnetic material, and hence is not magnetically or physically smooth. And the reason it doesn't have infinite (for audio purposes) frequency response is that it can't hold onto the very short wavelengths of extremely high frequencies. These closely spaced magnetic poles are neutralized through a number of mechanisms, either right at the moment of recording or later, with the passage of time and use.

Hence, tape manufacturers began a multi-pronged attack on the problems of tape, particularly those of oxide coatings. They worked to make oxides magnetically tougher (higher coercivity), so that they'd be less inclined to relapse from any magnetic state they had been put into. They strove to get the separate oxide particles more uniform in shape and size, and to pack them more densely and smoothly on the tape. The result was tapes with better high-frequency response (in other

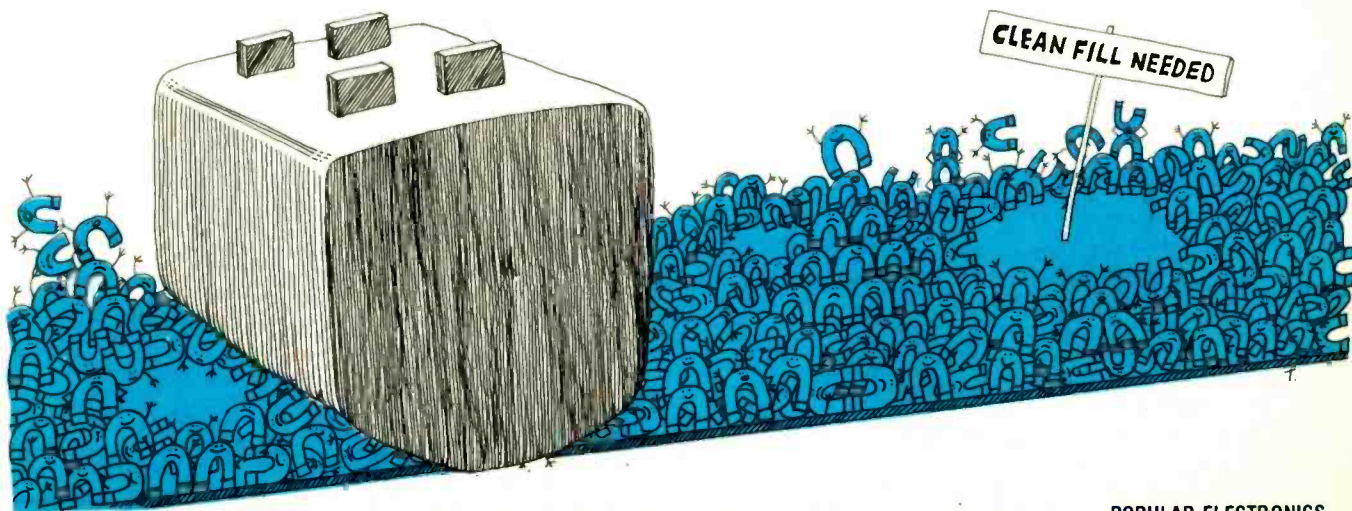

words, hotter), less noise, and higher potential output (since they had a greater concentration of magnetic material per unit area). The result also was tapes that had to be used under somewhat different conditions than the prevailing ones if the most was to be gotten out of them.

Bias. Everyone talks about bias but few seem to truly know anything about it. Bias was discovered long ago in tape's antiquity, when it was learned that the application of a rather strong dc field along with the recording signal served to reduce the distortion of tape and increase its sensitivity. In due time the dc was replaced with ac of very high (ultrasonic) frequency, since the dc bias produced objectionable tape noise. After that, developments in bias were sporadic and concentrated on making it higher in frequency (the Revox's bias oscillator puts out above 1.5 Mhz), less distorted (for instance, an asymmetric bias suggests a dc component, and therefore more noise), and more accurately positioned relative to the point where the recording signal is applied to the tape (the cross-field head technique, for example).

There's still no general agreement as to what these innovations achieved. However, it's unmistakable that bias, pure and simple, does reduce distortion and greatly increase the tape's sensitivity to the recording signal. And at least we can say, with technical accuracy, that it does so by putting the tape into a high state of flux, apparently making it more malleable. Imagine yourself with a stout steel I-beam, intending to sculpt it into a graceful curve for exhibition at some art show. After fruitless efforts with a sledgehammer you resort to a pile driver, which kinks and tortures the metal, and which is difficult to modulate in the intensity of its blows. Finally, it occurs to you to heat the metal almost to the molten state. Then you can approach (in your asbestos suit) and mold it effortlessly into the shape you desire.

This is a very rough analogy, but to carry it a little further, the hotter tapes generally require somewhat more heat (more bias) to achieve "optimum" malleability, and they can usually profit from a stronger molding force (a stronger recording signal). And the hotter a tape gets, the more bias and recording signal it's likely to need, which means readjustment of the tape machine.

Fig. 1. Bias versus harmonic distortion at three frequencies for a high-quality iron-oxide tape.

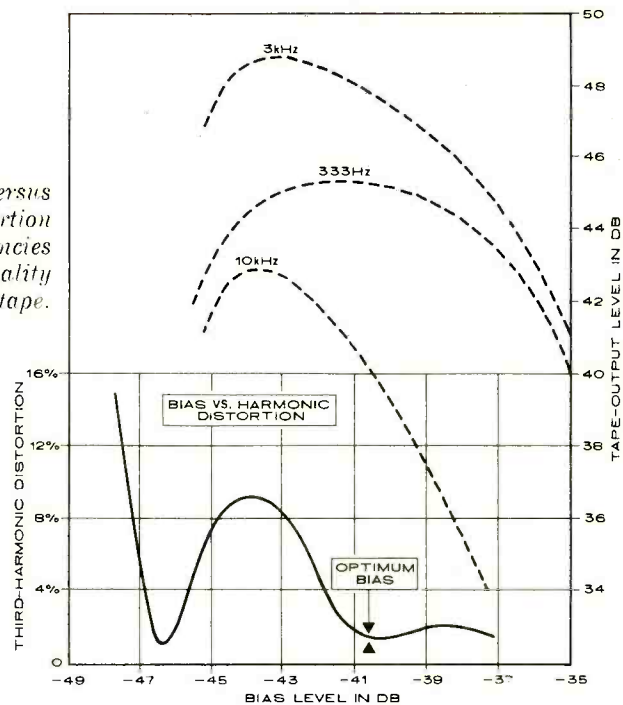

Bias and Equalization. Recording equalization (EQ) is merely a high-frequency level adjustment, and it is provided in most tape machines simply to complement the *playback* equalization (which should be fixed to conform to the standard NAB characteristics) and to touch up any frequency-response aberrations that things such as the bias adjustment might produce.

To illustrate: the bias signal can partially erase a tape even as it's helping to record it. (In fact, the bias oscillator also drives the erase head—with a much stronger signal.) This erasing potential is first exhibited at the high frequencies. If achieving the desired bias results in a moderate droop at the top end of the frequency response, EQ may then be able to flatten things out, with some cost in signal-to-noise ratio.

The important thing to realize about the EQ adjustment is that it *follows* the bias adjustment, and is in a sense subsidiary to it. Bias is not a fix-it for what you can't or prefer not to achieve with EQ. Certainly you can bring up the high-frequency response of a recording by reducing the bias, but you will also affect distortion and noise, as well as fail to make the most efficient use of the tape. The bias must be correct to begin with; then you can try to effect any repairs needed on frequency response with the EQ.

Setting the Bias. Figure 1 (Memorex MRX₂ curves) shows the way a varying bias affects the sensitivity and

distortion of a particular iron-oxide tape. The top of the figure gives the output levels obtained for recording signals of constant strength at three different frequencies. The solid curve near the bottom indicates total harmonic distortion for the 333-Hz signal. (Odd-order harmonic distortion is characteristic of tape, which means that distortion at the lower frequencies is of greatest concern. Any distortion products generated with the 10-kHz signal would all be at 30 kHz or above, and therefore inaudible.) The first thing that happens as bias increases is a precipitous drop in distortion. Then the output of the tape begins to climb—at the higher frequencies first—and so does distortion. Sensitivity nears a maximum at 333 Hz, as distortion meanwhile declines again, along with the tape's output at the higher frequencies. Ultimately an "optimum" bias point is achieved at just over -41 dB.

In this example, optimum bias occurs at a point very close to the conditions for highest output and lowest distortion at 333 Hz, but that is perhaps more by accident than design. There are other factors to consider, noise being an especially important one. Because a magnetic field obeys an inverse-square law, even a slight variation in distance between the recording-head gap and the tape can significantly affect the field strength impinging on it. And the word "slight" includes the minute surface roughness of a tape, with tiny troughs and bumps that pull and push the tape



Ken Fransen is using his electronics training where it really counts.

Helping to save lives in the U.S. Coast Guard.

It's up to Ken to keep sophisticated electronics communications equipment in top condition.

He's part of our lifesaving team. We count on Ken and need more people like him.

You may or may not have electronics training. If, like Ken, you have training, we'll put you to work fast, on a rewarding job with responsibility and challenges. If you don't have training, we'll train you.

Say your experience goes no further than building a crystal radio set. If you have an aptitude for electronics and qualify, we'll guarantee you 25 to 38 weeks of school and turn you into a seasoned professional who'll be able to troubleshoot the most complex electronics equipment. You'll study everything from theory and principle to practical application.

Those of you who already know your way around electronics systems may qualify for our advanced promotion program. After only ten weeks, you'll be promoted immediately to a higher pay grade (up to 2nd class petty officer with pay of over \$400 a month, plus food, housing and medical care). And you may qualify for even more advanced training.

Either way, your job as a Coast

Guard electronics technician will give you a broad range of experience. Using the most modern diagnostic tools, you'll maintain, repair and calibrate the latest electronics equipment, including LORAN systems, computer-controlled transmitters, solid-state equipment and AM, FM and SSB transceivers.

You might even qualify to help design, test and evaluate new equipment or prototype models in our research laboratories, or work on cesium and rubidium atomic clocks.

You'll be doing plenty for yourself, too. The training alone is worth thousands of dollars, and the skills you learn can lead to valuable, sought-after jobs in both the Coast Guard and civilian life.

What's more, the Coast Guard offers you a combination of pay and benefits most private companies can't match. (For more about our package of benefits, read the attached card.)

Find out more about a rewarding career in electronics. Mail us the card today.

**Help others/Help yourself.
Join the lifesavers.
The Coast Guard.**

toward and away from the head face. Referring again to Figure 1, you'll note that optimum bias closely corresponds to the broad peak in the tape's sensitivity at 333 Hz. Small changes in bias strength (as would be caused by tape-surface roughness) will therefore not affect the tape's output much at that frequency. But the 10-kHz curve's slope is quite steep at that bias value, meaning that small bias changes will produce much larger changes in output.

This is the mechanism—or one of them—responsible for drop-outs: momentary signal losses caused by tape-oxide irregularities (Fig. 2). If the tape's surface is consistently irregular and bias is not set at optimum, these drop-outs (or drops up and down) may become the steady susurrus known as modulation noise. The amplitude of the signal on the tape is then being constantly modulated by the tape's oxide-coating aberrations. Naturally, various other interesting types of distortion are also involved.

Drop-out and modulation effects are not as noticeable at 10 kHz as they are at 333 Hz, which is one good

For the foregoing two reasons, optimum bias for a tape is not likely to be many decibels away from the value that yields greatest sensitivity at lower frequencies. But with that bit of wisdom, the hard-and-fast rules end. Unless you have a better-equipped lab and a fuller understanding of all the considerations involved than most, you're not going to be able to deduce much more than this about how to bias a tape properly on your own.

What are your other recourses? The tape machine's manufacturer is the first one. His service manual will give the procedure for biasing to the tape he recommends. Usually this involves recording a high-frequency tone, monitoring the playback-head output, and raising the bias to where the output peaks and then beyond, until output falls perhaps 3 or 4 dB (whatever is specified) from its maximum. Note that this is essentially a process of adjusting to a benchmark. Presumably the manufacturer has considered *all* the relevant factors in advance, chosen the best bias for the combination of his machine and his selected tape, and then provided an easy way to

learning a bit about how to exploit its superiority. Its bias requirements could be identical to those of the tape you have been using, but you might never know. Furthermore, there are factors involving the machine itself. The way the bias field impinges on the tape depends on the configuration of the record head (or the cross-field head, if the machine has one). So another element of confusion is added to the mix.

Minimum-Noise Test. Through the good offices of the Boston Audio Society's newsletter, I recently became aware of a bias-adjusting procedure being used by dbx. It involves adjusting for minimum drop-out and modulation noise and forgetting about everything else. The rationale for this, I suppose, is that improvements in tape have rendered even distortion and frequency-response problems minor in comparison with tape noise. Also, according to dbx, the results achieved through this process typically differ only slightly from what you get with other bias-adjusting schemes.

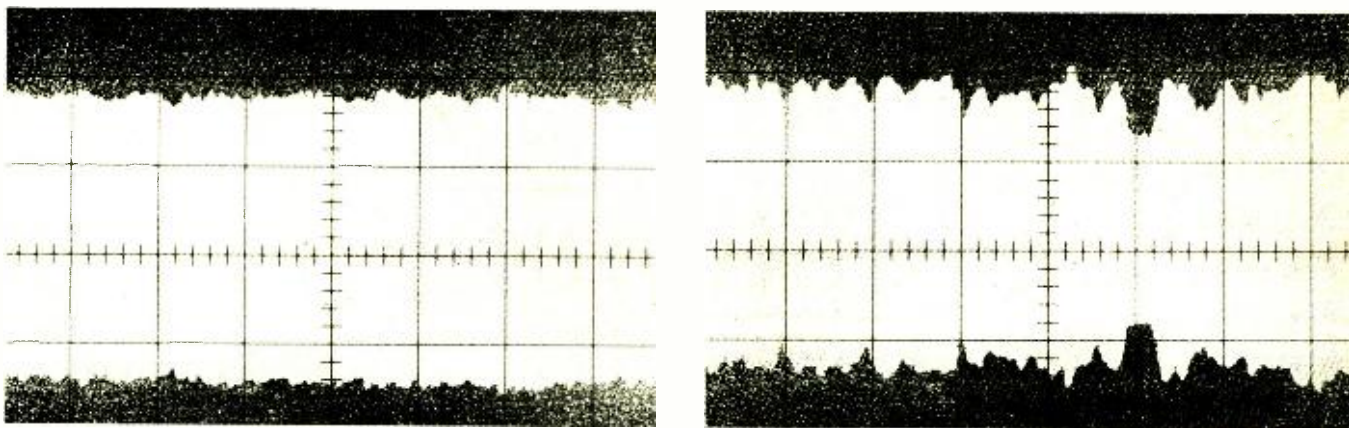

Fig. 2. Oscilloscope photo at left shows playback of a high frequency signal from tape with proper bias. At right is playback of same tape with improper bias. Momentary signal losses can be seen.

reason for biasing near the point where lower-frequency sensitivity changes least with bias. Another is that maximum low-frequency sensitivity implies that the bias field is penetrating down through the full thickness of the tape's oxide coating. (I should say that *particular* tape's oxide coating, since thicknesses vary.) Much low-frequency energy is recorded deep within the oxide layer, provided bias is also present at that depth to facilitate the process. If it is, then the full potential of the tape can theoretically be realized.

home in on it. He doesn't mean to imply (I trust) that a 3-dB or so falling off at 10 kHz results in optimum bias for *any* tape.

The machine's manufacturer may also have some idea of how to bias for other tapes you want to try. But if he doesn't, there's always the manufacturer of the tape himself. Unfortunately, unless you can make some sort of contact with the tape company's engineering staff, the information you get may not be particularly helpful. You might receive reams of literature on why the tape is superior without

The dbx approach goes like this. Start recording a 30-Hz steady tone on the tape and use appropriate filters to roll off the playback head's output below 400 Hz and above 4,000. Then just listen. The 30-Hz tone will be removed by the filter setup, so that all you will hear is noise—drop-out noise, which sounds like dull popcorn detonations, and hiss, which sounds more or less like the usual tape malady. Reportedly, by altering the bias, you should be able to locate a fairly precise point that minimizes both these noises. And that is optimum bias.

As soon as I could, I tried this technique on the Revox A700, starting with the 15-ips speed, since dbx advises that slower speeds are much more problematic with this test. I didn't know what recording level to use for the 30-Hz tone, so I opted for one that made the distortion and modulation effects of the tone (quite audible at low bias settings, even though the tone itself wasn't) effectively disappear at higher bias settings. Then to business, which proved even more difficult than I had expected. One of the problems was that drop-out noises are discrete and random in their occurrence, so that, as I manipulated the bias trimmer, I couldn't be sure if I had minimized them or just found a momentary quiet patch on the tape. Another was that the hiss I heard was composed both of tape and tape-machine noise, and noise from subsequent electronics in the chain (rather high gain settings were necessary for the test). Focussing in on the difference was exasperating.

At last I decided on a setting and, wonder of wonders, it turned out to be just a hair above Revox's recommended adjustment, which is essentially what dbx predicted. However, I'm not at all sure I could repeat it reliably. And when I tried the test at 7½ ips, I was utterly boggled. Even with electrostatic headphones, any decisive clues as to where the trimmer belonged simply eluded me. Perhaps my difficulties lay with the filters, which didn't precisely conform to dbx's specification. I can't say for sure until I try the test again.

Where does this leave us? For obvious reasons, I tend to favor the dbx technique whenever it proves workable. Barring that, you could try to compile the best information from tape and equipment manufacturers and attempt some kind of seat-of-the-pants interpolation. Of course, there's nothing wrong with taking a shot in the dark, aiming at the best compromise between frequency response (adjusted subsequently by EQ) and signal-to-noise ratio, for example. The point is to get results that satisfy your own special requirements, whether you be picky or easy-going. Do not, however, be over-hasty in blaming any new, highly touted tapes when their performance seems to fall short of your standards. It might just be that your machine and its recording environment fall short of *their* standards. ♦

MARCH 1975

**NEW!
MINI-BREADBOARD
BUDGET KIT
FOR THE ECONOMY-MINDED
EXPERIMENTER . . .**

Proto Board 100

Here's a low cost, big 10 IC capacity breadboard kit with all the quality of QT Sockets and the best of the Proto Board series. Complete down to the last nut, bolt 'n screw. Includes 2 QT-35S Sockets; 1 QT-35B Bus Strip; 2 5-way binding posts; 4 rubber feet, screws, nuts, bolts and easy assembly instructions. Order off-the-shelf today from CSC or local distributor. Charge: BAC, MC, AX. Write for free catalog. Free English/Metric Slide Rule with each order. Dealer inquiries invited.

Patent Pending
Made in USA

**Complete Kit:
19⁹⁵**

Add \$1.50 shipping/handling.
Foreign orders add 15%.
Prices subject to change

**CSC Continental
Specialties Corp.**
Box 1942, New Haven, CT 06509 • 203/624-3103
W. Coast Off.: Box 7809, S. Fran., CA 94119 415/383-4207
Canada: Available thru Len Finkler Ltd., Ontario



CIRCLE NO. 10 ON READER SERVICE CARD

FREE McIntosh CATALOG and FM DIRECTORY

Get all the newest and latest information on the new McIntosh Solid State equipment in the McIntosh catalog. In addition you will receive an FM station directory that covers all of North America.



MX 113

FM/FM STEREO - AM TUNER AND PREAMPLIFIER

**SEND
TODAY!**

McIntosh Laboratory, Inc.
East Side Station P.O. Box 96
Binghamton, N.Y. 13904
Dept. PE

NAME _____
ADDRESS _____
CITY _____ STATE _____ ZIP _____

If you are in a hurry for your catalog please send the coupon to McIntosh.
For non rush service send the *Reader Service Card* to the magazine.
CIRCLE NO. 22 ON READER SERVICE CARD

NEWS HIGHLIGHTS

Audio Systems Recreate Earthquake

Universal's new movie "Earthquake" relies on acoustic as well as visual means of stimulating the audience. The audio Sensurround™ system is composed of high-power amplifiers (750 watts rms/channel) and speaker columns manufactured by Cerwin-Vega. It reproduces a computer-synthesized signal which approximates actual impulses recorded during past Southern California quakes. While resulting 120-dB rumble, having a bandwidth of 300 Hz, is loud and low enough to vibrate the seats and the people viewing the film, it's not powerful enough to cause structural damage to the theatre, of course.

Hologram Reader & Projector

A new audio-visual tool—a hologram reader and projector—has been developed by a joint effort of the University of Michigan and the Environmental Research Institute of Michigan. The reader is housed in a box the size of a common TV, and has a similar viewing screen. Holographic film is mounted on two spools inside the box, and "tuning" knobs allow the viewer to rotate the film, which "revolves" the object. The reader is illuminated by a low-power argon-ion laser. Film may also be used in a projector, which is similar to the reader, except that the laser beam is directed through two lenses and produces two-dimensional images on a phosphor-coated screen.

FM Stations Going Quadraphonic

KRAV in Tulsa, WQIV and WRFM in New York City, WHUD in Peekskill, NY, and WDHA in Dover, NJ, have started broadcasting programs in stereo-compatible QS four-channel sound. At present, there are over thirty stations broadcasting QS-encoded signals.

AM Radio Fits On An Ear

A mini AM radio weighing only 0.6 ounce, designed for fitting on an ear, has been introduced by the Edmund

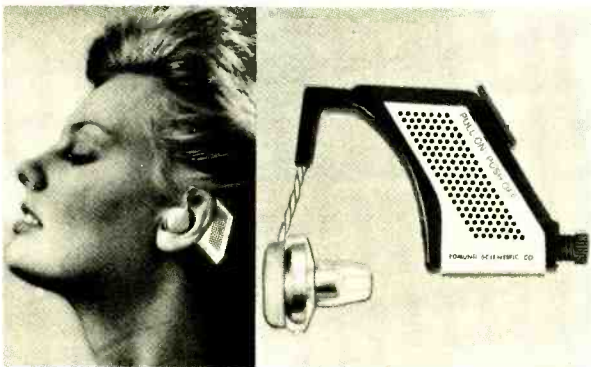

Scientific Co., Barrington, N.J. It uses an IC, a ferrite antenna, a hearing-aid-type earphone and silver-oxide battery. Range is said to be about 20 to 30 miles, and each battery is good for about 100 hours of listening.

All-Channel Radio Bill Delayed

By a unanimous voice vote, the House Rules Committee deferred action on the All-Channel Radio bill, ending any hope of passage during closing days of the last session of Congress. HR 8266, which requires FM capability on OEM car radios, never reached the House floor for a vote. A narrowly passed Senate version, S 585, requires that all radios over \$15 retail must have FM capability. Another attempt to get the House bill passed, and then reconciled with the Senate version, will probably take place in the current session of Congress.

FCC Amateur Proposals

A. Prose Walker, Chief of the Amateur and Citizens Division of the FCC, recently discussed forthcoming proposed changes in amateur regulations, as follows. A Communicator Class license, with no code requirement, permitting low-power phone operations on 2 meters and above, will be advanced, he said. Also an incentive licensing structure will be set up on vhf in the likeness of the h-f system. Under this set-up, the Technician would have roughly the same standing on vhf as the Advanced Class licensee has on the h-f bands. The FCC will also propose the establishment of an Expert Class license with all phone privileges above 29 MHz, a code requirement of 5 wpm and a theory test on par with that of the Advanced Class. Other proposals include the issuance of the Extra Class license for life, and special bicentennial call signs.

"Bubble" Memories

Bubble memories may replace conventional memories at some future time due to greater reliability and speed. Originally developed by Bell Labs in 1967, the Air Force Systems Command has now developed such magnetic-domain memories, anticipating that they will replace tape recorders and computer disc and drum memories in aircraft and spacecraft in a few years. . . . The bubble memory is contained in a very thin magnetic garnet material that has ribbon-shaped stripes (magnetic domains) in its natural state. When an external magnetic field is applied, the domains contract into stubby cylinders that look and behave like bubbles when viewed through a microscope. . . . Conversion of the bubbles into information bits requires two processes. On top of the garnet is etched a permalloy circuit in the form of T's and bars that controls the movement of the bubbles. When placed in a rotating magnetic field, the bubbles are attracted to either the T's or the bars. A bubble or its absence can then represent a logic-1 or a logic-0 binary bit of information. When moved past a sensing element, the bubble produces an electronic signal that is used in the same manner as the output of a conventional tape, drum, or disc memory. Information can be stored for many years. . . . Bubble memories have several other advantages over conventional systems. For example, Air Force engineers are aiming for a 10^6 to 2×10^6 bits/sq. in. density. The bubble memory is also immune to extreme shock, temperature, and radiation.

"CLEAR" "Solid" ..
"POWERFUL" ..
"Crisp" "PENETRATING" ..

Speech Compression is built-in every Johnson CB radio. State-of-the-art circuitry electronically selects voice frequencies that penetrate noise and interference . . . then boosts the level of modulation to give your signal that powerful "Johnson sound." It's one of many engineering advances — like receiver "steep skirt" filtering to cut interference and automatic threshold limiting to slice out noise — that gives U.S.-made Johnson CB that extra edge of performance. Performance that's backed by a full 1-year parts and labor warranty with over 700 authorized service centers nationwide.

Messenger 250
 100% solid-state base station



Messenger 123B 23-channel mobile with +/- ground switch



Messenger 130 and 132
 "The radiotelephone CB System"
 with private listening option



write for free catalog

E.F. Johnson Co.

Waseca, Minnesota 56093 • In Canada: A. C. Simmonds & Sons, Ltd.

no strings attached

NEW **Weller**[®] CORDLESS SOLDERING IRON GOES ANYWHERE

A professional quality tool, Weller's feather-light and fingertip-handly WC-100 Cordless Soldering Iron allows you to make connections anywhere...without dependence on an AC cord and outlet.

The heart of the WC-100 is its high-energy, long-life, nickel-cadmium battery which springs into action at the touch of your finger, heating the tip to over 700°F in just 6 seconds. And no danger of accidental discharge. Weller's exclusive sliding safety switch breaks the circuit when your finger is removed, won't lock in "on" position, and does lock in "off" position for added safety while restoring energy with fast-power recharger (UL listed).

Loosen two slotted set screws and you've got instant choice of four tips... regular, long-reach, fine-point, or miniature...each mounted on an extra-strong stainless tube to resist bending. Tip is continuously illuminated by the built-in light which focuses on the work area, a special advantage under poor lighting conditions.

Try this for size! It's a full-scale photo of the compact WC-100. And the real thing is waiting for you at your dealer or distributor...right now. Need to know more? Request literature.

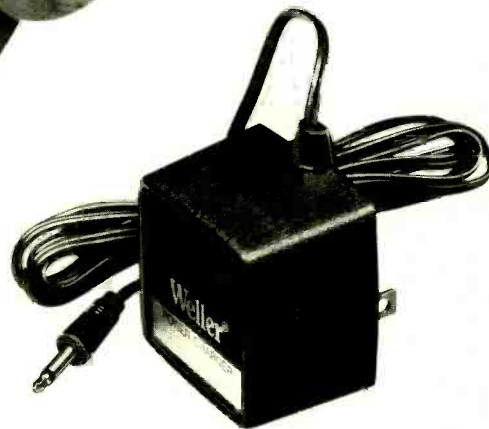
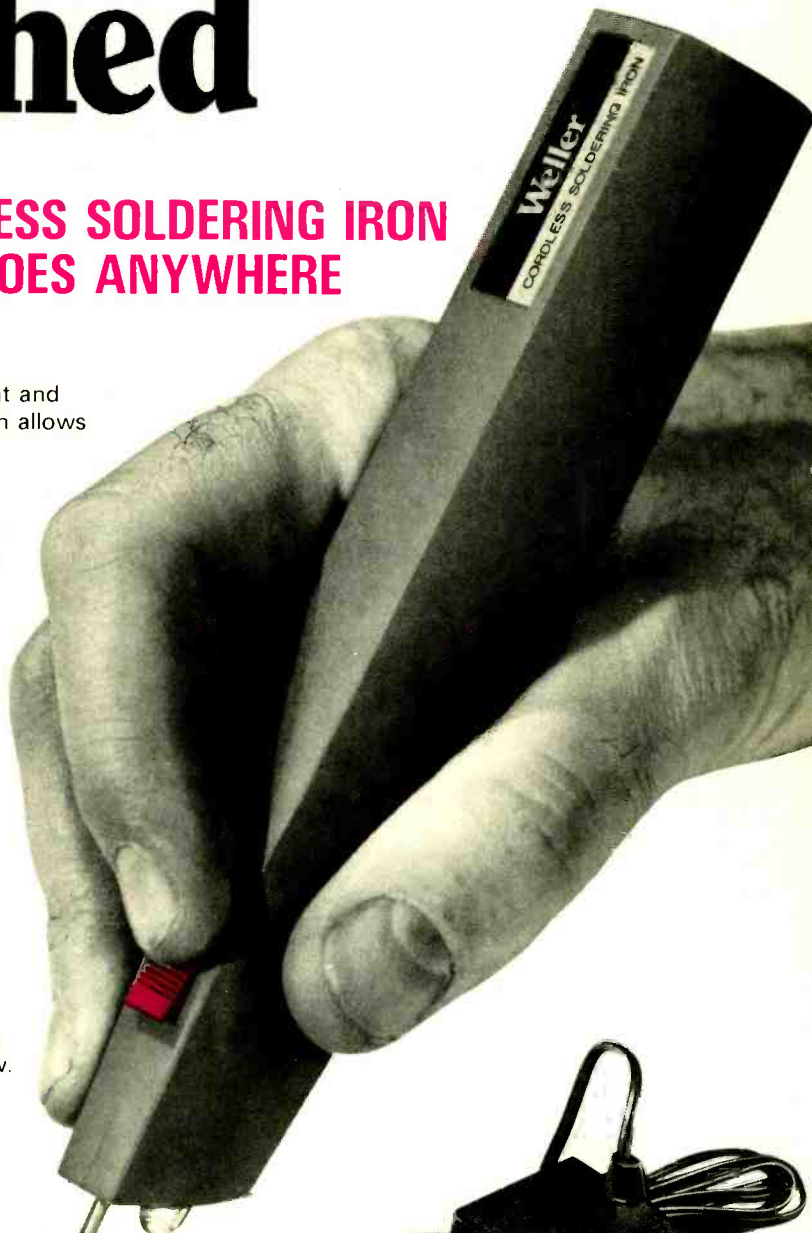

Weller-Xcelite Electronics Division
The Cooper Group

P. O. BOX 728, APEX, NORTH CAROLINA 27502

THE MODERN electronic organ has been profoundly influenced by recent developments in circuitry. A variety of advances have been made, including, among others, new voices and automatic playing functions.

With a host of manufacturers offering a wide range of models, it's no simple matter to choose an organ for home use. The multiplicity of options, the many exclusive features that differ from one manufacturer to another, and the broad range of prices are bewildering. Since an electronic organ represents a considerable investment, it is best to choose carefully from among the many different types offered. With this in mind, let us take a look at what makes up the basic organ and what manufacturers offer today.

The Basic Electronic Organ. The organ is a keyboard instrument. Unlike the standardized piano, however, there are startling differences between various makes and models of organs. Nevertheless, all electronic organs share common characteristics.

Except for the least expensive models, you will find two keyboards, or manuals, that cover from 3½ to 5 octaves each. The reason for the two manuals—and sometimes more—is that different manuals can have different tone settings. You can play melody accompaniment on yet another keyboard arranged as pedals. (An organ can have as few as 13 pedals for one-octave coverage or as many as 32 pedals for a full 2½ octaves, like pipe organs, depending on the size and cost of the instrument.)

In addition to keyboards, all organs have "stops" that determine the tonal characteristics of the final sound. Stops produce modified sounds that are sometimes similar to traditional instrument "voices" (trumpet, flute, oboe, even plucked instruments like celeste and harpsichord), and sometimes sounds that are peculiar to the organ.

Stops in different "pitch registers" can give voicings in different octaves. An organ might have a TRUMPET 8' stop (8' reads as "8-foot," a reference to the length of the particular pipe in a pipe organ), which means that you would hear a sound voiced like a trumpet, in the same octave as the key you are holding. You might also use a TRUMPET 4' stop, which sounds a trumpet an octave higher than the key.

MARCH 1975

How to Choose an Electronic Organ

A detailed guide to home electronic organs—types, operation, functions, and buying considerations.

BY CRAIG ANDERTON

A TRUMPET 16' stop sounds an octave lower than the depressed key.

Couplers are controls that transfer stops, add sounds from one keyboard to another or sound them in different octaves. For instance, if you are playing on the upper (Swell) keyboard, depressing a SWELL TO SWELL 16' coupler adds to the normal sound the same sounds an octave lower. Or, if you are playing on the upper keyboard and

wish to add voices from the lower (Great) manual, you would depress the GREAT TO SWELL 8' coupler.

Since organ keys are not dynamically sensitive, like those of a piano, a foot-operated volume control (the swell shoe) is provided—sometimes one for each manual.

Many organs have a percussion feature that produces sounds similar to struck or plucked instruments. "Sus-



Wurlitzer 545 Funmaker Spinnet



The Schober theatre organ has two full manuals and the familiar U-shaped ring of stops.



Baldwin's Zodiac model includes a synthesizer on the left end of the solo console.

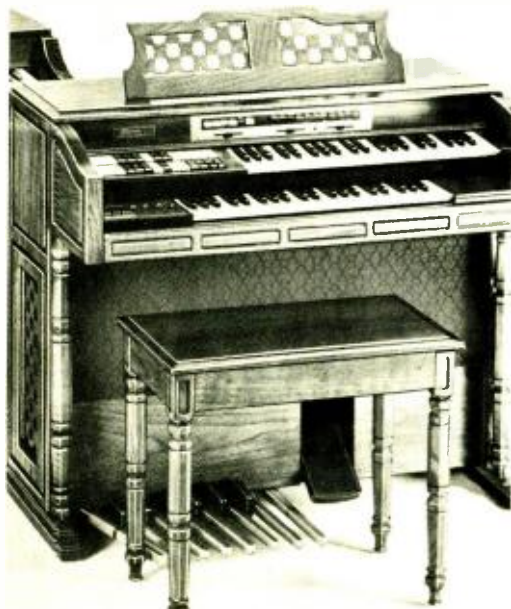

Heathkit/Thomas TO-1260.M spinet organ comes in kit form. (See Product Test Report.)

tain" sometimes is available to make notes fade away gradually when a key is released rather than stopping immediately in the usual way.

Another function often found on organs is reverberation. It simulates the effect of spaciousness produced in a large hall, and greatly enhances the pleasure of playing. There is also vibrato, which makes a periodic pitch change over a small range, like the warm effect produced by the fluttering of a violinist's left hand. There may be several vibrato speeds and intensities available. Rounding out the basic organ is the amplifier/speaker combination.

Even in the basics, electronic organs differ from each other. For example, the stops on one type might be tabs connected to switches; or they might be drawbars, or even a card reader. In addition to the basic sound functions, organ manufacturers have added a host of special effects, most of which would not have been possible only a few years ago.

The effectiveness and quality of each of these items, and the quantities vary from model to model. You cannot judge an organ by what is written about it on paper; all we can do is tell you what to look for and listen to.

New Organ Technology. The first organs were, and the best still are, the acoustic types that used pipes for resonance and forced air to make sound. Early electronic models used synchronized relaxation oscillators or flip-flops, or independent oscillators, with tubes. Several companies developed transistorized organs, then integrated-circuit organs, some of which use LSI chips in tone generation. Almost all solid-state organs employ synchronized flip-flops or independent oscillators.

It was not long before rhythm units, synchronized chord patterns, built-in cassette decks and other "gimmicks" appeared. Dividing lines became clearer as organs began to fit into one of three categories: (1) The combo organ, designed for travelling entertainment groups, is the smallest, lightest, and least versatile instrument. (2) The home organ in the \$1000 to \$6000 range is more sophisticated and has a variety of special effects. (3) The recital organ is designed for serious home organists as well as for use in churches, stadiums, etc. Further divisions are shown in an accompanying table.

Home organs routinely come with a variety of electronic devices to enhance and simplify playing. One of the most popular is the rhythm section that is capable of simulating the sounds of percussion instruments: bass drum, snare drum, bongo, cymbal, etc. There's often an automatic rhythm device with a choice of different patterns: waltz, polka, rumba, rock, etc. Tempo controls and a flash-light tempo light are usually included.

Some of the automatic types also have a down-beat control so that the rhythm pattern can be held off and started again with the resumption of playing. There are other rhythm-section possibilities. For example, Baldwin's "Real Rhythm" allows the triggering of manual drum rolls in addition to the metronome-like sound of the basic rhythm box. Schober takes a different approach with its "Dynabeat" accessory in which the drums are either manually played or triggered by the lower manual keys and the pedals. Hence, the rhythms can follow your playing instead of being automatic. The company's "Dyna-master" option adds many automatic rhythm patterns and even allows the organist to design five of his own automatic patterns.

On many home-type organs, the pedal and lower manual circuits are synchronized with the drum tempo by flipping a switch. Holding down one bass pedal gives a bass note triggered with the drums. As you continue to hold it down, the note recurs, triggered by the beat and sometimes even alternating to other harmonically related notes. The Heathkit TOA-60-1, among others, provides alternating bass pedal notes to fit rhythm patterns, and Gulbransen makes an "Automatic Walking Bass" accompaniment available as an option on many organs.

Synchronization with the lower manual usually means that holding down a chord will trigger that chord repeatedly on the beat, in a manner similar to that used for the automatic bass pedals. The Kimball "Entertainer II" system is a good example of this type of feature. An optional KEYED RHYTHM makes the rhythm accompaniment (drums) start when you begin playing and stop when you stop. When it starts with your playing, it is always on the down beat. The MUSICAL RHYTHM option has the lower manual and pedals come out in time with the drums, starting on the down-beat and

alternating between the pedal and the left-hand chord.

A MAGIC-CHORD switch allows you to depress a single key on the lower manual and hear a correct chord accompaniment (with pedal) alternating in rhythm and starting on the down-beat. (GTR takes a different approach in its model M-600 organ. A feature called RHYTHM MEMORY remembers the chord you play and plays it until you depress the next chord.)

Automatic arpeggio allows you to have the notes of a chord sound individually in sequence. Baldwin's "Fantom Fingers" system is a sophisticated example of this. By playing a chord and selecting a mode, the chord notes can be played normally, strummed or played as arpeggios up, or up and down, at a rate chosen by a rate control. You can change chords because the Fantom Fingers automatically change, too. There is also provision for the arpeggio rate to increase as the volume level increases. And the degree of sustain (time each note takes to die away) can be adjusted.

On Lowrey's "Symphonic Golden Harp," the options are arpeggios up and/or down over a switch selected one-, two-, or three-octave range. Holding the volume pedal to the right activates a pushbutton switch that starts and sustains the arpeggio for as long as the chord keys are held down by the player.

Another trend adds the capability of generating chords from a single note. Wurlitzer's "Sprite" line uses TOUCH TONE. It is similar in approach to chord organs, in that pressing a single button generates either a major, minor, or seventh chord, which also synchronizes with the rhythm section. Lowrey's contribution is AOC (Automatic Orchestra Control). If you sustain, say, a major chord on the lower manual, playing a single note on the upper manual will come out like a major chord, no matter where the note is. The more notes played, the more come out.

Many organs are now starting to emphasize synthesizer sounds and technology, whether by adding a synthesizer manual, or by adding synthesizer voices to the upper manual. For example, Thomas has collaborated with Moog Music on a series of synthesizer presets on its bigger organs. The Wurlitzer Custom 550 organ has a separate two-octave synthesizer manual available with sine-wave outputs, preset sounds, var-

iable attack and decay times, waa-waa, delta pitch (or pitch bending), and other features.

Kawai builds a synthesizer into its top-of-the-line Model T6 organ, with voltage-controlled filters and other synthesizer effects. Baldwin's "Syntha-Sound" is a three-octave manual. It is available as a separate unit, and has variable attack and decay times, etc. The Yamaha Model EX-42 organ adds another type of synthesizer controller to the traditional keyboard. This is similar to a Moog ribbon controller that provides a variety of glissando or sweeping sounds. (Interestingly, synthesizers combined with electronic organs can accurately reproduce the sound of many musical instruments.)

There have been many advancements in organ playing instruction, too. Generally, manufacturers provide either books or a cassette course to get you started playing right away. Companies such as Conn, Thomas, and Heathkit/Thomas backlight the letter keys on their organs. Gulbransen has gone so far as to include a digital cassette system in which organ pieces are converted into digital information that then "plays" the organ in much the same way as punched paper rolls do in a player piano. The same cassette "computer" also forms the basis of the "Musical Computer Organ Teaching System," in which individual key lights indicate the notes to play on the upper and lower manuals. As a natural outgrowth of the many cassette programs, several organ manufacturers offer cassette decks as an option or as original equipment, or at least provide inputs and outputs for installing a cassette deck of your own.

Narrowing Down Your Choice.

Though there are many features to consider when buying an electronic organ, it is possible to make the decision easier by examining category choices available.

If you're a neophyte, for example, and have no real desire to play well—just have fun—then you might consider one of the smallest instruments that are not actually called organs. They go by the name of "baby" organs, usually known by "trademark" names such as Wurlitzer's "Funmaker Sprite", Lowrey's "Teenie Genie", Baldwin's "Fun Machine", etc. The latter instrument is typical of the category, with a single 37-note



This Allen organ uses digital computer cards to generate different sets of voices.

keyboard, 13-note rhythm-section keyboard, automatic chord programmer, percussion patterns, and single-channel amplifier, but no pedal keyboard.

For those who have some musical experience or seriously plan to develop instrument playing, the next step is the "Spinnet" organ. It generally offers two keyboards, 44 keys each, and 13 pedals. These are often supplemented by a rhythm section and automatic features. The higher-priced spinnets often feature two-channel amplifiers, as well as more voices, additional automatic functions, waa-waa effects, multiple vibratos, better speaker systems, built-in cassette machines, etc. Some also offer built-in synthesizers.

For more serious organists, there

are classic-style and theatre organs (horseshoe styled cabinetry with overhanging voice tabs). These always have two or more manuals with 61 keys each and 25- or 32-note pedals. Beyond this are electronic organs which meet specifications of the American Guild of Organists.

Though the foregoing may seem to have put more emphasis on special effects and gadgets than on the basics, that is only because special features vary from maker to maker and take more words to talk about.

The fact is that your first and greatest attention ought to be focused on the basic capabilities of the organ—the largest possible variety of pleasing basic organ tones, the most flexible coupler system, and the largest number of generated tones. If

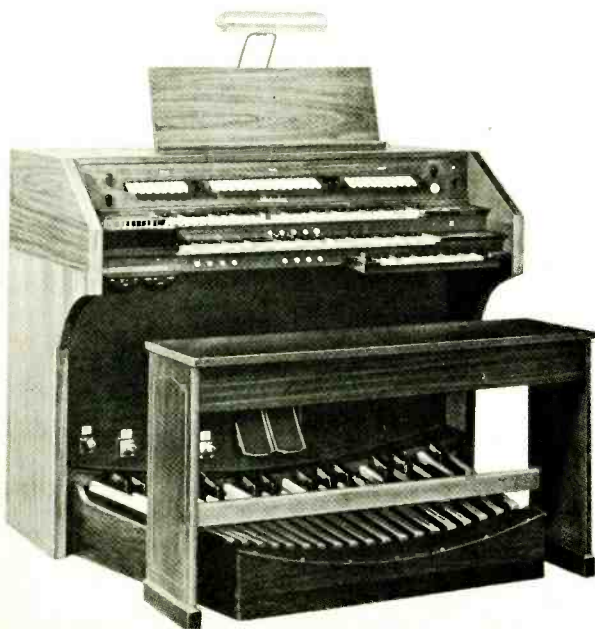

The Schober recital organ meets standards of the American Guild of Organists.

ELECTRONIC ORGAN COMPANY SAMPLER

The following is a list of companies that manufacture and/or distribute electronic organs and accessories. Kit suppliers are identified by an asterisk preceding the company name.

- ALLEN ORGAN CO., Macungie, PA 18062
- ARTISAN ELECTRONICS CORP., 5 Eastmans Road, Parsippany, N.J. 07054
- BALDWIN PIANO & ORGAN CO., 1801 Gilbert Ave., Cincinnati, OH 45202
- CONN ORGAN CORP., 616 Enterprise Drive, Oak Brook, IL 60521
- GENERAL ELECTRO MUSIC, Northvale Industrial Park, Northvale, NJ 07647
- GTR PRODUCTS INC., 42 Jackson Drive, Cranford, NJ 07016
- GULBRANSEN INDUSTRIES, INC., 8501 West Higgins Road, Chicago, IL 60631
- *HEATH COMPANY, Benton Harbor, MI 49022
- HAMMOND ORGAN CO., 4200 West Diversey, Chicago, IL 60639
- KAWAI ORGAN CO., 24200 S. Vermont Ave., Harbor City, CA 90710
- KIMBALL ORGAN CO., 15th and Cherry Sts., Jasper, IN 47546
- LOWREY ORGANS, Norlin Music, Inc., 7373 N. Cicero Ave., Lincolnwood, IL 60646
- *NEWPORT ORGANS, 842 Production Pl., Newport Beach, CA 92660
- ROCKY MOUNT INSTRUMENTS, INC., Macungie, PA 18062
- RODGERS ORGAN CO., Hillsboro, OR 97123
- SAVILLE ORGAN CO., 2901 Shermer Road, Northbrook, IL 60062
- *SCHOBEL ORGAN CORP., 43 West 61 St., New York, NY 10023
- THOMAS ORGAN CO., 7310 N. Lehigh Ave., Niles, IL 60648
- WHIPPANY ELECTRONICS INC., 1275 Bloomfield Ave., Fairfield, NJ 07006
- WURLITZER CO., 1700 Pleasant St., De Kalb, IL 60115
- YAMAHA INTERNATIONAL CORP., Box 6600, Los Angeles, CA 90620

**Also supplies organs in kit form.*

you can afford the space, a separate, well-built speaker system that can be placed at a distance from the organ console gives better sound than any speakers mounted in the console can, and the distance of the sound source from the player adds much to the pleasure of the sound. After you are sure an organ has these basic organ qualities you can consider the gadgets and gimmicks, all of which are fun as novelties, but become much less important to your satisfaction than basic musical quality over the long run.

A dramatic addition to any organ is a rotating speaker system that provides cyclic phase/frequency and volume change and resulting warmth and excitement. The Leslie™ Speaker has pretty much dominated this market over the years. But there are other methods of achieving this effect, including both mechanical and electronic systems.

Another important organ feature is reverberation. In addition to the spring-type reverb units and electronic delay circuits on the market, the Schober Organ Corporation makes the Reverbatape Unit, a small tape-type reverberator designed to be placed inside electronic organs of almost any make.

To play the electronic organ without disturbing others, headphone jacks will doubtlessly be an important feature. There are a variety of other electronic organ features that are available depending upon the manufacturer's design, such as chuff circuitry to simulate wind noise from a pipe organ.

In the Store. The first major rule, especially if you are relatively unfamiliar with organs, is never to buy the first organ or brand you see—at least not until you have seen as many others as you can find. The price of an organ involves a considerable investment.

Do not buy on impulse or because you are impressed with the first demonstration you hear.

The second rule is to require a demonstrator to show you how the organ sounds when none of its gadgets are used—just the basic organ voices. The gadgets can make for a fascinating demonstration, just because they seem to accomplish fantastic results. Most of this appeal is novelty. What should determine your long-term satisfaction is a large variety of pleasing organ voices. Then consider the more useful of the special effects.

Electronic organs (other than kit organs like Heathkit/Thomas and Schober) are always sold by local dealers, who are also responsible for their maintenance, both in and out of guarantee. Check the dealer's reputation for good service, preferably with other customers.

Understanding electronics will do you little good unless you have both the technical data on the organ (usually available in the service manual, which any reputable dealer will at least let you examine and which you should insist on receiving if you buy the organ) and a general understanding of electronic organs. The latter can be obtained from various magazine articles and a few books, such as *Electronic Musical Instruments*, 3rd Edition, (\$10.00) or *What Is An Electronic Organ?* (25 cents) both available from Schober Organ Corp., 43 West 61 St., New York, N.Y. 10023.

Remember that organ owners tend to trade up, moving toward more sophisticated instruments as their talents and tastes progress. So, check your retailer's policy on trade-ins. On the same subject, keep in mind that a second hand instrument might be a good buy. But before you buy a used organ, check the "Official Organ Bluebook" (available from Sight & Sound Systems, Inc. 6055 West

Fond-du-lac Ave., Milwaukee, WI, 53218) for market values. However, remember that many used electronic organs have been traded in because new electronic innovations have outstripped what these models offer.

It cannot be stressed strongly enough that intriguing and even useful electronic gadgets can never be a substitute for good, basic music sounds, voice variety and wide octave range. Listen carefully to the different voices on an organ. They should sound distinct, authentic, and clear. Potentiometers and other controls should not be scratchy, and the keyboard should feel "right." Another important consideration is the amplifier built into the organ. It should have sufficient power for the size of your listening room, as well as displaying low distortion. In many instances organ manufacturers do not have provisions for external hi-fi systems so you'll have to depend on the built-in system.

Kits Save Money. Price is an important consideration in any purchase, of course. Since an electronic organ you can "grow into" starts in a four-figure price category, one might pause before buying. However, while most electronic organs are factory-built, there is one way you can save a considerable amount of money without sacrificing quality. Build your own electronic organ from a kit!

The two most prominent names in kit organs are the Heath Company and the Schober Organ Corp. Heath, though not specializing in organs, sells two spinet electronic organ kits and a rhythm accessory kit, all of which are basically Thomas organs sold assembled by dealers. Schober, on the other hand, specializes in electronic organs, offering a broad line of electronic organs and accessories of its own design.

The Heath organ spinets are sold as all-inclusive kits, including assembled/finished cabinet and bench. (An automatic rhythm section kit is available separately.) Schober offers a wide range of organ kits—from studio through recital types—plus a host of optional equipment kits and accessories that can be purchased all-inclusive or a section at a time to permit one to build an instrument that his budget and time will allow. Further savings are possible by purchasing cabinetry in kit form. Both companies offer time payment plans. ♦

ELECTRONIC ORGAN CATEGORIES

Type	Features	Cost (\$)*
Single keyboard	Easy to play, limited octave range.	500 to 1000
Small spinet or studio	Dual 44-note keyboard and 13-note pedal, with automatic features.	Up to 2000
Large spinet	Same as above with many features of consoles, such as additional voices, dual amplifiers. Some with built-in synthesizers.	2000 to 6000
Console & theatre	Dual 61-note keyboards, 25- to 32-note pedal, additional voices.	35 to 10,000
Recital organ	Meets AGO specifications.	5000 and up

*Assembled unit; kits are less.

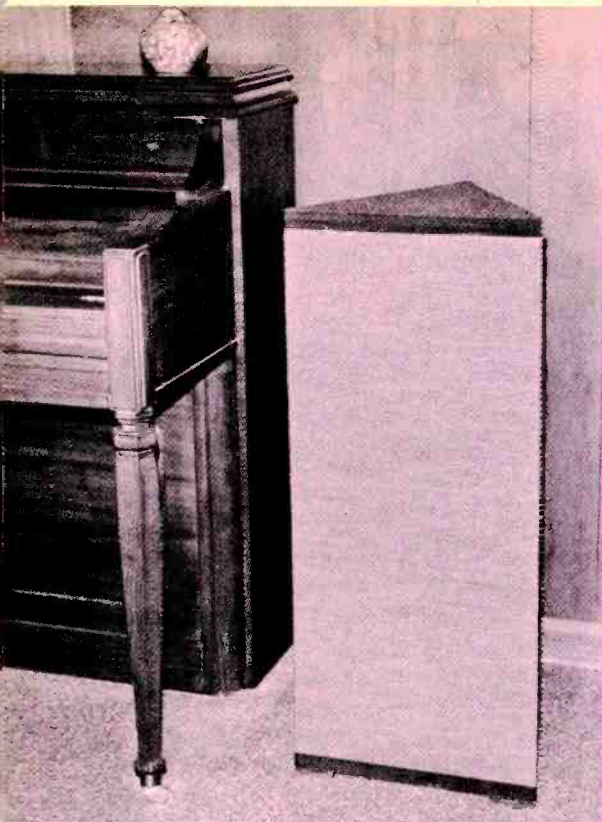

BUILD THE PLUS 4 OMNIDIRECTIONAL SPEAKER SYSTEM

*One woofer and
four tweeters combine
to provide good bass
response and "open-quality"
high frequencies.*

BY DAVID B. WEEMS

THERE are a number of ways to produce an omnidirectional speaker system. They range in cost and design complexity from a single speaker facing upward into a 360° reflector to an arrangement of multiple woofers, midrange drivers, and tweeters. In the Plus 4 speaker system described here, a single woofer is teamed up with four "tweeters."

The woofer is large enough to provide good bass response. The composite resonance of this butyl suspension high-compliance driver in its sealed enclosure is about 55 Hz, which means that its bass range compares favorably with that of commercial speaker systems costing several times the materials price for the Plus 4.

The inexpensive full-range speakers used as tweeters have whizzer cones. These drivers connect into the system through a simple high-pass filter. They face upward and outward to provide the wide dispersion pattern essential to good performance in the middle and high-frequency ranges.

Construction. Except for making the triangular shape of the enclosure, construction of the Plus 4 speaker system is simple and straightforward. A table saw will simplify the 30° saw cuts required at the edges of the side panels and cleats, but if you work carefully, you can use a portable, sabre, or even hand saw.

The shape of the enclosure adds to its rigidity. You can use nails instead

of screws for assembly. However, if you elect to use nails, select only ring-shank or screw-thread types. (The latter are superior in their holding power.) If you use enough nails, they will clamp the wood members under pressure while the glue sets.

The greater its strength and rigidity, the higher the pitch of the sound the enclosure produces when sharply rapped. We found that the Plus 4 will perform satisfactorily with side panels made from plywood as thin as 1/2-in. (12.7 mm). For higher density and even lower cost, you can use 1/2-in. particle board, but don't omit the bracing. You can substitute flat pieces of particle board or plywood for the pine braces specified. Just glue and nail them to the unsupported middle sections on the side panels.

Except for the top tweeter, the speakers are installed on separate speaker boards from outside the enclosure. The removable top simplifies the task of wiring the tweeter array. It is attached to the top of the enclosure with screws into the ends of the corner cleats and the top edges of the side panels. Seal the top panel to the enclosure with silicone rubber compound between the two. The compound will form an air-tight gasket that can be cut loose if you ever have to remove the top panel. (Note: If you remove the top panel, replace it with larger or longer screws because end-grain wood is not useful for holding the same size screw twice.)

Start construction by cutting the wood panels to the dimensions specified in Fig. 1 and the Bill of Materials. Use the speakers as patterns to mark their outlines on the side panels as shown in Fig. 2. Then use a sabre saw to make the cutouts, removing the line with the saw cut so that the speakers will easily pass through the holes. Break the sharp edges of the cutouts with a file or sandpaper. A beveled or rounded edge is desirable because of the tendency of sharp edges to produce diffraction that can alter the frequency response of the speakers.

Prepare the speaker boards and install them in their respective locations on the side panels. Center the round holes inside the octagonal cutouts and tack them lightly in place with two plain nails per board. Check the position of each board by inserting the proper speaker. If the speaker fits easily against the board without binding against the side panel, set the speaker aside and glue and nail the speaker board down, using the first two nails as guides.

Drill 1/4-in. (6.35-mm) mounting holes for the woofer. Use the woofer as a pattern to locate the eight holes. Then drill the holes. Install a 3/16-in. (4.76-mm) T nut in each hole at the rear of the speaker board. Mark drill points for the tweeter screws and use a 3/32-in. (2.38-mm) bit to make pilot holes for the panhead screws that will be used to mount the speakers.

Attach the cleats 3/16 in. in from the

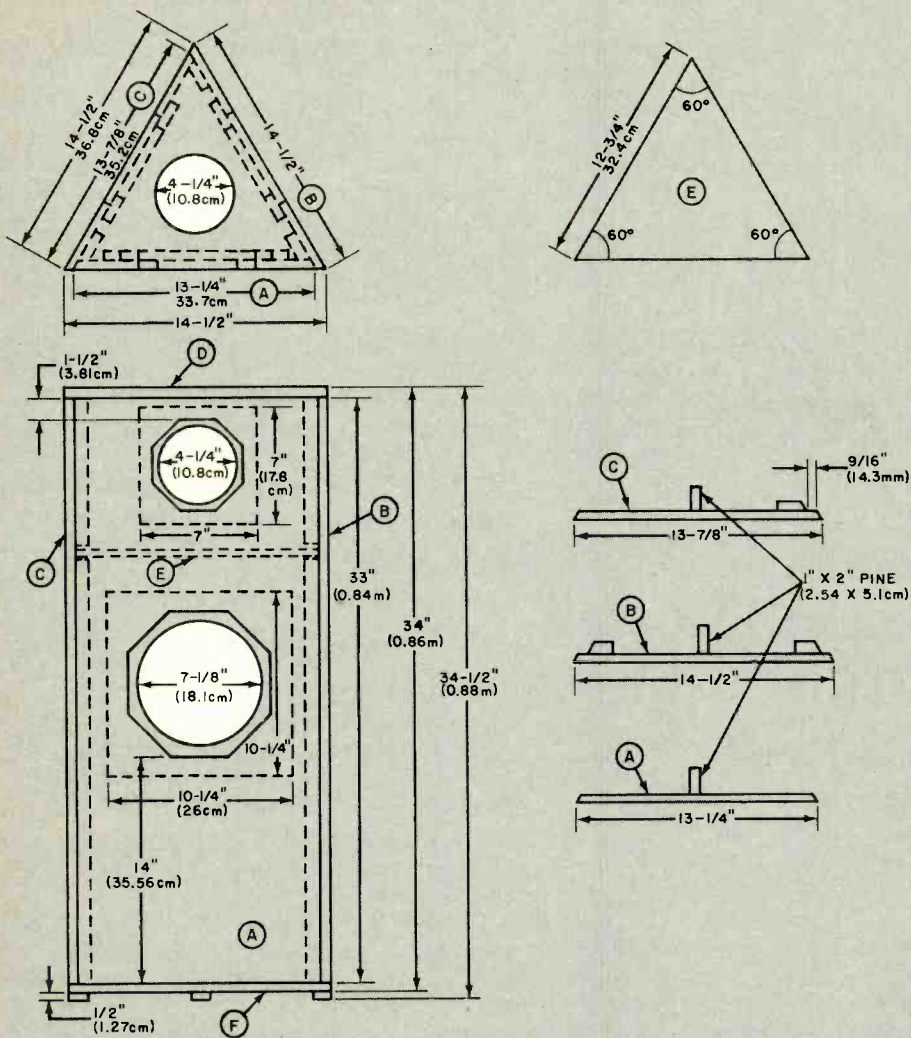

Fig. 1. Enclosure shape is triangular. Drawings show dimensions and details.

**BILL OF MATERIALS
(Per Speaker System)**

- 1—Norelco Model AD 8065/W8 woofer (\$9.95 each plus shipping)
 - 4—Norelco Model AD 5080/M8 tweeters (\$1.99 each plus shipping)
 - 1—8- μ F non polarized capacitor (29¢)
- (The above items are available from McGee Radio Co., 1901 McGee St., Kansas City, MO 64108.)
- 1—33" x 14 1/2" piece of 1/2" particle board or plywood for side panel B
 - 1—33" x 13 7/8" piece of 1/2" particle board or plywood for side panel C
 - 1—33" x 13 1/4" piece of 1/2" particle board or plywood for side panel A
 - 1—10 1/4" x 10 1/4" pieces of 1/2" particle board or plywood speaker board for woofer
 - 3—7" x 7" pieces of 1/2" particle board or plywood for tweeter mounting boards

- 2—14 1/2" per side pieces of 1/2" particle board or plywood for triangular top or bottom panels D and F
 - 1—12 3/4" per side piece of 1/2" particle board or plywood for triangular partition panel E
 - 3—24" lengths of 1" x 2" pine for woofer compartment corner cleats
 - 2—24" lengths of 1" x 2" pine for braces on sides B and C
 - 1—12" length of 1" x 2" pine for brace on side A
 - 3—8" lengths of 1" x 2" pine for tweeter compartment corner cleats.
 - 8—3/16" T nuts for woofer mounting
 - 8—1" x 3/16" roundhead bolts for woofer mounting
 - 32—# 8 x 1/2" panhead sheetmetal screws for tweeter mounting
- Misc.—1 1/4"-long ring-shank or screw-thread nails; grille cloth; silicone rubber compound; 1"-thick acoustical fiberglass wool batting; glue; lamp cord; solder; etc.

two side edges of panels B and C with glue and nails. Then nail and glue the braces to the sides.

Drive 12 to 15 nails into side C just far enough to penetrate through the panel. Locate these nails on a line about 3/4 in. (19.1 mm) from the edge that will join panel B. Coat the joining surfaces with glue, carefully match the panel edges, and drive home the nails. Next, drill a 1/4-in. (6.35-mm) hole through the center of partition panel E. Mount this panel in place with glue and nails. In addition to side nailing, try to put some vertical nails through the partition panel into the top ends of the cleats and braces. The assembly to this point is shown in Fig. 3.

Start a line of nails along both side edges of panel A, following the same instructions given above for the panel B/C assembly. Glue the mating surfaces between panels A and B and A and C, and drive the nails home, taking care to line up the edges. Tack or staple a 1-in. (25.4-mm) thickness of acoustical fiberglass wool batting to the upper inside walls and ceiling of the woofer compartment. Do not over damp. (The purpose of this acoustical treatment is to absorb internal reflections of midrange sound inside the woofer enclosure. The triangular shape of the enclosure reduces the severity of this problem from that encountered in an ordinary rectangular box.)

Trim the top and bottom panels to fit the enclosure with no more than 1/8 in. (3.18 mm) overhang. Drill shank holes into the proper locations to put screws through the panels into the ends of the cleats. Drill a 1/4-in. hole through the

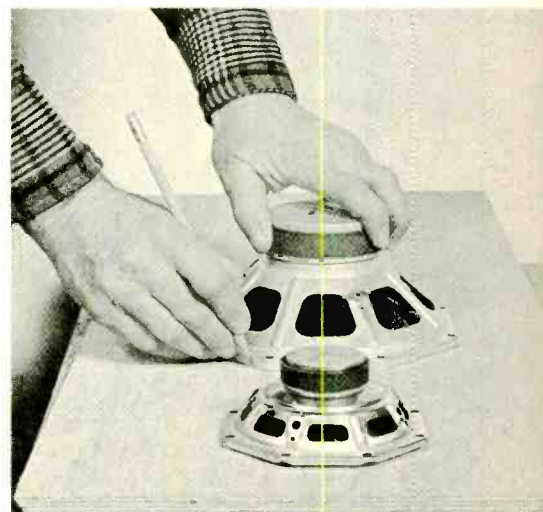

Fig. 2. Use speakers as patterns for octagonal cutouts on sides.

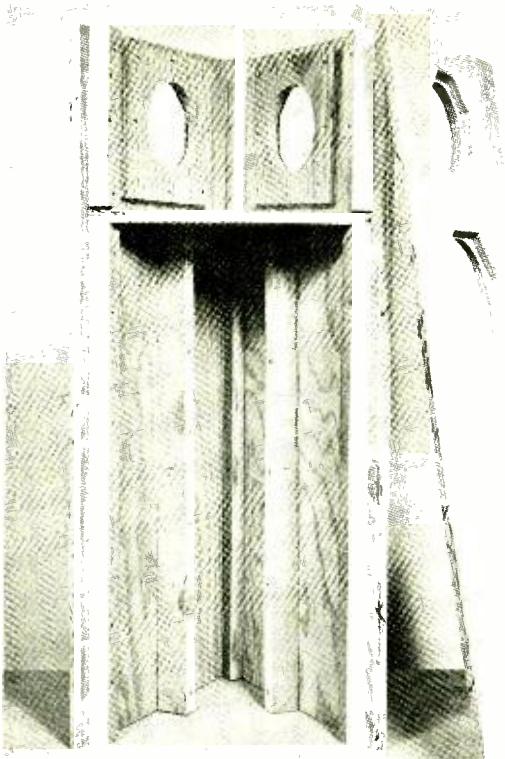

Fig. 3. Partially completed enclosure. Particle board would make denser enclosure than plywood as shown.

bottom panel, pass a length of lamp cord through the hole, and tie a knot 32 in. (0.81 m) from the inside end. Glue and nail the bottom panel to the sides of the enclosure and pack the speaker cord hole with silicone compound. Glue and nail small pieces of 1/2-in. thick wood to the bottom panel at each corner to serve as feet. Paint the enclosure's visible surfaces flat black.

When the paint has dried, thread the end of an 18-in. (45.7-cm) length of coded lamp cord through the hole in the center of the partition. (If coded cable is not available, use separate wires with different color insulation, or code a piece of lamp cord with tape at opposite ends of one conductor.) Connect and solder one end of this cable to the lugs on the woofer.

Run a bead of silicone rubber compound around the edge of the woofer board and install the woofer. Use

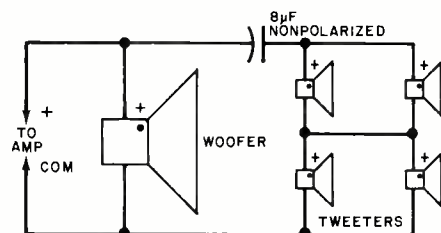

Fig. 4. Schematic of speaker connections shows use of capacitor.

3/16-in. bolts, passing them through the woofer's mounting holes and the mating holes in the speaker board, to tighten into the T nuts.

Pack the hole in the partition around the tweeter cable with silicone rubber compound. Install the tweeters in their respective locations, using a thin gasket of foam rubber or silicone rubber compound as an air seal between each driver and its mounting board. Fasten down the speakers with screws just tight enough to prevent rattles. Avoid over tightening, or you will warp the speaker frames. Then, referring to Fig. 4, wire the tweeters into the system, with two parallel-connected pairs in series with each other. Make sure you properly phase the tweeters as shown, and don't forget to install the 8- μ F non-polarized capacitor in the + line between the woofer and tweeter array. (See Fig. 5.)

Cut some fiberglass wool batting into small blocks or wedges and loosely fill the tweeter compartment with the chunks. Set the top panel temporarily on the enclosure and connect the system cord to the output of your amplifier

Turn on the amplifier and play a program rich in bass notes and lots of middle and high frequencies. Check that the low frequencies are reproduced by the woofer and not the mid-

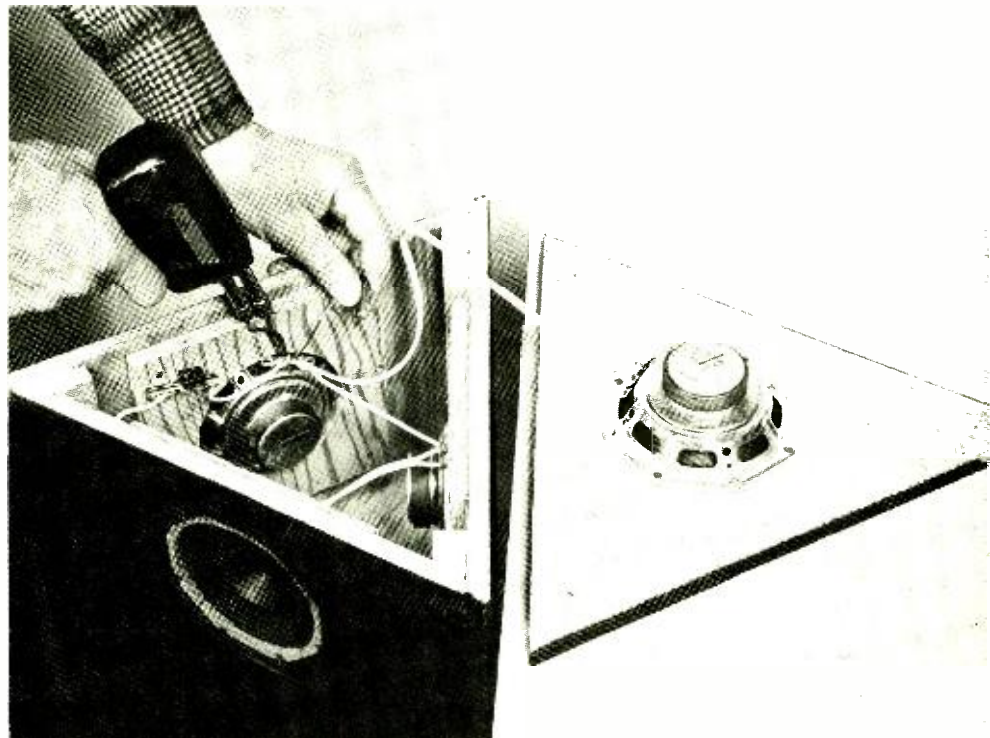

Fig. 5. The task of wiring the tweeters is made easier by using a removable top on enclosure.

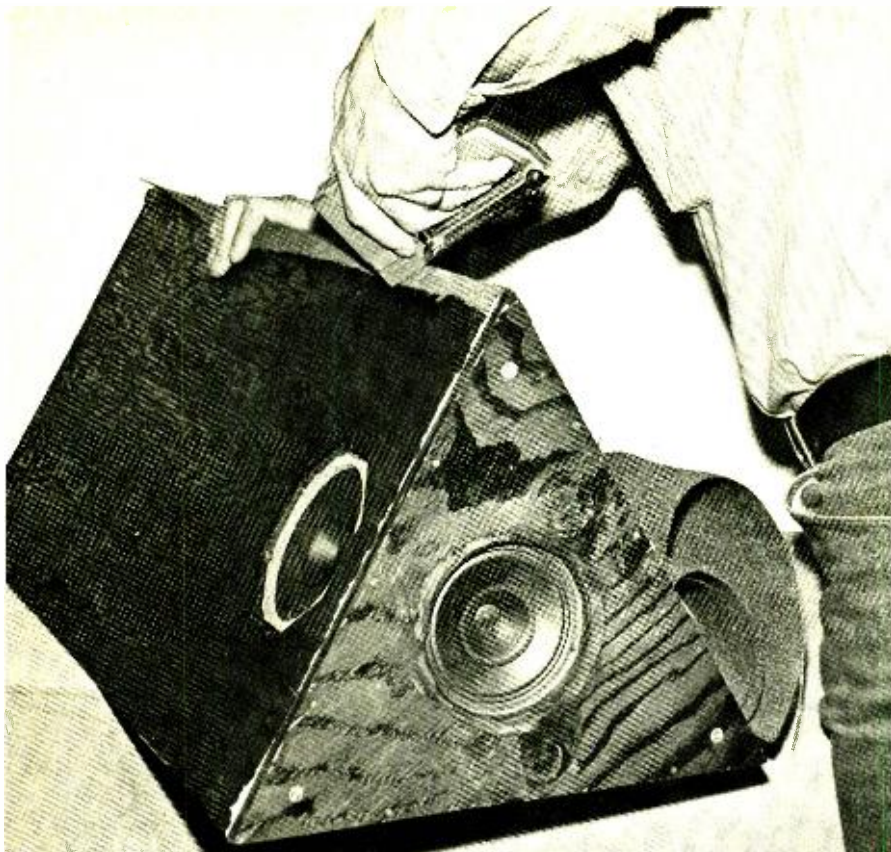
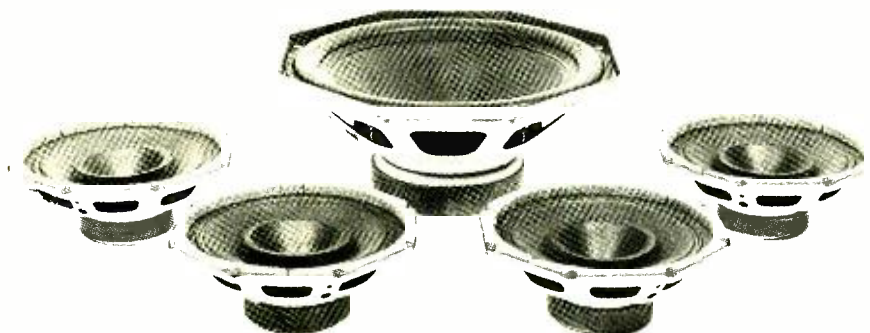

Fig. 6. Start installing wrap-around grille by stapling it to the rear corner.

Loosely fill the top compartment with small pieces of fiberglass batting.



Speakers used in the Plus-4: butyl suspension woofer and four tweeters with whizzer cones.

range "tweeters." If everything is okay, install the top panel, using a silicone rubber bead between it and the top edges of the enclosure. As mentioned earlier, the top panel mounts with the aid of flathead wood screws driven through it into the top edges of the enclosure walls and corner blocks.

After the gasket has had time to set, check the system out again with an amplified program. Listen for vibration around the top panel. Rap each side sharply near the center of the woofer section and listen for rattles and buzzing.

Finishing Up. When you are satisfied that the system is operating properly, install the grille cloth. Begin by stapling or tacking one edge of the cloth to the rear corner of the enclosure; just barely overlap the corner (Fig. 6).

Wrap the cloth around the body of the enclosure. Stretch the cloth both horizontally and vertically as you staple or tack it in place at the rear corner. Staple the top and bottom edges of the grille cloth to the enclosure walls, pulling out any wrinkles as you proceed, cover the staples with decorative ribbon material. Use glue to fasten the ribbon along the top and bottom edges and seam at the rear corner of the enclosure.

You should experiment with various locations and orientations to obtain the best stereo effect you want from the speaker systems. Start by placing the systems 10 to 12 in. (25.4 to 30.5 cm) from a reflective wall. (Measure from the rear corner of each enclosure.) Face the woofer forward, and use this position as a reference when you decide on a permanent location.

As with many sealed-woofer systems of moderate size, you might find that a bit of bass boost is beneficial. You will also notice here that the bass performance remains satisfyingly clean with the boost. The highs will have an open quality due to the sound coming from all three walls and the top of the enclosure. The height of the enclosure will add to the naturalness of the highs by getting them up off the floor. High-frequency dispersion will be much better than you could obtain from a single high-frequency driver system. ◆

*Lean band and batteries.



**BUILD A
LADY'S LED
TIME/DATE
WRISTWATCH
...ONLY \$75***

DIGITAL wristwatches are usually so large and cumbersome that they are unappealing to women. Now, the latest CMOS technology makes it possible to build a state-of-the-art electronic digital wristwatch that is truly sized for a lady's wrist.

The lady's digital wristwatch described here is not only about half the size of most men's watches, but it also gives more information than before in the smaller package. It uses four LED readouts to display the time in hours and minutes and also day of the month and seconds. Because of the relatively high current demands of the LED display, the readout is on an on-demand basis to conserve battery power.

*Single-IC watch
provides
hours/minutes/
seconds/date
on demand*

BY BILL GREEN

A lady's LED-type digital wristwatch is generally a high-cost item, selling for anywhere from \$250 on up for a factory-assembled version. The complete kit of parts and case (minus band and batteries) for this watch is \$75, plus handling and postage.

Although the emphasis in this article is on the lady's version of the wristwatch, the electronics package that makes up the timekeeping system can easily be set into the larger cases used for men's watches. Instructions for installation in both types of cases are provided in this article.

About the Circuit. The complete schematic diagram of the timekeeping system is based on the circuitry contained in a single large-scale CMOS integrated circuit (see *IC1* in Fig. 1). The IC contains all the counting, decoding, and multiplexing systems, plus an oscillator that works in conjunction with a crystal and several other outboard components.

Outputs from integrated circuit *IC1* are provided for driving hours, minutes, seconds, and date displays *DIS1* through *DIS4*. On-chip provisions are also provided for setting the time and date.

POPULAR ELECTRONICS

Fig. 1. The single IC contains a built-in oscillator and all logic to produce a four-digit multiplexed display with colon.

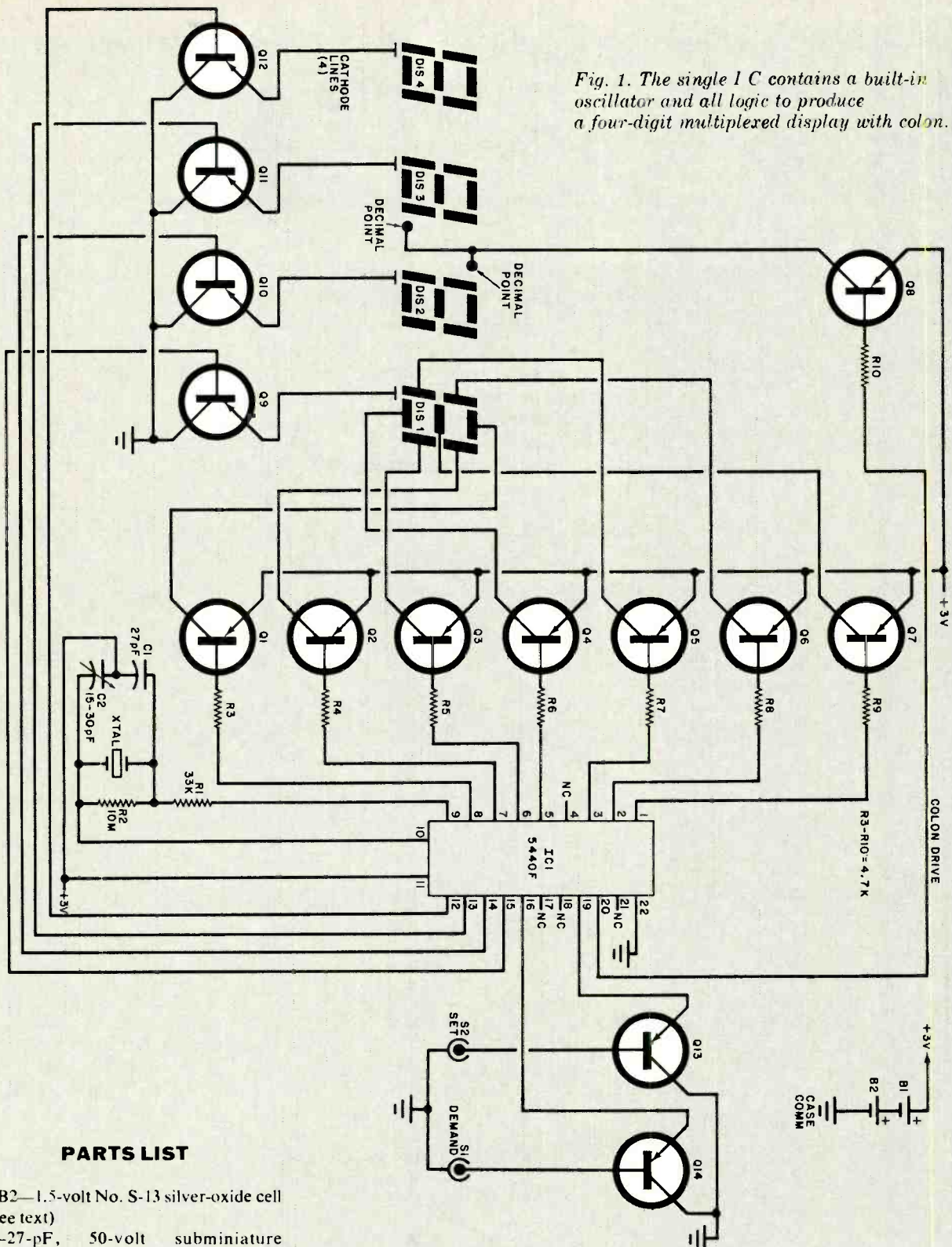

PARTS LIST

- B1, B2—1.5-volt No. S-13 silver-oxide cell (see text)
- C1—27-pF, 50-volt subminiature CK12-BX270K Kemet capacitor
- C2—15-30-pF subminiature trimmer capacitor
- DIS1 thru DIS4—Miniature 7-segment LED display with decimal point
- IC1—SLC5440F (Solid State Scientific) electronic watch integrated circuit
- Q1 thru Q12—MMT71 subminiature transistor (Motorola)
- Q13, Q14—2N5139 transistor
- R1—33,000-ohm, 1/8-W, 10% resistor
- R2—10-megohm, 1/8-W, 10% resistor

- R3 thru R10—4700-ohm, 1/8-W, 10% resistor
- S1, S2—Touch switch (see text)
- XTAL—32,768-Hz miniature crystal (CTS Knight)
- Misc.—Display filter; printed circuit board; watch case; watchband: 0.005-in. (0.127-mm) brass stock for battery contacts; tape; thin-walled plastic tubing; epoxy compound; straight pins (2); hookup wire; solder; etc.

Note: The following items are available from Alpha Electronics, P.O. Box 1005, Merritt Island, FL 32592: complete No. LED-1 kit of parts including all components, pc board, and case, but less band and batteries for \$75 plus \$2.95 postage and handling (specify men's or lady's version); No. LW-1 printed-circuit board for \$8.50; SCL5440F MOS integrated circuit (IC1) for \$40; 32,768-Hz crystal for \$15.

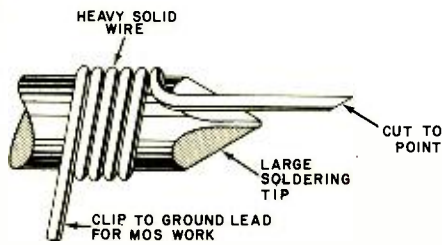

Fig. 2. To prevent damage to MOS devices during soldering, prepare this special tip for soldering iron.

Internal logic elements keep the display on for 1½ seconds after demand is made via S1. (Only the display is on-demand; the logic elements are always powered and driven.)

The colon between units-hours display DIS3 and tens-of-minutes display DIS2 is driven by transistor Q8. When the time is displayed, the colon glows steadily for a.m. hours and blinks at a 2-Hz rate for p.m. hours. The colon itself is made up of the decimal points built into DIS2 and DIS3.

Miniature transistors interface the outputs of IC1 with the LED displays. Transistors Q1 through Q7 provide current switching for the display segments, while transistors Q9 through Q12 are the digit-enable drivers when demand is made for displaying time or date. Resistors R3 through R10 in the base circuits of transistors Q1 through Q7 decouple the segment and colon driver transistors from IC1.

The oscillator circuit built into IC1 uses a 32,768-Hz crystal (XTAL in Fig. 1), capacitors C1 and C2, and resistors R1 and R2, all outboard of the LSI chip, to provide the clock pulses required for driving the system's logic. Capacitor C2 is made variable to permit the frequency of the clock oscillator to be accurately trimmed for precise timekeeping.

Transistors Q13 and Q14 act as switches between the time-demand and time/date setting pins of IC1 and case ground, which is also the common negative buss for the timekeeping system. These transistors are activated by touching S2 and S1, respectively. When either switch is touched, sufficient leakage current will flow between the center of the switch and the metal case of the watch to saturate that particular transistor. This sends the associated pin of IC1 to ground and activates the demanded function.

Power for the watch is provided by a pair of silver-oxide cells (B1 and B2) that generate the 3 volts dc required to run the timekeeping system. In the

ladies' version, a pair of low-cost S-13 cells are used for power. The larger case volume of the men's version permits larger and more powerful cells to be used, a good choice being the S-76 cell.

Since IC1 draws only 10 µW of power, the timekeeping system will yield from eight months to a year of operation from the smaller batteries, provided display demand does not exceed an average of ten times daily. The larger batteries permit more demands per day from the watch.

Construction. The components used in the wristwatch are physically much smaller and more delicate than those normally found in experimenter projects. One is a MOS LSI device (IC1) that requires particularly special handling to avoid damaging it by static electricity. (See the box for details on how to safely handle MOS devices.)

The printed circuit board on which the entire watch is built is extremely small for the number of components it accommodates. It has conductors on both sides, but it has none of the usual

Fig. 3. Same foil pattern, cut as shown below, is used for lady's or man's watch.

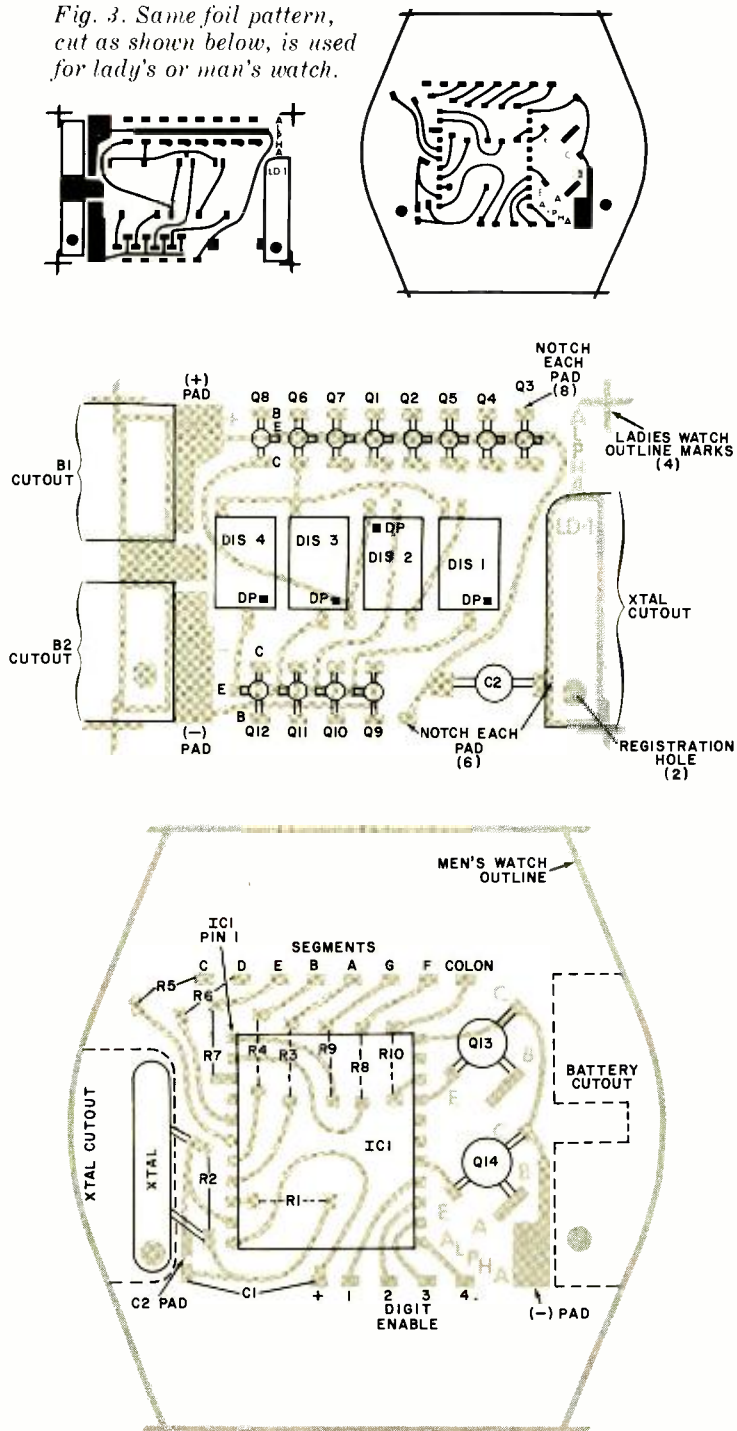

through-the-board holes for component leads. Lacking mounting holes, and owing to the high density of components and the close spacing between conductors and component leads, a special soldering technique and a very fine pointed soldering iron tip (see Fig. 2) must be employed when assembling the watch.

The soldering technique is familiar to many experimenters, though perhaps not by name. It's called reflow soldering. Before a component is mounted in place on the board, the copper pads and the component's leads are first pretinned with solder. This requires that the leads be cut to exact length and preformed prior to mounting. Then, when the component is set into place, heat from the soldering iron is applied to the joints between leads and pads until the pretinning solder films "reflow" and form sound electrical and mechanical bonds. No extra solder is used once the pads and leads are tinned.

If you examine the actual-size etching guides for the printed circuit board shown in Fig. 3, you will note the case outline for the men's version on the IC1 side and the crosses that define the limits of the ladies' version on the display side. Also note the areas that must be cut away for the batteries and crystal.

Use a jeweler's or other fine-bladed saw to cut the board to the shape required by the case in which it is to be mounted. Then cut out the notches for the batteries, leaving a narrow "tongue" of board material between the two cutouts. Make the cutout for the crystal. When this is done, use a fine file to smooth all cut edges and to fine-trim the board so that it just fits inside the case without binding.

If you are assembling the men's version of the watch, use a very fine drill to bore a hole through the board near each of the pads marked A through E and COLON, 1 through 4 and —, and the C2 pad adjacent to the crystal cutout. For the ladies' version, shallowly notch the edges of the board with a file in the center of each of the above pads.

Now, pass a strand of fine wire, pulled from a bundle of No. 22 stranded hookup wire, through each of the holes drilled through the pads on the men's board. Solder the wire to the paired pads on both sides of the board at each hole location. Use solder sparingly, taking care to avoid solder bridges, and clip the excess wires

as close as possible to the board's surfaces. For the ladies' version, first pretin the pads scored by the notches on both sides of the board. Reflow-solder the wire to the adjacent pads on both sides of the board, wrapping the wire over the edges of the board in the grooves. Interconnect all but the C2 pads—which will be connected later—in this manner.

Whichever version of the watch you are building, continue to pretin all the remaining pads on both sides of the pc board with a thin film of solder. Use solder and heat sparingly.

Referring to Fig. 4A, form the leads of the 12 subminiature transistors (Q1 through Q12) exactly as shown. Place the transistor on a flat surface with the side on which the raised marker in the center is facing up. Place your thumbnails on the collector and base leads near the transistor's case and gently but firmly press down until the leads are flat against the case sides. Repeat the procedure for the emitter lead.

Pretin with solder the leads of the transistors near their cases. Trim the transistor leads to just fit on the appropriate solder pads on the pc board. Then, referring back to Fig. 3 for component placement and orientation, reflow-solder the transistors down.

Referring to Fig. 4B, prepare the leads of the four displays (DIS1 through DIS4). Before clipping away any leads, carefully examine the individual displays to locate the decimal points for proper orientation. Once you are sure of the orientation of each of the displays, remove the leads specified. Then carefully bend the leads of each display with longnose pliers as shown in the side-view drawings. Pretin the bent leads of each of the displays and reflow-solder the displays in their respective locations, trimming leads as necessary and making sure to mount DIS2 upside-down so that its decimal point and the decimal point of DIS3 form a colon. Work carefully, and keep the displays in line with each other.

Place a narrow strip of insulating tape on the board under the free leads of the displays. Starting at DIS1, bend down the pin for segment E of each display until it touches the tape. Solder a length of thin bare wire (one strand from a length of No. 22 stranded hookup wire) across the E-segment pins, terminating it at the collector pad of Q5.

Place a second layer of tape over the E-segment wiring and repeat the

above procedure for the D-segment leads, terminating their wire at the collector pad of Q4. Continue working in this manner for the remaining segment leads, terminating the C, G, A, and B wires at the collector pads of Q3, Q7, Q1, and Q2, respectively. There is no need to bridge the G-segment leads of DIS1 and DIS2 since they share a common conductor once they are soldered down to the pads on the pc board. Also, no interconnecting wiring is needed for the F-segment leads to the collector of Q6 for the same reason.

Install trimmer capacitor C2 with its adjustment slot facing away from the board's surface. Wrap the lead near the crystal slot over the edge of the board and solder it to the pads on both the top and bottom of the board.

Next, install all the resistors, except R2, on the IC side of the pc board. Do not forget to tin the leads after they have been trimmed and formed. When properly installed, the resistors should lie flat against the board's surface.

Being very careful to observe the instructions for MOS devices in the box, remove IC1 from its protective carrier. Bend its leads downward about 1/32 in. (0.8 mm) from the flat side. At a point about 3/32 in. (2.4 mm) from the bottom of the IC package bend the leads out at a 90° angle. Temporarily place IC1 in position over its pads and, noting the position of pin 1 (it has an extra extension coming off the lead as shown in Fig. 4C), clip away the excess

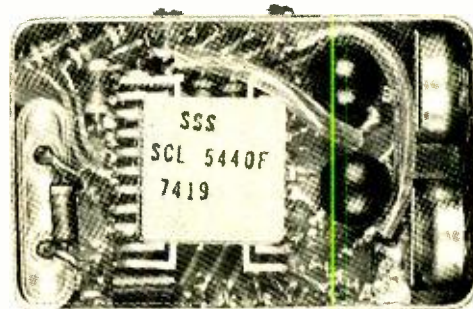

Photo shows how components are mounted on pc board.

lead lengths. Tin the lead stubs and carefully reflow-solder the IC's leads to the appropriate pads on the pc board. When in place, the IC should sit close atop the resistors mounted under it.

Form the leads of Q13 and Q14, trim them to fit the pads on the board, and tin the stubs. Set the transistors, one at a time, in place on the board and reflow-solder their leads to the ap-

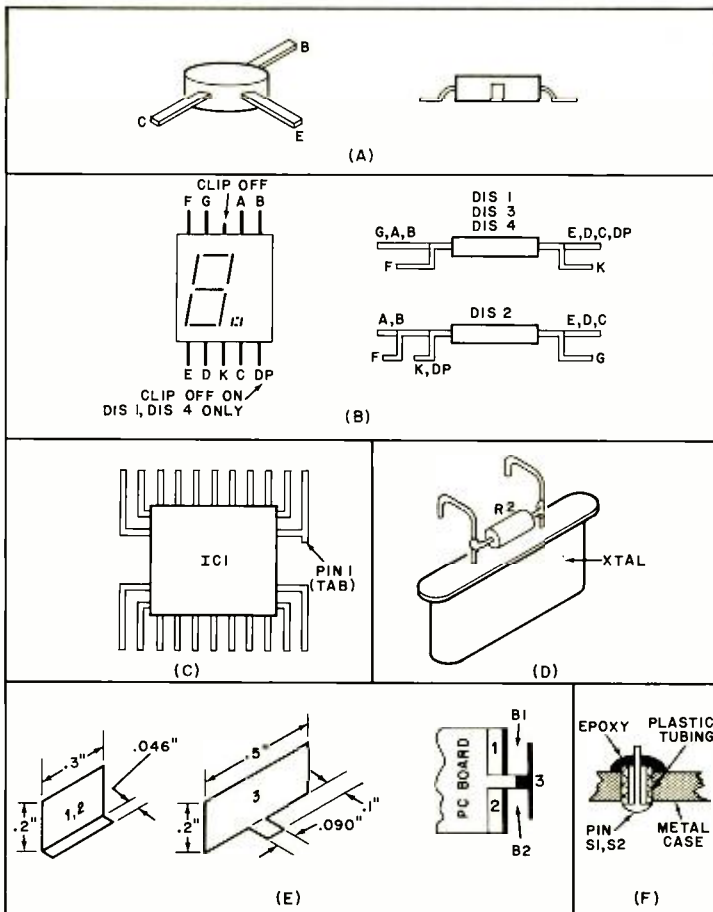

Fig. 4. Details for pin forming and assembly of parts.

appropriate pads. Then solder one end of a 1-in. (25.4-mm) length of bare hookup wire to the base pad of Q13. Repeat for Q14. The free ends of the wires will be connected later.

Cover the metal case of the crystal with a layer of insulating tape. Form the crystal's leads as shown in Fig. 4D. Clip the leads of R2 to 1/16 in. (1.59 mm) and solder this resistor across the leads of the crystal as shown, close to the case of the crystal. Set the crystal into its slot, and tin its leads. Reflow-solder the leads to the appropriate pads on the PC board. Form and clip the leads of C1 to length. Tin the leads and solder them to the pads on the circuit board.

Temporarily tack solder a length of hookup wire to the battery + pad on the board and another to the battery - pad on both sides of the board. Connect these wires, properly polarized, to a 3-volt dc supply. Two 1.5-volt cells of any type connected in series will do nicely.

The wire attached to the base pad of Q14 is the active part of time demand switch S1, while the wire attached to the base of Q13 is the active part of time/date SET switch S2. A low resis-

tance must be present between the switch to be used and battery - (case when the timekeeping package is installed in its case) to activate the function desired. Use your index finger to make contact between the battery - lead and the S1 wire. If the watch is operating properly, the display will come on and indicate some random number of hours and minutes. The display will remain on for 1 3/8 seconds after you remove your finger from contact with the wire.

After the display extinguishes, again contact the S1 wire, this time twice in quick succession. On the first contact, the display will indicate hours and minutes, while on the second contact, it will indicate the date and seconds. Unless continuous contact is made with the S1 wire, the display will extinguish after 1 3/8 seconds.

Setting the Watch. To set the hours and minutes, touch the S1 wire while maintaining contact with the battery - wire. Release the S1 wire, and, before the display blanks, touch the S2 wire. This will blank out the minutes displays and leave on the hours display(s). Touch the S1 wire until the

display indicates the proper number of hours. Don't forget to get the time in the proper cycle (a.m. or p.m.), while observing the colon.

Touch the S2 wire to blank out the hours display and turn on the minutes display. Then touch S1 until the correct number of minutes is displayed. Touch S2 again to blank the display.

The date and seconds are set in a similar manner. First touch the S1 wire twice to turn on the date and seconds function. Before the display blanks out, touch S2. This blanks the seconds and locks on the date displays. Touch S1 until the display indicates the correct date. Touch S2 to blank out the date and turn on the seconds. Touch S1 to reset the displays to 00. Release the S1 wire. When the real time corresponds to the time set in the watch, touch S1.

The above procedure checks out the operation of the timekeeping system prior to final assembly. It should be performed again exactly as outlined after the watch is fully assembled and ready to wear. Once you have checked the operation of the timekeeping system, remove the wires temporarily connected to the battery + and - pads.

Final Assembly. Referring to Fig. 4E, prepare three pieces of brass shim stock as shown. Mount and solder them into place as shown in the circuit

HANDLING MOS DEVICES

Because MOS devices—both discrete and integrated circuit—can be permanently damaged by static electricity charges, observe the following rules when handling and working with them:

- Never wear synthetic clothing; cotton is best.
- Ground anything that is to come into contact with the MOS device before it is installed in its circuit—including work area, tools, and yourself.
- Never let go of a MOS device after removing it from its special conductive carrier until it is installed in its circuit. When a good MOS device is removed from a circuit, immediately install it in a protective (conductive) carrier designed for MOS devices.
- Never install or remove a MOS device from a circuit when the power is on.

ALTERNATE DESIGN CHOICE

The digital wristwatch described in this article uses a Solid State Scientific IC to perform all time-keeping functions. As we were going to press, we were informed that another version of the kit has also become available from the same supplier mentioned in the Parts List. The new version uses either of two IC's made by Mostek.

While both the SSS and Mostek IC watches are designed to use LED displays, their drive systems are different. The SSS chip requires outboard isolation transistors to drive the LED segments, while the Mostek has built into it high-current outputs that can drive the displays directly. Both approaches have advantages and disadvantages.

The advantages to the SSS approach include the ability to vary the current through the drive transistors and LED's by changing resistor values to lower display brightness and extend battery life. Another advantage is that if one of the LED drive transistors should ever become defective, only that transistor need be replaced. The disadvantage of the SSS approach, of course, is those seven extra driver transistors that make assembly more complex.

Taking the Mostek chip approach offers the advantages of bright display, on-chip segment drivers, and the elimination of seven transistors, which simplifies assembly. The disadvantages are that the display brightness cannot be varied. Also if only one of the output drive circuits becomes defective, the entire chip must be replaced.

Both chips offer hours and minutes time indication with separate date and seconds on demand. The SSS chip offers time only in a 12-hour format, with a.m. hours indicated by a steady glow of

the colon and p.m. hours by the colon pulsing on and off. The Mostek chips offer a choice of either 12- or 24-hour time format. The colons glow steadily; so, there is no indication of a.m. or p.m. in the 12-hour watch. (It's not needed in the 24-hour watch.) A.m. and p.m. are indicated only when time is being set.

Further differences include two-button operation for the SSS chip as opposed to three-button for the Mostek chip. With the Mostek watch, if you want the time, you have to touch the demand contact continuously for as long as it takes to read the display. However, when you touch the contact on the SSS watch, you can let go immediately and the display will remain on 1.35 seconds after release. Finally, the Mostek watch kit is \$5 more expensive than the SSS kit.

The Mostek chip has one more function worth noting. The chip can be used as a stopwatch with a 1-second resolution. A resume function permits the elapsed-time count to be stopped during times out and resumed again without having to go to a reset-to-zero mode. When used as a stopwatch, the watch does not keep track of time and date, which means that the time and date must be set into the watch after using it as a stopwatch.

A complete kit for the Mostek IC watch, including pc board, case, and all electronics, but excluding band and batteries, sells for \$79.95 plus \$2.95 for shipping and handling. Specify lady's or man's version and give No. DD-12 for the 12-hour or DD-24 for the 24-hour version. The IC's are available separately for \$40 each; specify 5030M (12-hr) or 5031M (24-hr). Also available are the No. LW-2 pc board for \$8.50, and the crystal for \$15.

board detail. Use solder sparingly, but make sure to obtain good mechanical as well as electrical joints. Solder the minus pad on the IC side of the board to the minus battery clip.

Temporarily set the timekeeping module inside the watch case, display properly positioned in its window, to check the fit. The fit should be fairly loose, without binding anywhere. Remove the pc board assembly from the watch case.

Measure the inside depth of the watch case and subtract 1/16 in. (1.59 mm) from the figure obtained. Cut a strip of electrical tape to this width and 3 5/8 in. (76.2 mm) long. Press the tape strip to the inside walls of the ladies' watch case, leaving a gap in the center of the top wall. This insulation is necessary in the men's watch case only in the area where the batteries might come into contact with the case. Also apply a strip of tape on the inside

of the case top in the battery area.

Epoxy the filter over the display window in the watch case. Set the case aside until the epoxy has had time to completely set.

Then, temporarily set the pc board assembly into the watch case, positioning the display so that it is in the center of the window area. If the assembly binds because of the insulating tape, carefully trim it with a fine file for a snug fit. Locate and mark two points above and clear of the components on the board for S1 and S2.

Remove the pc assembly from the watch case and set it aside. Then drill a hole at each of the marked locations. Use a drill that is the same size as—or perhaps the tiniest bit smaller than—the diameter of the thin-walled plastic tubing that will be installed in these holes to insulate S1 and S2 from the case.

Referring to Fig. 4F, slip a short

length of the plastic tubing into each of the holes, positioning it so that it is almost flush with the outside wall and protrudes about 1/32 in. (0.8mm) beyond the inside wall of the watch case. Slip a straight pin into each piece of tubing from outside the case. Then epoxy pins and tubing to the case as shown. When the epoxy has had time to set, trim the straight pins, leaving just enough of their length behind to permit the wires coming from the bases of Q13 and Q14 to be soldered to them.

At this time, wristband support pins must be attached to the exterior of the metal watch case. In the prototype watch shown in the photo, small-diameter brass tubing was silver soldered to the case. If another type or style of wristband than that shown is used, appropriate metal brackets must be fashioned for them and silver soldered to the watch case.

If you have access to a frequency counter, you can initially set the crystal oscillator's frequency for a reading of 32,768 Hz by adjusting C2. The counter connects to the watch via pin 10 of IC1 and the case. Do not set the frequency to exactly 32,768; instead, set it about 0.5 Hz low to offset the loading effect of the counter on the oscillator.

If you do not have access to a frequency counter, you can tune the oscillator by trial and error. Operate the watch for some period of time. Assuming the time is off by some number of seconds, tune C2 and operate the watch again. Continue to operate and tune until you are satisfied that the timekeeping system is tracking with the smallest of errors.

Replace the watch module inside the case, making sure the displays are centered in the window area. Solder a short length of the thin bare wire from the battery — pad to the wall of the watch. To get to bare metal on the wall, notch out only as much of the tape as needed for the connection.

Slip a length of thin-walled plastic tubing over each of the wires coming from the bases of Q13 and Q14. Connect and solder the loose ends of these wires to the S1 and S2 pin stubs. Then, taking care to observe the correct polarity, install B1 and B2 in their holders. Push the cells down until they seat against the top of the watch case. Then install the bottom cover.

The ultimate timekeeping accuracy can be within one or two seconds a month if you take care to precisely trim C2.

ALTERNATELY FLASHING TAILLIGHTS

BY TERRY A. WILLIAMSON

A HEADLAMP up front to light your way and let people know you're coming toward them is great to have for night cycling. But it isn't enough if you leave your rear unprotected from oncoming motorists. For rear protection, you want something that will attract attention, like the flashing light system described here. Two lamps alternately flash on and off at a rate of about once a second to draw attention.

You can build the biker's rear safety flasher system for less than \$10, exclusive of generator.

About the Circuit. As shown in the schematic diagram, power for the flashing light system is obtained from a standard bicycle generator. The generator should be rated at 6 volts and be capable of delivering 3.3 watts or more to the load.

The circuit used to pulse lamps *I1* and *I2* is a relay (*K1*) driven by 555 timer *IC1* at a frequency of about 0.9 Hz with the component values shown. (Other rates can be obtained by manipulating the values of *C1* and *R2* in the formula $F = 1.5R2 \times C1$.)

Lamps *I1* and *I2* flash alternately because of the arrangement of *K1*'s contacts. When one lamp is on, the other is off. Then, when the next pulse from *IC1* energizes *K1*, its contacts close in the opposite direction, powering the second lamp and extinguishing the first.

Dc power for driving the circuit is obtained by rectifying the ac coming from the generator (actually an alternator) through *D1* and filtering it with *C1*. Since the output of the generator

often contains spikes with amplitudes in the 15- to 20-volt range, zener diode *D2* is used to protect *IC1* from over-voltage damage.

Diode *D3*, connected across the winding of *K1*, protects *IC1* from the inductive "kick" (back emf) that results when power is removed suddenly from the relay's coil.

The circuit does not use or need a power switch. Power is applied and removed from the circuit simply by engaging and disengaging the generator.

Construction. Since the circuit is very simple, it can be assembled on a printed circuit or a perforated board. Parts placement is not critical, whichever method of assembly you choose.

Relay *K1* should be a 6-volt unit with a coil resistance of about 500 ohms. Its contacts should be rated for at least 1 ampere at 6 volts. Bolt the relay directly to the circuit board. Then, after making all necessary connections to its coil and contacts, use silicone rubber cement to anchor its plastic cover to the board.

The two #63 auto backup lights used for *I1* and *I2* should be housed in 2½-in. (6.35-cm) diameter red-lensed holders, such as the Pathfinder #667 red taillight assemblies. The lights can be mounted anywhere convenient on the bike, such as a carrier or a mudguard. If you have a racing-type bike that has neither carrier nor mudguard, mount the lamp assemblies on the rear-wheel fork struts, but take care to avoid interfering with brake and shift cables. ♦



B ICYCLING on our roads can be a hazardous proposition, especially at night when visibility is drastically reduced. Manufacturers of bicycles try to circumvent the poor visibility problem by providing reflectors at strategic locations on their bikes to make them visible after dark.

The problem with reflectors is that they depend on an outside source of light to render them—and the bike on

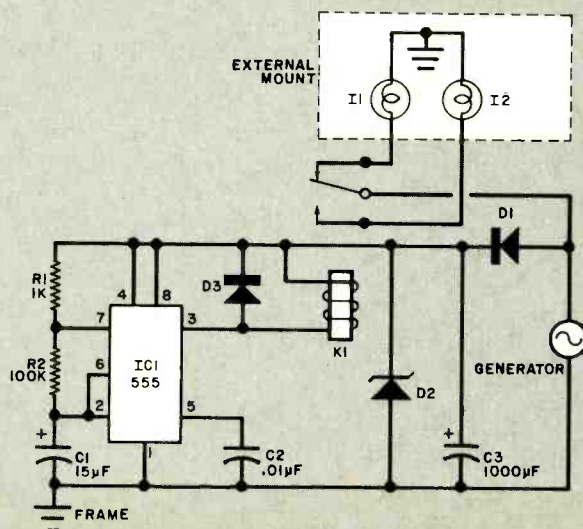

PARTS LIST

- C1—15-µF, 25-volt electrolytic capacitor
- C2—0.01-µF, 25-volt disc capacitor
- C3—1000-µF, 25-volt electrolytic capacitor
- D1, D3—1N4001 diode
- D2—12-volt, 1-watt zener diode (Motorola HEPZ 0415 or similar)
- I1, I2—#63 auto backup lamps
- IC1—555 timer integrated circuit
- K1—6-volt, 500-ohm relay (Archer No. 275-004 or similar)
- R1—1000-ohm, ½-watt resistor
- R2—100,000-ohm, ½-watt resistor
- Misc.—Suitable enclosure: red-lensed taillight assemblies (see text); pc or perforated board; 6-volt, 3.3- to 6.6-watt generator (if you don't already have one); rubber grommets; hookup wire; solder; machine hardware; etc.

15 exciting new projects for '75

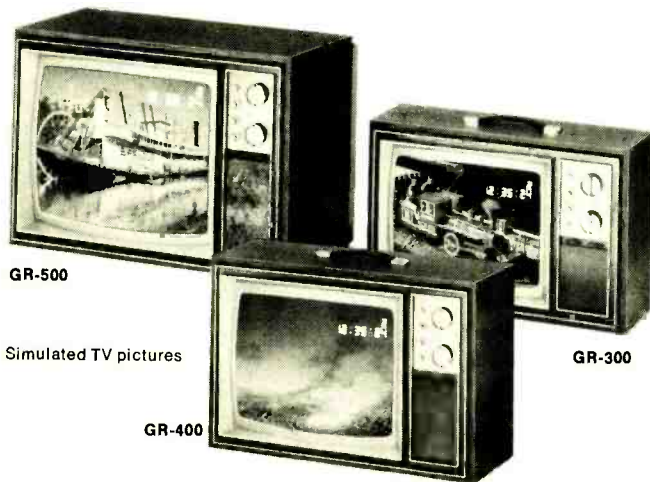

GR-500

Simulated TV pictures

GR-400

GR-300

15, 17 & 19" (diagonal) Color TVs with On-Screen Digital Readout

Advanced Heath engineering and outstanding picture quality. All feature on-screen channel readout & optional plug-in clock modules. In-line picture tubes with slotted shadow masks provide exceptionally bright, sharp pictures. In the GR-400 and 500, black matrix tubes improve contrast. And here's something new—static toroid yoke & magnet assemblies never require convergence & fixed LC filters eliminate instrument IF alignment. GR-300 & 400 come with walnut veneer cabinets; cabinets for the GR-500 start at \$39.95.*

Kit GR-300 (15" diag.), with cabinet	449.95*
Kit GR-400 (17" diag.), with cabinet	489.95*
Kit GR-500 (19" diag.), less cabinet	499.95*
Kit GRA-2000-1, Digital Clock Module	29.95*



GR-2000

Simulated TV picture

Highly Acclaimed GR-2000 Digital-Design Color TV

The set that brought TV into the digital age—and still one of the finest made. Tuning is totally digital solid-state & the channel number appears right on the big, 25" (diagonal) screen. The optional clock module also displays the time on the screen. For the ultimate in convenience, add the optional wireless remote control. Can be custom mounted; optional cabinets start at \$119.95*.

Kit GR-2000, less cabinet	669.95*
Kit GRA-2000-1, Digital Clock Module	29.95*



NEW Portable Digital Multimeter

Professional performance at a budget price. 26 ranges resolve voltages to 100 μ V, currents to 100 nA, measures AC & DC current up to 2 A, resistance from 100 to 1000K ohms. Big, bright 3½-digit readout with automatic over-range & polarity indications. Built-in reference standards for easy field calibration. With rechargeable batteries & AC line cord.

Kit IM-2202	179.95*
-------------------	---------



NEW DC-10MHz Oscilloscope

A great scope—a great value! Perfect for TV servicing. 10 mV vertical input sensitivity, time bases from 200 ms/cm to 200 ns/cm, internal or external digital triggering, two input channels. Mu-metal shielded tube with 8x10 cm graticule.

Kit IO-4530	299.95*
-------------------	---------



NEW Code Practice Oscillator

As much fun to build as it is to use. It's battery operated for complete portability. Built-in speaker, adjustable tone & volume, headphone jack. With key. Less battery.

Kit HD-1416	9.95*
-------------------	-------



NEW 40 kV Metered Probe

Ideal for high-voltage TV measurements—up to 40 kV with $\pm 3\%$ accuracy. On/off switch.

Kit IM-5210	17.95*
Assembled SM-5210	24.95*



NEW Emergency Car Strobe Light

Highly visible amber flash warns other drivers when your car stalls or breaks down. Non-marring magnetic base, 12' cord, plug fits cigarette lighter. For 12 VDC.

Kit GD-1026	29.95*
-------------------	--------



NEW Solid-State Dip Meter

Fully portable, fits in your hand. Covers 1.6 to 250 MHz in fundamentals. MOS-FET paraphrase amp, hot-carrier diodes, Q-multiplier. With case, 7 plug-in coils. Less battery.

Kit HD-1250	59.95*
-------------------	--------



NEW Windshield Wiper Delay

Provides exactly the wiper speed you need for safe driving in any weather, from light mist to heavy rain. Works with most 12 VDC positive or negative ground cars.

Kit CH-1068	14.95*
-------------------	--------

at traditional Heathkit savings

There are 350 more in the new FREE Heathkit catalog!

Who can build our kits? Anybody!

For over 27 years we've made superb electronic equipment that anyone can build—even with no prior knowledge of electronics or kit building. Famous Heathkit assembly manuals guide you step by step, showing you exactly what to do—even how to solder like a pro.

And we back every Heathkit purchase with people. Expert technical consultants at the factory and trained service personnel from coast to coast are ready to help every step of the way. Thousands of Heath customers will tell you—**we won't let you fail!**

When you're finished, you'll own one of the finest products available—kit or assembled. But don't take our word for it, independent reviewers consistently praise their quality.

You'll enjoy the satisfaction—and savings—of building a useful product with your own hands. And for years to come, you'll enjoy its unexcelled quality and performance. Build it yourself—with a little help from Heath.

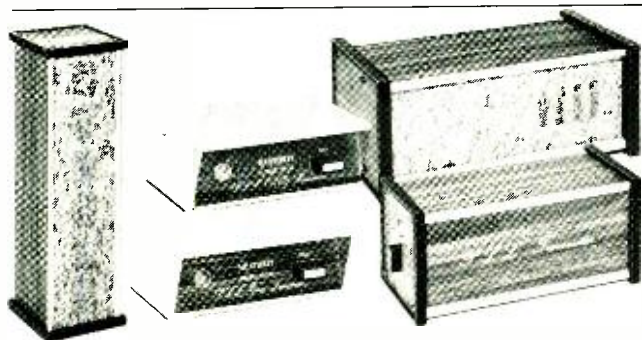
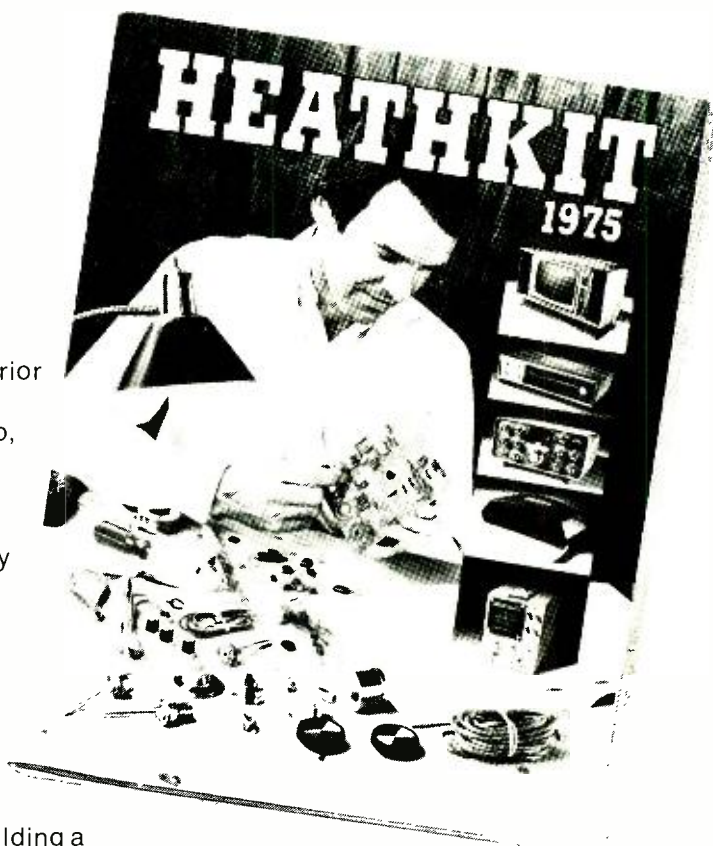

NEW Heathkit/Delta Home Security System

Everything you need for a complete home security system. Remote detectors connect to Central Processor through your home's electrical wiring. Inputs for ultrasonic intrusion detector, heat & smoke detectors plus "panic button" & remote on/off switch. Central Processor features built-in speaker; output for an external speaker. Sounds alarm during power failure.



AM/FM Digital Alarm Clock Radio

One of the world's most sophisticated radios. Big, bright Beckman planar gas discharge tubes display the time, automatically adjusting their brightness as room lighting changes. Standby battery power keeps the clock—and you—on time (without the display) even if the electricity is interrupted. It wakes you to your favorite station or a gentle, electronic beep with adjustable volume. The radio section uses fixed ceramic filters for AM and FM and a factory-assembled and aligned FM front-end with 5µV sensitivity.

Kit GR-1075, less batteries **129.95***

**Send for your free
1975 Heathkit Catalog today!**

HEATHKIT ELECTRONIC CENTERS—Units of Schlumberger Products Corporation
Retail prices slightly higher.

ARIZ.: Phoenix; CALIF.: Anaheim, El Cerrito, Los Angeles, Pomona, Redwood City, San Diego (La Mesa), Woodland Hills; COLO.: Denver; CONN.: Hartford (Avon); FLA.: Miami (Hialeah), Tampa; GA.: Atlanta; ILL.: Chicago, Downers Grove; IND.: Indianapolis; KANSAS: Kansas City (Mission); KY.: Louisville; LA.: New Orleans (Kenner); MD.: Baltimore, Rockville; MASS.: Boston (Wellesley); MICH.: Detroit; MINN.: Minneapolis (Hopkins); MO.: St. Louis (Bridgeton); NEB.: Omaha; N.J.: Fair Lawn; N.Y.: Buffalo (Amherst), New York City, Jericho (L.I.), Rochester, White Plains; OHIO: Cincinnati (Woodlawn), Cleveland, Columbus, Toledo; PA.: Philadelphia, Pittsburgh; R.I.: Providence (Warwick); TEXAS: Dallas, Houston; VA.: Norfolk (Va. Beach); WASH.: Seattle; WIS.: Milwaukee.

		HEATH Schlumberger
Heath Company		
Dept. 10-03		
Benton Harbor, Michigan 49022		
Name _____		
Address _____		
City _____	State _____	Zip _____
PRICES & SPECIFICATIONS SUBJECT TO CHANGE WITHOUT NOTICE. *MAIL ORDER PRICES! F.O.B. FACTORY.		
		CL-555

CB SPECIFICATIONS MADE EASY

Become a more knowledgeable CB'er and get the most for your money by understanding and interpreting specifications.

IF YOU'RE a CB'er and don't have a degree in communications engineering, you might find the spec sheet of that transceiver you're thinking of buying to be so much alphabet soup. If you know how to read and interpret one, however, it can give you a capsule summary of performance expectations.

Let's look at the receiving section of the CB rig, which is really more important than the transmitter. (No matter how loud your signal is, you won't be able to establish contact with another station unless you can hear him.)

Receiver Specifications. The most important spec of a receiver is *Sensitivity*, which is composed of two parts. The first expresses the minimum signal strength that the receiver will respond to, and is measured in microvolts. (μV). The second part gives the ratio of the signal to the noise generated by the receiver circuits.

If this internal noise is great enough, it will mask the signal and make reception impossible. Therefore, while it is important to have a low sensitivity figure, it is just as important that the signal-to-noise, S/N, or signal-plus-noise-to-noise, (S+N)/N, ratio be as large as possible. Combined, the two tell you how much *usable* sensitivity can be expected from the receiver. The S/N ratio is expressed in decibels, and the most common reference is 10 dB (the signal is 3.2 times the value of the noise level).

The Electronic Industries Associa-

tion (EIA) and the FCC set down minimum requirements for CB gear. Well-designed gear will meet or exceed these "worst-case" standards. In the case of receiver sensitivity, the EIA standard for an AM receiver is $1\mu\text{V}$ for a 10-dB (S+N)/N, using a 1000-Hz tone to modulate the carrier 30 percent. It is not uncommon to find transceivers with a sensitivity rating of $0.5\mu\text{V}$ or less. Since this figure can vary due to component tolerances, many manufacturers use a worst-case value and specify it with the words "or less" or "at least."

SSB receiver sensitivity is measured by applying an unmodulated signal to the receiver input. The test-signal frequency is adjusted to produce a 1000-Hz tone at the receiver output. Its level is then adjusted to produce the desired ratio of receiver output to no-signal noise appearing at the output terminals. The EIA standard for SSB sensitivity is $0.5\mu\text{V}$ for a 10-dB (S+N)/N ratio, in contrast to AM's $1\mu\text{V}$. You'll often find figures in the 0.1-to- $0.25\mu\text{V}$ range for the same (S+N)/N ratio. Occasionally, you may run across a receiver's "usable sensitivity" rating. This value is the minimum signal input required to produce half of the receiver's rated audio output for a given (S+N)/N ratio.

Selectivity, another important characteristic, is the receiver's ability to differentiate between an adjacent signal and the desired one. This is also referred to as the *Adjacent-Channel Rejection*, expressed as a ratio in decibels. This figure shows how much

stronger an adjacent-channel signal (10 kHz away) must be to interfere with intelligible reception of the desired one. Sometimes selectivity is stated as the i-f bandpass, which is the width of

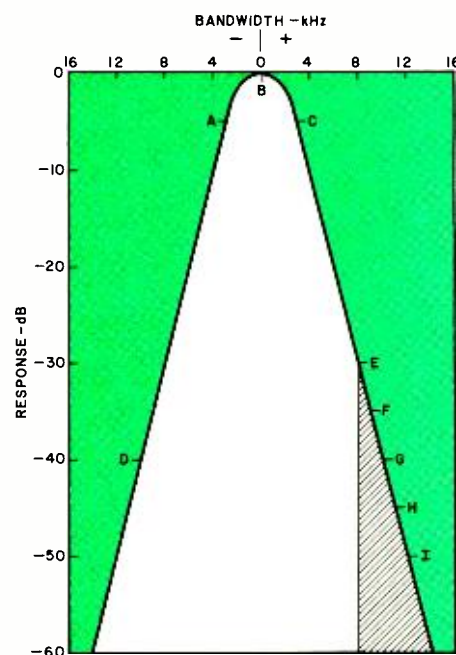

Fig. 1. The i-f selectivity curve of an AM receiver with 6-kHz bandwidth at 6 dB down and 2-kHz bandwidth at 40 dB down. Signal is tuned to center at (B). Shaded area may be occupied by 10-kHz adjacent channel with carrier at (G), modulated to 2 kHz. Lower sideband components will be down 35 and 30 dB (F and E). Upper sideband components are further attenuated (H and I).

the "window" the receiver can see through to detect signals of a specified strength.

Figure 1 shows a typical i-f response with a bandpass 6 kHz wide (± 3 kHz) for signals 6 dB below maximum response (points A and C), a 20-kHz width (± 10 kHz) at 40 dB down (D and G). The a-f response of a receiver can be approximated by halving the band-

cent channel. No matter what generates the spurious signal—the receiver itself or some remote transmitter—the rejection ratio should be as high as possible. A receiver should respond only to the station to which it is tuned. The EIA standard for spurious-signal rejection (on AM) is 25 dB, except for image (internally generated) rejection, which is 10 dB. Image rejection is the

iation is experienced when input levels are below 5 to 10 μ V, where minimum agc action is available. Above this point the output remains more constant.

A-F Output is the maximum a-f power output of the receiver at a specified distortion level (including public-address facilities). It is usually measured at 1000 Hz into a given load

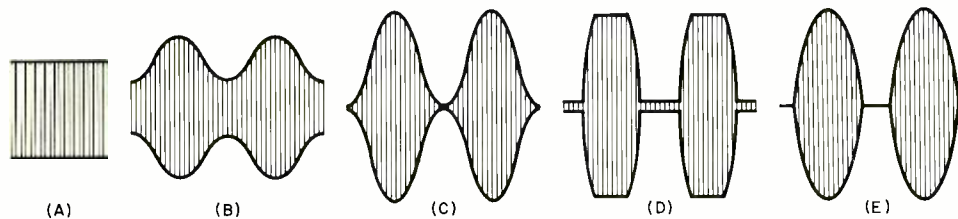

Fig. 2. R-f envelopes of an AM transmitter: (A) unmodulated; (B) 50% modulation; (C) 100%. Clipping (D) and overmodulation (E) cause station interference.

pass between the 6-dB points (2000 or 3000 Hz is considered optimum), while the ability to reject adjacent signals can be estimated by halving the bandpass between points of higher attenuation. For example, a 40-dB-down bandpass of 20 kHz (± 10 kHz) means that a signal 10 kHz away would have to be 40 dB higher (100 times stronger) than the desired signal if the two are to appear to have equal strength at the receiver output.

Selectivity depends not only on the i-f bandpass, but also on the receiver's *Desensitization* characteristic, which indicates to what extent a desired signal's strength will appear to be depressed by an adjacent signal. Such activity would further deteriorate the selectivity or adjacent-channel rejection rating. The EIA standard for adjacent-channel rejection is 30 dB. Typically, it will run from 30 to 50 dB.

SSB selectivity is commonly defined as the bandpass of the desired sideband response at the 6-dB points. Additionally, the bandpass at some point further down the selectivity curve (usually 60 dB) is specified. A complementary specification you should know is the unwanted sideband suppression at some specific audio frequency (1 kHz or so). This indicates the detected difference in signal strength between two equal-strength SSB signals operating on alternate sidebands of the same channel. The EIA standard for unwanted sideband suppression is 40 dB at 1 kHz (the tone used to modulate the sidebands). Many new SSB rigs are rated at 50 to 70 dB at 1 kHz.

Spurious Signal Rejection, expressed in decibels, tells how well the receiver is able to discriminate between a desired signal and another on some frequency other than the adja-

city of a receiver to ignore frequencies algebraically related to those of the desired signal and the receiver i-f. The image rejection of single-conversion receivers with 455-kHz i-f is rarely better than 10 dB (which is rather poor), but receivers with higher i-f do better—typically 40 to 80 dB.

Typical rejection performance for other spurious signals runs about 50 dB. The EIA SSB standard specifies a 35-dB spurious-response rejection ratio, an image response of 20 dB and an i-f rejection of 60 dB.

Squelch Threshold Sensitivity indicates the signal strength for which the squelch can be set to activate receiver audio, yet quiet the background noise in no-signal conditions. Maximum sensitivity allows the receiver to be squelched without missing weak signals. *Tight squelch* is the maximum signal-strength threshold to which the squelch can be adjusted. The EIA standard for squelch threshold sensitivity states that it shall be no greater than 1 μ V on AM and 0.5 μ V on SSB, and no greater than 1000 μ V (AM), 500 μ V (SSB), nor less than 30 μ V. In practice, a tight squelch of 30 to 100 μ V should be adequate.

Automatic Gain Control Figure of Merit indicates the change in audio output for a given change in r-f input, expressed in decibels. A good agc has a low figure of merit (ideally 0 dB). In operating practice it will minimize the need to readjust the volume control to reduce "blasting" by strong stations. The EIA minimum AM standard constrains the audio output to a 30-dB change in output for an r-f input change of 94 dB between 1 and 50,000 μ V. For SSB, a 16-dB audio output change is allowed for an r-f input change of 100 dB between 0.5 and 50,000 μ V. Generally, the greatest var-

impedance (most often 8 ohms). The EIA standard is 2 watts at no more than 10-percent distortion. Typically, audio output will run from 1.5 to 4 watts at 10-percent (or less) distortion. In quiet locations, 1 watt will be adequate, while greater output will be needed for noisier locations.

A-F Response is indicative of the uniformity or flatness of the audio output over the modulating frequency range. It is usually expressed as the audio passband over which the output is maintained within a specified range ($\pm X$ dB or from $-X$ dB to $+Y$ dB). The EIA standard for AM holds the audio response within a range from -14 to $+2$ dB of the 1000-Hz output level over a passband of 300 to 3000 Hz. Most manufacturers, however, specify the frequency range over a 3- or 6-dB level deviation. For SSB, the EIA standard a-f response is $+3$ dB to -6 dB over a passband of 2100 Hz.

Noise Limiter Figure of Merit described how well impulse noise can be suppressed while receiving a signal. It is expressed in decibels, relating the degree of suppression for a given signal-to-noise ratio. The EIA standard for noise limiter performance is 10 dB. However, this applies only to short-duration, "spike" noise like ignition interference. Generator hash, power-line and other noises will not necessarily be attenuated as effectively.

S-Meter Sensitivity tells what input-signal level is required to register an S-9 reading, which may vary anywhere from 10 to 1000 μ V, depending on the individual receiver. However, the customary standard is 50 to 100 μ V. A related standard defines an S unit as a 6-dB change in signal strength. Most S meters are not precisely calibrated, and many manufacturers do not provide calibration

charts. These meters are intended to be relative, not absolute, signal-strength indicators.

Transmitter Specifications. The spec most CB'ers look for first is *r-f power output*. For an AM transmitter, this specification rates the amount of carrier appearing at its nominal load impedance. At full modulation, the peak power output is four-times that of the carrier. Only a small portion, however, is useful "talk" power. The EIA standard (also the legal limit) requires that the carrier output not exceed 4 watts with the equipment operated from a 117-volt ac or 13.8-volt dc source.

CB vacuum-tube transmitters usually have 3 to 3.5 watts of output, while solid-state units produce from 3.5 to 4 watts. It is worth noting that it is unlikely that anyone can hear the difference between a 3- and 4-watt signal.

On SSB, there is no carrier on which a power rating might be based. A quantity called the "peak envelope power" (PEP) is used as the yardstick. This is the output power at the crest of the modulated waveform. Under recently amended FCC regulations, the maximum PEP output is 12 watts. Late-model equipment produces this level in most cases. Older units generally run 8 to 10 watts PEP in output, which is not significantly lower. In contrast to AM emissions, *all* of the SSB output is useful "talk" power.

AM Modulation Percentage describes the amount of carrier modulation. The optimum value is 100 percent. Most CB rigs are capable of 90- to 100-percent modulation. The difference between the two values is not audibly perceptible, however. R-f envelopes with varying degrees of modulation are shown in Fig. 2. Some of the following comments are based on these sketches.

AM Harmonic Distortion denotes the quality of the modulated signal at a given modulation level. The EIA standard specifies a maximum of 10-percent distortion when the carrier is modulated 80 percent by a 1000-Hz tone. Typical performance is in the order of 7- to 10-percent distortion at 90- to 100-percent modulation. Considerably higher distortion levels and "splatter" can result from overmodulation.

AM-Transmitter Modulation Spectrum specifications illustrate the frequency spectrum occupied by the modulated signal. This is an impor-

tant, though seldom-given, measurement. It shows the potential for "splatter" or interference to stations on other channels. Splatter is usually caused by overmodulation, which generates a wide band of spurious components. Excessive clipping may also be a cause. These are common operating conditions for many CB rigs, even those that employ some form of automatic modulation control (amc). The EIA standard (falling within FCC requirements) uses a 2500-Hz tone. Modulation products 4 to 8 kHz away from the carrier should be at least 25 dB below the unmodulated carrier level. At 8 to 10 kHz away they should be at least 35 dB down. Any products more than 20 kHz away should be 50 dB below the unmodulated carrier level. Typically, using the single-tone test, splatter at the adjacent channel will be at least 40 to 50 dB down.

SSB Intermodulation (IM) Distortion Products indicate if the modulated signal will extend beyond the normal passband. IM products, caused by transmitter nonlinearities or overmodulation, can produce splatter and deteriorate unwanted sideband suppression. The measurement uses two non-harmonically related tones of equal amplitude, such as 1000 and 1600 Hz to simultaneously modulate the transmitter. Odd-order distortion products are produced if the transmitter is not designed or driven correctly. They appear at odd multiples of the frequency difference between the test tones, as 3rd, 5th, 7th, etc., products away from the "carrier" frequency in ever-decreasing intensity.

The measurement is generally stated as follows: the X-order distortion products are at least Y dB below the peak level of the two equal-amplitude test tones. Other references include the mean power output (PEP/2), and the rated PEP output. Use of the latter references inflates the distortion measurement by 3 and 6 dB, respectively, but the performance only looks better. Therefore, the reference should always be specified. The EIA standard and the FCC requirement call for the SSB distortion products 2 to 6 kHz removed from the channel center to be at least 25 dB below the mean power output. Such products 6 to 10 kHz away must be 35 dB down. Equivalently, they must be 22 dB (2 to 6 kHz) and 32 dB (6 to 10 kHz) below the test tone's amplitude. We have typ-

ically found 3rd order products to run 19 to 22 dB down, with higher order products having greater attenuation.

Carrier Suppression tells how much the carrier is attenuated below a reference output level. The EIA standard states that the carrier must be at least 40 dB below the level of the two test tones, or 46 dB below rated PEP output. Typically, the carrier will run 40 to 50 dB below rated PEP.

Transmitter A-F Response. The definition of this spec is similar to that given for receiver a-f response. The EIA standard for AM transmitters is the same as that for receivers, except that a 6-dB/octave roll-off from 2500 to 3000 Hz is allowed. For SSB, the standard requires a minimum bandpass of 2000 Hz and a maximum of 3000 Hz over a range of -6 dB to +3 dB. See receiver specifications for the SSB low-frequency roll-off. Although the upper frequency limit for intelligibility in voice communications is generally recognized as 3000 Hz, the FCC-authorized bandwidth limit is 8000 Hz for AM and 4000 Hz for SSB, implying an upper a-f response limit of 4000 Hz.

Unwanted-Sideband Suppression ratings are the same as those for receivers.

Spurious Emissions indicate the strength of other transmitted signals outside the normal passband. This especially relates to r-f harmonics, a prime cause of interference (such as TVI) to other services. The EIA and FCC standards require that any spurious emissions of an AM transmitter removed 20 kHz or more from the center of the authorized bandwidth shall be at least $[43 + 10 \log_{10} (\text{mean power in watts})]$ dB below the mean power output. For SSB emissions, the frequency limit is 10 kHz. At CB power levels, this comes out to about 50 dB down, or an attenuation of 100,000 times the fundamental output.

Frequency Stability limits the output frequency to within a certain range of the nominal value. The legal tolerance for frequency stability is 0.005 percent of the assigned channel frequency, or about 1350 Hz on the CB band. This must be maintained over a wide range of supply voltages and ambient temperatures (such as -30 to +50°C).

Where a transmitter "clarifier" control is included (as in many SSB rigs), its range should be somewhat less than the frequency tolerance to ensure legal operations. In most cases, its range is about ± 800 Hz, centered on the assigned frequency. ♦

THE NEW COLOR TV PICTURE TUBES

BY ART MARGOLIS

IN 1950, when black-and-white television was sweeping the country, color TV was already well into the experimental stages. It was in March of that year that RCA held a special news conference at which they astounded their guests by demonstrating a working color TV receiver.

The receiver had a three-gun, tri-color shadow-mask picture tube, a radical departure from other color displays produced by rotating colored discs, projection optics, et al. That first picture tube exhibited only fair brightness, but the color itself was excellent. Interestingly, most color picture tubes today retain the same *basic* construction.

The Basic Color Tube. Most color picture tubes use a three-gun system in the tube's neck. Each gun "fires" an electron beam (cathode "ray") that is modulated by one of the signals for the three basic colors (red, green, and blue).

The second basic for the color picture tube is a metallic shadow mask located about $\frac{1}{2}$ in. (12.7 mm) from the face plate of the tube. The shadow mask is responsible for directing the individual beams onto their proper respective phosphors. Electrons that don't pass through the apertures in the shadow mask to strike the phosphors on the face plate of the tube are intercepted by the mask.

The phosphor area on the face plate of the picture tube is arranged in dot triads or stripes (the latter a relatively recent scheme) that are small enough for the human eye to resolve them into a moving color picture at normal viewing distances.

A Potpourri of Problems. From the beginning, it was obvious that three serious problems existed in shadow-mask color picture tubes. The most important was drastically reduced brightness when compared to conventional monochrome tubes to which we were accustomed.

The light emitted by a picture tube is the result of the intensity of the electron beam striking the phosphor material. The greater the number of electrons striking the phosphor, the brighter the picture. The beam can be "fortified" by using more durable heavy-duty cathodes, raising the acceleration voltage, and bundling the electrons into a tighter beam.

In the original shadow-mask tube, only about 20 percent of the electrons in the beams managed to get to the phosphors. The other 80 percent was impeded by the solid areas of the shadow mask, off which the electrons bounced and were collected by the high-voltage anode. Consequently, brightness was severely limited in the color tube, while the monochrome tube, in which there are no obstacles to the beam of electrons, could attain full brightness.

Setup adjustments were the root of another problem. In a monochrome tube, the only adjustments needed are for brightness and contrast. But in a color tube, 26 *more* adjustments were required. Eight were for adjusting the gray scale, two for proper beam landing, four for center convergence, and 12 for perimeter convergence. Further complicating matters, the 12 perimeter convergence adjustments could be set accurately only with the aid of a dot/bar generator.

How they will provide enhanced reception and easier maintenance.

Problem number three involved cost. A color picture tube was very expensive; it was many times more expensive than the same-size monochrome counterpart. This applied even for rebuilt tubes. (If the shadow mask/phosphor system is disturbed, one might as well build a new tube. As a result, rebuilding is limited to re-gunning.)

History of Improvements. In the years since the original shadow-mask was developed, hundreds of different schemes have been tried in attempts to obtain more brightness, simplify adjustments, and lower costs. Some of the attempts have been largely successful, but none has by any means been totally successful. For example, brightness has been increased from the original 22 foot-lamberts to about 115 foot-lamberts; in certain smaller-screen color TV receivers, 12 of the original 26 required adjustments have been eliminated; and the cost of the picture tube has dropped, though it is still considerably more expensive than a monochrome tube of the same size.

One-, two-, three-, and even four-gun tubes have been devised. However, the basic idea of three guns, aimed at three sets of phosphors, has stubbornly persisted as the most popular design approach to color picture tubes.

Historically, there were ten significant milestones in color TV since the inception of the three-gun/shadow-mask tube to the present same-type tube:

- The first, of course, was the original introduction. The phosphor screen was installed on an internal flat

plate that was fixed against the face plate of the tube.

- In 1953, the phosphor was placed directly on a curved glass face plate, which helped to bring down production costs. Photo-deposition was used to place the dot triads of phosphor on the face plate. (It was discovered that it was best to install the dots using the shadow mask itself as the director, rather than attempting to obtain standardization.)

- In 1954, the original color picture tubes had 15-in. (38.1-cm) diagonal measurements and 45° deflection angles. RCA devised new electron guns with internal pole pieces that permitted each cathode ray to be independently adjusted. This permitted deflection angles to widen to approximately 70° and made setup adjustments easier. Eventually, over 90° could be achieved as a result of this improvement.

- Between 1954 and 1963, a number of manufacturing techniques were developed. A way was devised to remove and reinstall the shadow mask during phosphor deposition, resulting in the development of tapered metal studs with circumferential springs and a lightweight frame for holding the shadow mask. Corning Glass developed a new "frit" glass seal that made a ceramic-like bond. This resulted in the development of the first all-glass picture tube envelope.

- The year of the 90°-deflection rectangular tube was 1964. The new tube began to work like a conventional monochrome tube as the neck narrowed and shortened and the deflection angle widened. With electron guns reaching closer to the screen due to the shortened neck, brightness has been increased, setup adjustments have been eased, and costs have been slightly reduced.

- Rare-earth phosphors appeared in 1965. The red phosphor's light output, weaker than the others, was many times brighter than before, enhancing color quality. In the same year, General Electric adapted the in-line electron gun arrangement to the color picture tube.

- In 1968, Sony Corp. of Japan introduced the Trinitron color picture tube using a single electron gun. The electron gun employed a single cathode that produced a large cathode ray that enters three electron lenses, each with its own set of beam controls. The output of the single gun was three beams. Also, instead of the

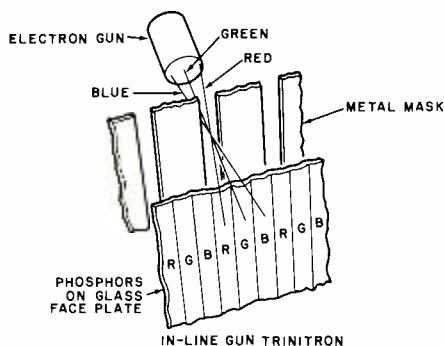

The Sony in-line Trinitron mask and color stripe system.

traditional shadow mask, the mask in the Trinitron tube consists of vertical strips that direct the three beams to vertical phosphor stripes. The large lens diameter reduces aberrations; vertical resolution is excellent because there are no horizontal cross ties; and the in-line beam lenses reduce setup adjustments. However, since the vertical-striped mask must have its own frame, the overall cost of the Trinitron system is substantially higher than the traditional RCA approach.

- The year of the black matrix tube was 1969, with Zenith leading the way. It was known that the areas on the screen not covered by phosphor should be black to prevent the "whiteness" of the phosphor materials from diffusing back ambient light and reducing contrast. In the early days, the only solution to the reflected light problem was the use of grey glass that absorbed the reflections. This doubled the contrast but, unfortunately, also reduced brightness by about 50 percent. However, by surrounding the

phosphor dots with jet black material, the reflections could not get out, allowing clear glass to be used and resulting in an almost two-fold increase in brightness.

(At first, a "positive" matrix was used. The holes in the shadow mask were smaller than the dots and the electron beam hit only the center of the phosphor dots. Not all of the dot was excited, and potential light was lost. The switch to the "negative" matrix permitted the use of larger holes in the shadow mask and a thicker electron beam. Now, the beam was able to cover the entire dot and even overlap into the black surround. The overall result was another increase in brightness.)

- The 110°-deflection color picture tube came on the scene in 1970. The new tube reduced the front-to-rear dimension of the receiver. More importantly, it also brought the electron guns closer to the phosphor screen. This resulted in tightly bundled beams that produced a tiny spot size with increased brightness and sharper focus. Sony engineers took the process a step further with a 114°-deflection Trinitron tube. The larger deflection angle was aided by the advent of new receiver designs, new deflection yokes, and new solid-state horizontal sweep devices.

- Finally, in 1972, came the precision in-line system. Combining all the advantages and trying to eliminate disadvantages, the in-line tube's beams (as in the Trinitron) are arranged in a horizontal plane, and the phosphor is in the form of vertical stripes. The shadow mask has vertical strips instead of round holes that line

COMPARISON OF GENERAL CHARACTERISTICS (15" SIZE)

	1954 Early Tube	1974 Up-To-Date Tube
Light Output	20 Fl	115 Fl
Length	26"	12.4"
Faceplate	14.6" Diam.	16.5" × 14.2"
Screen Area	8.6" × 11.5"=88 sq. in.	9.5" × 12.7"=117 sq. in.
Weight	25 lb.	18 lb.
Deflection Angle	45 degrees	110-114 degrees
Anode Voltage	25 kV	25 kV-30 kV
Gun	Delta	In-line
Mask	Holes	Slots
Neck Diameter	36 mm	29 mm
ITC	No	Yes
Phosphor Array	Dot triads	Vertical lines
Adjustments	Purity, static, dynamic	Purity, static
Black Surround	No	Yes

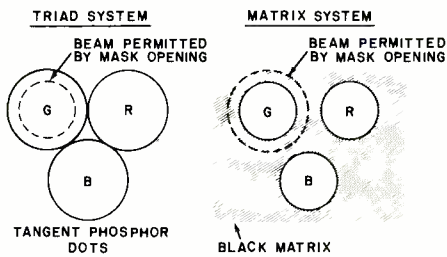

Comparison of original dot and negative guard-band matrix system.

up with the phosphor stripes. To give the mask rigidity so that it can be self-supporting and curved to match the curvature of the face plate of the tube, the strips are joined together with horizontal cross ties.

The in-line-gun system is complemented by a precision static toroid (PST) yoke that is permanently bonded to the neck of the tube. Since this makes the system virtually a "monolithic" structure, it is necessary to replace yoke and tube together. Between the in-line beams and the permanently affixed yoke, factory adjusted in place, all of the 12 dynamic convergence adjustments are eliminated.

Higher Anode Voltages. In spite of the X-ray scare of a few years ago, color TV receiver manufacturers are striving for higher and higher anode voltages to obtain more brightness from the picture tubes. It is not, however, a blatant disregard of the radiation hazard inherent when high voltages are used. A recent development makes reaching for those higher voltages a relatively safe proposition.

It is a known fact that a 30-kV anode potential results in a 10-percent brightness improvement when compared to a 25-kV anode potential. Also, if the current is increased on a tube operated at 30 kV, picture sharpness can be made as good as that obtained at 25 kV. In the case of equal sharpness, the improvement in brightness rises by another 30 percent because of the extra current. Consequently, the brightness can be as much as 50 percent higher without losing the spot quality of a 25-kV anode potential.

In terms of viewing, this is an excellent improvement, but a lot more X-rays are produced at the higher voltages and currents. However, new X-ray absorbing glass is now available. When this special glass is used, the federal limit of 0.5 milliroentgen/hour can be met.

Many of the new color TV receivers are designed for 30-kV operation. So, correct replacement of picture tubes with X-ray absorbing glass *must* be done to avoid possible hazard.

For 1975. The major color picture tube manufacturers for the U.S. market for 1975 will be Channel Master, General Electric, GTE Sylvania, RCA, and Zenith. (Philco is no longer manufacturing a color picture tube.) Overseas, Sony will continue to produce the Trinitron, and other manufacturers will make delta and in-line picture tubes under license from the larger companies. Here is what you can look for from the companies.

Channel Master is taking the utilized idea of hardware and glass to a further extreme. It is marketing the "Speed Fit" series that consists of the basic picture tube plus the tube strap, corner brackets, adhesive pads, shield, coils, and degaussing coil, all assembled and ready for installation. The series includes a tube to fit exactly into some Motorola, Zenith, and RCA color receiver chassis. All the serviceman has to do is pull the old tube and assembly, put in the new one and reset and tighten the yoke.

General Electric, the introducer of the in-line gun arrangement in its 1965 PortaColor TV receiver, is introducing the company's latest in-line tube, called the Quadline. The tube is similar to the precision in-line tubes being marketed.

In addition to producing the latest industry standards, GTE Sylvania has been working on picture tube

cathodes. Since solid-state circuitry is virtually instantaneous in power-up, only the picture tube's cathode lags behind full instantaneous turn-on. So, Sylvania now has a 5-second cathode that does away with continuously powered instant-on energy wasters. We expect to see the new cathode almost universally adopted in picture tubes during the next few years.

RCA continues to work on simplifying controls, reducing overall tube length and weight of the tube system, and building of tubes with more brightness, greater contrast, and sharper focus.

Zenith's new tubes have electron guns that are more precise than before. The shape of the beam has been improved and made almost perfectly round, while the electrons are more tightly bundled. The result is better picture sharpness and focus.

Sony still has its Trinitron with in-line gun lenses and full-length masks. Other foreign constructions are based on the in-line-gun/slotted-mask principle.

Panasonic's color TV receiver line for 1975 features both an improved dot-triad picture tube design as well as the newer in-line-gun color-stripe picture tube. The picture tube used in the company's Quatre-color line of receivers features an added prefocus grid in the electron gun assembly to insure brighter, sharper pictures. Both tube types employ a negative-guard-band black matrix surrounding the phosphor dots and stripes.

Toshiba also has dot-triad and in-line-gun/color-stripe picture tubes in its color receiver line this year. Both tube types employ the black matrix system.

The race for brighter, sharper, shorter and less expensive picture tubes that need the very minimum number of setup controls is going on at a furious pace. Right now, most smaller screen color picture tubes can be built in the traditional dot-triad or the newer in-line-gun/slotted-mask design. The largest picture tubes, measuring up to 25 in. (63.5 cm) diagonally, still rely heavily on the design originally introduced by RCA 25 years ago, although some very important innovations have been added to keep them up to date.

What the future holds for color picture displays is anyone's guess. The flat-screen picture "tube" may eventually emerge, given enough time, but it is not in the cards at the moment. ♦

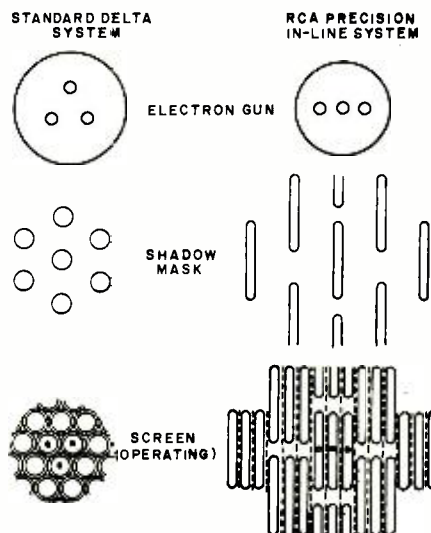

Triad vs in-line slot mask of RCA color CRT system.

CREI—the only home-study college-level training

and now

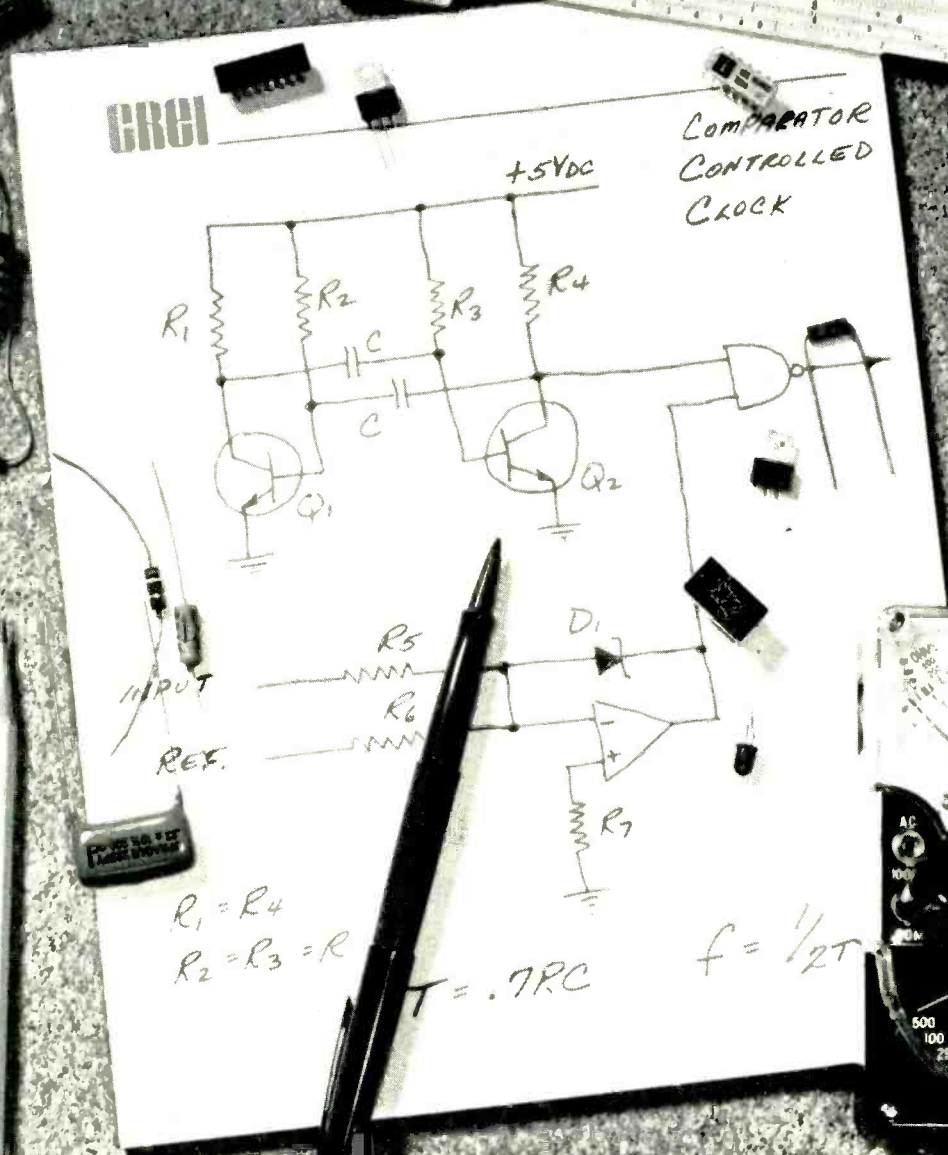
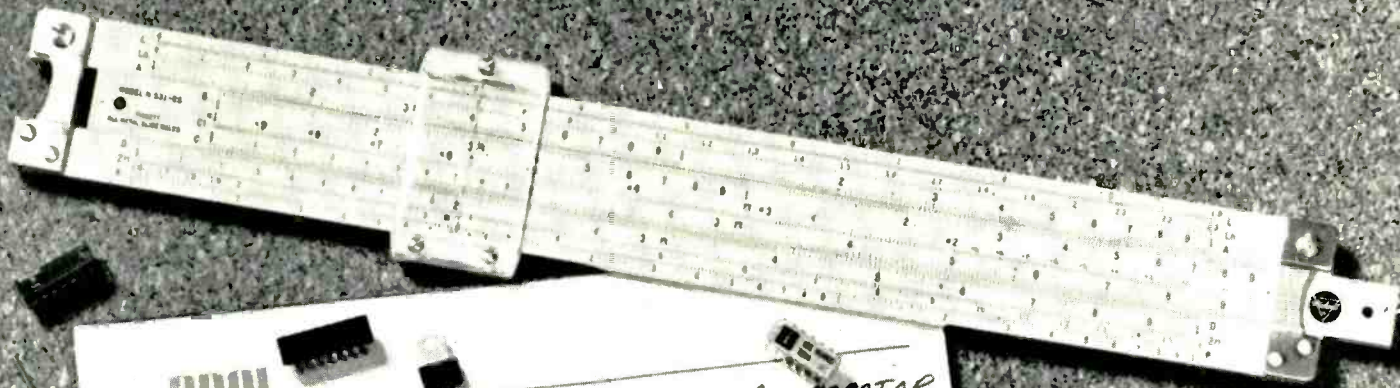

program which gives you in electronic circuit design

only CREI offers you a complete college-level Electronic Design Laboratory to speed your learning

Electronic circuit design—source of all new development in the application of electronics to new products and services. Without this skill, we would be unable to monitor the heartbeat of men in space. Without it, the computer revolution would never have occurred. And we would have yet to see our first TV show. Yet, *only CREI teaches electronic circuit design at home.*

ELECTRONIC CIRCUIT DESIGN

A key skill which paces our nation's progress in countless fields—from pollution control to satellite tracking to modern medicine to exploring the ocean's depths. And beyond. A skill which *you* must have to move to the top in advanced electronics.

CREI programs open up new worlds of opportunity for you.

In addition to electronic circuit design, CREI provides you with a full advanced electronics education in any of thirteen fields of specialization you choose. Communications, computers, space operations, television, nuclear power, industrial electronics—to mention just a few of the career fields for which CREI training is qualifying. With such preparation, you will have the background for a career which can take you to the frontiers of the nation's most exciting new developments. And around the world.

This free book can change your life. Send for it.

If you are a high-school graduate (or equivalent) and have previous training or experience in electronics, then you are qualified to enroll in a CREI program to move you ahead in advanced electronics.



Send now for our full-color, eighty page book on careers in advanced electronics. In it, you will find full facts on the exciting kinds of work which CREI programs open up to you. And full facts on the comprehensive courses of instruction, the strong *personal* help, and the professional laboratory equipment which CREI makes available to you. All at a surprisingly low tuition cost.

And when you have it, talk with your employer about it.

Tell him you're considering enrolling with CREI. He'll undoubtedly be happy to know you are planning to increase your value to him. *And he may offer to pay all or part of your tuition cost.* Hundreds of employers and government agencies do. Large and small. Including some of the giants in electronics. *If they are willing to pay for CREI training for their employees, you know it must be good.*

Send for Advanced Electronics today. You'll be glad you did.

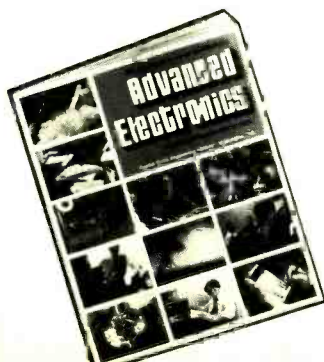

CREI Dept. E-1203-F
3939 Wisconsin Avenue
Washington, D.C. 20016

Rush me your FREE book describing my opportunities in advanced electronics. I am a high school graduate.

Name _____ Age _____

Address _____

City _____ State _____ ZIP _____

If you have previous training in electronics, check here

Employed by _____

Type of Present Work _____

Veterans and service www.americanradiohistory.com

CREI

**CAPITOL
RADIO
ENGINEERING
INSTITUTE**

WASHINGTON, D.C. 20016

4-CHANNEL EQUIPMENT REPORT

BY JULIAN D. HIRSCH



FOUR-CHANNEL or quadraphonic sound is an extension of stereophony, in much the same manner as stereo evolved from mono. By recording and reproducing through four program channels, an added sense of depth and spaciousness can be imparted to music. Also, it becomes possible to write and arrange music to be heard in different directions with the listener in the center of the stage. Although it is not what most of us are used to hearing, this is a legitimate musical experience which is made possible only by four-channel recording and reproduction.

Four-channel tape-recordings have been with us for many years, although an insignificant number of commercially recorded four-channel tapes is available (in open-reel form, at least). However, a growing number of four-channel tape decks is appearing on the market and we can probably expect new tapes to follow this trend.

Most four-channel tapes are in the form of Q-8 cartridges, playable on home or car cartridge decks which are

designed for their use. (These can also play the more common stereo cartridges.) The Q-8 cartridges have all the advantages and disadvantages of the cartridge format, but the sonic impact of the four-channel reproduction often overshadows any deficiencies in the tape system.

Theoretically, four-channel cassettes should be possible, but a combination of technical and patent licensing problems has so far blocked the entry of cassettes into the four-channel tape market.

Phonograph records dominate the quadraphonic scene and probably will continue to do so. Matrix records, such as Columbia's SQ and the Sansui QS system employed by a number of smaller record companies, can provide a moderate-to-good quadraphonic effect, although the four recorded channels are intermingled to a considerable degree. Special decoder "logic" circuits can greatly enhance the separation of matrixed four-channel recordings, and anyone with a serious interest in quadraphony

should invest in a good logic decoder. These are available as add-on accessories and are built into new four-channel receivers and amplifiers. You should be aware that most four-channel receivers claiming SQ capability do *not* have logic enhancement and cannot be expected to give a definite sense of separation.

The other major quadraphonic disc system is the CD-4 "compatible-discrete" system developed by the Victor Company of Japan. The majority of CD-4 records in this country is issued by RCA Victor but other labels are joining them as the system becomes more widespread. Unlike matrix records, which can be played by any stereo phono cartridge and can be transmitted over FM radio, the CD-4 system requires a special cartridge, with a frequency response extending to 45 kHz, and a separate decoder modulator. It cannot be broadcast in four-channel form. On the other hand, the CD-4 system has superior four-channel separation, producing a distinctly different overall effect than matrixed records, even when they are played through a full logic decoder.

Fortunately, SQ, QS, and CD-4 discs can be played as stereo discs. In this sense they are compatible—for stereo, but not with each other. It should also be noted that a stereo cartridge may ruin a CD-4 disc for future quadraphonic playback.

If you are planning a complete four-channel system, or intend to make a major changeover from an older stereo system, a receiver is the most logical choice for the central component. The better four-channel receivers have adequate power (25 to 50 watts per channel) for most purposes and many of them have decoding facilities for all types of four-channel records. However, *no* single receiver or decoding accessory gives optimum performance with all three record types. Each favors one of the systems to the detriment of the others. In every case, however, an external SQ or CD-4 accessory can provide full flexibility and performance for the least favored system. Another point to watch for is the very low audio power ratings of some lower-priced four-channel receivers. Often able to deliver between 7 and 10 watts per channel, these may not be suitable for driving many popular low-efficiency speakers except in a very small room.

It is easy to convert a stereo system to four channels without any obsoles-

cence. Connect a good, full-logic SQ decoder or CD-4 demodulator to the amplifier's tape recording outputs. The decoder front channels return to the tape monitoring inputs and the rear channels go to a second stereo amplifier which drives the rear speakers. The decoder acts as a system control unit and master volume control; and its tape outputs, in turn, can be used for a different type of four-channel decoder or a tape deck.

If your system is to include the CD-4 facility, check to see that your record player tonearm has low capacitance wiring, a necessity for most of the new CD cartridges if their high-frequency response is to be maintained. Check with the manufacturers of the cartridge and the record player if you have doubts. If you simply install a CD-4 cartridge in your old record player, you may be disappointed in the results.

There are no hard and fast rules on speaker choice or placement for quadrasonic listening. As with stereo, the better the speaker, the better the sound. It is not necessary to have identical speakers for all channels, but they should have roughly similar sound qualities. Often it is possible to use smaller speakers in the rear channels (from the same manufacturer as your front speakers), with completely satisfactory results.

As for your speaker placement, in most cases existing architecture or furnishings will prevent setting the rear speakers in the corners of the basic quadrasonic rectangle. This rarely impairs their effectiveness, but some experimentation is usually necessary for best results.

There are several four-channel headphones on the market for use with four-channel systems. Although they do not sound like stereo headphones, they also do not simulate the effect of the four-channel speaker listening. But neither do stereo headphones sound like stereo speakers!

Insofar as four-channel FM is concerned, it's being broadcast, spottily, in matrix form. This can be picked up with the appropriate matrix decoder, as incorporated in a four-channel receiver. Discrete four-channel FM systems have been proposed too, and are presently undergoing field tests. Unlike matrix broadcasts, this system does not utilize existing broadcast station stereo transmission equipment and therefore requires a change in FCC Rules and Regulations. ◆

PACE CB 2-WAY RADIOS FOR RUGGED OUTDOOR USE

CB 133: IDEAL FOR RUGGED USE IN YOUR MOTORHOME, CAMPER OR TRAILER

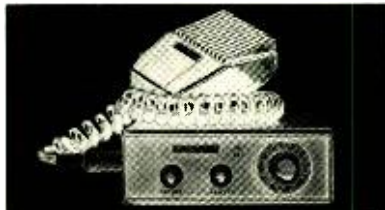

■ **GREATER RECEIVING RANGE:**

- Sensitive dual conversion superheterodyne narrow band receiver for adjacent channel rejection.
- Shaped audio response for more voice clarity.

■ **MORE TALK POWER:**

- Transmitter equipped with rugged silicon output and driver transistors for conservative delivery of maximum legal power output.
- 100% modulation to ensure full utilization of RF power and communications range.

■ **EXTRA VALUE FEATURES:**

- 23 channel synthesized design — no additional crystals to buy.
- Engineered for (+) or (-) ground vehicle applications.
- Mini-size — 1½" H x 5" W x 7" D.
- 2-year U.S. factory service program.

ONLY \$119.95

Total convenience and safety while trailering and camping for only \$179.90 for the combination of the CB 133 and CB 125. PACE CB radios offer you dependability and reliability when needed.

See your dealer today or write for further information. Please specify no. 62



Pace Communications, Div. of Pathcom Inc.
24049 S. Frampton Ave., Harbor City, Ca. 90710

Available in Canada.

CIRCLE NO. 26 ON READER SERVICE CARD

CB 125: IDEAL TO STAY IN TOUCH WITH YOUR BASE CAMP



WHEN GOING FISHING, OR HUNTING

- Squelch control for eliminating background noise.
- 3-position channel switch for channel selection.
- Remote speaker and earphone jacks (included).
- Optional battery charger AC adapter.
- Automatic gain control for listening convenience.
- High performance telescopic antenna.
- 2.5 watts RF power for increased range.
- Optional texon carrying case.

ONLY \$59.95



12 REASONS YOUR CAR NEEDS TIGER CDI

Instant starting in any weather - Eliminates tune-ups - Increases gas mileage - Increases horsepower 15% - Improves acceleration and performance - Spark plugs last up to 70,000 miles - Reduces engine maintenance expense - Amplifies spark plug voltage to 45,000 volts - Maintains spark plug voltage to 10,000 RPM - Reduces exhaust emissions - Dual ignition switch - An Unconditional LIFETIME GUARANTEE Installs in 10 minutes on any car with 12 volt negative ground - No rewiring - Most powerful, efficient and reliable Solid State Ignition made.

SATISFACTION GUARANTEED or money back

TIGER 500 assembled \$53.95

TIGER SST assembled \$42.95

Post Paid in U.S.A.

Send check or money order with order to:

Tri-Star Corporation

P. O. Box 1727 C
Grand Junction, Colorado 81501

DEALER INQUIRIES INVITED

CIRCLE NO. 38 ON READER SERVICE CARD

LARGE-LARGE DISCOUNTS LOW - LOW PRICES

NATIONALLY ADVERTISED STEREO EQUIPMENT AT LOWEST PRICES!

TURNTABLES • SPEAKERS • RECEIVERS
AMPLIFIERS • TAPE RECORDERS

WRITE FOR QUOTE ON
NATIONALLY ADVERTISED BRANDS OF STEREO
COMPONENTS. SATISFACTION
GUARANTEED!

Clifford's

HI-FI WHOLESALERS
P. O. Box 809
Kankakee, Illinois 60901
(815)-939-7868

CIRCLE NO. 9 ON READER SERVICE CARD



Product Test Reports

ABOUT THIS MONTH'S HI-FI REPORTS

This month we are reviewing two very different products. The growing trend toward deluxe, direct drive automatic single play turntables is exemplified by Pioneer's finest model, the PL-71. Outstanding overall performance and the utmost mechanical simplicity have earned the direct drive turntable a place in the product line of almost every major manufacturer of record players. The new Pioneer unit is a typical example of what is available to the audiophile who wants the latest and best in record playing equipment.

Although "new" speakers are announced regularly, few are really significantly different from—let alone better than—their competitors. The Philips RH532 Motional Feedback speaker system is a notable exception. In a sense, it has no competitors, since nothing else quite like it is available in this country. As our tests show, this speaker is different from the others on the market. It may not appeal to every listening taste, and is rather expensive, but it does deliver some of the most natural sound we have heard from any speaker, and it is unquestionably superior to any speaker of comparable size that we have ever heard.

—Julian D. Hirsch

PIONEER MODEL PL-71 RECORD PLAYER

Servo-controlled, direct-drive turntable for smooth, quiet operation.



The Model PL-71 is at the top of Pioneer's 1975 line of record players. It features a direct-drive turntable, a high-quality tone arm, and a handsome walnut-finished wood base, fitted with a hinged plastic dust cover. The system

comes ready to play as soon as you install a phono cartridge.

General Description. The record player's 3.5-lb (1.6-kg) cast aluminum-alloy platter measures 12.25 in. (31.8 cm) in diameter. It is mounted directly on the motor shaft, whose extension forms the center spindle for the record being played. The brushless dc motor is servo-controlled to operate at either 33 $\frac{1}{3}$ or 45 rpm.

A vernier control system permits each speed to be adjusted by about ± 2 percent, and the stroboscope markings around the edge of the platter (for both speeds and for 50- and 60-Hz line frequencies) make it easy to check and adjust the speed while a record is being played. A neon lamp, built-in near the platter, illuminates the stroboscope markings.

All operating controls are on a panel

located to the right of the turntable platter. Pushing one of the two **START** buttons puts the turntable into motion at the corresponding speed. Two small knobs nearby are the vernier controls. A separate pushbutton shuts off the motor.

The operation of the tonearm is entirely manual and separate from the turntable drive. The arm is constructed of thin stainless steel tubing, S-bent to provide the necessary offset angle for the cartridge. The counterweight can balance cartridges weighing between 2 and 32 grams. It slides into position for approximate balancing and rotates for final adjustment. The counterweight has a calibrated scale that is initially set to zero. The entire assembly is then rotated until the desired tracking force is indicated on the 0-to-3-gram scale by alignment with a mark on the arm tube. The scale is graduated in 0.5-gram increments.

The arm has a lateral balance weight, the function of which is not made clear in the instruction manual. (However, the manual does indicate the recommended settings for the weight positions.) The antiskating force knob next to the base of the tonearm is calibrated on a 0-to-4 scale, normally being set to agree with the vertical tracking force. The tonearm lift lever, also near the base of the arm, has a rapid lift action but a slowed and damped descent.

The low-mass cartridge shell is slotted for overhang adjustment. The 45-rpm spindle has rings calibrated at 1-mm intervals from 10 to 18 mm that are used to locate the stylus when adjusting the cartridge overhang beyond the center spindle. A small pin on the base stores the 45-rpm adapter when it is not in use. And a 45-in. (1.15-m) low-capacitance signal cable supplied with the player plugs into phono jacks located on the rear of the base of the player.

The retail price of the Pioneer Model PL-71 record player is \$299.95.

Laboratory Measurements. We tested the record player with an Ortofon Model VMS-20E phono cartridge installed in its tonearm. When we set the overhang to the recommended 14.5 mm, the tracking error was excessive. But then we used a stylus protractor to adjust the overhang for minimum tracking error (which turned out to be 18 mm, corresponding to the outer edge of the 45-rpm adapter/gauge). With this setting, the tracking

error was less than 0.5°/in. at all radii from 2 to 6 in. (5.1 to 15.2 cm). It was typically less than 0.33°/in.

The stylus force indications were accurate to within 0.1 gram. As with most antiskating devices we have used, the optimum setting of the control on this player was slightly higher than the vertical tracking force setting by about 1 gram. However, this adjustment, made on the basis of equal distortion in both channels when playing a high-velocity disc, is not critical.

The resonant frequency of the tonearm/cartridge assembly was approximately 6 Hz. The pickup tracked severely warped discs better than most conventional tonearms that we have tested, with relatively little tend-

ency to jump grooves on the disc.

The arm lift had to be handled carefully, since it was not damped and a rapid action could cause the arm to bounce and shift laterally. However, the descent was slow and damped, with little tendency to shift outward under the influence of the antiskating bias.

Pioneer has evidently designed the PL-71 for compatibility with CD-4 cartridges, most of which require less than 100 pF of total shunt capacitance for full frequency response. The PL-71's total cable capacitance, including that in the wiring in the tonearm, was about 90 pF.

Once set, the turntable speed did not change at all with line variations

between 85 to 140 volts. The vernier range was ± 3 percent for each speed (rms unweighted). The unweighted rumble was 33 dB down and was predominantly a subsonic 5-Hz component. With RRL 'audibility weighting, the rumble was 56 dB down, which is typical of the best turntables.

User Comment. This was a very easy player to use. Its well-designed finger lift, feather-touch operating controls, and total silence and smoothness conveyed a strong sense of precision. The entire base is supported on vibration-isolating feet that should make it relatively immune to acoustic feedback in troublesome installations. **CIRCLE NO. 65 ON READER SERVICE CARD**

PHILIPS MODEL RH-532 SPEAKER SYSTEM

Solid-state comparator system and built-in amplifier control speakers.

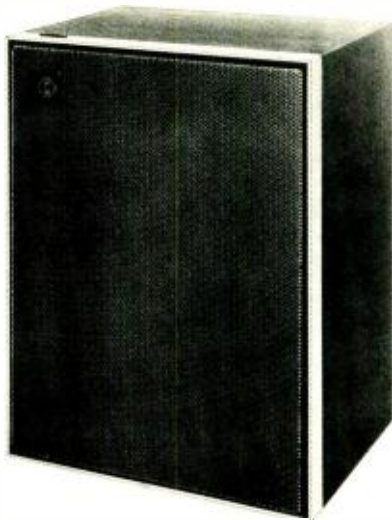

Over the years, a variety of ways of controlling a woofercone's excursions so that

they conform with its input signals have been introduced. The Philips Model RH-532 speaker system exemplifies the electronic servo system approach. It uses a solid-state comparator circuit and built-in bi-amplifiers for a unique "Motional Feedback System."

The three-speaker system's 8-in. (20.3-cm) woofer is driven by a 40-watt rms amplifier with an 18-dB/octave active crossover at 500 Hz to a 5-in. (12.7-cm) midrange driver. The latter and a 1-in. (2.54-cm) dome tweeter are driven by a separate 20-watt rms amplifier that has a 12-dB/octave passive crossover at 4000 Hz. Signals below 35

Hz are removed by a 12-dB/octave input filter.

The wood, walnut-veneer cabinet with perforated metal front measures 15 in. high by 11¼ in. wide by 8¾ in. deep (38.1 × 28.6 × 22.3 cm). Retail price is \$365.

General Information. The principle of the Motional Feedback system is simple enough. A piezo-electric element, mounted at the end of the woofer's voice coil, generates a signal based on voice-coil motion that is fed back to a comparator at the bass amplifier's input. The latter generates a distortion-correction signal.

Although the system is about half the size of most "bookshelf" speaker systems, its three drivers in their sealed compartment actually occupy only about half of the volume. The electronic portion of the system is mounted on a metal panel that forms the back of the cabinet and doubles as a heat sink for the amplifiers output transistors. The panel is hinged for servicing.

The amplifiers require only about 1 volt of driving signal to develop full output. They can be driven directly from preamplifier outputs. The 3000-ohm input impedance may be too low for some preamps, but most of the better units are compatible with it. (Philips makes a preamp, the Model SC102, that is designed to drive the RH-532 speakers.) The speakers can also be driven by external power amplifiers, since they contain 25-ohm load resistors and input attenuators

suitable for use with amplifiers nominally rated at 7 to 45 watts into 8-ohm loads. There's also a switch position for amplifiers with outputs exceeding 45 W. A switching arrangement on the rear of the cabinet alters the input characteristic.

Both audio channels can be connected to either speaker, with the second speaker plugged into parallel feedthrough jacks in the driven speaker in a stereo setup. This obviates the need for fanning out two sets of signal cables from the amplifier and makes it easier to hide the amplifier-to-speaker hookups. A switch on each speaker connects it to the right or the left signal channel, as desired. The power cables have a similar pass-through feature. Thus, only one speaker need be located near a power outlet.

Normally, the speakers are left on. A

Photo shows electronics used to control speakers.

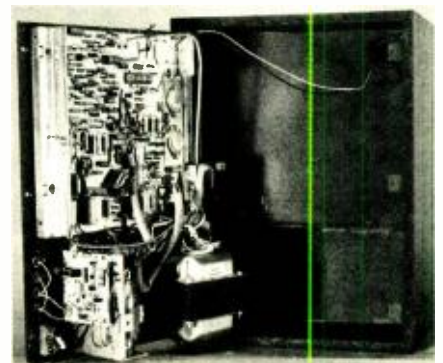

power switch is provided on the rear of each speaker system for safety purposes, but it is not used after initial setup. A sensing amplifier in each speaker responds to any input signal that exceeds about 1 mV, such as the turn-on transient or background noise level from any amplifier, and switches on power to the amplifiers.

stant input levels of 1 volt (rated maximum) and 0.3 volt (10 dB down). At the lower level, the distortion was about 1% between 80 and 100 Hz. It increased to 4% at 60 Hz and 9% at 50 Hz. At maximum input—producing a far greater sound pressure level (SPL) than normally used for a speaker distortion test—distortion was naturally

Philips speaker seems at first to sound somewhat bright and slightly weak in low bass performance. After a period of exposure to the speaker's sound, we switched back to one of our favorite conventional speaker systems. The A-B comparison astounded us because the latter sounded relatively "muddy."

Some of the difference can be explained by the fact that the resonant rise that colors the sound of almost every dynamic speaker system in its middle-bass range is totally absent in the Philips speaker system, where it is suppressed by the motional feedback setup. To determine if this difference in sound character could be due to its frequency response, we used an octave-band equalizer to alter the system's response to match that of a very good conventional system, and vice versa. The basic difference in sound quality remained, verifying our original reasoning.

The RH-532 exhibits a clarity, complex-passage definition, and overall natural musical quality that belies measured specifications.

Since the Philips speaker system sounds so dramatically different from other systems, it's likely that most listeners will develop strong pro and con opinions based on their listening experience. For example, the virtual absence of bass "tubbiness" may initially be disturbing to some. It has a tight bass that is strong and very clean down to the lowest musical fundamentals of most instruments, though pipe-organ and bass-drum devotees might find it wanting in the lowest audible octave.

A novel advantage of this speaker system is its ability to extend the capability of a good-quality but low-power amplifier or receiver. The output of a 10-watt amplifier, for example, becomes effectively 60 watts when it drives the RH-532 system. The quality of the sound is benefitted accordingly.

There is no doubt that Philips has developed an exceptional speaker system whose performance will appeal to many music listeners who seek convincingly realistic sound and have limited speaker-placement space. At \$730 a pair, it will likely appeal to those hi-fi aficionados who do not own costly amplifiers or receivers. However, don't forget that the RH-532 can also be used with high-power amplifiers.

CIRCLE NO. 66 ON READER SERVICE CARD

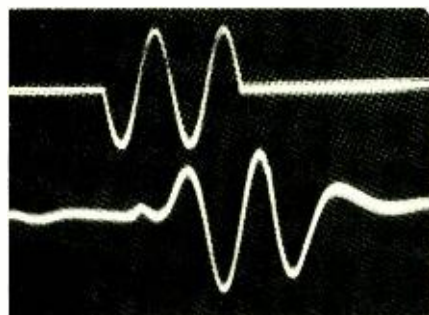
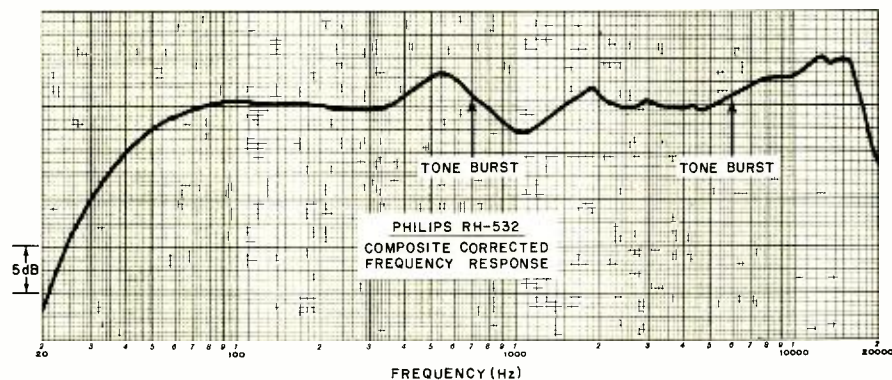

700-Hz tone burst.

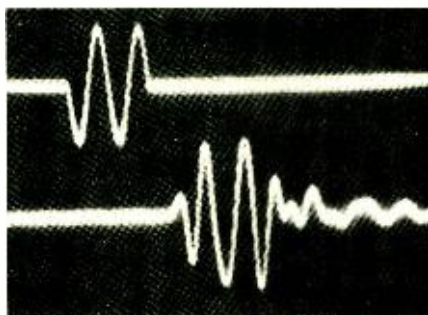

6000-Hz tone burst.

Low-level stages of the amplifier are always energized, eliminating speaker thumps due to starting transients. About three minutes after the driving signal is removed, the speakers automatically shut off.

Laboratory Measurements. In a normal listening room, the integrated and smoothed frequency response of the speaker system was within ± 4 dB from 50 Hz to 18,000 Hz. Between 65 Hz and about 350 Hz, the output varied only ± 0.5 dB, dropping off smoothly to -5 dB at 40 Hz. There was a ± 3 -dB variation in output between 400 and 2000 Hz, followed by an almost perfectly flat ± 0.5 -dB response up to 5500 Hz. The output rose gradually at higher frequencies to about $+5$ dB between 12,000 and 15,000 Hz.

Instead of relating bass distortion to input power, we measured it at con-

higher; 5% down to 80 Hz, 10% at 70 Hz, and 25% at 60 Hz.

Although the efficiency of the speaker system cannot be judged in the usual manner, a 1-volt input in the midrange produced a 104-dB SPL at a distance of 1 meter. With music sources, a pair of speakers easily generated SPL's exceeding 100 dB in the reverberant field of the room some 4 to 5 meters from the speakers. This is much louder than most people would use for listening, but there was no sense of strain or audible distortion at this level. High-frequency distortion was fair, and we could hear the beaming of the highs as we walked past the speaker at close range. At normal listening distances, however, this effect was not noticeable.

User Comment. As the measured frequency response suggests, the

REGENCY MODEL ACT-C4H SCANNING MONITOR RECEIVER

(A Hirsch-Houck Labs Report)

Automatic scanning of 4 channels in 150-to-174-MHz band.



THE Regency Electronics Model ACT-C4H Monitorradio is a compact, inexpensive vhf scanning receiver. It is designed for monitoring narrow-band police, fire, Civil Defense, and other radio service FM transmissions in the 150- to 174-MHz band. The fully self-contained receiver is housed in a high-impact ABS plastic case. A small speaker is located under the top surface of the case, and a telescoping antenna screws into the receiver through a hole in the case top. A sliding section of the case can be removed for easy installation of the crystals for the desired channel.

General Information. The front of the receiver is stepped, with the operating controls located on the horizontal portion of the step. The sloped-back portion contains the display numerals 1, 2, 3, and 4 that light up to identify the channel to which the receiver is tuned.

Two controls are provided for adjusting audio volume and the noise squelch threshold. All other functions are controlled by slide switches. One is the power switch that can set up the receiver for either scanning or manual operation. In manual operation, another switch can be used to advance the tuning one channel each time it is pressed. Four orange-colored knobs correspond to signal lights behind them. They enable any or all of the channels to be selected or locked out in both the manual and the automatic scanning modes.

The receiver employs a single-conversion superheterodyne design, with the i-f at 10.7 MHz. The local oscillator is crystal controlled. (Crystals are not included with the receiver, since each user will have his own spe-

cial requirements. The instruction manual included with the receiver provides information for ordering the crystals for any frequencies in the receiver's range.)

In the scanning mode, the channels are switched at a rate of approximately 15 per second. A two-pole crystal filter provides the i-f selectivity, and integrated circuits are used in the receiver.

The manufacturer's specifications indicate that the maximum separation between channels should be less than 8 MHz if full sensitivity is to be maintained. A 12-MHz separation is possible with reduced sensitivity. The rated sensitivity is 0.6 μ V for 20 dB quieting. Selectivity is rated at ± 7000 Hz at -6 dB and $\pm 32,000$ Hz at -50 dB. Transmitter deviations as great as 7000 Hz around the center frequency can be accepted by the receiver. Spurious rejection, other than images, is 50 dB.

The squelch threshold can be set as low as 0.5 μ V. The rated audio output power to the built-in 16-ohm loudspeaker is 0.5 watt at less than 10 percent distortion. The receiver operates from a 105-to-130-volt, 60-Hz ac power source and consumes less than 9 watts of power in operation.

The overall dimensions of the receiver are 6 $\frac{1}{8}$ in. wide by 6 $\frac{3}{4}$ in. deep by 2 $\frac{1}{8}$ in. high (17.5 \times 17.1 \times 5.4 cm). The antenna can extend to 26 in. (0.66 m) above the table top on which the receiver sits. Overall weight is 1.5 pounds (0.68 kg).

The retail price of the Regency Model ACT-C4H Monitorradio is \$89.95.

User Comment. Since there are no provisions for attaching other than the built-in antenna to the receiver and there is no access to the audio output, other than at the speaker, we were unable to make performance measurements with a signal generator and output meter. In spite of not being able to verify the claimed performance specifications, the receiver's operation was completely consistent with its published specifications.

The receiver we used for testing came supplied with crystals for frequencies between 151 and 156 MHz, two of which corresponded with

Are you,
of all people,
still opening
your garage

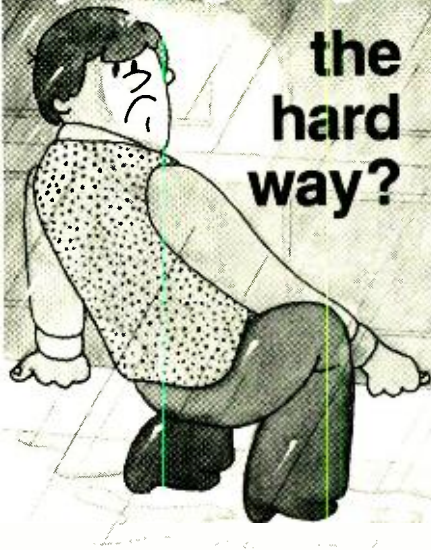

Anybody who's into electronics

certainly should be getting the everyday convenience and family security of automatic garage door operation... especially now, with Perma Power's great Electro Lift opener...

made to fit in the trunk of your car, designed for easy handling and simple do-it-yourself installation.

Available now at a surprisingly low price from your distributor.



P.S. Show off your opener to your friends and neighbors. You'll probably be able to pay for yours with what you make installing openers for them.

Perma Power

Chamberlain Manufacturing Corporation
Perma Power Division

845 Larch Avenue, Elmhurst, Illinois 60126
Telephone (312) 279-3600

CIRCLE NO. 29 ON READER SERVICE CARD

Build it yourself...

With a learn-at-home program as fascinating as home entertainment electronics, reading about it is just not enough!

Once you discover something that really fascinates you, no matter what it is, reading about it is just not enough. You want to be involved. You want firsthand experience.

That's exactly how Bell & Howell Schools' exciting learn-at-home program in electronics works. You learn by doing, experimenting, trying it yourself. That's why throughout this unique program you get practical "hands on" experience with some of today's latest electronics training tools.

Throughout your learning adventure with Bell & Howell Schools, the key word is build.

It doesn't matter if you've never had any training in electronics before. We start you off with the basics and help you work your way up one step at a time. As a matter of fact, with your very first lesson, you receive a special Lab Starter Kit to give you immediate working experience on equipment as you are picking up the fundamentals. It makes the learning process faster and certainly a lot more interesting.

You'll build and work with remarkable educational tools as you explore advances in electronics—"State-of-the-art" equipment that's being used today—and will be used tomorrow. So the skills and knowledge you will acquire will be useful for years to come.

You'll build your own electronics laboratory!

With Bell & Howell's Electro-Lab® electronic training system—theory comes to life. And you'll make it happen! In building each of these modern test instruments you'll get experience in wiring, soldering, assembling. Then you'll use the lab for testing, trouble-shooting and circuit analyzing.

First, the **design console**. After you assemble it, you'll be able to set up and examine circuits without having to solder them in place.

Next, you'll build a **digital multimeter**. This important instrument measures voltage, current and resistance, and displays its findings in big, clear numbers like on a digital clock.

Then comes the **solid-state "triggered sweep" oscilloscope** similar in principle to the kind used in hospitals to monitor heartbeats.

You'll use it to analyze tiny integrated circuits. The triggered sweep feature locks in signals for easier observation.

You'll actually build and work with the new generation color TV...investigating features you've probably never seen before!

This 25" diagonal color TV has digital features that are likely to appear on all TV's of the future. Features made possible by the applications of digital electronics to home entertainment.

You'll probe into the technology behind all-electronic tuning. And into the digital circuitry of channel numbers that appear on the screen! You'll build-in an on-the-screen digital clock and learn to program a special automatic channel selector that

goes directly to the channels of your choice.

You'll also better understand the exceptional color clarity of the Black Matrix picture tube, and gain working knowledge of "state-of-the-art" integrated circuitry and the 100% solid-state chassis.

After building and experimenting with this TV, you'll be equipped with the kinds of skills that could put you ahead in electronics know-how.

Once you've completed this program, your skills in electronic trouble-shooting could lead you in exciting new directions. While we cannot offer assurance of income opportunities you can use your training: to seek out a job in the electronics industry, to upgrade your current job, or as a foundation for advanced programs in electronics.

Building. Learning. Growing. Without missing a day of work or a single paycheck!

Because this is a home study program, you study at your convenience—without being a classroom captive. That means there'll be no conflicts with your job or other interests.

And even though you're on your own, we'll be there to help if you should ever run into a rough spot. Most schools make you mail in all your questions. We have a toll-free line you can call when you have a question that can't wait.

For even more personal attention, Bell & Howell Schools' "help sessions" are held in 50 major cities at various times throughout the year, where you can meet and talk with your instructors and fellow students.

A school's reputation can't be built on what it is going to do.

...but rather on what it has done and is doing right now. That's why Bell & Howell Schools' 43 years of experience in electronics home study is your best guarantee that our "hands-on" learning method really works.

Many thousands of people each year choose Bell & Howell Schools' home learning programs to start or further their electronics education. Discover this fascinating program in home entertainment electronics for yourself.

Mail in the postage-paid card for details, free!

Taken for vocational purposes, this program is approved by the state approval agency for Veterans' Benefits.

If card has been detached, please write to:

An Electronics Home Study School

DeVRY INSTITUTE OF TECHNOLOGY

ONE OF THE



BELL & HOWELL SCHOOLS

4141 Belmont, Chicago, Illinois 60641

728



"Electro-Lab" is a registered trademark of the Bell & Howell Company.

Simulated TV picture/test pattern.

channels of the New York City Fire Department and our local parkway police. Although our lab is located about 25 miles from mid-Manhattan, in a below-ground-level room, the small telescoping antenna provided with the receiver picked up the fire department transmissions with full quieting.

To start the automatic scan mode, the squelch control must be turned counterclockwise until the noise is

silenced. The lighted indicators then flash in sequence as the tuning steps through the selected channels. As soon as the signal is received, the scanning stops. The audio system then passes the transmission to the speaker, through which it is heard with more-than-adequate volume and excellent clarity. A moment after the carrier is removed, the receiver resumes scanning.

Regency recommends that the re-

ceiver be operated within ± 4 MHz of the 156-MHz design center frequency. However, the r-f section can be realigned for maximum sensitivity in other segments of the vhf communication band. It is probable that the receiver can even be realigned to operate in the 146-to-148-MHz (2-meter) amateur FM band. If so, it could serve as a convenient means of monitoring several repeater channels.

CIRCLE NO. 67 ON READER SERVICE CARD

HEATHKIT/THOMAS MODEL TO-1260 ELECTRONIC ORGAN

Fully solid-state spinet has two manuals, pedal keyboard and 22 voices.



NEXT to guitars, electronic organs are probably the most popular musical instruments used in the home today. Not merely solid-state versions of pipe organs, they are distinctive in that they produce a variety of exciting voices that pipe organs cannot achieve. (On the other hand, they do not simulate all the true pipe-organ sounds or the massive bass tones exhibited by large church pipe organs.)

The great attractions of electronic organs are: compactness, ac line operation, production of rich, wide-ranging tonal timbre, and sustained tones when a key is depressed that—unlike a piano—can mask imperfect playing technique. Furthermore, electronic organs often feature automatic devices to simplify and enhance one's limited playing ability.

The Heathkit/Thomas organ, Model TO-1260, reviewed here, is an electronic music instrument in this genre. A kit version of Thomas' mid-range-

priced commercial instrument (which retails for some \$1,100 more than the organ and rhythm kit sections), it offers builders the challenge and rewards that only large-scale electronics projects can. Kit price is \$1095 with contemporary cabinet and \$1150 with mediterranean cabinet. Cabinet and bench are supplied preassembled and finished. Overall dimensions are 44 in. high by 44 in. wide by 23½ in. deep. An optional Rhythm Section TOA-60-1 (to be reviewed in a later issue) costs \$275.95.

Description. The fully solid-state TO-1260 Heathkit electronic spinet organ features two medium-power amplifiers (rated 25 W rms/channel) and two full-range 12-inch speakers; a solo manual and an accompaniment manual, each of which has 44 keys that can be played separately or in combination. Twenty-two separate voices are available, such as Trombone 16, Clarinet 8, Flute 4, Violin 8, Harpsicord, etc. (Numbers follow pipe-organ tradition, with 16 being an equivalent to a 16-foot audio signal, a 32.5-Hz fundamental; 8 a 65-Hz fundamental, and so on. Preset voices such as Harpsichord do not carry numbers.) The pedal keyboard consists of 13 notes, with pedals arranged in a radial arc to simplify toe and heel playing.

Special-effect tabs include "Wah Wah" (a crying effect). Accompaniment Bright Timbre, Solo Bright Timbre, Pedal Sustain, Long Sustain, Automatic Sustainato, (sustains only last note played), and independent tremulant and reverberation effects.

Overall volume is controlled by a foot pedal (expression pedal), with separate volume controls for pedal and preset percussion voices. Additionally, there's a balance control for

adjusting or emphasizing solo and accompaniment voices, contained on two separate manuals.

Of special interest is a "Color Glo" system that can light up keys to identify key music notes, plus some color markings, for use with a programmed music-playing course that accompanies the kit. Clavier pedals, too, are marked with colors. An accessory panel permits easy use of a cassette tape recorder, headphones for private practice, plus provisions for an external tone cabinet (speaker system).

Construction. Two especially fine assembly manuals accompany the kit, with a total of 331 well-illustrated pages, including tuning and troubleshooting sections. Also provided are special tools: keyboard alignment tool, nut drivers, Phillips screwdriver, coil tuning tool and plastic nut driver, as well as a few spools of solder.

Kit construction time, excluding tuning and adjusting, is estimated at 100 to 150 hours. Going at a leisurely pace, it took the reviewer 135 hours.

Though most of the construction time was put into soldering, there's a healthy percentage of mechanical work. The latter is straightforward and easy to do, but is time consuming. For example, each of the 88 manual keys requires snapping on a spring-metal holder and attaching two elements into hard plastic keys with a screw. Two keyboard chassis are assembled with key guide posts, key rack brackets and terminal boards, all screwed onto metal worthy of a battleship's armor. Additionally, 88 coil springs must be attached and soldered, felt strips cut and applied, 88 key-rack brackets lubricated and 88 keys mounted in specific positions. But unlike completion of a pc board, there's the immediate sense of satisfaction on seeing a complete keyboard manual when construction is finished.

Key switch action is interesting. A

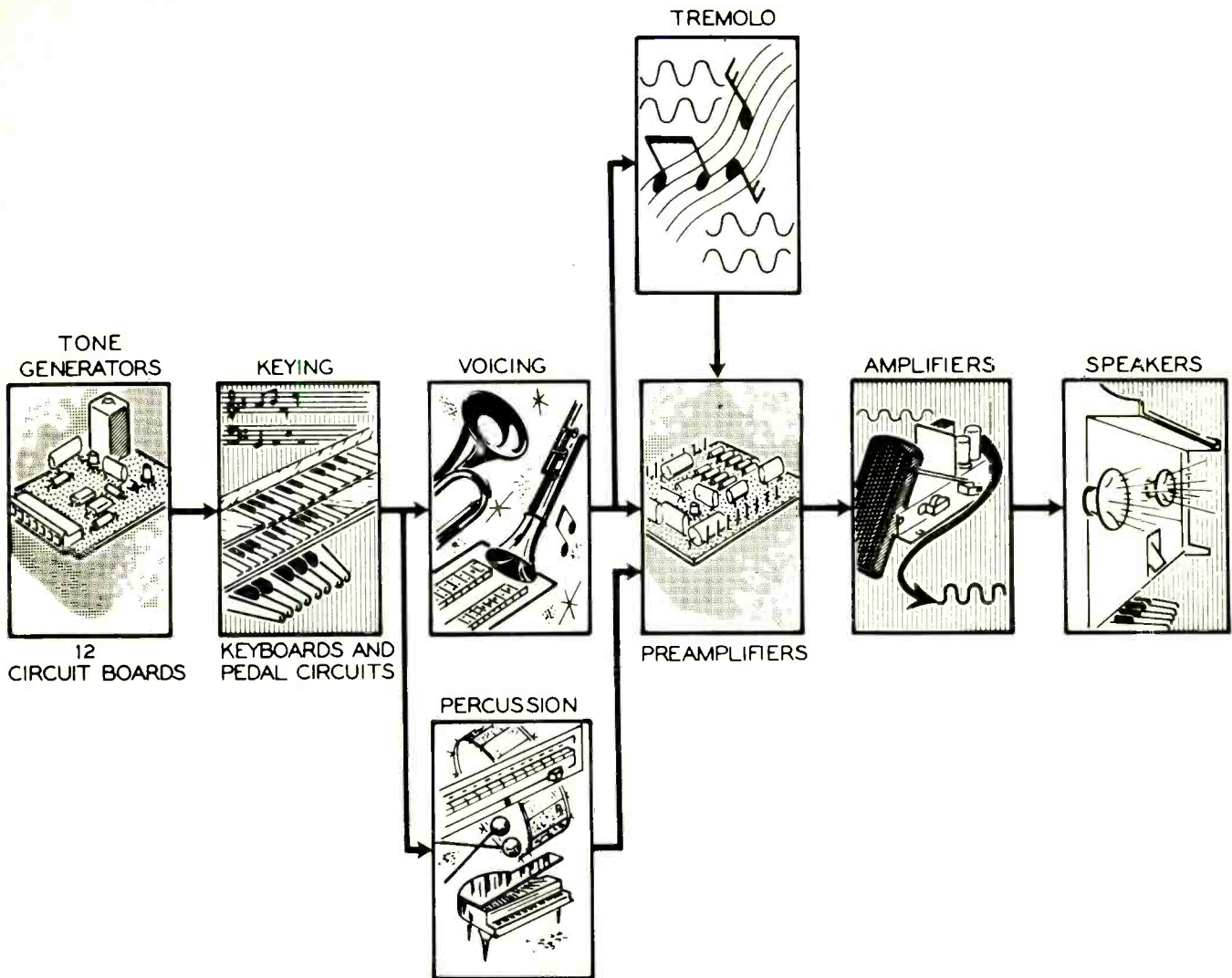

Simplified block diagram shows most of main sections and how signals progress.

gold-alloy wire contact is soldered to each key. The wire contact rests on a bus bar, with another bus bar about $\frac{1}{8}$ inch above it. When the front of a key is depressed $\frac{1}{3}$ to $\frac{2}{3}$ of its travel, the rear section, where the contact is, connects a +3-V bus bar to a keyer circuit, in the case of the solo manual. These circuits are divided into rows of 4-ft, 8-ft and 16-ft. Tones from one of 12 tone generators couple through keyer circuit elements, both transistors and diodes. The same mechanical procedure occurs with the second keyboard, the accompaniment manual.

Pedal claviers add an octave at the bass end. Here, too, there is substantial mechanical assembly work. Each pedal actuates a two-pole, double-throw switch that is mounted on a pc board. The board leads to a pedal electronic memory circuit.

The TO-1260 electronic organ employs tone generators that are essentially sawtooth waveform generators,

producing both odd and even harmonics. These generators are followed by frequency dividers to produce lower-octave frequencies, thus circumventing the need for individual oscillators and attendant alignment problems. However, the dividers produce square waves, which won't create sufficient musical richness. Consequently, accompaniment tone-generator outputs are connected to PEC's (packaged electronic circuits) on a distribution board for mixing purposes. Solo frequency-divider output is mixed directly in the solo voicing circuits. The voicing filters (formants) shape the waveforms into the characteristics of a desired music tone by passing them through reactive circuitry. Percussion waveforms to simulate, say, a drum, are achieved through use of one-shot multivibrators to generate square-wave pulses. For repeat-percussion, an astable multivibrator circuit is utilized.

A fully wired tone generator is sup-

plied as a model, while the builder assembles 11 more pc boards like it (with some component differences). Most of these 11 boards are supplied attached, like Siamese twins, and must be separated in much the same manner as one breaks a cracker. No problem at all here. Special care is needed, however, when working on the distribution board, which measures about 27 inches by 4½ inches. Loaded with the weight of 44 keyer packaged electronic circuits and two mixing PEC's, plus other components, the board might break if not handled properly. (We followed instructions and, though apprehensive, did not have any difficulties.)

Connectors soldered to the tone boards snap into pins on the distribution board.

Organ voices can be modulated to create certain desirable effects. For instance, tremolo effects are generally available with today's electronic organs. The Heathkit TO-1260 is no ex-

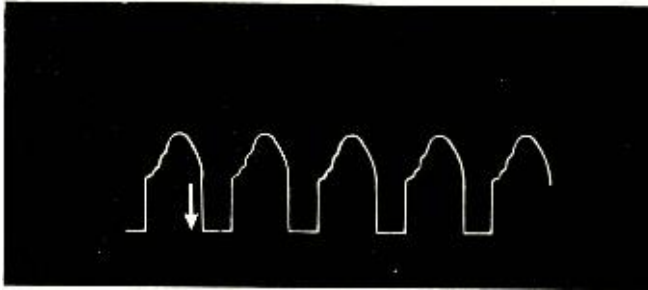

Oscillator output is rich in harmonics and has steep negative-going portion to drive frequency divider.

this procedure works, we found it much easier to use a chromatic pitch instrument for tuning purposes (about \$5 in any music supply store).

Final adjustments are made with a test board/meter that's assembled as part of the kit. This is used to balance outputs of the two preamplifiers and adjust pedal volume, tremolo bias, speed, etc. Installing the music rack and solo shelf hold-down brackets, and tightening legs on the bench complete assembly.

User Comments. The finished product justified the time spent in assembling and adjusting the Heathkit TO-1260 electronic organ. No one would ever guess this was assembled from a kit, considering the beautiful preassembled and prefinished cabinetry, and other high-quality elements exposed to view. There are provisions for the rhythm accessory, not yet completed, which will add eight pre-programmed percussion patterns, four preset ones on the lower manual (piano, guitar, banjo or harp-

ception. As many readers know, tremolo results when a tone is amplitude modulated at around six or seven Hz. A 6.7-Hz oscillator signal is used with a double-shaper circuit to achieve a Doppler effect. A phase-shifter circuit, with LDR's (light dependent resistors), provides a stereo tremolo effect.

A waa-waa circuit chassis, actually an adjustable-frequency bandpass filter, is mechanically linked to the volume (expression) pedal. To achieve this effect, the pedal is rocked, which varies the waa-waa's volume control. Reverberation, too, is an attractive aspect of an electronic organ. To accomplish this echo effect, one channel's output must be delayed in some manner. The TO-1260 does this with an electro-mechanical coil-spring system that gives the impression the organ is being played in a larger area. Its operation is simple. The output from an amplifier energizes an electromagnet that impresses an audio sound wave on a coil spring. This causes an armature at the other end of the spring to vibrate, which induces a voltage in a coil. The delayed sound signal is then amplified.

A host of wire harnesses must be soldered to pc connection points, then secured with tie wire (neatness counts). A hand drill is needed to drill holes in plastic circuit board mounting strips.

Construction completed, a series of operational circuit checks are made that do not require the use of an instrument. This is followed by tuning of the organ, again without use of an instrument. This is done by ear; a rough tuning first, followed by a fine-tuning procedure. The factory-assembled "C"-note tone generator, pretuned to an exact frequency, gives this aural method the potential for extreme accuracy.

The methodology is simple enough—the beat principle is used to tune the remaining 11 tone generators,

following a chart supplied by the Heath Company. Using the instruction manual's example, if a 440-Hz reference tone is mixed with that of a 442-Hz generator, the result will be a beat note at a rate of two beats per second. After a rough tuning, fine-tuning follows. For example, by depressing the pre-tuned middle C and G keys, the G slug is adjusted for 9 beats in 10 seconds (26 beats in 30 seconds). Each generator is fine-tuned in turn, following instructions on which two keys to press. Though

Output	Frequency	Note
Master oscillator (M.O.)	2093.003	C6
First divider	1046.502	C5
Second divider	523.251	C4
Third divider	261.626	C3
Fourth divider	130.813	C2

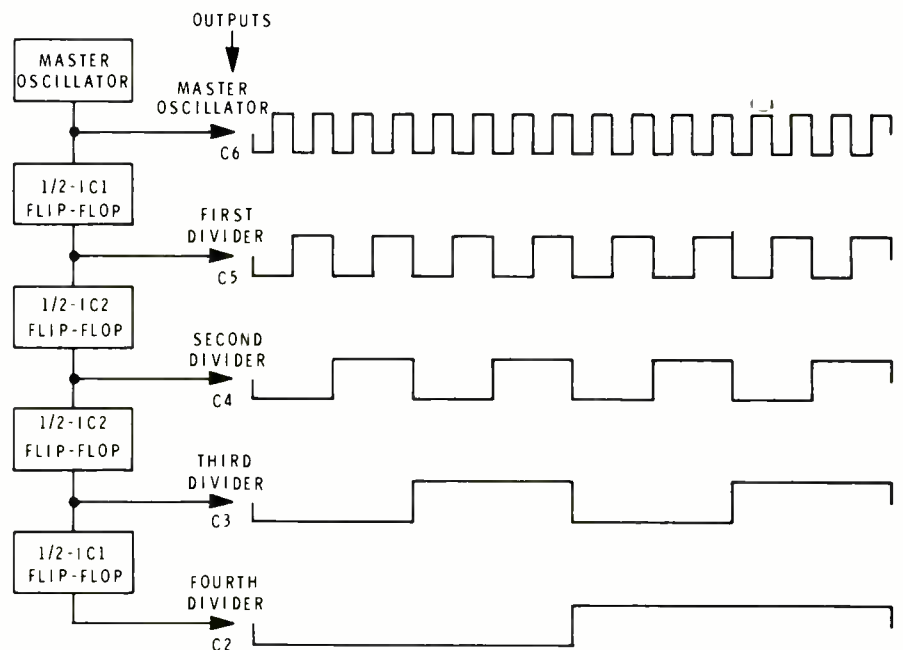

Diagram shows how flip-flops are connected to divide the master oscillator signal. In this case, the tone is C.

sichord), and alternating bass pedal notes.

The Heathkit TO-1260's wide choice of musical voices on the solo manual; its good tone quality, special effects, and impressive overall appearance; and the "feel" of the instrument cannot be matched by commercially assembled organs at anywhere near its kit price. Of course, the organ can be upgraded by adding a separate tone cabinet. If we had our "druthers" — which are always expensive — we

would prefer a nonmechanical reverb. We thought that we would miss the liquidity of a rotating speaker on tremolo but the electronic system of the TO-1260 proved to be surprisingly good.

By assembling the kit, one can save up to \$6/hour net, while working at home, at one's own pace. But a kit builder naturally realizes more than mere dollar savings. There's pride of building, and learning how the instrument works electronically and mechanically. The self-servicing and tuning know-how will also save money and time in the future. Then too, it is amazingly satisfying to be able to lift the solo board and adjust the mandolin strumming speed yourself.

Of special noteworthiness is the assist provided by the Heath Company in building the kit. A missing part, called in to a local Heath Co. store, was received by mail within a few days. Also each electronic organ kit includes a name, photo and telephone number of a Heath Co. technical consultant who can aid any kit builder who runs into difficulty. We tried it, and it works.

CIRCLE NO. 5 ON READER SERVICE CARD

VOICES AND PRESETS

Upper Keyboard: (Voices) Flute 16', Flute 8', Flute 4', Trombone 16', Bassoon 16', Trumpet 8', Diapason 8', Clarinet 8', Violin 8', (Presets) Harpsichord, Piano, Accordion.

Lower Keyboard: Tuba 8', Diapason 8', French Horn 8', Melodia 8', Cello 8'.

Pedal Keyboard: Bourdon 16', Major Flute 8', String Bass 8'.

COMING UP IN THE APRIL

Popular Electronics®

Build a:
**Portable Analog/Digital
Memory Translator**
and
**Minivolter With
500 μ V Full-Scale**

**Listening To Distant
AM Broadcasting**

TEST REPORTS:

Realistic STA-250 Stereo Receiver
Kenosonic C-200 Stereo Preamplifier
Stanton 681EEE Stereo Cartridge
Hy-Gain 623 AM/SSB CB Base Station
EL Electronics PG-2 Pulse Generator

Free

A P Test Clip

TC-16
for
16-pin
DIPS



with purchase
of each

A P Super- strip

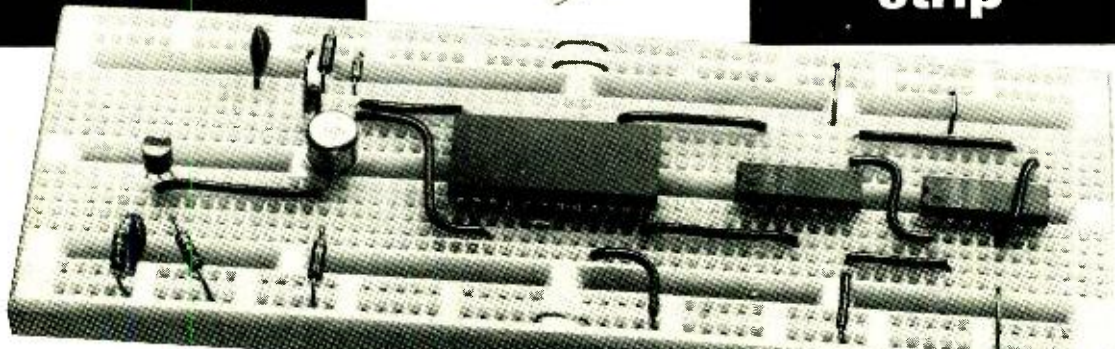

ORDER Part No. 923748
WITH FREE TEST CLIP
\$18.90

Add sales tax if resident of
Ohio or California.

F.O.B. PAINESVILLE, OH.
(Shipped post-paid if
payment is with order.)

OFFER EXPIRES
MARCH 31, 1975

●
Has 840 solderless
plug-in tie-points
on universal matrix

●
For all DIP sizes and
discretes with leads
.010" to .031" dia.



A P PRODUCTS INCORPORATED
Box 110-H, Painesville, Ohio 44077



HOW TO SERVICE A CLOCK RADIO

By John. T. Frye, W9EGV

AS MAC strode through the service department door, he stopped abruptly, a foot poised in the air, to keep from stepping on the midriff of Barney, his assistant. The latter was lying on his back on the floor, laboriously writing on the bottom of a small square of cardboard held in front of his face. He had punched three pencil holes in the cardboard.

"I'm almost afraid to ask," Mac said, stepping across the prostrate youth, "but what are you doing?"

"I'm trying to figure out which replacement transistor lead goes into what hole in that printed circuit board on the bench," Barney retorted. "I'm the kind of dude who can't read a map unless the top of it is pointing north, even though I have to read the printing upside down. And these transistors having three leads equally spaced in a straight line drive me right out of my skull."

"I just don't know about you," Mac said, shaking his head. "But get up off the floor and let me tell you about fixing clock radios."

"What's to know? A radio's a radio. What's different about clock radios?"

"Obviously the clock and timer mechanism. Electronic reliability has improved until the clock is often the first item to fail, especially with a transistorized clock radio. It quits running, becomes noisy, or develops trouble in the switch-control portion. Then the owner makes several disagreeable discoveries: (1) the electronic technician considers clock repair a jeweler's problem and will not work on it; (2) a jeweler thinks repairing electrical motors is a job for the electrician and will not work on it; (3) the electrician can't be bothered with such a small job; (4) any of these will order a new clock, but the price of a new clock, installed, may run fifty percent or more of the cost of a new clock radio. In the past, the answer has been the wasteful old American practice of junking the radio and buying a new one, simply

because no one wants to take the trouble to fix the electric clock. Now that we're beginning to see the bottom of the barrel of our natural resources, this is a practice we're going to have to forego. Instead of 'Junk it and buy a new one,' we're going to have to say to ourselves, 'Can't it be fixed? Can't we make it last?'"

"I'm ready," Barney said getting up and brushing off the seat of his pants.

"Okay. First let's take the case of a clock that won't run although the radio plays. You want to make sure the motor winding is not open before going further. This happens once in a blue moon, probably as a result of a lightning surge. With the radio turned off, make a resistance check across the line plug. A resistance reading of 500 to 700 ohms indicates the winding is intact. If it isn't, of course, you'll get a reading in megohms. In that case, you're probably out of luck with regard to getting a new winding. Neither the radio manufacturers nor the clock suppliers are interested in selling clock parts in my experience. Fortunately, an open coil is rare.

"The first symptom of trouble an electric clock usually gives is that it becomes noisy. It develops a rhythmic, grinding ick-ick-ick-ick sound that is especially annoying when the clock radio is by your pillow on a bedside table, as many of them are. You're hearing, in the parlance of the psychiatrists, 'a call for help.' The clock motor is trying to tell you that it's thirsty for oil and that its gears are running bare metal to bare metal. If this condition continues — and sometimes a clock motor will run for a long time after it first becomes noisy — eventually the small amount of oil left inside the sealed rotor-and-gear-train case of the motor will become gummy from the high heat and the motor will stop."

"Then all we have to do is squirt a little oil on the gears and all is well, huh?"

"It's not that easy. Remember I said the rotating portion of the motor was enclosed in a sealed case. The trick is to introduce fresh oil into that case without destroying the integrity of the metal enclosure, and it can be done. The whole rotor unit can be removed from the rest of the clock rather easily. Here's the way a typical clock motor looks," he said, sketching on the cardboard of a broken-open tube carton. "The rotor unit itself looks like this. The case is cylindrical and about 1½" in diameter and possibly 1" or more thick. This thickness takes in a round turret about ¾" in diameter that projects from the rear of the case. On the opposite side, the part of the case toward the front of the clock, a shaft projects through the case and carries a small gear about ¼" in diameter. When the rotor is in place, this gear meshes with another in the hand-moving gear train.

"To remove the rotor unit, remove the two long screws at A that pass down through the laminated pole pieces and through two spacers that also carry rotor-holding fingers. This is the way they look, here at C. Now loosen the two screws at B just enough so that you can tilt up the other ends of the pole pieces enough to allow the rotor unit to be lifted up until the little gear is disengaged and slid out from beneath the pole pieces.

"Now you're ready to put fresh oil in the case. To do this, rest the little turret of the case on top of a lighted 100-watt light bulb for ten or fifteen minutes until the case is quite hot — too hot to handle with your bare hands. The little gear will be up; and if you watch closely around the shaft, you will eventually see hot oil bubbling up around it, driven out by the expansion of the heated air inside the case. When no more air can be seen bubbling out, use a glove to lift the motor off the bulb and set it down on a flat metal surface. Use an aluminum sheet to conduct away the heat. Place two or three

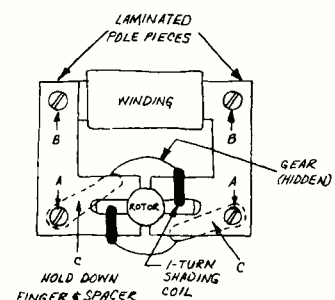

drops of a light oil, such as 3-in-one, on top of the gear so that it runs down and surrounds the shaft. Usually the shaft sits down in a small depression that will hold a small amount of oil. Watch closely, the oil can in your hand, and soon you will see the oil disappearing, sucked into the case by the cooling, shrinking volume of air in the case. That is your cue to apply more oil because it's essential that all the suction be applied to oil instead of mere air. You must watch closely because when the oil starts into the case it goes rapidly. Unless you're ready with more oil, the supply around the gear shaft will be exhausted before you know it."

"Do you do that just once?"

"I usually go through the heating-cooling sequence twice to insure getting enough fresh oil inside the case to last. Near the end of the final cooling, putting the case on an ice cube or spraying it with Frost Aid or Circuit Cooler will insure sucking in the maximum amount of oil."

"Then I suppose you put the motor back inside the clock."

"Yes, but before you do that, wrap a soft piece of glove leather around the little brass gear and grasp it gently with a pair of pliers and make sure you can turn it. Since you're driving a speed-reducing gear train from the low-speed end, you'll encounter considerable initial resistance to turning the gear, but this will lessen as you apply a steady, light torque to the gear. You should be able to turn it easily in either direction.

"The clock is reassembled in just the reverse of the procedure you used in taking it apart. Be sure the motor is properly located with the little gear meshed with its matching gear and that the fingers of the spacers are resting properly on the back of the case before you snug down the screws at A and B. Now when the cord is plugged in, the clock should run smoothly and quietly, and it should keep doing so for many months or years."

"Is that a synchronous motor?"

"Not exactly. It's a hysteresis motor. The first clock motors were true synchronous motors, and you had to start them and bring them up to synchronizing speed by a disengaging spinning knob at the rear. They ran equally well in either direction, depending on which way you started them. These hysteresis motors have the same characteristic of being synchronized with the line frequency but are self-starting."

"I've noticed these clock motors get pretty warm. Why is that?"

"The little motors are actually very inefficient, and most of their input wattage is converted to heat, with normal operating temperatures running around 180-190° F. Yet so little power is required that the motor still consumes only two or three watts of power. Incidentally, their 'locked rotor current' is identical with current consumed when running at synchronous speed. I probably should tell you not all electric clocks have the same mechanical arrangement as the one I've sketched. For example, some of the more recent General Time clock motors have the stator winding right beneath the rotor section, and the 'pole pieces' are in the form of a metal cage into which the rotor assembly nests; but the rotor can still be removed by releasing a couple of clips and lifting it out of the cage.

"Sometimes the switch, which can be actuated by either the timer or a manual function knob, develops poor contacts. You can usually restore proper operation to this black-bakelite-enclosed switch by forcing contact cleaner from an aerosol spray can in around the projecting sliding arm of the switch and working it a few times with the manual function knob. You may also find one of the actuating arms of the switch has become bent or has slipped off an actuating cam through rough usage. In such a case, the corrective measure will be obvious. The same thing goes for the alarm buzzer blade that has become bent so it fails to contact the laminations of the pole pieces.

"A nasty problem we often see with older clock radios is that the split ends of the actuating shafts for the On-Off-Auto, Sleep Switch, or Alarm-Set functions have one or both sides of the split ends broken off. In such cases I have slid a little piece of brass tubing over the broken shaft and soldered the shaft and tubing together and used a small setscrew knob on the new shaft. Those clock knobs are a poor arrangement. They invariably work loose and are lost, or they shear off the ears that are supposed to engage the shaft slot."

"You could glue them on," Barney suggested.

"Never!" Mac exploded. "I'm sure that down in Hades there must be a special place reserved between Tantalus and Sisyphus for the guy who glues on radio or TV knobs." ◆

... here Today!

"IGNITION OF THE FUTURE" ALLISON "OPTO-ELECTRIC"

★ The BEST... the ULTIMATE...
of ALL the Ignition Systems!

● (We challenge ANYONE to dispute this Fact.)



● Never wears out or needs any Maintenance!



● Does more than Pay for itself in GAS SAVINGS

... it gives you Maximum Power with continuous PEAK PERFORMANCE

... while reducing Maintenance and Operating Costs!



- The Allison OPTO-ELECTRIC System eliminates the Points and Condenser, replacing them with an OPTO-ELECTRONIC TRIGGER, using a Light-Emitting Diode and Photo transistor. As there are NO moving parts in rubbing contact... Timing adjustments are PERMANENT. The only "TFUE" Electronic Ignition... that you can buy for under \$100.
- Gives 40-Times more Timing Accuracy than ANY system using "Mechanical" Breaker-Points! UNLIMITED RPM! Electronically-Controlled "DWELL" automatically supplies HIGHEST Performance at both Low and High speeds. Spark strength does not fall off at high RPM. POSITIVE SPARK helps eliminate "Misfire" for faster acceleration and improved Engine Performance! Smoother running (No timing fluctuation as with Magnetic Units). Easier Starting under any condition! Sparkplugs LAST 3 to 10-Times LONGER.
- All SOLID-STATE Components UNAFFECTED By Temperature, Moisture, or Vibration! Highest grade materials Guarantee you solid, Dependable Performance.

★ Perfect Timing and Dwell never change.

Pays for itself! Eliminates Ignition Tune-Ups forever!
"INFINITE LIFE" Once installed Never needs replacing

- PERFECT TIMING INCREASES Engine Efficiency and Gas Mileage. SAVES Precious Fuel! Allison gives you MAXIMUM Engine Efficiency 100% of the time and that's the name of the game for BETTER Gas Mileage and Economy.



★ PROVEN RELIABILITY!
Dyno Tested up to 15,000 RPM.
Road and Race Proven.
(Opto-Electric Systems won at INDY Two years in a row!)

● QUICK AND EASY INSTALLATION

★ If you want the BEST, and SAVE! This is IT!

- ORDER with CONFIDENCE... SATISFACTION GUARANTEED!

1-YEAR FACTORY WARRANTY.

Only \$49.⁹⁵ COMPLETE.

- As you can see, you're not taking any chances at all. Send your Order Today.

State Make, Year, Engine Size (Call. Res. add Tax)

- (So New...it's Sold ONLY FROM FACTORY DIRECT).

You may use your MASTER CHARGE or BANKAMERICARD.
Send us (1) Your Number, (2) Interbank No. (3) Exp. Date

- Before buying any other Type ignition system.

Send Postcard for our FREE BROCHURE.

- ★ If you have already installed a C-D ignition system, Modernize and increase its Efficiency... CONVERT YOUR "C-D" UNIT TO BREAKERLESS! Opto-Electric "TRIGGER UNIT"... Only \$34.95

● Our BEST Salesmen are the owners and users of our ALLISON System!



ALLISON
AUTOMOTIVE COMPANY
1269 - P, East EDNA PL., COVINA, CAL. 91722

CIRCLE NO. 2 ON READER SERVICE CARD

The better the training the better you'll

Send for
FREE
illustrated
career
guide

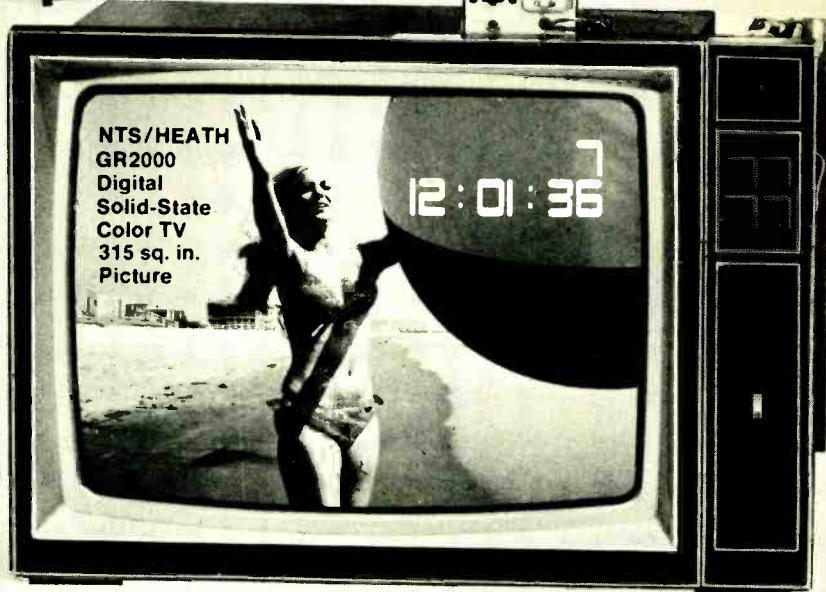
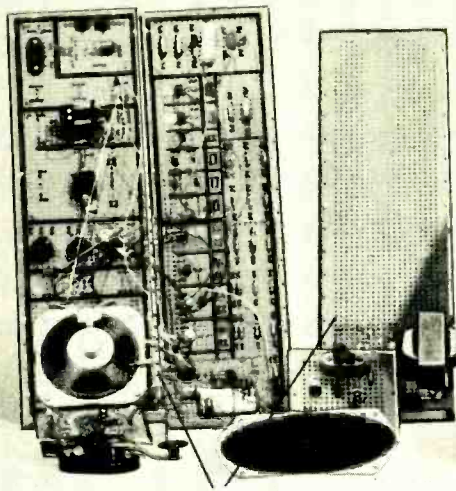
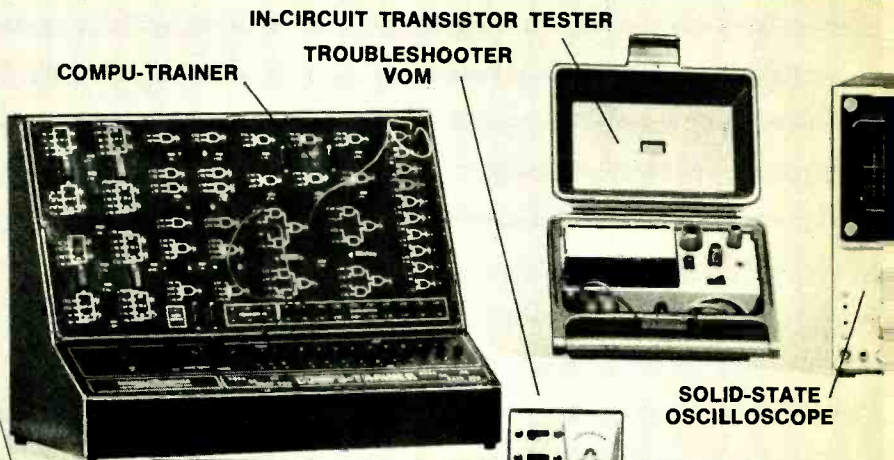
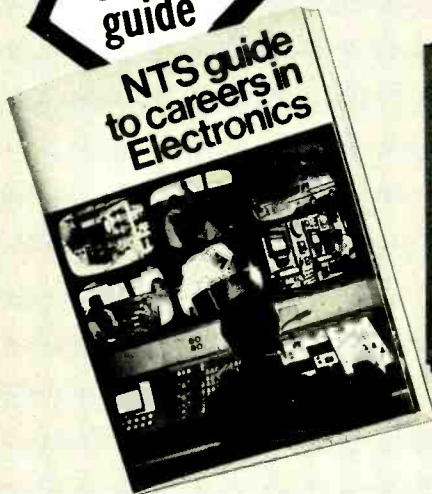

As an NTS student you'll acquire the know-how that comes with first-hand training on NTS professional equipment. **Equipment you'll build and keep.** Our courses include equipment like the **NTS/Heath Digital GR-2000 Solid State color TV** with first-ever features like silent varactor diode tuning; digital channel selection, (with optional digital clock), and big 315 sq. in. ultra-rectangular screen.

Also pictured above are other units — 5" solid state oscilloscope, vector monitor scope, solid-state stereo AM-FM receiver with twin speakers, digital multi-meter, and more. It's the kind of better equipment that gets you better equipped for the electronics industry.

This electronic gear is not only designed for training; it's field-type — like you'll meet on the job, or when you're making service calls. And with NTS easy-to-read, profusely illustrated lessons you learn the theory behind these tools of the trade.

Choose from 12 NTS courses covering a wide range of fields in electronics, each complete with equipment, lessons, and manuals to make your training more practical and interesting.

Compare our training; compare our lower tuition. We employ no salesmen, pay no commissions. You receive all home-study information by mail only. All Kits, lessons, and experiments are described in full color. Most liberal refund policy and cancella-

and the equipment be equipped.

COMPARE OUR
KITS AND LESSONS.
COMPARE OUR
TUITION.

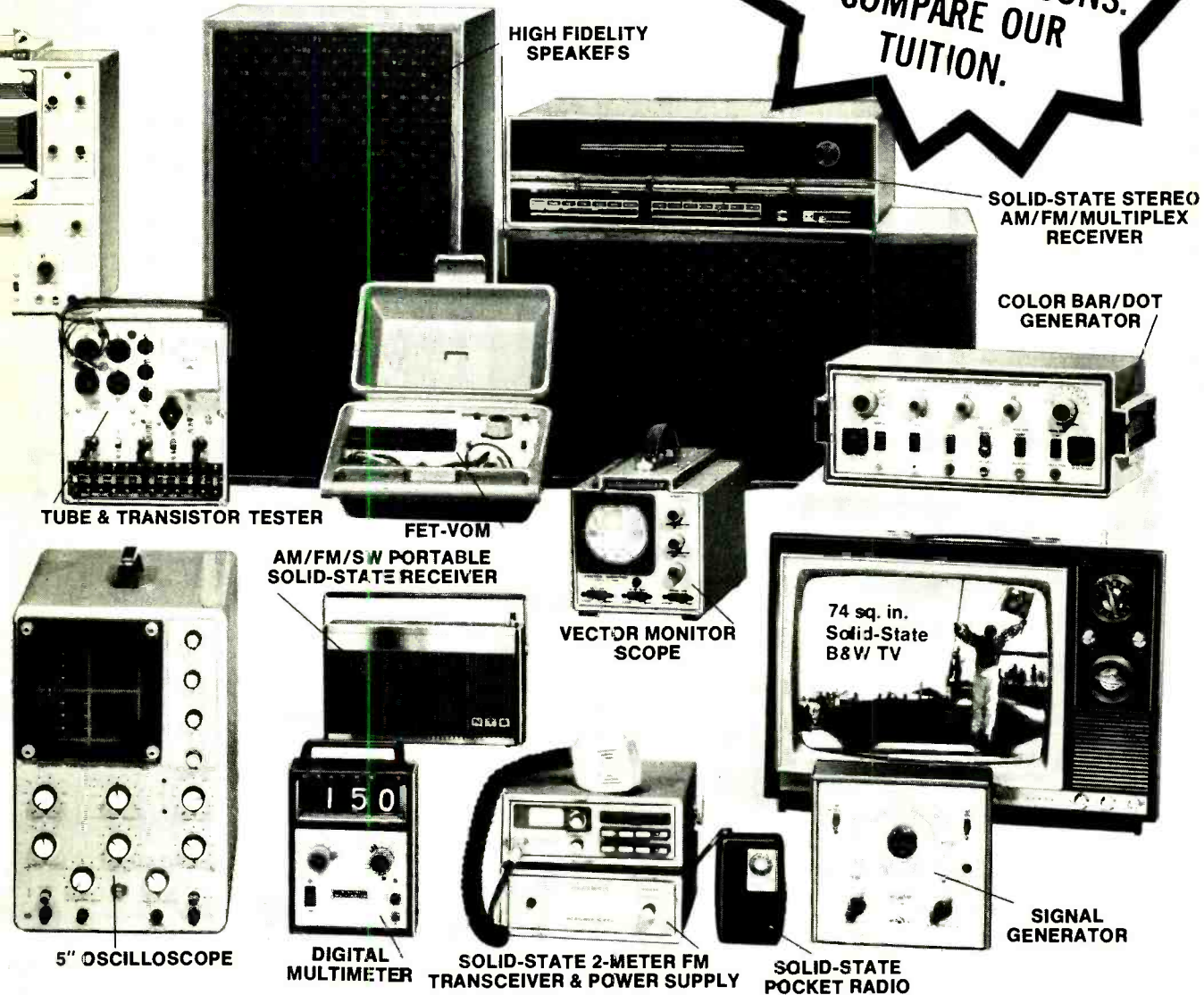

TUBE & TRANSISTOR TESTER

FET-VOM

AM/FM/SW PORTABLE
SOLID-STATE RECEIVER

VECTOR MONITOR
SCOPE

5" OSCILLOSCOPE

DIGITAL
MULTIMETER

SOLID-STATE 2-METER FM
TRANSCEIVER & POWER SUPPLY

SOLID-STATE
POCKET RADIO

SIGNAL
GENERATOR

tion privileges spelled out. Make your own comparisons, your own decision. Mail card today, or clip coupon if card is missing.

NO OBLIGATION. NO SALESMAN WILL CALL

APPROVED FOR VETERAN TRAINING

Get facts on new 2-year extension

NATIONAL TECHNICAL SCHOOLS

TECHNICAL-TRADE TRAINING SINCE 1905
Resident and Home-Study Schools
4000 So. Figueroa St., Los Angeles, Calif. 90037

NATIONAL TECHNICAL SCHOOLS Dept. 205-035
4000 South Figueroa St., Los Angeles, Calif. 90037
Please send FREE Color Catalog and Sample Lesson.
NO OBLIGATION. NO SALESMAN WILL CALL.

- | | |
|---|--|
| <input type="checkbox"/> Color TV Servicing | <input type="checkbox"/> Electronics Technology |
| <input type="checkbox"/> B & W TV and Radio Servicing | <input type="checkbox"/> Computer Electronics |
| <input type="checkbox"/> Electronic Communications | <input type="checkbox"/> Basic Electronics |
| <input type="checkbox"/> FCC License Course | <input type="checkbox"/> Audio Electronics Servicing |

NAME _____ AGE _____

ADDRESS _____ APT # _____

CITY _____ STATE _____

Please fill in Zip Code for fast service _____

- Check if interested in G.I. Bill information.
 Check if interested ONLY in classroom training in Los Angeles.

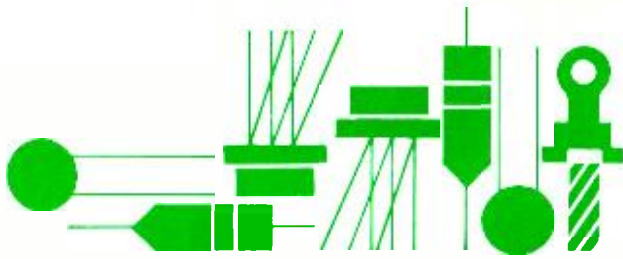

Solid State

By Lou Garner

EXPERIMENTING WITH LED'S

GENERALLY speaking, readers write to a magazine editor or contributor only when they (a) have a problem ("The circuit doesn't work!"); (b) need additional information ("Please send a pictorial diagram for converting my old Atwater Kent to television"); or (c) wish to contribute an idea or circuit ("Here's a terrific solid-state audio oscillator which can replace a doorbell for only \$125.00!") But recently I had few surprises.

When I discussed LED applications in last October's column, I felt that readers might find the topic of passing interest. But the response has been overwhelming. Letters, phone calls and post cards have poured in from all over the world. Many readers offered circuit applications, such as Michael Lindsey's dual-LED flasher described last month. Some asked for additional circuit data. I even learned about an unusual multicolor LED offered by a small manufacturer/distributor in Maryland.

A letter from Mr. Scott Gilson (35225 Caryn Drive, Farmington, MI 48024) is typical. Scott wrote, in part. . .

Dear Mr. Garner:

Thanks so much for your October column on LED's. The circuits shown were very interesting, so I built a few from some scrap parts I had. I couldn't believe it when I snapped on the battery and it worked! Most circuits I build need a lot of troubleshooting just to get them to work. . .

I built both of those oscillators right on top of a 9-V battery clip—just soldered the components on top of it. The old man thinks it's a pretty neat circuit!

I have one question I think you can answer. Could a UJT oscillator drive a LED directly? This would be interesting to pulse a LED this way.

In answer to your question,—yes, a UJT can be used to pulse a LED. I had, in fact, several UJT flasher circuits available, but omitted them in my original column because of space limitations.

Two additional LED flasher circuits are illustrated in Fig. 1. One features a unijunction transistor (UJT), the other a programmable unijunction (PUT). Both require a minimum

of components, are capable of working over a wide range of supply voltages, and can be duplicated quite easily in the home laboratory.

Referring first to Fig. 1A, a simple UJT relaxation oscillator is used to flash a LED in the device's lower base circuit. In operation, $C1$ is charged slowly through $R1$ by the power source, then discharged periodically through $R3$ and the LED by the UJT. The flashing rate is determined by the supply voltage and by $R1$ - $C1$'s time constant. The larger the value of the resistor or capacitor, the slower the flashing rate.

In bench tests, I used a type 2N4891 UJT, values of from 10 to 50 μ F for $R1$ and values of from 10 to 30 μ F for $C1$. The resistors may be 1/4 to 1 watt types (non-critical). With a 15-volt dc source, the flashing rate was about once a second. The circuit would flash with supply voltages of from 4.5 to 16 volts, although the light output is less with the lower voltages. Resistor $R3$ is optional and is used to insure capacitor discharge when low-current LED's are used. If a high-current LED is used, $R3$ may be omitted.

The PUT flasher circuit illustrated in Fig. 1B operates in much the same fashion as the basic UJT circuit, with $C1$ discharged periodically through the LED as the PUT switches on. In bench tests, I used a D13T2 PUT and an MV50 LED together with a 9-volt transistor battery. The flashing rate was about 100/minute with the component values listed.

This circuit is slightly more critical than the basic UJT flasher, in that the ratio of $R2$ to $R3$ must be adjusted for optimum performance. The proper resistance ratio depends on the PUT's characteristics and the supply voltage.

About the unusual multicolor LED. Available exclusively from the manufacturer/distributor, *Electronics Unlimited, Inc.*, this special device is designated type MV1. Unlike the more familiar bipolar multicolor LED, which is essentially two LED's connected back-to-back in the same case, the MV1 is a single diode which can supply red, orange, yellow or green light, depending on the applied voltage (current). With low voltages (and currents), the output is red, gradually changing through orange to yellow and green at higher voltages and at currents approaching 200mA (the device's maximum rated current).

With its unique color-changing feature, the MV1 can be used in a variety of both practical and experimental display applications.

One useful practical application is illustrated in Fig. 2A—an extremely simple battery tester. In operation, $R1$ serves to limit the LED's maximum current. As higher voltages are applied, the LED's current increases and its light color output changes. Unlike a basic voltmeter, this instrument checks the battery under load (to over 100 mA for a 9-12-volt battery). In tests with a typical MV1 and a

Fig. 1. UJT (A) and PUT (B) LED flasher circuits.

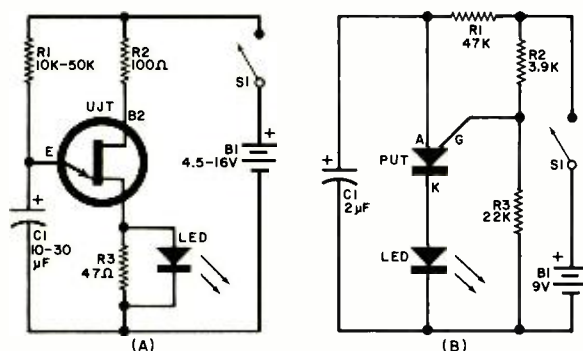

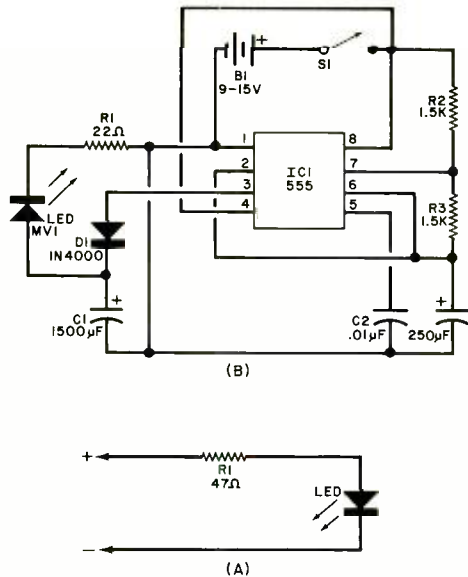

Fig. 2. (A) is a simple multicolor LED battery tester; (B) a multicolor LED flasher circuit.

47-ohm, 1/2-watt resistor, the tester's "calibration" was approximately as follows:

- 1.6 - 4.0 volts: RED
- 4.0 - 5.5 volts: ORANGE
- 5.5 - 9.0 volts: YELLOW
- 9.0 - 12 volts: CHARTREUSE
- 12 - 15 volts: GREEN

Of course, the exact voltages at which color changes occur vary somewhat from one MV1 to another and the delineation is not sharp. Each instrument should be "calibrated" by the individual user.

The battery tester can be assembled conveniently in a pocket-size probe using an old ball-point pen. In practice, it may be necessary to experiment with $R1$'s value to achieve optimum color variation at different voltages due to tolerance in the MV's characteristics. Although a 47-ohm, 1/2-watt unit is nominal, you may have to use values as low as 22 ohms to as high as 56 ohms. In a series of bench tests with several MV1's, I found 39 ohms optimum for some units, 47 ohms for others.

Another interesting application for the MV1 is illustrated in Fig. 2B—a multicolor flasher featuring a standard 555 timer IC. In operation, $C1$ is charged by $IC1$ and the battery through $D1$. As the voltage across the capacitor rises, the current through the LED increases and its color output changes from red through orange, yellow and green. When $C1$ is discharged, the cycle is repeated.

The MV1 multicolor LED is offered as part of a special *LED Designer's Kit*. Two of these devices are included in the kit, together with 8 miniature and 12 large assorted LED's in red, yellow and green, a red/green bipolar LED, a 555 timer IC, a 558 dual 741 IC, 10 assorted diodes and zeners, 20 assorted capacitors, 20 assorted resistors, a 4" x 6" perfboard, and a folder featuring 15 project circuits. The complete kit is priced at \$8.95, postpaid (plus sales tax, where applicable), and may be ordered directly from: Electronics Unlimited, Inc. P.O. Box 91, Olney, MD 20832.

Readers' Circuits. Frustrated by a relatively poor null indication when measuring low resistance values on his impedance bridge, reader Mike McNatt (7707 E. 118 Ter-

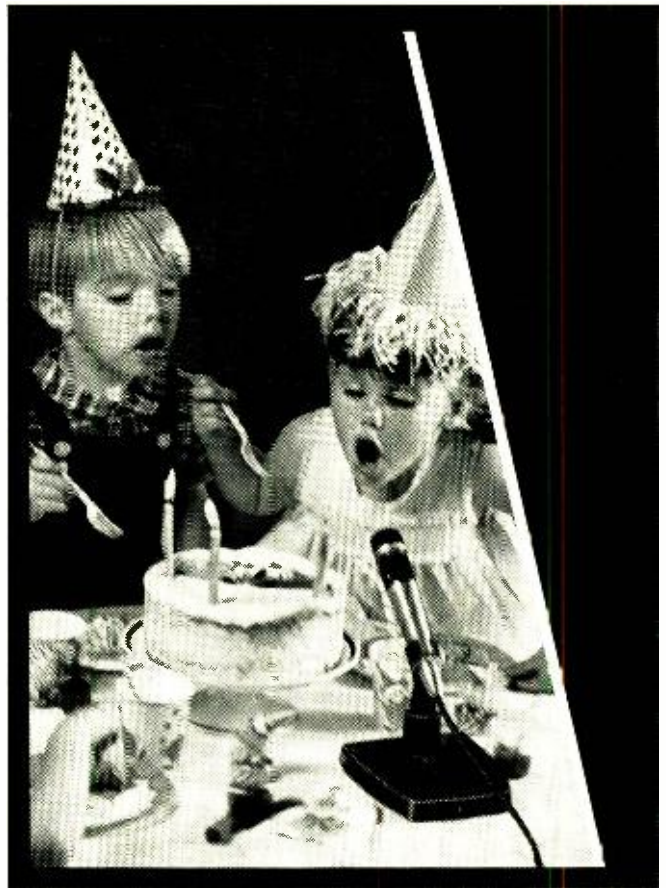

Good time capsule.

Saving fleeting moments requires a quality tape recorder. But, just as a camera can be no better than its lens, tapes can be no better than the microphone. Whether it costs \$200, \$500—even \$1,000—a tape recorder can be significantly improved by the addition of a Shure *unidirectional* microphone—a mike that can be "aimed" so that only the target sounds will be recorded. Microphone misers who ignore this will never hear the *true* sound of recorded music lessons, parties, classes, speech therapy, sound movies and rehearsals. With Shure microphones, creating tomorrow's treasures is today's pleasure.



Shure Brothers Inc.

222 Hartrey Ave.,

Evanston, Ill. 60204

In Canada: A. C. Simmonds & Sons Limited



Manufacturers of high fidelity components, microphones, sound systems and related circuitry.

CIRCLE NO. 35 ON READER SERVICE CARD

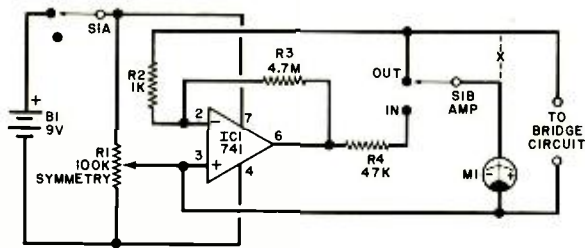

Fig. 3. A null meter amplifier circuit.

race, Kansas City, MO 64134) put on his thinking cap and devised a solution. He designed and built a meter amplifier. Mike reports that he can obtain sharp nulls even on the bridge's lowest resistance range (0.1 ohms full-scale) when he uses the amplifier in conjunction with the instrument's standard null meter.

Featuring an op amp IC, Mike's circuit is illustrated in Fig. 3. In operation, the amplifier and null meter can be switched in and out of the circuit alternately by means of switch S1, which also serves as a power switch for the amplifier. Symmetry control R1 serves to "split" the supply voltage, permitting operation on a single-ended power source.

Series load resistor R4 was chosen to provide a full-scale deflection on the 100-0-100- μ A meter used in his bridge and a different value may be required for other instruments. The original meter connection, shown dotted, is opened for amplifier installation.

With neither layout nor lead dress critical, the bridge amplifier circuit may be assembled on perfboard, on a pc board, or even on a small chassis.

Suitable for troubleshooting PA systems, intercoms, phonographs, tape recorders, and the audio sections of radio and TV sets, the audio signal tracer circuit in Fig. 4 was submitted by reader Bill Roberts (Roberts Electronic Service, Highway 81, Route 3, Winder, GA 30680). Bill, you may recall, contributed the stereo preamp circuit discussed in last December's column. Featuring readily available components, the signal tracer can be assembled in one or two evenings and makes a dandy addition to the home lab's complement of test instruments.

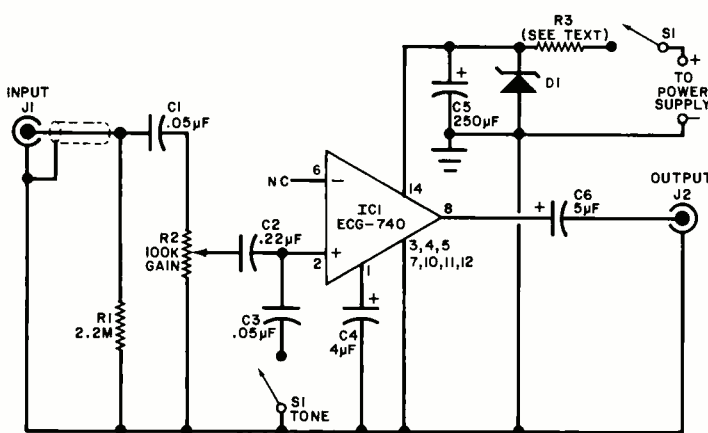

Fig. 4. Audio-signal tracer circuit.

Bill has used a 2.5-watt IC as the heart of his instrument. A shielded test probe connects to input jack J1, while the output, available at jack J2, may be used to drive any standard PM loudspeaker.

Gain control R2 is a 100k potentiometer, preferably with an "audio" taper, and R3, if used, is a 1-to-5-watt unit,

depending on the power source. The input capacitor, C1, should be a 600-volt ceramic or paper type, with C2 and C3 100-volt units. Electrolytic capacitors C4, C5 and C6 are all 25-volt types.

Any of several construction techniques can be used for assembling the signal tracer. Although neither parts placement nor wiring arrangement are overly critical, good audio wiring practice should be observed when duplicating the design, with signal carrying leads kept short and direct. Bill writes that he designed his original model around a 2" x 2" pc board, provided a socket for the 14-pin DIP IC, and used a dual RCA-type phono jack for J1 and J2, mounting the unit in a 2" x 4" Minibox. Standard red and black binding posts were installed for the power connections. The shielded input lead shown in the diagram may not be needed if the input and output jacks are well separated.

Bill suggests that an 18-20-volt dc external supply be used as a power source. If a higher voltage supply is employed, a 20-volt zener diode, D1, and appropriate series resistor, R3, should be used in a standard shunt regulator configuration to limit the applied voltage to 20 volts. The circuit's current requirement ranges from 8 mA at zero output to 110 mA at maximum output.

Device/Product News. GE's Semiconductor Products Department (Building 7, MD 49, Electronics Park, Syracuse, NY 13201) has introduced a new line of axial lead GE-MOV™ varistors to complement their standard line of radial devices. The new line, designated the "MA" series, is capable of both ac and dc operation, and offers voltage ratings of 121 to 365 volts dc, 88 to 264 volts rms. Designed primarily for use in transient suppression and circuit protection applications, GE-MOV™ varistors are voltage dependent, symmetrical metal oxide resistors which operate much like back-to-back zener diodes.

A version of the popular 2N3055 power transistor has been announced by RSM Sensitron Semiconductor (221 West Industry Court, Deer Park, NY 11729). Designated the 2N3055C, the new device offers a maximum I_c of 30 A as compared to the conventional 2N3055's maximum rating of 15 A, a power dissipation of 150 W compared to 115 W, a BV_{CEO} of 120 volts, and a h_{FE} of 10 at 8 A.

From the RCA, Electronic Components Group (Harrison, NJ 07029), comes news of a line of GaAs single-diode injection lasers suitable for use in such applications as intrusion alarms and control systems. Identified as the SG2000 series, the new units offer minimum power outputs ranging from 1 to 20 watts at peak drive currents of 10 to 100 amperes. The peak wavelength of spectral radiant intensity at 27°C is 904 nanometers. Ranging in price from \$10.00 to \$39.00 each in unit quantities, the new devices are supplied in RCA coaxial OP-3 and OP-12 packages.

In addition to announcing substantial price cuts in its CMOS product line, the National Semiconductor Corporation (2900 Semiconductor Drive, Santa Clara, CA 95051) has introduced a new hybrid instrumentation amplifier suitable for use in thermocouple amplifiers, active filters, isolation amplifiers, control interfaces and similar applications. Designated the LH0036G, the new IC features a high input impedance of 300 megohms and a common-mode rejection ratio of 100 dB. Its gain can be adjusted from X1 to X1000 with a single resistor, while its output bandwidth is also adjustable from 350 kHz (small signal) to 5 kHz (full power) at unity gain.

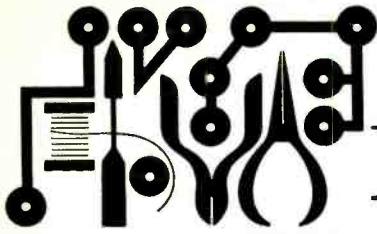

Hobby Scene

LOGIC LEVEL GENERATOR

Q. I am interested in digital electronics but have yet to find a simple pulse 1 and pulse 0 circuit for my breadboard. Do you have a simple circuit I could use?—D. Michelson, N. Vancouver, BC.

A. A simple, manually operated logic 0 and logic 1 generator is shown here.

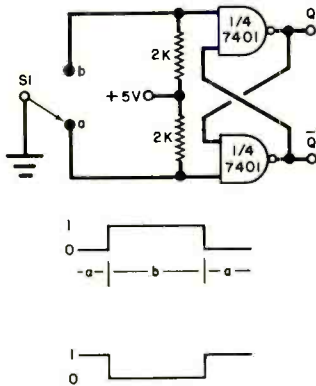

When S1 is in the "a" position, Q is logic one and \bar{Q} is logic zero. When the switch is thrown to "b" the states change—Q is logic zero and \bar{Q} is logic one. Be sure to use a well-regulated, five-volt supply for this circuit, which is really an S-R flip-flop, or you may not get an accurate logic-one level. A 5.1-volt zener and limiting resistor used with four "C" cells or with a 6-volt battery eliminator would work fine.

CHU MARKER

Q. Can you furnish a schematic for a 7.335 marker generator to allow me to home in on the time signals of CHU when WWV is not copyable. I tried to modify my 1-MHz marker, but it won't oscillate at this frequency.—S. Bloomfield, Rutherford, N.J.

We really don't think such a marker is necessary. If your 100- or 1000-kHz marker generator is even halfway decent, it won't need frequent trimming against WWV. Use it to locate 7000 or 7300 kHz, set the zero marker on your dial, and tune upward. During the day

and early evening at my location (New York City) CHU's carrier is very strong and needs no other means of announcing itself. At night, as the skip zone increases, the signal drops out. Even if I had a marker for this frequency, I still couldn't copy the time information.

SYNTHESIZER KEYBOARDS AND CRYSTALS

Q. I am planning to build an electronic organ/synthesizer. Where can I get an organ keyboard, preferably a split-level plastic type with DPST contacts? Also, where can I get a 2.00024-MHz crystal for a top-octave generator? Can the outputs of non-synchronous CMOS gates be connected together, or through isolation resistors?—G. Kim, N.Y., N.Y.

A. See "How to Select EM Keyboards" (POPULAR ELECTRONICS, July 1974). Inquiries on crystals may be made to PAIA (Box 14359, Oklahoma City, OK 73114) or Southwest Technical Products (219 W. Rhapsody, San Antonio, TX 78216). It is not advisable to tie nonsynchronous CMOS gate

outputs together either directly or through isolation resistors since low outputs will act as current sinks.

TRANSISTOR TESTER

Q. I have a number of old, unmarked transistors. Do you have a relatively simple circuit for a tester that could tell me if the transistors are shorted, open, npn or pnp?—P. Stys, Montreal, Quebec.

A. The circuit shown here will allow you to check the polarities and junction conditions of unmarked or

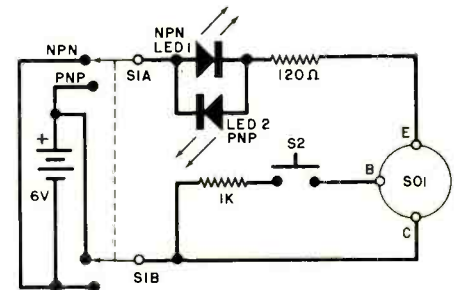

"grab-bag" transistors. Insert a transistor in the socket. While depressing S2, switch S1 between both positions. Only one LED should light up, indicating the polarity of the transistor. If both LED's alternately light up when S1 is varied, the transistor is exhibiting large leakage under reverse bias or has broken down. If the LED lights up when S2 is released, the collector-base junction is shorted. If neither LED lights when S2 is depressed, the transistor is open.

DIGITAL MULTIMETER KIT

BATTERY OPERATED · AUTO POLARITY · AUTO ZERO

AC VOLTS
1% 1 MV TO 300 VOLTS

DC VOLTS
1% 1 MV TO 300 VOLTS

OHMS
1% 1 OHM TO 3 MEG.

CURRENT
1 μ A TO 300 mA

COMPLETE KIT
LESS BATTERIES
AND TEST LEADS

\$99.95

+ \$2.00
SHIPPING

ALPHA Find the Finest on Electronic Kits for the Advanced Beginner

ALPHA ELECTRONICS 305 636 6951
P.O. BOX 1005 MERRITT ISLAND FLORIDA 32952

ENGLISH-LANGUAGE SHORTWAVE BROADCASTS FOR MARCH-APRIL 1975 By Roger Legge

TO EASTERN NORTH AMERICA

TIME-GMT	STATION	QUAL*	FREQUENCIES, MHz
1100-1215	London, England	G	11.905, 15.07
1100-1300	**VOA, Washington, U.S.A.	G	6.185, 9.565
1115-1215	Montreal, Canada	G	5.97, 9.655, 11.825
1115-1245	Melbourne, Australia	F	9.58, 11.71
1130-1200	Jerusalem, Israel	G	15.13, 17.69
1200-1255	Peking, China	F	11.685
1215-1630	HCJB, Quito, Ecuador	G	11.74, 15.115, 17.88
1315-1345	Berne, Switzerland	G	15.14
1400-1430	Helsinki, Finland	G	15.185
	Stockholm, Sweden	G	17.71
1430-1615	London, England	G	17.84 (via Ascension Is.)
2000-2055	Jerusalem, Israel	F	7.395, 9.495, 9.815, 12.025, 15.10
2115-2300	London, England	G	5.975, 9.58, 15.26
2130-2250	Hilversum, Holland	G	5.965, 9.715
2230-2300	Vilnius, U.S.S.R.	G	7.355, 9.665 (Sat/Sum)
2230-2320	Johannesburg, S. Africa	G	9.525, 9.895, 11.90, 11.97
2255-2315	Brussels, Belgium	F	9.73
2300-2350	**Buenos Aires, Argentina	F	11.71 (Mon-Fri)
2300-0030	Moscow, U.S.S.R.	G	7.15, 7.205, 7.355, 9.665
2300-0100	London, England	G	5.975, 6.175, 7.325, 9.51, 9.58, 15.26
2345-0045	Tokyo, Japan	F	11.725, 15.27
0000-0030	Tirana, Albania	G	7.065, 9.78
0000-0100	Peking, China	F	11.945, 15.06
	Sofia, Bulgaria	F	9.70
	**VOA, Washington, U.S.A.	G	6.19, 9.67, 11.83, 11.89, 15.40
0030-0100	Stockholm, Sweden	F	6.035
0030-0100	Kiev, U.S.S.R.	G	7.15, 7.205, 9.53
Tu/Fr/Su			
0030-0700	HCJB, Quito, Ecuador	G	5.97, 9.56, 11.915
0040-0100	Brussels, Belgium	F	6.055
0100-0115	Vatican City	G	5.995, 6.165, 9.605, 11.845
0100-0120	Rome, Italy	F	6.01, 9.575
0100-0130	Budapest, Hungary	F	6.00, 9.833, 11.91
0100-0145	Madrid, Spain	G	6.065, 11.925
0100-0200	Montreal, Canada	G	6.085, 9.755
	Peking, China	G	7.12, 9.78 (via Tirana)
	Prague, Czechoslovakia	F	5.93, 7.345, 9.54, 11.99
0100-0250	Cologne, Germany	G	6.04, 6.10, 9.565, 11.865
0100-0300	Melbourne, Australia	F	11.97, 15.32, 17.795
0100-0330	London, England	G	5.975, 6.175, 7.325, 9.51, 9.59, 15.26
0100-0500	Havana, Cuba	F	11.93
	Moscow, U.S.S.R.	G	7.15, 7.205, 7.355, 9.53, 9.665
0130-0155	Tirana, Albania	G	6.20, 7.30
	Vienna, Austria	F	6.155, 9.77
0130-0230	Bucharest, Romania	F	5.99, 9.57, 11.94

TO WESTERN NORTH AMERICA

TIME-GMT	STATION	QUAL*	FREQUENCIES, MHz
1400-1415	Tokyo, Japan	G	5.99
1400-1600	**VOA, Washington, U.S.A.	G	6.185, 9.565
2300-0030	London, England	G	6.175, 9.74 (via Canada)
0030-0330	London, England	G	6.175 (Via U.S.A.)
0030-0700	HCJB, Quito, Ecuador	G	5.97, 9.56, 11.915
0100-0200	Peking, China	G	11.945, 15.06
0100-0300	Melbourne, Australia	G	11.97, 15.32, 17.795
	Moscow, U.S.S.R.	G	12.05, 15.18, (via Khabarovsk)
0130-0230	Tokyo, Japan	G	15.195, 15.235, 17.825
0200-0350	Taipei, Taiwan	G	9.685, 11.86, 17.72
0230-0300	Stockholm, Sweden	F	6.135
0300-0330	Seoul, Korea	G	11.925
0300-0400	Buenos Aires, Argentina	F	9.69 (Mon-Fri)
0300-0500	Peking, China	G	15.06, 17.735, 17.855
0330-0730	Moscow, U.S.S.R.	G	12.05, 15.18, 17.775 (via Khabarovsk)
0400-0415	Tokyo, Japan	G	15.105
0400-0555	Montreal, Canada	G	6.135, 9.755
0430-0500	Berne, Switzerland	F	6.045, 9.725
0435-0555	Cologne, Germany	G	6.085, 9.605 (via Canada)
0500-0620	Hilversum, Holland	G	6.165, 9.715 (via Bonaire)
0600-0615	Tokyo, Japan	G	9.505
0600-0700	Buenos Aires, Argentina	G	9.69 (Mon.-Fri.)
0630-0800	Havana, Cuba	F	9.525

* Reception quality (Virginia location, Collins Communications Receiver, L antenna): G-good, F-fair, P-poor
Reception quality of Western North America broadcasts is expected reception in California.

** Not intended for North America, but receivable satisfactorily.

Note: Frequencies may change. Those given here were available at time of writing.

Times and days are given in GMT. Subtract 4 hours to get Eastern

Daylight Time. Subtract 7 hours for Pacific Daylight Time.

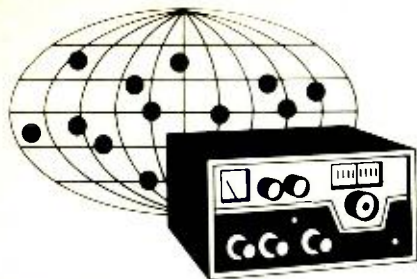

DX Listening

By Glenn Hauser

A WORLD OF NEWS

THE BBC "World Service" is widely recognized as the world's foremost news organization. Americans can broaden their grasp of world events by listening to BBC-WS. Domestic broadcasting networks inevitably filter news coverage through a scale of importance based on American values. BBC-WS attempts to project a worldwide system of values, not just a British one, in its World News bulletins.

BBC-WS sends out nine-minute newscasts daily at the following times (GMT): 1100, 1200 (exc. Sun), 1300, 1400 (Sat), 1600, 1700 (exc. Sat), 1800, 2000, 2200, 2300, 0000, 0200, 0300, and 0500. Voice reports from correspondents around the world are grouped into Radio Newsreels, at 1500, 1815 and 0015. An innovation for the BBC is half-hour mixtures of news and voice reports at 0400 and 0600.

Other BBC-WS news programs are "The World Today" (examining a single newsworthy topic in depth) weekdays at 1645, 2209, 0315, and 0545; "Twenty-Four Hours" (a 'live' coverage of current events) weekdays at 0509, 1109 and 2009; "Outlook" (lighter features with music and humorous touches) weekdays at 1345, 1900 and 0115; "Commentary" (usually delivered by an outside expert) daily at 1609 and 2309 and weekends at 2009; and an expanded Radio Newsreel called "From Our Own Correspondent" Sundays at 0315, 1615 and 2209.

BBC-WS offers many other programs of entertainment including all types of music and information. Among them: "World Radio Club," Wednesdays at 1330 and 2315 repeated Fridays at 2030; "Letter from America," the long-running series by Alistair Cooke, Sundays GMT at 0545, 1315, and Mondays at 1545 and 2315. Margaret Howard gives snappy replies to listeners' criticisms, on "Letterbox," Fridays at 1545, Saturdays GMT

at 0515 and 2315, and Sundays at 2015.

We've given times that are applicable when North Americans are likely to be awake. *Remember that, when it is evening (after 7 p.m. EST) in the U.S., it is the next day, by GMT.* Though BBC-WS does not beam toward America all day long, it's usually possible to pick up some other beam at just about any hour. For a complete schedule, ask for "London Calling" from BBC, 630 Fifth Avenue, New York, NY 10020 (or in Canada, % Box 500, Terminal A, Toronto, Ontario). You may have to wait because the supply is limited, but free.

The *Northern Service* of the CBC provides excellent news coverage of Europe, Canada and the USA (in contrast to American networks, which, as a rule, ignore Canada). One outstanding example is "As It Happens," in which newsmakers are interviewed in depth, by phone, weekdays 6:30-8:00 p.m. (ET) on 9625 and 11720 or 5960 kHz. Americans near the border can hear it on Canadian AM stations, but thanks to the peculiarities of shortwave, the Northern Service is also a "Southern Service." The CBC won't send you an N.S. program schedule unless you're in the Canadian North.

National Public Radio originates an award-winning news magazine, "All Things Considered," which runs 90 minutes on weekdays. Many parts of the USA are still beyond the reach of NPR affiliates, and some of those slice the program down to 30 minutes, or delay it several hours. But on shortwave, just about anywhere in the USA or abroad you can hear 60 live minutes of A.T.C., via the *American Forces Radio & Television Service*, weekdays at 5:00-6:00 p.m. (ET). (We're giving CBC-NS, and AFRTS schedules in Eastern Time.

In addition, AFRTS draws news on the hour from all domestic networks. Many news feature shows, often

skipped or relegated to the middle of the night by local network affiliates, are broadcast as many as eight times around the clock on AFRTS—usually beginning 35 minutes past the hour. The 60-minute news block weekdays at 7 p.m. combines commentaries from the big network names.

Sport fans should rate AFRTS "number one." If there's any play-by-play coverage available, chances are AFRTS is carrying it, preempting all other programming. Sports coverage plans and other program changes are announced in advance daily at 12:35 and 6:35 a.m. and p.m.

Among the frequencies AFRTS has used at various hours of day and night are 17.765, 15.430, 15.330, 11.790, 11.935, 11.900, 11.805, 11.795, 9.755, 9.700, 6.095, and 6.030 MHz. You can get a current schedule by writing to AFRTS-Washington, Room 301, 1117 North 19th Street, Arlington, VA 22209.

DX Programs, such as BBC-WS's "World Radio Club," are prepared especially for DX listeners; consequently, they are usually the most popular program on each station. Radio Nederland's "DX Juke Box" is on Thursdays, including a report from yours truly once a month. Radio Canada International's "Shortwave Club" appears every Saturday; Switzerland's "Merry-Go-Round" is on the 2nd and 4th Saturdays of each month. HCJB's "DX Party Line" is a half-hour of easy-going information for the beginner and potential convert, three times a week: GMT Tuesdays, Thursdays and Sundays at 0230.

Emphasizing DX tips alone are Radio Australia, Sunday at 1300 or 1200 (they neglected to adjust their morning schedule for standard time last October) and Monday GMT at 0215; and Radio Japan, Sunday at 1420 and 2320 and Monday GMT at 0025 and 0210. "Sweden Calling DX'ers" has a large following, each Tuesday. It's the only DX program to send out printed transcripts, free, to contributors.

In our last column we talked about *Courtesy Program Committees*, which arrange special late-night test broadcasts on AM stations. The 'season' is drawing to an end, but you can still try for WOTT-1410, Watertown, New York, Monday, Mar. 24 at 2:30 a.m. (ET) The program was arranged for the Newark News Radio Club, Box 539, Newark, NJ 07101. ◆

Just think how much in demand you would be if you could prevent a TV station from going off the air by repairing a transmitter . . . keep a whole assembly line moving by fixing automated production controls . . . prevent a bank, an airline, or your government from making serious mistakes by servicing a computer.

Today, whole industries depend on Electronics. When breakdowns or emergencies occur, someone has got to move in, take over, and keep things running. That calls for one of a new breed of technicians — The Troubleshooters.

Because they prevent expensive mistakes or delays, they get top pay — and a title to match. At Xerox and Philco, they're called Technical Representatives. At IBM they're Customer Engineers. In radio or TV, they're the Broadcast Engineers.

What do you need to break into the ranks of The Troubleshooters? You might think you need a college degree, but you don't. What you need is know-how—the kind a good TV service technician has—only lots more.

Learn at Home . . . In Your Spare Time

As one of The Troubleshooters, you'll have to be ready to tackle a wide variety of electronic problems. You may not be able to dismantle what you're working on — you must be able to take it apart "in your head." You'll have to know enough Electronics to understand the engineering specs, read the wiring diagrams, and calculate how the circuits should test at any given point.

Learning all this can be much simpler than you think. In fact, you can master it without setting foot in a classroom . . . and without giving up your job!

For over 37 years, the Cleveland Institute of Electronics has specialized in teaching Electronics at home. We've developed special techniques that make learning easy, even if you've had trouble studying before. Our AUTO-PROGRAMMED® Lessons build your knowledge as easily and solidly as you'd build a brick wall — one brick at a time. And our instruction is personal. Your teacher not only grades your work, he analyzes it to make sure you are thinking correctly. And he returns it the same day it is received, while everything is fresh in your mind.

The Science of the Seventies

To keep up with the latest developments, our courses are constantly being revised. CIE students receive lessons in Field Effect Transistors, Digital Switching Units, Microwave Systems, Lasers, Binary Coding and Computer Arithmetic.

In addition, CIE offers an exciting Electronics Technology with Laboratory course that includes 161 space-

age components to let you perform 242 fascinating electronics experiments. You learn the "how" as well as the "why" of Electronics . . . the Science of the Seventies. Many leading companies use CIE courses to train their own employees who are working on the latest electronic equipment.

Get an FCC License — or Your Money Back!

Two-way mobile work and many other types of troubleshooting call for a Government FCC License, and our training is designed to get it for you. But even if your work doesn't require a license, it's a good idea to get one. Your FCC License will be accepted anywhere as proof of good electronics training.

A good way to prepare for your FCC exam is to take a licensing course from CIE. Our training is so effective that, in a recent survey of 787 CIE graduates, better than 9 out of 10 CIE grads passed the Government FCC License examination. That's why we can offer this famous Money-Back Warranty: when you complete any CIE licensing course, you'll be able to pass your FCC exam or be entitled to a full refund of all tuition paid. This warranty is valid during the completion time allowed for your course. You get your FCC License — or your money back.

Mail Card for 2 Free Books

Want to know more? Then fill out and mail reply card or coupon today. We'll send you our two FREE books on opportunities in Electronics. For your convenience, we will try to have a representative call. Act now, and get a high-paying job that much sooner.

APPROVED UNDER G.I. BILL

All CIE career courses are approved for educational benefits under the G.I. Bill. If you are a veteran or in service now, check box for G.I. Bill information.

CIE Cleveland Institute of Electronics, Inc.

1776 East 17th Street, Cleveland, Ohio 44114

Accredited Member National Home Study Council

Cleveland Institute of Electronics, Inc.

1776 East 17th Street, Cleveland, Ohio 44114

Please send me your two FREE books:

1. Your school catalog, "Succeed in Electronics."
2. Your book on "How To Get A Commercial FCC License."

I am especially interested in:

- | | | |
|---|---|--|
| <input type="checkbox"/> Electronics Technology | <input type="checkbox"/> Broadcast Engineering | <input type="checkbox"/> First Class FCC License |
| <input type="checkbox"/> Electronic Communications | <input type="checkbox"/> Industrial Electronics | <input type="checkbox"/> Electronics Engineering |
| <input type="checkbox"/> Electronics Technology with Laboratory | | |

Name _____
(PLEASE PRINT)

Address _____

City _____ State _____ Zip _____

Veterans and Servicemen:

Check here for G.I. Bill information.

PE-78

Learn By Doing...

Electronics Technology with Laboratory Course teaches you the fundamentals. Using space-age components and testing techniques you will apply the principles you learn . . . actually analyze and troubleshoot modern electronics equipment.



DIXIE SAVE ON Brand Name Audio Components

BY MAIL

Write Today for Our
FREE Audio Catalog

DIXIE is one of the oldest and largest audio component mail order houses in the country. Our prices on brand name components are actually LOWER than "Discounters". See our new catalog or call us for a price quote. Everything shipped factory-sealed with full manufacturer's warranty.



DIXIE HI-FIDELITY

5600 Second St., N. E., Washington, D. C. 20011
Phone: 1-202-635-4900

Please rush me your FREE Audio Catalog and complete information. I understand there is no obligation.

Name _____
Address _____
City _____
State _____ Zip _____ PE 3

SAVE!

MONEY • TIME • FREIGHT

QUALITY STEREO EQUIPMENT
AT LOWEST PRICES.

YOUR REQUEST FOR QUOTA-
TION RETURNED SAME DAY.

FACTORY SEALED CARTONS—
GUARANTEED AND INSURED.

SAVE ON NAME BRANDS LIKE:
A.D.C. KLH
A.R. SHURE
DYNACO KOSS
SONY FISHER

AND MORE THAN 50 OTHERS

BUY THE MODERN WAY
BY MAIL—FROM

illinois audio

Department 217S
12 East Delaware
Chicago, Illinois 60611
312-664-0020

CIRCLE NO. 17 ON READER SERVICE CARD

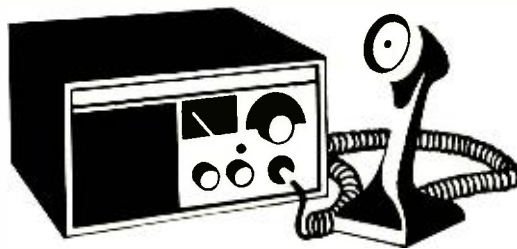

CB Scene

By Len Buckwalter, K10DH

THE BOOM IN CB CHANNELS

WHEN FCC proposals for overhaul of the Class D band appeared recently, I thought of calling a Philadelphia Lawyer and a couple of MIT physicists and asking them to explain the whole thing to me. The latest from Washington headquarters (see Editorial, November 1974) is a 13-page document with enough legalese for a couple of insurance policies. But a careful analysis of the Commission's proposals delivers a mighty surprise. Unlike FCC dockets of past years, which attacked CB as radio's black sheep, this one (No. 20120) is cause for celebration. It could more than triple the number of CB channels and ease the complaints about CB from the lawmakers.

The bonanza didn't become entirely clear until we plotted all the proposed

a whole slew of new frequencies—channels 60 through 99—are also tacked on to extend the band. A novel difference, however, is that these forty extra channels are spaced every 5 kHz apart. Further, they are reserved exclusively for SSB signals. To win an expanded slot in the spectrum, the Commission is exploiting SSB's prowess at occupying half the normal channel width. This explains how twice as many channels will fit into the same bandwidth as before. That's only part of the proposal. The Commission is also entertaining the idea of splitting the first 30 channels into 60 (SSB) five years after an effective date ruling. However, we do not anticipate that a ruling of this type will be adopted.

Probably the most important voice heard from—the Electronics Indus-

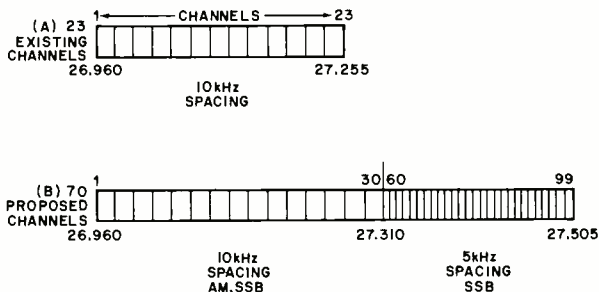

Fig. 1. FCC proposal to increase CB channels.

changes to reveal, at a glance, the band as it is today compared to what it will look like if the proposals become law. Figure 1A shows the class D band on 27 MHz and the familiar 23 channels positioned at 10-kHz intervals. This spacing accommodates the conventional variety of CB modulation—AM with double sidebands, although single-sideband signals may also share the channels.

The first expansion in the band, if the proposals go into effect, appears in Fig. 1B. As you can see, seven conventional channels (spaced every 10 kHz) are added to the lower 23 to bring the total to 30 channels. But note that

tries Association (EIA)—has expressed cogent opposition to it. At a meeting of the Citizens Radio Section held recently in Los Angeles, industry leaders unanimously agreed that the following actions taken simultaneously would provide for the greatest improvement of the Service:

- (1) Assignment of a new spectrum for CB in the vicinity of 220 MHz (Docket No. 19759, the earlier Class E proposal).
- (2) Provide for a program of faster licensing.
- (3) Carry out strong enforcement against sale of illegal equipment that can be used on 27 MHz.
- (4) Additional channels should be assigned for both AM and SSB-only

operation, with permission to operate SSB either upper or lower, in the AM portion.

Concerning the latter, the EIA feels a complete changeover to single-sideband equipment runs against a basic tenet of CB—encouraging inexpensive equipment and therefore allowing the greatest number of citizens to benefit from two-way radio. Further, the EIA notes that the economic im-

Today's band as shown in Fig. 2A is generally divided between two groups of stations; those units of the same callsign (intra) and units of different callsign (inter). Units of the same call may now speak to each other on any of the 23 channels except 9, the emergency frequency. Interstation channels are limited to 10 through 15 and 23. Under the new proposals, shown in Fig. 2B, units of the same

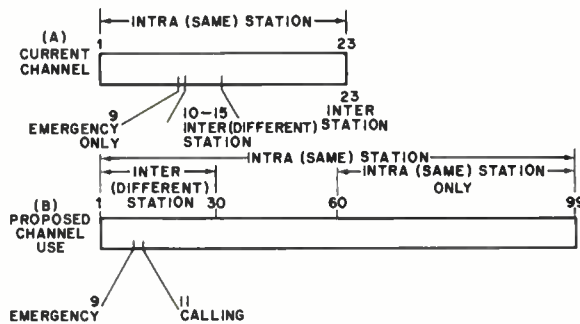

Fig. 2. Current and proposed channel usage.

pact on users—over 90 percent of CB units are AM—would be unreasonable; virtually all organized public service activity is on AM. SSB only is an unproven mode in the Citizens Radio Service. These are convincing arguments and we believe the FCC will recognize their merits.

Other points of EIA agreement include designating channel 11 as a calling channel. They also want one calling and one emergency channel to be added among channels to be designated SSB operation only. The Section also proposes that the present assignment of channels for inter- and intra-station communication be eliminated and that the proposed one-minute silence period be a guideline rather than an enforcement matter. The group further agreed with the Commission's proposed reduction of the age limit for licensing to 16. However, they oppose a requirement for station transmitter identification to be visible from outside a vehicle. As we view this, such identification would be an open invitation to thieves.

station may speak on any channel, as before, while interstation units are restricted to channels 1 through 30. A question mark appears between 30 and 60 because the FCC hasn't yet described how usage on these additional proposed channels will be assigned, if at all. Channel 9 in the new station scheme is again for emergencies.

The frequency explosion is the most significant section of the FCC proposals, but there are other plums, too. In response to many outcries to relax the ban on hobby-type communication, the Commission appears to be taking a softer line. It is still against a CB service "for those people who wish to operate a radio transmitter simply for the purpose of operating a radio." The Commission, however, does plan to eliminate several sections in the law which deal with the hobby-type activity. The strongest statement will merely say that activity must not relate to the use of the radio. You will not have to swear, when signing the application form that you will not engage in idle conversation or chit-chat. ♦

**CB CALLSIGNS OF POLICE DEPARTMENTS
(Granted Licenses to Communicate Directly With CB'ers.)**

Illinois State Police (2000 units)
Indiana State Police (900 units)
Missouri State Highway Patrol (150 units)
Ohio State Highway Patrol (360 units)
Oklahoma Dept. of Public Safety (50 units)
(Texas) Jones County Sheriff's Dept. (10 units)
Virginia Marine Resources Commission (65 units)

KFT-2177
KFP-2179
KGY-5621
KNN-3083
KFP-2180
KFP-2178
KFP-2181

BIG DISCOUNTS

STEREO COMPONENTS

Largest selection of top name brands... try us and see

It's worth a call
(301) 488-9600



DEPT. D

6330 Frankford Ave
Baltimore, Md 21206

All mail answered within 24 hours

Phone Daily 9 AM to 9 PM

Saturday 9 AM to 4 PM

Phone (301) 488-9600

CIRCLE NO. 19 ON READER SERVICE CARD

Expensive Stereo doesn't have to be.
Our CHEAP catalog shows how.

Mail the coupon for your FREE copy of our 25¢ catalog. With it, you'll save on over a hundred brands of fine components. Bonus features—a pull-out "HiFi Primer" section to get you started, plus articles on tape equipment and 4-channel. Write for your copy today.

Midwest HiFi

WHOLESALE and Mail Order Division

FREE with coupon

1626 Ogden Avenue
Downers Grove, Illinois 60515
(312) 852-5885

3309 E. Carpenter Freeway
Irving, Texas 75062
(214) 254-9771

Call for a quote. Lines open 1-4 pm C.S.T.



NAME _____
ADDRESS _____
CITY/STATE _____ ZIP _____ (PE5-03)

CIRCLE NO. 24 ON READER SERVICE CARD



Tips & Techniques

INTERMEDIATE RESISTANCE VALUES

Many times a circuit design calls for a value of resistance not in the commonly available 12 series. A close value may be found in the

24 series, but many dealers don't stock them. (Successive values in the 12 series are related by the factor 1.2, and by 1.1 in the 24 series). Here is a good rule-of-thumb for approximating these less common values. Take the next higher resistance above the desired value and parallel it with another ten times larger. For example, if a 24-series 51-ohm resistor is needed, take a 12-series 56-ohm one and parallel it with a 12-series 560-ohm resistor. Net resistance is 50.9 ohms, or 0.2% off. The error will never be greater than 3.1%, well below the manufacturer's tolerances.

—A.G. Fletcher

BETTER THAN A THIRD HAND!

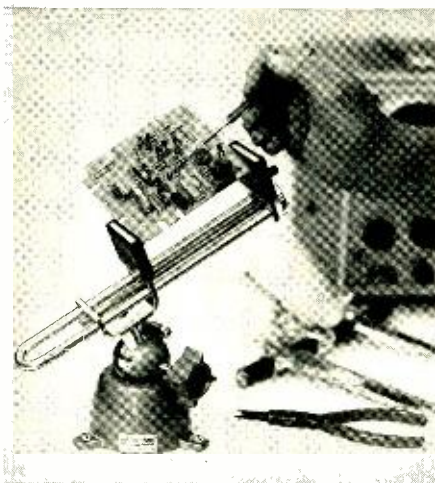

PANAVISE TILTS, TURNS, AND ROTATES TO ANY POSITION. IT HOLDS YOUR WORK EXACTLY WHERE YOU WANT IT.

PanaVise has great strength yet is gentle enough to firmly hold delicate objects.

Quite possibly the finest new tool you will buy this year, PanaVise is built to exacting professional standards. We guarantee it!

Illustrated is the Electronics Vise Model 396. Three other bases and a wide variety of heads are available. All interchangeable! Buy a basic unit, then add on to create your system.

Available through your dealer.
Write for a free catalog.

PANAVISE® Dept. 22E
10107 Adella Ave., South Gate, CA 90280
In Canada: 25 Toro Rd., Downsview, Ont. M3J 2A6

CI A Division of Colbert Industries

CIRCLE NO. 28 ON READER SERVICE CARD

AUTO LIGHTS WARNING BUZZER

Leaving your parking lights on all night can be almost as hard on the car battery as the headlamps. This simple warning system uses the ignition key/door buzzer. Only a diode is required. Install the 50-PIV diode as shown. If the lights are left on when the ignition switch is open, the diode turns the

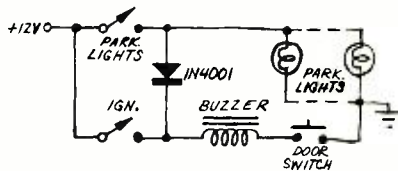

warning buzzer on. Since most headlight/parking light switches are ganged, you will be alerted when the headlights and/or parking lights are left on.

—Paul Reckling

CONTINUITY TESTER

When installing a new member of an antenna farm, or trying to do some simple troubleshooting in a car, it is helpful to have a continuity tester to trace leads. An inexpensive door bell and battery can perform this function. Hook up the doorbell at either end of the antenna feedline and place the battery across the various feedlines until the bell is heard. This isolates the desired line. For auto "hot" wires, ground one side of the doorbell and search out the "hot" lead with a test lead attached to the other side of the bell.

—C. W. Hart, Jr.

NO-COST OCTAL PLUGS

If you need an octal plug but all the stores are closed, you can make your own. Take a dead tube with an octal base and carefully remove the glass envelope and metal tube elements. Wires can be connected to existing pin leads, or directly into the pins after they have been cleaned up. Fill the tube base with epoxy cement to provide strain relief.

—Geoffrey Williams

SOLDERING IRON HOLDER

Soldering irons have a habit of rolling around the workbench, causing accidental burns to insulation and flesh. An easy way to make a holder is to notch and bend a

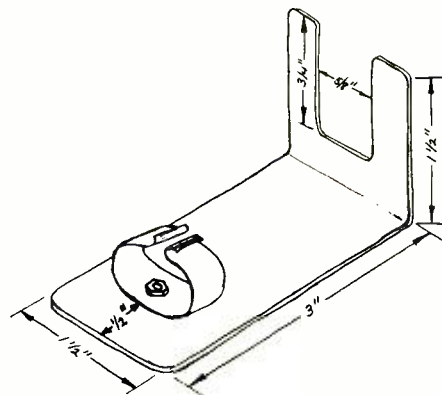

piece of steel strap as shown. Mount a clip made from springy steel or brass sheet about 1/2-in. (12.5 mm) from the unbent end. To use the stand while soldering, rest the iron on top of the stand. When the job is done, clip the iron into the stand and it will help dissipate residual heat as well as keep the iron stationary.

—Homer Jackson

ADD LIFE TO PILOT LIGHT BULBS

Replacing burnt-out pilot light bulbs in electronic gear can become tedious and expensive. Here's a simple way to extend bulb life many times. Insert a diode rectifier in the bulb voltage supply. Pulsating dc will be supplied to the bulbs, at about half the current previously drawn. The bulbs will operate at lower temperatures and last much longer. Light output will also decrease, but this is seldom a problem. If more brightness is required, use a higher wattage bulb. Even with these bulbs, lifetime will be greatly increased.

—Calvin Graf

INEXPENSIVE VOLTAGE BOOSTER

At times of peak demand, power companies drop their voltage 5% to stay within safety limits of their equipment. This small voltage drop can be hard on certain appliances—television receivers, small

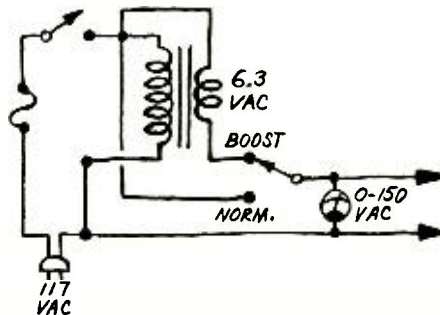

motors, etc. Using a 6.3-V filament transformer in the circuit below allows you to compensate for low line voltage. In the Boost position, voltage is stepped up about 5.4%. Any device which draws less than the rated current of the transformer may be used. For example, a 3-A transformer can handle 330 W, enough for most color TV receivers. The fuse should have the same current rating as the transformer.

—T.R. Fox

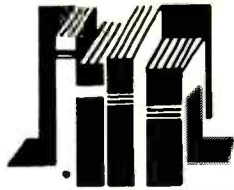

Electronics Library

BASIC RADIO (Revised Second Edition)

by Marvin Tepper

This six-volume series carries the reader through the fundamentals of electronic communications. It's profusely illustrated, leaning heavily on drawings that are largely self-explanatory. Dc electricity, beginning with key ideas in electrostatics, current flow, and Ohm's law, are covered in Volume One. Ac electricity, electron tube circuits, AM and FM receivers, transistors and IC's, and transmitters are dealt with in subsequent volumes. A glossary is included in each part to acquaint the reader with terms that are employed. Each volume also has a subject index, and the sixth volume has a cumulative index for the entire course.

Published by the Hayden Book Company, 50 Essex Street, Rochelle Park, NJ 07662. Soft cover. Volumes 1-5, \$3.50; Volume 6, \$3.75.

PICTORIAL GUIDE TO CB RADIO INSTALLATION AND REPAIR

by F. Belt

This book is a guide to the proper installation, checkout, and limited maintenance of CB transceivers and antennas. Common pitfalls of maintenance and installation are mentioned, and alternatives are given that allow the reader to avoid such traps. Included in base-station installation procedures are tips for reducing TV interference, minimizing possible lightning damage, and correct wiring of a microphone. A chapter on antenna setup shows optimum locations, how to support one, and how to feed an antenna with coaxial line. Two chapters are devoted to mounting and adjusting mobile equipment. Servicing tips for SSB gear, synthesizers, and receivers conclude the book.

Published by Tab Books, Blue Ridge Summit, PA 17214. 256 pages. \$7.95, hard cover; \$4.95, paperback.

ELECTRONIC SERVICE INSTRUMENTS

by Clyde N. Herrick

Describing the basic instruments used to troubleshoot today's home entertainment electronic products, this text includes service instrument operation and practical applications. It covers: multimeters, oscilloscopes, signal generators, transistor tes-

ters, FM stereo-multiplex generators, white-dot and crosshatch generators and color-bar generators, among others. It also has a section on basic logic gates. Questions and problems at the end of each chapter can be used for self-study or review purposes. Complemented by useful schematics and illustrations, the book can serve well as a reference tool and guide to modern electronic service instruments.

Published by Prentice-Hall, Inc., Englewood Cliffs, NJ 07632. 280 pages. \$13.95 clothbound.

THE RADIO AMATEUR'S HANDBOOK (1975)

This latest edition of the renowned ARRL Handbook keeps pace with the latest technical developments, while retaining a solid foundation of fundamental theory and practical techniques for radio communication. Revised and updated information is included in the areas of receiving techniques, transmitter design, antenna construction, and FM repeaters. Among the new construction projects are a 160-meter amplifier, a solid-state SSB/CW exciter, a portable receiver for 20 and 40 meters, a Unimatch antenna coupler and a 5-element triband quad.

Published by the American Radio Relay League, 225 Main Street, Newington, CN 06111. 704 pages. \$8.50 hard cover, \$5.50 soft cover.

CMOS MICROLAB

- * LEARN HOW DIGITAL CIRCUITS WORK
- * VERIFY DESIGNS QUICKLY
- * IDEAL TEACHING AID

The CMOS Microlab makes it possible to quickly check, or understand a variety of digital circuits. Battery operation makes the Microlab super convenient. Use it anywhere. Indicator lamps are all LED types that are rugged and will never burn out. Included in the Microlab are four (4) flip-flops, four (4) dual input NOR gates, four (4) dual input NAND gates, two (2) four input NAND gate and an inverter. No external signal sources are needed in most cases. Connections are made with reliable, easy to use push-on type connectors on the jumper wires. The entire instrument is "goof-proof". No possible combination of connections, no matter how wrong, can damage the circuit.

The kit is housed in a 5 x 7 x 3 break resistant impact plastic case. Powered by four (4) standard "D" cells. (Not included in kit)

CMOS Complete Microlab Kit.....\$34.50 PPd

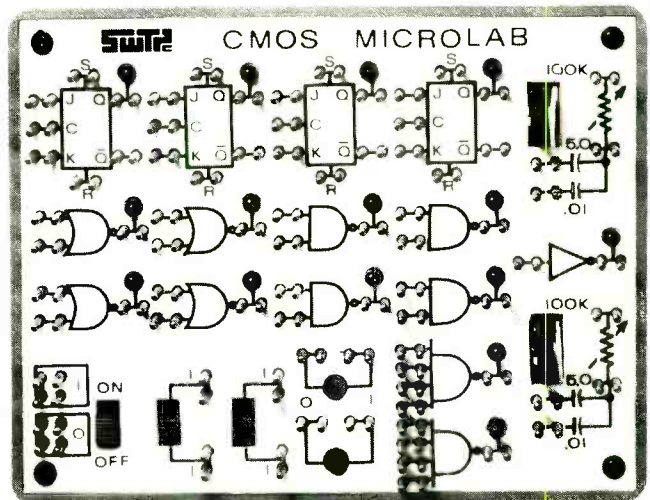

Southwest Technical Products Corp.
219 W. Rhapsody
San Antonio, Texas 78216

ELECTRONICS MARKET PLACE

NON-DISPLAY CLASSIFIED: COMMERCIAL RATE: For firms or individuals offering commercial products or services, \$1.80 per word (including name and address). Minimum order \$27.00. Payment must accompany copy except when ads are placed by accredited advertising agencies. Frequency discount, 5% for 6 months; 10% for 12 months paid in advance. **READER RATE:** For individuals with a personal item to buy or sell, \$1.10 per word (including name and address.) No minimum! Payment must accompany copy. **DISPLAY CLASSIFIED:** 1" by 1 column (2-1/4" wide), \$215.00. 2" by 1 column, \$430.00. 3" by 1 column, \$645.00. Advertiser to supply cuts. For frequency rates, please inquire.

GENERAL INFORMATION: First word in all ads set in bold caps at no extra charge. All copy subject to publisher's approval. All advertisers using Post Office Boxes in their addresses **MUST** supply publisher with permanent address and telephone number before ad can be run. Advertisements will not be published which advertise or promote the use of devices for the surreptitious interception of communications. Closing Date: 1st of the 2nd month preceding cover date (for example, March issue closes January 1st. Send order and remittance to **POPULAR ELECTRONICS**, One Park Avenue, New York, New York 10016, Attention: Hal Cymes.

FOR SALE

FREE! Bargain Catalog—I.C.'s, LED's, readouts, fiber optics, calculators parts & kits, semiconductors, parts, Poly Paks, Box 942PE, Lynnfield, Mass. 01940.

GOVERNMENT Surplus Receivers. Transmitters. Snoproscoops, Radios, Parts. Picture Catalog 25 cents. Meshna, Nahant, Mass. 01908.

LOWEST Prices Electronic Parts. Confidential Catalog Free. KNAPP, 3174 8th Ave. S.W., Largo, Fla. 33540.

ELECTRONIC PARTS, semiconductors, kits. FREE FLYER. Large catalog \$1.00 deposit. BIGELOW ELECTRONICS, Bluffton, Ohio 45817.

RADIO—T.V. Tubes—36 cents each. Send for free catalog. Cornell, 4213 University, San Diego, Calif. 92105.

AMATEUR SCIENTISTS, Electronics Experimenters, Science Fair Students. Construction plans—Complete, including drawings, schematics, parts list with prices and sources. Robot Man—Psychedeic shows—Lasers—Emotion/Lie Detector—Touch Tone Dial—Quadrasonic Adapter—Transistorized Ignition—Burglar Alarm—Sound Meter...over 60 items. Send 25 cents coin (no stamps) for complete catalog. Technical Writers Group, Box 5994, University Station, Raleigh, N.C. 27607.

SOUND SYNTHESIZER KITS—Surf \$12.95. Wind \$12.95. Wind Chimes \$17.95. Electronic Songbird \$6.95. Musical Accessories, many more. Catalog free. PAIA Electronics, Box J14359, Oklahoma City, OK 73114.

MECHANICAL, ELECTRONIC devices catalog 10 cents. Greatest Values—Lowest Prices. Fertik's, 5249 "D", Philadelphia, Pa. 19120.

FREE CATALOG. Parts, circuit boards for POPULAR ELECTRONICS projects. PAIA Electronics, Box C14359, Oklahoma City, OK 73114.

YOU WILL SAVE BIG MONEY! Surplus, Clearouts, Bankruptcy, Inventory, Deals. Catalog \$1 (redeemable). ETCOA Electronics, Box 741, Montreal, H3C 2V2, U.S. Inquiries.

BURGLAR-FIRE alarm supplies and information. Free catalog. Protecto Alarm Sales, Box 357-G, Birch Run, Michigan 48415.

BUGGED??? New locator finds them fast. Write. Clifton, 11500-L N.W. 7th Avenue, Miami, Florida 33168.

TELEPHONE "BUGGED"? Countermeasures Brochure \$1.00. Negeye, Drawer 547, Pennsboro, VA 26415.

HEAR POLICE/FIRE Dispatchers! Catalog shows exclusive directories of "confidential" channels, receivers. Send 10 cent stamp. Communications, Box 56-PE, Commack, N.Y. 11725.

CONVERT any television to sensitive, big-screen oscilloscope. Only minor changes required. No electronic experience necessary. Illustrated plans, \$2.00. Sanders, Dept. A-33, Box 92102, Houston, Texas 77010.

LEARN DESIGN TECHNIQUES. Electronics Monthly Newsletter. Digital, linear construction projects, design theory and procedures. Sample copy \$1.00. Valley West, Box 2119-B, Sunnyvale, California 94087.

METERS—Surplus, new used, panel or portable. Send for list. Hanchett, Box 5577, Riverside, CA 92507.

WE SELL CONSTRUCTION PLANS, TELEPHONE: Answering Machine, Speakerphone, Carphone, Phonevision, Auto Dialer, Touch Button Dialer, Central Dial System. TELEVISION: \$35.00 Color Converter, Video Tape Recorder, \$25.00 Camera. HOBBYIST: Electron Microscope, 96 Hour Tape Music System. Ultrasonic Dishwasher, Radar-Oven, Plans \$4.95 each. NEW ITEM: \$75. Electronic Pocket Calculator, \$7.50. COURSES: Telephone Engineering \$39.50. Detective Electronics \$22.50. Integrated Circuit Engineering, \$49.50. NEW SUPER HOBBY CATALOG plus year's subscription to Electronic News Letter AIRMAILED \$1.00. Don Britton Enterprises, 6200 Wilshire Blvd., Los Angeles, Calif. 90048.

LOOKING FOR A NEW CHALLENGE?
... then build a TV camera!



ONLY SOLID STATE CAMERA AVAILABLE IN KIT FORM OR FACTORY ASSEMBLED. COMPLETE KIT WITH VIDEO TUBE ONLY \$156.00. POSTPAID DELIVERY ANYWHERE IN U.S.A., CANADA AND MEXICO. OPTIONAL AUDIO SUBCARRIER \$18.95. WRITE OR PHONE NOW FOR COMPLETE CATALOG OF KITS, PARTS AND PLANS. Dial 402-987-3171.

1301 BROADWAY ATV Research DAKOTA CITY, NEBR. 68721

CD IGNITIONS, VHF/UHF monitors, crystals, CB radios. Southland, Box 3591-B, Baytown, Texas 77520.

DISCOUNT PRICES
B & K, SENCORE, LEADER and RCA
Test Equipment
RAYTHEON, ICC/MULLARD Tubes
TELEMATIC Test Jigs
Free Catalog
FORDHAM RADIO SUPPLY CO., INC.
558 Morris Ave. • Bronx, N.Y. 10451

CALCULATOR OWNERS: Use Your +x- calculator to compute square roots, trigonometric functions, logarithms, and more! Quickly, Accurately, Easily! Send today for the First and Best Calculator Manual... now in use throughout the world... still only \$2.00 Postpaid with Unconditional Money-Back Guarantee! Mailman Optics and Electronics, Dept. 24A, 836 South 113, West Allis, Wisconsin 53214.

CRYSTALS, Scanners, \$3.88, include make and frequency. G Enterprises, P.O. Box 461PC, Clearfield, UT 84105.

FREE CATALOG. Kits, Components, audio equipment. Electronic Supply Pacs, Box 175, Floral Park N.Y. 11001.

ALPHA/THETA BRAINWAVE biofeedback instruments. Analog instruments from \$125; digital processing systems from \$225. BioScan, Box 14168-E, Houston, Texas 77021.

SURPRISE! Build inexpensively, the most Unusual Test Instruments, Futuristic Gadgets using Numerical Readouts! Catalogue Free! GBS, Box 100A, Green Bank, West Virginia 24944.

ELECTRONIC IGNITION: Capacitor, transistor, pointless. Auburn sparkplugs. Information 10 cents. Anderson Engineering, Epsom, N.H. 03234.

WHOLESALE Scanners, CB, Crystals, Directories, SSB/AM, Catalog 25 cents. G—Enterprises, Box 461P, Clearfield, Utah 84105.

FREE 1975 Electronics Catalog. McCord Electronics, Box 276-N, Sylvania, Ohio 43560.

AUTORANGING DMM, deluxe VOM's, logic probes and more. Lowest prices. Free catalog. Electro Industries, 4201 Irving Park, Chicago, Illinois 60641.

PYROTECHNICAL chemicals, casings, tools, supplies, fuse. Price List 50 cents. Westech, Logan, Utah 84321.

CARBON FILM RESISTORS. Brand new as low as 2-1/4 cents. FREE samples and specifications. COMPONENTS CENTER—PE, Box 134, New York, NY 10038.

7,000 SEMICONDUCTORS, 100's Electronic Circuit Kits, Technical Reports, Energy Conservation, Computers, Cat. 50 cents. E/S Lab, Box 738, College Park, MD 20740.

OEMorsco

An OEM Distributor Of
Certified Integrated Circuits

A WARNING!!

Because of our large volume, and aggressive buying, our prices are lower than most manufacturer's 100 pc. OEM prices. If you wish to buy rejects, then buy the cheapest circuits you can find. This is sometimes OK for TTL circuits, but for MOS and CMOS, watch out! Our engineers like to have their projects work! We hope you feel the same way about yours. Is your time worth 20 cents/hour to troubleshoot marginal I.C.'s? If your time is worth more than that, then be advised that OEMorsco is the only mail order supplier of certified and guaranteed I.C.'s and that our prices reflect the true costs of buying prime I.C.'s and testing every one to insure quality performance.

MOS AND CMOS PRICES ARE COMING DOWN!

(TAKE A LOOK AT OUR DISCOUNT SCHEDULE)

USEFUL CMOS

The most useful logic family

GATES

CD4001AE QUAD 2 NOR	51
CD4002AE DUAL 4 NOR	51
CD4011AE QUAD 2 NAND	51
CD4012AE DUAL 2 NAND	51
CD4023AE TRIP 3 NAND	51
CD4025AE TRIP 3 NOR	51
CD4071AE QUAD 2 EXDR	51
CD4081AE QUAD 2 AND	51

BUFFERS

CD4009AE HEX INV	1.30
CD4010AE HEX	1.30
CD4049AE HEX INV	1.30
CD4050AE HEX	1.30

FLOPS

CD4013AE DUAL D	1.98
CD4027AE DUAL JK	1.98

SHIFT REGISTERS

CD4006AE 18 BIT STATIC	2.93
------------------------	------

COUNTERS, DIVIDERS

CD4017AE DECADE	3.27
CD4018AE N. PRESETTABLE	3.86
CD4020AE 14 STAGE BINARY	3.39
CD4021AE 7 STAGE BINARY	1.90
CD4026AE DECADE WITH 7 SEG. DECODE DRIVER	6.25
CD4029AE UP, DDWN PRESETTABLE	3.96

ADDERS

CD4008AE 4 BIT FULL	3.56
---------------------	------

DECODERS

CD4026AE DECADE TO 7	2.99
CD4033AE DECADE TO 7 W/RIPPLE BLANKING	3.85

MULTIPLEXERS

CD4016AE QUAD SWITCH	99
CD4051AE DNE 8 CH	3.45
CD4053AE TRIP 2 CH	3.45
CD4066AE QUAD SWITCH	2.25

TIME PIECE CIRCUITS

SCL4520F	29.00
SCL5437F	9.80
SCL5440F	43.25
SCL5441F	19.27
SCL5442F	28.41

MOS L.S.I. SPECIALS

MM5013N	SINGLE 1024 BIT DYNAMIC SHIFT REGISTER	6.00
MM5016N	SINGLE 512 BIT DYNAMIC SHIFT REGISTER	2.95
MM5017N	DUAL 512 BIT DYNAMIC SHIFT REGISTER	5.80
MM5055N	QUAD 128 BIT STATIC SHIFT REGISTER	4.50
MM5056N	DUAL 256 BIT STATIC SHIFT REGISTER	4.25
MM5057N	SINGLE 512 BIT STATIC SHIFT REGISTER	4.25
MM5058N	SINGLE 1024 BIT STATIC SHIFT REGISTER	7.95
2502B	QUAD 256 BIT DYNAMIC SHIFT REGISTER	6.10
2503V	DUAL 512 BIT DYNAMIC SHIFT REGISTER	5.90
2501TA	SINGLE 1024 BIT DYNAMIC SHIFT REGISTER	4.95
2501V	SINGLE 512 BIT DYNAMIC SHIFT REGISTER	4.75
2525V	SINGLE 512 RECIRCULATING DYNAMIC	4.00
2509A	DUAL 50 BIT STATIC SHIFT REGISTER	3.35
2510A	DUAL 100 BIT STATIC SHIFT REGISTER	3.95
2521V	DUAL 128 BIT STATIC SHIFT REGISTER	4.55
2527V	DUAL 256 BIT STATIC SHIFT REGISTER	4.95
2533V	SINGLE 1024 BIT STATIC SHIFT REGISTER	7.95
2602B	1024 BIT STATIC RAM	13.85

LINEAR SPECIALS

(WE WISH TO REDUCE OUR STOCK)

LM311N	COMPARATOR 8 PIN DIP	1.25
LM311N-14	COMPARATOR 14 PIN OIP	1.78
LM311H	COMPARATOR 8 PIN IOS	1.96
LM324N	QUAD OP AMP 14 PIN DIP	1.99
LM380N	AUDIO POWER 14 PIN DIP	1.15
LM380N-8	AUDIO POWER 8 PIN DIP	1.25
LM555N	TIMER 8 PIN DIP	.76
LM741CH	MOST POPULAR OP AMP	.60
LM320K-5	5.5, 12, 15 103	3.10
LM308H	H I Z INPUT OP AMP	1.50
LM308AH		4.95

OEMorsco

2403 Charleston Road
Mountain View, CA 94043
415-965-4446

Please inquire about DM8890 through DM8880, F9300 Series, Signetics 2500 and 8T series, and DTL, etc.

We also offer burn-in and custom testing (e.g., LM308AN-0 1mv) to OEM's.

DISCOUNTS: \$100—7%, \$350—14%, \$1000—22%, \$3500—30%, \$10K—36%

TERMS: Cash, check, or 25% on C.O.D. include post and California sales tax 6%.

MICROPROCESSORS by Poly Paks

8008

"THE COMPUTER ON THE CHIP"

Usually called "Microprocessor" — it is a p Channel Si gate MOS 8-bit Parallel Central Processor. A CPU Central Processing Unit on a chip. Features complete instruction decoding and control. Capability to address 16K x 8 bits of memory (RAM, ROM, SR). Built a micro-computer system when interfacing with other chips, such as 1101, 1103, 2102 (RAMS), etc. With spec sheets. 16-pin dip package. \$79.95

□ 2102 1000-bit "static" Ram for above. \$9.95

Only \$79.95

"ALL LED" MONSANTO READOUTS

MONSANTO TYPE	CHAR. HT.	SALE EACH	Quantity Discounts
MAN-1	.27	\$3.50	3 for \$ 9.
MAN-2	.32*	4.95	3 for \$14.
MAN-3	.12	1.00	3 for \$ 2.50
MAN-6	.60	4.50	3 for \$12.
MAN-64	.4	3.50	3 for \$ 9.
MAN-7	.27	1.50	3 for \$ 3.

* 35 LED matrix



20-Years of Business
INTEGRITY
20-Years of Money-Back GUARANTEES
20-Years of Economy!
LOWEST PRICES!
48-HR. SERVICE

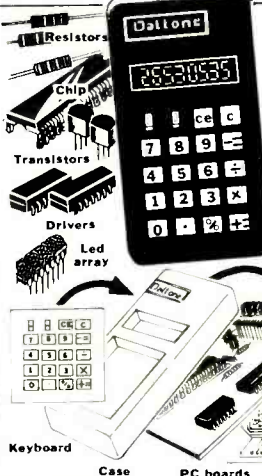

THE SIMPLEST! FINEST! SMALLEST! 6-FUNCTION AC-DC CALCULATOR KIT! \$24.50

Lightweight, pocket size
Extra large display
6 functions plus, minus, times, percentage, constant
Floating decimal
Chain and Mix calculations
True credit balance
Simplified indexing
Mark up and Mark down times, percentage, constant and division
AC adaptor jack

Designed specifically for Poly Paks under the Dalton 80 brand. IMAGINE! only 2 1/2 x 1 x 4 1/2". Slides easily into your vest pocket, brief case, or handbag. We hunted everywhere to find a calculator kit that can be small, do the many functions, with fine engineering design and SIMPLE TO BUILD! WHY? Because it has the fewest parts in a kit. Imagine the pc board only has the chip, 4 resistors, two transistors, two driver ic's with the 9 digit readout. SIMPLE! You bet it is. The entire kit is even packed in a multicolor attractively designed box that in itself tells the mini calculator story. Kit includes: attractive black case with red filter; Flex Key (type 20SK-66) 18 key keyboard that measures only 2 1/2 x 2" with 2 switches, one for ON-OFF, one for K constant; MAIN pc board; readout board; famous Cal Tech 5030 26-pin calculator chip; two 75491 ic drivers; Hewlett Packard 9 digit array; ac jack; 9 Volt battery connector resistors, two transistors; back protective plate; necessary wire plus easy instructions. (Less 9 volt standard battery and AC adapter) **EASIEST KIT TO BUILD**

GAS DISCHARGE DISPLAY POWER SUPPLIES

Only \$3.95

NATIONAL NUMERICAL DISPLAY PANEL

Only \$5.95 3 for \$15

Type NDP1252 cold cathode gas discharge. 7-segment, 8-digit symbols minus, overflow and dot. Properly multiplexed. Like Burroughs Panaplex-Two. Color: ORANGE. Used in calculators, equipment etc. Anode supply voltage 190 vdc. We have listed miniature power supply for them. With schematic. 3 x 1 1/4 x 1/2".

35 WATT AUDIO AMPLIFIER BASIC \$3.98

For Class AB use. Basic includes: Signetec 540.30 transistor high power driver TO-5 "IC", with a pair of complimentary 35-watt plastic transistors, i.e. 2N5296 npn and 2N6109 pnp. With schematics, printed circuit and parts board layouts.

BRAND NEW LOWEST PRICES GENERAL ELECTRIC 3-WATT \$2.50 AUDIO AMP 3 FOR \$6.00

Delivers 3.5 watts continuous, 10 watts peak. With heat sink, micro-mini size: 3/8 x 1/2 x 1/2". 9 to 30V supply. High sensitivity. 8 to 16 ohms.

GET KEY THE PARTS! Calculator Basics

Basic Kit #1 — includes case, all-function Flex Key Keyboard, Cal Tech CT5002 calculator chip, 9-digit Antex LED display with built-on individual ignifiers, plus sheets. □ \$16.95

Basic Kit #2 — same as Basic #1 except calculator chip is National 8-digit MM5726. □ \$16.95

Basic Kit #3 — same as Basic #1 except calculator chip is National 6-digit MM5736 and 75492. □ \$16.95

12 DIGIT BASIC #4 — Key parts include: CT5001 chip, 4-3 digit readouts, factory etched PC board, case, carrying case, 2-resistor networks, decimal switch, Wild Rover Keyboard with ON-OFF switch diagrams. Sale \$19.95.

8-DIGIT "TEXAS INSTRUMENT" BASIC KIT #7 — includes Texaskeyboard, 1KS149, standard 4-function. With T-I calculator chip TMS-0128, p.c. board, case, lens, Microswitch (on-off), 9-digit ANTEx array; includes diagram. \$16.95. □

6 & 8 DIGIT MINI CALCULATOR BASICS

"The key parts kits"

- *So small fits in 'ur palm!
- *Easiest basics around!
- *Requires approx. 6 more parts.

KIT NO. 5030 — 6 functions. Includes mini case, with lens, HIP nine digit readouts with multiplex pc board, main pc board, mini keyboard (with two switches, percent and constant), ac adapter jack, 2 - S75491 drivers, CT5030 calculator chip with diagram. □ \$16.95

KIT NO. 5031 — 4 function, same as 5030 except uses CT5031 chip. □ \$16.95

KIT NO. 5736 — 4 function, like 5031. Uses National MM5736 □ \$12.95

CLOCK CHIPS ON A "DIP" \$3.95

WITH DATA SHEETS		
MM5311	6-digit 28-Pin	\$6.99
MM5312	4-digit 24-Pin	6.99
MM5313	6-digit 28-Pin	6.99
MM5314	6-digit 24-Pin	6.99
MM5316	4-digit 40-Pin, alarm	6.99
MM5316-A	no alarm	3.95

35 WATT AUDIO AMPLIFIER BASIC \$3.98 □ 2 for \$7

For Class AB use. Basic includes: Signetec 540.30 transistor high power driver TO-5 "IC", with a pair of complimentary 35-watt plastic transistors, i.e. 2N5296 npn and 2N6109 pnp. With schematics, printed circuit and parts board layouts.

8 WATT STEREO AUDIO AMP \$5.95

The factory "snipped" most of the cables to this compact 8 watt stereo unit with aluminum escutcheon plate. It's easy to use because we have all the cables marked ready to use. Includes: 115V AC, 3 watt controls, LEFT and RIGHT VOLUME controls for two speakers for balancing and center TONE control. With knobs. 7 x 3 1/2 x 3 1/2". Hookup spec sheets.

60-WATT STEREO AM-FM-MULTI-PLEX TUNER WITH AMPLIFIER \$59.95

AM-FM-MUX-DIAL
100-Watts music power

Indicators: Features: 4-speaker system, built-in FM antenna, record player jacks on separate panel. Another external panel consists of provisions for external FM and AM antenna, "satellite" speakers to provide 4 speaker sound jacks for connecting a tape recorder, radio tuner or phono of systems to record. Lower inputs for connecting tape deck that will play back thru the internal amplifier for systems. AC jack for phono power connection. RED, GREEN and CLEAR indicators for Phono, AM, and FM respectively. Includes red indicator on front panel for STEREO indicator. Has separate input to plug into mike, guitar and other musical instruments (has front panel controls). PHONO, STEREO-AM-FM, MONO, FM, STEREO, GUITAR, TAPE, MIKE master control switch. LOUDNESS, BALANCE, TREBLE, BASS controls, with power ON-OFF rocker switch, and AFC ON-OFF. Designed for all audio-ophiles to use as wall unit in DEN or FAMILY ROOM, or control unit by easy chair in family room, or for those who wish to design their own console or modular system. With 6 ft. 11.5" VAC cord and plug. Only 13 x 7 x 3 1/2" deep. With knobs. Shpg. wt. 3 lbs.

"BEEPER" AND "DATER" CLOCK ON THE CHIPS \$8.50

Imagine a chip (MK50250) "Beeper" and audible alarm! All others are external. It also features internal brightness control. The CT7001 requires external triggering of alarm, date of the month and direct drive to LED readouts. Both require minimum current drain and voltages, for either 4 to 6 LED readouts, 12 or 24 hours, AM and PM.

"C" MOS IC'S

Type	Price	Type	Price
CD4000AE	.53	CD4022AE	2.10
CD4001AE	.53	CD4023AE	.53
CD4002AE	.53	CD4024AE	2.15
CD4006AE	3.75	CD4025AE	.53
CD4007AE	.61	CD4026AE	8.50
CD4009AE	3.50	CD4027AE	2.75
CD4009AE	1.09	CD4030AE	.53
CD4010AE	.55	CD4033AE	3.50
CD4011AE	.51	CD4040AE	4.50
CD4012AE	.53	CD4042AE	2.75
CD4013AE	1.05	CD4043AE	1.10
CD4014AE	3.50	CD4044AE	1.10
CD4019AE	1.10	CD4047AE	.80
CD4020AE	3.25	CD4066AE	3.75

Inflation-Fighting ECONOMY IC PRICES

Order by type number! Npcc sheets on request "ONLY" • Factory Marketed

SN7400	.17	SN7438	.35	SN7481	1.19	SN74141	1.19	SN74191	1.49
SN7401	.17	SN7440	.17	SN7482	.99	SN74145	1.12	SN74192	1.45
SN7402	.17	SN7441	.95	SN7483	.99	SN74148	2.50	SN74193	1.29
SN7403	.17	SN7442	.95	SN7486	.41	SN74150	.99	SN74195	.89
SN7404	.21	SN7443	.95	SN7489	2.50	SN74151	.85	SN74197	.89
SN7405	.21	SN7444	1.05	SN7490	.71	SN74153	1.05	SN74198	2.10
SN7406	.37	SN7445	1.05	SN7491	1.15	SN74154	1.49	SN74199	2.10
SN7408	.23	SN7446	1.10	SN7492	.71	SN74155	1.49	SN74200	4.95
SN7409	.23	SN7447	1.10	SN7493	1.10	SN74156	1.19		
SN7410	.18	SN7448	1.10	SN7496	.85	SN74157	1.19		
SN7411	.27	SN7450	1.17	SN74100	1.55	SN74158	1.45		
SN7413	.73	SN7451	.23	SN74104	1.25	SN74161	1.29		
SN7414	2.25	SN7453	.23	SN74105	.45	SN74163	1.49		
SN7415	.37	SN7455	.37	SN74106	.37	SN74164	1.79		
SN7416	.37	SN7462	.37	SN74107	.45	SN74165	1.79		
SN7417	.37	SN7464	.37	SN74108	.89	SN74166	1.55		
SN7420	.18	SN7465	.37	SN74112	.91	SN74173	1.55		
SN7422	.27	SN7471	.49	SN74113	.91	SN74174	1.49		
SN7423	.33	SN7472	.33	SN74114	.89	SN74175	.81		
SN7424	.33	SN7473	.41	SN74121	.55	SN74176	1.55		
SN7426	.27	SN7474	.41	SN74122	.51	SN74177	1.55		
SN7427	.31	SN7475	.71	SN74123	.91	SN74180	1.05		
SN7430	.17	SN7476	.45	SN74125	.65	SN74181	3.50		
SN7432	.27	SN7478	.55	SN74126	.73	SN74182	.79		
SN7437	.41	SN7480	.61	SN74140	2.50	SN74190	1.49		

INTEGRATED CIRCUIT SOCKETS

14-Pin, DIP	\$.45
14-Pin, Side Mount	1.00
16-Pin, DIP	.50
TO-5, 8 or 10-Pins	.29
8 Pins (Mini DIP)	.39
14-Pin, Wire Wrap	.69c
16-Pin, Wire Wrap	.89c

Buy Any 3 Take 10% Discount!

Terms: add postage. Rated: net 10
Phone Orders: Wakefield, Mass. (617) 245-3829
Retail: 118-188 Del Carmine St., Wakefield, Mass.
(off Water Street) (C.O.D.'s MAJ. & PH.D.)

20c CATALOG on Fiber Optics, '1c's, Semi's, Parts
MINIMUM ORDER — \$4.00

POLY PAKS

P.O. BOX 942E, LYNNFIELD, MASS. 01940

BUY 10 IC'S TAKE 15% 100 TAKE 25%

Quality Electronic Components

SPECIAL SAVINGS DISCOUNT ON LINEAR AND DIGITAL INTEGRATED CIRCUITS

Discount 4% from the total of your I.C. order if it exceeds \$25.00 based on single lot prices 7% for \$50.00 or more, 10% for \$100.00 or more. Additional large quantity discounts offered.

DIGITAL INTEGRATED CIRCUITS

7400N .25.5c	7437N .42.0c	7480N .70.5c	74155N \$2.22
7401N .25.5c	7438N .42.0c	7482N .99.0c	74156N \$1.17
7402N .25.5c	7440N .25.5c	7483N .11.17	74156N \$1.14
7403N .25.5c	7441N .11.40	7485N .11.40	74157N \$1.11
7404N .30.0c	7442N .90.0c	7486N .45.0c	74158N \$1.53
7405N .30.0c	7445N .11.49	7489N .11.47	74160N \$1.50
7406N .48.0c	7446N .11.14	7490N .66.0c	74161N \$1.50
7407N .48.0c	7447N .11.11	7491N .11.05	74162N \$1.50
7408N .28.5c	7448N .11.22	7492N .66.0c	74163N \$1.50
7409N .28.5c	7450N .25.5c	7493N .66.0c	74164N \$1.58
7410N .25.5c	7451N .25.5c	7494N .11.10	74165N \$2.45
7411N .25.5c	7453N .25.5c	7495N .11.14	74166N \$2.00
7413N .60.0c	7454N .25.5c	7496N .11.14	74175N \$1.00
7416N .46.5c	7459N .48.5c	74107N .45.0c	74180N \$1.17
7417N .46.5c	7460N .25.5c	74121N .46.5c	74181N \$1.42
7418N .31.5c	7470N .33.0c	74122N .49.5c	74182N \$1.14
7420N .25.5c	7472N .36.0c	74123N .11.08	74192N \$1.73
7421N .25.5c	7473N .43.5c	74141N .11.10	74193N \$1.73
7423N .72.0c	7474N .43.5c	74150N .11.53	74198N \$2.75
7425N .33.0c	7475N .69.0c	74151N .11.17	74199N \$2.75
7430N .25.5c	7476N .46.5c	74153N .11.17	

LINEAR INTEGRATED CIRCUITS

555V MINDIP TIMER .82.5c	558V MINDIP DUAL AMP .75.0c
565A DIP PLL .33.38	567V MINDIP DECODER .33.38
709V MINDIP OP AMP .36.0c	723A DIP VOLTAGE REG .82.5c
741V MINDIP OP AMP .50.0c	747A DIP DUAL AMP .97.5c
748V MINDIP OP AMP .42.0c	LM3900 DIP QUAD AMP .60.0c
LM25 5 VOLT REG .11.80	LM30 12 VOLT REG .11.80
LM31 15 VOLT REG .11.80	LM309K 5 VOLT REG .11.75

MINIATURE ALUMINUM ELECTROLYTIC CAPACITORS

AXIAL LEAD TYPE

-40°C plus 85°C Tolerance -10 plus 50% (greater than 4.7 µF) -10 plus 75% (4.7 µF or less)	
1 µF/50V .14c	12c 11c 33 µF/16V .15c
2.2 µF/50V .14c	12c 11c 33 µF/25V .17c
3.3 µF/50V .14c	12c 11c 47 µF/16V .17c
4.7 µF/50V .14c	12c 11c 47 µF/25V .19c
10 µF/16V .14c	12c 11c 100 µF/16V .19c
10 µF/25V .14c	12c 11c 100 µF/25V .24c
22 µF/16V .14c	12c 11c 220 µF/16V .24c
22 µF/25V .15c	15c 16c 220 µF/25V .25c

1 AMP SILICON RECTIFIERS

1N4001 50 PIV 12/51 100/56 1000/548	1N4005 600 PIV 8/51 100/59 1000/570
1N4007 1000 PIV 6/51 100/511 1000/588	

SILICON SIGNAL & SWITCHING DIODE

1N4148 (1N914 equiv.) 12/51 100/57 1M/550 5M/520

MOLEX SOLDERCON IC TERMINALS

100/51 500/54 20 1000/58 20 5000/538 20 50,000/5275

LED 7 SEGMENT DISPLAYS

DATALL-704 .11.00 DATALL-707 .11.50

MACHINE SCREWS, NUTS & LOCKWASHERS

2-56 1/4 Screw 90c/ea	2-56 1/2 Screw 98c/ea
4-40 1/4 Screw 96c/ea	4-40 1/2 Screw 96c/ea
6-32 1/4 Screw 92c/ea	6-32 1/2 Screw 86c/ea
8-32 3/8 Screw \$1.05/ea	8-32 1/2 Screw \$1.35/ea
2-56 Hex Nut .51/45c	2 Lock Washer .45c/ea
4-40 Hex Nut .51/45c	4 Lock Washer .45c/ea
6-32 Hex Nut .51/45c	6 Lock Washer .45c/ea
8-32 Hex Nut .51/50c	8 Lock Washer .45c/ea

REED RELAYS

6 AMP SPST N.O. CONTACTS

Call Voltage	\$
5V	\$2.00 \$1.50
6V	\$2.00 \$1.50
12V	\$2.00 \$1.50
24V	\$2.00 \$1.50

DISC CAPACITORS

100 pf/500V .7c	5.0c	200	1000
220 pf/500V .7c	5.5c	4.5c	3.6c
470 pf/500V .7c	5.5c	4.5c	3.6c
001/500V .7c	5.5c	4.5c	3.6c
.0022/500V .7c	5.5c	4.5c	3.6c
.0047/500V .7c	5.5c	4.5c	3.6c
.01/500V .10c	7.5c	6.3c	5.0c
.022/25V .6c	3.5c	3.0c	2.4c
.047/25V .9c	4.0c	3.5c	2.7c
.1/25V .9c	6.0c	5.3c	4.2c
.1/25V .12c	9.0c	7.5c	6.0c

I.C. SOCKETS

8 pin Solder .27c	21c
14 pin Solder .29c	23c
16 pin Solder .32c	25c
18 pin Solder .34c	26c
24 pin Solder .34c	42c
8 pin W.W. .38c	30c
14 pin W.W. .50c	39c
16 pin W.W. .54c	42c
18 pin W.W. .88c	68c
24 pin W.W. .99c	80c

1/2 & 1/4 WATT CARBON COMP. RESISTORS

5 each of the 85 standard 10% values (2.2-22M) 1/2 W Resistors (425 pcs.) Sorted by value \$12/set 2-4 ea \$11/set 5-9 ea \$10/set.
5 each of the 70 standard 10% values (10-5.6M) 1/4 W Resistors (350 pcs.) Sorted by value \$12/set 2-4 ea \$11/set 5-9 ea \$10/set.

SILICON TRANSISTORS

2N918 .10-106	1.9	18.99	100	2N3645 .10-105	2.0c	17.99	100
2N930 .10-106	21c	18.5c	16.5c	2N3646 .10-106	22c	19.0c	17.5c
2N222 .10-106	21c	18.5c	16.5c	2N3904 .10-92	22c	19.0c	17.5c
2N2696 .10-106	21c	18.5c	16.5c	2N3906 .10-92	22c	19.0c	17.5c
2N2907 .10-106	21c	18.5c	16.5c	2N4124 .10-92	22c	19.0c	17.5c
2N2712 .10-98	18c	16.0c	14.5c	2N4126 .10-92	22c	19.0c	17.5c
2N391A .10-98	22c	19.0c	17.5c	2N4401 .10-92	22c	19.0c	17.5c
2N392 .10-98	22c	19.0c	17.5c	2N4403 .10-92	22c	19.0c	17.5c
2N393 .10-98	22c	19.0c	17.5c	2N5087 .10-92	22c	19.0c	17.5c
2N394 .10-98	22c	19.0c	17.5c	2N5089 .10-92	22c	19.0c	17.5c
2N395 .10-106	20c	17.5c	16.0c	2N5139 .10-106	19c	17.0c	15.0c
2N365 .10-106	20c	17.5c	16.0c	2N5133 .10-106	19c	17.0c	15.0c
2N368 .10-105	20c	17.5c	16.0c	2N5134 .10-106	19c	17.0c	15.0c
2N368A .10-105	20c	17.5c	16.0c	2N5137 .10-106	19c	17.0c	15.0c
2N3640 .10-106	22c	19.0c	16.0c	2N5138 .10-106	19c	17.0c	15.0c
2N3641 .10-105	20c	17.5c	16.0c	2N5139 .10-106	19c	17.0c	15.0c
2N3643 .10-105	20c	17.5c	16.0c	2N3055 .10-3	\$1.00	95.0c	85.0c

FIELD EFFECT TRANSISTORS

MPP102 .10-92	44	380	350	2N5457 .10-92	47	420	375
---------------	----	-----	-----	---------------	----	-----	-----

NPN DARLINGTON TRANSISTOR

MPS-A13 .10-92 Min. DC Current Gain of 5,000 at 10mA 36 320 290

Send for Free Catalog or Mail Readers Service Card

COD ORDERS ACCEPTED FOR SAME DAY SHIPMENT

CALL 218-681-6674

Orders Less than \$10.00 add \$3c Service Charge—Others Postpaid

"Only Quality Components Sold"

DIGI-KEY CORPORATION

P.O. Box 126 Thief River Falls, MN 56701

CIRCLE NO. 13 ON READER SERVICE CARD

UNSCRAMBLERS: Fits any scanner or monitor, easily adjusts to all scrambled frequencies. Only 4" square \$29.95, fully guaranteed. Dealer inquiries welcomed. PDQ Electronics, Box 841, North Little Rock, Arkansas 72115.

TELEPHONES UNLIMITED, equipment, supplies. Catalog 50 cents. Box 1654E, Costa Mesa, Calif. 92626.

WE SELL MONEY MAKING CONSTRUCTION MANUALS!!! — Reclaim GOLD, SILVER for EXCELLENT full or part time money!!! — PLUS, we buy scrap gold & silver — ALSO, we sell 99.999% pure SILVER BARS!!! — Color Catalog 25 cents — Airmailed 50 cents — Creative Products, Dept. PE-375, 4913 Northridge NE, Albuquerque, New Mexico 87111.

DIGITAL IC Manual—Latest Edition—1500 types by types/diagram number \$3.95, 32—function digital computer kit—IC, transistors, instructions, \$14.00. IC applications manual—numerous circuits—Analog/Digital, \$3.95. Electronics, P. O. Box 127, Hopedale, Mass. 01747.

COMPUTER countless uses. 8 bit word, powerful instruction set. Complete \$225. Brochure 10 cents. RAECO, Box 14, Readville, Mass. 02137.

QUALITY military and industrial surplus electronics. Send 25 cents for last 3 of our monthly picture flyers. US only. Startronic, Box 17127, Portland, OR 97217.

COMPUTER SCHEMATICS. 256 bits, expandable to several K. Many other schematics available. SP Electronics, Box 5E, Prospect Heights, Illinois 60070.

DIGITAL Transistor Tester, LED Display, plans \$2.50. Photoelectronics, Box 343, Geyserville, CA 95441.

AUTHENTIC, INSTRUMENTED, FLYING ROCKETS for casual or serious experimenters. Over 80 scale original, multi-stage or ready-to-fly models. Solid-propellant engines for safe, electric launch system liftoffs up to 2,500 feet. Measure altitude, temp, inversions, more. Real telemetry, electronic tracking, aerial still and movie photography with super-miniaturized equipment. New, detailed tech manual and full-color catalog. 25 cents from ESTES INDUSTRIES Dept. 18G, Penrose, Colo. 81240.

ALPHA Biofeedback Instruments. DIGITAL: Heart Monitor, Thermometer, VOM, Frequency Counter, Logic Probe with readout, etc. Free Catalog. COSMIC ELECTRONICS, BOX 282, Lawrence, NY 11559.

LIFE-GUARD: The finest HEAT-SMOKE-GAS Alarm available, 100% solid state. COSMIC ELECTRONICS, Box 282, Lawrence, NY 11559.

ELECTRONIC ORGAN KITS, KEYBOARDS for organs and synthesizers. Independent and divider organ tone generators, diode keying. 35 cents for catalog. DEVTRONIX ORGAN PRODUCTS, Dept. C, 5872 Amapola Dr., San Jose, CA 95129.

I.Q. TEST Questions and Answers. Send \$2.00 to Ruden Enterprises, Box 944, Frazer, PA 19355.

DIGITAL ELECTRONICS! Highly effective course brings immediate results, \$10.00. Satisfaction or \$11.00 refunded! Plans, Projects. Free Literature. DYNASIGN, Box 60A7, Wayland, Mass. 01778.

CMOS INTEGRATED CIRCUITS. While they last. Guaranteed, Tested: 1103 \$2.89, 4011 39 cents, 4049 89 cents, 4116 99 cents. Dual NPN like 2N4880 47 cents, more types. Postage free with \$5 order. Electronic Product Associates, Inc., Box 80341, San Diego, Calif. 92138.

COMPLETE CONSTRUCTION PLANS—TELEPHONE: Answering Device, Automatic Dialing Machine, "Black Boxes", Call Diverter, Call Limiter, Conference Bridge, Central Dial Exchange, Melodic Ringing Generator, Recorder-Actuator, Remote Control, Schematics, Speakerphone, Telinelk Burglar Alarm, Voice Scrambler, \$3.00 each. ELECTRONIC: Biofeedback Conditioner, Horticulture Stimulator, Multifrequency Encoder Network (Speeds telephone calling 500%), \$5.00 each. ONE YEAR SUBSCRIPTION: Telephone Electronics Line (TEL) \$3.00. Super Illustrated CATALOG of plans, many more, 50 cents. ALL OF THE CONSTRUCTION PLANS ABOVE PLUS A YEAR'S SUBSCRIPTION TO TEL AND A CATALOG: \$24.95. TELETRONICS COMPANY OF AMERICA, P.O. DRAWER 3450, HOLLYWOOD, CALIFORNIA 90028.

ALPHA BRAINWAVE MONITOR—Discover your alpha brainwaves with the world's lowest cost professional brainwave biofeedback monitor as featured in Radio-Electronics Magazine (for January, 1975). Kit, \$34.50, assembled, \$59.50 PPD. Reprint of article, 50 cents. Dean Advertising, Inc., 283 Malta Street, Brooklyn, N.Y. 11207.

CARTRIVISION color video tape recorder \$250.00. TV camera for above recorder \$175.00. Close up lens set \$10.00. New blank cartivision videotapes fifteen minute \$4, thirty minute \$9, sixty minute \$17, hundred minute \$22. Also have Service Manual, spare parts, head cleaner, I/O plugs, interface. SASE for complete list. Dennis Trimble, 5154 Roeder Road, San Jose, California 95111.

MICROPROCESSORS, MEMORIES, 8008, 8080, 1101A, 2102. UARTS, kits, prime components, surplus prices, computer accessories, ASCII keyboards \$40, Mini Micro Mart, 1618 James, Syracuse, NY 13203.

BOOKLETS ABOUT CONNECTING TELEPHONES, new color telephones, and accessories. Details 25 cents. Queens Village Telephone Supply, Box 29002-J, Queens Village, New York 11429.

CITIZENS BAND equipment discount prices. Free list. CRS Communications, 2271 Morris Avenue, New York, N.Y. 10453.

FREE bargain catalog. LED's transistors, IC's, PUT's, relays, xtals, unique microminiature components, misc. CHANEYS, Box 15431, Lakewood, CO 80215.

POLICE, FIRE Monitors, scanners, crystals. Discount Priced. Some CB. Box 19224, Denver, CO. 80219.

BURGLAR ALARM dialing unit automatically calls police. \$29.95. Free literature. S&S Supply, Box 12375A, North Kansas City, MO 64116.

TRIACS! 8 amp 400 volt. Only 60 cents each. Silicon Surplus, 38 Whitney Avenue, Southington, Conn. 06489.

LED'S! This month it's 0.6" DIGITS, pin compatible with Litronix DL-747. \$1.95 ea. UNBELIEVABLE? Try our bargain catalog, 50 cents. DIAMONDBACK ENGINEERING, P.O. Box 194, Spring Valley, Illinois 61362.

SUBSCRIBE NOW!

LEARN THE SECRETS OF YOUR TELEPHONE

Telephone Electronics Line

FACTS NEVER PUBLISHED FOR THE PUBLIC

A UNIQUE REFERENCE GUIDE
TO THE INSIDE STORY

FROM THE HOBBIST TO THE TECHNICIAN
Current News Items • Plans • Illustrations
Stories • History • Comics • Facts • Games
Code Numbers • Projects • And Many More

— One year subscription only \$3.00 —

TELETRONICS COMPANY OF AMERICA
P.O. BOX 3450
LOS ANGELES, CA 90028

FREE giant bargain electronic catalog listing thousands of components, tubes, transistors, IC's kits, test equipment. EDLIE'S, 2700-PA Hempstead Tpke., Levittown, N.Y. 11756.

ELECTRONIC parts, low prices, free flyer: DARTEK ELECTRONICS, Box 2460, Dartmouth, Nova Scotia, Canada. U.S. Inquiries.

CONVERT any transistorized T.V. Tuner to a Tuner Substituter. Plans \$2.00. \$35.00 for completed and tested Super Substituter. Radio Television Training, Box 279, P-35, Syracuse, N.Y. 13206.

ABOUT YOUR SUBSCRIPTION

Your subscription to POPULAR ELECTRONICS is maintained on one of the world's most modern, efficient computer systems, and if you're like 99% of our subscribers, you'll never have any reason to complain about your subscription service.

We have found that when complaints do arise, the majority of them occur because people have written their names or addresses differently at different times. For example, if your subscription were listed under "William Jones, Cedar Lane, Middletown, Arizona," and you were to renew it as "Bill Jones, Cedar Lane, Middletown, Arizona," our computer would think that two separate subscriptions were involved, and it would start sending you two copies of POPULAR ELECTRONICS each month. Other examples of combinations of names that would confuse the computer would include: John Henry Smith and Henry Smith; and Mrs. Joseph Jones and Mary Jones. Minor differences in addresses can also lead to difficulties. For example, to the computer, 100 Second St. is not the same as 100 2nd St.

So, please, when you write us about your subscription, be sure to enclose the mailing label from the cover of the magazine—or else copy your name and address exactly as they appear on the mailing label. This will greatly reduce any chance of error, and we will be able to service your request much more quickly.

C-MOS

4000AE	\$.50	48
4001AE	.49	48
4002AE	.49	48
4004AE	5.85	5.85
4006AE	3.85	3.75
4007AE	.60	.55
4008AE	3.55	3.25
4009AE	.90	.89
4010AE	.90	.89
4011AE	.90	.89
4012AE	.49	.48
4013AE	1.10	1.00
4014AE	3.65	3.20
4015AE	3.75	3.65
4016AE	1.10	1.00
4017AE	2.85	2.65
4018AE	3.15	3.00
4019AE	1.25	1.15
4020AE	3.85	3.25
4021AE	3.75	3.55
4022AE	2.70	2.50
4023AE	.49	.48
4024AE	2.25	1.95
4025AE	.49	.45
4026AE	9.75	7.05
4027AE	1.30	1.17
4028AE	2.90	2.70
4029AE	5.35	4.55
4030AE	1.20	1.00
4035AE	2.80	2.75
4040AE	4.55	4.35
4041AE	3.25	3.15
4042AE	2.90	2.80
4043AE	2.90	2.80
4044AE	2.90	2.80
4047AE	3.65	3.55
4048AE	1.45	1.35
4049AE	1.30	1.00
4050AE	1.30	1.00
4056AE	3.45	3.41
4060AE	5.15	4.85
4066AE	3.15	2.91
4069AE	.80	.70

Schottky TTL

SN74S00N	\$.80
SN74S02N	.80
SN74S03N	.80
SN74S04N	.80
SN74S08N	.80
SN74S10N	.80
SN74S11N	.80
SN74S20N	.80
SN74S30N	.80
SN74S32N	.80
SN74S40N	.80
SN74S64N	.80
SN74S74N	1.50
SN74S85N	6.10
SN74S86N	2.90
SN74S112N	2.50
SN74S113N	1.50
SN74S133N	1.00
SN74S138N	4.50
SN74S139N	3.90
SN74S140N	1.00
SN74S151N	3.30
SN74S153N	3.30
SN74S154N	3.40
SN74S157N	2.70
SN74S158N	3.00
SN74S160N	6.60
SN74S161N	6.60
SN74S174N	4.75
SN74S175N	4.00
SN74S181N	11.50
SN74S189N	5.10
SN74S194N	3.30
SN74S195N	4.40
SN74S251N	4.20
SN74S253N	4.20
SN74S275N	3.20
SN74S280N	3.70
SN74S289N	.90
SN74S289N	5.70
SN74S289N	5.00
93S10	6.80
93S16	6.80
93S21	3.50
93S22	3.20
93S48	3.70

HIGH SPEED TTL

74H00N	.34
74H01N	.40
74H04N	.36
74H05N	.38
74H08N	.44
74H10N	.44
74H11N	.44
74H15N	.38
74H20N	.39
74H40N	.36
74H74N	.69

I-Amp Rectifiers

1N4001	\$ 1.00	7.00	60.00
1N4002	1.10	8.00	70.00
1N4003	1.20	9.00	80.00
1N4004	1.30	10.00	90.00
1N4005	1.40	11.00	100.00
1N4006	1.50	12.00	110.00
1N4007	1.60	13.00	120.00

Waveform Generator Kit



XR205K Only \$28.00
Here's a highly versatile lab instrument at a fraction of the cost of conventional unit. Kit includes two XR205 IC's, data & applications, PC board (etched & drilled, ready for assembly) and detailed instructions.

FM Stereo Demodulator

XR1310 \$3.90

Audio Amps

LM352	6.15V, 1.15W, 8Ω	1.60
LM354A	6.27V, 2.80W, 8Ω	2.50
TAA611B12	6.15V, 1.15W, 8Ω	1.60
TAA621A12	6.27V, 1.40W, 8Ω	2.00
TBA641B11	6.15V, 2.20W, 4Ω	3.00
TBA800	5.30V, 4.70W, 8Ω	2.20
TBA810A5	4.20V, 2.50W, 4Ω	3.00
TBA820	3.16V, 0.75W, 4Ω	1.20
TC4830	5.20V, 2.00W, 4Ω	2.70
TC4940	6.24V, 6.50W, 8Ω	4.40

Power Transistors

BU204	3A	1300V	\$4.14
BU205	3A	1500V	4.95
BU206	3A	1700V	5.94
BU207	6A	1300V	5.85
BU208	6A	1500V	6.93
BU209	6A	1700V	8.64

2N512B	\$3.00
2N1136	1.50
2N1483	1.20
2N1534	1.00
2N1540	1.10
2N1544	.90
2N3053	.35
2N3055	.35
2N3375	5.50
2N3442	2.20
2N3730	1.70
2N3731	2.00
2N3732	1.50
2N3771	2.20
2N3772	2.30
2N3773	3.40
2N3789	3.00
2N3866	.95
2N4347	1.60
2N4348	1.00
2N4395	1.30
2N4427	1.10
2N5109	2.10
2N5322	.92
2N5323	.70
2N6099	.80
2N6101	.80
2N6103	.90

DUAL LOW NOISE OP AMP

LM331N:	
V _{io}	= 6mV
I _e	= 1000nA
I _b	= 2000nA
Noise	= 1.5dB
	\$2.20

HYBRID POWER AMPLIFIERS

SI-1010G	10W	\$ 6.90
SI-1020G	20W	9.90
SI-1030G	30W	18.70
SI-1050G	50W	25.90

PREMIUM QUALITY COMPONENTS

We've been buying and selling top quality components for nearly ten years. Our annual volume exceeds \$3 million. We handle only original parts, from the world's leading manufacturers and our customers include some of the largest and most quality-conscious companies.

Now you can take advantage of our component buying skills and power and select from a broad range of advanced circuits.



IC sockets

Solder	3 pin TO-5	.55
	4 pin TO-5	.65
	6 pin TO-5	.90
	8 pin TO-5	1.10
	10 pin TO-5	1.40
Teflon	TO-5	.55
	TO-5	.65
	TO-5	.90
	TO-5	1.10
	TO-5	1.40
Wire Wrap	14 pin DIL	.40
	16 pin DIL	.45

7400N TTL

74150N	\$ 1.14
74151N	.75
74152N	2.25
74153N	1.12
74154N	1.63
74155N	1.49
74156N	1.49
74157N	1.19
74158N	1.54
74160N	1.50
74161N	1.35
74162N	1.50
74163N	1.50
74164N	1.89
74165N	1.89
74166N	1.98
74170N	2.55
74173N	1.79
74174N	1.52
74175N	1.50
74176N	1.69
74177N	1.69
74180N	2.49
74182N	1.19
74184N	2.89
74185N	2.29
74190N	2.89
74191N	2.89
74192N	1.49
74193N	1.39
74194N	1.35
74195N	.99
74196N	2.39
74197N	2.39
74198N	2.59
74199N	4.48
74200N	5.05
74212N	1.75
74251N	1.75
74278N	2.95
74293N	.92
74293N	.92
74298N	2.55

LOW POWER TTL

74L00N	\$.34
74L02N	.39
74L03N	.39
74L04N	.39
74L10N	.34
74L20N	.39
74L42N	1.62
74L51N	.34
74L73N	.74
74L74N	.89
74L90N	1.62
74L93N	1.74
74L95N	1.62
93L00	1.50
93L01	1.60
93L08	3.20
93L09	1.80
93L10	2.80
93L11	4.20
93L12	1.80
93L14	1.70
93L16	3.20
93L18	3.50
93L21	1.50
93L22	1.80
93L24	2.80
93L28	3.70
93L34	4.00
93L38	4.20
93L40	6.50
93L41	6.50
93L60	3.00
93L62	2.70

Model 4440 A PORTABLE 4 1/2 DIGIT MULTIMETER FOR \$299. A 10 MHZ COUNTER OPTION FOR \$50.



Interface Modules

CY1010	Instr. Amp., Bipolar Input	\$ 29.00
CY1011A	Instr. Amp., Bipolar Input	49.00
CY1020	Instr. Amp., FET Input	34.00
CY1021	Instr. Amp., FET Input	49.00
CY1021A	Instr. Amp., FET Input	59.00
CY2015	DAC, 8 Bit, 2 Quad Multiplying	99.00
CY2137	DAC, 10 Bit, Low Drift	39.00
CY2218	DAC, 12 Bit, 2 Quad Multiplying	149.00
CY2236	DAC, 12 Bit, Fast Settling, Low Drift	89.00
CY2237	DAC, 12 Bit, Low Drift	69.00
CY2735	DAC, 4 Digit BCD, Low Cost	79.00
CY2737	DAC, 4 Digit BCD, Low Drift	139.00
CY3035	ADC, 8 Bit, Sect. Counting, Low Cost	89.00
CY3635	ADC, 3 Digit BCD, Sect. Count, Low Cost	119.00

Calculator



Limited QUANTITY \$19.00

9-Digit Display

- 1/8" character height
- compact, thin PC package
- wide viewing angle

Displays



SLA1	Red	\$2.25
SLA11	Green	4.25
SLA21	Orange	4.25
SLA2	11 Red	2.25
SLA12	11 Grn	2.25
SLA22	11 Org	2.25
SLA3	Red	7.50
SLA4	Red	7.50
XAN72	Red	2.50
XAN52	Green	2.50

Memories

P1101A	\$ 6.90
P1101A1	8.50
P1402A	7.90
P2102	15.00
P3101	5.50
P3101A	5.50
MM6560N	5.00
MM6561N	5.00
DM8599N	5.00
93403	5.00

Decoded Read/Write RAM

P1103 \$6.20

Voltage Regulators

LM100H	\$ 5.50
LM104H	6.50
LM105H	5.10
LM105F	8.50
LM109H	9.50
LM109K	6.30
LM200H	3.80
LM204H	4.70
LM205H	3.00
LM209H	3.50
LM209K	3.70
LM300H	.90
LM300N	1.40
LM304H	1.40
LM305H	1.10
LM305A	1.40
LM305N	1.20
LM309H	1.75
LM309K	1.95
LM340-05K	2.60
LM340-06K	2.60
LM340-08K	2.60
LM340-12K	2.60
LM340-15K	2.60
LM340-18K	2.60
LM340-24K	2.60
LM723H</	

TIME DELAY RELAYS

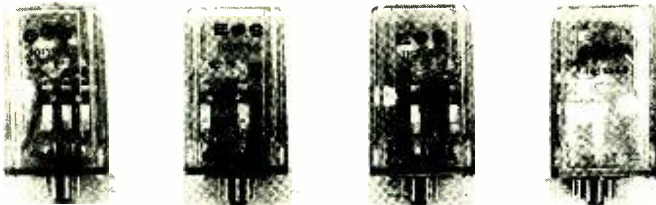

We have 2 time delay relays, similar, except that one has a delay of 10 seconds, and the other has a variable delay from 3 to 10 seconds. Each relay is enclosed in a clear plastic case, with an octal base. We provide the octal socket. Relays operate from 24 to 60 volts. The relays are DPDT, Potter & Brumfield KA series, with 10 Amp contacts. Time delay is solid state with Unijunct circuitry, all built into the plastic case. Provision is made for adding external capacitance or resistance to change or increase the time delay Data sheet provided.

STOCK NO.P5229 Fixed delay (10 sec.) 2.95 ea. 2/5.00
 STOCK NO.P5230 3-10 second delay 3.95 ea. 2/7.00

STEREO AMPLIFIER



Small 10 transistor STEREO AMPLIFIER is complete, except for speakers and small AC transformer. Contains tone, balance and volume controls. 6"x2"x1 1/4". 2 units make

a quadraphonic amplifier. Makes a good basic unit for an intercom. The transformer for above is available.

STOCK NO.P5228 \$9.95 ea. 2/19.00

STOCK NO.P9713, Transformer for above. \$1.50

HIGH POWER TRANSFORMER 64 volts ct @ 8 volts, tapped @ 32 volts 8 amp, .18 volts ct @ 8 amp, .400 volts @ .15 amp.
 STOCK NO. P9905 wt. 10 lbs. 9.95 Ea. 11.95 ea. 2/22.00

Include sufficient postage; Excess refunded. Write for new catalog 13, just of the press & loaded.



DELTA ELECTRONICS CO.

BOX 1, LYNN, MASSACHUSETTS 01903
 Phone (617) 388-4705

CIRCLE NO. 11 ON READER SERVICE CARD

Planning to move?

Let us know 8 weeks in advance so that you won't miss a single issue of POPULAR ELECTRONICS.

Attach old label where indicated and print new address in space provided. Also include your mailing label whenever you write concerning your subscription. It helps us serve you promptly.

Write to: P.O. Box 2774, Boulder, CO 80302, giving the following information:

- Change address only.
- Extend subscription. Enter new subscription.
- 1 year \$6.98
- Payment enclosed (1 extra BONUS issue)
- Bill me later

AFFIX LABEL

if you have no label handy, print OLD address here.

name
address
city
state
zip-code

name
address
city
state
zip-code

Add'l postage: \$2 per year outside U.S., its poss. & Can.

T T L		CMOS	
7400*	6/\$1.00	7488	4.00 CD4001 \$.55
7401	.23	7489*	2.25ea CD4002 .55
7402	.23	7490*	.69ea CD4007 1.25
7403	6/1.00	7491*	1.00 CD4009 1.40
7404	.25	7492	.95 CD4010 .60
7405	.24	7493	.95 CD4011 .55
7406	.50	7494	.97 CD4012 .55
7407	.50	7495	.95 CD4013 1.50
7408	.25	7496	.95 CD4016 1.40
7409	.25	74100	1.50 CD4017 2.75
7410*	6/1.00	74107	.47 CD4019 1.25
7411	.30	74121	.55 CD4020 1.50
7412	.40	74122	.47 CD4022 2.50
7413*	.75	74123	1.05 CD4023 .55
7416	.45	74125	.60 CD4025 .55
7417	.45	74126	.80 CD4027 1.25
7418	.25	74141	1.15 CD4030 .60
7420	.23	74145	1.15 CD4035 2.75
7421	.27	74150	.95 CD4049 1.25
7423	.32	75151	1.20 CD4050 1.25
7425	.27	74153	1.50 74C00 .45
7426	.31	74154	1.25 74C02 .45
7427	.32	74155	1.30 74C04 .70
7429	.40	74156	1.30 74C20 .65
7430	.33	74157	1.55 74C74 1.15
7432	.26	74160	1.65 74C160 3.25
7437	.45	74161	1.65 74C161 3.25
7438	.50	74163	2.50 74C107 1.50
7439	.50	74164	2.50 74C151 2.90
7440	.23	74165	2.50 74C154 3.50
7441	1.10	74166	1.75 74C163 3.25
7442	1.05	74170	3.00 74C164 3.50
7443	1.10	74173	1.75 74C173 2.90
7444	1.15	74174	1.85 74C195 3.00
7445	1.10	74175	1.85
7446	1.25	74176	.85
7447*	.89	74177	.85
7448	1.25	74180*	1.00
7450	.25	74181	3.75 IN456 6/\$1
7451	.27	74182	1.00 IN458 6/\$1
7453	.27	74184	2.30 IN485A 5/\$1
7454	.40	74185	2.30 IN746 4/\$1
7459	.25	74187	7.00 IN752 4/\$1
7460	.25	74190	1.50 IN1183 1.60
7470	.45	74191	1.50 IN1184 1.70
7472	.41	74192*	1.25 IN1186 1.80
7473*	.39	74193*	1.25 IN3600 6/\$1
7474	.47	74194	1.50 IN4001 .09
7475*	.75	74195	1.05 IN4002 .10
7476*	.40	74196	1.25 IN4004 .10
7480	.50	74197	1.05 IN4148 15/\$1
7482	1.75	74198	2.25 IN4154 12/\$1
7483	1.15	74199	2.75 IN4734 .28c
7485*	1.10	74200	7.00 IN4735 .28c
7486*	.47	84250	5.00 IN5232 .28c
			IN5234 .28c
			IN5243 .28c
			IN5282 5/\$1

20% Discount for 100 pcs.
 Combined 7400's
 (except Specials)

* MARCH SPECIALS \$

1101	256 Bit Ram Mos	\$ 2.95
2102	1024 Bit Ram	8.00 ea.
8008	8 Bit Processor	60.00

Miniature Aluminum Electrolytic Capacitors

MFD-VOLTS	1-	9-	99	100	MFD-VOLTS	1-	9-	99	100
1 UFD/50V	14c	12c	11c	100	UFD/16V	19c	15c	14c	
2-2 UFD/50V	14c	12c	11c	100	UFD/25V	24c	18c	17c	
3-3 UFD/25V	14c	12c	11c	220	UFD/16V	24c	18c	17c	
4-7 UFD/25V	14c	12c	11c	220	UFD/25V	35c	25c	24c	
10 UFD/16V	14c	12c	11c	330	UFD/16V	35c	25c	24c	
10 UFD/25V	14c	12c	11c	330	UFD/25V	44c	35c	32c	
22 UFD/16V	14c	12c	11c	470	UFD/16V	37c	30c	27c	
22 UFD/25V	15c	13c	12c	470	UFD/25V	49c	39c	35c	
33 UFD/16V	15c	12c	11c	1000	UFD/16V	49c	39c	35c	
33 UFD/25V	17c	13c	12c	1000	UFD/25V	75c	60c	55c	
47 UFD/16V	17c	14c	13c	2200	UFD/16V	75c	60c	55c	
47 UFD/25V	19c	15c	14c						

Axial or Radial Lead Type

50 VOLT CERAMIC DISC CAPACITORS

.001 mf.	5c	3.5c	3c	.033 mf.	6c	4c	3.5c
.0047 mf.	6c	4c	3.5c	.047 mf.	6c	4c	3.5c
.01 mf.	5c	3.5c	3c	.1	mf.	12c	7.5c
.022 mf.	6c	4c	3.5c	100 pf	6c	4c	3.5c

MPS-A05 5/\$1 TRANSISTORS

2N918	.25	2N2906A	4/\$1	2N3905	4/\$1
2N2219A	3/\$1	2N2907A	5/\$1	2N3906	4/\$1
2N2221A	4/\$1	2N3053	2/\$1	PN4249	4/\$1
2N2222A	5/\$1	2N3724A	2/\$1	PN4250	4/\$1
2N2369	5/\$1	2N3725A	2/\$1	2N4409	5/\$1
2N2369A	4/\$1	2N3903	5/\$1	2N5129	.19
2N2484	4/\$1	2N3904	4/\$1	2N5139	.19
				C106B1-SCR-2/\$1	

CALCULATOR & CLOCK CHIPS w/data

5001 LSI	40 pin DIP 4 funct	\$3.95
5005 LSI	28 pin DIP 4 funct w/mem	6.95
5030	28 pin - one Chip Calculator	7.95
MM5311	28 pin bcd 6 dig Mux	5.95
MM5312	24 pin 1 pps BCD 4 dig mux	5.95
MM5313	28 pin 1 pps BCD 6 dig mux	5.95
MM5314	24 pin 6 dig mux	5.95
MM5316	40 pin alarm 6 dig	6.95

Satisfaction Guaranteed. All Items 100% Tested
 \$5.00 Min. Order - 1st Class Mail - No Charge
 California Residents - Add 6% Sales Tax
 Wholesale Outlets - Write for Special Discounts
 Write for FREE 1975 Catalog - Data Sheets .25¢ each



P.O. BOX 822, BELMONT, CA. 94002
 PHONE ORDERS - (415) 592-8097
 CIRCLE NO. 20 ON READER SERVICE CARD

LINEAR

LM300		\$.79
LM301H/N*		3/1.00
LM302H	Voltage Follower	.79
LM304H	Negative Volt Reg	.89
LM305H	Positive Volt Reg	1.00
LM307H/N	Op Amp (Super 741)	.35
LM308H/N	Micro Power Op Amp	1.15
LM309K*	5 Volt Regulator/Amp	1.25
LM310H	Impred Volt Follower	1.19
LM311H/N	Hi-perform Volt Comp.	1.00
LM318N	Hi-Speed Op Amp	2.00
LM320K	-5V 5.2V 12V 15V-24 Neg. Reg.	1.75
LM324N	Quad 741 Op Amp	1.90
LM339N	Quad Comparator	2.35
LM340K	+5V 12V 15V 24V Pos. Reg.	1.89
LM340T	+5V 12V 15V 24V Pos. Reg.	1.75
LM370N	A 6 C - Squelch Amp	1.15
LM373N	AM/FM \$B Strip	3.15
LM380N*	2 Watt Audio Power Amp	1.25
LM380-8N*	.6 Watt Audio Amp	1.00
NE531T	OP Amp	3.00
NE550N	Volt. Reg.	.79
LM555V*	Timer	.75
NE565H*	Phase Lock Loop (TO5)	1.75
LM565N*	Phase Lock Loop (DIL)	2.00
LM566CN*	Function Generator	2.00
LM567H*	Tone Generator (TO5)	1.75
LM567CN	Tone Generator (MINI)	2.00
LM703H	RF/IF Amp	.45
LM723H/N*	Voltage Regulator	.55
LM741H/N*	Comp. Op Amp	3/1.00
LM747H/N	Dual Compn. Op Amp	.90
LM1310P	Stereo Demodulator	4.10
LM1458N	Dual Comp. Op Amp	.65
LM1556N*	5 Times Faster 741	1.85
LM2307P	Current Controlled	3.15
LM3065N	T.V.-FM Sound System	.75
LM3900N*	Quad Amp	.50
LM3905N*	Precision Timer	.65

PROJECTS	LEDS	8000 Series
8263 \$ 7.00	MV 10	5/1 8090-98 .55
8267 4.00	MV 50	6/1 8123 .50
2513* 11.00	MV 5024	5/1 8223* 3.00
2519 7.00	MAN-1	1.95 8263 7.00
2524* 4.00	MAN-3	1.95 8267 4.00
2525 5.00	MAN-4	1.95 8280 .75
2529 4.00	MAN-7	1.50 8281 .85
4024P* 2.25	DL 33	1.95 8288 1.15
	DL747	2.50 8880 1.35

Altaj Electronic Bargains

PRICES SLASHED! WE WANT YOUR BUSINESS. SATISFACTION GUARANTEED ON EVERY ITEM



CALCULATOR BASIC KIT WITH TI CHIP
Includes case with matching all function keyboard, and 9 digits of LED readouts plus a Texas Instruments TMS 103 NC calculator chip. (Same style chip as in TI Datamath calculator). All the basics for building your own hand held calculator. Special — \$9.95 Quantity Limited.



BURROUGHS PANAPLEX II 12 DIGIT READOUT

#BR13251 Neon 7 segment readout. Latest design for calculators, etc. Requires 160 VDC Right hand decimals. Brand new, factory fresh. We include mating socket FREE. \$4.95
NOTE: With purchase of above readout array we offer motorola 2N5401 PNP High Voltage driver transistor for 10¢ each.



LM309K
TO-3 Case, 1 AMP 5 VDC Voltage Regulator. Brand New By National 95¢



3 DIGIT LED READOUT ARRAY
Like Litronix DL-33. 3 MAN-3 style readouts in one package. Factory new units Designed for calculators. Special — \$1.19 (3 Digits)



OPCOA SLA-1 LED READOUT
.33 In. character. Left decimal pt. Uses 7447 driver. Easier to read than MAN-1. Factory prime units. Best Price in USA! \$.95 ea.



MAN-3 LED READOUTS
Brand new, factory prime units .12 in. character. Common cathode. Perfect for calculators. 3 FOR \$1 Best Price Anywhere!

CALCULATOR CHIP BONANZA PRICES SLASHED!
The newest and easiest to use chips available today. Made by famous US mfg. All are 28 pin DIP. Features: direct LED segment drive, low power consumption, internal keyboard debounce, internal clock oscillator, single supply voltage, internal keyboard encoding, and floating decimal point. Does not require many external components as do older types like CT5001, 5002, 5005, etc. We offer the most sophisticated functions for the lowest price anywhere.
Chip #1 — 8 Digit, Constant, Six Function (—, ., x, +, %, √) — \$3.95
Chip #2 — 8 Digit, Memory, Six Function (—, ., x, +, %, √, M) — \$4.95
Chip #3 — 8 Digit, Memory, Six Function (—, ., x, +, %, 1/x) — \$4.95

DIGITAL ALARM CLOCK IC
The newest and easiest to use alarm chip on the market today. Features:
1. Single supply voltage.
2. LED Intensity control
3. Simple time set.
4. 4 or 6 Digit LED Display
5. AM-PM Indication
6. 24 Hr. Alarm.
7. 10 minute snooze
8. Outperforms MM5316
Order #70250 — \$6.95 (2 FOR \$12)



MM5314 NATIONAL CLOCK CHIP
The most popular clock chip around. We made a huge special purchase of factory fresh, prime units. Lowest price in USA. 24 Pin DIP. 4 or 6 Digits. With Specs. \$4.95

MINI CORE MEMORY SPECIAL
Mfg. by DATARAM. Stores 180 words of 18 bits each. With sense amps and associated drive circuits. A complete memory system. We include 50 pages of data and schematics. Data only \$2.50 Brand New. Special \$24.95



DIGITAL WRIST WATCH CRYSTAL
Brand new, mfg. by CTS-KNIGHT. 32.768 KHZ. Standard, most popular type. Special \$1.95

SOLID STATE MEMORY ARRAY
Brand new. MFG by Monolithic Systems Corp. Consists of 16-1101 (256 Bit Ram) and associated drive circuits. Drive circuits include 24 assorted 7400 series devices and various transistors, diodes, etc. Array is mounted on two stacked 6 x 8 in. PC boards. Original cost \$300 ea. With schematic. These are recommended for experienced hobbyists only. Limitac quantity — \$29.95 ea

NI-CAD BATTERY SPECIAL
Two cell battery packs 2.75 V capacity is 250 MA HRS. Two of these make a great power pack for TTL. Special 95¢

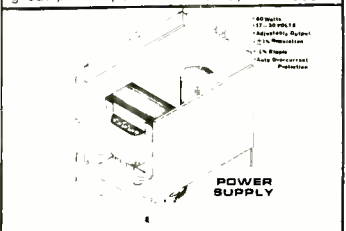

REGULATED DC POWER SUPPLY
Brand new by wattless. DC output 17 to 30 V Rated 60 WATTS out. Our tests show these units will put out 12 VDC by changing one resistor. #OEM 60-3. Original cost \$57.50. In original factory boxes, with specs. Special \$14.95

7805 STYLE REGULATORS
TO-220 Plastic Case 5VDC Regulator. Brand New by National — 89¢

FACTORY NEW LED'S
Jumbo Red-Like MV5024-8/\$1
Jumbo Green-Like MV5222-5/\$1
Jumbo Yellow-5/\$1
Mini Red-Like MV50-10/\$1

MOS 4 DIGIT COUNTER IC
An ALTAJ exclusive. These are the latest, state of the art. MOS chips. By a famous US mfg. Contains a complete 4 digit counter including 4 decade counters, latches, multiplexing circuits, display decoders, etc. Features 5 VDC operation, 25 MW power consumption both 7 segment and BCD outputs. Perfect for making DVM's, frequency meters, tachometers, stopwatches or any other device requiring 4 or more digits. Complete with specs. 28 PIN DIP. QTY Limited
Special — \$12.50

CT7001 BY CAL-TEX
Digital alarm clock chip with calendar feature. 4 or 6 digits. Also has timing circuitry for radio ON-OFF control factory fresh
\$6.95

JUMBO LED READOUT
Twice the size of regular readouts. .65 inches. Like Litronix DL747. Outperforms and easier to read than SLA-3, only 20 MA per segment. Our best readout for digital clocks.
\$2.95 ea (6 FOR \$15) Common Anode

COLOR ORGAN CONTROL MODULE
Completely self-contained. Has SCR circuitry. AC line cord, etc. From a close out by a mfg. of color organs. New unused
\$1.95

GE POWER TRANSISTOR ASSORTMENT
Plastic power devices. Includes NPN and PNP, darlington's, high voltage, high current, and various other types. Cases are color coded for easy sorting. Un-tested but includes many useable units.
Special — 20 FOR \$1

Digital Wrist Watch by Gruen
Complete, factory new units. Not a kit. Sold nationally at \$225. Features: One minute a year accuracy, easy to read LCD Display, heavy gold style case and band. Factory boxed, fully guaranteed. We offer this Name Brand unit at less money than the off-brand watches sold by others. Limited quantity. Sold on a first come basis. \$89.95 (add \$3 Postage and Handling)

FREE SPECIAL BONUS
With purchase of any of our clock or calculator chips we will include a free 28 pin IC socket. A \$1 value Free.

ELECTROLYTIC CAPACITOR SPECIAL
220 MFD at 25 WVDC. AXIAL Leads by GI. Brand New 8 FOR \$1

MINIATURE SWITCH
Rocker style. Small size. SPDT. Perfect for use on digital clocks.
4 FOR \$1

PRIME TTL DIP IC'S

7400-16c	7448-85c	74157-1 19
7402-16c	7473-39c	74161-1 15
7404-16c	7474-38c	74164-1 29
7406-24c	7475-69c	74165-1 50
7408-16c	7476-42c	74174-1 75
7410-16c	7483-88c	74175-1 \$1 50
7413-49c	7490-75c	74181-\$2 95
7420-16c	7492-85c	74192-\$1 25
7430-16c	7493-85c	74193-\$1 25
7437-39c	74121-38c	74195-95c
7438-39c	74123-75c	74197-\$1 25
7440-16c	74150-70c	
7442-69c	75151-75c	
	74153-95c	
	74154-95c	

8038 FUNCTION GENERATOR
Brand new Voltage controlled oscillator. Has sine, square wave, and triangular outputs. \$4.50 each.

IN4148 DIODES
High speed switching diodes. Brand new units, however, leads are cut and bent for PC board insertion, still plenty long. 30 For \$1

POLAROID FILTERS
The real thing by Polaroid Corp. Pale green in color. 2.3 x 12 inches. Use with various readouts or for optical experiments, limited Qty. 2 For \$1.

MOTOROLA AUDIO AMP
MFC 4000. 4 lead mini DIP. 250 MW. 9 volt operation. Hobbyist Special
59c

MOTOROLA POWER TRANSISTOR
MJ3029 — T03 Case — NPN Silicon High Voltage — VCEO — 250V Used in horiz. and vert. TV Circuits. Regular Price \$4. Our Price 95¢

ELECTROLYTIC CAPACITORS
10MFD 25WVDC — Upright — 7c
50MFD 15WVDC — Upright — 10c
50MFD 15WVDC — Axial — 10c
100MFD 15WVDC — Upright — 14c

PLASTIC SILICON TRANSISTORS
Use for drivers in clock or calculators.
MPS2222A — NPN
MPS2714 — NPN
MPS3704 — NPN
2N 3904 — NPN
2N 3906 — PNP
2N 4249 — PNP
YOUR CHOICE 6 FOR \$1 ALL NEW UNITS

ZENERS
IN746 — 400MW — 3.3V
IN752 — 400MW — 5.6V
YOUR CHOICE
8 FOR \$1

TTL IC ASSORTMENT
Various types. Most are marked. Our best selling assortment. Un-tested but includes many useable devices.
200 PCS FOR \$3.95

Our lower prices and superior quality have made ALTAJ one of the fastest growing electronic suppliers in the USA. Put your trust in our unconditional money back guarantee.

ALTAJ ELECTRONICS
P.O. BOX 38544
DALLAS, TEXAS 75238
TERMS: Check or money order. No COD. Add 10% Pstg and Hdig. Tex Res. add 5%.

RECEIVING TUBES, popular tubes 75% + OFF current list. Top makes, brand new, factory cartoned, fully guaranteed. Ceco, 2115 Avenue X, Brooklyn, N.Y. 11235. (212) 646-6300.

JAPANESE TRANSISTORS, Kit only \$23.44 including 14 powers, 10 others. Many types available. Free catalog. West Pacific Electronics, Box 25837, W. Los Angeles, Calif. 90025.

MONITOR RECEIVER, Preamp, Scanner, UHF Converter kits. Hamtronics, 182 Belmont, Rochester, NY 14612.

LIQUID CRYSTAL, 3-1/2 digit wristwatch display. New, with instructions for building wristwatch. Final closeout. Less than original, factory wholesale price. \$5.50 each. Two for \$10. Tricounty Winslow, Inc., Box 5885, Grand Central Station, New York, N.Y. 10017.

NOVEL INNOVATION in security alarm systems, and intruder detection. Send \$1.00 to cover cost of brochure to W. B. Ramsey, 125 Delaware Street, Newcastle, Delaware 19720.

PC Boards—From magazine page: original, magic marker, art, 1/2-1 + 1 2-1 Size. \$3.30 up BECO, Inc. Box 686PE, Salem, VA 24153.

RECONDITIONED Test Equipment, \$0.50 for catalog. Walter, 2697 Nickel, San Pablo, CA 94806.

COMPONENTS. 8038CC \$5.75, AY5-1013A UART \$13.95, AY5-1008 Receiver \$7.95, Crystal Time Base Kit, 5VDC input, 60HzTTL output \$9.75. Postpaid. Latest Flyer, 10 cents stamp. TRI-TEK, 6522 N. 43rd Ave., Glendale, Arizona 85301.

ALTAIR 8800 programming. Write assembly language; receive ready-to-load program. Easy! Details, sample, 50 cents. Dodd, 234 Waples Park, Fairfax, VA 22030.

WEIRNU Special Sale									
LINEAR	1845H	.75	7445	.80	8090	1.50	8811	.90	
7410	.25	7520H	2.00	7475	.95	8097	.40	8830	.50
304R	.80	7542M	.30	7471	.60	8123	1.10	8831	2.40
305H	.80	7544H	.70	74122	.60	8210	2.75	8832	2.40
307R/B	.25			74123	.90	8211	1.50	8833	2.40
308H	.85	1101	1.50	74141	1.50	8220	1.25	8835	.80
594R	.80	5013	4.75	74145	1.00	8210	1.75	8836	or
701H	.25	5060	3.75	74153	1.25	8288	2.00	SP	380
709H	.25	5128	3.00	74160	1.25	8520	1.00	8837	1.25
723H	.40	5738	4.0	74152	1.25	8599	2.50	8838	.60
741R	.25	5823	1.30	74173	1.75	8613	.90	8895	.75
741C/D/1	.18	8224	2.75	74193	1.25	8810	.40	8880	1.25

all parts guaranteed. 74129, 90. Spec sheets. 25¢ each. Send check or MO to WEIRNU, P.O. Box 1307, Colton, CA 92324. Send self addressed stamped envelop for bargain flyer.

ELECTRONIC COMPONENTS for the hobbyist. IC's, LED's, resistors, capacitors, etc. First quality and fast delivery. Send 25 cents for catalog. DIGI-CRAFT ELECTRONICS, P.O. Box 94, Brookline, MA 02146.

FREE Catalog p.c. boards and kits. Counters .99-1.79; Kits 3.99-5.49. Jeff Rose, 3015 Eaton, Cleveland, Ohio 44122.

DIODES, Mallory 2-1/2A, 1000V. 10/\$2.00, 50/\$8.00, 100/\$15.00, 1000/\$120.00. BECO, Inc., Box 686PE, Salem, VA 24153.

BURGLAR-FIRE ALARM components, hardware. Free catalog. Information. Silmar, 133 S.W. 57 Ave., Miami, Florida 33144.

READ AND USE MICROCOMPUTER Hardware/Software ideas in ECS monthly. Write for free catalog and subscription inf. MP Publishing Co. Box 378P, Belmont, Massachusetts 02178.

LASER CATALOG, 60 cents. CO, Plans \$1.50, Hologram \$10.00. Moynihan, 107 Brighton, Atlantic City, New Jersey 08401.

Electronics Enclosure

\$17.95 discounts for quantities

size approximately 3" H x 6" D x 7" W



Tracewell Electronic Enclosures will give your project that look of a thoughtfully designed commercial product. Tracewell Enclosures are beautiful blue textured 1/8" ABS plastic with black knobs and handle. Front and rear panels are flat 1/16" anodized aluminum for easy punching and silk screening. Extra panels are available.

Features include molded-in vertical grooves and stand-offs for PC board mounting, light weight and ventilation slots.

To order, send \$17.95 plus \$2.00 shipping and handling in check or money order to Tracewell Enclosures, Inc.

Telephone and mail COD orders also accepted. Ohio residents add 4% sales tax.

Tracewell Enclosures, Inc.
200 Montrose Way
Columbus, Ohio 43214
phone 614/263-3702



PLANS AND KITS

ATTENTION AUDIO FREAKS!! ... Audio Processing Circuits ... designs, kits, units. Laboratory tested designs for hobbyist through professional use—limiters, compressors, equalizers, phasers, mixers and more! Send now—\$1.00 (refundable) for complete catalog—CIRCUIT RESEARCH LABS, 3920 E. Indian School, Phoenix, AZ 85018.

FREE CATALOG. 200+ unique electronic projects. Bio-feedback, acupuncture, more! Cimarron Labs, 4183A Springfield St., Burton, Michigan 48509.

AMAZING ELECTRONIC PRODUCTS—Pocket Laser, See-in-The-Dark, Scramblers, Penlight Strobe, Energy Devices, TV Disruptor, Many More. All New Catalog \$1.00. INFORMATION UNLTD., West St., Millford, N.H. 03055.

CONSTRUCTION PLANS. Telephone, Surveillance, others. Catalog and free circuit, \$1.00. Alley, 233 Laurelton, Rochester, N.Y. 14609.

TESLA COIL—40" SPARKS! Plans \$7.50. Information 75 cents. Huntington Electronics, Box 2009-P, Huntington, Conn. 06484.

DIGITAL ALARM CLOCK KITS. Complete kit of electronic parts for four digit. LED display alarm clock—\$22.30 post paid. Send for free flyer, bargain kits, components. Digitex, Box 4731, Dallas, Texas 75247.

FREQUENCY counter, Digital Clock, Logic Probe and more to come. Complete kits or PC Boards, reasonable priced full details \$3.00. Refundable. East Coast Electronics, 50 Scott, Hamburg, New York 14075.

AUTOMOTIVE voltage regulator, IC construction. (PE April 1971) \$16.95-\$19.95 Lab Power Supply, 0-30V, 0-1.2A., 0.2% Regulation (PE Feb. 1972) \$79.40. BECO, Inc., Box 686PE, Salem, VA 24153.

HIGH FIDELITY

DIAMOND NEEDLES and Stereo Cartridges at Discount prices for Shure, Pickering, Stanton, Emphre, Grado and ADC. Send for free catalog. LYLE CARTRIDGES, Dept. P, Box 69, Kensington Station, Brooklyn, New York 11218.

SHOTGLASS. As seen in Esquire. Glasscone Column Speaker. \$129.50 each. F.O.B. Moneyback Guarantee. TACHYON™, Box 1012, Roselle, Illinois 60172.

SAVE 50%. Build your own speaker systems featuring Nor-elco, Eminence and CTS. Famous brands from world's largest speaker factories at lowest wholesale prices. Write for free catalog of speakers and electronic accessories. McGee Radio Company, 1901 McGee Street, Kansas City, Missouri 64108.

INTEL 8008	
4 BIT PROCESSING CHIP (PRIME CONDITION)	\$79.50
MINIATURE TRIM POTS	
5K, 10K, 25K, 50K, 100K, 75.0A.	3/\$2.00
MULTI-TRIM POTS	
Similar to Bourns 3010 style 3/16" x 1/8" x 1 1/4" 50, 100, 500, 2000, 5000, 10,000 ohms \$1.50 ea.	3/\$4.00
PRINTED CIRCUIT BOARD	
4 1/2" x 6 1/2" single sided EPOXY board, 1/16" thick, unetched	\$5.00 ea.
LIGHT ACTIVATED SCR's, TO-18 200V 1A	\$1.75

NIXIE TUBES	
Similar to Raytheon 8650 tubes, with socket & data sheet	\$2.25 \$3/6.00
4 WATT IR LASER	
DIODES	\$7.95
TIS 73 N FET	\$5.00
2N4891 UJT	\$5.00
ER900 TRIGGER DIODES	4/\$1.00
2N6027 PROG. UJT	\$7.75

VERIPAX PC BOARD
This board is a 1 1/16" single sided paper epoxy board, 4 1/2" x 6 1/2" (standard veripax). DRILLED and ETCHED which will hold up to 21 single 14 pin IC's or 8, 16 or LSI DIP IC's with buses for power supply connections. Is also etched for 22 pin connector \$5.25

FLV 100 VISIBLE LED	\$5.00
ME-4 IR LED	\$4.00
MT-2 PHOTO TRANSISTOR	\$6.00
GREEN GAP OSL-16 LED	\$6.00
RED GAP OSL-3 LED	\$4.00
14 PIN DIP SOCKETS	\$4.00
16 PIN DIP SOCKETS	\$5.00
10 WATT ZENERS	
3.9 4.7 OR 5.6 V	\$7.50 EA
4 WATT ZENERS	
3.9 5.6 6.8 OR 12 V	\$3.00 EA

Silicon Power Rectifiers				
PRV	1A	3A	12A	50A
100	.06	.14	.30	.80
200	.07	.20	.35	1.15
400	.09	.25	.50	1.40
600	.11	.30	.70	1.80
800	.15	.35	.90	2.20
1000	.20	.45	1.10	2.60

REGULATED MODULAR POWER SUPPLIES	
+ - 15VDC AT 100 ma, 115VAC INPUT	\$19.95
5VDC AT 1A, 115VAC INPUT	\$19.95
IN 4148	14/\$1.00

Terms: FOB Cambridge Mass. Send check or Money Order. Include Postage. Minimum Order \$5.00

TRANSISTOR SPECIALS	
2N256 PNP GE TO-3	\$.50
2N404 PNP GE TO-5	4/\$1.00
2N1137B PNP GE TO-3	\$.95
2N1016A NPN Si TO-82	\$1.95
2N3904 NPN Si TO-92	4/\$1.00
MP53393 NPN Si TO-92	4/\$1.00
2N3906 PNP Si TO-92	4/\$1.00
MPS A13 NPN Si TO-92	3/\$1.00
2N3767 NPN Si TO-66	\$.70
2N2222 NPN Si TO-18	5/\$1.00
2N3055 PNP Si TO-18	\$1.00
2N5296 NPN Si TO-220	\$.50
2N6109 PNP Si TO-220	\$.50
2N4898 PNP Si TO-66	\$.50
2N3919 NPN Si TO-3 RF	\$1.50
2N3638 PNP Si TO-5	5/\$1.00
2N2218A NPN Si TO-5	4/\$1.00

CAPACITORS	
6V 30 UF TANT. 5/\$1	
20V 4.7UF TANT. 5/\$1	MAN-1, RED OR YELLOW
6.8UF 35V TANT. 3/\$1	LED READOUT \$2.50
50V 100UF ELECT \$4.00	MAN-3 READOUTS \$1.75
25V 30UF ELECT 4/\$1.00	MAN-4 READOUTS \$2.00

Conductive Elastometer low profile calculator keyboard. A 2 3/4" x 3 3/4" x 1/2" flex key. 195K-6 keyboard having 0-9, +, -, *, /, K, C buttons with off, on switch. \$6.00

TTL IC SERIES	
74L00	30 7476 .47
7400	18 7480 .65
7401	18 7483-1.00
7402	18 7485-1.30
7403	18 7486-.48
7404	22 7489-2.75
7405	22 7490-.75
7406	37 7491-1.30
7407	37 7492-.75
7408	24 7493-.75
7410	18 7495-.85
7411	30 7496-.85
7412	45 8220-1.50
7413	75 74107-.48
7416	37 74121-.54
7417	37 74123-.95
7420	18 74125-1.40
7426	30 74126-1.40
7427	33 74150-1.15
7430	18 74151-.75
7432	30 74153-1.10
7437	44 74154-1.60
7438	37 74157-1.15
7440	21 74163-1.50
7441	05 74164-1.85
7442	100 74165-1.85
7445	100 74173-1.80
7446	115 74175-1.40
7447	115 74177-1.60
7448	120 74181-3.60
7450	18 74192-1.45
7472	40 74193-1.40
7473	43 74195-1.00
7474	43 75324-1.75
7475	67 75491-1.10

CT5005-12 DIGIT CALCULATOR CHIP \$7.95

C/MOS (DIODE CLAMPED)	
74C 02	\$.55 CD 4019 \$1.20
74C 10	\$.60 CD 4022 \$2.25
74C 157	\$2.15 CD 4023 \$.53
74C 165	\$3.50 CD 4024 \$2.30
CD 4001	\$.53 CD 4025 \$.50
CD 4002	\$.53 CD 4026 \$5.00
CD 4006	\$3.60 CD 4027 \$1.20
CD 4007	\$.60 CD 4028 \$2.75
CD 4009	\$.80 CD 4029 \$4.80
CD 4010	\$.65 CD 4030 \$.65
CD 4011	\$.53 CD 4035 \$2.30
CD 4012	\$.53 CD 4042 \$2.75
CD 4013	\$1.00 CD 4046 \$3.75
CD 4015	\$3.25 CD 4047 \$3.60
CD 4016	\$1.05 CD 4050 \$1.05
CD 4017	\$2.70 CD 4055 \$3.20

CAPACITORS	
20V 4.7UF TANT. 5/\$1	MAN-1, RED OR YELLOW
6.8UF 35V TANT. 3/\$1	LED READOUT \$2.50
50V 100UF ELECT \$4.00	MAN-3 READOUTS \$1.75
25V 30UF ELECT 4/\$1.00	MAN-4 READOUTS \$2.00

Full Wave Bridges			
PRV	2A	6A	25A
200	.95	1.25	\$3.00
400	1.15	1.50	\$4.00
600	1.35	1.75	\$5.00

5311—CLOCK CHIP 6 DIGIT BCD HOLD COUNT. OUTPUT STROBE	\$6.75
5314—CLOCK CHIP 6 DIGIT HDLD COUNT. OUTPUT STROBE	\$6.75
5316—ALARM CLOCK CHIP	\$6.75

2513 64-7 x 5 CHARACTER GEN	\$9.95
2516 64-6 x 8 STATIC CHARACTER GEN	\$9.95

SANKEN AUDIO POWER AMPS	
SI 1010 G 10 WATTS	\$ 6.40
SI 1025 E 25 WATTS	\$17.95
SI 1050 E 50 WATTS	\$24.95

LINEAR CIRCUITS	
LM 309K 5V 1A REGULATOR	\$1.65
723 -40 +40V REGULATOR	\$ 5.58
301/748 HI Per. Op. AMP.	\$ 3.35
LM 320 -5 or -15V REGULATOR	\$1.75
LM 376 -V to 37V POS REG.	\$ 5.58
741A or 741C OP AMP	\$ 3.31
709C OPER AMP	\$ 2.25
340T-5 12, 15, 18, 24V POS. REG. TD-220	\$1.75
101 OPER. AMP. HI PERFORMANCE	\$ 7.75
LM 308 OPER. AMP. LOW PWRWR	\$1.05
747 -DUAL 741	\$ 5.75
711 COMPARATOR	\$ 3.31
537—PRECISION OP AMP	\$2.60
LM 3900—QUAD OP AMP	\$ 4.49
LM 324—QUAD 741	\$2.20
560—PHASE LOCK LOOP	\$2.60
561—PHASE LOCK LOOP	\$2.60
565—PHASE LOCK LOOP	\$2.60
567—TONE DECODER	\$2.95
703—RF IF AMP	\$ 5.55
LM 370—AGC SQUELCH AMP	\$1.15
555—2 μs - 2 HR. TIMER	\$ 8.88
1458 DUAL OP AMP	\$ 6.60
1456 OPER. AMP	\$ 9.95
LM 380—2W AUDIO AMP	\$13.99
LM 381—2W STEREO AUDIO AMP	\$2.60
LM 387—STEREO PREAMP	\$1.69
LM 382—DUAL AUDIO PREAMP	\$1.69
LM 311—HI PER. COMPARTOR	\$ 9.95
LM 319—DUAL HI SPEED COMP	\$1.15
LM 339—QUAD COMPARTOR	\$1.65

TRIACS	
PRV	1A 10A 25A 15A 6A 35A
300	.40 70 1.30 40 50 1.20
200	.70 1.10 1.75 60 70 1.60
400	1.10 1.60 2.60 1.00 1.20 2.20
600	1.70 2.30 3.00



SOLID STATE SALES
P.O. BOX 74A
SOMERVILLE, MASS. 02143 TEL. (617) 547-4005

WE SHIP OVER 95% OF OUR ORDERS THE DAY WE RECEIVE THEM

IC SOCKETS PBC Mounting

8 pin--\$.22	24 pin--\$.75
14 " ---.70	40 " --\$1.25
16 " ---.30	

POTTER & BRUMFIELD



Type KHP Relay 4 PDT 3A Contacts
24 VDC (650 coil) ea. \$1.50 10/\$14.00
120 VAC (10.5 MA coil) ea. \$1.75 10/\$15.75

CARBON RESISTORS

Carbon Resistors 1/4-Watt 5%-full prime, all values in stock. 10 per value (minimum quantity). ten for \$4.5

FAIRCHILD "TRIMPOTS"



ea. only \$.89 10 for \$7.50
Brand new 20 turn precision trimmers. These are prime parts mostly individually packed in sealed envelopes. These values in stock:
50 OHM 1 K 5 K 25 K
500 OHM 2 K 10 K

DIODE ARRAY



10 1N914 Silicon Signal Diodes in one package. 20 leads spaced .1" no common connections. ea. \$.25 10 for \$2.25

8270 DIP 4-BIT SHIFT REGISTER

4-Bit Shift Register---parallel and serial input and output; data entry is synchronized with clock pulse.
ea. \$.50 10 for \$3.95

2N3055 NPN TRANSISTOR

2N3055 Transistor (power): PD-115W; VCE-60V; HFE-50; FT-30K; Case-T0-3
ea. \$1.15 10 for \$6.95

HEWLETT PACKARD 7-SEGMENT READOUT



7 Segment, Man-1, Pin Compatible, Super-Bright .33" W/LH decimal.
ea. \$1.75 10 for \$16.00

7400 DIP TTL SPECIAL

7400 DIP TTL Special Signetic/House Numbered. ea. \$.17 10 for \$1.50

7404 DIP TTL

7404 DIP TTL Special Hex Inverter, Signetic/House Numbered.
ea. \$.17 10 for \$1.50

SEND FOR FREE FLYER! C.O.D. PHONE ORDERS ACCEPTED--\$10 MINIMUM

All parts surplus and tested; leads plated with gold or solder. Orders for \$5 or more are shipped prepaid; smaller orders add 55¢ California residents add Sales Tax. ICs shipped within 24 hours.

BABYLON ELECTRONICS
P. O. Box 41727
Sacramento, Ca. 95841
(916) 334-2161

CIRCLE NO. 43 ON READER SERVICE CARD

LISTEN TO SPECTACULAR 4-CHANNEL SOUND!
Expand your stereo to quadrasonic Hi-Fi.
Build the VISTA Full Logic "SQ" Decoder.
Latest CBS licensed circuitry using 3 IC's to provide Full Logic and Wave Matching.
Exclusively ours. Kit SQ-1 \$37.50. Shipped prepaid in USA & CANADA.
Send for information.

PHOTOLUME CORPORATION
118 East 28th Street, New York, N.Y. 10016

WANTED

QUICKSILVER, Platinum, Silver, Gold, Ores Analyzed
Free Circular Mercury Terminal, Norwood, Mass 02062

MUSICAL INSTRUMENTS

UP TO 60% DISCOUNT. Name brand instruments catalog.
Freeport Music, 455N Route 110, Melville, N.Y. 11746.
WHOLESALE! Professional Guitars, PA Systems, Altec Speakers, 240W RMS Amplifiers. Free Catalog, Carvin, Escondido, Calif. 92028.

MARCH 1975

TUBES

RADIO & T.V. Tubes—36 cents each Send for free Catalog Cornell, 4213 University, San Diego, Calif. 92105.

RECEIVING & INDUSTRIAL TUBES, TRANSISTORS, All Brands — Biggest Discounts, Technicians, Hobbyists. Experimenters — Request FREE Giant Catalog and SAVE! ZALYTRON, 469 Jericho Turnpike, Mineola, N.Y. 11501.

TUBES 60% OFF LIST PRICE. McCord Electronics, Box 276-T, Sylvania, Ohio 43560.

CASH PAID FOR OBSOLETE RECEIVING TUBES WE300B, WE300A, WE350B, WE252A, WE274A/B, WE284D, RCA45, RCA50, Small and large quantities, and movie theatre equipment, amplifier WE86A, WE59A, WE30A, WE91A/B, pick-up WE9A, WE10A, etc. Contact M. Takabe, 303 Fifth Ave., N.Y.C. 10016. Tel: (212) 679-1970.

TUBES receiving, factory boxed, low prices, free price list. Transleteronic, Inc. 1306 40th Street, Brooklyn, N.Y. 11218A. Telephone: 212-633-2800.

TUBES "Oldies", latest. Lists free. Steinmetz, 7519 Maplewood, Hammond, Indiana 46324.

ELECTRICAL SUPPLIES & EQUIPMENT

PLATING Equipment, Portable Platers, Supplies and "Know-How." Build your own tanks for nickel, chrome, etc. Easy-to-install PVC liners. Rectifier components—all sizes. Schematics, parts lists, formulas, operating instructions for all plating. Guaranteed to save you 25%-75%. Some good units for sale. Write for details Platers Service Company, 1511-PE Esperanza, Los Angeles, Calif. 90023

TAPE AND RECORDERS

RENT 4-Track open reel tapes—all major labels—3,000 different — free brochure Stereo-Part, 55 St James Drive, Santa Rosa, Ca. 95401

1930-1962 Radio Programs, Reels, \$1.00 Hour! Cassettes, \$2.00 Hour! Mammoth Catalog, \$1.25. AM Treasures, Box 192F, Babylon, N.Y. 11702

CASSETTE LABELS

Plain white cassette labels. Norelco cassette cleaners famous brand cassettes. Like new 10/12 metal reels. Send for open reel and cassette discount catalog

Cassette Labels (Multiples of 10)	10 99	100	1000	10M
	92	915	91	007
Norelco Cassette Cleaner	60	55	50	45
Scotch Cassette SC90H. Buy 10 get 5 FREE	3.25	3.10	2.95	2.80
10/12 Metal, NAB Reel Used	1.00	90	80	75

Plus Postage by Weight and Zone Minimum Order: \$5.00

SAXITONE TAPE SALES
1776 COLUMBIA ROAD, N.W.
WASHINGTON, D.C. 20009

WE have a few competitively priced used Revox A77 decks available. These have been completely reconditioned by Revox, are virtually indistinguishable from new, and have the standard Revox 90 day warranty for rebuilt machines. Satisfaction guaranteed. One example is an A77 Dolby for \$675 plus shipping. Please write stating your requirements to ESSI, Box 854, Hicksville, N.Y. 11802 (212) 895-9257

GOVERNMENT SURPLUS

GOVERNMENT Surplus How and Where to Buy in Your Area. Send \$2.00. Surplus 30177-PE Headquarters Bldg., Washington, D.C. 20014

MANUALS for Govt Surplus radios, test sets, scopes. List 50 cents (coin). Books. 7218 Roanne Drive, Washington, D.C. 20021.

PERSONALS

MAKE FRIENDS WORLDWIDE through international correspondence. Illustrated brochure free. Hermes, Berlin 11, Box 110660/ZD, Germany

INSTRUCTION

INTENSIVE 5 week course for Broadcast Engineers. F C C First Class license. Radio Engineering Incorporated, 61 N. Pineapple Ave., Sarasota, Florida 33577

F.C.C. EXAM MANUAL

PASS FCC EXAMS! Memorize, study — "Test Answers" for FCC 1st and 2nd class Radio Telephone Licenses. Newly revised multiple choice questions and diagrams cover all areas tested in FCC exams plus "Self-Study Ability Test." \$9.95 postpaid. Moneyback Guarantee.

COMMAND PRODUCTIONS
RADIO ENGINEERING DIVISION
P.O. BOX 26348-P
SAN FRANCISCO, CALIF. 94126

FREE DATA SHEETS WITH EVERY ITEM 739/749 IC WITH EVERY \$10 ORDER*

- REDUCE YOUR PROJECT COSTS
- MONEY-BACK GUARANTEE
- 24-HOUR SHIPMENT
- ALL TESTED AND GUARANTEED

- TRANSISTORS (NPN):

2N3563 TYPE RF Amp & Osc to 1 GHz (pl.2N916)	6/\$1.00
2N3565 TYPE Gen. Purpose High Gain (TO-92/06)	6/\$1.00
2N3567 TYPE High Current Amplifier/Sw 500 r/A	4/\$1.00
2N3866 TYPE RF Pwr Amp 1-2 W @ 100-600 MHz	\$1.50
2N3903 TYPE GP Amp & Sw to 100 mA and 30 MHz	6/\$1.00
2N3904 TYPE GP Amp & Sw to 100 mA (TO-92/106)	5/\$1.00
2N3919 TYPE RF Pwr Amp 3-5 W @ 3-30 MHz	\$3.00
2N4274 TYPE Ultra-High Speed Switch 12 ns	4/\$1.00
MPS6515 TYPE High-Gain Amplifier f _T 250	3/\$1.00
Assort. NPN GP TYPES, 2N3565, 2N3641, etc. (15)	\$2.00
2N3638 TYPE (PNP) GP Amp & Sw to 300 mA	4/\$1.00
2N4249 TYPE (PNP) Low-Noise Amp 1 μA to 50 mA	4/\$1.00

- FET's:

N-CHANNEL (LOW-NOISE):	
2N4091 TYPE RF Amp & Switch (TO-18/106)	3/\$1.00
2N4416 TYPE RF Amplifier to 450 MHz (TO 72)	2/\$1.00
2N5163 TYPE Gen. Purpose Amp & Sw (TO-106)	3/\$1.00
2N5486 TYPE RF Amp to 450 MHz (plastic 2N4416)	3/\$1.00
E100 TYPE Low-Cost Audio Amplifier	4/\$1.00
ITE4868 TYPE Ultra-Low Noise Audio Amp.	2/\$1.00
T1574 TYPE High-Speed Switch 4052	3/\$1.00
Assort. RF & GP FET's, 2N5163, 2N5486, etc. (8)	\$2.00
- P-CHANNEL:

2N4360 TYPE Gen. Purpose Amp & Sw (TO-106)	3/\$1.00
E175 TYPE High-speed Switch 125Ω (TO-106)	3/\$1.00

MARCH SPECIALS:

2N2222 or 2N2222A NPN TRANSISTOR GP Amp & Switch	5/\$1.00
2N3569 TYPE NPN TRANSISTOR GP Amp & Switch	4/\$1.00
741 Freq. Compensated Op Amp (DIP/TO-5/MINI DIP)	3/\$1.00
2N3906 TYPE PNP TRANSISTOR GP Amp & Switch	5/\$1.00
MM5316 Digital Alarm Clock Snooze/Alarm/Timer	
1 Hrs, Min, Secs, 4 or 6 Digit — with Specs/Schematics	\$7.95
MM5736 6-Digit 4-Function Calculator 18 PIN DIP	\$3.95

- LINEAR IC's:

308 Micro-Power Op Amp (TO-5/MINI-DIP)	\$1.00
309K Voltage Regulator 5 V @ 1 A (TO 3)	\$1.50
324 Quad 741 Op Amp, Compensated (DIP)	\$1.90
380 2.5 Watt Audio Amplifier 34 dB (DIP)	\$1.29
555X Timer 1 μs 1 hr. Dif. pinout from 555 (DIP)	\$.85
709 Popular Op Amp (DIP/TO-5)	\$.29
723 Voltage Regulator 3-30 V @ 1-250mA (DIP/TO-5)	\$.58
739 Dual Low-Noise Audio Preamp/Dp Amp (LIP)	\$1.00
1458 Dual 741 Op Amp (MINI-DIP)	\$.65
2556 Dual 555 Timer 1 μsec to 1 Hour (DIP)	\$1.55

- DIODES:

1N3600 TYPE Hi Speed Sw 75 V/200 mA	6/\$1.00
1N3893 TYPE RECTIFIER Stud Mount 400 V/12 A	2/\$1.00
1N914 or 1N4148 TYPE Gen. Purp. 100V/10mA	10/\$1.00
1N749 ZENER 4.3 Volt (±10%) 400 mW	4/\$1.00
1N753 ZENER 6.2 Volt (±10%) 400 mW	4/\$1.00
1N755 ZENER 7.5 Volt (±10%) 400 mW	4/\$1.00
1N757 ZENER 9.1 Volt (±10%) 400 mW	4/\$1.00
1N758 ZENER 10 Volt (±10%) 400 mW	4/\$1.00
1N965 ZENER 15 Volt (±10%) 400 mW	4/\$1.00
1N968 ZENER 20 Volt (±10%) 400 mW	4/\$1.00
D5 VARACTOR 5-50 W Output @ 30-250 MHz, 7-70 pF	\$5.00
F7 VARACTOR 1-3 W Output @ 100-500 MHz, 5-30 pF	\$1.00

*MAIL NOW! FREE DATA SHEETS supplied with every item from this ad. FREE 739 or 749 Low-Noise Dual Op Amp included (\$1.00 value) with every order of \$10 or more, postmarked prior to 4/30/75

ORDER TODAY — All items subject to prior sale and prices subject to change without notice

WRITE FOR FREE CATALOG offering hundreds of semiconductors not listed here. Send 10¢ stamp.

TERMS: All orders must be prepaid. We pay postage. \$1.00 handling charge on orders under \$10. Calif. residents add 6% sales tax.

ADVA ELECTRONICS
BOX 4181-Z, WOODSIDE, CA 94062
Tel. (415) 851-0455

CIRCLE NO. 1 ON READER SERVICE CARD

SCORE high on F C C Exams Over 300 questions and answers. Covers 3rd, 2nd, 1st and even Radar. Third and Second Test, \$14.50. First Class Test, \$15.00. All tests, \$26.50. R.E.I., Inc., Box 806, Sarasota, Fla 33577

SELF-STUDY CB RADIO REPAIR COURSE. THERE'S MONEY TO BE MADE REPAIRING CB RADIOS. This easy-to-learn course can prepare you for a career in electronics enabling you to earn as much as \$16.00 an hour in your spare time. For more information write: CB Radio Repair Course, Dept. PE-0275, 531 N Ann Arbor Oklahoma City, Okla 73127

LEARN WHILE ASLEEP. Hypnotize! Strange catalog free Auto-suggestion, Box 24-ZD, Olympia, Washington 98501

DEGREE IN ELECTRONICS through correspondence. Free catalog. Grantham, 2000 Stoner Avenue, Los Angeles, California 90025

FCC License, electronics design, satellite communications, through correspondence. Free catalog. Gen Tech, 5540 Hollywood Blvd., Los Angeles, Calif. 90028.

UNDERSTAND Digital Electronics Calculators. Clocks. Microprocessors. New programmed-learning courses. Design of Digital Systems, 6 parts, only \$14.95. Digital Computer Logic, 4 parts \$9.95. Both \$19.95 Unconditional refund if dissatisfied. Cambridge Learning, Box 2301, Santa Clara, Calif. 95051.

LEARN ELECTRONIC ORGAN SERVICING at home all makes including transistor. Experimental kit—trouble-shooting. Accredited NHSC. Free Booklet. NILES BRYANT SCHOOL, 3631 Stockton, Dept. A, Sacramento, Calif. 95820.

BUSINESS OPPORTUNITIES

MADE \$40,000.00 Year by Mailorder! Helped others make money! Free Proof. Torrey, Box 318-NN, Ypsilanti, Michigan 48197

FREE CATALOGS Repair air conditioning, refrigeration. Tools, supplies, full instructions Doolin, 2016 Canton, Dallas, Texas 75201.

PIANO TUNING LEARNED QUICKLY AT HOME! Tremendous field! Musical knowledge unnecessary GI approved. Information free. Empire School, Box 450327, Miami 33145.

\$200.00 DAILY In Your Mailbox! Your opportunity to do what mail-order experts do. Free details. Associates, Box 136-J, Holland, Michigan 49423.

FREE BOOK "2042 unique proven enterprises." Work home! Hayling-B, Carlsbad, CA 92008.

HIGHLY PROFITABLE ONE-MAN ELECTRONIC FACTORY

Investment unnecessary, knowledge not required, sales handled by professionals. Postcard brings facts about this unusual opportunity. Write today! Barta-DP, Box 248, Walnut Creek, CA 94597.

MAILORDER MILLIONAIRE helps beginners make \$500 weekly. Free report reveals secret plan! Executive (1K3), 333 North Michigan, Chicago 60601.

wanted CITIZENS BAND
DEALER-DISTRIBUTORS
Send this Ad to:
PAL ELECTRONICS CO.
P. O. Box 778 • Westminster, Ca. 92683

CAPITAL CONTACTS We reach underwriters who consider companies having net earnings to go public or private placement. Write for helpful information Confidential Consultant, 817 51st St., Brooklyn, N.Y. 11220.

GET AHEAD! Buy College Degrees without studying! Free details Counseling, Box 1162-PE3, Tustin, Calif. 92680.

MAIL OUR HIGH PROFIT paying circulars under your name! No postage or mailing envelopes to buy! Circulars furnished FREE! Send stamped addressed envelope. Wright, 949 Broadway, 602-PE, New York City 10010.

MOVIE FILMS

8MM-SUPER 8-16MM MOVIES! Biggest Selection! Lowest Prices! Free Catalog! Cinema Eight, Box PE, Chester, Connecticut 06412.

INVENTIONS WANTED

CASH-ROYALTIES for patented, unpatented inventions. Global Marketing Service, 139-P Lake Merced Hill South, San Francisco, California 94132.

INVENTORS: Protect your ideas! Free "Recommended Procedure" Washington Inventors Service, 422T Washington Building, Washington, D.C. 20005.

FREE PAMPHLET "Tips on Safeguarding Your Invention" Write United States Inventors Service Company, 708-T Carry Building, Washington, D.C. 20005.

MR. INVENTOR: Manufacturers need inventions. For development assistance, patent searches, sales for cash or royalty, free "Proof of Invention" forms and other important information, write: Charles S. Prince, Invention Consultant, 509-E 5th Avenue, NYC 10017.

INTERNATIONAL ELECTRONICS UNLIMITED

MARCH SPECIALS

5001	12 DIG 4 funct fix dec	\$2.95	1103	256 bit RAM MOS	\$2.95
5002	Same as 5001 exc btry pwr	4.95	5260	1024 bit RAM	2.95
5005	12 DIG 4 funct w/mem	6.95	5261	1024 bit RAM	2.95
5725	8 DIG 4 funct chain & dec	2.25	5262	2048 bit RAM	7.95
5736	18 pin 6 DIG 4 funct	4.45	2102	1024 bit static RAM	6.95
5738	8 DIG 5 funct K & Mem	4.95	5203	UV Eras.	19.85
5739	9 DIG 4 funct (btry sur)	4.95	HP50827414	4 digit common cathode	
5311	28 pin BCD 6 dig mux	4.95		Fits 14 pin DIP - .11 bubble lens	2.75
5312	24 pin 1 pps BCD 4 dig mux	4.95	MAN 7	Red 7 seg .270"	.99
5313	28 pin 1 pps BCD 6 dig mux	4.95	MAN 66	Red .6" spaced seg	3.50
5314	24 pin 6 dig mux	4.95	MAN 6	Red .6" solid seg	4.25
5316	40 pin alarm 4 dig	5.95	8008	8 bit CPU prime quality	64.50

TTL

7400	\$.19	7485	\$1.39
7401	.19	7486	.44
7402	.19	7489	2.75
7403	.19	7490	.76
7404	.22	7491	1.29
7405	.22	7492	.79
7406	.39	7493	.79
7407	.39	7494	.89
7408	.25	7495	.89
7409	.25	7496	.89
7410	.19	74105	.49
7411	.29	74107	.49
7413	.79	74121	.57
7415	.39	74122	.53
7416	.39	74123	.99
7417	.39	74125	.69
7420	.19	74126	.79
7422	.29	74141	1.23
7423	.35	74145	1.15
7425	.39	74150	1.09
7426	.29	74151	.89
7427	.35	74153	1.29
7430	.22	74154	1.59
7432	.29	74155	1.19
7437	.45	74156	1.29
7438	.39	74157	1.29
7440	.19	74161	1.39
7441	1.09	74163	1.59
7442	.99	74164	1.89
7443	.99	74165	1.89
7444	1.10	74166	1.65
7445	1.10	74173	1.65
7446	1.15	74175	1.89
7447	1.15	74176	1.65
7448	1.15	74177	.99
7450	.24	74180	1.09
7453	.27	74181	3.65
7454	.39	74182	.89
7460	.19	74190	1.59
7464	.39	74192	1.49
7465	.39	74193	1.39
7472	.36	74194	1.39
7473	.43	74195	.99
7474	.43	74196	1.85
7475	.75	74197	1.15
7476	.47	74198	2.19
7483	1.11	74199	2.19

Data sheets supplied on request. Add \$.50 for items less than \$1.00.

LINEAR CIRCUITS

301	Hi perf. op amp	mDIP	\$ 32
307	Op amp	mDIP	.35
308	Micro pwr op amp	mDIP	1.10
309K	5V reg 1A	TO-3	1.65
310	V follr. Op Amp	mDIP	1.19
311	Hi perf. V comp	mDIP	1.05
319	Hi-speed dual comp	DIP	1.29
320	Neg. regulator		
	(5V, 5.2V, 12V, 15V)	TO3	1.35
324	Quad op amp	DIP	1.95
339	Quad comp	DIP	1.69
340T	Pos V reg (5V, 6V, 8V, 12V, 15V, 18V, 24V)	TO-220	1.95
372	AG-IF strip det	DIP	.79
376	Pos V reg	mDIP	.59
377	2 w stereo amp	DIP	2.69
380	2w audio amp	DIP	1.49
380-8	.6w audio amp	mDIP	.89
381	Lo noise dual preamp	DIP	1.79
550	Pre. V reg	DIP	.79
555	Timer	mDIP	.99
560	Phase locked loop	DIP	2.75
562	Phase locked loop	DIP	2.65
565	Phase locked loop	DIP	2.65
566	Function gen	mDIP	2.75
709	Op amp	DIP	.29
710	Hi speed V comp	DIP	.39
723	Volt reg.	DIP	.69
739	Dual hi perf amp	DIP	1.19
741	Comp. op amp	mDIP	.35
747	Dual 741	DIP	.79
748	Freq adj 741	mDIP	.39
1304	FM mux st demod	DIP	1.19
1307	FM mux st demod	DIP	.89
1458	Dual Comp op amp	mDIP	.69
3900	Quad amp	DIP	.65
3905	Pre. timer	DIP	.65
7524	Core mem sense amp	DIP	1.89
7525	Core mem sense amp	DIP	.95
7535	Core mem sense amp	DIP	1.25
75451	Dual pri. driver	mDIP	.39
75452	Dual pri. driver	mDIP	.39
75453	Dual pri. driver	mDIP	.39
75491	Quad seg driver	DIP	.79
75492	Hex dig driver	DIP	.89

Data sheets supplied on request. Add \$.50 for items less than \$1.00.

CALCULATOR & CLOCK CHIPS w/data

5001	12 DIG 4 funct fix dec	3.95
5002	Same as 5001 exc btry pwr	7.95
5005	12 DIG 4 funct w/mem	8.45
MM5725	8 DIG 4 funct chain & dec	2.79
MM5736	18 pin 6 DIG 4 funct	4.95
MM5738	8 DIG 5 funct K & Mem	7.95
MM5739	9 DIG 4 funct (btry sur)	6.95
MM 5311	28 pin BCD 6 dig mux	6.95
MM 5312	24 pin 1 pps BCD 4 dig mux	6.95
MM 5313	28 pin 1 pps BCD 6 dig mux	7.95
MM 5314	24 pin 6 dig mux	8.95
MM 5316	40 pin alarm 4 dig	8.95

CMOS

74C00	\$.39	74C154	3.50
74C02	.55	74C157	2.19
74C04	.75	74C160	3.25
74C08	.75	74C161	3.25
74C10	.65	74C163	3.25
74C20	.65	74C164	3.50
74C42	2.15	74C173	2.90
74C73	1.55	74C195	3.00
74C74	1.15	80C95	1.50
74C76	1.70	80C97	1.50

4000 SERIES RCA-EQUIV.

CD4001	\$.55	CD4017	2.95
CD4009	.85	CD4019	1.35
CD4010	.85	CD4022	2.75
CD4011	.55	CD4023	.55
CD4012	.55	CD4025	.55
CD4013	1.20	CD4027	1.35
CD4016	1.25	CD4035	2.85



(408) 659-3171

ON ORDERS OVER \$25.00 DEDUCT 10%

All items are new, unused surplus parts - tested functional. Satisfaction is guaranteed. Shipment will be made via first class mail - postage paid - in U.S., Canada and Mexico within three days from receipt of order. Minimum order - \$5.00. California residents add sales tax.

INTERNATIONAL ELECTRONICS UNLIMITED
P.O. BOX 1708 MONTEREY, CALIF. 93940 USA

MICROPROCESSOR KIT

Basic kit provides a very versatile 16 bit microprocessor. Optional memory boards are available allowing possible expansion of the basic system to microcomputer or minicomputer proportions.

Basic Kit Includes:

- A Printed circuit boards (compatible with 22 pin edge connectors - not supplied)
- B microprocessor chip sets
- C gates, interface elements, clock drivers, etc.
- D transistors, diodes, capacitors
- E 75 page data package which includes an introduction to microprocessors, all necessary data sheets and extensive data on the workings and applications of microprocessor chips.

PRICE (basic kit) \$349.50

Available Options

- Power supply component pkg (P.P. or UPS) \$11.95
- Memory board B4 8-1101 26.95
- Memory board B5 4-1101 4-5203 98.00
- Memory board B6 space for 16 memories 11.95
- DATA PACKAGE REFUNDABLE WITH PURCHASE OF BASIC KIT 7.50

MEMORIES

1101	256 bit RAM MOS	\$1.75
1103	1024 bit RAM MOS	4.95
5203	2048 bit Eras. PROM	24.95
5260	1024 bit RAM low power	3.95
7489	64 bit RAM TTL	2.75
8223	Programmable ROM	4.95
74200	256 bit Ram-tri-state	7.95

LED'S AND OPTO ISOLATORS

MV10B	Red TO 18	\$.25 ea.
MV50	Axial leads	.20
MV5020	Jumpo visible red	.33
ME4	Infra red diff. dome	.60
MAN1	Red 7 seg. .270"	2.50
MAN2	Red alpha num. .32"	4.95
MAN3A	Red 7 seg. .127"	.79
MAN3M	Red 7 seg. .127" claw	1.15
MAN4	Red 7 seg. .190"	2.15
MAN5	Green 7 seg. .270"	2.95
MAN7	Red 7 seg. .270"	1.35
MAN8	Yellow 7 seg. .270"	3.95
MAN66	60" high dir. view	4.65
DL707	Red 7 seg. .3"	2.15
MCT2	Opto-iso transistor	.69

inventors

...Manufacturers Need New Products

If you have an idea for a new product, or a way to make an old product better, contact us, "the idea people." We'll develop your idea, introduce it to industry, negotiate for cash sale or licensing.

Send for our FREE "Invention Kit." It has a special "Invention Record Form," an important brochure, "Your Invention - Its Development, Protection & Marketing," and a Directory of 500 Corporations Seeking New Products. You'll learn how ideas become a reality!

RAYMOND LEE ORGANIZATION
230 Park Avenue, New York, N.Y. 10017

I'd like to find out how to take action on my idea. Send Free "Invention Kit No.A-112"

Name Please Print
Address
City State Zip

SAN FRANCISCO LOS ANGELES TORONTO VANCOUVER DENVER CHICAGO

STAMPS

200 WORLDWIDE stamps only 10 cents. Inexpensive foreign approvals included. White Company, Box 24211-TC, Indianapolis, Indiana 46224.

BOOKS

FREE catalog aviation/electronic space books. Aero Publishers, 329PE Aviation Road, Fallbrook, California 92028.

FREE book prophet Elijah coming before Christ. Wonderful bible evidence. Megiddo Mission, Dept. 64, 481 Thurston Rd., Rochester, N.Y. 14619.

BOOKS—thousands titles, bargains. Catalog Free. Cassiano, 92-27 New York Blvd., Jamaica, New York 11433.

POPULAR ELECTRONICS INDEXES. Detailed and complete subject indexes now available to both 1972 and 1973 magazines. Hundreds of subject references to help you quickly find that special project, article, or product test. 1972 and 1973 editions \$1.00 each. INDEX, box 2228, Falls Church, Va. 22042.

INSTRUCTION MANUALS—Thousands available for test equipment, military electronics. Send \$1.00 (Refundable first order) for listing. A service of Tucker Electronics, Box 1050, Garland, Texas 75040.

Popular Electronics

MARCH 1975

ADVERTISERS INDEX

READER SERVICE NO.	ADVERTISER	PAGE NUMBER
42	A.P. Products, Inc	71
1	Adva Electronics	101
2	Allison Automotive Company	73
	Alpha Electronics	81
3	Altaj Electronics	99
	Anconra Corp	97
7	B&K Precision, Products of Dynascan	1
43	Babylon Electronics	101
	Bell & Howell Schools	64, 65, 66, 67
	CREI, Capitol Radio Engineering Institute	54, 55, 56, 57
8	Cleveland Institute of Electronics	84, 85, 86, 87
9	Clifford's Hi-Fi Wholesalers	59
10	Continental Specialties Co	23
11	Delta Electronics Co	98
12	Delta Products, Inc	15
13	Digi-Key Corporation	94
	Dixie Hi-Fidelity	88
14	EICO	12
	Edmund Scientific Co	104
16	Electronics and Control Engineers' Book Club	5
	G C Electronics	13
5	Heath Company	44, 45, 46, 47
17	Illinois Audio	88
18	International Electronics Unlimited	102
19	International Hi-Fi Distributors	89
20	James	98
33	Johnson Co., E.F.	25
21	Lafayette Radio Electronics	14
22	McIntosh Laboratory, Inc	23
23	MIT	7
24	Midwest HiFi Wholesalers	89
	NRI Schools	8, 9, 10, 11
	National Technical Schools	74, 75, 76, 77
25	OEMorsco	92
26	Pace Communications	59
27	PAIA Electronics, Inc	13
28	PanaVise	90
29	Perma Power	63
30	Phase Linear Corporation	6
31	Poly Paks	93
32	Radio Shack	THIRD COVER
35	Shure Brothers Inc	79
36	Solid State Sales	100
37	Southwest Technical Products Corp	91
38	Tri-Star Corporation	59
	U.S. Coast Guard	18, 19, 20, 21
39	U.S. Pioneer Electronics Corp	SECOND COVER
4	United Audio Products, Inc	FOURTH COVER
41	Weller/Xcelite Electronics Division	26
CLASSIFIED ADVERTISING		92, 94, 100, 101, 102, 103

MARCH 1975

HOME ENTERTAINMENT FILMS

SAVE A BUCK (\$1.00) IN '75! Order the '71 NFL Highlights, 200' Standard 8, B&W only, \$7.95 each Postpaid; or see Ali get beat in the Ali-Norton (first fight), 200' Super 8, B&W, \$7.95 each. Both titles subject to prior sale and only while supply lasts. Or, choose your own titles from revised Castle, Columbia or Sportlite catalogs, 30 cents each (coins or stamps — no checks, please). SPORTLITE, Elect. Dept.-3, Box 24-500, Speedway, Indiana 46224.

EMPLOYMENT OPPORTUNITIES

ELECTRONICS/AVIONICS EMPLOYMENT OPPORTUNITIES. Report on jobs now open. Details FREE. Aviation Employment Information Service, Box 240, Northport, New York 11768.

TREASURE FINDERS

FREE FACT-FILLED CATALOG! World's largest selection! Metal detectors starting at \$79.50. Two year guarantee! Three factories. U.S.-Canada. 1,200 dealers - Service Centers nationwide. Finest instruments at any price! Budget Terms. Dealer inquiries invited. Write: White's Electronics, Inc. Dept. PD5Q, 1011 Pleasant Valley Road, Sweet Home, Oregon 97386.

TREASURE FINDER locates buried gold, silver, coins, treasures. 6 powerful models. Instant financing available. Write or call for free catalog. Phone (713) 682-2728 day or night. Dealer inquiries invited. Relco, Dept. AA20, Box 10839, Houston, Texas 77018.

REAL ESTATE

BIG...FREE...CATALOG! Over 2,500 top values in 40 states coast to coast! UNITED FARM AGENCY. 612-EP West 47th St., Kansas City, Mo. 64112.

MINICOMPUTERS

WILL Buy, Sell or Trade homemade and other peripheral devices, software programs, etc. AL COVE. 230 Main, North Reading, Mass. 01864.

MAGNETS

MAGNETS. All types. Specials-20 disc, or 10 bar, or 2 stick, or 8 assorted magnets, \$1.00. Magnets. Box 192-H, Randallstown, Maryland 21133.

RECORDS

OLDIES. 45rpm. Free Catalog. Corny's Record Shop, Box 166TD, Mason, Ohio 45040.

RUBBER STAMPS

RUBBER address stamps. Free catalog. 45 type styles. Jackson's, Box 443G, Franklin Park, Ill. 60131

PLASTICS

CASTOLITE pours like water, hardens like glass without heat. Crystal clear, colors. Embed flowers, seashells, mementos, anything. Make fine gifts. Form flexible molds over patterns of any shape, size. Reproduce your own designs in plastics, candlewax, metal, plaster, cement. Free Brochure. Or send \$1.00 for illustrated Manual, Catalog. Profitable. CASTOLITE, Dept. 75C/PE, Woodstock, Ill. 60098.

HYPNOTISM

SLEEP learning. Hypnotic method. 92% effective. Details free. ASR Foundation, Box 23429EG, Fort Lauderdale, Florida 33307.

FREE Hypnotism. Self-Hypnosis. Sleep Learning Catalog! Drawer H400, Ruidoso, New Mexico 88345.

AMAZING self-hypnosis record releases fantastic mental power. Instant results! Free trial. Write: Forum (AA3), 333 North Michigan, Chicago 60601.

MISCELLANEOUS

WINEMAKERS: Free illustrated catalog yeasts, equipment. Semplex, Box 12276P, Minneapolis, Minn. 55412.



DELUXE MAGAZINE CASES

Designed Exclusively for
POPULAR ELECTRONICS

● The ideal way to save your valuable copies, keep them well protected and make it easy for you to refer to any issue at any time. Both decorative and attractive enough to enhance the decor of any room, each case holds a full year's copies. Constructed of reinforced fiberboard, these durable cases are covered in a rich-textured leatherette. The gold embossed back adds to its elegance and makes each case a welcome addition to your bookshelf or cabinet.

Cases are available for your favorite magazines. Only \$5.95 each, 3 for \$15.50 in any combination of titles, including all postage and handling charges. Outside U.S.A. add \$1 per case.

CHARGE YOUR ORDER TO YOUR AMERICAN EXPRESS, BANKAMERICARD, MASTER CHARGE OR DINERS CLUB ACCOUNT.

Ziff-Davis Serv. Div., Dept. JJ, 595 Broadway, N.Y. 10012
Please send the Magazine Cases indicated below:

TITLE	QUANTITY
CHECK: <input type="checkbox"/> All Black <input type="checkbox"/> Maroon Back, Black Sides	
<input type="checkbox"/> ENCLOSED IS \$	PE-35
<input type="checkbox"/> CHARGE: <input type="checkbox"/> BankAmericard <input type="checkbox"/> Master Charge	
<input type="checkbox"/> American Express <input type="checkbox"/> Diners Club	
Account #	Exp. Date
Master Charge Interbank #	(4 numbers over your name)
Signature	
Print Name	
Address	
City	State
Zip	
Residents of Calif., Col., Fla., Ill., Mich., Mo., N.Y. State, D.C. and Tex. add applicable sales tax.	

RETAIL DISPLAY PLAN

All magazine retailers in the United States and Canada interested in earning an allowance for the display and sale of a minimum of five publications of the Ziff-Davis Publishing Company, to be paid quarterly on the basis of ten per cent of the cover price of each sold copy, assuming that all terms and conditions of the contract are satisfied, are entitled to do so and are invited to write for full details and copies of the contract to Single Copy Sales Director, Ziff-Davis Publishing Company, One Park Avenue, New York, New York 10016.

LIVE IN THE WORLD OF TOMORROW... TODAY!

And our FREE 180 PAGE CATALOG is packed with exciting and unusual values in electronic, hobby and science items — plus 4,500 finds for fun, study or profit... for every member of the family.

A BETTER LIFE STARTS HERE

TEST YOUR DEGREE OF ESP!

Which light comes on when you push the button—Star, Square, Triangle or Circle? If you've got ESP you or your subject will guess right significantly. Solid state ESP Tester has guaranteed random circuit for accuracy—you can't beat the machine by memorizing! Run classic ESP, precognition, Probability, telepathy experiments. Portable. Req. 4 "D" batt.



No. 72,090AV... (6 1/4 x 3 3/4 x 2) \$29.95 Ppd.
 EXTRA PADS TO RECORD 250 EXPERIMENTS
 Stock No. 72,092AV \$3.50 Ppd.

"FISH" WITH A MAGNET

Go treasure hunting on the bottom! Fascinating fun & sometimes profitable! Tie a line to our powerful new specially designed 150 lb. pull PVC coated Magnet—drop it overboard in bay, river, lake or ocean. Troll it along bottom—your "treasured" haul can be out-board motors, anchors, other metal valuables. Has 6 stacked ceramic magnets. Lifts over 150 lbs. under water!



No. 71,135AV... (3-1/4 x 3-7/8) \$17.50 Ppd.
 75-LB. PULL (1 LB) W/ 3 CERAMIC MAGNETS
 No. 71,150AV... (1-11/16 x 3-1/4") \$11.00 Ppd.

NEW! KIRLIAN PHOTOGRAPHY KIT!

Experiment in the fascinating new field of "Kirlian electrophotography"—images obtained on film without camera or lens by direct recording of electric charge transmitted by animate & inanimate objects. Each "aura" differs—animate aura said to change corresponding to physical changes. Kit incl. portable darkroom, double transformer isolated from power source, instrs.



Stock No. 71,938AV \$49.95 Ppd. SEE
 "HIGH VOLTAGE PHOTOGRAPHY" by H.S. Dakin
 No. 91299AV. (60-PG. PAPERBACK BOOK) \$5.00 Ppd. FEATURE ARTICLE
 DELUXE KIRLIAN PHOTOGRAPHY SET JANUARY 1975
 No. 72,053AV \$399.00 Ppd.

BUILD A SOLAR ENERGY FURNACE

Fascinating new field. Harness the incredible heat of the sun for experimentation - many practical uses. Easy! Inexpensive! Use scrap-wood. We furnish instructions. This sun powered furnace generates terrific heat - 2000° to 3000°. Fuses enamel to metal. Sets paper aflame in seconds. Use our Fresnel lens-11" square, 1/16" thick, 19" focal length, effective speed of f/1.9.

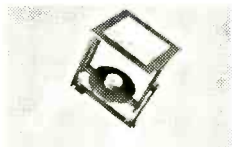

Stock No. 70,533AV \$6.00 Ppd.

3-CHANNEL COLOR ORGAN KIT



Easy to build low-cost kit needs no technical knowledge. Completed unit has 3 bands of audio frequencies to modulate 3 independent strings of colored lamps (i.e. "lows"-reds, "middles"-greens, "highs"-blues. Just connect hi-fi, radio, power lamp etc. & plug ea. lamp string into own channel (max. 300w ea.). Kit features 3 neon indicators, color intensity controls, controlled individ SCR circuits; isolation transformer; custom plastic housing; instr.

Stock No. 41,831AV \$18.95 Ppd

WAR SURPLUS ELECTRIC GENERATOR



Brand new Signal Corps Model. Up to 90 volts by turning crank. Use in high impedance relays. Charge ground & bring up night crawlers for bait or study. 2 Alnico Magnets alone now worth more than original \$15 gov't cost.

No. 50,225 AV (2 lbs.) \$8.50 Ppd.

KNOW YOUR ALPHA FROM THETA!



For greater relaxation, concentration, listen to your Alpha-Theta brainwaves. Ultra-sensitive electrode headband slips on/off in seconds—eliminates need for messy creams, etc. Atch'd to amplifier, filters brainwaves, signals beep for ea. Alpha or Theta wave passed. Monitoring button stimulates Alpha sound; audio & visual (L. E. D.) feedback. Reliable, easy-to-use unit comparable to costlier models. Completely safe. Comprehensive instruction booklet.

No. 1635AV (8x3x4; 24. oz.) \$134.50 Ppd.
 LOW COST "STARTER" UNIT
 No. 71809AV \$55.00 Ppd.
 DELUXE "ON" TIME MONITOR—Measures and records %
 No. 1652AV (15x10x6") \$349.50 Ppd.

WHICH ARE YOUR CRITICAL DAYS?



Can Bio-rhythm tell you? We're not sure, but we're told that vast mood shifts are caused by your body's Internal Time Clock whose rhythms can be charted ahead to possibly warn you of "critical" days. Some are great, some blah. Maybe it's your physical, emotional & intellectual rhythms converging at the right or wrong time. Compute your cycles with our Bio-rhythm kit and judge for yourself. Incl. Charting kit, metal Dialgraf Calc., instrs.

Stock No. 71,949AV \$11.50 Ppd.
 1 YR. PERSONALIZED REPORT BY COMPUTER
 Stock No. 19,200AV... (send Birthdate) \$15.95 Ppd.

3" ASTRONOMICAL REFLECTING TELESCOPE



See stars, moon, planets close-up! 30 to 90X. Famous Mt. Palomar Type. Aluminized & overcoated 3" diameter f/10 primary mirror, ventilated cell. Fork type equatorial mount. Durable PVC tube. Includes 1" F.L. 30X Ramsden, Barlow lens to triple power, 3X finder

telescopes, hardwood tripod. FREE: "STAR CHART"; "HOW TO USE" book.
 Stock No. 85,240 AV \$49.95 Ppd.
 DELUXE 3" REFLECTOR TELESCOPE #80,162AV \$79.95 Ppd.
 4 1/4" REFLECTOR (45X to 135X) #85,105AV \$149.50 FOB
 4 1/4" REFLECTOR W/CLOCK DRIVE #85,107AV \$189.50 FOB
 6" REFLECTOR (48X to 360X) #85,187AV \$249.50 FOB
 6" REFLECTOR W/CLOCK DRIVE #85,086AV \$285.00 FOB



MAIL COUPON FOR GIANT FREE CATALOG!

180 PAGES • MORE THAN 4500 UNUSUAL BARGAINS

Completely new 1975 edition. New items, categories, illustrations. Dozens of electrical and electromagnet parts, accessories. Enormous selection of Astronomical Telescopes. Unique lighting and ecological items. Microscopes, Binoculars, Magnifiers, Magnets, Lenses, Prisms. Hard-to-get-surplus bargains. Ingenious scientific tools. 1000's of components.

EDMUND SCIENTIFIC CO.
 300 Edscorp Building, Barrington, N. J. 08007
 Please rush Free Giant Catalog "AV"

Name _____
 Address _____
 City _____ State _____ Zip _____



COMPLETE & MAIL WITH CHECK OR M.O.

EDMUND SCIENTIFIC CO. 300 Edscorp Building, Barrington, N.J. 08007

How Many	Stock No	Description	Price Each	Total

Add Handling Chg.: \$1.00, Orders Under \$5.00, 50¢, Orders Over \$5.00

I enclose check money order for \$ _____ TOTAL \$ _____

NAME _____

ADDRESS _____

CITY _____ STATE _____ ZIP _____



99.9% Pure!

New Radio Shack/Realistic AM/FM Receiver



319⁹⁵

including 29.95-value walnut veneer case

FREE New 1975 Radio Shack Catalog

OVER 2000 PRODUCTS
EXCLUSIVES ON EVERY PAGE
BEAUTIFUL FULL COLOR

Stereo • Quadraphonic • Phonographs
TV Antennas • Radios • Citizens Band
Kits • Amateur Radio • Tools
Auto Tune-Up • Batteries • Wire
Test Instruments • More!

164 pages of the finest in home and hobby electronics. Respected names like Realistic, Micronta, Archer, Science Fair — and they're available only at Radio Shack stores and dealers nationwide! See what's really new in electronics by sending for this exciting catalog.

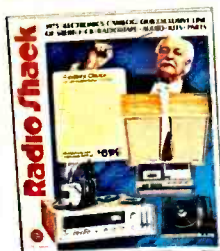

**SEND FOR YOURS TODAY!
FILL OUT COUPON BELOW**

1975 Catalog Mail to Radio Shack, P. O. Box 1052, 489 Ft. Worth, Texas 76101. (Please print.)

Name _____ Apt. No. _____

Street _____

City _____

State _____ ZIP _____

The Realistic® STA-250 delivers 44 watts RMS per channel at 8 ohms (202 watts IHF ± 1 dB total). Its THD at half power (1 kHz) is actually less than 0.1%. Obviously the STA-250 keeps music pure even at "live performance" volume. With triple-ganged tuning, two FET's in the front end and two IC's, the FM is exceptional too. Muting eliminates tuning noise and a center-channel meter assures lowest distortion. Even the AM is triple-ganged and has a signal strength meter. Other features include high and low filters, inputs for two changers and a mag/ceramic switch. When you're ready, exclusive Quatravox® lets you add a second speaker pair for synthesized 4-channel. U.L. listed. #31-2052. A great value, that's for pure. There's only one place you can find it . . . Radio Shack.

Complete Realistic STA-250 System

save 79⁸⁵

regular 579.80

499⁹⁵

- Realistic STA-250 Receiver
- Two Optimus-1B Speaker Systems
- LAB-36A Changer, Base, \$22.95-Value Elliptical Cartridge



Mastercharge or Bank Americard at participating stores

Radio Shack®

A TANDY CORPORATION COMPANY

OVER 3000 STORES • 50 STATES • 8 COUNTRIES

Retail prices may vary at individual stores.

CIRCLE NO. 32 ON READER SERVICE CARD

Belt, rim, or direct drive?

Some reasonably unbiased comments from the people who make all three.

Manufacturers of turntables with just one type of drive system — belt, rim, or direct-drive — naturally favor their own. Dual, however, makes all three, and we fully agree with Julian Hirsch who said: "It would make little difference if the platter were powered by well-disciplined hamsters on a treadmill. It is the end result that counts."

The belt-drive system.

The main benefit of the belt-drive system is its effectiveness in filtering out motor vibration. It is a simple system that can be used with light duty motors and platters, and lends itself to low-cost manufacture.

The belt-driven Dual 601 is not compromised. It employs a high-torque 8-pole synchronous motor which drives a 4.5 pound dynamically-balanced platter, taking full advantage of a heavy platter's flywheel effect to filter out speed variations.

Thus, music lovers who prefer belt-drive single-play design can now enjoy the precision and performance of a Dual.

The rim-drive system.

In the rim-drive system, the platter is driven by an idler wheel which disengages when not in play. Since each part must be machined and carefully quality-controlled for perfect concentricity, this system is not inexpensive to make. When correctly made, it will perform not only precisely, but reliably and durably.

More audio experts — hifi editors, record reviewers, engineers and music/equipment magazine readers — own and continue to purchase Duals (with this system) than any other make of quality turntable.

The direct-drive system.

In direct-drive systems, the motor rotates at record speed and drives the platter directly, without need for intermediate coupling. The result is a somewhat quieter and smoother platter rotation than is achieved with any



The belt-drive Dual 601. Fully automatic, single play. \$270, including base and dust cover.



The rim-drive Dual 1229Q. Fully automatic plus multi-play. \$259.95, less base and dust cover.



The electronic direct-drive Dual 701. Fully automatic, single play. \$400, including base and dust cover.

other system. But direct drive motors require a much more expensive technology.

The most advanced of all direct-drive systems is in the Dual 701. Among the exclusive features of its electronic motor: two sets of overlapping field coils that provide a totally gapless magnetic field that eliminates the successive pulses common to all other motor designs. Result: almost total elimination of wow and flutter.

How drive system performances compare.

As measured by the highly conservative European standard (DIN), the performances of the rim-drive 1229Q and the belt-drive 601 are identical: weighted rumble: -63dB; wow and flutter less than 0.06%. The direct-drive 701 does even better: weighted rumble, -70dB; wow and flutter, less than 0.03%.

Although the 701 specifications are more impressive than those of the 1229Q and 601, you are not likely to detect any difference unless your other components also meet the highest possible performance standards and you are an exceptionally critical listener.

So much for drive systems.

We now suggest you forget about differences among drive systems and simply decide which turntable best suits your requirements for total performance and convenience.

With a reasonable amount of bias, we also suggest your decision can be made quite happily from among the three types of Duals now available: Our automatic models with provision for multi-play, priced from \$129.95 to \$259.95. The belt-drive 601 at \$270. Or the direct-drive 701 at \$400.

Dual® **United Audio Products**
120 So. Columbus Ave.,
Mt. Vernon, N.Y. 10553
Exclusive U.S. Distribution Agency for Dual

CIRCLE NO. 4 ON READER SERVICE CARD