

BUYING GUIDE TO MOBILE CB TRANSCEIVERS

Popular Electronics

WORLD'S LARGEST-SELLING ELECTRONICS MAGAZINE SEPTEMBER 1974/60¢

Low-Cost Voice Scrambler *For Secret Communications*

Anatomy of a Stereo Phono Cartridge

Single-Sideband Primer *For Hams and CB'ers*

Check CMOS & TTL with Digiviewer II

Test Reports

Pioneer QX-747 4-Channel Receiver
Wollensak 8075 Cartridge Tape Deck

Johnson Messenger 250 CB Transceiver
Robyn Porta-Scan 1000 VHF Monitor
Triplett Model 615 Maintenance Tester

Build the "Ampzilla" Stereo Power Amp!

**400 WATTS AT
8 OHMS, 0.05% DISTORTION,
1 TO 100 kHz \pm 1 dB**



Fidelity.



The Allman Brothers' Band is available exclusively on Capricorn records and tapes.

Pioneer High



The Allman Brothers Band has a great new sound...



More than anything else, the Allman Brothers Band are musicians. Accomplished, sophisticated musicians whose blues-rooted improvisations have carried them to the top of their field.

Musicians, not rock stars. Their success doesn't depend on sequins or serpents, or make-up, or put-on showmanship. Instead, they innovate. And they stake their fame on their music.

As musicians, the Allman Brothers Band prefer the sound of Pioneer speakers. They prefer Pioneer speakers because of their clarity and overall sound quality. They prefer Pioneer speakers because they reproduce the sound of an original performance without adding coloration, hyped-up bass or artificial brilliance. They prefer Pioneer speakers because exactly what goes in is exactly what comes out.

With Pioneer speakers, the Allman Brothers sound right to the Allman Brothers. It's that simple.

Pioneer makes a variety of speakers to match any hi-fi system. Speakers that are consistent in their clarity, sound quality and ability to exactly reproduce the sound of an original performance. Speakers that vary because people vary, hi-fi systems vary, room acoustics vary, budgets vary and tastes vary.

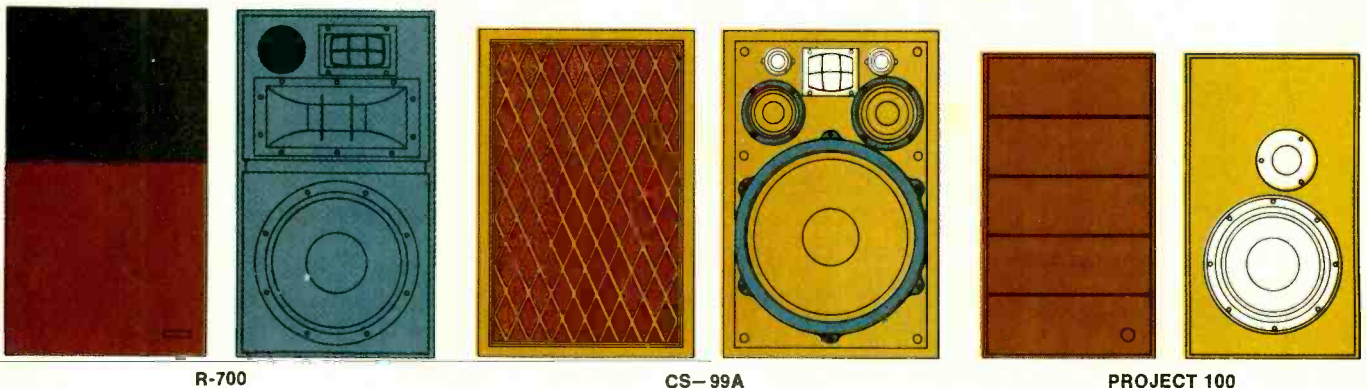

Series R

Series R speakers are designed for the individual who demands the finest in styling, design and sound. Styling and design as contemporary as the state of the art. And sound as contemporary as a live performance.

Series R speakers bring new life to live performances. And truly live performances to your listening room. Their high efficiency, extreme accuracy and zero coloration have been equally praised by artists, engineers, critics and musicians.

All of the Series R speakers — R700, R500 and R300 — deliver the true vibrancy of a live performance. In an untouched, uncolored and unusually natural way.

Project Series

Project Series speakers are designed to deliver maximum performance per dollar in a contemporary bookshelf design. Smallest of the three, the Project 60 is an extremely efficient speaker system that delivers a surprisingly high sound level from moderately powered receivers and amplifiers. It is perfect for smaller hi-fi systems. And equally well suited for 4-channel systems — since many of the new 4-channel receivers and amplifiers have less power per channel than their stereo counterparts.

Project 80 and 100 speaker systems use their air suspension design to deliver a beautiful natural

sound. Their superb bass response can effortlessly reproduce the lowest of lows with minimal distortion and uncanny accuracy. Their dome tweeters provide exceptionally wide dispersion and highs of unsurpassed clarity.

CS Series

There is a myth about speakers that handsome cabinets hide inferior sound. Fortunately, it need not be the case.

If you seriously demand the acoustic quality of custom cabinetry along with powerfully smooth sound, the CS series speakers will be your first choice. Their sound is precise and natural. And their craftsmanship is a reflection of an almost bygone era.

The air suspension design of the CS series speakers help to provide the quality of sound that is the hallmark of Pioneer engineering excellence. From the compact 2-way 2-speaker CS-44 to the 4-way 6-speaker CS-63DX, Pioneer CS series speakers offer a combination of superb sound reproduction and custom-crafted cabinetry.

There are 12 different speakers in the Pioneer line. There are six different musicians in the Allman Brothers Band. Different people have different needs and different tastes. Even the Allman Brothers. But they agree that Pioneer speakers deliver the best sound available.

Pioneer speakers are part of a complete line of Pioneer audio components — components preferred by the Allman Brothers Band. A fact you might consider when you make your own selection.

U. S. Pioneer Electronics Corp.
75 Oxford Drive, Moonachie,
New Jersey 07074.
West: 13300 S. Estrella, Los Angeles,
Cal. 90248 / Midwest: 1500
Greenleaf, Elk Grove Village, Ill.
60007 / Canada: S. H. Parker Co.

Model	Type	Maximum Input Power	Size (HxWxD)	Price
R-700	12" 3-way	75 watts	26"x15"x14"	\$249.95*
R-500B	10" 3-way	60 watts	24"x14"x12"	169.95*
R-300	10" 2-way	40 watts	23"x13"x11"	119.95*
PROJ. 100	10" 2-way	35 watts	23"x13"x10½"	129.95
PROJ. 80	10" 2-way	30 watts	20¾"x11¾"x11"	99.95
PROJ. 60	8" 2-way	20 watts	18½"x10½"x8½"	79.95
CS-63DX	15" 4-way	80 watts	28"x19"x13"	279.95
CS-99A	15" 5-way	100 watts	25"x16"x11"	239.95
CS-A700	12" 3-way	60 watts	26"x15"x12"	199.95
CS-A500	10" 3-way	50 watts	22"x13"x12"	149.95
CS-66G	10" 3-way	40 watts	22"x12"x12"	119.95
CS-44G	8" 2-way	25 watts	19"x11"x9"	79.95

*Fair Trade resale price where applicable.

Our New Digital IC color generator deserves a hand...

MODEL
1230



YOURS!

The time you waste running back to the truck to pick up your bulky color convergence generator costs you money. B & K's solution to the problem is the model 1230 Digital IC Color Generator—a solution you can hold on the palm of your hand.

How much performance can you expect from a package just 1 $\frac{3}{4}$ " high, 5" wide and 7 $\frac{3}{4}$ " deep that snuggles nicely into the place of a few tubes in your caddy? Plenty—like a broadcast-stable 10,000 μ V signal with four rock-steady patterns so jitter-free that you can expand and examine the quality of the color subcarrier with an oscilloscope. And that's unique.

Why is it so stable? Because all video, sync, blanking and color signals are derived from a crystal-controlled 4.751748MHz master oscillator. Because of the progressive scan system, which presents the same signal on each field. Because all counting functions and signal processing are performed by accurate, reliable digital integrated circuits. And because the ripple-free regulated power supply maintains generator stability even under abnormal line conditions. No expensive batteries to replace, either.

Plenty of good reasons to get your hands on one today. In stock at your distributor or write DYNASCAN.

MODEL 1230 \$96.00

B&K PRODUCTS OF
DYNASCAN
1801 W. Belle Plaine Ave.
Chicago, IL 60613 • (312) 327-7270

CIRCLE NO. 7 ON READERS SERVICE CARD

Popular Electronics

WORLD'S LARGEST-SELLING ELECTRONICS MAGAZINE

FEATURE ARTICLES

A PRIMER ON SINGLE SIDEBAND	James E. Trulove	41
<i>How an SSB signal is generated, transmitted and received</i>		
BUYING GUIDE TO MOBILE CB RADIOS		51
<i>What to look for in AM, SSB, and AM/SSB models</i>		
DIRECTORY OF MOBILE CB RADIOS		52
<i>Complete listings with specifications</i>		
SECURITY THROUGH ELECTRONICS	Clay Tatom	56
<i>The art and techniques of security in communications</i>		
ANATOMY OF A STEREO PHONO CARTRIDGE	Julian Hirsch	62
<i>Construction of modern cartridges and how they work</i>		
ENGLISH-LANGUAGE SHORTWAVE BROADCASTS	Roger Legge	98
<i>Frequencies and times for September and October</i>		

CONSTRUCTION STORIES

GET 400 WATTS OF CLEAN STEREO POWER WITH AMPZILLA	James Bongiorno	33
<i>A super-power, high-fidelity stereo amplifier</i>		
ENJOY PRIVATE MESSAGES WITH A VOICE SCRAMBLER	Joseph B. Wicklund, Jr.	56
<i>Low-cost IC circuit makes messages unintelligible</i>		
BUILD DIGIVIEWER II	Don Lancaster	63
<i>Simultaneously checks up to 16 pins of any digital IC</i>		

COLUMNS

STEREO SCENE	Ralph Hodges	22
<i>Some unfinished "noise" business</i>		
SOLID STATE	Lou Garner	81
<i>Rewarding projects with medium-power transistors</i>		
TEST EQUIPMENT SCENE	Leslie Solomon	90
<i>Uses for the VTVM or VOM</i>		
ART'S TV SHOP	Art Margolis	92
<i>Checking tube nationality</i>		
HOBBY SCENE	Editorial Staff	93
DX LISTENING	Glenn Hauser	100
<i>TV and FM DX'ing</i>		
CB SCENE	Len Buckwalter	102
<i>How to boost club attendance</i>		

PRODUCT TEST REPORTS

PIONEER MODEL QX-747 4-CHANNEL RECEIVER	70
WOLLENSAK MODEL 8074 8-TRACK CARTRIDGE DECK	72
E. F. JOHNSON MESSENGER 250 CB BASE STATION	73
ROBYN PORTA-SCAN 1000 MONITOR RECEIVER	78
TRIPLETT MODEL 615-K MAINTENANCE TESTER KIT	80

DEPARTMENTS

EDITORIAL	Art Salsberg	4
<i>Electronics Show Biz</i>		
LETTERS		6
NEW PRODUCTS		12
NEW LITERATURE		16
NEWS HIGHLIGHTS		27

POPULAR ELECTRONICS, September 1974, Volume 6, Number 3. Published monthly at One Park Avenue, New York, NY 10016. One year subscription rate for U.S., U.S. Possessions and Canada, \$6.98; all other countries, \$8.98. Second class postage paid at New York, NY and at additional mailing offices. Authorized as second class mail by the Post Office Department, Ottawa, Canada and for payment of postage in cash. Subscription service and Forms 3579: P.O. Box 2774, Boulder, CO 80302. POPULAR ELECTRONICS including ELECTRONICS WORLD, Trade Mark Registered. Indexed in the Reader's Guide to Periodical Literature. Copyright © 1974 by ZIFF-DAVIS PUBLISHING COMPANY. All rights reserved.

Ziff-Davis also publishes Boating, Car and Driver, Cycle, Flying, Modern Bride, Popular Photography, Skiing, and Stereo Review.

Forms 3579 and all subscription correspondence should be addressed to POPULAR ELECTRONICS, Circulation Dept., P. O. Box 2774, Boulder, CO 80302. Please allow at least eight weeks for change of address. Include your old address, as well as new—enclosing, if possible, an address label from a recent issue.

Editorial contributions must be accompanied by return postage and will be handled with reasonable care; however, publisher assumes no responsibility for return or safety of art work, photographs, models, or manuscripts.

EDGAR W. HOPPER
Publisher

ARTHUR P. SALSBERG
Editorial Director

LESLIE SOLOMON
Technical Editor

JOHN R. RIGGS
Managing Editor

EDWARD I. BUXBAUM
Art Director

ALEXANDER W. BURAWA
Associate Editor

ANDRE DUZANT
Technical Illustrator

ELLEN S. FINKELSTEIN
Editorial Assistant

LEN BUCKWALTER
LOU GARNER
JULIAN D. HIRSCH
RALPH HODGES
WALTER G. JUNG
MILTON S. SNITZER
Contributing Editors

JOSEPH E. HALLORAN
Advertising Director

JOHN J. CORTON
Advertising Sales

MADELEINE LITTMAN
Advertising Service Manager

PEGI McENEANEY
Executive Assistant

STANLEY NEUFELD
Associate Publisher

FURMAN H. HEBB
Group VP, Electronics & Photo

ZIFF-DAVIS PUBLISHING COMPANY
Popular Electronics
Editorial and Executive Offices
One Park Avenue New York, New York 10016
212-725-3500

William Ziff, President
W. Bradford Briggs, Executive Vice President
Hershel B. Sarbin, Senior Vice President,
Secretary, and Treasurer
Philip Sine, Senior Vice President
Phillip T. Heffernan, Vice President, Marketing
Frank Pomerantz, Vice President, Creative Services
Arthur W. Butzow, Vice President, Production
Edward D. Muhlfeld, Vice President, Aviation
and Automotive Divisions
George Morrissey, Vice President
Sydney H. Rogers, Vice President
Sidney Holtz, Vice President
Lawrence Sporn, Vice President, Circulation

Midwestern Office
The Pattis Group, 4761 West Touhy Ave.,
Lincolnwood, Illinois 60644, 312 679-1100
GERALD E. WOLFE, GEORGE B. MANNION
DAVID ALLEN

Western Office
9025 Wilshire Boulevard,
Beverly Hills, California 90211
213 273-8050; BRadshaw 2-1161
Western Advertising Manager, BUD DEAN

Japan: James Yagi
Oji Palace Aoyama: 6-25, Minami Aoyama
6 Chome, Minato-Ku, Tokyo 407-1930/6821



Editorial

ELECTRONICS SHOW BIZ

Many of our readers probably don't realize that editors spend a considerable amount of time at shows—conventions, exhibitions, technical paper presentations, press meetings, and the like. Primary reasons for these efforts are to learn about new product developments before they reach the consumer level, to select new equipment for testing, and to meet and develop new authors.

Our most recent major trip was to the 1974 Summer Consumer Electronics Show, held in Chicago. We saw portents of what will likely be found on dealers' shelves in the near future. For example, it was apparent that the single-play turntable has made a Phoenix-like return, with a host of manufacturers adding these items to their hi-fi product lines. In the TV receiver area, there are indications that other manufacturers will follow the Heath Company's lead in TV sets that feature digital electronic tuning. (Perhaps the clunk-clunk of traditional TV tuning will eventually go the way of vacuum-tube circuitry.) In the Public Safety "police/fire" scanner field, a new unit was demonstrated that utilizes digital pushbuttons (0 and 1) to set channel frequencies instead of relying on crystals. We expect to be testing it and reporting the results.

While "breaking bread" during the NEW/COM show, held on the West Coast in May, the manuscript of "Ampzilla," featured in this issue, was finalized. And between CES and NEW/Com, an exciting article was generated as a result of a speech made by Walter Jung, one of our contributing editors, at an evening Audio Engineering Society meeting.

There are many shows to be explored throughout the year, of course. For example, WESCON, an engineering-oriented show, will be held September 10-13 at the Los Angeles Convention Center, while the Institute of High Fidelity will sponsor a hi-fi show for consumers Oct. 3-6, in New York City. Interestingly, the WESCON show will feature a session devoted to "Psychotronics," from bio-energy to Kirlian photography.

Nonetheless, the most *important* source we have for articles is our readers—almost 400,000 strong! If you'd like to be "published," and you have what you believe is an interesting topic or construction project that might appeal to other readers, why not send in a brief outline? We'll guide you from there. Aside from soothing the ego, there are other rewards that accompany accepted manuscripts: article payment and the possibility of a manufacturer buying your circuit concept and paying royalties. So let's hear your ideas soon! They're welcome here.



The publisher has no knowledge of any proprietary rights which will be violated by the making or using of any items disclosed in this issue.

Art Salsberg

Radio Shack/Realistic 82 watt Receiver Sale!



Reg. 249⁹⁵

Sale 159⁹⁵

SAVE \$90 on the magnificent STA-80 during this sale. Hurry—it's one of our best Realistic® sellers.

It'll make the heart of a great stereo system—a tape monitor lets you record like a "pro" and a switch lets you select main and/or remote speakers. For great sound we gave the STA-80 wideband AM, FET/IC FM, a hi-filter, FM muting, signal strength and center-channel meters, exclusive Loudness® for natural bass even at low volume and unique Glide-Path™ volume/balance controls. For beauty we gave it a blackout dial, a lighted dial pointer that doubles as a stereo beacon and a 29.95-value walnut veneer case. There's only one place you can find it... Radio Shack! #31-2046.

Complete Realistic STA-80 System

save 119⁹⁵
regular 469.90
349⁹⁵

- Realistic STA-80 Receiver
- Two Solo-3B Speaker Systems
- LAB-36A Changer, Base, \$22.95-Value Elliptical Cartridge



Master Charge or Bank Americard at participating stores.

Radio Shack®

A TANDY CORPORATION COMPANY

OVER 3000 STORES • 50 STATES • 8 COUNTRIES

Retail prices may vary at individual stores.

FREE New 1975 Radio Shack Catalog

OVER 2000 PRODUCTS
EXCLUSIVES ON EVERY PAGE
BEAUTIFUL FULL COLOR

Stereo • Quadraphonic • Phonographs
TV Antennas • Radios • Citizens Band
Kits • Recorders • Tape • Tools
Auto Tune-Up • Electronic Parts
Test Instruments • More!



164 pages of the finest in home and hobby electronics. Respected names like Realistic, Micronta, Archer, Science Fair — and they're available only at Radio Shack stores and dealers nationwide! See what's really new in electronics.

SEND FOR YOURS TODAY!
FILL OUT COUPON BELOW

1975 Catalog Mail to Radio Shack, P. O. Box 1052, 427
Ft. Worth, Texas 76101. (Please print.)

Name _____ Apt. No. _____

Street _____

City _____

State _____ ZIP _____

CIRCLE NO. 28 ON READERS SERVICE CARD



Letters

POLYPHONIC SYNTHESIS ELECTRONIC MUSIC

With all due respect to Mr. Lancaster, I feel that he has overlooked some major problems in a polyphonic synthesis system. It is not the capacity of playing chords that makes an instrument interesting. It is the capability of expression, the tonal colors and inflections it is able to produce. For this reason, orchestras are made up of mostly monophonic instruments, not collections of organs, pianos, and guitars. It is true that violins can play simple chords, but these are rarely used.

When a synthesizer is used in a studio, the result is the same as with an orchestra. As each "track" is laid down on tape, the synthesist is able to devote his attention to that section without having to split his concentration with other segments. Most synthesizer "voicings" would be lost as a chord. The subtle inflections that distin-

guish a single voice would lose their identity when spaced closely together.

A polyphonic keyboard would be another form of control for a synthesizer, but at this time it would introduce more problems than it would solve. Aside from making sloppy playing possible, one would either wind up with just another big organ that makes weird noises or lost in a maze of 88 separate trigger pulses.

Polyphonic synthesizers have been built in the past and there are current experiments with computer systems, but at this time they still have the problems of complexity on a near infinite scale. And, short of having a few mega-bucks to play with, these systems are not available. A practical polyphonic synthesizer is still a long way off.

RICHARD BUGG
Composer in Residence
PAIA Electronics
Oklahoma City, Okla.

FET VU METER IMPROVEMENT

I built the FET VU meter according to the schematic in the June issue. When I tried it on a meterless cassette recorder and a low-wattage amplifier, I found that the outputs of these units, with their inherent low impedances, simply could not drive the meter to the 0-dB mark even when the volume was turned to maximum.

To rectify this, I added a small imped-

ance-matching transformer (Lafayette 33E85465, 3.2:20,000 ohms) and a dpdt switch for a rough matching of impedances of the meter and the unit to be connected to it. When switched to high impedance, the transformer is bypassed; when switched to low impedance, the transformer is inserted.

JAMES C. H. WANG
Newark, Del.

SHORTWAVE BROADCAST SCHEDULES

I am pleased to see that you have returned to publishing schedules of shortwave broadcasts directed to North America in English. I hope that you will continue to publish these schedules four times a year when major frequency revisions are made. May I suggest that you include Voice of America transmissions from stateside in English.

ARNOLD M. DUKE
Ottawa, Ont.

In response to letters from our readers, we do plan to continue to publish these schedules on a regular basis. Other articles are planned on shortwave listening as well. Voice of America listings are included this month.

LOGIC PROBE MEMORY

With reference to your May Letters col-

Affordable, portable function generator. \$149⁹⁵

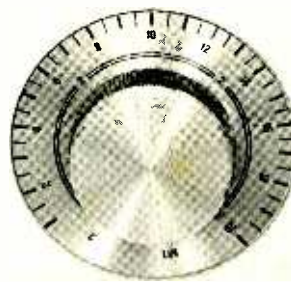

WAVETEK

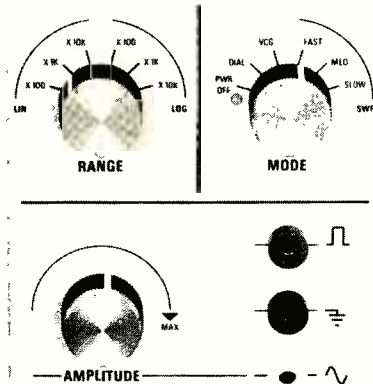

We've built ultra-sophisticated function generators that sell for nearly two thousand dollars. But the Model 30 may be our greatest achievement. An under-\$150 function generator that can do all this: 2Hz to 200 KHz frequency range; sine, square, triangle outputs; linear and logarithmic sweep. Because it's battery operated, the Model 30 can be used anywhere, with complete line isolation. (A rechargeable power supply kit is available for line operation.) Because it's only \$149.95, everyone can afford to buy one. How can you function without it?

WAVETEK®
P.O. Box 651, San Diego, Calif. 92112:
TWX 910-335-2007. Tel. (714) 279-2200

umn and the item from Keith Wentzel about adding memory to a previously described logic probe, I think Keith meant to show a normally open reset switch, because with a normally closed switch, Clear (pin 13) would be grounded and the flip-flop would be unable to change state to operate the "Mem" LED. Also the strap from Q to K is not necessary as this is done internally.

Even with this arrangement, I believe the next pulse detected would then extinguish the "Mem" LED. Therefore, I would propose the following minor change to complete the trap. Simply ground terminal K of IC2. With this arrangement the flip-flop would operate the "Mem" LED and hold.

TED GRONSKI
Springfield, Mass.

LOTS OF WORK BUT STILL THE SAME SPEED?

I thought I had it made. "How To Break the 10-Words-Per-Minute Code Barrier" sounded like an article that might help me learn how to pass the test for my General class amateur license. So, I read and read.

I found that if I could speed up, I should do it on a typewriter. But nowhere in the article did I find out how to go about increasing my code speed. Then I reached the end of the article, which promised to tell me how a former Navy Chief Radio Electrician was able to break the barrier. The Chief stated that he was stuck at

nine-a-minute and that he copied "until (his) eyes fell out," including Russian and Spanish code. The result? "Later, aboard ship, they tested me on taped copy, and I made nine words-a-minute," in the Chief's own words.

So much for the Chief. And so much for the article. I still don't know how to break the 10 words-per-minute code barrier.

Leonard Rutstein, WN2UPH
New York, N.Y.

Through an unfortunate oversight, a typographical error appeared in the article. The aboard-ship test should have read a 90 wpm proficiency — not 9 wpm. The Chief claims that even today he can copy 50 to 60 wpm.

NOISE FILTER FOR RECORDS

I enjoyed Ralph Hodges' "Noise on Records" in your March issue. I saw an ad recently for a device that might be useful as a tick eliminator. It's a device manufactured by Non Linear Filters, Box 338, Trumbull, Conn. 06611 that is described as a "voltage-controlled low-pass nonlinear spike-rejecting filter with recovery rapid enough to introduce no phase lag into signal passing through it." You might want to look into such a device.

DANA CRAIG
Norwood, Mass.

MURRAY G. CROSBY

Multiplex FM Stereo Pioneer

Murray G. Crosby, developer of a compatible system of broadcasting multiplex FM stereo and holder of more than 200 patents, died at the age of 70 this past June.

A creative technical giant in the manner of Major Edwin Armstrong, developer of FM, Murray Crosby's proposed stereo FM system was widely expected to be chosen by the FCC for our national system. Instead, the hi-fi industry was crestfallen when the GE-Zenith system, which exhibited a deteriorated signal-to-noise ratio on the second channel, was adopted. His company, Crosby Laboratories, specialized in manufacturing single-sideband receivers. In later years, he engaged in consulting work and devoted considerable time to innovative developments, such as a sub-audible coding system for verification of broadcast commercials.

A little Traveling Music, Please

Daily frustrations make a person want to get away from it all. And, the UTAH MP-3000 Speaker will take you there better, faster than any comparable unit. With the MP-3000, you know you are in Tahiti, Paris or even Nashville. Your day becomes more pleasant, too, as the MP-3000 conquers the sound barriers.

MP-3000 combines the rare attributes of sound and styling. Clean, undistorted sound comes from this 4-speaker, 3-way speaker system. The oiled and hand-rubbed walnut veneer cabinets, and unique grille of sculptured foam are both acoustically and geometrically beautiful. The system contains a 15" high compliance woofer with a 2" voice coil, as well as two horn-loaded-dome-tweeters. It's a distinguished combination of well-defined, distortion-free sound reproduction. Size: 27" x 20½" x 14" deep, excluding base. Shipping weight: 70#.

Come travel with us. Get complete information about the exciting MP-3000 Speaker System.



UTAH ELECTRONICS
Huntington, Ind. 46750



Compare what you get training and you'll

Compare costs

Only NRI offers complete TV/Audio Servicing Courses from \$312 to \$955 . . . with terms as low as \$10 down and \$22 monthly. In the Master Course in color TV servicing, with a 25" diagonal solid state color TV, you save \$800 or more over other comparable courses. And NRI provides you with a handsome TV cabinet and other equipment at no extra charge.

NRI saves you money because our costs are lower. We pay no salesmen, and we design our own kits and equipment. We don't buy "hobby kits" from others. Nor do we penalize you with big interest charges for time payments. We pass the savings on to you.

Compare training

NRI is one of the few home study schools that maintains its own full-time staff of technical writers, editors, illustrators, development engineers and publications experts. The people who design the kits also design the lessons . . . so that theory and practice go hand in hand. The lessons aren't "retro-fitted" to an outside-source "hobby kit". The NRI set is designed exclusively for training. The fact that it is also a superb receiver for your personal use is an added plus.

Compare choices

Most schools offer one course in color TV servicing, period. Only NRI offers you five different courses to match your needs and budget. The 65-lesson basic course, complete with 7 kits, costs as little as \$312. Or you can step up to a \$425 course that includes a 12" diagonal black & white portable TV for hands-on experience. Then there's the 19" diagonal solid-state color TV course for \$695; the advanced color TV course for trained technicians with the same 19" TV for \$535; and finally, the magnificent 25" diagonal solid-state color TV course, complete with console cabinet, oscilloscope, TV pattern generator, and digital multimeter, for \$995. Other schools charge you up to \$800 more for an equivalent course.



in TV/Audio home choose NRI.

Compare equipment Compare schools

NRI has engineered the widest variety of professional electronic lab equipment ever designed entirely for training at home. When you enroll in the master course in TV/Audio Servicing, for instance, you receive kits to build a wide band, solid-state, triggered sweep, service type 5" Oscilloscope; color pattern generator; solid-state radio; and a digital multimeter.

Before you settle on any home training course, compare the over-all program. See if you are getting kits engineered for experimentation and training . . . or merely "hobby kits". Count the experiments . . . compare the components. Don't just count kits. (Some schools even call a slide rule a kit.)

Home study isn't a sideline with NRI. We've been its innovating leader for 60 years. Ask any of the hundreds of thousands of NRI graduates. They'll tell you . . . you can pay more but you can't buy better training.

Along with each course, NRI provides bite-size, fully-illustrated lessons; personally graded tests; and the kind of person-to-person teaching that makes learning easier and faster.

Send for the free NRI full-color electronics catalog and discover why so many choose NRI. You'll find courses offered in TV/Audio Servicing, FCC License, Complete Communications Electronics, Digital Computer Electronics, Marine and Aircraft Electronics, Mobile Communications, etc.

MAIL
THIS CARD
FOR YOUR
FREE NRI
CATALOG



NO SALESMAN WILL CALL.

AVAILABLE UNDER GI BILL

Check the GI Bill Box on the card for information.



NRI SCHOOLS
McGraw-Hill Continuing Education Center
3939 Wisconsin Avenue,
Washington, D.C. 20016





New Products

Additional information on new products covered in this section is available from the manufacturers. Either circle the item's code number on the Reader Service Card inside the back cover or write to the manufacturer at the address given.

UTAH SPEAKER SYSTEM

Designed for big sound at a sensible price, the new AS-7 three-way speaker system is the top model in Utah's AS-Series of systems. The AS-7 features a 12-in. high-compliance woofer with aluminum voice coil; a midrange horn-loaded compression drive; and a 3½-in. sealed-chassis direct radiator tweeter. The plush brown tweed grille cloth blends with the walnut finish of the ported enclosure, which measures 14 x 23 x 10 in. deep. Price is \$89.95.

CIRCLE NO. 69 ON READER SERVICE CARD

TELEPHONICS FOUR-CHANNEL HEADPHONES

New four-channel headphones have been introduced by Telephonics, a division of Instrument Systems Corp. Designated Model TEL-101F, the headphones use the



Fixler Effect patents, under license, to create a discrete four-channel listening experience, according to the company. Each phone contains two high-velocity, wide-frequency-range dynamic drivers with a special sound-coupling system. An integral electrical network can be adjusted by the listener for both channel separation and "room size" to suit his own personal taste. An accessory, called the Quadramate, permits the phones to derive four-channel sound from regular two-channel stereo sources. Prices are \$75 for the phones and \$25 for the adapter.

CIRCLE NO. 70 ON READER SERVICE CARD

ANTENNA SPECIALISTS MOBILE CB ANTENNAS

The Antenna Specialists Co. has announced the development of a new series

of antenna systems for increased CB range. Called "Super Can II" and "Super Can III," the models have fold-down mounts which permit extra height when in operation. The overall height is 77 in., but the antennas are easily folded down for garage or other overhead obstruction clearance. A positive locking sleeve holds the antenna securely upright when in operation, yet unlocks in seconds for fold-down. List price is \$34.95.

CIRCLE NO. 71 ON READER SERVICE CARD

HARMAN/KARDON CD-4 DEMODULATOR

A new CD-4 demodulator adaptor designed for use with existing four-channel receivers which lack CD-4 circuitry has



been developed by Harman/Kardon. Called the "44+", it provides the impedance characteristics required by the special cartridges necessary for discrete disc playback, and feeds the high-level inputs on existing 4-channel receivers. The same circuitry and styling have been used as are employed in the company's multichannel receivers. Suggested retail price is \$119.95.

CIRCLE NO. 72 ON READER SERVICE CARD

RCA 3-INCH OSCILLOSCOPE

A new concept in oscilloscope design that encompasses not only a high-performance scope, but an entire servicing system including the company's popular transistor/diode tester, vectorscope functions and a "ringing" test function has been announced. The high gain and exceptional bandwidth (about 10 mV p-p/inch and useful up to 10 MHz) make the instrument suitable for general servicing and alignment work in TV troubleshooting, audio work, sweep alignment and for industrial applications. Price is \$229.

CIRCLE NO. 73 ON READER SERVICE CARD

PEARCE-SIMPSON MARINE RADIOTELEPHONE

The Catalina VHF is a 12-channel, 6-watt vhf/FM marine radiotelephone which is all

solid-state and mounts on table top, bulkhead or overhead. It runs from ship's power and has a quick-disconnect mounting cradle, antenna plug and power plug. Complete with 6 channels of crystals including weather, the unit is also unique in this respect. It is a completely self-contained rig. Put in some standard nickel-cadmium penlight batteries, pull out the telescope antenna, press the button and you're on the air. There is also a built-in battery charger along with a carrying strap.

CIRCLE NO. 74 ON READER SERVICE CARD

SONY 4-CHANNEL TAPE DECK

Superscope, Inc. has added the Model TC-388-4, a new modestly priced, 4-channel tape deck from Sony, to its line of tape recorders. The TC-388-4 is a 3-head, 2-speed open-reel unit that combines complete 4-channel/2-channel compatibility with a number of important features. Among them are built-in mike/line mixing, and center-mixing capability in both 2-channel and 4-channel modes. Twin pan pots are provided to allow variable mixing of the rear with the front channels. A total mechanism shut-off automatically returns the tape drive mechanism to the stop position at the end of the tape in any mode, thereby preventing unnecessary wear on both machine and tape. Price of the model is \$549.95.

CIRCLE NO. 75 ON READER SERVICE CARD

DOKORDER CASSETTE DECK

The MK-50 automatic stereo cassette deck with Dolby-B has been introduced by Dokorder. The unit's performance characteristics are due in large part to two features: a molybdenum record/play head with precision micro-gap delivering up to



18,000-Hz response for CrO₂ tapes, and a Dolby-B noise reduction system which achieves a signal-to-noise ratio of better than 60 dB. An electric-governor dc motor maintains an even drive speed; and wow and flutter are said to be reduced to less than 0.10% rms. The new unit is priced at \$249.95.

CIRCLE NO. 76 ON READER SERVICE CARD

FISHER STUDIO STANDARD RECEIVERS

Fisher Radio has announced the introduction of two new Studio Standard Series receivers: the "X" series, consisting of the

new breadboard test equipment

...with power for the professional... with economy for the hobbyist!

Fresh, from the laboratories of Continental Specialties, whose QT Sockets and Proto-Boards have taken the electronics market by storm... here are exciting NEW ideas to make your circuit design and testing faster, safer, easier and less expensive!

NOW...PROTO POWER!

NEW PROTO BOARD-203

New Proto Board 203 with built-in regulated short-proof 5V, 1AMP power supply. Ready-to-use. Just plug-in and start building!
 2 extra floating 5-way binding posts for external signals. Completely self-contained with power switch indicator lamp and power fuse. 24-14 pin DIP capacity. All metal construction... no chipping or cracking like plastic cases. Two-tone gold/black quality case makes PB203 aesthetically, as well as technically, pleasing.

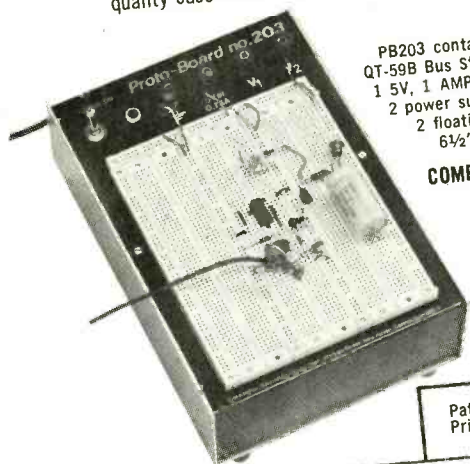

PB203 contains: 3 QT-59S Sockets; 4 QT-59B Bus Strips; 1 QT-47B Bus Strip; 1 5V, 1 AMP regulated power supply; 2 power supply 5-way binding posts; 2 floating binding posts; 9 3/4" L x 6 1/2" W x 2 3/4" H. Weight: 5 lbs.

COMPLETE
\$75
 ORDER TODAY!

Patents Pending • Made in U.S.A.
 Prices subject to change

Build and test circuits as fast as you can think without soldering or patch cords with NEW

Proto Board

Breadboard Assemblies

Here are four versatile new Continental Specialties' Proto Boards, made from convenient combinations of QT Sockets and Bus Strips, that let you make all circuit and power interconnections with common solid #22 wire, while power distribution busses make wiring a snap. Aluminum base plates offer solid work surfaces and perfect ground plane. Rubber feet prevent scratching. Each Proto Board features one or more 5-way binding posts to tie into system or power supply ground. And all are compatible with digital and linear ICs, in T05s, DIP packs and discrete components. Each is assembled and ready-to-use.

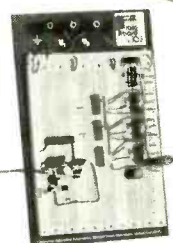

Proto Board 101. Compact. Inexpensive. 10-14 pin DIP capacity. 5.8" long x 4.5" wide. **29⁹⁵**

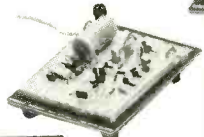

Proto Board 102. Compact. 12-14 pin DIP capacity. 7", 4 1/2". **39⁹⁵**

Proto Board 103. 2,250 solderless tie points. (4) 5-way binding posts. 24-14 pin DIP capacity. 9" x 6". **59⁹⁵**

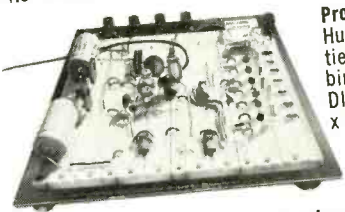

Proto Board 104. Huge. 3,060 solderless tie points. (4) 5-way binding posts. 32-14 pin DIP capacity. 9 1/2" long x 8" wide. **79⁹⁵**

NEW PROTO BOARD-100

For the economy-minded student or experimenter... Here's a low cost, big 10 IC capacity breadboard kit with all the quality of QT Sockets and the best of the Proto-Board series... complete down to the last nut, bolt and screw. Includes 2 QT-35S Sockets; 1 QT-35B Bus Strip; 2 5-way binding posts; 4 rubber feet; screws, nuts, bolts; and easy assembly instructions.



COMPLETE KIT...
\$19⁹⁵ ORDER YOURS TODAY!

NEW! PROTO-CLIP for power-on, hands-off signal tracing. Eliminates shorting leads... and costs under \$5!

Bring IC leads up from pc board for fast signal tracing and trouble-shooting. Inject signals. Wire unused circuits into boards. Scope probes and test leads lock onto Dynagrip (see circle) inset for hands-off testing. New plastic construction eliminates springs, pivots. Non-corrosive nickel/silver contacts for simultaneous low resistance connections. Narrow throat for high density pc boards.

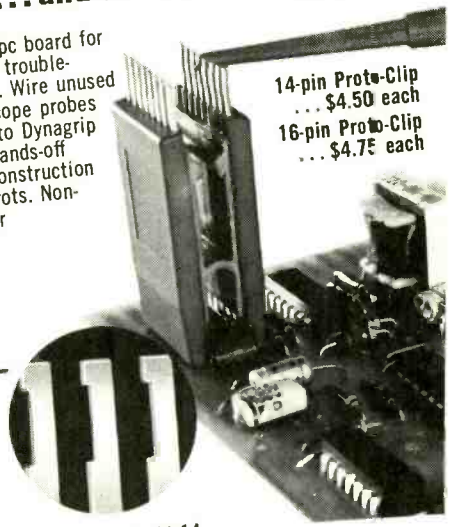

14-pin Proto-Clip ... \$4.50 each
 16-pin Proto-Clip ... \$4.75 each

FREE! Metric-to-English SLIDE RULE. Convert lengths, area, weight, volume instantly. Yours FREE with a minimum \$5.00 order!

Available off-the-shelf at your local distributor or order directly from Continental Specialties. Phone charges accepted for BankAmericard, Master Charge, American Express. Write for Free catalog. Dealer inquiries invited.



Continental Specialties Corporation
 325 East St., Box 1942, New Haven, CT 06509
 Telephone: (203) 624-3103

CANADA: Available thru Len Finkler, Ltd. Ontario

304X, 404X, 504X, and the "14" series, consisting of the 314, 414, and 514. The "X" series offers a flexibility feature for those who desire it. These receivers are designed to accommodate the addition at a future date of a CD-4 circuit board within the confines of the receiver. The customer will have the option of purchasing a CD-4 board within one year and have it incorporated into the receiver at one of the Fisher service agencies.

CIRCLE NO. 77 ON READER SERVICE CARD

JFD COLOR TV ANTENNA

A new series of vhf/uhf/TV/FM antennas has been announced by JFD. The new antennas, known as the LPV-UC Color Best, combine the patented log periodic design with a new ultra-sensitive corner reflector and uhf driver for more sharply detailed reception in color or black and white on all channels. A rugged, triple-square, cross-arm construction maintains solid rigidity. The use of gold-colored anodized aluminum is said to protect the antenna.

CIRCLE NO. 78 ON READER SERVICE CARD

SYLVANIA TV YOKE PROGRAMMER KIT

An accessory yoke programmer kit which makes it possible to fully test most solid-state color TV sets using existing tube sweep test jigs is being offered by GTE Sylvania. The Rig-a-Jig CK1900X, when installed on virtually any 19-in. color test jig,

will provide performance comparable to the company's existing CK1500X test unit. It has a self-contained anode meter and offers the option of using the receiver focus supply or an internal supply. Through the yoke programmer, the receiver deflection output is coupled to the test jig and inductance is matched to the receiver with an assortment of programmer plugs.

CIRCLE NO. 79 ON READER SERVICE CARD

HEATHKIT SEMICONDUCTOR CURVE TRACER

Used with an oscilloscope, the new Heathkit IT-1121 semiconductor curve tracer accurately displays operating

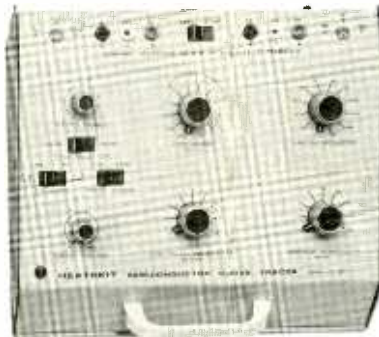

parameters of virtually all types of semiconductors. Extra leads are provided for tests of larger devices or for in-circuit tests. Hobbyists, TV technicians—anyone who works with electronic circuits—will

find the unit a valuable aid in selecting devices or for sorting, inspecting and testing. The kit is mail-order priced at \$89.95.

CIRCLE NO. 80 ON READER SERVICE CARD

CUSH CRAFT CB ANTENNAS

A complete line of CB base-station antennas is being offered by Cush Craft. Ranging from a basic half-wave antenna with power-ring tuning (at \$23.50) through an 8-element horizontal-vertical beam antenna with a forward gain of 12.5 dB (at \$119.50), a complete intermediate line is offered. Some of these include 3-element, 4-element, 5-element and dual-beam types. Simple single-element monitor antennas are also available from the manufacturer.

CIRCLE NO. 81 ON READER SERVICE CARD

HELPMATE REMOTE CONTROLLER

A remote-control system that switches on and off 117-volt ac appliances rated at up to 1500 watts is available from the Helpmate Equipment Co. The system features a radio (vhf or uhf) transmitter for control up to 150 ft away and remote/local "wired" switches. On the controller is a dual ac receptacle for the appliance(s). The receiver operates on 24 volts dc, while the transmitter uses a 9-volt battery.

CIRCLE NO. 82 ON READER SERVICE CARD

SBE *Sentinel*

SCANNING MONITOR RECEIVERS
HF/FM • VHF/FM • UHF/FM

Now—the "Sentinels", a series of fine monitor receivers joins the big, world-wide-accepted line of SBE communications equipment. Single or dual band models of these versatile, application-oriented SBE scanners provide coverage of the most widely used VHF/UHF bands. For example, the six different receivers available give FM reception and positive scanning operation for business, industrial (including RCC and other mobile telephone), law enforcement, fire, highway emergency, traffic advisory, marine—including intership / Ship-to-shore / Coast Guard/Weather — many other services.

SIX MODELS:

- Sentinel I:** Hi-144-171MHz, Lo, 30-51MHz.
- Sentinel II:** 144-171MHz.
- Sentinel III:** 30-51MHz.
- Sentinel V:** 450-470MHz.
- Sentinel VI:** Hi-450-470MHz,
Lo-144-171 MHz.
- Sentinel VII:** Marine, 156-164MHz.



8 channels—continuous "scanning". Receiver locks on first channel on which signal appears.

Priority channel feature: Receiver shifts instantly to designated channel whenever carrier appears on it regardless of existing channel status.

Channel lock-out buttons: Unwanted channels can be locked out.

Manual advance button allows channels to be scanned manually.

Base or mobile (AC or DC). Use in car or home/office. Operates both on 12VDC for mobile and 115VAC for home station.

- Big audio volume**—3 to 4 watts.
- Fractional microvolt sensitivity
 - Squelch • Built-in speaker • Jack for external speaker • Crystals used are readily available types (not included).
- Complete w/ plug-in telescoping antenna, mobile mounting bracket and cord, plug sets for 12VAC and 115VAC.

Write for Brochure

SBE LINEAR SYSTEMS, INC.
220 Airport Blvd., Watsonville, CA 95076.

MARK TEN B, THE GAS SAVING, PLUG SAVING, TUNE-UP SAVING, ELECTRONIC IGNITION FROM DELTA. NOW AS LOW AS \$49.95.



Years of testing and use by race car drivers in all categories have proven Delta's Mark Ten B the most advanced ignition system on the market today.

Prove it to yourself. Give your car vroom! With a Mark Ten B Capacitive Discharge Ignition System under the hood of your car great things will happen...like reducing costly tune-ups by as much as 75%. Further, you get better all-weather starts, quicker acceleration and better mileage.

Many operational problems caused by emission control devices, poor manifolding or improper fuel mixtures disappear. Delta's Mark Ten B even improves the performance of brand-new factory installed electronic ignitions (Chrysler and Ford). Factory systems merely eliminate points and condenser, but the Delta Mark Ten B combines the advantages of capacitive discharge with solid state

electronics to give real performance and increased energy.

Are you a do-it-yourselfer?

Build your own Mark Ten B...it's available in low-cost kit form. Or, if you prefer, get the complete ready-to-install unit. Either way, you can install it yourself in minutes with no rewiring, even over Chrysler and Ford systems.

Mail the coupon today and discover how to enjoy happy motoring with Delta's Mark Ten B. The do-it-yourselfer's dream that really pays off.



DELTA PRODUCTS, INC.

P.O. Box 1147, Dept. PE Grand Junction, Colo. 81501
303-242-9000

Please send me free literature.

Enclosed is \$ _____ Ship ppd. Ship C.O.D. Please send: _____ Mark Ten B assembled @ \$64.95 ppd. _____ Mark Ten B Kit @ \$49.95 ppd. (12 volt negative ground only) _____ Standard Mark Ten assembled, @ \$49.95 ppd. _____ 6 Volt: Neg. Ground Only _____ 12 Volt: Specify _____ Pos. Ground _____ Neg. Ground _____ Standard Mark Ten Deltakit® @ \$34.95 ppd. (12 Volt Positive or Negative Ground Only)

Car Year _____ Make _____

Name _____

Address _____

City/State _____ Zip _____

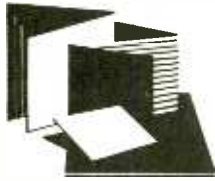

New Literature

SPRAGUE SEMICONDUCTOR MANUAL

A comprehensive revision of its Semiconductor Manual and Replacement Guide has been published by Sprague. The new 64-page manual K-500A lists over 38,000

of the most popular domestic and foreign semiconductor part numbers and their recommended replacements with just 137 Sprague RT, TVCM, and ZT series semiconductors. All listings are alphanumeric to make the manual easy to use. Address: Sprague Products Co., Marshall St., North Adams, Mass. 01247

SYLVANIA SEMICONDUCTOR GUIDE

A supplement of its ECG semiconductor replacement guide, adding 11,000 type numbers to the total replaced by the Sylvania Semiconductor ECG line, has been published. The line includes transistors, IC's, diodes and rectifiers, special-purpose devices, and accessories. The

type numbers listed in the new 20-page supplement bring the total number of foreign and domestic semiconductors cross-referenced to the line to nearly 90,000. Copies may be obtained from GTE Sylvania distributors.

RCA THYRISTOR AND RECTIFIER CATALOGS

Two catalogs that show the wide selection of RCA thyristors and rectifiers and that provide descriptive data on these devices are available. "Thyristors/Rectifiers," THC-500C, is a 32-page catalog that includes both commercial and development types currently available. Characteristics and ratings are included along with applications. "Thyristors/Rectifiers Product Matrix," TPM-510A, is an 8-page catalog that includes quick-reference matrices showing the selection of more than 425 devices, classified according to ratings and type of package. Address: RCA Solid State Div., Box 3200, Somerville, N.J. 08876.

C & K SWITCHES CATALOG

A new 12-page brochure, Catalog No. 702, contains complete information on the company's line of subminiature toggle, rocker, paddle-handle, subminiature and microminiature pushbutton switches. General specs, outline drawings, mounting data, materials and finishes are included. Address: Sales Manager, C&K Components, Inc., 103 Morse St., Watertown, MA 02172.

B&K TEST EQUIPMENT CATALOG

A 32-page catalog showing the complete line of B&K test equipment includes photos and specs of the company's multimeters, oscilloscopes, semiconductor testers, generators of various types, power supplies, substitution boxes, tube testers, CRT restorers, probes and accessories. Address: Dynascan Corp., 1801 W. Belle Plaine Ave., Chicago, Ill. 60613

TURNER MICROPHONE BROCHURE

A new catalog and brochure showing the complete line of Turner communications microphones includes both base and mobile mikes, with specifications and prices. Units with transistorized preamps, volume controls, and push-to-talk switches are included. Address: Turner Microphones, 909 17th St. N.E., Cedar Rapids, Iowa 52402.

LMB BOXED CHASSIS CATALOG

A catalog from LMB for the experimenter and hobbyist, as well as the engineer, describes chassis, boxed chassis, cabinets, panels and all types of metal boxes. Also included and shown is a new line of small cabinets in various colors with 1/2-in. rubber feet to dress up your latest project. All dimensions and prices are included. Address: LMB, 725 Ceres Ave., Los Angeles, Calif. 90021.



With the biggest little 23 Channel AM Mobile you've ever handled.

CRANK UP the MIC gain control and listen to 'em jump.

"EARS?" you bet. The most selective and sensitive in the business.

EFFICIENCY? You've got it with our professional SWR meter that tells you how your antenna and transmission line are doing.

AUTOMATIC FAIL-SAFE prevents those final failures other sets experience.

**READY TO GO . . .
F.C.C. TYPE ACCEPTED
AT YOUR AUTHORIZED
TRAM/DIAMOND DISTRIBUTOR**

**TRAM[®]
CORPORATION**

Lower Bay Road, P. O. Box 187
Winnisquam, NH 03289
Phone (603) 524-0626

free

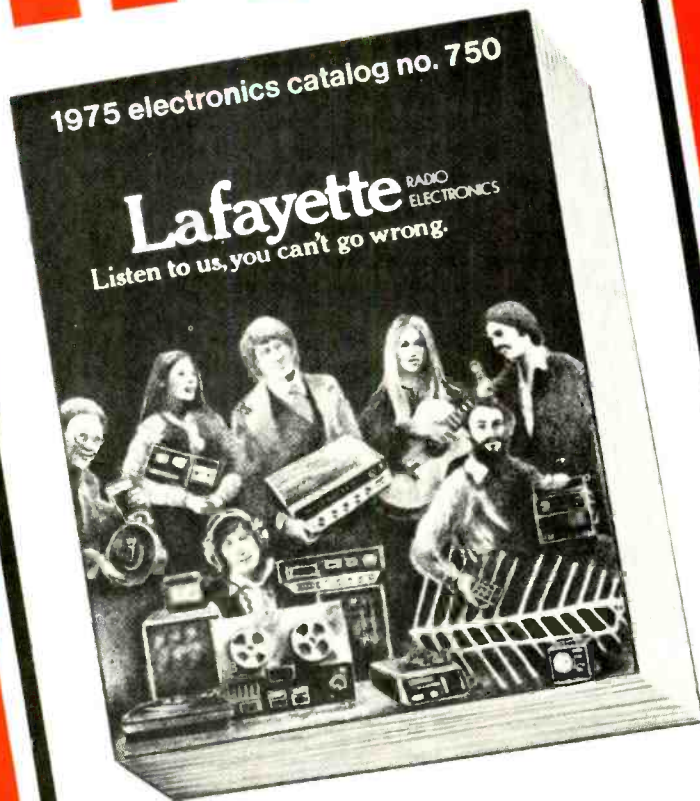

**IT'S THE ONLY NATIONALLY DISTRIBUTED
FULL-LINE CATALOG WITH A MAJOR
SHOWING OF THE NEWEST NAME-BRAND
ELECTRONICS PRODUCTS
FOR 1975!**

The "NEW LOOK" 1975 LAFAYETTE RADIO ELECTRONICS CATALOG

If you're interested in electronics you **NEED** this catalog! Completely re-designed for easier-than-ever ordering, with the newest and best Lafayette and national-brand products for '75. And you get the same quality and service that has made Lafayette a leader for 55 years. Iron-clad guarantees! Lowest Prices! Professional Service! State-of-the-art Equipment! Pick and choose from over 18,000 quality electronics products! Now, more than ever, we're your "Single-trip" shopping center for everything in electronics.

SAVE ON EXCLUSIVE LAFAYETTE PRODUCTS PLUS THE BEST MAJOR BRAND NAMES

- Stereo and 4-Channel Music Systems
- Tape Recording Equipment • Car Stereo and Accessories • CB and Ham Gear • Police/Public Service Receivers • Car Stereo and Accessories • Antennas • Cameras • TV • PA and Test Equipment • Music Instruments and Amplifiers • Books • Electronic Calculators • Security Systems • PLUS PARTS, TUBES, BATTERIES, HARDWARE — ALL YOU NEED FOR QUALITY LIVING THROUGH ELECTRONICS

Lafayette

Listen to us, you can't go wrong.

STORES COAST TO COAST Check Your Yellow Pages or Shop by Mail

NEW! Bigger Pages

NEW! More Full Color

NEW! Easier-to-Read Type

free

MAIL TODAY!

Lafayette Radio Electronics

111 Jericho Tpke., Syosset, L.I., N.Y. 11791

35094

Send me your FREE 1975 Catalog.

Send a 1975 Electronics Catalog to my friend.

Name _____ Apt. _____

Name _____ Apt. _____

Street _____

Street _____

City _____

City _____

State _____ Zip _____

State _____ Zip _____

Build it yourself!

Build this exciting color TV as part of Bell & Howell Schools' fascinating learn-at-home program employing digital electronics!

Digital clock that flashes on the screen!

Channel numbers that flash on the screen!

Automatic pre-set channel selector!

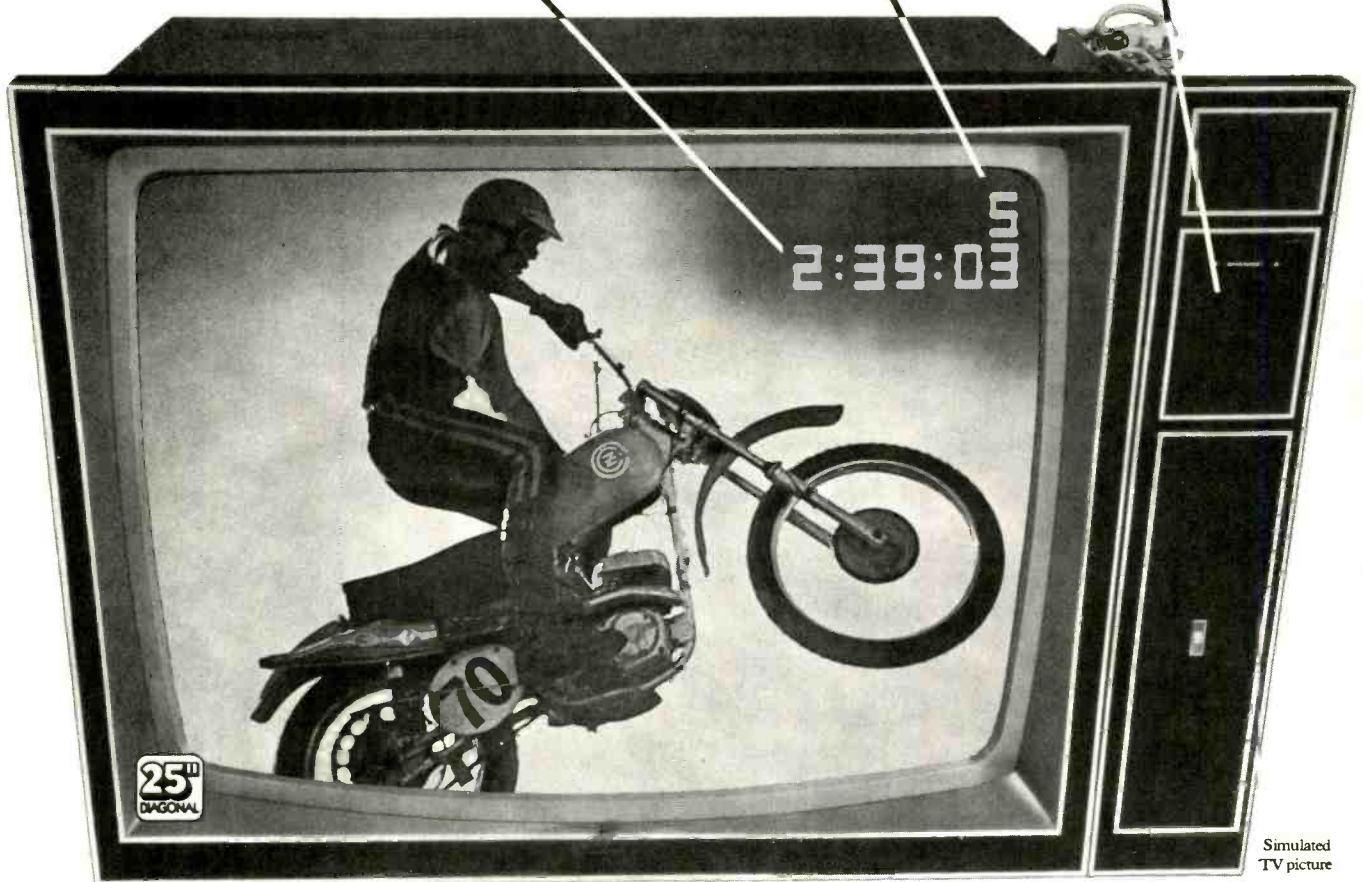



"Electro-Lab" is a registered trademark of the Bell & Howell Company.

Simulated TV picture

You get valuable "hands on" experience right from the very start...it makes learning faster and all the more exciting!

Digital electronics is a fascinating world to explore! It's an expanding technology that's changing not only our clocks, wristwatches and pocket calculators, but now, color TV!

By building Bell & Howell's big-screen color TV with digital features, you'll learn about this exciting field first hand. And you'll take special pride in this remarkable TV because you built it yourself!

You work with a color TV that's ahead of its time . . . and learn about these exciting features:

Digital channel numbers that flash on the screen

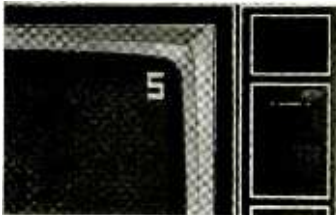

Press the instant-on button and the channel number flashes big and clear, right on the screen — and stays there as long as you want!

Automatic pre-set channel selector

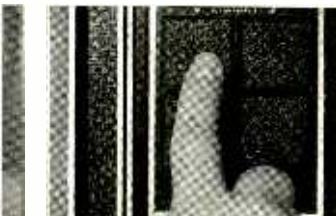

Just a push of the forward or reverse channel buttons and instantly the VHF and UHF channels come on in a pre-set sequence. All "dead" channels are skipped over.

Digital clock that flashes on screen



With just the push of a button, this TV tells the correct time. The hours, minutes and seconds appear in clear, easy-to-read digital numbers.

You need no prior electronics background . . . we help you every step of the way!

We start you off with the basics and help you work your way

up, one step at a time.

With your first lesson, you'll receive a special Lab Starter Kit that aids your understanding of electronics fundamentals . . . gives you immediate "hands on" experience. If there's a "snag," call one of our expert instructors toll-free. You can also talk shop with instructors and fellow students at our "help-sessions" scheduled in 50 cities at various times throughout the year.

Perform fascinating experiments with the exclusive Electro-Lab® electronics training system. It's yours to build.



Your program includes professional testing equipment to give you valuable "hands on" experience. You'll build and use a *digital multimeter*, a *solid-state oscilloscope* with "triggered sweep," and a modular *design console*. You will have the most up-to-date tools of the trade, including instruments you can use professionally after you finish the program.

The occupational skills you learn in digital electronics could lead to new income opportunities, full or part-time . . . perhaps a business of your own!

Once you've completed this learn-at-home program, you'll have the skills to service color TV's, plus repair a variety of home electronics equipment.

While many of our students do not ask for employment assistance, it is available. Of course, no assurance of income opportunities can be offered. No better or more practical at-home training in electronics is available anywhere!

Mail the postage-free card today!

This Bell & Howell Schools' program is approved by the state approval agency for Veterans' Benefits. Please check the appropriate box on the card for free information.

If card has been removed, write:

An Electronics Home Study School
DeVRY INSTITUTE OF TECHNOLOGY



ONE OF THE
BELL & HOWELL SCHOOLS

4141 Belmont, Chicago, Illinois 60641

663R2



Stereo Scene

By Ralph Hodges

SOME UNFINISHED "NOISE" BUSINESS

HERE are some notes I've been holding onto for a while, figuring I could find a way to expand them into column-length topics. I never did, but since they deal largely with a common theme, perhaps I can serve them up kind of scrambled together, and hope they contain enough total sustenance to make a meal.

Noise Reduction. There seems to be renewed interest in noise-reduction devices — especially in the "single-pass" playback processors such as are offered by Phase Linear and, shortly, Infinity Systems. Burwen Labs have been looking into prospects for a consumer version of their sophisticated dynamic noise filter, while one of the high-volume audio manufacturers, Pioneer, has been soliciting outside reaction to a newly developed circuit called the RG Dynamic Processor.

The Burwen device is sort of a combination automatic variable filter and noise gate. Acting at a pre-selected signal-level threshold (adjustable by the user), it essentially lops off, from moment-to-moment, those portions of the audio spectrum that aren't occupied by music at the time. Its attack and release times are exceedingly fast, so the noise content

of the program is never left "uncovered" when the music dies away suddenly. The consumer version of the Burwen operates as a low-pass filter. It is reportedly compact enough, in terms of circuit space, for incorporation into receivers and integrated amplifiers.

The RG Dynamic Processor (after Robert Grodinsky, the inventor) obtains noise reduction as a side benefit of its principal function, which is dynamic-range expansion. It is a thoughtfully designed device, although reported to be no more complex or expensive than a Dolby B module. The attack time is rather fast (under 2 milliseconds), while the release time is automatically regulated by the nature of the program material to prevent any obvious bobbing up and down of levels. (Rhythm and other factors are taken into account, according to Grodinsky.) Expansion takes place upward and downward: i.e., louds become louder, softs softer. It's the downward expansion that provides the noise reduction, since the overall level — noise *and* program — is reduced during the quiet moments when noise is most audible.

I first heard the RG processor several weeks ago, along with other members of the press, at Pioneer's

invitation. I thought the action of the device in manipulating levels was a bit too audible at times, but a subsequent hearing with the time constants somewhat altered impressed me much more favorably.

To summarize, both these devices are playback processors designed — like the much less subtle "scratch" filters included in most audio systems — to remove noise that has already intruded into the program source. The Burwen is exclusively a noise remover, and a very good one by all accounts. However, in the opinion of Bob Grodinsky, noise reduction is only half — and a poor half at that — of what should be done to enliven the reproduction of recorded music. Dynamic-range expansion is the other half. And this leads us directly into the next topic.

The dbx System. The dbx people (they prefer lower case letters) have been active in both consumer and professional audio for some years. Their new disc encode/decode process brings these two spheres of activity together. The system was formally introduced in mid-May at the Midwest Acoustics Conference; but a month before that, a dbx representative managed to grope his way to our offices in the thick of midtown Manhattan and set up shop for an hour or so.

When the dbx man lowered the phono stylus on the record, there was, literally, dead silence — a disconcerting sound suggestive of faulty connections or blown fuses. I was just bending down to check the position of the receiver's input selector when somebody, not fifteen feet away, walloped a bass drum. Up to then I hadn't really been sure that a sound such as I heard could be recorded. And in a sense I was right, because the true

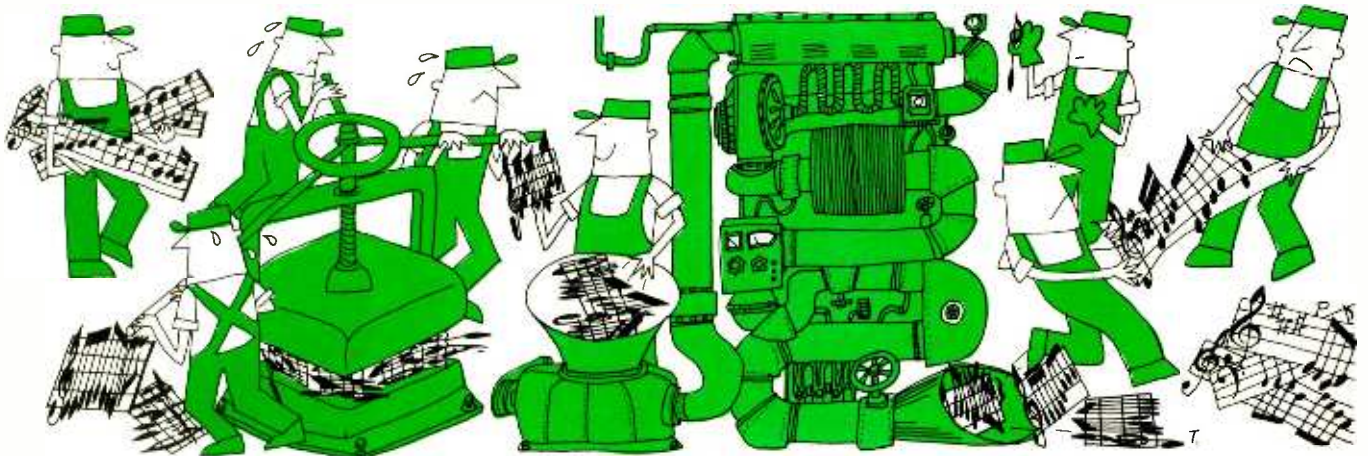

Hobby and special interest books that make self-instruction easier

EASI-GUIDE TO INDOOR HOME REPAIRS

by Forest H. Belt, John Statzer, and Melba Statzer

If you only knew how to fix the little things that can go wrong in a home, you'd save a mint. This book shows you how. Simple terms and explanations and step-by-step photographs show how to solve the irritating plumbing, plastering, and furniture problems that face homeowners in kitchens, bathrooms, utility rooms, and bedrooms. 128 pages, softbound.

No. 21073 \$3.50

EASI-GUIDE TO SMALL GASOLINE ENGINES

by Forest H. Belt and Calton E. Taylor

The minor gasoline engine repairs and adjustments that are needed to keep lawnmowers, tillers, snow plows, and chain saws in good operating condition can be done easily by any homeowner who follows the simple yet detailed instructions and photographs given here. The book covers repair and operation of both two- and four-cycle engines. 144 pages, softbound.

No. 21095 \$3.50

METRICS FOR THE MILLIONS

by Rufus P. Turner

Here is an essential reference manual for all who will be affected by the coming change-over from our present system of measuring to the metric system. Each of the various metric units is covered, and examples show how to convert from U.S. to metric and from metric to U.S. 96 pages, softbound.

No. 21036 \$3.50

TAPE RECORDERS—HOW THEY WORK 3rd Edition

by Charles G. Westcott and Richard F. Dubbe, revised by Norman Crowhurst

An easy-to-grasp explanation of tape recorders that is equally popular with owners and repair technicians. Updated and revised to include the latest techniques and equipment. Explains principles; covers mechanisms and components; describes types of recorders; gives test procedures. Numerous illustrations and charts. 240 pages, softbound.

No. 20989 \$5.50

MODERN RECORDING TECHNIQUES

by Robert E. Runstein

In explaining the intricacies of recording pop music, this book fills a gap that has been neglected or overlooked. It is of particular value to the recording engineer since it covers equipment, controls, and operating techniques currently in use in recording studios. 368 pages, softbound.

No. 21037 \$9.95

ABC'S OF ZENER DIODES

by Rufus P. Turner

Zener diodes are increasingly more important in the automotive electronics field and in metal-oxide-semiconductor technology. Regardless of your connection with the electronics industry, this book will increase your knowledge of zener diodes in terms of their fundamentals, functions, and their many possible applications. 96 pages, softbound.

No. 21045 \$3.95

HI-FI STEREO SERVICING GUIDE 2nd Edition

by Robert G. Middleton

Anyone servicing a-m tuners, fm tuners, stereo-multiplex units, and audio amplifiers can gain valuable service direction and assistance from this guide. It also covers hi-fi speaker installations, system evaluation, troubleshooting, and methods of verifying test equipment performance. 104 pages, softbound.

No. 21075 \$4.50

PRINCIPLES OF ILLUMINATION

by John E. Traister

A thorough coverage of the subject, including defining the measurements used for lighting, the different types of lamps available, design techniques, and cost analysis of specific types of lighting. Covers practically every application for lighting. 176 pages, softbound.

No. 20973 \$9.95

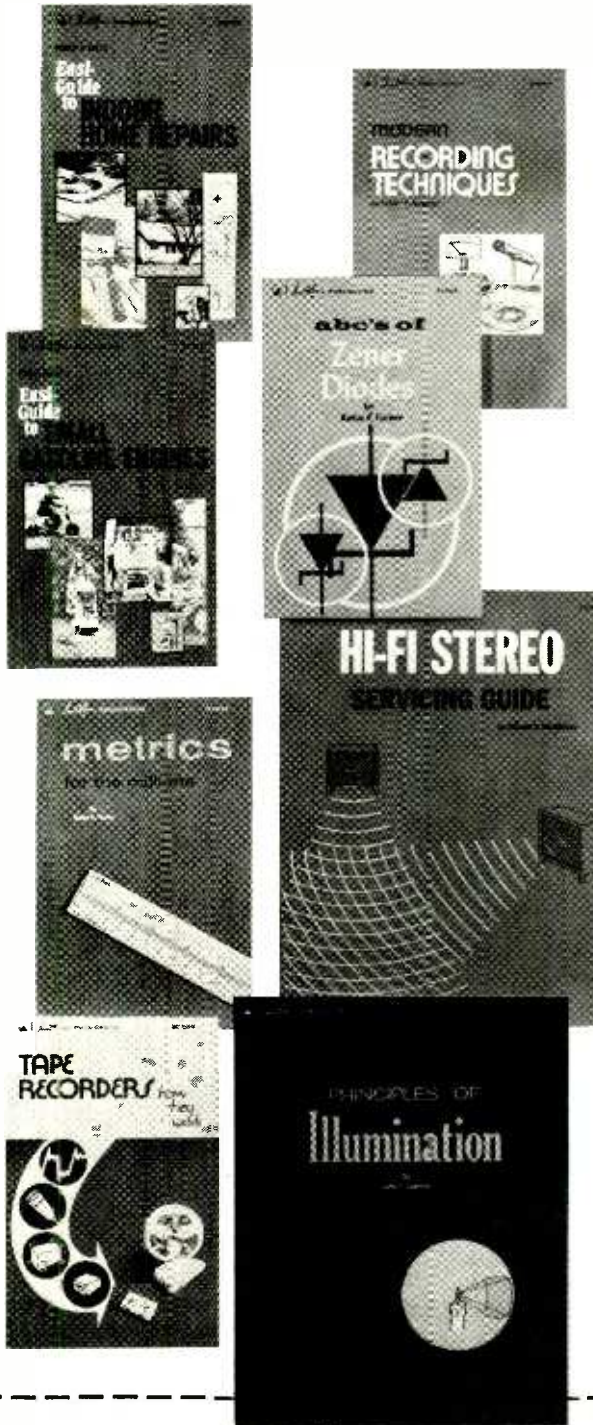

HOWARD W. SAMs & CO., INC.
4300 West 62nd Street,
Indianapolis, Indiana 46206

Order from your electronics parts distributor, or mail to Howard W. Sams & Co., Inc.

Send books checked at right. \$ enclosed. Please include sales tax where applicable.

- 21073
- 21095
- 21036
- 20989
- 21037
- 21045
- 21075
- 20973

Send FREE 1974 Sams Book Catalog 007146

Name _____

Address _____

City _____

State _____

Zip _____

PE-094

drum sound *wasn't* recorded, at least not on the record being played. A version highly compressed in dynamic range is what had gone down on the tape and been transferred to the disc. It was now being expanded to its original dynamics by the dbx processor connected to the receiver, which was doing the inverse of what had been done during the recording session.

The dbx system is a "componder" (compression/expansion) process that is capable, it is said, of approaching 100 dB of dynamic range with no audible noise. This claim assumes, of course, that it is used as a fully "closed" system, with a compression processor employed early on in the making of the master tape. The compression takes place both upwards and downwards, as does the complementary expansion during playback. Then upward compression improves the signal-to-noise ratio and is responsible for the noise reduction. The downward compression (and later expansion) permits the enormous dynamic range without overtaxing the recording medium. Not just the high frequencies but the entire audible spectrum is treated in the processing, which is more drastic than that of Dolby B and therefore less compatible with playback systems not equipped with a decoder.

Earlier this year (March 1974) I commented on possible disc noise-reduction systems and expressed concern about how low-frequency noise (mold grain, etc.) could be handled without reducing playing time. One claim for the dbx technique is that it potentially *increases* playing time through downward compression. This proposition seems reasonable enough. But whether it assumes that low-frequency noise is kept to a minimum by careful disc manufacture, or suggests that dbx has chosen the proper compression values to take care of low-frequency problems, I really don't know.

At the Midwest Acoustics Conference, where the system was publicly demonstrated for the first time, the question of dbx-type disc encoding came up for discussion by the technical panel. Since I'm sure the panelists' remarks will be of interest to you, I'll attempt to paraphrase them. Elmar Stetter, representing Dolby Labs, said that his company maintains an open mind on disc encoding, but seeks a more positive in-

dication of consumer interest in such technology. Bernard Jakobs of Shure Brothers was obviously concerned about new variables in disc recording that might complicate the task of the phono-cartridge designer. And John Bittner, who heads a high-quality record mastering and pressing facility in Phoenix, Arizona, struck a grimmer note when he speculated that the average disc manufacturer, afforded a "cushion" of noise reduction by a dbx-type system, would simply relax his quality-control standards commensurately, and nothing in disc performance would be gained.

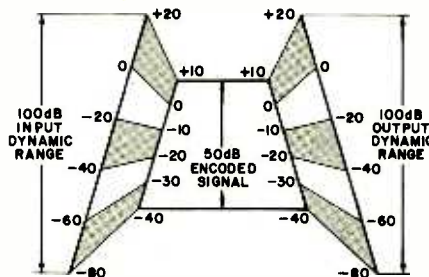

The dbx system employs linear compression and expansion in a 2-to-1 ratio. All frequencies are processed equally.

As I recall, it was Joe Wells of RCA who raised the most provocative point: "Does the consumer really want more dynamic range? Aren't there enough complaints already about records that blast at you one moment, and fall below the level of room noise the next?"

Ultimately we'll all have to answer Mr. Wells' question for ourselves. Maybe, as was wistfully suggested, a playback processor like the RG device, that lets the consumer dial in exactly what he wants, is the final solution. Meanwhile, if dbx should turn up in your neighborhood during the hi-fi show season, I urge you to pay them a visit. Insist on hearing the brass band recording that dbx has produced privately; it's guaranteed to stand your hair on end. A small west-coast company called Klavier has already begun offering a few dbx discs, but none of them that I've heard is quite as dramatic in showing up the capabilities of the system.

When will dbx discs be available from Columbia, Deutsche Gramophon, and RCA? As soon as all the bargain-basement stereo systems in the land have acquired the necessary decoding electronics (perhaps \$50 per channel to begin with). Maybe

even a little sooner. But, it looks like dbx has an uphill fight from here.

Ambiphony. "Ambiphonics" is a term that has been used in England and Europe to refer to the theory and practice of reproducing ambience (the acoustic environment of the recording location), usually through multi-channel techniques such as quadraphonics. As a rule this type of recording aims at presenting the performers up between the two front speakers, while the natural reverberation of the concert hall (or whatever) surrounds the listener. This reverber-

ation, states the theory, is more than just second-hand sound bounced from walls and ceiling. Correctly reproduced, it defines for the listener's ears the actual space in which the performance took place. Thus it can presumably turn a small listening room into a large auditorium, and generally provide a wealth of aural cues that bring the recorded version several steps closer to reality.

In this country, a sharp distinction is usually drawn between ambience four-channel recordings and the "surround-sound" productions that group the performers roughly in a circle, with you in the middle. And there has been debate, sometimes acrimonious, over which recording technique is more valid, more exciting, "purer," etc.

I don't want to get drawn into argument with back-to-front ping-pong fanciers about the kind of four-channel effect they favor. (Personally, I can't see that it does much more for you than a pair of able-bodied kangaroos, each with a speaker strapped to his back, could accomplish by hopping around the room. But let that pass. There's plenty of room for different preferences here.) However, from my point of view, ambience re-

THE EASIEST MONEY YOU'LL EVER MAKE...BELIEVE IT OR NOT! IT'S TRUE

**"I MADE \$35,000 IN JUST 1 DAY
AT HOME IN BED WITH THE FLU"**

By simply putting my successful money method
in action I'm making thousands of dollars
every week whether I work or not...

**I WILL QUICKLY TEACH ANY MAN OR WOMAN
MY PROVEN "EASY MONEY SECRET" OF
STARTING FROM SCRATCH AND MAKING A
FORTUNE PRACTICALLY OVERNIGHT!**

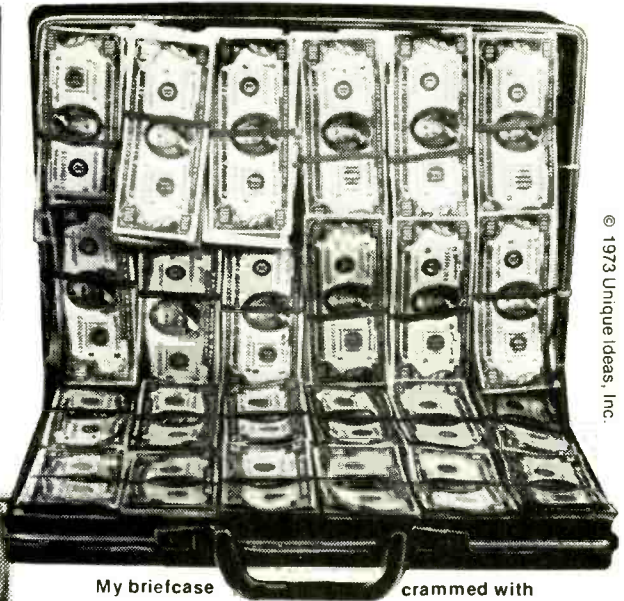

© 1973 Unique Ideas, Inc.

My briefcase crammed with thousands of dollars to be deposited in my bank.

**AN HONEST NO NONSENSE WAY TO RICHES
IT ACTUALLY WORKS FOR YOU**

No equipment to buy or lease, no hustling
your friends to buy junk merchandise and no
books or correspondence course required.

**DEFINITELY NOT A CON GAME, FRANCHISE,
INVESTMENT SCHEME OR GIMMICK**

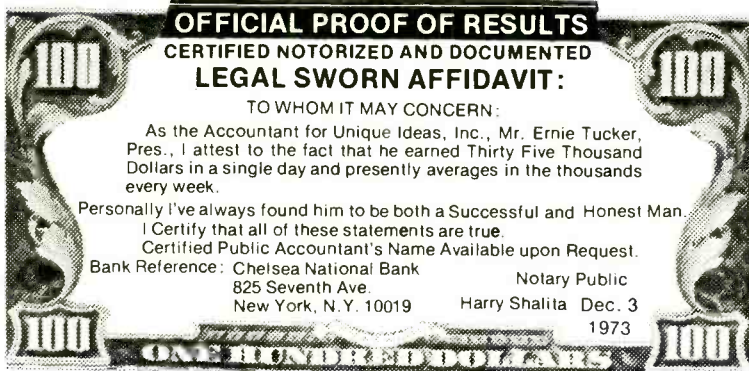

**OFFICIAL PROOF OF RESULTS
CERTIFIED NOTORIZED AND DOCUMENTED
LEGAL SWORN AFFIDAVIT:**

TO WHOM IT MAY CONCERN:

As the Accountant for Unique Ideas, Inc., Mr. Ernie Tucker, Pres., I attest to the fact that he earned Thirty Five Thousand Dollars in a single day and presently averages in the thousands every week.

Personally I've always found him to be both a Successful and Honest Man.

I Certify that all of these statements are true.

Certified Public Accountant's Name Available upon Request.

Bank Reference: Chelsea National Bank

Notary Public

825 Seventh Ave.

Harry Shalita Dec. 3

New York, N.Y. 10019

1973

**YOU DON'T NEED MONEY
TO MAKE MONEY**

Obviously you were not born rich so what? 85% of the men and women who are rich today started with very little money and had only average education, so why not be honest with yourself and stop using lame excuses, stand up and face the fact that the only real difference between you and thousands of rich Americans is that they discovered the right moves to make and you did not!

**YOU GET RICH MAKING
"THE RIGHT MOVES"**

I've proven this to be true despite the fact that I was born poor and barely squeaked through high school. I still made a fortune in just a short period by making the right moves and I'll show you exactly how I did it.

But why am I so anxious to reveal to you my secret money making method? Surely there's more to it than because I enjoy helping others share in the rich good life as I have but frankly I expect to profit at least two hundred thousand dollars, maybe more, from the publishing of these ads in nationally famous magazines and newspapers.

STOP WASTING PRECIOUS YEARS

I should know, I wasted more good years than I care to remember, before I finally discovered the secret of making money, I stayed up to my neck in debt, bounced around from one eight hour dead end job to another. Just working, waiting and wishing for a great fortune to fall in my lap. I got married, became a proud father at a young age. I worked in a toy factory for a short time and peddled cosmetics from door to door, but everything I tried my hands at failed because I didn't know the right moves to make. This only happened to me twelve years ago. No doubt there are millions who are suffering this agonizing torment now.

**REVEALING: THE RICH MAN'S
SECRET MONEY MAKING METHOD**

It's true that most rich persons keep

their money making secrets to themselves, seldom sharing it with others, but fortunately I met several unusually fair minded rich men who were so impressed with my ambition to get rich that they agreed to teach me the secret money making techniques that their many years of making millions had taught them, providing I would virtually work for them at least one year. I eagerly jumped at the opportunity to gain this valuable knowledge and said yes to their generous proposition. So for one year I listened and watched very closely, until I learned from A to Z how these financial wizards made thousands of dollars every single day. I'll always be most grateful to these men for teaching me their fast and easy money making secrets. It didn't even matter that I was practically penniless when I first put these methods into action.

**SUDDENLY IT STARTED
MAKING MONEY FOR ME**

At first it was unbelievable ... I paid off all my bills and my wealth continued to multiply. Huge sums of cash poured in so fast that I was forced to employ a full time bookkeeper and retain a corporation attorney, accountant and tax expert to help manage my prosperous financial affairs.

We had investments, property, stocks, money in the bank and can afford most anything we want. My family and I enjoyed our wealth and success. We were very proud of our accomplishments and it was our secret of making the right easy moves that made it all happen.

**THIS IS YOUR CHANCE
DON'T BLOW IT**

It's a better chance than I had. If you're really serious I'm willing to share my secret. Surely I can afford to give it to you free of charge, but I won't, why should I give you something for nothing? Instead I'm going to ask you to send me ten dollars for sharing my secret. What's more, I want you to know that I intend to make a fair profit

from the information I mail you, why not? If I can show you how to make more money than you ever made in your life why should you care if I make a profit? Remember what I'm giving you for only ten dollars cost me 12 years to master. Even more important you get certified and documented proof beyond the slightest doubt that my method can make a fortune, this is why I can offer you the strongest legally binding guarantee possible!! A guarantee so incredible that you'll probably think it sounds too good to be true.

**UNUSUAL \$1000
GUARANTEE**

This is a legal and binding guarantee from me to you. The information I'll send you can actually put thousands of dollars in your pocket. But this is my pledge to you, after just 10 days if you don't agree my secret method is worth at least \$1000.00 in cash to you (one hundred times the ten dollars you pay) send it back and I'll rush a full refund, including your 8¢ postage. You take absolutely no-risk — not even the price of a stamp.

GET READY TO GET RICH

Every single day my method can bring you more cash. You'll never again need to borrow, budget or ask anyone for credit. You'll be proudly independent. You can enjoy those luxuries you've always dreamed about, but never could afford. Sound impossible? But it's not, you only need a serious belief in my proven method, very small capital and enough ambition to give it a try. Remember "nothing ventured nothing gained" and there's absolutely no way you can lose.

**JOIN THOUSANDS WHO ENJOY
THE RICH GOOD LIFE:**

Ed K. says: "I never earned over one hundred dollars a week in my life until I

made 2 thousand dollars the first month using your money making method. I'm glad I took a chance." Sincerely, Ed K., N.Y. You can easily learn what I taught him and now his money worries are over, so why not take advantage of this rewarding opportunity. Any news of good fortune travels fast, already thousands of just average men and women have benefited from my concept, you will too. But I will not promise you'll make as much money as fast as I have, yet, it's possible you'll make a lot more even faster.

**YOU CAN LIVE HIGH ON THE HOG
AND DO LESS WORK...**

I'll show you how to stop breaking your back to make ends meet and start using your head to get easy riches. If you're seriously fed up with being treated like a hard working stiff while others enjoy the rich good life, then don't pass up this opportunity—you risk absolutely nothing—not even the price of a stamp.

MAKE THE RIGHT MOVE NOW

RUSH ORDER COUPON

Ernie Tucker, Pres.
Unique Ideas, Inc. Dept. PE-S
1674 Broadway
New York, N.Y. 10019

Yes count me in on your \$1000 guarantee offer. I enclose \$10. Rush your proven easy money method. I understand that it has been officially certified, notorized and documented. If I don't agree it can actually put \$1000 or more in my pocket within 10 days I can return it for a full refund, including my 10¢ postage. There is no risk on my part.

Name.....
Address.....
City.....
State..... Zip.....

ording is intellectually more interesting because it seems to be much harder to do convincingly and consistently. Rarely do I hear a sense of space simulated realistically. Half the time I can't even make up my mind about which are the front speakers. So it was with keen anticipation that I recently accepted an invitation from an outfit named Ambiphon to audition their approach to the problem.

Ambiphon's goal for the past several years has been to develop optimum techniques for ambience four-channel recording. Evidently this has involved them in the design and construction of an entire recording system, from microphones right on through to tape and tape recorder. Everything they produce is on "discrete" four-track tape, which is recorded "straight" — no signal processing such as Dolby, no gain riding or limiting, no special adjustments whatsoever except for careful microphone placement.

I listened to the Ambiphon efforts with a growing sense of wonderment, not only at the superb overall quality of the recordings, but also at the perfection of the four-channel effect. For practically the first time I was able to wander freely in the listening area without the sound field shifting toward the nearest speaker. In fact, standing with my back against the left rear speaker upset the sonic perspective hardly at all. Despite this remarkable stability, a sense of the recording site's acoustics was always present, sometimes vividly. Many of the recordings were classical works on solo piano, recorded in a room of about the same size as that we were in. These were realistic to say the least. But what really hit home were some tapes made in RCA's huge Studio A. The air around me — and around the somewhat distant performers — just seemed to sparkle with the presence of a large, acoustically live space. Another shocker was an abortive outdoor Dixieland concert in which a gang of neighborhood kids (and automobiles!) got loose among the recording microphones.

The Ambiphon project is a high-minded enterprise, and because these latter recordings are considered to lack intrinsic musical worth they aren't offered to consumers. But the piano recordings are, at \$19.95 each. (Of course, you'll need an

open-reel 7½-ips tape deck capable of four-channel playback to hear them.) Twenty-five cents to Ambiphon Records, Dept. J., P.O. Box 341, Kingsbridge Station, Bronx, NY 10463, brings a brochure which also includes some more details on the recording philosophy.

A talk with Mitchell Cotter, Ambiphon's engineering consultant, seemed to confirm some suspicions about four-channel reproduction that I had heard voiced before but had frankly hoped weren't true. For one thing, Cotter finds that deep, powerful low-bass capability in all four speakers is crucial to ambience simulation. I don't know if that means the rear speakers *must* duplicate the output of the front, but it tends toward that conclusion. Secondly, since ambience recording is the capturing of a sound *field*, you have to mike that field as such. This means pulling the microphones back from individual instruments so that they can get a perspective on the whole acoustical environment. The trouble is that, if the big recording companies ever decide to give Ambiphon's techniques a try (which is, of course, what I hope will happen), they're likely to balk at this condition, which runs precisely counter to the trend of recent years.

Another thing that's bound to perplex the big record outfits is the total lack of signal processing. The Ambiphon people studiously avoid it and anything else likely to affect phase at any frequency. (They are, for example, openly dubious about their tapes' bearing up under conversion to the current matrix systems for this reason.) Well, fine, but how much hiss does an uncompressed tape recording made without Dolby have? The latest of the Ambiphon tapes I heard (second-generation masters) had none! Claimed signal-to-noise ratio for the whole recording system approaches 90 dB — a figure I can't absolutely verify, but who can argue with a total absence of hiss at distances greater than a foot from any speaker?

How this is achieved remains Ambiphon's secret for the moment. But at no time was I led to believe that the recorder employed anything other than a rather standard 15-ips studio format, with ½-inch tape (Scotch 206, in fact).

So this brings us full circle, back to considerations of dynamic range and

noise reduction. I hope the future in these areas is as bright as the Ambiphon developments seem to paint it. Because, in my view, there is no dynamic range better than the dynamic range of the live performance, and no noise reducer like a recording medium that has no noise to begin with.

Postscript. Just before press time it was learned that the Federal Communications Commission has granted Dolby Labs' petition to permit a 25-microsecond pre-emphasis to be used with Dolby-encoded FM broadcasts. Previously a pre-emphasis (high-frequency boost before transmission) characteristic of 75 microseconds was the U.S. standard. This is a much more severe boost, and was, as the Dolby people have pointed out, often responsible for excessive limiting applied by FM stations to prevent illegal overmodulation of the transmitter at high frequencies.

The 25 microseconds combined with Dolby encoding should accomplish four things. (1) It will of course permit Dolby-equipped FM listeners to hear noise-reduced broadcasts, along with an increase in dynamic range if the station cooperates. (2) It will rid non-Dolbyized listeners of the curse of excess brightness they now hear on Dolby stations such as New York's WQXR. (3) It may permit FM stations to broadcast at higher average modulations than they've been able to (which is what they want to do, since the louder stations attract more listeners). (4) This in turn should rapidly accelerate acceptance of the Dolby system among FM broadcasters. Naturally, those who want to listen with Dolby decoding will have to convert their existing tuners to the 25-microsecond *de*-emphasis characteristic; but this is rarely a difficult modification. Many of the newer tuners and receivers already provide for it with readily accessible switching. And inexpensive add-on adapters (for use with external Dolby facilities) are already well into the product-planning stage.

It sounds like a good deal for everybody, and will bear further close watching. Incidentally, the first such broadcasts are scheduled for Chicago at the time of the 1974 Consumer Electronics Show, about which, more next month.

NEWS HIGHLIGHTS

Quasar Electronics Corp. is Born

Matsushita Electric Industrial Co., Ltd. has closed the agreement with Motorola, Inc. for the purchase by Matsushita of the operating assets of Motorola's home television receiver business in the U.S. and Canada. The purchases of the company's TV facilities at Franklin Park, Pontiac and Quincy, Ill., and the leased assembly plant in Markham, Ontario, and related inventories are all included in the transaction. Motorola will continue some of its auto radio operations at the Quincy plant until the title to the plant passes to Matsushita. Matsushita will operate the acquired assets through a new company called Quasar Electronics Corp., which will be a subsidiary of Matsushita Electric Corp. of America. The new company will market its TV sets under the "Quasar" brand. Matsushita's "Panasonic" brand products will continue to be marketed through their distributors in the U.S., Canada and Puerto Rico.

Philips Becomes "SQ" Licensee

Philips, a Netherlands-based international manufacturer and developer of the tape cassette system, has been licensed to manufacture and sell the CBS Records "SQ" quadraphonic system. Philips displayed a prototype of an audio product with a built-in SQ decoder at the Berlin Audio Fair and during the recent Festival du Son in Paris. With the addition of Philips, there are now over 100 audio manufacturers who have licensed and are using the matrixed quadraphonic disc system. CBS estimates that over 90 percent of all four-channel audio equipment sold is capable of playing SQ discs.

More Uhf TV Frequencies Not Needed by Land Mobile, Says NAB

Land mobile interests have requested that TV channels 14 to 20 be shared with mobiles in additional urban markets. These interests contend that the additional 115 MHz of spectrum already designated for land mobile use will not be adequate to meet their needs. Responding to this request, the National Association of Broadcasters told the FCC. "It is time to put an end to the land mobile practice of crying for additional use of uhf TV frequencies each time some of their channels become congested." NAB said that until there is a nationwide system of efficient frequency management techniques, the FCC should use mobile vans for local monitoring and reassign channels that are congested to those which show little use.

Demand for Calculator Chips Exceeds Supply

The world-wide demand for microelectronic calculator circuits will far exceed supply this year, according to the C.V. Kovac, vice president and general manager of the Microelectronic Device Div. of Rockwell International Corp. In spite of the build-up of circuit capacity by nearly every manufacturer of calculators, Kovac said that it still won't be possible to supply the demand in the exploding market in 1974, or even in 1975 and beyond if the present growth rate continues. He said that in 1974 the production of all calculators—consumer and professional models—is expected to be double the 14 million which were manufactured in 1973.

Largest Linear IC for Consumer Use

An integrated circuit is being produced that contains a complete four-channel, high-fidelity sound demodulator and preamplifier. Designated as the model QSI 5022, the circuit is said to be the largest linear IC ever produced for the consumer electronic industry. Developed by Signetics Corp., the circuit decodes four discrete channels of sound from a single CD-4 hi-fi disc recording. The IC contains all the sub-system functions needed to demodulate the disc. It handles the audio signal all the way from the phono pickup to the output drive for a four-channel volume and tone control. Another section of the IC amplifies and limits the carrier signal which is fed to two other sections on the chip—a phase-locked-loop FM demodulator and a carrier level detector.

Flat "Ribbon" Carbon-Zinc Battery

A flat throwaway carbon-zinc battery printed like a ribbon and cut to size is used in the film pack for Polaroid's new SX-70 camera. The battery represents the results of four years of intensive research and is manufactured by Ray-O-Vac. The battery operates the automatic exposure controls, the flash bulbs, and ejects the exposed film from the camera. It consists of four cells of 1.5 volts each, connected in series. Measuring less than 3½ in. x 2¾ in. and just ⅛ in. thick, the battery is designed to have a shelf life of about 18 months. The battery is bonded to a stiff paper card. It is then covered by a thin plastic film overwrap that is edge-bonded into place. The card itself has two punched circular holes that provide access to the steel foil contact areas on the battery's bottom surface.

From Cleveland Institute of Electronics

learn by doing!

Perform more than 200 exciting experiments with CIE's fascinating **ELECTRONICS LABORATORY PROGRAM!**

Put theory... into practice

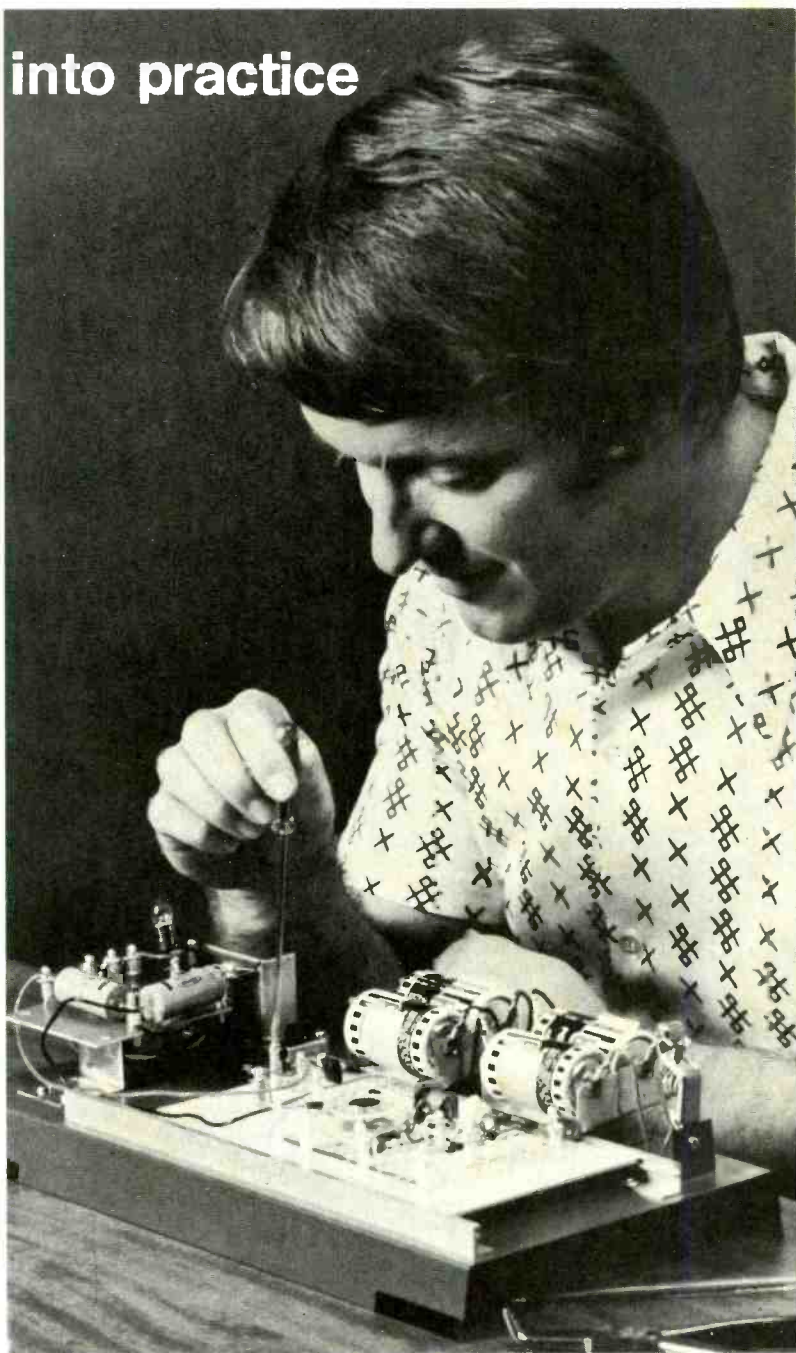
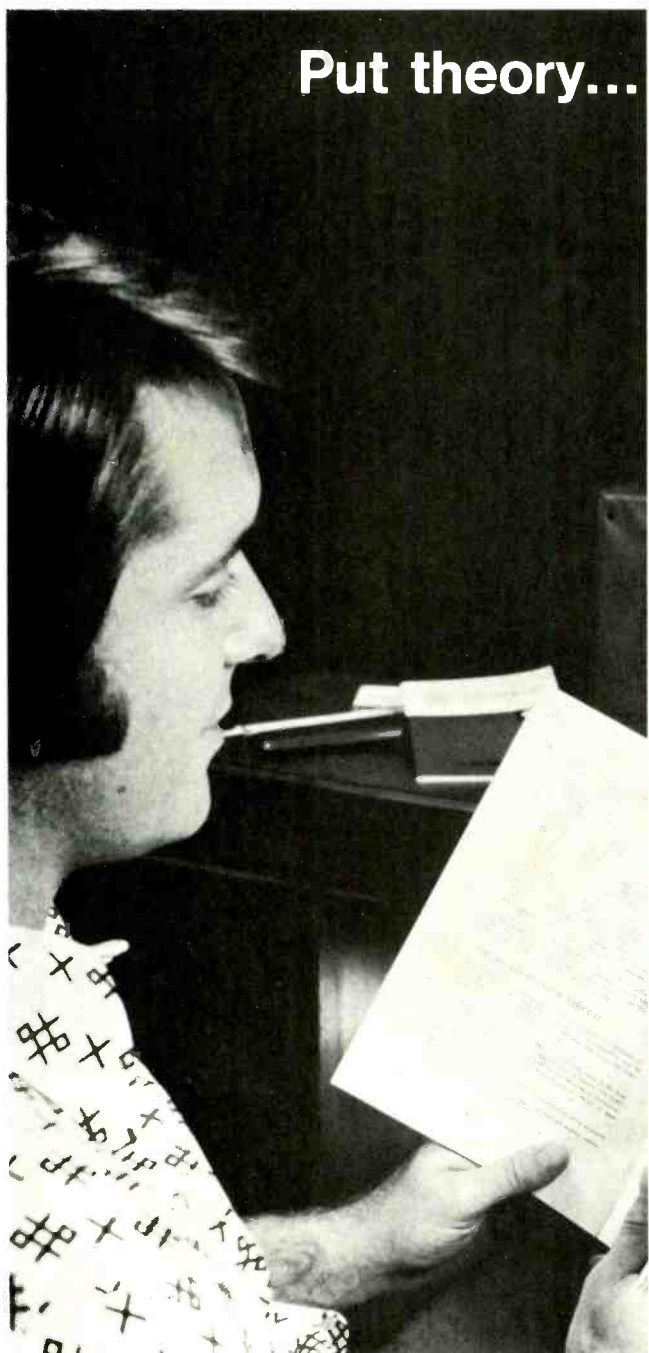

You get your own 161-piece electronics laboratory... with authentic electronic components used by industry!

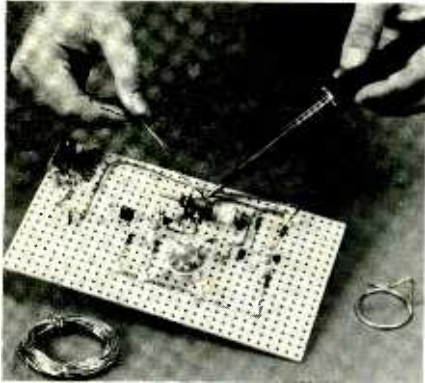

You learn how to construct circuits and connect them with a soldering iron, which is part of your CIE laboratory equipment. This "hands on" experience is extremely valuable in applying what you learn.

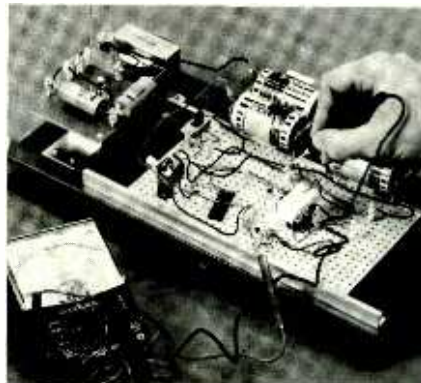

Testing and troubleshooting are an important part of your learning experience. Included in your laboratory is a precision "multimeter" to diagnose electrical and electronic troubles quickly and accurately.

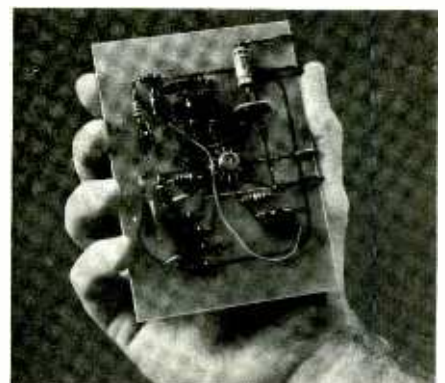

Modern space-age components like this IC (integrated circuit) are professional quality and can be used again and again in many of your projects. Lesson by lesson, piece by piece your knowledge grows!

Prepare now for a high income career in Electronics...the Science of the Seventies.

Electronic miracles are changing today's world with breathtaking speed.

And with this growth in electronics technology has come a brand new need . . . a demand for thousands of electronics technicians, trained in theory and practice to build the products, operate them and service them during the Seventies.

Don't just wait for something to "happen" in your present job. Get ready now for a career you'll really enjoy with a good income and plenty of opportunity for advancement.

Experience with experiments is your best teacher

"Hands on" experience helps to reinforce basic theory. When you learn by doing, you discover the "how" as well as the "why." You'll find out for yourself the right way as well as the wrong way to use electronic components. How to construct your own circuits, to discover trouble spots and learn how to fix them. And with CIE's special Auto-Programmed® Lessons, you learn faster and easier than you'd believe possible.

CIE's fascinating course, Electronics Technology with Laboratory, teaches you Electronics by making it work before your eyes. And you do it yourself, with your own hands.

Importance of FCC License and our Money-Back Warranty

Many important jobs require an FCC License and you must pass a Government licensing exam to get one.

But, a recent survey of 787 CIE graduates reveals that better than 9 out of 10 CIE grads passed the FCC License exam.

That's why we can offer this famous Money-Back Warranty: when

you complete our Laboratory Course, which provides FCC License preparation, you'll be able to pass your FCC exam or be entitled to a full refund of all tuition paid. This warranty is valid during the completion time allowed for your course.

You get your FCC License — or your money back!

You'll have high paying job opportunities

Electronics is still young and growing. In nearly every one of the new exciting fields of the Seventies you find electronics skills and knowledge are in demand. Computers and data processing. Air traffic control. Medical technology. Pollution control. Broadcasting and communications. With a CIE Diploma and an FCC License you can choose the career field you want . . . work for a big corporation, a small company or even go into business for yourself.

Here's how two outstanding CIE students carved out new careers: After his CIE training, Edward J. Dulaney, President of D & A Manu-

facturing, Inc., Scottsbluff, Nebraska, moved from TV repairman to lab technician to radio station chief engineer to manufacturer of electronic equipment with annual sales of more than \$500,000. Ed Dulaney says, "While studying with CIE, I learned the electronics theories that made my present business possible."

Marvin Hutchens, Woodbridge, Virginia, says: "I was surprised at the relevancy of the CIE course to actual working conditions. I'm now servicing two-way radio systems in the Greater Washington area. My earnings have increased \$3,000. I bought a new home for my family and I feel more financially secure than ever before."

Send now for 2 FREE BOOKS

Mail the reply card or coupon for our school catalog *plus* a special book on how to get your FCC License. For your convenience, we will try to have a representative call. If coupon is missing, write: Cleveland Institute of Electronics, Inc., 1776 E. 17th St., Cleveland, Ohio 44114. Do it now!



Approved
under
G. I. Bill

All CIE career courses are approved for educational benefits under the G. I. Bill. If you are a Veteran or in service now, check box for G. I. Bill information.

CIE Cleveland Institute of Electronics, Inc.
1776 East 17th Street, Cleveland, Ohio 44114
Accredited Member National Home Study Council

Please send me your two FREE books:

1. Your illustrated school catalog, "Succeed in Electronics."
2. Your book, "How to Get a Commercial FCC License."

I am especially interested in: Electronics Technology with Laboratory
 Electronics Technology Industrial Electronics
 Electronic Communications First Class FCC License
 Broadcast Engineering Electronics Engineering

Name _____ Age _____
(PLEASE PRINT)

Address _____

City _____ State _____ Zip _____

Veterans and Servicemen: Check here for G. I. Bill information.

PE-62

DISCRETE 4-CHANNEL

UV-15 2400 Q
DCF 2400

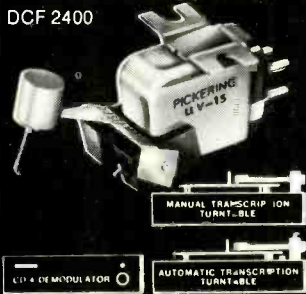

UV-15 2000 Q
DCF 2000

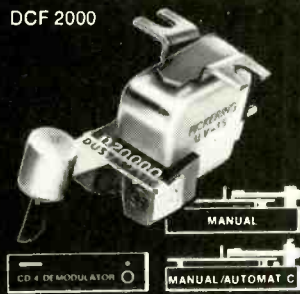

STEREO AND MATRIX

XV-151200E
DCF 1200

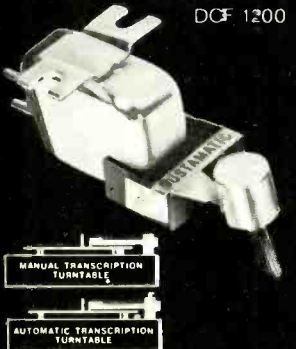

XV-15750E
DCF 750

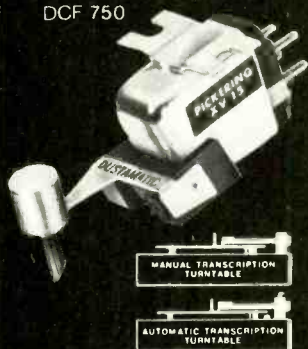

XV-15400E
DCF 400



XV-15350
DCF 350



XV-15200E
DCF 200



XV-15150
DCF 150



XV-15140E
DCF 140

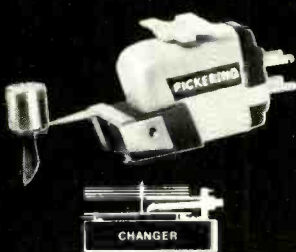

XV-15100
DCF 100

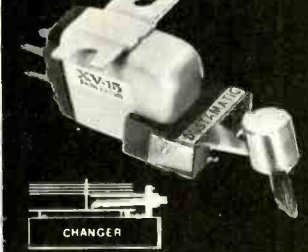

The right PICKERING cartridge for your equipment is the best cartridge money can buy.

They feature low frequency tracking and high frequency tracing ability!*

Pickering offers you "The Best of Both Worlds" in discrete 4-channel and in stereo cartridges. These cartridges have been specifically designed and engineered not only to peak specifications and performance characteristics, but also to achieve total compatibility with your music system to help you get the most out of it.

Only Pickering has developed a way for you to be absolutely certain you select the "right" cartridge for your music system. We did it first for stereo by developing our Dynamic Coupling Factor rating system—DCF for short—which identifies pick-up performance in terms of a quantitative measurement. The value of a DCF rating lies not only in its merit to define low frequency tracking ability but also in its measure as an index of **high frequency** (8 to 50 kHz) **tracing ability**. Pickering's DCF-rated pick-ups have exceptional **high frequency tracing characteristics**, vital for both stereo and discrete 4-channel performance. The Pickering cartridge exactly "right" for maximum performance with your equipment is simple to select because of this rating method.

Now, Pickering is also applying application engineering techniques and DCF ratings to its discrete cartridges. They fulfill the stringent requirements necessitated by the sophisticated nature of discrete discs.

So, whether stereo or discrete is your preference, choose from "The Best of Both Worlds" the Pickering cartridge exactly right for your equipment.

For further information write to Pickering & Co., Inc. Dept. PE, 101 Sunnyside Blvd., Plainview, New York 11803

***traceAbility™**

 **PICKERING**

"for those who can hear the difference"

GET 400 WATTS OF CLEAN
STEREO POWER WITH

AMPZILLA

SPECIFICATIONS

CONTINUOUS POWER (both channels driven)	4 OHMS Over 300 W per channel	8 OHMS 200 W per channel	16 OHMS 100 W per channel
THD OR IM (any level to full power)	Less than 0.2%	Less than 0.05%	Less than 0.05%
FULL-POWER FREQUENCY RESPONSE	±1 dB from 1 Hz to 100 kHz		
1-WATT FREQUENCY RESPONSE	±3 dB from 0.02 Hz to 500 kHz		



CONSTRUCTION

BY JAMES BONGIORNO

NOW YOU can build a super-power, high-fidelity stereo amplifier (200 watts per channel at 8 ohms with both channels driven) that boasts extremely low distortion, extra-wide bandwidth, ultra stability, very low noise and high inherent reliability! Called "Ampzilla," it is an audio power amplifier for kit builders who want truly high output power (see Hirsch-Houck Labs evaluation) that promises to retain its state-of-the-art design for many years.

The most distinctive visible feature of Ampzilla is its cooling chimney. This is a six-inch square opening extending from top to bottom of the amplifier. The output transistor heat-sink fins are interleaved within the chimney. A fan draws cooling air in at the bottom (which is raised from the supporting surface by plastic feet) and blows it over the fins and out the top.

In examining performance speci-

fications, observe that the full-power frequency response is within 1 dB from under 1 Hz to over 100 kHz. As a result, it will pass a full-power 20-kHz

square wave. Adherents of low-efficiency speaker systems and rock groups should also note that there's full power at the low end, 20 Hz. Addi-

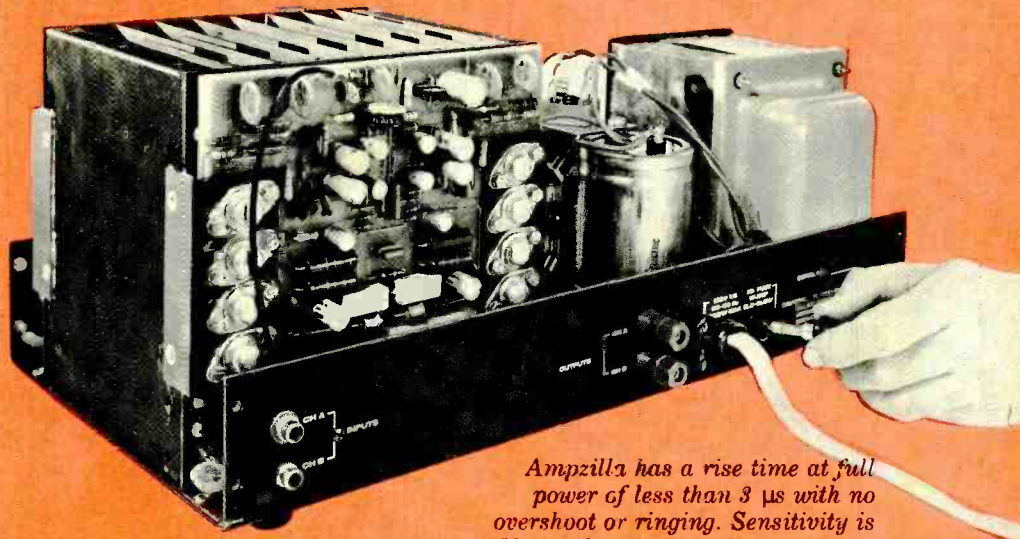

Ampzilla has a rise time at full power of less than 3 μs with no overshoot or ringing. Sensitivity is 1.63 V rms for 200 W at 8 ohms; input impedance: 70,000 ohms; damping factor; over 100.

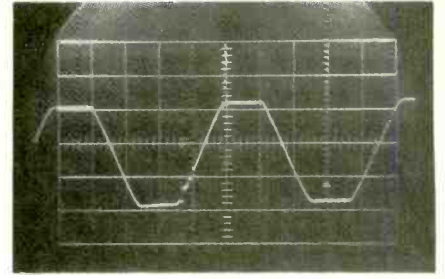
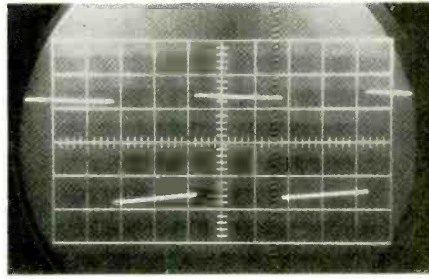
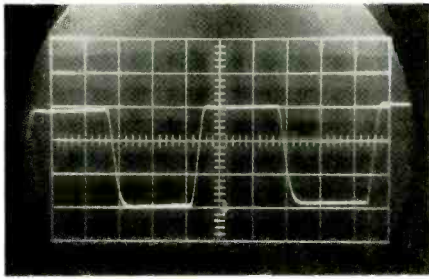

Fig. 1. Left to right: 20-kHz and 20-Hz square waves into 8 ohms at 200 W rms; and clipped 20-kHz sine wave also into 8 ohms.

tionally, if the amplifier should ever be driven into overload, clipping is as clean as can be. All this can be verified by examining the scope photos in Fig. 1.

Total harmonic and intermodulation distortion figures are unusually low at any power level up to clipping, as indicated in the specifications. Of special interest here is the absence of

crossover notch in the milliwatt region. The highly stable amplifier will not oscillate, blow fuses or otherwise misbehave even when working into a pure reactive load. And since the

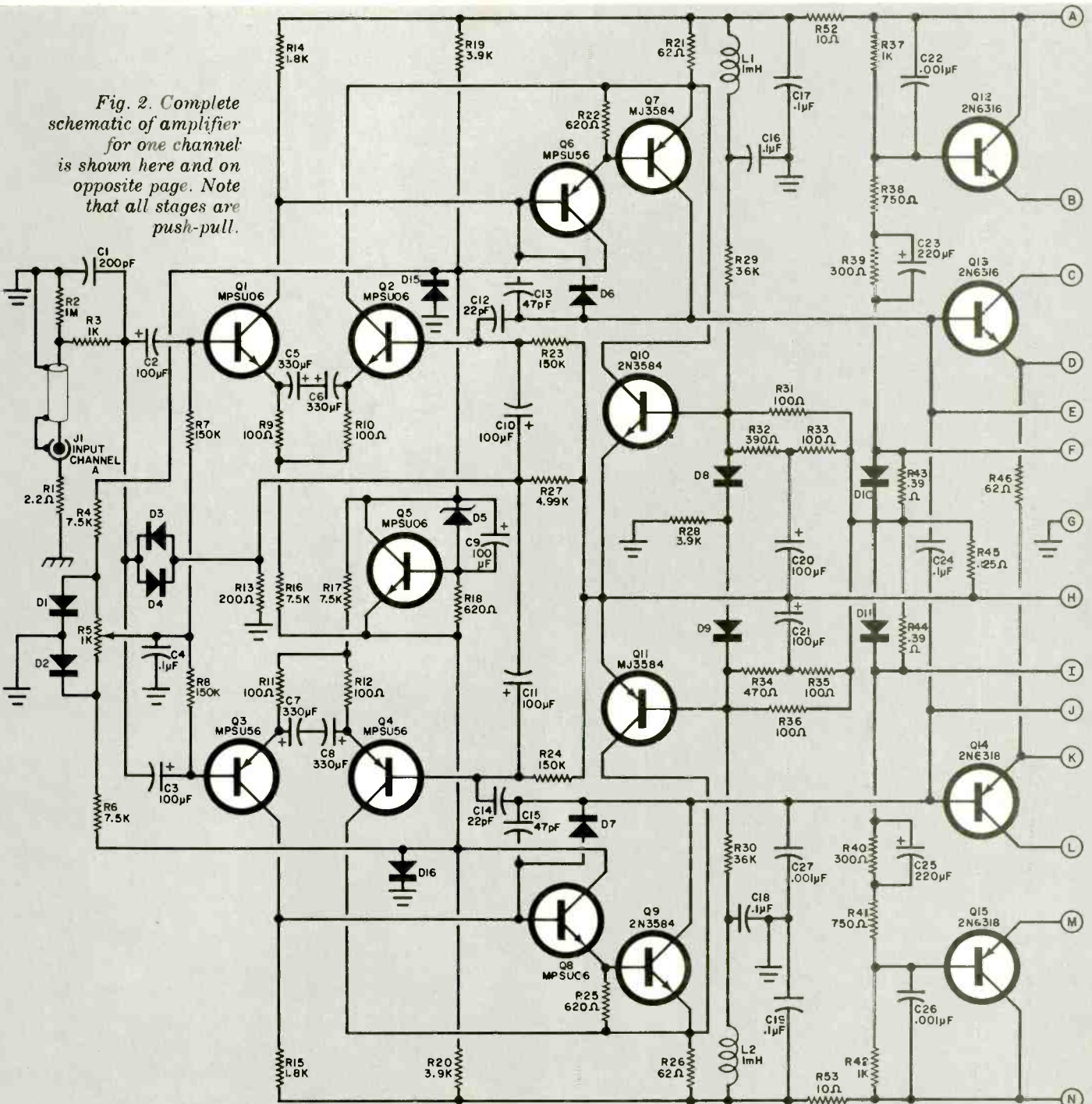

Fig. 2. Complete schematic of amplifier for one channel is shown here and on opposite page. Note that all stages are push-pull.

unit's design is fully pushpull from input to output, modulation noise is totally absent at low frequencies. Overall noise, too, is diminished since there is no ground loop. Measurements made with an r-f filter to eliminate r-f contamination yield a noise figure of -112 dB.

About the Circuit. Since most amplifiers employ a single differential input circuit, they are essentially single-ended designs. Virtually all power amplifiers can accurately reproduce sine waves fed into their inputs. However, it is not necessarily true that all amplifiers will accurately

reproduce music and voice signals that are generally nonsinusoidal and rarely have positive and negative peaks that are equal in amplitude. The obvious solution to accurately amplifying music and voice signals, of course, is to use separate amplifiers for the positive and the negative half cycles. If the amplifiers are identical, it is then possible to obtain a virtually "perfect" amplifier.

Due to its unique mirror-image design, Ampzilla is an almost perfect amplifier. The positive and negative half-cycle amplifiers in Ampzilla share a common feedback loop, an advantage for any source that must drive

the amplifier.

The biasing system in Ampzilla employs a unique integrated circuit (IC1 in Fig. 2) that contains five operational amplifiers. The op amps in this IC track the quiescent output current in such a way as to make thermal runaway impossible.

The output stage of Ampzilla operates in a quasi-class-A mode, while the driver and slave output stages are driven class A for the full cycle. Only the driven output transistors, Q17 and Q18, are operated class B. However, Q17 and Q18 do not switch from positive to negative. Rather, they traverse back through the class-A region at

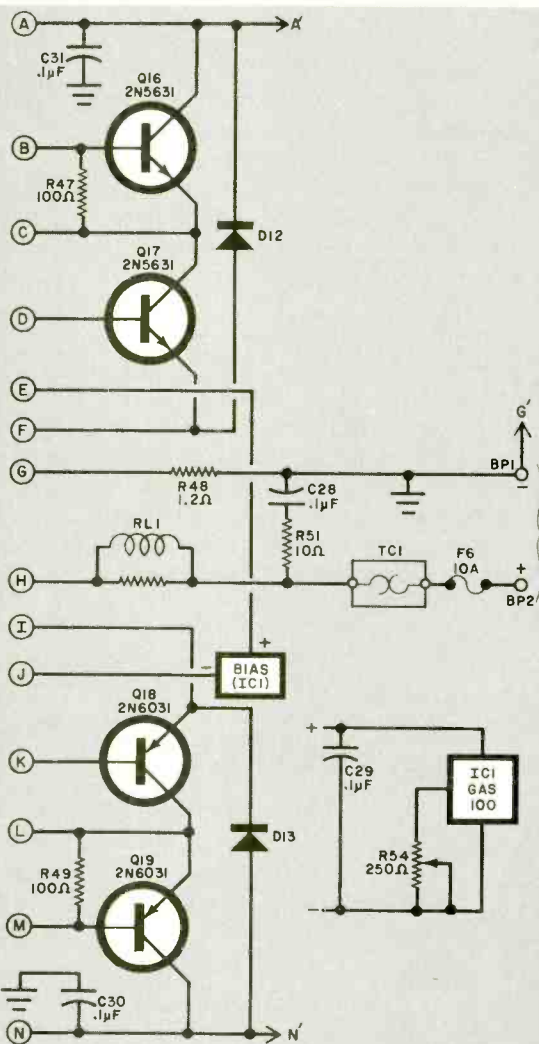

PARTS LIST

(For power supply and one channel)

- BP1, BP2—Five-way binding post (one red, one black)
- C1—200-pF, 100-volt ceramic capacitor
- C2, C3, C10, C11, C20, C21—100µF, 10-volt electrolytic capacitor
- C4, C24, C29—0.1-µF, 16-volt ceramic capacitor
- C5-C8—330-µF, 10-volt electrolytic capacitor
- C9—100-µF, 50-volt electrolytic capacitor

- C12, C14—22-pF, 500-volt, 10% ceramic capacitor
- C13, C15—47-pF, 500-volt, 10% ceramic capacitor
- C16-C19, C28, C30, C31—0.1-µF, 100-volt ceramic capacitor
- C22, C26, C27—0.001-µF, 500-volt, 10% ceramic capacitor
- C23, C25—220-µF, 16-volt electrolytic capacitor
- C32, C33—16,800-µF, 75-volt computer-grade electrolytic capacitor
- D1-D4, D15, D16—1N4148 diode
- D5—1N5878C 51-volt, 5% zener diode
- D6-D9—1N4938 diode
- D10, D11—1N5823 diode (do not substitute)
- D12, D13—1N4004 diode
- D14—MV5022 (Monsanto) diode
- F1-F4—AGC 6-ampere fuse
- F5—MDL 10-ampere slow-blow fuse
- F6—AGC 10-ampere fuse
- IC1—GAS100 op amp integrated circuit
- J1—Phono jack
- L1, L2—1-mH r.f.c. (12-ohm dc resistance) (Do not substitute for following transistors.)
- Q1, Q2, Q5, Q8—MPSU06 transistor (Motorola)
- Q3, Q4, Q6—MPSU56 transistor (Motorola)
- Q7, Q11—MJ3584 transistor (Motorola)
- Q9, Q10—2N3584 transistor
- Q12, Q13—2N6316 transistor
- Q14, Q15—2N6318 transistor
- Q16, Q17—2N5631 transistor
- Q18, Q19—2N6031 transistor
- R1—2.2-ohm
- R2—1-megohm
- R3—1000-ohm
- R4, R6, R16, R17—7500-ohm
- R7, R8, R23, R24—150,000-ohm
- R9-R12, R31, R33, R35, R36, R47, R49—100-ohm
- R14, R15—1800-ohm
- R18, R22, R25—620-ohm
- R21, R26, R46—62-ohm
- R29, R30—36,000-ohm
- R32—390-ohm
- R34—470-ohm
- R48—1.2-ohm
- R52, R53—10-ohm
- R5—1000-ohm, linear-taper trimmer potentiometer
- R13—200-ohm, ½-watt, 1% resistor
- R19, R20, R28—3900-ohm, 1-watt, 10% resistor
- R27—4990-ohm, ½-watt, 1% resistor

- R43, R44—0.39-ohm, 5-watt, 10% resistor
- R55—2000-ohm, 5-watt, 10% resistor
- R50—2.2-ohm, 2-watt, 5% resistor
- R51—10-ohm, 2-watt, 5% resistor
- R45—0.125-ohm, 10-watt, 3% resistor
- R39, R40—300-ohm, 1-watt, 2% resistor
- R37, R42—1000-ohm, 2-watt, 2% resistor
- R38, R41—750-ohm, 2-watt, 2% resistor
- R54—250-ohm, linear-taper trimmer potentiometer
- RECT1—200-PIV, 25-ampere bridge rectifier
- RL1—32 turns #16 enameled wire wound on R50
- S1—Dpdt 15-ampere switch (Cutler-Hammer No. 7241K2 or similar)
- T1—106-volt center-tapped, 12-ampere transformer (1500 volt/amperes)
- TC1—70° C thermal cutout (Elmwood Sensors)
- Misc.—Suitable heavy-duty alum. chassis; mounting bracket for RECT1 and fuse block; 1000-sq-in. finned heat sink; fuse block for four fuses; fuse holder for F5; fuse holder for F6; "Boxer" fan (IMC Magnetics Corp.); 3½-in. long L bracket with 1½-in. and 1-in. legs for small heat sink; silicone paste; insulators for transistors; insulating fish paper (goes between large pc board and chimney); shielded cable; No. 16 or No. 14 stranded and solid hook-up wire; heavy-duty ½-in. (minimum) tall hard plastic feet; No. 6 solder lugs (3); No. 6 crimp ring-type solderless lugs; small rubber grommet; heavy-duty three-conductor line cord; shoulder fiber washers (2) for J1; machine hardware; rubber washers (4) for mounting power transformer; solder; etc.

Note: The following items are available from the Great American Sound Co., Inc., 8780 Shoreham Dr., West Hollywood, CA 90069: Complete stereo amplifier kit, including assembly manual for \$340, plus shipping for 65 lbs. (specify fan speed: slow, medium of fast.); factory-wired for \$475; with wattmeters for \$525 (plus shipping); Set of four etched, drilled, screened, and staked pc boards for \$20; Special power transformer for \$100, plus shipping for 45 pounds; Chimney and L brackets, \$50; Special GAS100 operational amplifier IC for \$1.50. A power-reading wattmeter system with 2 meters and with a range selector switch is also available for \$35 in kit form or \$50 factory wired and tested.

All resistors ½ watt, 5%

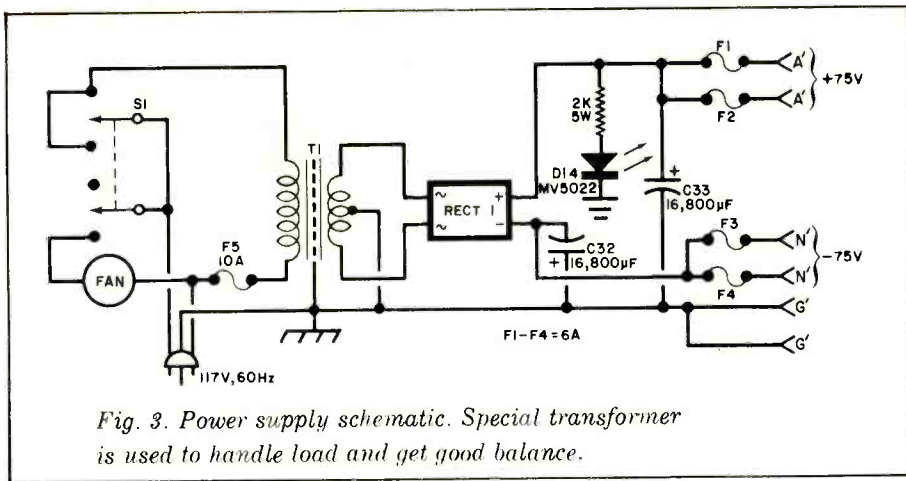

Fig. 3. Power supply schematic. Special transformer is used to handle load and get good balance.

the zero-crossing point. This eliminates the cross-over notch found in most other power amplifiers.

The complementary differential input pairs consisting of $Q1/Q2$ and $Q3/Q4$ are supplied current by the $Q5$ floating regulator circuit. This regulator also provides a turn-on/turn-off delay that eliminates thumps.

The output stage of the amplifier is a full-complementary series system that employs the latest in epitaxial-base power transistors. (These are special transistors. No attempt should be made to replace them with other types.) The predrivers and protection devices are designed to operate at frequencies up to 30 MHz; do not try to substitute other devices for them.

The power supply circuit for Ampzilla is shown in Fig. 3. Power transformer T1 has a special bifilar winding that exactly locates the center tap. The wire used in winding the transformer is heavy-gauge copper with a square cross section designed to eliminate ground loops. There are no commercial substitutes for the transformer that will work as well as that available from the kit supplier (see Parts List).

The open-loop gain of the amplifier is about 70 dB. So, filter capacitors C32 and C33 have unusually high capacity values because only the minimum amount of feedback has been designed into the amplifier to optimize the stability factor.

Construction. Assembling Ampzilla is a relatively simple, straightforward job. Almost all of the components mount on two (for each channel) printed circuit boards. The half-size etching and drilling guides and components placement diagram are shown in Fig. 4.

A convenient place to start assembly is by wiring the large pc board, referring to Fig. 4 for parts locations and Fig. 5 for details on how to mount $Q7$ and $Q9$ through $Q15$ and the metal heat sink bracket to the board. Note in Fig. 5 that the transistor mounting screw heads must be soldered to the board, necessitating the use of nickel-plated screws. Before soldering the screws down, place over each

a nylon shoulder bushing, followed by the bracket (make sure the bushings engage the bracket holes). Temporarily screw down the nuts to hold the assembly together.

After soldering the heads of the screws to the board, remove the nuts and mount the transistors, sandwiching between each transistor and the bracket an insulator liberally coated on both sides with silicone paste. Make absolutely certain that you install the transistors in their proper locations on the board. Then fasten each transistor down via its pair of machine screws with No. 6 lock-washers and 6-32 machine nuts. Solder the transistor leads to the board and clip away the excess lead lengths.

Finish assembling the large pc board by soldering into place a plastic-sleeve-insulated jumper wire on the foil side of the board (indicated by a dashed line in Fig. 4) and 16 small swage terminals at the locations indicated by the large black dots.

The small output circuit board has components mounted on both sides. Begin assembling the board by installing and soldering into place the socket for IC1 (on the side of the board that has no foil conductors), taking care to avoid solder bridges between the closely-spaced conductors. Mount the remaining parts of the out-

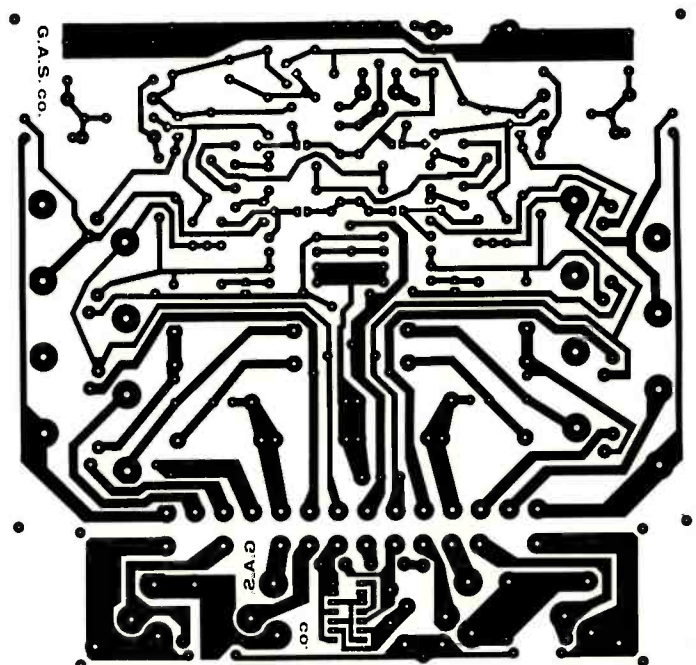
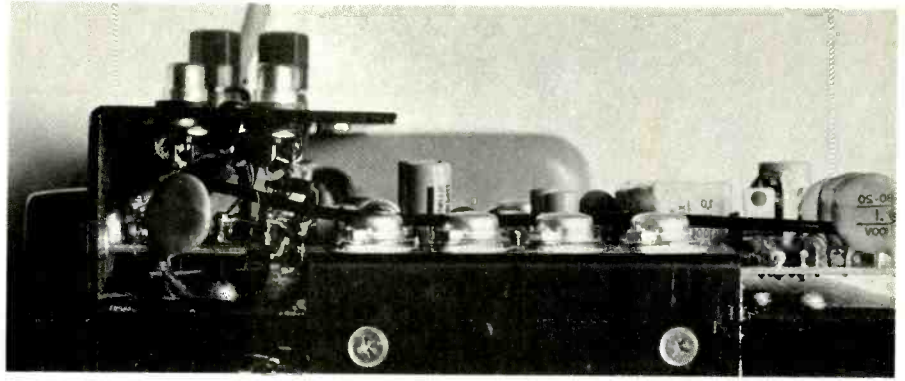

Fig. 4. Foil patterns for pc boards for one channel are shown half-size at the right. Component placement on opposite page.

put circuit (except R48 and the RL assembly), including the 14 small swage terminals along the board's upper edge and 3 large swage terminals along the lower edge.

Install IC1 in its socket. The power transistors *must* be installed in the following manner. First, place an insulator, liberally coated on both sides, on each transistor. Next, install the transistors in their respective locations on the chimney wall, and push into place the four molded transistor sockets. Make sure the shoulders on the sockets engage the holes in the chimney wall. Then, anchor the transistors in place with machine hardware. Finally, install the pc board assembly over the sockets



Detail photo of J1-input end of chassis and C31/C32 installation. Mounting of metal heat sink bracket is shown in Fig. 5.

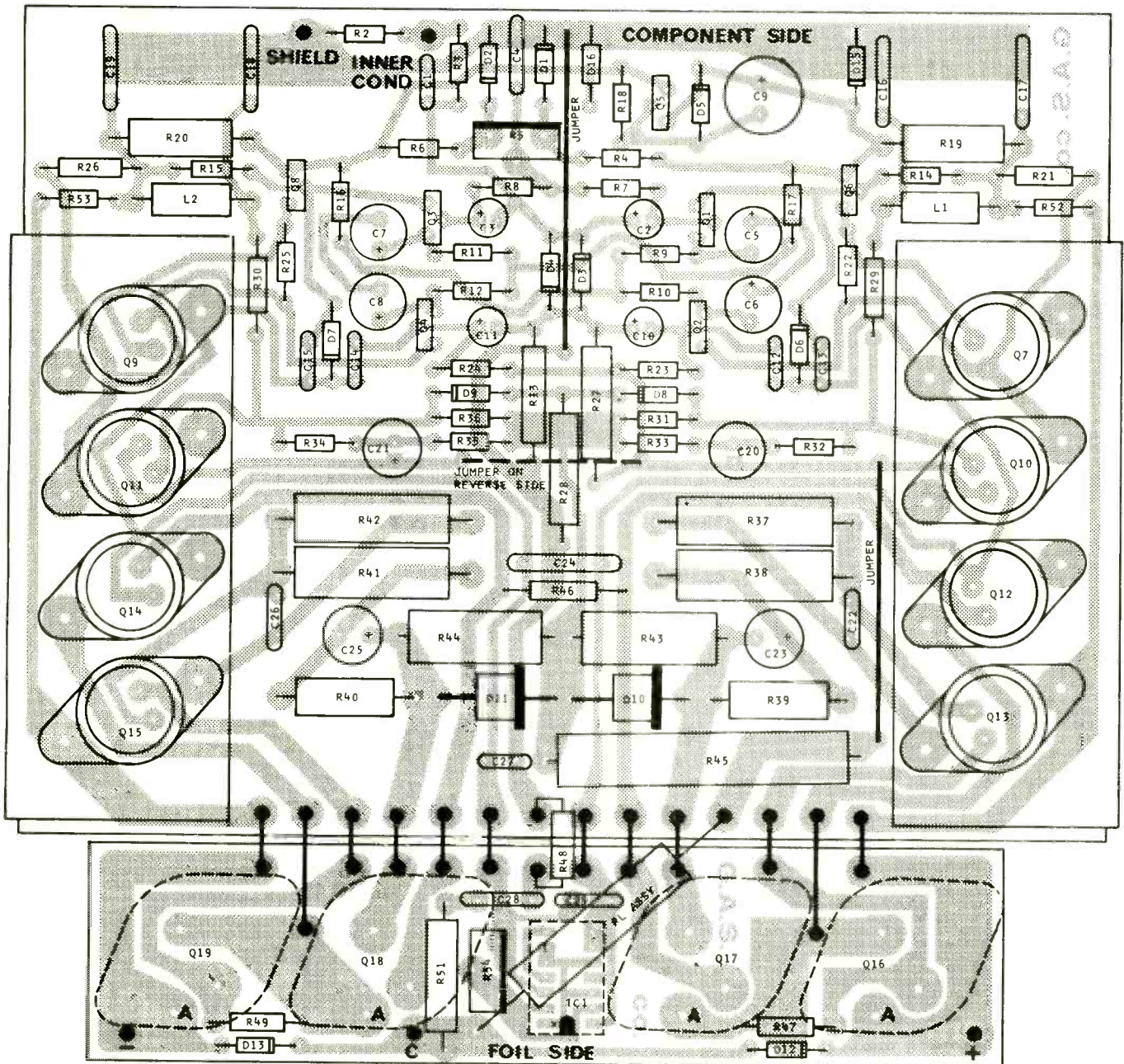

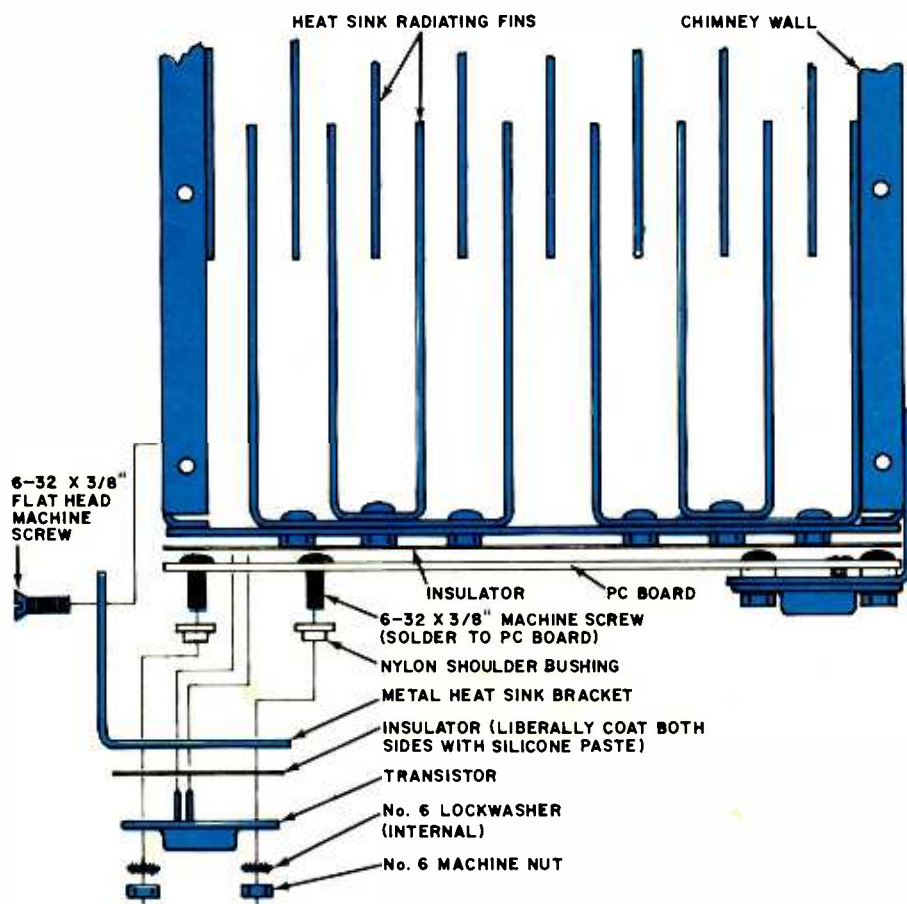

Fig. 5. Diagram shows mounting of the output transistors on their heat sinks.

and solder the socket tabs to the foil. (See Fig. 6.)

Bend a 1½-in. long by ½-in. wide piece of 0.040-in. thick aluminum shim stock into a shallow V shape. Wedge this between the top of the IC and chimney wall, with the point of the V against the IC's case.

Once the output circuit board is mounted in place, refer back to Fig. 5 and mount the large pc board to the chimney wall just above the output circuit board with four 6-32 × ⅜-in. flathead machine screws. Be sure that you sandwich a large piece of insulating fish paper between the foil side of this board and the chimney wall to avoid short circuits. Then,

using the small swage terminals on the small board and the lower row of terminals on the large board, interconnect the two boards with No. 16 or larger solid wire as shown in Fig. 4. Install and solder into place *R48* and the *RL* assembly.

What is left of assembly is largely mechanical work. The first things you should mount on the heavy-duty chassis are the four hard-plastic feet. These feet must be no less than ½-in. high to permit sufficient air to circulate. Next, mount the speaker output binding posts, *F5* fuse holder, three-conductor line cord (via a strain relief), and *J1* phono jack on the rear panel. Note that *J1* must be insulated

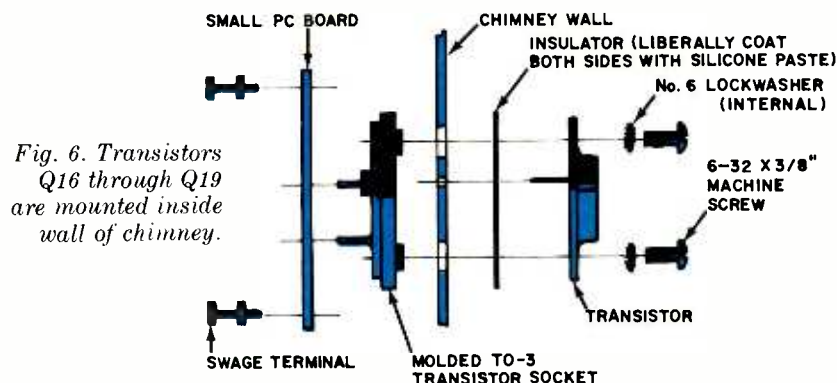

Fig. 6. Transistors Q16 through Q19 are mounted inside wall of chimney.

from chassis ground with a shoulder fiber washer setup.

The front panel contains power switch *S1* and speaker fuse holder. Note that *S1* has two power-on positions — one for fan only, and the other for fan and amplifier. If you elect to install a power-on indicator (the optional LED and current limiting resistor shown connected to the 75-volt line in Fig. 2), this should also go on the front panel, at the opposite end from the power switch.

Now, mount the heavy power transformer at one end of the chassis with No. 8 or No. 10 machine hardware (⅝-in. long screws, nuts, ½-in. flat washers, and lockwashers) as shown in Fig. 7. Shock mount the transformer by placing a deformable rubber washer between the mounting tabs and the chassis. Mount the dc-line power supply fuse block on the long side of the filter capacitor bracket and the rectifier bridge assembly on the top of the bracket.

Mount the filter capacitors in the center of the chassis with mounting rings and No. 6 machine hardware. Then mount the bracket to the positive terminal of *C32* and the negative side of *C33*, using the screws and lockwashers provided with the capacitors. Temporarily fasten down the bottom edge of the bracket to the chassis with a 6-32 × ¼-in. machine screw and nut.

Whether you build a monophonic or a stereophonic version of Ampzilla, the chimney must be complete to properly direct any heat buildup out the top of the amplifier with the aid of the fan. Once all four walls are in place, set the chimney assembly in place over its cutout and estimate the lengths of stranded No. 16 or No. 14 wire needed to interconnect the amplifier circuits with the input and output connectors, fuses, and power supply. Cut the wires needed to length and solder them to the appropriate swage terminals on both boards (four boards if you are building a stereo amplifier). (Note: If you buy the kit from the supplier given in the Parts List, these wires will come already cut to size and prepared at one end with solderless connectors.)

Remove the chimney assembly from the chassis. Coat the sensor end of *TC1* with silicone paste, and mount the thermal cutout on the blank wall of the chimney facing the filter capacitors. Fasten a No. 6 solder lug to the chimney wall near each end of

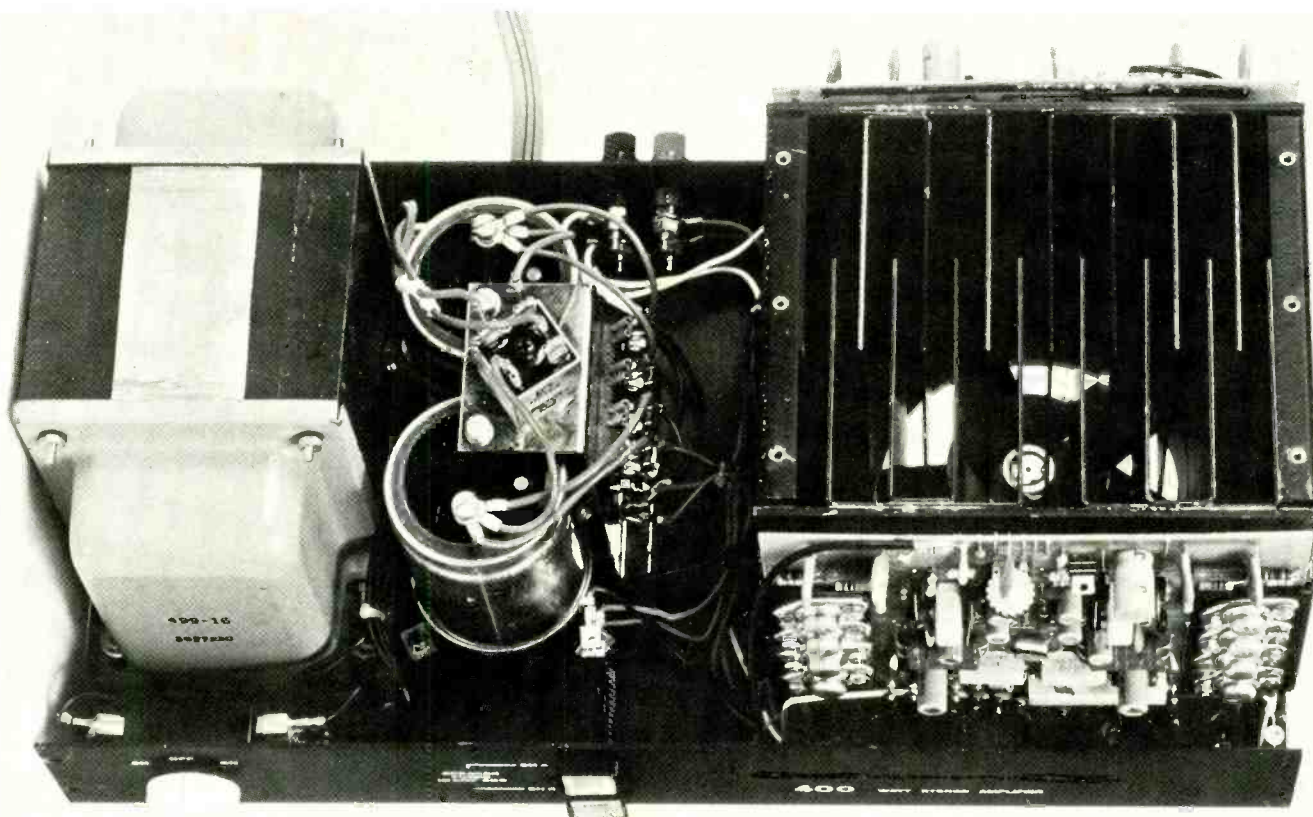

Fig. 7. Overall view of amplifier shows transformer mounting and fan at bottom of heat sink chimney.

the output circuit board and install and solder *C30* between the (-) swage terminal on the output board and one lug and *C31* between the (+) terminal and the other solder lug.

Mount the fan on the chassis over its cutout. Then pass its power cord through a rubber-grommet-lined hole in the chimney wall. Before mounting the chimney assembly in place, connect the shielded cable coming from across *R2* on the large pc board to *J1* and *R1* from the common lug on *J1* to a No. 6 solder lug mounted on the rear of the chassis.

With the chimney assembly in place, interconnect the rest of the cir-

cuit. The three heavy-gauge ground wires, two from the speaker ground terminals (in a stereo system) and the other from *T1*'s center tap, should be terminated in No. 6 crimp-type ring lugs and fastened to the chassis via the bottom mounting screw on the filter capacitor bracket. Finally, *D12* and *D13* install in the circuit directly from the appropriate lugs on the fuse block and proper terminal of *TC1*. To keep everything neat, bundle the cables with several cable ties.

Checkout & Adjustment. Install the Ampzilla's fuses. Then set bias potentiometer *R54* for minimum re-

sistance and offset potentiometer *R5* to center of rotation. Using an ohmmeter, connect one lead to speaker output binding post *BP2* ("hot" output connector) and touch the other test lead to each of the output transistors' cases (points marked with an A in Fig. 4), one at a time, and note the resistances. The meter pointer must indicate more than 500 ohms dc resistance for each transistor. Remove the test lead from *BP2* and connect it directly to chassis ground. Repeat the measurements on the output transistor cases. Allowing time for the filter capacitors to charge up, which might take several seconds, there should be no short-circuit indications from the transistor cases to ground.

Touch one ohmmeter test probe to the case of *Q7* and the other to the case of *Q9* (both on the large pc board). These are the two bias points, and the ohmmeter should indicate a resistance of 2000 ohms or less — if the bias potentiometer is still set for lowest resistance.

If the resistance measurements check out, connect a dc voltmeter between one channel's "hot" output speaker binding post (*BP2*) and chassis ground. Disconnect the power lines from the channel not under test. Wrap a couple of turns of electrician's tape around the free ends of the dis-



The complete Ampzilla with covers in place measures 17½ inches wide by 7 inches high by 9 inches deep.

Hirsch-Houck Labs Tests Ampzilla

Ampzilla is aptly named. Its 45-pound (20.5-kg) weight and more than 400 watts of output power place it solidly in the audio "monster" amplifier class. The heavy-duty, three-conductor power cord emphasizes the fact that this brute is definitely not to be plugged into an ordinary switched outlet on a preamplifier.

Laboratory Measurements. With both channels driven simultaneously at 1000 Hz into 8-ohm loads, the output waveform clipped at 225 watts/channel. Into 4-ohm loads, the maximum power was 350 watts/channel, while into 16-ohm loads it was 132 watts/channel.

Using 8-ohm loads, the 1000-Hz THD was less than 0.01 percent for all power outputs up to 200 watts/channel. It rose to 0.03 percent at 220 watts/channel just before clipping occurred. The IM distortion followed a similar pattern, measuring just less than 0.01 percent up to 200 watts/channel and reaching 0.43 percent at 220 watts/channel. The low-level IM distortion was exceptionally low, indicating a complete lack of crossover "notch" distortion. It measured about 0.01 percent from 7 milliwatts to 25 watts output, with a smooth rise to 0.037 percent at the rated 200-watt output.

We drove the amplifier at frequencies from 20 Hz to 20,000 Hz to 200, 100, and 20 watts/channel output into 8-ohm loads. The harmonic distortion measured between 0.003 percent and 0.01 percent at all power levels for frequencies higher than 200 Hz. It rose slightly at the lower frequencies to a maximum of 0.05 percent at 20 Hz (at the 200-watts/channel level).

The gain of the amplifier is fixed. An input of 0.35 volt (350 mV) was needed to drive it to a reference 10-watt output, while 1.7 volts drove it to the clipping level. The output noise was 83 dB below

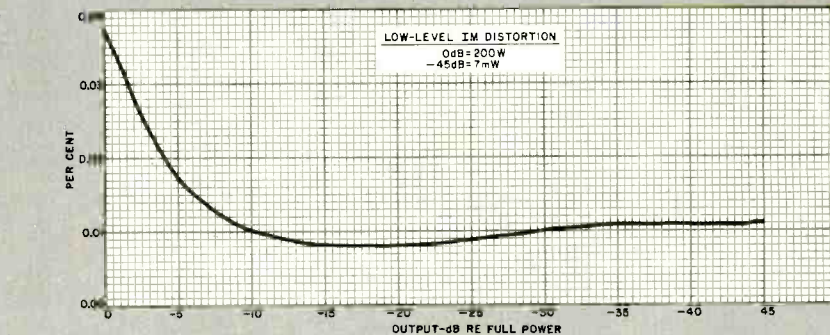

Low-Level IM distortion is exceptionally small, indicating there is no crossover notch.

Curves of distortion vs power output show under 0.01% THD to 200 watts output.

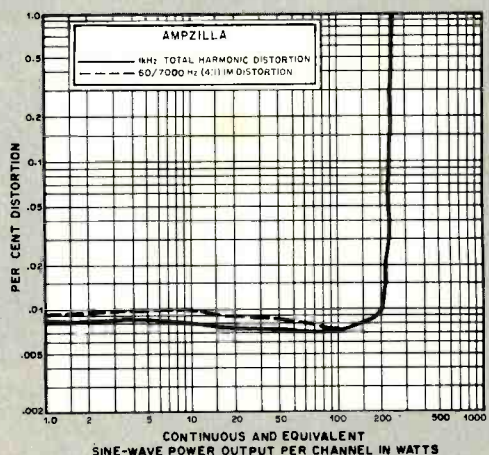

10 watts (96 dB below rated power). As would be expected from a top-quality amplifier, the frequency response of Ampzilla was flat over the entire audio range and well beyond. Our measurements revealed a variation of less than ± 0.1 dB from 5 Hz to 40,000 Hz. The response was down 1 dB at 200,000 Hz and 3 dB at 330,000 Hz. The square-wave rise time was 1.3 μ s.

User Comment. Ampzilla is a state-of-the-art amplifier in its electrical characteristics. Unlike other amplifiers of comparable ratings, this one runs lit-

erally cool to the touch even after extended full-power operation. (The middle-speed cooling fan was incorporated in the test unit.) In fact, at the conclusion of our tests, which frequently overheat amplifiers and trip their thermal protective devices, the heat sinks on Ampzilla were still cool to the touch. The only signs of heat were in the vicinity of our test load resistors.

All in all, we cannot imagine a less expensive way of obtaining several hundred watts of cool audio power with truly insignificant distortion than is available with Ampzilla.

connected wires to prevent them from shorting together or to the chassis while you perform the following test. Plug the line cord into a three-wire grounded 117-volt, 50-Hz ac receptacle and set power switch S1 to the amplifier-on position. With the power on, if the voltage indication is greater than +0.5 or -0.5 volt, immediately turn off the power and look for the trouble. However, if you obtain the proper voltage indication, turn off the power and unplug the line cord. Wait a minute or so until the charge on the filter capacitors bleeds off; then, reconnect the wires to the unchecked channel's pc board. Perform

the same test on the untested channel with power disconnected from the first channel.

If both amplifier channels check out good, adjust the offset potentiometer (R5) in each channel for a zero dc voltage indication between each BP2 speaker output binding post and ground.

To obtain the best results from this amplifier, a commercial distortion analyzer should be used. But since most of us do not have access to such a piece of test equipment, very good results can be obtained when making adjustments with the aid of only a dc voltmeter.

Connect the voltmeter's test leads to the cases of Q7 and Q9, one on each. Adjust bias potentiometer R54 until you obtain a reading of 2.0 volts. This is an approximate setting, just a little less than is actually needed. But it is in a "safe" area because too much bias can thermally destruct the output transistors.

The amplifier is now ready to be put into service in your hi-fi system. One word of caution: It is very possible to destroy a set of loudspeakers with an amplifier as powerful as Ampzilla. So, take care with your selection of speakers and hold the drive signal down to a reasonable level. ♦

A PRIMER ON SINGLE SIDEBAND

Methods of SSB signal generation, transmission and reception

BY JAMES E. TRULOVE

SINGLE-SIDEBAND, or SSB, modulation has begun to supplant conventional amplitude modulation (AM) in electronics communication. Many military and commercial systems have made the switch. So, too, have a great many amateur radio operators. More recently, Citizens Banders have joined the ranks of the SSB communicators.

SSB modulation has distinct advantages in communications. One of the most important is its inherent conservation of the crowded frequency spectrum. When compared to conventional AM, SSB requires only half the spectrum space, in effect doubling the number of channels in a given portion of the frequency band. A good example of this is the 27-MHz CB band where only 23 channels are available with AM, while 46 channels of SSB fit into the same band.

SSB is also much more efficient than AM. In AM, most of the power is

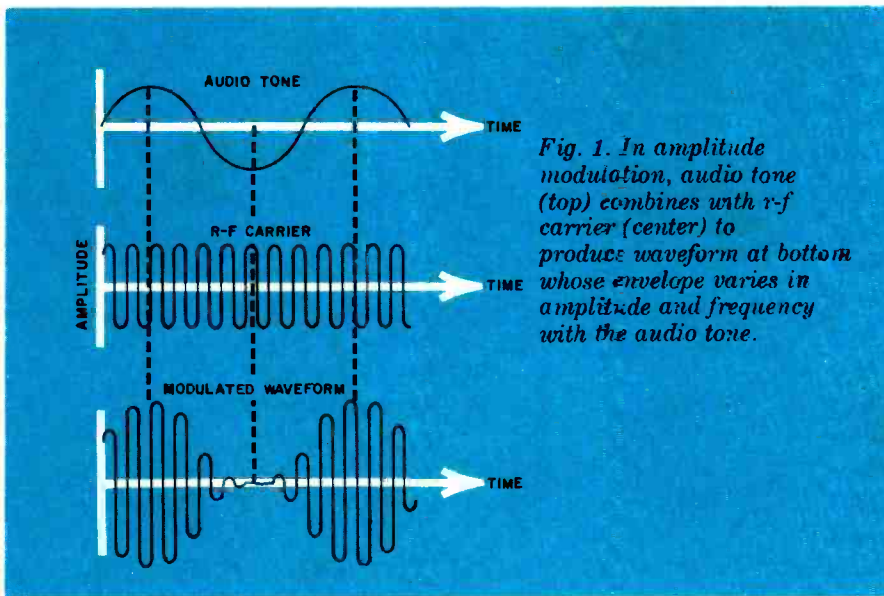

Fig. 1. In amplitude modulation, audio tone (top) combines with r-f carrier (center) to produce waveform at bottom whose envelope varies in amplitude and frequency with the audio tone.

concentrated in the r-f carrier. By contrast, SSB suppresses the carrier and concentrates most of the power in the information-bearing sideband signal. This, coupled with greater immunity to selective fading, gives SSB communication much greater "talk power" than is possible with conventional modulation techniques.

The Basis of SSB. To transmit a signal over a given distance, information is imposed on a r-f wave. The r-f wave serves as a "carrier" — hence its name — for the lower-frequency information. Successful communication results from proper utilization of the frequency-dependent properties of the carrier, as well as efficient use of the transmitted energy.

The information can be imposed on the r-f wave by modifying, or modulating, the carrier as the result of varying the carrier's frequency or amplitude (or both). Frequency modulation (FM) and amplitude modulation (AM) and simultaneous amplitude and frequency modulation (AM/FM) can take a wide variety of forms.

AM in its basic form is perhaps the easiest to produce. To impress an

audio-frequency (a-f) modulation on a r-f carrier, the carrier is made to vary in amplitude according to the instantaneous amplitude of the a-f signal by a process known as "mixing." In Fig. 1, the audio and carrier waveforms are combined to produce the modulated r-f wave shown at the bottom. Notice that the relative peak-to-peak amplitude of the modulated wave varies in accordance with the relative amplitude of the modulating audio.

Mathematically, the amplitude-modulated signal contains several discrete frequencies for any given carrier and audio inputs. As shown in Fig. 2A, the output consists primarily of the original and carrier signals, plus two additional mixing products whose frequencies are the sum and difference of the a-f and r-f signals. Called "sidetones," these two frequencies are equally spaced on either side of the r-f carrier's frequency. (There are many other mixing products, including harmonics of the inputs and outputs and their mixing products, but these are almost negligible and need not be considered in this discussion.)

When the audio input is of varying

frequency and amplitude, as is the case with voice, the sidetones vary in strict accordance, producing what may be termed "sidebands" on either side of the carrier. The sidebands form the characteristic "envelope" of the modulated waveform. These sidebands contain all the original audio information and are essentially mirror images of each other. With 100-percent modulation, the carrier contains twice as much power as the total in both sidebands, yet the carrier conveys no usable information. Also, since the sidebands are mirror images of each other, only one is needed for effective communication. This means that what remaining power there is must be divided between the two sidebands. Hence, under the very best of modulating conditions in AM, less than 25 percent of the available power goes into the information signal.

In SSB communications, one sideband and virtually all of the carrier are eliminated. After all, the audio signal already has both frequency and intensity. The frequency information is transmitted as the difference between the carrier reference and sidetone frequencies. The intensity information is characterized by the amplitude of the sidetone. So, one sideband of an amplitude-modulated wave can carry the audio signal if the reference frequency of the original carrier is available. The suppression of the carrier and elimination of one sideband permits all of the available power to be concentrated in the information-bearing signal (see Fig. 2B), effectively multiplying power efficiency while halving the bandwidth required.

An interesting aspect of the SSB signal is that it disappears when there is no modulation. (In conventional AM, the carrier is present regardless of whether or not it is modulated. In other words, the carrier has accompanying sidebands only when modulated.) In SSB, filtering out all but

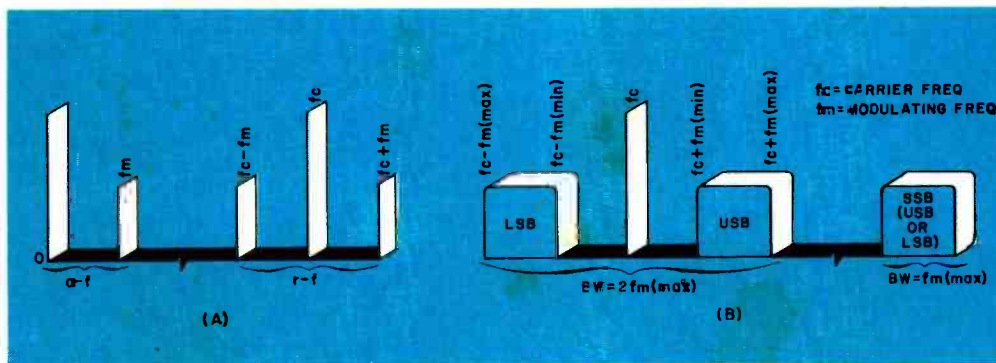

Fig. 2. Frequency components of AM and SSB signals are shown in (A) and (B), respectively.

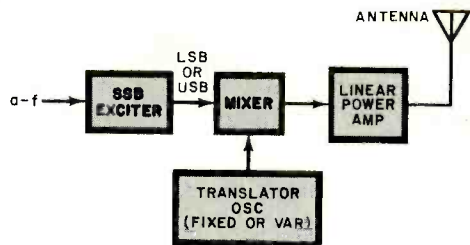

Fig. 3. Basic block diagram of SSB transmitter.

one sideband causes the sideband to disappear when modulation ceases.

The SSB Exciter. Unlike conventional AM, the SSB signal is usually generated at a low power level in a separate transmitter stage known as an "exciter." SSB signal generation is easier to accomplish at a fixed frequency. The output of the exciter is translated in a mixer to the desired transmit frequency and is then amplified to the desired power level. (See Fig. 3.)

output voltages and lower unwanted mixing products than both the shunt and series modulators.

After the double-sideband (DSB) suppressed-carrier signal is generated in the balanced modulator, one of the sidebands must be eliminated by filtering. This is no easy task because the two sidebands are very close together in frequency. If the lowest modulating frequency is 300 Hz, the sidebands will be only 600 Hz apart. Hence, filtering must be accomplished by a very high-Q filter

Since the filter is designed for a fixed frequency, some method must be used to permit selection between the upper sideband (USB) and lower sideband (LSB). Two expensive filters can be used, but it is simpler and more economical to switch the carrier frequency input to the balanced modulator. For example, if the filter's output is the USB signal, the carrier oscillator can simply be raised by a fixed amount (usually 3 kHz) so that the LSB signal is at the filter's frequency. The carrier oscillator is usually crystal controlled. So, the change from USB to LSB and vice versa can be easily accomplished by switching crystals as shown in Fig. 5B.

The "phasing" exciter is another type sometimes encountered in SSB. It has two balanced modulators and two phase-shift networks, one for audio and the other for the carrier. The modulator outputs are combined in such a manner that one sideband is reinforced while the other is cancelled. This scheme requires critical

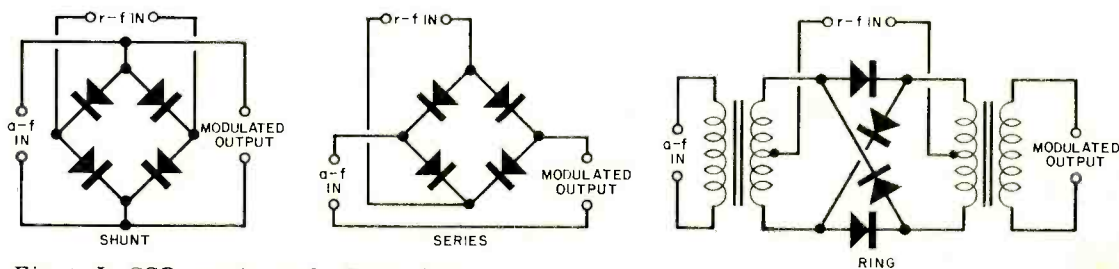

Fig. 4. In SSB, carrier and r-f signals are mixed in balanced modulators. Outputs have suppressed carriers.

The balanced modulator, a type of mixer that suppresses the carrier at its output, is basic to the SSB exciter. The basic types of balanced modulators shown in Fig. 4 include shunt, series, and ring (or double-balanced) types. The shunt and series types may contain two or four diodes, with the latter versions often referred to as "bridge" or "quad" modulators.

The operation of the balanced modulator can be visualized as an audio signal being switched on and off at the rate (frequency) of the r-f carrier. If the modulator is in balance, the carrier is cancelled at the output and only the two sidebands remain. Balancing of the modulator is achieved by close matching of the diodes and by trimming. In a properly designed and balanced circuit, carrier suppression can be as much as 50 dB. The ring modulator provides good carrier suppression with higher

with a narrow passband and steep side skirts. A relative comparison between an ideal filter, a multiple-pole crystal or ceramic lattice filter, and an ordinary LC filter is shown in Fig. 5A. From the evidence of the curves, it is obvious why a crystal or ceramic filter is the usual choice in SSB.

phasing for each frequency if no frequency translation is provided. Another disadvantage is that circuit complexity is considerably greater than with the filter method.

Frequency Conversion. Since filter requirements force the exciter to

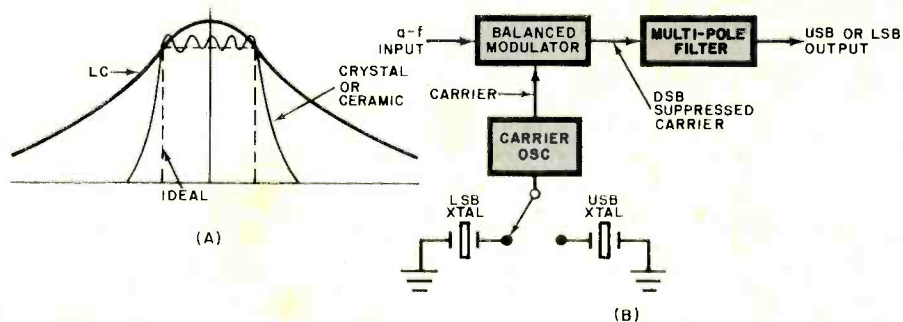

Fig. 5. Relative comparison between ideal, crystal or ceramic and LC filters shown at (A). (B) shows elements of SSB exciter.

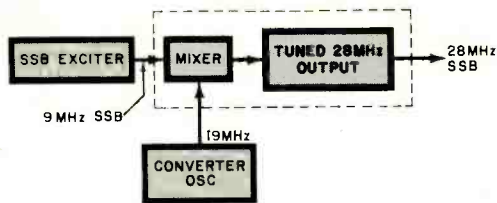

Fig. 6. Typical converter stage translates exciter output to desired transmit frequency.

operate at a fixed frequency, a converter must be used to translate the exciter's output to the operating frequency. The converter consists of a mixer with a tuned output and an oscillator that can be either fixed or variable, depending on the requirements. The mixer produces the sum and difference products of the output of the exciter and the converter oscillator. The tuned mixer output passes the mixer product at the transmitter frequency.

To illustrate this process, refer to Fig. 6. Here, a 9-MHz SSB signal, mixed with a 19-MHz crystal oscillator frequency, produces sum and difference products at 10 and 28 MHz. The tuned output allows only the 28-MHz signal to pass. The 28-MHz signal has acquired the SSB-modulation from the 9-MHz exciter output. The signal can now be amplified and transmitted.

The conversion from 9 to 28 MHz is referred to as "up-conversion." Similarly, "down-conversion" can be used to convert from 9 MHz to, say, 7 MHz. If a band of frequencies, such as from 28.0 to 28.5 MHz, must be covered, switching crystals from 19.0 to 19.5 MHz could be used in the converter. However, this can become cumbersome if many frequencies are required. Frequently, a variable-frequency oscillator (vfo) is substituted in the converter to allow continuous coverage of a given frequency increment. A vfo with a 500-kHz range from 19.0 to 19.5 MHz would do the job, but it must be very stable to obviate any drift in frequency.

The converter provides two choices for the oscillator frequency that will produce the desired output. In the above example, a 37-MHz oscillator would produce primary mixing products of 28 and 46 MHz. The choice between the two oscillator frequencies is based on a number of factors, including oscillator stability, mixer efficiency, crystal stability, and cost. If the difference product is selected, as in the 37-MHz case, an inversion of

the sideband occurs. This means that, if the 9-MHz exciter output was USB, the converter output produced by subtracting 9 MHz from 37 MHz would be the 28-MHz LSB. This phenomenon does not occur when the sum product is selected.

Linear Amplifiers. Once the SSB signal at the proper frequency is generated, it must be amplified to the desired output power level. Both AM and SSB signals can be severely distorted by any nonlinearities in the

harmonic mixing are shown. Notice that some of these products are within the normal bandpass and others are adjacent to it. These spurious outputs can cause significant interference to adjacent channels and, if distortion is very bad, even frequencies far removed.

There is another common source of distortion that can be confused with power amplifier nonlinearity. This is distortion at the audio input due to either excessive clipping or compression in the audio stages or overmodulation.

The two-tone signal can also be used for determining the power contained in an SSB signal. The waveform of a two-tone SSB signal is shown in Fig. 9. The signal is rated in peak-envelope power (pep) developed by two tones of equal amplitude. Pep can be calculated by squaring the rms value of the peak envelope voltage E_p and dividing the

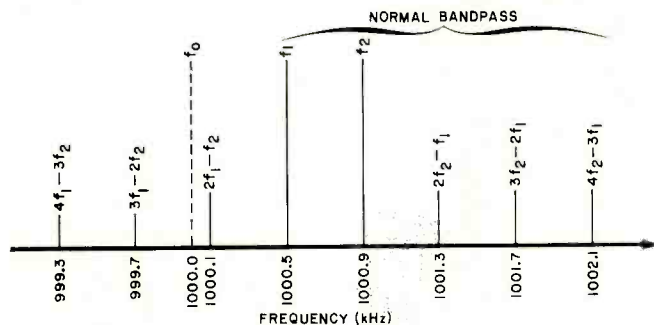

Fig. 7. Distortion products created by r-f amplifier nonlinearities create "splatter" on adjacent frequencies.

driver or power amplifiers. In an AM transmitter, this problem is usually avoided by modulating the carrier in the final r-f stage. This "high-level" modulation cannot be used in an SSB transmitter where a low-level exciter signal must be greatly amplified. For this reason, it is important that amplifier stages be extremely linear to limit distortion to an absolute minimum.

The distortion products created by amplifier nonlinearities can appear in and around the SSB signal at appreciable power levels. Distortion products are produced by means similar to those in the mixer. To illustrate, if a two-tone 500- and 900-Hz test signal were applied to the audio input using a 1000.0-kHz USB signal, the modulation would appear at 1000.5 and 1000.9 kHz. In Fig. 7, the lower-order distortion products resulting from

result by load resistance R ($\text{pep} = E_p^2/R$). In the two-tone case, the pep is twice the average power dissipated in the load.

Receiving SSB. The SSB receiver is similar to any other superheterodyne receiver (see Fig. 9). Nonlinearities in the r-f or i-f amplifiers will cause distortion in the SSB receiver just as they will in the AM receiver. Distortion due to overloading the amplifier is reduced by the automatic gain control (agc).

The agc must be designed differently for SSB reception. Unlike AM where the carrier is present even when there is no modulation, the SSB signal disappears completely in the absence of modulation. For this reason, the agc must reduce amplifier gain quickly when it first senses a strong SSB signal and increase the

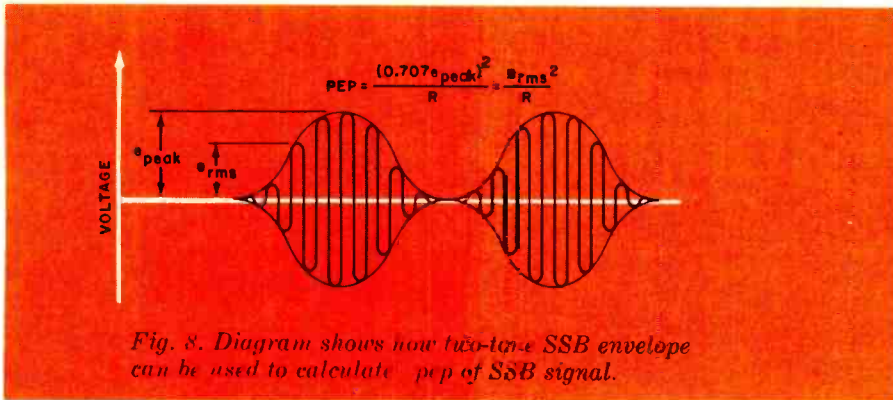

gain very slowly when the signal disappears. This fast-attack, slow-release response compensates for short pauses in conversation. In some receivers, the sustaining time of the agc can be adjusted as desired.

The r-f amplifier, mixer, and local oscillator are similar to the circuits found in AM receivers. The i-f amplifier, however, can be much narrower in bandwidth since the SSB signal is less than half the bandwidth of an AM signal. Reducing i-f bandwidth has the added advantage of reducing the total noise power presented to the detector. Frequently, the local oscillator frequency is selected so that the high-Q mechanical or crystal filter in the SSB exciter can also serve as the i-f filter.

SSB demodulation is radically different from AM detection. As mentioned earlier, the SSB signal varies in frequency from a reference, depending on the modulating signal frequency. The reference was originally supplied by the r-f carrier. That reference carrier must again be simulated to provide something with which to compare the SSB signal frequency. Thus, the receiver must inject a simulated carrier into the detector by means of a carrier-reinsertion oscillator or beat-frequency oscillator (bfo). The bfo is usually crystal controlled to maintain a high order of stability.

The proper bfo frequency depends on whether the signal to be received is USB or LSB. In the case of USB, the bfo frequency must be lower than the signal frequency, while for LSB it must be higher than the signal frequency. Crystal switching changes the bfo from the lower edge of the i-f passband to the upper edge to receive USB or LSB.

The actual process of detection can occur in an AM-type integrating detector after the bfo signal is injected. But much higher quality detection

can be obtained with a "product detector." (Examples of product detectors are shown in Fig. 10.)

The quality of the received audio depends to a large extent on how close the reinserted carrier is to the frequency of the original carrier. To allow for some drift or misalignment between the transmitted signal and the receiver's local oscillator and bfo, a means of adjusting one or both oscillators must be included. A trimmer for either oscillator might go under various names, the two most popular being "fine tuning control" and, in

the case of CB radio, "clarifier." In some sophisticated receivers, this function is accomplished by an automatic-frequency control, similar in function to the afc circuit used in FM receivers. Without the aforementioned control, speech would be unintelligible.

In Conclusion. The use of SSB modulation offers distinct advantages for the modern communicator. Especially in the high-frequency bands, SSB conserves valuable spectrum space. Where the total output power (or input power to the transmitter's final amplifier) is limited by government regulation, SSB packs all the power into one no-nonsense information signal to provide greater communicating range and reliability. If maximum power is limited by tubes or transistors, SSB provides an increase in overall efficiency. In fact, it can be demonstrated that, compared to an AM transceiving system, an SSB system using similar components can provide an effective 9-dB increase in system performance. ♦

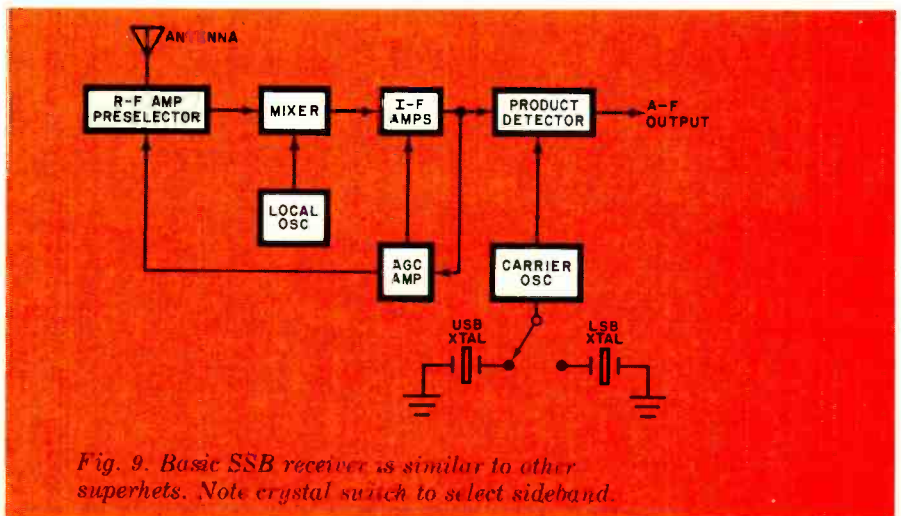

Fig. 9. Basic SSB receiver is similar to other superhets. Note crystal switch to select sideband.

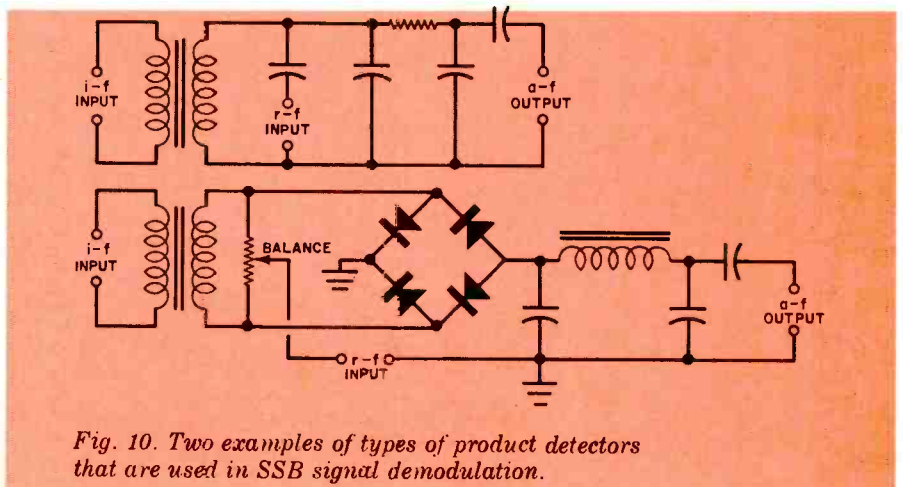
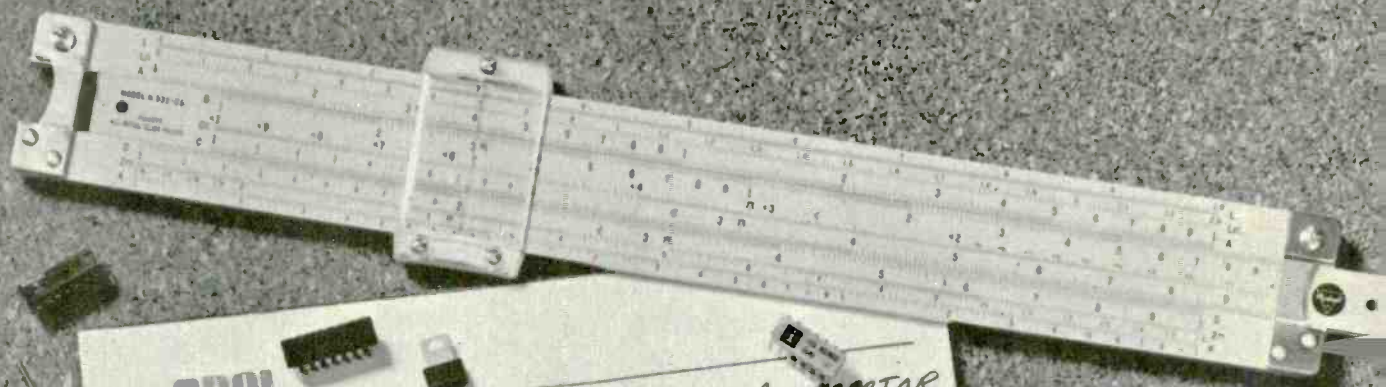

Fig. 10. Two examples of types of product detectors that are used in SSB signal demodulation.

CREI—the only home-study college-level training

and now



CREI

COMPARATOR
CONTROLLED
CLOCK

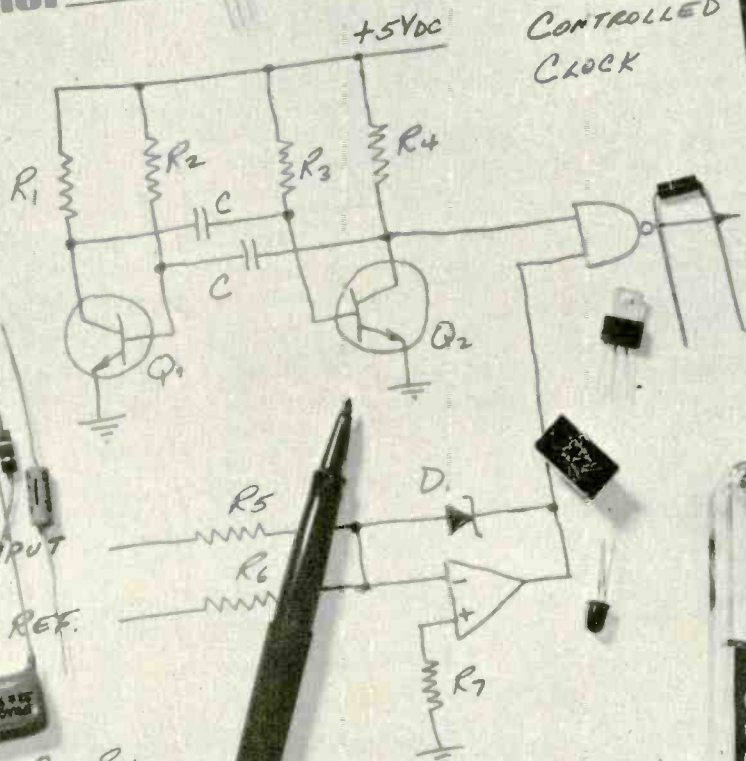

$$R_1 = R_4$$
$$R_2 = R_3 = R$$

$$T = .7RC$$

$$f = \frac{1}{2T}$$



program which gives you in electronic circuit design

only CREI offers you a complete college-level Electronic Design Laboratory to speed your learning

Electronic circuit design—source of all new development in the application of electronics to new products and services. Without this skill, we would be unable to monitor the heartbeat of men in space. Without it, the computer revolution would never have occurred. And we would have yet to see our first TV show. *Yet, only CREI teaches electronic circuit design at home.*

ELECTRONIC CIRCUIT DESIGN

A key skill which paces our nation's progress in countless fields—from pollution control to satellite tracking to modern medicine to exploring the ocean's depths. And beyond. A skill which *you* must have to move to the top in advanced electronics.

CREI programs open up new worlds of opportunity for you.

In addition to electronic circuit design, CREI provides you with a full advanced electronics education in any of thirteen fields of specialization you choose. Communications, computers, space operations, television, nuclear power, industrial electronics—to mention just a few of the career fields for which CREI training is qualifying. With such preparation, you will have the background for a career which can take you to the frontiers of the nation's most exciting new developments. And around the world.

This free book can change your life. Send for it.

If you are a high-school graduate (or equivalent) and have previous training or experience in electronics, then you are qualified to enroll in a CREI program to move you ahead in advanced electronics.



Send now for our full-color, eighty page book on careers in advanced electronics. In it, you will find full facts on the exciting kinds of work which CREI programs open up to you. And full facts on the comprehensive courses of instruction, the strong *personal* help, and the professional laboratory equipment which CREI makes available to you. All at a surprisingly low tuition cost.

And when you have it, talk with your employer about it.

Tell him you're considering enrolling with CREI. He'll undoubtedly be happy to know you are planning to increase your value to him. *And he may offer to pay all or part of your tuition cost.* Hundreds of employers and government agencies do. Large and small. Including some of the giants in electronics. *If they are willing to pay for CREI training for their employees, you know it must be good.*

Send for Advanced Electronics today. You'll be glad you did.

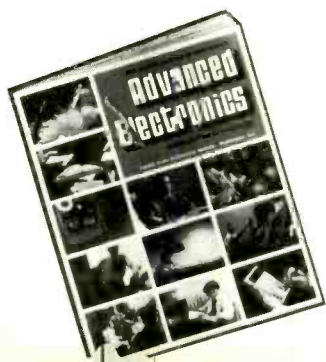

CREI Dept. E-1209-E
3939 Wisconsin Avenue
Washington, D.C. 20016

Rush me your FREE book describing my opportunities in advanced electronics. I am a high school graduate.

Name _____ Age _____

Address _____

City _____ State _____ ZIP _____

If you have previous training in electronics, check here

Employed by _____

Type of Present Work _____

CREI

**CAPITOL
RADIO
ENGINEERING
INSTITUTE**

WASHINGTON, D.C. 20016

...refines and surpasses the V-15's basic identity — which has, from the beginning, been very attractive. This is the best the lab has measured to far..."

...not be reckoned as one of the very best cartridges on the market."

High Fidelity, July, 1973 (U.S.A.)

...a lot of listening to this cartridge extremely smooth, without the usual breakup even on heavy-duty programs. It's transparent production is breathtaking."

...of a phono cartridge is... And the V-15 Type III... It is apparent that Shure... to the top of the hill and... others will have to catch up."

Hi-Fi Times, Summer, 1973 (U.S.A.)

...Era III was really as... implied, we tried the... previously available and... I was able to track... the record without... a free copy of the... and mailing the... with the cartridge... but the superiority... will soon dispel... ds, 'and...'

...firm... certa... passag... V-15 Ty... yet, comb... and electri...

"Shure Bros., in introducing the V-15 Type III, has created a new standard for other cartridges to shoot at."

"... an amazing curve for... and Shure guarantees that... perform this way."

"... we were unable to find a... this cartridge could not track cle..."

"... our subjective IM distortion... showed a significant improvement... last year's best cartridges."

"... a clinically clean performance... will be hard to improve upon."

Electron, July, 1973 (Canada)

"I cannot think in terms of 'presence' to describe this cartridge so much as its 'absence'. The sound is completely neutral and the quiet background is a tribute to its smooth response and high resonance. I found no trouble from hum and no special cables or connecting techniques were needed to maintain the response. Needless to say, it tracked the most difficult records with scornful..."

Aw shucks, folks...



The Shure V-15 Type III Cartridge is a product of which we are supremely proud, one that took seven years of grueling laboratory work to take shape. And, although we expected an enthusiastic reaction, the response we're getting is, frankly, a bit overwhelming to us. Hi-fi authorities and critics from all over the world have written—each in his own way—that the V-15 Type III sets a performance standard beyond any other cartridge available today. They use words we wouldn't dare use ourselves—like “the standard for years to come,” “perfect,” “ultimate,” etc., etc., etc. Please write for the highlights of published reports we've assembled (ask for AL482)—and read and judge for yourself. (We feel about it the way a proud papa feels about his newborn's photograph.)

Shure Brothers Inc.
222 Hartrey Ave., Evanston, Ill. 60204
In Canada: A. C. Simmonds & Sons Ltd.



*What to look for
in AM, SSB,
and AM/SSB
transceivers
for
Citizens Radio*

Citizens Band transceivers have been the beneficiaries of unusually sophisticated electronic designs, easily surpassing ham gear in the use of innovative concepts. For example, phase-locked-loop circuitry is commonplace in CB, and all-solid-state design appeared when amateur radio equipment was still in the all-vacuum-tube stage. (Yes, hams, we know about the serious infraction of communications rules, et al., but we're talking about the equipment now.)

The purpose of CB for communications is to enable persons to make contact with others (up to a 150-mile range) when standard means of communicating, such as by telephone, are not available. (This contact is for important personal or business messages, of course.) A

BUYING GUIDE TO MOBILE CB RADIOS

major use of CB radios is, therefore, in the automobile. The "Buying Guide to Mobile CB Radios" that follows illustrates the wide range of mobile CB gear available that boast 23 channels (46 channels for SSB, 69 channels for AM/SSB).

If you are shopping for a CB transceiver, you will quickly discover that there is a shortage of AM transceivers, the type most CB'ers own. Single-sideband and combined SSB and AM equipment, however, are more plentiful at this time. Single-sideband modulation is comparatively new to CB; and the units are more expensive. Prices for AM units, for example, range from about \$100 to \$250; while AM/SSB sets start at \$250.

However, industry pundits feel that more and more BC'ers will turn to SSB because; (a) it provides more "talk power" with the same power input limit set by the FCC; (b) users are expected to be less inclined to violate communications rules (though this has not yet been proved); and (c) there is less interference since the number of channels available is doubled. They also have seen what happened in the radio amateur field,

where the overwhelming majority of hams now use SSB equipment.

Features to Look For. On Following pages are details and specifications on some 80 mobile CB units, about 26% of them being SSB or AM/SSB. They come in sizes as small as 2 in. by 5½ in. by 7 in. Others are larger, of course; and some can be used on either 12 volts dc or 117 volts ac which makes them suitable for base or mobile use. However, they are listed here because they possess the mobility that is necessary for use in an automobile (or boat). There are other transceivers that are described by the manufacturers as base/mobile units, and they operate on 12 or 117 volts; but their degree of mobility limits them to campers, trailers, etc.

Check the Guide for the features that are of interest to you.

Receiver Sensitivity. No single figure will describe just how weak a signal a receiver will pick up. Noise

and interference from other signals have a lot to do with reception of a weak signal. However, the figure in microvolts indicates the minimum required to make the signal audible. The figure in parentheses indicates that the input will make the signal plus noise 10 dB stronger than the noise alone. The lower the figure for sensitivity the better.

Selectivity. This is generally stated as the frequency range (kHz) for each channel at stated dB-down points. A number of manufacturers use a 6-dB down reference (6 dB at 3 kHz, for example), while others may state the figures in tens of dB down.

Image Response and I-F Rejection. Signal image and i-f interference contribute most to the reception of signals not on the desired channel. Obviously, the best reception is

achieved when these two indications show high dB-down figures.

SSB Carrier Suppression. This is determined primarily by how well the modulator is balanced. The figures indicate how many dB the carrier is below the transmitted sideband. The higher the figure, the better the reception.

Delta Tuning. Sometimes it is necessary to adjust the receiver frequency a small amount to obtain sharp reception of stations operating just off center frequency. The frequency figure given indicates the adjustment available from the center.

Special Features. Most rigs have provisions for public address use, meters to indicate S units and r-f power, and squelch control to set the signal-to-noise ratio threshold. Some units have clocks, scanners to monitor channel 9 for emergencies, automatic noise limiting and/or automatic modulation limiting.

Units with SSB modulation have clarifier controls to correct for slight changes in the oscillators in the transmitter and receiver. Adjusting the clarifier may sometimes take a little patience. ♦

(Directory starts overleaf)

DIRECTORY OF MOBILE CB RADIOS

Manufacturer and Model	Price (\$)*	Dimensions (H x W x D)	Weight (lb)	Speaker		AM/SSB	Receiver Sensitivity (microvolts)		Receiver Selectivity (-dB at kHz)		Image Response (-dB)		I-F Rejection (-dB)		SSB Carrier Suppression (-dB)	Delta Tune Range (± kHz)	Power Supply (V)		Special Features	
				Int	Ext		AM	SSB	AM	SSB	AM	SSB	DC	AC						
Browning																				
SST	180	2 3/8 x 6 1/2 x 8 3/16	6	X	X	AM	.3 (10 dB)		60 (10 kHz)		60	80			1.3	12			PA, Squelch, ANL	
LTD	360	2 3/8 x 6 1/2 x 9 7/8	6 3/4	X	X	Both	.5 (12 dB)	.25 (10 dB)	60 (10 kHz)	75 (5.5 kHz)	70	80	55	1.3	12				PA, Squelch, ANL	
Dynascan																				
Cobra 21	150	2 1/2 x 6 x 7	3 1/2	X	X	AM	1		40 (20 kHz)		30	80			12				PA, Squelch, ANL	
Cobra 28	190	2 1/4 x 6 x 8 1/2	4 1/2	X	X	AM	.5		50 (20 kHz)		40	80		1.5	12				PA, Squelch, meter, chan 9 scan, ANL	
Cobra 29	185	2 1/4 x 6 7/8 x 8 1/2	5 1/2	X	X	AM	1		50 (20 kHz)		30	80		1.5	12				PA, Squelch, meter, ANL	
Cobra 132	340	2 3/8 x 7 1/2 x 10 5/16	8	X	X	Both	.5	.25	50 (20 kHz)	60 (50 kHz)	50	50	50	.6	12				PA, Squelch, meter, ANL	
Cobra 138	320	2 1/2 x 7 1/2 x 10 1/2	5	X	X	Both	.75	.25	60 (7 kHz)	60 (7 kHz)	55	50	40	.6	12				PA, Squelch, meter, ANL	
Fanon/Courier																				
Rebel	135	2 x 5 7/8 x 8 1/4	3 1/2	X	X	AM	.5 (10 dB)		6 (3 kHz)		50	70			12				PA, Squelch, meter, AML, ANL	
Traveller II	180	1 7/8 x 5 3/4 x 6 1/4	3 1/2	X	X	AM	.5 (10 dB)		6 (3 kHz)		50	70			12				PA, Squelch, meter, AML, ANL	
Comet	210	2 3/4 x 7 x 9 1/2	6 1/2	X	X	AM	.3 (10 dB)		6 (6 kHz)		60	90	1		12				PA, Squelch, AML, ANL	
Classic II	230	2 5/8 x 7 1/4 x 8 3/4	7 1/2	X	X	AM	.3 (10 dB)		6 (3 kHz)		50	80	1		12, 117				PA, Squelch, AML, ANL, meter	
Spartan	330	2 1/4 x 7 1/2 x 9 1/2	6	X	X	Both	.4 (10 dB)	.15 (10 dB)	6 (3.5 kHz)	6 (2.1 kHz)	60	85	40	.6	12				PA, Squelch, AML, ANL, meter	
Gladiator	430	2 3/4 x 10 1/2 x 11 1/2	9 1/2	X	X	Both	.25 (10 dB)	.15 (10 dB)	6 (2.5 kHz)	6 (2.1 kHz)	60	90	45	.6	12				PA, Squelch, AML, ANL, meter	
Hy-Gain																				
Hy-Range I, 670	135	2 1/4 x 6 3/8 x 7 5/8	5 1/2	X		AM	.7 (10 dB)		6 (6 kHz)						12				Squelch, ANL	
Hy-Range II, 671	175	2 1/4 x 6 3/4 x 7 5/8	5 1/2	X	X	AM	.7 (10 dB)		6 (6 kHz)					1.5	12				PA, Squelch, ANL, meter	
Hy-Range III, 672	225	2 1/4 x 7 1/8 x 9 5/8	6	X	X	AM	.7 (10 dB)		6 (6 kHz)					1.5	12				PA, Squelch, ANL, meter	
Hy-Range V, 674	350	2 3/4 x 9 x 11 1/2	8	X		Both	1 (10 dB)	.25 (10 dB)	6 (7 kHz)	6 (2.4 kHz)			40	.8	12				Squelch, ANL, meter	
Ray Jefferson																				
CB-705	140	2 x 5 1/2 x 7	3	X	X	AM	1		40 (10 kHz)		60	70			12				PA, Squelch, AML, meter	
CB-905	185	1 1/2 x 6 x 8	5 1/2	X	X	AM	.5		50 (10 kHz)		60	70	1		12				PA, Squelch, AML, meter	
E.F. Johnson																				
Messenger 123A	160	2 1/2 x 6 3/16 x 9 5/8	3	X	X	AM	.5		60 (30 kHz)		12	42			12, 117				Squelch, AML, ANL, meter	
Messenger 130	200	6 1/2 x 9 x 7	5 1/2	X	X	AM	.5		60 (30 kHz)		10	50			12				PA, Squelch, AML, ANL, Hand set	
Messenger 323	250	2 1/2 x 8 x 9 1/2	5 7/8	X	X	AM	.5		60 (19 kHz)		50	50			12, 117				PA, Squelch, AML, ANL	
Kris																				
Valiant	119	2 1/8 x 6 x 6 1/2	4	X	X	AM	.7		50 (10 kHz)		40				12				PA, Squelch, ANL, meter	
Vega	139	2 x 5 3/4 x 7 3/4	4	X	X	AM	.7		50 (10 kHz)		50				12				PA, Squelch, AML, meter	
T23B	169			X	X	AM	.5		50 (10 kHz)		50			2.5	12				PA, Squelch, ANL	

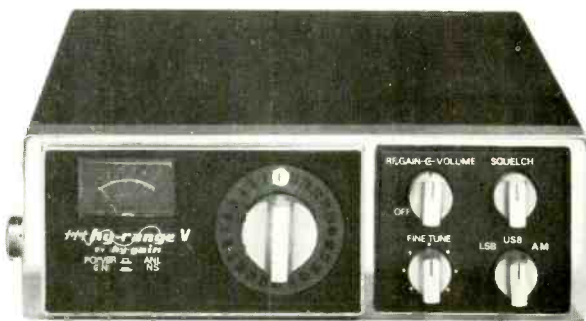

Hy-Gain Hy-Range V



Carrier Classic II

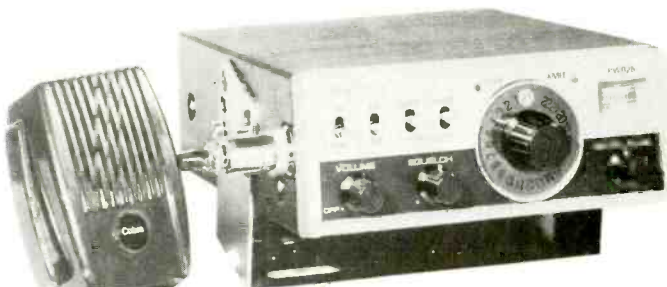

Dynascan Cobra 28



Ray Jefferson CB 905

Manufacturer and Model	Price (\$)*	Dimensions (H x W x D)	Weight (lb)	Speaker		AM/SSB		Receiver Sensitivity (microvolts)		Receiver Selectivity (-dB at kHz)		Image Response (-dB)		I-F Rejection (-dB)		SSB Carrier Suppression (-dB)		Delta Tune Range (± kHz)		Power Supply (V)		Special Features
				Int	Ext	AM	SSB	AM	SSB	AM	SSB	AM	SSB	DC	AC							
Lafayette																						
Micro-723	100	2 x 6 1/4 x 8 1/2	4	X	X	AM		1 (10 dB)														Squelch, AML, ANL, meter
Micro-923	130	2 x 6 1/8 x 7 1/8	3 3/4	X	X	AM		1 (10 dB)														Squelch, AML, ANL, Chan 9 scan,
HB23A	120**	2 x 6 x 8	6	X	X	AM		.7 (10 dB)														Squelch, AML, meter, burglar alarm
HB525F	180	2 3/8 x 6 1/4 x 8	5 1/4	X	X	AM		.5 (10 dB)														Squelch, AML, meter, burglar alarm
HB625A	215	2 3/8 x 5 1/4 x 8	5 1/4	X	X	AM		.7 (10 dB)														PA, Squelch, AML, ANL, meter
HB700	180	8 1/4 x 9 x 10 5/8	5 2/3	X	X	AM		.7 (10 dB)														Weather, 2 vhf channels, Squelch, AML, meter, ant. load
SSB50A	320	2 7/8 x 7 13/16 x 9 13/16	7	X	X	Both		.5	.15													Squelch, ANL, meter, fine tune, ant. load
Midland																						
13-862B	120	2 x 5 1/8 x 9	3	X	X	AM		.5														PA, Squelch, ANL meter
13-866	140	2 x 5 1/2 x 7 1/4	3 1/4	X	X	AM		.7			6 (3.5 kHz)											PA, Squelch, ANL
13-867	170	2 x 5 7/8 x 7 3/4	4 1/2	X	X	AM		.5														PA, Squelch, ANL
13-881B	260	2 1/8 x 7 7/8 x 8 7/8	4 1/2	X	X	AM		.5														PA, ANL, Auto scanning (2 chan.)
13-883	200	2 1/4 x 6 7/8 x 8 7/16	4 1/2	X	X	AM		.5				6 (5 kHz)										PA, AML, ANL, SWR calib.
13-893	350	2 1/2 x 7 1/2 x 10 1/2	5	X	X	Both		.75	.25													PA, Squelch, ANL
13-895	387	4 1/4 x 7 1/2 x 10 1/2	10	X	X	Both		.75	.25													PA, Squelch, ANL
Pace																						
CB 100ASA	110***	1 3/8 x 4 3/4 x 6	2 1/2	X		AM		.5					50	50								Meter, ANL
CB 223	140	2 1/2 x 6 3/4 x 9 1/4	4	X		AM		1					50	50								12
CB 2300	220	2 1/2 x 6 3/4 x 9 1/4	5 1/2	X	X	AM		.35					50	50								PA, ANL, meter
CB 2376A	180	2 1/2 x 6 3/4 x 8 1/2	4 1/2	X	X	AM		.6					50	50								PA, Squelch, ANL, meter
Pearce-Simpson																						
Tomcat	130	2 x 5 7/8 x 8 1/4	3 7/8	X		AM		.6 (10 dB)					40	40								Meter
Puma	160	2 1/2 x 6 x 7 1/2	3 7/8	X	X	AM		.5 (10 dB)					40	50								PA, Squelch
Bobcat	180	2 1/2 x 6 x 7 1/2	4	X	X	AM		.5 (10 dB)					40	50								PA, Squelch
Tiger	190	2 1/4 x 7 x 8 1/2	4 1/2	X	X	AM		.5 (10 dB)					40	50								PA, ANL
Cougar	230	2 1/4 x 7 x 8 1/2	4 1/2	X	X	AM		.5 (10 dB)					45	45								PA, ANL, meter
Panther	350	2 1/4 x 7 1/2 x 9 3/4	5 1/2	X	X	Both		.5 (10 dB)	.3				50	80	40							PA, ANL, meter, slide tune
Cheetah	400	2 1/2 x 8 3/4 x 10 1/2	8 1/2	X	X	Both		.5 (10 dB)	.2				50	80	40							PA, ANL, meter, slide tune



Royce 1-635



Lafayette Micro 923

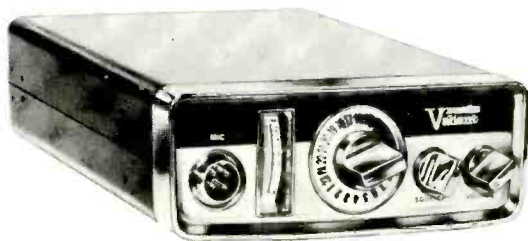

Kris Valiant

E. F. Johnson Messenger 130



Manufacturer and Model	Price (\$)*	Dimensions (H x W x D)	Weight (lb)	Speaker		Receiver Sensitivity (microvolts)		Receiver Selectivity (-dB at kHz)		Image Response (-dB)			I-F Rejection (-dB)		SSB Carrier Suppression (-dB)		Delta Tune Range (± kHz)		Power Supply (V)		Special Features
				Int	Ext	AM	SSB	AM	SSB	AM	SSB	DC	AC	DC	AC	DC	AC	DC	AC		
																				AM/SSB	
Realistic																					
Mini 23B	110	1 1/2 x 5 1/4 x 7 7/8		X		AM	.5 (10 dB)		6 (6 kHz)										12		Squelch
TRC 24B	160	1 3/4 x 6 x 7		X	X	AM	.5 (10 dB)		6 (6 kHz)										12		PA, Squelch, ANL
TRC 30	160	4 x 11 1/2 x 9		X		AM	.5 (10 dB)		6 (5 kHz)										12, 117		Squelch, delta tune
TRC 46	330	2 3/4 x 8 7/8 x 10 1/2		X		Both	.5 (10 dB)	.2 (10 dB)	6 (5 kHz)	6 (2.1 kHz)				.6					12, 117		Squelch
TRC 47	250	2 1/8 x 7 1/8 x 9 1/8		X		Both	.5 (10 dB)	.2 (10 dB)	6 (5 kHz)	6 (2.1 kHz)				.6					12		Squelch
TRC 55	230	5 x 14 3/4 x 9		X		AM	.5 (10 dB)		6 (5 kHz)										12, 117		Squelch, meter, clock
Regency																					
CR 123	329	2 1/2 x 7 1/2 x 10 1/2	5	X	X	Both	.5 (10 dB)	.15 (10 dB)	6 (7.5 kHz)	6 (2 kHz)	55	55	45	.6	12				12		PA, Squelch, AML, ANL, meter
CR 185	165	2 1/4 x 6 3/4 x 8 1/2	3 1/2	X	X	AM	.5 (10 dB)		6 (5.5 kHz)					.8	12				12		PA, Squelch, AML, ANL, meter
CR 186	139	2 1/4 x 5 3/4 x 7 1/2	2 3/4	X	X	AM	.5 (10 dB)		6 (6 kHz)						12				12		PA, Squelch, AML, meter
Robyn																					
T-123B	240	5 x 12 x 8 1/4		X	X	AM	.8 (10 dB)		6 (6 kHz)						70				12, 117		PA, Squelch, AML, meter, delta tune, ant. load
TR-123C	180	2 x 6 x 7 3/4	4 1/2	X	X	AM	.5 (10 dB)		60 (10 kHz)										12		PA, Squelch, AML, ANL, meter, with PA spkr & ant.
WV-23	130	2 x 5 1/2 x 7 1/8	2 7/8	X	X	AM	.7 (10 dB)		45 (10 kHz)										12		PA, Squelch, ANL, meter
XL-2	140	2 3/8 x 5 7/8 x 7 1/16	4 1/2	X	X	AM	.6 (10 dB)		50 (10 kHz)										12		PA, Squelch, ANL, meter
Royce																					
1-600	125	2 1/8 x 6 x 6 1/2	4 1/2	X	X	AM	.5 (10 dB)		6 (6 kHz)					50	45				12		PA, Squelch, ANL, meter
1-602	170	2 1/2 x 7 x 8 1/2	5 1/2	X	X	AM	.4 (10 dB)		6 (5 kHz)					55	60	1.5	12		12		PA, Squelch, ANL, meter
1-605	190	2 1/2 x 7 x 7	5 1/2	X	X	AM	.4 (10 dB)		6 (5 kHz)					55	65	1.5	12		12		PA, Squelch, ANL
1-606	230	2 1/2 x 8 1/2 x 8	6 1/2	X	X	AM	.35 (10 dB)		6 (5 kHz)					60	65	1.5	12		12		PA, Squelch, ANL, meter remote channel changer
1-630	360	2 1/4 x 8 1/2 x 8 1/2	5 1/2	X	X	Both	.4	.2	6 (5 kHz)	6 (2.2 kHz)	80	60	45	1.5	12				12		PA, Squelch, ANL
1-631	390	3 x 8 1/2 x 10 1/2	12	X	X	Both	.4	.2	6 (5 kHz)	6 (2.2 kHz)	80	60	45	1.5	12, 117				12		PA, Squelch, ANL remote volume changer
1-635	440	2 1/4 x 8 x 9	7	X	X	Both	.4	.2	6 (5 kHz)	6 (2.2 kHz)	80	65	50	1.5	12				12		PA, Squelch, remote channel changer

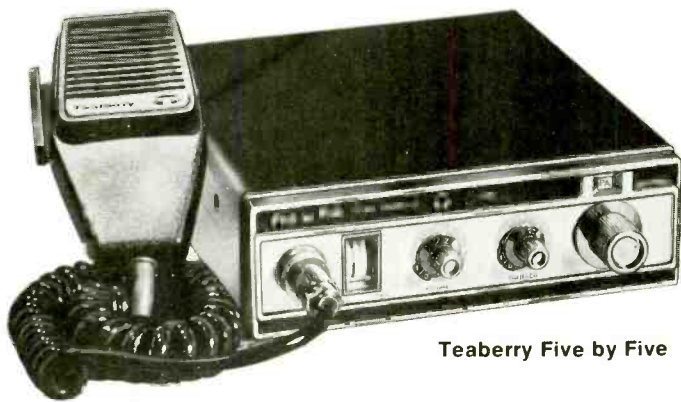

Teaberry Five by Five



Pearce-Simpson Panther

Robyn T-123D

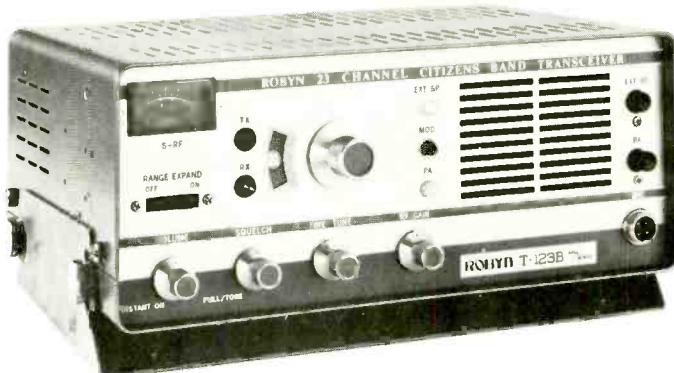

Realistic TRC-46



Tram Diamond 60

Manufacturer and Model	Price (\$)*	Dimensions (H x W x D)	Weight (lb)	Speaker		AM/SSB	Receiver Sensitivity (microvolts)		Receiver Selectivity (-dB at kHz)		Image Response (-dB)		I-F Rejection (-dB)		SSB Carrier Suppression (-dB)	Delta Tune Range (+/- kHz)	Power Supply (V)		Special Features
				Int	Ext		AM	SSB	AM	SSB	DC	AC							
SBE-Linear																			
Catalina II	120	1 1/2 x 6 1/2 x 7 1/2	3 1/2	X	X	AM	1 (10 dB)		60 (20 kHz)		35	70					12		Squelch, ANL
Cortez	150	2 1/8 x 5 7/8 x 8 3/4	4	X	X	AM	1 (10 dB)		60 (20 kHz)		50	70					12		PA, Squelch, ANL
Coronado II	200	2 1/2 x 8 3/8 x 9 3/8	6 1/2	X	X	AM	1 (10 dB)		60 (20 kHz)		50	70					12		PA, Squelch, ANL
Sidebender II	360	2 1/4 x 7 1/2 x 9 1/2	6 1/2	X	X	Both	1 (10 dB)	.5 (15 dB)	50 (55 kHz)	50 (5.5 kHz)	50	50	40	1			12		PA, Squelch, ANL
Sidebender III	290	2 1/8 x 5 7/8 x 8 3/4	4	X	X	SSB		.5 (15 dB)		50 (3.5 kHz)	50	50	40	1			12		Squelch, ANL
Siltronix																			
SSB-23	329	2 1/2 x 8 x 11	5 1/2	X	X	Both	.7	.2	50 (10 kHz)	50 (2.3 kHz)	50	50	40				12		PA, Squelch, ANL, meter, ant. load
Teaberry																			
T-Charlie I	155	2 1/2 x 6 5/8 x 7 3/4	6	X	X	AM	.5 (10 dB)				40	20					12		PA, Squelch, meter
Big T	189	3 3/4 x 9 3/4 x 8	9	X	X	AM	.3 (10 dB)				40	20					12, 117		PA, Squelch, ANL, meter
5x5	169	5 1/4 x 13 x 4 5/8		X	X	AM	.3 (10 dB)				50	20					12		PA, Squelch, ANL, meter
Tram																			
Diamond 40	210	2 3/8 x 6 5/8 x 8 1/16	6	X	X	AM	.3 (10 dB)		60 (20 kHz)		50	80			1.5		12		PA, Squelch, ANL, meter
Diamond 60	370	2 3/8 x 6 5/8 x 9 2/3	6 1/2	X	X	Both	.3 (10 dB)	.1 (10 dB)	60 (20 kHz)	50 (5.5 kHz)	50	80			1.5		12		PA, Squelch, ANL, meter

*Includes crystals unless otherwise noted.

**Includes crystals for channels 9, 13, 14.

***Does not include crystals.

Abbreviations: PA—public address using external speaker jack.

ANL—automatic modulation limiter.

ANL—Automatic noise limiter or blanker.

Note: All information is based on manufacturers' specifications.

Though every effort has been made to obtain current prices, because of the dollar devaluation, the lifting of certain price controls, and the floating of Japanese and European currencies, all prices are subject to some adjustment. The prices listed are the latest manufacturers and/or importers were able to supply before press time—and are subject to change.



Siltronix SSB-23



Midland 13-867



Pace CB 2300



Regency CR-123



SBE-Linear Sidebender III



Browning SST



ENJOY PRIVATE MESSAGES WITH A VOICE SCRAMBLER

*Low-cost IC circuit
makes messages unintelligible
without a similar unit*

BY JOSEPH B. WICKLUND, JR.

WOULD you like to be able to keep unauthorized people from listening to your private communications? Thanks to recent advances in integrated circuit technology, it is possible to build a low-cost voice scrambler that will make your message unintelligible to anyone who doesn't have a compatible unscrambler. Of course, voice scramblers have been around for many years, but most of them are too expensive or too difficult to use (or both). This circuit is easy to build, is reliable, and can be used as either the scrambler or unscrambler.

How Scrambling Works. The block diagram in Fig. 1 shows how the scrambler works. The incoming audio signal is filtered to remove all frequency components above 3 kHz as shown at (A). The signal is then used to modulate a 3.5-kHz oscillator signal, with a linear four-quadrant multiplier as the balanced modulator. The output (B) of the multiplier includes the sum and difference frequencies between the two inputs. Another filter removes the sum frequencies and any remaining 3.5-kHz carrier, leaving only the difference frequencies as shown at (C).

Secrecy Through Electronics

*The art and techniques of
security in
communications today*

BY CLAY TATOM

Motorola Inc.
Semiconductor Products Div.

NOT TOO long ago, "security" meant something very different from what it does today. Now, it is a synonym for "protection" from thefts of anything from real property to communication information. So high is the interest in secure communications that the U.S. Government plans to make all official communications secure by the mid-1980's. Other governments and many industrial and commercial establishments throughout the world are following suit. So too are a number of private citizens who want to preserve the privacy of their communications.

The growth of electronic communication since 1940 has revolutionized the secret world of cryptology. Wires and radio waves now carry unbelievable quantities of communication information at staggering rates. Electronics provides the means of unauthorized and illegal eavesdropping on this information. Some of this eavesdropping is done by specialists with expensive "bugging" equipment, posing a real threat. Much of it is by amateurs, listening in on business, Public Safety, and other "private" radio broadcasts.

It is interesting to note that, in the output, the voice channel from 300 to 3000 Hz is contained in a single-sideband signal from 3200 to 500 Hz. It can be recorded or transmitted like any other voice signal, but the frequency spectrum of the output is an inversion of the input. (For example, an input frequency of 300 Hz is 3200 Hz in the output and an input of 2500 Hz is 1000 Hz in the output.) The inversion thus makes the voice message unintelligible.

When the scrambled signal is coupled to the input of a similar unit, the signal is re-inverted and the original audio comes out in unscrambled form as shown at (D) and (E) in Fig. 1.

Circuit Operation. The complete schematic of the voice scrambler is shown in Fig. 2. Integrated circuit IC1 is used as a high-input-impedance buffer amplifier to prevent loading on the signal source. Resistors R2 and R3 control the gain of the buffer. An active low-pass filter with a cutoff frequency of 3000 Hz is provided by IC2 and IC3. The shape of the filter is controlled by the feedback components (R4-R7 and C2-C7) and the circuit is designed to provide a four-pole Chebyshev filter characteristic with 1 dB of ripple in the passband and a sharp rolloff. Integrated circuit IC5 is a stable square-wave oscillator operating at a frequency determined by R16, R17, and C9. Potentiometer R17 is used to adjust the oscillator frequency so that two or more units can be matched. The oscillator output is attenuated by resistors R18 and R19 and modulated by the output of IC3, the filtered input signal. The balanced modulator is IC4. Trimpots R27 and R28 provide balancing adjustments for the modulator. When they are properly adjusted, only the sum and difference frequencies of the two inputs will appear at the output. Integrated circuits IC6 and IC7 form a low-pass filter to pass only the desired output signal.

The output of IC7 can be used to drive load impe-

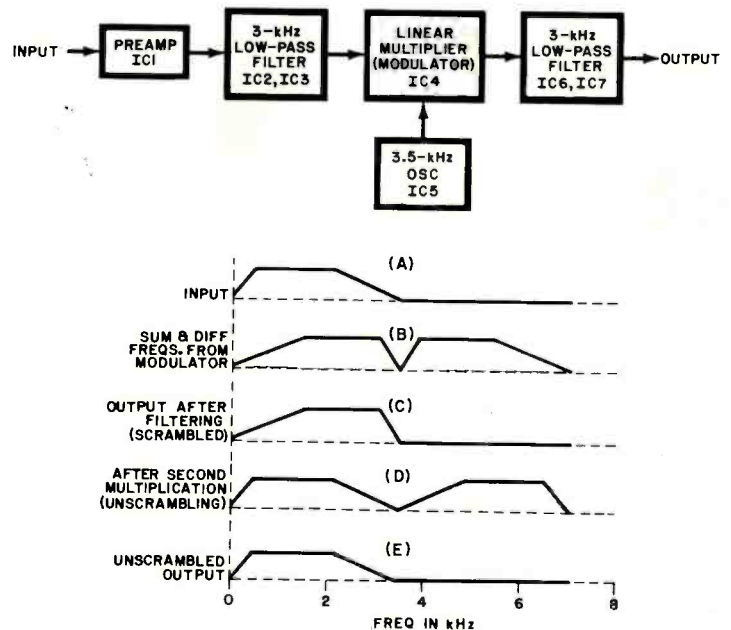

Fig. 1. Block diagram and waveforms show how the scrambler works. (A) is incoming signal; (B) is sum and difference; and (C) is output after filtering. Unscrambling is shown in (D) and (E).

Radio receivers are readily available for monitoring taxicab, aircraft, and police despatches. Some police departments might condone "good-citizen" monitoring of their broadcasts since it increases the number of observers on the lookout for stolen cars, fleeing suspects, etc. More often than not, however, they prefer that private citizens do not listen in. Some communities, in fact, have enacted laws that make it illegal for any but authorized law enforcement personnel to monitor police broadcasts.

Security Goes Public. Industrial and private secure-communication systems generally employ simpler enciphering techniques than those used by the high-level governmental agencies. While these are relatively simple systems today, they would have boggled a cryptanalyst's mind only a few decades ago. Most such systems are electronic, designed to effectively thwart the casual would-be eavesdropper. They are, however, relatively easy to decode if the eavesdropper is willing to spend the money to attack them with sophisticated techniques.

Most companies that make secure voice systems use a "scrambler" technique. The scrambler, as its name implies, mixes up (scrambles) the speech portions of the audio-frequency range. Scramblers have the advantage over more secure governmental systems in that they are inexpensive, compact, often require only narrow-bandwidth transmission channels, and offer adequate security for their proposed use. They generally provide several hours of security even against the serious commercial eavesdropper.

A generalized block diagram of a

speech scrambler is shown in Fig. 1. The operator speaks into the microphone. Following the mike may be special processing circuits like speech compressors, delta-modulation response-curve generators, etc. The processed speech signal then undergoes some form of encoding, analog or digital, in some combination with an electronic "key" whose methodology appears to be random in nature. If an all-digital scheme is used, an analog-to-digital (A/D) converter becomes part of the encoder, while a digital-to-analog (D/A) converter be-

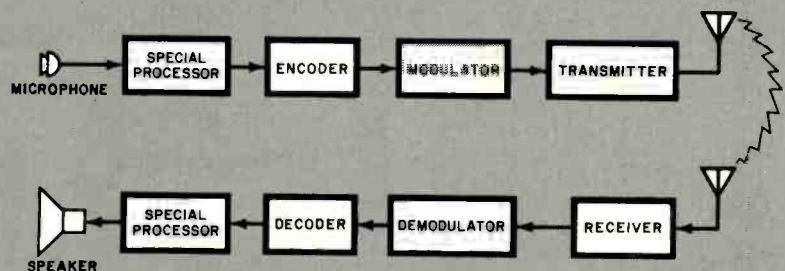
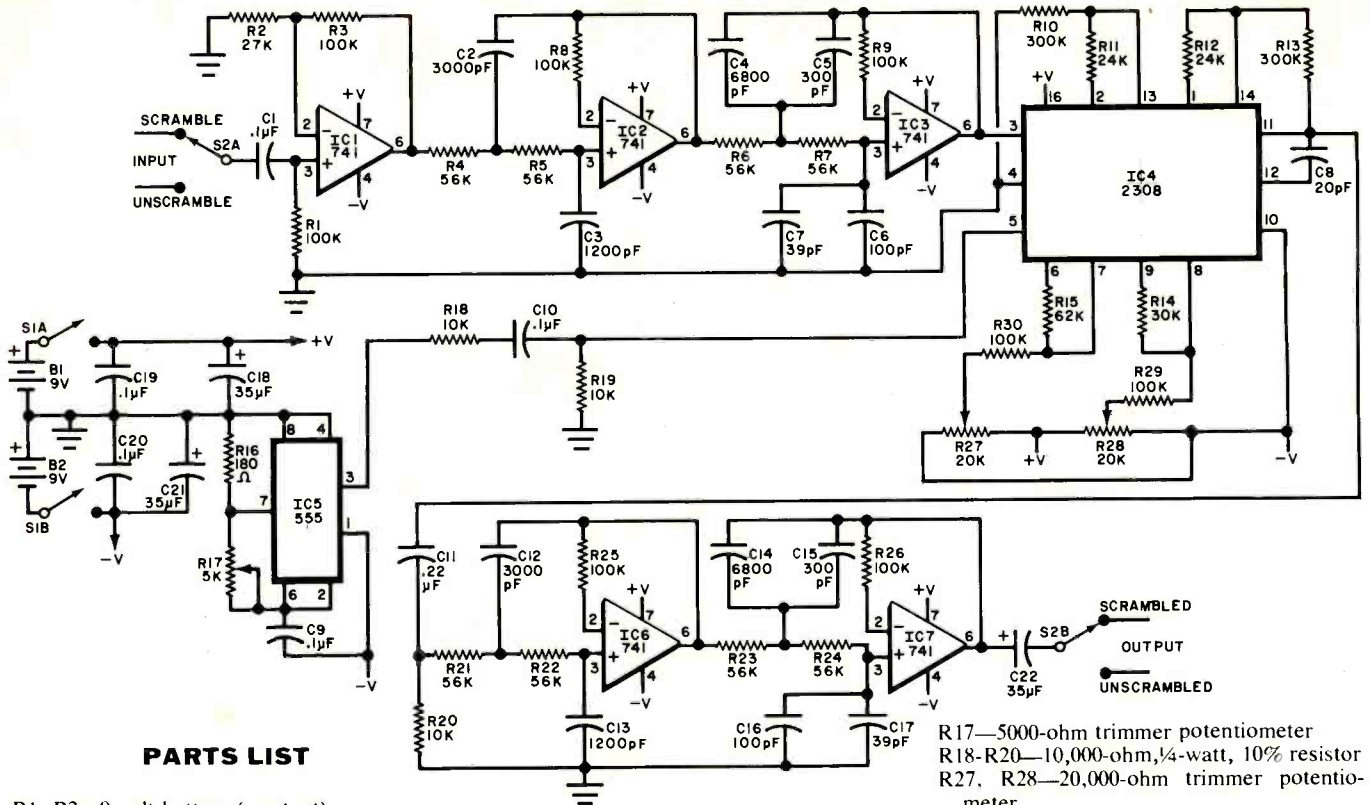

Fig. 1. Simplified block diagram of scrambler using radio link, but transmitter and receiver can be direct-coupled.



PARTS LIST

- B1, B2—9-volt battery (see text)
- C1, C9, C10, C19, C20—0.1- μ F Mylar capacitor
- C2, C12—3000-pF, 5% capacitor
- C3, C13—1200-pF, 5% capacitor
- C4, C14—6800-pF, 5% capacitor
- C5, C15—300-pF, 5% capacitor
- C6, C16—100-pF, 5% capacitor
- C7, C17—39-pF, 5% capacitor
- C8—20-pF, 5% capacitor
- C11—0.22- μ F, Mylar capacitor
- C18, C21, C22—35- μ F, 25-volt electrolytic capacitor
- IC1, IC2, IC3, IC6, IC7—741 op amp

- IC4—2308 multiplier (Exar)
- IC5—555 timer
- R1, R3, R8, R9, R25, R26, R29, R30—100,000 ohm, 1/4-watt, 10% resistor
- R2—27,000-ohm, 1/4-watt, 10% resistor
- R4-R7, R21-R24—56,000-ohm, 1/4-watt, 5% resistor
- R10, R13—300,000-ohm, 1/4-watt, 5% resistor
- R11, R12—24,000-ohm, 1/4-watt, 5% resistor
- R14—30,000-ohm, 1/4-watt, 5% resistor
- R15—62,000-ohm, 1/4-watt, 5% resistor
- R16—180-ohm, 1/4-watt, 10% resistor

- R17—5000-ohm trimmer potentiometer
 - R18-R20—10,000-ohm, 1/4-watt, 10% resistor
 - R27, R28—20,000-ohm trimmer potentiometer
 - S1, S2—Dpdt switch
 - Misc.—Suitable chassis (Bud SC2132), battery holders and connectors, mounting hardware, suitable input/output jacks, etc.
- Note—The following are available from Northwest Engineering Co., 801 Duchess Rd., Bothell, WA 98011: Pc board (N007-PCB) at \$7; IC4 (N007-MULT) at \$8.50; case, switches, input/output jacks, batteries (N007-CASE) at \$17.50; pc board and components (N007-PK) at \$33.50. All postage paid in U.S. via parcel post or UPS.

Fig. 2. Complete schematic of scrambler.

comes part of the decoder. The encoded signal passes on to a modulator where it is impressed on a carrier or other transmission medium. At the receiving end, the reverse of the process occurs.

Encoding Techniques. There are basically two types of techniques used for encoding communication signals to secure them against immediate unauthorized decoding by eavesdroppers. They include a variety of analog and digital approaches.

Simple Speech Inverters: Inverters

transpose the high-frequency components of the speech signal to low frequencies. This is done before carrier modulation in radio transmitters or before line transmission in telephone systems. A stable audio oscillator operating at about 3000 Hz can feed a balanced modulator along with the voice signal. The lower sideband generated reflects the mirror image of the speech frequencies. (See Fig. 2.)

Bandsplitters: Bandsplitters divide the audio speech frequencies into several ranges, permitting the narrow frequency

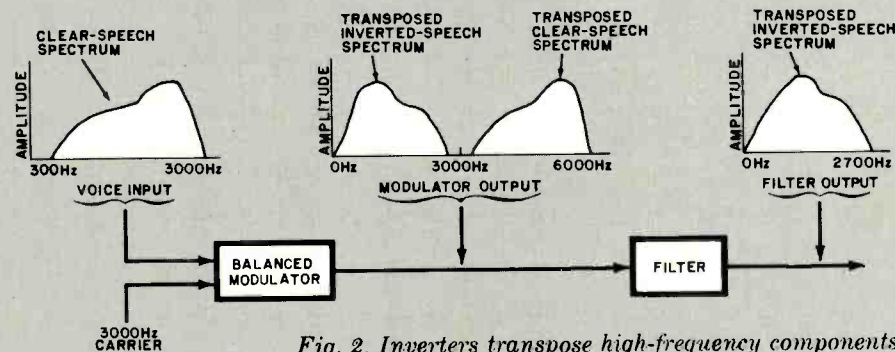

Fig. 2. Inverters transpose high-frequency components.

bands to be rearranged as shown in Fig. 3. Bandsplitting is usually accomplished with the aid of narrow-bandpass filters. The outputs of the filters are mixed or shifted in frequency, then added together so that some ranges are translated in frequency.

Combined Bandsplitters: Combination techniques offer added security to the basic bandsplitting approach. Not only can the speech frequencies be split and translated, but some can be inverted as well. The order in which the frequency ranges are recombined can also be changed with time as illustrated in Fig. 4. (Some manufacturers term these "rolling-code" bandsplitters and rearrange the frequency band order several times.) Using more bands makes this approach more difficult to decode, and changing the band sequence a greater number of times per second makes the system more secure.

Penalties of the combined bandsplitting technique are that the recovered speech begins to sound unnatural when frequency slices increase in number and closer synchronization tolerances must

dances as low as 2000 ohms. It can be used with most amplifiers, for speaker applications, or a set of 2000-ohm headphones.

Construction. To ensure that the active filters are properly tuned, it is recommended that 5% resistors and capacitors be used for the critical components (R4-R7,

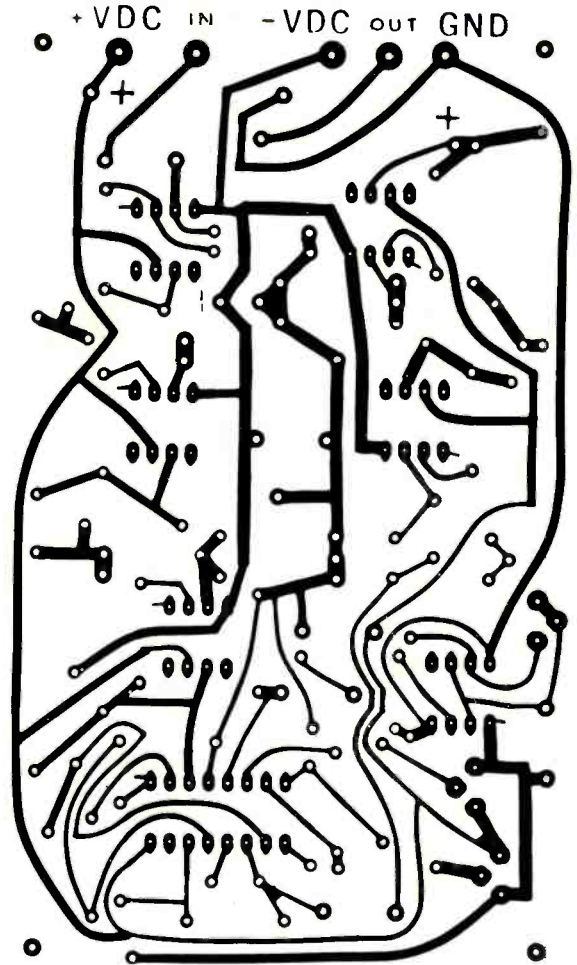
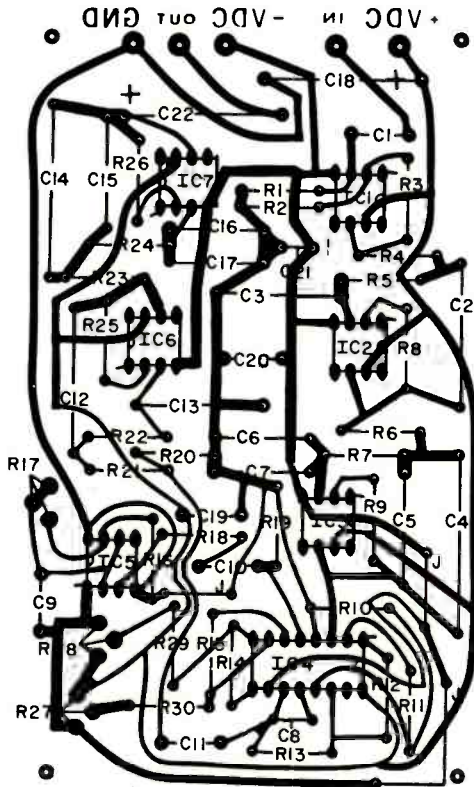

Fig. 3 Actual-size foil pattern for scrambler is shown above at right, component layout at left.

be exercised during band rearrangement.

Masking Techniques: Constant audio tones, or coded sequences of tones, are often used with bandsplitting and inversion. The tones, subtracted from the signal during recovery and decoding, can be higher than or the same level as the intelligence signal (voice). If they are higher in level, they can reduce range since they make up much of the sideband energy and, hence, reduce the system's overall signal-to-noise (S/N) ratio.

Pseudo-random noise generators can also be used in masking techniques. In

practice, the human ear and brain provide such selective filtering that in a system supposedly offering about 400 word codes, only 10 or 12 might be all that are really different to a listener. To someone trained in decrypting such systems, often 50 percent of the information can be extracted in just a few attempts. Even inverted speech becomes intelligible after training. Some languages are often less affected than others by these conventional scrambling techniques.

The above mentioned analog encoding techniques have been discussed with

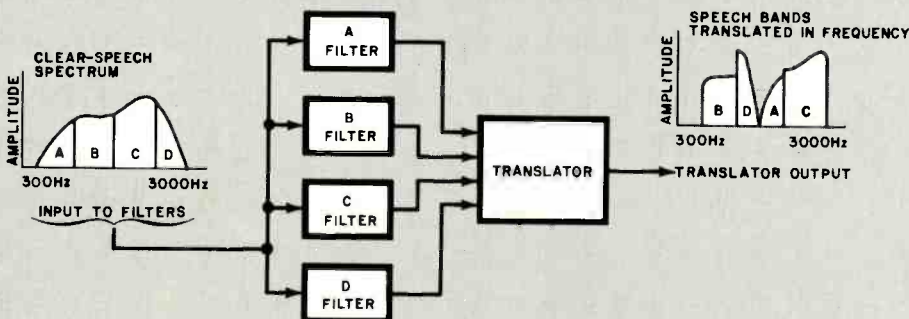

Fig. 3. Bandsplitters divide signal and then recombine.

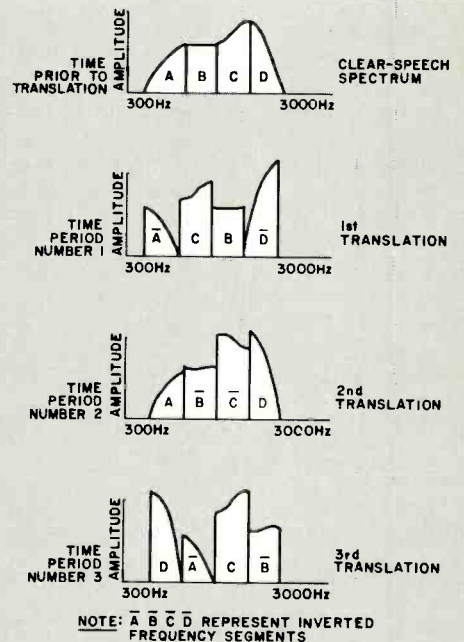

Fig. 4. Combined bandsplitters split and translate speech frequencies to provide more security than simple systems.

R21-R24, C2-C7, and C12-C17). The gain-controlling resistors for the multiplier (R10-R13) should also have 5% tolerances.

Although the circuit can be wired point-to-point on perforated board, it is preferable to use a pc board such as that shown in Fig. 3. Be sure to observe the notch codes on the IC's and the polarities of the electrolytic capacitors so that they are properly installed.

In using a pc board, note that 8-pin DIP 741 op amps are required. If point-to-point wiring is used, other versions of the 741 (round, 14-pin DIP or dual) can be substituted.

Mount the batteries in holders in any convenient location in the chassis. If desired, the power can be obtained from an external supply between ± 6 and ± 15 volts. The supply voltage is not critical as far as circuit operation is concerned, but the maximum input signal level and the overall gain will vary for different supply voltages. The gain can be adjusted by changing the values of R3 (raising it to increase the gain) and R18 (lowering it to increase oscillator signal level).

The input and output connectors on the front panel must be chosen to suit the application.

Adjustment. For proper operation, the oscillator should be adjusted to 3500 Hz. If an accurate counter or oscilloscope is available, R17 can be adjusted while monitoring the output of IC5 (pin 3). An alternate method of adjustment based on the accuracy of the lowpass filter can be used if necessary. With the input shorted to ground and R17 turned fully counterclockwise, adjust R28 to get an output of 0.15 volt on an ac voltmeter. Now adjust R17 until the output voltage falls to 0.026 volt. The oscillator is now adjusted to approximately 3500 Hz.

To balance the multiplier, it will be necessary to adjust R27 and R28 while monitoring the scrambler output with an ac voltmeter or a set of headphones. With no signal

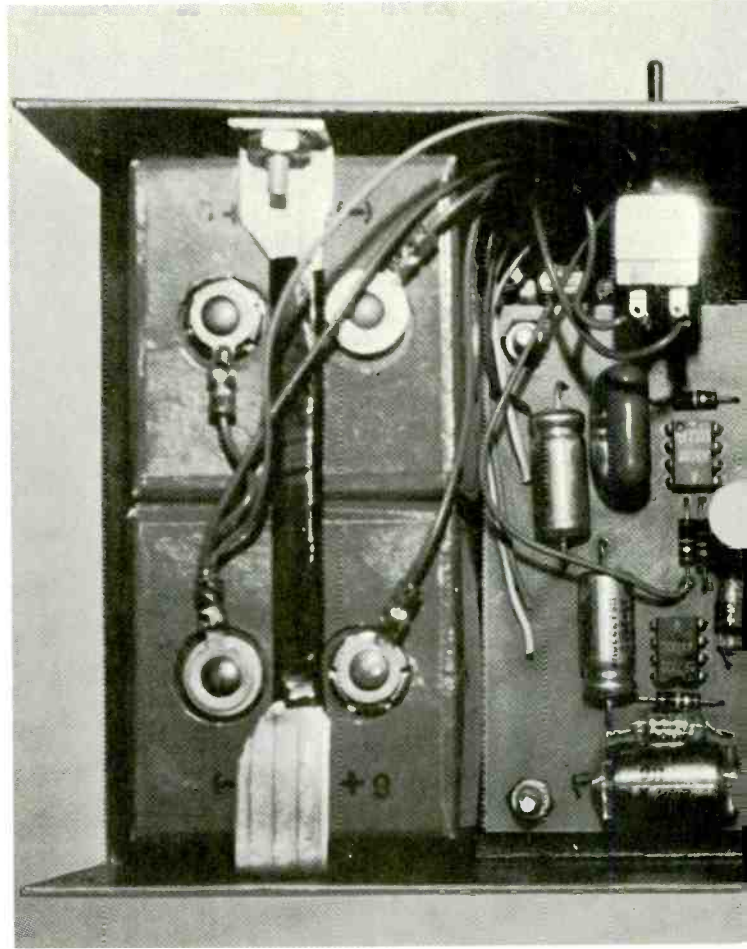

reference to voice signals. However, the same techniques can also be used to scramble data. They can be applied after the data is fed into a modem and converted to a series of audio tones for analog transmission.

The most sophisticated, expensive, and secure communication systems are digital. In Fig. 5 is shown a typical digital voice-encoding system. At the heart of the security system are the digital encoder/modulator and its counterpart, the decoder/demodulator. These systems combine some digital key with the di-

gitized signal. In many cases, synchronization requirements can be very stringent.

The complexity of the digital encoder varies with the degree of security required. Requirements can range from several years security for high-level governmental communications to a few hours or minutes in the field for military tactical operations. A few hours to several days generally suffice for most industrial and commercial activities.

The main disadvantages of digital encoding systems are their high cost, large size, and often greater bandwidth re-

quirements on the transmission links. On the other hand, such systems provide the highest degree of security available for both voice and data. There is also high flexibility in transmission routing and voice, and data links are often compatible.

Most government systems are classified. Hence, no details of their design or operating principles can be provided here. There is a book, however, *The Codebreakers* by David Kahn, that goes into some detail on the subject, using material from unclassified sources.

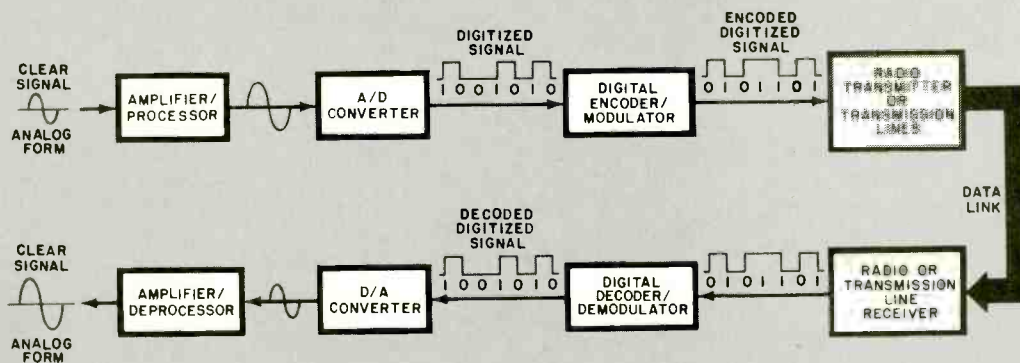

Fig. 5. Diagram of digital voice encoder which provides the best security.

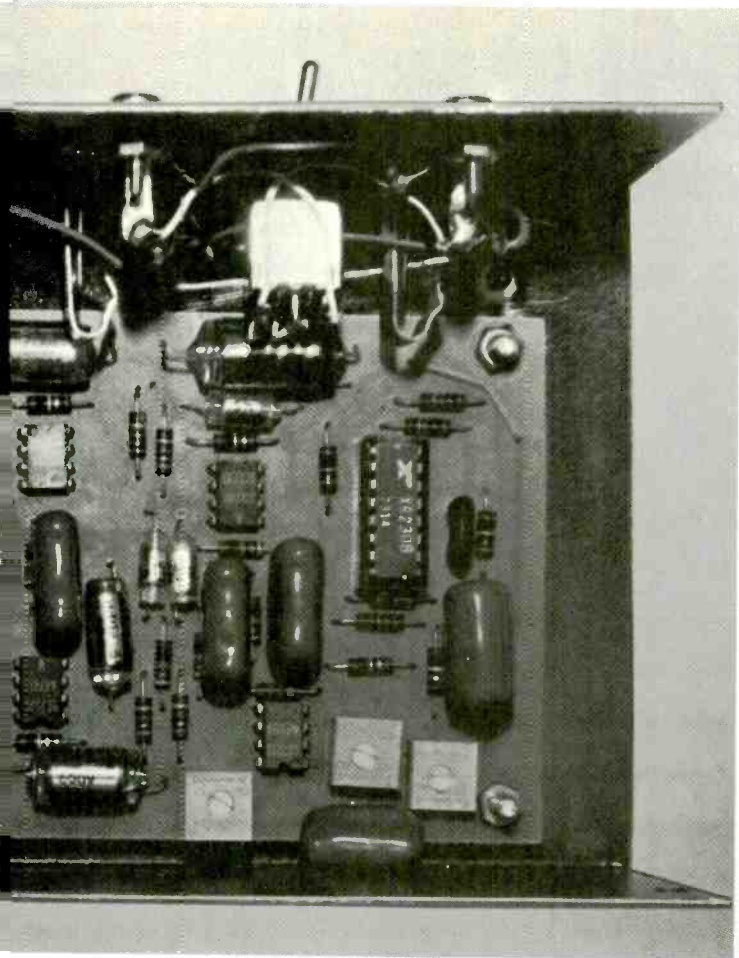

Photo shows how the prototype was assembled. Batteries are at left, but an external supply can be used if desired.

input, adjust *R28* for minimum output (near the middle of its range). To adjust *R27*, it is necessary to disable the oscillator by shorting across capacitor *C9*. With an input signal of about ½ volt (1000 to 3000 Hz), adjust *R27* for minimum output signal. The scrambler is now ready for use.

Use. A crystal microphone can be connected to the input of the scrambler with the output (with unity gain) connected to the mic input of a tape recorder or transmitter. If headphones are used, the scrambled signal is connected to the unscrambler. Alternatively, the unscrambler can be connected between the recorder preamplifier and speaker amplifier (or receiver detector and audio amplifier).

The multiplier portion of the circuit can be used as a single-sideband modulator. The multiplier can be modified to operate with carrier frequencies as high as 5 MHz. Pins 13 and 14 of *IC4* should be shorted to pin 4, with *R10* through *R13* removed, a 5100-ohm resistor connected between pins 4 and 15, and pin 2 connected to pin 16. With *IC5* removed, the desired carrier signal can be coupled into pin 4 (using about 1 volt). The output of *IC4*, from pin 15, can be coupled into a SSB filter to remove the unwanted sideband.

The multiplier can also be used as a variable-gain amplifier, or remote volume control. If the oscillator is removed, the gain of the multiplier can be controlled by varying the dc level on pin 5 of *IC4* from 0 to 5 volts. One way to accomplish this is to include a 100,000-ohm potentiometer in series with a 100,000-ohm resistor across the positive supply. Remove *IC5*, *R18*, and *R19*. Connect *C10* from *IC4* (pin 5) to ground. Connecting the wiper from the potentiometer to *IC4* (pin 5) will provide the desired variable voltage. For wide-band or hi-fi use, remove the two active filters. A control range of 50 dB can be obtained with low distortion. ♦

Cryptanalysis. Most industrial spies record an intercepted message on tape and then apply successive demodulation and/or decrypting techniques. Several switched filter banks and balanced modulators are used to decrypt band splitting, while the eavesdropper uses his ear and brain to tell him when he is getting close to his goal.

Computers are no doubt used in digital cryptanalysis. They make a series of possible solutions of transpositions and substitutions easy to print out. Also, it is easy for the computer to look for patterns in given languages by determining which symbols occur most often. In straight English text, the frequencies of occurrence of alphabet letters are as follows:

e = 1000	d = 392	g = 168
t = 770	l = 360	b = 120
a = 728	u = 296	k = 88
i = 704	c = 280	j = 55
s = 680	m = 272	v = 52
o = 672	f = 236	q = 50
n = 670	w = 190	x = 26
h = 540	y = 184	z = 22
r = 528	p = 168	

(In any average piece of English writing, letters are found in a standard ratio that varies only slightly from message to message. If the message is long enough, it can be decoded by use of letter-frequency tables. Since e is the most common letter, all other letters are given in relation to it. Hence, if e occurs 1000 times, the other letters will be found to have the approximate ratios given above.)

Future Trends. As one might expect, all of the communications security equipment currently being designed relies heavily on solid-state electronics. Most of the industrial and commercial systems still employ discrete components, but the government is forging ahead with more integrated circuits.

The trend is toward more and more sophisticated systems, with the demand for tighter security increasing, as is the technical competence of the would-be eavesdropper. Non-government users are beginning to look at digital techniques. As lower prices and new IC's to perform digital-to-analog and analog-to-digital conversions become widespread, this

trend toward digital systems will undoubtedly accelerate.

The Motorola MC1408 D/A converter IC is representative of the new integrated circuits on the market today. A practical encoder would combine an MC1408 with other logic and/or speech-processing circuits to give the particular results desired. Most filtering and speech processing is accomplished with the aid of operational-amplifier IC's.

The encoding and decoding circuits themselves can employ many of the standard shift registers, read-only memories (ROM's), random-access memories (RAM's), and gate arrays already in common use. These types of IC's are available in today's popular logic families.

At one time, governments were the only users of secure communication systems. Later, commercial organizations became security-conscious in their efforts to thwart industrial espionage. Now, the private citizen, concerned over bugging operations and other invasions of privacy, has taken up the security banner. For him, the voice scrambler seems made to order. ♦

ALMOST every stereo system today has a turntable that is equipped with a stereo cartridge for playing disc recordings. The stereo phono cartridge itself is a miniaturized pair of electric generators that are coupled to a single-jewel stylus. The stylus follows the undulations of the V-shaped record groove. Each of the groove walls, containing one of the two stereo program channels, moves the stylus independently to produce an electrical voltage at the appropriate output of the phono cartridge.

The two basic types of modern phono cartridges are amplitude-responding and the velocity-responding. The amplitude-responding variety's output voltage is proportional to the magnitude of the stylus motion, while the velocity-responding cartridge generates a voltage that is proportional to its velocity, which is the product of amplitude and frequency. Examples of amplitude-responding cartridges include piezoelectric (crystal and ceramic), strain-gauge, and photoelectric designs. Magnetic cartridges, used almost exclusively in modern high-fidelity sound systems, are velocity-responding types.

The magnetic cartridge operates by varying the strength of a magnetic field surrounding a coil of wire or by varying the position of a small wire coil in a fixed magnetic field. Both designs are capable of generating a voltage in a coil. Magnetic cartridges are known by various names, including moving-iron, moving-magnet, induced-magnet, variable-reluctance, and moving-coil, depending on the specific design employed in their manufacture. No matter what the name, each cartridge type offers certain advantages and disadvantages, and all are capable of equivalent performance.

The output of a magnetic cartridge, being proportional to frequency, requires equalization to produce a flat frequency response. The output of the cartridge is very low, generally only a few millivolts. Hence, the required amplification and equalization to produce a usable signal for the sound system must be supplied by the phono-preamplifier section of the system's amplifier or receiver.

The mechanical design of the moving elements in the phono cartridge is usually more important than the method of transduction—a demand

Anatomy of a Stereo Phono Cartridge

BY JULIAN HIRSCH
Hirsch-Houck Labs

not always appreciated by the user. The stylus must be able to reverse its direction thousands of times each second in exactly tracking the complex modulation on the groove walls; yet, it must not damage or permanently alter the shape of the groove modulation pattern.

Diamond, which can be shaped and polished with great accuracy, is universally used for high-quality playback styli. The tiny jewel (which may be difficult to see with the naked eye) is mounted with a precise orientation at one end of a light, hollow metal tube that is pivoted near the other end. The deflection of the tube by the motion of the stylus moves a portion of the magnetic circuit to generate the output voltage.

The dynamic contact force between the stylus and the groove, which determines the amount of tracking force needed, depends on several factors. Among these are the mass of the moving elements that must be accelerated during the rapid direction changes and the compliance (the inverse of stiffness) of the stylus cantilever system. Designed to track at forces as low as 1 gram, the best modern phono cartridges often have an effective stylus mass of less than 1 milligram and a compliance of 35×10^{-6} centimeters/dyne or more. Such cartridges are relatively delicate and should be used only in properly designed tonearms. Cartridges designed for low- and medium-priced record players have sturdier and less compliant stylus assembly systems that are meant to operate at forces of 2 to 3 grams. Although there is sometimes surprisingly little difference in sound quality between a 3-gram cartridge and one rated for 1-gram operation, the latter can be expected to produce somewhat less record wear over a long period of time. Cartridges

requiring a force of 4 grams or more should not be used for serious high-fidelity listening applications.

Although stylus mass and compliance ratings of cartridges are sometimes published, they are of limited usefulness in judging cartridge quality since many other unspecified factors are involved. In the absence of other information, the manufacturer's rated range of tracking forces is a good indication of overall cartridge performance (a lower force implying a generally superior product), although not necessarily of its listening quality compared to other cartridges.

The tracking ability of a cartridge refers to its ability to faithfully reproduce high recorded velocities (levels) over a wide frequency range at a given tracking force. Exceeding the tracking ability of a cartridge causes an unmistakable harsh, shattering sound. Sometimes, but not always, increasing tracking force will help. Almost all cartridges operate best when used near the high end of the recommended tracking force range. Few manufacturers provide specific information on tracking ability, but test reports such as those in this magazine serve as a useful guide.

The shape of the tip of the stylus jewel, which is the only part of the cartridge to actually contact the record, is an important factor in performance. The standard stylus has a spherical tip with a radius of 0.0007 in. (0.7 mil). More accurate tracking of very short recorded wavelengths (the higher frequencies, especially near the center of the record) is possible with a small tip radius, such as 0.5 mil. However, this causes a higher pressure per unit of area on the vinyl record, which can increase record wear unless a very low tracking force is used. A 0.5-mil stylus is not well suited to playing monophonic LP records.

An excellent compromise in stylus design, now widely used, is the elliptical stylus. Across the record groove, it has a radius of 0.7 to 0.9 mil, but along the length of the groove the radius is only 0.2 to 0.4 mil. The elliptical design yields superior high-frequency performance without excessive record wear as well as improved quality on mono discs. However, the most common elliptical size of 0.2×0.7 mil should not be used at forces exceeding 2 grams, which limits its use to the higher-priced phono cartridges. ♦

SOONER or later if you are working with digital IC's you're going to have to check the states of the signals at the various pins. You can view the waveforms on a scope, check the voltages with a meter, or use a standard logic probe. With either of these procedures, however, you can only check one pin at a time.

Now, with the Digiviewer II (costing less than \$19), you can simultaneously check all 14 or 16 pins of an in-circuit DIP package. The IC can be CMOS, TTL, DTL, RTL or other positive-supply digital logic. All you do is "glomper" the Digiviewer on the IC and LED readouts will indicate the state (0 or 1) at each pin. Masks can be inserted in the face of the Digiviewer to show the internal arrangement of common IC's so that there is no need to refer to a data book.

The Digiviewer also allows a solderless, snap-on connection to IC pins for measurements, monitoring, or "force-feeding" functions such as a reset. The glomper clip has gold-plated contacts that cannot short between pins, and a sliding clamp firmly locks the Digiviewer to the IC being tested.

The fixture locates the positive power supply automatically and the ground point is obtained either by plugging the Digiviewer's ground lead into the proper test pin or by using a ground extender to the system ground. The top half of the Digiviewer can be used alone as a permanent 16-place state monitor to be built into any circuit.

The logic decision point of the Digiviewer is 1.3 volts. Input signals above this level cause the associated LED's to light. Signals below 1.3 V indicate a logic 0, a ground, no connection, or an unterminated tri-state or open collector output.

While the Digiviewer works best on a visual rate with static clockings of the digital circuit, at higher speeds, the duty cycle of a particular pin will show up as a variable brightness. For instance, the Q and \bar{Q} pins of a binary dividing flip-flop will cause the LED to glow at half brightness.

The input impedance of the Digiviewer is 100,000 ohms at 1.2 volts and it will operate over any supply voltage from +4 to +10 volts. For higher supplies, voltage-dropping resistors can be used.

Circuit Operation. As shown in Fig. 1, each of the 16 pins of the glomper

BUILD DIGIVIEWER II

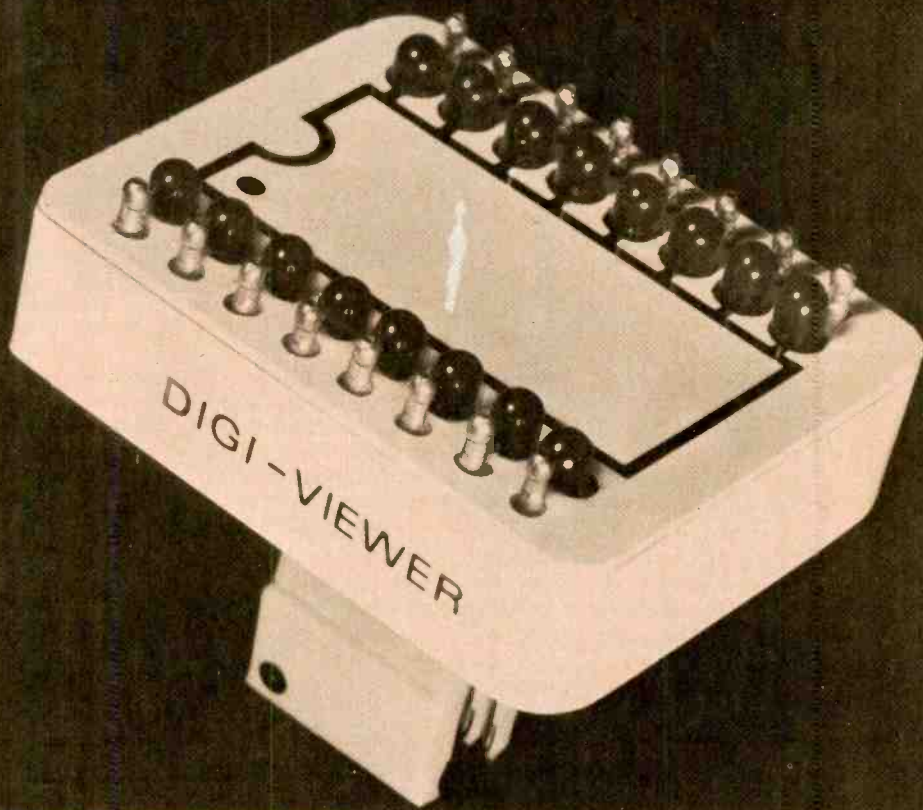

*Simultaneously checks up to
16 pins of any digital IC*

BY DON LANCASTER

EXPERTS AGREE

The TV of the future is here... in the Heathkit Digital-Design GR-2000 TV

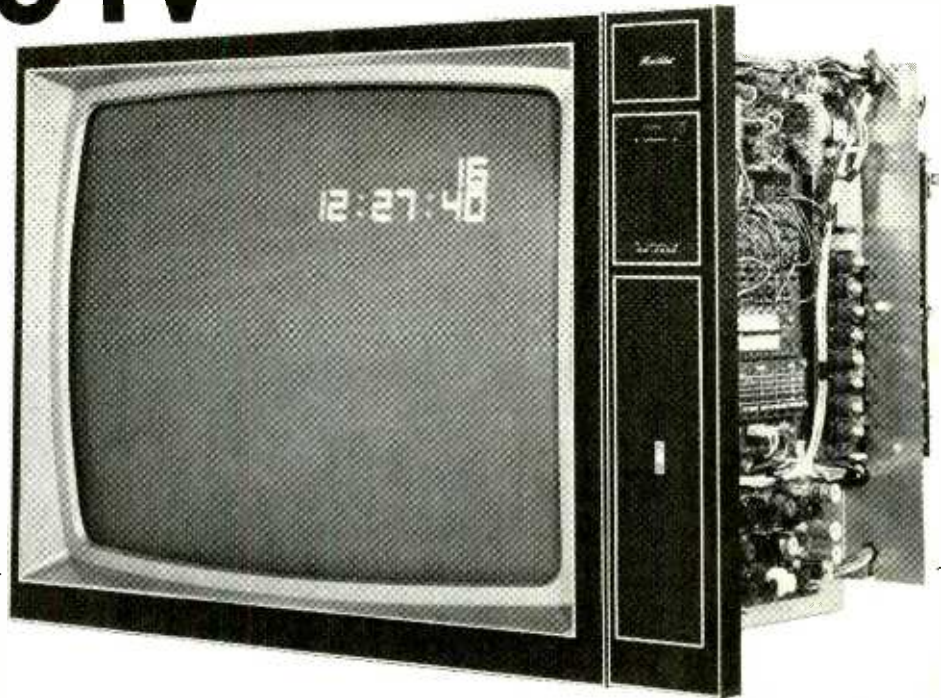

At **ELEMENTARY ELECTRONICS** they said: "The fact is, today's Heathkit GR-2000 is the color TV the rest of the industry will be making tomorrow... there is no other TV available at any price which incorporates what Heath has built into their latest color TV."

The **FAMILY HANDYMAN** reviewer put it this way: "The picture quality of the GR-2000 is flawless, natural tints, excellent definition, and pictures are steady as a rock. It's better than any this writer has ever seen."

POPULAR SCIENCE pointed out "more linear IC's, improved vertical sweep, regulators that prevent power supply shorts, and an industry first: the permanently tuned I.F. filter."

The **RADIO-ELECTRONICS** editors said the Heathkit Digital TV has "features that are not to be found in any other production color TV being sold in the U.S.:

"On-screen electronic digital channel readout... numbers appear each time you switch channels or touch the RE-CALL button... On-screen electronic digital clock... an optional low cost feature... will display in 12- or 24-hour format... Silent all-electronic tuning. It's done with uhf and vhf varactor diode tuners... Touch-to-tune, reprogrammable, digital channel selection... up to 16 channels, uhf or vhf... in whatever order you wish... there's no need to ever tune to an unused channel. LC IF amplifier with fixed ten-section LC IF bandpass filter in the IF strip... eliminates the need for critically adjusted traps for eliminating adjacent-channel and in-channel

carrier beats. No IF alignment is needed ever. Touch volume controls... when the remote control is used... touch switches raise or lower the volume in small steps."

POPULAR ELECTRONICS took a look at the 25-in. (diagonal) picture and said it "can only be described as superb. The Black (Negative) Matrix CRT, the tuner and IF strip, and the video amplifier provide a picture equal to that of many studio monitors..."

Furthermore, the Heathkit GR-2000 is an easier kit-form TV to build. **POPULAR ELECTRONICS** pointed out that "Each semiconductor has its own socket and there are 12 factory-fabricated interconnecting cables... The complete color adjustments can be performed in less than an hour."

To sum up, **POPULAR ELECTRONICS** concluded its study by stating, "In our view, the color TV of the future is here—and Heath's GR-2000 is it!"

Why not see what the experts have seen? The Heathkit Digital Design Color TV—without question the most remarkable TV available today.

Mail order price for chassis and tube, \$659.95. Remote Control, \$89.95 mail order. Clock, \$29.95 mail order. Cabinets start at \$139.95 (Retail prices slightly higher.)



TOMORROW'S PRODUCTS are in kit-form today- with Heathkit electronics



(A) New Heathkit Digital Electronic Alarm Clock. Like no other clock you've ever owned... with features as new as tomorrow! Wakes you with an electronic "beep" and shuts off at a touch—no fumbling for knobs or switches. And if the power goes off, you still get to work on time—the clock has its own emergency battery supply. Other features are a 24-hour alarm cycle with AM indicator light to aid in setting; 7-minute repeatable snooze cycle; 12 or 24-hour time format; automatic brightness control. Kit GC-1092A, 79.95*. Shipping weight, 5 lbs.

(B) New Heathkit Digital Electronic Calendar/Clock. In this unique timepiece, we swapped the alarm feature for the date—and held the same low kit price featured in its alarm clock twin. Reads out the time in hours, minutes & seconds, with big orange digits. Plus, it gives you the month and day, either automatically for 2 seconds out of every 10, or anytime at the touch of an electronically activated control. It also features 12 or 24-hour time format, automatic brightness control, and built-in fail-safe reserve battery supply. Kit GC-1092D, 79.95.* Shipping weight, 5 lbs.

(C) New Heathkit Exhaust Gas Analyzer. A timely kit for the week-end mechanic and the professional alike. Checks exhaust gas of cars for pollution level and measures air/fuel mixture to help you tune for top economy.

Also a great training aid in automotive mechanics classes for demonstrating results of proper anti-pollution system adjustments. Easy to assemble, simple to use. Kit CL-1080, 59.95*. Shipping weight 6 lbs.

(D) New Heathkit Tune-up Meter. Successor to the popular Heathkit ID-29—now with new, extended 0-20 VDC range. Checks dwell on 4-cycle, 3, 4, 6 & 8 cylinder engines with conventional ignition. Two rpm ranges. Reads voltage from 0-20 VDC. Use on 6 or 12V systems, either ground. No batteries required. Kit CM-1073, 29.95*. Shipping weight, 5 lbs.

HEATHKIT ELECTRONIC CENTERS —
Units of Schlumberger Products Corporation.
Retail prices slightly higher.

ARIZ.: Phoenix; CALIF.: Anaheim, El Cerrito, Los Angeles, Pomona, Redwood City, San Diego (La Mesa), Woodland Hills; COLO.: Denver; CONN.: Hartford (Avon); FLA.: Miami (Hialeah), Tampa; GA.: Atlanta; ILL.: Chicago, Downers Grove; IND.: Indianapolis; KANSAS: Kansas City (Mission); KY.: Louisville; LA.: New Orleans (Kenner); MD.: Baltimore, Rockville; MASS.: Boston (Wellesley); MICH.: Detroit; MINN.: Minneapolis (Hopkins); MO.: St. Louis; NEB.: Omaha; N.J.: Fair Lawn; N.Y.: Buffalo (Amherst), New York City, Jericho, L.I., Rochester, White Plains; OHIO: Cincinnati (Woodlawn), Cleveland, Columbus; PA.: Philadelphia, Pittsburgh; R.I.: Providence (Warwick); TEXAS: Dallas, Houston; WASH.: Seattle; WIS.: Milwaukee.



FREE 1975 HEATHKIT CATALOG

350 easy-to-build kits in all price ranges. Send for your free copy today!

Heath Company
Dept. 10-9
Benton Harbor, Michigan 49022

- Please send my free 1975 Heathkit Catalog.
- Enclosed is \$ _____, plus shipping.

Please send model(s) _____

Name _____

Address _____

City _____ State _____ Zip _____

Prices & specifications subject to change without notice.

*Mail order prices; F.O.B. factory

HEATH

Schlumberger

CL-525

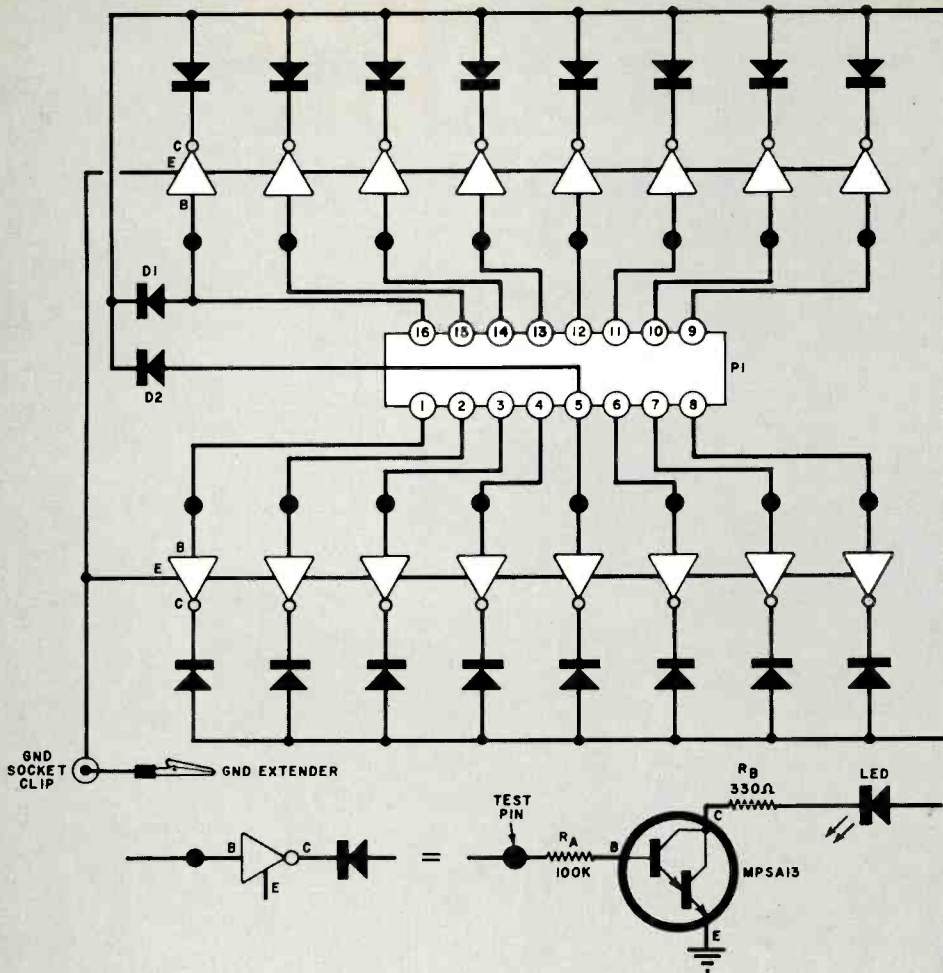

PARTS LIST

D1, D2 — 1-ampere silicon rectifier diode
 LED1-LED16 — 0.2-in. diameter LED
 P1 — Glomper clip (Guest International)
 Q1-Q16 — MPSA13 or MPSA14 npn Darlington transistor (minimum gain 5000, do not substitute)

$R_A(16)$ — 100,000-ohm, 1/4-watt resistor
 $R_B(16)$ — 330-ohm, 1/4-watt resistor
 Misc. — Test pins (Molex 0.093" diameter by 0.6" high, 17 required); heavy wire for board interconnections; flexible insulated wire; test socket (Molex 02-09-1118); heat-shrinkable tubing; insulated alligator clip; etc.

Note: The following are available from Southwest Technical Products, 219 W. Rhapsody, San Antonio, TX 78216: etched and drilled pc boards at \$3.25; complete kit of parts (#VU-2) at \$19.50; mask sets (specify RTL, 7400TTL, 4000CMOS, or blank) at \$2.50.

Fig. 1. Circuit consists of 17 identical high-input-resistance Darlington LED drivers. Power is derived from pin 5 or pins 14/16, common positive pins.

clip (P1) is connected to a Darlington transistor npn amplifier through a 100,000-ohm resistor. The output of each transistor goes through a current-limiting resistor and then through an LED indicator to the positive line. All 16 emitters are connected to the common ground. Diodes D1 and D2 are connected to pin 5 and pins 14/16 to handle the positive power supply. On a 14-pin DIP IC, pin 16 becomes pin 14 and the two

right-hand LED's should be ignored. Only the most positive pin contributes to the Digiviewer power; the other diode is back biased and does not load the input. To test an IC that does not have pin 5 or pin 14/16 as the supply, another diode is needed (or 14 more diodes can be added—one for each pin).

Construction. Two printed circuit boards, stacked, are recommended

for the Digiviewer. One is used to hold the glomper clip and the rest of the electronics is mounted on the second.

Assemble the top board (Fig. 2A and B) first. Attach the resistors first. In mounting the transistors, arrange their leads so that the transistor bodies are as close as possible to the pc board. The emitter terminal of each transistor goes on the inside, so half of the transistor "flats" point one

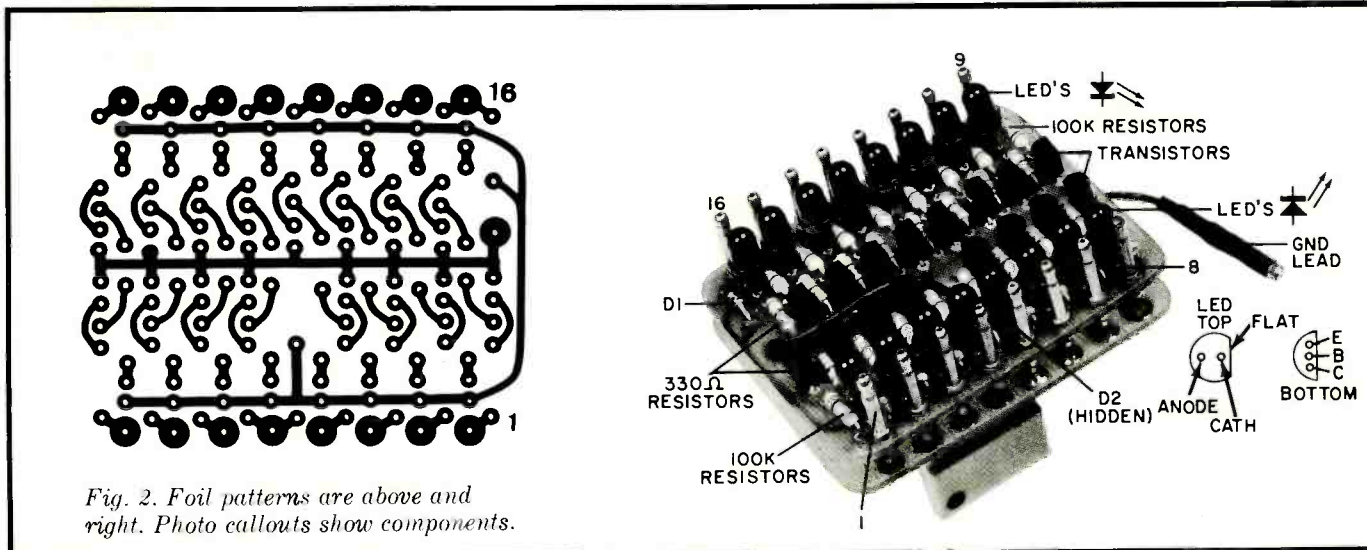

Fig. 2. Foil patterns are above and right. Photo callouts show components.

way and the other half the other way. This insures that all the emitter terminals are connected to the common grounds. Attach the diodes last.

Now temporarily insert and solder tack a test pin in each of the four corners. These pins and a flat surface are used to set the height of the LED's, which are uniformly spaced 0.2 in. off the pc board.

Note that an LED has a critical polarity. The cathode or resistor end has a slight flat on the plastic base. If the leads are of different lengths, the longer lead is usually the anode. One LED at a time is slipped into place and the pc board is then turned upside down (on the flat surface) to stand on the four corner test pins. Each LED pin is brought out vertically and tacked in place. Be sure the tops of the LED's just touch the flat surface and that the units are vertical.

The remainder of the test pins are then inserted on the same side as the LED's. Make sure that the pins are vertical and firmly seated before soldering them in place. Be careful not to let solder flow into the small hole at the bottom of each pin.

Complete assembly of the top board by adding an insulated (black) flexible ground lead, feeding it through a hole drilled above D2.

To test the board, use a 5-volt dc power supply and connect the loose end of the ground lead to the power supply negative. Connect the positive supply (5 volts) to the 14/16 test pin and note that the associated LED comes on. Make a connection between pin 5 (+5 volts) and each of the other pins and note that each associated LED comes on. To make a

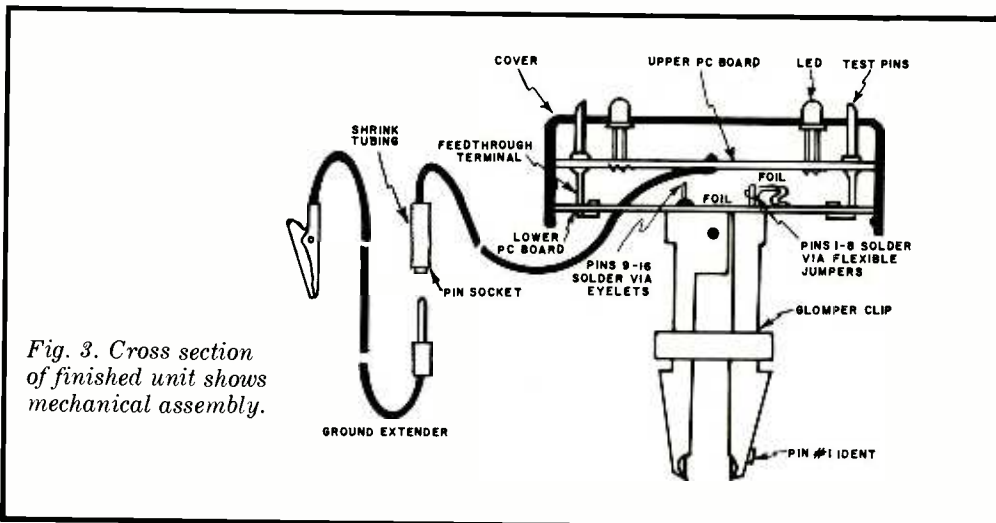

Fig. 3. Cross section of finished unit shows mechanical assembly.

threshold check, leave the 5-volt supply on and use another, variable dc supply to check each input. The LED's should be off at about 1.1 V and fully lit at 1.5 V.

The foil pattern for the lower pc is shown in Fig. 2C. The outside dimensions of this board should be exactly the same as those of the upper board. Note that there is a slot in the board spanning pins 1 through 8.

Pins 9 through 16 of the glomper clip mount in the indicated holes, with the glomper on the nonfoil side of the board. (In the finished project, the foil sides of the board are facing each other.) Pins 1 through 8 of the clip pass through the slot in the board so that the arm of the clip can swing through a slight arc when the clip is mounted on an IC. The arm of the clip is the thinner side.

Each of the arm pins is connected to the pc foil through a short length of very flexible, thin, insulated wire. Be sure that these leads do not get covered with solder which will make them stiff. Be sure the clip arm moves freely.

The two pc boards are attached as shown in Fig. 3, with a spacing of 1/4 in. Make up 16 short, heavy wire stubs just thick enough to slip through the holes in the bottom board. Insert the stubs in the holes and solder them in place on the foil side. Allow a small stub on the nonfoil side so that optional contact can be made to each pin.

Fit the boards together, soldering each stub into the hole of its associated test pin. Be sure not to loosen the test pin as you solder. Pass the insulated ground wire through the hole in the lower board and cut it so

that it is about 6 or 8 inches long. Solder a push-on connector to the end and cover it with a length of heat-shrinkable tubing. Make up an extension ground lead, using a mating push-in connector and heat-shrinkable tubing at one end and an insulated alligator clip at the other.

The snap-on cover is fabricated of thin-walled (preferably white) plastic sheet. It can be made in two pieces (the top and a skirt) which are then cemented together after all drilling is complete.

The upper surface is 2¹/₁₆ in. by 2⁷/₁₆ in., which is just large enough to fit over the LED's and test pins, with a little to spare. Sixteen 3³/₁₆ in. holes should be drilled to mate with the LED's. Also drill 16 1/8-in. holes to mate with the test pins. The outline of a 16-pin DIP should be drawn on the upper surface with a notch and dot code used to identify pin 1. The skirt, about 5/8" deep, is cemented to the upper cover. When the assembly is complete, the snap-on cover should seat firmly over the pc board assembly.

Use. Make up a series of masks for the most commonly used DIP IC's. Use indelible pencil or ink to draw the logic of the IC and identify the positive and ground pins. The masks should be held snugly against the LED's.

In fitting the glomper clip over an IC, be sure that pin 1 of the clip is on pin 1 of the IC. Connect the floating ground test lead to the circuit ground, or to the ground pin of the Digiviewer. Note that the supply voltage is present at the correct pin as indicated by an illuminated LED at that position.◆

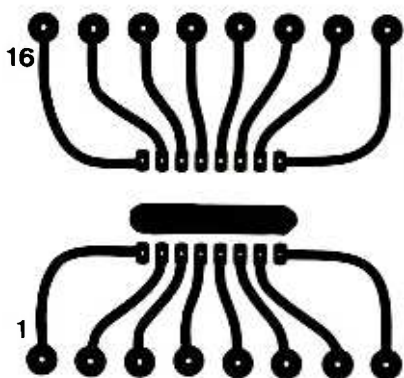



Product Test Reports

PIONEER MODEL QX-747 4-CHANNEL RECEIVER (A Hirsch-Houck Labs Report)

Has built-in decoding for SQ and RM and demodulator for CD-4



THE Pioneer Model QX-747 4-channel receiver features built-in decoding matrices for SQ and RM discs, a demodulator for CD-4 discrete 4-channel discs, and a high-quality AM/stereo FM tuner. Its 4-channel amplifier is rated at 20 watts/channel with all channels driven over the entire audio frequency range. Additionally, a 2CH POWER BOOST operational mode provides a rated output of 40 watts/channel from the two stereo channels.

The retail price of the QX-747 receiver is \$649.95.

General Description. The operating mode and functions of the re-

ceiver are displayed by lighted indicators located across the top of the blackout dial area. The mode switch has positions for 2CH, CD-4, RM, and SQ. The CD-4 mode is also used for playing discrete 4-channel material from an external tape deck or other program source. A stereo FM signal illuminates the legend STEREO on the dial, while a red dot next to the CD-4 indicator comes on when a CD-4 disc is played.

Tape monitoring from a 2- or 4-channel deck is controlled by pushbutton switches. Another pushbutton turns on and off an external Dolby noise reduction system for use with Dolby-encoded FM transmis-

sions or with a tape deck lacking the noise reduction feature.

This receiver employs Pioneer's unique 4-channel level indicator. It resembles a 3-in. (7.62-cm) cathode ray tube screen with four green-illuminated sectors whose length is proportional to the program signal level in each channel. Surrounding the "screen" are four small channel-level control knobs. Two pushbutton switches, located below the dial scales, increase display sensitivity by 10, 20, or 30 dB. (To obtain a 30-dB increase in sensitivity, both switches must be activated simultaneously.)

The master VOLUME control is flanked by two small control knobs that are used to optimize the front-to-rear separation for the particular cartridge in use when the receiver is operated in the CD-4 mode. A special test record is supplied with the receiver for making these adjustments.

Lifting a hinged cover on the rear apron of the receiver reveals the 4CH/2CH plug that must be removed and reinserted, upside down, to boost the per-channel power for 2-channel stereo operation. The setting of this plug is visible through a transparent window in the cover.

Laboratory Measurements. The FM tuner in the QX-747 receiver has a usable IHF sensitivity of 1.8 μ V and a 50-dB quieting sensitivity of 2.5 μ V in mono. In stereo, the usable sensitivity was 3.7 μ V, and the 50-dB quieting sensitivity was 38 μ V. The ultimate distortion and S/N ratio at 1000 μ V were, respectively, 0.18 percent and 70 dB in mono (0.20 percent and 68.4 dB in stereo).

Other FM performance parameters were equally impressive. Capture ratio was 1 dB, AM rejection was 53 dB, image rejection was 93.5 dB, and alternate-channel selectivity was 45 dB. The automatic stereo switching threshold was 2 μ V, and the muting threshold was 2.4 μ V. Muting action was positive and noise-free.

The stereo FM frequency response was flat within ± 0.25 dB from 30 Hz to about 12,000 Hz, falling to -2 dB at 15,000 Hz. The 19-kHz pilot carrier suppression was an exceptional 95 dB. Channel separation was unique in our test experience, with the two channels absolutely identical as well as nearly constant over the full audio-frequency range. Separation was about 32.5 dB from 30 Hz to 5000 Hz and better than 30 dB up to 15,000 Hz. The AM performance was also

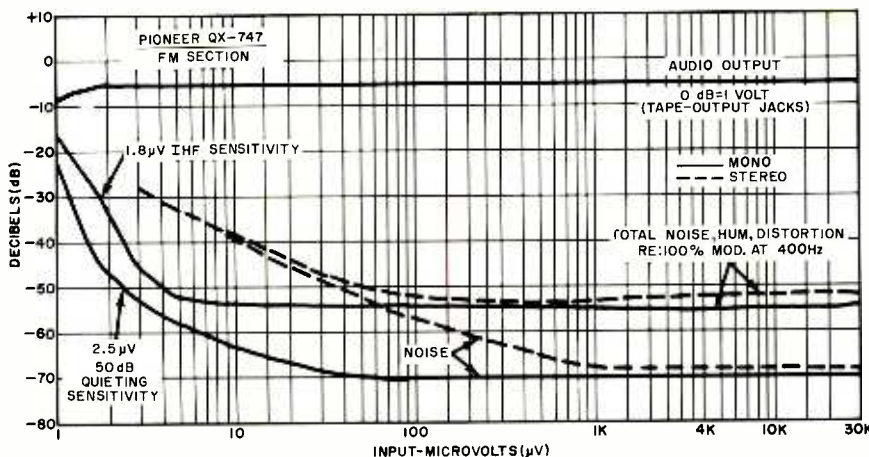

better than average, with the frequency response down 6 dB at 30 Hz and 5700 Hz.

The audio amplifiers proved to be very conservatively rated. With all four channels driven simultaneously at 1000 Hz into 8-ohm loads, the outputs clipped at 29.3 watts/channel. In the 2CH POWER BOOST mode, clipping power was 50 watts/channel into 8 ohms, 69 watts/channel into 4 ohms, and 31.8 watts/channel into 16 ohms. Unlike many receivers that use a "bridging" system to combine front and rear channels in the 2-channel mode, Pioneer simply removes the power from the rear amplifiers in the QX-747, thereby boosting the available supply voltage (and hence output power) of the front channel amplifiers.

At the rated 20 watts/channel output power (and at half power), with all channels driven, the THD was less than 0.03 percent from 20 Hz to 2000 Hz. It rose to 0.2 percent at 20,000 Hz. At 2 watts output, the distortion at frequencies below 2000 Hz was slightly higher but still an insignificant 0.05 percent even at 20,000 Hz. At 1000 Hz, the distortion was below the noise level until the output reached 1 watt. From 1 watt to 27 watts output, it measured between 0.025 and 0.03 percent. The IM distortion was an almost constant 0.055 percent from 0.1 watt to 23 watts output.

We measured the receiver's phono sensitivity with the individual channel levels and the CD-4 separation adjustments (which also serve as phono gain adjustments) set at their midpositions. For 10 watts output, the phono input was 3.9 mV, with a S/N ratio of 68 dB. The overload point was a safe 100 mV. When the channel gains and CD-4 controls were set to maximum, the sensitivity was 0.2 mV, and overload occurred at 23 mV. The actual settings of the CD-4 controls must be governed by the phono cartridge's output. Hence, in practice, there is little likelihood of overload from heavily modulated discs. The aux sensitivity was 65 mV, with a 78.6-dB S/N ratio.

The RIAA equalization accuracy was within ± 2 dB from 50 Hz to 15,000 Hz. The response fell rapidly at higher frequencies due to the filter in the CD-4 demodulator (which is always in the circuit). A useful byproduct of the CD-4 demodulator is that the isolation of its equalizing circuits from the phono cartridge's inductance has a

SEPTEMBER 1974

negligible effect on the high-frequency response.

The tone control characteristics were conventional, with a sliding bass turnover frequency. The loudness compensation provided a moderate bass and treble boost. The individual channel level controls can be set so that the master volume control operates in almost any desired portion of its range, thereby using loudness compensation most effectively.

User Comment. The Pioneer Model QX-747 receiver is clearly a superb unit when judged by all normal performance standards. In fact, its power capabilities in the 2-channel mode

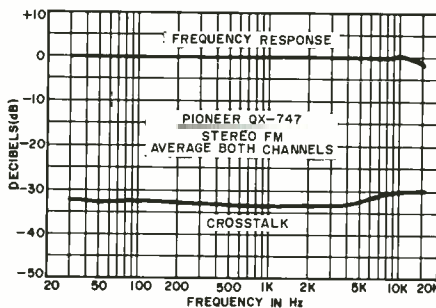
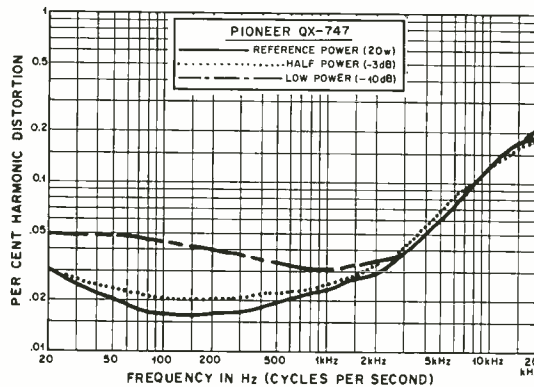
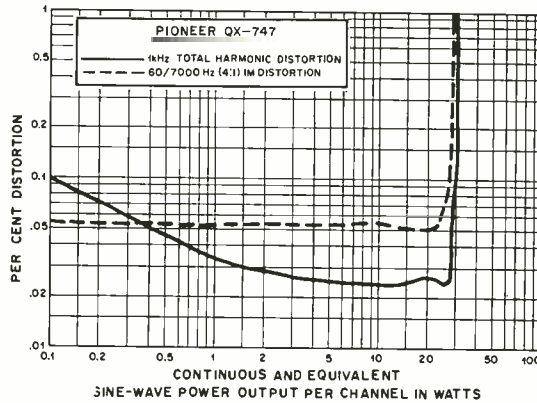

SAVE!

MONEY • TIME • FREIGHT

QUALITY STEREO EQUIPMENT AT LOWEST PRICES.

YOUR REQUEST FOR QUOTATION RETURNED SAME DAY.

FACTORY SEALED CARTONS—GUARANTEED AND INSURED.

SAVE ON NAME BRANDS LIKE:

A.D.C.	KLH
A.R.	SHURE
DYNACO	KOSS
SONY	FISHER

AND MORE THAN 50 OTHERS

BUY THE MODERN WAY

BY MAIL—FROM

ia
illinois audio

Department 217S
12 East Delaware
Chicago, Illinois 60611
312-664-0020

CIRCLE NO. 19 ON READERS SERVICE CARD

make it a fine value even as a stereo-only receiver.

The CD-4 demodulator operated flawlessly. Adjustment is a matter of moments with the supplied test disc. (Our impression is that the end results are more likely to be determined by the cartridge and disc than by the receiver's demodulator circuits.)

As a matrix 4-channel receiver, the QX-747 does at least as well as other such receivers that lack logic assistance for the SQ matrix. The results were good but are completely outclassed by the CD-4 mode's performance. The RM matrix (which is unfortunately omitted in many other receivers) produces some highly effective 4-channel sound from those rec-

ords issued with the Sansui QS-encoding.

Not only is the FM tuner in this receiver of outstanding quality, but we were impressed by the quiet back-

ground and excellent sound quality of the AM tuner. All in all, the QX-747 is one of the most satisfactory and complete 4-channel receivers we have so far seen.

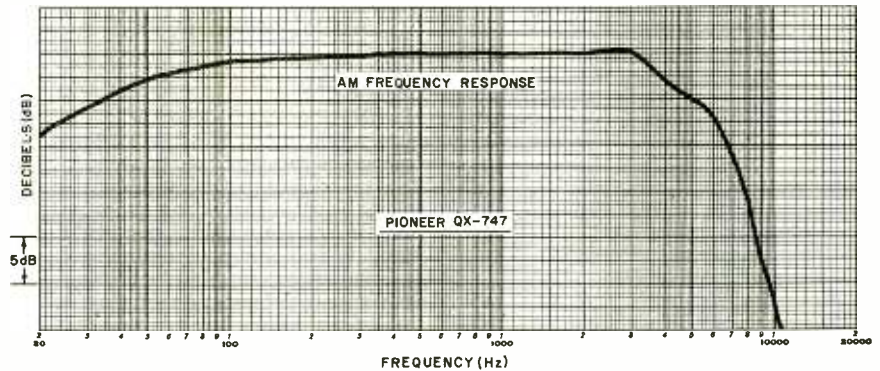

WOLLENSAK MODEL 8075 8-TRACK CARTRIDGE DECK

(A Hirsch-Houck Labs Report)

First high-performance cartridge deck



UNTIL recently, manufacturers paid little attention to the "high-fidelity" possibilities of the 8-track cartridge tape format. In any event, it was reasoned, good hi-fi quality would be of no benefit in the normally noisy environment of a car, for which the cartridge format was first developed. The deficiencies of the 8-track format, however, are very apparent when the cartridges are played through a home music system of even modest quality. Hence, limited frequency range, high noise levels, and excessive wow and flutter have come to characterize the cartridge format.

Now, however, Wollensak is changing that picture. Their Model 8075 record/playback deck is perhaps the first of its kind to depart from traditional "mobile" design. Consequently, it can qualify as a true high-

fidelity sound component. Its transport is rated for 0.1 percent weighted rms flutter (several times less than the typical cartridge deck). A Dolby-noise reduction system that can be used both in the tape recording and playing process and with Dolby-encoded FM broadcasts is built into the deck.

Although the 8075's frequency response is rated at ± 3 dB from 30 Hz to 12,000 Hz with standard tapes—which is several times better than with most cartridge decks—3M's newly developed "Special" cartridge extends the rated upper-frequency to 15,000 Hz. This requires a special recording equalization characteristic, for which a switch is provided on the deck. The rated S/N ratio is also comparable to that of a good cassette recorder (60 dB with the Dolby circuits switched in and 50 dB when they are switched out).

General Description. The Wollensak Model 8075 cartridge deck is about as large as many stereo receivers, measuring 19 3/4 in. by 10 1/4 in. by 5 in. (50.17 cm by 26.04 cm by 12.7 cm). It weighs 17 pounds (7.73 kg). Retail price is \$299.95.

The usual track-selection and recording interlocks are provided. In addition, there are PAUSE and FAST WIND levers. The index counter provides an indication in actual playing time (minutes and seconds) instead of the usual arbitrary units. The two VU meters indicate both recording and playback levels. Green lights under the tape loading slot show which channel is in use, while a red light comes on when the deck is set to the recording mode.

The DOLBY switch has three positions. OFF disconnects the noise reducing circuits from the system; REC/PLAY is used for encoding and decoding tapes; and FM DECODE shuts off the transport's motor, connecting the Dolby playback circuits between the input and output terminals of the deck for decoding FM transmissions. Screwdriver adjustments are provided for setting the correct levels for FM Dolby decoding. Another switch permits selection of REGULAR or SPECIAL recording equalization. (Red lights identify the settings of the DOLBY and TAPE switches.)

The AUTO EJECT and REPEAT switches can be set to eject the cartridge from its slot after playing either

one track or all four tracks, or to repeat one track or all four tracks indefinitely until the cartridge is manually ejected. An FM LISTEN switch turns on the electronics portions of the deck without a cartridge in the slot.

Laboratory Measurements. We measured the playback frequency response of the deck with an Audiotex 30-213 test cartridge. The response was ± 2 dB from 45 Hz to 8500 Hz and was down 4.5 dB at 40 Hz and 10,000 Hz. The overall record/playback response was measured with a "regular" tape (TDK SD) and the new Scotch Special tape, using the appropriate settings of the EQUALIZATION switch. Below about 500 Hz, there were irregularities caused by the head design in the response of both tapes. The response with TDK SD tape was ± 4.5 dB from 20 Hz to 14,500 Hz; above 200 Hz, the variation was less than ± 2.5 dB, with a slight peak at 11,000 Hz. The Special tape produced a smoother and peakless high-frequency response that was ± 2 dB from 200 Hz to 14,000 Hz and ± 3 dB from 20 Hz to 14,000 Hz. The "tracking" or the Dolby noise reduction circuit was good, with less than 1.5 dB variation in response at frequencies beyond 1000 Hz.

An output of 100 mV produced a 0-dB recording level (which played back at about a 1-volt output level). The THD at 0 dB was 1 percent to 1.5 percent with either tape. The S/N ratio, relative to the 0-dB level, was measured with IEC weighting (similar to ANSI "A") for better correlation with subjective effects. It was 50.3 dB with Special and 53 dB with TDK SD tape.

Using the noise reduction system, the respective figures were 59.5 dB and 61 dB.

The wow and flutter were measured as a combined record/playback effect. There was a great variation with different tape cartridges, some of which produced intolerable wow. The best of them were very good, with 0.05 percent wow and from 0.12 percent to 0.15 percent flutter. Our measurements were unweighted rms.

User Comment. By dubbing high-quality discs onto the tape deck and

proved to be a convenient and generally accurate means of locating a specific portion of the recording. However, the tape does not instantly stop and start when the PAUSE and FAST WIND controls are operated; so, care is needed to insure that the deck's mechanism and tape have come to a full stop before removing the cartridge. Failure to follow this procedure may result in indexing errors.

Although this cartridge deck has many of the convenience and performance features of a cassette deck, it

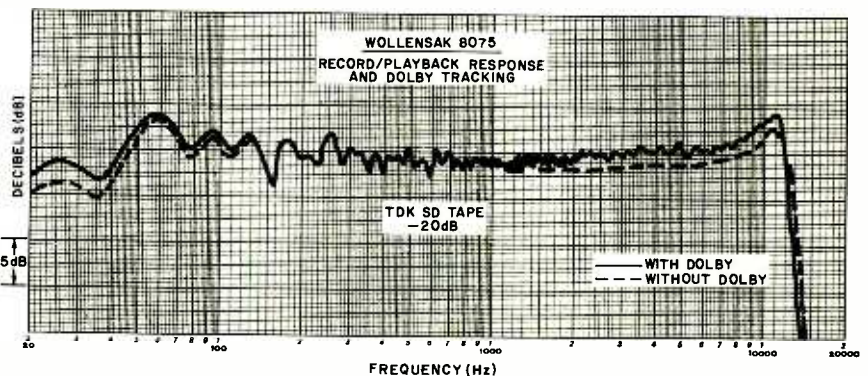

comparing the playback to the original in an A-B test, we satisfied ourselves that this can honestly be described as a "high-fidelity" cartridge recorder. The differences we heard generally took the form of a slight "hardness" of the higher frequencies. The noise level contributed by the record/playback process was inaudible when the Dolby circuits were switched in.

The FAST WIND mode was about four times (rated 3.5 times) the normal $3\frac{3}{4}$ ips (9.53 cm/s) tape speed. The timer

requires a very different operating technique for successful use as a recorder. Patience is the most important requirement, since even at the "fast" speed it may require five to six minutes to reach the starting point of a 90-minute cartridge. Any error in recording will require a similar wait before it can be corrected, since you cannot "rewind" a cartridge. Fortunately, the listening quality of the end product can be excellent, justifying the care taken in its production.

CIRCLE NO. 65 ON READER SERVICE CARD

E.F. JOHNSON MESSENGER 250 CB BASE STATION

AM base station with high sensitivity can double as mobile



MOST of the CB transceivers currently making their appearance in the market are designed specifically for mobile installations. Although many of them can be set up

and used as base stations, it might be well to look at a CB rig that is designed specifically for such fixed-stations service—for instance, the Messenger 250 base station transceiver made by the E.F. Johnson Company.

The Messenger 250 is an AM transceiver that provides 23-channel operational capability and employs most of the features that are desirable in a CB base station. It has high sensitivity with good selectivity, an automatic noise limiter (anl), adjustable squelch, a meter that indicates S units on receive and relative output power on transmit, and operates at

the full legal power. Also featured are a front-facing speaker, automatic modulation control (amc), a detachable ceramic microphone, and PA service via an external speaker.

The transceiver's built-in power supply permits operation from any 117-volt, 50/60-Hz line power source. Alternatively, the rig can be powered from an external 13.8-volt dc source; so, mobile operation is not precluded. The power supply employs silicon rectifiers in a bridge configuration, with three transistors and a zener diode providing electronic voltage regulation. The line cord is a three-conductor safety affair that automati-

Sylvania goes



TV reception simulated

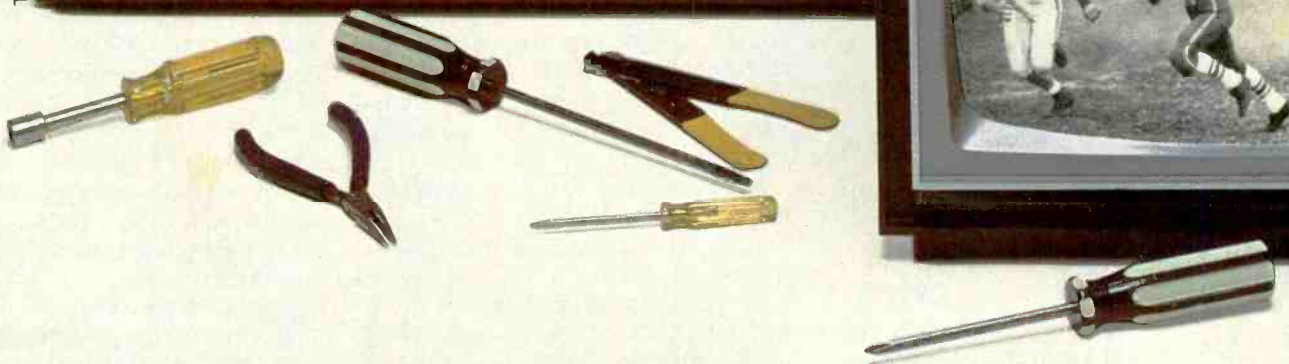

one better.

We give you two TVs instead of one.

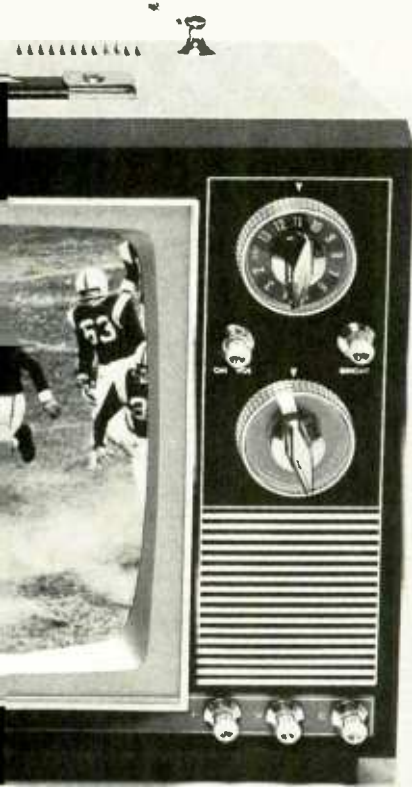

With Sylvania's Master TV Career Program you get not just one but *two* TV sets to build. *Color and Black & White.* Both Solid State.

With all Sylvania Career Programs you get our exclusive Autotext method of instruction, a modern, step-by-step approach to learning, which gets you through the basics of electronics quickly and easily.

An optional Cassette System, a technique that adds an extra dimension to learning. It's almost like having an instructor right in your own home. As you play the tapes, he'll guide you through your lessons, explaining as you read, going over schematics and reinforcing everything you learn!

Plus a choice of Programs that can lead to any number of career goals. In TV, communications, automation, digital and solid-state electronics. And in fields you haven't even dreamed of.

Plus specialized advanced training and carefully-engineered Project Kits for that "hands-on" training you need to make it in the world of electronics.

Throughout your training, Sylvania makes that extra effort to go one better.

Send the card or mail in coupon today for our FREE Catalog. And go with Sylvania.

SYLVANIA Technical Schools
Home Study Division 694-409-0
Sylvania Technical Systems, Inc.
909 Third Avenue
New York, N.Y. 10022

Please send me FREE illustrated career catalog. I understand that I am under no obligation.

Name _____

Address _____

City _____

State _____ Zip _____

Age _____

Veterans: Check here

GTE SYLVANIA

Cabinet optional.

cally grounds the transceiver when it is plugged into an ac outlet.

The Messenger 250 transceiver retails for \$239.95, which includes microphone and fused dc cable with connector. It measures 11 in. by 8 in. by 5 in. (27.9 cm by 20.3 cm by 12.7 cm) and weighs approximately 11 lb (5 kg).

The Receiver. The sensitivity of the receiver was higher than usual, measuring 0.25 μV for 10 dB (S + N)/N with 30 percent modulation at 400 and 1000 Hz. It uses single conversion to a 455-kHz i-f. As is generally the case with single conversion, the image rejection was only 10 dB. In practice, however, this apparently poor showing would not ordinarily be of too much concern since the image signal is 910 kHz away on the lower-frequency side of the desired signal where there is little activity.

Selectivity is obtained with a bandpass filter, which in our tests provided a nominal 50-dB adjacent-channel rejection figure. The overall bandpass, including that of the a-f system's response, was 250 to 1200 Hz at 6 dB below a 1000-Hz reference, with a 5-dB rise at 550 Hz. You might think that this relatively low cutoff point at the high-frequency end might somewhat restrict intelligibility, but this is not the case in the Messenger 250. The reasons are that the speaker faces forward (instead of toward the bottom or side as is often the case with CB transceivers) and the speaker itself has a somewhat better frequency response than is the norm in

CB gear, both of which aid intelligibility.

The transceiver's amplified thermistor-stabilized squelch system had a 0.25- μV to 400- μV threshold-sensitivity range. The agc was quite flat, maintaining no more than a 7-dB a-f output change with a 20-dB input deviation (1 μV to 10 μV) and 3 dB with a 60-dB input variation (10 μV to 100,000 μV). The large, easy-to-read illuminated S meter registered S9 with a nominal 50- μV input signal. The full-time series-gate anl was highly effective.

The a-f system employs a class-B pushpull output stage that, in our tests, developed 1.75 watts with 4 percent distortion at the start of clipping with a test signal frequency of 1000 Hz and an 8-ohm speaker load. (A single jack is provided for an external speaker. It is live only when the transceiver is set for PA operation, in which case, either the output of the receiver or the PA is applied to the external speaker.)

The conventional synthesizer contains a total of 14 crystals. Six are nominally at 32.800 MHz, four near 6.190 MHz (on receive), and four near 5.735 MHz (on transmit).

The Transmitter. On transmit, the synthesizer's output goes through two bandpass-coupled stages to minimize spurious responses. It is then applied to three cascaded r-f stages, including the power output stage where an antenna-matching network further minimizes spurious responses. The send/receive func-

tions are handled by the microphone's pushbutton that switches the receiver and transmitter potentials as required.

The microphone must be plugged into its jack before the transceiver can be made operational. Antenna routing is electronically shifted with a diode switch, thus eliminating relays with their attendant problem of dirty contacts.

Modulation of the driver and power amplifier stages is obtained, as usual, from the receiver's a-f output stage, while audio compression (or amc) is obtained with a control voltage fed back to the speech amplifier.

The carrier output of the transmitter measured out at 3.75 watts, indicated both by a wattmeter at a 50-ohm dummy load and the transceiver's panel meter. (The panel meter is calibrated to indicate actual power at the 4-watt point when used with a 50-ohm, non-reactive load—SWR of 1:1. The calibration, of course, will not hold with higher SWR's.) The meter's pointer also swings slightly up-scale to indicate when modulation is taking place.

We obtained 100 percent modulation with 10 percent distortion at 1000 Hz. Using 10 dB of compression, the distortion rose to 20 percent. Adjacent-channel splatter with a test tone was 50 dB down, while with voice operation it was more than 60 dB down. The overall frequency response was 250 to 2700 Hz at the 6-dB points, and the frequency tolerance on any channel was within 350 Hz.

CIRCLE NO. 66 ON READER SERVICE CARD

ROBYN PORTA-SCAN 1000 MONITOR RECEIVER (A Hirsch-Houck Labs Report)

Portable VHF scanner for up to four frequencies

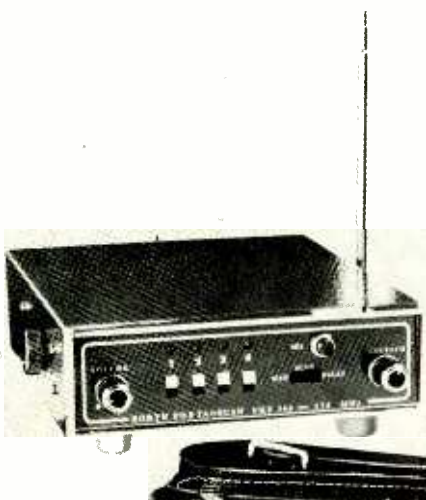

THE Robyn International Porta-Scan 1000 is a compact vhf FM monitor receiver that can be scanned both manually and automatically through up to four frequencies. The frequencies scanned must be within a 10-MHz bandwidth in the 144- to 174-MHz range.

The self-contained receiver has a built-in speaker and 20-in. (50.8-cm) swivel-type telescoping antenna, although connectors are provided for using an external speaker and/or antenna. Power can be derived from eight AA cells installed within the receiver, 12-volt automobile battery, or 117-volt ac line sources (the latter two

depending on which of the two supplied power cords is used).

The compact receiver measures 5 $\frac{1}{2}$ in. (14 cm) wide by 7 $\frac{1}{4}$ in. (18.4 cm) deep by 2 $\frac{1}{4}$ in. (5.7 cm) high and weighs approximately 2 $\frac{3}{4}$ lb (1.25 kg). Retail price is \$109.95.

General Description. Four switches permit undesired channels to be excluded from the scan sequence. A red LED lamp above each switch glows when the receiver is tuned to that channel. Another switch permits selection of the MANUAL, SCAN, or DELAY operating mode. A red SELECTOR button initiates scanning at

any time on demand or, in the MANUAL mode, advances the tuning to the next channel in the sequence. In the SCAN mode, the receiver tunes through four channels in a fraction of a second, locking onto the first signal that exceeds the muting threshold.

When a signal ceases, scanning immediately resumes unless the DELAY mode is selected. This causes the receiver to remain on a channel for about a second after it becomes vacant before resuming scanning. Consequently, this allows the monitoring of a channel used by more than one transmitter without going into the scanning mode after each standby.

The receiver is factory tuned to 155 MHz to yield its maximum sensitivity in the 150- to 160-MHz range. However, it can be realigned for lower or higher frequencies. The rated 20-dB quieting sensitivity is 0.5 μ V to 0.7 μ V. Rated minimum squelch threshold is 0.5 μ V, while image rejection is 30 dB, selectivity is ± 6 kHz at 6 dB down and ± 15 kHz at 50 dB down, and audio output is 0.5 watt at 10 percent distortion. Minimum channel spacing is 25 kHz.

A sophisticated double-conversion superheterodyne design is used in this receiver. Its single r-f stage is preceded by four tuned circuits, and diode protection is provided to guard against damage from excessive input signal levels. A ceramic filter is used in the 10.7-MHz first i-f and another in the 455-kHz second i-f.

Laboratory Measurements.

Our tests of the Porta-Scan 1000 monitor receiver were made at 154.65 MHz. The 20-dB noise quieting sensitivity was 0.8 μ V, and the squelch threshold could be adjusted from 0.5 μ V to more than 200,000 μ V. The lowest signal level that would lock the receiver on channel in the SCAN mode was 0.7 μ V.

The maximum rated FM deviation is ± 5 kHz, but we were able to receive, without distortion, signals with deviations as large as ± 11 kHz. The audio output into a 4-ohm load was 0.5 watt. Image rejection was 31 dB.

User Comment. We evaluated the performance of the monitor receiver with two crystals installed (154.65 MHz and 162.55 MHz). The receiver readily picked up stations more than 20 miles (32.2 km) away with its built-in telescoping antenna from a below-ground basement location. All

Model AT15S cartridge shown in Model AT1009 tone arm.

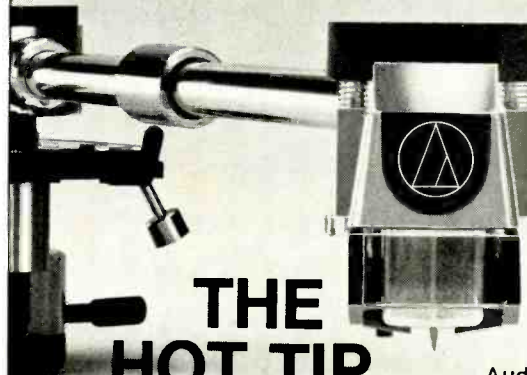

THE HOT TIP IS SHIBATA ...and audio-technica!

The only phono stylus tip designed for the new discrete 4-channel records is the new Shibata multifaceted stylus.

It's the stylus we include on our AT12S, AT14S, AT15S & AT20SL Audio-Technica Dual Magnet*

audio-technica.

cartridges. To give you correct, long-lasting performance from discrete 4-channel records. And better sound from any matrix record or present stereo disc as well.

Audio-Technica Dual Magnet cartridges are brand new and loaded with features. Like a separate, independent magnetic system for each side of the stereo groove. And smooth response to 45,000 Hz and beyond. Plus very low moving mass for superior tracing ability.

Get a tip from leading audio showrooms throughout the country who are now stocking and recommending the Audio-Technica Dual Magnet cartridges. For every modern record you own.

*U.S. Patent No. 3,720,796; 3,761,647

AUDIO-TECHNICA U.S., INC., Dept. 94P, 33 Shiawassee, Ave., Fairlawn, Ohio 44313
In Canada: Superior Electronics, Inc.

CIRCLE NO. 3 ON READERS SERVICE CARD

Control!

If you are a critical audiophile who demands more from your system, the Mark VII and Mark XXVII will get it for you. Each unit can alter the frequency response, octave by octave, of any sound system. They offer a form and extent of frequency correction that is unprecedented in conventional equipment. Send in the coupon today for detailed information.

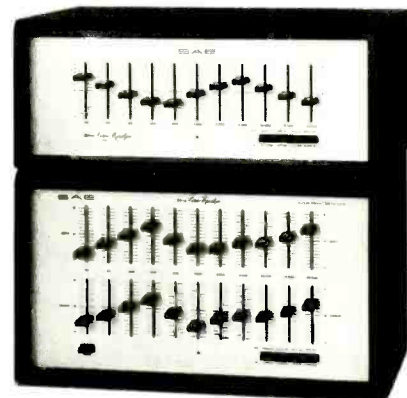

SAE
*Components
for the
Connoisseur*

SAE, Inc., Electronics Division
P.O. Box 60271, Terminal Annex, Dept. PE-974
Los Angeles, California 90060

Gentlemen:

Please rush free information on the Mark VII and Mark XXVII by return mail.

Name

Address

City State Zip

CIRCLE NO. 29 ON READERS SERVICE CARD

functions operated quite properly.

We noted that the ac power supply (which we used in our tests) is energized at all times when it is plugged into an outlet, although the receiver's power switch does remove the voltage from its internal circuits. The line

cord is fused for the sake of safety.

Although it is only a fraction of the size of most vhf FM scanning monitors, this receiver's performance is comparable to the "full-size" models we have tested in the past. This is a notable accomplishment for a re-

ceiver that is very nearly "pocket" size, and it has been achieved with no apparent sacrifice other than the restriction to four channels (instead of the eight or more channels offered in more elaborate models).

CIRCLE NO. 67 ON READER SERVICE CARD

TRIPLETT MODEL 615-K MAINTENANCE TESTER KIT

Multimeter also measures temperature and current leakage.



QUITE a number of technicians perform maintenance and service on various types of heavy-duty residential and industrial appliances. Because of the broad nature of most of this equipment (which can range from a heater or air conditioner in a home to a multi-horsepower motor in a massive piece of factory machinery), the serviceman is often required to carry along a wide range of test gear.

The Triplet Company has given some serious thought to the plight of the appliance serviceman. The result of that effort is the company's Model 615 maintenance tester that is basically a multimeter capable of measuring ac and dc voltage, current, resistance, and temperature in °F.

The Model 615 multimeter can be purchased as a separate item for \$130, while its accessory Model 20-A clamp-on ac ammeter adapter retails for \$24, Model 101 ac line separator for \$8.40, and heavy-duty thermocouple probe for \$12.50. There is even a soft-plastic-lined, molded carrying case for the multimeter and all accessories that retails for \$20. All of the items mentioned can be obtained collectively as the Model 615-K maintenance tester kit for \$180.

General Description. The basic multimeter's dc voltage ranges go from 0.06 to 300 volts full-scale in eight steps. Sensitivity is 20,000 ohms/volt, and accuracy is 2 percent of full-scale. Five ranges are provided for ac voltage measurements to 600 volts full-scale. Sensitivity is 5000 ohms/volt, and accuracy is 3 percent full-scale. The three resistance ranges (X1, X100, X1000) give a measurement capability of up to 1 megohm full-scale.

Using the thermocouple probe supplied in the Model 615-K, the multimeter can measure from -50° F to +150° F on its LO range and to 1500° F on its HI range. Both ranges are accurate to within 3 percent.

The multimeter also measures the

all-important alternating current leakage through a network that electrically simulates the human body. This function is used to check between the metal case of an electrical appliance and ground for the existence of hazardous leakage currents.

Using the Model 20-A clamp-on ac ammeter adapter boosts the multimeter's basic current-measuring capability. It allows the Model 615 to measure currents to 6, 12, 30, 60, and 120 amperes full-scale.

The multimeter itself features a large 4½-in. (11.4-cm), 50 µA meter movement. The movement has diode protection to guard it against damage resulting from overloads. The remainder of the circuit is fuse protected. The case of the instrument is made from molded high-impact plastic and incorporates a metal handle that doubles as a convenient tilt stand for bench work.

User Report. The complete Model 615-K maintenance kit was tested by a heavy-appliance service center over a period of several weeks. In general, the report on its versatility and ruggedness was very favorable, verifying our in-shop observations. On a number of service calls, only the kit and a few hand tools were required, saving time and effort.

The foamed-plastic-lined case for the instrument and adapters bore up very well in the rugged environment of the service truck and on the job.

In conclusion, if you do any heavy-appliance servicing, especially in the field, you would do well to take a look at this new "testbench in a case."

CIRCLE NO. 68 ON READER SERVICE CARD

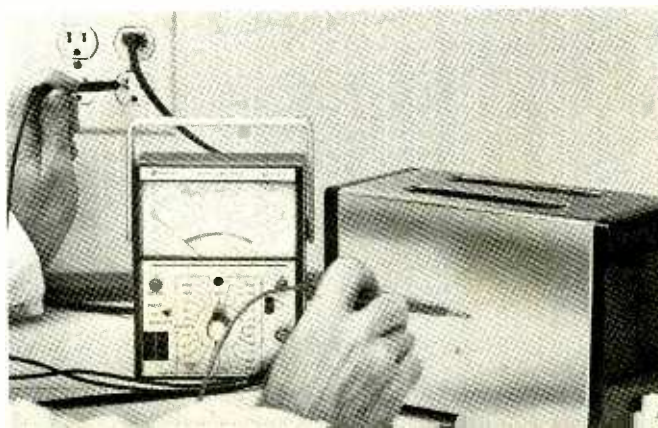

Using the 615 VOM to check for ac leakage in toaster.

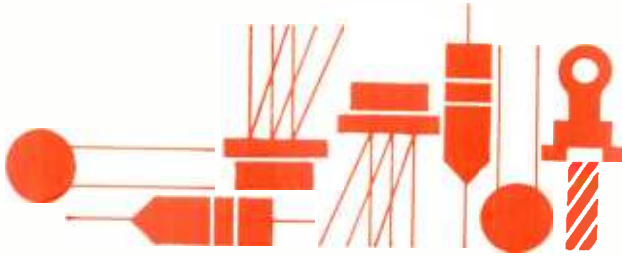

Solid State

By Lou Garner

REWARDING PROJECTS WITH MEDIUM-POWER TRANSISTORS

PERHAPS the most popular construction projects are those requiring a minimum of time, from one, say, to five hours, permitting their completion in a single evening. Novices find them particularly rewarding because they are not only easy to complete but, as a general rule, relatively inexpensive. Even advanced hobbyists appreciate such projects as a change of pace from working on complex projects requiring dozens or scores of hours.

With power dissipation ratings of from 10 to 20 watts, moderate gain, and current handling capabilities of 2 to 5 amperes, medium-power transistors are ideal for such simple projects. They can be used in circuits ranging from dc power supplies to audio amplifiers, and from self-contained oscillators to household controls and alarms.

Fortunately, inexpensive medium-power transistors are available from a number of sources. Not only are various standard types offered in Motorola's HEP, Sylvania's ECG, RCA's SK, General Electric's GE, Workman's WEP, and Radio Shack's Archer lines, but several mail order firms and many local distributors can supply bargain assortments of these devices at cut-rate prices. More-over, if you're a typical hobbyist, you're likely to have from two to a half-dozen or so such units on hand in your lab stock.

Four useful circuits using medium-power transistors are illustrated in Figs. 1 and 2. Easily assembled, non-critical as far as transistor specifications, layout and lead dress are concerned, and requiring relatively few additional components, these are suitable for "one evening" projects. All four were adapted from application brochures published several years ago by Motorola and CBS-Hytron. Although pnp types are indicated, comparable npn units may be substituted if dc polarities are reversed where appropriate, and, of course, either germanium or silicon devices may be used in the designs.

Developed before inexpensive triacs became available commercially, the interesting ac power control circuit illustrated in Fig. 1(A) may be used with line loads of from 50 to 100 watts. Typically, it can be used as a light dimmer or as a speed control for light duty motors, such as those used on sewing machines and small household mixers.

Although the circuit requires a power transformer and, therefore, is more costly than a triac design, it actually offers several advantages over the latter. First, the control element, $R1$, is completely isolated from the ac line, providing a high degree of safety from shock. Second, the control element operates at comparatively low voltage and current levels, permitting it to be placed at a remote location and connected to the main circuit using ordinary bell or intercom wiring. Third, the circuit itself is non-critical and can be assembled with low-cost salvaged or surplus components.

Transformer $T1$ is a filament type and $R1$ is a 1000-ohm, 2-watt potentiometer. For optimum performance, suitable heat sinks should be provided for the transistors. On-off switch $S1$ and the protective fuse are part of the load cir-

Fig. 1. An ac power control circuit is shown at (A), while (B) is a general-purpose oscillator.

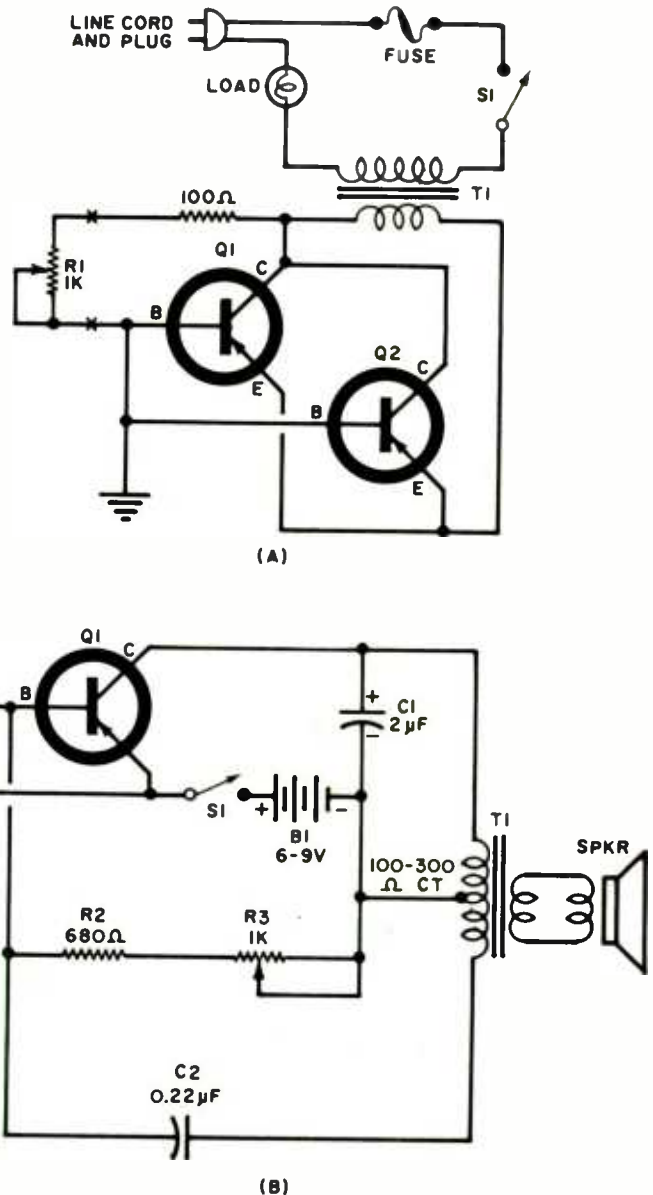

NOW A PROFESSIONAL BURGLAR-FIRE ALARM SYSTEM YOU CAN INSTALL YOURSELF.



ONLY 149.95

Save hundreds of dollars in alarm installation and monthly service charges. The EICO SS-500 "install-it-yourself" burglar-fire alarm system offers you the kind of professional protection you have been looking for, at a price you can afford. The SS-500 has been designed on the EICO "Expandability Concept" that enables you to "add-on" protection to meet your own special needs. Before you purchase any security system, we suggest you read the EICO Security Handbook and see how easy EICO makes it to "Do-it-Yourself."

FREE EICO CATALOG/SPECIAL OFFER!

Security handbook (Reg. \$2.95) only \$1.50 with this ad. Includes a catalog on EICO Security Systems, Test Instruments, Stereo, Hobby Kits and name of nearest distributor. For catalog only, check reader service card or send 50¢ for first class mail service.

EICO, 283 Malta Street, Brooklyn, N.Y. 11207



CIRCLE NO. 14 ON READERS SERVICE CARD

the NEW

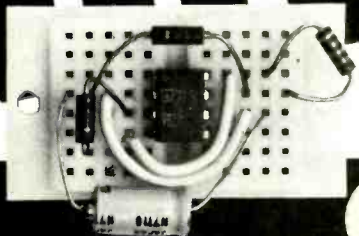

only
\$275

E&L SK-20 SOCKET

TEST NEW CIRCUIT IDEAS, I.C.'S, DISCRETE COMPONENTS WITH NO SOLDERING!

Just insert components directly into the Socket. Make all of your interconnections with common 22 gage solid wire and you've got your design complete in minutes. Plug in 1/4 watt resistors, ceramic capacitors, diodes, I.C.'s, transistors and more, and your circuit is built! Handles wide range of wire leads from .015" to .032".

Money back if not completely satisfied. Send check or M.O. today. Add 50¢ for postage and handling. PLUS . . . ask for New Free Catalog.

CIRCUIT DESIGNS, INC.
P.O. BOX 24, SHELTON, CONN. 06484
Exclusive mail order dist. for E&L Instruments.



CIRCLE NO. 15 ON READERS SERVICE CARD

circuit. Although a lamp load is shown, as in light dimmer applications, the load could be a small universal motor.

In operation, $T1$'s primary (117-volt) winding serves as a variable impedance in series with the ac load, thus limiting the current through the latter device. The transformer's primary impedance, however, depends on the effective loading of its low-voltage secondary by parallel transistors $Q1$ and $Q2$, and hence on $R1$'s adjustment, for this control determines the instantaneous forward base bias applied to the transistors. As $R1$'s value is reduced, $Q1$ and $Q2$ conduct more heavily on alternate half-cycles, increasing $T1$'s secondary load and thus reducing its effective primary impedance, thereby increasing the ac load current. The opposite action occurs when $R1$'s value is increased.

The circuit's power handling capability depends on the rating of the transformer as well as on the number of power transistors used to load the secondary winding. With $T1$ a 12-volt, 4-ampere filament transformer and a pair of medium-power transistors, the circuit can handle ac loads of up to 100 watts. If greater ac load capacity is needed, a larger transformer should be used, with one or more additional transistors connected in parallel with $Q1$ and $Q2$. Naturally, a single high-power transistor could be used in place of parallel medium-power types. If two or more parallel transistors are used, they should be identical types.

Where the application calls for remote operation, simply extend the leads to the control potentiometer ($R1$) at the points indicated by "X" on the schematic diagram.

The general-purpose audio oscillator illustrated in Fig. 1(B) may be used in a number of applications. With power switch $S1$ replaced by a handkey, the circuit can be used as a code-practice oscillator. The circuit could be assembled in a small case as a self-contained audio source for checking microphone and loudspeaker placement when installing PA, music or intercom systems. Switched remotely by relay, it could be used as a signal for flood, fire, smoke, or burglar alarm installations. Transistor $Q1$ is a medium-power type.

In operation, $T1$ serves both to match the oscillator to the loudspeaker and to provide the feedback necessary to start and maintain oscillation. Base bias is provided by voltage divider $R1-R2-R3$, with $R3$ acting in a secondary role as a fine tone control, but both shunt capacitor $C1$ and feedback capacitor $C2$ can affect the operating frequency.

Suitable for use either as a bench power supply or as a permanent power source for other equipment, the series regulated dc power supply circuit given in Fig. 2(A) requires a minimum of components — a general-purpose rectifier, a step-down power transformer, a medium-power transistor, a 500- μ F electrolytic capacitor, and a small zener diode. The zener diode's voltage rating determines the circuit's dc output voltage which, in general, will be within a half volt or so of $D1$'s voltage. For optimum regulation, $T1$'s secondary should supply an ac voltage from 50% to 100% higher than the desired dc output voltage; but, of course, not higher than the rectifier's or transistor's maximum ratings.

This basic design may be used for power supplies furnishing from 3 to 25 volts (or more) at currents of up to several amperes, depending on the choice of power transformer, rectifier diode, control transistor, and zener diode. The voltage rating of $C1$ should be consistent with the voltage levels.

The adjustable-current dc power supply circuit illus-

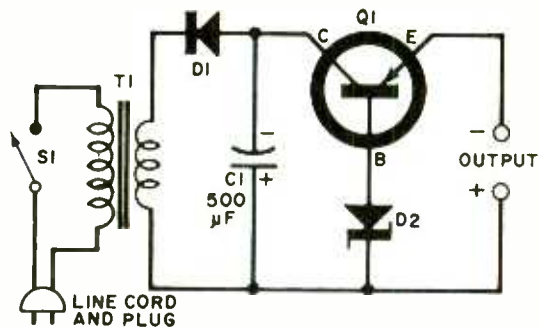

(A)

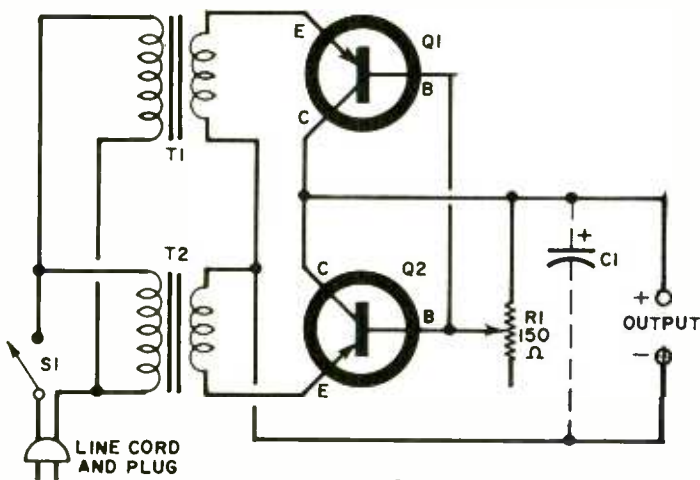

(B)

Fig. 2. A voltage-regulated power supply is shown at (A). At (B) is a power supply with adjustable current.

trated in Fig. 2(B) may be used as a battery charger, as a speed control and power source for battery-operated models and toys, and for light-duty electroplating. It is a unique design in that transistors are used both to provide full-wave rectification and as current-control devices.

Standard medium-power transistors are used for *Q1* and *Q2*. Resistor *R1* is a 150-ohm, 4-watt potentiometer, while *C1*, a 1000- μ F electrolytic capacitor, is optional and should be included only if ac ripple might cause problems in the circuit's intended application.

A single step-down transformer with a center-tapped secondary could be used in place of *T1* and *T2*, if preferred. The use of two identical transformers with their primaries connected in parallel and their secondaries in series-aiding, is a clever, but old, technique to avoid purchasing a special unit, and is especially useful where one has a stock of filament transformers which, alas and alack, do not have center-tapped secondary windings.

In operation, the step-down transformer(s) supplies low-voltage ac to *Q1* and *Q2*, with *Q1* conducting on one half-cycle, *Q2* on the other. The potentiometer varies the base bias applied to both transistors, controlling their internal impedances and thus limiting their maximum current flow, regardless of load.

In both power supply circuits, adequate heat sinks should be provided for the transistors to insure safe operation at maximum output levels.

Reader's Circuit. When his seven-year old son received virtually black slides from the film developer of photos

mitScope

FOUR CHANNEL DIGITAL HANDHELD MEMORY SCOPE

MS-416 is a valuable tool for circuit analysis: TV - stereo receivers - electronic calculators - digital clocks - digital auto electronics and more. • The MITS MS416- digital pocket scope is a four-channel, digital logic oriented, handheld scope with full memory capability. • The clock time-base is from .5 sec. to 200 m sec. • The scope may be operated in two modes, selected by another switch. Besides the normal mode, there is a store mode which enables the scope to remember the information on all four channels within the time-base range and display it continuously.



SIZE: 9 1/4" x 3 1/4" x 1 1/4"

SPECIAL OFFER
MS-416 regular price \$189.50
order now for \$161.50

MITS INC.
"Creative Electronics"

Prices, specifications and delivery/subject to change without notice. WARRANTY: 1 year

Enclosed is a Check for \$ _____
or BankAmericard # _____
or Master Charge # _____
Credit Card Expiration Date _____
Include \$5.00 for Postage and Handling

MS-416
 Please send information on Entire MITS Line.

NAME _____
ADDRESS _____
CITY _____
STATE & ZIP _____

MITS / 6328 Linn, N.E., Albuquerque, New Mexico 87108 505/265-7553 Telex # 660401

CIRCLE NO. 24 ON READERS SERVICE CARD



spend a dime, save a mint.

Invest a dime. Send for our catalog. We'll prove to you that you *can* have selection and convenience and still get a great price for the finest hifi gear.

For an immediate free copy of our new 64-page catalog, including pull-out "Hifi Primer" section, mail the coupon below to the location nearest you. Please print.



Wholesale and Mail Order Division

1626 Ogden Ave. (US 34), Downers Grove, Ill. 60515
3309 E. Carpenter Frwy. (Texas 183), Irving, Tex. 75062

NAME _____
ADDRESS _____
CITY/STATE _____ ZIP _____ (PE4-09)

CIRCLE NO. 26 ON READERS SERVICE CARD

The better the the better you

SOLID STATE
OSCILLOSCOPE

COMPU-TRAINER

TUBE & TRANSISTOR
TESTER

DIGITAL
MULTIMETER

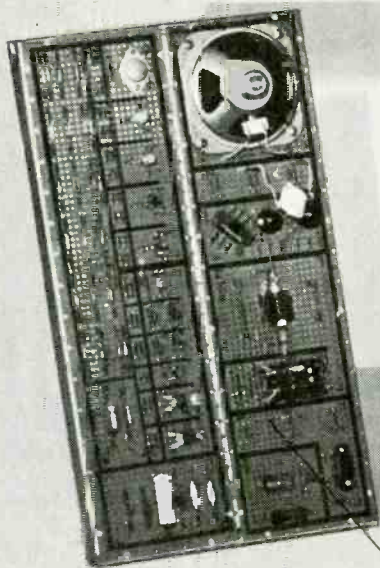
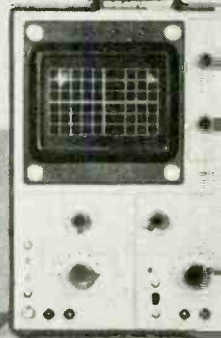
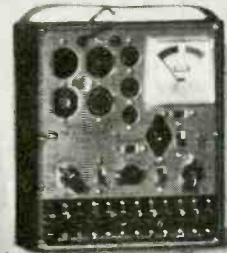
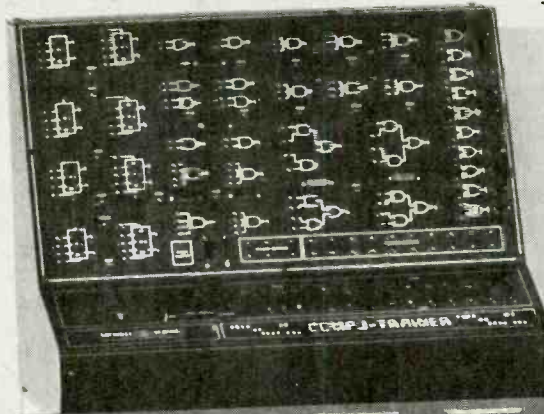

ELECTRO - LAB

NTS DIGITAL GR-2000 SOLID STATE
COLOR TV WITH 315 SQ. IN. PICTURE
AND VARACTOR DIGITAL TUNING

TROUBLESHOOTER
VOM

As an NTS student, you'll acquire the experience and know-how that comes with first hand training on NTS "pro" equipment. Equipment you'll build and keep. Our courses include equipment like the 5" solid-state oscilloscope, a transistor and tube-tester, a vector monitor scope, 74 sq. in. B&W TV, or a solid-state stereo AM-FM receiver. The unique new **NTS Digital GR-2000 Color TV** with first-ever features like silent varactor diode tuning; digital channel selection, digital clock, an option at additional cost; and big 315 sq. in. ultra rectangular

screen. This is just a sampling of the kind of better equipment that get you better equipped for the electronics industry.

By following the easy-to-read NTS lessons, you learn the theory behind these tools of the trade. You'll learn and develop skill and confidence fast.

Choose from 12 NTS Electronics Courses, including Color TV and B&W TV Servicing, Electronics and Computer Technology, Electronics Communications & FCC, and Industrial & Automation

equipment will be equipped.

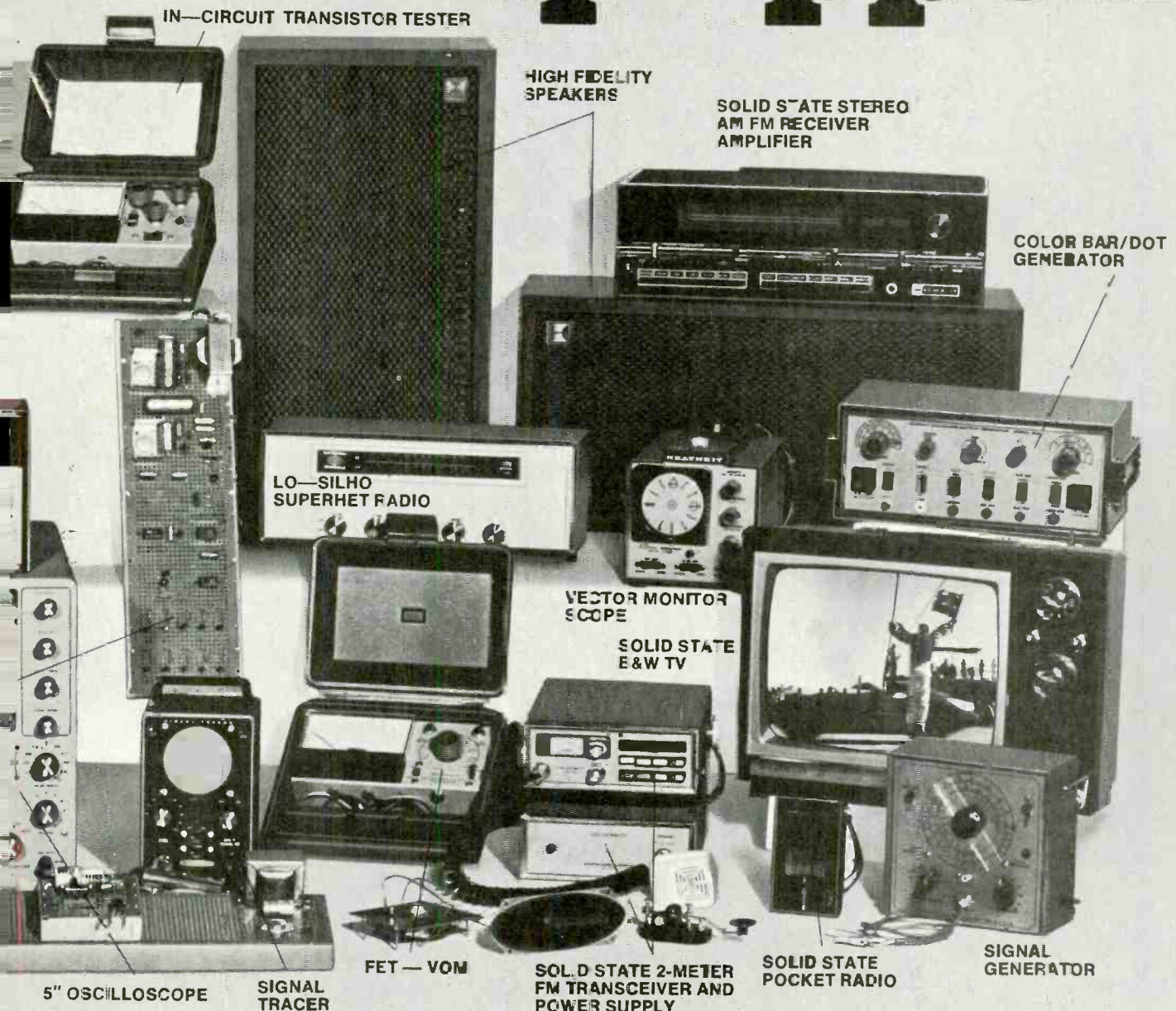

Electronics. All courses can provide you excellent opportunities to expand your career in the exciting world of electronics! So get started right now by checking the coupon and mailing it today.

COMPARE WHAT WE OFFER IN KITS AND LESSONS. COMPARE OUR TUITION.

Classroom Training at Los Angeles. You can take classroom training at Los Angeles in sunny Southern California. NTS occupies a city block with over a million dollars in facilities devoted exclusively to

technical training. Check box in coupon.

Approved for Veteran Training. Accredited Member: National Association of Trade & Technical Schools; National Home Study Council

NATIONAL TECHNICAL SCHOOLS

TECHNICAL-TRADE TRAINING SINCE 1905
Resident & Home Study Schools

4000 South Figueroa St., Los Angeles, Calif. 90037

LOOK TO *Lenk* FOR YOUR SOLDERING TOOLS

You'll find the right product at the right price in the Lenk line — made by long-time specialists in soldering equipment.



CORDLESS

Battery powered. Built-in light. Fits easily into a tool box. Can be used while re-charging. Over 700°F tip temperature. Heats almost instantly. Very light — very useful!



PENCIL TYPE IRONS

Lightweight, cool handles, screw-in tips.



PACEMAKER

An instant type gun at low, low cost. Lightweight — no heavy transformer. Fast heating. Thermostatic action. Long thin reach. Needs no stand, rests with tip upright. Interchangeable tiptip.

AND OTHERS —

ALL MADE IN THE U.S.A. BY SKILLED CRAFTSMEN
See the Lenk line where quality soldering tools are sold

SINCE
1864

WALL-LENK MFG. CO.
WORLD'S LARGEST MANUFACTURER OF SOLDERING IRONS
KINSTON, N. C. 28501

CIRCLE NO. 34 ON READERS SERVICE CARD

**EVERYTHING YOU
WANTED TO KNOW
ABOUT CD IGNITION
SYSTEMS BUT DIDN'T
KNOW WHOM TO ASK.**

Send for *FREE Tiger booklet* (20 pages) which answers all your questions.

Name _____

Address _____

City _____

State _____ Zip _____

CLIP OUT THIS AD AND SEND TO—

TRI-STAR CORP.
P. O. Box 1727 Dept. E
Grand Junction, Colo. 81501
CIRCLE NO. 37 ON READERS SERVICE CARD

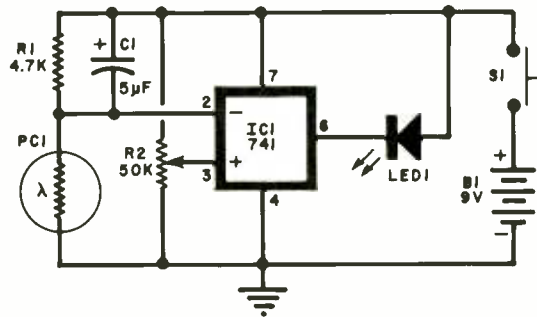

Fig. 3. Reader's circuit for low-light indicator.

taken with his "instant" type camera, reader John M. King (1194 Idylberry Road, San Rafael, CA 94903) decided to devise a simple low-light indicator to avoid such accidents in the future. The circuit, in Fig. 3, has proven to be a real confidence builder for his young amateur photographer.

John has used standard components in his design. A small cadmium-sulfide photocell (*PC1*) serves as a light sensor, while a light-emitting diode (*LED1*) is used as an output indicator. Operating power is furnished by a conventional 9-volt transistor radio battery.

In operation, op amp *IC1* compares the bias applied to its inverting (-) input terminal by voltage-divider *R1-PC1* with the fixed bias applied to its non-inverting (+) input through calibration potentiometer *R2*. If the ambient light level is low, the photocell sensor has a high resistance, increasing the positive bias applied to the inverting input and causing the op amp to deliver a differential current of sufficient amplitude to operate the LED. The bias point, hence light level, at which this occurs is determined by *R2*'s adjustment, permitting the instrument to be preset for various film speeds. Capacitor *C1* serves a dual role — it reduces noise sensitivity and, at the same time, provides a brief flash of the LED as a battery check when the push-button power switch, *S1*, is first depressed.

Non-critical as far as layout is concerned, the instrument may be wired using any of several construction techniques. John assembled his original model on perf board and mounted it in a small metal box designed to fit on top of his son's camera. He suggests mounting the photocell back of a small hole in the instrument's case, adjusting the hole size experimentally until the photocell has a resistance of from 3 to 9 kilohms in deep shadow. The *PC* should face in the same direction as the camera lens. The terminal connections for *IC1* given in Fig. 3 are for a 741 in an 8-pin TO-type package. Different terminal numbers apply if DIP or V package devices are used.

Once the instrument is completed, *R2* can be adjusted for optimum performance by using a professional light meter, if available. As an alternative, this control can be set simply by adjusting it until the LED lights in deep shadow while *S1* is held depressed.

In use, the photographer simply depresses the power switch (*S1*). The LED should flash momentarily (as *C1* charges) as a battery check, then remain dark. If the LED remains lit, the light level is too low for successful photography unless a flash is used.

Device/Product News. Another manufacturer has jumped on the FET vacuum-tube replacement bandwagon. The National Semiconductor Corporation (2900 Semiconductor Drive, Santa Clara, CA 95051) has announced a series of competitively priced plug-in replace-

ments for both pentodes, such as the 6AG5, 6AK5, 6AM6, 6BH6, 12AU6, and twin-triodes, such as the 6BC6, 12AT7, 12AU7, 12AV7, 12AX7, and 12AZ7. National's FET/tube replacements are designated *FUBES* (really!), not to be confused with *FETRONS*, which is Teledyne Semiconductor's name for their FET/tube devices.

Working with electronic musical instruments? If so, check out Mostek's (1215 West Crosby Road, Carrollton, TX 75006) MK 50240 series of octave frequency generators. Packaged in 16-pin ceramic DIP's, these p-channel MOS IC's are offered in three versions with different output duty cycles. Each accepts a crystal-controlled clock signal of approximately 2 MHz and subdivides it into a full octave plus one of notes on the equal tempered scale. Designed to operate on a single-ended dc power source, the devices require less than 600 mW.

Motorola Semiconductor Products, Inc. (P.O. Box 20924, Phoenix, AZ 85036) has introduced several new IC devices of potential interest to experimenters, hobbyists, and students, including a multi-function gate, a time-base generator, and a pair of successive approximation registers.

It's a hex of a gate is the way Motorola describes their new MC14572 Hex Functional Gate. Of particular interest to anyone working with digital circuits, the new device contains four inverters, a NAND, and a NOR gate in a single 16-pin DIP. Designed for maximum utility, the individual CMOS circuits can be used independently or interconnected to provide additional functions. Typically, the NOR output can be applied to one of the inverters to provide OR operation and, similarly, the NAND gate and an inverter can be combined for AND applications.

Accurate time outputs can be generated from either 60- or 50-Hz line-frequency signals using Motorola's new MC14566 CMOS IC. Capable of dividing by 5, 6, 10, 50 or 60, the time-base generator can convert the incoming power-line frequency to a binary-coded decimal output and thus is suitable for a variety of clock and timer applications. The new device consists of a monostable multivibrator and two ripple counters. One ripple counter is divide by 10, the other divide by 5 or 6, selectable by external pin control. By cascading to obtain divide-by-60 operation, seconds and minutes can be counted, furnished in BCD format at the circuit outputs. The internal monostable multivibrator output can be used as a reset or clock pulse generator to provide added frequency flexibility. The new MC14566 is supplied in 16-pin ceramic or plastic DIP's.

If you're experimenting with analog-to-digital instruments, such as digital voltmeters, then Motorola's new single-package successive-approximation registers may be just what you need for your projects. In the successive approximation technique of analog-to-digital conversion, the digital output is determined using a repetitive comparison process to establish one bit at a time, starting with the most significant bit. Designated types MC14549 and MC14559, the new LSI CMOS devices are 8-bit registers providing all the digital control and storage needed for successive-approximation analog-to-digital conversion systems. The two units differ in only one control input. Both are offered in 16-pin ceramic or plastic DIP's.

You can add another name to the list of firms offering quad op amp IC's. Silicon General, Inc. (2712 McGaw Ave., Irvine, GA 92705) has announced its own line of units second-sourcing National Semiconductor's popular LM124/224/324 series. Silicon General's devices are designated the SG124/224/324 series.

SEPTEMBER 1974

All New

Includes **FREE Ohms Calculator**

Includes **20"x30" Wall Chart**

72 pages of products, projects, tips, formulas, tables, etc. from your local **CALECTRO Electronics Distributor!**

GC ELECTRONICS
DIVISION OF HYDROMETALS, INC.
ROCKFORD, ILLINOIS 61101 U.S.A.

CIRCLE NO. 17 ON READERS SERVICE CARD

SUPER CB TALK POWER!

What gives Johnson CB two-way radios their "extra sock" for longer range? Built-in Electronic Speech Compression, that's what! It's the kind of engineering you expect from U.S.-made Johnson radios . . . backed by a full 1-year parts and labor warranty with over 700 service centers nationwide.

PRICES START AT UNDER \$1001
SEND COUPON FOR FREE CATALOG!

E. F. Johnson Co.
Dept. PE Waseca, Minn. 56093

Name _____
Address _____
City _____ State _____ Zip _____
In Canada: A. C. Simmonds & Sons, Ltd.

CIRCLE NO. 43 ON READERS SERVICE CARD



Test Equipment Scene

By Leslie Solomon

USING YOUR VTVM OR VOM

THIS may sound a bit trite, but there are some electronic devices that we use so often and so easily that we are inclined to take them for granted—not always realizing their intricacies and overall characteristics. We are thinking specifically here of the VTVM or VOM—that ubiquitous instrument that every technician has on his workbench and which he uses constantly without giving much thought to its actual operation. Let's remedy the situation, then, by taking a closer look at how and why we use this valuable meter.

First, consider its accuracy. Have you ever noticed that your meter is not as accurate on ac as it is on dc? For example, a meter with 3% accuracy (full scale) on dc may be only 5% accurate on ac. The discrepancy results from the fact that the meter is basically a dc device and in measuring ac, some form of rectification must be used. As the rectifier ages, inaccuracy creeps in.

Other inaccuracies can come from overloading situations where precision attenuator resistors get enough of a "jolt" to affect their values. Division ratios are thus thrown off so that incorrect readings are obtained. In the case of an ac overload, the meter rectifier can be affected, reducing its accuracy. Severe overloads can also bend the needle so that the entire scale is thrown off.

If you do any degaussing of color TV receivers, keep in mind that the degaussing that wipes out stray magnetic fields on the TV can also affect the magnet in a meter movement, permanently.

Some meter "windows" are made of plastic that may maintain a static charge which causes the slender needle to assume all kinds of wrong positions. This charge is easily built up when the window is cleaned with a dry cloth. If you find that this situation

exists, try one of the anti-static sprays that are now available.

Some Different Uses. There are many uses for the VTVM that are not always employed to advantage. For example, when using an r-f signal generator to align a tuned circuit, don't forget that the generator may not have a flat output over the entire range of interest. Thus, the generated curve may be drastically wrong. Before suspecting the circuit under test, check the generator using the circuit shown at (A). This simple probe and

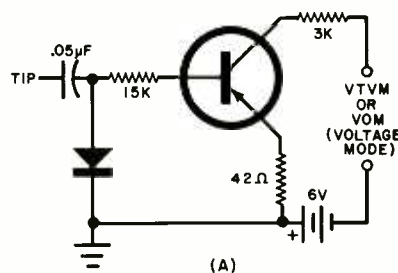

Probe and VTVM circuit is used to check r-f generators.

VTVM arrangement (measuring current) is connected to the r-f generator, which is then tuned across the desired spectrum. This will show whether the generator is really "flat." (This circuit can also be permanently wired to the r-f generator using a low-cost milliammeter instead of the VTVM.)

Here's another unusual use for your VTVM. Did you know it can double as a capacitance checker for odd-ball or unmarked capacitors? The circuit to use is shown at (B). The isolation transformer is a safety device. For capacitor values between 0.001 and 0.01 microfarads, the resistor is not necessary. Use the 10-volt ac range on the meter. Calibrate the meter scale by checking a number of known capacitances. For capacitances be-

tween 0.01 and 0.1 microfarads, use a 2960-ohm resistor and calibrate the meter for various known values. This odd resistance value can be obtained either by connecting a number of resistors in series and parallel or by "filling up" a 2700-ohm carbon resistor. For capacitor values between 0.1 and 1 microfarad, use a 231-ohm resistor. Here again, you can connect resistors together or use a file on a 220-ohm carbon unit. If you get the resistance values close enough, you will find a linear relationship between the capacitor value and the meter scale.

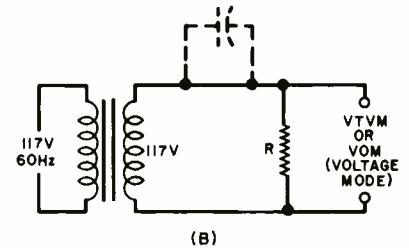

Using a VTVM or VOM to check values of unknown capacitors.

A VTVM can also be used to determine the impedance of an inductor. Using the circuit shown at (C), all you need is an audio oscillator that covers the frequencies of interest and a 1%, 10-ohm resistor. Connect the unknown inductor as shown and set the oscillator to the desired frequency. Carefully measure and record voltages E1 and E2. The impedance is then equal to $E1/0.1E2$. You can now determine the impedance of almost any inductor, anywhere in the range of your oscillator.

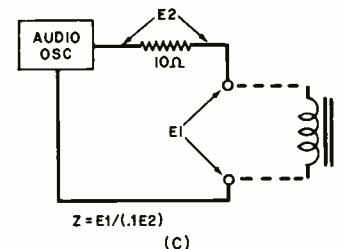

An audio oscillator is used to check inductor impedance

The same setup can be used to determine the turns ratio of a transformer. Connect the audio oscillator to the primary of the transformer using a frequency of about 1 kHz for an audio transformer, 60 Hz for a power transformer, and about 5 kHz for a TV flyback. Measure the ac voltage across the primary. Then meas-

ure the voltage across the secondary. The turns ratio is the same as the voltage ratio of the two windings.

Power Monitor. If you don't have a power consumption monitor, you can make one easily by using a 1-ohm high-power resistor (which can be made of the resistance wire from an old toaster) and your VTVM. Connect the resistor in series with the power line supplying the unit being tested and measure the ac voltage across the resistor. Since the resistor is 1 ohm, 1 ampere of current will produce a 1-volt reading on the meter. Multiply the current by the line voltage to determine the power. The value should be the same as that shown on the manufacturer's nameplate.

Many technicians, though they invariably use a VTVM to measure dc voltage levels, never think to use the ac voltmeter function to measure the amount of ripple on a dc line. After all, ripple is ac, so why not measure it? This is a good way to check a rectifier filter system.

To check the audio-frequency range of your ac meter, use the circuit

shown at (A) with the VTVM connected directly across the oscillator output. Keeping the oscillator output at some fixed level, gradually sweep from the lowest audio frequency to the highest available at the generator. If you record the VTVM voltage versus frequency, you will be able to plot the frequency response of the ac mode of your VTVM. This comes in hand in performing voltage measurements on audio systems.

Semiconductor Checks. Some people like to use a VTVM to check the front-to-back ratio of a semiconductor diode to see if it is good. It usually comes as a surprise to them to find that the diode shows different resistance values on different ranges of the resistance portion of the meter. This is easily understood if you remember that a semiconductor diode is a nonlinear device and the actual dc resistance depends on the amount of dc voltage applied. Since different voltages are used in the various resistance ranges (in most meters), different resistances give different readings on the scales. To obtain the front-to-back ratio, divide the larger

resistance by the smaller. The most useful check is to compare the resistances with a known good diode of similar type (silicon or germanium).

Adding It Up. We hope these examples have shown that even the most common type of bench test equipment can be put to unusual and valuable service—often in areas where you would not ordinarily expect to use it. Keep in mind that there are many low-cost paper-back books on sale at local electronics distributors covering just about every piece of test equipment you may have. These basic books contain a wealth of odd bits of information that may enable you, in effect, to double the value of your test equipment. You will also find you can make tests that would otherwise be impossible without a new piece of equipment or tests that you had never even thought of.

Get yourself a couple of precision resistors (1% is fine), and a new battery (not to be used in any projects), and use these as "standard" any time you suspect your meter has undergone any excessive abuse. It only takes a moment to check. ♦

**ONLY—
Southwest Technical
Gives you all three**

***Advanced Engineering
*Quality Parts
*Reasonable Prices**



POWER AMPLIFIERS
From 20 to 200 Watts
Distortion as low as .01%



PREAMPS—Stereo and Instrument
Unmatched Tone Flexibility
Low Noise—Exact Equalization



**ALSO—Digital Instruments—Color Organs
Logic Labs—Reverb Adaptors—Expanders
Compressors—SCA Adaptors—Tachometers**



Write for our *FREE 1974 Catalog now.*
Southwest Technical Products Corporation, 219 W. Rhapsody, San Antonio, Texas 78216



Art's TV Shop

By Art Margolis

CHECKING TUBE NATIONALITY

AS SOON as I cut the engine of my van, I could hear voices coming from my service shop. I recognized one loud bellow as my bench assistant's war cry. And if that was Harry Harris, the other kung-fu style yells had to be coming from Joe Wong, chief chef from the diner up the street.

As I ran into the shop, sure enough, little Harry was squared off with an even littler Joe. The two looked like caricatures of old enemies determined to relive World War II.

"Hold it!" I yelled. "Okay, what's the problem this time?"

Harry was quick on the uptake. "Art, this guy is trying to make me look like a dope. He says I did something to his TV set." Harry pointed to a 17-inch, made-in-Japan Magnavox TV receiver sitting on the service counter.

Joe threw out his chest and snarled, "Look like a dope — you are a dope! You can't even change a tube without breaking something."

Holding up my hand, I yelled, "Peace!" Harry went behind the counter, while Joe glared belligerently, hands firmly planted on hips.

Sound But No Picture. The back of the black-and-white receiver was off, and the horizontal output tube was out of its socket. A couple of new replacement tubes lay alongside the set. Before I could get in a question edgewise, Joe said angrily, "The picture went out last night, leaving just the sound. So, I brought the set in a little while ago and checked out the tubes. The 21KA6 tested bad. Then I made the mistake of asking this dunce to change it for me. He must have broken something because now the new tube won't work."

I looked at Harry, who answered defensively, "Honest, Art, all I did was pull the old one and put in a new tube. In fact, I even tried three new tubes.

None of them worked." Casting a glance at Joe, Harry continued with a miserable expression on his face, "He said when I come for lunch he's gonna slip something into my soup."

Tuning out Harry and Joe, I slipped a new tube into the empty socket and turned on the receiver. After a slight warm-up period, the sound blasted out loud and clear. I turned down the volume to a listenable level. The replacement 21KA6 tube's filaments were glowing, but there was no brightness on the TV screen.

with the substitute signal. Somehow, the receiver's own signal was being lost.

Next, I took a horizontal control grid signal from the Analyst, injecting it into the pin-4 control-grid lug on the tube socket. This time no raster. Since a raster did appear during injection to the plate but not during injection to the grid, the trouble had to be between these two points.

Harry was looking morose, and Joe had an ear-to-ear grin that neatly displayed his pearly-whites. Suddenly, Harry disappeared into the inner sanctum, as I reached for my voltmeter. Without a word, Harry returned and handed me the schematic of the TV receiver.

It was time to check the B voltages being applied to the 21KA6 tube. Setting the receiver on its side so that I could get at the bottom of the tube socket, I once again turned on the power. The tube's cathode pin was grounded, and the socket itself looked to be in good condition. Pin 4, the suppressor grid, according to the schematic was supposed to be at 28

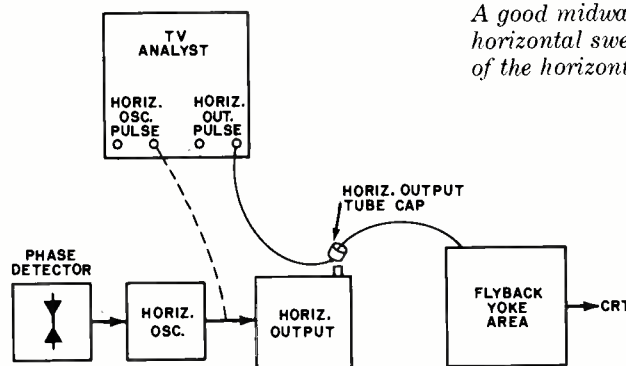

A good midway test point in the horizontal sweep system is cap of the horizontal output tube.

Picking up a neon lamp fastened to the end of a long stick, I poked around the cap of the horizontal output tube to test for r-f emanations. The lamp didn't fire. That meant the high-voltage system wasn't producing.

Since the HV system encompasses the horizontal phase detector, oscillator, output, and flyback-yoke circuits, I now had to narrow down the suspect area. I brought my B & K Analyst over to the workbench. I knew through long experience that a good midway test point would be the cap of the horizontal output tube. So, I put a substitute horizontal pulse from the Analyst on the tube's cap. When I turned on the Analyst and receiver, a bright raster appeared on the picture tube screen. Obviously, the flyback-yoke area was operating properly —

volts. On the meter, it was 80 volts. Pin 7, the screen grid, was supposed to be at 118 volts; it measured 125 volts. Aha! A couple of differences — one of them rather large — from what the schematic prescribed.

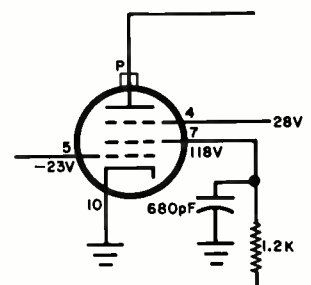

Voltages measured on the 21KA6 in the set.

All this time, Harry and Joe stared silently, waiting for some word. It was

hard to do, but I kept a straight face. All I did was grunt, "Uh huh."

Voltage Symptoms. The two grids had elevated voltages. Now, how could that occur. I took a voltage check on the other side of the 1200-ohm screen-grid resistor. The voltmeter read 125 volts. There was no voltage drop across the resistor, and that meant that no current was being drawn. There was obviously no tube conduction. But why?

If the control grid has too high a negative bias, I reasoned, this could occur. Taking a voltage reading at control grid pin 5, I noted that it registered the proper -23-volt level. Scratch that possibility.

I rearranged the tubes and boxes Harry had left on the counter and thought over the problem and symptoms. The cathode and all three grid circuits in the TV receiver were good. So, the trouble had to be in the tubes themselves.

I pulled the RCA tube manual from beneath the counter and looked up the 21KA6 tube. The manual directed me to refer to the type 16KA6 tube, which I did. And then I saw the problem. The RCA tube had the screen grid tied to pin 3. The Magnavox schematic showed the 118-volt line tied to pin 7, while pin 7 on the RCA tube was blank. The B voltage on pin 7 of the receiver's tube socket was at a dead end! This line had to be soldered to pin 3 to turn on the American-made tube.

Here were two tubes, one Japanese and one American-made, with the same number, same characteristics, and switched around screen-grid connections.

As I soldered a small length of wire from pin 7 to pin 3 of the tube socket, I didn't say a word. With the modification made and power turned on, a good bright picture appeared.

Harry came alive first. "See, there was more trouble than just the tube! Right, Art?"

Joe gritted his teeth and shot back, "If there was, you caused it."

My turn. "You're both wrong. There was no extra trouble, except that the Japanese and American tubes have different pin configurations. The voltage had to be rerouted."

Both men were appeased and stopped yelling at each other. Harry picked up the back of the receiver and screwed it into place. Then he pushed the repaired receiver toward Joe with a shrug.

SEPTEMBER 1974

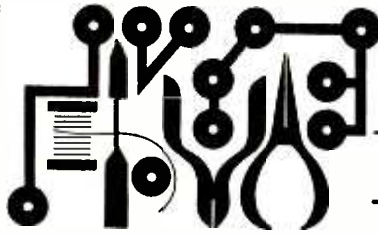

Hobby Scene

BASEMENT WATER WARNING

Q. For my country home, I need some sort of simple warning system to provide an alert when the water in the basement backs up.

A. This circuit is just about as simple as you can get—and quite sensitive. The lamp can easily be replaced with a Sonalert, or other low-voltage sound generator, to provide an audible warning. Use the resistor tips as

the probe. The circuit draws no power when not working so a set of batteries should last all summer.

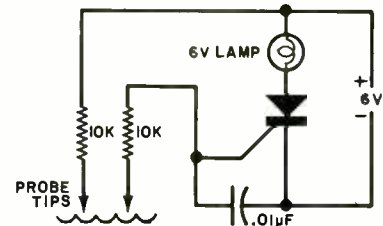

ONE-OCTAVE TONE GENERATOR

Q. I have seen a lot in your magazine about complicated music generators and synthesizer circuits. Is it possible to build a simple one-octave tone generator that could be used as a sort of toy "organ"?

A. It certainly is. This circuit is a common multivibrator having a selectable time constant on one leg. Adjust each potentiometer so that depressing each key in turn will produce one complete octave. Any type of pnp transistor can be used and the output is fed to an audio amplifier.

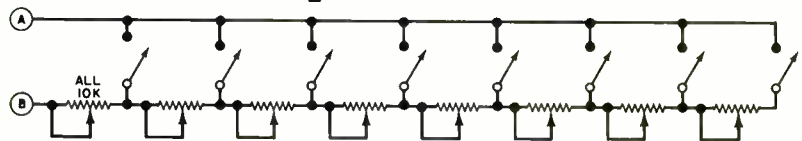
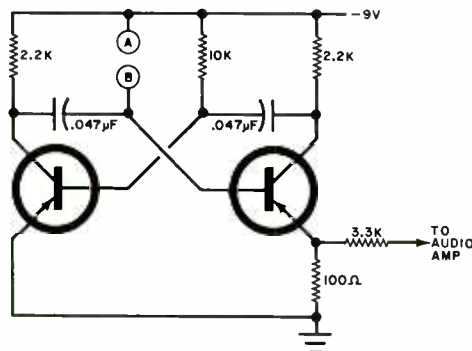

"WHELPER" ALARM

Q. I am looking for a circuit for a low-cost "whelper" alarm (that makes the kind of noise police cars do) to use with my burglar protection system. Can this be done easily?

using any type of pnp (silicon) transistor, with one npn in the audio oscillator. The output stage should be a medium-power pnp transistor. You can adjust the tone by changing the capacitor in the last stage and the on/off times by varying the time constants of the multivibrator.

A. The circuit shown here can be built

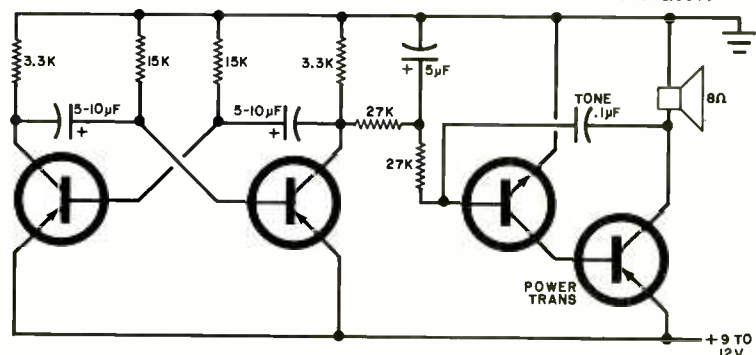

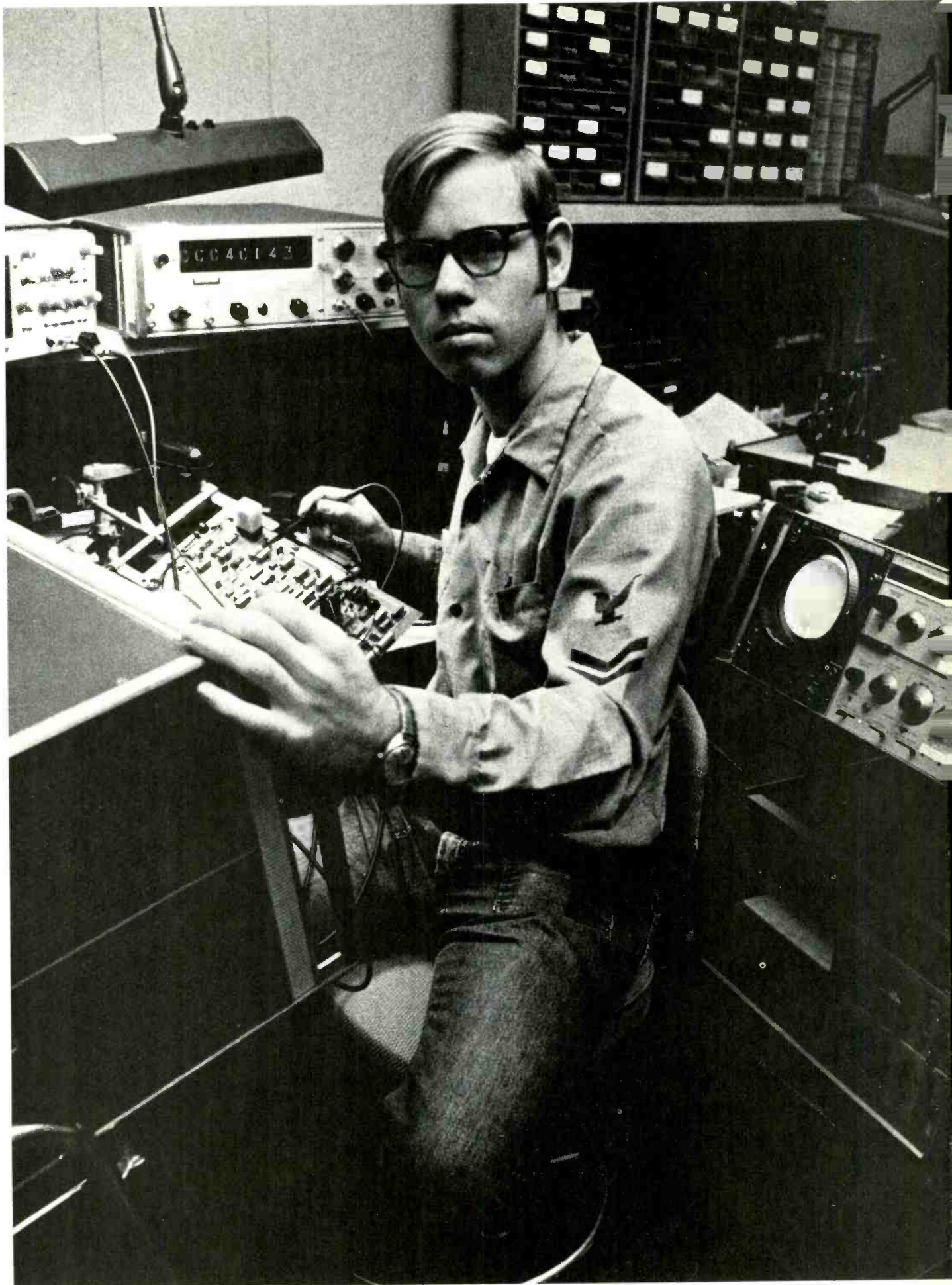

Ken Fransen is using his electronics training where it really counts.

Helping to save lives in the U.S. Coast Guard.

It's up to Ken to keep sophisticated electronics communications equipment in top condition.

He's part of our lifesaving team. We count on Ken and need more people like him.

You may or may not have electronics training. If, like Ken, you have training, we'll put you to work fast, on a rewarding job with responsibility and challenges. If you don't have training, we'll train you.

Say your experience goes no further than building a crystal radio set. If you have an aptitude for electronics and qualify, we'll guarantee you 25 to 38 weeks of school and turn you into a seasoned professional who'll be able to troubleshoot the most complex electronics equipment. You'll study everything from theory and principle to practical application.

Those of you who already know your way around electronics systems may qualify for our advanced promotion program. After only ten weeks, you'll be promoted immediately to a higher pay grade (up to 2nd class petty officer with pay of over \$400 a month, plus food, housing and medical care). And you may qualify for even more advanced training.

Either way, your job as a Coast

Guard electronics technician will give you a broad range of experience. Using the most modern diagnostic tools, you'll maintain, repair and calibrate the latest electronics equipment, including LORAN systems, computer-controlled transmitters, solid-state equipment and AM, FM and SSB transceivers.

You might even qualify to help design, test and evaluate new equipment or prototype models in our research laboratories, or work on cesium and rubidium atomic clocks.

You'll be doing plenty for yourself, too. The training alone is worth thousands of dollars, and the skills you learn can lead to valuable, sought-after jobs in both the Coast Guard and civilian life.

What's more, the Coast Guard offers you a combination of pay and benefits most private companies can't match. (For more about our package of benefits, read the attached card.)

Find out more about a rewarding career in electronics. Mail us the card today.

**Help others/Help yourself.
Join the lifesavers.
The Coast Guard.**

ENGLISH-LANGUAGE SHORTWAVE BROADCASTS FOR SEPTEMBER & OCTOBER by Roger Legge

TO EASTERN NORTH AMERICA

TIME-EDT	TIME-GMT	STATION	QUAL*	FREQUENCIES, MHz
7:00-8:15 a.m.	1100-1215	London, England	G	11.905, 15.07
7:00-9:00 a.m.	1100-1300	**VOA, Washington, U.S.A.	G	6.185, 9.565
7:15-8:45 a.m.	1115-1245	Melbourne, Australia	G	9.58, 11.71
7:30-8:00 a.m.	1130-1200	Jerusalem, Israel	F	15.13, 17.69
8:00-8:55 a.m.	1200-1255	Montreal, Canada	G	5.97, 11.825, 15.315
9:15-9:45 a.m.	1315-1345	Peking, China	F	11.685
10:00-10:30 a.m.	1400-1430	Berne, Switzerland	G	15.14
		Helsinki, Finland	G	15.185
		Stockholm, Sweden	G	17.71
10:30 a.m.-12:15 p.m.	1430-1615	London, England	G	17.84 (via Ascension Is.)
4:00-4:45 p.m.	2000-2045	Jerusalem, Israel	F	7.395, 9.495, 9.815, 11.70, 15.10
5:15-7:00 p.m.	2115-2300	London, England	G	9.58, 11.78, 15.26
5:30-6:50 p.m.	2130-2250	Hilversum, Holland	G	9.715, 11.73 (Sun.: Dutch)
6:30-8:30 p.m.	2230-0030	Johannesburg, S. Africa	G	9.585, 9.695, 11.90, 11.97
6:55-7:15 p.m.	2255-2315	Brussels, Belgium	G	9.655
7:00-8:30 p.m.	2300-0030	Moscow, U.S.S.R.	G	7.15, 7.205, 9.685, 11.87
7:00-9:00 p.m.	2300-0100	London, England	G	5.975, 7.325, 9.51, 9.58
7:45-8:45 p.m.	2345-0045	Tokyo, Japan	F	15.27, 17.825
8:00-8:30 p.m.	0000-0030	Tirana, Albania	G	7.065, 9.78
8:00-9:00 p.m.	0000-0100	Peking, China	F	15.06, 17.673
		Sofia, Bulgaria	F	9.70
8:00-10:00 p.m.	0000-0200	**VOA, Washington, U.S.A.	G	6.13, 9.65, 11.71, 15.205
8:30-9:00 p.m.	0000-0030	Stockholm, Sweden	F	6.00
8:30-9:00 p.m.	0030-0100	Kiev, U.S.S.R.	G	7.15, 7.205, 9.685
8:30-10:45 p.m.	0030-0245	Johannesburg, S. Africa	G	9.585, 9.695, 11.90, 11.97
8:30 p.m.-3:00 a.m.	0030-0700	HCJB, Quito, Ecuador	G	9.56, 11.915, 15.115 (9-11:30 p.m.)
8:40-9:00 p.m.	0040-0100	Brussels, Belgium	G	6.055
9:00-9:15 p.m.	0100-0115	Vatican City	G	5.995, 9.605, 11.845
9:00-9:20 p.m.	0100-0120	Rome, Italy	F	9.575, 11.81
9:00-9:30 p.m.	0100-0130	Budapest, Hungary	F	9.833, 11.91
9:00-9:45 p.m.	0100-0145	Berlin, DDR	F	9.73, 11.89
9:00-10:00 p.m.	0100-0200	Madrid, Spain	F	6.065, 11.925
		Montreal, Canada	G	6.085, 9.755
		Peking, China	G	7.12, 9.78 (via Tirana)
9:00-11:00 p.m.	0100-0300	Prague, Czechoslovakia	G	5.93, 7.345, 9.54, 11.99
9:00-11:30 p.m.	0100-0330	Melbourne, Australia	G	15.32, 17.795, 21.74
9:00-11:30 p.m.	0100-0330	London, England	G	5.975, 7.325, 9.51, 9.58
		Havana, Cuba	G	11.725, 11.93
		Moscow, U.S.S.R.	G	7.15, 7.205, 9.685
9:30-9:55 p.m.	0130-0155	Tirana, Albania	G	6.20, 7.30
9:30-10:30 p.m.	0130-0230	Vienna, Austria	F	6.155, 9.77
		Bucharest, Romania	F	5.99, 9.57, 11.94

TIME-EDT	TIME-GMT	STATION	QUAL*	FREQUENCIES, MHz
9:30-10:50 p.m.	0130-0250	Cologne, Germany	G	6.04, 6.075, 9.545, 9.69
9:45-10:15 p.m.	0145-0215	Berne, Switzerland	G	5.98, 6.12, 9.535, 11.715
10:00-10:45 p.m.	0200-0245	Lisbon, Portugal	G	6.025, 11.935
10:00-11:20 p.m.	0200-0320	Hilversum, Holland	G	6.165 (via Bonaire)
10:00-11:30 p.m.	0200-0330	Cairo, Egypt	F	9.475
10:30-11:00 p.m.	0230-0300	Beirut, Lebanon	F	9.66
11:00 pm-12 mdt	0300-0400	Buenos Aires, Arg.	F	9.69 (Mon.-Fri.)
		Peking, China	G	7.12, 9.78 (via Tirana)
		Prague, Czechoslovakia	F	5.93, 7.345, 9.54, 9.74
11:30 p.m.-2 a.m.	0330-0600	Havana, Cuba	G	11.76

TO WESTERN NORTH AMERICA

TIME-PDT	TIME-GMT	STATION	QUAL*	FREQUENCIES, MHz
7:00-9:00 a.m.	1400-1600	**VOA, Washington, U.S.A.	G	6.185, 9.565
4:00-5:30 p.m.	2300-0030	London, England	G	6.175, 9.74 (via Canada)
5:00-7:00 p.m.	0000-0200	London, England	G	9.51, 15.26 (via Ascension Is.)
5:00-7:00 p.m.	0000-0200	**VOA, Washington, U.S.A.	G	15.29, 17.895
5:30 p.m.-12 mdt.	0030-0700	HCJB, Quito, Ecuador	G	9.56, 11.915, 15.115 (6-8:30 p.m.)
6:00-7:00 p.m.	0100-0200	Peking, China	G	9.94, 11.945, 15.06
6:00-8:00 p.m.	0100-0300	Melbourne, Australia	G	15.32, 17.795, 21.74
		Moscow, U.S.S.R.	G	12.05, 15.18, 17.775 (via Khabarovsk)
		Tokyo, Japan	G	15.235, 15.445, 17.825
6:30-7:30 p.m.	0130-0230	Johannesburg, S. Africa	F	9.585, 9.695, 11.90, 11.97
6:30-7:45 p.m.	0130-0245	Taipei, Taiwan	F	11.86, 15.125, 17.72
7:00-8:50 p.m.	0200-0350	London, England	F	9.51, 15.26 (via Ascension Is.)
7:00-9:15 p.m.	0200-0415	Stockholm, Sweden	P	9.725
7:30-8:00 p.m.	0230-0300	Seoul, Korea	F	15.335
8:00-8:30 p.m.	0300-0330	Madrid, Spain	F	6.065, 11.925
8:00-8:45 p.m.	0300-0345	Peking, China	F	15.06, 17.735, 17.855
8:00-10:00 p.m.	0300-0500	Tirana, Albania	G	6.20, 7.30
8:30-9:00 p.m.	0330-0400	Moscow, U.S.S.R.	G	11.72, 12.05, 15.18
8:30 p.m.-12 mdt.	0400-0415	Tokyo, Japan	G	15.105
9:00-9:15 p.m.	0400-0430	Sofia, Bulgaria	F	9.70
9:00-9:30 p.m.	0400-0445	Lisbon, Portugal	F	6.025, 11.935
9:00-9:45 p.m.	0400-0455	Montreal, Canada	G	6.135, 9.655
9:15-9:45 p.m.	0415-0445	Budapest, Hungary	F	9.833
9:30-10:00 p.m.	0430-0500	Berne, Switzerland	F	5.98, 9.75
9:35-10:55 p.m.	0435-0555	Cologne, Germany	G	6.085, 9.605 (via Canada)
10:00-10:15 p.m.	0500-0515	Jerusalem, Israel	F	7.395, 9.495, 9.785
10:00-11:20 p.m.	0500-0620	Hilversum, Holland	G	6.165, 9.715 (via Bonaire)
11:00-11:15 p.m.	0600-0615	Tokyo, Japan	G	9.505
11:00 pm-12 mdt.	0600-0700	Buenos Aires, Arg.	F	9.69 (Mon.-Fri.)
11:30 p.m.-1 a.m.	0630-0800	Havana, Cuba	G	9.525

* Reception quality (Virginia location, Collins Communications Receiver, L antenna): G-good, F-fair, P-poor. ** - Not intended for North America, but receivable satisfactorily.

EVEN IF THEY NEVER SEE YOUR SLEEK NEW COBRA 135, THEY'LL KNOW YOU HAVE THE BEST.



They'll know by listening. Because you'll send with all the power allowed—15 watts P.E.P. input. Plus the extra authority of 100% modulation with Dynaboost speech compression.

You'll transmit on 23 AM and 46 SSB modes. Two separate transmitters give you the best of each, with overload protection.

Your own ears will confirm what we say. This Cobra has the crispest, cleanest

sound ever. Over 60 dB cross modulation interference rejection completely eliminates bleedover.

Cobra's drift-free Voice Lock lets you locate and lock-in sideband signals over a wide range. Three filters—one crystal, two ceramic—keep adjacent channels under wraps.

And Cobra's noise blanker really punches holes in noise, both AM and SSB.

The control console has everything. Adjustable AM/SSB RF gain control. Backlit RF output/SWR/S meter. 24-hour digital-leaf clock. Illuminated mode selector. And full-function controls.

Both talking and listening, it's the first base station to combine all the features you want in one package. And as for looks—wow!

Ask your CB dealer to show you the best. Cobra 135.

COBRA 135 AM/SSB \$450⁰⁰

microphone included

Product of Dynascan Corporation, 1801 West Belle Plaine Avenue, Chicago, Illinois 60613

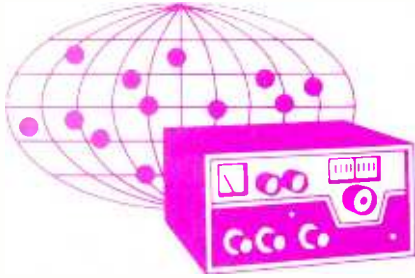

DX Listening

By Glen Hauser

TV AND FM DX'ING

NORTH & SOUTH. Television and FM DX'ers take advantage of several distinct propagation modes. This fall, two of the more exotic propagations reach their peaks, one in the North, one in the South.

Auroral skip correlates closely with latitude; the further north you are, the more often it happens. Seldom does it extend beyond the 35th parallel. Ionospheric disturbances setting off auroral displays, and hence TV/FM DX, tend to group around the equinoxes, but may occur any time. A good indicator of auroral, or approaching auroral conditions is the "A Index" broadcast by WWV every hour at :18, updated at 0400 UTC. When the A Index is above 30, it's time to check all the VHF TV and FM channels for DX. A visible auroral display is not necessary, but if there is, DX chances are excellent. Signals peak from an angle between due north and the true bearing of the station.

FM DX'ers have no problem, as the shimmering northern lights do not greatly distort FM audio. Video signals are quite another matter, as they cover a much wider range of frequencies (bandwidth). Video is so choppy that seldom can a DX station be identified. But — television uses FM audio! Now, if FM tuners were widely available covering TV audio frequencies, there would be no problem. But channel 6 is the only one available to most DX'ers since it happens to lie next to the FM band (87.75 ± 0.01 MHz)

Even worse, TV receivers are designed to *reject* audio that is not accompanied by a strong, steady video signal! This *intercarrier* system may be fine for normal viewing, but is an obstacle to DX'ing. Fortunately, there are two little-known tricks that put DX'ers back in business — and neither requires any wiring or internal modifications!

Video carrier injection is one of them. VCI means supplying a locally generated signal at the video frequency so the audio can "ride in." The easiest way is to tune a signal generator to the video carrier frequency of the channel desired; lacking this, any shortwave receiver will serve. You must tune it so that a harmonic of the oscillator frequency (above or below the dial frequency by the intermediate frequency) falls on the video frequency. By trial and error you'll find certain bands produce a 'darkening' on the screen, and at one precise point, a particular herringbone pattern of interference appears, beating with whatever video is already there — *and the TV audio appears as if by magic!* For channels 7-13, an FM tuner (usually 10.7 MHz) may be more effective.

A more direct method has the advantages of leaving video unmarred and eliminating the audible video heterodyne interference. Pick up the TV set's audio i-f on a nearby 30-50-MHz receiver (ours appears at 41.35 MHz). The radio may be more selective than the TV, enabling you to tune between different TV audio signals offset 10 or 20 kHz apart.

These same techniques are a must in DX'ing TV via *trans-equatorial scatter*. The fall season begins September 1, but only DX'ers in the Gulf coastal states can hope to see any DX by *TE* unless it links up with conventional sporadic E or tropo propaga-

tion. *TE* builds up quickly after sunset and peaks around 2000 local mean time. You'll need a clear shot on channel 2, 3 or 4 and a station at least 3000 km away to the south or south-east. In *TE*, the MUF fluctuates extremely rapidly, tearing up broadband video signals. But the fluttering audio can be made intelligible with VCI.

While checking for this rare *TE*, you may be rewarded with an off-season sporadic-E opening, which favors stations to the south like YSR, El Salvador. We snapped its ID design from Von Ormy, Texas, 1950 km away, at 1837 GMT on 22 November 1972. If you're not already a TV or FH DX'er, *Beyond Shortwave* provides the basics on propagation, TV DX'ing, FM DX'ing, and vhf radio DX'ing. The booklet is \$1 from the Worldwide TV-FM DX Association, Box 163, Deerfield, IL 60015.

East & West. Ever notice how many overseas stations claim to broadcast to the East Coast or the West Coast of North America? Fortunately, few stations are so situated that they can broadcast a narrow beam limited to coastal areas! But why do they keep talking as if the continent is uninhabited between the coasts? We figure that close to half the population of Canada and the United States lives in states and provinces *not* on the Atlantic or Pacific Coast — even with Vermont and Pennsylvania thrown in with the coastals. It's about time this tide of coastal chauvinism ebbed.

Experienced DX listeners favor the 60-meter band (4750- 5060 kHz) because it is the home of a great many low-powered, exotic broadcasting stations — mostly in tropical regions of Latin America, Africa, Asia and the Pacific. Conditions are improving now, as thunderstorm static diminishes and nights grow longer (darkness paths are essential to DX propagation below 7 MHz). But as we

Identification design of YSR, El Salvador, was snapped from TV in Van Ormy, Texas on Nov. 22, 1972, 1837 GMT.



pass through the slump in the sunspot cycle, higher frequency bands become almost useless for international broadcasting, especially between Europe and North America.

This drives more and more international broadcasters into the 49-meter band (5950-6200 kHz) — already densely populated by Latin American stations. And that's as low as law-abiding non-tropical stations can go. None of the lower bands is allocated for broadcasting to or within North America.

Radio Moscow, however, took a step last spring which may set a precedent for other stations not adhering to international agreements — it began using 4860 kHz for its North American Service between 2300 and 0100 GMT. DX'er Scott Reeves in Maryland reported the news to the North American Shortwave Association (NASWA), Box 8452, South Charleston, WV 25303.

Radio Canada International has also been using 60 meters. Many DX'ers have reported it on 4910 kHz around 0700 GMT, but this may be a point-to-point feeder. Radio RSA has also put a superpower transmitter on 4875 kHz to cover most of Africa. So this fall and winter DX'ers may have to contend not only with the legal CW and RTTY transmitters operating domestically on sixty, but also overseas superpower broadcasters fleeing the dropping MUF!

F.R.C. Some stations prefer to make more efficient use of existing international frequency bands, but lack the skilled monitoring staff to select the frequency suffering least from interference. To assist such stations reach their targeted audience in North America, the Association of North American Radio Clubs operates a Frequency Recommendation Committee. If you'd like to assist the F.R.C. in improving the audibility of stations broadcasting to North America, contact the committee's chairman, Charles A. Wooten, 4911 Battery Lane, Bethesda, MD 20014. As a former chairman of the F.R.C., we can attest that the time consumed by frequency searching is amply rewarded.

Country-Counters. Look for tests from a new station on Guam, KTWR. Trans World Radio holds a construction permit to complement its transmitters in France, Bonaire, and another being built in Swaziland, with this 250-kilowatt sender. For some

years, certain DX clubs have pretended the U.S. Naval Communications Station NPN on Guam is a broadcaster — though it has no programs — so they can tally Guam as a "shortwave broadcast radio country." KTWR should put an end to that.

Rozglosnia Harcerska. This is one of Europe's least-known SWBC stations, even when translated into "Polish Pathfinder's Station." Hearing Radio Warsaw is no great achievement, but the true DX'er doesn't mark off a country once he's logged its main station. Harcerska's 300-watt transmitter on 6850 kHz could make it to North America, but rarely does because of a daytime-only schedule. Ed Shaw of NASWA persuaded the station to broadcast a special half-hour test in English last spring, but it was postponed until a more favorable hour this fall. The exact time of the special is to be announced in NASWA's journal, FRENEX.

Bahamas On the Air, In the Air. A bizarre balloon is boosting a Miami TV station on Grand Bahama Island. The island's first TV operation was discovered by West Palm Beach DX'er Ken Simon on June 2. The 250,000 cu ft aerostat floats 10,000 ft over the High Rock area, rebroadcasting WTVJ, channel 4, on channel 11. A black-and-white ID slide showing the balloon and call sign ZFHQ-6 appears every hour. The transmission with 5-kW ERP is directed away from the North American mainland.

BCB DX'ers. If you are getting set for another season of domestic station chasing, prepare yourself with the NRC Domestic Log of all licensed U.S. and Canadian AM stations. The club plans to release a new printing of the Log, with the requisite updater sections and cross-indexing, on September 1. For details, contact National Radio Club, Box 127, Boonton, NJ 07005.

Long Wave. This is probably the most neglected DX band of all. Yet, only here can you DX beacons from such exotic spots as Swan Island, Sable Island, and San Andrés — and get fairly reliable reception of domestic broadcasts from Europe and Asia. A new club has been formed to fill the gap: Long Wave Club of America, c/o John Clements, 11425 Albera, No. 5, North Hollywood, CA 91601.

The Ultimate in Ignition Systems!

★ **ELIMINATES BREAKER POINTS.**
Perfect Timing and Dwell never change!

★ **Eliminates Tune-ups.**
Never wears out or needs any Maintenance.



★ **The Most Advanced**
"OPTO-ELECTRIC SYSTEM"

• The Allison Breakerless System eliminates the Points and Condenser, replacing them with an Opto-Electronic Trigger, using a Light-Emitting Diode and Phototransistor. Also completely eliminates wiper-arm "friction" wear. The only "TRUE" Electronic Ignition ... that you can install for under \$100. Gives 40-times more Timing Accuracy than ANY system using mechanical Breaker-Points! Unlimited RPM. Smoother running. (No timing fluctuation as with Magnetic units). Unaffected by Temperature, Moisture, or Vibration! All Solid-State Components. Easier Starting under any condition! Increased Horsepower. Sparkplugs last longer. Perfect timing increases engine Efficiency and Gas Mileage up to 30%!

• **Quick and Easy Installation!**

★ **Tested and Proven reliability.**

Only \$49.95 • **SATISFACTION GUARANTEED!**

• Complete. • **1-YEAR FACTORY WARRANTY.**

(State Make, Year, Engine Size). (Calif. Res. add Tax).

• **CONVERT YOUR "C-D" UNIT TO BREAKERLESS!**
"TRIGGER-UNIT" ONLY \$34.95

★ **Send Postcard for FREE BROCHURE Today.**

ALLISON AUTOMOTIVE CO.

P. O. Box 881-P, TEMPLE CITY, CAL. 91780

CIRCLE NO. 1 ON READERS SERVICE CARD

HUGE SAVINGS ON FAMOUS BRAND STEREO COMPONENTS

DISCOUNTS

ON NATIONALLY ADVERTISED

TURNABLES • CARTRIDGES

COMPACTS • RECEIVERS

AMPLIFIERS • TAPE RECORDERS

Wholesale Prices! Audio Warehouse Sales, One of the Capitols largest stereo wholesalers will fill and deliver all your mail orders promptly in factory sealed cartons, at prices that will amaze you.

Write for quote on Famous Brand, Stereo Components. We guarantee satisfaction.

AUDIO WAREHOUSE SALES
3310 NEW YORK AVE. N.E.
WASHINGTON, D.C. 20002
(202) 832-1616

CIRCLE NO. 6 ON READERS SERVICE CARD

LARGE-LARGE DISCOUNTS LOW - LOW PRICES

NATIONALLY
ADVERTISED STEREO EQUIPMENT
AT LOWEST PRICES!

TURNABLES * SPEAKERS * RECEIVERS
AMPLIFIERS * TAPE RECORDERS

WRITE FOR QUOTE ON
NATIONALLY ADVERTISED BRANDS OF STEREO
COMPONENTS. SATISFACTION
GUARANTEED!

Clifford's
HI-FI WHOLESALERS
231 W. COURT ST.
Kankakee, Illinois 60901
(815)-939-7868

CIRCLE NO. 9 ON READERS SERVICE CARD

COLLECTORS!

Here's how to enjoy
Old-Time Radios—
A fascinating hobby!



VINTAGE RADIO tells you how to collect valuable old radios, and is the standard reference for collectors. Over 1,000 pictures. 263 pages, \$6.95 hard-cover, \$4.95 handbook.

S. GERNBACK'S 1927 RADIO ENCYCLOPEDIA is your deluxe illustrated technical book on early radio. 175 pages, \$12.95 hard-cover, \$9.95 handbook.

RADIO COLLECTOR'S GUIDE is your data book with 50,000 facts, 1921-1932. 264 pages, \$3.95.

MOST-OFTEN-NEEDED RADIO DIAGRAMS gives circuits of 600 models, 1926-1938. 240 pages, \$7.00.

SEND CHECK TODAY to Vintage Radio, Dep't P,
Box 2045, Palos Verdes Peninsula, CA., 90274
Postage Paid. Ten Day Guarantee, Calif. add 6%

_____	\$ _____
_____	\$ _____
_____	\$ _____
_____	\$ _____
TOTAL	\$ _____

NAME _____
STREET _____
CITY _____ ST _____ ZIP _____

COLLECTORS!

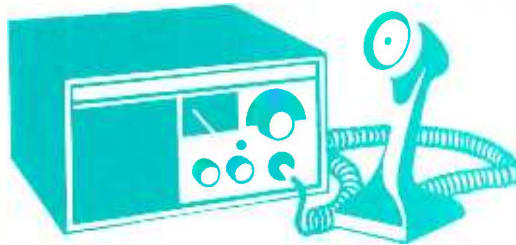

CB Scene

By Len Buckwalter

HOW FILMS BOOST CLUB ATTENDANCE

THE attendance curve for a CB club meeting often resembles a sawtooth — fast rise time followed by long decay. Among the lures for boosting attendance are the door prize, coffee break, having a state trooper as guest speaker or showing a movie. That last item is worth a closer look because a notice in a club newsletter about a scheduled movie can double or triple attendance. Most people enjoy seeing a movie in their special-interest area and good films are easy to obtain. They won't strain the treasury, either, because films are loaned free and incidental costs, as we'll see, are modest.

What do you show at a CB club? Although some 5000 free films are available for showing to clubs, no-one has yet produced "So this is CBI". The titles include everything from a short on Hookworm Disease to a half hour on "Better Internal Grinding." As you might suspect, free films are heavily weighted in the direction of training movies by government agencies and military services. To appease the taxpayer, however, many such films have been cleared for public viewing and are suitable for clubs.

Another rich source is commercial and industrial films, even with their obvious messages. Big insurance companies have a stake in keeping policy-holders healthy and put considerable money into producing films about safety — some quite viewable. Utility companies produce movies about the benefits of the all-electric home (which may be difficult to push these days), but also offer an animated cartoon on topics like how an electrical generator works.

The quality of these movies, to borrow a Hollywood phrase, varies all over the lot. Some have the excitement of those Dept. of Agriculture dramas seen at 6:00 a.m. on television — where the county agent explains the miracle of concrete floors in a hog

house. Many films, though, boast names like Disney, Chet Huntley and film companies whose major output is the Hollywood movie or TV network production.

Each of the armed services will lend certain training films in electronics. The U.S. Navy has a radio technician series with sections (each about 15 minutes) on capacitance, inductance, oscillators, standing waves, signal generators, volt-ohmmeter operation and elementary electricity. These films, incidentally, often use an excellent visual technique: they break down an abstraction, like electron flow, and show it happening in animated fashion. The Air Force has films about radio antennas, printed circuits and their repair, and radar.

The military services usually don't distribute their films from Washington, but by regions. If you don't know where your nearest Army, Navy or Air Force office is, check under U.S. Government in a phone book or ask at a local post office. Request from each service a catalog of films available to the public and you'll receive a booklet describing each title, running time, other details and an application form. Your local library may also have film catalogs in its reference room.

Since many CB'ers toy with the idea of becoming hams someday, there are two films of special interest. A recent one from the Army is called "Visit to Mars," a 28-minute feature in color that tells about the worldwide Military Affiliate Radio System (comprised of both civilian and military hams) that handles a vast amount of free telegram and phonepatch traffic for men in uniform here and overseas. Another film, this one produced by the American Radio Relay League, is called "Ham's Wide World," probably the best single movie on the wide-ranging activities of hams; from disasters to satellites. This 27½-minute color film on 16-mm is available from:

Modern Talking Picture Service, 1212 Ave. of the Americas, New York, N.Y.10036.

The telephone company — more specifically, the Bell System — is another good source of free films. Since CB'ers often cooperate with law enforcement officers, there might be interest in "Good Guys are Faster." This 14-minute color film shows how communications aid the daily activities of local, state and federal law enforcement agencies. Much of the shooting was done with the Arizona State Highway Patrol. Slightly further afield, but still of potential interest, is "Plane Talk," which details (in 21 minutes) all the communications during a typical flight from Chicago to Los Angeles. If you want to order any of these films, or learn of other titles, contact your Bell System telephone office. The company's films are handled on a local basis.

A film showing at a CB club meeting doesn't *have* to deal with electronics or communications. There are other topics of parallel and widespread interest. Since much CB'ing is done in mobile operation or involves roadside emergencies, automobiles are also a potential topic. Allstate Insurance Company, for example, sneaks in its safety message in a half-hour film called "The Driving Scene," replete with the roar of engines, color and action. It also offers "In the Crash," or 20 minutes of what happens when a car hits a solid object at 5, 10 and 15 mph. Allstate's films are also distributed through local offices so check your phone-book listing for the number. General Motors has its say about drunk driving in a 16-minute film that feeds highballs to volunteer drivers, then photographs their performances on an obstacle course as their blood alcohol rises. You can find out about this and other GM films by writing to General Motors Corp., Film Library, GM Building, Detroit, Mich. 48202. The company also lists a Walt Disney film of 33 minutes that tells in cartoon style all about how to use hand tools.

You'll have to check each film-lender's catalog for the specific details, but here's what you can generally expect. Order a film several months in advance — certainly not less than one month — to get confirmation that the film will be available on the desired date. Since these films are not authorized for showing to individuals in private homes, make the request on club stationery or, at least,

put your club name and address at the top of the page as if it were a business letter. An official of the club should make the request and give his title. That letter should not be typed on anything smaller than an 8½ x 11 sheet or it's too easily lost in the filing system of large organizations. It's also important that you do not use these films for profit, charge an admission fee or use them to raise money. This is copyrighted material and must be used within the narrow confines of a non-profit organization for educational purposes. It is most usual for the loaning organization to send the film postage paid, then expect you to pay for the return postage. (Films of this sort travel at lower postage rates.) There are no other charges.

But, you will need, in most cases, a 16-mm sound projector. In a large number of instances, a club member will have access to this equipment through a school or similar organization. Otherwise, a machine can be rented; a check of rates in the northeast reveals that a 16-mm sound projector is available for one day at \$15. It includes screen, spare lamp, take-up reel and power cord. When

show-time arrives (usually after the business portion of the meeting) be sure you have little more to do than douse the lights and roll the film. Nothing kills an audience's pleasant anticipation faster than watching you fumble with reels, focus, rearrange the screen and look for the light switch. This is show business and a few minutes of equipment rehearsal before the meeting are worth the trouble.

After the movie, you'll put the film directly back into the can without re-winding, a request made by nearly all sponsoring organizations. Another requirement is to fill out a form that indicates when the film was shown and the number of people in the audience. It's not only good sense to return the film promptly, but it assures that the next school, club or other group meeting will meet its showing date.

The number of free films in recent years has increased significantly and they enjoy wide circulation. One film catalog claims that the number of new titles increased by 50% in a recent two-year period alone. There's no reason why a CB club can't join the informational bonanza. ♦

FREE McIntosh CATALOG and FM DIRECTORY

Get all the newest and latest information on the new McIntosh Solid State equipment in the McIntosh catalog. In addition you will receive an FM station directory that covers all of North America.



MX 113

FM/FM STEREO - AM TUNER AND PREAMPLIFIER

**SEND
TODAY!**

McIntosh Laboratory, Inc.
East Side Station P.O. Box 96
Binghamton, N.Y. 13904
Dept. PE

NAME _____

ADDRESS _____

CITY _____ STATE _____ ZIP _____

If you are in a hurry for your catalog please send the coupon to McIntosh.
For non rush service send the *Reader Service Card* to the magazine.

CIRCLE NO. 23 ON READERS SERVICE CARD

ELECTRONICS MARKET PLACE

NON-DISPLAY CLASSIFIED: COMMERCIAL RATE: For firms or individuals offering commercial products or services, \$1.60 per word (including name and address). Minimum order \$16.00. Payment must accompany copy except when ads are placed by accredited advertising agencies. Frequency discount: 5% for 6 months; 10% for 12 months paid in advance. **READER RATE:** For individuals with a personal item to buy or sell, \$1.00 per word (including name and address.) No minimum! Payment must accompany copy. **DISPLAY CLASSIFIED:** 1" by 1 column (2-1/4" wide), \$200.00. 2" by 1 column, \$400.00. 3" by 1 column, \$600.00. Advertiser to supply cuts. For frequency rates, please inquire.

GENERAL INFORMATION: First word in all ads set in bold caps at no extra charge. All copy subject to publisher's approval. All advertisers using Post Office Boxes in their addresses **MUST** supply publisher with permanent address and telephone number before ad can be run. Advertisements will not be published which advertise or promote the use of devices for the surreptitious interception of communications. Closing Date: 1st of the 2nd month preceding cover date (for example, March issue closes January 1st. Send order and remittance to **POPULAR ELECTRONICS**, One Park Avenue, New York, New York 10016, Attention: Hal Cymes.

FOR SALE

FREE! bargain catalog. Fiber optics. LED's, transistors, diodes, rectifiers, SCR's, triacs, parts. Poly Paks, Box 942, Lynnfield, Mass. 01940.

GOODER Surplus Receivers, Transmitters, Sniperscopes, Radios, Parts. Picture Catalog 25 cents. Meshna, Nahant, Mass. 01908.

LOWEST Prices Electronic Parts. Confidential Catalog Free. KNAPP, 3174 8th Ave. S.W., Largo, Fla. 33540.

ELECTRONIC PARTS, semiconductors, kits. **FREE FLYER.** Large catalog \$1.00 deposit. **BIGELOW ELECTRONICS**, Bluffton, Ohio 45817.

PYROTECHNICAL chemicals, casings, fuse, supplies. Listings—50 cents, with samples—\$1.00. Westech, RFD, Logan, Utah 84321.

RADIO—T.V. Tubes—36 cents each. Send for free catalog. Cornell, 4213 University, San Diego, Calif. 92105.

AMATEUR SCIENTISTS, Electronics Experimenters, Science Fair Students Construction plans—Complete, including drawings, schematics, parts list with prices and sources. Robot Man — Psychedelic shows — Lasers — Emotion/Lie Detector — Touch Tone Dial — Quadraphonic Adapter — Transistorized Ignition — Burglar Alarm — Sound Meter over 60 items. Send 25 cents coin (no stamps) for complete catalog. Technical Writers Group, Box 5994, University Station, Raleigh, N.C. 27607.

METERS—Surplus, new, used, panel or portable. Send for list. Hanchett, Box 5577, Riverside, CA 92507.

WE SELL CONSTRUCTION PLANS. TELEPHONE: Answering Machine, Speakerphone, Carphone, Phonevision, Auto Dialer, Touch Button Dialer, Central Dial System. TELEVISION: \$35.00 Color Converter, Video Tape Recorder, \$25.00 Camera. HOBBYIST: Electron Microscope, 96 Hour Tape Music System, Ultrasonic Dishwasher, Radar-Oven, Plans \$4.95 each. NEW ITEM: \$75. Electronic Pocket Calculator, \$7.50. COURSES: Telephone Engineering \$39.50. Detective Electronics \$22.50. Integrated Circuit Engineering, \$49.50. NEW SUPER HOBBY CATALOG plus year's subscription to Electronic New Letter AIRMAILED \$1.00. Don Britton Enterprises, 6200 Wilshire Blvd., Los Angeles, Calif. 90048.

JAPAN HONG KONG DIRECTORY. World products information, \$1.00 today. World Trade Inquiries, Hillyard, Washington 99207.

SCOPES, meters, test equipment. military and industrial surplus. Send 25 cents for "Bargain Bulletin". Lawrence Instruments, P.O. Box 744, Sunbury, Pa. 17801.

WAVEFORM GENERATOR KIT 8038 Function Generator IC Producing Sine, Square, Triangular Waveforms, \$10.95 PPD. 8038 IC, \$6.75 each PPD. **PHOTOLUME CORPORATION**, 118 East 28th Street, New York, NY 10016.

WE SELL MONEY MAKING CONSTRUCTION MANUALS!—Reclaim refined GOLD and SILVER for EXCELLENT profit or part time money!—Color Catalog 25 cents—Airmailed 50 cents. Creative Products, Dept. PE-874, 8415 Loffland, Houston, Texas 77055.

LOOKING FOR A NEW CHALLENGE?
... then build a TV camera!



ONLY SOLID STATE CAMERA AVAILABLE IN KIT FORM OR FACTORY ASSEMBLED. COMPLETE KIT WITH VIDEO TUBE. ONLY \$169.00. POSTPAID DELIVERY ANYWHERE IN U.S.A., CANADA AND MEXICO. OPTIONAL AUDIO SUBCARRIER \$18.95. WRITE OR PHONE NOW FOR COMPLETE CATALOG OF KITS, PARTS AND PLANS. Dial 402-382-3777.

ATV Research DAKOTA CITY, NEBR. 68731

DIGITAL ELECTRONICS: Complete schematics, parts lists, theories — Discrete Component Digital Clock, \$3.00 — Sound Sensitive Switch, \$1.50. Increase technical competence, hobby skills — Complete Course in Digital Electronics is highly effective, \$10.00. Free literature. DYNASIGN, Box 60A7, Wayland, Mass. 01778.

MECHANICAL, ELECTRONIC devices catalog 10 cents. Greatest Values — Lowest Prices. Ferrik's, 5249 "D", Philadelphia, Pa. 19120.

SOUND SYNTHESIZER KITS—Surf \$11.95, Wind \$11.95, Wind Chimes \$16.95, Electronic Songbird \$6.95, Musical Accessories, many more. Catalog free. PAIA Electronics, Box J14359, Oklahoma City, OK 73114.

BURGLAR-FIRE alarm components, hardware. Free catalog—information. Silmar, 133 S.W. 57 Ave., Miami, Florida 33144.

FREE CATALOG. Parts, circuit boards for POPULAR ELECTRONICS projects. PAIA Electronics, Box C14359, Oklahoma City, OK 73114.

PRICES SLASHED!!

In celebration of our parent companies 21st anniversary we are cutting prices on several items. These prices will be honored through September 21st.

POWER SUPPLIES. Use them in all your projects!

F0510 5v 1.5 amp. was \$ 8.95 NOW Only \$7.95

F1210 12v 1.5 amp. was \$ 9.95 NOW Only \$8.95

F1510 15v 1.5 amp. was \$10.95 NOW Only \$9.95

Predrilled epoxy board and all parts included except transformer. Transformer PC-16 plugs into board.



Our unexcelled quality 5% carbon FILM 1/2 watt resistors now only .07c each, minimum of 5 each value. Get them while they last!!

All Electrolytic and film capacitors reduced 10%.



NEW ITEM!! We've got Hewlett Packard red LEDs for only 39c each. Includes Panel mounting hardware. T-1 3/4 size. Part no. 5082.



If you're serious about quality then you'll want our new MAN71 series of displays. They are typically 50% brighter than the old MAN 7 series. We've got them in Red, Yellow and Green. All .3" char. ht. With each display we will include one HP 5082 panel indicator LED.

We also have 3 sizes of display bezels and filters that will fit most of your needs. Plus we have 7400 series logic, transistors and many other Brand New first quality parts and kits.

Mastercharge and Bank Americard Accepted.

Tracy Design Corporation

15870 Schaefer

Detroit, Mi. 48227

CIRCLE NO. 33 ON READERS SERVICE CARD

MAGNUS ORGAN TONE GENERATOR BOARD



MAGNUS Model 1700 tone generator boards, contain 12 separate oscillators for a total of 37 notes. 3 additional oscillators for chords, plus power output stage of about 5 watts. A great basic start for your electronic organ. Boards are new, but may have a spring contact bent, or a part broken. Board measures 27 1/2" x 4 1/2". Value of parts alone worth many times our price. With data sheet.

STOCK NO. F5200 Wt. 2 lbs. 14.95 ea. 2/27.00

256 BIT MAGNETIC MEMORY CORE

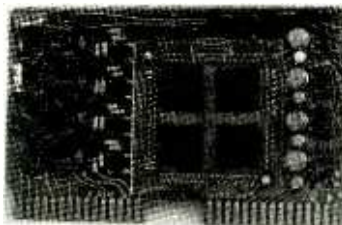

This 6" x 3 3/4" board is a complete memory, with core drivers and sensors. Brand new, made by RCA for a computer manufacturer.

STOCK NO. F5202

\$9.95 ea. 2/18.00 10/80.00

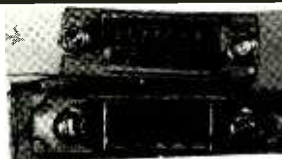

12 VOLT AM AUTO RADIOS

All transistor radios, removed from new cars as having minor defects. Since cars were under warranty they were replaced. Some have knobs missing, some work as is.

STK. NO. F5201 \$7.95 3/20.00

HI-CURRENT TRANSFORMER

10 volts @ 10 A., 17 volts @ 6 A., 18 volts @ 6 A. Conservatively rated. 2 1/2" x 3 3/4" x 3". 6 lbs.

STOCK NO. F9906 \$8.95 ea. 2/15.00

MINIMUM ORDER \$5.00. Include postage, excess refunded. New edition of our catalog now available.



DELTA ELECTRONICS CO.

BOX 1, LYNN, MASSACHUSETTS 01903

Phone (617) 388-4705

CIRCLE NO. 11 ON READERS SERVICE CARD

DISCOUNT PRICES

B & K, SENCORE, LEADER and RCA
Test Equipment

RAYTHEON, ICC/MULLARD Tubes
TELEMATIC Test Jigs

Free Catalog

FORDHAM RADIO SUPPLY CO., INC.
558 Morris Ave. • Bronx, N.Y. 10451

YOU WILL SAVE BIG MONEY! Surplus. Clearouts. Bankruptcy. Inventory. Deals. Catalog \$1 (redeemable). ETCOA Electronics, Box 741, Montreal, H3C 2V2. U.S. Inquiries.

ELECTRONIC Parts wholesale. Catalog 10 cents. Donlyn Electronics, P.O. Box 15421. Phoenix, Arizona 85060.

BURGLAR-FIRE alarm supplies and information. Free catalog. Protecto Alarm Sales, Box 357-G, Birch Run, Michigan 48415.

FREE CATALOG. IC's, Puts, Transducers. Thermocouples, Led's, Transistors, Circuit Boards, parts. Chaney's, Box 15431, Lakewood, Colo. 80215.

AUTHENTIC, INSTRUMENTED, FLYING ROCKETS for casual or serious experimenters Over 80 scale original, multi-stage or ready-to-fly models. Solid-propellant engines for safe, electric launch system liftoffs up to 2,500 feet. Measure altitude, temp. inversions, more. Real telemetry, electronic tracking, aerial still and movie photography with super-miniaturized equipment. New, detailed tech manual and full-color catalog. 25 cents from ESTES INDUSTRIES Dept. 18A, Penrose, Colo. 81240.

CALCULATOR OWNERS: Use your + - X ÷ calculator to compute square roots, cube roots, sin(x), cos(x), tan(x), arcsin(x), arccos(x), arctan(x), logarithms, exponentials, and more! Quickly, Accurately, Easily! Send today for the IMPROVED AND EXPANDED EDITION of the first and best calculator manual—now in use throughout the world only \$2.00. Unconditional money-back guarantee—and FAST service! Mallmann Optics and Electronics, Dept. 19A, 836 South 113, West Allis, Wisconsin 53214.

TELEPHONE "BUGGED"? Countermeasures Brochure \$1.00. Negeye, Drawer 547, Pennsboro, W. Va 26415.

HEAR POLICE/FIRE Dispatchers! Catalog shows exclusive directories of "confidential" channels, receivers. Send 10 cent stamp. Communications, Box 56-PE, Commack, N.Y. 11725.

CONVERT any television to sensitive, big-screen oscilloscope. Only minor changes required. No electronic experience necessary. Illustrated plans. \$2.00. Sanders, Dept. A-33, Box 92102, Houston, Texas 77010.

DIGITAL IC Manual—Latest Edition—1500 types by types/diagram number, \$3.95. 32—function digital computer kit—IC, transistors, instructions, \$14.00. IC applications manual—numerous circuits—Analog/Digital, \$3.95. Electronics, P.O. Box 127, Hopedale, Mass. 01747.

CONSTRUCTION PLANS: Laser \$2.00. Rocket Tracking Transmitter \$2.00. Space Monitor-Missile Tracker \$2.00. Free Catalog. Electro-Research, P.O. Box 20285, Ferndale, Michigan 48220.

CD IGNITIONS, VHF/UHF monitors, crystals, CB radios, Southland, Box 3591-B, Baytown, Texas 77520.

PAIA HAS...
modular SYNTHESIZER KITS
demo record \$1.00 free catalog
PAIA ELECTRONICS, INC.
BOX P14369, OKLAHOMA CITY, OK 73114

CRYSTALS, Scanners, \$3.88, include make and frequency. G Enterprises, P.O. Box 461PC, Clearfield, UT 84105.

LOW NOISE RESISTORS—carbon film. Brand new as low as 2-1/4 cents each. Components Center-PE Box 134, N.Y., N.Y. 10038.

FREE CATALOG. Kits, Components, audio equipment. Electronic Supply Pacs, Box 175, Floral Park N.Y. 11001.

PRACTICAL Applications of Digital IC's. 100's of tips, circuits, projects, on TTL. 443pp \$19.95. Money Back Guarantee, GEA, P.O. Box 285, Northfield, Ohio 44067.

BUGGED??? New locator finds them fast. Write, Clifton, 11500-L N.W. 7th Avenue, Miami, Florida 33168.

ALPHA/THETA BRAINWAVE biofeedback instruments. Analog instruments from \$125; digital processing systems from \$225. BioScan, Box 14168-E, Houston, Texas 77021.

SURPRISE! Build inexpensively, the most Unusual Test Instruments, Futuristic Gadgets using Numerical Readouts! Catalogue Free! GBS, Box 100A, Green Bank, West Virginia 24944.

POWER SUPPLY plans, precision regulated 9 to 12vdc, 2 amps. \$5.00. Airborne Systems, Box 1175, Hartford, Conn. 06101.

ELECTRONIC ORGAN KITS, KEYBOARDS and many components. Independent and divider tone generators. All diode keying, I.C. circuitry. Supplement your Artisan Organ, 35 cents for catalog. DEVTRONIX ORGAN PRODUCTS, Dept. C., 5872 Amapola Dr., San Jose, Calif. 95129.

PARANOID??? Electronic Surveillance Countermeasure Equipment Catalog \$1.00. SECURITY, Box 671, Westwood, New Jersey 07675.

SCOTCH TAPE—2400' on 7" reel boxed, may have music. 12 for \$14 POSTPAID—free list—WIDE RESPONSE, 6114P SANTA MONICA BLVD., HOLLYWOOD, CA. 90038.

ELECTRONIC IGNITION: Capacitor, transistor, pointless, Auburn sparkplugs. Information 10 cents. Anderson Engineering, Epsom, N.H. 03234.

LASER DIODE, 6W, GaAs: \$10.25; Liquid Xtal (Iliox) 3-1/2 digit, .4": \$9.75; 8038 VCO: \$5.95; INTEL 1103: \$3.00; CATALOG 10 cents. ELECTRONIC DISCOUNT SALES, 138 N. 81st St., Mesa, Arizona 85207.

WHOLESALE Scanners, CB, Crystals, Directories, SSB/AM, Catalog 25 cents. G—Enterprises, Box 461P, Clearfield, Utah 84105.

PROTECT your vehicles from theft, against "hot wiring", etc., with Auto Guard. Fits all cars. Instructions included. Residents continental U.S.A. only. \$6.95 (add 6% tax in Calif.) Ck. or M.O. Whitesell Sales, 245 Woodlawn, Chula Vista, Calif. 92010.

MINIATURE transmitters, lie detectors you can build for less than \$5. Complete plans \$2. Tom Henry, 96 Sturges St., Staten Island, New York 10314.

WEATHER SATELLITE pictures of your own. Can be constructed for \$100.00. \$2.00 for plans to: Weather, P.O. Box 362, Tupelo, Miss. 38801.

UNSCRAMBLERS: Fits any scanner or monitor, easily adjusts to all scrambled frequencies. Only 4" square, \$29.95, fully guaranteed. Dealer inquiries welcomed. PDQ Electronics, Box 841, North Little Rock, Arkansas 72115.

ALTAJ ELECTRONIC BARGAINS 'ALTAJ



Brand new National Clock chips. A complete digital clock in one dip. Best Price in U.S.A. With Specs.

MM 5314 — 24 Pin Dip 6 Digits, 12 or 24 Hr. \$5.95
MM 5316 — Alarm Clock, 40 pin dip, for fluorescent or liquid crystal readouts — \$8.95

LED READOUTS — Perfect for clocks large size, 14 pin style, .30 in. character, made by famous US mfg. Like MAN-1 or SLA-1. But brighter and easier to read. uses 7447 driver. Special \$1.49 ea. or 6 for 7.95.



JUMBO LED LAMPS
Red — Like MV 5024 8 for \$1
Green — Like MV 5222 5 for \$1

MOTOROLA RTL IC'S

Brand new. These are getting hard to find.

MC719P-77c	MC770P-89c	MC790P-89c
MC724P-77c	MC778P-89c	MC792P-77c
MC725P-77c	MC786P-77c	MC793P-77c
MC726P-77c	MC789P-77c	MC9722P-89c

PRIME TTL DIP IC'S

7400-19c	7442-75c	74109-59c
74S00-49c	7445-69c	74121-39c
7402-19c	7447-95c	74121-89c
7404-22c	7448-95c	74145-79c
74S04-49c	7450-23c	74150-1.39
7406-35c	7453-23c	74151-89c
7407-29c	7472-39c	74153-1.19
7408-20c	7473-39c	74154-1.59
7409-29c	74H73-40c	74157-1.19
7410-20c	7474-44c	74161-1.49
7413-60c	7474-69c	74164-1.69
7416-49c	7476-44c	74165-1.49
7420-20c	7483-89c	74174-1.89
7427-35c	7486-39c	74175-1.95
7430-20c	7490-79c	74180-99c
7432-30c	7491-95c	74181-3.50
7437-49c	7492-89c	74182-95c
7438-49c	7493-89c	74192-1.39
.7439-65c	74107-44c	74197-1.25
		74200-5.95

WE OFFER LOWER PRICES
AND HIGHER QUALITY PARTS

ALTAJ ELECTRONICS
P.O. Box 38544
Dallas, Texas 75238

THIS MONTH'S SPECIALS

LM 309 K 5v Reg. — 1.39 ☆ P1103 1024 Bit Ram — \$4.95

MAN 3-7 Segment LED Readout for pocket calculators

89c ea.

Nixie Tube — New #B5853-1. 0-9 W/Decimal — 89c

HOBBYIST SEMICONDUCTOR GRAB BAGS

We bought several million semi's, too many to test. You buy untested and save. All bags contain many useable devices with specs.

#2277 STEREO 2 watt audio amps in one dip — 3 for \$1

#2126 STEREO Pre Amps. Works on single +12VDC — 4 for \$1

#2137 AM Radio Chip. All the basics in one dip. — 3 for \$1

TI Plastic Transistors. NPN + PNP Silicon — 500 for \$4.95

2N3055 — untested. To-3. NPN Silicon 115W. 15AMP. — 8 for \$1

Silicon Computer Diodes. Like IN914 or IN4148. 500 for \$1.95

IC ASSORTMENT. TTL and Linears. 14 + 16 Pin Dips. 200 for \$4.95.

Triacs — 10 amps. to-220 case. up to 200 prv — 6 for \$1

3 DIGIT LED READOUTS

Perfect for pocket calculators. Has 3 digits same size as MAN-3 in one 12 pin dip. only 5ma per segment. Properly multiplexed. 100% Prime Units. Like Litronix DL-33. Best Price in U.S.A.!

\$1.49 each (3 digits)

CALCULATOR KEYBOARDS

New by Flex-Key. For pocket units. 4 function + per cent. \$4.95 each.

CALCULATOR CHIP

National MM5736. 6 Digits. 9vDC operation. Has interval oscillator and direct segment drive. Easiest to use of all chips on the market. Special \$3.95 ea. with specs.

MALLORY FILTER CAPACITORS

Miniature, twist lock. Perfect for small power supply. 2000 MFD — 30 WVDC — 59c 4000 MFD 20 WVDC — 79c

ELECTROLYTIC CAPS — UPRIGHT STYLE

MINIATURE SIZE
10 MFD 25V — 8c 50 MFD 16V — 12c 100MFD 16V — 16c

SEND CHECK OR MONEY ORDER

NO C.O.D. ADD 10% TO HELP COVER
PSTG & HDLG. TEX. RES. ADD5% TAX.

DISCOUNT

LEDS

—MV10B Visible red SPECIAL5 for \$1.00
 —MV50 type red emitting6 for 1.00
 —MAN 3 type\$1.45 ea.—3 or more 1.00
 —MAN 4 type2.25 ea.—3 or more 2.00

TTL

7400—\$.23	7451— .27	74157— 1.55	8000 SERIES
7401— .23	7453— .27	74161— 1.65	
7402— .23	7454— .40	74163— 2.50	
7403— .25	7470— .45	74164— 2.50	8090— \$.35
7404— .25	7472— .41	74165— 2.50	8091— .55
7405— .24	7473— .47	74166— 1.75	8092— .55
7406— .50	7474— .47	74170— 3.00	8093— .55
7407— .50	7475— .90	74173— 1.75	8094— .55
7408— .25	7476— .47	74176— .85	8095— .55
7409— .25	7476— .47	74177— .85	8096— .55
7410— .23	7480— .50	74177— .85	8097— .55
7411— .30	7482— 1.75	74180— 1.05	8098— .55
7413— .89	7483— 1.15	74181— 3.75	8121— .90
7416— .45	7485— 1.10	74182— 1.00	8123— 1.60
7417— .45	7486— .47	74190— 1.50	8130— 2.25
7418— .25	7489— 3.00	74192— 1.50	8200— 2.70
7420— .23	7490— 1.00	74193— 1.50	8210— 3.25
7421— .27	7491— 1.15	74194— 1.50	8214— 1.60
7423— .32	7493— .95	74195— 1.05	8220— 1.60
7425— .27	7494— .97	74199— 2.75	8280— .75
7426— .31	7495— .95		8288— .90
7427— .32	7496— .95		8520— 1.20
7429— .40	74100— 1.50	CD 4001— .65	8551— 1.75
7430— .33	74107— .47	CD 4002— .65	8554— 2.70
7432— .26	74121— .55	CD 4009— 1.50	8570— 1.00
7437— .45	74122— .47	CD 4010— .65	8600— .85
7438— .50	74123— 1.05	CD 4011— .65	8810— .75
7440— .23	74125— .60	CD 4012— .65	8812— 1.10
7441— 1.10	74126— .90	CD 4013— 1.60	8820— 1.50
7442— 1.05	74141— 1.15	CD 4016— 1.50	8822— 2.70
7443— 1.10	74145— 1.15	CD 4023— .65	8830— .60
7444— 1.15	74150— .95	CD 4025— .65	8831— 2.70
7445— 1.10	74151— 1.20	CD 4027— 1.35	8832— 2.70
7446— 1.25	74153— 1.50	CD 4030— .65	8836— .60
7447— \$1.25	74154— 1.20	74 C00N— .65	8837— 1.50
7448— 1.25	74155— 1.30	74 C04N— .70	8838— 1.50
7450— .25	74156— 1.30	74 C20N— .65	8880— 1.35

ALL DIP PACKAGES

20% DISCOUNT FOR 100 PIECES COMBINED ORDER

SPECIALS

7400-7401-7403-7404-7410-7420	5 for \$1.00
R-2307CP Current-Controlled Oscillator	\$3.15
R-205K Waveform Generator Kit	\$28.00
R-1310P Stereo Demodulator	\$4.10
NE555V	\$1.00 each
NE556V	\$1.85 each
LM309K 5V 1A regulator	\$1.25 each
723 Regulator	\$.50 each
741 operational Amp	\$.39 each
LM 311 — comparators	\$1.00 each
NE 565 Phase Locked Loop	DIP OR TO-5 \$2.00 each
NE 566 Function Generator	MINI DIP OR TO-5 \$2.00 each
NE 567 Tone Decoder	MINI DIP OR TO-5 \$2.00 each
7489 64 bit RAM TTL	\$2.75 each
8223 Programmable ROM	\$4.50 each

LINEAR

LM*00	Pos V Reg (super 723)	TO-5	\$.85
LM301	Hi performance AMPL	TO-5 or MINI DIP	.40
LM302	Voltage Follower	TO-5	.85
LM305	Positive Voltage Regulator	TO-5	1.00
LM307	Op AMP (super 741)	TO-5 or MINI-DIP	.40
LM308	Micro Power Op Amp	TO-5 or MINI-DIP	1.15
LM309H	5V Regulator	TO-5	1.15
LM309H	5 V 1A Regulator	TO-3	1.70
LM311	Hi perf. Voltage Comparator	TO-5 or MINI-DIP	1.15
LM380	2 Watt Audio AMPL	DIP	1.60
LM709	Operational AMPL	TO-5 or DIP	.40
LM711	Dual Differential Comparator	DIP	.39
LM723	Voltage Regulator	DIP	.65
LM739	Dual Hi Performance Op AMP	DIP	1.15
LM741	Comp. Op AMP	TO-5 or MINI-DIP	.55
LM747	Dual 741 Op AMP	TO-5 or DIP	.90
LM1458	Dual Comp. Op. Amp	MINI-DIP	.65
LM3900	Quad Amplifier	DIP	.65
LM3905	Precision Timer	MINI-DIP	.95
LM7524	Core Memory Sense AMPL	DIP	1.75
LM7525	Core Memory Sense AMPL	DIP	.90
LM7535	Core Memory Sense AMPL	DIP	.90
LM9601	Retriggerable One Shot	DIP	.75
LM75451	Dual Peripheral Driver	MINI-DIP	.49
LM75452	Dual Peripheral Driver	MINI-DIP	.49
LM75453	(LM351) Dual	MINI-DIP	.65
LM320K	Minus 5, 12 or 24 V. V.R. TO-3		\$1.25

Satisfaction guaranteed. All items are fully tested.

\$5.00 Minimum order. FIRST CLASS MAIL — NO EXTRA CHARGE
 California residents — add 9% sales tax.

WHOLESALE OUTLETS — Write for special discounts:

JAMES

Electronics

P.O. Box 822 BELMONT, CA. 94002

(415) 592-8097

CIRCLE NO. 20 ON READERS SERVICE CARD

P.C. BOARDS — Artwork — Negatives — Fabrication — Fast Prototype Service — P.E. Project Boards — Send pattern for price quote — B&S Circuits, 6573 Allatona Pt., Morrow, GA 30260.

1/2 INCH VIDEO TAPE. \$7.25 per hour on 7" reel. Free information. Oregon Magnetics, Box 13374, Portland, Oregon 97213.

COMPLETE CONSTRUCTION PLANS—TELEPHONE: Answering Device, Automatic Dialer, "Black Boxes", Call Diverter, Call Limiter, Conference Bridge, Central Dial Exchange, Melodic Ringing, Recorder-Actuator, Remote Control, Schematics, Speakerphone, Teletalk Burglar Alarm, Voice Scrambler, \$3.00 each. ELECTRONIC: Biofeedback Conditioner, Horticulture Stimulator, Multifrequency Encoder Network (Speeds telephone calling 100%!), \$5.00 each. DODECAHEDRON Speaker Enclosure \$7.50, Photographic Pinhole Camera \$2.00. ONE YEAR SUBSCRIPTION: Telephone-Electronics Newsline \$3.00. CORRESPONDENCE COURSES: Telecommunications, Electronic Protective Systems, F. E. T. Theory and Application, \$24.95 each. Catalog of plans 50 cents. All of the construction plans above, \$19.95. TELETRONICS COMPANY OF AMERICA, P.O. Box 3486, Los Angeles, California 90028, USA.

POCKET CALCULATOR KITS. All parts with educational instruction manual, 8 digit — \$25, 9 digit — \$28, 12 digit with addressable memory — \$50. Also 8 digit assembled untested — \$20. WIZARD, Box 161, Santa Clara, CA 95054

ELECTROENCEPHALOPHONE: Brainwave monitor. Professional biofeedback instruments. J&J, 8102-E, Bainbridge, WA 98110.

RAMS, 1024 Bit, (Mostek MK 4006P). New, perfect! \$3.50 each; 16 + \$3 each. D. Vail, 5454 Plainview, Cedar Rapids, IA 52405.

CAPACITIVE Discharge Ignition: Build your own! Trans-formers, Circuit boards, plans. Details 10 cent stamp. Petersen Electronics, Box 5471, Long Beach, CA 90805.

CB RADIO, accessories. Free discount list. Capitol, Box 3523, Des Moines, Iowa 50322.

HOBBYISTS—For all your electronic parts requirements at low prices, send for free flyer to: Dartek Electronics, Dept. P, Box 2460, Dartmouth, Nova Scotia, Canada. U.S. Inquiries.

ELECTRONIC SURPLUS. 1974 catalog—25 cents. Refundable w/order. Atlantis, Box 12654P, Tucson, AZ 85711.

FREQUENCY RESEARCH detailed information any two HF signals \$1. Comint, Box 45, Mantor, Ohio 44060.

DIAGRAMS, Radio, TV, etc., \$2. CIRCUIT design service, request quotation. TECHSERVUS, Box 1167, Berkeley, CA 94701.

CORVAIR PARTS—500 item catalogue, 50 cents: Clark's Corvair Parts, Colrain, Mass. 01340.

FANTASTIC DIRECTORY of Bargain Electronics suppliers. \$1.00. Sarty, Box 64581-P, Rancho Park, Calif. 90064.

UHF AFC TV TUNER with six channel memory selection. Send for details and time-saving converter applications. Versitronics Co., Box 872 - 582 Roger Williams, Highland Park, Illinois 60035.

25-FOOT PHONE CORDS for 500-type telephones. \$2.25 plus 34 cents postage. Specify color. Complete phone cord list, 10 cents. Flemco, 20272 37th Ave., N.E., Seattle, Wash 98155.

MERCURY BATTERIES: Send \$1.00 for sample assortment of three hardy mercury cells and bulletin describing other government surplus electronic goodies. AEROPARTS, Box 1492, International Airport, Del Rio, Texas 78840.

TYPEWRITTEN PICTURES. Unique, breathtaking. Three samples, details, \$2.00. Joe Dickens, 601 S. Dodson, Urbana, Ill. 61801.

LIQUID crystal digital wristwatch display. Includes instructions for building your own. Identical display used in high priced wristwatches. Could also be used in projects requiring 4-digit display. \$12.95 each. Limited quantity. Tricounty Winslow, Box 5885, Grand Central Station, New York, N.Y. 10017.

PARTS! CORNELL TUBES!

FREE Send For FREE
CORNELL'S
 New Color
 Catalog
 48 Pgs. New Items

33c Per Tube
 IN LOTS OF 100

36c Per Tube
 ORDER FREE IF NOT SHIPPED IN 24 HOURS!

4218 UNIVERSITY AVE. • SAN DIEGO, CALIF. 92105

DIGITAL/ANALOG PLANS for Home and Lab!!! Send for free 16-page ideas catalog featuring the EXPERIMENTER'S COMPUTER SYSTEM, practical plans, tutorials, etc. M.P. Publishing Co., Box 378-P, Belmont, Massachusetts 02178.

PLANS AND KITS

TESLA COIL—40" SPARKS! Plans \$7.50. Information 75 cents. Huntington Electronics, Box 2009-P, Huntington, Conn. 06848.

DIGITAL CLOCK KIT, 6 digit, anodized case, power supply, complete with instructions \$34.95. Semi-strobe shimmer kit \$7.95. Blinkie kit \$3.95. 15 1000v piv 1 amp diodes \$2.50, 12 assorted jumbo LEDES \$2.50, 25 assorted transistor sockets \$1.50. Orders over \$10.00 PPD otherwise 50 cents handling. HAL-TRONIX, Box 1101, Southgate, Mich. 48195.

TRIGGER SWEEP GENERATOR—improve your low cost scope by adding solid state trigger sweep. Complete kit, \$20.00 PPD. Information Free. PHOTOLUMINE CORPORATION, PO Box 139, New York, N.Y. 10016.

HIGH FIDELITY

DIAMOND NEEDLES and Stereo Cartridges at Discount prices for Shure, Pickering, Stanton, Empire, Grado and ADC. Send for free catalog. LYLE CARTRIDGES, Dept. P, Box 69, Kensington Station, Brooklyn, New York 11218.

KITS! LOUDSPEAKERS, CABINETS, AMPLIFIER. Featuring genuine walnut, heavy gauge chassis, top quality components and engineering at factory savings. Pride and performance combined Ruxton, Dept. P1, PO Box 30312, Santa Barbara, CA 93105.

WANTED

QUICKSILVER, Platinum, Silver, Gold, Ores Analyzed. Free Circular, Mercury Terminal, Norwood, Mass. 02062.

SHORTWAVE LISTENING

ANTENNA TUNER, \$17.95. SWLs Magazine, 50 cents. SWL Guide, 414 Newcastle, Syracuse, NY 13219

TUBES

RADIO & T.V. Tubes—36 cents each. Send for free Catalog, Cornell, 4213 University, San Diego, Calif 92105.

RECEIVING & INDUSTRIAL TUBES, TRANSISTORS All Brands — Biggest Discounts, Technicians, Hobbyists, Experimenters — Request Free Giant Catalog and SAVE! ZALYTRON, 469 Jericho Turnpike, Mineola, N.Y. 11501.

TUBES receiving, factory boxed, low prices, free price list. Transleteronic, Inc., 1306 40th Street, Brooklyn, N.Y. 11218A, Telephone: 212-633-2800

"TUBES ANTIQUE" Send your want list, P.O. Box 5570, Compton, Calif. 90224

TUBES 'Oldies', latest. Lists free Steinmetz, 7519 Maplewood, Hammond, Indiana 46324.

MOVIE FILMS

BMM-SUPER 8-16MM MOVIES! Biggest Selection! Lowest Prices! Free Catalog! Cinema Eight, Box PE, Chester, Connecticut 06412

ELECTRICAL SUPPLIES & EQUIPMENT

PLATING Equipment, Portable Platers, Supplies and "Know-How". Build your own tanks for nickel, chrome, etc. Easy-to-install PVC liners. Rectifier components—all sizes. Schematics, parts lists, formulas, operating instructions for all plating. Guaranteed to save you 25%-75%. Some, good units for sale. Write for details Platers Service Company, 1511-PE Esperanza, Los Angeles, Calif 90023.

TAPE AND RECORDERS

RENT 4-Track open reel tapes—all major labels—3,000 different — free brochure Stereo-Parti, 55 St. James Drive, Santa Rosa, Ca. 95401.

1930-1962 Radio Programs Reels, \$1.00 Hour! Cassettes, \$2.00 Hour! Mammoth Catalog, \$1.25 AM Treasures, Box 192F, Babylon, N.Y. 11702.

CASSETTES

Plain white cassette labels, Norelco cassette cleaners, famous brand cassettes. Metal or fiberglass 10 reels (Send for tape discount sheets) 1-9 10-99 100 1000

Cassette Labels (Multiples of 10) 65 60 55 50 45

Norelco Cassette Cleaner 65 60 55 50 45

Cassette Mailer Boxes .03 .025 .022 .02

Scotch Cassette SC90HE 2.72 (Buy 2, GET ONE FREE)

10' Fiberglass Reels, Used 50 50 40 35

10' Metal, NAB Hole, Used 1.00 1.00 90 80

Plus Postage by Weight and Zone Minimum Order, \$5.00

SAXITONE TAPE SALES
 1776 COLUMBIA ROAD, N.W.
 WASHINGTON, D.C. 20009

16,000 OLD RADIO SHOWS on tape. Catalog \$2.00, supplement 50 cents (refundable). Hart Enterprises, 1329H George Washington, Richland, WA 99352.

CASSETTE—TAB Erase defect. Record over recording \$1.00. H. Hodges, Sholola, Penn. 18458.

NOW AVAILABLE! TRIACS From



The Hutson line of sensitive gate and regular gate triacs are designed to be driven directly with IC and MOS devices. These triacs feature proprietary, void-free glass passivated chips and are hermetically sealed in TO-5 and Isotab packages.

These 3-15 Ampere triacs are available in voltage ratings from 50 to 400 Volts (VDRM) and in 3mA or 50mA (IGT) ratings. All devices are tested at their upper operating limits before shipment.

The economical and highly reliable triacs are the result of Hutson's advanced engineering and manufacturing technology, state-of-the-art passivation materials and techniques and experience in switching device applications.

Hutson triacs are bi-directional triode thyristors and may be switched from off-state to conduction for either polarity of applied voltage with positive or negative gate-trigger current. They are designed for control applications in lighting, heating, cooling and static switching relays.

PRICE LISTING

Catalog Number	Description of Item	Any Quantity Per Item (Mix)			Multiples of 10 Per Item (Mix)		Grouping Code
		1-99	100-999	1000-up	100-990	1000-9990	
45-03003	3mA Gate 50V 3 Amp. TRIAC	1.69	1.62	1.54	1.46	1.39	30
45-03203	3mA Gate 200V 3 Amp. TRIAC	2.18	2.08	1.98	1.88	1.78	30
45-03403	3mA Gate 400V 3 Amp. TRIAC	2.73	2.60	2.48	2.36	2.23	30
45-10003	10mA Gate 50V 3 Amp. TRIAC	1.36	1.30	1.24	1.18	1.12	30
45-10203	10mA Gate 200V 3 Amp. TRIAC	1.76	1.68	1.60	1.52	1.44	30
45-10403	10mA Gate 400V 3 Amp. TRIAC	2.20	2.10	2.00	1.90	1.80	30
45-25003	25mA Gate 50V 3 Amp. TRIAC	1.10	1.05	1.00	.95	.90	30
45-25203	25mA Gate 200V 3 Amp. TRIAC	1.54	1.47	1.40	1.33	1.26	30
45-25403	25mA Gate 400V 3 Amp. TRIAC	1.98	1.89	1.80	1.71	1.62	30
45-50010	50mA Gate 50V 10 Amp. TRIAC	1.08	1.03	.98	.93	.88	30
45-50015	50mA Gate 50V 15 Amp. TRIAC	1.69	1.62	1.54	1.46	1.39	30
45-50210	50mA Gate 200V 10 Amp. TRIAC	1.76	1.68	1.60	1.52	1.44	30
45-50215	50mA Gate 200V 15 Amp. TRIAC	3.01	2.88	2.74	2.60	2.47	30
45-50410	50mA Gate 400V 10 Amp. TRIAC	2.22	2.12	2.02	1.92	1.82	30
45-50415	50mA Gate 400V 15 Amp. TRIAC	3.81	3.63	3.46	3.29	3.11	30
46-50010	50mA Gate 50V 10 Amp. TRIAC	.97	.92	.88	.84	.79	30
46-50015	50mA Gate 50V 15 Amp. TRIAC	1.52	1.45	1.38	1.31	1.24	30
46-50210	50mA Gate 200V 10 Amp. TRIAC	1.58	1.51	1.44	1.37	1.30	30
46-50215	50mA Gate 200V 15 Amp. TRIAC	2.71	2.58	2.46	2.34	2.21	30
46-50410	50mA Gate 400V 10 Amp. TRIAC	2.00	1.91	1.82	1.73	1.64	30
46-50415	50mA Gate 400V 15 Amp. TRIAC	3.37	3.21	3.06	2.91	2.75	30

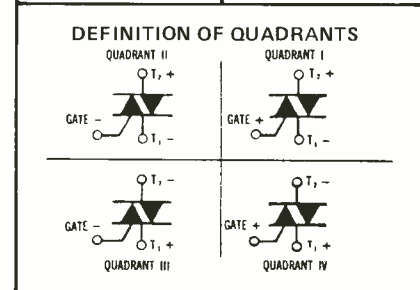
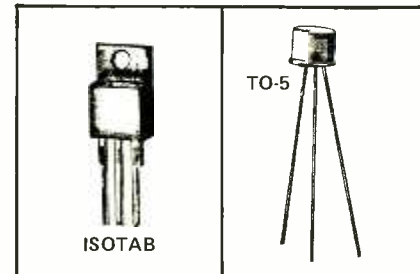

SPECIFICATIONS

Electrical Characteristics & Maximum Ratings	Catalog Number								Unit	
Repetitive Peak Off-State Voltage, Gate Open and $T_J=100^\circ\text{C}$	50	45-03003	45-10003	45-25003	46-50010	45-50010	46-50015	45-50015	VOLT	
	200	45-03203	45-10203	45-25203	46-50210	45-50210	46-50215	45-50215	VOLT	
	400	45-03403	45-10403	45-25403	46-50410	45-50410	46-50415	45-50415	VOLT	
RMS On-State Current at $T_C=75^\circ\text{C}$ and Conduction Angle of 360°		3	3	3	10	10	15	15	AMP	
Peak Surge (Non-Repetitive) On-State Current, One-Cycle, at:										
60 Hz		30	30	30	110	110	150	150	AMP	
50 Hz		30	30	30	90	90	125	125	AMP	
Peak Gate-Trigger Current for 3 $\mu\text{sec. Max.}$		1	1	1	4	4	4	4	AMP	
Peak Gate-Power Dissipation at $I_{GT} \leq I_{GTM}$ for 3 $\mu\text{sec. Max.}$		20	20	20	20	20	20	20	WATT	
Average Gate-Power Dissipation		0.2	0.2	0.2	0.2	0.2	0.2	0.2	WATT	
Peak Off-State Current, Gate Open at $T_J=100^\circ\text{C}$		0.75 Max.	0.75 Max.	0.75 Max.	2	2	2	2	mA	
Maximum On-State Voltage at $T_C=25^\circ\text{C}$ and i_t =Rated Value		2.20 Max.	2.20 Max.	2.20 Max.	1.8	1.8	1.8	1.8	VOLT	
DC Gate-Trigger Current at 25°C for $V_D=24\text{ VDC}$, $R_L=12\Omega$										
Quads I & III					50	50	50	50	mA	
Quads II & IV					80	50	80	50	mA	
$V_D=6\text{ VDC}$, $R_L=39\Omega$										
Quads I & III		3 Max.	10 Max.	25 Max.					mA	
Quads II & IV		3 Max.	10 Max.	25 Max.					mA	
DC Gate Trigger Voltage for $V_D=24\text{ VDC}$, $R_L=20\Omega$ and at $T_C=25^\circ\text{C}$					2.2	2.2	2.2	2.2	VDC	
DC Gate-Trigger Voltage for $V_D=6\text{ VDC}$, $R_L=39\Omega$ and at $T_C=25^\circ\text{C}$		2.2 Max.	2.2 Max.	2.2 Max.					VOLT	
Storage Temperature Range		-40 to +150								$^\circ\text{C}$
Operating Temperature Range, T_C		-40 to +100								$^\circ\text{C}$
Case Type		TO-5	TO-5	TO-5	Isotab	Isotab	Isotab	Isotab		



SEND YOUR ORDER TO:

SOLID STATE SYSTEMS, INC.
P. O. BOX 617
COLUMBIA, MISSOURI 65201



CALL OUR ORDER DESK (TOLL FREE): 800-325-2595 & 800-325-2981

ABOUT YOUR SUBSCRIPTION

Your subscription to POPULAR ELECTRONICS is maintained on one of the world's most modern, efficient computer systems, and if you're like 99% of our subscribers, you'll never have any reason to complain about your subscription service.

We have found that when complaints do arise, the majority of them occur because people have written their names or addresses differently at different times. For example, if your subscription were listed under "William Jones, Cedar Lane, Middletown, Arizona," and you were to renew it as "Bill Jones, Cedar Lane, Middletown, Arizona," our computer would think that two separate subscriptions were involved, and it would start sending you two copies of POPULAR ELECTRONICS each month. Other examples of combinations of names that would confuse the computer would include: John Henry Smith and Henry Smith; and Mrs. Joseph Jones and Mary Jones. Minor differences in addresses can also lead to difficulties. For example, to the computer, 100 Second St. is not the same as 100 2nd St.

So, please, when you write us about your subscription, be sure to enclose the mailing label from the cover of the magazine—or else copy your name and address exactly as they appear on the mailing label. This will greatly reduce any chance of error, and we will be able to service your request much more quickly.

Planning to move?

Let us know 8 weeks in advance so that you won't miss a single issue of POPULAR ELECTRONICS.

Attach old label where indicated and print new address in space provided. Also include your mailing label whenever you write concerning your subscription. It helps us serve you promptly. Write to: P.O. Box 2774, Boulder, CO 80302, giving the following information:

- Change address only.
 Extend subscription. Enter new subscription.
 1 year \$6.98
 Payment enclosed (1 extra BONUS issue)
 Bill me later

← AFFIX LABEL →

if you have no label handy, print OLD address here.

name	please print	0886	zip code
address			
city			zip code
state			
name	please print		zip code
address			
city			zip code
state			

Add'l postage: \$2 per year outside U.S., its poss. & Can.

GOVERNMENT SURPLUS

GOVERNMENT Surplus. How and Where to Buy in Your Area. Send \$2.00. Surplus Information, Headquarters Bldg., Box 30177-PE, Washington, D.C. 20014.

ELECTRONIC Equipment and Parts. Big 36 page Free Catalog. Send for your copy today! Fair Radio Sales, Box 1105-P, Lima, Ohio 45802.

MANUALS for Govt Surplus radios, test sets, scopes. List 50 cents (coin). Books, 7218 Roanne Drive, Washington, D.C. 20021.

SEND \$5.00 for postpaid new U. S. Army headset with boom microphone. AEROPARTS, Box 1492. International Airport, Del Rio, Texas 78840.

PERSONALS

MAKE FRIENDS WORLDWIDE through international correspondence. Illustrated brochure free. Hermes, Berlin 11, Germany.

INVENTIONS WANTED

CASH-ROYALTIES for patented, unpatented inventions. Global Marketing Service, 2354-P Telegraph, Oakland, California 94612.

INVENTORS: Protect your ideas! Free "Recommended Procedure" Washington Inventors Service, 422T Washington Building, Washington, D.C. 20005.

PATENT Searches including Maximum speed, full airmail report and closest patent copies. Quality searches expertly administered with complete secrecy guaranteed. Free Invention Protection form and "Patent Information." Write Dept. 909, Washington Patent Office Search Bureau, Benjamin Franklin Substation, P.O. Box 7167, Washington, D.C. 20044.

FREE PAMPHLET: "Tips on Safeguarding Your Invention." Write: United States Inventors Service Company, 708-T Carry Building, Washington, D.C. 20005.

FILE your own patent application. Complete information and materials. Write: Inventor's Guide, 468-R, Goodspeed Road, Virginia Beach, Virginia 23451.

FREE "DIRECTORY OF 500 CORPORATIONS Seeking New Products." For information regarding Development, Sale, Licensing of your patented/unpatented invention, write for FREE "INVENTOR'S KIT NO. A-73. RAYMOND LEE ORGANIZATION, 230 Park Avenue, New York, N.Y. 10017.

INVENTORS! FREE BROCHURE LISTING 1,000 CORPORATIONS which may be interested in your invention. Many well-known manufacturers have engaged us to locate new products. For Free brochure and information regarding the promotion of your invention, contact: Gilbert Adams Organization, Dept. 20J, 80 Wall Street, New York, New York 10005.

INVENTORS! Don't sell or license your invention until you receive our offer. Eagle Development Company, Dept. P-9, 82 Wall Street, New York City 10005.

YOUR INVENTION—IDEA PRODUCT—WANTED NOW. Your invention properly developed, searched and prepared for outright sale or cash/royalty. U.S. and overseas manufacturers are in touch with us looking for new products to market. Your invention may be patented or unpatented. Our staff includes Graduate Engineer and Patent Engineers who are ready to develop and market your invention. The Gilbert Adams Organization, Dept. 20J-1, 80 Wall Street, New York, N.Y. 10005.

INSTRUCTION

LEARN ELECTRONIC ORGAN SERVICING at home all makes including transistor. Experimental kit—trouble-shooting. Accredited NHSC. Free Booklet NILES BRYANT SCHOOL, 3631 Stockton, Dept. A, Sacramento, Calif. 95820.

LEARN WHILE ASLEEP. Hypnotize! Strange catalog free. Auto-suggestion, Box 24-ZD, Olympia, Washington 98501. DEGREE IN ELECTRONICS through correspondence. Free catalog. Grantham, 2000 Stoner Avenue, Los Angeles, California 90025.

INTENSIVE 5 week course for Broadcast Engineers. F.C.C. First Class license. Radio Engineering Incorporated, 52 S. Palm Ave., Sarasota, Florida 33577.

SHORTCUTS To Success! Highly Effective. Profitable Short Courses (75 Choices). Study At Home. Diploma Awarded. Our 29th Year. Free Literature. CIEE-D, Box 20345, Jackson, Miss. 39209.

SCORE high on F.C.C. Exams Over 300 questions and answers. Covers 3rd, 2nd, 1st and even Radar. Third and Second Test, \$14.50; First Class Test, \$15.00. All tests, \$26.50. R.E.I., Inc., Box 806, Sarasota, Fla. 33577.

DEGREE Program in Electronics Engineering. Our 29th Year! Free literature. Cook's Institute, Dept. 13, Box 20345, Jackson, Miss. 39209.

DIGITAL:THEORY,DESIGN, CONSTRUCTION

LOGIC NEWSLETTER ©

SAMPLE COPY \$ 1.00
LOGIC NEWSLETTER
POB 252
WALDWICK,N.J. 07463

SELF-STUDY CB RADIO REPAIR COURSE. THERE'S MONEY TO BE MADE REPAIRING CB RADIOS. This easy-to-learn course can prepare you for a career in electronics enabling you to earn as much as \$16.00 an hour in your spare time. For more information write: CB Radio Repair Course, Dept. PE-9, 15S. Overmyer Dr., Oklahoma City, Okla. 73127.

LEARN design techniques. Electronics Monthly Newsletter. Digital, linear construction projects, design theory and procedures. Sample copy \$1.00. Valley West, Box 2119-B, Sunnyvale, California 94087.

FCC LICENSE through tape recorded lessons. Also Radar Endorsement, Radio License Training, 1060D Duncan, Manhattan Beach, Calif. 90266.

LEARN ELECTRONICS. College level course. FCC license, Broadcast Engineering. Satellite Communications. Home Study. Free brochure. Genn Tech, 5540 Hollywood Bv., Los Angeles, Calif. 90028.

DRAFTING—Blueprint Reading (Mechanical, Electronic, Architectural). Home Courses \$25.00. Send \$2.00 first lesson. Prior Inc., 23-09 169th Street, Whitestone, New York 11357.

F.C.C. EXAM MANUAL

Tests Answers for FCC First and Second Class Commercial Licenses

PASS FCC EXAMS! Memorize, study — "Test Answers" for FCC 1st and 2nd class Radio Telephone licenses. Newly revised multiple-choice questions and diagrams cover all areas tested in FCC exams plus "Self-Study Ability Test." \$9.95 postpaid. Moneyback Guarantee.

COMMAND PRODUCTIONS P.O. BOX 26348-P
SAN FRANCISCO, CALIF. 94126

MAGAZINES

MAGAZINE SUBSCRIPTIONS at lowest prices available anywhere. Magazine House, Box 390E, Millwood, N.Y. 10546.

EMPLOYMENT OPPORTUNITIES

ELECTRONICS/AVIONICS EMPLOYMENT OPPORTUNITIES. Report on jobs now open Details FREE. Aviation Employment Information Service, Box 4240E, Northport, New York 11768.

EMPLOYMENT INFORMATION

EXCITING Overseas jobs. Directory \$1.00. Research Associates, Box 1167-E, Kailua, Hawaii 96734.

TREASURE FINDERS

FAMILY FUN! OUTDOOR ADVENTURE! Find valuable coins and treasure with world famous metal detectors. Free illustrated booklet. Detectron, Dept. PE, Box 243, San Gabriel, Calif. 91778.

TREASURE FINDER locates buried gold, silver, coins, treasures. 5 powerful models \$19.95 up Instant financing available. Free catalog. Dealer inquiries invited. Relco, Dept. A-33, Box 10839, Houston, Texas 77018

REAL ESTATE

NEW FREE FALL CATALOG! Over 2,500 top values in FARMS, RANCHES, RECREATIONAL LANDS, BUSINESSES, TOWN and COUNTRY HOMES in 39 states coast to coast! UNITED FARM AGENCY, 612-EP West 47th St., Kansas City, MO 64112.

RECORDS

OLDIES. 45rpm. Free Catalog. Corny's Record Shop, Box 335TM, Mason, Ohio 45040.



MALLORY SOLID STATE ALARM

'SONARLERT' Only

3 for \$12 **\$4.50**

Never before offered at these low prices. This unique intrusion alarm device may be used for

1000's of circuits where the voltage is 6 to 28 VDC. Responds to 3 mils with a sound output of 70 db. Mounts in 1.9" x 1.1" holes in panels up to 1/4" thick. Type SC62R with color-coded leads. 2.5KHz minus 10% to 85°C. Size: 1 3/4" x 1 1/2"



WITH GLASS ESCUTCHEON

The most unusual Hi-Fi stereo buy of 1974. A unit that has so many unique and different functions, makes it only price-features: built-in FM antenna, record player on separate panel. Another external panel consists of provisions for "right" and "left" speaker jacks, for external FM ground, jacks for connecting a tape recorder to radio tuner or phono of connecting a tape recorder for connecting tape deck that will play back thru tor on front panel for STEREO indicator. Another jack for plugging in a pair of stereo headphones.

Only **\$39.95**

20-WATT STEREO AM-FM-MULTIPLEX

60-WATT AM-FM-MULTIPLEX amplifier heavy-duty stereo 60 watt unit. **\$59.95**

Has the following controls on front panel. PHONO-STEREO-AM-FM MONO, FM STEREO, TAPE, master control switch, LOUDNESS, BALANCE, TREBLE, BASS controls, with power ON-OFF rocker switch. Designed for all audio-phones to use as easy chair in DEN or room, or for those who wish to design their own complete modular system. With 6 ft. 115 VAC cord supplied. Only 13 x 7 x 3 1/2" plus diagram. Shpg. wt. 3 lbs. With knobs.

2 for **\$19.95**

20 Years of Business INTEGRITY
20 Years of Money-Back GUARANTEES
20 Years of Economy! LOWEST PRICES!
48-HR. SERVICE

INDUSTRIAL SPEED CONTROL

\$4.95

NEW! TO-3 NATIONAL LM-340 VR's

* TO-3 Case * 1 Amp * POSITIVE VOLTAGE
Your Choice **\$2.95**

Type	Volts
LM-340-05	5 v
LM-340-06	6 v
LM-340-08	8 v
LM-340-12	12 v
LM-340-15	15 v
LM-340-18	18 v
LM-340-24	24 v

A \$30 item from G.E. Model 538A (made for Xerox) that controls home, shop and industrial lighting too! A very elaborate circuit for controlling many electrical and electronic devices. Easily controls speeds of electric drills, brush type motors, etc. 115vac, rated at 1100 watts. With variable speed or dimming control in heavy-duty aluminum case. 3 x 2 3/4 x 2. With diagram and hookups.

7-SEGMENT LED Readouts

(All "LED" TYPES)

Type	Char.	Each	Special
MAN-1	.27	\$3.75	3 for \$3.
MAN-3	.12	1.49	3 for \$3.
MAN-4	.19	2.50	3 for \$6.

REFLECTIVE BAR TYPES

SLA-1**	.33	2.10	3 for \$5.
SLA-3**	.70	4.95	3 for \$13.
SLA-11**	.33†	3.50	3 for \$10.
SLA-21**	.33††	3.95	3 for \$10.

* By Opco, equal to
MAN-1 or MAN-4 specs. Color - R (Red)
† Green, †† yellow

LED MITY DIGIT "DCM'S"

Scientific Devices "Digital Counting Modules" outperform any other DCM on the market today. More features than ever before! Not gaseous, not incandescent, not noisy but the modern LED. Choose from such famous manufacturers as Monsanto's MAN-1, MAN-4, Litronics 707 and 704, Opco's SLA-1 (the last 4 having character heights of 0.33 at no extra charge). Each kit includes 3x2" p.c board with fingers for a FREE edge connector, side-mounting dip socket, LED readout of your choice, resistors, IC's, and Molex connectors (this ELIMINATES SOLDERING YOUR IC's) and a booklet. INCLUDES P.C. EDGE CONNECTOR — FREE!

Buy 3 — Take 10%
Only **\$8.88**

REARLEAD Char. Maker
MAN-1 .27 h. Monsanto
MAN-4 .19 h. Monsanto
707* .33 h. Litronics
704** .33 h. Litronics
SLA-1* .33 h. Opco * Pin-for-pin MAN-1, ** Pin-for-pin MAN-4, elec. char.

SANKEN HYBRID AUDIO POWER AMPS

Migr's Type Watts Sale
SI-1010 10 8.88
SI-1025 25 18.88
SI-1050 50 29.95

Used extensively in hi-fi systems, tape decks, FM tuners, record players, stereo components, musical instruments, P.A., etc. All amplifiers fit within 1/2 db from 20 to 100,000. Each unit properly heat-sinked, with heavy-duty connecting tie lug connections, Single-ended pushpull output. Power supply required 24VDC. Output to 8 ohms. Order by Stock No.

BRAND NEW LOWEST PRICES GENERAL ELECTRIC 3-WATT AUDIO AMP

Delivers 3.5 watts continuous, 10 watts peak. With heat sinks; micro-mini size: 3/4 x 2 1/2". 9 to 30V supply. High sensitivity. 8 to 16 ohms. **\$2.50**

POCKET CALCULATOR KEYBOARD

Only **\$6.95**

3 for \$18

For hand-held units, in early multichip design. CT-5001, 2, 12 or Mostek 5010-12, 18 feather-touch keys, by FLEX-KEY.

WITH DATA SHEETS CLOCK CHIPS as Low as ON A "DIP" \$7.77

MMS311	6-digit 28-Pin	\$7.77
MMS312	4-digit 24-Pin	7.77
MMS313	6-digit 28-Pin	7.77
MMS314	6-digit 24-Pin	7.77
MMS316	4-digit 40-Pin, Alarm	9.95

MAKE YOUR OWN CALCULATORS WITH OUR LOW PRICED 6 & 8 DIGIT POCKET CALCULATOR BASIC KITS

\$16.95

Your Choice

BASIC KIT #1 — includes case, all-function Flex Key Keyboard, Cal Tech CT5002 calculator chip, 9-digit Antex LED display with built-on individual magnifiers, plus sheets

BASIC KIT #2 — same as Basic #1 except calculator chip is National 8-digit MM5725.

BASIC KIT #3 — same as Basic #1 except calculator chip is National 6-digit MM5736 and 75492.

WRIST WATCH Only \$19.95 LIQUID CRYSTAL DISPLAY

*3-1/2 digit, 7 segment
*Only 1-1/16 x 1 1/16 x 1 1/4"

See POPULAR ELECTRONICS (Jan., 1974) for building your own electronic digital wristwatch using the Liquid Crystal Display (LCD) as its basic. Easy to see, 3 1/2 digit display, requires less than 1/1000 of power as LED'S. Visibility increases with ambient light. Difficult reading of LED'S in light. Pulsates 3200 Hz in center of display. NO NEED OF TRANSISTOR-RESISTOR interface, as LED'S, thus smaller package. Chip contains holder, tiny connecting terminals, and "slide-in-place chrome spring face plate". Size of display in holder: 1-1/16 x 1 1/16 x 3/4". Operating from 32 hertz, 45-microwatts of power. Operates from 1.5V hearing aid cell. Uses the new and latest CMOS micro-circuitry. We include copy of write up from PE magazine.

FIRST TIME ANYWHERE!
SCRS! TRIACS! QUADRACS!
SAME PRICE SALE!
10-Amp Power Tab Plastic Units

PRV	Sale
50	\$.75
100	.95
200	1.25
300	1.50
400	1.98
500	2.25
600	2.50

Exclusive Poly Pak Sale

BRAND NEW LOWEST PRICES LINEAR Op Amps

531 Hi slow rate op-amp (TO-5)	\$2.50
532 Micro power 741 (TO-5)	2.50
533 Micro power 709 (TO-5)	2.50
536 FET Input op amp (TO-5)	2.95
550 Precision 723 voltage reg. (DIP)	1.17
555 Timer 2 to 5 seconds to 1-hr. (A)	1.25
556 5 Times faster than 741C	2.19
558 Dual 741 (DIP)	1.00
560 Phase lock loops (DIP)	2.95
561 Phase lock loops (DIP)	2.95
562 Phase lock loops (DIP)	2.95
563 Phase lock loops (A)	2.95
567 Tone decoder (A)	2.95
702C Hi-gain, DC amp (TO-5)	.49
704 TV sound IF system	1.50
711C Dual diff. comp (A)	.33
723C Voltage regulator (A)	2.19
741CV Freq. comp 709 (Mini DIP)	.44
748C Freq. adj. 741C (A)	.44
753 Gain Block	1.75
739739 Dual stereo preamp	1.99
741-741 Dual 741C (TO-5)	1.89
PA265 5-Watt voltage regulator	1.00
ULN2300M Op amp with SCR	1.00
CA3065 Video Audio system	1.00
RC475 Dual 15V Tracking V.R.	2.50
4136 Quad 741 (DIP)	2.50
RC-2556 Dual 555's	2.25
TVR-2000 Super 723, TO-5	\$1.

(A) TO-5 or DIP BUY ANY 3 — TAKE 10%

NATIONAL LINEAR OP AMPS

Buy any 3 — Take 10% (A) TO-5, Dip or Mini Dip

LM-300 POS V.R. (super 723) TO-5	\$.91
LM-301 Hi-performance op amp (A)	.41
LM-302 Voltage follower TO-5	.91
LM-305 Pos. Voltage Reg. TO-5	1.19
LM-307 Super 741 op amp (A)	.41
LM-308 Hi-Q fet type op amp TO-5	1.19
LM-309H 5V Volt-Regulator TO-5	1.19
LM-309K 5V Volt-Reg. 1 Amp TO-3	1.85
LM-310 Voltage-Follower TO-5	1.19
LM-311 Hi-perf. Volt. Comp. (A)	1.19
LM-319 Hi-speed Dual Comp. DIP	1.50
LM-320 MINUS 5, 12 or 24V V.R. TO-3	1.50
LM-329 Quad Comparator, DIP	2.50
LM-324 Quad (4-741's in DIP)	2.50
LM-350 Dual peripheral driver	.41
LM-370 AGC Squelch op amp, TO-5	1.19
LM-371 R-F, I-F, op amp	1.25
LM-373 AM-FM 558 I.A.O, TO-5	3.50
LM-374 AM-FM 55 I.VAD TO-5	3.50
LM-377 Dual 2-watt audio amp	3.00
LM-380 2-watt audio amplifier TO-5	1.69
LM-381 Low noise dual pre amp DIP	1.95
LM-382 Low noise dual pre amp DIP	1.95
LM-383 R-F, I-F, op amp	.55
LM-709 Operational amplifier (A)	3.36
LM-710 Differential amplifier (A)	.45
LM-711 Dual Differential Amp (A)	.36
LM-723 Voltage Regulator (A)	.69
LM-725 Instrument Op Amp	.95
LM-733 Differential Video	1.05
LM-741 Freq. Comp. 709 (A)	1.49
LM-741CV Mini DIP 741C	.89
LM-747 Dual 741 (A)	.45
LM-748 Freq. adjustable 741C (A)	4.44
LM-1303 Stereo pre amp DIP	.95
LM-1304 FM Stereo Multiplexer	1.25
LM-1307 FM Multi. Stereo Dem. DIP	.91
LM-3028 Differential R/F amp	1.50
LM-3900 Quad "current mirror" amp	2.50
LM-4250C Programmable op amp	2.50
LM-75451 Dual peripheral driver	.44
LM-75453 Dual peripheral driver	.44
LM-75491 Quad seg. driver, LED (DIP)	1.65
LM-75492 Hex digit driver, 250ma, DIP	1.85

"CALCULATOR CHIPS"

Brand New OVER 1,000,000-PC INVENTORY

Buy 3 or more 10% discount

CT5001	12-Digits, 40 Pin	\$6.50	3 for \$18.
CT5002	9-Volt version of 5001	8.50	3 for \$24.
CT5005	12-Digits, 28-Pin with 3-function memory.	9.95	3 for \$27.
MM5725	8-Digits, 4-Pin, LED	6.95	3 for \$18.
MM5736	6-Digits, 28-Pin, 9V	4.95	3 for \$12.

Inflation-Fighting ECONOMY IC PRICES

* Factory Marked Order by type number! See sheets on request "ONLY" Buy 100 — Take 20%

SN7400	\$.24	SN7432	\$.35	SN7471	\$.55	SN74108	\$.95	SN74160	1.85
SN7401	\$.24	SN7437	\$.49	SN7472	\$.41	SN74112	\$.95	SN74161	1.59
SN7402	\$.24	SN7440	\$.52	SN7473	\$.49	SN74113	\$.95	SN74162	1.75
SN7403	\$.24	SN7441	1.12	SN7474	\$.49	SN74114	\$.95	SN74163	1.75
SN7404	\$.26	SN7442	1.19	SN7475	\$.85	SN74115	\$.61	SN74164	1.10
SN7405	\$.26	SN7443	1.12	SN7476	\$.53	SN74121	\$.69	SN74165	1.85
SN7406	\$.45	SN7444	1.25	SN7478	\$.85	SN74123	1.05	SN74166	1.85
SN7407	\$.49	SN7445	1.19	SN7481	\$.65	SN74125	1.45	SN74173	1.85
SN7408	\$.27	SN7446	1.29	SN7482	\$.99	SN74126	1.45	SN74176	1.85
SN7410	\$.24	SN7447	1.29	SN7483	1.15	SN74140	2.50	SN74177	2.60
SN7411	\$.31	SN7448	1.35	SN7484	1.15	SN74141	1.95	SN74178	1.85
SN7416	\$.89	SN7450	\$.27	SN7486	\$.49	SN74145	1.15	SN74180	1.10
SN7420	\$.24	SN7451	\$.31	SN7489	3.10	SN74148	4.50	SN74181	4.10
SN7421	\$.55	SN7452	\$.31	SN7491	\$.85	SN74150	1.19	SN74182	1.05
SN7422	\$.31	SN7453	\$.31	SN7492	1.35	SN74151	1.00	SN74185	2.50
SN7425	\$.50	SN7454	\$.31	SN7493	1.35	SN74152	1.39	SN74189	1.55
SN7426	\$.50	SN7462	\$.35	SN7493	1.05	SN74154	1.69	SN74193	1.50
SN7430	\$.24	SN7464	\$.43	SN7494	1.05	SN74155	1.29	SN74194	1.55
		SN7465	\$.43	SN7496	1.00	SN74156	1.45	SN74195	1.10
				SN7497	1.65	SN74157	1.45	SN74196	1.25
				SN74107	\$.51	SN74158	1.45	SN74197	1.10
								SN74198	2.35
								SN74200	9.95

*DIP Packages

IC'S FOR EXPERIMENTERS

Money Back Guarantee! Factory Marked **\$1.00**

SN7400	20 for \$1.	SN7490	5 for \$1.
SN7404	20 for \$1.	SN74107	10 for \$1.
SN7413	5 for \$1.	SN74121	10 for \$1.
SN7441	5 for \$1.	SN74123	10 for \$1.
SN7444	5 for \$1.	SN74150	3 for \$1.
SN7445	5 for \$1.	SN74154	5 for \$1.
SN7446	5 for \$1.	SN74181	5 for \$1.
SN7447	5 for \$1.	SN74189	5 for \$1.
SN7448	5 for \$1.	SN74192	5 for \$1.
SN7472	10 for \$1.	SN74193	3 for \$1.
SN7473	10 for \$1.	SN74199	3 for \$1.
SN7474	10 for \$1.		
SN7475	5 for \$1.		

Includes factory-good, rejects & defects, who knows at these prices!

INTEGRATED CIRCUIT SOCKETS

Buy Any 10 — 14-Pin, DIP Mount \$4.50
Buy 100 — 14-Pin, DIP \$1.00
Discount: TO-5, 8 or 10-Pins .29

14-Pin, Wire Wrap	60c
16-Pin, Wire Wrap	89c

Terms: add postage. Rated: net 30
Phone Orders: Wakefield, Mass. (617) 245-3829
Retail: 10-18 Del Carmine St., Wakefield, Mass.
10th Water Street, D. S. MAY, INC. PHOENIX

20c CATALOG on Fiber Optics, IC's, Semi's, Parts
MINIMUM ORDER — \$4.00

POLY PAKS

P.O. Box 942E, LYNNFIELD, MASS. 01940

MUSICAL INSTRUMENTS

30% DISCOUNT name brand musical instruments. Free Catalog. Freeport Music. 455N. Route 110. Melville, N.Y. 11746.

WHOLESALE! Professional Guitars, PA Systems, Altec Speakers, 240W RMS Amplifiers. Free Catalog. Carvin, Escondido, Calif. 92028.

30% + DISCOUNT Name Brand Musical Instruments. Free Catalog. Continental Music, Dept. H, P.O. Box 3001, Garden City, New York 11530.

BUSINESS OPPORTUNITIES

I MADE \$40,000.00 Year by Mailorder! Helped others make money! Start with \$15.00—Free Proof. Torrey, Box 318-N, Ypsilanti, Michigan 48197.

EARN MONEY, read this book. "500 Moneymaking Mail Order Ideas." \$9.95 post paid. Satisfaction or money back. Conestoga Supply House, 1014F Willow St. Pike, Lancaster, PA 17602.

PIANO TUNING LEARNED QUICKLY AT HOME! Tremendous field! Musical knowledge unnecessary. GI approved. Information free. Empire School, Box 450327, Miami 33145.

FREE Secret Book "2042 Unique Proven Enterprises." Fabulous "Little Knowns." Work home! Haylings-BH, Carlsbad, California 92008.

\$200.00 DAILY in Your Mailbox! Your opportunity to do what mail-order experts do. Free details. Associates. Box 136-J, Holland, Michigan 49423.

\$49.95 Telephone Answering Machine! Your cost \$33.50! Details: Palomar, Box 17384EB, Jacksonville, Florida 32216.

FREE CATALOGS. Repair air conditioning, refrigeration. Tools, supplies, full instructions. Doolin, 2016 Canton, Dallas, Texas 75201.

MAILORDER MILLIONAIRE helps beginners make \$500 weekly. Free report reveals secret plan! Executive (1K9), 333 North Michigan, Chicago 60601.

FIRST TIME OFFERED, fantastic new double power speaker sells like hot cakes. Be the first distributor in your area. Rush \$5 for complete sales package to C.T.A.S., 320 Grant Ave., Pgh., PA 15209.

MAKE \$1.00 PER SALE selling engraved metal Social Security plates. FREE SALES KIT. Engravaplates, Box 10460-200 Jacksonville, Fla. 32207.

\$178.00 WEEKLY. Work one hour daily. Free brochure. FAS, Box 13703-A, San Antonio TX, 78213.

wanted

CITIZENS BAND
DEALER-DISTRIBUTORS

Send this Ad to:
PAL ELECTRONICS CO.
P. O. Box 778 • Westminster, Ca. 92683

EARN \$15,000 annually plus. Full year trial plan Import-Mailorder business. Postcard brings details: Northeast Imports, Box 121PE9, Fremont, N.H. 03044.

MAKE \$500 month mailorder! Free Report. Fiddes, Box 1242, Glen Burnie, Maryland 21061.

Make BIG Profits In
YOUR OWN ONE-MAN
ELECTRONIC FACTORY!

Start home, spare time. A postcard with your name & address, will bring you Free Illustrated Literature about this unusual opportunity! Write TODAY!

BARTA-DI, Box 248,
Walnut Creek, Calif. 94597

START SMALL, highly profitable electronic production in your basement. Investment, knowledge unnecessary. Free illustrated literature. Barta-CI, Box 248, Walnut Creek, California 94597.

RUBBER STAMPS

RUBBER address stamps Free catalog. 45 type styles. Jackson s. Box 443G, Franklin Park, Ill. 60131.

BOOKS

FREE catalog aviation/electronic/space books Aero Publishers, 329PE Aviation Road, Fallbrook, California 92028.

FREE book prophet Elijah coming before Christ. Wonderful bible. Evange Mission, Dept. 64, 481 Thurston Rd., Rochester, N.Y. 14619.

BOOKS—thousands titles, bargains. Catalog Free. Cassiano, 92-27 New York Blvd., Jamaica, New York 11433.

UNUSUAL BOOKS! Catalogue Free! International Imports, Box 7789PE, Atlanta, Georgia 30309

LEARN RADIO ANNOUNCING! Books, Magazines, Deejay, Box 1355-C, Sioux Falls, South Dakota 57101.

POPULAR ELECTRONICS INDEXES. Detailed and complete subject indexes now available to both 1972 and 1973 magazines. Hundreds of subject references to help you quickly find that special project, article, or product test. 1972 and 1973 editions \$1.00 each. INDEX, box 2228, Falls Church, Va. 22042.

PLASTICS

CASTOLITE pours like water, hardens like glass without heat. Crystal clear, colors. Embed flowers, seashells, mementos, anything. Make fine gifts. Form flexible molds over any pattern, size. Reproduce your own designs in plastics candlewax, metal, plaster, cement. Send 50 cents for illustrated literature. Profitable CASTOLITE, Dept. 74K/PE, Woodstock, Ill. 60098.

HYPNOTISM

SLEEP learning Hypnotic method 92% effective Details free. ASR Foundation, Box 7566EG, Fort Lauderdale, Florida 33304.

FREE Hypnotism, Self-Hypnosis, Sleep Learning Catalog! Drawer H400, Ruidoso, New Mexico 88345.

AMAZING self-hypnosis record releases fantastic mental power. Instant results! Free trial. Write: Forum (AA9), 333 North Michigan, Chicago 60601.

SLA-37 segment LED readouts .77" numbers. 45 Ma/seg., red or yellow **\$7.50**

MINIATURE TRIM POTS
5K, 10K, 20K, 25K, 50K, 100K, **\$75 3/\$2.00**

MULTI-TURN TRIM POTS
Similar to Bourns 3010 style
3/16" x 5/8" x 1 1/4"
50, 100, 500, 2000, 5000,
10,000 and 20,000 ohms.
\$1.50 ea. 3/\$4.00

PRINTED CIRCUIT BOARD
4 1/2" x 6 1/2" single sided fiber
glass board, 1/16" thick, un-
etched
\$4.00 ea. 5/\$1.75

NIXIE TUBES
Similar to Raytheon 8650
tubes, with socket & data
sheet **\$2.25 3/\$6.00**

NSN 33—3 DIGIT LED
ARRAY, MAN-3 SIZE (1.2")
INTERNALLY MULTIPLEXED AND
DRIVEN BY 7448 **\$1.95 EA.**

VERIPAX PC BOARD
This board is a 1 1/6" single
sided paper epoxy board,
4 1/2" x 6 1/2" (standard veripax),
DRILLED and ETCHED which
will hold up to 21 single 14 pin
IC's or 8, 16 or LSI DIP IC's with
busses for power supply con-
nections. Is also etched for 22
pin connector **\$5.25**

FLV 100 VISIBLE LED **\$5.50**
ME-4 IR LED **\$5.50**
MCD-2 OPTO-ISOL **\$9.00**
GREEN GAP DSL-16 LED **\$9.00**
RED GAP OSL-3 LED **\$6.00**
14 PIN DIP SOCKETS **\$3.40**

10 WATT ZENERS
3.9, 4.7 OR 5.6 V **\$7.50 EA**
4 WATT ZENERS
3.9, 5.6, 6.8 OR 12 V. **\$3.00 EA**

Silicon Power Rectifiers

PRV	1A	3A	12A	50A
100	.06	.11	.30	.80
200	.07	.16	.35	1.15
400	.09	.20	.50	1.40
600	.11	.25	.70	1.80
800	.15	.35	.90	2.20
000	.20	.45	1.10	2.60

**REGULATED MODULAR
POWER SUPPLIES**
+-15VDC AT 100 ma, 115VAC
INPUT **\$19.95**
5VDC AT 1A, 115VAC
INPUT **\$19.95**

IN 4148 **14/\$1.00**

Terms: FOB Cambridge
Mass. Send check or Money
Order. Include Postage.
Minimum Order \$3.00



SOLID STATE SALES

P.O. BOX 74A
SOMERVILLE, MASS. 02143 TEL. (617) 547-4005

TRANSISTOR SPECIALS

2N256 PNP GE TO-3	\$.50
2N404 PNP GE TO-5	4/\$1.00
2N1137B PNP GE TO-3	\$.95
2N1016A NPN Si TO-82	\$ 1.95
2N2226 NPN Si TO-82	\$2.50
MPS3393 NPN Si TO-92	4/\$1.00
2N3866 NPN Si TO-5	\$.75
2N3929 NPN Si TO-18	5/\$1.00
2N2757 NPN Si TO-66	\$.70
2N2222 NPN Si TO-18	5/\$1.00
2N3055 NPN Si TO-3	\$ 1.00
2N5296 NPN Si TO-220	\$.50
2N6109 PNP Si TO-220	\$.55
2N4898 PNP Si TO-66	\$.60
MJ2252 NPN Si TO-66	\$.90
2N3638 PNP Si TO-5	5/\$1.00
2N2218A NPN Si TO-5	4/\$1.00

CAPACITORS

6V 30 UF TANT 5/\$1	
20V 4.7UF TANT 5/\$1	
12V 10UF ELECT 5/\$1	
50V 100UF ELECT \$4.00	
25V 30UF ELECT 4/\$1.00	

1103 1024 bit RAM **\$6.25**
NEC 6003 2048 bit RAM **\$9.50**
1101 256 bit RAM **\$2.75**
8225 64 bit-write RAM **\$2.75**
8223-PROGRAMMABLE ROM **\$6.25**

Conductive Elastometer low
profile calculator keyboard. A
2 3/4" x 3 1/4" x 1/2" flex key.
19SK-6 keyboard having 0-9, .,
+, -, x, -, =, K+C buttons with
off, on, switch. **\$6.00**

TTL IC SERIES

74L00—50	7474—48
7400—24	7475—80
7401—24	7476—52
7402—24	7480—65
7403—24	7483—110
7404—26	7485—150
7405—26	7486—48
7406—43	7489—300
7407—50	7490—83
7408—27	7491—130
7410—24	7492—85
7411—30	7493—85
7412—45	7495—99
7413—85	7496—95
7416—48	74107—50
7417—48	74121—60
7420—24	74123—100
7422—30	74125—140
7426—30	74126—140
7427—55	74150—115
7430—24	74151—95
7432—30	74153—110
7437—60	74154—165
7438—50	74157—125
7440—24	74163—160
7441—15	74164—205
7442—100	74165—205
7445—115	74173—180
7446—125	74176—180
7448—130	74177—180
7450—24	74181—395
7451—30	74192—50
7472—40	74193—145
7473—48	74195—100
	74451—100

Similar to 8038C IC Voltage con-
trolled oscillator, as featured in
Oct. 73 P.E. they have sine, square
and triangular outputs good to
1MHz. Two of them can be used to
make an FM generator. **\$5.95**

C/MOS (DIODE CLAMPED)

74C 02	\$3.75
74C 10	\$3.65
74C 157	\$2.15
74C 165	\$3.50
CD 4001	\$.65
CD 4002	\$.65
CD 4009	\$1.50
CD 4010	\$.65
CD 4011	\$.65
CD 4012	\$.65
CD 4013	\$1.60
CD 4016	\$1.25
CD 4022	\$2.25
CD 4023	\$.65
CD 4025	\$1.50
CD 4027	\$1.35
CD 4030	\$.65

**MAN-1, RED OR YELLOW
LED READOUT** **\$3.25**

**MAN-3 LED
READOUTS** **\$1.75**

**MAN-4 LED
READOUTS** **\$2.50**

Full Wave Bridges

PRV	2A	6A
200	.95	1.25
400	1.15	1.50
600	1.35	1.75

2513—64x7x5
CHARACTER GEN **\$11.50**

2516—64x6x8 STATIC
CHARACTER GEN **\$11.50**

SANKEN AUDIO POWER AMPS

Si 1010 Y 10 WATTS	\$ 7.95
Si 1025 E 25 WATTS	\$18.88
Si 1050 E 50 WATTS	\$29.95

TIS 73 N FET **\$5.00**
2N4891 UJT **\$5.00**
ER900 TRIGGER DIODES 4/\$1.00

LINEAR CIRCUITS

LM 309K 5V 1A REGULATOR	\$1.80
723—40 +40V REGULATOR	\$7.75
LM 300H REGULATOR POSITIVE	\$9.90
LM 320—5 or -15V REGULATOR	\$1.75
LM 376—V to 37V POS REG	\$1.25
741A or 741C OP AMP	\$4.15
709C OPER AMP	\$4.15
DUAL 709 DUAL OP AMP	\$1.25
101 OPER AMP, HI PERFORM	\$7.75
LM 308 OPER AMP, LOW POWER	\$1.15
301/748—Hi Per. Op. Amp.	\$4.41
536—FET INPUT OPER AMP	\$2.90
537—PRECISION OP AMP	\$2.50
LM 3900—QUAD OP. AMP.	\$7.75
LM 324—QUAD 741	\$2.20
560—PHASE LOCK LOOP	\$2.95
561—PHASE LOCK LOOP	\$2.95
565—PHASE LOCK LOOP	\$2.95
567—TONE DECODER	\$2.95
703—RF-IF AMP	\$6.65
LM 370—AGC SQUELCH AMP	\$1.15
555—2 μs—2 HR. TIMER	\$1.20
3822—TRANSISTOR ARRAY	\$9.95
LM 380—2W AUDIO AMP	\$1.75
LM 377—2W STEREO AUDIO AMP	\$3.25
LM 381—STEREO PREAMP	\$1.75
LM 382—DUAL AUDIO PREAMP	\$1.95
LM 311—HI PER. COMPARETOR	\$1.15
LM 319—DUAL, HI SPEED COMP.	\$1.50
LM 339—QUAD COMPARETOR	\$1.95

TRIACS

PRV	1A	10A	25A	1.5A	6A	35A
100	.40	.70	1.30	.40	.50	1.20
200	.70	1.10	1.75	.60	.70	1.60
400	1.10	1.60	2.60	1.00	.20	2.20
600	1.70	2.30	3.00			3.00

RELIABLE
EAST COAST SEMICONDUCTOR
PRODUCTS

SEPTEMBER 1974

ADVERTISERS INDEX

READER SERVICE NO.	ADVERTISER	PAGE NUMBER
1	Allison Automotive Co.	101
2	Altaj Electronics	107
3	Audio-Technica US, Inc.	79
6	Audio Warehouse	101
7	B & K Products of Dynascan	2
	Bell & Howell Schools	18, 19, 20, 21
	CREI Capitol Radio Engineering Institute	46, 47, 48, 49
15	Circuit Designs, Inc.	82
8	Cleveland Institute of Electronics	28, 29, 30, 31
9	Clifford's Hi-Fi Wholesalers	102
39	Cobra Division of Dynascan	99
10	Continental Specialties Corp.	13
11	Delta Electronics Co.	104
12	Delta Products, Inc.	15
13	Digi-Key	113
14	EICO	82
16	Edmund Scientific Co.	114
17	GC Electronics	89
18	GTE Sylvania	74, 75, 76, 77
5	Heath Company	64, 65, 66, 67
19	Illinois Audio	71
20	James Electronics	108
43	Johnson Co., E.F.	89
21	Lafayette Radio Electronics	17
22	Linear Systems, Inc.	14
23	McIntosh Laboratory, Inc.	103
24	MITS, Inc.	83
25	Metal Circuit Systems Corporation	THIRD COVER
26	Midwest Hi-Fi Wholesale & Mail Order Division	83
	NRI Schools	8, 9, 10, 11
	National Technical Schools	84, 85, 86, 87
40	Pickering & Co.	32
27	Poly Paks	111
28	Radio Shack	5
29	S A E, Inc.	79
30	Sams & Co., Inc., Howard W.	23
41	Shure Brothers, Inc.	50
31	Solid State Sales	112
44	Solid State Systems, Inc.	109
32	Southwest Technical Products Corporation	91
33	Tracy Design	104
42	Tram Electronics	16
34	Tri-Star Corporation	88
	U.S. Coast Guard	94, 95, 96, 97
	U.S. Pioneer Electronics Corp.	SECOND COVER, 1
35	Unique Ideas, Inc.	25
4	United Audio Products, Inc.	FOURTH COVER
36	Utah Electronics	7
	Vintage Radio	102
37	Wall Lenk Mfg. Co.	88
38	Wavetek	6
	CLASSIFIED ADVERTISING	104, 107, 108, 110, 112, 113

SPORTS ACTION FILMS

HOME ENTERTAINMENT SPECIALS—Order 1974 Super Bowl VIII on 200' reel, Super 8 or Standard 8, Color, \$15.95; B&W \$7.95 each PPD. 1972 World Series (Oakland "A's" vs Cincinnati "Reds") 200' Super 8, Silent Color, \$15.95 per. Super 8 Color Sound, 400', only \$32.95. 1973 All Star Baseball, 200' Super 8, Color, Silent, \$15.95 or 400' Color, Super 8, Sound, \$39.95. To put the frosting on the cake, order NBA 1974 Playoffs, Color, Sound, Super 8, 400' reel, \$39.95. \$15.95 for 200' silent, color, Super 8 This fall, program sports action films of your choice for Instant Replay and Enjoyment. Add a quarter each (coins or stamps, please) for Columbia, Castle and Sportlite Catalogs. SPORTLITE, Elect-9 Dept., PO Box 24-500, Speedway, Indiana 46224.

MAGNETS

MAGNETS. All types. Specials-20 disc, or 10 bar, or 2 stick, or 8 assorted magnets, \$1.00 Magnets, Box 192-H, Randallstown, Maryland 21133.

MISCELLANEOUS

WINEMAKERS: Free illustrated catalog yeasts, equipment. Semplex, Box 12276P, Minneapolis, Minn. 55412.

SAVE GAS. Professionally maintain your car. Use ignition analyzer adapter with your oscilloscope. Complete instructions and diagnostic manual \$5.00. Assembled unit \$19.95. JJ Industries, Box 62, Stamford, Conn. 06904.

SAVE! INSTALL CARPET professionally. Booklet \$3.95. Satisfaction Guaranteed. Surprise Bonus. Carpet Club of America, 511, Kenilworth, Utah 84529.

FREE!
SPECIAL
INTEREST
RECORD
CATALOG

Spectacular sound! Stereo testing! Background music and sound effects! Special Interest Records available exclusively from Ziff-Davis. Send for your free Record Catalog — Ziff-Davis Publishing Co., Dept. 23, One Park Ave., New York, N.Y. 10016

RETAIL DISPLAY PLAN

All magazine retailers in the United States and Canada interested in earning an allowance for the display and sale of a minimum of five publications of the Ziff-Davis Publishing Company, to be paid quarterly on the basis of ten per cent of the cover price of each sold copy, assuming that all terms and conditions of the contract are satisfied, are entitled to do so and are invited to write for full details and copies of the contract to Single Copy Sales Director, Ziff-Davis Publishing Company, One Park Avenue, New York, New York 10016.

Quality Electronic Components

MINIATURE ALUMINUM ELECTROLYTIC CAPACITORS — AXIAL LEAD TYPE —

Temp range: 40°C plus 85°C Tolerance -10 plus 50% (greater than 4.7 UFD) -10 plus 75% (4.7 UFD or less)

Value	1	10-90*	100-240*	Value	1	10-90*	100-240*
1 UFD/50V	14c	12c	11c	100 UFD/16V	19c	15c	14c
2.2 UFD/50V	14c	12c	11c	100 UFD/25V	24c	18c	17c
3.3 UFD/35V	14c	12c	11c	220 UFD/16V	24c	18c	17c
4.7 UFD/35V	14c	12c	11c	220 UFD/25V	35c	25c	24c
10 UFD/16V	14c	12c	11c	330 UFD/16V	35c	25c	24c
10 UFD/25V	14c	12c	11c	330 UFD/25V	44c	35c	32c
22 UFD/16V	14c	12c	11c	470 UFD/16V	37c	30c	27c
22 UFD/25V	15c	13c	12c	470 UFD/25V	49c	39c	35c
33 UFD/16V	15c	12c	11c	1000 UFD/16V	49c	39c	35c
33 UFD/25V	17c	13c	12c	1000 UFD/25V	75c	60c	55c
47 UFD/16V	17c	14c	13c	2200 UFD/16V	75c	60c	55c
47 UFD/25V	19c	15c	14c				

* 10 pcs. per capacitance value

Litronix 1100 Calculator



PRICE \$29.95

IC SOCKETS

8 Pin DIP Solder	35c	10/\$ 3.00
14 Pin DIP Solder	45c	10/\$ 4.30
16 Pin DIP Solder	50c	10/\$ 4.75
24 Pin DIP Solder	\$1.25	10/\$11.00
8 Pin DIP WW	35c	10/\$ 3.00
14 Pin DIP WW	50c	10/\$ 4.75
16 Pin DIP WW	60c	10/\$ 5.50
24 Pin DIP WW	\$1.25	10/\$11.00

Also available are Linear U.S. Transistors, Diodes, LEDs, Relays, Switches, Displays and more.

1/2 & 1/4 WATT CARBON COMP. RESISTORS

5 each of the 85 standard 10% values (2.2-22M) 1/2 W Resistors (425 pcs.) Sorted by value \$12/set 2-4 are \$11/set 5-9 are \$10/set.

5 each of the 70 standard 10% values (10-5.6M) 1/4 W Resistors (350 pcs.) Sorted by value \$12/set 2-4 are \$11/set 5-9 are \$10/set.

Resistors also available individually, in other assortments or in boxes of 1000 pcs. per value. 1/2 W are hot molded MIL-R-111 specification types.



DIGITAL TTL

1-99*	100-999*	1-99*	100-999*	1-99*	100-999*			
7400N	.32c	28c	7446N	\$1.30	\$1.10	7496N	\$1.20	\$1.07
7401N	.32c	28c	7447N	\$1.30	\$1.10	74107N	.55c	50c
7402N	.32c	28c	7448N	\$1.35	\$1.15	74121N	.70c	60c
7403N	.32c	28c	7450N	.32c	28c	74122N	.72c	62c
7404N	.35c	31c	7451N	.32c	28c	74123N	\$1.11	99c
7405N	.35c	31c	7453N	.32c	28c	74141N	\$1.61	\$1.43
7406N	.52c	46c	7454N	.32c	28c	74150N	\$1.56	\$1.39
7407N	.52c	46c	7459N	.32c	28c	74151N	\$1.20	\$1.07
7408N	.36c	32c	7460N	.32c	28c	74153N	\$1.58	\$1.40
7409N	.36c	32c	7470N	.36c	32c	74154N	\$2.25	\$2.00
7410N	.32c	28c	7472N	.40c	35c	74155N	\$1.46	\$1.29
7411N	.35c	31c	7473N	.52c	45c	74156N	\$1.17	\$1.04
7413N	.63c	56c	7474N	.52c	45c	74157N	\$1.56	\$1.39
7416N	.50c	44c	7475N	.85c	72c	74158N	\$1.56	\$1.39
7417N	.50c	44c	7476N	.60c	55c	74160N	\$1.95	\$1.74
7418N	.35c	31c	7480N	.74c	65c	74161N	\$1.95	\$1.74
7420N	.32c	28c	7482N	\$1.02	91c	74162N	\$1.95	\$1.74
7423N	.75c	67c	7483N	\$1.58	\$1.40	74163N	\$1.95	\$1.74
7426N	.36c	32c	7486N	.60c	55c	74164N	\$1.95	\$1.74
7430N	.32c	28c	7489N	\$4.50	\$4.00	74165N	\$2.48	\$2.20
7437N	.51c	46c	7490N	.85c	72c	74166N	\$2.03	\$1.80
7438N	.51c	46c	7491N	\$1.37	\$1.22	74180N	\$1.20	\$1.07
7440N	.32c	28c	7492N	.85c	72c	74181N	\$3.38	\$3.00
7441N	\$1.45	\$1.27	7493N	.85c	72c	74182N	\$1.17	\$1.04
7442N	\$1.20	\$1.07	7494N	\$1.20	\$1.07	74192N	\$1.80	\$1.60
7445N	\$1.62	\$1.44	7495N	\$1.20	\$1.07	74193N	\$1.80	\$1.60
						74198N	\$2.78	\$2.47
						74199N	\$2.78	\$2.47

* Any Quantity per Item (TTL only) Mixed

1 AMP SILICON RECTIFIERS

IN4001	50 PIV	\$12/\$1.00	100/\$ 6.00	1000/\$48.00
IN4005	600 PIV	8/\$1.00	100/\$ 9.00	1000/\$70.00
IN4007	1000 PIV	6/\$1.00	100/\$11.00	1000/\$88.00

Send for Free Catalog or Mail Readers Service Card

COD ORDERS ACCEPTED FOR SAME DAY SHIPMENT CALL 218-681-6674

Orders Less than \$10.00 add 50c Service Charge—Others Postpaid "Only Quality Components Sold!"

DIGI-KEY CORPORATION

P.O. Box 126 Thief River Falls, MN 56701 CIRCLE NO. 13 ON READERS SERVICE CARD

LIVE IN THE WORLD OF TOMORROW...TODAY!

(And our FREE CATALOG is packed with exciting and unusual ecological & physical science items—plus 4,500 finds for fun, study or profit . . . for every member of the family.)

A BETTER LIFE STARTS HERE



12v WIND-POWERED GENERATOR

Cheapest continuous source of electricity available! Attach to 12v truck batt. (not incl) and get free electricity from the wind. Needs only 7 mph wind — 15 amps output in 23 mph wind; double the watt-hour output of ordinary radio chargers. Perfect remote area and alternate energy source. Big 6' propeller (Albers Air-princ.) turns 200w generator; governor prevents overcharging/action. Price includes packing & shipping.

No. 19,189AV . . . (10'-145 LB.) . . . \$425.00 Ppd.

3-CHANNEL COLOR ORGAN KIT

Easy to build low-cost kit needs no technical knowledge. Completed unit has 3 bands of audio frequencies to modulate 3 independent strings of colored lamps (i.e. "lows" reds, "middles" — greens, "highs" — blues. Just connect hi-fi, radio power lamp etc. & plug ea. lampstring into own channel (max, 300w ea.). Kit features 3 neon indicators, color intensity controls controlled individ SCR circuits; isolation transformer; custom plastic housing; instr.



Stock No, 41,831AV . . . \$17.50 Ppd.

"FISH" WITH A GIANT MAGNET

Fascinating fun, and sometimes very profitable! Tie a line of our 3½-pound Magnet drop it overboard in bay, river, lake or ocean. Troll it along the bottom. Your "treasured" haul can be outboard motors, anchors, other metal valuables. Five-pound Magnet is war surplus — Alnico V Tye that cost the Government twice our price. It lifts over 40 pounds on land much greater weights under water!

Stock No. 70,570AV 3½ lbs. . . \$11.50 Ppd.
Stock No, 60,215 AV 1½ lbs. . . \$ 6.50 Ppd.



ON-TIME BIOFEEDBACK MONITOR

New—measures & records % of tng. time spent producing alpha/theta! Electronic scoring device to observe exact degree of progress in alpha-theta prod'n. for greater relaxation, concentration. Deluxe sensitive instrument gives reliable audio & visual feedback of alpha/theta brainwaves. Tracking time (0-20 min.) of alpha or theta rhythm generated is switch-controlled. Other innovative features incl. artifact inhibitor (no muscle interference). 12 lb.

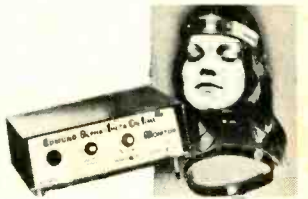

No. 1652AV . . . (15x10x6") . . . \$349.50 Ppd.

NEW! KIRLIAN PHOTOGRAPHY KIT!

Experiment in the fascinating new field of "Kirlian" electrophotography — images obtained on film without camera or lens by direct recording of electric charge transmitted by animate & inanimate objects. Each "aura" differs — animate aura said to change corresponding to physical changes. Kit incl portable dark-room, double transformer isolated from power source; instrs.

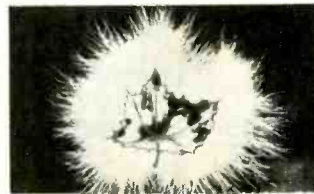

Stock No. 71,938AV . . . \$49.95 Ppd.

"HIGH VOLTAGE PHOTOGRAPHY" by H.S. Dakin
No. 9129AV. . . . (60-PG. PAPER BACK BOOK) . . . \$5.00 Ppd.

GET A CHARGE FROM THE SUN!

Our 12V Solar Battery Charger allows direct conversion of light-to-electricity. Compact panel put on a boat can automatically charge its 12V battery over entire daylite period. Use anywhere for a trickle charge. Big value, it comprises 30 ½V silicon solar cells in series w/ diode.

No. 71,971AV (AB. 30 W-HRS./WK.) \$89.95 Ppd.
9x18" HI CURRENT MODEL (6W, 12V, 500 mA)

No. 72,010AV (AB. 150 W-HRS./WK) . . . \$420.00 Ppd.

6x6" LO VOLTAGE MODEL (1.5V, .38W, 250 mA)

No. 42,172AV . . . \$49.95 Ppd.

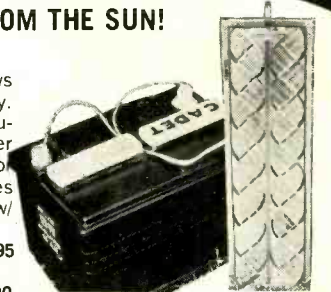

MAIL COUPON FOR GIANT FREE CATALOG!

164 PAGES! MORE THAN 4,500 UNUSUAL BARGAINS!

Completely new catalog. Packed with all kinds of unusual bargains. Exciting new categories. Many new items. 100's of charts, illustrations. Many hard-to-get war-surplus bargains. Enormous selection of telescopes, microscopes, binoculars, magnets, ecological and unique lighting items, kits, parts, and so forth, for hobbyists, experimenters, workshops. Simply mail coupon or write for free Catalog "AV."

EDMUND SCIENTIFIC CO.
300 Edscorp Bldg., Barrington, N. J. 08007

Name _____
Address _____
City _____ State _____ Zip _____

COMPLETE & MAIL WITH CHECK OR M.O.

EDMUND SCIENTIFIC CO.
300 Edscorp Building, Barrington, N.J. 08007

How Many	Stock No.	Description	Price Each	Total

PLEASE SEND CATALOG "AV"

MERCHANDISE TOTAL \$

ADD HANDLING CHARGE: \$1.00 ON ORDERS

UNDER \$5.00; 50c ON ORDERS OVER \$5.00

TOTAL \$



I enclose check
 money order for \$ _____

NAME _____

ADDRESS _____

CITY _____ STATE _____ ZIP _____

METAL CIRCUIT SYSTEMS CORPORATION

Presents

AN ELECTRONIC BREAKTHROUGH

Convert Your

IDEAS TO REALITY
IN MINUTES

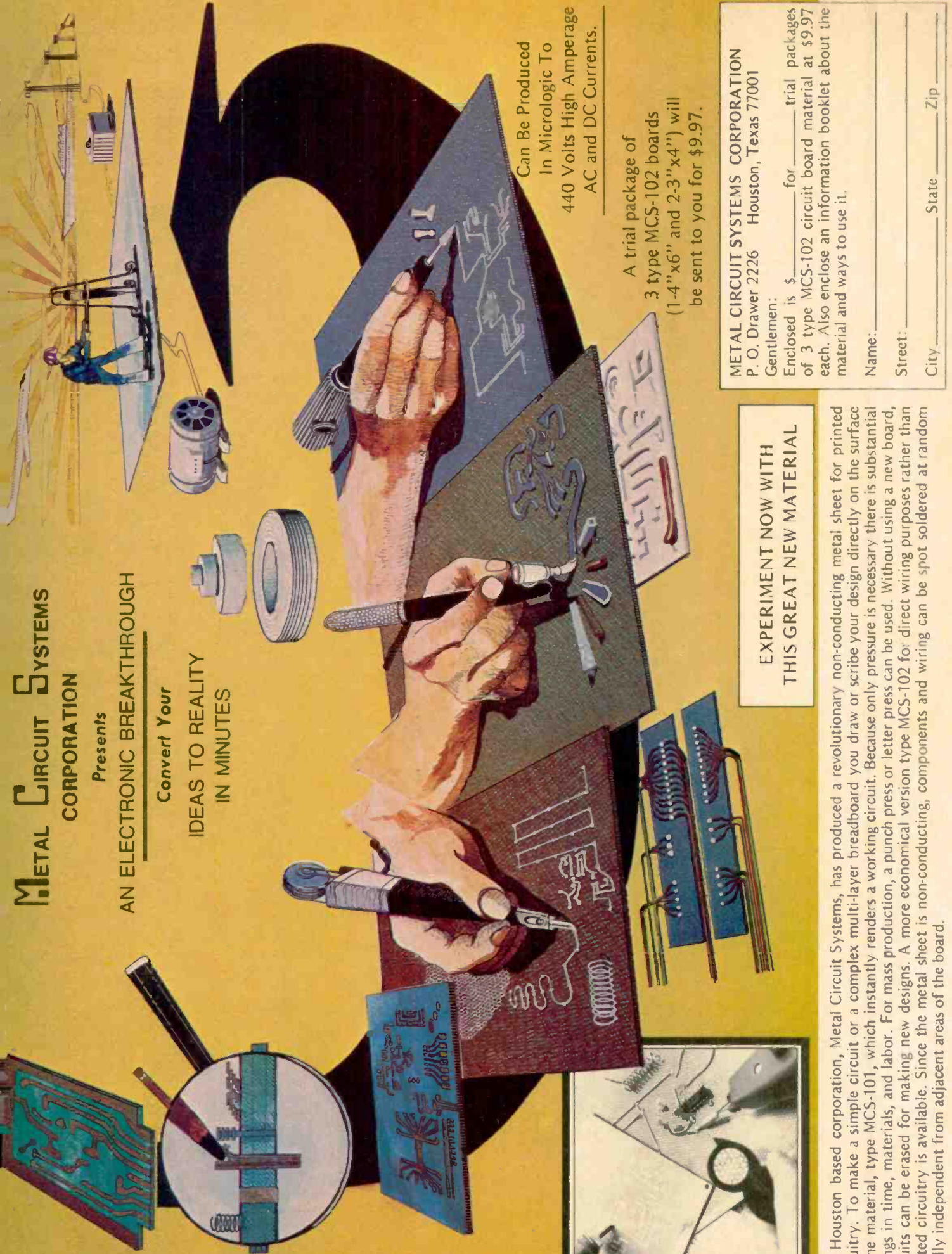

CIRCLE NO. 25 ON READERS SERVICE CARD

Can Be Produced
In Micrologic To
440 Volts High Amperage
AC and DC Currents.

A trial package of
3 type MCS-102 boards
(1-4" x 6" and 2-3" x 4") will
be sent to you for \$9.97.

EXPERIMENT NOW WITH THIS GREAT NEW MATERIAL

Our Houston based corporation, Metal Circuit Systems, has produced a revolutionary non-conducting metal sheet for printed circuitry. To make a simple circuit or a complex multi-layer breadboard you draw or scribe your design directly on the surface of the material, type MCS-101, which instantly renders a working circuit. Because only pressure is necessary there is substantial savings in time, materials, and labor. For mass production, a punch press or letter press can be used. Without using a new board, circuits can be erased for making new designs. A more economical version type MCS-102 for direct wiring purposes rather than printed circuitry is available. Since the metal sheet is non-conducting, components and wiring can be spot soldered at random totally independent from adjacent areas of the board.

METAL CIRCUIT SYSTEMS CORPORATION
P. O. Drawer 2226 Houston, Texas 77001

Gentlemen:

Enclosed is \$_____ for _____ trial packages
of 3 type MCS-102 circuit board material at \$9.97
each. Also enclose an information booklet about the
material and ways to use it.

Name: _____

Street: _____

City: _____ State: _____ Zip: _____

Introducing Dual's new generation.

A matter of subtle refinement rather than radical change.

If you've known previous Duals, our new generation will look familiar. Which is not surprising since no radical change has been made in design or technology.

Dual, after all, is the multi-play turntable that music experts—record reviewers, audio engineers, hi-fi editors—have long preferred to use in their personal systems.

The reason is simple: Dual provides superior performance (with the added convenience of being fully automatic). And because of Dual's proven reliability, many owners are reluctant to give up their original Dual; even after ten years of constant use.

Through the years Dual has introduced many "firsts" among automatic turntables: pitch control; separate anti-skating scales for

different stylus types; gimbal tonearm suspension, and rotating single-play spindles.

Dual engineers have never strayed from their original concept: to build every Dual turntable with more precision than you are ever likely to need. For example, even the lowest-priced Dual can track flawlessly at one gram.

Another Dual policy: refinements introduced on the higher-priced Duals typically appear later on the lower-priced models. For example: illuminated strobes, rotating single-play spindles, low capacitance tonearm leads and the special anti-skating scale for CD-4.

With these subtle refinements, each Dual remains the most advanced multi-play turntable in its price class. Radical change, after all, is necessary only when one is radically behind.

Dual[®]

Dual 1225, \$129.95

Dual 1226, \$159.95

Dual 1228, \$189.95

Dual 1229Q, \$259.95

United Audio Products, 120 So. Columbus Ave., Mt. Vernon, N.Y. 10553

Exclusive U.S. Distribution Agency for Dual