

STATUS REPORT: 4-CHANNEL TAPE RECORDERS

Popular Electronics

SIXTY CENTS / JULY 1974

Build an



ESP TEST MACHINE

Check telepathy,
clairvoyance,
precognition



Construction Projects

IC Timer Noise Makers

Low-Cost Metal Locator

Photoflash Tripper

Features

Electronic Music Keyboards

Breaking the 10-wpm
Code Barrier

Test Reports

Avid 103 Speaker System

dbx Audio Compressor/
Expander

Browning Labs LTD SSB/AM
CB Transceiver

561256 0LS B0245M97 DEC74 1 10
M DELSCHLAGER
BX 245
BROWNS MILLS NJ 08015
07

CREI—the only home-study college-level training

and now

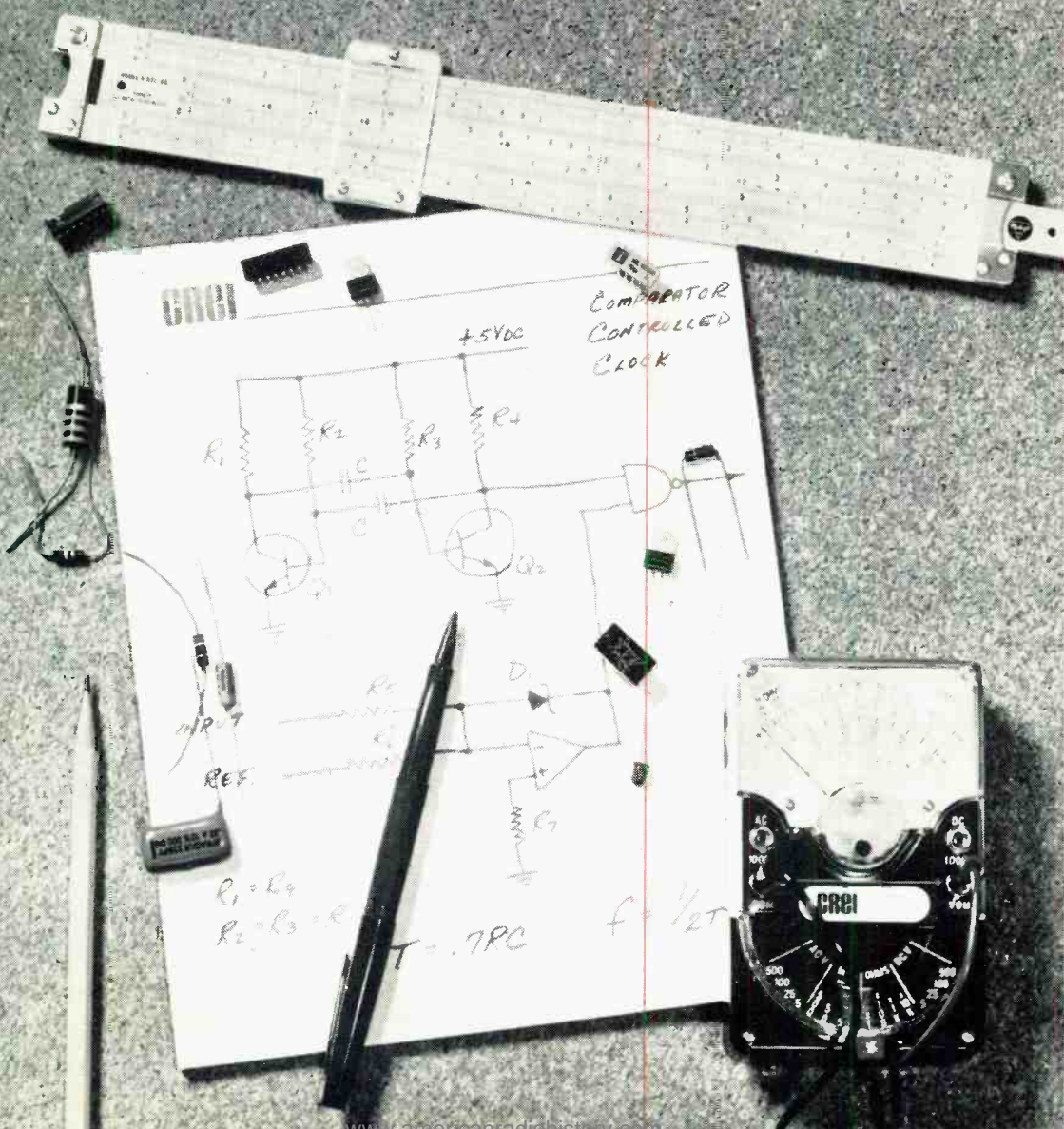

rogram which gives you n electronic circuit design

only CREI offers you a complete college-level Electronic Design laboratory to speed your learning

ronic circuit design—source of all new development
he application of electronics to new products and
vices. Without this skill, we would be unable to monitor
heartbeat of men in space. Without it, the computer
olution would never have occurred. And we would have
to see our first TV show. *Yet, only CREI teaches
ronic circuit design at home.*

ELECTRONIC CIRCUIT DESIGN

A key skill which paces our nation's progress in count-
less fields—from pollution control to satellite tracking
to modern medicine to exploring the ocean's depths.
And beyond. A skill which you must have to move to
the top in advanced electronics.

El programs open up
w worlds of opportunity for you.

In addition to electronic circuit design, CREI provides
u with a full advanced electronics education in any of
irteen fields of specialization you choose. Communica-
ions, computers, space operations, television, nuclear
wer, industrial electronics—to mention just a few of
e career fields for which CREI training is qualifying.
th such preparation, you will have the background for a
reer which can take you to the frontiers of the nation's
ost exciting new developments. And around the world.

This free book can change your life.
Send for it.

If you are a high-school graduate (or
equivalent) and have previous training or
experience in electronics, then you are
qualified to enroll in a CREI program to
move you ahead in advanced electronics.



Send now for our full-color, eighty page book on
careers in advanced electronics. In it, you will find full
facts on the exciting kinds of work which CREI pro-
grams open up to you. And full facts on the compre-
hensive courses of instruction, the strong *personal*
help, and the professional laboratory equipment which
CREI makes available to you. All at a surprisingly
low tuition cost.

And when you have it, talk with your employer about it.
Tell him you're considering enrolling with CREI. He'll
undoubtedly be happy to know you are planning to
increase your value to him. *And he may offer to pay all or
part of your tuition cost.* Hundreds of employers and
government agencies do. Large and small. Including some
of the giants in electronics. *If they are willing to pay for
CREI training for their employees, you know it must
be good.*

Send for Advanced Electronics today. You'll be glad
you did.

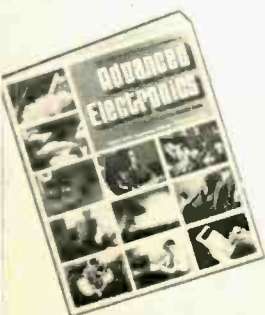

CREI Dept. E1207E
3939 Wisconsin Avenue
Washington, D.C. 20016

Rush me your FREE book describing my opportu-
nities in advanced electronics. I am a high school
graduate.

Name _____ Age _____

Address _____

City _____ State _____ ZIP _____

If you have previous training in electronics, check here

Employed by _____

Type of Present Work _____

Veterans and servicemen, check here for G. I. Bill information

CREI

CAPITOL
RADIO
ENGINEERING
INSTITUTE

WASHINGTON, D.C. 20016

Popular Electronics

WORLD'S LARGEST-SELLING ELECTRONICS MAGAZINE

FEATURE ARTICLES

- 33 STATUS REPORT: 4-CHANNEL TAPE MACHINES** Leonard Feldman
Late developments in open-reel, 8-track and cassette recorders.
- 42 HOW TO SELECT EM KEYBOARDS & CONTROLLERS** Don Lancaster
Types and availability for electronic music synthesizers.
- 50 SUPPRESSING TRANSIENTS IN SOLID-STATE EQUIPMENT**
- 59 ELECTRONIC SENSORY AIDS FOR THE BLIND** Forrest Mims
How electronics is helping the sightless.
- 64 SOLID-STATE PHOTOCELLS FOR HOBBYISTS, Part 2.** L. George Lawrence
Using light-sensitive semiconductors in practical circuits.
- 67 HOW TO BREAK THE 10-WORDS-PER-MINUTE CODE BARRIER**
Richard Humphrey

CONSTRUCTION STORIES

- 27 BUILD AN ESP TESTING MACHINE** Ira H. Spector
Explore the "hidden channels" of the mind.
- 45 BUILD A GUITAR SOUND INTENSIFIER** Ken Lang
- 47 LOW-COST METAL LOCATOR** Joe A. Rolf
Detects buried metal at depths of 6 inches.
- 50 MAKING NOISES WITH THE 555 IC TIMER** Michael S. Robbins
One chip used in a variety of circuits.
- 52 3-WAY (SOUND, LIGHT, MANUAL) PHOTOFLASH TRIPPER**
John F. Hollabaugh
For novel stop-action effects.
- 58 IN-CIRCUIT/OUT-OF-CIRCUIT SEMICONDUCTOR JUNCTION TESTER**
Myles H. Marks
- 91 PORTABLE TIME BASE FOR DIGITAL CLOCKS** Paul Michael

ZIFF-DAVIS PUBLISHING COMPANY
Popular Electronics
Editorial and Executive Offices
One Park Avenue, New York, New York 10016
212-725-3500

William Ziff, President
W. Bradford Briggs, Executive Vice President
Hershel B. Sarbin, Senior Vice President, Secretary, and Treasurer
Philip Sine, Senior Vice President
Phillip T. Heffernan, Vice President, Marketing
Frank Pomerantz, Vice President, Creative Services
Arthur W. Butzow, Vice President, Production
Edward D. Muhlfield, Vice President, Aviation Division
Irwin Robinson, Vice President, Travel Division
George Morrissey, Vice President
Sydney H. Rogers, Vice President
Sidney Holtz, Vice President
Lawrence Sporn, Vice President, Circulation

POPULAR ELECTRONICS, July 1974, Volume 6, Number 1. Published monthly at One Park Avenue., New York, NY 10016. One year subscription rate for U.S., U.S. Possessions and Canada, \$6.98; all other countries, \$8.98. Second class postage paid at New York, N.Y. and at additional mailing offices. Authorized as second class mail by the Post Office Department, Ottawa, Canada and for payment of postage in cash. Subscription service and Forms 3579: P.O. Box 2774, Boulder, CO 80302. Editorial offices for manuscript contributions, reader inquiries, etc.: One Park Ave., New York, NY 10016.

POPULAR ELECTRONICS Including ELECTRONICS WORLD, Trade Mark Registered. Indexed in the Reader's Guide to Periodical Literature.

Copyright © 1974 by ZIFF-DAVIS PUBLISHING COMPANY. All rights reserved.

POPULAR ELECTRONICS

EDGAR W. HOPPER
Publisher
ARTHUR P. SALSBERG
Editorial Director
MILTON S. SNITZER
Editor
LESLIE SOLOMON
Technical Editor
JOHN R. RIGGS
Managing Editor
EDWARD I. BUXBAUM
Art Director

ALEXANDER W. BURAWA
Associate Editor
ANDRE DUZANT
Technical Illustrator
ELLEN S. FINKELSTEIN
Editorial Assistant
LEN BUCKWALTER
LOU GARNER
JULIAN D. HIRSCH
RALPH HODGES
WALTER G. JUNG
Contributing Editors

JOSEPH E. HALLORAN
Advertising Director
JOHN J. CORTON
Advertising Sales
MADELEINE LITTMAN
Advertising Service Manager
PEGI MCENEANEY
Executive Assistant
STANLEY NEUFELD
Associate Publisher
FURMAN H. HEBB
Group VP, Electronics & Photo

THE SCENES

- 14 STEREO SCENE** *Ralph Hodges*
Matching tonearms and cartridges.
- 24 HOBBY SCENE** *Editorial Staff*
- 81 SOLID STATE** *Lou Garner*
Designing with ingenuity.
- 89 CB SCENE** *Len Buckwalter*
Antennas for cars.
- 92 TEST EQUIPMENT SCENE** *Leslie Solomon*
Testing internal combustion engines.

PRODUCT TEST REPORTS

- 69 AVID MODEL 103 SPEAKER SYSTEM**
- 71 dbx MODEL 119 DYNAMIC RANGE ENHANCER**
- 77 BROWNING LTD AM/SSB MOBILE CB TRANSCEIVER**
- 78 HEATHKIT MODEL AD-1013 AUDIO OSCILLOSCOPE**

DEPARTMENTS

- 6 EDITORIAL** *Milton S. Snitzer*
Communications for the Boat Owner
- 8 LETTERS**
- 22 NEWS HIGHLIGHTS**
- 94 NEW PRODUCTS**
- 98 NEW LITERATURE**
- 99 ELECTRONICS LIBRARY**

COMING NEXT MONTH

New Big Format!
Display Alphanumeric
with Scopewriter
Build a Reflex/Omni Speaker System
Guide to CB Mobile Antennas
Linear CMOS Applications

Midwestern Office
The Pattis Group, 4761 West Touhy Ave.,
Lincolnwood, Illinois 60644. 312 679-1100
GERALD E. WOLFE, GEORGE B. MANNION

Western Office
9025 Wilshire Boulevard, Beverly Hills, California 90211
213 273-8050; Bradshaw 2-1161
Western Advertising Manager, **BUD DEAN**

Japan: James Yagi
Oji Palace Aoyama; 6-25, Minami Aoyama
6 Chome, Minato-Ku, Tokyo 407-1930/6821



Member Audit Bureau
of Circulations



Ziff-Davis also publishes Boating, Car and Driver, Cycle, Flying, Modern Bride, Popular Photography, Skiing, and Stereo Review.

Forms 3579 and all subscription correspondence should be addressed to POPULAR ELECTRONICS, Circulation Department, P.O. Box 2774, Boulder, CO 80302. Please allow at least eight weeks for change of address. Include your old address, as well as new—enclosing, if possible, an address label from a recent issue.

Editorial contributions must be accompanied by return postage and will be handled with reasonable care; however, publisher assumes no responsibility for return or safety of art work, photographs, models, or manuscripts.



Editorial

By Milton S. Snitzer, Editor

COMMUNICATIONS FOR THE BOAT OWNER

In 1973, there were an estimated 9½ million recreational boats in use on the waterways and along the shorelines of the United States. A substantial percentage need some means of communicating with each other, with bases on land, and with the Coast Guard. Sometimes a life depends on it!

Boaters often ponder over the choice of which communications rig to buy. Should it be a CB transceiver, a vhf FM marine radio, an AM marine radio or an SSB AM marine radio? The decision isn't all that difficult if needs, regulations, and available dollars are considered.

For example, over 300,000 boats are said to be equipped with CB radios. Though CB is not a direct link with the Coast Guard, in some areas it is monitored by local or state police or the sheriff's office. Also, there are many inland lake and river areas where the Coast Guard cannot be reached by short-range radio; even if they could, the CG might not have rescue facilities. So check your local boating vicinity. REACT, the CB emergency association, can be a vital center in emergencies, also.

Marine radio, on the other hand, provides a direct link for help with the Coast Guard, as well as weather information. Whereas channel 9 is the emergency channel for CB, channel 16 (156.8 MHz) is the distress channel and initial calling channel for vhf FM marine radio. It is monitored 24 hours a day by the Coast Guard. Another CG link on vhf FM is for nondistress calls on channel 22 (157.1 MHz). Cost of a vhf FM marine radio is higher than CB, though relatively low-priced units are now available.

For greater transmission punch, there's a temptation to consider the 2-to-4-MHz AM marine radio, where up to 150 watts of output is permitted (contrasted to vhf FM's 25-watt limit). Resist the temptation, though. New FCC rules will ban double-sideband AM by 1977. Furthermore, new licenses for this type of gear are no longer being issued. So, even if one buys a boat that has DSB AM, it won't be possible to get a license. Of course, SSB AM is available. But such rigs are very expensive and FCC rules requires that they be supplemented by a vhf FM set. Besides, unless your boating takes place in blue water, you don't want long-distance communications.

Should you opt for a marine radio rig, you must observe some special rules: no frivolous chatter, maintenance of a logbook, obtaining a restricted radiotelephone operator's permit (no test), and lowering output power when making nearby contacts. You might also consider having the best of both worlds—CB and vhf FM.

Though pleasure boats are not required to carry a radiotelephone, the ability to communicate when boating is convenient and sometimes essential. That "Mayday" distress call wasn't designed just for fun.

News Flash: Starting with the next issue, POPULAR ELECTRONICS will appear in a new, large (8½" x 11") format.

Are you playing your records or ruining them?

If you're like most music listeners, you never think about your records after putting them on your record player.

You just sit back and enjoy the music.

Chances are you'd be less relaxed if you knew that your records might be losing something with every play.

Like the high notes.

It's something to think about. Especially when you consider how many hundreds or even thousands of dollars you have invested in your record collection. And will be investing in the future.

What happens during play.

Even the cheapest record changer can bring its tonearm to the record and lift it off again. But what happens during the twenty minutes or so of playing time is something else.

The stylus is responding with incredible speed to the roller-coaster contour of the stereo grooves. This action recreates all the music you hear, whether it's the driving energy of a rock band or the richness of a symphony orchestra.

The higher the frequency of the music, the more rapidly the contours change, and the sharper the peaks the stylus has to trace. If the stylus bears down too heavily, it won't go around those soft vinyl peaks. Instead, it will lop them off. The record will look unchanged, but your piccolos will never sound quite the same. Nor will Jascha Heifitz.

Dual 1214, \$119.95

It's all up to the tonearm.

What does it take for the stylus to travel

the obstacle course of the stereo groove without a trace that it's been there? It takes a precision tonearm. One that can allow today's finest cartridges to track optimally at low pressures of one gram or less. For flawless tracking, the tonearm should be perfectly balanced with the weight of the cartridge, and must maintain the stylus pressure equally on each side wall of the stereo groove. And in order to maintain this equal pressure during play, the tonearm must not introduce any drag. This requires extremely low friction pivot bearings.

There is much more to the design and engineering of tonearms and turntables. But this should be sufficient to give you the idea.

Dual: the music lovers' preference.

By now you probably understand why serious music lovers won't play their precious records on anything but a precision turntable. And the most serious of these people, the readers of the leading music magazines, buy more Duals than any other make of quality turntable.

If you would like to know more about Dual turntables, we'll send you lots of interesting literature, including an article on how to buy a turntable, and reports by independent test labs. Or better yet, just visit your franchised United Audio dealer and ask for a Dual demonstration. You will never have to worry about your records again.

Dual 1216, \$154.95

Dual 1229, \$259.95

Dual 1218, \$189.95



Dual

United Audio Products, Inc., 120 So. Columbus Ave., Mt. Vernon, N.Y. 10553

Exclusive U.S. Distribution Agency for Dual.

CIRCLE NO. 4 ON READER SERVICE CARD

If You Work In Electronics:

GRANTHAM OFFERS YOU College-Level Training and a college degree.

Electronic Circuit Design, Engineering Analysis (including mathematics thru calculus), Classical and Solid-State Physics, Engineering Design, etc., etc., are all part of the Grantham home-study degree program in Electronics Engineering.

PUT PROFESSIONAL RECOGNITION IN YOUR CAREER.

By adding college-level home training and a college degree to your experience, you can *move up* to greater opportunities in electronics.

Grantham offers the A.S.E.T. degree by correspondence. After earning this degree, you may continue with additional correspondence plus a 3-day residential seminar and certain transfer credits, to earn the B.S.E.T. degree. Then, the B.S.E.E. is available through further study.

GRANTHAM SCHOOL OF ENGINEERING
2000 Stoner Ave., Los Angeles CA 90025

● Telephone (213) 477-1901 ●

Worldwide Career Training thru Home Study
Mail the coupon below for free bulletin.

Grantham School of Engineering PE-7-74
2000 Stoner Ave., Los Angeles, CA 90025

I have been in electronics for _____ years. Please mail me your free bulletin which gives details concerning your electronics degree programs.

Name _____ Age _____

Address _____

City _____ State _____ Zip _____

CIRCLE NO. 16 ON READER SERVICE CARD

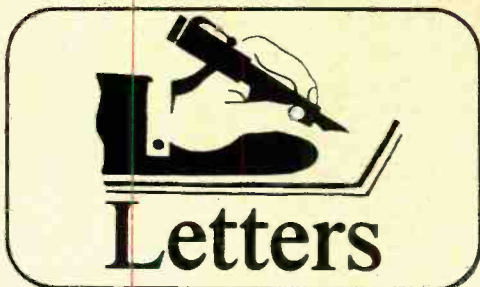

LOCAL GROUPS COULD HELP CB

My compliments on your April editorial, "The CB Pleasure Seekers."

I was away from CB for four years. When I turned on my rig again some six months ago, I was amazed at how slack the FCC had gotten in controlling the band. This brings to mind a question that I know has come up before: Why can't the FCC designate such groups as REACT and ALERT and other recognized organizations to help clean up the air in their own areas? With thousands of REACT and ALERT "ears" across the country, it would be quite easy for the FCC to be informed of the locations of violators.

KENNETH B. ROTHMAN, KBY0535
Warrensville Heights, Ohio

HIGH-POWER AMPLIFIER TESTS

On reading Ralph Hodges's comments on high-power requirements ("Stereo Scene," May 1974), I recalled some experiments that Bud Fried (IMF Products) and I made on this subject back in 1956. We wanted to find out how much power was required to reproduce a piano using an AR-JansZen speaker combination. We recorded a selection on the piano. Then, in the same room, we played it back and set the amplifier level to match the original moderate sound levels.

We found that it required 250 watts of monophonic power to reproduce a piano at its normal living room level.

DAVID HAFLER
Merion, Pa.

HOW TO "CUT" A RESISTOR

In "How To Make Custom Meters From Salvaged Parts" (April 1974), it was stated that a standard resistor can be "cut" to a custom value by notching it with a triangular file. This is true, but a few words of caution are in order. First, unless a very light cut is made, the desired value can be easily passed. Second, the file produces a high stress concentration at the apex of the cut that can lead to mechanical failure of the resistor. The first danger can be obviated by exercising care, while the second can be dealt with by strengthening the cut resistor. After cutting the notch, clean the resistor with

alcohol; then add strength by filling the void with epoxy.

Some people reading the article might form the opinion that notching a resistor is an almost perfect method of obtaining a custom-value resistor. However, we suggest that, before proceeding with the filing, they select a resistor of the next higher wattage rating.

WILLIAM E. PIERCE
V. P., Engineering
LAM Research
Huntsville, Ala.

CERTIFICATION FOR TV SERVICING

We read with interest your May editorial and must take issue with your recommendations on CET as a proper test to determine a technician's qualifications. . . . (This test) will not meet the criteria of the National Business Council for Consumers Affairs. NATESA (National Alliance of Television & Electronic Service Associations) cannot permit CET to be used as a criteria for any license.

The NATESA Certification program, based upon EIA's "TV Symptom Diagnosis" study course, we believe employers will agree, is far more effective. . . .

FRANK J. MOCH
Executive Director, NATESA

In our editorial, we did not recommend the

CET program. It was mentioned as one of the "good starts" toward a better image of servicing for the public.

KUDOS FOR CAPACITANCE METER

Thanks for the "IC Capacitance Meter" (February 1974). It is a perfect, foolproof project. My unit was designed on a printed circuit board and used a 100-microampere meter. None of the ranges needed trimming and accuracy is excellent. However, I would like to see a modification that would add a full-scale range of 100 pF.

JOSEPH F. DINEEN
Westwood, Mass.

The "IC Capacitance Meter" is one of my most-used pieces of test equipment. I have one note to pass on to other experimenters. The schematic and photograph do not seem to match with respect to the range switch. I suggest that the connections be reversed on S1A and S1B during assembly so that, when tests are being conducted, one can start with the highest range and work down.

One small disadvantage of the meter is that, with larger capacitances (0.5 to 1 microfarad), the lower frequency causes the meter's pointer to oscillate, providing an *average* reading.

GEORGE LORIMER
Dimondale, Mich.

**Affordable,
portable
function
generator.**
\$149⁹⁵

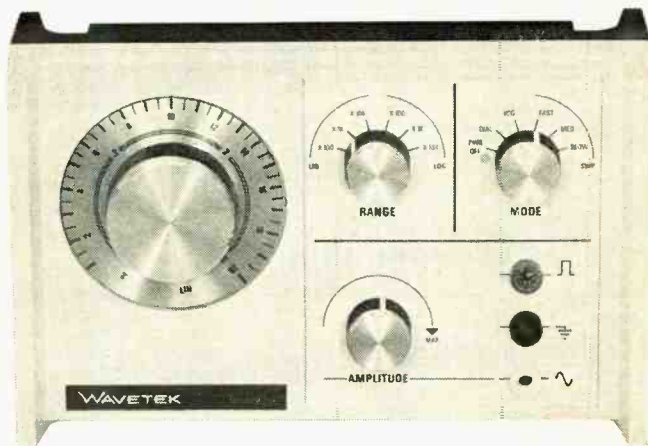

We've built ultra-sophisticated function generators that sell for nearly two thousand dollars. But the Model 30 may be our greatest achievement. An under-\$150 function generator that can do all this: 2Hz to 200 KHz frequency range; sine, square, triangle outputs; linear and logarithmic sweep. Because it's battery operated, the Model 30 can be used anywhere, with complete line isolation. (A rechargeable power supply kit is available for line operation.) Because it's only \$149.95, everyone can afford to buy one. How can you function without it?

WAVETEK®
P.O. Box 651, San Diego, Calif. 92112
TWX 910-335-2007, Tel. (714) 279-2200

Discover the ease and excitement of learning Electronics with programmed equipment NRI Sends you

When you train at home with NRI, you train with your hands as well as your head. You learn the WHY of Electronics, Communications, TV-Radio the NRI pioneering "3-Dimensional" way. NRI training is the result of more than half a century of simplifying, organizing, dramatizing subject matter, and providing personal services unique for a home study school. You get the kind of technical training that gives you priceless confidence as you gain experience equal to many, many months of training on the job.



NRI—The Leader in Electronics Training for more than Fifty Years

APPROVED UNDER NEW GI BILL

If you served since January 31, 1955, or are in service, check GI line in postage-free card.



*Earn \$5 to \$7 an hour
spare or full time in*

TV-RADIO SERVICING

Color television sales are soaring. And so is the demand for trained repairmen. If you can service TV sets, portable radios, tape recorders, hi-fi sets, phonographs and auto radios, you'll always be in demand. It's one of your best routes to spare-time earnings, a good paying job or a business of your own. NRI trains you quickly and expertly, showing you how to get started in servicing soon after you enroll, earning as you learn. NRI trains you in today's method of installing and repairing all electronic equipment for the home—including solid state Color TV. You even build, experiment with and keep to enjoy your own solid-state radio plus your choice of black-and-white or the new 25" diagonal solid state Color TV receiver NRI developed from the chassis up for training. Like thousands of others, you can soon be earning good money in your spare time... the easy NRI way.

*There's money and
success awaiting you in*

COMMUNICATIONS MOBILE RADIO & BROADCASTING

NRI training in Complete Communications equals as much as two years of training on the job. With NRI, you can train for a choice of careers ranging from mobile, marine and aviation radio to TV broadcasting and space communications. You learn how to install, maintain and operate today's remarkable transmitting and receiving equipment by actually *doing* it. You build and experiment with test equipment, like a TVOM you keep. You build and operate amplifier circuits, transmission line and antenna systems, even build and use a phone-cw transmitter suitable for transmission on the 80-meter amateur band. Whichever of these five intensely practical NRI Communications courses you choose, you prepare for your FCC License exams, and *you must pass your FCC exams or NRI refunds your tuition in full.*

*Move ahead in America's
fast growing industry as*

COMPUTER TECHNICIAN

Ours is rapidly becoming the age of the computer... and NRI can train you to cash in on the opportunities in this field. Only NRI trains you at home on a real computer—not a simple logic trainer, but a complete, stored program digital computer using over 50 integrated circuits. As you build the NRI Computer, you explore all fundamental logic circuits, then how to combine them in a complete, stored program computer. You observe the "heart" of a real computer. You solve typical problems and learn how to locate faults with diagnostic programs. Bite-size texts make studying easier. Prove to yourself what nearly a million NRI students could tell you—that you get more for your money from NRI. Check the card and mail it today for your free NRI Color Catalog. **NO SALESMAN WILL CALL.** NRI Training, 3939 Wisconsin Ave., Washington, D.C. 20016.

YOU GET MORE FOR YOUR MONEY FROM NRI



NRI Kits and Equipment

Dollar for dollar, you get more value from NRI training kits, because they are designed as educational tools. In the TV-Radio Servicing Course, for instance, the end product is a superb 25" diagonal color TV your whole family will enjoy. The set is designed so that, while building it, you can introduce and correct defects... for trouble-shooting and hands-on experience in circuitry and servicing. The kits include, at no additional cost, a wide-band service type oscilloscope and color cross-hatch generator, and other valuable equipment that will let you start earning money in your spare time making repairs... even before the course is completed.

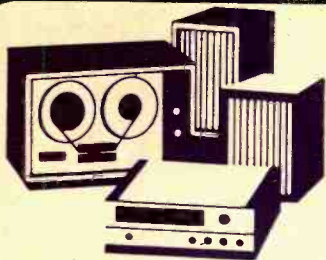

Stereo Scene

By Ralph Hodges

WHEN the assembling of a hi-fi system by purchasing individual components first became popular, the problem of matching components caused many a headache for the audiophile. The tape recorder enthusiast, for example, was often forced to buy a mechanical tape deck from one supplier, record/playback preamplifiers from a second source, and sometimes separate tape heads from still another. Fortunately, those days are past—at least for the tape recordist. He can now buy the whole integrated package from the manufacturer of his choice. The picture is not so bright, however, when it comes to record players. There, the component business still operates just as it did with tape recorders 25 years ago!

What does this mean to the consumer? As a rule, he must shop for a turntable with an integrated tonearm and try to match it to a phono cartridge. Further, he will be plugging the cartridge into a preamp that was probably not developed with that specific cartridge in mind. Aside from creating buying frustrations, the matchmaking process offers plenty of opportunities for the consumer to go astray.

Minor mismatches of equipment are actually common in home music systems. Fortunately, the audible effects tend to be neg-

ligible; but every once in a while, some hapless individual makes a big mistake. It may be in pairing a cartridge and phono preamplifier that combine to produce a significant high-frequency rolloff in response (a fairly remote but still definite possibility). More often, it involves a cartridge and tonearm combination whose mass-compliance interaction affects the system's ability to cope with ordinary record warping.

Warps and Record Players. Shure Brothers gave a seminar on phono cartridges last year that included a presentation by Frank Karlov (now head of cartridge development at Shure) on the specific subject of record warps. He reported that, in a study of 67 randomly selected records, 210 warp characteristics were classified—an average of three per record—on the basis of frequency and amplitude. The frequencies ranged from 0.55 Hz (the rotational rate of a 33 $\frac{1}{3}$ -rpm record) to well beyond 10 Hz. Some amplitudes exceeded ten times the recorded levels cut into the discs, with the greatest amplitudes tending to occur at the lower frequencies. Not all of the warps were the result of bent or twisted records. Some seemed to be “profile deformations”—irregularities in the thickness of the vinyl material. Figure 1 shows the results of the Shure study.

Ideally, the negotiating of all the material on a phonograph record—warps as well as recorded information—should involve a cooperative effort between cartridge and tonearm. The stylus should respond only to the recorded undulations of the groove. The tonearm should absorb the grosser up-and-down movements of the record surface, leaving the stylus undisturbed. This is evidently a realizable goal, as long as both arm and cartridge are designed to be used together as a team.

The stylus has compliance (“springy” flexibility) and the tonearm has mass. Together,

Matching Tonearms and Cartridges

Free home and car security project book

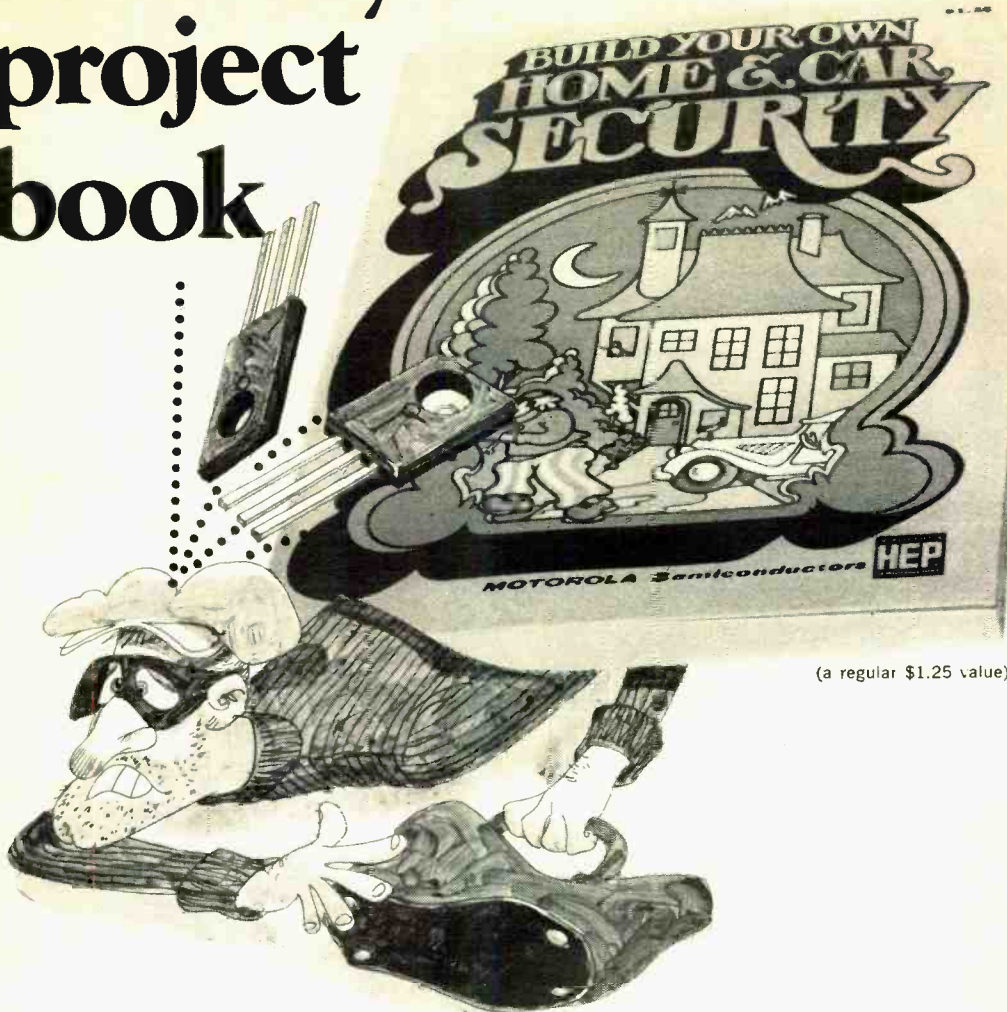

(a regular \$1.25 value)

When you buy two HEP R1215's

These are 30V-4A Sensitive Gate SCR's... which can be used in building any of four different home and car security projects:

- Security Alarm System
- Master Alarm Control System
- Car Intrusion Alarm
- Long Range Optical Detector

This HEP 409 Project Book has 11 security projects, and it's yours when you buy two HEP R1215 devices at the regular price of \$1.25 each from your local HEP dealer. (Offer expires August 30, 1974)

P. O. Box 2953 / Phoenix, Arizona 85036



they constitute a simple spring-and-weight system that, like any such system, has a natural frequency at which it prefers to vibrate—its frequency of resonance. Speaking very simplistically, what generally happens is that, above the resonant frequency, only the spring (stylus) moves in response to any excitation. Below resonance, only the mass (tonearm) moves. Directly at the resonant frequency, both the spring and the mass move, usually rather energetically and, more often than not, out of phase.

Knowing this, it becomes a theoretically simple matter to “tune” the stylus to groove modulations and the tonearm to warps. Mass and compliance are merely adjusted so that the resonance is located between the frequency ranges of the two conditions. (Reducing compliance and/or mass raises resonance, increasing either or both lowers resonance.) Fortunately, the Shure study shows that there is a band of frequencies between about 8 and 20 Hz where there is a region of relative tranquility on most discs. The serious warp activity has died out, and the lowest frequencies of recorded music haven’t yet begun. This is an ideal spot in which to tuck the resonant frequency of the cartridge/tonearm combination. Since resonance is a highly unstable condition in

this case, it is wise to have it where it will receive as little stimulation as possible.

Enter the Consumer. So far, all well and good. But who does the matching of mass and compliance to ensure the proper performance of the combination? Not, I’m afraid, the cartridge and tonearm manufacturers if they have no knowledge of the devices with which their respective products are to be used. At present, this is the consumer’s problem; and he, as a rule, has little information on which to formulate a solution.

Where record warp is concerned, both mass and compliance are frequency-dependent quantities, so the “static-compliance” specifications provided by cartridge manufacturers are not guaranteed to be of any help. (These specifications are simply an indication of how far a unit force can push the stylus to one side or the other.) As for the tonearm, its mass is neither its weight when put on a scale or the gram or so of tracking force it exerts on a stationary record. The mass is actually the inertia the arm presents when you try to wiggle it around by pushing on the stylus tip. As far as I know, there are no recognized standards for specifying this. It depends, to a significant extent, on the mass of the cartridge installed,

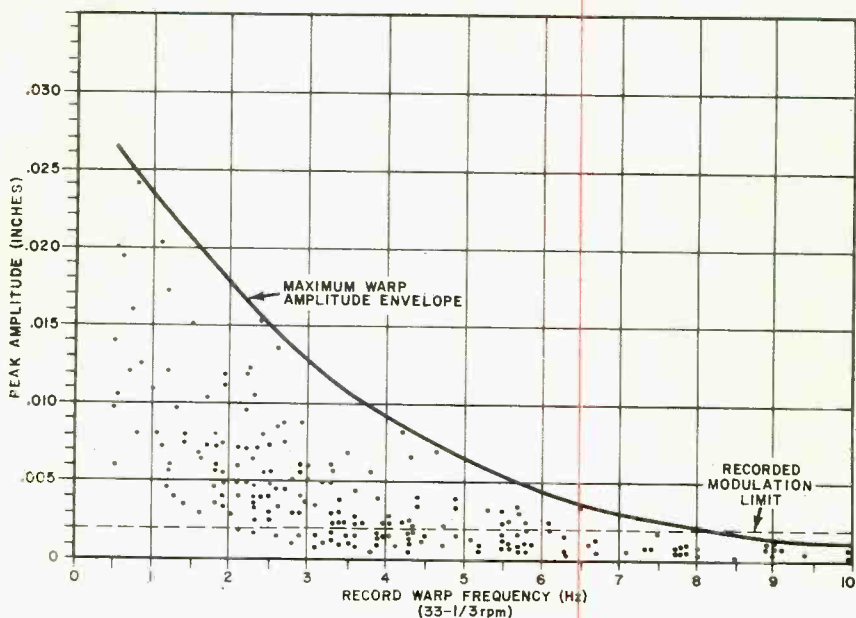

Fig. 1. The distribution of the warps measured by Shure on 67 LP records. Each dot indicates the amplitude and frequency of one of the warps that was found. The dashed line indicates typical maximum recorded amplitudes (about 2 mils).

3 REASONS WHY YOU SHOULD BUY YOUR CALCULATOR FROM 'THE BIG T'

1. YOU GET THE BEST PRICE but what happens later when you want an improved model? At Tucker you can trade-up - just like a used car.

CORVUS 310 HAND-HELD PORTABLE 6 function (+, -, x, ÷, %, square root) with automatic constant, 8 digit readout, floating decimal and negative sign and many features.

With disposable batteries \$59.95
 Disposable batteries & AC 64.95
 Rechargeable batteries & recharger 69.95

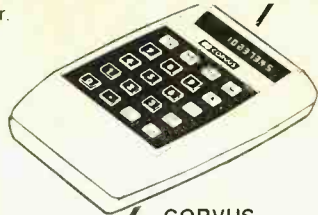

CORVUS 322 HAND-HELD PORTABLE WITH MEMORY

- 5 function (+, -, x, ÷, %) with memory
- Floating decimal, floating negative sign, 8 digit display
- Automatic constant of all functions
- Rechargeable battery pack including recharger

\$79.95

2. **Guarantees** 30 day money-back guarantee... One year repair or replace guarantee and THEN TUCKER will repair any unit **after** the warranty expires for only \$9.95 (excluding any shipping and excessive damage)

CORVUS 305 DESK-TOP CALCULATOR WITH CLOCK & CALENDAR

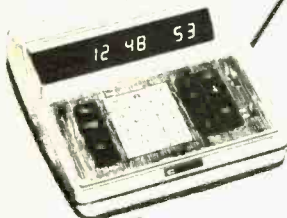

full 7 function (+, -, x, ÷, %, square root and reciprocal) with 10 digit readout, selectable 2-4 or floating decimal, automatic, constant and many features. But when the 305 isn't being used as a calculator it's a digital clock and calendar that keeps perfect time as long as it's plugged in.

Model 305 \$99.95
 Model 300 w/o clock 84.95

3. **Convenience** You can order by mail and use your Bank cards or American Express with up to 12 months to pay. You can talk to a salesman toll free anytime - just call 800-527-4642.

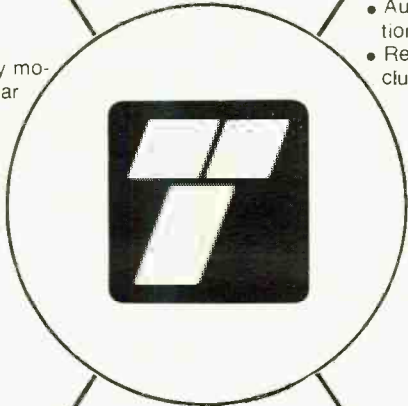

ADD \$2.75 TO EACH ORDER FOR SHIPPING.

Send check, money order, Bank Americard No., Mastercharge No. or American Express No. to: (Residents of Texas, Illinois, New Jersey & California include 5% sales tax)

TUCKER
 ELECTRONICS • COMPANY

P.O. Box No. 1050C
 Garland, Texas 75040

FOR RUSH ORDERS CALL TOLL-FREE 800-527-4642 (In Texas call 214-348-8800)

which the tonearm designer cannot predict.

Some people are reasonably successful in picking a workable combination of arm and cartridge. Others, and I include myself, have not always been so blessed. The symptoms of a mismatch can be surprisingly varied; they almost have to be described one by one.

A combination with too high a resonance (the result of a very light tonearm or a very stiff stylus) would tend to get involved with the audio frequencies, causing aberrations in the deep bass response of the system. Probably, there would be a severe peak in the response, with a sharp rolloff below. I can't say from experience since I've never come across such a combination.

The majority of tonearms tend to be too massy for the compliance of many cartridges. This includes a few of the beautifully machined arms from abroad, which often exact a certain price in performance for their cosmetic appeal. A massive arm tends to force the frequency of resonance down into the warp region, with sundry effects. The warps occurring above resonance have to be managed by the flexing of the stylus. This causes heavy pulses of subsonic energy from the cartridge and can possibly overload the amplifier and speakers. (Even if the latter are not audibly bothered by these throbs, a tape recorder or the tape you are using to dub a record may be affected. They are also subject to overload.)

Warps above resonance can also cause the cartridge to exhibit what is known as "warp wow." The stylus, in flexing up and down, is also thrust forward and back along the length of the record groove, which imposes a low-frequency "wow" modulation on the music (see Fig. 2).

All this might seem like trouble enough, but it is nothing compared to what happens when the warps occur near or at resonance.

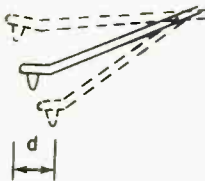

Fig. 2. Warp problems can produce severe vertical deflections of stylus assemblies, causing the tip to move forward and back in the groove over distance d . This imposes a "wow" modulation on music. Tone arms, especially shorter ones, are also subject to the effect.

Due to the extreme agitation of both stylus and tonearm, the tracking force may vary, moment to moment, from extremely heavy to nothing—or even less. When it becomes less than nothing, the stylus leaves the record surface, usually jumping a groove or two. As the tracking force approaches nothing, the cartridge goes into mistracking distortion on the recorded material. The possibility of having overload problems is usually great at resonance because of the vigorous stylus motion. Warp wow also occurs, but it may go unnoticed amid all the other audible activity. (It may be some comfort to know that performance is usually adequate when warp frequencies are below resonance.)

I always try to look for tonearms that have very low rotational mass. This would seem to make good sense because, with today's high-compliance cartridges, there is no readily available tonearm light enough to drive resonance up into the audio-frequency range. But does this approach keep me out of trouble? Definitely not. The least massive of modern tonearms, paired with modern cartridges, seem to produce a resonance somewhere above 6 or 7 Hz, which is near the top of the warp frequency range. Generally this is fine, but some cartridges mated with light arms have occasionally been prone to certain kinds of instability. Sometimes, when high-frequency warps do crop up, they produce (because of their higher rate) warp flutter instead of warp wow. Or an unstable arm/cartridge combination can apparently suffer from flutter and other effects even when no obvious cause (such as a warp) is present.

Subtle amounts of flutter can masquerade as distortion, quite successfully, which can get you very involved with troubleshooting your amplifier when you should be paying attention to the record player. The worst case of flutter I have ever experienced was when I managed to select a tonearm/cartridge combination that apparently coincided with the resonance of the spring-mounted turntable motorboard. Fortunately, the flutter was quite audible as such, so I didn't rush out to have my amplifier checked. But I was fascinated by some of the side effects that came along with the flutter. First of all, the quality of the stereo was definitely affected. I don't really know the reason for this, but I tentatively attributed it to phase irregularities caused by the disturbance of the stylus-groove relation-

10Mhz 3" Triggered Sweep Scope ... 1/3 the size of comparably performing scopes



Model
1431

\$400⁰⁰

only 4³/₄"
high

It's a lightweight 13 pounds in your hand with heavy-weight wideband scope performance on your bench or jobsite. Only 35 nanosecond rise time, 10 millivolts/division sensitivity and 19 calibrated auto or triggered sweep speeds from 0.5 usec/cm to 0.5 sec/cm with 5X magnification. Pushbutton selected sync modes include internal, external, pos and neg slope, and TV horizontal and TV vertical with exclusive TV sync separator. If you've been waiting to buy a portable scope until you could get all the features you'll ever need at a price you want to pay, you've been waiting for the B&K Precision Model 1431. See your distributor or write Dynascan Corporation.

B&K PRODUCTS OF
DYNASCAN

1801 W. Belle Plaine Ave.

Chicago, IL 60613 • (312) 327-7270

The Ultimate in Ignition Systems!
★ ELIMINATES BREAKER POINTS. ★
Perfect Timing and Dwell never change!

- Never wears out or needs any Maintenance.
- Eliminates Tune-ups.



- **The Most Advanced OPTO-ELECTRIC SYSTEM**
- The Allison Breakerless System eliminates the Points and Condenser, replacing them with an Opto-Electronic Trigger, using a Light-Emitting Diode and Phototransistor. The only "TRUE" Electronic Ignition! Gives 40 times more Timing Accuracy than ANY system using mechanical Breaker-Points! Unlimited RPM. Smoother running... (No timing fluctuation as with Magnetic units). Unaffected by Temperature, Moisture, or Vibration! All Solid-State Components. Easier Starting under any condition. Increased Horsepower. Sparkplugs last longer. Perfect timing increases engine Efficiency and Gas Mileage up to 30%!

Quick and Easy Installation! Tested and Proven reliability.

- Only **\$49.95**
- **SATISFACTION GUARANTEED!**
- **1-YEAR FACTORY WARRANTY!**

(State Make, Year, Engine Size). (Calif. Res. add Tax).

- **CONVERT YOUR "C-D" UNIT TO BREAKERLESS!**
- **"TRIGGER-UNIT" ONLY \$34.95**

- **Send Postcard for FREE BROCHURE Today.**

ALLISON AUTOMOTIVE CO.

P.O. Box 881-P, TEMPLE CITY, CAL. 91780

CIRCLE NO. 1 ON READER SERVICE CARD



SAVE ON
Brand Name Audio
Components **BY MAIL**

WRITE TODAY FOR OUR FREE WHOLESALE AUDIO CATALOG

DIXIE, one of the largest stereo wholesalers, fills all your orders promptly. At prices actually LOWER than "Discounters". Write for our Wholesale Price Catalog, or quotes. Choose the famous brand stereo equipment and accessories you desire. Everything shipped factory-sealed.

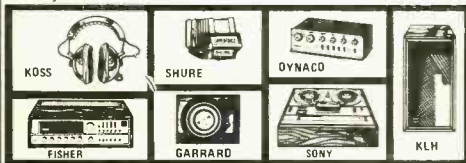

Master Charge
BankAmericard
honored on
mail orders

DIXIE HI-FI WHOLESALE

5600 Second St., N. E., Washington, D. C. 20011
Phone: 1-202-635-4900

Please rush me your FREE Wholesale Audio Catalog and complete information. I understand there is no obligation.

- Please Check Your Music Preference: (1 only)
 Rock Classical Country

PE-7

Name _____
 Address _____
 City _____
 State _____ Zip _____

CIRCLE NO. 12 ON READER SERVICE CARD

ship. (An oscilloscope check suggested that the tonearm was moving not just up and down, but also from side to side in a sort of shimmy.) Subtle cartridge mistracking could also have been responsible.

In addition, there seemed to be an increase in the amount of high-frequency record noise. Perhaps this was a type of modulation noise imposed on the recorded signal, or on the noise in the signal. Again, I don't really know; but I do know that this particular arm/cartridge/turntable combination was useless except as a curiosity.

Some Tentative Advice. Despite what I said above, a low-mass (low-inertia) tonearm still seems to be the best answer. What are the identifiable characteristics of a low-mass arm? The rotational inertia of a tonearm increases only linearly with an increase in mass, while it increases according to the square of the distance the mass is located from the pivot assembly. This indicates that a large counterweight located close to the pivot is better than a small one that rides well back toward the rear of the turntable.

Short arms tend to exhibit less inertia than longer ones. Among the best arms for dealing with warps seem to be short designs that have their principal masses located very close to the pivot points. However, short arms describe a tighter arc in negotiating up-and-down warps and therefore, like styli, are susceptible to warp wow. However, unless the wow tendency is severe on many records, the improved tracking ability afforded the cartridge by a short, light arm may prove to be worthwhile.

Probably the best and easiest way to evaluate the inertia of an arm is to use and observe it for a while. I generally find that an excessively massy arm can be detected just by hefting it around a bit by hand, watching how it responds to the movements of your finger and wrist. You can see how much agility it displays when it is lowered to the record surface. Surprisingly, some very good arms can occasionally be reluctant in letting the stylus "find" the groove when first set down. They are perfectly capable of playing the "land" area of the record between the grooves; and a slight jog may be necessary to locate the stylus properly.

When playing a record, a tonearm is best judged by the amount of gyration it *doesn't* require the stylus to perform in negotiating warps. If you get your eyes on a level with

the turntable, you can observe the stylus pretty closely. It should appear to remain almost perfectly stationary, with the tonearm absorbing all the vertical jolts of the record surface. Small, abrupt warps are frequently more revealing in this test than large, leisurely ones.

An oscilloscope is the best tool for discovering whether or not a record player is having serious problems with mechanical instability. Use a record with a simple recorded signal, such as a sine or square wave. Usually, the trace will display a small amount of vertical "jitter." If the jitter is excessive, and if the switching in of the amplifier's rumble filter virtually cures the jitter, then there is reason to be suspicious. Severe cases of instability will cause the trace to "bowstring" or form shuddery, multiple images. Gross problems will break up parts of the trace because of cartridge mistracking.

Unfortunately, once you detect signs of tonearm difficulties, there is usually very little you can do to alleviate them without replacing some component in the record-playing system. More effective remedies

await cooperation between tonearm and cartridge manufacturers. ♦



"Dididit Dahdahdah Dididit!"

THANKS FOR WAITING—

Sorry it took so long, but at last we can offer you an octave equalizer kit that meets our standards of quality and value. Our EQ-1 features nine single octave controls per channel. Each can be set for up to 12dB of boost or cut. Total harmonic distortion is less than .01% at any output level up to 5 Volts RMS. Hum and noise are more than 65 dB down. You can add this equalizer at the tape monitor jacks, or between your preamp and amplifier. When you don't need equalization, the response is flat within less than 0.5 dB from 10 to 100,000 cycles. All filter circuits are active filter operational amplifier types for hum free, no ringing response. The cabinet has a satin red-gold front panel and a vinyl covered steel top. What more could you want? 115 Volts AC 50-60 cycles.

EQ-1 Stereo Octave Equalizer Kit

\$99.50 Postpaid

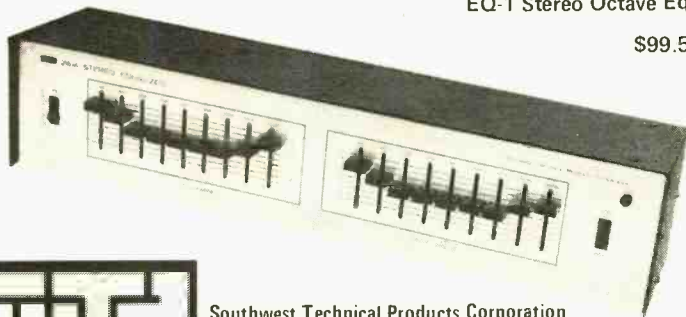

Southwest Technical Products Corporation
219 W. Rhapsody, Dept. RE
San Antonio, Texas

CIRCLE NO. 24 ON READER SERVICE CARD



News Highlights

Columbia Records and Fairchild Embark on SQ IC Program

Columbia Records has announced that Fairchild Semiconductor will produce the full range of SQ integrated circuits for world-wide distribution to manufacturers of SQ audio equipment. The IC's are expected to make their debut commercially this year. At its highest level of quadrasonic performance, the SQ system consists of three low-cost chips—the matrix IC, in conjunction with a logic-control IC and a voltage-control amplifier IC. The matrix IC by itself can be used in less-expensive audio equipment to achieve decoding but it is not as effective as the "full SQ" system. Motorola and Sony have also developed IC chips for the SQ system.

Optical Supermarket Checkout System

If you've ever done supermarket shopping for yourself or your wife, you know the long delays required for the checker to locate the price of each item and ring it up on the register. Sperry Univac's supermarket checkout system should speed things up. It is the first optical scanning system fully tested in a large supermarket, where it read symbols marked on more than eight million items during 5135 hours of operation over a 15-month interval. The system uses a fixed laser beam optical reader at the end of the checkstand to detect, read, and decode symbols on product containers or labels. A specially designed minicomputer retrieves the price of the item, based on the code number, for visual display and printing on a customer receipt tape.

REACT Helps Save Fuel

REACT teams everywhere are participating in a special effort to aid motorists equipped with CB radios during the energy crisis. With over 4-million such radios in use in the U.S.A., and most of them installed in vehicles, REACT members are receiving many calls on Channel 9 from motorists seeking assistance. The members are prepared to supply route information that can save mileage and fuel during the current shortage. They can also direct the motorist around traffic jams caused by accidents or road repairs.

Voice Encoding System for Automatic Baggage Handling

All outgoing baggage routing at TWA's JFK Airport in New York City will be handled by a new voice-encoded system. Customers check baggage either at curbside or at the ticket counter. The baggage is labeled in the usual fashion with a tag containing an identification number, flight and destination. It is then conveyed to TWA's central automated sorting system where it first reaches an "induction station." Here an operator speaks the flight number and destination for each bag into a microphone while simultaneously placing the bag on the central sorting conveyor. The system recognizes and responds to the spoken words by the operator and sends the baggage to the appropriate loading area for its flight. When the flight is fully ready to be loaded, the system prints out a list of the number of bags on that particular flight by destination.

The editors' choice: Heathkit Digital Design Color TV!



“At **ELEMENTARY ELECTRONICS** they said: “The fact is, today’s Heathkit GR-2000 is the color TV the rest of the industry will be making tomorrow...there is no other TV available at any price which incorporates what Heath has built into their latest color TV.”

The **FAMILY HANDYMAN** reviewer put it this way: “The picture quality of the GR-2000 is flawless, natural tints, excellent definition, and pictures are steady as a rock. It’s better than any this writer has ever seen.”

POPULAR SCIENCE pointed out “more linear IC’s, improved vertical sweep, regulators that prevent power supply shorts, and an industry first: the permanently tuned I.F. filter.”

The **RADIO-ELECTRONICS** editors said the Heathkit Digital TV has “features that are not to be found in any other production color TV being sold in the U.S.:

“On-screen electronic digital channel readout...numbers appear each time you switch channels or touch the **RECALL** button...*On-screen electronic digital clock*...an optional low cost feature...will display in 12- or 24-hour format...*Silent all-electronic tuning*. It’s done with uhf and vhf varactor diode tuners...*Touch-to-tune, reprogrammable, digital channel selection*...up to 16 channels, uhf or vhf...in whatever order you wish...there’s no need to ever tune to an unused channel. *LC IF amplifier* with fixed ten-section *LC IF bandpass*

filter in the IF strip...eliminates the need for critically adjusted traps for eliminating adjacent-channel and in-channel carrier beats. No IF alignment is needed ever. *Touch volume control*...when the remote control is used...touch switches raise or lower the volume in small steps.”

POPULAR ELECTRONICS took a look at the 25-in. (diagonal) picture and said it “can only be described as superb. The Black (Negative) Matrix CRT, the tuner and IF strip, and the video amplifier provide a picture equal to that of many studio monitors...”

Furthermore, the Heathkit GR-2000 is an easier kit-form TV to build. **POPULAR ELECTRONICS** pointed out that “Each semiconductor has its own socket and there are 12 factory-fabricated interconnecting cables...The complete color adjustments can be performed in less than an hour.”

To sum up, **POPULAR ELECTRONICS** concluded its study by stating, “In our view, the color TV of the future is here—and Heath’s GR-2000 is it!”

Why not see what the experts have seen? The Heathkit Digital Design Color TV—without question the most remarkable TV available today.

Mail order price for chassis and tube, \$659.95. Remote Control, \$89.95 mail order. Clock, \$29.95 mail order. Cabinets start at \$139.95. (Retail prices slightly higher).



Send for your **FREE '74 Heathkit Catalog** – world’s largest selection of electronic kits

HEATHKIT ELECTRONIC CENTERS
Units of Schlumberger Products Corporation
Retail prices slightly higher.

ARIZ.: Phoenix; CALIF.: Anaheim, El Cerrito, Los Angeles, Pomona, Redwood City, San Diego (La Mesa), Woodland Hills; COLO.: Denver; CONN.: Hartford (Avon); FLA.: Miami (Hialeah), Tampa; GA.: Atlanta; ILL.: Chicago, Downers Grove; IND.: Indianapolis; KANSAS: Kansas City (Mission); KY.: Louisville; LA.: New Orleans (Kenner); MD.: Baltimore, Rockville; MASS.: Boston (Wellesley); MICH.: Detroit; MINN.: Minneapolis (Hopkins); MO.: St. Louis; NEB.: Omaha; N.J.: Fair Lawn; N.Y.: Buffalo (Amherst), New York City, Jericho, L.I., Rochester, White Plains; OHIO: Cincinnati (Woodlawn), Cleveland, Columbus; PA.: Philadelphia, Pittsburgh; R.I.: Providence (Warwick); TEXAS: Dallas, Houston; WASH.: Seattle; WIS.: Milwaukee.



HEATH COMPANY, Dept. 10-7
Benton Harbor, Michigan 49022

HEATH
Schlumberger

Please send **FREE** Heathkit Catalog.

Name _____

Address _____

City _____ State _____ Zip _____

* Mail order prices; F.O.B. factory.

CL-516R

CIRCLE NO. 5 ON READER SERVICE CARD

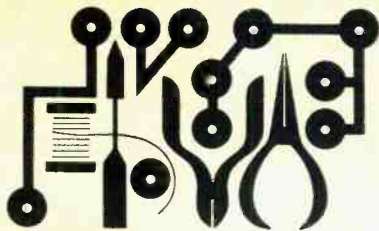

Hobby Scene

Checking Zener Diodes

Q. I have a number of unmarked zener diodes. How can I determine their voltage ratings?

A. In the circuit shown here, a high-voltage, external dc power supply is used. The maximum voltage would depend on what you think will be the highest rating of the zeners you have. A 100-volt supply should cover most contingencies. Now, adjust the potentiometer until the indication on the meter comes to a stop. The reading on the meter is the zener's breakdown voltage.

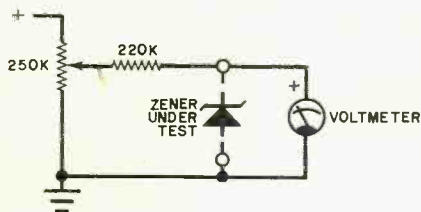

A "Turn-Off-The-Lights" Reminder

Q. I have a bad habit of leaving the car lights on after I have removed the ignition key and left the car. The next morning, of course, there is trouble. Do you have a very simple circuit that would alert me when I do this stupid thing?



A. Try the circuit shown here. Use any silicon rectifier diode and any kind of 10-to-12-volt buzzer, bell, or tone alert module. The alarm will sound if you leave the lights on after the ignition is turned off.

How to Detect Water in the Basement

Q. With all of the rain we've had this spring, I keep getting flooding in the basement. Could I rig up some sort of simple system that would let me know when to go down and turn on the sump pump? I'm not really very experienced electronically.

A. The circuit here is about the simplest you could build to do the job. You can use some

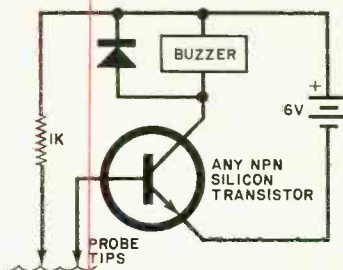

ordinary D cells for the power and any type of warning device that will operate on 6 volts. The circuit draws very little current on standby, but when water touches the probe tips, the alarm will sound off.

Getting Semiconductor Information

We get a lot of mail asking where certain semiconductors and other special parts can be obtained. Most of the parts used in construction projects can be found in the catalogs of our advertisers. Of course, they can't show everything in their ads, so please write to them for their catalogs. You will find a goldmine of useful information in them.

Have a problem or question on circuitry, components, parts availability, etc.? Send it to the Hobby Scene Editor, POPULAR ELECTRONICS, One Park Ave., New York, NY 10016. Though all letters can't be answered individually, those with wide interest will be published.

NEW! Build and test circuits as fast as you can think! No soldering or patch cords!

Plug in...wire...modify...build...test

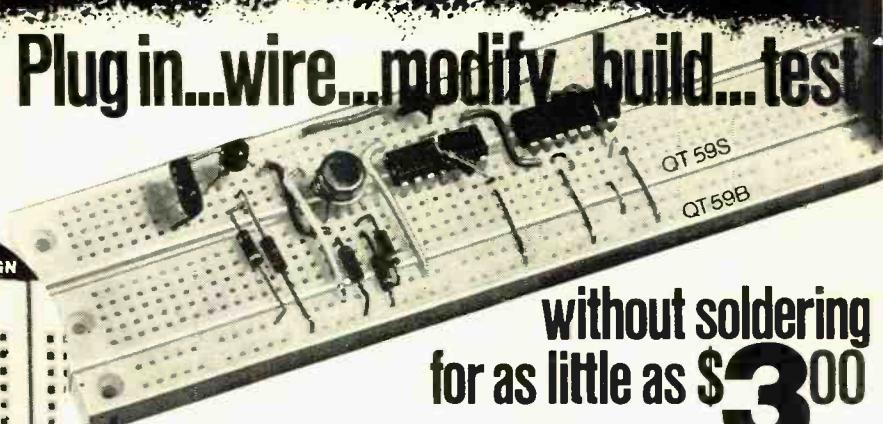

without soldering
for as little as \$3.00

Flexible new Continental Specialties QT SOCKETS® and BUS STRIPS are a fast, easy breadboarding system with unique SNAP/LOCK that lets you add or remove as many QTs as you need instantly. Now you can test ICs, transistors, resistors, capacitors and more. Just plug in, and connect with solid #22 AWG hook up wire... no soldering is needed! No more shorts! No more burnt fingers! No special patch cords! And you can use QTs again and again! QTs come in different sizes, starting as low as \$3 for QT Sockets and \$2 for Bus Strips. Order yours today!

plus, four new completely assembled PROTO BOARDS...

PAT. PENDING

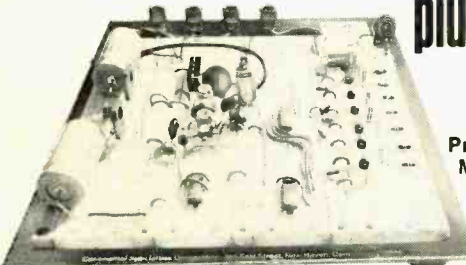

Proto Board Model No.	14 Pin DIP Capacity	Size (L" x W")	Price (U.S. only)
101	10	5.8" x 4.5"	\$29.95
102	12	7.0" x 4.5"	\$39.95
103	24	9.0" x 6.0"	\$59.95
104	32	9.5" x 8.0"	\$79.95

Four new Continental Specialties Proto Boards, made from combinations of QT Sockets and Bus Strips let you make all circuit and power interconnections with common solid #22 wire, while power distribution busses make wiring a snap. Aluminum base plates offer solid work surfaces and perfect ground plane. Rubber feet prevent scratching. Each Proto Board features one or more 5-way binding posts to tie into system or power supply ground. All are compatible with ICs (digital or linear), in TO5s, DIP packs and discrete components. Each is assembled and ready-to-use.

Order today — or send for free selection guide, with applications, photos, specs and more.



Continental Specialties Corp.

325 East St., Box 1942
New Haven, CT 06509
Telephone (203) 624-3103

CANADA: Available thru Len Finkler, Ltd., Downsview, Ontario

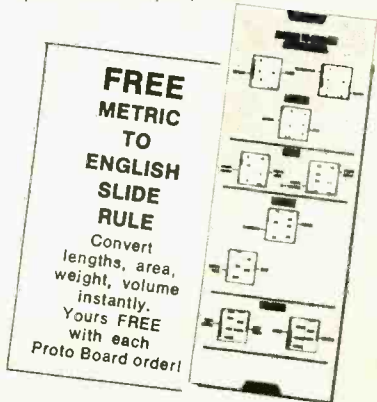

CIRCLE NO. 8 ON READER SERVICE CARD

THERE'S A BETTER WAY TO GO.



Energy shortages tell us we have to change our driving style. Now! It doesn't mean we have to go back to horse and buggy days. But it does mean we have to make every drop of gas give us the most go for our money. Anyone with horse sense knows that a well-tuned car gets better mileage, and in times of fuel shortages, better mileage means a lot.

The Mark Ten B Capacitive Discharge System keeps your car in better tune so it burns less gas. Using Mark Ten B is more than horse sense. It's the smart move under the hood, helping a nation survive an energy crisis and keeping you on the road. Delta Mark Ten. The best way to go.



CIRCLE NO. 10 ON READER SERVICE CARD

DELTA PRODUCTS, INC.

P.O. Box 1147, Dept. PE
Grand Junction, Colo. 81501
(303) 242-9000

Please send me free literature.
Enclosed is \$ _____ Ship p.p.d. Ship C.O.D.
Please send: _____ Mark Ten B assembled @ \$64.95 p.p.d. _____ Mark Ten B Kit @ \$49.95 p.p.d. (12 volt negative ground only) _____ Standard Mark Ten assembled, @ \$49.95 p.p.d. _____ 6 Volt: Neg. Ground Only _____ 12 Volt: Specify _____ Pos. Ground _____ Neg. Ground _____ Standard Mark Ten Deltakit® @ \$34.95 p.p.d. (12 Volt Positive or Negative Ground Only)

Car Year _____ Make _____

Name _____

Address _____

City/State _____ Zip _____

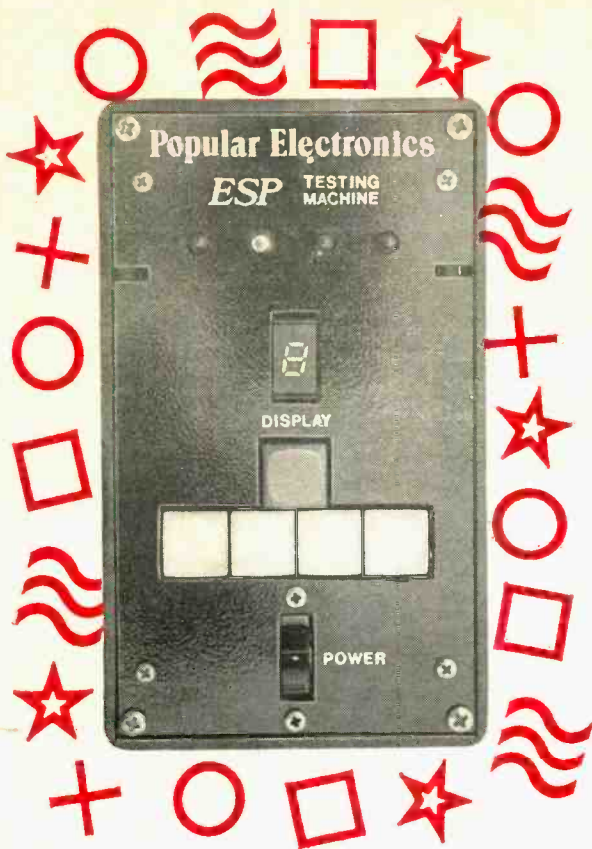

BUILD AN

ESP TESTING MACHINE



*Experiment with
a young science
and provide
entertainment
too!*

BY IRA H. SPECTOR

OVER forty years ago, Dr. J. B. Rhine, of the Duke University Parapsychology Laboratory, began the first thorough scientific research into extrasensory perception (ESP). In those days, testing for ESP consisted of thousands of card-guessing experiments in which subjects would try to pick the exact order of a deck of cards to see how close they could come. Since a certain amount of "hits" were expected by chance, Dr. Rhine and his associates were only interested in those individuals who could consistently achieve scores that were significantly above chance. Those persons provided the experimenters with overwhelming evidence of the existence of ESP.

For today's advanced parapsychological research projects, the trend is away from card guessing. Recent ESP testing machines provide a test, automatically keep score, and can be interfaced with other instruments for determining physiological and psychological

correlates of extrasensory perception.

The ESP Testing Machine described here incorporates many of these features. It is a portable, battery-operated device that allows the experimenter to test for all three types of ESP—telepathy, clairvoyance, and precognition. Additionally, it's a fun game for entertainment purposes.

General Description. The ESP Test Machine consists of four light-emitting diodes (LED's) which serve as ESP "targets." There are four corresponding target-select pushbuttons. An internal random-number generator selects one of the LED's for illumination behind a small partition so that the target is not visible to the subject.

Although the procedure varies according to the type of ESP under investigation, the general objective is for the subject to achieve a "hit" by pressing the pushbutton corresponding to the hidden target. After each

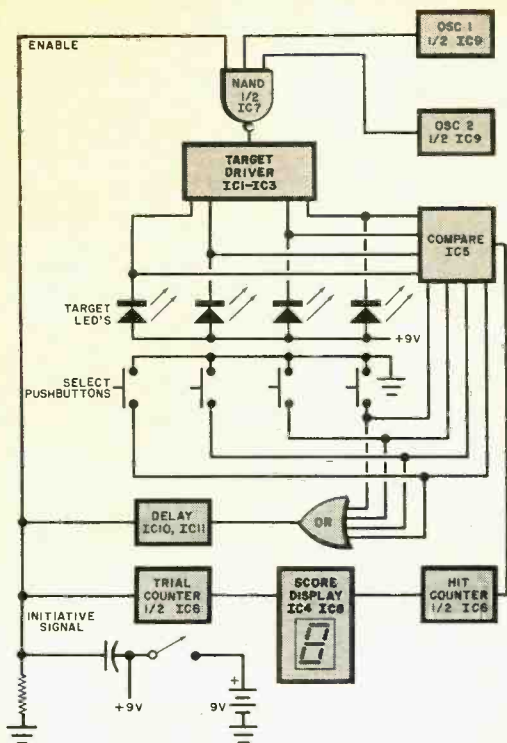

Fig. 1. Logic diagram of the Testing Machine. Two oscillators are gated to turn on one LED at random. When switch for lighted LED is pressed, a hit is shown on display.

trial, the random-number generator automatically selects the next target. When ten trials are completed, the number of hits is automatically displayed by a numeric indicator. A manual-display pushbutton is also provided to allow immediate feedback of the score anytime during the test run.

Since there are four equally probable target choices, the probability of a hit during any trial is 25%. Therefore, in ten runs (100 trials), the chance score is 25 hits. Tests scores which regularly deviate significantly from chance are considered evidence of ESP.

Circuit Operation. The basic logic circuit is shown in Fig. 1. When power is first turned on, an initiating signal generated by an RC circuit turns on a single, randomly selected LED.

When one of the four pushbuttons is depressed, an enable signal is generated. This goes through a delay to a three-input NAND gate formed by half of IC7. The other two inputs to the NAND gate come from a pair of non-synchronized pulse-generator oscillators

(IC9). When the NAND gate is enabled, it allows two non-synchronized pulse trains to clock the target driver made up of IC1, IC2, IC3. This causes the LED's to illuminate in a 1-2-3-4 sequence at a random rate. At this speed of operation, the four LED's will all glow weakly. When the selected pushbutton is released, the enable signal is removed from the NAND gate (after a random delay), and only one of the LED's will remain lit.

Each time the enable signal is generated, it also clocks the trial counter (IC6). After counting up to 10 trials, this counter generates a stop signal which turns on the seven-segment readout to display the number of "hits." It simultaneously turns off all four LED's. In the case of 10 consecutive hits, the logic produces a capital letter "H" on the seven-segment readout. To start a new test run, the power is turned off and then on again.

If the operated pushbutton corresponds to the illuminated LED, a comparator (IC5) generates a signal which is counted by the hit counter to form the display on the readout.

The length of the enable signal is a function of the time that one of the selection pushbuttons is held down. The delay in the circuit depends on the amount of bounce that occurs when the switch is operated. This adds human and mechanical randomizing elements to the target selection.

The actual circuit of the machine is shown in Fig. 2.

Construction. The ESP Testing Machine uses a double-sided pc board. Due to the large size of the foil patterns, they cannot be reproduced here. However, you can obtain them, free of charge, by writing (enclosing a self-addressed, stamped envelop for return) to Editorial Dept., POPULAR ELECTRONICS, 1 Park Ave., New York, NY 10016. The layout of components is shown in Fig. 3.



Piece of opaque plastic is cut to fit on top of chassis to form the vision barrier.

In working with the CMOS IC's, be sure that they do not come in contact with anything that can build up a static charge. Keep them in their conducting foam until ready for installation and handle them only by their non-pin edges. Use a small, low-wattage soldering iron with a grounded tip and observe the notch index for proper positioning.

Install the four white (S2 through S5) and one red (S1) pushbutton switches on

the Display Side of the board, along with the seven-segment readout. Mount the four LED's so that their bases are about $\frac{1}{8}$ " above the board. Use short lengths of bare wire, soldered on both sides of the board, for the test points.

Mark the cover of the plastic box so that it can be drilled and cut to allow the six switches, ROI, and LED's to protrude. The pc board is mounted on the front panel using $\frac{3}{16}$ " spacers. The power switch (S6) is

ESP TESTING PROCEDURES

General Principles. It is desirable to experiment in a quiet, comfortable room with subdued lighting. Take the test slowly, allowing enough time during each trial to develop a "feel" for the correct target. Use the DISPLAY pushbutton for immediate feedback when you think you are performing well.

Try to correlate any psychological factors (mood, approach, etc.) or physiological factors (tiredness, physical comfort, etc.) with test scores to see if patterns emerge. Use the figures in the Performance Chart to evaluate your scores.

Always keep the target partition in place during tests and always press the target select button for at least $\frac{1}{2}$ second to ensure the registering of your trial and to provide extensive randomizing of the targets.

Testing for Telepathy. Mental telepathy is the transferring of information from one individual to another without the use of the five senses. The procedure for conducting a telepathy test is as follows:

1. Place the ESP Testing Machine on a table between the subject (receiver) and the sender. Make sure that the machine is oriented so that the targets are visible only to the sender.

2. When the power is turned on and the initial target is illuminated, the sender concentrates on the number on the target partition that corresponds to the target selected by the machine.

3. The subject should then try to get a mental image of the correct number and press the corresponding target select pushbutton. The subject should never look at the sender during the test to avoid "sensory leakage."

4. Repeat this procedure until ten trials are complete and the score is displayed.

Note: You may want to substitute

other target material for the numbers on the partition to see how scores are affected. Use letters, colors, pictures—anything that you feel will enhance the visualization process.

Testing for Clairvoyance. Clairvoyance is the perception of objects without the use of the five senses. The procedure is as follows:

1. Position the ESP Testing Machine so that the targets are not visible to anyone. This precaution avoids the possibility of "telepathic leakage."

2. Turn on the power and try to visualize which target is illuminated. Then press the appropriate pushbutton.

3. Continue this procedure until the run is complete and the score is displayed.

Testing for Precognition. Precognition is the prediction of future events that cannot be inferred from present knowledge. The procedure is:

1. Write down a list of ten numbers from among the target integers 1, 2, 3, and 4. Use any sequence which you "feel" will be selected by the machine when you actually perform the test.

2. Turn on the power and press the target select pushbuttons in accordance with the chosen sequence. When the last number is entered, your score will automatically be displayed.

Other Tests. The use of the ESP Testing Machine with other electronic equipment will permit a more detailed investigation of the nature of ESP. For example, if ham radio equipment is available, telepathy-over-distance tests can be performed either to verify or challenge previous results indicating that telepathy performance is unaffected by distance. If high scores are achieved, it would be an indication that the telepathy signal was not appreciably affected by distance.

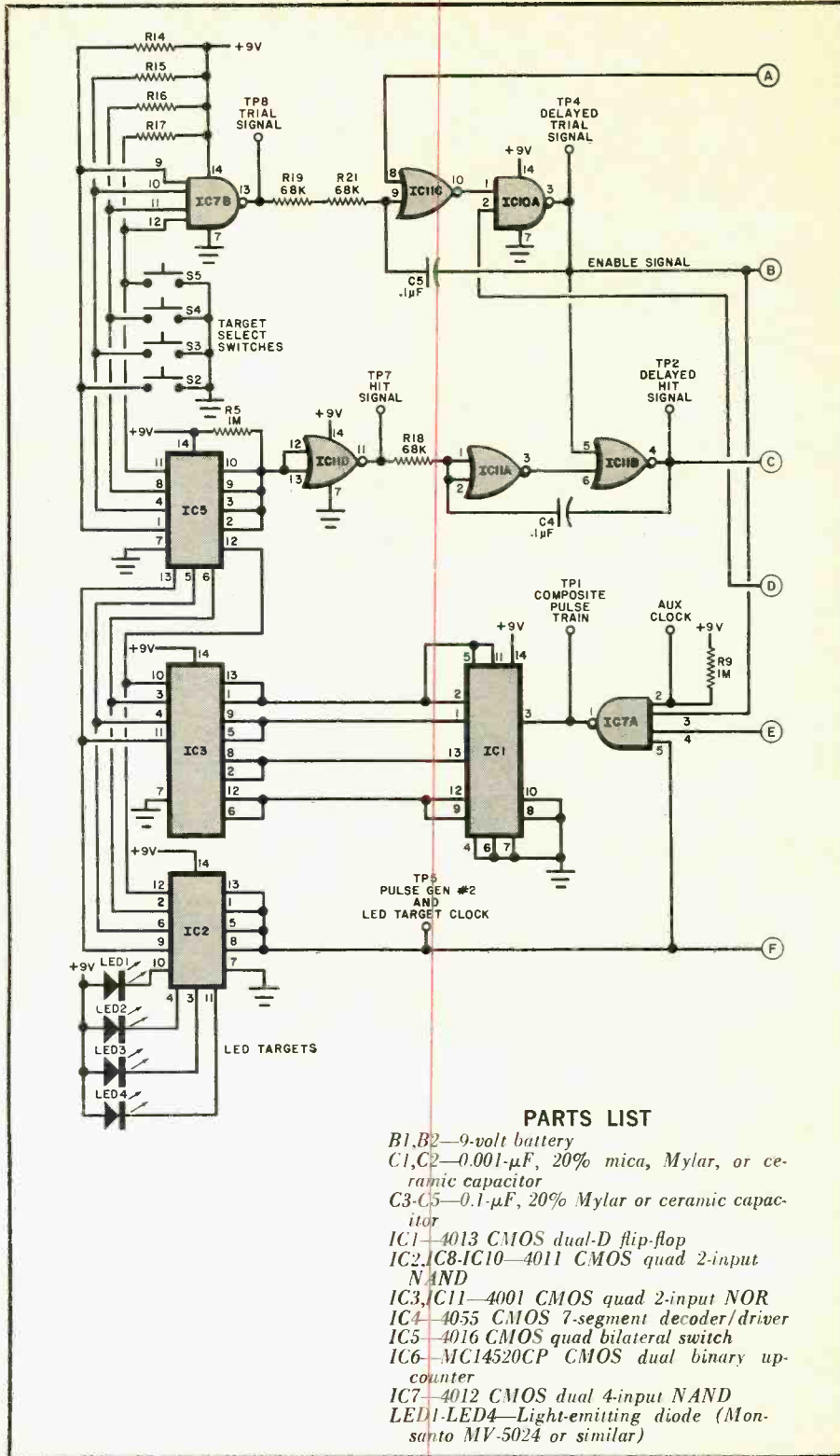

PARTS LIST

- B1,B2—9-volt battery
 C1,C2—0.001- μ F, 20% mica, Mylar, or ceramic capacitor
 C3-C5—0.1- μ F, 20% Mylar or ceramic capacitor
 IC1—4013 CMOS dual-D flip-flop
 IC2,IC8-IC10—4011 CMOS quad 2-input NAND
 IC3,IC11—4001 CMOS quad 2-input NOR
 IC4—4055 CMOS 7-segment decoder/driver
 IC5—4016 CMOS quad bilateral switch
 IC6—MC14520CP CMOS dual binary up-counter
 IC7—4012 CMOS dual 4-input NAND
 LED1-LED4—Light-emitting diode (Monsanto MV-5024 or similar)

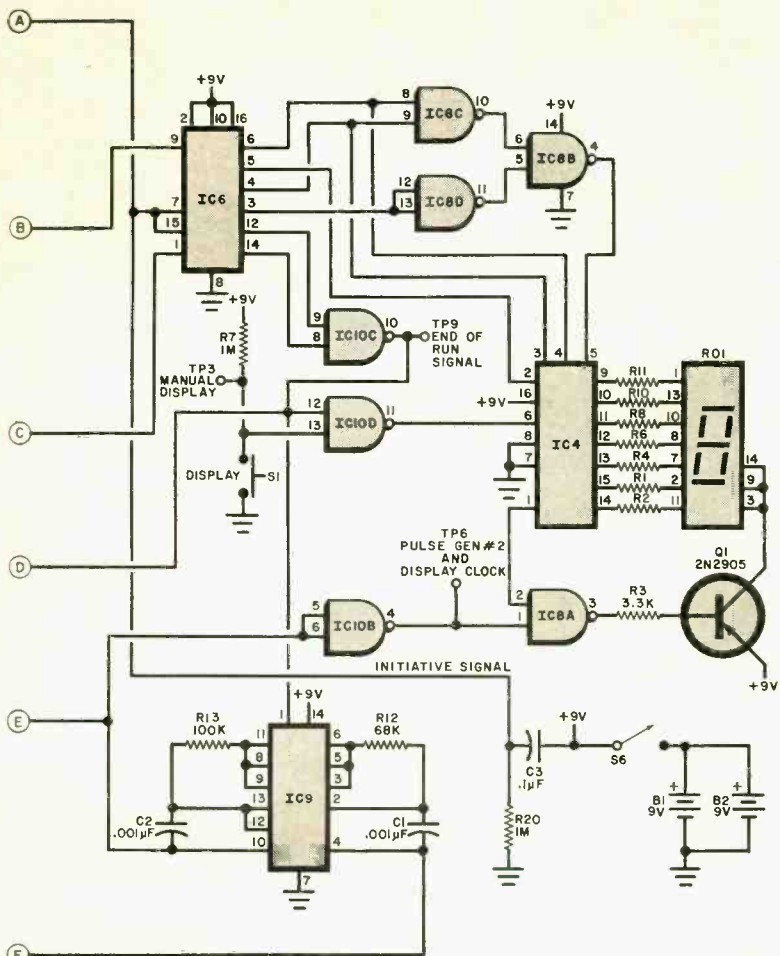

Fig. 2. The complete schematic for the ESP Testing Machine is shown above and on the opposite page. The circuit is powered by two 9-volt batteries. CMOS logic units are used to reduce drain on the batteries.

- Q1—2N2905 transistor
 R1,R2,R4,R6,R8,R10,R11—560-ohm, $\frac{1}{4}$ -watt, 10% resistor
 R3—3300-ohm, $\frac{1}{4}$ -watt, 10% resistor
 R5,R7,R9,R14-R17,R20—1-megohm, $\frac{1}{4}$ -watt, 10% resistor
 R12,R18,R19,R21—68,000-ohm, $\frac{1}{4}$ -watt, 10% resistor
 R13—100,000-ohm, $\frac{1}{4}$ -watt, 10% resistor
 RO1—7-segment LED readout (Litronix DL-707 or similar)
 S1—Spst momentary pushbutton switch (red) (Oak 415-399592-LP or similar)
 S2-S5—Spst momentary pushbutton switch (white) (Oak 415-399596-LP or similar)
 S6—Spst alternate-action rocker switch (Chicago 26-220-100 or similar)
 Misc.—Case (H. H. Smith 2255), cover (H. H. Smith 2256), plastic for target partition,

battery holders (2), battery connectors (2), mounting hardware, etc.

Note 1—The following are available from Paratronics, 150 Tait Ave., Los Gatos, CA 95030: etched and drilled pc board (ESP-1PC) at \$7.00; finished and labelled panel, case, and target partition (ESP-1PP) at \$5.50; complete kit of parts (less batteries) (ESP-1KN) at \$69.00; assembled and tested unit (ESP-1AT) at \$86.00. All items postpaid. California residents please add 6% sales tax.

Note 2—Foil patterns for the double-sided pc board can be obtained free of charge by writing (enclosing a self-addressed, stamped envelope) to Editorial Department, POPULAR ELECTRONICS, 1 Park Ave., New York, NY 10016.

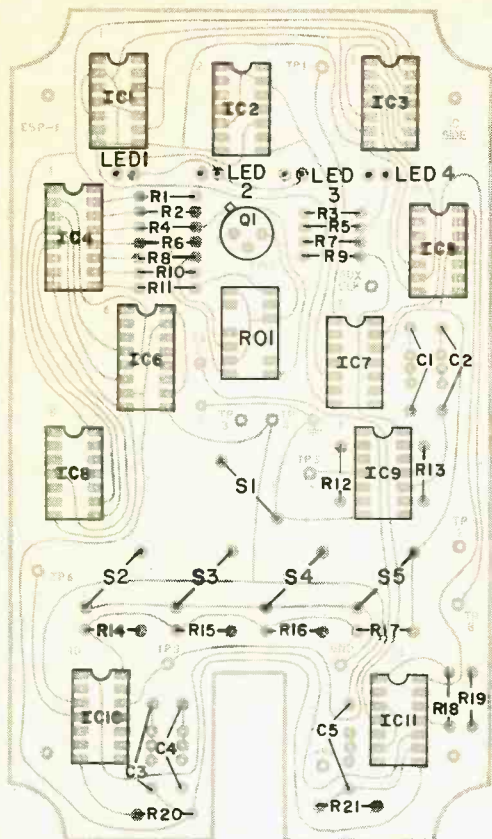

NOTE: LED1-LED4, ROI, & SI-S5 ON SIDE OPPOSITE IC'S

Fig. 3. Component layout for the pc board.

mounted directly to the front panel and fits into the cutout on the board.

The chassis cover should also have two slots, one on each side, between the LED's and the readout. A piece of opaque plastic should be cut so that it will fit into the slots on each side. This forms a vision barrier so that the person operating the pushbuttons cannot see the LED's. Mark the barrier with the numbers 1, 2, 3, and 4 on each side, keeping in mind that on one side the numbers must read from left to right, and right to left on the other.

PERFORMANCE CHART			
No. of Runs*	Chance Score	Good Score (Odds 20:1)	Excellent Score (Odds 100:1)
10	25	34	36
20	50	62	66
30	75	90	94

*10 trials in each run.

Complete the wiring in accordance with Fig. 2.

Checkout. Turn on the power and observe that only one of the four LED targets is illuminated. Press the DISPLAY button and note that the numeral "0" appears on the readout. Then press the target select pushbutton opposite the illuminated LED and notice an immediate mixing of the targets. Upon release of the pushbutton, one of the four LED's will be lighted for the next target. Press the DISPLAY button again and note that the numeral "1" appears on the readout. Continue this procedure until numerals "1" through "9" have been checked out. On the tenth hit, the letter "H" should automatically appear and further trials should be inhibited.

If trouble occurs, first be sure that the batteries are fresh. Further trouble-shooting will be aided by the use of the test points labeled on the pc board and shown in Fig. 2.

One Final Note. In the event that some readers view the subject of ESP incredulously, consider the following. The prestigious IEEE (Institute of Electrical and Electronics Engineers) at its recent annual convention, held a seminar at which researchers presented professional papers outlining their work in ESP and related subjects. The session was attended by several hundred enthusiastic electronics engineers. ♦

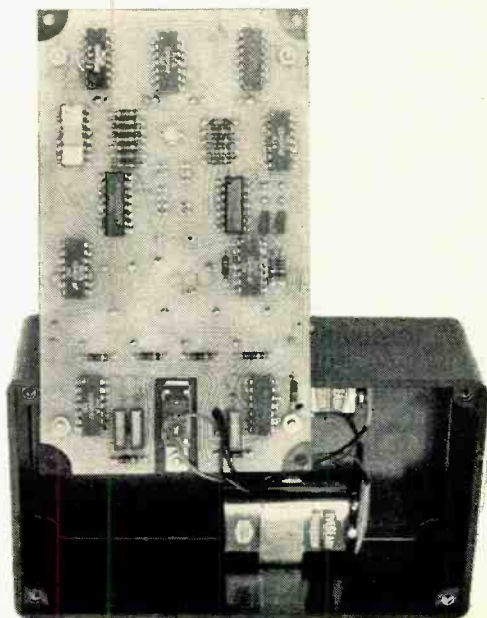
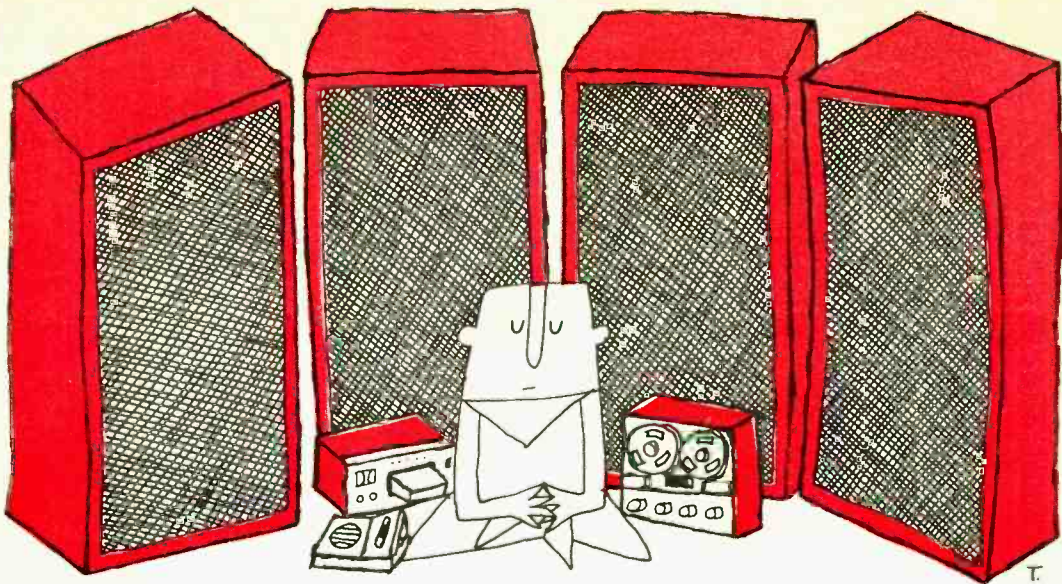

Photo shows pc board and the enclosure.



Status Report: **4-CHANNEL TAPE MACHINES**

*Here are the latest developments on
quadraphonic open-reel, 8-track and cassette
tape recorders*

BY LEONARD FELDMAN

THE 4-channel tape medium has, for some time, lagged behind the quadraphonic disc format—although that situation is changing. (Equipment manufacturers are designing new lines of quadraphonic open-reel and 8-track cartridge recorders; and there is the promise of 4-channel cassette decks on the horizon.) Here is a status report on quadraphonic tape machines.

Open-Reel Four-Channel Tape. No real problem was posed in translating open-

reel tape formats to quadraphonics. For years, stereo open-reel tape machines had four-track capability, as shown in Fig. 1. One stereo program was recorded and played back on tracks 1 and 3, while a second stereo program was recorded and played in the reverse direction, using tracks 2 and 4. To get four-channel recordings on open-reel tapes, it was only necessary to devise new tape record and play heads which incorporated four magnetic gap circuits instead of two, as shown in Fig. 2. Driven by additional

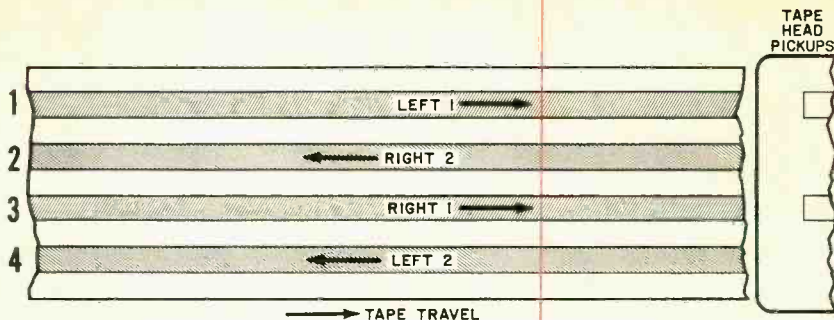

Fig. 1. Arrangement of two stereo programs on open-reel 4-track tapes.

record and playback preamplifiers, each gap magnetized one of the available four tracks during record; on playback, each recorded track was picked up by a separate section of the playback head and suitable playback preamplifying circuits.

The only element of the system that is altered is the available length of recording time in a given length of tape. (Obviously, with full tape width used for the four channels of recording, playing time is cut in half for any tape speed.) This open-reel tape format inherently offers best fidelity and the most "discrete" four-channel sound of all. Separation in excess of 40 or 50 dB between channels is easy to achieve, compared with the 20 or 25 dB of separation offered by even the most carefully recorded (and played back) CD-4 "discrete" phono discs. Why, then has the open-reel four-channel machine become the preferred "pet" of only a limited number of dedicated audiophiles?

If you thumb through any hi-fi equipment catalogue you will be surprised to learn that open-reel machines, stereo or quadrasonic, carry very high price tags. Unlike a decade ago, when good stereo decks could be bought for \$200 or \$300, components of this type are now largely

confined to the over-\$500 category and, in the case of good quadrasonic decks, they approach the "\$1000 and up" bracket.

Cassette Four-Channel Tape. Track layout of a standard cassette differs from that used in open-reel tapes. Here, related stereo tracks are placed side by side, as diagrammed in Fig. 3. Thus, one stereo program is heard when the cassette is played in one direction; when it is inverted and played in the other direction, a second full program is heard. This format was decided upon by Philips Company of Holland, licensors of the cassette principle to all other manufacturers. This arrangement makes cassettes fully compatible. That is, a stereo cassette played on a mono machine has its two channels picked up simultaneously by a wide playback head gap, while a mono cassette played on a stereo machine induces the same magnetic information in both stereo head gaps (and hence both speakers).

At first glance, the simplest transition to quadrasonic cassettes might be made by using all four available tracks, recorded in the same direction, much as is being done for open-reel pre-recorded

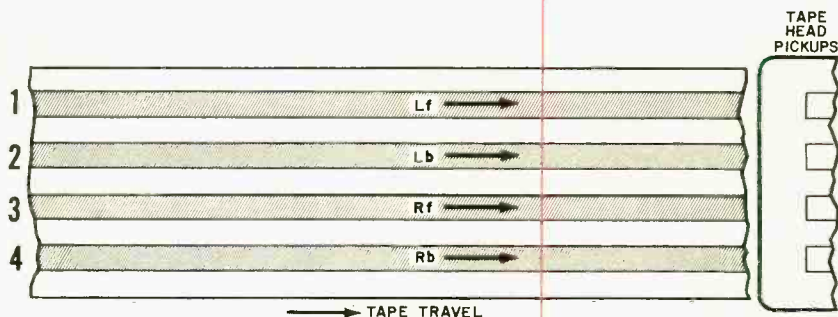

Fig. 2. In 4-channel open-reel, all four tracks are played at once.

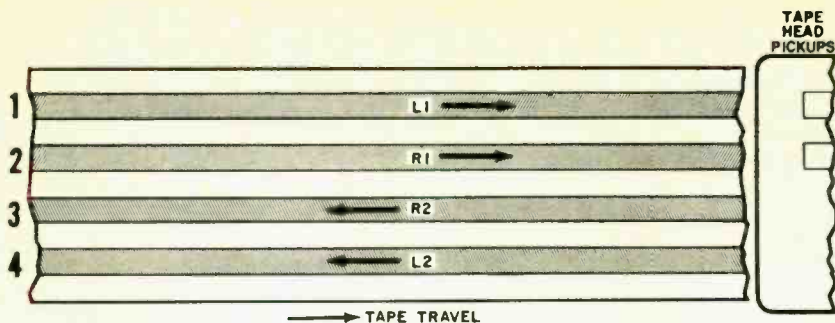

Fig. 3. Cassette track utilization for stereo differs from open-reel.

tapes. The track arrangement would be that shown in Fig. 4. New record and play heads would have to be engineered, but this would be no more difficult than the transition in open-reel machines. The problem lies with the compatibility of cassettes. Since Philips decrees that all cassettes must be compatible with all machines, the solution using the track layout of Fig. 4 would not fill the bill. A listener playing a quadraphonic cassette on a stereo machine would hear, first, the two front channels (with no contribution from the two rear channels). Upon inverting the cassette, he would not only be treated to the back channels *only*, but would hear their content played *backwards*.

Accordingly, Philips has repeatedly suggested that the way to four-channel cassettes must involve a further reduction of track width. Specifically, this is eight *very* narrow tracks all within the width of a little more than $\frac{1}{8}$ inch, as shown in Fig. 5. Each track would be just a few thousandths of an inch wide and, while manufacturers might be able to keep their record/play heads in reasonable alignment so as to prevent crosstalk and poor frequency response, signal-

to-noise ratios would take a "step backwards," negating some of the improvement brought about by the Dolby system. An even more severe problem would be faced by cassette duplicating firms (who "dub" pre-recorded music onto cassettes at much higher speeds for reasons of economy). Cassette tapes, moving at high speeds, have a tendency to wobble up and down. Therefore, with decreased track widths proposed by Philips, alignment problems in duplicating could become horrendous.

Despite the problems envisaged, at least one company has announced production plans for a quadraphonic cassette tape deck following the Philips 8-track proposals. But, seeing is believing. It has also been suggested that "matrix" encoding from four channels to two channels might be the best solution for cassettes. Indeed, the two encoded channels of a matrix system could be recorded onto cassettes without any change of parameters, format, frequency response, or signal-to-noise specifications, much as is done with matrix-encoded records. It would seem a pity to have to go this route with any tape format, however, since tape, of all storage media, seems so right

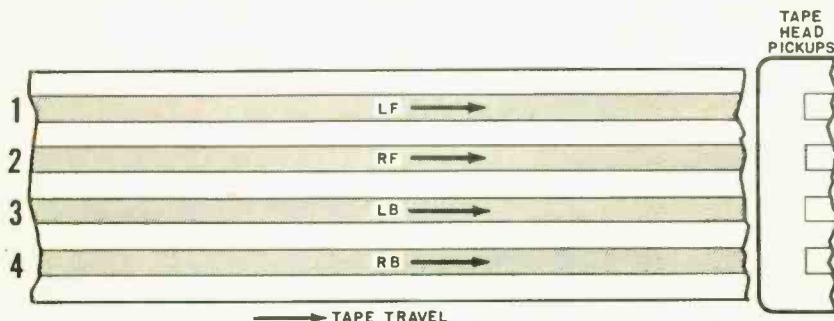
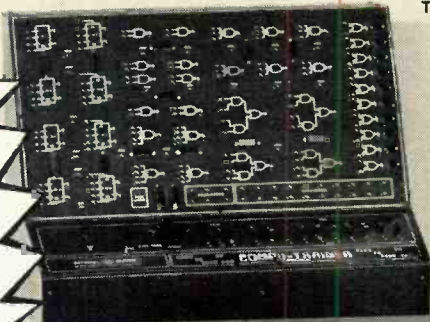

Fig. 4. The simplest transition to 4-channel cassettes can't be used.

The better the the better you

And
you can
get started
for just
\$10.

COMPU-TRAINER



TUBE & TRANSISTOR
TESTER



SOLID STATE
OSCILLOSCOPE

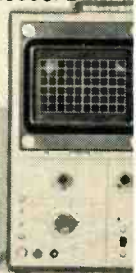

DIGITAL
MULTIMETER

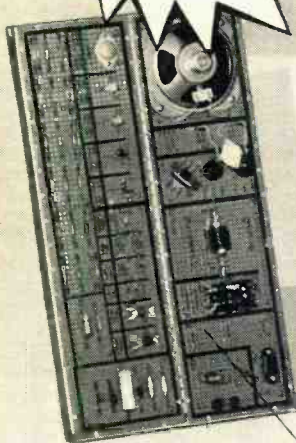

ELECTRO - LAB



NTS DIGITAL GR-2000 SOLID STATE
COLOR TV WITH 315 SQ. IN. PICTURE
AND VARACTOR DIGITAL TUNING

TROUBLESHOOTER
VOM

Only \$10 down gets you into any NTS Home-Study Courses in Electronics.* Just \$10 that can lead to a top-dollar job, a big, bright career in electronics.

As an NTS student, you'll acquire the experience and know-how that comes with first hand training on NTS "pro" equipment. Equipment you'll build and keep. Our courses include equipment like the 5" solid-state oscilloscope, a transistor and tube-tester, a vector monitor scope, 74 sq. in. B&W TV, or a solid-state stereo AM-FM receiver. The unique

*Not including Advanced Color TV Servicing

new NTS Digital GR-2000 Color TV with first-ever features like silent varactor diode tuning; digital channel selection, digital clock, an option at additional cost; and big 315 sq. in. ultra rectangular screen. This is just a sampling of the kind of better equipment that gets you better equipped for the electronics industry.

By following the easy-to-read NTS lessons, you learn the theory behind these tools of the trade. You'll learn and develop skill and confidence fast.

Equipment I be equipped.



Choose from 12 NTS Electronics Courses, including Color TV and B&W TV Servicing, Electronics and Computer Technology, Electronics Communications & FCC, and Industrial & Automation Electronics. All courses can provide you excellent opportunities to expand your career in the exciting world of electronics! So get started right now by checking the coupon and mailing it today.

Classroom Training at Los Angeles. You can take classroom training at Los Angeles in sunny Southern California. NTS occupies a city block with over

a million dollars in facilities devoted exclusively to technical training. Check box in coupon.

Approved for Veteran Training. Accredited Member: National Association of Trade & Technical Schools; National Home Study Council

NATIONAL TECHNICAL SCHOOLS

TECHNICAL-TRADE TRAINING SINCE 1905
Resident & Home Study Schools

4000 South Figueroa St., Los Angeles, Calif. 90037

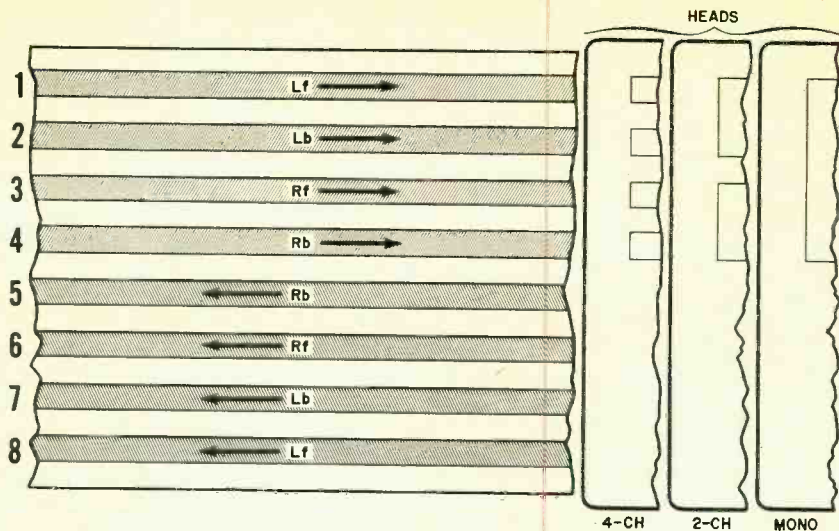

Fig. 5. Further division of cassette tracks to 8 maintains quad-stereo-mono compatibility and playing time while reducing the track width.

for discrete approaches to multi-track recording.

Cartridge Four-Channel Tape. The last of the tape formats to be considered in terms of its four-channel applicability is the 8-track cartridge. First dubbed "Quad-8" cartridges, and later Q-8 by RCA, four-channel sound on cartridges appeared very early in the quadraphonic era. Stereo 8-track cartridges of the "endless loop" variety had been introduced years before, primarily as a back-

ground music program source for automobile use. The track arrangement of stereo 8-track cartridges is shown in Fig. 6. Four full programs of two tracks each is standard. As each program is completed, a metal foil strip bonded to the tape itself actuates a switch and solenoid which moves the tape playback head downward (or upward) an appropriate distance so that the succeeding program can be played. Play is continuous, of course, and in most machines the cartridge will repeat playings of its various

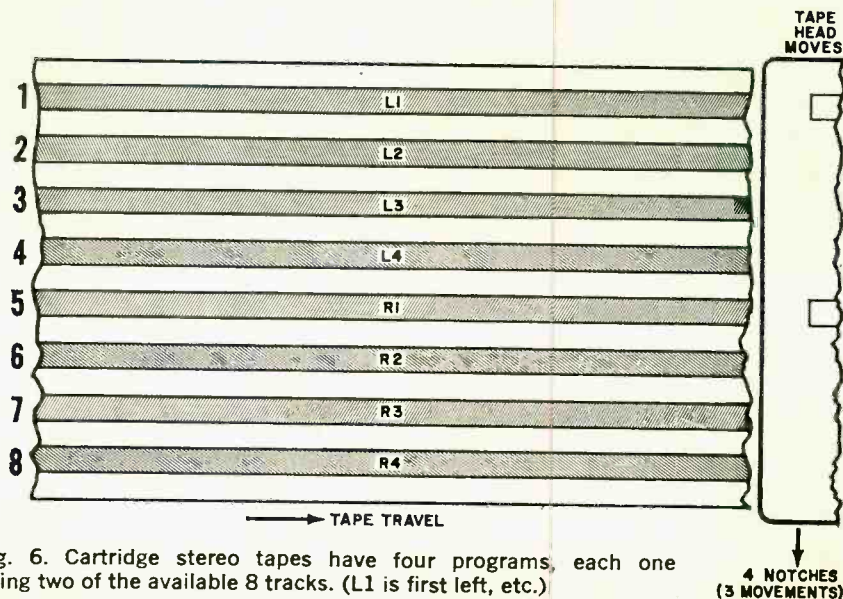

Fig. 6. Cartridge stereo tapes have four programs, each one using two of the available 8 tracks. (L1 is first left, etc.)

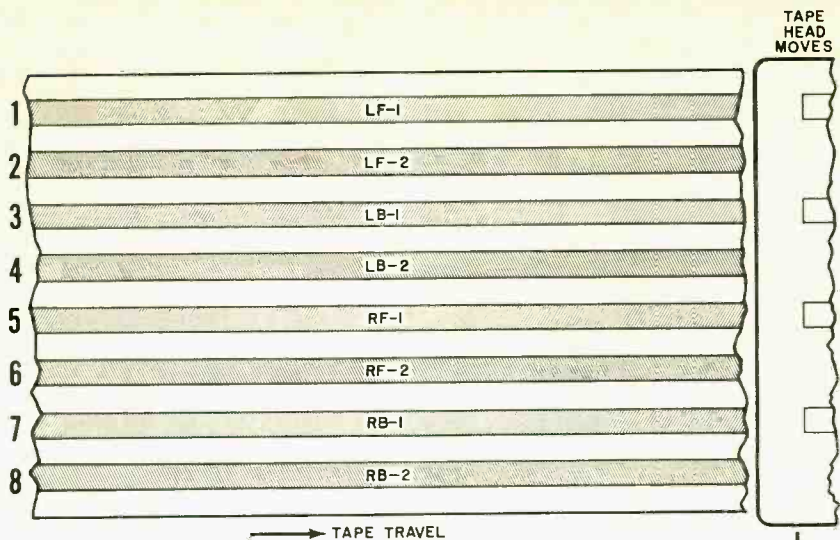

Fig. 7. The Q-8 cartridges have two full programs of quadraphonic sound, each occupying four of eight available tracks.

ONE SPACE
DOWNWARD

programs until it is physically extracted from its slot.

In Q-8 cartridges, only two program loops are possible, since each uses four of the eight available tracks, arranged as shown in Fig. 7. New machines designed to play these cartridges have a built-in measure of compatibility. That is, a stereo cartridge inserted in the slot of such a machine will have all its four programs played in sequence, while a Q-8 quadraphonic cartridge, equipped with a special slot in its plastic housing, will cause the head to move only once when switching from the first quadraphonic program to the second. On the other hand, a quadraphonic cartridge inserted in a stereo cartridge player will first play the front channels of program "A," followed by the back channels of program "A," the front channels of program "B" and, finally, the back channels of program "B."

Even though 8-track cartridges operate at higher speeds than cassettes (3½ ips) and one would expect the fidelity and S/N ratio to be better than that obtained in slower-speed cassettes, the reverse is true. The fact that the head itself is required to move from program to program makes permanent, precision head alignment almost impossible. The endless-loop principle in which tape is drawn from the inside of the wound tape and returned to

the outer diameter involves a tricky drive system which does not lend itself to the extremely low wow and flutter figures possible with either open-reel or cassette mechanisms.

The closed-loop tape also makes it impossible to have a "fast rewind" feature on these machines. (There is no rewind of any kind possible, since it is not possible to squeeze the tape back into the center of the roll.) Though some late-model machines do feature a somewhat faster-than-play "fast forward" mode. Signal-to-noise ratios (tape hiss) are generally poorer than those found in better cassette machines, even before Dolby is applied. Not surprisingly, Dolby noise reduction has not been applied to either pre-recorded 8-track cartridges or to the playback machines with which they are used. A few machines now have record as well as playback facilities, but the vast majority are built for playback of pre-recorded music only. In short, the 8-track format just has not caught on with the true audio buff. That is not to say that these mechanisms could not be built for improved specifications—they simply have not been up to now. Some of these shortcomings are masked by road and engine noise, of course. And it's in automobiles where cartridges made their mark. Also, 8-track offers a much greater pre-recorded library than other formats. ♦

HOW TO SELECT EM KEYBOARDS & CONTROLLERS

*Types and availability for
electronic music synthesizers*

BY DON LANCASTER

WE HAVE received a number of inquiries from readers about the types and availability of keyboards for use with music synthesizers. We have also gotten quite a bit of manufacturers' literature on the subject. We'll try, here, to answer some of the questions and also pass along information we have received.

Controllers. A controller is a device that provides some means of deciding when and in what sequence the notes are going to occur. It can also simultaneously set the frequency, duration, envelope, volume, and special effects. The most common—and obvious—controller is the keyboard, usually based on the traditional type used on pianos and organs with seven white and five black keys per octave. (The preferred size, shape, and locations of the keys are illustrated in the drawing on the next page.)

There are many other controller possibilities. For example, the theremin, dating back to the 1920's, was one of the earliest of electronic musical instruments. It employs two capacitance-sensing antennas. A hand near one an-

tenna sets the pitch, while a hand near the other controls volume. The instrument is literally played in mid-air. The theremin was extremely popular in providing eerie background sounds on radio programs and in motion pictures.

A computer or a digital sequencer can also be used to set the sequencing, duration, beginning, and ending of a note. One obvious example was the "Psych-Tone" (February 1971) in which a pseudo-random sequence generator set the frequency and duration of each note. Other special sequence generators can be used for rhythm and accompaniment, forming a sideman or bandbox. Usually, a group of counters is suitably decoded to provide the desired rhythm pattern.

Some digital sequencers are mechanically or electronically programmable. The earliest example of this was the player piano, but today's minicomputers provide tremendous control possibilities, far beyond those offered by the player piano. Tape cassettes, too, offer all sorts of stor-

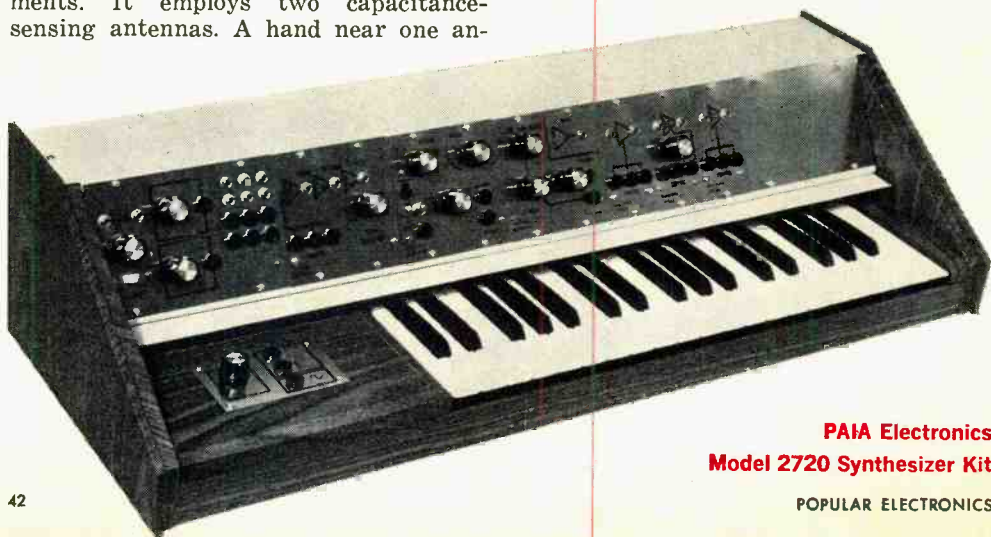

**PAIA Electronics
Model 2720 Synthesizer Kit**

POPULAR ELECTRONICS

age and control possibilities for electronic music.

Digital sequencers can be too regular or too random. Much of what we call music can be described as a sequence of expected surprises, regular sequences dominating, with changes and randomness essential but in a minority. Most of our music, consequently, consists of a 65 to 95 percent redundancy.

If everything is redundant, the sound is boring—a sideman that never changes or misses. Make it all random, and somehow it is not music. Any good digital sequencer must play the middle ground, perhaps by adding slight randomness to break up an "exactitude," or by having alternate sequences so elaborate that they do not bore.

It can be argued that traditional keyboards limit the flexibility of musical composition, making many effects (particularly loudness control) and glides and trombone slides difficult to obtain. But the piano keyboard is a product of hundreds of years of adaptation to the human mechanism. It has been so highly optimized that no other traditional instrument can come even remotely near it for range and flexibility of expression.

In the studio, we are free to custom-build each note and use multiple recording techniques and individual sequencers to build up a final sound image without a keyboard. To this end, we use patchboards, switches, punched or magnetic tapes or cards, scissors, etc. Interestingly, though, whenever an attempt is made to turn this into a real-time process, all patches and switches turn into stop tablets and the result is a keyboard.

Commercial Keyboards. There are two basic keying systems in current use. In *direct* keying, all notes go through the keyboard; this is the traditional electronic route, but it limits what can be done with attack and decay and contains cross-talk problems.

Most synthesizers and many newer organ circuits employ an *indirect* system in which only control voltages are routed through the keyboard. For example, the keyboard can send the supply voltage to an oscillator or keyer in the separate-voicing pitch-generation method. It can select a division ratio or route a command to an envelope generator or a digital pitch generator. On the other hand, it can select a fixed precision resistor for the vco method of pitch generation, or it can route a frequency reference to a phase-locked loop tracker pitch generator.

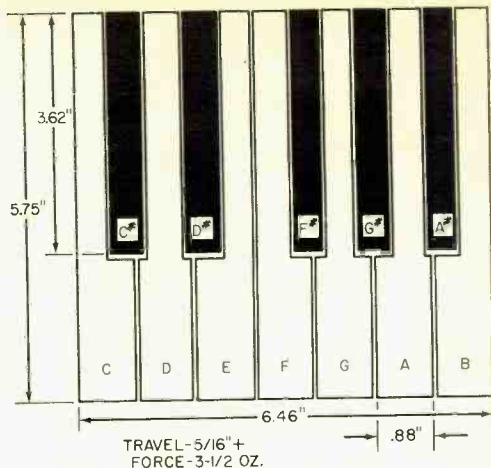

One octave of traditional piano or organ keyboard. White keys are different shapes in order to get a "piano" spacing in the front and even mechanical spacing at back.

Almost always, the equivalent of multiple contacts on the keyboard is desired. In a synthesizer, you might select a pitch resistor with one contact and at the same time generate a common command: "A note has been played in octave #3." In traditional electronic organs, you might sum up pipe voices onto 2', 4', 8', and 16' buses and provide for manual-to-manual coupling.

Perhaps, in your system, you might like to move up a fifth without changing key positions (done in groups for automatic chording) or be able to switch keys for transposition without moving all over the keyboard. To do this, the equivalent of a new set of contacts is needed for each desired effect.

As you can probably imagine, multiple contacts can become a headache. Commercial keyboards are available with up to eight contacts per key; but two, three, and five contacts are more common. A better route today is the use of electronic expansion or contact multiplication, using diodes or digital-logic gates to provide virtually any number of contacts per key. CMOS logic is ideal for this and can handle both digital and analog signals. Check out the CD4016 in particular.

Two general classes of keyboard systems are "regular" and "touch-sensitive." In the first system, the contacts simply close when a key is pressed. The closure is independent of the speed and force at which the key is closed. Loudness of the note or other special effects must be controlled by some other

means. How fast the key is pressed in a velocity-sensitive keyboard or how hard it is pressed in a pressure-sensitive keyboard also initiates a separate electrical control-signal output.

An ideal velocity-sensitive setup would have some mechanism similar to that of a piano on each key. Its final velocity would be converted into an electronic signal and used for control. More reasonable methods can be imagined by using optical couplers or by using the fixed charge on a capacitor whose plates move together as the key is pressed. Alternatively, key motion or displacement can be sensed and used to establish velocity. Both velocity and pressure could be sensed in this manner.

In single-voiced instruments, one common velocity generator can be used for velocity or pressure sensing to eliminate key-to-key variations. An obvious way to sense pressure is to use conductive foam under each key, but the big problems include obtaining key-to-key uniformity and good wear properties combined with long-term stability.

Selecting a Keyboard. If you are an experimenter, chances are that you are considering making your own keyboard. You might save some money going this route, but be prepared to run into numerous obstacles. On the other hand, if you are serious about music and have the money to spend, a commercial keyboard may be more to your liking.

Commercial keyboards run from a minimum of \$1.60 to more than \$3.00 *per key*. At first glance, this might seem extravagantly expensive, but bear in mind that these

keyboards represent a good deal of research, have a great deal of integrity, and are characterized by uniformity. In the long run, a commercial keyboard is the only possibility for the serious musician.

Many commercial keyboards are made by the 176-year-old Pratt & Reed Co. to the high standards set by the American Guild of Organists. They are professional units, custom designed for specific users; so, do not expect to find them as "off-the-shelf" items and at bargain prices. There are, however, other sources of supply to which you can turn as shown in the table below.

When last we checked, PAIA Electronics had the lowest price per key for a 37-note system. Even so, an AGO keyboard *without* velocity or pressure sensing is going to cost a minimum of \$1.60 per key.

You might try to build up a simpler keying system for experimental use or initial setups. For the keyboard, you might want to use a surplus calculator or computer keyboard as is or rearrange it into a more "playable" setup. This approach will get your system operating for only a few dollars—even if it is essentially unplayable. If you plan on imitating the traditional key shapes, you can get keytops and sharps from Tuners Supply Co. (94 Wheatland St., Somerville, MA 02145); the white ones #531A sell for \$7.20 for a set of 52, and the black #523L are \$6.50 per set of 36.

Touch-sensitive foams and vinyls are available from Emerson and Cuming (604 West 182 St., Gardena, CA 90247). Their Eccoshield CLV vinyl and MOSFET foams might prove of interest. Another good conductive foam is #7611 Vellofoam available from Custom Materials Inc. (Alpha Industrial Park, Chelmsford, MA 01824). While the price per square inch of these materials is very low, the normal minimum order seems to run about \$25, which will buy a large sheet.

Sealed key switches with integral return springs are available from Southwest Technical Products Corp. (219 West Rhapsody, San Antonio, TX 78216) at \$4 per octave. They are single-contact high-quality reed switches with the normal range of travel and force.

Designing and building your own keyboard may be difficult, but it isn't impossible—else how could the commercial units have evolved? If you come up with something that is inexpensive, reliable, and suitable for professional use, let us know about it. ♦

SUPPLIERS OF COMMERCIAL AGO KEYBOARDS

Devtronix Organ Products

5872 Amapola Dr.
San Jose, CA 95129

E μ Systems

3455 Homestead Road
Santa Clara, CA 95051

Newport Organs

846 Production Place
Newport Beach, CA 92660

PAIA Electronics

Box 14359
Oklahoma City, OK 73114

Schober Organ Company

43 W. 61st ST.
New York, NY 10023



BUILD A

GUITAR SOUND INTENSIFIER

IMPROVES FREQUENCY RESPONSE, GIVES COMPLETE
TONE CONTROL

BY KEN LANG

THERE are few families with youngsters (or young-at-heart oldsters) that don't have guitars these days. The instrument may be the familiar acoustic type, whose shape and size have not changed much during its long history, or it may be a solid-body electric type. With a smaller body, the electric guitar relies entirely on electronic amplification for its sound—and it is probably today's largest selling electronic instrument.

The solid-body electric guitar has a thick wooden section instead of a resonant box. Magnetic pickups are mounted inside the body under the metal strings. Without the nuances of body size and shape to provide differences in tone, most solid-body guitars sound pretty much alike. The combination of pickup, strings and electronic resonance provides a pure inductance, which contributes little to sound character and causes peak emphasis at one particular frequency (with attendant ringing and hangover). The subtle string overtones get lost because they can't compete with the sound output at circuit resonance.

Of course, special effects can be added to electric guitars, but a means of really changing the coloration of the sound is

more desirable. Such a change can be achieved by adding this Guitar Intensifier. It has its own volume, bass, and treble controls and can be mounted in the cavity of many solid-body electric guitars. Having independent tone-control arrangements, this approach gives the user a variety of tonal colorations and produces a wide frequency response. There is no loss of high-frequency overtones at low volume settings, but the GI provides the instrument with more "punch."

Circuit Operation. The signal induced in the guitar pickup (Fig. 1) is coupled through *S1* and *C1* to the base of *Q1*, a preamplifier. Potentiometer *R12* is a volume control, while *R13* and *R14* provide bass and treble control.

The complete bass cut-and-boost circuit is composed of *R5*, *R13*, *R6*, *C3*, and *C4*. The treble cut-and-boost consists of *C5*, *R14*, and *C7*. The contoured signal is then applied to output amplifier *Q2*, which is coupled to *J1* through *C8*.

When *S2* is placed in the bypass position, the transistor amplifier is turned off and the input signal goes through only the volume, bass, and treble controls.

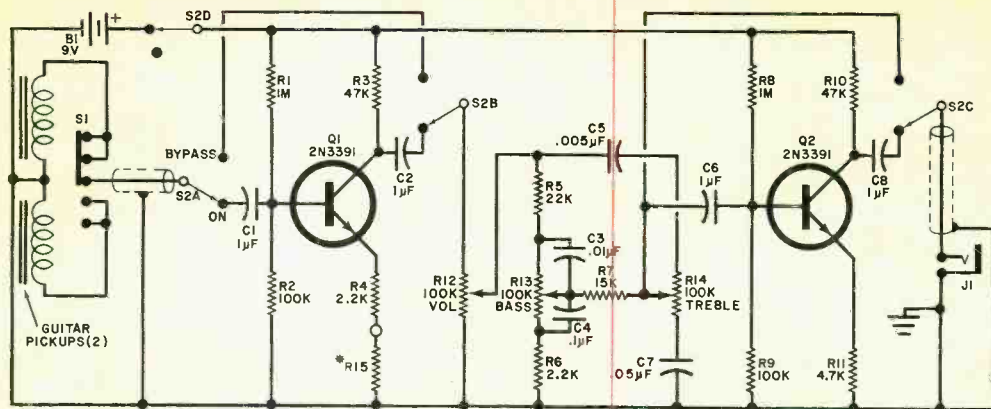

Fig. 1. Spectracom IGI™ circuit (patent applied for) is similar to discrete model.

Construction. The complete circuit can be assembled on a small pc board as shown in Fig. 2. If the unit is to be mounted in the cavity of a solid-body guitar, be sure all components are mounted so that they take up a minimum of height.

The value of $R15$ must be selected so that it prevents distortion due to overloading of the first stage. Because of variations among guitar pickups, this resistor can be any value from zero to 10,000 ohms.

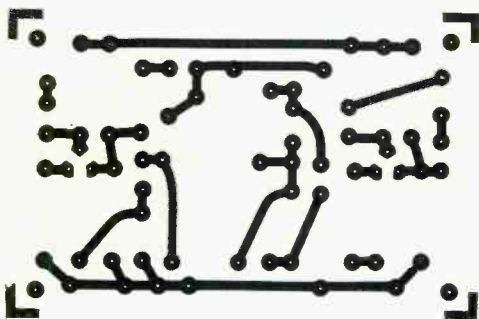
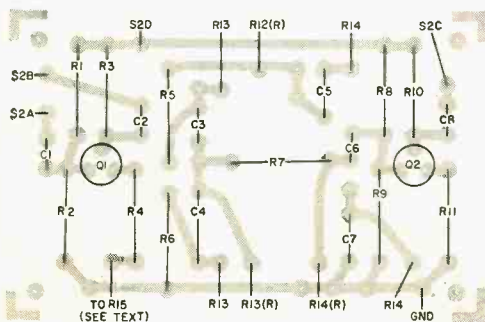

Fig. 2. Actual-size foil pattern for intensifier is above; component layout below.



PARTS LIST

- B1—9-volt battery
 - C1,C2,C6,C8—1- μ F tantalum capacitor
 - C3—0.01- μ F, 20-volt, ceramic disc capacitor
 - C4—0.1- μ F, 20-volt, ceramic disc capacitor
 - C5—0.005- μ F, 20-volt, ceramic disc capacitor
 - C7—0.05- μ F, 20-volt, ceramic disc capacitor
 - J1—Phone jack
 - Q1,Q2—2N3391A transistor
 - R1,R8—1-megohm, $\frac{1}{4}$ -watt resistor
 - R2,R9—100,000-ohm, $\frac{1}{4}$ -watt resistor
 - R3,R10—47,000-ohm, $\frac{1}{4}$ -watt resistor
 - R4,R6—2200-ohm, $\frac{1}{4}$ -watt resistor
 - R5—22,000-ohm, $\frac{1}{4}$ -watt resistor
 - R7—15,000-ohm, $\frac{1}{4}$ -watt resistor
 - R11—4700-ohm, $\frac{1}{4}$ -watt resistor
 - R12-R14—100,000-ohm potentiometer
 - R15—See text
 - S1—On guitar
 - S2—4-pole, 2-position rotary switch
 - Misc.—Suitable chassis (if not put in guitar), knobs (3), battery holder, battery connector, mounting hardware.
- Note—A kit (in hybrid IC form rather than discrete components) of the circuit described here is available from Spectracom Corp., Box 307, 1101 State Rd., Princeton, NJ 08540, for \$49.50, including installation instructions and switch.

After determining that the amplifier operates with $S2$ in the bypass position, connect the loose end of $R4$ to ground and place $S2$ in the on position. If you get distortion, start by using 2200 ohms for $R15$. If the distortion continues, try 4700 ohms. Continue to increase the resistance if necessary.

Set the amplifier volume and tone controls as you normally do. Then play the guitar and test the operation of volume control $R12$, bass control $R13$, and treble control $R14$. The results should be very noticeable. Tone response is tailored by adjusting the bass and treble controls for a broad range of coloration. The wider frequency response gives both slashing chords and softly picked solo notes. The attack is fast and the sound is clean. Chord sustain is excellent. ♦

CONSTRUCTION

MOST inexpensive metal locators are "heterodyne" types where the output frequencies of a fixed and variable oscillator "beat." The fixed-frequency oscillator serves as a reference, while the other oscillator has a sensing loop that changes its frequency when brought near metal. The resulting heterodyne (difference frequency between the two oscillator signals) is amplified and fed to a speaker or meter.

The low-cost metal locator described here is a heterodyne unit. But it is less expensive and easier to build than most because it can be used with an ordinary portable AM broadcast-band receiver. The radio already contains everything but the sensing-oscillator circuit. The necessary oscillator and sensing loop are easily added.

How It Works. The schematic diagram for the sensing oscillator is shown in Fig. 1. Essentially, it is a tuned-gate, field-effect transistor (*Q1*) oscillator. Variable capacitor *C2* permits the circuit to be tuned across the middle frequencies of the AM band.

The sensing oscillator is first tuned exactly to a broadcast station (which must be done far away from any metal objects). Subsequently, any metal in the vicinity of the sensing loop (*L1*) will change the oscillator's frequency to produce a beat note at the receiver's speaker. Moving the loop away from the metal will cause the beat note to cease.

Construction. The oscillator circuit can be built into any 3¼-in. by 2½-in. by 1½-in. metal utility box. To simplify assembly, use a piece of perforated phenolic board and solder clips to mount the oscillator components as shown in Fig. 2. Referring to Fig. 3, machine the top half of the utility box and mount on it *B1* (in a battery holder), *C2*, *J1*, and *S1*. Then mount the board assembly with #6 machine hardware and ¼-in. metal spacers. Refer back to Fig. 2 and interconnect the chassis-mounted and on-the-board components.

Drill two ¼-in.-diameter holes and mount the bottom half of the utility box to the handle you plan to use for your metal locator. For the handle, you can use either ¼-in.-outer-diameter aluminum tubing or an old broom handle. Whichever you choose, cut it to a length of 36 in. and wrap the top with several layers of electrical tape



LOW-COST METAL LOCATOR

*An easy-to-build locator
that detects buried metal
objects at depths of 6 inches*

BY JOE A. ROLF

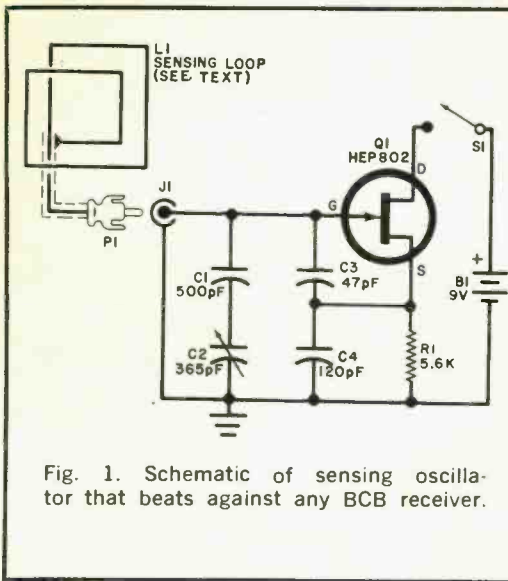

Fig. 1. Schematic of sensing oscillator that beats against any BCB receiver.

PARTS LIST

- B1—9-volt transistor battery
- C1—500-pF ceramic capacitor
- C2—365-pF miniature variable capacitor
- C3—47-pF ceramic capacitor
- C4—120-pF ceramic capacitor
- J1—Phono jack
- L1—See text
- P1—Phono plug
- Q1—2N3819 or HEP-802 (Motorola) field-effect transistor
- S1—Spst slide or toggle switch
- Misc.—3 1/4" x 2 1/8" x 1 1/8" utility box; perforated phenolic board and solder clips; No. 32 enameled wire for L1; 3/4" outer-diameter aluminum tubing or broom handle, cut to 36" length; coil form for L1 (see text); 36" Belden No. 8411 microphone cable; control knob; #6 machine hardware; spacers; battery holder; phono jack and plug for sensing coil cable (optional); solder; solder lug; etc.

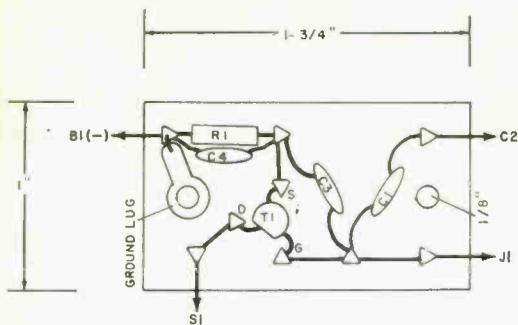

Fig. 2. Diagram shows how components are laid out on a perforated phenolic board.

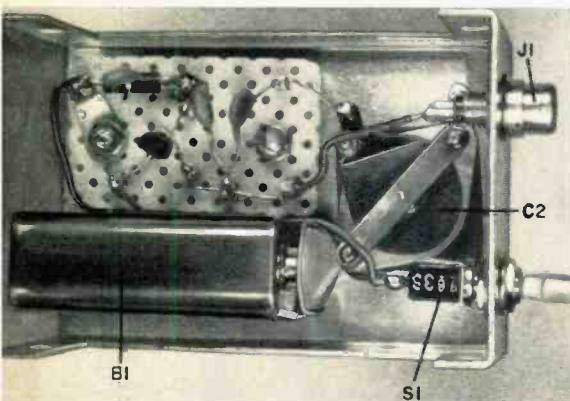

Fig. 3. Photo of prototype showing how the board and components go into chassis.

to provide a comfortable grip. Then mount the bottom half of the utility box to the aluminum tubing with sheet metal screws (wood screws if you are using a broom handle) as shown in Fig. 4.

An 8-in. by 6-in. lid for a plastic freezer container makes an ideal form for winding sensing coil *L1*. For durability, however, it should be made rigid by adding a 6-in. by 3-in. piece of 1/8-in. Bakelite or phenolic board as shown in Fig. 5. The board that adds rigidity can be fastened with three sets of #6 machine hardware, one set of which also anchors into place the U bracket required for fastening the sensing loop assembly to the handle of the metal locator.

Sensing loop *L1* consists of 20 tightly wrapped turns of No. 32 enameled wire around the rim of the freezer container lid. Secure the turns with coil dope and a turn or two of electrical tape. You can either bring the ends of *L1* out to a phono jack mounted on the freezer container lid, or solder the cable that interconnects loop and oscillator directly to the loop's leads. The connecting cable itself should not exceed 36 in. in length and should be a low-capacitance variety like the Belden No. 8411 used for lapel microphone cables.

In Use. To operate the metal locator, tune your transistor receiver to a strong station in the middle of the AM band and slowly tune *C2* back and forth. A beat note will be heard when you cross the station tuned on the receiver. Carefully adjust *C2*

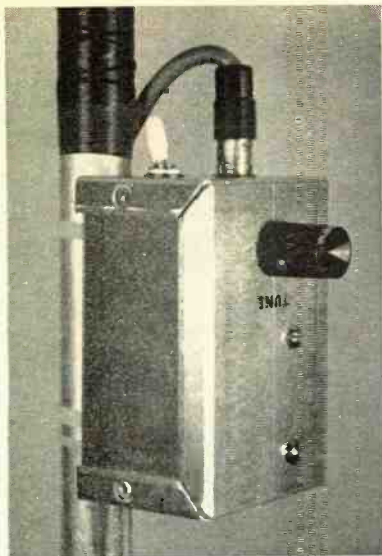

Fig. 4. Attach bottom half of box to handle and mount top half as shown.

until the beat note disappears, or is as low as possible. (Do not forget to do this with the sensing loop far away from any metal

objects.) Now, sweep the sensing loop near to a metal object; the tone should re-occur.

The sensing loop described above is most useful for general-purpose work, but other sensing-coil configurations can be built for specific applications. A round (6-in.-diameter) plastic container lid with 25 turns of enameled wire can be used for exploring smaller areas, while a ferrite antenna coil (designed for use in transistor radios) inside a length of plastic tubing will provide a wand-type sensor that is useful for locating ducts, studs, and pipes in walls. Whichever sensor you plan to use, it is important that the cable between loop and utility box be less than 36 in. long.

While using the metal locator, you will discover that the audible indication you get is proportional to the size of the object being sensed, its depth below the surface of the soil, and soil condition. An object the size of a soup can at a depth of 6 in. is easily detected in dry soil, but at a lesser depth in wet soil. With practice, it is possible to determine the size and depth of an object—a good thing to know before you begin digging. ♦

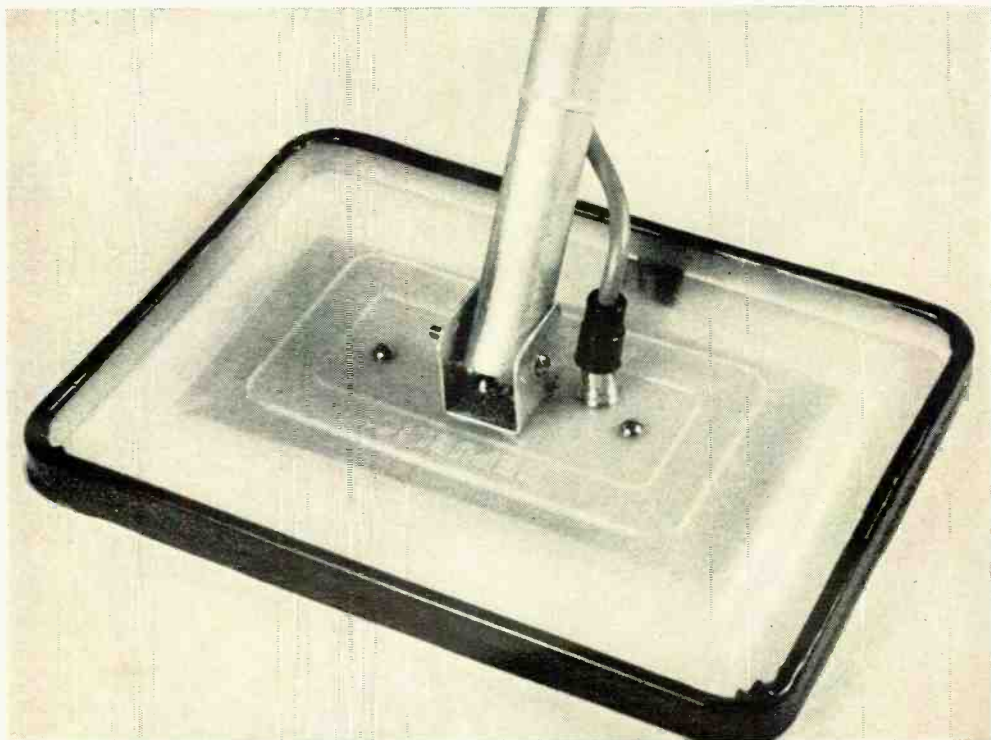

Fig. 5. The sensing coil is wound on a plastic freezer container lid that is stiffened with Bakelite or phenolic. A phono jack is used to connect loop to oscillator cable.

Making Noises with the 555 IC Timer

*One popular chip can be the heart of
a variety of circuits*

BY MICHAEL S. ROBBINS

THE 555 IC timer can be used to generate a wide variety of tones and noises. Some have been described in these pages before. Here are other applications for this versatile, easily obtainable IC, whose output is a harmonic-rich square wave. As shown in the sketches, very few components external to the IC are required. (For a complete discussion of how the 555 works, see "The IC Time Machine," *POPULAR ELECTRONICS*, November 1973.)

Basic Tone Generator. The circuit for a basic variable-frequency tone generator using a small permanent-magnet speaker is shown at (A). The volume can be controlled by using the 20-ohm potentiometer in the speaker circuit. With the values

shown, the output frequency is continuously variable over an approximate range of 76 Hz to 22 kHz.

Code Practice Oscillator. The circuit shown at (B) is a CPO with adjustable tone and volume controls. The rest of the circuit is the same as that in (A). The speaker can be replaced with headphones if desired.

CW Monitor. The CW amateur radio operator often finds that having an audio signal to go with his code transmission is very helpful. A circuit to do this is shown at (C). The r-f signal on the short antenna is rectified and applied to pin 4 of the IC. When the positive pulse appears at pin 4, the tone generator turns on. The circuit should be as-

Suppressing Transients in Solid-State Equipment

VOLTAGE transients can prove to be destructive to some solid-state electronic equipment, particularly the new "super-power" hi-fi amplifiers. There are any numbers of ways by which voltage transients can be developed, but the biggest culprit in hi-fi amplifiers is the transient (surge) that results whenever the equipment is turned on or off. You can often hear this surge as a "thump" coming from your speakers when the power switch of the amplifier is turned on or off.

There is a rather effective way of coping with transients and voltage surges; and it can save a lot of expensive repairs. All you need is a simple device made by General Electric and costing \$1.13. It

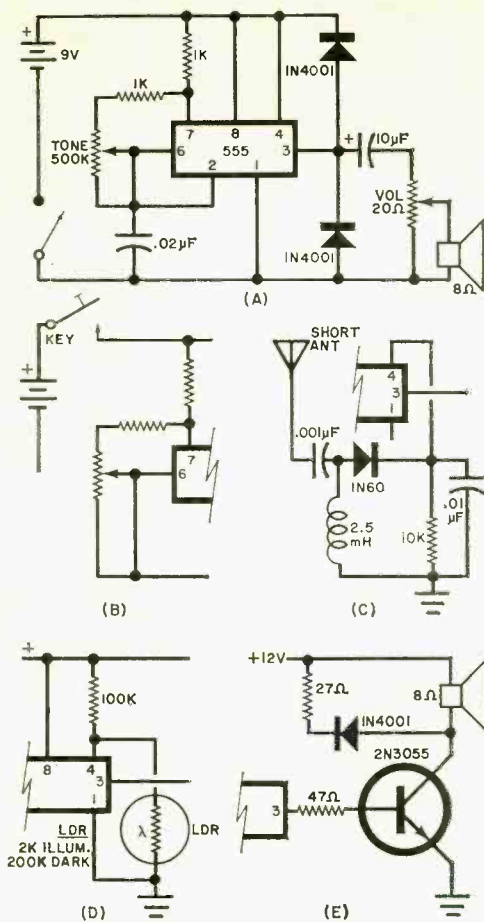

Some circuits based on the 555 timer chip.

sembled in a small shielded enclosure with only the short antenna protruding.

Electric-Eye Annunciator. A compact doorway alarm for stores and other applications can be built around the 555. It eliminates the need for the usual relays and chimes. In the circuit shown at (D), a cadmium-sulfide LDR and a light source (such as a flashlight powered by an ac supply) will bias the reset transistor within the IC. With the LDR illuminated, there is a very low voltage at pin 4. When the light beam is interrupted, the resistance of the LDR rises rapidly, placing the positive voltage on pin 4. When this happens, the 555 breaks into oscillation and provides a "screaming" tone to the speaker.

Louder Noises. Though the 555 is capable of driving a small speaker at high volume, louder noises are possible. In the circuit shown at (E), the output circuit on pin 3 is replaced with a switching amplifier. With a 12-volt battery (lantern or vehicle type), the output is an ear-piercing (approximately 10 watts) square wave into the 8-ohm trumpet speaker.

Construction. Any of the circuits described here can be assembled on perf board or on a small pc board. No special precautions are required if the supply is kept within 12 volts and the resistor between the positive supply and pin 7 of the 555 is 1000 ohms or more. ♦

is a GE No. 6RS20-SP4B4 Thyrector. (It should be available at your local electronics store or they can order it for you.)

The Thyrector is a selenium rectifier designed for intermittent operation in its reverse direction. It was developed primarily to protect other semiconductors from high-voltage reverse transient spikes. Since it has a relatively high power-dissipation capability under transient conditions, it is very useful for surge voltage protection as well.

Thyrectors are commonly connected directly across the primary winding of the amplifier's power transformer, immediately after the power switch and pilot lamp, if any. In operation, the Thy-

rector diode begins to suppress transients at about 150 percent of its peak rated voltage.

In a modest test, a Thyrector was installed in a breakdown-prone hi-fi amplifier that had made several trips back to the factory for repairs. The last time the amplifier was repaired and returned, a note accompanied it. The note mentioned on/off transients and made the suggestion that the amplifier be left with the power on at all times. This was not necessary, however, because after two years of operation with Thyrector protection, not once has the problem returned. What is more, the characteristic on/off thump has been eliminated. ♦

3-WAY (SOUND LIGHT MANUAL) PHOTO FLASH TRIPPER

FOR NOVEL STOP-ACTION EFFECTS

BY JOHN F. HOLLABAUGH

SOME exciting and different photographic effects can be obtained with a strobe flash rigged to trigger from stimuli independent of the normal shutter switch. The photoflash tripper described here can initiate and delay the flash cycle with a sound or light stimulus or by completing an electrical circuit. For example, after the tripper receives a sound stimulus, a delay starts. Then, after a preset time, the flash fires and exposes the picture.

About The Circuit. The common part of the flash timer is the delay circuit consisting of *SCR1*, *SCR2*, and *Q4* (see schematic). The cycle is begun by firing *SCR1* via a sound input at *SPKR*, light at *LDRI*, or mechanical trip wires connected to terminal strip *TS1*.

When *SCR1* fires, it applies voltage from battery *B1* to the *R10/C5* circuit, and *C5* begins to charge through *R10* at a rate determined by the value of the resistor. (The lower the value of *R10*, the shorter the charging time.) When *C5* has charged sufficiently to forward bias the emitter junction of *Q4*, a rapid rise in the current between the *B1* and *B2* terminals of *Q4* generates a positive pulse across *R11*.

This positive pulse is applied to the gate

of *SCR2*, causing it to conduct current (from inside the flash unit connected to the tripper via *SO1*) and fire the electronic flash. After the cycle is complete, the circuit is reset to its initial conditions by momentarily depressing and releasing pushbutton switch *S3*.

Placing *S1* in position L (light) powers the *Q5* circuit and sets the system up for light tripping. Light falling on light-dependent resistor *LDRI* causes the circuit to trip. Potentiometer *R12* serves as a sensitivity control.

When *S1* is placed in position S (sound), power is applied to the audio amplifier circuit consisting of *Q1* through *Q3*. The speaker (*SPKR*) at the input of *Q1* is used here as a microphone. When a popping or other sharp sound is picked up by this microphone, a pulse is produced which is amplified sufficiently to trigger *SCR1* into conduction and start the timing cycle which, ultimately, fires the flash unit.

The final position of *S1* is marked M for mechanical contact. In this position, neither the light nor the sound circuits is powered. A pair of wires, terminated in a switch or left bare, is connected to terminal strip *TS1*. To start the timing cycle, the switch at the end of the wires need only be mo-

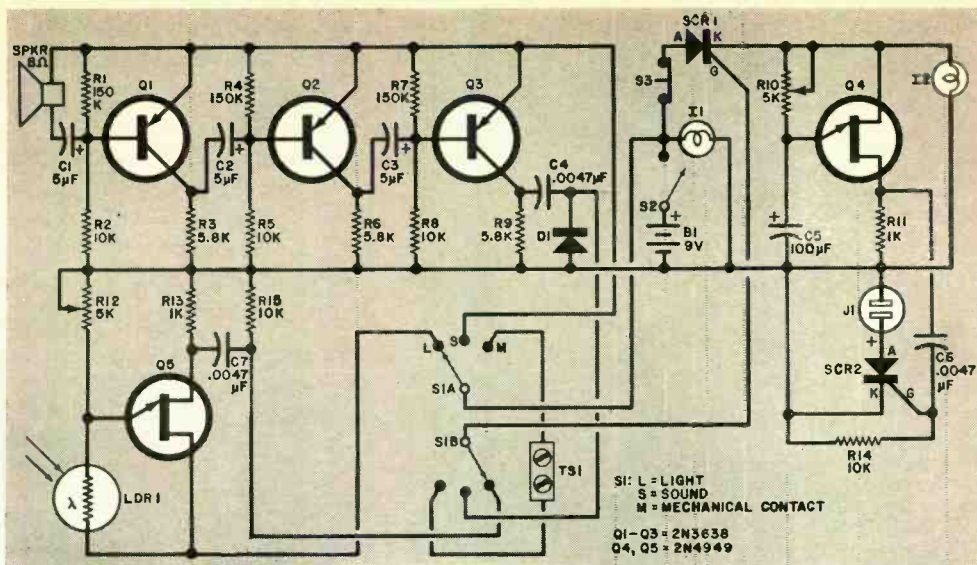

PARTS LIST

B1—Six 1.5-volt AA cells in series
 C1-C3—5- μ F, 15-volt electrolytic capacitor
 C4,C6—.0047- μ F ceramic capacitor
 C5—100- μ F, 25-volt electrolytic capacitor
 D1—1N4001 silicon diode
 I1,I2—Miniature 10-volt panel lamp
 J1—Camera shutter jack (includes length of cable)
 LDR1—Light-dependent resistor (Clairex No. CL704 or similar)
 Q1-Q3—2N3638 transistor
 Q4,Q5—2N4949 unijunction transistor
 R1,R4,R7—150,000-ohm, $\frac{1}{2}$ -watt resistor
 R2,R5,R8,R14,R15—10,000-ohm, $\frac{1}{2}$ -watt resistor

R3,R6,R9—5800-ohm, $\frac{1}{2}$ -watt resistor
 R10,R12—5000-ohm linear-taper potentiometer
 R11,R13—1000-ohm, $\frac{1}{2}$ -watt resistor
 S1—Double-pole/3-throw non-shorting rotary switch
 S2—Spst switch (part of R10)
 S3—Normally-closed pushbutton switch
 SCR1,SCR2—Silicon controlled rectifier (1 ampere, 200 volts)
 SPKR—8-ohm, 2 $\frac{3}{4}$ -in. diameter speaker
 TS1—Two-lug, screw-type terminal strip
 Misc.—Bakelite or metal utility box; perforated board and solder clips; battery holder; pointer knobs (2); rubber grommet (for J1 cable exit hole); hookup wire; solder; hardware; etc.

The delay circuit, composed of two SCR's and Q4 is triggered by signals from either the audible input through speaker, light striking LDR1, or a switch action at TB1.

mentarily closed or the bare wires momentarily touched together.

The time lag between the firing of SCR1 and the completion of the cycle with the firing of SCR2 can be varied by adjusting potentiometer R10.

Construction. The circuit of the photo-flash tripper is very simple, lending itself nicely to almost any type of chassis assembly. Just be sure that you observe proper polarity and basing connections.

When you mount LDR1 in the chassis box you have chosen for your project, make certain that there is an access hole for the light to fall on the active element of this component. A good mounting method is to use an ordinary plastic pill container, its inside surfaces painted flat black, to hold the LDR.

When you wire the shutter cord into the tripper (this cord is terminated in I1), make certain that it is properly polarized. If it is improperly wired, the photoflash will not trigger because current flow through SCR2 is unidirectional.

How To Use. Photography with the tripper requires the use of "red blind" ortho film. This permits the setup to be made in an area illuminated by only a dark red safe light.

Immediately before action begins, open the camera's shutter and leave it open until after the flash has fired. Setting the amount of delay required for any given filming sequence will have to be determined by trial and error. You can estimate how much delay is required by observing the event in total darkness. ♦

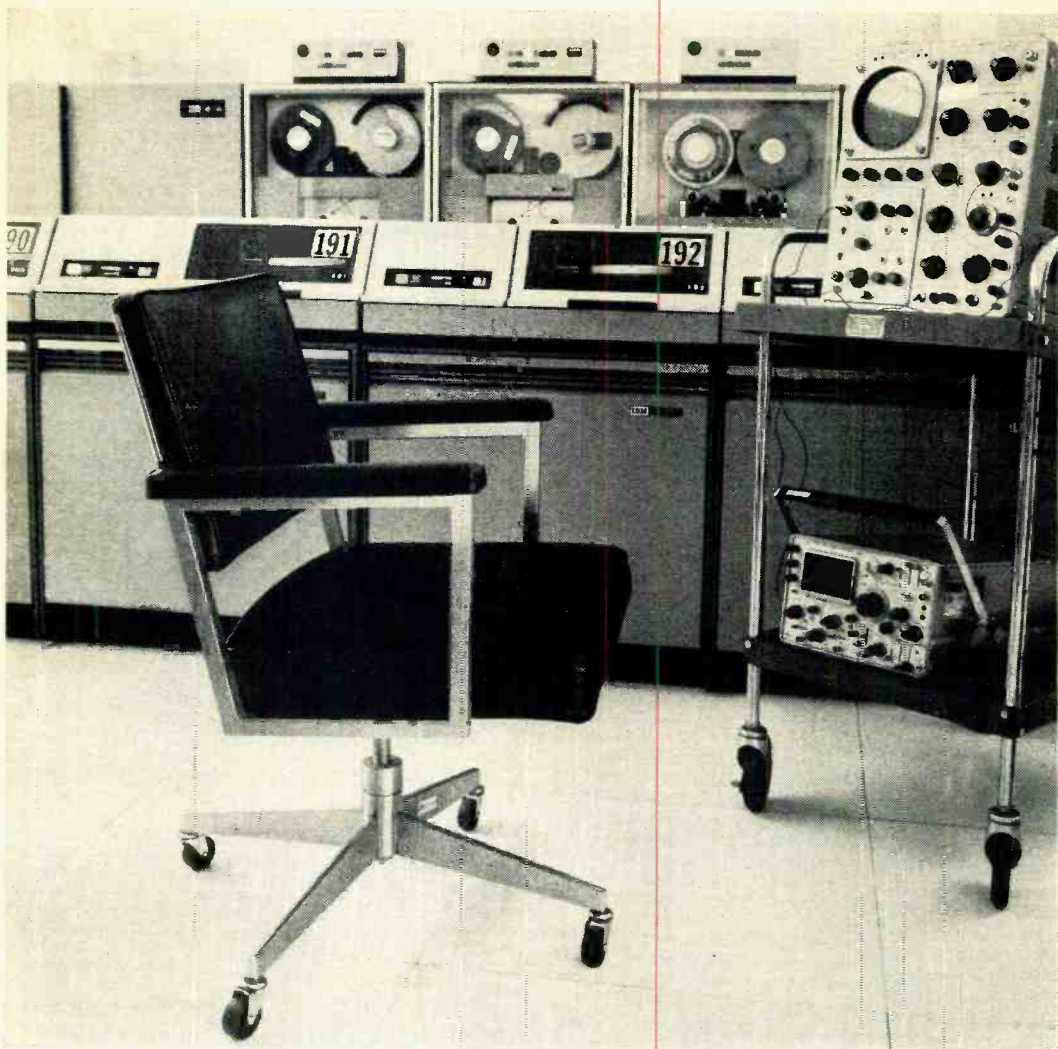

This important job (and its big income) is reserved for a qualified electronics technician. It can be you!

It's a fact. There are *thousands* of jobs like this one available *right now* for skilled electronics technicians. What's more, these men are going to be in *even greater* demand in the years ahead. But how about you? Where do you fit into the picture? Your opportunity will never be greater . . . so act *now* to take advantage of it. The first step? Learn electronics fundamentals . . . develop a practical understanding of transistors, trouble-shooting techniques, pulse circuitry, micro-electronics, computers and many other exciting new developments in this growth field. Prepare yourself now for a job with a

bright future . . . unlimited opportunity with lasting security . . . prestige and a steadily growing paycheck.

Cleveland Institute of Electronics courses have been stepping stones to good jobs in electronics for thousands of ambitious men. Why not join them? You can learn at home, in your spare time, and tuition is remarkably low. Read the important information on the facing page. Then fill out and mail the reply card or coupon today. We'll send you all the details and for your convenience, we will try to have a representative call. Act now . . . and get your high-paying job just that much sooner.

How You Can Succeed In Electronics

... Select Your Future From Seven Career Programs

The "right" course for your career

Cleveland Institute offers not one, but seven different and up-to-date Electronics Home-Study Programs. Look them over. Pick the one that is "right" for you. Then mark your selection on the reply card or coupon and mail today. In a few days, you will have the complete details.

1A. Electronics Technology

A comprehensive program covering Automation, Communications, Computers, Industrial Controls, Solid-State Devices, and preparation for a 1st Class FCC License.



1B. Electronics Technology with Laboratory

Includes all areas of Course 1A including 1st Class FCC License preparation. In addition, student receives 161-piece Electronics Laboratory and 17 "lab" lessons for "hands-on" experience.



2. Broadcast Engineering

Here's an excellent studio engineering program which will get you a 1st Class FCC License. Now includes Video Systems, Monitors, FM Stereo Multiplex, Color Transmitter Operation and Remote Control.



3. First Class FCC License

If a 1st Class FCC ticket is your goal, this streamlined program will do the trick and enable you to maintain and service all types of transmitting equipment.



4. Electronic Communications

Mobile Radio, Microwave and 2nd Class FCC preparation are just a few of the topics covered in this "compact" program. Highly recommended for jobs with telephone companies.



5. Industrial Electronics & Automation

This exciting program includes many important subjects such as Instrumentation, Solid-State Devices used in Pulse, Digital and power controls.



6. Electronics Engineering

A college-level course for men already working in Electronics... covers Steady-State and Transient Network Theory, Solid-State Physics and Circuitry, Pulse Techniques, Computer Logic and Mathematics through Calculus.



An FCC License... or your money back!

The CIE courses described here will prepare you for the FCC License specified. In fact, we are so certain of their effectiveness we offer this Money-Back Warranty: when you complete any CIE licensing course, you'll be able to pass your FCC exam or be entitled to a full refund of all tuition paid. This warranty is valid during the completion time allowed for your course. You get your FCC License — or your money back.

CIE's AUTO-PROGRAMMED® Lessons help you learn faster and easier

Cleveland Institute uses the new programmed learning approach. Our Auto-Programmed Lessons present facts and concepts in small, easy-to-understand bits... reinforce them with clear explanations and examples. Students learn more thoroughly and faster through this modern, simplified method. You, too, will absorb... retain... advance at your own pace.

Employment Assistance available for all CIE students... at no extra cost

Once enrolled with CIE, you will get a bimonthly listing of high-paying, interesting jobs available with top companies throughout the country. Many CIE graduates hold such jobs with leading companies like American Airlines, AT&T, General Electric, General Telephone and Electronics, IBM, Motorola, Penn Central Railroad, Raytheon, RCA, Westinghouse and Xerox... to name a few.

CIE Lessons are continually up-dated

All lesson books and materials from CIE are continually revised or replaced according to the current needs of industry and the rapidly advancing and changing state of the art.

Approved Under G.I. Bill

All CIE career courses are approved for educational benefits under the G.I. Bill. If you are a Veteran or in service now, check box for G.I. Bill information.

CIE Cleveland Institute of Electronics, Inc.

1776 East 17th Street, Cleveland, Ohio 44114
Accredited Member National Home Study Council

Mail coupon for 2 FREE BOOKS

Cleveland Institute of Electronics, Inc.

1776 East 17th Street, Cleveland, Ohio 44114

Please send me your two FREE books:

1. Your school catalog, "Succeed in Electronics."
2. Your book on "How To Get a Commercial FCC License."

I am especially interested in:

- | | | |
|---|--|--|
| <input type="checkbox"/> Electronics Technology | <input type="checkbox"/> Broadcast Engineering | <input type="checkbox"/> Electronic Communications |
| <input type="checkbox"/> Electronics Technology with Laboratory | <input type="checkbox"/> First Class FCC License | <input type="checkbox"/> Industrial Electronics & Automation |
| | <input type="checkbox"/> Electronics Engineering | |

Name _____ Age _____

Address _____
(please print)

City _____ State _____ Zip _____

Veterans and Servicemen:

Check here for G.I. Bill information.

PE-60

CIRCLE NO. 7 ON READER SERVICE CARD

CONSTRUCTION

IN-CIRCUIT/OUT-OF-CIRCUIT

SEMICONDUCTOR JUNCTION TESTER

*Checks
bipolar
transistors
and diodes
with scope display*

BY MYLES H. MARKS

HERE is a transistor tester you can build yourself—easily and inexpensively. Though it does not display any parameters, it will tell you whether or not a junction is still operable. The tester can be used either in or out of a circuit and the only other equipment needed to use with it is an oscilloscope to display the results.

The circuit is shown in Fig. 1. When the test leads are open, the scope displays a horizontal line as shown in Fig. 2A. When the leads are shorted, a vertical line is displayed. The output of the transformer is a 60-Hz signal, and a good diode junction connected to the test leads will conduct on every other half cycle. It remains off during the other half cycle. This is indicated in

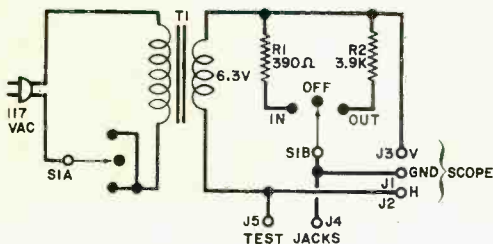

PARTS LIST

J1-J5—Five-way binding post
R1—390-ohm, 1/2-watt resistor
R2—3900-ohm, 1/2-watt resistor
S1—Dpdt center-off switch
T1—6.3-volt filament transformer
Misc.—Suitable chassis, terminal strip, line cord, mounting hardware, etc.
Note—A complete kit of parts is available for \$12.00, postpaid, from Marks, 315 Thornberry Ct. Dr., Pittsburgh, PA 15237

Fig. 1. Tester is a simple resistor circuit.

Fig. 2A by the sharp, L-shaped display. If the device has leakage, the display will be curved, as shown in the diagram.

Resistors R1 and R2 are used to limit the current through the junction and avoid damaging it. The lower resistance is used for in-circuit testing, the higher for individual junctions.

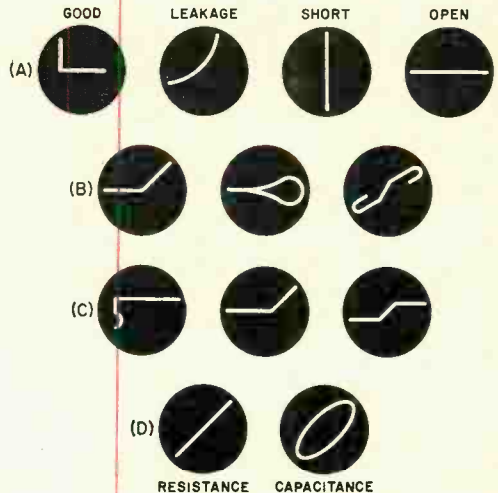

Fig. 2. Idealized scope display patterns show what to expect for different conditions.

Use. With the tester connected to the scope, set the scope's horizontal gain to approximately two-thirds of the scale. Short the test leads together, and set the scope's vertical gain also for two-thirds of the scale.

To check a transistor, three tests are required: base-to-collector, base-to-emitter, and collector-to-emitter. The polarities of the test leads are unimportant. For out-of-circuit tests, set S1 to OUT and look for a sharp break in the waveform, indicating a good junction.

When checking a device in a circuit, place S1 on the IN position and note the display. Due to the shunting effects of passive components that may be connected to the transistor, some confusing displays may be observed as shown in Fig. 2B. These displays all indicate a good junction.

Because of the intrinsic properties of the transistor, some emitter-to-collector waveforms of a good transistor will appear as shown in Fig. 2C.

You can also check standard resistors and capacitors with the tester. Waveforms for non-faulty devices should be as shown in Fig. 2D.

ELECTRONIC *Sensory Aids for the Blind*

LASER CANES, OPTICAL SCANNERS, AUDIBLE COMPASSES, AND BRAILLE-MARKED TESTERS ARE SOME OF THE DEVICES TO HELP THE SIGHTLESS

BY FORREST MIMS

A FEW years ago at the MIT Sensory Aids Evaluation & Development Center in Cambridge, Mass., a strange contrivance about the size and shape of a flashlight was demonstrated. To it was attached a small earphone from which emerged strange and complex sounds as the "flashlight" was scanned around the room. Even a coat rack some 10 feet away came in loud and clear as a *whoosh . . . WHEEP . . . whoosh* as it was scanned.

Surely, this was no ordinary flashlight. In fact, it was a radar-like ultrasonic mobility aid for the blind, developed by Dr. Leslie Kay in England. At the time, it was undergoing tests at the Center.

After demonstrating the Kay device, Center director Vito Proscia strapped a small box-like object around his neck and proceeded to give a demonstration of another ultrasonic mobility aid. Though himself blind, he always managed to stop short of any obstacle in his path.

As an object was approached, a ticking sound came from two small speakers inconspicuously mounted on the device's neck strap. As the object came within one pace's distance, the ticking became a tone, a warning to change course or reach out to investigate. The simple but efficient aid was developed by Lindsay Russell, a Cambridge engineer, and was called the "Travel Path Sounder."

In general, there are two major classes of mobility aids under development: passive

and active. Passive devices sense objects in the manner the human eye does. Active devices, such as the two ultrasonic aids just described, transmit a beam of light, sound, or radio waves and then receive reflections from obstacles that are in the path of the beam.

Active & Passive Aids. While only active devices have so far proved practical, passive aids have several advantages to recommend them: They are sometimes much smaller than their active counterparts; they usually require far less operating power; they have the potential for providing far more information; and they are considerably lower in cost.

One of the most interesting passive devices to come along was the "Optar," developed more than 15 years ago by H. E. Kallman. It was able to measure the range to objects by means of a slight adjustment required to bring the object into sharp focus on a photocell. An earphone provided the focussing information in the form of an audible tone.

Unfortunately, the Optar's audio tones were complex and difficult to interpret. The project was abandoned but later expanded upon by J. C. Bliss at Stanford University. Bliss modified the basic Optar concept by adding a vibrating device to the photocell and using signal-processing circuitry to simplify the device's output. The resultant signal was fed into an earphone or to an electro-

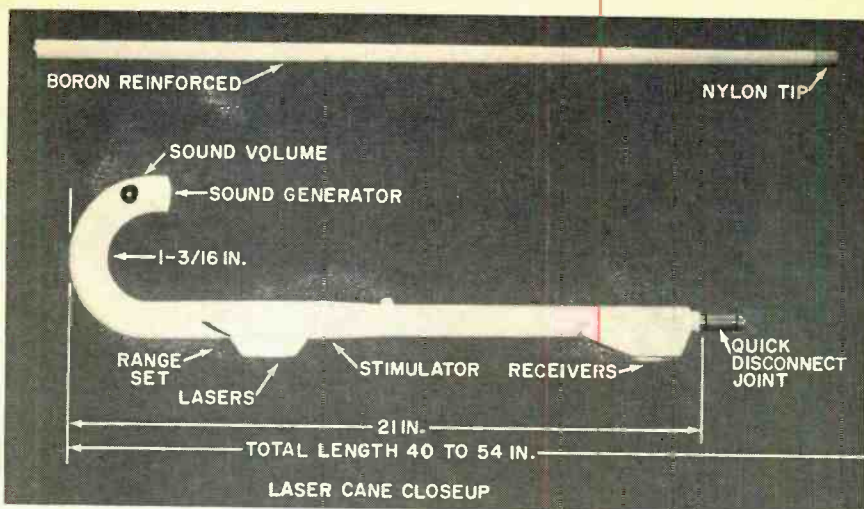

Laser Cane, developed by Bionic Instruments, uses three lasers and receivers to detect obstacles by triangulation. Tactile stimulator warns user about obstacles.

mechanical tactile stimulator. Even so, this device suffered from too many limitations for it to be a practical mobility aid.

The problems of the passive sensor are in large part eliminated by active devices that carry an energy source that makes them independent of the uncertainties of natural illumination. Some mobility aids use radio or microwaves, but most current research centers around a few devices using infrared light and ultrasonics.

The operating principles of an ultrasonic aid can be likened to those of sonar. A transducer in the device projects a narrow beam of ultrasonic sound, some of which is reflected by nearby obstacles and returned like an echo to a second transducer on the mobility aid. Since sound travels at a rather slow velocity of about 1100 ft/s, it is easy to electronically measure the time of the round-trip circuit of the beam. This "range" information is then presented to the blind user as a tone or tactile stimulation.

The output of the Kay aid presents a great deal of unprocessed information. Since each burst of sound emitted by the device is swept through a wide frequency range, the signal is in the form of a series of strange-sounding "rushes" that are interrupted by music-like tones when an object is detected. Smooth surfaces like glass and wood yield a steady tone; contoured surfaces like draperies and clothing give complex tonal patterns.

The output of the Travel Path Sounder is

much less complex. Processing circuitry absorbs the information received and merely informs the user by clicks and a single tone, when he is near an obstacle. While this technique provides significantly less information than the Kay device does, it requires much less concentration and is easier to use.

Though the signals from the Kay device are sometimes difficult to interpret, Dr. Kay feels that the approach warrants additional study. He has developed an ultrasonic aid that has transducers and earphones mounted in a modified pair of spectacles and a small external case for the electronics and battery. About 200 of the aids are currently being evaluated in several countries.

Infrared Aids. A number of active mobility aids that use infrared light have been developed. Early versions used inefficient incandescent and gas-discharge lamps. But modern devices employ light-emitting diodes (LED's) and semiconductor lasers. (For discussions of LED's and semiconductor lasers see *POPULAR ELECTRONICS* Nov. 1970 and Oct. 1971, respectively.)

One of the most advanced infrared mobility aids available is the "Laser Typhlocane" developed by Bionic Instruments, Inc. This laser cane consists of three pairs of tiny lasers and receivers mounted on a conventional long cane. The lasers are housed in a nacelle near the cane's crook, and the receiver photodiodes are located in another nacelle about 12 in. below the first. Rechargeable batteries

and all electronics are housed in the cane itself.

The laser cane determines the presence and approximate range of obstacles by triangulation. Each laser/photodiode pair is optically aligned so that objects coming within their mutual field of illumination and view are detected when light from the laser strikes the object and is reflected directly back to the photodiode. When an object is detected, a tactile stimulator in the cane's handle comes alive. Also, one of the channels uses a warning tone from a tiny speaker in the end of the cane's handle to signal the presence of certain obstacles.

With a range of more than 20 ft, the laser cane is remarkably sensitive. Furthermore, the cane performs the important—and difficult—function of detecting obstacles such as low curbs, drop offs, and glass. Unfortunately, the system is rather costly, but results with test subjects are encouraging, and it is expected that costs will decline when and if the cane goes into commercial production.

A less costly infrared aid, the "Seeing Aid," uses a single LED. It provides far less information than the laser cane, but its low cost makes it a good candidate as a supplemental mobility aid. A series of tests with blind children in Saigon revealed that the Seeing Aid is easy to operate and detects most common obstacles at a range of several paces. Work with the device continues with the addition of a more sensitive receiver and a triangulation feature. The unit has also been built into a pair of eyeglasses.

Reading Machines. While mobility aids may one day give their blind users improved travel ability, reading machines will enable them to move beyond Braille and "Talking Books." Surprisingly, the first crude reading machine—the "Exploring Octophone"—was invented by British scientist Fournier d'Albe in 1912. It employed a selenium cell in a Wheatstone bridge to signal about light intensity variations with a musical tone. Originally intended for environmental exploring, the Octophone was soon equipped with an adjustable aperture and used in experiments to read print. In 1923, blind Mary Jameson was able to read several words per minute with the device. Mary's continued interest in reading machines and her comments and evaluation have played important roles in the development of more sophisticated devices in recent years.

After the Octophone, Batelle Memorial

Institute developed a reading machine with advanced electronics and other improvements. A more recent device, the "Visotoner," was developed by Mauch Laboratories. Like the original Octophone, these devices presented information about printed letters in the form of complex tone patterns that require long training to properly interpret.

Reading machines that stimulate the fingertips with the actual shape of the printed characters may hold more promise than those with complex audio outputs. Mauch Labs has converted its Visotoner to this type of operation, dubbing it "Visotactor." In operation, the scanning head is moved along a



Le Que Manh learned to use infrared mobility aid quickly, even though he spoke no English. Developed by the author, this prototype aid was tested by blind children in Vietnam.

line of print as small tactile stimulators signal each of four fingers on one hand about the shape of a letter.

In a more sophisticated tactile stimulation machine that actually displays each letter in a raised relief with an array of stimulators has been developed at Stanford University. One of the machine's chief developers is the same James Bliss who developed one of the passive aids described earlier. Called the "Optacon," it uses a sensing head containing an array of 144 integrated phototransistors. As the sensing head is moved along a line of



Shari Gabrielson, Berkeley High School student, reads bulletin board with an Optacon reading machine developed at Stanford Univ. While scanning with probe in right hand, her left hand makes contact with an array of tiny tactile stimulators which form outline of each scanned letter. Single finger tip can be employed to read the letters.

print, each letter, number, and symbol is indicated in outline form on a 24 X 6 array of tactile stimulators that a single finger can "read."

Battery powered and weighing only about 8 lb, the Optacon is sufficiently portable for use in a variety of locations. Several test subjects who have used Optacons for quite some time all report that the aid is extremely useful in performing many tasks heretofore impossible for them.

The reading machines described thus far are limited to a maximum speed of less than 100 words per minute in the majority of cases. A much more efficient approach is a computer-assisted technique developed at MIT. In this method, a mini-computer performs complex analysis of each letter as it is scanned and then selects a prerecorded spoken letter.

Mauch Labs has also developed a reading machine with a voice output. Their "Cognodictor" uses photodetectors in a hand-operated scanning probe that reads up to 31 different letters and numbers. The machine is capable of storing up to eight letters at a time while it searches its optically recorded vocabulary for the proper letter. A reading speed of up to 90 wpm is hoped for with the Cognodictor.

Perhaps the most advanced reading machine of all has been developed by Haskins Laboratory. Other machines read but one letter at a time. The Haskins machine has a spoken vocabulary of 7200 of the most often

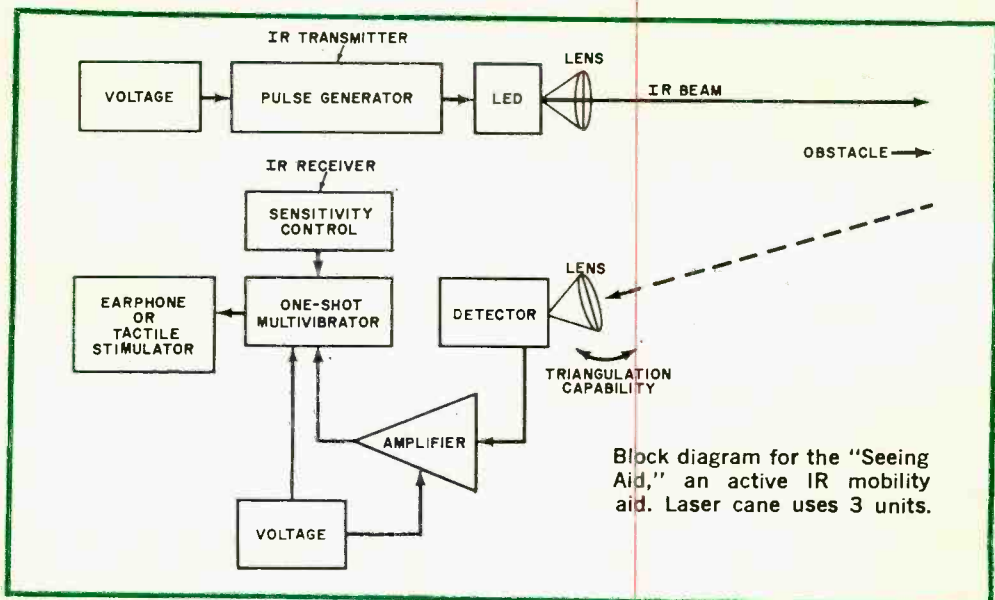

used *words* and the entire alphabet. The alphabet permits words not in the machine's vocabulary to be spelled out.

Owing to cost, if either the MIT or Haskins machines can be developed so that they prove practical, a good likelihood, their high costs will probably limit their use to reading rooms, libraries, and other public places frequented by the blind.

Meanwhile, the development of less costly devices continues. The Optacon developed at Stanford University is currently commercially available, and Mauch Labs continues to make significant improvements in their machines. Advanced versions, for

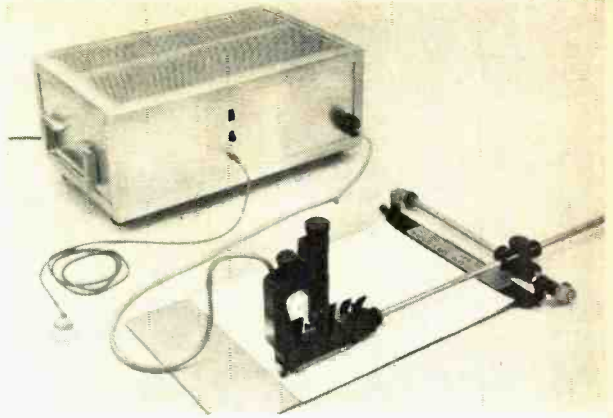

The Mauch Laboratories Cognodictor reading machine. Device produces spoken letters one at a time as detected by scanning probe.



A compass, photocell, and Mallory Sonalert combine to produce electronic compass with audible output. Device uses a penlite cell.

example, will be able to read spoken letters at rates up to 200-300 wpm. Since the Cognodictor employs a Visotactor as a scanner, the Visotactor can be disconnected from the spoken-letter output and used independently.

A variety of simple, important sensory aids have also been fabricated. There is the "beeping ball" that enables blind children to play games normally restricted to sighted children. The beeping ball was developed by Telephone Pioneers, a Bell Telephone Company employee organization.

Still other aids include electronic compasses and directional radio receivers designed to help the blind traveler to navigate from one place to another without becoming lost. For the blind electronics technician or hobbyist, there are several types of test equipment made especially for the sightless;

multimeters that produce a tone instead of a meter reading are just one example.

One ingenious aid has been developed to warn deaf-blind employees at a New York establishment in the event of a fire. Each employee carries a small receiver that is capable of detecting signals from a master loop antenna. When the receiver is triggered, a motor rotates and an eccentric wheel causes the entire assembly to vibrate.

At present, most of the advanced electronic sensory aids described in this article are still laboratory devices. But many of them are undergoing trial use with blind test subjects, and a few are on the commercial market. Thanks to recent significant advances in semiconductor technology, the long awaited development of a range of sensory aids for the blind that can be put to practical use is almost here. ♦



This American Foundation for Blind instrument provides tactile readings of voltage, resistance, and current. Earphones supply signal which is nulled to obtain reading.

Author's practical embodiment of electromechanical light chopper shown in Fig. 3. Calibration lamp is at left. An r-f transmitter triggers lamp.

**How
light-sensitive
semiconductors
are used
in practical circuits**

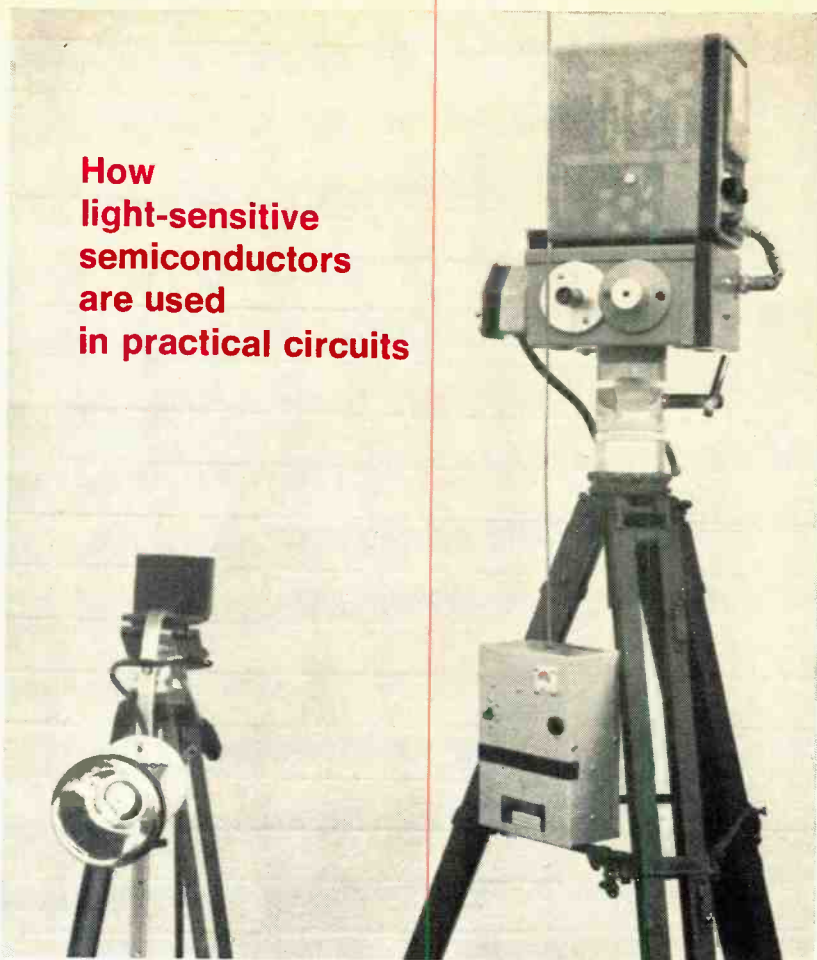

Solid-State PHOTOCELLS FOR HOBBYISTS Part 2

BY L. GEORGE LAWRENCE

LAST month, different types of photocells and their general characteristics were discussed. Now we will illustrate how photocells are used in actual applications.

In some of the circuits described here, we use an NSL-446 (National Semiconductors Ltd., 331 Cornelia St., Plattsburgh, NY 12901). It has a light-to-dark resistance ratio of about 1:1000 (11,400 ohms in light to 12,000,000 ohms in darkness). Maximum peak voltage is 420 V at peak power of 1 watt. These specifications make it suitable for a wide range of sensing and control functions and are typical of many high-power photoconductive cells. Low-power photo-

cells, such as the P-41,108 from Edmund Scientific Corp. (300 Edscorp Bldg., Barrington, NJ 08007), can also be used in similar circuits. For example, it can be used to control a relay with a 0.2-watt coil rating, as opposed to 1 watt for the 446.

A good way to experiment with photocells without damaging them is to use alligator clips for temporary connections. Many cells with pin-type leads are heat sensitive. Thus, both substrates and light-sensitive materials can be damaged by frequent soldering. To be on the safe side, use a simple heat-sink tool (Miller No. 80, for example) or long-nose pliers when soldering.

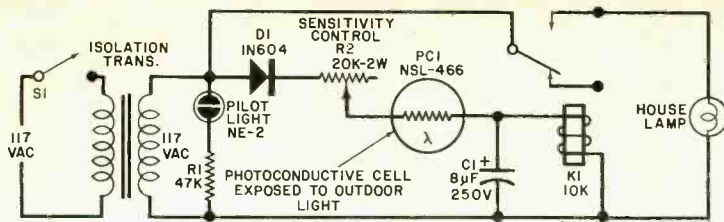

Fig. 1 Simplicity of application of photoconductive cells is demonstrated in this construction project. House Sitter stops conducting at night, making relay drop out and turn on lamp.

Daylight-Operated Controller. A basic application for the NSL-446 is the "house sitter" shown in Fig. 1. The photocell is exposed to outdoor light and it automatically turns on a lamp circuit when the sun goes down. Potentiometer *R2* and relay *K1* provide current limiting for the photocell. Half-wave rectification is provided by *D1*, and *C1* prevents relay chatter. During daylight hours, the photocell's resistance is low, and

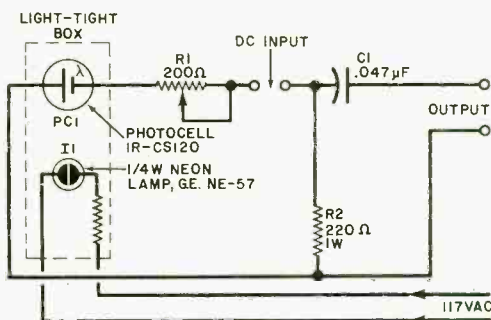

Fig. 2 Photoelectric chopper for converting dc to amplitude-variable ac for oscilloscope.

the relay is kept energized. The lamp circuit is thus turned off. When the resistance of the photocell rises with waning light, the relay drops out and the lamp circuit is energized. The neon pilot light indicates that the unit is on and ready to operate.

Choppers. When the circuit shown in Fig. 2 (called a photoelectric chopper) is used with a conventional ac-type oscilloscope, the latter can be used to display dc signals. The photocell, *PC1*, is optically coupled to a 1/4-watt neon lamp, *I1*. Since the cell is gated on and off by the neon lamp's flicker frequency of 60 Hz, a dc signal applied to the input of the circuit is chopped and appears as ac across *R2*. High dc input provides an analog increase in the amplitude of the ac output. This arrangement works well in

many non-critical applications. The excitation current can be derived from the scope's power supply.

The ac processing of a photocell's dc signal is desirable in many applications where the inherent drift of "straight" dc amplifiers (including low-cost IC's) cannot be condoned. In the setup shown in Fig. 3, for instance, a motor-driven wheel "chops" the light to the photocell. The frequency of the electromechanical chopper is determined by the number of apertures in the wheel and the speed of rotation. If, for example, the wheel is driven by a synchronous motor at 1800 rpm and has 4 holes, the effective chopping frequency is $(1800/60) \times 4 = 120$ Hz. The chopped dc (actually a square-wave signal) across *R1* is amplified and applied to a meter readout through a full-wave rectifier.

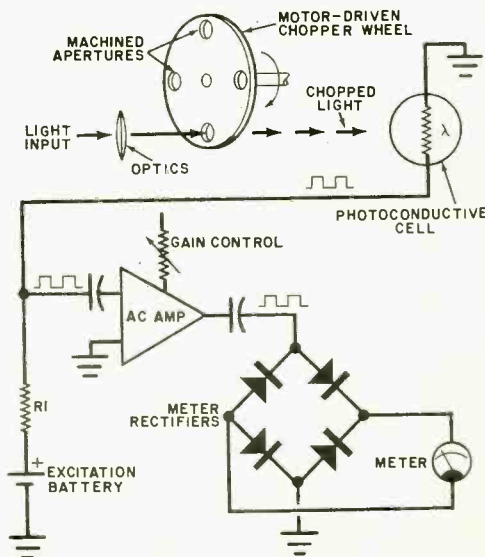

Fig. 3. Electromechanical light chopper has rotating aperture wheel, amplifier, meter.

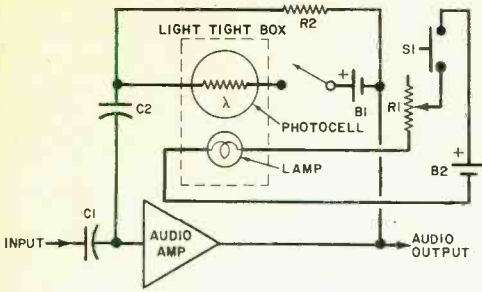

Fig. 4 Photocell feedback for audio effects.

Audio Use. Photoconductive cells can be used in many fascinating experiments and money-saving conveniences in audio work.

The circuit shown in Fig. 4, for example, provides light-controlled feedback of an audio amplifier. If the intensity of the lamp (controlled by *S1*) is sufficient to lower the resistance of the photocell, part of the amplifier's output signal is fed back to the input. Depending on the lamp's brightness, which is set by potentiometer *R1*, powerful feedback oscillations of variable intensity can be obtained. Thus, the amplifier can be converted into a single-frequency "cue" generator, an aid in cutting master tapes.

If desired, the amplifier can trigger a special-effects instrument. The photocell can be activated by the dominant light of a color organ during original deep bass sequences, with the photocell's output triggering a solenoid-operated drum.

In the circuit shown in Fig. 4, *R2* provides a "keep-alive" current path for the cell. Since its own resistance is high, no feedback will ensue unless resistive circuit values are lowered by the activated photocell. Best results can be obtained by actual experimentation.

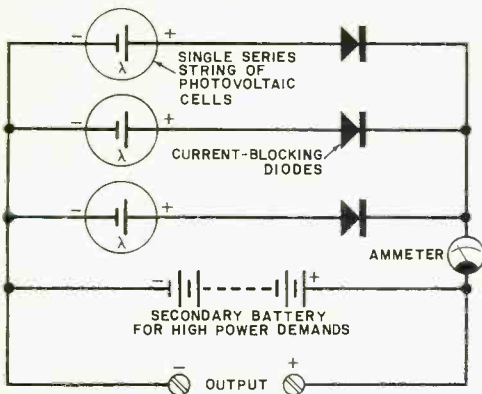

Fig. 5 Solar cells in series-parallel array.

Power Generators. Photovoltaic cells are used primarily as sources of dc power. An excellent application is in the generation of power for emergencies. As shown in Fig. 5, silicon or selenium cells in series can furnish charging currents to a secondary battery, with current-blocking diodes to protect the cells from reverse current. The ammeter (optional) indicates the total amount of charge.

Since the output of the cells is governed by the amount of ambient sunlight, special allowances must be made in computing charging rates and effective load resistances. An excellent guide for this purpose is International Rectifier's handbook, *Solar Cells and Photocells* (HB-30), which is available for \$2.00 from most electronics distributors.

In typical applications, solar batteries act as trickle chargers for conventional batteries that furnish high dc power (100 A or more) for a few minutes at a time. This concept is used in satellite applications, with silicon photocells assembled in arrays on the satellite.

An excellent hobby project is the sun-powered emergency radio receiver shown in

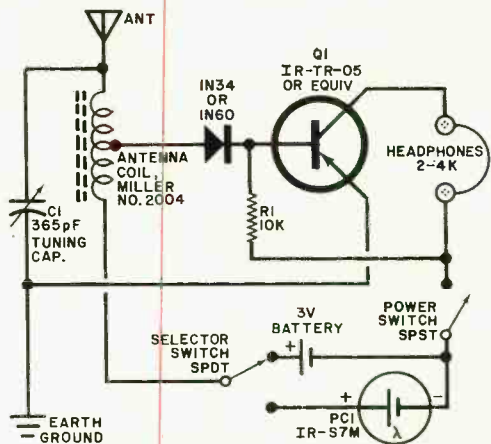
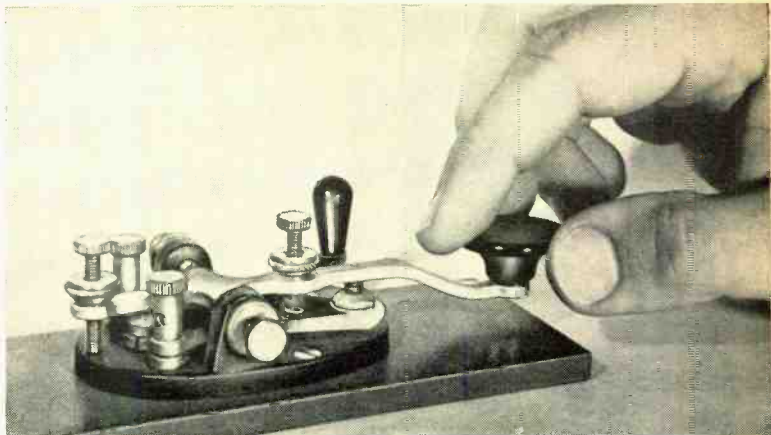

Fig. 6. Sun-powered emergency radio receiver.

Fig. 6. It is simple and reliable, with a 3-volt standby battery (two C or D cells in series) for sunless days. For use on land or at sea, the receiver works best with a true earth ground and a long antenna. The ground can be a metal frame or a submerged metal plate in the case of a boat. A small transistor amplifier can be added to improve the power output. Wiring and layout are not critical, but the electronic components should be housed in a sturdy metal container. ♦

How to break the 10-words-per-minute CODE BARRIER

BY RICHARD HUMPHREY



LUCKY is the radio amateur who doesn't "plateau out" somewhere around ten words-per-minute when he's learning code. There may be a fortunate few who march right up to 20 or 30 wpm without a break, but most of us make it to 10 wpm literally in a matter of days, then struggle for many months to get up to 15 wpm solid copy so we can be sure of hacking 13 wpm when we go up for our General. Once definitely past the 10 wpm "hump," progress is seldom a problem.

Hams aren't the only ones bothered by the CW plateau. The Navy, Army, Coast Guard, and Air Force all have their difficulties in getting their radio-operator trainees off the 10 wpm dime. When asked if the Army had a problem, Colonel A.J. Sullivan in Washington said:

"Yes we do. Approximately 60% of trainees reach a hump somewhere between 10 and 13 words-a-minute. Our goal is to raise them to 15," he said, "and often we're able to get them to go as high as 25 and 30 words-a-minute." Col. Sullivan went on to explain how the Army did it. "The first way is to have the student and instructor analyze error patterns and then determine remedial patterns to correct them in the student.

"The second way," he continued, "is to analyze individual rhythm patterns and make recommendations to improve these.

The third thing is to try and get these students to copy 'behind' one or two characters so that they might be able to comprehend a whole word instead of a letter at a time."

A spokesman for the U.S. Navy, Lt. Tim Mennuti, echoed Col. Sullivan. "It takes three weeks to peak out," he said, "at which point the average person has reached 12 to 14 words-per-minute." Mennuti added, "The problem is that over 14 words-per-minute there are no breaks between letters." It appears the Navy considers the "hump" serious since we understand the training program is undergoing considerable revision.

Everyone interviewed agreed on one of two positions: either (a) the plateau was caused by reaching a speed where you had to stop copying *letters* and start copying *words* or (b) the "letter-to-word" transition was a coincidence and the reason for the "hump" had to be found elsewhere. The Navy seems to favor the latter view. "Apparently," said Mennuti, "there's some psychology connected with this thing that we didn't have before. What we're finding out," he explained, "is there may be a certain type of individual who can copy fast code and a certain type who can't.

Strangely, two things which might be expected to have had an effect on an almost auditory process such as learning CW seem not to have affected it at all: the increasing

use of audio-visual aids in teaching and the tremendous impact of television on those who have been coming into the military. The generation which has been studying code for the past several years are, say the experts, "picture" oriented rather than "word" oriented. One might expect that hams and others cramming code today would be having more trouble. But Col. Sullivan says the percent of those hitting the "hump" hasn't changed "in the last 20 years."

Psychologists and authorities in the business of teaching brought up the point when they were interviewed that getting past the 10 wpm plateau wasn't a "learning" problem but a "fluency" problem. Obviously, they said, if you can copy and send ten words-a-minute, you *know* the code. The point was also made that gaining fluency in code might be similar to gaining fluency in a foreign language. If you learn a foreign language by "reading" it—in high school or college, for instance—you will usually have tremendous difficulty in *speaking* (or understanding) the language fluently. You will find that you translate from the foreign tongue into your own language, absorb the information, form an answer, in your own language, translate the answer into the foreign language, and then say it. To gain any fluency whatsoever you must *think* in the foreign language.

But how do you "think in code?"

Here, the experts and authorities as well as military instructors and radio amateurs are more-or-less in agreement. Number one on everyone's bugaboo list: *don't* sit down and learn the code before you start listening to it! Many hams fall into this bottomless pit. The CW trainee in the military has usually been sitting there for three hours with the cans on his head listening to taped copy before someone tells him what it is he's doing. Even so, six out of ten plateau out somewhere around 10 wpm, according to the Army. The attrition rate among radio amateurs must be tremendous. One instructor put the problem this way:

"When you find yourself hearing *dah-dit-dah-dit* and saying 'Aha, that's a C' and then writing it down, you're in big trouble. It's got to be instantaneous," he said. "You hear it, you write it. No translating!"

The way you transcribe CW may also have a direct bearing on the 10 wpm hump. Without exception, everybody agrees that the best way is to use a typewriter. For two

reasons. First, the mental attitude you have when you learn to touch type is quite similar to what it should be in learning code. You're not translating. You learn by rote that the right forefinger goes *there* and the left forefinger goes *here* for this letter or that letter. You're not falling into the bad habit of reading a letter, looking for it on the keyboard, then hitting it.

Second, copying by hand in capitals will limit your speed to around 15 wpm. Long-hand script will only take you to 25 wpm or so. The only thing limiting your code speed when using touch typing is your typing speed. A 40-wpm typing speed is only fair. A 40-wpm speed in copying code is very good. (It's undoubtedly no coincidence that of the Air Force's 630 hour CW course, 435 hours are devoted to "touch typing and transcribing International Morse code with a typewriter.")

The various tapes and records on the market to teach you the code undoubtedly have some value. The unanimous comment from radio amateurs is that they'll memorize each tape or record after a few playings and once this has happened the recording is useless. Tapes work out fine for the military because they can afford thousands-of-hours of it so there's little chance of copy memorization. Hams usually aren't so affluent.

What to do if you "studied" the code before you began listening to it? You can try the Army's recommendation of "copying behind" to try to progress from *letter* copying to *word* copying. Or you can try the method used by a former Navy Chief Radio Electrician.

"My hump was around nine-a-minute," he says. "It made me mad. I just kept at it. I copied until my eyes fell out. I even copied Russian and Spanish code, though I didn't understand it. Later, aboard ship, they tested me on taped copy, and I made 9 words-a-minute."

To many would-be hams, all this insistence on an "antiquated" form of communications is ridiculous. With FM, SSB, facsimile, and other things to come in the future, they may be right. But CW is still the simplest form of long-range communications. Because when you are using CW, you can cut through QRM with modest power, a minimum number of components with simple antenna, and troubleshooting and repairs can be made with almost no training. CW is a unique case of the Old Gray Mare being just as good as she "used to be." ♦

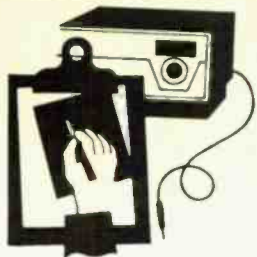

Product Test Reports

AVID MODEL 103 SPEAKER SYSTEM (A Hirsch-Houck Labs Report)

THE Avid Model 103 acoustic suspension speaker system employs a three-way design. Its 10-in. woofer crosses over at 500 Hz to a 4½-in. cone-type midrange driver. Then at 3500 Hz, a second crossover to a 1-in. dome tweeter takes place.

Behind the system's snap-out grille is a five-position switch for adjusting the middle- and high-frequency levels over a moderate range. Nominally an 8-ohm system, the Model 103 can handle up to 150 watts of program power. An amplifier of at least 20 watts (per channel) output is recommended for driving the system. The midrange driver and tweeter are protected by a fast-acting 2-ampere fuse, access to which is provided behind the grille.

This is a compact system. Its cabinet measures 25 in. by 15 in. by only 9¾ in. deep. Although the system can be placed vertically or horizontally on a floor, its shallow depth makes it especially suited to shelf mounting. Overall weight is 38 pounds.

The retail price of the Avid Model 103 speaker system, including matching floor stand, is \$144.50.

Laboratory Measurements. The smoothed and averaged frequency response of the speaker system was within ± 3 dB from 47 Hz to 13,500 Hz. Its output increased at the highest frequencies (with the level switch set to position 3, nominally the flat-test). It reached a maximum of +6 dB at 15,000 Hz, relative to the midrange level, and was still a strong -3 dB at our upper test limit of 20,000 Hz. The level switch could raise or lower the output at most frequencies above about 1000 Hz by 2 to 3 dB at its extreme settings.

Like other fine acoustic-suspension speaker systems, the Model 103 had very low bass

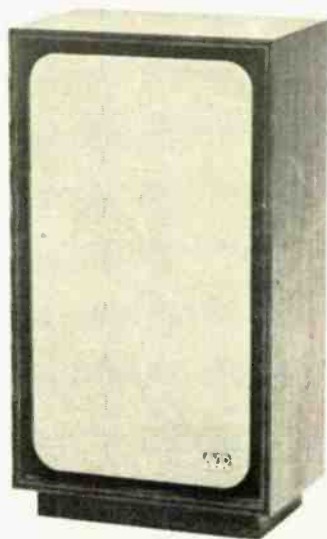

distortion. With a 1-watt drive level, distortion was only 3 percent at 30 Hz and 8.5 percent at 20 Hz. Even with a 10-watt drive level, distortion remained moderate, measuring 3 percent at 45 Hz and only 7 percent at 30 Hz.

This is a relatively inefficient speaker system. It required just over 1 watt of drive power in the midrange to produce a sound pressure level of 90 dB at a distance of 1 meter from the grille. The system's impedance characteristic was unusually uniform, measuring between 8 and 12 ohms from 200 Hz to 20,000 Hz. It dropped to 7 ohms at 120 Hz, and with a well-damped resonance, it rose to 10 ohms at 45 Hz. The minimum impedance of 6 ohms was at 20 Hz.

The tone-burst response of the system was uniformly excellent over the full frequency range. Less than 1 cycle was required to

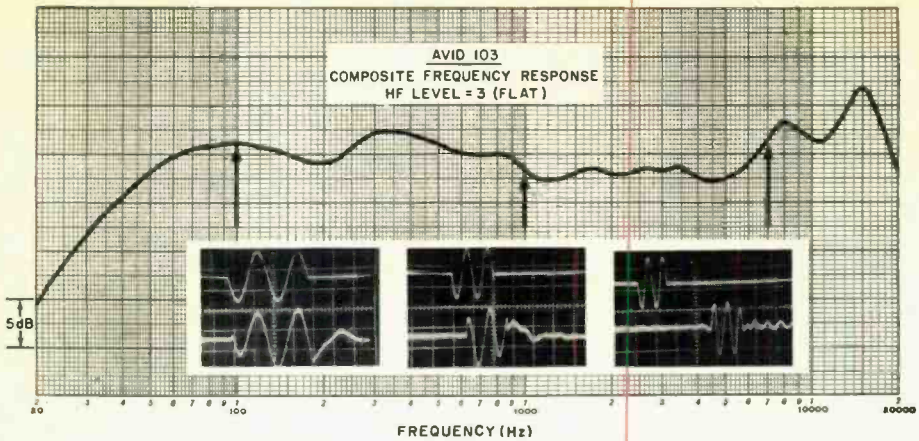

reach the full burst amplitude, without overshoot, ringing, or spurious responses.

User Comment. The sound of the Avid Model 103 speaker system can best be described as smooth, easy, and free from emphasis or coloration in any portion of the frequency spectrum.

As expected, the "live-versus-recorded" test revealed the effect of the rising high-end response in the form of a slight prominence of the uppermost frequencies and harmonics in such sounds as wire brushes and triangles. Reducing the setting of the level switch by one step produced a near-perfect response. The only difference between the original sound and its reproduction through the Model 103 was in the midrange. A boost of about 2 dB between 1200 and 5000 Hz with an octave-band equalizer nearly eliminated even this slight effect.

The high-frequency dispersion of the speaker system was as good as we have heard from a single-dome, 1-in. radiator, although we could of course detect some loss of extreme highs in off-axis listening positions.

The very low distortion of the Avid speaker system encouraged us to try it out with a high-power amplifier with 200 watts/channel. The system was able to absorb the full output of the amplifier with musical program material without damage, strain, or objectionable distortion of any kind. This is unusual for speaker systems in the \$145 price range.

In every respect, the Avid Model 103 proved to be one of the best moderately priced speaker systems we have heard. It should be able to compete effectively with many speaker systems costing as much as \$200 or more.

Circle No. 65 on Reader Service Card

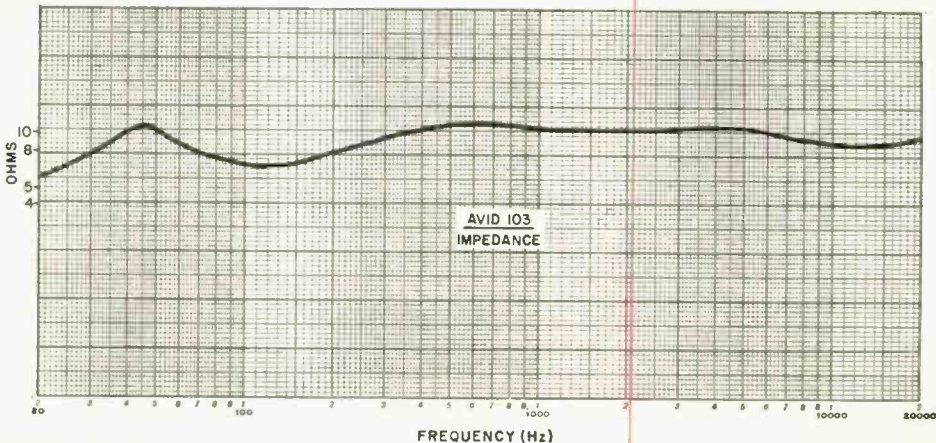

dbx MODEL 119 DYNAMIC RANGE ENHANCER
(A Hirsch-Houck Labs Report)

THE dbx Model 119 "dynamic range enhancer" audio compressor/expander employs a true rms detector and two (for stereo) low-noise, variable-gain elements. The input/output characteristic can be continuously adjusted to obtain a positive slope greater than unity for expansion, through unity, to a slope less than unity for compression. It is even possible to set the slope to zero for infinite compression so that the output level remains essentially constant over an input range of greater than 100 dB. At all times, the relationship between input and output levels, expressed in dB, is linear, which dbx calls "decilinear" operation.



General Description. The range enhancer has at least three distinctly different modes of operation. As a compressor, the output change is less than the input change. As an expander, the output change is greater than the input change. Finally, by making recordings in the compressor mode and playing them back with the complementary degree of expansion, the unit can serve as an effective tape noise reduction system.

which the unit has unity gain. Hence, the first control changes the slope of the input/output characteristic, while the latter shifts the entire characteristic over a wide range of voltage levels. The only other control is the MODE switch. In its LINEAR position, operation is as described above. In the ABOVE THRESHOLD position, expansion or compression occurs only when the signal level exceeds the threshold setting, at which time a LED lights up.

On the front panel of the range enhancer is a SLOPE control knob backed by a calibrated scale that goes from 2.0 maximum expansion through 0 to infinite compression. A THRESHOLD control shifts the level at

Since the unit contains only a single pair of control elements, it must be switched between a tape deck's input and output circuits when going from record to playback, and the slope must be changed from compression to expansion. Because it is not possible to operate the unit simultaneously

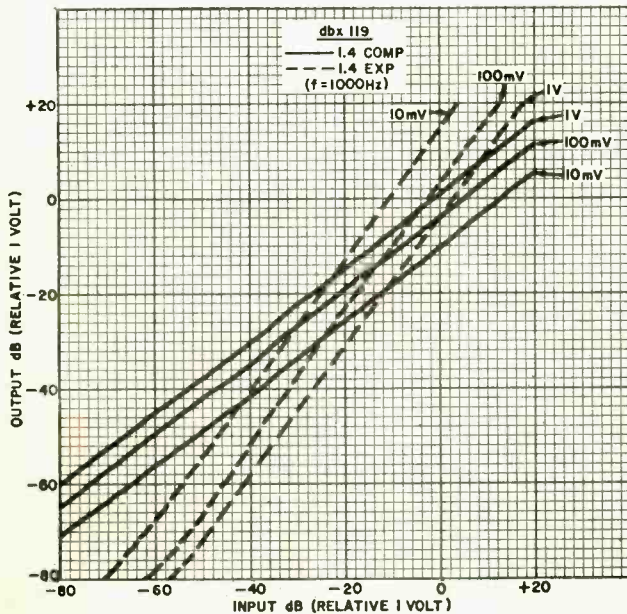

DIGITAL COLO

Bell & Howell Schools announces an exciting at-home learning program that includes this advanced color TV with digital features... you build it yourself!

You learn valuable skills in electronics through experiments and testing as you build a color television that's ahead of its time!

You've seen TV's that swivel, TV's with radios built in, TV's small enough to stuff in a suitcase and TV's that have remote control.

But now comes a color television with features you've never seen before. Features now possible as a result of the new applications of digital electronics --- features that make Bell & Howell's 25-inch diagonal color TV ahead of its time! You learn about...

Channel numbers that flash big and clear right on the screen. An on-screen digital clock that flashes the time in hours, minutes and seconds with just the push of a button. An automatic channel selector that you pre-set to skip over "dead" channels and go directly to the channels of your choice.

And to insure highest quality performance, this TV has silent, all-



electronic tuning, "state-of-the-art" integrated circuitry, Black Matrix picture tube for a brighter, sharper picture and 100% solid-state chassis for longer life and dependability.

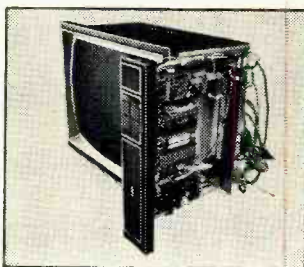

Perform fascinating experiments with the exclusive Electro-Lab® electronics training system. It's yours to build.

Designed exclusively for our students, this Bell & Howell Electro-Lab®

Simulated TV picture.



You build this revolutionary Bell & Howell 25" diagonal color TV with amazing digital features! Mail the postage-free card today for complete details, free!

gives you up-to-date "tools of the trade," including instruments you can use professionally after you finish the program.

A digital multimeter that measures voltage, current and resistance and displays its findings in big, clear numbers. Far more accurate and readable than conventional "needle pointer" meters



that require guesswork and interpretation.

The solid-state "triggered sweep" oscilloscope is a "must" for accurate analysis of digital circuitry. Includes DC wide-band vertical amplifier and "triggered sweep" feature to lock in signals for easier observation.

The design console is a valuable device for setting up and examining circuits without soldering! Features patented modular connectors, AC power supply and transistorized dual range DC power supply.

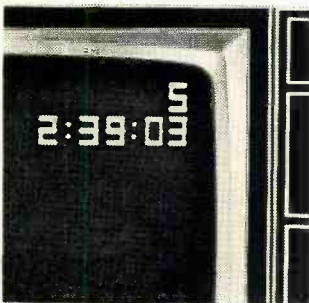

R TV IS HERE!

Build it yourself... the perfect way to discover the exciting field of digital electronics!

It's part of a complete learn-at-home program!

Imagine spending your spare time actually building your own 25-inch diagonal color TV! It's a project you can work on right in your home. You'll enjoy the challenge...exploring the new systems of digital circuitry and performing experiments to test what you learn.

There's no travelling to classes, no lectures to attend, and you don't have to give up your job or paycheck just because you want to get ahead. When you finish this Bell & Howell Schools program you'll have learned new skills, plus you'll have a great color TV to enjoy for years!

You need no prior electronics background!

We start you off with the basics.

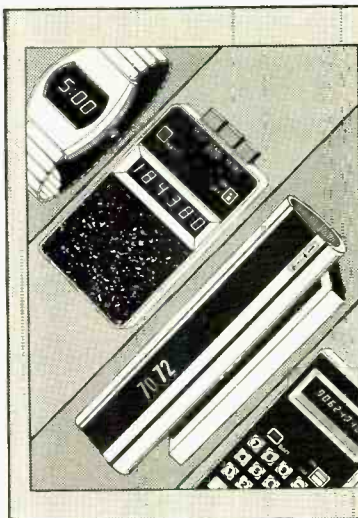

Digital electronics is changing our lives!

There's a lot more to digital electronics than just the numbers! True, that's what you see on more and more products like digital calculators, clocks and watches. But behind the numbers lies a fantastic technology that's creating higher standards of accuracy and dependability. The versatility of digital electronics has begun another industrial revolution. Its growth and applications are giving us new and better ways of doing things and spectacular products.

You'll receive a special Lab Starter Kit with your first lesson so that you can get immediate "hands on" experience to help you better understand newly-learned electronics principles. Later, you'll use your new knowledge and learn valuable skills as you build the color TV. You can take advantage of our toll-free phone-in assistance service throughout the program and also our in person "help sessions" held in 50 cities at various times throughout the year where you can "talk shop" with your instructors and fellow students.

Pick up valuable skills in electronics that could lead to extra income, full or part time... perhaps a business of your own!

Once you complete this learn-at-home program from Bell & Howell Schools, you'll have the specialized skills to service color TV's plus the knowledge that you can apply to repair a variety of home electronics equipment. No better or more practical at-home training in electronics is available anywhere!

These skills could open up new income opportunities for you full or part time. While many of our students do not ask for employment assistance, it is available. Of course, no assurance of income opportunities can be offered. Get the complete story on this exciting, learn-at-home program... the world's first color TV course employing digital electronics technology!

Mail card today for full details, free!

If card has been removed, write:
An Electronics Home Study School
DEVRY INSTITUTE OF TECHNOLOGY
ONE OF THE

BELL & HOWELL SCHOOLS
4131 Belmont, Chicago, Illinois 60641

Electro-Lab is a registered trademark of the Bell & Howell Company.

597 R5



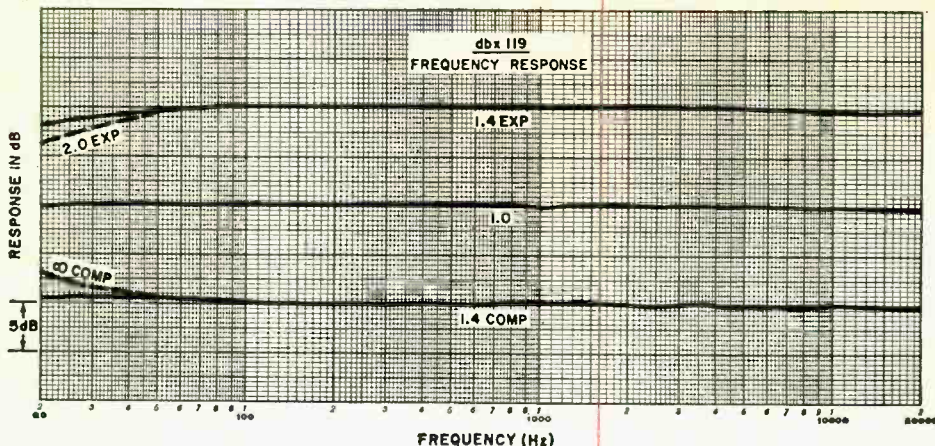

in both the compression and expansion modes, the tape recorder's playback must go to the amplifier's AUX inputs instead of the usual tape inputs.

Operated as a tape noise reduction system, the range enhancer can provide about 10 dB of noise reduction with recordings that have poor S/N ratios. Noise reduction of up to 20 dB can be obtained with the best recorders. Unlike the Dolby system in which only the higher frequencies are affected, the range enhancer reduces noise over the entire 20-20,000-Hz range. Its sensing circuits respond to the sum of the two channel levels with its effects applied equally to both channels, while the Dolby system operates as two independent channels.

The retail price of the dbx Model 119 dynamic range enhancer is \$189.

Laboratory Measurements. We measured the input/output transfer characteristic of the system with several degrees of expansion and compression and over the full threshold range. In every case, the slopes agreed almost exactly with the calibration marks on the front panel.

The frequency response was within 1 dB overall from 40 to 20,000 Hz at any slope setting. At lower frequencies, there was a slight variation in response with different slopes: a maximum drop of 3.5 dB at 20 Hz with a 2.0 expansion, and a 3-dB boost with infinite compression.

The output at the clipping level was 10 volts. The 1000-Hz THD was between 0.04 and 0.07 percent for outputs of up to 3 volts and expansions up to 1.4. At 20,000 Hz, distortion was less than 0.1 percent at 1 volt (with a compression or expansion slope of 1.4). Maximum distortion, at 20 Hz with a

1.4 expansion and 1-volt output, was 0.63 percent.

Using tone bursts, we were able to estimate the dynamic properties of the range enhancer. With not more than a 1.4 compression or expansion slope, the action appeared to be 90 percent complete in about 20 ms. Greater expansion slopes required more time (about 100 ms) to reach final levels, but most of the change occurred in the first 20 ms.

User Comment. To avoid unnatural effects, the instruction manual suggests using no more expansion or compression than necessary. Slopes exceeding 1.4 are not recommended for noise reduction or expanding the range of typical musical programs.

When the threshold is correctly set, introducing expansion has little effect on the maximum program level. But during pauses or drops in average level, background noise rose perceptibly—especially with slope settings exceeding 1.4. Similarly, in expansion, the background noise dropped markedly during program pauses. With slopes exceeding 1.4, the noise level shifts could be heard as "swishes".

As a tape noise reduction system, the unit's chief limitation is the need for precise matching of the compression and expansion slopes. Threshold levels are not critical, since the 120-dB dynamic range of the system leaves plenty of room for a 60- or 70-dB program range without exceeding the unit's capabilities.

Attempting to obtain greater noise reduction with slopes of 2.0, we found the fluctuation of the background noise was more noticeable during the attack and release times, although the average noise level cer-

tainly was much lower. We suspect that this was due as much to the differences between attack times in the two modes as to any slope errors.

In our opinion, the dbx Model 119 dynamic range enhancer is an exceptionally useful adjunct to a music system whether it has a tape deck or not.

Circle No. 66 on Reader Service Card

BROWNING LTD AM/SSB MOBILE CB TRANSCEIVER



THE Browning Labs LTD mobile CB transceiver provides 23 channels of operation in each of its AM and SSB modes. The transceiver offers the customary features of r-f and a-f gain controls, AM/LSB/USB selector, Delta tune, adjustable squelch, switchable r-f noise blanker, alc for SSB and amc (automatic modulation compression) for AM, agc, PA or CB operation with external speakers, and transmit indication. It also has a 13.8-volt dc negative- or positive-ground system with reverse-polarity protection, line filter, and electronic voltage regulation. An illuminated channel-selector dial and an edgewise S-unit/relative-power meter is easier to read than on some rigs.

Retail price of the LTD is \$360, which includes the transceiver, microphone, and anti-theft mobile mounting bracket.

SSB Operation. The basic circuit configuration of the LTD is similar to some other transceivers now making their appearance on the market. The frequency synthesizer, employing 14 crystals, provides outputs in the 22-MHz range (as needed for each channel). When combined with a 12.8-MHz crystal-controlled signal, a nominal 34.8-MHz heterodyning signal results, producing a 7.8-MHz i-f. Single conversion to this i-f in conjunction with a crystal-lattice sideband filter is thus employed for SSB operation.

This setup provides an unwanted-sideband rejection of 60 dB at 1000 Hz. Together with the product detector circuit and the characteristics of the a-f amplifier, the

overall a-f response was found to be nominally 300-2700 Hz at 6 dB. Sidebands are changed by shifting the bfo about 3000 Hz, using one of two crystals and similarly "rubbering" the 12.8-MHz crystal to maintain operation on exactly the same channel frequency of either sideband.

The r-f amplifier is built around a field-effect transistor which, along with a low-noise bipolar transistor mixer, provides an excellent $0.1 \mu\text{V}$ for 10 dB (S + N)/N SSB sensitivity.

The SSB transmitting signal is generated in the conventional way, through the sideband filter and several r-f stages, ending up with the power-amplifier stage that is then set up for linear operation. Included in the power-output stage is a matching and filtering network that provides a high order of spurious-signal attenuation.

The SSB power input was originally rated at 15 watts pep with 8 watts pep output. However, under the recently amended FCC regulations, a somewhat higher input is permissible as long as the pep output does not exceed 12 watts. Our unit, therefore, was factory adjusted for 12 watts pep output with a 13.8-volt dc source. At this level and at the alc threshold, third-order intermodulation distortion products were 26 dB below the maximum output, while all higher-order products were down 40 or more dB. The fundamental a-f output response was nominally 500 to 2750 Hz at 6 dB, while carrier suppression was 50 dB.

AM Operation. Double conversion is used in the LTD for AM operation, with the 7.8-MHz i-f combined with a 7.345-MHz crystal signal to provide a 455-kHz second i-f where selectivity is obtained with two ceramic filters. The overall 6-dB a-f response with this arrangement was nominally 200 to 2200 Hz, and adjacent-channel rejection was 45 to 50 dB. A full-time a-f noise limiter is used for AM. The AM sensitivity was $0.3 \mu\text{V}$ for 10 dB (S + N)/N with 30 percent modulation at 1000 Hz.

The carrier for the AM transmitter is developed by the synthesis system, while the r-f driver and power amplifier are collector-modulated, as usual, by the a-f power-output amplifier of the receiver (with automatic modulation compression included). The power amplifier parameters are altered for optimizing AM operation.

A carrier output of 4 watts was measured with operation from a 13.8-volt dc source. Full modulation was attainable with good waveform, exhibiting only 5 percent distortion when complete modulation was first reached. Although the amc held the positive peaks properly to 100 percent with increased speech-input levels, it did not prevent over-modulation and carrier breakup at the negative peaks—a condition common to most CB rigs. Nevertheless, with 10 dB of compression, the modulation splatter with a test tone was down 40 dB at the adjacent channel. (Under normal voice operation, the attenuation will actually be greater.) Otherwise, a-f response was 550-3600 Hz.

Other Test Results. With either mode of operation, the squelch threshold range was 0.3-1000 μ V. The S meter registered S9 with about a 100- μ V signal. Image rejection was 68 dB, and i-f signal rejection was 80 dB. The agc held the a-f output to within 2 dB

on SSB and 4 dB on AM with a 60-dB r-f input change (10-10,000 μ V).

The noise blanker is an r-f parallel-gate type that can be used on either AM or SSB. Its effectiveness hinges on the type of noise to be suppressed, according to the pulse width, rise time, repetition rate, amplitude, etc. Thus, the blanker can attenuate certain noise pulses by 20 to 40 dB and yet be relatively ineffective with others. In addition, its use is more beneficial with SSB reception than with AM reception.

For PA operation, the class-B output amplifier put out 4.5 watts with 6 percent distortion at the start of clipping, and 5 watts at 7.5 percent distortion with very slight clipping at 1000 Hz into 8 ohms. On receive, the distortion was slightly higher.

The Delta tune circuit varies that frequency on SSB and AM transmit and on SSB receive by ± 800 Hz. At maximum deviation, the frequency held to within a tolerance of 0.0035 percent. On AM receive, the tuning range was about ± 1500 Hz.

The r-f gain is usually referred to as a means for reducing receiver overload, but it should be noted that reduction of r-f gain can also minimize adjacent-channel interference. In addition, it can improve unwanted-sideband suppression under dynamic operating conditions.

Circle No. 67 on Reader Service Card

HEATHKIT MODEL AD-1013 AUDIO OSCILLOSCOPE (A Hirsch-Houck Labs Report)

AN AUDIO oscilloscope can be a very useful addition to an advanced hi-fi setup, especially in a 4-channel sound system. Such a scope should have a 4-channel matrix for displaying the directional properties of quadraphonic programs and direct-coupled vertical and horizontal amplifiers for monitoring multipath distortion.

Although there are a few specialized audio scopes available, most are rather expensive. One sophisticated instrument is the Heath Company's Model AD-1013 scope that sells for \$200 in kit form (plus \$25 for optional walnut cabinet). It is intended for the advanced audiophile who wants to check out the performance of 2- and 4-channel systems.

The AD-1013 is actually two instruments in one. It is primarily an audio oscilloscope

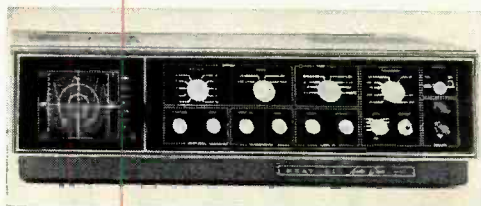

with a 3-in. CRT display. However, it also has a built-in audio signal generator that comes in handy for tests, setting levels, and balancing channels.

General Description. The scope's horizontal sweep is set by a range switch and a continuously variable control. The sweep is triggered by the input signal and is automatically synchronized to it. In the absence

of a signal, the sweep is free-running with a line always visible on the CRT screen.

The **FUNCTION** switch connects the vertical amplifier to any of the four input channels, or to a pair of binding posts on the instrument's front panel for use as a conventional oscilloscope. In the 2 CH mode, the scope provides an X-Y display of the stereo channels, with the right channel producing a horizontal deflection and the left channel a vertical deflection.

A mono program appears as a 45° line, and stereo can be identified by a broadening of the line, which can take on an amorphous, fuzzy shape.

In the 4 CH mode, an internal matrix combines the channel outputs to move the spot radially from the center of the screen in proportion to the instantaneous channel levels. A front-right (FR) signal produces a 45° line, while a back-right (BR) signal appears at 135°, BL at 225°, and FL at 315°. (Hence, the top of the screen corresponds to the front spread and the bottom to the rear spread in a 4-channel display.) Intermediate directions are seen as dimly filled areas of light on the screen.

Finally, in the **MULT** mode, the instrument becomes an accurate FM tuning indicator that displays the instantaneous signal deviation and the amount of multipath distortion on the received signal. A suitably equipped tuner or receiver is required to take advantage of this function.

Many audio system checks require a test signal that can be varied in frequency and level. The AD-1013 provides such a signal through its built-in oscillator. Coverage is from 20 Hz to 20,000 Hz in the audio band, continuously variable with a single turn of the instrument's **FREQUENCY** control knob. The continuously variable **LEVEL** control has a **CAL** position that provides an accurate 1-volt peak-to-peak, 60-Hz signal at the osc output. With the aid of this signal, the vertical sensitivity of the scope can be calibrated so that approximate peak power levels at the outputs of the amplifier under test can be determined. The oscillator waveform has less than 1 percent distortion, and its level is constant over the full frequency range.

A row of neon lamps near the scope's CRT screen shows the operating mode selected by the **FUNCTION** switch. Power to the instrument is controlled by a pushbutton switch. The rear apron contains jacks for the audio and H and V multipath inputs. There

It's about time!

DISPLAYS:
MONTH
DAY
HOUR
MINUTE
SECONDS



MITS presents the DC 100

An alarm — to wake you — (plus a snooze alarm).
An automatic timer — (to turn on the coffee;
to turn off the radio, etc.)
12 OR 24 HOUR MODE — (specify which).

MITS

SIZE: 3"x5-3/5"x5-1/10"

PRICES: Kit \$79.95
Assembled \$98.95

Warranty: 1 year on assembled units, 30 days on kits

Enclosed is a Check for \$ _____
or BankAmericard # _____
or Master Charge # _____

Credit Card Expiration Date _____ Kit
Include \$5.00 for Postage and Handling Assembled

Model DC-100; 12 Hour 24 Hour
 Please send information on Entire MITS Line.

NAME _____
ADDRESS _____
CITY _____
STATE & ZIP _____

MITS / 6328 Linn, N.E., Albuquerque, New Mexico 87108 505/265-7553 Telex = 660401

PE-7-74

CIRCLE NO. 20 ON READER SERVICE CARD



POSITIVELY THE ULTIMATE IGNITION SYSTEM! LONG-TERM FIELD-TEST PROOF! SAVE GAS—INCREASE PERFORMANCE—CUT MAINTENANCE

Popular Challenge capacitor discharge ignition system, with no breaker points, provides instant all-weather starting — a much hotter spark **AT ALL SPEEDS** and peak-performance reliability. This is due to our modern, pointless, CDI system design. The same basic Chrysler pointless system, **BUT** with added vitally beneficial refinements! Our system fits all neg. gnd. distributors and may be easily changed from car-to-car. Can be installed in just minutes. Install a Challenge superb quality CDI system now! Get longer spark plug life, peak performance at all speeds, **SAVE GAS** and reduce exhaust emissions. **SAVE MONEY AND VALUABLE TIME!** Made in U.S.A. Satisfaction guaranteed or money back. Only \$49.50 ppd. Free literature available. Send check or M.O. today, or order C.O.D.

CHALLENGE ELECTRONICS

Dept. M, P.O. Box 3345, Whittier, Ca. 90605
CIRCLE NO. 6 ON READER SERVICE CARD

is also an osc jack that parallels the one on the front panel. A switch is provided to permit phase reversal in the back channels to provide a correct 4-channel display when the front and back channels of the amplifier being monitored are out of phase.

The built-in oscillator is actually a square-wave generator whose output is integrated to form a triangle wave. This is then shaped by a diode/resistor network to create a low-distortion sine-wave signal.

The AD-1013's styling complements the company's Model AR-1500 receiver and AJ-1510 tuner that already have built into them the H and V outputs for the necessary multipath display. It should be noted that the instrument can be used with any tuner or receiver so equipped. For those people who have the Heath Model AR-15 receiver and AJ-15 tuner that do not have the H and V outputs, there is available for \$25 the Model ARA-15-1 conversion kit.

Laboratory Measurements. The scope in the AD-1013 met or surpassed all of its published specifications. The vertical sensitivity was 25 mV/cm, while input impedance was 100,000 ohms. The frequency response was flat from 5 Hz (our lowest measurement limit) to beyond 30,000 Hz. It was down 3 dB at 250,000 Hz. The triggered sweep generator operated from less than 5 Hz to beyond 300,000 Hz.

The audio oscillator had a range of from 5 Hz to just beyond 21,000 Hz. Its frequency calibrations are very approximate (within 30 percent according to Heath and confirmed by us). The output level range of 2 mV to 3 V was measured by us as 3.8 mV to 4.2 V. The variation in output level, rated at less than 0.25 dB, proved to be an almost unmeasurable 0.1 dB. The CAL volt-

age was within 1 percent of the specified 1.0-V p-p value.

The distortion in the audio oscillator is critically dependent on two adjustments in the shaping network. The visual method, in which the controls are set for the best approximation of a sine wave seen on the CRT screen, cannot be expected to result in the rated 1-percent THD. Our best efforts produced about 5 to 6 percent distortion, although the waveform appeared to be quite sinusoidal and would probably be satisfactory in most cases. To optimize distortion (which varies a bit with frequency), we used a distortion analyzer and obtained a 0.75-percent figure at 20 Hz, 1.5 percent at 1000 Hz, and 1.0 percent at 20,000 Hz.

Comment. The construction of the kit was straightforward and uncomplicated even though the finished instrument is a fairly complicated unit. It took us about 14 hours for assembly and checkout.

We used the instrument with several 4-channel receivers. It provided a welcome insight into the effectiveness of the demodulators and decoders in the receivers, and it simplified the balancing of channels. (Final balancing should always be done by ear.)

Perhaps the greatest value of the AD-1013 in everyday operation is as a multipath indicator for FM reception. Owners of suitably equipped tuners and receivers will find this feature extremely helpful in properly orienting antennas and for explaining away the distorted signals sometimes heard over the air on FM signals.

Although there are a few models of commercial scopes intended for applications similar to that of the AD-1013, we know of only one with comparable versatility—and it sells for about \$600.

Circle No. 5 on Reader Service Card

FREE McIntosh CATALOG and FM DIRECTORY

McIntosh Laboratory, Inc.
East Side Station P.O. Box 96
Binghamton, N.Y. 13904
Dept. 16-5

**SEND
TODAY!**

NAME _____

ADDRESS _____

CITY _____ STATE _____ ZIP _____

Get all the news and latest information on the new McIntosh Solid State equipment in the McIntosh catalog. In addition you will receive an FM station directory that covers all of North America.



MX 113

AM FM/STEREO TUNER PREAMPLIFIER

CIRCLE NO. 19 ON READER SERVICE CARD

POPULAR ELECTRONICS



Solid State

By Lou Garner

INGENUITY—that happy blend of imagination, knowledge, intelligence and skill—can be the most valuable talent which an experimenter, hobbyist or project builder can possess. Properly applied, it can change the routine to the rare, the commonplace to the curious, the mundane to the marvelous, accident to advantage, and problems to progress.

One person may look at an amplifier circuit and see just that—an amplifier. An ingenious person, on the other hand, may look at the same circuit and envision a whole spectrum of exciting projects: controls, alarm systems, musical instruments, test equipment, intercoms, paging systems, or electronic games and toys.

There are many who feel that a project *has* to be complex to be useful. Some, experienced engineers included, will even lift their noses in disdain at simple circuits, considering any design requiring less than, say, a half-dozen IC's beneath their talent and dignity.

In the final analysis, however, it's really no trick to find complex solutions to complex problems or, for that matter, even to simple problems. All that is required is technical knowledge, routine design procedures, and hard work. The real trick is to find simple solutions to complex problems . . . to find the simplest circuit or design that will solve the problem or accomplish the desired

result. And that's where ingenuity can play a role.

A good example is the pnp Darlington amplifier illustrated in Fig. 1A. Two direct-coupled transistors in this configuration are equivalent in performance to a single very-high-gain transistor and, in practice, may be used as such. Although the circuit can be assembled from discrete devices, several semiconductor manufacturers offer fabricated Darlington transistor assemblies in low, medium and high power versions in both pnp and npn types. Typical commercial units are Motorola's low power HEP types S9100 (nnp) and S9120 (pnp) and high power types S9140 (nnp) and S9141 (pnp). Where npn devices are used, circuit dc polarities are reversed.

As in a conventional single-transistor, common-emitter amplifier, dc is supplied by power source *BI*, with base bias applied through current limiting resistor *Rb*. The input signal is applied between the base (B) terminal and either circuit ground or the emitter (E). Any of a variety of input arrangements and output loads may be used, depending on the circuit's application.

Now let's add a bit of ingenuity and consider a *few* of the many possible applications for this one simple circuit.

METER AMPLIFIER. Use a low-power Darlington and a D'Arsonval meter as the collector load, applying the dc input signal between the base (B) and emitter (E) terminals. Resistor *Rb* is not used. This arrangement can increase the meter's effective sensitivity by factors ranging from 100 to 1000 or more, depending on the components used.

SENSITIVE RELAY. Use a low-to-medium-power Darlington and an electromagnetic relay as the collector load, applying the input dc control signal between the base and emitter electrodes. Resistor *Rb* is not used, but a current limiting resistor in series

Designing With Ingenuity

Why a Sylvania home training program may be

your best investment for a rewarding career in electronics

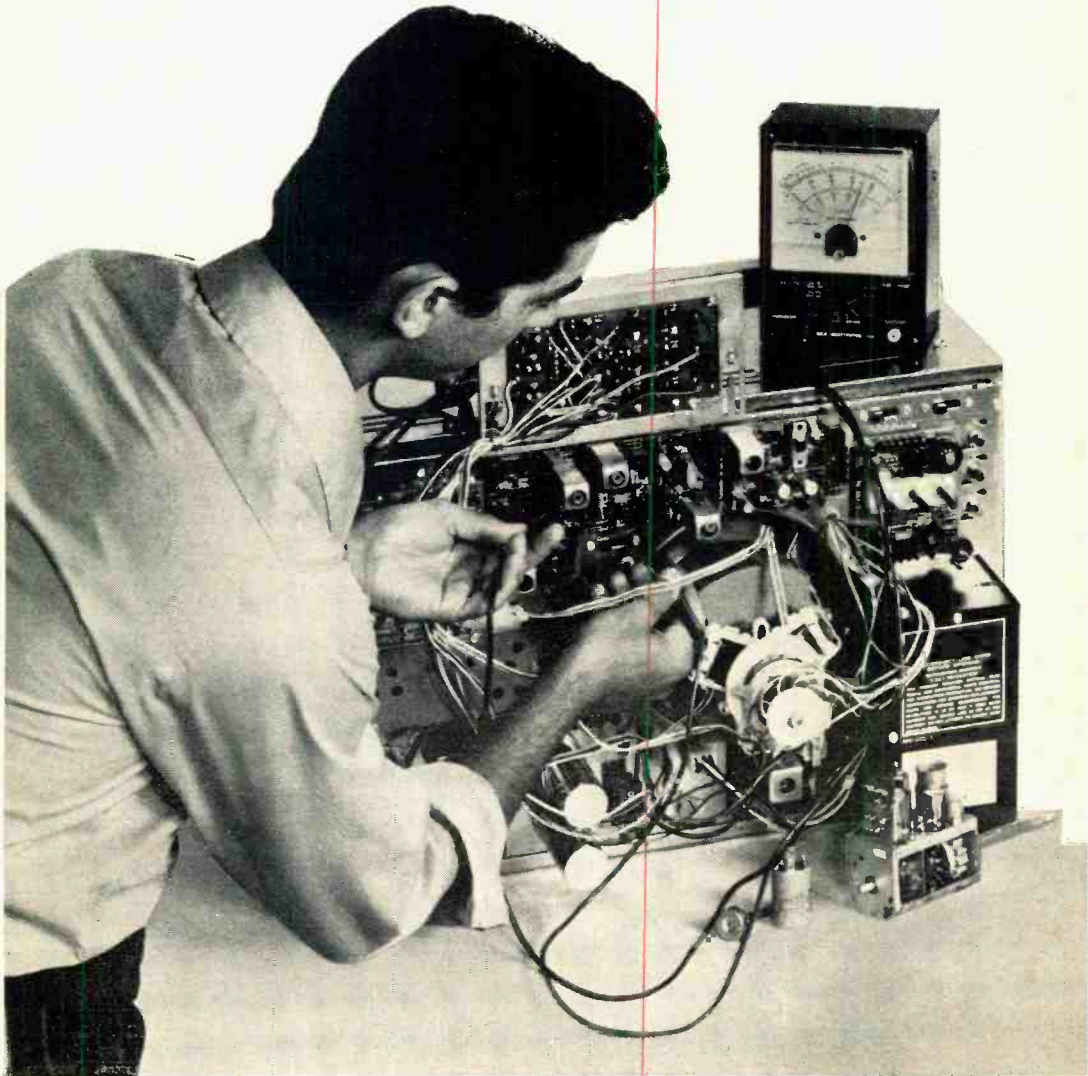

1 LEADER IN ELECTRONICS TRAINING

Over the years, Sylvania Resident Schools have trained thousands of men and women for key positions in the electronics field. Now, through Sylvania Home Training, you can receive the same high-quality career training at home. In your spare time. While you hold your present job. Remember, this training is designed with one purpose in mind — to give you the background you need to land the electronics job you really want!

2 AUTOTEXT TEACHES YOU ELECTRONICS RAPIDLY, EASILY.

AUTOTEXT, offered exclusively by Sylvania, is the proven step-by-step method of home training that can help you learn the basics of electronics quickly and easily.

3 CASSETTE SYSTEM

This innovative learning-by-hearing approach is a special option that adds an extra dimension to AUTOTEXT. It's almost like having an instructor in your own home. As you play the cassette tapes, you'll have an instructor guiding you through your AUTOTEXT lessons. Explaining the material as you read it. Going over schematics with you, reinforcing the basic electricity and electronics study materials with you. Everything you need to know to get you started towards a highly regarded position as an electronics technician — all in an easy-to-understand, conversational tone.

4 SPECIALIZED ADVANCED TRAINING

For those already working in electronics or with previous training, Sylvania offers advanced courses. You can start on a higher level without wasting time on work you already know.

5 PERSONAL SUPERVISION THROUGHOUT

All during your program of home study, your exams are reviewed and your questions are answered by Sylvania instructors who become personally involved in your efforts and help you over any "rough spots" that may develop.

6 HANDS-ON TRAINING

To give practical application to your studies, a variety of valuable kits are included in many programs. In Sylvania's Master TV/Radio Servicing Program, you will actually build and keep an all solid-state black and white TV set, and a color TV set. You also construct an oscilloscope which is yours to keep and use on the job.

7 FCC LICENSE TRAINING — MONEY BACK AGREEMENT

Take Sylvania's Communications Career Program — or enter with advanced standing and prepare immediately for your 1st, 2nd, or 3rd class FCC Radio Telephone License examinations. Our money-back agreement assures you of your money

back if you take, and fail to pass, the FCC examination taken within 6 months after completing the course.

8 CONVENIENT PAYMENT PLANS

You get a selection of tuition plans. And, there are never any interest or finance charges.

SEND ATTACHED POSTAGE PAID CARD TODAY! FREE DESCRIPTIVE BOOK YOURS WITHOUT OBLIGATION!

If reply card is detached send this coupon

SYLVANIA TECHNICAL SCHOOL	
Home Study	694-407-0
909 Third Avenue	
New York, N.Y. 10022	
Please send me FREE illustrated career catalog. I understand that I am under no obligation.	
Name	_____
Address	_____
City	_____
State	_____ Zip _____
Age	_____
Veterans: Check here <input type="checkbox"/>	

Sylvania Technical Systems, Inc.

GTE SYLVANIA



In the Master TV/Radio Servicing Program, you build and keep the all solid-state black and white TV set, the color TV set, the oscilloscope and the multimeter shown above.

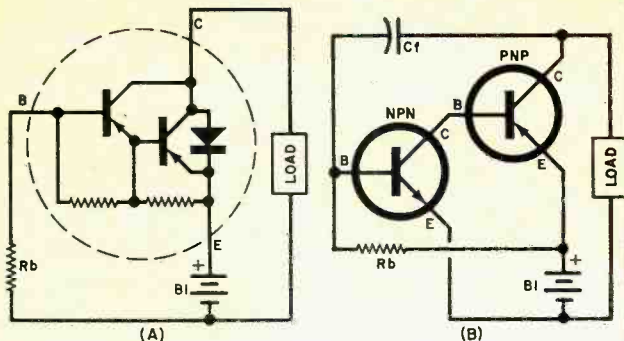

Fig. 1. The Darlington amplifier (A) and complementary relaxation oscillator (B) are simple circuits; but, with ingenuity, can be used in many diverse types of applications.

with the base is advisable. Would you believe a 10 microampere relay?

PHOTOMETER. Use a low-power Darlington and a D'Arsonval meter as the collector load. Connect a photovoltaic or photoresistive cell in series with R_b , adjusting its value accordingly.

PHOTORELAY. Replace the meter in the previous circuit with a suitable electromagnetic relay. This arrangement can be used for burglar alarms, doorway annunciators, slave photoflash, and equipment control applications.

TEMPERATURE CONTROL. Use a low-to-medium-power Darlington and a relay as the collector load. Replace R_b with a thermistor bridge circuit. Use the relay contacts to switch external heating or cooling equipment.

ELECTRONIC THERMOMETER. Replace the relay in the previous circuit with a D'Arsonval meter. Calibrate the meter's scale in degrees C or F.

BURGLAR ALARM. Use a low-power Darlington with a relay as the collector load and connect window foil and closed-circuit door switches in series with R_b . The relay contacts are used to switch an external alarm bell or horn. The value of R_b is adjusted so that the relay is closed. Opening the base circuit at any point, as by breaking a foil protected window or opening a door, will cause the relay to drop out, sounding the alarm.

BOOSTER AMPLIFIER. Use a medium-power Darlington with an output transformer driving a PM loudspeaker as the collector load. The input signal is applied to the base (B) through a dc blocking capacitor and may be obtained, say, from the earphone jack of a small transistor radio or similar source.

POWER MEGAPHONE. Replace the PM loudspeaker in the previous circuit with a horn-type paging speaker and connect a

carbon microphone in series with R_b , readjusting the value if necessary.

AUDIO SIGNAL TRACER. Use a low-power Darlington and an earphone as the collector load. Add a potentiometer gain control ahead of the base, coupling to the base through a dc blocking capacitor. Assemble in a probe body with self-contained battery.

R-F SIGNAL TRACER. Add a simple diode detector and r-f bypass capacitor ahead of the gain control in the previous circuit. In both, a suitable dc blocking capacitor should be connected in series with the input lead or probe terminal.

Another simple but, with a touch of ingenuity, extremely versatile circuit is illustrated in Fig. 1B. Here, npn and pnp transistors are direct-coupled as a complementary relaxation oscillator powered by B_1 . The two devices may be interchanged if dc polarities are reversed. Feedback is provided by C_f .

In operation, the circuit develops a pulse-like harmonic-rich signal at a repetition rate determined by the C_f - R_b time constant, by the transistors' characteristics, and by the supply voltage. Depending on one's choice of components, the circuit can be operated at rates from less than 1 Hz to the upper kHz or lower MHz values. It can be used with small-signal or medium-power devices, or even with a combination of a small-signal transistor driving a power type. A number of different load devices can be used in the design.

To some, this would be "just an oscillator." To the ingenious, however, this circuit could become one of these:

POCKET METRONOME. A potentiometer is connected in series with R_b , a moderately large value is used for C_f , and an earphone is used as an output load.

STANDARD METRONOME. The previous circuit is modified by using a power

transistor for the output stage and replacing the earphone with a PM loudspeaker.

CODE PRACTICE OSCILLATOR. The value of C_f is reduced in the previous circuit and a handkey is connected in series with $B1$.

TOY ELECTRONIC ORGAN. A number of different capacitors are used for C_f , selected by separate momentary contact key or pushbutton switches to provide different frequencies (tones).

SIGNAL INJECTOR. Small signal transistors are used with an inductive load (such as a small iron-core choke) and the instrument is packaged in a probe body.

AUDIO PHOTOMETER. A photovoltaic or photoresistive cell is connected in series with R_b in the CPO circuit. Here, the circuit's output frequency will vary with the light falling on the photocell.

LIGHT FLASHER. An incandescent lamp or LED load is used and a moderately large value is chosen for C_f .

CYCLIC PULSE TIMER. An electromagnetic relay is used as the output load.

ELECTRONIC CRICKET. A thermistor is substituted for the photocell in the photometer circuit.

Reader Circuits. Reader John Lord (16 N 4th Ave., Clayton, NM 88415), who works for a cable system firm, wanted to switch moderately low-level audio and r-f (4.5 MHz) signals without using electro-mechanical relays. He decided to use diodes as switching elements and devised the circuits shown in Figs. 2A and 2B.

Both circuits utilize an externally applied 12-volt dc signal to achieve switching action. Depending on the control voltage polarity, the switching diodes are biased in either a forward (conducting) or reverse (high-resistance) direction. In both circuits,

a positive control voltage transfers input signal 1 to the common output terminal, while a negative voltage switches input 2 to the output.

John used standard components in his designs. The input and output terminals are conventional coaxial connectors. All diodes are type 1N914 silicon devices and the resistors are half-watt types. Capacitor $C1$, Fig. 2B, is a disc ceramic capacitor.

Suggesting that other readers may find applications for his electronic switching circuits, John writes that his models have given excellent service for over a year without problems.

Device/Product News. Recognizing that a constant motor speed is essential for optimum performance in tape recorders, cartridge players, phonographs, and similar types of equipment, the SGS-ATES Semiconductor Corporation (435 Newtonville Ave., Newtonville, MA 02160) is offering a pair of linear IC dc motor speed-control regulators, types TCA 900 and TCA 910. Both devices are housed in standard TO-126 three-lead packages, with the TCA 900 designed primarily for use in battery-operated portable equipment, while the TCA 910 is intended for applications at the higher voltages found in automotive and line operated equipment. The maximum source

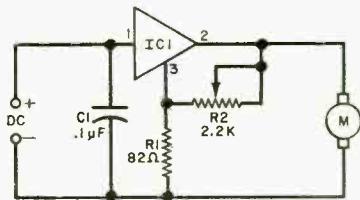
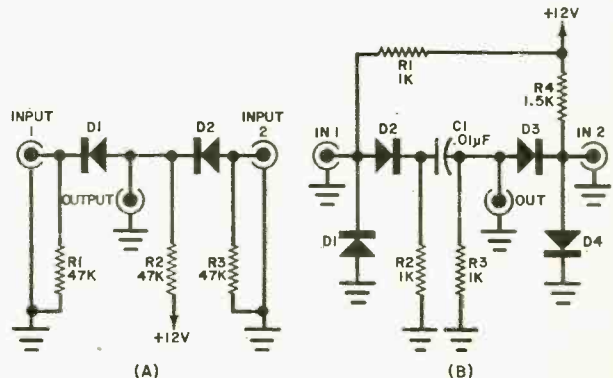

Fig. 3. The SGS-ATES circuit for motor regulation uses one IC.

Fig. 2. Two different circuits for switching moderately low-level audio and r-f signals, without using standard relays.



voltage ratings are 14 volts for the TCA 900, 20 volts for the TCA 910.

Requiring only two external components for operation, as illustrated in Fig. 3, the new SGS-ATES devices are designed to maintain a virtually constant motor speed despite variations in supply voltage, ambient temperature, or load.

The National Semiconductor Corporation (2900 Semiconductor Drive, Santa Clara, CA 95051) has introduced several new devices of potential interest to serious hobbyists, including two digital alarm clock IC's, a two-wire transmitter, and what is termed a "second generation" phase-locked loop (PLL) FM stereo demodulator.

Intended for use with seven-segment gas discharge displays, National's new digital alarm clock circuits are low-threshold p-channel MOS devices containing all of the logic needed to build several types of clocks and timers. Identified as types MM5370 (for 60-Hz operation) and MM5371 (for 50-Hz applications), the two IC's can provide three displays modes: time, alarm set, and sleep time. The display format may be either 12 hours with leading-zero blanking and a.m./p.m. indication, or 24 hours. Operating over a wide power supply range of from 8 to 29 volts, and with an integral power failure indicator, the MM5370 and MM5371 are available in either 28-pin Epoxy-B or ceramic DIP's.

Suitable for use with various sensors, including thermocouples, strain gauges, and thermistors, National's two-wire transmitter, type LH0045, is designed to convert a voltage signal from the sensor into a current and to transmit the current down a simple twisted-pair line to a receiver. The same twisted pair can serve to supply the device with its dc operating voltage, permitting the IC's use in remote sensing applications. Comprising a sensitive input amplifier, an output current source, and a reference designed to power the sensor bridge, the LH0045 is offered in both 12-pin TO-8 and 8-pin TO-3 packages.

Designated type LM1800, National's new PLL FM stereo demodulator features automatic stereo/monaural switching, a built-in stereo indicator lamp driver, an improved output decoder circuit, an on-chip voltage regulator, and a wide operating supply range of from 10 to 24 volts. Its design permits the use of a single, inexpensive potentiometer, rather than a coil, for all tuning functions. With a typical channel separa-

tion of 45 dB, the LM1800 is supplied in a 16-pin Epoxy-B DIP.

Both Motorola Semiconductor Products, Inc. (P. O. Box 20924, Phoenix, AZ 85036) and RCA's Solid State Division (Box 3200, Somerville, NJ 08876) have introduced new devices which should be of interest to hams, advanced experimenters, or students working with uhf and microwave circuits.

Motorola's 3N209 and 3N210 dual-gate MOSFETs are diode protected n-channel silicon-nitride passivated devices developed for use through the 500-MHz band. Featuring designed-in age capability, low feedback capacitance, and very low intermodulation distortion, they offer a common-source power gain of 13 dB at 500 MHz, with a 4.5-dB noise figure.

Assembled in tiny ceramic "pills," Motorola's new vhf/microwave diodes are identified as types MV205 and MV206 hyper-abrupt tuning diodes, MBD103 silicon hot-carrier mixer (Schottky) diode, and the MPN3601 PIN microwave switching diode.

Supplied in HF-46 style flanged ceramic-metal packages, RCA's new microwave power transistors are designated types RCA2001 and RCA2310. Of these, the RCA2001 is intended for applications in the 500-MHz to 2-GHz range and, used with a 28-volt supply, can yield 1 watt output power with 7 dB gain at 2 GHz. The RCA2310 is rated to supply 10 watts CW at 2.3 GHz with a 24-volt dc source and is designed especially for telemetry service.

With a maximum turn-off time of 8 μ s, RCA's first SCR family consists of 10-amp devices, types S5210B, S5210D and S5210M, rated at 200, 400 and 600 volts, respectively. The second family includes 35-amp devices with a maximum turn-off time of 10 μ s, types 2N3654, 2N3655, 2N3656, 2N3657, 2N3658 and S7432M, with voltage ratings from 50 volts for the 2N3654 to 600 volts for the S7432M. Both SCR families are suited to a broad range of applications.

Consisting of a gallium-arsenide infrared emitting diode and a silicon npn phototransistor supplied in a modified hermetically-sealed TO-5 package, RCA's new optically-coupled isolator type C30111, can be used for data processing, control, alarm, instrumentation, and power-supply regulation applications. The device features a maximum isolation voltage rating of ± 1000 volts and a minimum dc current transfer ratio of 20 percent. ♦

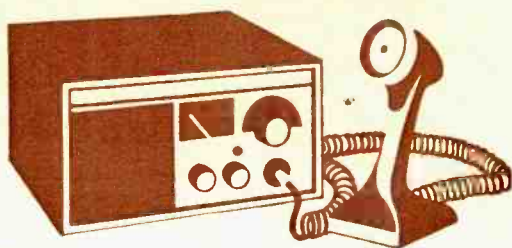

CB Scene

By Len Buckwalter, KQA5012

ASK any antenna engineer where the best place to mount a mobile CB whip is, and he'll probably say the center of the car roof. From a technical point of view, this is sound reasoning, primarily because the location usually provides a more symmetrical pattern than any other. The mass of the car's metal, which acts as a ground plane, is most equally distributed about the antenna and encourages signal radiation in all directions.

By comparison, if an antenna is located on the left rear fender, then most of the metal is toward the front right of the car, so that would be the direction of the strongest signal. (This condition can be exploited, of course, by turning the car so that the strongest lobe is pointed toward the station you want to contact.)

Another engineering reason for the rooftoper is that the antenna is on the highest part of the vehicle. The loftier location thrusts the radiation slightly farther over the horizon and provides a little more range. Also, it helps the signal clear the car itself—as well as nearby objects.

Why, then, don't all CB'ers center their whips on the car roof to obtain maximum communications? Since estimates from the industry put the percentage of such whips at considerably less than half of all mobiles, there must be a reason—or two. Of course, there is the problem of installing the antenna in the first place. And then there is

the matter of what to do with the hole when you sell the car and remove the antenna.

To deal with the latter problem first, there are about five ways to take care of the rooftop mounting when the car is offered for resale. The easiest is to remove the whip and cover the hole with a rubber plug. Antenna Specialists sells plugs in a variety of sizes for this purpose.

Another possibility is to leave the antenna, or at least the rooftop fitting, in place at the time of sale. Maybe this was objectionable ten years ago, but about one out of every 60 cars on the road now has CB radio. Like an automatic transmission or air conditioner, a CB antenna installation might even increase a car's resale value.

Another option is to have the hole repaired by a professional body-and-fender shop. Since this work commands about the same fees as for brain surgery, however, you might try your own hand at covering the hole. It is, after all, only about $\frac{3}{8}$ to $\frac{1}{2}$ of an inch in diameter. Western Auto offers a body patch kit with all the ingredients necessary to seal 136 square inches for only \$2.39. They also sell spray enamel paint to match the color of almost any car.

Mounting Problems. If the hole is no threat to you or your car, then you have to consider probing the inner mysteries of the car roof to make the installation. In some automobiles there are major barriers here and you should know about them in advance. But thanks to the car's dome light, you can discover the pitfalls before doing any irreversible damage. By lowering the dome-light assembly (see illustrations), you can look into and explore a section of the car roof that is very close to where the antenna will mount. This gives an idea of whether

Antennas for Cars

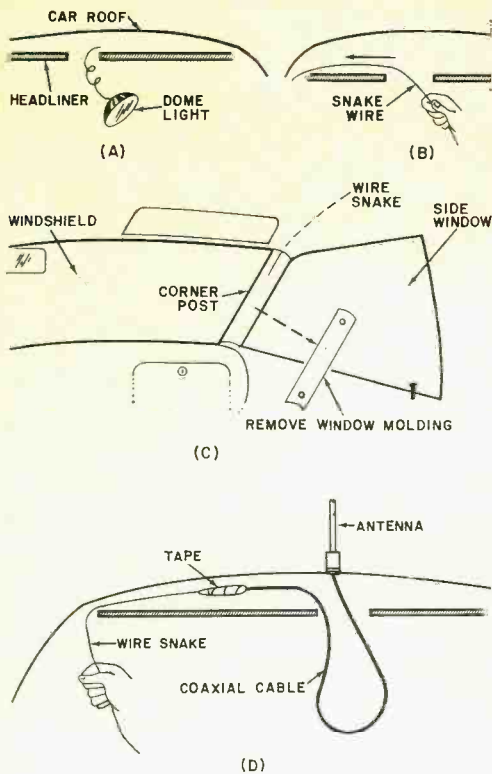

For rooftop installation lower dome light (A), feed snake wire through light hole to corner post (B) and (C), drill hole, attach antenna and pull coax through with snake.

any obstacles will interfere with the cabling or antenna mounting hardware. First, check whether the roof has a double thickness—a type of construction found in late-model cars. If so, much of the antenna mounting hardware now on the market may be difficult or impossible to install. (Even the antenna designers are wrestling with this one!). But in a huge number of autos and pickups you'll find a single sheet of metal that accepts the popular fittings.

Also from the vantage point of the dome-light hole, you can make a trial run at snaking a wire through the headliner (the decorative covering over your head) to a window post on either side of the windshield. If you can fish a stiff wire through that area without hitting solid barriers, you've solved the next most difficult phase of the job. Sometimes it takes a couple of trials with the wire to work your way through. If you can't find a clear patch, you might have to lower part of the headliner, but this is a job that

may be difficult unless you're familiar with how it's done.

But let us say these early steps present no problem and you're ready to cut metal. The first precaution when working on a car roof is to avoid denting the sheet metal. If you step on the roof with all your weight on one shoe, friends and family seeing the dents will wonder if you were in a roll-over accident or hit by a low-flying airplane. By carefully distributing your weight on knees and shoes (preferably sneakers) you won't mar the surface.

Next for the hole itself. The antenna manufacturer tells you the diameter, often $\frac{3}{8}$ inch, but it may be as wide as $\frac{1}{2}$ inch. If you can manage a tube-socket punch to cut the hole (meaning you must be able to install the punch from the bottom, through the dome light hole) you can make a perfect circle. Alternatively, drill a pilot hole and widen it to size with a reamer or round file.

No matter what the method, beware of drilling that first hole. The slope of an average car roof encourages the drill bit to skitter across the surface, exposing a jagged streak of bare steel that will succumb to rusting in a few days. You can avoid the runaway drill with a hammer and nail or center punch to drive a starting dimple at the center, or with a variable-speed drill turning at its lowest speed. Never press down hard on the drill or you might break through the ceiling and ruin the headliner. You merely want to cut through the sheet metal layer.

With the antenna finally in place, the coaxial cable is taped to the snake wire and pulled through the headliner. The rest of the path to the transceiver is usually easy.

Some Typical Antennas. There is a good variety of rooftopers from which to choose. Here's a sampling: Lafayette's "Auto-Top" is a 39-inch base-loaded stainless steel whip that mounts in a $\frac{3}{8}$ -inch hole. Price is \$8.95 less the cable. Antenna Specialists' M-125 is a 40-incher that snaps into a $\frac{3}{8}$ -inch hole and has a solderless connector with 17 feet of cable for \$18.59. Hy-Gain offers the Hellcat 3, a 35-inch model with a magnetic mount which eliminates holes entirely and withstands winds up to 100 mph. (Note, though, that the coaxial cable must run outside the roof and enter the car through a window). Radio Shack offers a 42-inch roof mount of stainless steel with a chrome-

plated shock spring and 16 feet of cable for \$17.95. The durability of the rooftop models in the marketplace seems to indicate they're doing something right.

CB Items. *F.C.F., the Fraternal Communications Foundation, is looking for new members to help "clean the airways." Now incorporated in six states—Utah, Nevada, Colorado, Wyoming, Michigan and Texas—the organization hopes to build a national headquarters in Utah within ten years. get the names and address of all "bootleggers, power pushers, and troublemakers" and forward them to the FCC. They'll also send a man to Washington to fight for better laws and lower license fees. It costs \$6 to join F.C.F. with \$10 per year dues. A package*

on the organization is \$2 from: F.C.F., 444 Erie Street, Salt Lake City, UT 84116.

North Jersey REACT (P.O. Box 1330, Secaucus, NJ 07094) is looking for new members, or anyone wanting more information about how CB radio improves the safety and convenience of anyone's daily affairs. . . Arnie Timm, of Electronic Associations, writes that one solution to the problem of unlicensed stations is to require a buyer to show his license to a dealer, distributor or technician before he can obtain equipment. . . The "Quit Skip QSL Club" is circulating a questionnaire with queries on most major CB issues: e.g. should antennas be higher, liners be necessary, rules be freer? To get one write: George Capps, Rt. 2, Box 174, Rolla, MO 65401. ♦

PORTABLE TIME BASE for DIGITAL CLOCKS

BY PAUL MICHAEL, Signetics Corp.

IF YOU have a camper, recreation vehicle or boat, you know that you can't use a digital clock because you don't have a source of 60 Hz for the timing. This problem can be solved easily by using one of the new 555 timers in the circuit shown below.

Essentially, the circuit consists of a Signetics NE555 timer operating at a stable rate of 6 kHz and driving a pair of 7490 TTL's in a divide-by-100 configuration. Although the 555 can operate as a 60-Hz source directly, it is more stable operating at 6 kHz.

Trimmer potentiometer R2 is adjusted

for an exact 60-Hz square-wave output. The timing error of the circuit was found to be less than two seconds every 10 hours. The output voltage is 3.8 volts when a 5-volt supply is used.

The 5-volt supply can be obtained easily by using a regulator such as the Signetics LM309 operating off the vehicle's regular 12-volt supply.

In constructing the circuit, the IC's and four other components can be mounted on a small piece of perf board or a pc board can be made. Once the correct position for trimmer R2 is determined, fix its rotor with cement. ♦

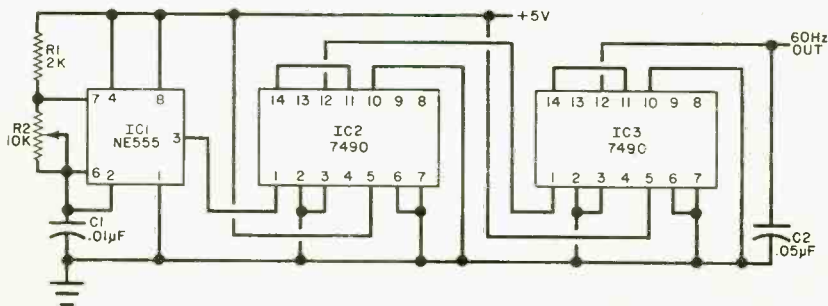



Test Equipment Scene

By Leslie Solomon, Technical Editor

GETTING the most from our transportation dollar is a major concern these days. With the rising cost of gasoline, it's little wonder that there is a lot of interest in test equipment to use in improving the performance of internal combustion engines (automobile or marine). Let's investigate how we can make use of conventional electronic equipment in tuning up a motor.

Probably the best-known piece of electronic test gear for engines is the tachometer. This is simply a pulse counter. (We'll have a project on this item next month.) The tachometer is useful in measuring and setting engine speed under certain conditions. The thing to remember in using a tachometer is to be sure that it is accurate. To determine whether it is or not, you need a basic audio square-wave generator that can deliver 8 to 12 volts to provide the signal from the "points" and a 12-volt dc power supply.

The test frequency supplied to the tachometer by the signal generator is equal to the desired rpm reading on the tach multiplied by the number of cylinders and divided by 120 for a conventional four-cycle engine. (For a two-cycle engine, divide by 60 instead of 120.) As an example, assume you want to check the 1200-rpm indication on the tachometer and you are working

with a six-cylinder, four-cycle car. Then $(1200 \times 6) / 120$ is 60, so you would apply a 60-Hz signal to the tachometer to see if it reads 1200. (Incidentally, these values are convenient if you want to use a common filament transformer operating off the commercial power line as a source of 60 Hz.)

One diagnostic use for the tachometer is in checking engine cylinder compression. With the engine and tachometer operating, lift the connection off of one plug and note the drop in rpm. A cylinder with low compression will show only a small drop in rpm. A good cylinder will show a large drop.

Using a Dwell Meter. A dwell meter is simply a special type of ohmmeter. It measures the apparent resistance of the points as they rapidly open and close. Dwell refers to the time that the points are closed.

During the dwell time, battery current flows through the primary of the ignition coil to build up the magnetic field that is then collapsed to produce the high voltage for the spark plugs. We say that the meter measures the apparent resistance because, as the points open and close, the dwell meter receives either full current or none at all. Therefore the current is proportional to the percentage of time that the points are closed. However, don't trust a conventional ohmmeter to make this measurement. In many cases there may be sufficient resistance when the points are closed to produce an offset which will provide the wrong indication of dwell.

A conventional oscilloscope (or ac voltmeter) can be used to check alternator diodes. Simply apply the dc supply in the car to the scope and check for ripple. Under normal conditions, the ripple may be as much as 0.5 volt. If it is greater than that, there is probably a faulty diode.

A standard bench power supply can be used to check an engine's condenser. The condenser should allow no appreciable cur-

Testing Internal Combustion Engines

rent flow with about 300 volts dc across it. With a resistance of about 5 megohms in the condenser, the current would be only 0.00006 ampere.

Checking Ignition Circuits. One of the best ways to check an ignition circuit is to use an oscilloscope. Professional tune-up experts have a specially designed scope for this purpose but a regular scope can be used by attaching the adapter circuits shown in the sketch. To check the primary waveform use the voltage divider shown at (A).

To check the secondary (high-voltage) waveform, use the arrangement shown at (B). First, a word of caution: in installing and handling the adapter, remember that some very high voltages (about 20 or 30 kV) are present. The adapter is essentially a capacitor divider with one part made up of a brass tube, fiber sleeve and one or two turns of wire and the other part of a 0.002- μ F high-voltage (the higher the better) unit.

Suitable thin-wall brass tubing for the adapter can be obtained at almost any hobby shop. It should fit between the top of the ignition coil and the cable going to the distributor cap. The insulator is made of thick fiber sleeving. If the latter is not available, use several layers of good fiberglass insulation. Just be sure to keep the high voltage in mind. It may be necessary to alter the ratio of the capacitors by changing the loop around the fiber sleeve.

To use the adapter, run the engine at about 1000 rpm and adjust the scope sweep rate to show one waveform for each cylinder in the engine. The waveforms will follow the firing sequence for your engine. Consult the engine manual to determine

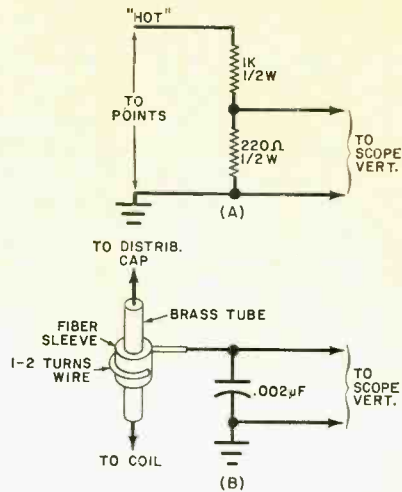

Checking ignition with an oscilloscope.

the sequence. The waveforms may be upside down—commercial ignition analyzers usually invert the waveform so that the positive-going elements go toward the top of the CRT display.

When all the waveforms are displayed sequentially, the display is called a parade. If the sweep rate is changed so that all of the waveforms are on top of each other, the display is called superimposed. In the parade mode, you will see the operation of all of the cylinders at once so that you can instantly spot one that is not firing properly. In the superimposed mode, you can check that all waveforms have approximately the same shape. We don't have the space here to analyze all of the waveforms and the conditions that produce them. They are easily checked, however, by using a good manual on electronic diagnostic techniques. ♦

Planning to move?

Let us know **8 weeks in advance** so that you won't miss a single issue of **POPULAR ELECTRONICS**.

Attach old label where indicated and print new address in space provided. Also include your mailing label whenever you write concerning your subscription. It helps us serve you promptly.

Write to: P.O. Box 2774, Boulder, CO 80302, giving the following information.

- Change address only.
- Extend subscription. Enter new subscription.
- 1 year \$6.98
- Payment enclosed (1 extra BONUS issue)
- Bill me later

If you have no label handy, print OLD address here.

name _____ please print

address _____

city _____

state _____ zip-code _____

AFFIX LABEL

name _____ please print 0884

address _____

city _____ state _____ zip _____

Add'l postage: \$2 per year outside U.S., its possessions & Canada.

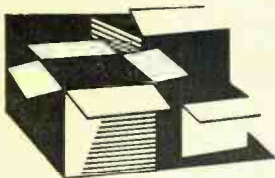

New Products

Additional information on new products covered in this section is available from the manufacturers. Either circle the item's code number on the Reader Service Card inside the back cover or write to the manufacturer if address is given.

MIDLAND 2-METER MOBILE FM TRANSCEIVER

Midland Electronics Co. has announced availability of the Model 13-505 FM mobile transceiver designed for 2-meter ham work. Separate transmit and receive channel selectors provide simultaneous control of all transmit and receive frequencies in the 144-148-MHz range. The dual-power transmitter delivers 30 or 5 watts of r-f output power and has automatic VSWR protection. The transceiver is equipped with a discriminator meter that registers frequency shift in received signals and can be used to



calibrate both the receiver and the transmitter. Also built in is a S/r-f/SWR meter, squelch control, and double 12-channel selectors. Crystals come installed for 146.16, 146.34, and 146.94 MHz on transmit and 146.76 and 146.94 MHz on receive. Retail price is \$299.95.

Circle No. 68 on Reader Service Card

GC DESOLDERING AID

You can desolder any connection quickly and cleanly with Soder-Wick (Cat. No. 684) according to G.C. Electronics. Soder-Wick is designed to absorb molten solder instantly and is said to eliminate component-damaging heat buildup, leaving no residue or flux contamination.

Circle No. 69 on Reader Service Card

JERROLD TUNABLE FM INTERFERENCE TRAP

A tunable trap, designated the Model RFT-300, from Jerrold Electronics is said to eliminate FM interference in TV receivers. Strong local

stations can cause interference lines on TV screens, especially when the receiver is tuned to channel 6. The trap connects to the 300-ohm antenna terminals on the back of the TV receiver or indoor amplifier. The user simply watches his TV screen, while turning the trap's knob, until the FM interference disappears. The trap can easily be tuned to any industrial radio (72-76 MHz) or FM broadcast (88-108 MHz) frequency. The tunable notch is 250 kHz wide and 18 dB deep. Retail price is \$39.95.

Circle No. 70 on Reader Service Card

ACOUSTIC RESEARCH SPEAKER SYSTEM

The Model LST-2 is the result of Acoustic Research's desire to produce a speaker system employing the same basic design principles used in the LST-1—at a lower cost. The LST-2



represents a blending of drivers. A unique crossover network and spectral balance switch permit three repeatable and accurate spectral energy profiles, allowing the user to select the energy output best suited for room acoustics and program material. The geometric design of the cabinet and the characteristics of the drivers in the three planes are claimed to result in uniform dispersion at all frequencies. The driver complement includes a 10-in. woofer, three 1½-in. hemispherical dome midrange radiators, and three ¾-in. hemispherical dome tweeters. Retail price is \$400.

Circle No. 71 on Reader Service Card

SIMPSON GENERAL-PURPOSE OSCILLOSCOPE

The Model 455 oscilloscope introduced by Simpson Electric Co. has a 10-MHz bandwidth and 10-mV/cm vertical sensitivity. The scope accepts camera or light hood and has a low-parallax, high-contrast graticule with both amplitude and vector display indexes. Sweep frequency is adjustable from 1 Hz to 200 kHz in five overlapping ranges. For TV work, there is a special sweep rate for horizontal sync and R-Y/B-Y inputs for vector alignment. Horizontal sensitivity is 300 mV/cm, with a dc-to-500-kHz bandwidth. A 1-kHz, 500-V p-p square-

wave signal is provided for external circuit testing and voltage calibration. Retail price is \$295.

Circle No. 72 on Reader Service Card

HARMAN/KARDON MULTICHANNEL RECEIVER

The new top-of-the-line product in Harman/Kardon's hi-fi equipment is the Model 900+ multichannel receiver. The amplifiers are designed to drive up to eight speaker systems,



even when high sound levels are desired. When operated in the 2-channel mode, its outputs are rated at 90 watts/channel, while in the 4-channel mode, output power is 32 watts/channel (both driven into 8-ohm loads). The tuner is for AM/stereo FM. The mode switch has positions for SQ matrix, phase-shifted enhanced stereo, and CD-4/discrete, as well as mono and stereo programs. Included in the controls complement are switches for high- and low-cut filters, contour, FM muting, and Dolby noise reduction system. Retail price is \$749.95.

Circle No. 73 on Reader Service Card

MARANTZ FLOOR-STANDING SPEAKER SYSTEM

The Marantz Co. recently introduced a new floor-standing speaker system to the Imperial line. The Imperial 8 is designed around a variable-density 12" woofer, three midrange drivers, and two tweeters. The array results in minimal air pressure on the individual speaker cones to provide high efficiency and low distortion. Also, the transducer array can be rotated so that a pair of Imperial 8's can be matched with mirror image. Frequency response is specified at 40 Hz to 18,000 Hz ± 2 dB, while power handling capacity is 125 program watts.

Circle No. 74 on Reader Service Card

SBE UHF AND VHF SCANNERS

Linear Systems recently announced the introduction of a complete line of SBE Sentinel



JULY 1974

NOW A PROFESSIONAL BURGLAR-FIRE ALARM SYSTEM YOU CAN INSTALL YOURSELF.



ONLY 139.95

Save hundreds of dollars in alarm installation and monthly service charges. The EICO SS-500 "install-it-yourself" burglar-fire alarm system offers you the kind of professional protection you have been looking for, at a price you can afford. The SS-500 has been designed on the EICO "Expandability Concept" that enables you to "add-on" protection to meet your own special needs. Before you purchase any security system, we suggest you read the EICO Security Handbook and see how easy EICO makes it to "Do-it-Yourself."

FREE EICO CATALOG/SPECIAL OFFER!

Security handbook (Reg. \$2.95) only \$1.50 with this ad. Includes a catalog on EICO Security Systems, Test Instruments, Stereo, Hobby Kits and name of nearest distributor. For catalog only, check reader service card or send 50¢ for first class mail service.

EICO, 283 Malta Street, Brooklyn, N.Y. 11207



CIRCLE NO. 13 ON READER SERVICE CARD



spend a dime, save a mint.

Invest a dime—send for our catalog. We'll prove to you that you can have selection and convenience and still get a great price.

For an immediate free copy of our 32 page catalog, mail the coupon below to the location nearest you. Please print.



Midwest Hifi Wholesale & MAIL ORDER DIVISION

2455 Wisconsin Ave., Downers Grove, Ill. 60515
3309 E. J W Carpenter Frwy., Irving, Tex. 75062

NAME _____
ADDRESS _____
CITY/STATE _____ ZIP _____ (PE4-07)

CIRCLE NO. 21 ON READER SERVICE CARD



Your Complete Electronics Buying Guide

- Stereo/Hi-Fi Components • CB Transceivers & Walkie-talkies • PA Systems • Tools & Test Equipment
- Police/Fire Monitor Receivers • Antennas • Photography Equipment • Ham Gear • Books, Parts, and More!

Send Today!

Lafayette Radio Electronics
 P.O. Box 10, Dept. 35074
 Syosset, L.I., N.Y. 11791

35074

NAME _____

ADDRESS _____

CITY _____

STATE _____

ZIP _____

CIRCLE NO. 18 ON READER SERVICE CARD

ABOUT YOUR SUBSCRIPTION

Your subscription to POPULAR ELECTRONICS is maintained on one of the world's most modern, efficient computer systems, and if you're like 99% of our subscribers, you'll never have any reason to complain about your subscription service.

We have found that when complaints do arise, the majority of them occur because people have written their names or addresses differently at different times. For example, if your subscription were listed under "William Jones, Cedar Lane, Middletown, Arizona," and you were to renew it as "Bill Jones, Cedar Lane, Middletown, Arizona," our computer would think that two separate subscriptions were involved, and it would start sending you two copies of POPULAR ELECTRONICS each month. Other examples of combinations of names that would confuse the computer would include: John Henry Smith and Henry Smith; and Mrs. Joseph Jones and Mary Jones. Minor differences in addresses can also lead to difficulties. For example, to the computer, 100 Second St. is not the same as 100 2nd St.

So, please, when you write us about your subscription, be sure to enclose the mailing label from the cover of the magazine—or else copy your name and address exactly as they appear on the mailing label. This will greatly reduce any chance of error, and we will be able to service your request much more quickly.

Series scanning monitors which cover 30 to 470 MHz in six models. The Sentinel package is the smallest eight-channel scanner around. It includes eight channels for scanning, lock-out switches, manual/automatic scan, and operation on ac or dc. An important feature of the Sentinels is the priority channel which assures the reception of the most important user-designated channel.

Circle No. 75 on Reader Service Card

CONTINENTAL SPECIALTIES BREADBOARDING SYSTEM

A new Proto Board #103 has been developed that allows users to build, plug-in, modify, wire, test, add or remove circuits quickly, using as many as 24 14-pin DIP's, without soldering or patch cords. Input/output and processing circuits can be separated easily by using different power buses and separate sockets for every part of the design. Each section of the user's design can be tested independently because he can break up power and ground lines. Further, extra IC's or components can be plugged in and interconnected with #22 AWG solid hookup wire. The entire unit measures 6" x 9" x 1/8".

Circle No. 76 on Reader Service Card

ZI-TECH IC LOGIC PROBE/PULSE COUNTER

A versatile new logic probe (Model DP-6000) from Zi-Tech Division of Aikenwood Co. has the dual capability of displaying logic states

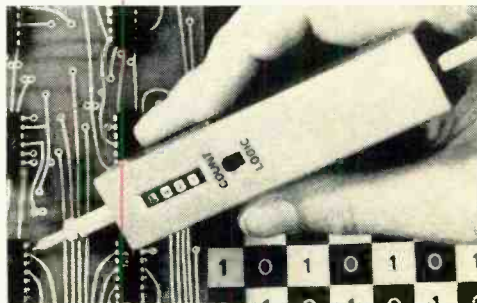

and functioning as a fast-pulse counter. The probe indicates logic states and identifies faults in IC's. When switched to the counting mode, it acts as an indicator for short pulses. The pulse counting circuit requires no accessories or options to detect multiple clock and trigger pulses, and it can indicate the presence of spurious oscillations. Price is \$66.

Circle No. 77 on Reader Service Card

KENWOOD 2/4-CHANNEL FM RECEIVER

The newest addition to the Kenwood line of "Two-Four" receivers, the Model KR-5340, provides 2/4-channel compatibility with all program sources. When used in the 4-channel mode, the receiver develops 10 watts rms/channel. Operated in the 2-channel mode, a unique strapping circuit combines the separate 4-chan-



nel amplifier channels to provide 25 watts rms/channel at 8 ohms. The receiver is compatible with all 4-channel program sources. It has built-in SQ and RM decoders and provisions for a 4-channel tape deck. A CD-4 demodulator is available as an optional accessory. The receiver's front-rear, left-right balance and separate bass and treble controls make it possible for the listener to compensate for any room in which the receiver (with four speaker systems) is used.

Circle No. 78 on Reader Service Card

AKAI SOLENOID-OPERATED TAPE DECK

The Model GX-285D is a new solenoid-operated, two-speed reel-to-reel tape deck from Akai America. It features three GX glass and crystal tape heads, a Dolby noise reduction system, and a unique automatic-reverse playback system. The four-track (2-channel stereo/mono) deck employs a servo-controlled capstan motor and two outer rotor motors. It also has sound-on-sound and sound-with-sound mixing; mike and line mixing; universal voltage control; standard/

low-noise, high-output tape switching; and a four-digit tape counter. (\$750).

Circle No. 79 on Reader Service Card

GOLD LINE MOBILE PHONE PATCH

The Model GLC phone patch from Gold Line allows an operator to expand communications contacts from his car's CB rig. A simple instal-



lation connects the phone to a CB transceiver. The patch can be used with 3- to 16-ohm speakers and high-impedance microphone inputs. The modulation gain control compensates for varying line levels, while an on/off switch disconnects the patch when not in use. Retail price is \$15.95.

Circle No. 80 on Reader Service Card



utah PRESENTS

Cascade

**MOST POWERFUL, MOST
EPIC PRODUCTION EVER!**

This is the one you will want to see and hear. It is the most powerful die-cast High Fidelity speaker series ever produced by Utah. Its name is CASCADE... the totally new co-axial speaker line. It has the largest magnets ever and larger voice coils to handle more power for a longer time. Cloth rolls enhance bass performance. The rigid die-cast frame is designed for maximum structural length, and it can be mounted to either the front or rear of the baffle board. Your choice of 2-way or 3-way models in 8" and 12" sizes, some with co-axially mounted compression tweeters. Your ticket to the powerful CASCADE performance can be hurried along by writing us for complete information.



UTAH ELECTRONICS
HUNTINGTON, INDIANA 46750

CIRCLE NO. 29 ON READER SERVICE CARD

WORTH
LOOKING
FOR!

Lenk

**SOLDERING
IRONS - GUNS**

BY THE WORLD'S LARGEST
MANUFACTURER OF SOLDERING IRONS

Get the right soldering tool for
your jobs. You'll find the
right product at the
right price in the
Lenk line - at
better hardware
and supply
stores.



**PENCIL
TYPE
IRONS**

CORDLESS
Battery Powered
COMPLETE WITH
RECHARGER

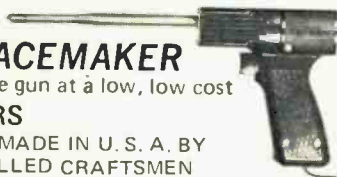

PACEMAKER

Instant type gun at a low, low cost
AND OTHERS

ALL MADE IN U. S. A. BY
SKILLED CRAFTSMEN

If your dealer does not have the Lenk line,
please send us his name and address.

WALL-LENK MANUFACTURING COMPANY
BOX 3349 KINSTON, N. C. 28501

CIRCLE NO. 30 ON READER SERVICE CARD

**EVERYTHING YOU
WANTED TO KNOW
ABOUT CD IGNITION
SYSTEMS BUT DIDN'T
KNOW WHOM TO ASK.**

*Send for FREE Tiger booklet (20
pages) which answers all your
questions.*

Name _____

Address _____

City _____

State _____ Zip _____

CLIP OUT THIS AD AND SEND TO—

TRI-STAR CORP.

P. O. Box 1727 Dept. E

Grand Junction, Colo. 81501

CIRCLE NO. 27 ON READER SERVICE CARD

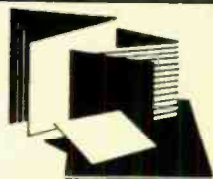

New Literature

IR RECTIFIER PRODUCT LOCATOR

A product locator (No. PL-2.0) for 86 models of silicon rectifiers is available from International Rectifier Corp. The company's broad range of rectifiers is listed according to specific current ratings, surge current ratings, voltage range, case style, and data sheet number. Each series part number is followed by a brief explanation of distinguishing features. Fast-recovery rectifiers are listed separately. Address: Semiconductor Product Div., International Rectifier Corp., 238 Kansas St., El Segundo, CA 90245.

ELECTRONIC DEVICES SOLID-TUBE® DATA BROCHURE

Electronic Devices, Inc., has added a new model to its Solid-Tube line of silicon solid-state plug-in rectifier tube replacements. You can learn more about it (and the other Solid Tubes in EDI's line) by writing for the four-page Form No. C-372-10, which gives the vacuum-tube numbers it replaces. Address: Electronic Devices, Inc., 21 Gray Oaks Ave., Yonkers, NY 10710.

CAMBION COMPONENTS CATALOG

The Cambion XQ Components Catalog (No. 31001) illustrates various Cambion components available through retail outlets. Items listed include terminals, jacks, plugs, knobs, handles, battery holders, IC sockets, IC breadboards, coils, chokes, etc. Most of the items listed are ideal for hobbyist and experimenter prototype project building. For a copy of the catalog, write to: Cambion, Dept. XQ, 145 Concord Ave., Cambridge, MA 02138.

1974 ANSI STANDARDS CATALOG

More than 8600 domestic and international standards for all areas of industry are listed in the new 1974 American National Standards Institute's catalog. This 176-page catalog contains all ANSI-approved standards and such international standards as adopted by the ISO, IEC, and CEE as of the close of 1973. The standards cover almost every area in which standardization must be used, including the electrical and electronics fields. Also listed are special ANSI publications. Address: American National Standards Institute, Inc., 1430 Broadway, New York, NY 10018.

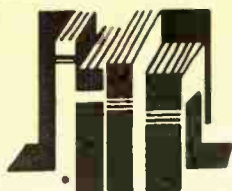

Electronics Library

PRINCIPLES AND PRACTICE OF ELECTRONIC MUSIC

by Gilbert Tryhall

A fundamental approach to understanding the new sound sources, this book starts off with basic acoustics. Then it proceeds to tape techniques and the form and notation used in electronic music. The technical chapters cover basic principles of electronics, circuits used in electronic music, function and operation of EM blocks.

Published by Grosset & Dunlap, 51 Madison Ave., New York, NY 10010. 214 pages. \$7.99 hard cover; \$6.95 soft cover.

ELECTRICAL TECHNOLOGY

by T. Baitch

This book is written for students in the first year of any course leading to a technician qualification in electrical engineering, electronics, and allied fields. It covers, in particular, direct-current phenomena. The first chapter leads off with fundamental concepts. The next three chapters deal with electromotive force (emf). Then Ohm's Law is introduced, and the text takes off with discussions on resistance, energy and power, network theorems, magnetism and induction.

Published by John Wiley & Sons, Inc., 605 Third Ave., New York, NY 10016. Hard cover. 502 pages. \$18.50.

EXPERIMENTS WITH A HELIUM-NEON LASER, Second Edition

This is a reference manual and experiment guide for use with He-Ne lasers and optics education kits. It begins with the theory of laser operation, then goes on to explain what a laser is. This is followed by 26 experiments that can be performed with the laser and accessories. Among the experiments presented are: an ophthalmology test, polarization effects, measuring the index of refraction of glass, measuring critical angles, Foucault knife-edge test, Lloyd's mirror experiment, the elementary form of the Michelson interferometer, holography, measuring the speed of light, etc.

Published by Metrologic Instruments, Inc., 143 Harding Ave., Bellmawr, NJ 08030. Soft cover. 59 pages. \$5.00.

JULY 1974

SAVE!

MONEY • TIME • FREIGHT

QUALITY STEREO EQUIPMENT AT LOWEST PRICES.

YOUR REQUEST FOR QUOTATION RETURNED SAME DAY.

FACTORY SEALED CARTONS—GUARANTEED AND INSURED.

SAVE ON NAME BRANDS LIKE A.D.C.

DYNACO

A.R.

KLH

FISHER

KOSS

SHURE

SONY

AND MORE THAN 50 OTHERS
BUY THE MODERN WAY
BY MAIL—FROM

illinois audio

12 E. Delaware Place
Chicago, Illinois 60611
312-664-0020

CIRCLE NO. 17 ON READER SERVICE CARD

HIRSCH-HOUCK LABS: THE NEW CASSETTE TAPES

Popular Electronics

WORLD'S LARGEST SELLING ELECTRONICS MAGAZINE AUGUST 1974/NOV

A Breakthrough Project!

ADD THE
"SCOPEWRITER"
TO ANY
OSCILLOSCOPE

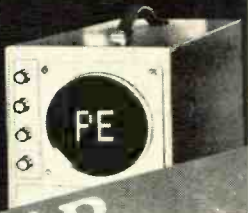

POPULAR ELECTRONICS CHANGES TO NEW FORMAT

Don't Miss Next Month's Issue
NEW, LARGE (8½" X 11") SIZE

ELECTRONICS MARKET PLACE

NON-DISPLAY CLASSIFIED: COMMERCIAL RATE: For firms or individuals offering commercial products or services, \$1.60 per word (including name and address). Minimum order \$16.00. Payment must accompany copy except when ads are placed by accredited advertising agencies. Frequency discount: 5% for 6 months; 10% for 12 months paid in advance. **READER RATE:** For individuals with a personal item to buy or sell, \$1.00 per word (including name and address.) No minimum! Payment must accompany copy. **DISPLAY CLASSIFIED:** 1" by 1 column (2 5/8" wide), \$200.00. 2" by 1 column, \$400.00. 3" by 1 column, \$600.00. Advertiser to supply cuts. For frequency rates, please inquire.

GENERAL INFORMATION: First word in all ads set in bold caps at no extra charge. All copy subject to publisher's approval. All advertisers using Post Office Boxes in their addresses **MUST** supply publisher with permanent address and telephone number before ad can be run. Advertisements will not be published which advertise or promote the use of devices for the surreptitious interception of communications. Closing Date: 1st of the 2nd month preceding cover date (for example, March issue closes January 1st. Send order and remittance to **POPULAR ELECTRONICS**, One Park Avenue, New York, New York 10016, Attention: Hal Cymes.

FOR SALE

FREE! Bargain catalog. Fiber optics, LED's, transistors, diodes, rectifiers, SCR's, triacs, parts. Poly Paks, Box 942, Lynnfield, Mass. 01940.

GOVERNMENT Surplus Receivers. Transmitters, Snooperscopes, Radios, Parts, Picture Catalog 25¢. Meshna. Nahant. Mass. 01908.

LOWEST Prices Electronic Parts. Confidential Catalog Free. **KNAPP**, 3174 8TH Ave. S.W., Largo, Fla. 33540.

ELECTRONIC PARTS, semiconductors, kits. **FREE FLYER**. Large catalog \$1.00 deposit. **BIGELOW ELECTRONICS**, Bluffton, Ohio 45817.

PYROTECHNICAL chemicals, casings, tools, fuse, literature, supplies. Catalog—50¢, with samples—\$1.00. Westech, Box 593, Logan, Utah 84321.

RADIO—T.V. Tubes—36¢ each. Send for free catalog. Cornell, 4213 University, San Diego, Calif. 92105.

AMATEUR SCIENTISTS, Electronics Experimenters, Science Fair Students . . . Construction Plans—Complete, including drawings, schematics, parts list with prices and sources . . . Robot Man — Psychedelic shows — Lasers — Emotion/Lie Detector — Touch Tone Dial—Quadrasonic Adapter—Transistorized Ignition —Burglar Alarm—Sound Meter . . . over 60 items. Send 25¢ coin (no stamps) for complete catalog. Technical Writers Group, Box 5994, University Station, Raleigh, N.C. 27607.

METERS—Surplus, new, used, panel or portable. Send for list. Hanchett, Box 5577, Riverside, CA 92507.

WE SELL CONSTRUCTION PLANS. TELEPHONE: Answering Machine, Speakerphone, Carphone, Phonevision. Auto Dialer. Touch Button Dialer, Central Dial System. **TELEVISION:** \$35.00 Color Converter, Video Tape Recorder. \$25.00 Camera. **HOBBYIST:** Electron Microscope, 96 Hour Tape Music System, Ultrasonic Dishwasher, Radar-Oven. Plans \$4.95 each. **NEW ITEM:** \$75. Electronic Pocket Calculator, \$7.50. **COURSES:** Telephone Engineering \$39.50. Detective Electronics \$22.50, Integrated Circuit Engineering, \$49.50. **NEW SUPER HOBBY CATALOG** plus year's subscription to Electronic New Letter **AIRMAILED \$1.00.** Don Britton Enterprises, 6200 Wilshire Blvd., Los Angeles, Calif. 90048.

JAPAN HONG KONG DIRECTORY. World products information. \$1.00 today. World Trade Inquiries, Hillyard, Washington 99207.

SCOPES, meters, test equipment, military and industrial surplus. Send 25¢ for "Bargain Bulletin". Lawrence Instruments, P.O. Box 744, Sunbury, Pa. 17801.

TEST EQUIPMENT, Aerospace-Laboratory Grade. Request your needs; will mail appropriate catalogs (we have 24 catalog categories). Only for Engineers, Businesses, Schools and advanced Technicians. Goodheart, Box 1220PE, Beverly Hills, Calif. 90213.

WAVEFORM GENERATOR KIT 8038 Function Generator IC Producing Sine, Square, Triangular Waveforms, \$10.95 PPD. **8038 IC**, \$6.75 each PPD. **PHOTOLUME CORPORATION**, 118 East 28th Street, New York, NY 10016.

Led Readouts with Internal Logic Space Savers! Everything on one Dip.

This is the best readout buy of 1974. Brand new. Factory fresh T.I. #TIL306 readouts. These contain the equivalent of 1-Man-1 Led readout 1-7490, 1-7475, 1-7447 plus current limiting resistors. Imagine, a complete digital counting system with **readout** in one 16 PIN Dip. Regular catalog price on these is \$22.00 ea. Our price: \$8.95 with specs. Quantity limited — Sold on a first come basis.

Led lamps at new lower prices

Jumbo red — Large like MV5024 — 6 for \$1
 Jumbo green — Large like MV5222 — 4 for \$1
 Jumbo yellow — Large like MV5322 — 4 for \$1
SPECIAL: Miniature red lamps like MV-50, but better. 8 for \$1

RTL IC's by Motorola

Brand new. These are getting hard to find. Best price anywhere
 MC724-P — \$ 77 MC789P — \$ 77 MC790P — \$ 89

Calculator chip — Mostek MK5011 — Improved CT5001 — \$5.95 with specs

New Low Prices

PRIME DIP TTL IC'S

7400 — \$ 23	7427 — \$ 35	74H73 — \$.49	74151 — \$ 89
74S00 — \$ 49	7430 — \$ 23	7483 — \$ 89	74154 — \$1.59
7402 — \$ 23	7437 — \$ 49	7486 — \$ 39	74157 — \$1.19
7404 — \$ 25	7438 — \$ 49	7490 — \$ 89	74164 — \$1.79
74S04 — \$.49	7439 — \$ 65	7491 — \$ 95	74165 — \$1.49
74S07 — \$.29	7442 — \$ 77	7492 — \$ 89	74174 — \$1.95
7408 — \$ 23	7447 — \$ 95	74121 — \$.49	74181 — \$3.50
7409 — \$ 29	7448 — \$ 95	74123 — \$ 95	74192 — \$1.39
7410 — \$ 23	7473 — \$ 39	74150 — \$1.39	74193 — \$1.39
	7474 — \$ 39		

IC Breadboard Panel

Removed from computers. Consists of an Augat panel with 210 14 pin wirewrap sockets. Also has 44 — MV-50 Led lamps. Board has also 2 oscillators, one is a CTS — Knights unit at 4.000000 MHZ, and the other is 2,000 HZ ± 1% tuning fork osc. Both are set up to work on 5v DC. There is also a Beckman 10v reg. IC. Original cost on these units was \$750. Our price is \$12.50 ea.

Send
 Check or M. O.
 Add 10% for Pstg.
 and handling

ALTAJ ELECTRONICS
 P. O. Box 28592A
 Dallas, Texas 75228

Bargain flyer (10¢),
 Free with order,
 No C.O.D.

Texas Residents. Add 5% State Sales Tax

CIRCLE NO. 2 ON READER SERVICE CARD

LOOKING FOR A NEW CHALLENGE?

... then build a TV camera!



ONLY SOLID-STATE CAMERA AVAILABLE IN KIT FORM OR FACTORY ASSEMBLED. COMPLETE KIT WITH VICON TUBE ONLY \$166.00. POSTPAID DELIVERY ANYWHERE IN USA, CANADA and MEXICO. OPTIONAL AUDIO SUBCARRIER \$18.95. WRITE or PHONE NOW FOR COMPLETE CATALOG OF KITS, PARTS and PLANS. DIAL 402-987-3771.

1301 BROADWAY ATV Research DAKOTA CITY, NEBR. 68731

DIGITAL ELECTRONICS: Complete schematics, parts lists, theories — Discrete Component Digital Clock, \$3.00—Sound Sensitive Switch, \$1.50. Increase technical competence, hobby skills—Complete course in Digital Electronics is highly effective, \$10.00. Free literature. **DYNASIGN**, Box 60A7, Wayland, Mass. 01778.

MECHANICAL, ELECTRONIC devices catalog 10¢. Greatest Values — Lowest Prices. Fertik's, 5249 "D", Philadelphia, Pa. 19120.

SOUND SYNTHESIZER KITS—Surf \$11.95, Wind \$11.95, Wind Chimes \$16.95, Electronic Songbird \$6.95, Musical Accessories, many more. Catalog free. PAIA Electronics, Box J14359, Oklahoma City, OK 73114.

BURGLAR-FIRE alarm components, hardware. Free catalog—information. Silmar, 133 S.W. 57 Ave., Miami, Florida 33144.

DISCOUNT PRICES

B & K, SENCORE, LEADER Test Equipment
RAYTHEON, ICC/MULLARD Tubes
TELEMATIC Test Kits

Free Catalog

FORDHAM RADIO SUPPLY CO. INC.
558 Morris Ave., Bronx, N.Y. 10451

FREE CATALOG. Parts, circuit boards for POPULAR ELECTRONICS projects. PAIA Electronics, Box C14359, Oklahoma City, OK 73114.

YOU SAVE BIG MONEY! Surplus, Clearouts, Bankruptcy, Inventory, Deals. Catalog \$1 (redeemable). ETCOA Electronics, Box 741, Montreal, H3C 2V2. U.S. Inquiries.

ELECTRONIC Parts wholesale. Catalog 10¢. Donlyn Electronics, P.O. Box 15421, Phoenix, Arizona 85060.

FREE Catalog lists resistors, tubes, transistors, rectifiers, condensers, tools, tuners, etc. Hytron Hudson, Dept. PE, 2818 Kennedy Blvd., Union City, N.J. 07087.

BURGLAR-FIRE alarm supplies and information. Free catalog. Protecto Alarm Sales, Box 357-G, Birch Run, Michigan 48415.

FREE CATALOG. IC's, Puts, Transducers, Thermocouples, Led's, Transistors, Circuit Boards, parts. Chaney's, Box 15431, Lakewood, Colo. 80215.

AUTHENTIC, INSTRUMENTED, FLYING ROCKETS for casual or serious experimenters. Over 80 scale original, multi-stage or ready-to-fly models. Solid-propellant engines for safe, electric launch system liftoffs up to 2,500 feet. Measure altitude, temp, inersions, more. Real telemetry, electronic tracking, aerial still and movie photography with super-miniaturized equipment. New, detailed tech manual and full-color catalog. 25¢ from ESTES INDUSTRIES Dept. 18X, Penrose, Colo. 81240.



PAIA KITS

synthesizer
demo record \$1.00
free catalog

PAIA ELECTRONICS, INC.
BOX P14359, OKLAHOMA CITY, OK 73114

CALCULATOR OWNERS: Use your $+ - \times \div$ calculator to compute square roots, cube roots, $\sin(x)$, $\cos(x)$, $\tan(x)$, $\arcsin(x)$, $\arccos(x)$, $\arctan(x)$, logarithms, exponentials, and more! Quickly, Accurately, Easily! Send today for the IMPROVED AND EXPANDED EDITION of the first and best calculator manual—now in use throughout the world . . . only \$2.00. Unconditional money-back guarantee—and FAST service! Mallmann Optics and Electronics, Dept. 17A, 836 South 113, West Allis, Wisconsin 53214.

WE SELL MONEY MAKING CONSTRUCTION MANUALS!—Reclaim refined GOLD and SILVER for EXCELLENT full time or part time money!—Color Catalog 25¢—Airmailed 50¢. Creative Products, Dept. PE-774, 8415 Lofland, Houston, Texas 77055.

FREE 1974 CATALOG!!

NEW .3" Char. Height YELLOW MAN 81 and red MAN 74 LEDs. 3-4 only \$5.00 each. Also available with 7490, 7447, 7475 latch and G-10 epoxy board for 2, 4, or 6 digits.



POWER SUPPLY KITS!

5, 12, 15 vDC @ 1 Amp. $\pm 15 @ \pm .1$ or 1 amp. Short Circuit, thermal overload protection. All models include space for transformer on the circuit board. 5v kit for only \$8.95 (less transformer). Instructions included.

RESISTORS - 5% 1/2 watt CARBON FILM Superior to composition in everyway, but at the same low price 12c each. Quantity Discounts.



CAPACITORS for bypassing, coupling, etc. Sub-miniature case. .001-.22uF, 100 vDC .001 15c each. Quantity Discounts.

ALUMINUM ELECTROLYTICS 1-2200 uF from 16-50 vDC. These are high quality ICC units at a very low price.

OTHER 7400 SERIES PARTS AVAILABLE as well as op amps, transistors, display bezels, and cases for your projects. MANY OTHER KITS also. All products guaranteed. NAME BRANDS ONLY. Mastercharge and Bank Americard accepted.

Tracy Design Corporation

15870 Schaefer

Detroit, Mich. 48227

CIRCLE NO. 26 ON READER SERVICE CARD

BUGGED??? New locator finds them fast. Write, Clifton, 11500-L N.W. 7th Avenue, Miami, Florida 33168.

TELEPHONE "BUGGED"? Countermeasures Brochure \$1.00. Negeye, Drawer 547, Painsboro, W. VA 26415.

ELECTROSLEEP, acupuncture. Catalog of 200 more projects free. Cimarron Labs, G-13060 Center Rd., Clio, Michigan 48420.

HEAR POLICE/FIRE Dispatchers! Catalog shows exclusive directories of "confidential" channels, receivers. Send 10¢ stamp. Communications, Box 56-PE, Commack, N.Y. 11725.

FIREWORKS NEWS—Magazine Covering Commercial—Display Fireworks, Sources, Construction, Pyrotechnical Supplies, Fuse, Literature. Free Catalogs/Booklist With Subscription! Calendar Year \$9.00 "1974" Fireworks Buyers' Guide" \$5.95. Pyro Press, Box 12010N, Lexington, Kentucky 40511.

CONVERT any television to sensitive, big-screen oscilloscope. Only minor changes required. No electronic experience necessary. Illustrated plans. \$2.00. Sanders, Dept. A-33, Box 92102, Houston, Texas 77010.

BIOFEEDBACK. Professional instruments: Electroencephalophone, Galvanic Skin Response. J&J, 8102E, Bainbridge, WA 98110.

DIGITAL IC Manual—Latest Edition—1500 types by types/diagram number, \$3.95. 32—function digital computer kit—IC, transistors, instructions, \$14.00. IC applications manual—numerous circuits—Analog/Digital, \$3.95. Electronetics, P.O. Box 127, Hopedale, Mass. 01747.

CONSTRUCTION PLANS: Laser . . . \$2.00. Rocket Tracking Transmitter . . . \$2.00. Space Monitor-Missile Tracker . . . \$2.00. Free Catalog. Electro-Research, P.O. Box 20285, Ferndale, Michigan 48220.

CD IGNITIONS, VHF/UHF monitors, crystals, CB radios. Southland, Box 3591-B, Baytown, Texas 77520.



MINIATURE ALUMINUM ELECTROLYTIC CAPACITORS

Temp. range: -40°C to +85°C Tolerance: -10 to +50% for more than 4.7 ufd., -10 to +75% for 4.7 ufd or less

Value	1	10-99	100-240*	Value	1	10-99	100-240*
1 ufd/50V	14c	12c	11c	100 ufd/16 V	19c	15c	14c
2.2 ufd/50 V	14c	12c	11c	100 ufd/25V	24c	18c	17c
3.3 ufd/35V	14c	12c	11c	220 ufd/16 V	24c	18c	17c
4.7 ufd/35 V	14c	12c	11c	220 ufd/25 V	35c	25c	24c
10 ufd/16 V	13c	10c	9c	330 ufd/16 V	35c	25c	24c
10 ufd/25 V	14c	11c	10c	330 ufd/25 V	44c	35c	32c
22 ufd/16 V	14c	11c	10c	470 ufd/16 V	37c	30c	27c
22 ufd/25 V	15c	13c	12c	470 ufd/25 V	49c	39c	35c
33 ufd/16 V	15c	12c	11c	1000 ufd/16 V	49c	39c	35c
33 ufd/25 V	17c	13c	12c	1000 ufd/25 V	75c	60c	55c
47 ufd/16 V	17c	14c	13c	2200 ufd/16 V	75c	60c	55c
47 ufd/25 V	19c	15c	14c				

1/2 & 1/4 WATT CARBON COMP. RESISTORS

5 each of the 85 standard 10% values (2.2-2.22M) 1/2 W Resistors (425 pcs)
Sorted by value \$12/set 2-4 ore \$11/set 5-9 ore \$10/set.

5 each of the 70 standard 10% values (10-5.6M) 1/4 W Resistors (350 pcs)
Sorted by value \$12/set 2-4 ore \$11/set 5-9 ore \$10/set.

Also available are TTL & Linear IC's, Silicon Rectifiers, Molex Pins, LED Redouts & Lamps, Transistors, IC Sockets, Slide Switches, Reed Relays and more!



Send for FREE CATALOG or Mail Readers Service Card

C.O.D. ORDERS ACCEPTED FOR SAME DAY SHIPMENT

CALL 218-681-6674

Orders Less Than \$10.00 Add 50¢—Others Postpaid

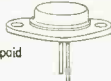

DIGI-KEY

Box 126

Thief River Falls, MN 56701

CIRCLE NO. 11 ON READER SERVICE CARD

CRYSTALS, Scanners, \$3.88, include make and frequency. G Enterprises, P.O. Box 461PC, Clearfield, UT 84015.

ELECTRONIC TEST INSTRUMENT CATALOG—160 illustrated pages list over 5,000 new, used and reconditioned test instruments—600 manufacturers. Send \$2.50 refundable with first purchase. Tucker Electronics, P.O.B. 1050, Garland, Texas 75040.

LOW NOISE RESISTORS—carbon film. Brand new as low as 2 1/4 cents each. Components Center-PE, Box 134, N.Y., N.Y. 10038.

FREE CATALOG. Kits, Components, audio equipment. Electronic Supply Pacs, Box 175, Floral Park, N.Y. 11001.

SEMICONDUCTORS, components unusual items, discount prices, catalog 20 cents. Seaboard International Electronics, Box 906, Clute, Texas 77531.

PRACTICAL Applications of Digital IC's. 100's of tips, circuits, projects, on TTL. 443pp \$19.95. Money Back Guarantee, GEA, P.O. Box 285, Northfield, Ohio 44067.

WEATHER SATELLITE pictures of your own. Can be constructed for \$100.00. \$2.00 for plans to: Weather, P. O. Box 362, Tupelo, Miss. 38801.

LASER parts catalog, 60¢. Moynihan, 107 North Brighton, Atlantic City, New Jersey 08401.

ALPHA/THETA BRAINWAVE biofeedback instruments. Analog instruments from \$125; digital processing systems from \$225. BioScan, Box 14168-E, Houston, Texas 77021.

FREE Catalog—Big Savings, Lists. Diodes, Capacitors, Resistors, IC's, Sockets, more. PRASAD ELECTRONICS, Box 32, Addison, Ill. 60101.

SURPRISE! Build inexpensively, the most Unusual Test Instruments, Futuristic Gadgets using Numerical Redouts! Catalogue Free! GBS, Box 100A, Green Bank, West Virginia 24944.

POWER SUPPLY plans, precision regulated 9 to 12vdc, 2 amps. \$5.00. Airborne Systems, Box 1175, Hartford, Conn. 06101.

STROBELIGHT plans, includes theory, diagrams, parts sources, \$1.00, build for \$10.00. RRM Electronics, 206 Parkway Drive, Newport News Va. 23606.

ELECTRICAL and ELECTROMAGNETIC Phenomena in the Brain and Human Thinking. 17p. Short Exposition of Brain's Functioning and Problems. Z. J. Daszewski, Research Lab., 361 Garretson Ave., Perth Amboy, N.J. 08861.

PRINTED CIRCUIT TECHNIQUES FOR THE HOBBYIST. Ferric chloride "suspension etching"; cutting epoxy glass; screen printing, etc. Booklet \$2.00. Trumbull, 833 Balra Dr., El Cerrito, Ca. 94530.

PROTECT your vehicles from theft, against "hot wiring" etc., with "Auto Guard". Fits all cars, instructions included. Residents continental U.S.A. only. Add 6% tax in Calif. \$6.95 ck. or m.o. Whitesell Sales, 245 Woodlawn, Chula Vista, Calif. 92010.

BCD ADDER-SUBTRACTOR EXPERIMENT. Complete instructions tell how to build, add, subtract, multiply and divide for only \$2.00. Solfee Enterprises-Q, Box 41283, Los Angeles, Cal. 90041.

EXPLORE THE MICROCOMPUTER OPTION! LSI System Plans for Experimenters! Write for Free Catalog! M.P. Publishing Co., Box 378, Belmont, Massachusetts 02178.

ELECTROLESS Tin Solution for PC board plating—\$5.50/quart, \$11.95/gallon + shipping. Etchant \$2.98/gallon + shipping. Catalog-25¢. Box 687, Arlington, MN 55307.

NE555V: \$1.10 8038 Waveform Generator: \$6.95, Intel 1103: \$4.50, 2N6084: \$10.50, Catalog: 10¢. **ELECTRONIC DISCOUNT SALES**, 138 N. 81st St., Mesa, Arizona 85207.

LOGIC tester of unusual design to identify and test Logic IC'S, educational, versatile yet simple, easy to use. \$3.00 for schematic and description. S. Smith, P. O. Box 574, Murphysboro, Ill. 62966.

ELECTRONIC ORGAN KITS, KEYBOARDS and many components. Independent and divider tone generators. All diode keying. I.C. circuitry. Supplement your Artisan Organ, 35¢ for catalog. DEVTRONIX ORGAN PRODUCTS, Dept. C., 5872 Amapola Dr., San Jose, Calif. 95129.

COMPLETE CONSTRUCTION PLANS—TELEPHONE: Schematics, Answering Device, Automatic Dialer, Call Diverter, Conference Bridge, Central Dial Exchange, Remote Control, Speakerphone, Telelink Burglar Alarm, \$3.00 each. **ELECTRONIC:** Biofeedback Conditioner, Horticulture Stimulator, Multifrequency Encoder Network (Speeds telephone calling 100%), \$5.00 each. **DODECAHEDRON** Speaker Enclosure \$7.50. **PRECISION** Stenciling Device \$2.00. **One year subscription:** Telephone-Electronics Newsline \$3.00. **Correspondence Course:** Telecommunications \$24.95. Teletronics Company of America, P.O. Box 3486, Los Angeles, California 90028.

PARANOID??? Surveillance Countermeasure Equipment Catalog \$1.00. SECURITY, Box 671, Westwood, New Jersey 07675.

BARGAINS: Electronic Components. 1974 Catalog 25¢—refundable w/order. Atlantis, Box 12654P, Tucson, Az. 85711.

EXPERIMENTERS! Send \$10.00 for postpaid "Grab Bag" of assorted electronic goodies. Satisfaction guaranteed. Aeroaparts, Box 1492, International Airport, Del Rio, Texas 78840.

SCOTCH TAPE—2400' on 7" reel boxed, may have music. 12 for \$14 POSTPAID—free list—WIDE RESPONSE, 6114P SANTA MONICA BLVD., HOLLYWOOD, CA. 90038.

KRYSTAL KITS new catalog of kits, scramblers, descramblers, encoders, decoders, parts. Catalog 25¢. Krystal Kits, Box 445, Bentonville, Ark. 72712.

C-D electronic ignition, \$4.95, guaranteed, free details, Cardinale, 96 Home St., Somerset, N.J. 08873.

WALKIE-TALKIE accessories, free literature. C&C, Box 91654, L.A., Calif. 90009.

TRUST YOUR OSCILLOSCOPE READINGS? If not, my calibrator for \$9.95 is for you. Guaranteed. Bailey, 174 North Coleman Road, Centereach, N.Y. 11720.

LIGHT EMITTING DIODES

MRD 14B Photo	
Darlington	
OS-3 GaP VIS. LED	\$.75
MCD-2 Opto. Isolator	\$.90
ME4 IR LED's	\$.50
GREEN GaP OS-16 LED	\$.90
74100	50 7476 .52
7400	24 7480 .65
7401	24 7483 1.10
7402	24 7486 .48
7403	24 7489 3.00
7404	24 7490 .93
7405	26 7491 .83
7406	43 7492 .85
7407	50 7493 .85
7408	27 7495 .99
7410	24 7496 .95
7411	30 74107 .50
7412	45 74121 .60
7413	85 74123 1.00
7416	48 74125 1.40
7417	30 74152 1.40
7420	24 74150 1.15
7422	30 74151 .95
7426	30 74154 1.65
7427	55 74157 1.25
7430	24 74163 1.60
7432	30 74164 .75
7437	60 74165 2.05
7438	50 74173 1.80
7440	24 74177 .75
7441	115 74181 3.95
7442	100 74182 1.50
7445	115 74183 1.45
7446	125 74195 1.00
7447	125 74481 1.00
7448	30 74522 1.00
7450	24 74549 1.10
7451	30 82110 1.50
7472	40 82111 1.50
7473	48 8220 1.50
7474	48 8520 1.75
7475	80

TRANSISTORS SPECIALS

2N256 PNP GE TO-3	\$.50
2N333 NPN Si TO-106 4	\$1.00
2N222 NPN Si TO-82	\$2.50
2N1016A NPN Si TO-62	\$1.95
2N404 PNP GE TO-5 4	\$1.00
2N3638 PNP Si TO-5 5	\$1.00
2N2218A NPN Si TO-5 4	\$1.00
2N2222 NPN Si TO-92 5	\$1.00
2N3137 NPN Si TO-5 4	\$1.00
2N3767 NPN Si TO-66	\$.70
2N3866 NPN Si TO-5	\$.75
2N4109 NPN Si TO-220	\$.25
2N5296 NPN Si TO-220	\$.50
2N4898 PNP Si TO-66	\$.60
MJ2522 NPN Si TO-66	\$.90
2N3055 NPN Si TO-3	\$1.00

5311—Clock Chip featuring BCD, hold count and output

5311—Clock Chip featuring BCD, hold count and output	\$8.50
5314—Clock Chip 6 digit readout hold count	\$8.50
5316—Alarm Clock Chip	\$13.25
TIS 73 N FET	\$.50
2N4891 JJT	\$.50
ER900 Trigger Diodes	4 \$1.00
14 Pin IC Sockets	\$.40

C. MOOS (Diode Clamped)

CD 4001	\$.65
CD 4002	\$.65
CD 4009	\$1.50
CD 4010	\$.65
CD 4011	\$.65
CD 4012	\$.65
CD 4013	\$1.60
CD 4016	\$1.50
CD 4023	\$.65
CD 4025	\$.65
CD 4027	\$1.35
CD 4030	\$.65
74C02	\$1.60
74C157	\$2.15
74C165	\$3.50
4022	\$2.25

SLA-3 Segment LED Readout 77" Num-

bers 45 MA	\$7.50
1 Seg. Red or Yellow	

INJECTION LASER—A SINGLE DIODE 6W.

25A GaAs UNIT SIMILAR TO RCA 40859	\$10.95
------------------------------------	---------

Miniature Trim Pots

5K, 10K, 20K, 25K	
50K, 100K	\$.75 3 \$2.00

FULL WAVE BRIDGES

PRV	2A	5A
	200	95 1.25
	400	1.15 1.50
	600	1.35 1.75

MAN-1, Red or Yellow READOUT

MAN-4 LED READOUT	\$2.50
MAN-3 LED READOUT	\$1.75

CAPACITORS

60V 30 UF TANT	5 \$1.00
20V 4.7 UF TANT	5 \$1.00
12V 01 UF ELECT.	5 \$1.00
50V 100 UF ELECT.	5 .90
25V AT 30 UF	4 \$1.00

SANKEN AUDIO POWER AMPS

Si 1010Y 10 WATTS	\$ 7.95
Si 1025E 25 WATTS	\$18.88
Si 1050E 50 WATTS	\$29.95

SIMILAR TO 8038C IC VOLT-

AGE-CONTROLLED OSCILLATOR AS FEATURED IN P.E. OCT 73. THEY HAVE SINE, SQUARE AND TRIANGULAR OUTPUT GOOD TO 1 MHz.	\$5.95
---	--------

RAYTHEON 8550 WITH SOCKET AND DATA SHEET \$2.25 3 \$6.00

Silicon Power Rectifiers

PRV	1A	3A	12A	50A
100	.06	.11	.30	.35
200	.07	.16	.35	1.25
400	.09	.20	.45	1.50
600	.11	.30	.70	2.00
800	.15	.40	.85	2.30
1000	.20	.55	1.10	

TRIACS

PRV	1A	10A	25A
100	.40	.70	1.30
200	.70	1.10	1.75
400	1.10	1.60	2.60
600	1.70	2.30	3.00

SCR's

PRV	1A	10A	25A
100	.40	.70	1.30
200	.70	1.10	1.75
400	1.10	1.60	2.60
600	1.70	2.30	3.00

NSN 33-3 Digit LED Array, MAN-3 Size

Internally Multiplexed and Driven By 7448	\$1.95
---	--------

LINEAR CIRCUITS

LM309K—5V 1A regulator	\$1.80
723—40 40V regulator	\$.75
LM300H Op. Amp.	\$.90
741A or 741C oper. amp.	\$.47
709C oper. amp.	\$.47
Dual 709	\$1.25
LM101 Hi perf. oper. amp.	\$.75
LM308—Low power op. amp.	\$1.15
747—Dual 741	\$.85
536—FET input op. amp.	\$2.90
537—Prec. op. amp.	\$2.50
LM3900—Quad oper. amp.	\$.75
LM324—Quad 741	\$2.20
560—Phase lock loop	\$2.00
561—Phase lock loop	\$2.95
565—Phase lock loop	\$2.95
567—Tone decoder	\$2.85
703—RF-IF amp.	\$.65
LM370—AGC squelch amp.	\$1.15
555 2NS 2 hr timer	\$1.20
3822 Transistor array	\$.95
LM380—2W audio amp.	\$1.75
LM381—Stereo preamp	\$1.75
LM382—Dual audio preamp	\$1.95
LM311—Hi perf. comp	\$1.15
LM319—Dual hi speed comp.	\$1.50
LM139—Quad comparator	\$1.95

CONDUCTIVE ELASTOMETER

LOW PROFILE CALCULATOR KEYBOARD A 2 3/4" x 3 1/4" x 1/4" FLEX KEY, 19 SK-6 KEYBOARD HAVING 0-9, *, /, #, K, C BUTTONS WITH OFF ON SWITCH, \$6.50	
--	--

Terms: FOB Cambridge, Mass.

VERIPAX PC BOARD

This board is a 1 1/2" single sided paper epoxy board 4 1/2" x 6 3/4" (standard veripax) DRILLED and etched, which will hold 21 single 14 pin IC's, or R-16 or LSI DIF IC's with buses for power supply connections. It is also etched for a 22 pin connector. \$5.25 3 \$14.50
Walt Zeners
3-9, 4-7 or 5-6V 7.5 ea.



SOLID STATE SALES

P.O. BOX 74 A
SOMERVELL, MASS. 02143
TEL. (617) 547-0005

THE RELIABLE EAST COAST
SEMICONDUCTOR SURPLUS HOUSE

CIRCLE NO. 23 ON READER SERVICE CARD

KEYBOARDS, General Telephone. Advertised elsewhere at \$8.88—only \$5.25. Limited quantity. S.E.E., 331 37th St., Sacramento, CA 95816.

FREE! Giant Catalog. Semiconductors, IC's Parts. Crown Electronics, 501 Baldwin Avenue, Lodi, N.J. 07644.

PLANS AND KITS

TRIGGER SWEEP GENERATOR—improve your low cost scope by adding solid state trigger sweep. Complete kit, \$20.00 PPD. Information Free. **PHOTOLUM CORPORATION**, PO Box 139, New York, N.Y. 10016.

TESLA COIL—40" SPARKS! Plans! \$7.50. Information 75¢. Huntington Electronics, Box 2009-P, Huntington, Conn. 06484.

REUSEABLE PC layout kit—1000 + opaque 1x pads (IC, Xister, donuts, tape) on transparent sheets. Artsheet included. 2x Available. \$4.98. Flynnco, Box 32187, Mpls., Minn. 55432.

CB MOBILE co-phase antenna harness. VSWR 1-1:1 match. Plans \$2.00. Enclose self-addressed stamped envelope. DUFFY'S, P.O. Box 808, Nevada City, CA. 95959.

LIQUID LEVEL CONTROLLER plus three other transistor circuit plans. \$2.00 to: Summit Electronics, 333 West Ludlow Street, Summit Hill, Pa. 18250.

HIGH FIDELITY

DIAMOND NEEDLES and Stereo Cartridges at Discount prices for Shure, Pickering, Stanton, Empire, Grado and ADC. Send for free catalog. **LYLE CARTRIDGES**, Dept. P, Box 69, Kensington Station, Brooklyn, New York 11218.

WANTED

QUICKSILVER, Platinum, Silver, Gold, Ores Analyzed. Free Circular. Mercury Terminal, Norwood, Mass. 02062.

TUBES

RADIO & T.V. Tubes—36¢ each. Send for free Catalog. Cornell, 4213 University, San Diego, Calif. 92105.

RECEIVING & INDUSTRIAL TUBES, TRANSISTORS. All Brands—Biggest Discounts. Technicians, Hobbyists, Experimenters—Request **FREE** Giant Catalog and **SAVE!** ZALYTRON, 469 Jericho Turnpike, Mineola, N.Y. 11501.

TUBES "Oldies", latest. Lists free. Steinmetz, 7519 Maplewood, Hammond, Indiana 46324.

TUBES receiving, factory boxed. low prices. free price list. Transletronic, Inc., 1306 40th Street, Brooklyn, N.Y. 11218A, Telephone: 212-633-2800.

CASH Paid for obsolete receiving tubes WE300B, WE350B, WE252A, WE310A, WE274A, WE262B, WE284D, RCA45, RCA50Q, and Movie Theatre we amplifier models 91B, 86F. Contact: M. Takabe, 303 Fifth Avenue, N.Y.C. (212) 679-1970.

MOVIE FILMS

8MM-SUPER 8-16MM MOVIES! Biggest Selection! Lowest Prices! Free Catalog! Cinema Eight, Box PE, Chester, Connecticut 06412.

ELECTRICAL SUPPLIES AND EQUIPMENT

PLATING Equipment, Portable Platers, Supplies and "Know-How." Build your own tanks for nickel, chrome, etc. Easy-to-install PVC liners. Rectifier components—all sizes. Schematics, parts lists, formulas, operating instructions for all plating. Guaranteed to save you 25%-75%. Some good units for sale. Write for details. Platers Service Company, 1511-PE Esperanza, Los Angeles, Calif. 90023.

TAPE AND RECORDERS

RENT 4-Track open reel tapes—all major labels—3,000 different—free brochure. Stereo-Parti, 55 St. James Drive, Santa Rosa, Ca. 95401.

1930-1962 Radio Programs. Reels, \$1.00 Hour! Cassettes, \$2.00 Hour! . . . Mammoth Catalog, \$1.00. AM Treasures, Box 192F, Babylon, N.Y. 11702.

CASSETTES

PLAIN WHITE CASSETTE LABELS. NORELCO CASSETTE CLEANERS. PAPER MAILER BOXES** HOLDS NORELCO-TYPE PLASTIC BOX. FAMOUS BRAND CASSETTES. "LIKE NEW" 10 1/2% METAL OR FIBERGLASS REELS. SEND FOR OPEN REEL AND CASSETTE DISCOUNT CATALOG. QUANTITY 1-9 10-99 100 1000
CASSETTE LABELS (Multiples of 10) .02 .15 .01
NORELCO CASSETTE CLEANER .65 .60 .55 .50
SCOTCH CASSETTE SC90HE 2.72 (BUY 2, GET ONE FREE)
10 1/2% FIBERGLASS REELS, USED 50 40 35 25
10 1/2% METAL, NAB HOLE, USED 1.00 1.00 .90 .70
**PLUS POSTAGE BY WEIGHT AND ZONE MINIMUM ORDER. \$5.00
1776 COLUMBIA ROAD, N.W.
SAXITONE TAPE SALES WASHINGTON, D.C. 20009

16,000 OLD RADIO SHOWS on tape. Catalog \$2.00, supplement 50¢ (refundable). Hart Enterprises, 1329H George Washington, Richland, WA 99352.

TOOLS

WRAP Tool \$1.00, Wire, Panels. Xycon, Box 9341, Phoenix, AZ. 85020.

GOVERNMENT SURPLUS

GOVERNMENT Surplus. How and Where to Buy in Your Area. Send \$2.00. Surplus Information, Headquarters Bldg., Box 30177-PE, Washington, D.C. 20014.

ELECTRONIC Equipment and Parts. Big 36 page Free Catalog. Send for your copy today! Fair Radio Sales, Box 1105-P, Lima, Ohio 45802.

MANUALS for Govt Surplus radios, test sets, scopes. List 50¢ (coin). Books, 7218 Roanne Drive, Washington, D.C. 20021.

ELECTRONIC gadgets and parts. Send for free bulletin. Aeroparts, International Airport, Box 1492, Del Rio, Texas 78840.

PERSONALS

MAKE FRIENDS WORLDWIDE through international correspondence. Illustrated brochure free. Hermes, Berlin 11, Germany.

INVENTIONS WANTED

CASH-ROYALTIES for patented, unpatented inventions. Global Marketing Service, 2354-P Telegraph, Oakland, California 94612.

INVENTORS: Protect your ideas! Free "Recommended Procedure". Washington Inventors Service, 422T Washington Building, Washington, D.C. 20005.

PATENT Searches including Maximum speed, full airmail report and closest patent copies. Quality searches expertly administered. Complete secrecy guaranteed. Free Invention Protection forms and "Patent Information." Write Dept. 9, Washington Patent Office Search Bureau, Benjamin Franklin Substation, P.O. Box 7167, Washington, D.C. 20044.

FREE PAMPHLET: "Tips on Safeguarding Your Invention." Write: United States Inventors Service Company, 708-T Carry Building, Washington, D.C. 20005.

INVENTORS! Either we will sell your Invention before you or anyone else does, or we will pay you a cash bonus. Get Free Invention Evaluation and information: Write Gilbert Adams Organization, Invention Brokerage, Dept. 20, 80 Wall St., New York, NY 10005.

FILE your own patent application. Complete information and materials. Write: Inventor's Guide, 468-R, Goodspeed Road, Virginia Beach, Virginia 23451.

FREE "DIRECTORY OF 500 CORPORATIONS Seeking New Products." For information regarding Development, Sale, Licensing of your patented/unpatented invention, write for FREE "INVENTOR'S KIT NO. A-73, RAYMOND LEE ORGANIZATION, 230 Park Avenue, New York, N.Y. 10017.

MARKETS SURVEYS revealing Sales Outlets and Buyers. Patent Searchers with Patentability Report and nearest patent copies. Inventors Selling, and Financing Guides. Free Literature. Registered Engineer, Box 8001, Kennedy P.O., Boston, Mass. 02114.

PRINTING

ADMANUAL describes low-cost printing. Outstanding results. Chris Gundlach, 719 Vine, Ironton, Ohio 45638. Fees include typesetting, artwork—unusual value!

INSTRUCTION

LEARN ELECTRONIC ORGAN SERVICING at home all makes including transistor. Experimental kit—trouble-shooting. Accredited NHSC, Free Booklet. NILES BRYANT SCHOOL, 3631 Stockton, Dept. A, Sacramento, Calif. 95820.

LEARN WHILE ASLEEP, Hypnotize! Strange catalog free. Auto-suggestion, Box 24-ZD, Olympia, Washington 98501.

DEGREE IN ELECTRONICS through correspondence. Free catalog. Grantham, 2000 Stoner Avenue, Los Angeles, California 90025.

INTENSIVE 5 week course for Broadcast Engineers. F.C.C. First Class license. Radio Engineering Incorporated, 52 S. Palm Ave., Sarasota, Florida 33577.

SHORTCUTS To Success! Highly Effective, Profitable Short Courses. (75 Choices). Study At Home. Diploma Awarded. Our 29th Year. Free Literature. CIEE-D, Box 20345, Jackson, Miss. 39209.

F.C.C. EXAM MANUAL
Tests-Answers for FCC First and Second Class Commercial Licenses
PASS FCC EXAMS! Memorize, study "Tests-Answers" for FCC 1st and 2nd class Radio-telephone licenses. Newly revised multiple-choice questions and diagrams cover all areas tested in FCC exams, plus "Self-Study Ability Test." \$9.95 postpaid. Moneyback Guarantee.
COMMAND PRODUCTIONS P.O. BOX 26348-P
RADIO ENGINEERING DIVISION SAN FRANCISCO, CALIF. 94126

DEGREE Program in Electronics Engineering. Our 29th Year! Free literature. Cook's Institute, Dept. 13, Box 20345, Jackson, Miss. 39209.

EARN College Degrees at home. Many subjects. Florida State Christian University, P.O. Box 1674, Fort Lauderdale, Florida 33302.

DIGITAL:THEORY,DESIGN
CONSTRUCTION

LOGIC NEWSLETTER ©

SAMPLE COPY \$1.00
LOGIC NEWSLETTER
POB 252
WALDWICK,N.J. 07463

SCORE high on F.C.C. Exams . . . Over 300 questions and answers. Covers 3rd, 2nd, 1st and even Radar. Third and Second Test, \$14.50; First Class Test, \$15.00. All tests, \$26.50. R.E.I., Inc, Box 806, Sarasota, Fla. 33577.

FCC license. Broadcast Engineering. Communications Electronics. Home Study. Free catalog. GTI, 5540 Hollywood, Los Angeles, Calif. 90028.

FCC LICENSE Q&A. Cassette recorded. Radio License Training, 1060D Duncan, Manhattan Beach, Calif. 90266.

POLY
PAKS

1st: Opto & Calculator Components!

NATIONAL BUY ANY 3 — TAKE 10%
LINEAR OP AMPS

LM-300 POS V.R. (super 723) TO-5	\$.91
LM-301 Hi-performance op amp (A)	.41
LM-302 Voltage follower TO-5	.91
LM-305 Pos. Voltage Reg. TO-5	1.19
LM-307 Super 741 op amp (A)	.41
LM-308 Hi-Q fet type op amp TO-5	1.19
LM-309H 5V Volt-Regulator TO-5	1.19
LM-309K 5V Volt-Reg. 1 Amp TO-3	1.85
LM-310 Voltage-Follower TO-5	1.25
LM-311 Hi-perf. Volt. Comp. (A)	1.19
LM-319 Hi-speed Dual Comp. DIP	1.50
LM-320 MINUS 5, 12 or 24V V.R. TO-3	1.50
LM-339 Quad Comparator, DIP	2.50
LM-324 Quad (4-741's in DIP)	2.50
LM-350 Dual peripheral driver	1.19
LM-370 AC Switch op amp, TO-5	1.19
LM-373 AM-FM 55B (A.D. TO-5	3.50
LM-374 AM-FM 55 IVAD TO-5	3.50
LM-377 Dual 2-watt audio amp	1.69
LM-380 2-watt audio amplifier TO-5	1.95
LM-381 Low noise dual pre amp DIP	1.95
LM-382 Low noise dual pre amp DIP	1.95
LM-703 RF IF amp, TO-5	.36
LM-709 Operational amplifier (A)	.45
LM-710 Differential amplifier (A)	.45
LM-711 Dual Differential Amp (A)	.36
LM-723 Voltage Regulator (A)	.95
LM-725 Instrument Amp	.95
LM-733 Differential Video	1.75
LM-741 Freq. Comp. 709 (A)	.41
LM-741CV Mini DIP 741C	.45
LM-747 Dual 741 (A)	.89
LM-748 Freq. adjustable 741C (A)	.44
LM-1303 Stereo pre amp DIP	.95
LM-1304 FM Stereo Multiplexer	1.25
LM-1305 FM Multi. Stereo Dem. DIP	.91
LM-1307 FM Multi. Stereo Dem. DIP	.91
LM-3028 Differential RF/IF amp	1.50
LM-3900 Quad "current mirror" amp	2.50
LM-4250C Programmable op amp	2.50
LM-75451 Dual peripheral driver	.44
LM-75453 Dual peripheral driver	.44
LM-75491 Quad seg. LED (DIP)	1.50
LM-75492 Hex digit driver, 250ma. DIP	1.85

LINEAR Op Amps

531 Hi slow rate op-amp (TO-5)	\$2.50
532 Micro power 741 (TO-5)	2.50
533 Micro power 709 (TO-5)	2.50
536 FET input op amp (TO-5)	2.95
550 Precision 723 voltage reg. (DIP)	1.17
555 Timer 2 u Seconds to 1-hr. (A)	1.25
556 5 Times faster than 741C	1.00
558 Dual 741 (DIP)	1.00
560 Phase lock loops (DIP)	2.95
561 Phase lock loops (DIP)	2.95
562 Phase lock loops (DIP)	2.95
565 Phase lock loops (A)	2.95
566 Function generator (TO-5)	2.95

567 Tone decoder (A)	2.95
702C Hi-grain. DC amp (TO-5)	.49
704 TV sound IF system	1.50
711C Dual diff. comp (A)	1.33
723C Voltage regulator (A)	.69
741CV Freq. comp 709 (Mini DIP)	.44
748C Freq. adl. 741C (A)	.44
754 Gain Block	1.75
739-739 Dual stereo preamp	1.98
741-741 Dual 741C (TO-5)	.89
PA265 5-Watt voltage regulator	1.00
CA3065 Video Audio system	1.00
RC4195 Dual 15V Tracking V.R.	2.50
4136 Quad 741's (DIP)	1.95

(A) TO-5 or DIP Buy any 3 — Take 10%

LOWEST PRICES ON NATIONAL "CALCULATOR CHIPS"

CT5001 12-Digits, 40 Pin	\$6.50	3 for \$18
CT5002 8-Volt version of 5001	8.50	3 for \$24
CT5005 12-Digits, 28-Pin with 3-function memory	9.95	3 for \$27
MM5725 8-Digits, 4-Function LED	4.95	3 for \$12
MM5736 6-Digits, 28-Pin, 9V	4.95	3 for \$12

CALCULATOR CHIPS ON A "DIP"

Similar to Mostek 5001. Outperforms Texas 8-digit TMS1002. A 40-pin DIP. Adds, multiplies, subtracts, and divides. Use with 7-segment readouts, Nixies, and LED's. DATA SHEETS.

WRIST WATCH *3-1/2 digit, 7 segment LIQUID CRYSTAL DISPLAY

See POPULAR ELECTRONICS (Jan. 1974) for building your own electronic digital wristwatch using the Liquid Crystal Display (LCD) as its basic. Easy to see, 3 1/2 digit display, requires less than 1/1000 of power as LED's. Visibility increases with ambient light. Difficult reading of LED's in light. Pulsates SECONIM in center of display. NO NEED OF TRANSISTOR-RESISTOR Interface, as LED's, thus smaller package. Chip contains holder, tiny connecting terminals, and "slide-in-place chrome spring face plate". Size of display in holder: 1-1/16 x 1/16 x 1/4". Operating freq. 32 kHz. 45-microwatts of power. Operates from 1.5V hearing aid cell. Uses the new and latest CMOS micro-circuitry. We include copy of write up from PE magazine.

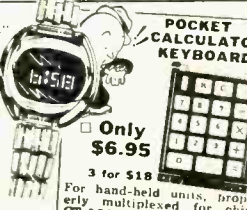

Only \$6.95
3 for \$18

For hand-held units, properly multiplexed for chip 5010-12, 18 leather-touch keys, by FLEX-KEY.

OVER 1,000,000-PC INVENTORY

Buy 3 or more 10% discount

POLY PAKS SMASHES IC PRICES

* Factory Marked		order by type number! Spec sheets on request "ONLY". Buy 100 — Take 20%.	
Type	Sale	Type	Sale
SN7400	\$0.30	SN7471	.55
SN7401	.30	SN7472	.55
SN7402	.30	SN7473	.55
SN7403	.30	SN7474	.55
SN7404	.35	SN7475	1.00
SN7405	.35	SN7476	.65
SN7406	.45	SN7477	.65
SN7407	.55	SN7478	.95
SN7408	.55	SN7479	1.35
SN7410	.30	SN7480	.65
SN7411	.35	SN7481	1.25
SN7412	.35	SN7482	.99
SN7413	.35	SN7483	1.25
SN7414	.35	SN7484	1.25
SN7415	.35	SN7485	.55
SN7416	.55	SN7486	.55
SN7420	.30	SN7487	1.35
SN7421	.35	SN7488	1.35
SN7422	.35	SN7489	3.50
SN7423	.35	SN7490	1.45
SN7424	.35	SN7491	1.35
SN7425	.50	SN7492	1.35
SN7426	.50	SN7493	1.35
SN7430	.30	SN7494	1.35
		SN7495	1.35
		SN7496	1.35
		SN7497	1.65
		SN7498	1.65
		SN7499	1.65
		SN7500	1.65
		SN7501	1.65
		SN7502	1.65
		SN7503	1.65
		SN7504	1.65
		SN7505	1.65
		SN7506	1.65
		SN7507	1.65
		SN7508	1.65
		SN7509	1.65
		SN7510	1.65
		SN7511	1.65
		SN7512	1.65
		SN7513	1.65
		SN7514	1.65
		SN7515	1.65
		SN7516	1.65
		SN7517	1.65
		SN7518	1.65
		SN7519	1.65
		SN7520	1.65

* "DIP" Packages

7-SEGMENT LED Readouts

(All "LED" TYPES)

Type	Char.	Each	Special
MAN-1	27	\$3.75	3 for \$9.
MAN-3	12	1.49	3 for \$3.
MAN-4	.19	2.50	3 for \$6.

REFLECTIVE BAR TYPES

707*	.33	2.50	3 for \$6.
704*	.33	2.50	3 for \$6.
MAN-3*	.33	2.10	3 for \$5.
SLA-3*	.70	4.95	3 for \$13
SLA-11*	.33†	3.50	3 for \$10
SLA-21*	.33††	3.50	3 for \$10.

* By Litronix. ** By Opcon, equal to MAN-1 or MAN-4 spec. Color - RED. † Green. †† yellow

IC'S FOR EXPERIMENTERS \$1.00

SN7400	20 for \$1.	SN7445	5 for \$1.
SN7404	20 for \$1.	SN7446	5 for \$1.
SN7413	5 for \$1.	SN7447	5 for \$1.
SN7441	5 for \$1.	SN7448	5 for \$1.
SN7442	5 for \$1.	SN7472	10 for \$1.
SN7444	5 for \$1.	SN7473	10 for \$1.

Includes factory-good, rejects & defects, who knows at these prices!

SN7474	10 for \$1.	SN74150	3 for \$1.
SN7475	5 for \$1.	SN74151	5 for \$1.
SN7490	5 for \$1.	SN74181	3 for \$1.
SN74107	10 for \$1.	SN74192	5 for \$1.
SN74121	10 for \$1.	SN74193	5 for \$1.
SN74123	10 for \$1.	SN74199	3 for \$1.

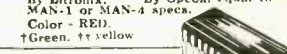

CLOCK CHIPS as Low as ON A "DIP" 8.88

MM5311	6-digit 28-Pin	8.88
MM5312	4-digit 24-Pin	8.88
MM5313	6-digit 28-Pin	8.88
MM5314	6-digit 24-Pin	8.88
MM5316	4-digit 40 Pin, Alarm	13.50

SANKEN HYBRID AUDIO POWER AMPS

Used extensively in hi-fi systems, tape decks, FM tuners, record players, stereo components, musical instruments, P.A., etc. All amplifiers, flat within 1 db from 20 to 100,000. Each unit properly heat-sinked, with heavy-duty connecting tie line connections. Single-ended pushpull output. Power supply required 21VDC. Output to 8 ohms. Order by Stock No.



BRAND NEW LOWEST PRICES

GENERAL ELECTRIC 3-WATT AUDIO AMP \$2.50
3 for \$6.00
Delivers 3 watts continuous, 10 watts peak. With heat sink; micro-mini sized; 8 x 8 x 3 to 30V supply. High sensitivity, 8 to 16 ohms. For mono and stereo phonos, tube, FM, AM, TV, servo.



WITH DATA SHEETS

POLY PAKS "BLUE RIBBON" POLICY
20-Years of Business INTEGRITY
20-Years of Money-Back GUARANTEES
20-Years of Prompt SERVICE
20-Years of Economy! LOWEST PRICES!

Terms: add postage. Rated: net 30.
Phone Orders: Wakefield, Mass. (617) 245-3820
Retail: 16-18 Del Carmine St., Wakefield, Mass. (off Water Street) C.O.D.'S MAY BE PHONED

POLY PAKS P.O. BOX 942 E
Lynnfield, Mass. 01940

15 WATT STEREO AMPLIFIER

12" x
5 1/2" x
1 1/4"



S
S
O
L
I
D
S
T
A
T
E

We have a limited supply of the STEREO AMP—
LIFIER that was part of the OLYMPIC 515
stereo receiver chassis. Needs only a power supply.
STOCK NO. F5195 (with data) \$8.95 2/15.00

EMBOSSED & ENAMELED BRASS CLOCK

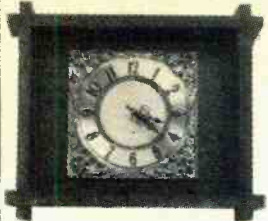

Clock is made up of
movement by a lead-
ing movement maker,
and cabinet of heavy
walnut covered board,
originally designed for
use in a grandfathers
clock. Unit is sold as
a kit, and is easily as-
sembled without tools
in 10 minutes. Heavy
brass face plate. Wt.
8 lbs. 16" x 13"

STOCK NO. F5189 11.95 ea. 2/22.00

KLH Mod. 40 tape deck manual, 88 pages.
STOCK NO. K6000 (post. paid) \$10.00

MINIMUM ORDER \$5.00. Include sufficient
postage; excess refunded. Send for latest 56
page catalog with exciting values.



DELTA ELECTRONICS CO.

BOX 1, LYNN, MASSACHUSETTS 01903

CIRCLE NO. 9 ON READER SERVICE CARD

MUSICAL INSTRUMENTS

30% DISCOUNT name brand musical instruments. Free Catalog.
Freeport Music, 455N, Route 110, Melville, N.Y. 11746.

WHOLESALE! Professional Guitars, PA Systems, Altec Speakers,
240W RMS Amplifiers. Free Catalog, Carvin, Escondido, Calif.
92028.

30% + DISCOUNT. Name Brand Musical Instruments. Free
Catalog. Continental Music, Dept. H, P.O. Box 3001, Garden City,
New York 11530.

BUSINESS OPPORTUNITIES

I MADE \$40,000.00 Year by Mailorder! Helped others make
money! Start with \$15.00—Free Proof. Torrey, Box 318-N,
Ypsilanti, Michigan 48197.

FREE CATALOGS. Repair air conditioning, refrigeration. Tools, sup-
plies, full instructions. Doolin, 2016 Canton, Dallas, Texas 75201.

MAILORDER MILLIONAIRE helps beginners make \$500 weekly.
Free report reveals secret plan! Executive (1K7), 333 North
Michigan, Chicago 60601.

PIANO TUNING LEARNED QUICKLY AT HOME! Tremendous field!
Musical knowledge unnecessary. GI approved. Information free.
Empire School, Box 450327, Miami 33145.

FREE Secret Book "2042 Unique Proven Enterprises." Fabulous
"Little Knowns." Work home! Haylings-BH, Carlsbad, California
92008.

\$200.00 DAILY In Your Mailbox! Your opportunity to do what
mail-order experts do. Free details. Associates, Box 136-1,
Holland, Michigan 49423.

\$49.95 Telephone Answering Machine! Your cost \$33.50! Details:
Palomar, Box 17384EB, Jacksonville, Florida 32216.

TELEPHONE answering machine manufacturer is looking for
dealers. Our high-fidelity unit takes 90 messages. It can even
ask questions from callers! Retail Value \$225. For limited time
anyone can buy one sample at factory cost for only \$78.
Telephonic, 4880 49th Street North, St. Petersburg, Florida
33709.

wanted Citizens Band DEALER-DISTRIBUTORS

SEND THIS AD TO:
PAL ELECTRONICS CO.
P. O. BOX 778 • WESTMINSTER, CA. 92683

EARN \$15,000 annually plus. Full year trial plan Import-Mailorder
business. Postcard brings details: Northeast Imports, Box
121PE7, Fremont, N.H. 03044.

HOMEWORKERS, Earn \$1.60 each mailing envelopes—Rush 25¢.
Gemco, P. O. Box 21244.253, Indpls. 46221.

EMPLOYMENT OPPORTUNITIES

ELECTRONICS/AVIONICS EMPLOYMENT OPPORTUNITIES. Report
on jobs now open. Details FREE. Aviation Employment Informa-
tion Service, Box 240E, Northport, New York 11768.

HELP WANTED part/full time, familiar building Popular Elec-
tronics solid state projects. Phone (212) 651-8900. IMEC,
96-18 43rd Ave., Corona, NY 11368.

TREASURE FINDERS

FAMILY FUN! OUTDOOR ADVENTURE! Find valuable coins and
treasure with world famous metal detectors. Free illustrated
booklet. Detectron, Dept. PE, Box 243, San Gabriel, Calif. 91778.

TIRED OF DIGGING UP TRASH? The all new "Coinshooter" rejects
bottle caps, tin foil, nails and shallow trash. Detects gold, silver,
coins and jewelry. FREE LITERATURE. D-TEX ELECTRONICS,
Box 451-P, Garland, Texas 75040.

AUTHORS' SERVICES

AUTHORS WANTED BY NEW YORK PUBLISHER

Leading book publisher seeks manuscripts of all
types: fiction, non-fiction, poetry, scholarly and
juvenile works, etc. New authors welcomed. For
complete information, send for free booklet P-56.
Vantage Press, 516 W. 34 St., New York 10001

SHORTWAVE LISTENING

SWL's MAGAZINE. Sample 50¢. SWL Guide, 414 Newcastle,
Syracuse, NY 13219.

REAL ESTATE

BIG...FREE...SUMMER CATALOG! Over 2,500 top values in
FARMS, RANCHES, RECREATIONAL LANDS, BUSINESSES, TOWN
and COUNTRY HOMES in 39 states coast to coast! Over 4,100
PHOTOS! UNITED FARM AGENCY, 612-EP, West 47th St., Kansas
City, MO. 64112.

RESORTS AND TRAVEL

BERTH & Partnership in 155 ft. 3-masted Barquentine for
\$10,700. Join in Europe, assist conversion then help sail on
2-year Adventure & Business World Voyage. Write: R. Bruderer,
IYC, Box 149 Broadway, NSW Australia 2007.

Popular Electronics

JULY 1974

ADVERTISERS INDEX

READER SERVICE NO.	ADVERTISER	PAGE NO.	READER SERVICE NO.	ADVERTISER	PAGE NO.
1	Allison Automotive Co	20	18	Lafayette Radio Electronics	96
2	Altaj Electronics	100	19	McIntosh Laboratory, Inc	80
3	B&K Products of Dynascan	19	20	MITS Inc	79
	Bell & Howell Schools	72, 73, 74, 75	21	Midwest Hi-Fi Wholesale & Mail Order Division	95
	CREI Capitol Radio Engineering Institute			Motorola HEP Semiconductors	15
		SECOND COVER, 1, 2, 3		National Radio Institute	10, 11, 12, 13
6	Challenge Electronics	79		National Technical Schools	36, 37, 38, 39
7	Cleveland Institute of Electronics	54, 55, 56, 57	22	Poly Paks	105
8	Continental Specialties Corp.	25	25	Shure Brothers Inc	FOURTH COVER
9	Delta Electronics Co	106	23	Solid State Sales	103
10	Delta Products, Inc	26	24	Southwest Technical Products Corporation	21
11	Digi-Key	102	26	Tracy Design Corporation	101
12	Dixie Hi-Fi Wholesalers	20	27	Tri-Star Corp	98
13	EICO	95	28	Tucker Electronics Company	17
14	Edmund Scientific Co	108		United Audio Products, Inc	7
15	GTE Sylvania	82, 83, 84, 85	29	Utah Electronics	97
16	Grantham School of Engineering	8	30	Wall Lenk Manufacturing Company	98
5	Heath Company	23	31	Wavetek	9
17	Illinois Audio	99			100, 101, 102, 103, 104, 106, 107
	CLASSIFIED ADVERTISING				

SPORTS ACTION FILMS

ORDER FILMS BY MAIL—SAVE TIME AND MONEY! Start with our Indy "500" Special your choice of 1962 thru 1970 each a separate 200' color film, \$14.95 PPD. Save \$1.00 on every print purchased or make your selections from current Columbia, Castle and Sportlite Films catalog, only 25¢ each (coins or stamps, please). SPORTLITE, Elect-7 Dept., Box 500, Speedway, Indiana 46224.

MAGNETS

MAGNETS. All types. Specials-20 disc, or 10 bar, or 2 stick, or 8 assorted magnets, \$1.00 Magnets, Box 192-H, Randallstown, Maryland 21133.

EMPLOYMENT INFORMATION

EXCITING Overseas jobs. Directory \$1.00. Research Associates, Box 1167-E, Kailua, Hawaii 96734.

RECORDS

OLDIES. 45rpm. Free Catalog. Corny's Record Shop, Box 335TJ, Mason, Ohio 45040.

RUBBER STAMPS

RUBBER address stamps. Free catalog. 45 type styles. Jackson's, Box 443G, Franklin Park, Ill. 60131.

BOOKS

FREE catalog aviation/electronic/snace books. Aero Publishers, 329PE Aviation Road, Fallbrook, California 92028.

FREE book prophet Elijah coming before Christ. Wonderful bible evidence. Megiddo Mission, Dept. 64, 481 Thurston Rd., Rochester, N.Y. 14619.

BOOKS—thousands titles, bargains. Catalog Free. Cassiano, 92-27 New York Blvd., Jamaica, New York 11433.

UNUSUAL BOOKS! Catalogue Free! International Imports, Box 7798PE, Atlanta, Georgia 30309.

PLASTICS

CASTOLITE pours like water, hardens like glass without heat. Crystal clear, colors. Embed flowers, seashells, mementos, anything. Make fine gifts. Form flexible molds over any pattern, size. Reproduce your own designs in plastics, candlewax, metal, plaster, cement. Send 10¢ for illustrated literature. **CASTOLITE**, Dept. 74H/PE, Woodstock, Ill. 60098.

HYPNOTISM

SLEEP learning. Hypnotic method. 92% effective. Details free. ASR Foundation, Box 7566EG, Fort Lauderdale, Florida 33304.

FREE Hypnotism. Self-Hypnosis. Sleep Learning Catalog! Drawer H400, Ruidoso, New Mexico 88345.

AMAZING self-hypnosis record releases fantastic mental power. Instant results! Free trial. Write: Forum (AA7), 333 North Michigan, Chicago 60601.

MISCELLANEOUS

WINEMAKERS: Free illustrated catalog yeasts, equipment. Semplex, Box 12276P, Minneapolis, Minn. 55412.

CATALOGS! Receive many! Catalog Directory \$1.00. Box 33098, District Heights, Md. 20028.

LIVE IN THE WORLD OF TOMORROW... TODAY!

A BETTER LIFE STARTS HERE

HE-NE LASERS... \$99.50 UP!

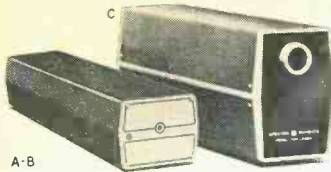

Top quality Spectra Physics lasers feature TEA mode, internal mirror plasma tubes w/ 10,000 hr life, self-starting cold aluminum cathodes, low noise & ripple, guaranteed output, power stability and more for demanding lab work. 18-mo. mfr. wty. 115V AC (A) 0.5mW... 0.88 Beam Dia... 1mrad Diverg. 2.6x8.5x14.8" = 79.073AV \$99.50 Ppd. = 79.073AV \$99.50 Ppd. = \$125.00 Ppd. (B) 1.0mW... (as above) = 79.073AV (C) 4.0mW... 0.8 Beam Dia, 1.1 mRad Diverg. = 79.079AV (3.9x5.5x15.6") \$465.00 Ppd.

NEW! KIRLIAN PHOTOGRAPHY KIT!

Experiment in the fascinating new field of "Kirlian" electrophotography—images obtained on film without camera or lens by direct recording of electric charge transmitted by animate & inanimate objects. Each "aura" differs—animate aura said to change corresponding to physical changes. Kit incl's portable darkroom, double transformer isolated from power source, instrs.



Stock No. 71.938AV \$49.95 Ppd. "HIGH VOLTAGE PHOTOGRAPHY" by H. S. Dakin No. 9129AV (60-PG. PPBK BK.) \$5.00 Ppd.

GET A CHARGE FROM THE SUN!



Our 12V Solar Battery Charger, like those used aboard satellites but redesigned for broad usage, allows direct conversion of light-to-electricity. Compact panel put on a boat can automatically charge its 12V battery over entire daylight period; no power drain at nite. Use it anywhere a trickle charge is needed (trans. radios, etc.). Terrific value, it comprises thirty 1/2V silicon solar cells in series w/ a diode. Cap.: 30 Watts. a wk., approx.

Stock No. 71.971AV \$89.95 Ppd.

(And our FREE CATALOG is packed with exciting and unusual ecological & physical science items—plus 4,500 finds for fun, study or profit... for every member of the family.)

KNOW YOUR ALPHA FROM THETA!

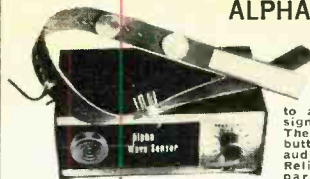

For greater relaxation, concentration, listen to your Alpha-Theta brainwaves. Ultra-sensitive electrode headband slips on/off in seconds—eliminates need for messy creams, etc. Attach'd to amplifier, filters brainwaves, signals beep for ea. Alpha or Theta wave passed. Monitoring button simulates Alpha sound; audio & visual (L.E.D.) feedback. Reliable, easy-to-use unit—comparable to costlier models.

Completely safe. Comprehensive instruction booklet. No. 1635AV (8x3x4"; 24 oz.) \$128.00 Ppd. (LOW COST "STARTER" UNIT) No. 71.809AV \$49.95 Ppd.

3-CHANNEL COLOR ORGAN KIT

Easy to build low-cost kit needs no technical knowledge. Completed unit has 3 bands of audio frequencies to modulate 3 independent strings of colored lamps (i.e. "lows"—reds, "middles"—greens, "highs"—blues. Just connect hi-fi, radio, power lamp etc. & plug ea. lamp string into own channel (max. 300W ea.). Kit features 3 neon indicators, color intensity controls, controlled individ SCR circuits; isolation transformer; custom plastic housing; instr.

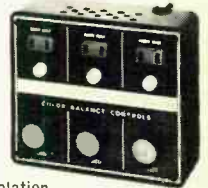

Stock No. 41.831AV \$17.50 Ppd.

"FISH" WITH A GIANT MAGNET

Fascinating fun, and sometimes very profitable! Tie a line to our 3 1/2-pound Magnet—drop it overboard in bay, river, lake or ocean. Troll it along the bottom. Your "treasured" haul can be outboard motors, anchors, other metal valuables. Five-pound Magnet is war surplus—Alnico V Type that cost the Government twice our price. It lifts over 40 pounds on land—much greater weights under water!



Stock No. 70.570AV 3 1/2 lbs. \$11.50 Ppd. Stock No. 60.215AV 1 1/2 lbs. \$ 6.50 Ppd.



MAIL COUPON FOR GIANT FREE CATALOG!

180 PAGES • MORE THAN 4,500 UNUSUAL BARGAINS!

Completely new '74 Catalog. Packed with huge selection of telescopes, microscopes, binoculars, magnets, magnifiers, prisms, photo components, ecology and Unique Lighting items, parts, kits, accessories—many hard-to-get surplus bargains. 100's of charts, illustrations. For hobbyists, experimenters, schools, industry.

EDMUND SCIENTIFIC CO.
300 Edscorp Building, Barrington, N. J. 08007
Please rush Free Giant Catalog "AV"

Name _____
Address _____
City _____ State _____ Zip _____

COMPLETE & MAIL WITH CHECK OR M.O.

EDMUND SCIENTIFIC CO.
300 Edscorp Building, Barrington, N. J. 08007

How Many	Stock No.	Description	Price Each	Total

PLEASE SEND GIANT FREE CATALOG "AV" MERCHANDISE Total

ADD HANDLING CHARGE: \$1.00 ON ORDERS UNDER \$5.00; 50¢ ON ORDERS OVER \$5.00

TOTAL \$ _____

I enclose check
 money order for \$ _____



NAME _____
ADDRESS _____
CITY _____ STATE _____ ZIP _____

CIRCLE NO. 14 ON READER SERVICE CARD

POPULAR ELECTRONICS

Popular Electronics

READER SERVICE

Here's an easy and convenient way for you to get additional information about products advertised or mentioned editorially (if it has a reader service number) in this issue. Just follow the directions below... and the material will be sent to you promptly and free of charge.

1

On the attached postage-free card, print or type your name and address on the lines indicated.

2

Circle the number (s) that corresponds to the key number (s) at the bottom or next to the advertisement or editorial mention that is of interest to you. (Key numbers for advertised products also appear in the Advertisers' Index.)

3

Simply cut out the card and mail. No postage required.

FREE INFORMATION

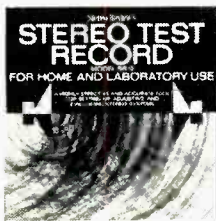

the *NEW STANDARD* in Stereo Testing!

Model SR12 STEREO TEST RECORD

The most complete... most sophisticated... most versatile Test Disc available today.

Whether you're an avid audiophile, a casual listener or a professional technician... the new MODEL SR12 will be the most important disc in your entire collection.

MODEL SR12 has been produced by Stereo Review Magazine for music lovers who want immediate answers to questions about the performance of their stereo systems and how to get the best possible sound reproduction.

It is the most complete test record of its kind - containing the widest range of checks ever included on one test disc.

Make these important stereo checks BY EAR... (no test instruments required)

- ▶ Frequency response—a direct warble-tone check of nineteen sections of the frequency spectrum, from 20 to 20,840 Hz, which will pinpoint any frequency response defects in your system.
 - ▶ Separation—an ingenious test which indicates whether you have adequate separation for good stereo.
 - ▶ Cartridge tracking—the most sophisticated tests ever devised for checking the performance of your cartridge, stylus and tone arm.
 - ▶ Channel balance—two broad-band, random-noise signals which permit you to eliminate any imbalances originating in cartridge, amplifier, speakers or room acoustics.
 - ▶ Hum and rumble—foolproof tests that help you evaluate the actual audible levels of rumble and hum in your system.
 - ▶ Flutter—a sensitive "musical" test to check whether your turntable's flutter is low, moderate, or high.
- PLUS!**
- Cartridge and Speaker Phasing
 - Anti-Skating Adjustment
 - "Gun Shot Test" for Stereo Spread
 - Multi-purpose Musician's "A"
 - Equal-tempered Chromatic Octave
 - Guitar-tuning Tones

Attention Professionals... Model SR12 is also designed to be used as a highly efficient design and measurement tool. Tests below have been controlled to laboratory tolerances—affording accurate numerical evaluation when used with oscilloscope, chart recorder, output meter, intermodulation-distortion meter and flutter meter.

- 1,000-Hz square waves to test transient and high-frequency response of phono pickups.
- 500 to 20,000 Hz frequency-response sweep.
- Sine-wave tone-bursts to test transient response of pickup.
- Intermodulation test using simultaneous 400-Hz and 4,000-Hz signals.
- Intermodulation sweep to show distortion caused by excessive resonances in tone arm and cartridge.
- 1,000-Hz reference tones to determine groove velocity.
- 3,000-Hz tone for flutter and speed tests.

Sample waveforms—illustrating both accurate and faulty responses are provided in the Instruction Manual for comparison with the patterns appearing on your own oscilloscope screen.

FREE Instruction Manual Includes Detailed Instructions, Charts, Tables and Diagrams

CASH: Mail your order along with your name, address and remittance in the amount of \$5.98, postpaid.

CHARGE: Your American Express or Bank Americard account! Mail your order, name, address and credit card number. You will be billed at \$5.98, postpaid.

MAIL ALL ORDERS TO: RECORDS, ZIFF-DAVIS SERVICE DIVISION, 595 BROADWAY, NEW YORK, N.Y. 10012
OUTSIDE U.S.A. RECORDS ARE \$8.00, POSTPAID.



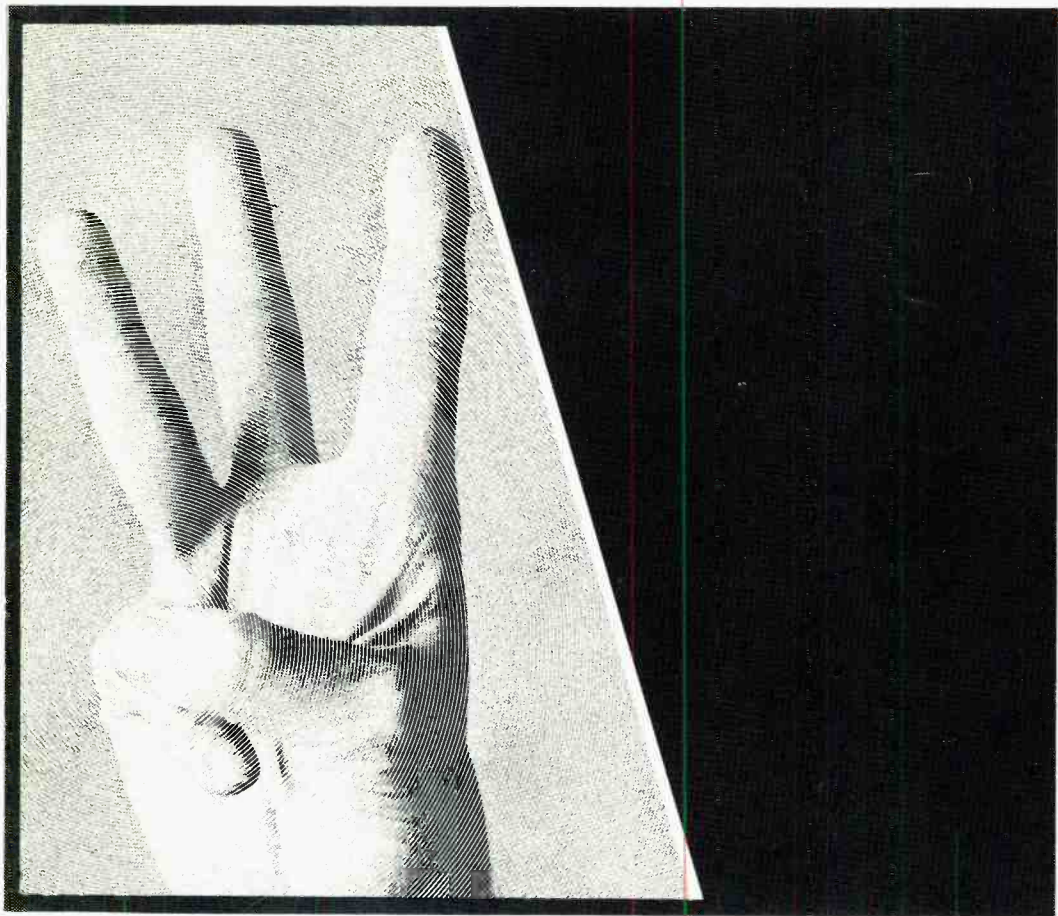

Best. Best. Best.

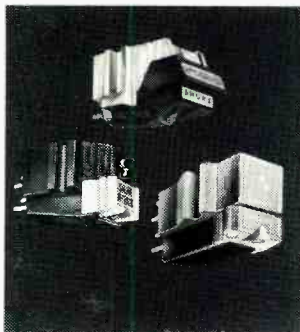

Permit us this momentary bit of self-indulgence, because our intentions are pure: to assist you in choosing the best phono cartridge for your hi-fi system, within the practical limitations of your audio budget. To begin, if you feel uncomfortable with anything less than state-of-the-art playback perfection, we heartily recommend the Shure V-15 Type III, a cartridge of such flawless performance it is the perfect companion to the finest turntables and tone arms available today — and those coming tomorrow. At a more moderate level of performance and price, we suggest the Shure M91ED, a superb performer second in trackability only to the Type III. Finally, for optimum performance under a budget austerity program, the yeoman Shure M44E is for you. All in all, these are three great ways to enjoy music with the kind of system you have decided is best for you.

Shure Brothers Inc.
222 Hartrey Ave., Evanston, Ill. 60204
In Canada: A. C. Simmonds & Sons Ltd.



CIRCLE NO. 25 ON READER SERVICE CARD