

**BUYING GUIDE TO SCANNING MONITORS**

# Popular Electronics

FEBRUARY 1974/FIFTY CENTS

## 4 UNIQUE CONSTRUCTION PROJECTS

- Poisoned-Air Detector
- The Torture Box (MINIATURE TEST CHAMBER)
- High-Speed, Adjustable Electronic Fuse
- Single-IC Capacitance Meter

## TEST REPORTS

- Lafayette LR-221 Full-Logic SQ AM/FM Receiver
- B&O 3000 Single-Play Automatic Turntable
- Courier Spartan SSB CB Transceiver
- Ballantine 3/24 Digital Multimeter
- Heath 3- or 4-Channel R/C

## RADIO CONTROL FOR HOBBYISTS



18101

Retailers: Notice of display-allowance plan is within last page

# Discover the ease and excitement of learning Electronics with programmed equipment NRI Sends you

When you train at home with NRI, you train with your hands as well as your head. You learn the WHY of Electronics, Communications, TV-Radio the NRI pioneering "3-Dimensional" way. NRI training is the result of more than half a century of simplifying, organizing, dramatizing subject matter, and providing personal services unique for a home study school. You get the kind of technical training that gives you priceless confidence as you gain experience equal to many, many months of training on the job.



*NRI—The Leader in Electronics Training for more than Fifty Years*

## APPROVED UNDER NEW GI BILL

If you served since January 31, 1955, or are in service, check GI line in postage-free card.



*Earn \$5 to \$7 an hour  
spare or full time in*

## **TV-RADIO SERVICING**

Color television sales are soaring. And so is the demand for trained repairmen. If you can service TV sets, portable radios, tape recorders, hi-fi sets, phonographs and auto radios, you'll always be in demand. It's one of your best routes to spare-time earnings, a good paying job or a business of your own. NRI trains you quickly and expertly, showing you how to get started in servicing soon after you enroll, earning as you learn. NRI trains you in today's method of installing and repairing all electronic equipment for the home—including solid state Color TV. You even build, experiment with and keep to enjoy your own solid-state radio plus your choice of black-and-white or the new 25" diagonal solid state Color TV receiver NRI developed from the chassis up for training. Like thousands of others, you can soon be earning good money in your spare time... the easy NRI way.

*There's money and  
success awaiting you in*

## **COMMUNICATIONS MOBILE RADIO & BROADCASTING**

NRI training in Complete Communications equals as much as two years of training on the job. With NRI, you can train for a choice of careers ranging from mobile, marine and aviation radio to TV broadcasting and space communications. You learn how to install, maintain and operate today's remarkable transmitting and receiving equipment by actually *doing* it. You build and experiment with test equipment, like a TVOM you keep. You build and operate amplifier circuits, transmission line and antenna systems, even build and use a phone-cw transmitter suitable for transmission on the 80-meter amateur band. Whichever of these five intensely practical NRI Communications courses you choose, you prepare for your FCC License exams, and *you must pass your FCC exams or NRI refunds your tuition in full.*

*Move ahead in America's  
fast growing industry as*

## **COMPUTER TECHNICIAN**

Ours is rapidly becoming the age of the computer... and NRI can train you to cash in on the opportunities in this field. Only NRI trains you at home on a real computer—not a simple logic trainer, but a complete, stored program digital computer using over 50 integrated circuits. As you build the NRI Computer, you explore all fundamental logic circuits, then how to combine them in a complete, stored program computer. You observe the "heart" of a real computer. You solve typical problems and learn how to locate faults with diagnostic programs. Bite-size texts make studying easier. Prove to yourself what nearly a million NRI students could tell you—that you get more for your money from NRI. Check the card and mail it today for your free NRI Color Catalog. **NO SALESMAN WILL CALL.** NRI Training, 3939 Wisconsin Ave., Washington, D.C. 20016.

# **YOU GET MORE FOR YOUR MONEY FROM NRI**



## **NRI Kits and Equipment**

Dollar for dollar, you get more value from NRI training kits, because they are designed as educational tools. In the TV-Radio Servicing Course, for instance, the end product is a superb 25" diagonal color TV your whole family will enjoy. The set is designed so that, while building it, you can introduce and correct defects... for trouble-shooting and hands-on experience in circuitry and servicing. The kits include, at no additional cost, a wide-band service type oscilloscope and color cross-hatch generator, and other valuable equipment that will let you start earning money in your spare time making repairs... even before the course is completed.

# Popular Electronics

WORLD'S LARGEST-SELLING ELECTRONICS MAGAZINE

## FEATURE ARTICLES

- 29 HOW TO GET STARTED IN RADIO CONTROL MODELING** *Fred Marks*
- 46 VHF/UHF SCANNING MONITORS** *Herb Friedman*  
*A comprehensive buying guide.*
- 52 LIGHT BEAM COMMUNICATIONS** *Forrest M. Mims*  
*New developments in a rapidly growing field.*
- 70 DESIGN YOUR OWN BASS-REFLEX HI-FI SPEAKER SYSTEMS**  
*Part 2. Construction details.* *David B. Weems*
- 89 SERVICING WITHOUT SERVICE DATA** *John T. Frye*  
*How to check out an unfamiliar piece of gear.*
- 92 THE SHORTWAVE BROADCAST BANDS—  
AND WHAT TO FIND ON THEM** *Richard E. Wood*
- 98 PITCH GENERATORS FOR ELECTRONIC MUSIC** *Don Lancaster*  
*Part 1. Separate voicing and vco with sample-hold.*

## CONSTRUCTION STORIES

- 34 BUILD THE TORTURE BOX** *Ralph Tenny*  
*Miniature environmental test chamber.*
- 44 SINGLE-IC CAPACITANCE METER** *Harry Garland and Roger Melen*
- 55 POISONED AIR DETECTOR** *Herb Cohen*  
*New semiconductor senses dangerous levels.*
- 62 HOW THE 741 OP AMP BECOMES SUPER-OP** *J. R. Laughlin*  
*An ultra-versatile bench instrument.*
- 67 FAST-ACTING RESETTABLE ELECTRONIC FUSE** *William A. Russo*

### ZIFF-DAVIS PUBLISHING COMPANY

Popular Electronics  
Editorial and Executive Offices  
One Park Avenue, New York, New York 10016  
212 679-7200

William Ziff, President  
W. Bradford Briggs, Executive Vice President  
Hershel B. Sarbin, Senior Vice President, Secretary, and Treasurer  
Philip Sine, Senior Vice President  
Phillip T. Heffernan, Vice President, Marketing  
Frank Pomerantz, Vice President, Creative Services  
Arthur W. Butzow, Vice President, Production  
Edward D. Muhlfeld, Vice President, Aviation Division  
Irwin Robinson, Vice President, Travel Division  
George Morrissey, Vice President  
Sydney H. Rogers, Vice President  
Sidney Holtz, Vice President  
Lawrence Sporn, Vice President, Circulation

POPULAR ELECTRONICS, February 1974, Volume 5, Number 2. Published monthly at One Park Ave., New York, NY 10016. One year subscription rate for U.S., U.S. Possessions and Canada, \$6.00; all other countries, \$7.00. Second class postage paid at New York, N.Y. and at additional mailing offices. Authorized as second class mail by the Post Office Department, Ottawa, Canada and for payment of postage in cash. Subscription service and Forms 3579: P.O. Box 2774, Boulder, CO 80302. Editorial offices for manuscript contributions, reader inquiries, etc.: One Park Ave., New York, NY 10016.

POPULAR ELECTRONICS Including ELECTRONICS WORLD, Trade Mark Registered. Indexed in the Reader's Guide to Periodical Literature.

Copyright © 1974 by ZIFF-DAVIS PUBLISHING COMPANY. All rights reserved.

**EDGAR W. HOPPER**  
*Publisher*  
**ARTHUR P. SALSBERG**  
*Editorial Director*  
**MILTON S. SNITZER**  
*Editor*  
**LESLIE SOLOMON**  
*Technical Editor*  
**JOHN R. RIGGS**  
*Managing Editor*  
**EDWARD I. BUXBAUM**  
*Art Director*

**ALEXANDER W. BURAWA**  
*Associate Editor*  
**ANDRE DUZANT**  
*Technical Illustrator*  
**ELLEN S. FINKELSTEIN**  
*Editorial Assistant*  
**LEN BUCKWALTER**  
**JOHN T. FRYE**  
**LOU GARNER**  
**RALPH HODGES**  
**WALTER G. JUNG**  
*Contributing Editors*

**JOSEPH E. HALLORAN**  
*Advertising Director*  
**JOHN J. CORTON**  
*Advertising Sales*  
**MADELEINE LITTMAN**  
*Advertising Service Manager*  
**PEGI McENEANEY**  
*Executive Assistant*  
**STANLEY NEUFELD**  
*Associate Publisher*  
**FURMAN H. HEBB**  
*Group VP, Electronics & Photo*

## THE SCENES

- 10 STEREO SCENE** *Ralph Hodges*
- 26 HOBBY SCENE**
- 102 SOLID-STATE** *Lou Garner*
- 106 TEST EQUIPMENT SCENE** *Les Solomon*
- 109 CB SCENE** *Len Buckwalter*

## PRODUCT TEST REPORTS

- 80 LAFAYETTE MODEL LR-221 4-CHANNEL RECEIVER**
- 82 BANG & OLUFSEN MODEL 3000 TURNTABLE/TONEARM**
- 84 COURIER SPARTAN SSB CB TRANSCEIVER**
- 86 BALLANTINE MODEL 3/24 DIGITAL MULTIMETER**
- 87 BRANSON MODEL B-220 ULTRASONIC CLEANER**

## DEPARTMENTS

- 6 EDITORIAL** *Milton S. Snitzer*  
*Looking Over the Issue*
- 8 LETTERS**
- 16 NEWS HIGHLIGHTS**
- 116 NEW LITERATURE**
- 118 NEW PRODUCTS**

## COMING NEXT MONTH

*Build the LED Infrared Light-Beam Communicator*  
*Using Audio Sweep Generator for Testing*  
*A Guide to CMOS Operation*  
*Are Your Speakers in Phase?*

Midwestern Office  
The Pattis Group, 4761 West Touhy Ave.,  
Lincolnwood, Illinois 60644, 312 679-1100  
GERALD E. WOLFE, GEORGE B. MANNION

Western Office  
9025 Wilshire Boulevard, Beverly Hills, California 90211  
213 273-8050; BRadshaw 2-1161  
Western Advertising Manager, BUD DEAN

Japan: James Yagi  
Oji Palace Aoyama; 6-25, Minami Aoyama  
6 Chome, Minato-Ku, Tokyo 407-1930/6821

Ziff-Davis also publishes Boating, Car and Driver, Cycle, Flying, Modern Bride, Popular Photography, Skiing, and Stereo Review.

Forms 3579 and all subscription correspondence should be addressed to POPULAR ELECTRONICS, Circulation Department, P.O. Box 2774, Boulder, CO 80302, Please allow at least eight weeks for change of address. Include your old address, as well as new—enclosing, if possible, an address label from a recent issue.

Editorial contributions must be accompanied by return postage and will be handled with reasonable care; however, publisher assumes no responsibility for return or safety of art work, photographs, models, or manuscripts.

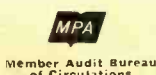



# Editorial

By Milton S. Snitzer, Editor

## LOOKING OVER THE ISSUE

Putting together an issue of POPULAR ELECTRONICS is not just a matter of pounding typewriters and yelling for the "copy boy" to rush things to the printer. We always find something of personal or professional interest in each article; and sometimes we go all out on a project, generating so much enthusiasm that editors of our sister publications come around to see what's going on.

That's what happened this month in preparing our cover story—as we assembled and tested the model car and radio control system. There was a lot of excitement around the office and we discovered what a really fascinating hobby it is—and easy to get into. An article in a future issue will dig into the innards of radio control circuits, detailing the various techniques that are used by the hobbyist.

Another article of special interest this month is the story on light beam communications, which lays the groundwork for a subsequent construction article on the first light beam communicator project we've seen that uses a single infrared light-emitting diode as both source and detector. This area of communications is close to our hearts, and we have been in the forefront of publishing articles on it for many years. In 1970, for example, we described a build-it-yourself helium-neon laser voice communications system that was later exhibited at the Smithsonian Institution. We'll have a more refined one to present soon. Watch for it!

Then there's our story on vhf/uhf scanning monitors, a roundup discussion of this exciting hobby. Monitoring the vhf and uhf Public Safety bands is a recent outgrowth of the hobby of shortwave listening. On these bands, you can hear your local police, fire, business radio, tow trucks, taxi operations, computer repair services, newspaper reporters, and continuous weather broadcasts. Since most of these transmissions are intermittent, scanning monitor receivers (which automatically tune from one channel to another, stopping on an active channel) have grown in popularity. The article includes a directory covering more than 70 different models from 15 manufacturers.

And, of course, we have a group of truly unique construction projects—an ultra-sensitive gas/smoke detector with meter readout, a home experimenter's miniature environmental test chamber, a fast-acting resettable electronic fuse, and a single-IC direct-reading capacitance meter, among others.

All-in-all, it adds up to an issue we think you will find interesting to read—stimulating both thought and action.

# Another introductory offer to new members of the ELECTRONICS AND CONTROL ENGINEERS' BOOK CLUB

	<p>404/445 <b>ELECTRONIC CIRCUITS MANUAL</b> by J. Markus Pub. price, \$22.00 Club price, \$15.75</p>		<p>286/515 <b>INTEGRATED CIRCUITS: A Basic Course for Engineers and Technicians</b> by R. G. Hibberd Pub. price, \$10.25 Club price, \$8.45</p>	<div style="text-align: center;"> <h2>ANY ONE</h2> <p>of these great professional books</p> <h1>for only \$1.00</h1> <p>VALUES FROM \$9.95 to \$34.75</p> <p><b>Special \$1.00 bonus book comes to you with your first club selection</b></p> </div>			
	<p>637/458 <b>DESIGNING WITH TTL INTEGRATED CIRCUITS</b> by Texas Instruments Inc. Pub. price, \$19.50 Club price, \$13.50</p>		<p>100/810 <b>MOS/LSI DESIGN AND APPLICATION</b> by Carr &amp; Mize Pub. price, \$18.50 Club price, \$13.50</p>				
	<p>404/437 <b>SOURCEBOOK OF ELECTRONIC CIRCUITS</b> by J. Markus Pub. price, \$21.50 Club price, \$17.50</p>		<p>313/059 <b>HANDBOOK OF SEMI-CONDUCTOR ELECTRONICS, 3/e</b> by P. Hunter Pub. price, \$29.85 Club price, \$21.50</p>				
	<p>484/368 <b>COMMUNICATION SYSTEMS DESIGN</b> by P. F. Panter Pub. price, \$19.50 Club price, \$13.50</p>		<p>287/341 <b>STANDARD HANDBOOK OF ENGINEERING CALCULATIONS</b> by T. G. Hicks Pub. price, \$19.50 Club price, \$14.25</p>				
	<p>491/364 <b>THE DESIGN OF DIGITAL SYSTEMS</b> by J. B. Peatman Pub. price, \$15.50 Club price, \$11.75</p>		<p>124/035 <b>HANDBOOK OF PHYSICS, 2/e</b> by Condon and Odishaw Pub. price, \$37.45 Club price, \$14.95</p>		<p>773/777 <b>NOMOGRAPHS FOR ELECTRONICS</b> by R. L. Peters Pub. price, \$27.50 Club price, \$19.95</p>		<p>649/170 <b>OPERATIONAL AMPLIFIERS</b> by Tobey, Graeme &amp; Huelsman Pub. price, \$15.00 Club price, \$11.50</p>
					<p>353/387 <b>MINICOMPUTERS FOR ENGINEERS &amp; SCIENTISTS</b> by Korn &amp; Korn Pub. price, \$17.75 Club price, \$10.50</p>		<p>209/731 <b>STANDARD HANDBOOK FOR ELECTRICAL ENGINEERS, 10/e</b> by Fink and Carroll Pub. price, \$34.85 Club price, \$24.95</p>

Save time and money by joining the  
Electronics and Control Engineers' Book Club



MAIL THIS COUPON TODAY

ELECTRONICS AND CONTROL ENGINEERS' BOOK CLUB  
582 Princeton Road, Hightstown, N.J. 08520

Please enroll me as a member of the Electronics and Control Engineers' Book Club and send me the two books indicated below. I am to receive the bonus for just \$1.00, and my first selection at the special Club price shown. These books are to be shipped on approval, and I may return them both without cost or further obligation. If I decide to keep the books, I agree to purchase as few as four books during the next two years at special Club prices (at least 15% below list).

Write Code No. of  
bonus book  
here

Write Code No. of  
first selection  
here



Name \_\_\_\_\_

Address \_\_\_\_\_

City \_\_\_\_\_

State \_\_\_\_\_ Zip \_\_\_\_\_

E33237

HERE is a professional club designed specifically to meet your day-to-day engineering needs by providing practical books in your field on a regular basis at below publisher prices.

How the Club operates: Basic to the Club's service is its publication, the *Electronics and Control Engineers' Book Club Bulletin*, which brings you news of books in your field. Sent to members without cost, it announces and describes in detail the Club's featured book of the month as well as alternate selections which are available at special members' prices.

When you want to examine the Club's feature of the month, you do nothing. The book will be mailed to you as a regular part of your Club service. If you prefer one of the alternate selections—or if you want no book at all for that month—you notify the Club by returning the convenient card enclosed with each *Bulletin*.

As a Club member, you agree only to the purchase of four books over a two-year period. Considering the many books published annually in your field, there will surely be at least four that you would want to own anyway. By joining the Club, you save both money and the trouble of searching for the best books.

CIRCLE NO. 14 ON READER SERVICE CARD

# FAR OUT

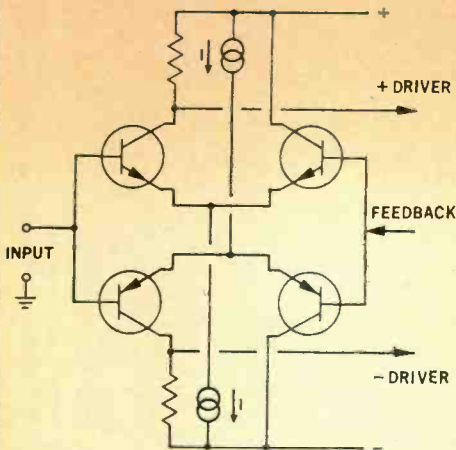

Yes the circuits used in our power amplifiers and preamp kits are rather unique and unusual. They probably are as good, or better than anything else available too. We don't however charge you a large premium for the engineering that has gone into these outstanding products. Get a copy of our new catalog and compare prices and specifications.

Where else are you going to buy a 60 watt amplifier kit that has less than 0.01% IM distortion all the way up to full rated RMS output for \$75.00? In addition to the unmatched performance you get bronze anodized chassis and cover and even an output level meter on the front panel—like we said "far out".

GET OUR  
**NEW 1974  
CATALOG**

listing this and other unique kits

**FREE**

by simply circling our number  
on the reader service card.



**SOUTHWEST TECHNICAL  
PRODUCTS CORPORATION**

DEPT. PE

219 W. Rhapsody, San Antonio, Texas 78216

**CIRCLE NO. 29 ON READER SERVICE CARD**

# Letters

## ELECTRONIC MUSIC MANUFACTURERS

Your October issue, on page 36, lists the manufacturers of electronic music equipment. The third company listed was CBS Laboratories, 1300 East Valencia, Fullerton, Calif. 92631.

We wish to advise that our company purchased the complete inventory of the CBS system, both as to parts and completed units, approximately one year ago. We are now the sole distributor of these synthesizers and synthesizer parts.

GREGORY KRAMER, Pres.  
Electron Farm  
2 Ketch St. Suite 201  
Marina Del Rey, CA 90291

I wish to add to your list of electronic music manufacturers the name of Chalice Organ Co. which has been producing kit organs and synthesizers since 1970.

Chalice manufactures a large line of very sophisticated organs and synthesizers which use the latest digital multiplexing techniques, along with digital wave shaping. We make instruments which use either full digital tone generation, independent oscillators for tone generation, or frequency division for tone generation.

PAUL J. ISHAM, Pres.  
Chalice Organ Co.  
P.O. Box 209  
Santee, CA 92071

## FAIL-SAFE DIGITAL CLOCK

The phase detector circuit shown in my article "Make Your Digital Clock 'Fail-Safe'" (December 1973 issue) is in error. The correct configuration for the circuit shown in Fig. 4

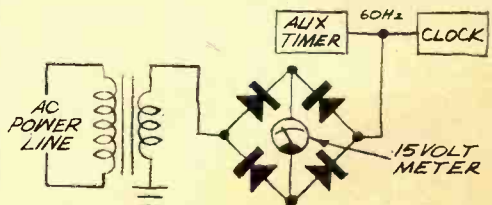

is shown in the drawing. Sorry, I should have caught the error during proofreading.

CALVIN DILLER  
Bluffton, Ohio

POPULAR ELECTRONICS



## SCOPES VS PROBES

I must take exception to Leslie Solomon's statement in the November "Test Equipment Scene" to the effect that a scope is not as reliable as a logic probe. This may be true for inexpensive scopes used by hobbyists and experimenters, but professionals in the field of digital logic realize that a logic probe falls far short of a good quality oscilloscope.

Some logic probes cannot distinguish between an open input to a gate and a high level on that gate. It is virtually impossible with a logic probe to determine whether you have a high dc level or a pulse with a high rep rate. A logic probe will also not reveal illegal OR-tied gates which are usually visible on a scope.

I'm not knocking probes; they have their place. But to say that they are better than a scope is stretching things a little.

GARTH FISHER  
Grand Terrace, Calif.

*It is true that there are times when a probe is not the best instrument to use. However, Les's discussion was aimed at the hobbyists and experimenters who do not have lab-grade scopes. He was trying to show that, in this case, a logic probe has discrete 1 and 0 switching levels while a scope just displays signals.*

## FOUR-WAY FLASHER ADDITION

I was quite interested in your brief item on a "Four-Way Flasher" in your December 1973 issue. Here's an additional item of safety.

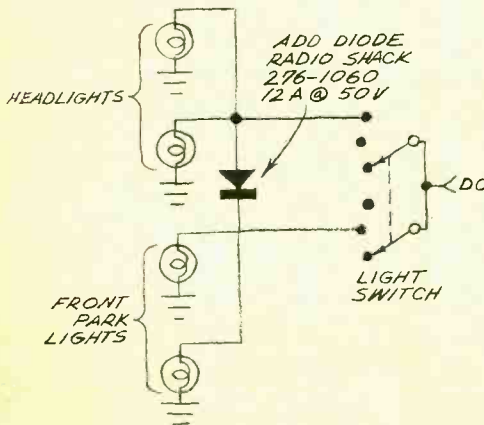

On older cars whenever the headlights are turned on, the front parking lights are turned off. If one headlight goes out, one side of the front of the car will be unlighted. By adding one more diode as suggested on the schematic, the parking lights will be turned on whenever the light switch is on. The operation of the headlights will remain unchanged.

ROBERT SERGENT  
St. Charles, Mo.

# PUT PROFESSIONAL RECOGNITION IN YOUR CAREER... YES, YOU CAN BE AN ELECTRONICS ENGINEER



## GRANTHAM

**OFFERS YOU THE OPPORTUNITY TO EARN YOUR DEGREE IN THIS FAST-GROWING FIELD AT HOME!**

Add a degree to your technician level experience and enjoy professional prestige, recognition, confidence, and greater career opportunities. By 1976, it is predicted there will be more engineering jobs available than graduates to fill them. Get started now.

### COLLEGE LEVEL ALL THE WAY

Only Grantham School of Engineering offers you the specialized college level education and college level projects needed to earn your degree at home. We teach electronics, computer science, circuit design, plus other related subjects at the college level. Your training is fast moving, easy to understand, and you learn in your spare time.

### EARN YOUR DEGREE AT HOME

Grantham School is authorized to award degrees through home study. Yes, you can earn your A.S.E.T. degree at home. AND, then you may continue with other Grantham home study programs to earn your B.S.E.T. and your B.S.E.E. degrees.

### PUT A BIG FUTURE IN YOUR CAREER PLANS

Your knowledge can knock out roadblocks in your career. It lets you take full advantage of opportunities to move ahead. You enjoy the rewards of being a professional. And you don't need to give up your present job or income to do it through Grantham home study programs.

### FREE CAREER BULLETIN

We have prepared vital information on how you can earn your electronics degree at home. Mail coupon for your free copy. No obligation.



### MAIL COUPON TODAY!

**GRANTHAM SCHOOL OF ENGINEERING**  
ELECTRONICS DEGREES BY HOME STUDY  
2000 Stoner Avenue Dept. PE 2-74  
Los Angeles, CA 90025

Please rush free Career Bulletin giving full details of your Electronics Degrees Programs.

Name \_\_\_\_\_ Age \_\_\_\_\_

Address \_\_\_\_\_

City \_\_\_\_\_

State \_\_\_\_\_ Zip \_\_\_\_\_

I have been in electronics for \_\_\_\_\_ years.

CHECK HERE FOR G.I. BILL INFORMATION

**CIRCLE NO. 17 ON READER SERVICE CARD**



# Stereo Scene

By Ralph Hodges

**T**HE cassette is finally overcoming its tendency to wow, flutter, and (occasionally) snarl itself up in the innards of even the better cassette-deck mechanisms. It's about time. Of the remaining performance problems that face it, I can see only one looming large enough to be of serious concern: distortion caused by tape overload. Many recordists—particularly those who tape live music—are finding that working with cassettes can be a game of blindman's buff with high-frequency distortion that makes easy losers of the unwary. The game is blind because the recording-level meters, your hedge against distortion-producing levels, are not always to be trusted; dB numbers that are "safe" in one situation can lead you astray in another.

While tape overload (magnetic saturation) is the bane of tape recording in all its forms, it is nowhere so prevalent as with the cassette. All the parameters of the cassette medium—thin tape, narrow recorded tracks, very slow tape speed—add up to very little magnetic-oxide material per inch of tape, and very little material per unit of time. To skimp on oxide is to invite magnetic saturation, and this is likely to occur most often at high frequencies, because of the treble boost the recording circuits apply to offset inevitable high-frequency losses and to fight the hiss that is rampant with cassettes. The

combination record-playback head of most cassette decks is an additional complication. A head that is ideal for playback is itself prone to overload when recording high-level signals.

**Meters That Lie.** Assuming you agree to put up with the cassette's limitations, why can't you at least have recording-level meters that do their job (let you know when you're exceeding the capabilities of the medium)? Apparently, the answer is that the development of suitable cassette recording-level indicators has lagged behind the progress made by the rest of the technology. Too many of the meters have response characteristics approximating those of VU devices, and while this may sound admirably rigorous and "professional," this type of meter is not really appropriate for cassette recording.

True VU meters conform to a well-defined standard of ballistic damping. As a result, they respond to the recording signal in a kind of lagging, lingering manner. This is good, because it makes the meters readable. An undamped meter, responding to every brief spike of the musical waveform, would wiggle, shudder, and overshoot its way across the dial in a blur of movement. However, it's also bad because a VU meter is incapable of registering momentary peaks that might be just long and strong enough to cause audible trouble. This is very much a matter of degree.

At one time the VU meter was admired for its tendency to stolidly ignore a little bit of "blasting," since the ear is tolerant of very short bursts of distortion, and to distract the recording engineer with split-second overloads that no one would ever hear seemed self-defeating. But mind you, these rules applied only to the finest recording equipment of that time. And even so, a good deal of practical experience was

## Cassette Recording Levels

# In Quest of Perfection...

Neil Diamond is an artist who creates scenes with music. So when he decided that state-of-the-art sound systems be used during press premières to reproduce his original music score for the film *JONATHAN LIVINGSTON SEAGULL*,\* realism in terms of spectral balance, spatial character, and lifelike sound-power levels were mandatory requirements.

To reproduce the music he created, Neil Diamond personally selected BOSE 901 Speakers, commenting: "After auditioning what were reputed to be the best high fidelity speakers on the market today, I chose BOSE 901 Speakers because they offer the ultimate in theatre music reproduction." This will come as no surprise to thousands of BOSE 901 owners around the world who believe they have the ultimate in music reproduction in the home.

In our continued quest of audible perfection, we have introduced the new BOSE 901 SERIES II Speakers -- a product of over 15 years of research in musical acoustics.† We invite you to compare the 901s with any speaker on the market today, regardless of size or price. And judge for yourself if you agree with Neil Diamond's selection and with the rave reviews of the music and equipment critics.

For information on the 901 SERIES II, complimentary copies of the reviews, and a report on the theatre sound system competition, circle your reader service card or write Dept. K1

\*Original motion picture soundtrack recording available on Columbia records and tapes.

†This research is presented in the article "Sound Recording and Reproduction" published in *TECHNOLOGY REVIEW* (MIT), Vol. 75, No. 7, June '73. Reprints are available from BOSE for fifty cents a copy.



**BOSE**

The Mountain, Framingham, Mass. 01701

necessary to interpret a VU's readings accurately and safely in every situation.

With cassettes, and particularly in live recording situations, a VU meter is definitely not the level indicator of preference. The cassette has a hair-trigger readiness to overload not shared by studio recording equipment. Signal peaks of very short duration must be taken into account; they can produce very audible distortion. And large peaks come along frequently in live recording.

When you dub a disc, FM broadcast, or any kind of second-hand program source onto a cassette, you are dealing with material that has been "pre-limited"—all the severe peaks have been chopped off (not audibly, one hopes). This stands to reason when you consider that a full-scale live performance may have a dynamic range well exceeding 80 dB, whereas a disc or tape recording with a 60-dB dynamic range is really pushing the state of the art.

Most cassette decks have been designed with copying chores in mind; and in this application, brief meter excursions up to 0 dB and a little above usually create no problem. But the live cassette recordist quickly finds that, to keep the meter needle from going berserk on fortissimos, he must choose levels that have it resting on its bottom peg, barely moving, for distressingly long periods. And even if he doesn't succumb to the temptation to inch the level controls up gradually (sheer disaster when a climax takes him by surprise), he may still not be entirely safe if the meters aren't fast enough.

**Meters That Level with you.** Of late the recording industry has been taking peak levels very seriously, and many of the newer consoles and mixing desks are festooned with light displays that register and hold peaks, and even "remember," for later reference, the maximum levels achieved during a recording session. Some of these devices have already begun filtering down to the consumer sphere, where they exist—in a simpler, modified form—in a few recently introduced cassette decks. Among these devices are:

**Peak-Reading Indicator Lights.** These are warning flashers that supplement the meters (usually more-or-less conventional VU-type level indicators) by flickering on in the presence of sharp, potentially troublesome transients that the meters are too slow to

register. Logically enough, LED's (light-emitting diodes), with their virtually instantaneous response, are becoming rather popular in this application. The levels that trigger these indicators, and the time constants they follow, are discretionary with the manufacturer, who has presumably taken the trouble to find out what types of signal are likeliest to cause audible distortion with his machine.

**Peak-reading meters.** As noted earlier, an unaided meter fast enough to respond accurately to brief musical transients would have to be so underdamped that it would whip all over the dial in an undecipherable fandango. But if a conventional meter is driven by its own little amplifier, the time constants of the meter's response to the recording signal can be controlled electrically for whatever result is desired. The combination of a meter and a driving amplifier with a fast attack time and slow release time (the electronics hold onto the transient somewhat longer than it actually lasts) produces a reasonably valid peak-reading indicator. (Fig. 1.) One manufacturer's device

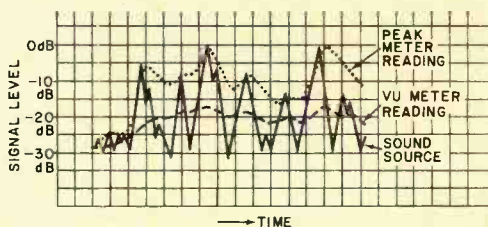

Fig. 1. Response of two meters to dynamic profile of typical music signal (solid line). The VU meter (dashed line) roughly indicates average level. Because of fast attack and slow release, the peak-reading meter (dotted line) follows contour of the peak levels.

of this type gets to within 2 dB of actual value for a signal lasting only 50 milliseconds. (Compare this with a VU meter's attack time, which is somewhere around 2 to 4 tenths of a second.) Another manufacturer advertises an attack time of 20 microseconds (and release time of 70 milliseconds) for his meters' amplifiers.

Because of their slow release times, peak-reading meters tend to display a somewhat compressed picture of the actual signal dynamics. This tends to make them fairly readable. At the same time, since they ride along the peaks of the musical waveform, ample indication of excessive levels is given.

**Equalized meters.** A conventional record-

# THERE'S A BETTER WAY TO GO.



Energy shortages tell us we have to change our driving style. Now! It doesn't mean we have to go back to horse and buggy days. But it does mean we have to make every drop of gas give us the most go for our money. Anyone with horse sense knows that a well-tuned car gets better mileage, and in times of fuel shortages, better mileage means a lot.

The Mark Ten B Capacitive Discharge System keeps your car in better tune so it burns less gas. Using Mark Ten B is more than horse sense. It's the smart move under the hood, helping a nation survive an energy crisis and keeping you on the road. Delta Mark Ten. The best way to go.



## DELTA PRODUCTS, INC.

P.O. Box 1147, Dept. PE  
Grand Junction, Colo. 81501  
(303) 242-9000

Please send me free literature.  
Enclosed is \$ \_\_\_\_\_  Ship ppd.  Ship C.O.D.  
Please send: \_\_\_\_\_ Mark Ten B assembled @ \$59.95 ppd. \_\_\_\_\_ Mark Ten B Kit @ \$44.95 ppd. (12 volt negative ground only) \_\_\_\_\_ Standard Mark Ten assembled, @ \$44.95 ppd. \_\_\_\_\_ 6 Volt: Neg. Ground Only \_\_\_\_\_ 12 Volt: Specify \_\_\_\_\_ Pos. Ground \_\_\_\_\_ Neg. Ground \_\_\_\_\_ Standard Mark Ten Deltakit\* @ \$29.95 ppd. (12 Volt Positive or Negative Ground Only)

Car Year \_\_\_\_\_ Make \_\_\_\_\_

Name \_\_\_\_\_

Address \_\_\_\_\_

City/State \_\_\_\_\_ Zip \_\_\_\_\_

CIRCLE NO. 9 ON READER SERVICE CARD

ing-level meter reads the "flat" signal as it comes from the inputs of the tape recorder. The signal applied to the tape, however, has received a strong high-frequency boost to offset hiss and treble losses. This means that the tape can easily get into trouble with excessive high-frequency levels that the meters know nothing about. The obvious remedy is to have the meters monitor levels *after* the recording-equalization stage—in other words, equalized meters. As a rule, this requires separate driving amplifiers for the meters, which may or may not have peak-reading time constants. Also, the meter movements should be able to tolerate substantial amounts of high-frequency energy without burning out.

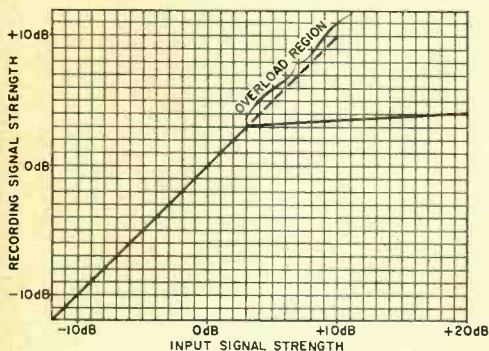

Fig. 2. In ideal limiting circuit, instead of following high-level signals into overload region (dashed lines), the amplifiers are gain-controlled to permit little or no signal increase above a certain threshold.

**Peak limiters.** A limiting circuit controls the gain of the recording amplifiers, typically acting only when a preset threshold level (usually a level that produces 1 to 3 percent distortion) is reached. A good limiter just won't let the signal going onto the tape get any stronger than that, no matter what the level at the inputs. (Fig. 2.) All the worrisome transient peaks are thereby simply eliminated.

An audibly unobtrusive limiting circuit has to be designed with a rather fast attack time and a *very* slow release time—several seconds or so. Otherwise the decaying tails of cymbal crashes and similar abrupt, loud sounds would disconcertingly "bob up" in level. Therefore, any limiter which is working (in many live-recording situations, it will work quite a lot) is going to introduce considerable compression in the recorded signal. And since no limiter found in con-

sumer equipment is likely to be sophisticated enough to be inaudible under every circumstance, there should be a switch to take it out of the circuit when it's not wanted.

But how does the ear react to being deprived of the high-level musical transients we tend to associate with excitement and "realism" in reproduced sound? Up to a point, the ear is forgiving. The action of a limiter will be heard if it is allowed to affect the average levels of the program. But if the recordist chooses levels that result in only the briefest clipping of peaks, the limiter may very well go unnoticed in the final recording.

**What Won't Help.** All over the recording world, the perils of high-level transients have been a little slow in receiving acknowledgment. In fact, none of the developments that made the cassette a high-fidelity medium have any direct bearing on the tape-overload situation. The B-Type Dolby noise reduction system is a help only because it permits lower recording levels *overall* while still retaining a good signal-to-noise ratio. Chromium-dioxide tape is somewhat more resistant to overload distortion than iron oxide, but it's clear from the proposed standards for CrO<sub>2</sub> playback equalization that its potential is generally being exploited in another way—to *increase* the recorded levels of high frequencies and thereby further improve the S/N. This is probably the correct priority to follow for most cassette users. However, it eases the plight of the overload-prone cassette medium hardly at all.

If the new meters, overload indicators, and limiters can't do anything to counter the cassette's real limitations, at least they can give a more complete representation of where the problems are, as well as prevent some of the grosser consequences of overload from taking place.

Of course, the benefits these devices can provide depend entirely on their being used properly. Meters in particular communicate in a language you have to learn pretty thoroughly for best results, and complete mastery in every situation probably won't come until you've had a chance to assess what went wrong with a number of previous recordings. Which is another way of saying that there's no substitute for experience in tape recording, as seasoned recordists are already aware. ♦



**'golden anniversary  
Messenger® 250**

**AN ENTIRELY NEW SLANT  
ON CB BASE STATION  
PERFORMANCE**

From its professional sloping control panel, to its special golden trim cabinetry, you know this is an extraordinary CB radio. But it's when you get it on-the-air that you'll see why Messenger 250 is the new criteria for 23-channel base station performance. Then you'll appreciate its all solid-state chassis — the most powerfully efficient we've yet developed. And its advanced circuitry, including built-in electronic speech compression, "steep skirt" mechanical filter, fully automatic noise limiting and sophisticated automatic gain control. Plus the operational flexibility of the built-in PA function, remote speaker option, and the dual 117 VAC/12 VDC power supply that can keep you on-the-air with battery power if need be. It's quite a radio — but we wouldn't have made it our Golden Anniversary model if it wasn't.



**\$239.95** suggested price complete with high capacity, ceramic element hand-type microphone.



**E. F. Johnson Co.**

Waseca, Minnesota 56093

*Excellence through half a century of experience.*

®

Circle No. 33 On Reader Service Card



# News Highlights

## First Quadraphonic Juke Box

Wurlitzer, which brought out the first coin-operated music box in 1896, has now introduced the first quadraphonic juke box. The unit, on which marketing has just begun, will incorporate full-logic SQ™ circuits. The announcement came just weeks after Columbia Records released the first quadraphonic single disc to be distributed in the U.S.—Art Garfunkel's "All I Know."

## Sony Trading Sells Heathkit in Japan

Sony Trading Corp., a Tokyo subsidiary of Sony Corp., has been named exclusive representative for the Heath Co.'s electronic kits in Japan. Sony will sell a line of Heath stereo, amateur-radio, test-equipment and general products. All will operate on 50 or 60 Hz ac. The equipment sold in Japan will contain translated construction manuals. This marks the first time in Heath's history that a major foreign corporation has been appointed to sell their products overseas. Heath sells through its own facilities in the U.S., Canada, England and Europe. The company, the world's largest manufacturer of electronic kits, had sales in 1972 of over \$66 million.

## Sylvania Acquires RCA Institutes Schools

An agreement has been announced whereby GTE Sylvania Inc. acquires four schools of RCA Institutes. Involved are the schools in Cherry Hill, N.J. and Upper Darby, Pa., as well as the Home Study School and TV Studio School in New York City. The RCA Resident School in New York City is not included in the acquisition. It's reported that there will be no interruption in any of the courses currently underway at the facilities. (About 10,000 students, American and foreign, are currently enrolled in the schools.)

## Troubles With Liquid Crystal Watch Displays

Some buyers of the new digital electronic watches with dynamic scatter liquid crystal displays have experienced difficulties in reading the displays. The watches do have to be tilted at an angle in order to see the display clearly and users must recognize this limitation. There are some other reasons for possible lack of legibility. If the display is not hermetically sealed properly, moisture may get inside and contaminate the liquid display; and if watches are baking in direct sunlight in the jeweler's window or if direct sunlight is allowed to beat down on the user's arm while riding in an open car, temperatures may rise to well over 100 degrees F, causing the display to be temporarily transparent. Finally, if the MOS interface circuit is improperly designed so that residual dc offset is not minimized, the display will be degraded.

## FTC Revises Proposed Rule on Audio Sound Power Rating

The Federal Trade Commission has revised its proposed rule on what power must be promoted and disclosed by manufacturers of



# Put "Dyna-Mike" in your talkpower

Noise Limiter and Noise Blanker to cut down on your own and others' ignition noise and interference

CB/PA switch lets you use audio output to drive a PA horn

Extra-large illuminated meter

Modulation Light shows you're modulating to maximum

Transmit Light shows you're on the air



"Dyna-Mike" Gain Control for maximum modulation to cut through noise

Squelch threshold adjusts to below 1  $\mu$ V

Big illuminated channel selector

Delta Tune helps you tune in off-frequency signals

Full audio output you can hear even over road noise

RF Gain cuts back strong signals when the skip is in

## PLUS...

Positive or negative ground operation, plug-in microphone, output for extension speaker and the quality that COBRA is famous for! Send for more details or see your dealer.

**COBRA 29**  
**\$180<sup>00</sup>**

PRODUCT OF DYNASCAN CORPORATION • 1801 W. Belle Plaine • Chicago, Ill. 60613

CIRCLE NO. 7 ON READER SERVICE CARD

audio equipment. First, they have deleted the incorrect term "rms power" and have substituted the proper term "average power" or more completely "sine wave continuous average power." Although rms output voltage is properly used in calculating the output power, this value of power is *not* an rms power. Second, a new section has been added covering "standard test conditions" under which power measurements are to be made. The section states that the line voltage shall be 117 volts (the IHF specifies 120 volts); the frequency shall be 60 Hz; the amplifier shall be preconditioned by operating it at one-third rated output power for one hour; and rated power and distortion are to be obtained with test signal applied for not less than five minutes at the amplifier's auxiliary input. It has not yet been decided when the ruling will go into effect.

### **Color Pictures Recorded on Audio Tape Cassettes**

A new cassette picture system that records stereo sound as well as still color pictures for reproduction on a TV set has been demonstrated by Hitachi in Japan. Slide films, opaque cards or still frames of a TV picture can be recorded and reproduced for any length of time over 12 seconds. About 240 still pictures can be recorded on a C-120 tape cassette. The recorder is expected to be available on the market in October. The price has not been announced, though it is said to be less than that of present VTR systems.

### **Pocket TV from England**

A pocket-size black-and-white television set is expected to be introduced by England's Sinclair Radionics Ltd. around the middle of the year. The receiver may sell for under \$100. Distribution in the U.S. is to be by Sinclair Radionics, N.Y.

### **Automotive Electronics Market Approaches \$1 Billion**

By 1977 the automotive electronics market is expected to reach nearly \$1 billion, climbing from less than \$600 million in 1973, according to a study by a West Coast market research company, Creative Strategies, Inc. Entertainment products, primarily radios, form the largest segment of the market at this time, though this segment is not expected to show significant change. The engine control electronics market, consisting of electronic ignition, carburetion and transmission controls, is expected to reach \$200 million in 1977. The market for electronic test equipment for cars will probably expand substantially due to more complex engines, emission testing, and the need to test and repair electronic devices.

### **Heath Introduces New Digital Color TV**

Heath has just announced a unique solid-state 25-in. color TV kit that uses digital design techniques to silently change vhf or uhf channels at a touch. What's more it displays the channel numbers on the screen along with the time digits using an optional digital clock assembly. The silent, all-electronic touch tuning requires no knobs to turn, no humming motors and no mechanical contacts to clean. Channels can be intermixed in any combination. Even the sound is controlled digitally, changing levels in small increments at the touch of a button. Also there is a new fixed-tuned LC filter with an IC i-f amplifier—a first in the TV industry. There are no traps to go out of adjustment either. Although the set uses 19 IC's, 71 transistors, 20 glass-epoxy circuits boards and 12 cables, the assembly operations are said to be greatly simplified.

# MIT'S Presents

## The new 908DM, Desk-Top Calculator.

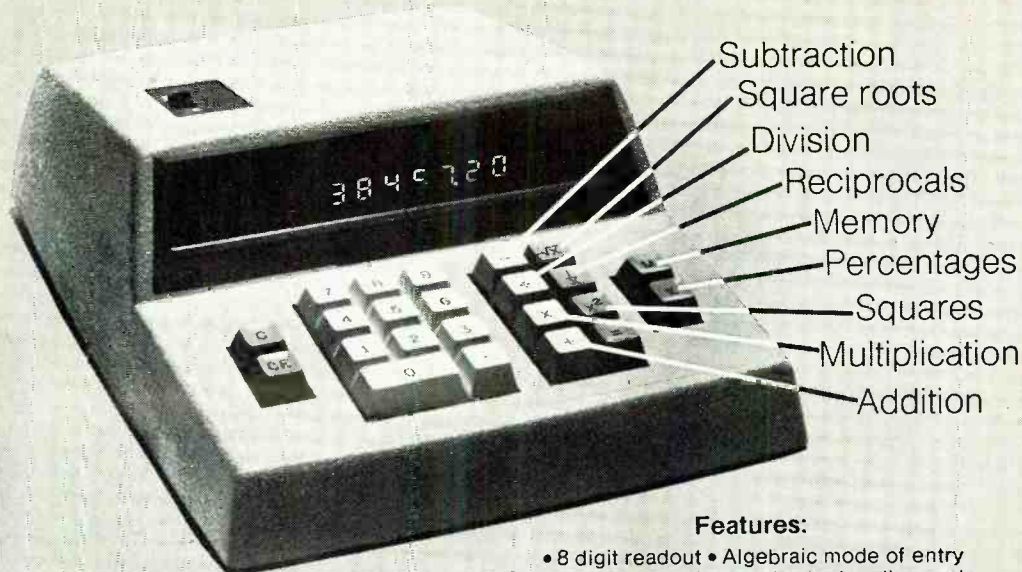

**Full Operation Memory**  
**Memory may be used as:**

1. A constant
2. A temporary storage register
3. An accumulator

**Indicators:**  
 • True credit balance sign • Overflow

**Features:**

- 8 digit readout • Algebraic mode of entry
- Fixed or floating decimal • Leading and trailing zero suppression • Chain and mixed operations
- \* Plus the option of programmability.

**\*Prices: 908DM**  
 Kit . . . \$129.95 Assembled . . . \$149.95  
**Size: 8-1/2" x 12" x 3-1/4"**

**\*Programmer**

To be used with the MITS 816, 1440, or the new 908DM, desk calculators.

1. Provides 256 programming steps. (With option of expandability to 512 steps.)
2. Stores up to 64 separate programs. Size: 8-1/2" x 12" x 3-1/4"

**Instructions:**

A. "If Neg," B. "Go To," C. "Return," D. "Remember," E. 2 Run modes of operation

\*Programmer Kit . . . \$199.95 Assembled . . . \$299.95

\*Combination 908DM and Programmer Kit . . . \$299.95 Assembled . . . \$399.95

Warranty: Kit: 90 days on parts, Assembled: 2 years on parts and labor.

\*Prices subject to change without notice. Available from your local Olson Electronics Dealer

**MIT'S INC.**  
 "Creative Electronics"

6328 Linn, N.E., Albuquerque, New Mexico 87108  
 505/265-7553 Telex Number 660401

PE-2-74

Enclosed is a Check for \$ \_\_\_\_\_

or  BankAmericard # \_\_\_\_\_

or  Master Charge # \_\_\_\_\_

Credit Card Expiration Date \_\_\_\_\_  Kit

Include \$5.00 for Postage and Handling  Assembled

Model 908DM  Programmer  908DM & Programmer

Please Send Information on Entire MITS Line.

NAME \_\_\_\_\_

ADDRESS \_\_\_\_\_

CITY \_\_\_\_\_

STATE & ZIP \_\_\_\_\_

MIT'S / 6328 Linn, N.E., Albuquerque, New Mexico 87108 505/265-7553 Telex # 660401

CIRCLE NO. 15 ON READER SERVICE CARD

# Born Smart?

The Navy  
will make it  
pay off.



## If you've got what it takes, the Navy can challenge you with over \$17,000 worth of advanced training in electronics or nuclear power.

The New Navy offers high school graduates a challenge with a future. And if you're qualified to meet the challenge, you can get training and experience that puts you ahead of the pack in the exciting fields of nuclear power or electronics.

These special Navy programs are tough. And besides the technical training, you'll have your share of the unglamorous chores. Everybody does. But the rewards and your personal satisfaction make it all worthwhile. Learning to operate and maintain the Navy's sophisticated electronic systems or nuclear power plants will give you skills you can use for a lifetime.

And as a sailor, you'll see the

world while you're still young. You'll make new friends. And get higher pay than any sailor in history.

Get all the details from your local Navy Recruiter. Or mail the coupon below. Or call toll-free 800-841-8000 anytime.

### Be someone special in the new Navy.

490

TO: Captain Robert W. Watkins, USN  
Navy Opportunity Information Center  
P.O. Box 2000, Pelham Manor, N.Y. 10803

Please send more information on:  Advanced Electronics Program  
 Nuclear Power Program  Other Navy career opportunities.

If you really don't want to wait, call 800-841-8000 toll-free (24 hours a day, seven days a week). In Georgia, call 800-342-5855. Call collect: In Alaska—272-9133, in Hawaii—533-1871.

Name \_\_\_\_\_ Date of Birth \_\_\_\_\_  
(Please Print)

Address \_\_\_\_\_

City \_\_\_\_\_ Phone \_\_\_\_\_

State \_\_\_\_\_ Zip \_\_\_\_\_



# Kiss that "nothing" job good-bye forever!

We'll show you how to be a "somebody" in  
the dynamic world of **ELECTRONICS**.

Send for this **FREE** sample lesson.

Why stay in a job with a limited future when there are so many opportunities in the big, exciting world of electronics? That's where the action is today. We'll send you a free sample lesson to demonstrate how LaSalle's practical method can train you at home for entry into the field.

#### Thousands of technicians in demand

Electronics technicians are needed at all levels in TV and radio broadcasting. And in the fascinating new areas of electronic crime detection, electronic factory automation, electronic medicine, and other "world of tomorrow" fields. No wonder there are so many opportunities at all levels for the man who knows electronics. With LaSalle training and subsequent on the job experience, you'll have every chance to move ahead in electronics.

No previous experience is necessary for LaSalle electronics training. Experienced instructors teach you basic principles, then lead you step-by-step to practical applications. You learn to build your own electronic equipment. Emphasis is on modern techniques. And, if you choose the communication field, LaSalle will prepare you to pass the FCC first class radio-telephone operator license exam.

LaSalle has enrolled more than 2,000,000 men and women in its many career programs. It gives you a great feeling of confidence to know that your training is in the hands of a leader in home study.



#### Send for **FREE** lesson and booklets

Get with it today! You owe it to yourself to find out how LaSalle can prepare you for a future in electronics. Mail the attached card for free sample lesson and also free booklets shown on facing page. No postage stamp needed. There's no obligation. If card is missing, write to: LaSalle, 417 South Dearborn Street, Chicago, Illinois 60605.



**LA SALLE EXTENSION UNIVERSITY**

A Correspondence Institution • 417 S. Dearborn Street, Dept. 50-067, Chicago, Illinois 60605

© 1974 LaSalle Extension University • A Correspondence Institution



Here's where it's  
all happening...and  
you can make it  
happen to you.

**also  
Free**

These 2 valuable booklets

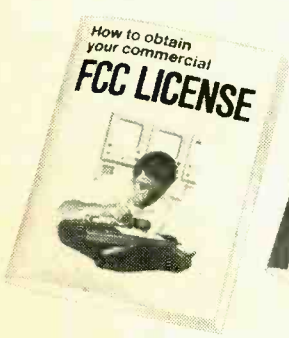

Gives information on getting a Federal Communications license, and provides typical FCC exam questions and answers. *Yours free.*

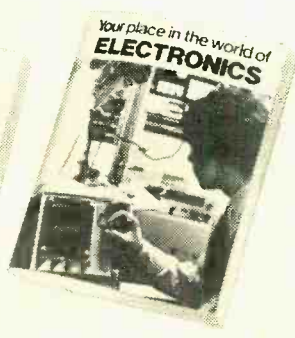

Tells about opportunities in electronics, what you need to know, how LaSalle prepares you at home to start a career. *Yours free.*



**COMMUNICATIONS** — Growing field includes servicing radio, television, CATV, mobile or aircraft broadcast equipment, public address, industrial and crime control systems.



**AUTOMATION** — More and more manufacturing processes are controlled by electronic systems —from food processing to toolmaking. Technicians are needed to inspect, maintain and repair equipment.



**INSTRUMENTATION** — Well-paid jobs servicing sophisticated electronic devices used in hospitals, laboratories, space centers, computer installations, many other fields.

**MAIL ATTACHED CARD, NO OBLIGATION**  
CIRCLE NO. 20 ON READER SERVICE CARD

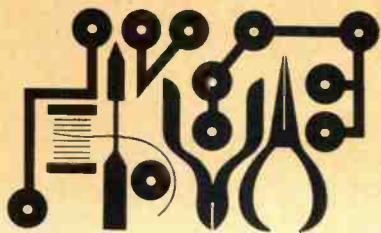

# Hobby Scene

## Rectifier Bridge Leads

**Q.** I bought a package of semiconductors, and among the unmarked ones, is a device that appears to be a rectifier bridge, but it has no markings on it. How can I identify which lead is which?

**A.** Using the high-resistance range of your ohmmeter, check all combinations of the four leads until you find a pair that has infinite resistance. This is the ac input.

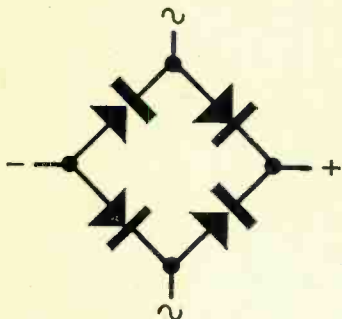

(We are assuming that all four diodes are good.) The other two leads are then the dc output. If you know the polarity of your ohmmeter (red usually positive), you can easily determine which is the positive output. That is, when the positive lead is on the upper ac input, there will be conduction through the upper right diode, making this the cathode or positive end.

## Does "Instant On" Wear Out Tubes?

**Q.** I have a TV receiver with an "instant on" feature. Do the tubes "wear out" faster since they always have a slight heater current flowing, and should I disconnect the receiver from the power (when not using it) to save the tubes?

**A.** Tests have shown that tube life is not shortened by continuous application of heater current. In fact, there is more damage done when turning a tube set on and off due to heater thermal shock. Some manu-

facturers even claim a longer tube life with "instant on" due to constant heater temperature.

## Why Won't a Diode Work?

**Q.** I have an old crystal-detector radio that used a "cat's whisker" and a piece of galena. Recently, I lost the galena so I decided to replace it with a modern diode. Although the receiver still works, all I can get are the very strong stations. When I had the galena crystal, I received quite a number of stations. The circuit is still the same. What is going on?

**A.** Although a modern diode can run rings around the old galena-cat's whisker combination in most cases, this is one area where the old way is better. The galena-cat's whisker diode started to conduct at almost zero voltage, while the germanium diode starts its conduction at about 200 mV and silicon types start at about half a volt. So you see why you are getting only the strong stations. If you are building a crystal set, germanium diodes are recommended.

## What Is DIN?

**Q.** I keep seeing the word (or letters) DIN on more and more audio equipment. What does it mean?

**A.** DIN stands for Deutsche Industrie Normenausschuss, a West German institute which sets certain industrial standards. The largest contact we have with them is in the audio field, where various plugs and sockets having DIN geometry and connections are used.

Have a problem or question on circuitry, components, parts availability, etc.? Send it to the Hobby Scene Editor, POPULAR ELECTRONICS, One Park Ave., New York, NY 10016. Though all letters can't be answered individually, those with wide interest will be published.



# Radio Shack Is Electronic Parts Paradise!

## We're "The Parts Place"

### For magazine projects & Do-it-Yourself experiments!

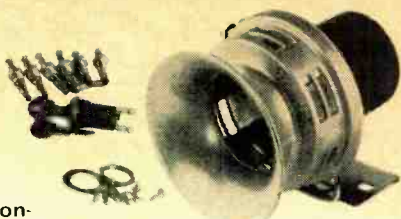

**Auto Siren Alarm Kit.** For 24-hour protection against would-be car thieves or vandals. Shrill alarm sounds if hood, trunk or doors are tampered with. 6 switches, 2 keys, lock, wire/hardware included. For 12-volt DC neg. ground. **21<sup>95</sup>**

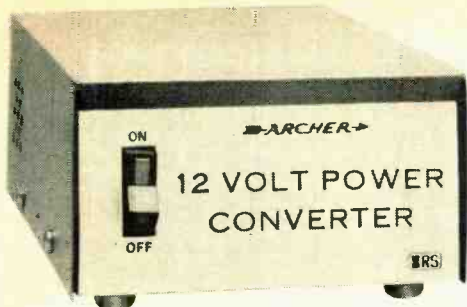

**12-Volt Power Converter.** Converts 120 VAC to 12 VDC. Use to charge 12-volt batteries or as a battery eliminator when servicing 12 VDC equipment. Output: 12V at 1.75 amps continuous, 5 amps surge. Blow-out protected. **18<sup>95</sup>**

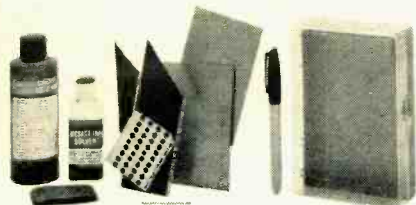

**Printed Circuit Kit.** All you need to custom-design your own circuits. Two 4 1/2 x 3" copperclad boards, resist-ink solvent with pen, 6-oz. bottle of etchant, layout strips & circles, scouring pad, 1/16" drill bit, 4 1/2 x 6 1/4 x 2 1/4" plastic etching tank. Safe to use. **6<sup>95</sup>**



**6 to 12 VDC Inverter.** Converts 6-VDC input to 12-VDC output. Dual inputs — 6V neg. & 12V pos. grd. Output: 12V neg. grd. at 3 amps. Solid state, fuse protected. Ideal for use in VW's, dune buggies, etc. **18<sup>95</sup>**



**Etchant Solution.** Removes copper from PC boards without damage to the board. Safe, easy to use. A "must" for hobbyists, builders & experimenters. 16 fluid oz. **1<sup>69</sup>**



**Hook-Up Wire.** Five 100' coils in assorted colors. Sizes #18 thru #22. Solid & stranded types. **3<sup>69</sup>**



**Transistor Substitution Guide.** Indispensable for technicians. Lists up to 15,000 types, foreign & domestic. Also has biasing diagrams, polarities, etc. **1<sup>00</sup>**



**SPST Magnet Contact Switches.** Rated 0.5 A at 125 VAC. **1<sup>99</sup>**

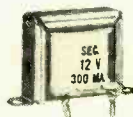

**"Mini" Size Filament Transformer.** From 6.3V to 24V. 300 mA DC rated. Low as **1<sup>29</sup>**



**Aluminum "Mini" Boxes.** Lightweight, sturdy. Many sizes available. Low as **1<sup>19</sup>**

Prices may vary at individual stores.



**FREE 1974 CATALOG** 335  
 AT 2000 RADIO SHACKS OR BY MAIL  
 180-Pages — Full Color! Hi-Fi, CB, Kits, Recorders, Antennas, Parts, More!

Name (print) \_\_\_\_\_ Apt. # \_\_\_\_\_  
 Street \_\_\_\_\_  
 City \_\_\_\_\_ State \_\_\_\_\_ ZIP \_\_\_\_\_  
 MAIL TO: Radio Shack, P.O. Box 1052, Fort Worth, Texas 76107

**Radio Shack®**  
 and ALLIED RADIO STORES  
 A TANDY CORPORATION COMPANY

CIRCLE NO. 27 ON READER SERVICE CARD

**THE BEST OF BOTH WORLDS**

**STEREO and MATRIX\***  
**XV-15/1200 E**



\*DERIVED 4-CHANNEL

**DISCRETE 4-CHANNEL**  
**UV-15/SERIES**



**PICKERING'S STATE-OF-THE-ART CARTRIDGES...**

**For the world of STEREO—  
XV-15/1200E**

Designed for use with all stereo and four-channel derived compatible systems.

"PRECISION" is the one word that best characterizes the extraordinary quality of the new Pickering XV-15/1200E cartridge. We sincerely feel that the 1200E is the furthest advance achievable today—and perhaps in the foreseeable future—in stereo cartridge design and performance. Its exceptional ability to pick up *all* the material recorded at the lightest possible tracking forces make it totally unique and superior.

And all of Pickering's exhaustive testing shows that the 1200E is superior in the flatness of its frequency response and channel separation in comparison to competitive cartridges.

SPECIFICATIONS:	
Frequency Response:	10 Hz to 30 kHz
Channel Separation, Nominal:	35 dB
Tracking Force:	¾ gram, + ½ gram, - ¼ gram.
Nominal Output:	4.4 mv
Stylus Tip:	0.0002" x 0.0007"

**For the world of DISCRETE 4-CHANNEL—  
UV-15/2400-Q**



**QUADRAREDRAL™**

Designed and engineered specifically for playback of discrete recordings.

The discrete 4-channel system requires a completely new cartridge that could not only faithfully reproduce the 20 Hz to 20 kHz AM signals, but also the 30 kHz FM modulated signals. The result is the Pickering UV-15/2400-Q. It consists of a completely redesigned cartridge and a new high performance stylus assembly, the Quadraredral™, specially developed for this application. The UV-15/2400-Q performs in a superior manner by every test, and is capable of satisfying all technical and aesthetic requirements for playback of both discrete and stereo disks. Moreover, its stylus is designed to reduce record wear.

SPECIFICATIONS:	
Frequency Response <sup>1</sup> :	10-50,000 Hz
Channel Separation:	35 dB
Tracking Force <sup>2</sup> :	1-3 grams
Output <sup>3</sup> :	3.6 mv ± 2 dB
Stylus:	Quadraredral

Notes: 1. Recommended by manufacturer for optimum performance. 2. When the cartridge is terminated in the recommended load of 100K ohms and 100 PF. 3. Output with reference to 5.5 cm/sec record velocity.



*"for those who can [hear] the difference"*

The right Pickering cartridge for your equipment is the best cartridge money can buy.

For further information write Pickering & Co., Inc., Dept. E, 101 Sunnyside Boulevard, Plainview, New York 11803

**CIRCLE NO. 25 ON READER SERVICE CARD**

# HOW TO GET STARTED IN RADIO CONTROL MODELING

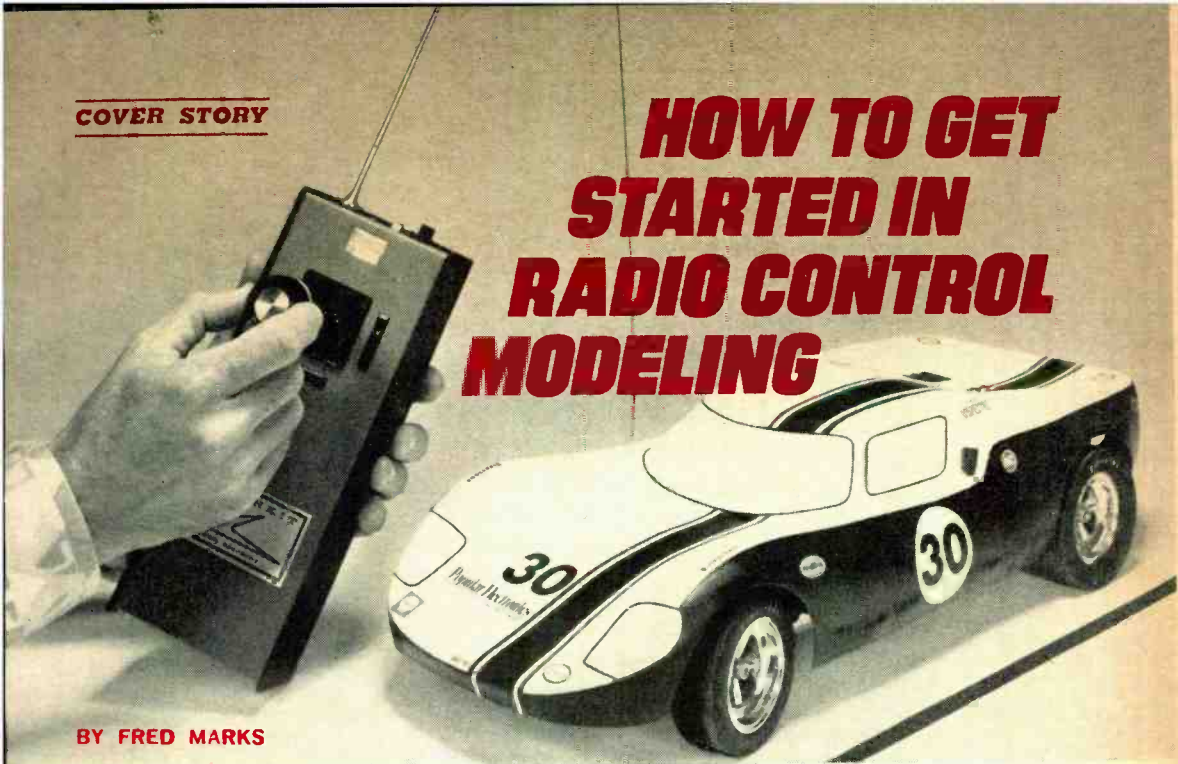

BY FRED MARKS

*Solid-state designs spur growth of exciting hobby*

IT IS almost impossible to convey the full excitement of radio control (R/C) modeling to anyone who has never been at the controls. While some of the glamour and excitement of the hobby are almost certain to rub off on the "audience" at a modeling meet, the ultimate thrill is reserved for the hobbyist at the transmitter controls as he maneuvers his model airplane, racing car, or boat over an intricate course.

Operating a model by radio control is similar to—yet vastly different from—operating a full-size vehicle. The major difference, of course, is that the model under your control is always at a distance from you. Even so, you can almost feel the G forces acting on it.

R/C modeling is one hobby that lets you exercise maximum creativity, manual dexterity, and competitive spirit. And you will learn a great deal about electronics, mechanics, and physics while having fun.

**How It Started.** Radio control for modelers dates back to the 1930's. By today's standards, the electronic gear that the pioneers of the hobby used was primitive and massive. Back then, you needed a ham license to operate R/C equipment, which

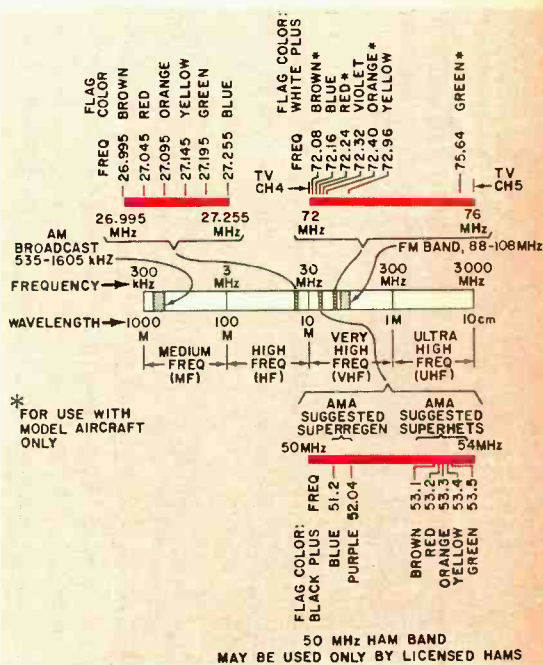

Three bands of frequencies have been allotted for use by hobbyists in radio control. Flag colors designate channel being used.

## HOW WE TESTED HEATH'S

**T**O PRESENT a full report on R/C modeling, the staff of POPULAR ELECTRONICS built and tested its own car and control system. We used kits made by the Heath Company, which included a Model GDA-1057-1 3-channel transmitter, Model GDA-1057-2 receiver, Model GDA-405-3 receiver battery, and two Model GDA-405-44 miniature servos. (These items have a special system price of \$150, though, if purchased separately, the total cost would be \$170.) For future use, we added an optional Model GDA-1057-4 fourth channel (\$20) and two more miniature servos (\$25 each).

To use with our radio control system, we decided on a model racing car, which is probably the easiest thing to control and can be operated under less favorable circumstances than a boat or a plane. We used the now discontinued Heath "Spectre" racing car in which we installed a locally obtained \$25 glow-plug engine.

**The R/C System.** The transmitter is basically a three-channel digital-proportional unit that supplies 500 milliwatts to the input of the power amplifier. A joy stick controls the encoding for channels 1 and 2 (left and right turning on channel 1 with nothing on channel 2, or, for a model plane, elevator and rudder), both of which are equipped with secondary trim-pot tabs. The channel-3 control (throttle) is a similar trim-pot tab located on the right side of the transmitter case, which is the size of a walkie-talkie. The stick is spring-loaded on both channels so that it returns to its center

(neutral) position. The throttle control stays where it is set. When converting to a four-channel system for model planes, the control for channel 4 (rudder, with channel 2 becoming aileron) goes on top of the stick.

The only other external control is the power switch located on top of the case near the telescoping whip antenna. The switch is equipped with a lock-off tab that slips into place to prevent accidental turn-on. The state of the battery charge is indicated by a small meter on the front of the case just above the stick assembly.

The transmitter (and receiver) operates on one frequency, which can be any one of 17 in the 27-, 50-, and 72-MHz bands. We chose our transmitter to operate on 26.995 MHz.

The receiver measures 2 $\frac{1}{8}$ " by 1 $\frac{1}{16}$ " by 1 $\frac{1}{2}$ " and weighs 2.5 oz, exclusive of the battery pack. Its i-f is 453 kHz, while its sensitivity is 5 microvolts or better. Operating from its 4.8-volt nickel-cadmium battery pack while driving two miniature servos, the current drain is roughly 6 mA, providing four hours of service from a full charge. Three ceramic filters are used in the i-f section.

Each of the miniature servos measures 2 $\frac{1}{32}$ " by 1 $\frac{5}{8}$ " by  $\frac{7}{8}$ " and weighs 1.75 oz. They will accept a pulse 1 to 2 ms wide at 4 volts peak-to-peak. Thrust is 4 lb, minimum; travel time is 0.6 second; linear output travel is  $\frac{1}{2}$ " end to end; and rotary output travel is 90°. The mechanical outputs include one rotary arm, one wheel, and two linear racks.

Assembling the transmitter was a

limited the number of hobbyists to a relative few.

In 1952, the FCC established the Citizens Radio Service, permitting almost anyone who wanted one to obtain a radio operator's (CB) license. No code or written test was required for the new license, and many people who did not feel it was worth it to study code and theory for ham licensing exams clamored for the new CB license. Some wanted it for voice communication; prospective R/C hobbyists wanted it to get into modeling.

With the opening of the Citizens Band, R/C modeling started to grow. By 1958, in fact, there were as many as 50 modelers who met at flying fields or boat sites

During this period, the equipment remained relatively unchanged. Furthermore,

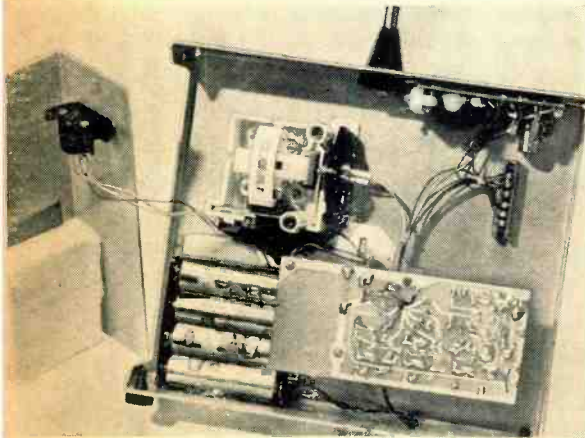

A typical 3-channel transmitter using conventional cells rather than rechargeable.

### 3- OR 4-CHANNEL DIGITAL-PROPO R/C SYSTEM

straightforward job, simplified by the fact that the transmitter section comes fully assembled and pre-aligned to the frequency specified. Assembly time was about nine hours.

The receiver and servos employ very small PC boards, the former containing two closely packed assemblies that require careful component mounting and lead soldering. In neither case was assembly particularly difficult, and the servos went together quickly because most of the electronic functions are performed by a single IC in each. Assembly time for the receiver (including installation of fourth-channel option) was about 5½ hours, while only 1½ hours are required for each of the servos. (Note: the battery charger was assembled with the transmitter. It simultaneously charges the nickel-cadmium batteries for both the transmitter and receiver.)

**How It Performed.** The combination of Heath car, engine and R/C system proved to be an excellent choice for us. After tuning the system for the proper responses at maximum range, we were ready for our first run. We found an immediate snag; the new battery we had bought the day before must have stood too long on the shelf because it would not start the engine. But once it was replaced by a fresh unit, the engine turned over with a roar and spewed out billows of bluish smoke (normal for a glow-plug engine).

At first we operated the controls timidly. For example, we opened the throttle

just enough for the racing car to move at about a normal walking pace while controlling left-right steering in a slalom-like pattern. A few minutes of this, and we were ready for more speed. But owing to our lead fist, we advanced the throttle to almost wide open. There was an immediate increase in decibels as the engine wound out and the car almost flew away from us. Just a touch on the steering was enough to send it spinning out. Then when we attempted to throttle down and apply the brake a second snag appeared: the car slowed too gradually for proper operation. An inspection revealed that the brake had torn loose from its lever.

The next weekend, after soldering the brake back onto its lever, the car and R/C system performed flawlessly. Another mishap occurred when we forgot to lubricate the axle between runs; the axle seized in its bushings. Fortunately, after it cooled and was lubricated, we found that no permanent damage was done. We now remember to obey the lubrication caution noted in the Heath manual.

Owing to the car's mass, low center of gravity, and fast steering response, the Spectre stayed glued to the racing course at speed. Getting used to the light touch required on the steering at speed and to switch perspectives as the car is coming toward us took only about a half hour. Now that we have many hours of operation behind us, we feel confident enough to entertain the idea of entering some races. ♦

all modelers had to share primarily 27.255 MHz, a frequency also used by voice-communicating CB'ers, taxicabs, and traffic departments for controlling signal lights. The modeler's maximum transmitter power was limited to an input of 5 watts, but other services on the same frequency were permitted up to several hundred watts.

Through the efforts of the Academy of Model Aeronautics (AMA), the national association of model aviation, hobbyists were permitted, commencing September 11, 1958, to operate on five new Class C frequencies: 26.995, 27.045, 27.095, 27.145, and 27.195 MHz. The new frequencies and the development of more selective receivers bought interference problems to a temporary halt.

Operating on the new frequencies offered



Simple projects like a converted Baja Bug are fine first projects for learning basics.

## R/C EQUIPMENT MANUFACTURERS

**Ace Radio Control**, 203 W. 19 St., Higginsville, MO 64037

**Citizenship Radio Co.**, P. O. Box 297, Westfield, IN 46074

**EK Products, Inc.**, 3233 W. Euless Blvd., Hurst, TX 76053

**Futaba**, 1124 E. Amo Blvd., Carson, CA 90746

**Heath Co.**, Benton Harbor, MI 49022

**Model Rectifier Corp.**, 2500 Woodbridge Ave., Edison, NJ 08817

**Orbit Electronics**, 312 Gillette St., Santa Ana, CA 92705

**Pro-Line Electronics, Inc.**, 1213 E. Glendale Ave., Phoenix, AZ 85011

**Royal Electronics Corp.**, 2119 S. Hudson St., Denver, CO 80222

**RS Systems**, 2407 S. Broadway, Santa Ana, CA 90707

**World Engines, Inc.**, 8960 Rossash Ave., Cincinnati, OH 45326

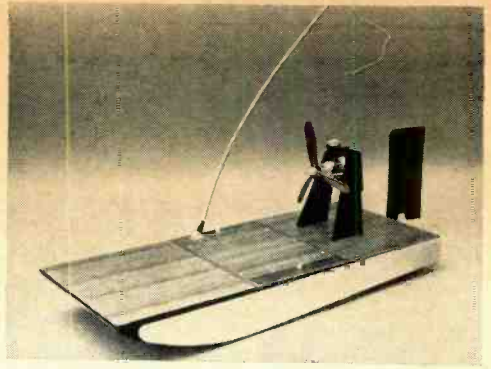

Another simple first project is an airboat. It is ideal for use on local city park ponds.

The present frequencies on which R/C modeling is permitted are shown in the frequency spectrum diagram. Six frequencies are available in the 27-MHz CB band, seven in the 72-76-MHz band (four for model aircraft use only), and seven in the 50-54-MHz 6-meter ham band. If all available frequencies were in simultaneous use at a given site, as many as 20 models could be active.

On the 27-MHz band, excluding 27.255 MHz, a maximum of 3 watts input to the final amplifier in the transmitter is permitted, and crystals must be ground to a 0.01-percent tolerance. On 27.255 MHz, 3 to 5 watts input, also 30 watts, is permitted, provided that the crystal is ground to a tolerance of 0.005 percent. The 27.255-MHz frequency, however, is seldom used by modelers because of the severity of the interference often encountered.

A 3-watt input for R/C transmitters is rather high. For practical purposes, a 1-watt input would be typical, while 0.5 watt is quite acceptable. Some transmitters are rated at 100 mW or less input. They require no station license, but are subject to the same tolerance and modulation requirements of the higher-powered transmitters.

**Requirements for Operating R/C.** Operating R/C equipment is a privilege granted the operator by the citizens of this country in that (a) one must properly share the radio spectrum and (b) be familiar with and observe the applicable regulations. Transmitters rated at over 100 mW may be operated only by those who have secured an FCC license. Any citizen of the U.S. who is 12 years of age or older can qualify for this non-ham station license.

To obtain a license for the non-ham bands,

a greater advantage. Selectivity made the new receivers immune to transmitters on other frequencies. Hence, as many as six models could be controlled simultaneously. At large meets, flight lines actually formed for each frequency.

Meanwhile, the introduction of the transistor in the mid-1950's gave a tremendous boost to R/C modeling. Small and lightweight, the transistor considerably reduced the demands placed on battery supplies in both transmitters and receivers, which in turn, reduced the size and weight of the batteries themselves. As transistors replaced tubes, R/C equipment became miniaturized to the point where transmitters were, for the first time, small enough to be hand-held. And transistor circuits proved to be much more reliable than tube-circuit counterparts.

**An Era of Change.** By 1963, interference had again become a serious problem to R/C modelers. Class D CB's had crowded the airwaves, and there were now more modelers than there was spectrum space to meet their needs. It was common at many flying fields for a strong signal from a passing mobile CB rig to completely disrupt operations.

An organized effort, begun in 1963 and led by officers of the AMA, culminated in 1966 with the FCC's approving five new frequencies for R/C operation: 72.08, 72.24, 72.40, 72.96, and 75.64 MHz. In 1971, 72.16 and 72.32 MHz were added to the list.

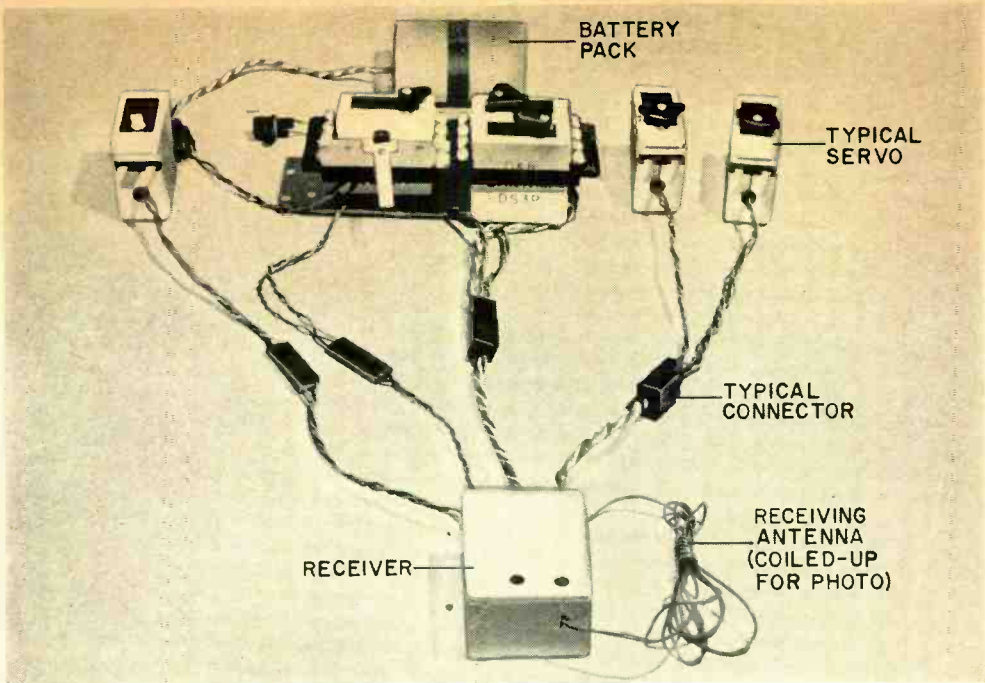

Airborne control package provides one to eight channels depending on transmitter used.

you must familiarize yourself with Volume VI, Part 95 of the FCC Rules and Regulations (obtainable from: Superintendent of Documents, Government Printing Office, Washington, DC 20402 for \$1.25) pertaining to the Citizens Radio Service. Then fill out FCC Form 505 (get it from: Federal Communications Commission, Washington,

Tiny Ace R/C Microgem pulse receiver is not very much bigger than an ordinary quarter.

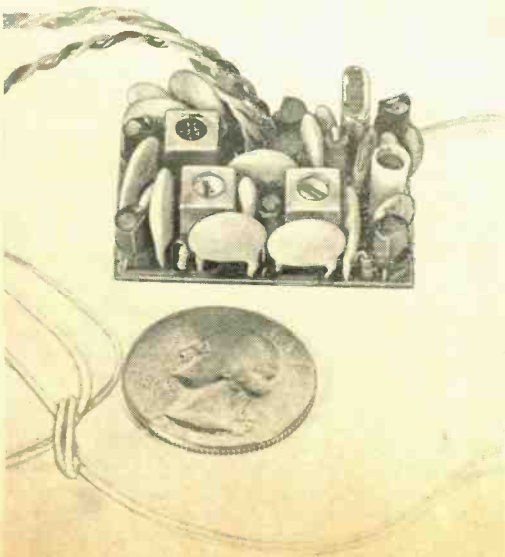

DC 20544) and mail it with a check or money order for \$20 to: Federal Communications Commission, Gettysburg, PA 17325. The \$20 fee covers station licensing for five years. The station license covers all transmitters listed by you on Form 505 and bears your call letters.

The ham license required for R/C operation on 50 to 54 MHz offers the advantage of being able to become active in other ham communications. You must pass a 5-wpm code test and a simple written test. Try to get your technician ticket at the outset. A novice ticket is good for only two years, after which you must pass the technician test to remain a ham.

**Summing Up.** Many hobby shops stock everything you need for R/C modeling. Your investment for electronic gear can be as low as \$50 for the most basic single-channel pulse-type system to several hundred dollars for the most sophisticated multi-channel digital-proportional system. For more information about R/C gear, you might write to the companies listed in the accompanying table.

We are planning additional coverage of various R/C systems and how they work in a future issue. Watch for it. ◆

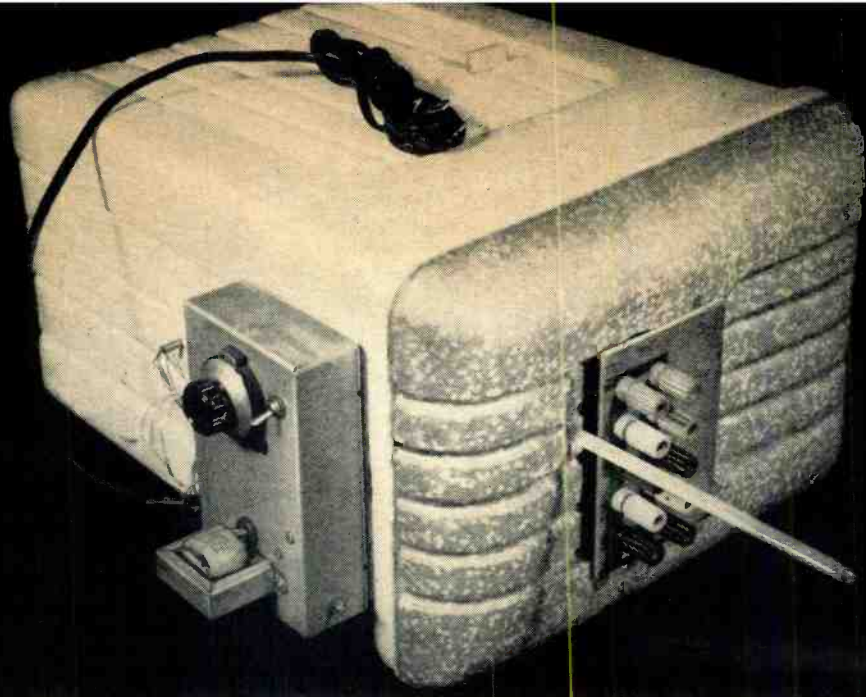

---

## TEST BENCH

---

# BUILD THE TORTURE BOX

MINIATURE ENVIRONMENTAL TEST CHAMBER CAN BE SET  
FROM 14°F TO 158°F WITH 1-DEGREE ACCURACY **BY RALPH TENNY**

**WE ALL** know how strict the temperature tolerance specifications are on components and systems for military and space applications; but do we ever stop to think whether the projects we build in our workshops will operate satisfactorily "in the field"? A fire detector, for example, that works fine in the controlled conditions of the workshop can go haywire in an attic in the summer when the temperature can reach 140°F. A metal locator may operate quite differently in the coolness of the forest in the fall and in the heat of summer on the beach.

Maybe it's time to take the guesswork out of building for unusual temperature ranges and install your own temperature test cham-

ber, simply by building the Torture Box described here. It can be used to test circuits at temperatures from below  $-10^{\circ}\text{C}$  (14°F) to  $+70^{\circ}\text{C}$  (158°F). Of course, this range is probably more than you will need since it exceeds the range of many commercial components.

The Torture Box is a low-cost project that provides a change of pace for experimenters. The electronic circuits are fairly simple, but the project uses a combination of materials and techniques that is a little different. The basic box is an ordinary molded plastic picnic-type cooler. All sub-assemblies in the Torture Box are fastened to thin pieces of plywood or wall-panel



material, which are fastened to the plastic using either white furniture glue or aliphatic (fatty, acrylic) resin. Do not use an aromatic glue or cement!

The operating range of the Torture Box can be extended, but temperatures higher than 80°C (176°F) should not be attempted since they may soften the plastic. A large quantity of dry ice will lower the temperature below -28°C (-18°F), but the non-linearity of the control thermistor may hamper control below about -10°C.

**Construction.** Select a picnic cooler of sufficient internal volume. The one shown in the photos of the prototype is 12" by 9" by 12" and has an internal volume of about 700 cu in.

The assembly of the small mechanical

units that are attached to the chamber is described in the following paragraphs. Plan the location of these units in your particular cooler so that the weight distribution will not cause the finished chamber to tip. (Remember that the basic cooler is very light compared to the weight of the mechanical subassemblies.) As shown in the photos, the cooler was placed on its wide side, and four small pieces of a similar plastic were glued to the bottom to serve as feet. Use a sharp instrument to make the required openings and holes. Keep the hot soldering iron away from the plastic. The cover should be tight fitting. If necessary, some type of locking device can be used.

**Fan Motor.** Any small motor is suitable. In the prototype, a shaded-pole motor/fan combination originally intended for elec-

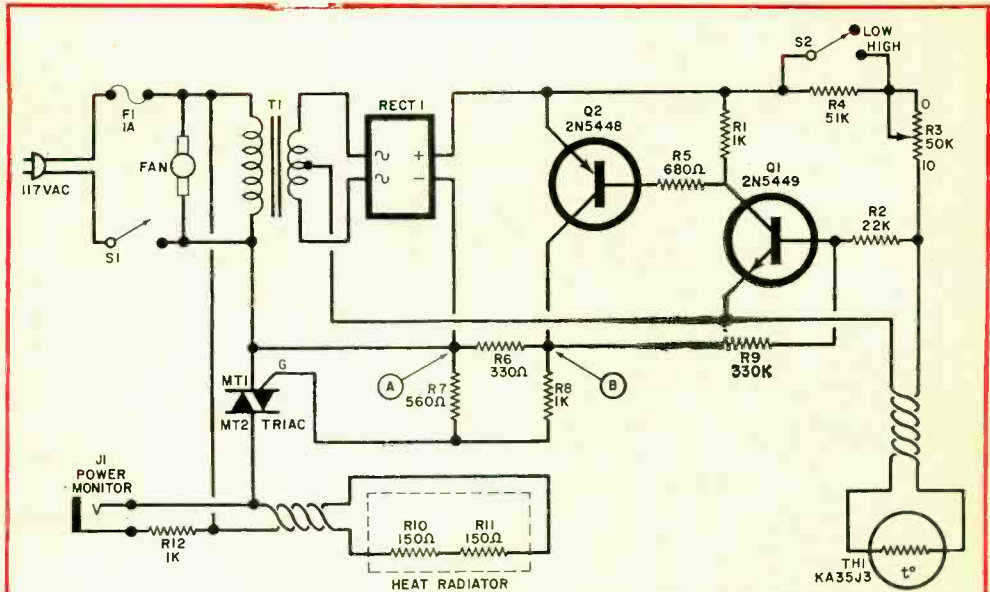

Fig. 1. Thermistor TH1 senses the heat radiated by power resistors R10 and R11.

#### PARTS LIST

F1—1-ampere fuse and holder  
 J1—Open-circuit jack (Calectro F2-842) or neon lamp (Radio Shack 272-1105)  
 Q1—2N5449 transistor  
 Q2—2N5448 transistor  
 R1,R8,R12—1000-ohm, ¼-watt resistor  
 R2—22,000-ohm, ¼-watt resistor  
 R3—50,000-ohm potentiometer  
 R4—51,000-ohm, ¼-watt resistor  
 R5—680-ohm, ¼-watt resistor  
 R6—330-ohm, ¼-watt resistor  
 R7—560-ohm, ¼-watt resistor  
 R9—330,000-ohm, ¼-watt resistor  
 R10,R11—150-ohm, 50-watt resistor (Dale RH-50 or similar, with heat-sink mounting)

RECT1—50-volt, 2-ampere rectifier (Radio Shack 276-1151)  
 S1,S2—Spst slide or toggle switch  
 T1—Transformer—12.6-VCT. 0.1-A secondary (Calectro DI-750)  
 TH1—Thermistor (Gulton 35TF1, Fenwal KA35J3, YS144007)  
 TRIAC—RCA 40529  
 Misc.—Small shaded-pole motor and fan (see text), plastic container, white glue, ¼" x ¼" pine stock, 4" brass tube, sheet metal, wire screen, thermometer, perf board, mounting clips, sockets, control dial (Radio Shack 274-605), five-way binding posts, plywood, mounting hardware, etc.

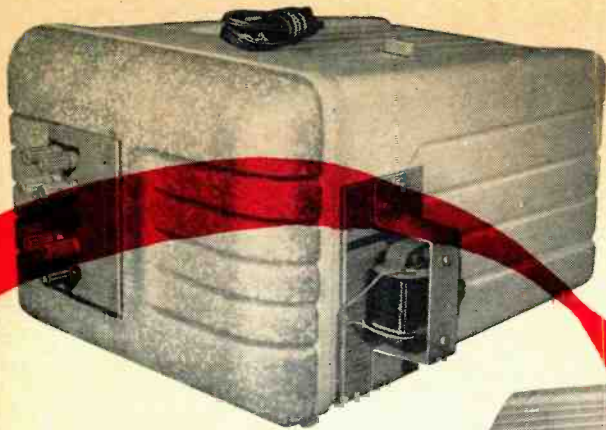

Fig. 2



Fig. 3

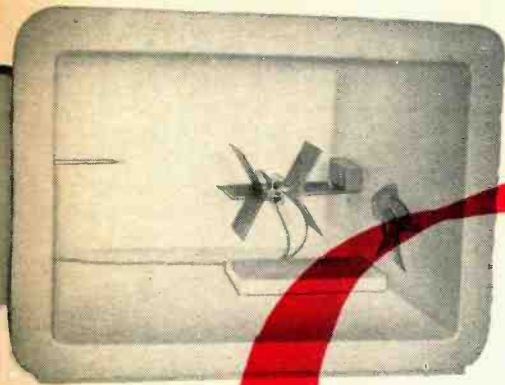

Fig. 4



Fig. 5

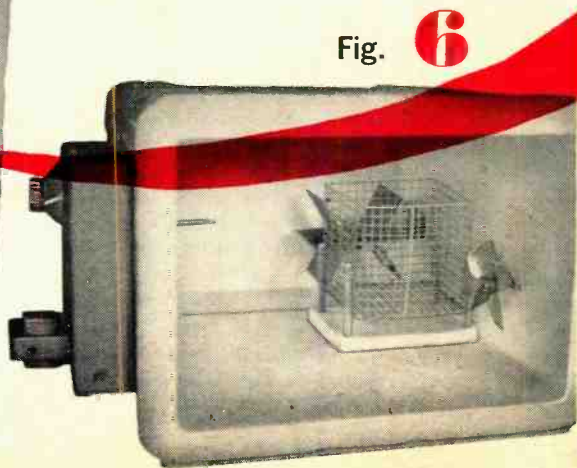

Fig. 6

tronic chassis ventilation was used. After drilling a hole for the motor shaft in the cooler wall, bend a mounting bracket or  $\frac{1}{16}$ " aluminum to secure the motor to the wooden mounting plate. Extend the motor shaft (using tubing) so that the fan will be located about  $\frac{3}{8}$ " inside the cooler. Attach the motor mounting to the cooler as shown in Fig. 2.

**Control Circuit.** The control circuit is mounted in a suitable chassis, the bottom plate of which is affixed to the cooler on the side opposite the fan as shown in the photo in Fig. 3.

With the exception of the thermistor (TH1), the triac, T1, R10, R11, and potentiometer R3, the circuit can be assembled on a small perf board, which is mounted in the upper portion of the control chassis. Potentiometer R3 is mounted on the front panel and provided with a vernier dial drive.

The thermistor is connected to the end of a length of twisted-pair wire which is fed through a narrow tube 3" or 4" long. The tube is then inserted through the Styrofoam so that the thermistor is located within the box and the twisted pair can be connected to the perf board. The triac is mounted on a small heat sink isolated from the metal chassis. Range switch S2 and power monitor connector J1 are mounted on the front panel. The transformer is mounted on the outside of the control chassis.

Power resistors R10 and R11 are mounted on a three-piece heat radiator whose configuration is shown in Fig. 4. The radiator consists of three pieces of thin brass sheet at least 2" wide and 4" long. Use heat-sink grease between the pieces of the radiator and between each power resistor and heat sink.

When the electronic assembly is complete, temporarily disconnect the triac and connect a 10-volt dc voltmeter between points A and B of Fig. 1. With R3 set to a low resistance, no dc voltage should be indicated between the test points. As the resistance of R3 is increased, a 10-volt signal will appear. Make a check for both positions of range switch S2 and note that the dc voltage appears at a much higher resistance on R3 when S2 is in the low range. If everything is OK, disconnect the unit from the power line and replace the triac.

**Air Baffle.** The baffle covers the fan and directs the air to the rear and thus counter-clockwise around the interior of the chamber. The layout is shown in Fig. 5. The baffle is

made of thin metal stock but you should make a pattern using a piece of paper first to get the proper size and configuration. The baffle will be fixed to the side wall and bottom of the box using  $\frac{1}{4}$ " square pine blocks. Once the shape has been determined, cut the metal stock and install.

**Ice Basket.** The basket is an open-topped cube, about 3" on each edge, made of wire screen. Four  $\frac{1}{8}$ " round dowels are glued to the corners with epoxy and the dowels are used to secure the basket to a plywood or plastic plate which is secured to the base of the chamber as shown in Fig. 6. When the basket is in place, cut a small hatch directly over it as shown in Fig. 7. Note that the hatch is cut with sloping sides so that the cover cannot drop into the cooler. Any small handle can be used on the cover.

**Input Terminal Block.** A minimum of ten 5-way color-coded binding posts should be provided for input, output, and power supply connections to the equipment being tested. The terminals are affixed to a piece of plywood as shown in Fig. 2, with their leads protruding through the cover of the cooler.

**Internal Circuit Board.** As shown in Fig. 8, the internal terminal block is made from a  $4\frac{1}{2}$ " by 6" glass-epoxy laminated board mounted in a frame of  $\frac{1}{4}$ " pine strips so that the board is far enough from the cover to be well within the chamber. Make sure that the wooden frame is waterproofed with varnish. The various input binding posts can be connected to color-coded perf-board pins on one edge of the board. Various combinations of sockets and perf-board pins can be attached to the board for testing different types of circuits.

Note also, in Fig. 8, that a conventional laboratory-type immersion thermometer is inserted through the cover to check the internal temperature. The thermometer must have an appropriate temperature range so that it can be read from the outside of the chamber.

**Test and Calibration.** Recheck the mechanical assembly of all cooler-mounted components, making sure that all elements are firmly secured and that all glued joints are hard and dry. Recheck all the wiring in accordance with Fig. 1. Keep in mind that power-line ac is present on some leads and be very careful to avoid the possibility of an electrical shock.

Set the vernier dial on R3 to 10 and slip

## HOW IT WORKS

The environmental chamber creates hot or cold temperatures by balancing a heater against the cooling effect of dry ice. A fan continuously circulates the air in the chamber, while a thermistor-controlled regulator circuit (Fig. 1) adjusts the temperature to the desired value, which is set on a dial. Transistors *Q1* and *Q2* form a complementary Schmitt trigger which normally has about 1.5 volts of lag (hysteresis). Since the trigger is powered by full-wave rectified dc with no filtering, the circuit voltage sweeps from zero through about 17 volts at a rate of 120 times per second. This varying power reduces the hysteresis to a few millivolts and thus provides control to  $\pm 1$  degree.

If the thermistor resistance is below the set point (temperature dial setting), both *Q1* and *Q2* are cut off and *R7* keeps the triac cut off. As the chamber cools, the thermistor resistance increases until *Q1* starts to turn on. Shortly after that *Q2* turns on and feedback through *R9* increases the turn-on signal for *Q1*, causing the trigger to snap full on. A pulse of current through *R8* turns on the triac until the end of that half cycle of ac power. As the power passes through zero, the triac turns off and the cycle starts again. If the thermistor resistance is greatly out of balance, the triac will be turned on early in each cycle; a small unbalance will delay the triac turn-on until late in the cycle. Consequently, heating power (triac current in *R10* and *R11*) is applied in proportion to the difference between the actual temperature measured by the thermistor and the temperature set by the control dial.

Range switch *S2* and potentiometer *R4* extend the control range to low temperatures, without losing the resolution on *R3*. Consequently, the set point resolution approaches 1°F per division on the specified control dial.

the shaft of *R3* until the in-circuit resistance is about 3000 ohms. Set the range switch to high and set the control dial to zero. Connect a 150-volt ac meter to *J1* and, with a thermometer inserted into the chamber, turn on the power. The fan should start to run and the voltmeter should indicate zero.

Advance the temperature control dial toward 10 until the voltmeter indicates upscale and note the dial indication. Advance the control toward the next major dial graduation and wait until the voltmeter shows that the heater power is cycling on and off every four or five minutes. Record the dial indication and the thermometer temperature. Continue this process until the control dial has

reached 10 or the temperature reaches 70°C (158°F). Slip the shaft on *R3* until the 10 on the temperature control dial causes the temperature to stabilize at 70°C.

Set the range switch to low and the temperature dial to 5. Put approximately 3 cu in. of dry ice into the ice basket (through the small hatch on the top) and operate the system until the voltmeter shows that the heater circuit is cycling. Note the temperature and try new settings until the dial setting for 0°C (32°F) is found. At this point, the operation has been checked and the end points of the operating range have been found and calibrated. You can now fill in a calibration chart by recording temperatures at other major dial settings on both ranges. Here is a typical calibration chart.

Control Dial Settings (Major Div.)	Temperature (°F) (S2 Position)	
	(Low)	(High)
0	7	43
1	10	49
2	13	55
3	18	60
4	21	66
5	24	74
6	29	86
7	32	94
8	38	108
9	—	129
10	—	161

One-half pound of dry ice (usually available from ice cream stores) is sufficient for most tests. *Do not* handle dry ice with the bare hands as severe frostbite can result. A wide-mouth thermos bottle can be used to store dry ice for as long as 8 hours, but *do not* close the lid tightly. Long-term storage of dry ice is essentially not possible for the home experimenter, but between 25% and 50% of a given amount will remain after 24 hours if stored in a good thermos. To break dry ice into chunks, wrap it in a heavy cloth and pound with a hammer.

The power monitor jack (*J1*) can be replaced with a neon lamp if desired since, once the monitor is calibrated, there is no further need for the jack—unless recalibration becomes necessary.

**Using the Chamber.** To test a circuit, you can assemble the circuit on the chamber's internal perf board or attach a finished board to the internal board mounts. Connect the power leads, inputs, and outputs to the cover



Fig. 7

binding posts and check for normal operation of the circuit with the chamber at room temperature.

Then supply power to the chamber, set the desired elevated temperature and see how your circuit works. If it passes this test, cool the chamber, checking circuit operation along the way. If the circuit doesn't pass the temperature test or (more commonly) if its operation drifts with temperature, the circuit must be temperature-compensated to limit drift to allowable levels. This means selecting components whose temperature coefficients compensate for temperature change or adding components that drift in the opposite direction.

The term "temperature coefficient" simply means how much a component will change in value with changes in temperature. This is usually expressed as % per °C. For example, a fixed resistor of 1000 ohms having 0.1%/°C temperature coefficient will change

1 ohm for each 1°C change in temperature. A +0.1%/°C coefficient indicates that the resistor will increase 1 ohm for each 1°C change in temperature. If the 1000 ohms is measured at 25°C, the resistor will measure 1050 ohms at 75°C and 975 ohms at 0°C.

There are capacitors with either positive or negative temperature coefficients. Most thermistors are resistors with negative temperature coefficients, though some companies also make thermistors with positive temperature coefficients. Also, silicon or germanium diodes can be added to a circuit to compensate for temperature drifts in transistors of the same material.

As an example of temperature compensation, consider the circuit in Fig. 9A, where Q1 is a current source feeding a load,  $R_x$ . Resistors  $R_1$  and  $R_2$  set the reference level, while  $R_3$  determines the amount of current flowing through the load. As the circuit elements heat up, the current through Q1 will

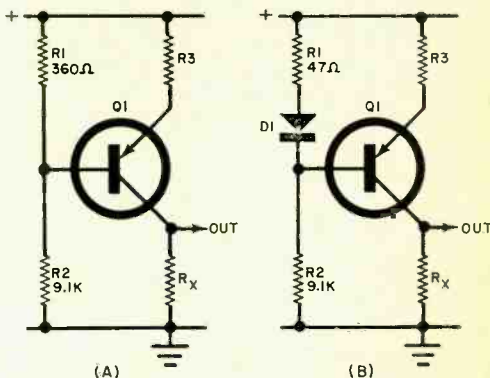

Fig. 9. Temperature compensation circuits.

start to increase, thus increasing the load current. One way of compensating for this increase is shown in Fig. 9B, where a diode has been added in series with Q1. If Q1 is a silicon type, the diode must also be silicon. The modified circuit acts exactly the same as before except that the reference voltage is now the voltage across  $R_1$  and  $D_1$ . Resistor  $R_2$  helps to control the current through the diode, but has less effect than it did in Fig. 9A.

To make a complete and proper compensation of load current with temperature, it is now necessary to vary  $R_2$  and  $R_3$  to get the desired current level and good stability with changes in temperature. You will see this method of temperature compensation used in many commercial units. ♦

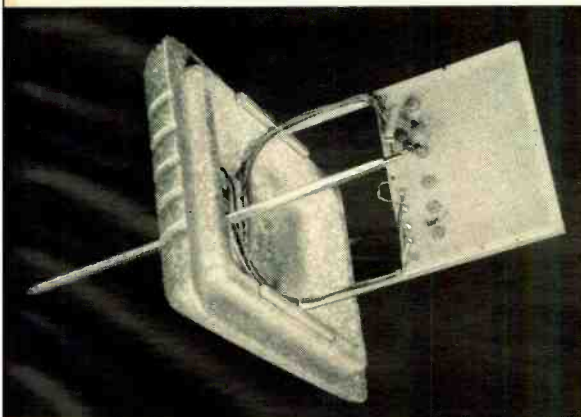
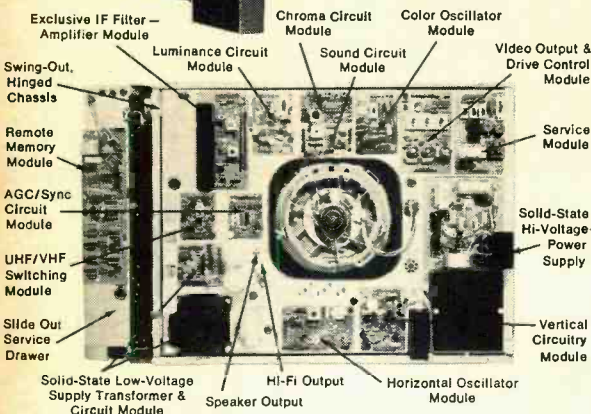
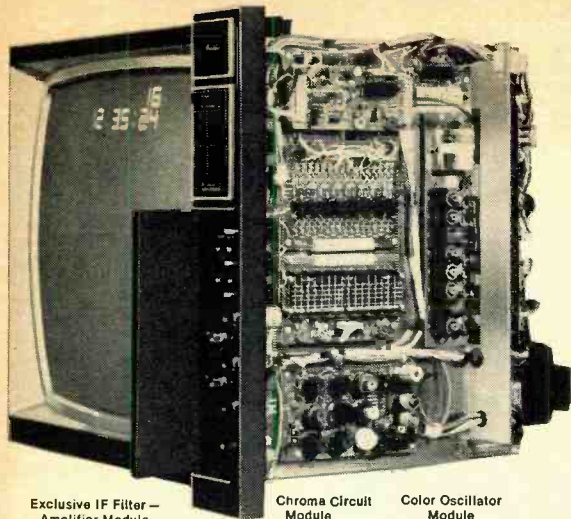

Fig. 8

# The all-new digital-design

It offers you these important advances in technology, quality, and performance:



**Programmable Channel Selection** through digital up-down counter with computer-like programming board.



**100% Solid-State Design** — the picture is the only tube-type device.



**Silent All Electronic Tuning** with new combination UHF/VHF Varactor Tuner located inside the chassis — completely shielded.



**Touch Tuning** at front panel (or remote) — touch to change channels up or down — hold in to sweep all channels.



**On-Screen Channel Readout** — big, bright 1½" numerals for both UHF and VHF.



**On-Screen Clock Readout** gives time in 4 or 6-digit format, 12 or 24 hour time.



**Fixed Filter IF** totally eliminates instrument IF alignment forever.



**19 Integrated Circuits** simplify kit building and permit ultra-sophisticated technology with long-term reliability.



**Solid-State Hi-Voltage Supply** in tripler configuration for efficiency and long life.



**Solid-State Low-Voltage Supply** has short-circuit proof integrated circuit regulators.



**New Deluxe Black (Negative) Matrix Picture Tube** — fully illuminated color dots with black background matrix for greater brightness and contrast — new, etched, face plate reduces glare.



**New Vertical Sweep Design** gives better picture interlace, improved picture detail; complementary power transformers eliminate output transformers for better linearity.



**True Digital Design Dot Generator** makes picture convergence easier and more precise.



**Twelve Wiring Harnesses** — pre-fabricated, connectors installed, pre-stripped, ready to solder — this TV is easier to build.



## Eleven-Function Touch-Tune Remote Control for the Heathkit GR-2000... 79.95\*

This all solid-state ultrasonic system utilizes 13 integrated circuits, 28 transistors to give you wireless arm-chair control of on and off, volume, VHF/UHF channel selection, up or down color intensity, and tint. Plus, a touch of the volume button automatically recalls the digital readout to the screen. Kit includes receiver for in-chassis mounting and hand-held transmitter. Operates from 20-feet away from set.

Kit GRA-2000-6, 4 lbs. .... 79.95\*

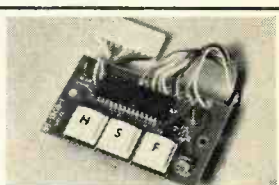

## Optional Digital Clock for your GR-2000

In just a couple hours' time you can build the GRA-2000-1 Digital Clock Accessory. Everything mounts on one small board that plugs into the readout board in the GR-2000 service drawer. That's all there is to it. Clock circuit board has slow, fast and hold pushbuttons for setting time, jumper wire for selecting 12 or 24-hour format. You set your on-screen display for hours and minutes, or hours, minutes and seconds using the programming circuitry on the channel readout board. Order with your GR-2000, or add it on later, if you prefer.

Kit GRA-2000-1, Digital Clock Accessory, 1 lb. .... 29.95\*

# Heathkit GR-2000 Color TV

Three years ago, in response to your requests, we set out to design a truly unique color TV. We have. It uses digital design techniques unusual to TV technology. The result is spectacular.

The 100% solid-state GR-2000 25V color TV — it silently selects channels with digital-logic accuracy — it displays the channel digits on the screen — it displays the time digits on the screen — it uses a fixed filter IF that never needs alignment — it uses more integrated circuitry than any other set. Yet the kit-building process is now easier than ever.

**Silent, All-Electronic Touch-Tuning** — no knobs to turn, no noisy turrets, no humming motors and no mechanical contacts to clean. Now you just touch a button on the front panel or optional remote control transmitter and the new programmable Digital Counter silently sweeps up or down through any 16 preselected stations. Release the button and the new UHF/VHF Varactor Tuner is precisely locked-in on the channel of your choice.

You program up to 16 channels into the Touch-Tune System located in the convenient slide-out service drawer. You can program any channels in any sequence, interspersing UHF with VHF, even programming the same channel to appear more than once if you like.

After you have programmed a channel-selection sequence, Automatic Fine Tuning keeps picture and color consistent from station to station. The UHF/VHF Varactor Tuner is positioned inside the chassis, away from the control panel. This helps keep the picture free of spurious signals that find their way into front-mounted tuners.

**The channel number is seen on the screen** — The Heath-designed On-Screen Electronic Digital Channel Readout has bright white numerals that are easy to see — from across the room, from any viewing angle. Each time you change channels, using the Touch-Tune button either on the set or on the remote control, illuminated digits (adjustable brightness) identify the UHF and VHF stations as you cycle through the channels. After stopping at a desired program, the readout remains on for as long as you want, up to 1½ minutes, or stays on all the time...the choice is yours. You pre-program the Digital Channel Readout to your requirements with a computer-like programming board located in the service drawer. When the readout is timed to shut off after a few moments, it can always be recalled by changing channels or by tapping the volume "down" button. What's more, you can position the readout anywhere you want it on the 25V screen and adjust its brightness for optimum contrast with the overall picture. The digital readout generator uses a custom designed MOS large scale integrated circuit containing the equivalent of over 2000 transistors, plus diodes, and resistors.

The new Heath Electronic Digital Channel Readout completely eliminates the confusion often found with mechanical tuning devices — especially when trying to find an elusive UHF station. And it makes across-the-room remote control tuning easier than ever.

**We even changed the way you adjust the sound** — With the GR-2000 a touch of either of two buttons automatically raises or lowers the sound in a series of small steps. Just hold the button down until the sound level is right where you want it. This also controls the volume of the Hi-Fi Sound Output (to your separate amplifier) so you can control it with your remote transmitter.

**Build-in an optional Electronic Clock with Digital On-screen Readout** — true digital circuitry gives you the time in four-digit, six-digit, 12-hour or 24-hour format. A programming board in the slide-out service drawer lets you set your clock to display time the way you want to see it. The on-screen display appears directly below the channel numeral in same-size 1½" digits. And when you add the clock option, it becomes an integral part of the channel display, responding to the same controls. It can be positioned anywhere on the screen with the channel digits, remains on for the same pre-set length of time, or remains on constantly. For setting the time, Hold, Fast and Slow pushbuttons are located in the service drawer. And once set, the electronic clock continues to run even when the set is off, unless the set's Master Switch has been turned off. In normal operation, whenever the set is turned on and the on-screen display is activated, the time is right to the second.

**A Heath-designed IF Filter sets this TV apart from all others** — You wanted truly superior color reception, particularly in urban areas where multiple transmitters are located or where multi-channel cable service is available. So we designed a fixed LC-type filter with an IC IF amplifier...a "first" in the television industry, and you can

have it now with the Heathkit GR-2000. This unique circuitry produces an ideally shaped bandpass that greatly reduces adjacent-channel interference. And, this totally new approach to IF design gives the GR-2000 another equally important plus — a consistently excellent color picture, year after year with no need for periodic Instrument alignment. The GR-2000 IF system eliminates the highly critical traps that go out of adjustment because of normal component value changes through aging. In short, the Heathkit GR-2000 will maintain its best picture longer than any set with ordinary IF design.

**Add Total Touch-Tune Remote Control** — it's an all solid-state ultra-sonic system that lets you select UHF/VHF channels, control volume, color tint and intensity, on and off. And you do so from as far as 20 feet from the set. The channel selector and volume buttons on the remote also may be used to return the channel and clock readouts to the picture screen whenever you wish.

**The easiest-to-build color TV we've ever offered** — We said 100% solid-state. And for the GR-2000 that means 19 integrated circuits (33 including the remote and clock), 71 transistors, all of which mount in sockets; 20 glass-epoxy circuit boards; and 12 cables. Imposing? Perhaps, but actual assembly operations for this kit have been greatly simplified. The GR-2000 has fewer point-to-point connections, more ICs, more modular circuit boards, more prefabricated wiring harnesses and cables, and fewer chassis-mounted parts to make it easier to build.

Here's what all those solid-state components do for you to produce truly exceptional color entertainment. To start off, there is DC controlled contrast for less picture interference. An IC color amplifier for truer colors. An IC color oscillator and automatic phase control for more precise and reliable tints. An IC automatic gain control for improved sensitivity, stability and noise immunity. Improved picture interlace for remarkable image definition and crispness. A new solid-state high voltage rectifier. Short-circuit-proof IC regulators eliminate component damage through accidental shorts. Dual VHF antenna inputs, 300 ohm balun for your twin-lead antenna, true 75-ohm for proper cable TV and coax hook-up. Exclusive Heath Magna-Shield Chassis to keep stray magnetic fields from interfering with picture quality.

**New, latest-design picture tube** — a deluxe Black (Negative) Matrix 25V picture tube now with fully illuminated dots with black "surround" and new, etched, face plate...it all adds up to brighter, more vivid pictures with reduced glare and reflections and greater contrast.

**New exclusive Heath self-service features** — no other manufacturer offers them to you at any price. Built-in service facilities such as a new digital-design true dot generator, purity and convergence adjustments; test meter; new vertical and horizontal centering circuits; new Top-Bottom-Sides pinch cushioning corrections; new "Service" circuit board puts everything in an easy-to-find place.

We set out to design the most advanced and unique color TV available today...we believe the performance of the set will speak for itself. The new digital-design Heathkit GR-2000...it will change your mind about color TV.

**Kit GR-2000, 147 lbs. . . . . 649.95\***

Four new cabinet designs from \$139.95\*, see catalog.

**Send for FREE Heathkit catalog.**

## HEATHKIT ELECTRONIC CENTERS

Units of  
Schlumberger Products Corporation  
ARIZ.: Phoenix; CALIF.: Anaheim, El Cerrito, Los Angeles, Pomona, Redwood City, San Diego (La Mesa), Woodland Hills; COLO.: Denver; CONN.: Hartford (Avon); FLA.: Miami (Hialeah); TAMPA: GA.: Atlanta; ILL.: Chicago, Downers Grove; IND.: Indianapolis; KANSAS: Kansas City (Mission); KY.: Louisville; LA.: New Orleans (Kenner); MD.: Baltimore, Rockville; MASS.: Boston (Wellesley); MICH.: Detroit; MINN.: Minneapolis (Hopkins); MO.: St. Louis; NEB.: Omaha; N.J.: Fair Lawn; N.Y.: Buffalo (Amherst), New York City, Jericho, L.I., Rochester, White Plains; OHIO: Cincinnati (Woodlawn), Cleveland, Columbus; PA.: Philadelphia, Pittsburgh; R.I.: Providence (Warwick); TEXAS: Dallas, Houston; WASH.: Seattle; WIS.: Milwaukee.

HEATH Schlumberger	
HEATH COMPANY, Dept. 10-2 Benton Harbor, Michigan 49022	
<input type="checkbox"/> Please send FREE Heathkit Catalog	
<input type="checkbox"/> Please send model(s)	
Enclosed is \$ _____	
plus shipping.	
Name _____	
Address _____	
City _____	
State _____ Zip _____	
* Mail order prices; F.O.B. factory.	
CL-494R	

**CIRCLE NO. 5 ON READER SERVICE CARD**



**CONSTRUCTION**

## Single-IC Capacitance Meter



MEASURES FROM 100 pF TO 1  $\mu$ F ON A LINEAR METER SCALE

BY HARRY GARLAND AND ROGER MELEN

**T**HERE are meters available to the electronics experimenter and service technician that can be used to measure just about any quantity in electronics. However, when it comes to measuring capacitance, the meter is probably complex and expensive. There are some instruments that have a capacitance measuring feature; but they usually have some form of bridge circuit that requires the nulling of a meter through the simultaneous operation of two or more (sometimes interacting) controls. In using this type of instrument, it is often difficult to find the correct meter null unless the approximate value of the capacitance is known before the measurement begins.

The simple capacitance meter described here is very easy to use, requiring only the connecting of the unknown capacitance to a pair of binding posts and operation of a single rotary switch. When the correct range is found, the meter will indicate up-scale to give the capacitance value. The indications on the meter scale are linear and the instrument covers a range from 100 pF to 1  $\mu$ F. If desired, an external digital multimeter or VTVM can be used as the readout instead of the built-in meter. Since the meter is powered by batteries, its operation is independent of the power line.

**How It Works.** Most of the circuit (Fig. 1) is contained on a single IC, a CMOS quad NOR gate whose extremely low power requirement ensures long battery life.

Gates *IC1A* and *IC1B* are connected to form an astable multivibrator whose frequency of operation is determined by the value of *C1* and a resistor selected by *S1A*. This signal is coupled through *C2* to trigger *IC1C* and *IC1D*, wired as a monostable pulse generator whose output pulse duration is determined by the value of the unknown capacitance (*Cx*) connected between *J1* and *J2* and the resistance value selected by *S1B*. If the selected resistor value is accurately known, the output pulse duration is then determined by the unknown capacitor.

In the prototype meter shown in the photo, the output pulse duration is measured by the circuit shown in Fig. 2A, where the readout is on a milliammeter. In this circuit, *Q1* is used as a saturating switch while *R8* is used to calibrate the meter. Since the meter indicates dc current flowing through *Q1*, and since the amount of dc current is directly related to the pulse duration, the meter can be calibrated directly in capacitance. Capacitor *C4* is used to integrate the dc pulses appearing across the meter; it thus removes the ac component.



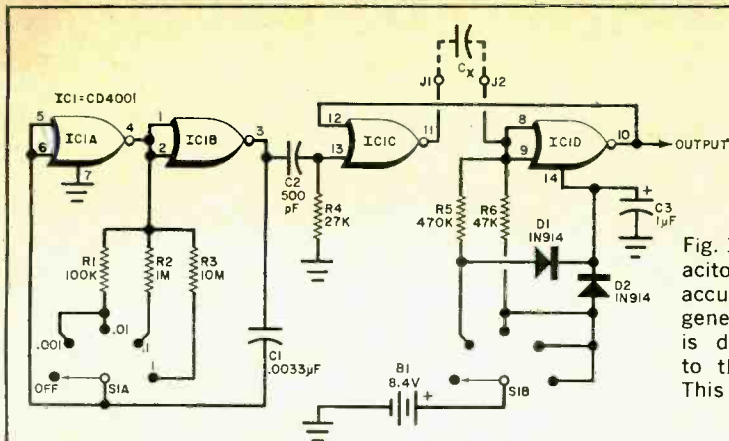

Fig. 1. The unknown capacitor forms part of an accurate pulse duration generator, whose output is directly proportional to the unknown value. This output is metered.

### PARTS LIST

- B1—8.4-volt or 9-volt battery
- C1—0.0033- $\mu$ F capacitor
- C2—500-pF capacitor
- C3, C5—1- $\mu$ F capacitor
- C4—2000- $\mu$ F electrolytic capacitor
- D1, D2—1N914 silicon diode
- IC1—CD4001 CMOS quad NOR gate
- J1, J2—5-way binding posts
- Q1—2N3565 transistor
- M1—0-1-mA, dc meter
- R1, R11—100,000-ohm,  $\frac{1}{4}$ -watt, 5% resistor
- R2—1-megohm,  $\frac{1}{4}$ -watt, 5% resistor
- R3—10-megohm,  $\frac{1}{4}$ -watt, 5% resistor

- R4—27,000-ohm,  $\frac{1}{4}$ -watt, 5% resistor
- R5—470,000-ohm,  $\frac{1}{4}$ -watt, 5% resistor
- R6—47,000-ohm,  $\frac{1}{4}$ -watt, 5% resistor
- R7—10,000-ohm,  $\frac{1}{4}$ -watt, 5% resistor
- R8—5000-ohm potentiometer
- R9—470-ohm,  $\frac{1}{4}$ -watt, 5% resistor
- R10—2700-ohm,  $\frac{1}{4}$ -watt, 5% resistor
- R12—100,000-ohm potentiometer
- S1—2-pole, 5-position rotary switch
- Misc.—Perf board, suitable chassis, switch knob, mounting hardware, etc.

Note—A kit of all the above parts (not including case) is available from the authors, 565 Arastradero, Suite 310, Palo Alto, CA 94306, for \$19.95, postpaid.

The circuit in Fig. 2B is used when an external digital voltmeter or VTVM (1-volt dc range) is used as the readout instead of M1. In this circuit, R11 and R12 operate as a voltage divider while C5 filters out the ac component.

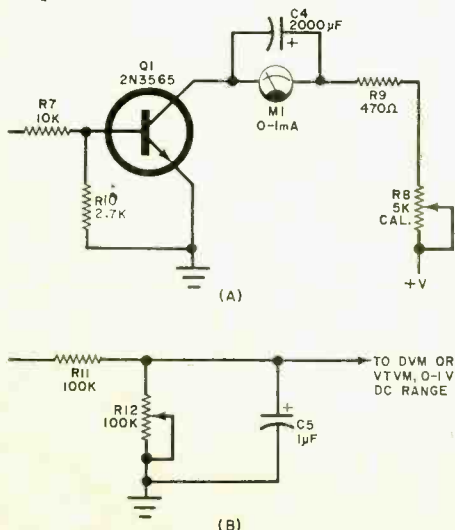

Fig. 2. (A) is used when you desire built-in metering, and (B) for external metering.

**Construction.** The circuit can be assembled on a piece of perf board, using a socket for IC1. Switch S1, the two binding posts and the meter (if used) are mounted on the front panel of the selected chassis. The battery is mounted in a holder on the perf board.

**Calibration.** Connect a known value of capacitance (5% or better tolerance) between J1 and J2. Place the range multiplier switch, S1, in the appropriate position and adjust R8 until the meter indicates the correct capacitance. If you are using the external metering device, set it to its 1-volt dc range and adjust R12 for the correct indication. The calibration on one range suffices for all other ranges.

The accuracy of the instrument is limited by the accuracy of resistors R1, R2, R3, R5, and R6. Although 5% tolerance is adequate in most cases, you can use more precise resistors or trim each range individually with small potentiometers. If you decide to trim each range separately, use a separate precision capacitor for each range. Trim R1 before trimming R5. ♦



# VHF/UHF SCANNING MONITORS

## A COMPREHENSIVE BUYING GUIDE



WIDE VARIETY OF MODELS  
FOR LISTENING TO POLICE, FIRE, AND WEATHER

BY HERB FRIEDMAN

**B**ACK in the not too distant past, outside of the people directly involved in emergency services (fire, police, smoke jumpers, etc.), there were few eavesdroppers on the Public Safety frequencies—those parts of the radio spectrum from 30 to 50 MHz (low band) and 152 to 174 MHz (high band). But when SWL's and the general public discovered they could listen in on private radiotelephone calls, hear weather reports, and monitor the G-men on a stake-out, police-fire radios (vhf monitors as they are more commonly termed) became the hottest thing in consumer electronics since CB.

Since we have just about run out of available frequencies, many other services have been crowded into what were the old police-fire bands; the crowding became

so bad, in fact, that it was necessary to open up another Public Safety band—the so-called uhf band between 450 and 470 MHz. Today, the three Public Safety bands still have the old police and firefighters, plus air rescue, marine ship-to-shore, police walkie-talkie, common-carrier, regional weather forecasts, back-country search and rescue, and just about any other safety service imaginable.

The fact is that some of the most interesting radio "programs" can be found on the Public Safety frequencies rather than on the broadcast band. No news report or fictional radio or TV show can truly duplicate the high adventure of actually listening to police track a thief through your local shopping center, or to your local Coast Guard crew handling a marine disaster.



Teaberry Crimefighter



Pace 108



Sonar FR-2516



Robyn Hi-Bander



Tenneiec Tennetrac IV



Radio Shack Realistic Pro-88

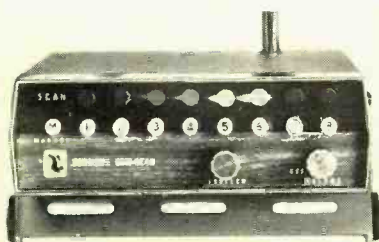

E. F. Johnson Duo-Scan

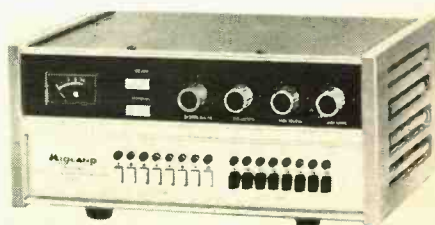

Midland 13-950

# VHF/UHF SCANNING MONITORS

Manufacturers and model	Price (\$)	No. of Channels	Bands	Features
<b>Electra</b>				
JR-1H;-1U	80	2	Hi vhf; uhf	Has AM BCB radio, portable
Bearcat III	140-160	8	Any 2 of 3	R-f plug-in modules select bands
<b>Heath</b>				
GR-110	120	8	Hi vhf	Digital channel readout, kit
<b>Hy-Gain</b>				
618	130	10	Any 1 of 3	R-f plug-in module selects band
625;626	150	4	Hi vhf; uhf	Pocket size
<b>E. F. Johnson</b>				
Duo-Scan	170	8	Lo, hi vhf	Dual conversion, mobile or base
High-Band, UHF	180	8	Hi vhf, uhf	Same as Duo-Scan
Mono-Scan	140;160	8	Hi vhf; uhf	Two separate models
<b>Lafayette</b>				
Moniterscan-8	100	8	Hi vhf	Dual conversion
Portascan-4	100	4	Hi vhf	Pocket size, 150-160 MHz or 160-170 MHz
<b>Midland</b>				
13-906	120	4	Hi vhf	Pocket size 4 ch, 152-159 MHz
13-912;-914	100;125	4	Hi vhf; uhf	Portable
13-930;-934	200	8	Lo,hi vhf;hi vhf,uhf	Mobile mounting bracket
13-940;-944	220	8	Lo,hi vhf;hi vhf,uhf	Larger version of 930
13-950	280	8	Lo,hi vhf, uhf	Memory, S meter, adj. scan rate
<b>Pace</b>				
Scan 108L;H;U	140	8	Lo vhf;hi vhf;uhf	Built-in or remote speaker and antenna
Scan 208	170	8	Lo, hi vhf	Same as 108 with 2 bands
Scan 216	180	8	Hi vhf, uhf	Base or mobile with bracket
Scan 308	200	8	Lo, hi vhf, uhf	30-39, 152-164, 450-465 MHz
Scan 10-4H;-4U	90;100	4	Hi vhf; uhf	154-162 and 454-462 MHz
<b>Pearce-Simpson</b>				
Cheyenne-8	150	8	Hi vhf	Dual conversion, one priority channel
Cherokee-8+8	180	8	Lo,hi vhf	Dual conversion, one priority channel
Gladding HiScan	115	8	Hi vhf	144-175 MHz, dual conversion
Comanche-16	200	16	Lo, hi vhf	Scans 16 high and 8 low channels
<b>Radio Shack</b>				
PRO-7A	120	8	Hi vhf	148-174 MHz, base or mobile
PRO-77;-7	150;120	8	Lo,hi vhf;hi vhf	30-50 and 148-174 MHz, base or mobile
PRO-88	200	8	Hi vhf, uhf	Base or mobile with bracket
Pocket-Scan	100	4	Hi vhf	Pocket size, built-in speaker and antenna

**Enter the Scanner.** With so much going on at more or less the same time, and spread out through three distinct frequency bands, how can the average listener keep track of everything at once? The solution is the use of a special monitor receiver known as a scanner.

A scanner is a crystal-controlled receiver with an automatic sweep trigger that activates each frequency in turn, or only those with crystals specifically selected (punched up) for monitoring at that time. It takes but milliseconds for the scanner to sweep from one crystal frequency to the next; if four frequencies are selected, the sweep will scan all four and then start over. As soon as

a signal appears on a selected crystal frequency, the sweep locks to the signal and keeps the receiver tuned to that frequency as long as the signal remains on the air. As soon as the signal goes off, the sweep resumes its automatic check of each crystal frequency.

In a typical scanner receiver, the front end consists of a relatively broadband r-f amplifier, a crystal-controlled oscillator and a mixer. The crystals are switched into the oscillator circuit by diodes controlled either by a ramp or sawtooth waveform, or an electronic counter. It doesn't matter how the crystals are switched as long as the switching is fast. The mixer's output is generally

# FOR PUBLIC SAFETY BANDS

<b>Regency</b>				
ACT-E-8H/U;-8H/L	159	8	Hi vhf,uhf;hi,lo vhf	Base station, speaker & antenna jacks
ACT-E-8H;-8L	139	8	Hi vhf;lo vhf	Single bands, base station
ACT-E-16H/L/U;-16H/L	219	16	Lo,hi vhf,uhf;hi,lo, vhf	Two antennas, plus jacks
ACT-R-8H;-8L	139	8	Hi vhf; lo vhf	Base or mobile with mounting bracket
ACT-R-8H/L	159	8	Lo, hi vhf	Base or mobile with mounting bracket
ACT-R-10H/L/U	169	10	Lo,hi vhf, uhf	Base or mobile with mounting bracket
<b>Robyn</b>				
Hi-Bander	140	8	Hi vhf	Includes 2-meter ham band
200 FM	180	16	Hi vhf, uhf	Scans 8 channels in either or both bands
HL8+8	180	16	Lo,hi vhf	Dual scan speeds, covers ham bands
1000 Porta-Scan	110	4	Lo,hi vhf	Mobile, scans four vhf frequencies
<b>SBE (Sentinel Series)</b>				
1SM	170	8	Lo,hi vhf	Coverage 6 Mhz on low, 8 MHz on high
2SM	150	8	Hi vhf	Coverage 8 MHz
3SM	150	8	Lo vhf	Coverage 6 MHz
5SM	160	8	Uhf	Coverage 10 MHz
6SM	190	8	Hi vhf, uhf	Coverage 8 MHz on vhf, 10 MHz on uhf
7SM	150	8	Hi vhf	Marine channels
<b>Sonar</b>				
FR-104	140	6	Lo vhf	Similar model for hi vhf, base or mobile
FR-2512;-2513	170	24	Lo vhf;hi vhf	Dual conversion
FR-2516;-2517	160	10	Lo vhf;hi vhf	Can be set for priority channel
FR-2525	180	10	Uhf	Mounting bracket, antenna included
FR-2526;-2528	190	10	Hi vhf, uhf;lo,hi vhf	Mounting bracket, antenna included
<b>Teaberry</b>				
Crimefighter	199	8	Lo,hi vhf,uhf	Program card instead of crystals
T-Scan	129	4	Hi vhf	Pocket size
<b>Tennelec</b>				
Tennetrac II	180	12	Lo,hi vhf,uhf	Mobile or base station
Tennetrac III	200	16	Lo,hi vhf,uhf	Variable scan rate
Tennetrac IV	220	16	Lo,hi vhf,uhf	Local/distance switch, wood cabinet
Tennetrac V	250	16	Lo,hi vhf,uhf	Variable scan rate
TN-150;450	120	4	Hi vhf; uhf	Pocket size, earphone jack

**AN IMPORTANT WORD ABOUT PRICES:** Most prices exclude crystals, which are usually about \$5 each. Although we have made every effort to obtain current prices for all products listed, because of the dollar devaluation, the lifting of certain price controls, etc., all prices are subject to some adjustment. The prices listed are the latest that manufacturers and/or importers were able to supply before press time—and are subject to change.

fed into a low-frequency i-f amplifier (for selectivity), an FM detector, and finally the audio amplifier. An audio squelch—to eliminate interstation and atmospheric noises—is always provided in scanners. This is mostly because the sweep is stopped by an audio signal, and if the squelch isn't set, the background noise will usually prevent sweep operation and the receiver will remain locked to one particular frequency.

To backtrack a little, since the r-f amplifier can be tuned to only part of each Public Safety band, for maximum sensitivity, the particular frequencies of interest must fall within the manufacturer's specified band. This is usually quite broad. However,

it is not possible to monitor one station at, say, 152 MHz and another at 174 MHz. That is too broad a band for maximum sensitivity at both ends. As a rule, most, if not all, scanner manufacturers peak the receiver for the specific frequency bandwidth needed.

The typical scanner has from four to eight or more frequencies for a single band. The crystal sockets are easily accessible to the user so crystals can be added or changed almost at will. The front panel has an indicator lamp or digital display device for each crystal and a selector switch. The switch determines which crystals are activated and the indicators show that these frequencies are being scanned; the indicators



Hy-Gain 618



SBE 7SM



Lafayette Monitorscan-8



Regency ACT-E-16H/L



Electra Bearcat III



Heath GR-110

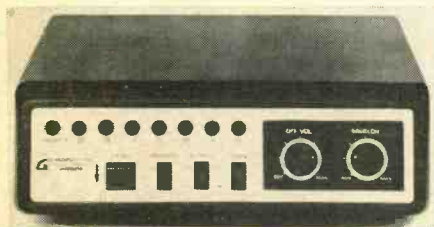

Pearce-Simpson Gladding HiScan

**Note:** A few states have antiquated laws prohibiting the installation of monitors in vehicles. Also, the FCC prohibits private use of information heard, but not directed to, the listener.

for the channels that are off do not light. When the receiver locks onto a signal, the indicator shows the channel or frequency being heard. The front panel also contains a manual-sweep selector and perhaps a manual control touch-bar or selector. In the manual mode, the scanner remains locked to a crystal until the user deliberately switches to the next selected frequency.

Monitor receivers are available for mobile operation (12 V dc), base (117 V ac), or both. As a rule, most monitors are provided

with only a coaxial jack or terminals for an external antenna. Some models, however, in addition to the antenna connection, also have a built-in telescopic antenna which delivers good performance for local signals. (A distance of 25 miles is considered local for a vhf base station.)

Some of the more expensive models have an r-f gain control, and external speaker output, a mobile mounting bracket, or possibly a line-level audio output jack for a tape recorder.

**Multi-Band Scanners.** When the stations to be monitored are on two or more bands, it is possible to cover all frequencies with a multi-band scanner. This is basically the usual scanner with two or three separate and independent front ends, each with its separate antenna input and/or individual built-in telescopic antennas. Each front end feeds into the i-f amplifier, and each is assigned part of the total number of crystal channels; or the front ends might share the total available channels.

In a two-band scanner with specific channels, the low-band front end might have, say, channels 1 through 4, while the high-band tuner has channels 5 through 8. In such an arrangement, there is usually an extra front-panel control with a designation such as LOW/HIGH/BOTH. Thus either the low, the high, or both bands could be scanned.

When a receiver has shared channels either a low- or high-band crystal can be installed in any socket. For example, channel 1 might be set up for low band, while 2, 3, 4, and 5 are high band, 6 is low band, 7 high band and 8 low band. The scanner will skip from channel to channel in order, regardless of how the crystals are arranged. The advantage of shared channels is that there is no fixed limit to the number of channels assigned to each band. All channels can be used for a single band if the need arises.

With activity increasing on the uhf band, more and more monitors are being equipped for both the high vhf and the uhf, or for all three bands: low vhf, high vhf, and uhf. Where there are two front ends for high vhf and uhf, there are usually two independent antenna inputs. When the receiver has three front ends to cover all three bands, the low- and high-band tuners will often share an antenna.

If a multi-band receiver includes uhf, several channels are generally reserved only for the uhf band, though new crystal switching circuits now allow shared crystal sockets to be used even for uhf reception. This convenience is probably reflected in a slightly higher initial cost.

If most of the action in a locality is on the low- and high-vhf bands, but expansion to uhf is desired, it is possible to obtain a monitor receiver with plug-in front ends. The plug-in arrangement, with prewired connectors, can be applied to any arrangement of the three bands.

**Special Scanners.** As the value of scanning techniques is realized by potential users, the conveniences of automatic scanning are being applied in unusual, but worthwhile, ways. A recent addition to the list of monitor radios is a portable AM broadcast radio with two vhf crystal-controlled Public Safety frequencies. In typical operation, the portable radio can be used as an ordinary two-channel scanner or a broadcast radio with vhf override. While tuned to the AM radio, the receiver silently scans the Public Safety channels. As soon as a signal appears on the vhf monitor, the AM radio is muted and only the vhf signal is heard. When the signal goes off, AM reception is restored.

An application of the scanner/override facility presently talked about but not yet available in production models is the combination of a channel-9 CB receiver with a vhf scanner for use by REACT and CB emergency teams. With such a receiver, the REACT team could keep tabs on the CB emergency channel as well as the local Public Safety frequencies.

Speaking of CB, one more-or-less standard CB transceiver has two independent channel selectors, each covering all 23 CB channels. The user selects two channels he wants to monitor; say channel 9 and local emergency channel 11. The scanner sweeps the two channels and locks onto the one that becomes active, simultaneously locking the transmitter to the received channel. When the received channel goes off, the receiver resumes scanning, just as with a Public Safety monitor.

While CB is a long way from eavesdropping on the Public Safety services, it is nevertheless true that many CB'ers are actively involved in emergency teams and services. Several CB transceivers presently come equipped with built-in low- or high-band monitors. These monitors are tunable, with one or two crystal-controlled channels. Logically, just as soon as there is sufficient interest, full Public Safety scanners will be built into some CB transceivers.

Frequency scanning is a very convenient, almost instantaneous way of monitoring several channels simultaneously. With modern solid-state techniques, the necessary electronic hardware causes almost no (or very little) increase in cost compared to tunable receivers. A scanner should therefore be a first choice when you're ready to listen to the Public Safety bands. ♦

## STATE OF THE ART

### *New developments promise bright future for optical communications*

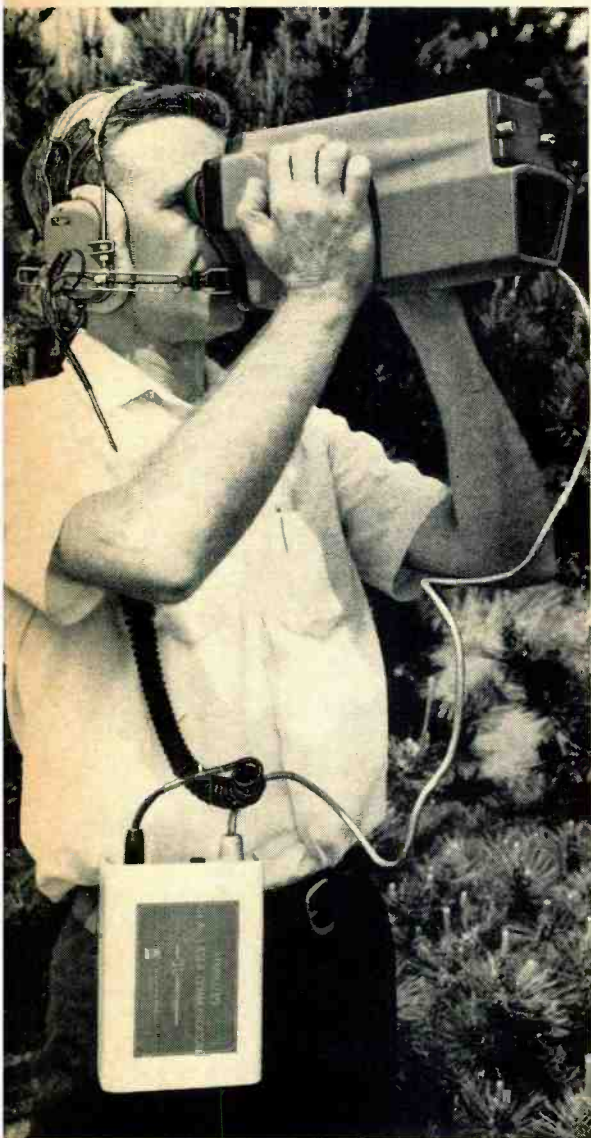

**The American Laser System's Slacom laser diode communications system incorporates a novel optical technique to cancel movement effects and permit handheld communications up to about 20 miles.**

**C**OMMUNICATING by the use of a light beam has been around since before recorded history when men signaled one another with fires, lanterns, and mirrors. More recently, in 1880, Alexander Graham Bell and Sumner Tainter transmitted high-quality voice and tones over a beam of reflected sunlight scores of years before radio was used for the same purpose.

Bell's "Photophone" consisted of a transmitter containing a flexible mirror. A beam of sunlight was modulated by projecting sound waves against the mirror. In the receiver to which the beam was "transmitted" were a selenium detector, a telephone receiver, and a battery. The transmitter's condensing and projecting lenses and the receiver's parabolic reflector yielded a range of several hundred meters.

In 1901, a German scientist sent intel-

# LIGHT BEAM COMMUNICATIONS

ligible voice signals a distance of 1 km by modulating the carbon arc of a searchlight. And during World War II, American amateur radio operators experimented with a variety of moderately long-range light-beam communicators.

Although some researchers predicted a possible role for modulated visible and invisible (infrared) light beams in communications of the future, most research ceased after the war until about 12 years ago when the introduction of gallium-arsenide light-emitting diodes sparked a revival. In early 1963, scientists at the Massachusetts Institute of Technology transmitted voice and TV signals some 30



miles using a LED and a photomultiplier receiver.

The laser, developed a few years before the MIT demonstration, was, as predicted, an excellent candidate for light-beam communication. With its development, optical communication began to emerge as a realistic alternative to communicating by wire.

**Recent Developments.** Ordinary non-coherent light sources emit radiation into a wide, uncollimated beam. Cumbersome optical arrangements are required to project the light into the narrow beam required for long-range light-beam communication. Most lasers, on the other hand, emit radiation in a relatively narrow beam. More significantly, the coherence of the laser beam permits an external optical system to collect most or all of the light and collimate

it into a very narrow beam. And the ultra-pure spectral output of some lasers permits incredibly high modulation rates.

Four recent developments have brought widespread light-beam communication closer to reality than ever before: new low-loss optical fibers, semiconductor lasers that permit very high pulse-modulation rates, a solid-state laser pumped by an array of LED'S, and ultrasensitive photodetectors.

Practical LED's have been available for a decade. They are ideally suited to transmitting multi-megabit data over medium-range atmospheric and fiber-optic links. For faster and more efficient communication, semiconductor lasers would be a better choice. But until 1970, they could not be operated continuously at room temperature. However, the degradation mechanism has recently become better understood, and

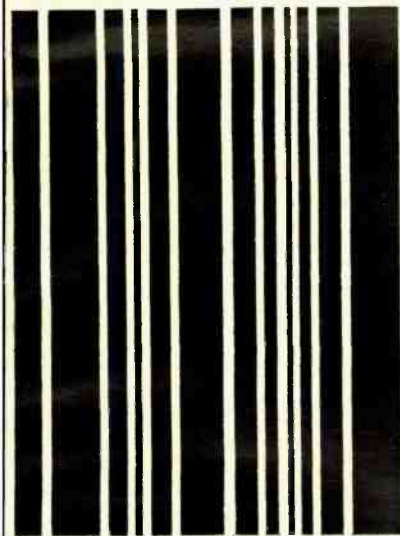

BY FORREST M. MIMS



**Don't miss next month's construction project article for building an LED Infrared Light-Beam Communicator.**

Handheld laser communicator developed by Santa Barbara Research Center, subsidiary of Hughes Aircraft. The communicator is held like ordinary binoculars and it has a range on the order of several miles.

reasonably long-life CW diode lasers have been developed.

Bell Labs recently announced a miniature YAG (yttrium aluminum garnet) laser that is pumped by a *single* LED. This laser is ideally suited for communication since it can be directly modulated by varying the current through the LED. It is much smaller and more efficient than conventional YAG lasers.

The development of ultrasensitive avalanche photodetectors with less than 1 nW ( $10^{-9}$ W) sensitivity means that long-range optical communication is now possible. Conventional semiconductor photodetectors operate with a carrier multiplication process that yields large internal gain. By biasing the detector just below breakdown, a low-power optical signal triggers avalanche and a large signal output.

**Fiber Optics.** Perhaps the most important development of optical communications is the new class of low-loss optical fibers. Practical non-atmospheric light-beam communication would probably not be feasible without these new fibers. AT&T long ago ruled out atmospheric links for telephone service due to the adverse nature of weather on atmospheric transmissions.

Until recently, the best available optical fibers had losses of about 1 dB/meter—far too high for more than short-range links. Now, researchers in Japan and the U.S. have succeeded in making glass fibers of such purity that losses have been reduced to only a few decibels per *thousand* meters.

A fiber with a loss of 5 dB/km will attenuate only 50 percent of an optical signal's power in 2000 ft—significantly less than conventional wire system losses. This means that repeaters can be placed farther apart in an optical system. One proposed fiber optic system using a 5-dB fiber, for example, would require repeaters every 8 miles, while conventional wire systems require 5-mile intervals.

Low-loss fibers mean that a ¼-in. cable of hair-thin glass fibers can carry the same volume of communications as thousands of conventional telephone cables, with existing technology. The glass cables, much smaller than metal ones, could be threaded through the spaces in existing conduits.

Since there is no radiating electromagnetic field around an optical fiber, crosstalk can be completely eliminated with a light-tight sheathing. Glass fibers are much

smaller and have greater information capacity—not to mention greater strength—than hard wire systems. Although present costs for high-quality fibers are high, they are expected to drop sharply when the fibers are mass produced.

The major drawbacks of optical fibers include the need to develop efficient manufacturing techniques, the fact that electrical power cannot be transmitted through the fiber, and the need for new installation and repair techniques.

**Operational Systems.** In recent years, practical light-beam communication systems have made an appearance. Americal Laser Systems has developed a 15-20-mile-range hand-held laser communicator, the SLACOM (stabilized laser communicator), that uses a 2-watt peak semiconductor laser and operates for 5 to 7 hours on its self-contained batteries. Portable laser diode communicators have also been built by IBM, RCA, Holobeam, and others—most of them patterned after early systems developed by RCA.

A number of moderate-range intracity atmospheric links using LED's and diode lasers are already in commercial operation in the U.S. The Telebeam Corp., for example, uses an LED system to transmit closed-circuit pay TV to several New York City hotels. The system puts out 20 mW and has a half-mile range.

**Looking Ahead.** The technology needed to implement practical widespread optical communication has virtually arrived. Whether or not light beams and glass fibers will replace or supplement conventional telephone lines depends on the cost and crowding conditions of the already overworked existing communication channels.

AT&T sees an important future for light-beam communication. If their Picturephone® is accepted by the public, AT&T will be forced to use optical transmission systems because this service requires about 100 times the transmission capacity needed for a single telephone channel. If only 1 percent of AT&T subscribers request Picturephone, present system capacity would have to be doubled.

Meanwhile, short-to-medium-range atmospheric and optical fiber links are ideal for interoffice and intracity communication. All in all, light-beam communication has a very bright future indeed. ♦

## CONSTRUCTION



LOW-COST SENSOR  
SOUNDS AN ALARM  
WITH AS LITTLE AS  
50 PARTS PER MILLION  
OF MOST TOXIC GASES



# POISONED AIR DETECTOR

BY HERB COHEN

**I**F YOU live in a large industrial area, the air you breathe may contain varying amounts of carbon monoxide, hydrocarbons, soot, smoke, cooking gas, and many other potentially dangerous contaminants. These toxic elements may be odorless; most of them are combustible, and some are dangerously explosive.

Even a home in the "clean" suburbs could contain excessive amounts of cooking gas, cleaning chemicals, paint fumes, carbon monoxide seepage from garages, or potentially dangerous smoke. In a closed camper or boat, you can get carbon monoxide or gasoline fume leakage due to faulty engine exhaust and chassis or deck leakage.

What do you do about all this? You can't do much unless you know it is there. Thanks to a simple new gas detector semiconductor you can now find out whether the contaminants in your air are dangerous or not. The semiconductor is used in construction of a low-cost (about \$25) sensor system that can detect a considerable number of potentially dangerous gases at levels of less than fifty parts per million—well below the government safety standards for industrial hygiene. When the detector senses a sufficient amount of gas, a buzzer sounds off or, if a relay is added, an external alarm can be powered.

**How It Works.** The actual detector (*DET*) is an n-type semiconductor of tin dioxide, heated by a platinum wire. (Fig. 1.) In the presence of a gas, the difference in electron

energy levels between the molecules of gas and the semiconductor causes electrons to move from the gas to the semiconductor, decreasing its bulk resistance. For example, with a propane gas level of only 1000 parts per million, the sensor resistance will decrease to 5% of its resistance in clean air.

The semiconductor's internal heater operates at 1.5 volts and 500 mA ac supplied by half of the secondary of *T1* through dropping resistor *R1*. Resistor *R2* is the output load for the detector and is connected in series with meter *M1*, which is used as a readout for sensor current—hence gas presence. Diode *D3* provides a constant 0.5-volt offset to allow the transistor amplifier to work at low levels of sensor current. Potentiometer *R3* determines the alarm amplifier's operating point.

When a gas is present, the voltage across *R2* increases (meter indicating up scale), and, depending on the setting of *R3*, transistor *Q1* turns on. Transistor *Q2*, which was in saturation while *Q1* was off, comes out of saturation causing its collector to go positive. This turns on the gate of *SCR1* causing current to flow through the alarm buzzer (or the external circuit connected to terminal strip *TS1*).

The SCR is isolated from the amplifier power supply by rectifier *D2*. This gives the SCR a source of half-wave ac which allows it to turn off at the next zero crossing after the gas level drops and the transistors return to their normal operating states. An optional LED and associated 470-ohm ser-

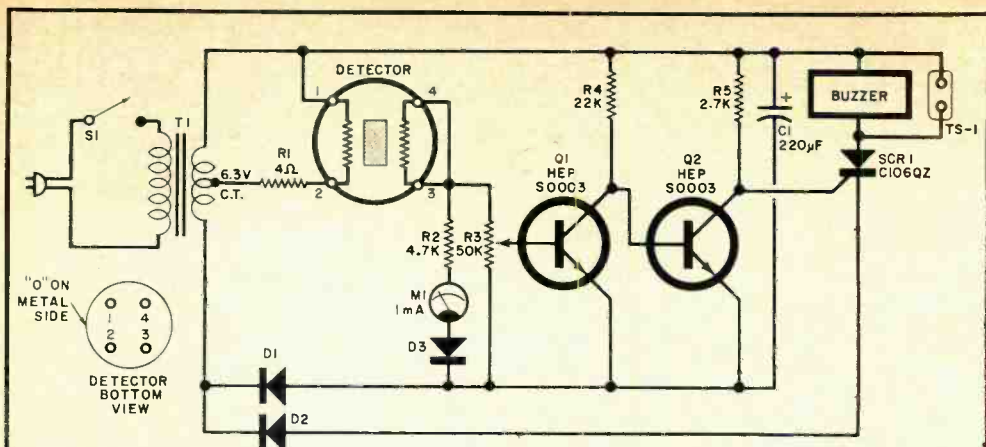

### PARTS LIST

*C1*—220- $\mu$ F, 12-volt electrolytic capacitor

*D1-D3*—1-A, 50-V PIV silicon diode

*DET*—Gas sensor (see note below)

*M1*—1-mA meter (Calestro D1-912 or similar)

*Q1, Q2*—HEPS0003 transistor

*R1*—4-ohm, 5-watt resistor

*R2*—4700-ohm,  $\frac{1}{2}$ -watt resistor

*R3*—50,000-ohm, linear potentiometer with Switch *S1* attached

*R4*—22,000-ohm resistor

*R5*—2700-ohm resistor

*S1*—Spst switch (on *R3*)

*SCR1*—Silicon controlled rectifier (C106Q2 or similar)

*T1*—6.3-VCT transformer (Lafayette 33E80490 or similar)

*TS1*—Two-connector terminal strip

Misc.—Seven-pin vacuum tube socket, suitable chassis, 6-volt buzzer, perf board, knob, etc.

Note—The gas sensor can be ordered as *DET-2* from Detector Inc., P.O. Box 313A, Sag Harbor, NY 11963, for \$6.25 postpaid. N.Y. residents, please add sales tax.

Fig. 1. When detector senses gas, current flow in meter indicates relative level.

ies resistor can be connected across the buzzer for visual indication.

**Construction.** Other than the detector (*DET*), *T1*, *M1*, and the buzzer and *TS1*, the circuit can be assembled on a piece of perf board, using the meter terminals as the mounting. Almost any chassis can be used as long as it will hold the transformer and buzzer and has a front panel large enough to accommodate the meter and *R3* and the socket for the detector.

A conventional 7-pin vacuum tube socket can be used to mount the detector. The socket should be attached to the exterior of the front panel. Note that the detector has a small circle stamped on its side between pins 1 and 2.

**Operation.** Before applying power, set *R3* to its minimum position to keep the alarm from sounding off immediately. Apply power and note that the meter needle rises to full scale and remains there for some time. This large sensor current is due to the

“burning off” of impurities collected on the detector’s surface while it was not in use. In cases of severe contamination, it may take quite a while for the sensor to clean itself, during which time, the meter indication will gradually drop to some minimum value. Once the meter has dropped to its minimum, advance *R3* (sensitivity control) until the buzzer starts to sound off. Back *R3* off slightly until the buzzer stops and mark this point on the knob scale. This will be your local “normal.” If the air is very clean, the buzzer may not sound, even at full sensitivity.

The unit is now ready for testing. You can blow cigarette smoke at the sensor or open a bottle of ammonia, perfume, etc., and blow the fumes toward the detector. The meter should suddenly jump upscale, and the buzzer should sound off.

For relative measurements, such as hunting for gas leaks, the buzzer can be silenced by rotating *R3* to its minimum with the meter indications used for probing for maximum gas concentrations.  $\diamond$

# 1974 ELECTRONIC EXPERIMENTER'S HANDBOOK

## SPRING EDITION

*Helps you get it together...  
with a score of  
build-it-yourself projects.*

You can count on Electronic Experimenter's Handbook. It's by the editors of Popular Electronics including Electronics World. With features and articles and complete lab-tested instructions that guarantee successful hours and months of mind-absorbing projects for fun and practicality.

*Be sure you don't miss the all-new 1974 Spring Edition scheduled to go on sale nationally Mar. 19, 1974.*

**YOU CAN RESERVE YOUR COPY  
NOW AT  
THE SPECIAL MONEY-SAVING  
PRE-PUBLICATION PRICE OF  
ONLY \$1.00, POSTPAID.**

This offer is being made to readers of POPULAR ELECTRONICS Magazine only. Regular price is \$1.25; mail order price \$1.60. You can reserve your copy now at this special pre-publication price of only \$1 by completing the Reservation Form and returning it promptly along with your remittance. The 1974 Spring ELECTRONIC EXPERIMENTER'S HANDBOOK will be mailed to you on or before publication date from first-off-the-press copies.

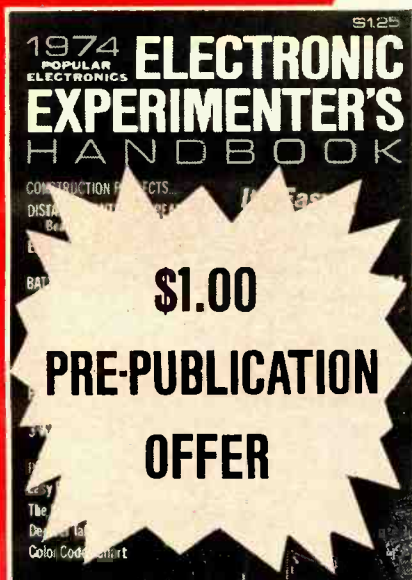

### PRE-PUBLICATION RESERVATION FORM

ZIFF-DAVIS SERVICE DIVISION • DEPT. EEH  
595 BROADWAY • NEW YORK, N.Y. 10012

Enclosed is \$\_\_\_\_\_. Please reserve\_\_\_\_\_copies of the 1974 Spring ELECTRONIC EXPERIMENTER'S HANDBOOK at the special pre-publication price of only \$1.00 per copy, postpaid, to be mailed to me from first-off-the-press copies on or before March 19, 1974.

Print Name\_\_\_\_\_

Address\_\_\_\_\_

City\_\_\_\_\_

State\_\_\_\_\_ Zip\_\_\_\_\_

**PLEASE ENCLOSE PAYMENT WITH ORDER.**

PE-274

# CREI—the only home-study college-level training

## and now

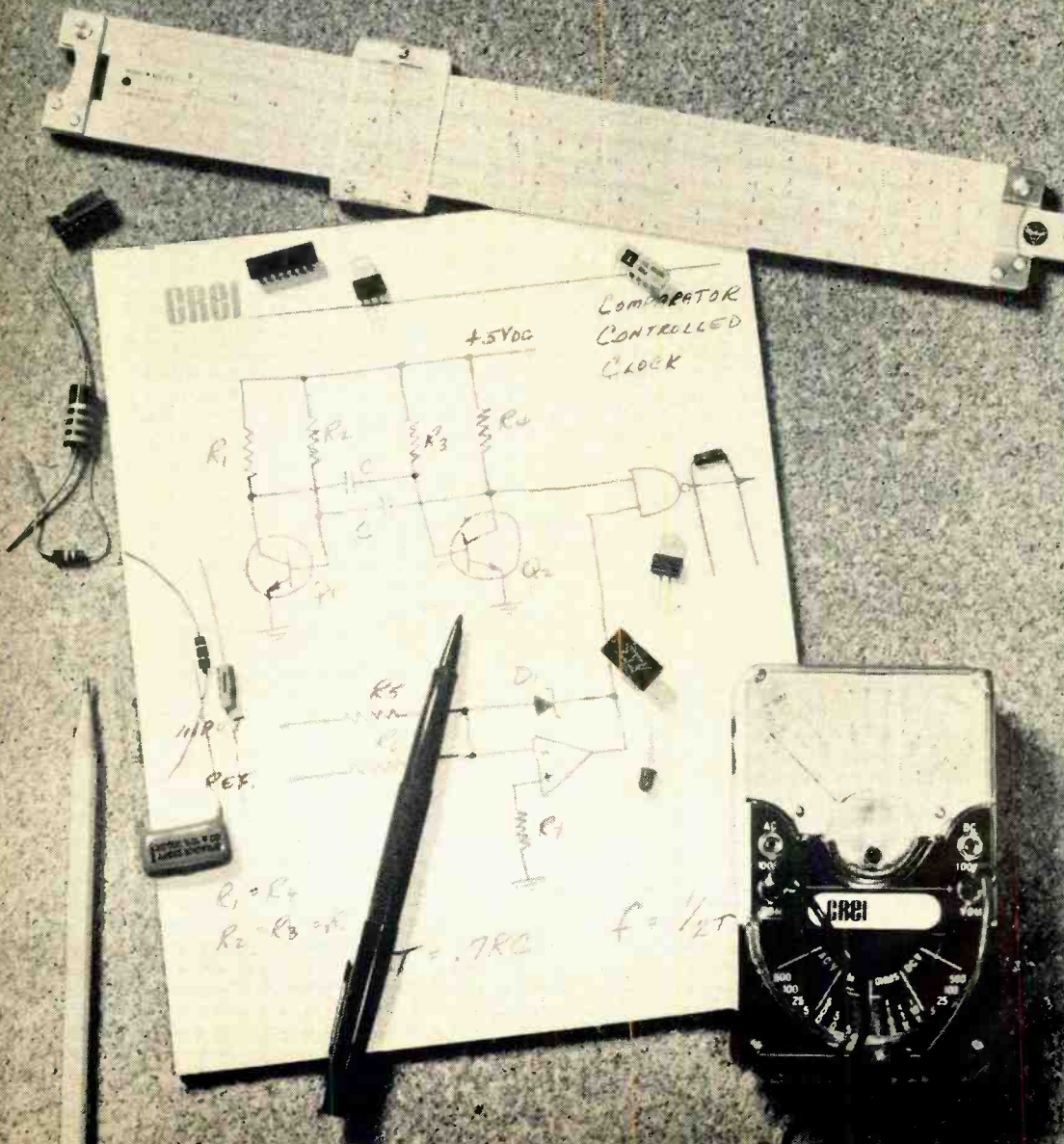

CREI

COMPARATOR  
CONTROLLED  
CLOCK

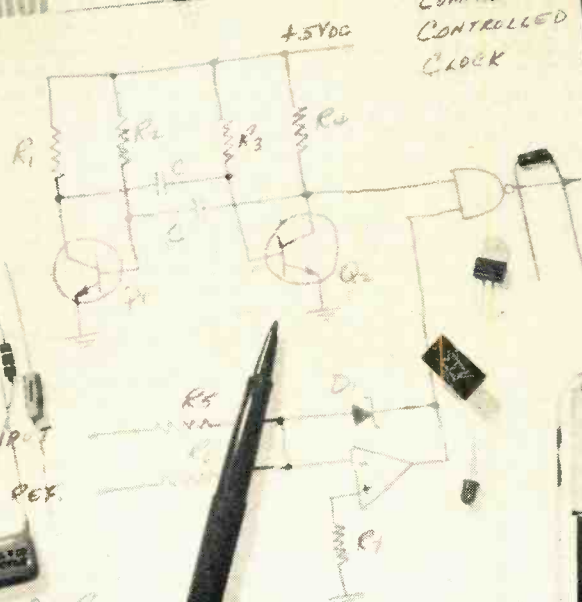

$R_1 = R_4$   
 $R_2 = R_3 = R$

$T = .7RC$

$f = 1/2T$



# Program which gives you an electronic circuit design

## Only CREI offers you a complete college-level Electronic Design laboratory to speed your learning

Electronic circuit design—source of all new development in the application of electronics to new products and services. Without this skill, we would be unable to monitor the heartbeat of men in space. Without it, the computer revolution would never have occurred. And we would have had to see our first TV show. *Yet, only CREI teaches electronic circuit design at home.*

### ELECTRONIC CIRCUIT DESIGN

A key skill which paces our nation's progress in countless fields—from pollution control to satellite tracking to modern medicine to exploring the ocean's depths. And beyond. A skill which *you* must have to move to the top in advanced electronics.

### CREI programs open up new worlds of opportunity for you.

In addition to electronic circuit design, CREI provides you with a full advanced electronics education in any of sixteen fields of specialization you choose. Communications, computers, space operations, television, nuclear power, industrial electronics—to mention just a few of the career fields for which CREI training is qualifying. With such preparation, you will have the background for a career which can take you to the frontiers of the nation's most exciting new developments. And around the world.

### This free book can change your life. Send for it.

If you are a high-school graduate (or equivalent) and have previous training or experience in electronics, then you are qualified to enroll in a CREI program to move you ahead in advanced electronics.



Send now for our full-color, eighty page book on careers in advanced electronics. In it, you will find full facts on the exciting kinds of work which CREI programs open up to you. And full facts on the comprehensive courses of instruction, the strong *personal* help, and the professional laboratory equipment which CREI makes available to you. All at a surprisingly low tuition cost.

### And when you have it, talk with your employer about it.

Tell him you're considering enrolling with CREI. He'll undoubtedly be happy to know you are planning to increase your value to him. *And he may offer to pay all or part of your tuition cost.* Hundreds of employers and government agencies do. Large and small. Including some of the giants in electronics. *If they are willing to pay for CREI training for their employees, you know it must be good.*

Send for Advanced Electronics today. You'll be glad you did.



CREI Dept. E1202E  
3939 Wisconsin Avenue  
Washington, D.C. 20016

Rush me your FREE book describing my opportunities in advanced electronics. I am a high school graduate.

Name \_\_\_\_\_ Age \_\_\_\_\_

Address \_\_\_\_\_

City \_\_\_\_\_ State \_\_\_\_\_ ZIP \_\_\_\_\_

If you have previous training in electronics, check here

Employed by \_\_\_\_\_

Type of Present Work \_\_\_\_\_

Veterans and servicemen, check here for G. I. Bill information

# CREI

CAPITOL  
RADIO  
ENGINEERING  
INSTITUTE

WASHINGTON, D.C. 20016

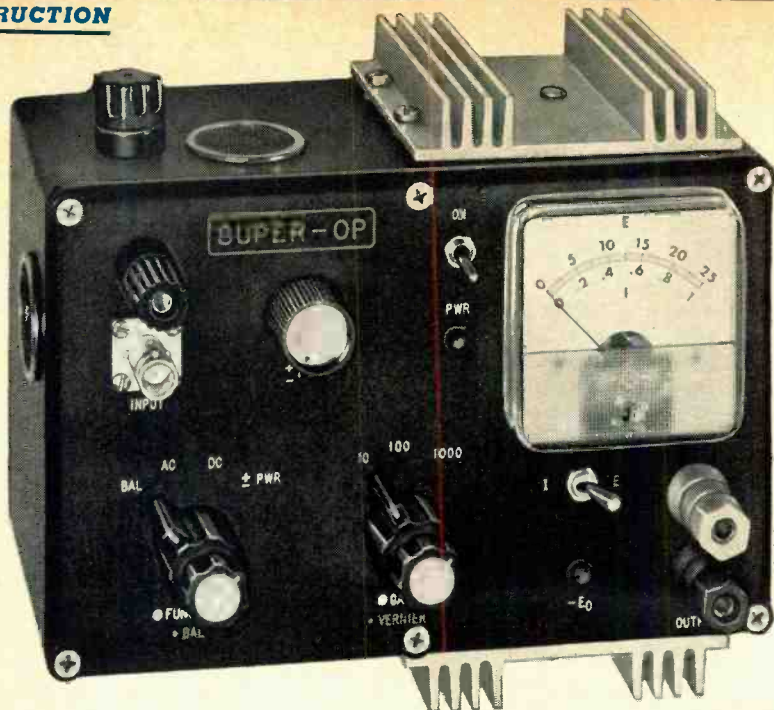

## HOW THE 741 OP AMP BECOMES

# SUPER-OP

*an ultra-versatile bench instrument*

BY J. R. LAUGHLIN

ONE of the heroes of the electronics world today is the 741 operational amplifier. It is sort of like a jack-of-all-trades in the number of applications to which it is put. Of course, the op amp itself has certain limits, but the addition of outboard components increases its usefulness—as in the Super-Op described here. This instrument can be a valuable addition to any experimenter's work bench.

What can Super-Op do? It can be an adjustable, well-regulated positive/negative 20-volt power supply; a battery charger or eliminator (1-ampere output); a general-purpose ac or dc amplifier; a hi-fi audio amplifier; a servo amplifier; a

chart recorder drive; etc. It also has built-in dc offset nulling, variable gain, and overload protection. The circuit retains all of the characteristics of the 741, such as frequency response, dc thermal drift, etc.

**Construction.** Any type of construction can be used, though a PC board using the foil pattern in Fig. 3 simplifies the wiring. The board is mounted directly on the meter terminals.

On the front panel are the BNC connector, *I1*; its associated ground jack, *J2*; output connector, *J3*; its ground connector, *J4*; the  $\pm$ PWR control, *R32*; the power on/off switch; metering switch *S3*; power-on indicator *LED1*;  $-V$  (or  $-E_o$ ) indicator *LED2*; the meter; and switches *S1* and *S2*.

Note: The Superman "S" symbol is a trademark of National Periodical Publications Inc., used with their permission.



Resistors *R15*, *R16* and *R17* are attached to *J3* and *J4*.

The frame of the chassis supports the transformer, *T1*; capacitors *C1* and *C2*; the four rectifier diodes; the two fuses in their holders; and *Q6* and *Q7*, with their respective heat sinks.

If you are using a metal chassis, mount the power transformer so that its core is in good thermal contact with the chassis, using transistor thermal grease between the two. This keeps the transformer temperature down. The use of venting holes on the chassis bottom and sides and rubber feet on the bottom will allow cooling air to pass through the unit. When mounting the PC board, allow room for air to circulate around it.

The output transistors are mounted on heat sinks, one on each side of the chassis. The heat sinks should be mounted on short standoffs to allow air to pass on both sides of the sinks. If large venting holes are made in the bottom and sides of the chassis, they can be covered with snap-in grilles.

**Checkout.** The first thing to do is determine the values of *R23* and *R24*. While monitoring the emitter voltage of *Q1*, connect a 10,000-ohm potentiometer in the circuit where *R24* goes. Carefully adjust the potentiometer until +20 volts is indicated. To avoid damaging the op amps, do not allow this voltage to go above 22 volts. Once the correct voltage is obtained, measure the value of the potentiometer and install a fixed resistor of comparable value. Do the same for *R23* in the circuit of *Q2*, except that this time the voltage is -20.

With *S1* in the first (BAL) position and the GAIN VERNIER (*R29*) fully clockwise, try the various positions of GAIN switch *S2* and adjust the BAL control (*R30*) until the meter indicates zero.

With the FUNCTION switch in the second position (AC) and a signal applied to *J1* and *J2*, the instrument will act as an amplifier with a gain of 10, 100, or 1000, depending on the setting of *S2*. Similar gains will exist with the FUNCTION switch in the third position (DC).

To use the Super-Op as a positive or negative power supply, place *S1* in the fourth position (PWR), *S2* on 10, and *S3* on  $\epsilon$  (voltage). The output voltage is de-

termined by the setting of the  $\pm$ PWR control (*R23*). The -V light (*LED2*) should come on as the output passes through zero from positive to negative. An output of about -0.2 volt will turn on the lamp. The output regulation should be better

#### HOW IT WORKS

As shown in Fig 1, *IC1* (a 741) is connected as a non-inverting amplifier. Switched feedback resistors (*R2*, *R3*, or *R4*, selected by *S2*) allow control of the voltage gain. Input potentiometer *R29* provides front-panel gain adjustment. With an input signal applied to *J1*, switch *S1B* can select either ac or dc input. (With ac input, *C1* is in the circuit.) In the ac mode, *C3* is lifted off ground, and *C2* is connected through *S1A*. This produces a gain of one in the op-amp circuit and minimizes dc errors.

Input protection is provided by *D1* and *D2*, while *R30* is used to balance the dc of the op amp. The latter is necessary to set the output to zero in the dc mode. This control is critical when using high values of dc gain since any small offset is amplified by the remainder of the circuit.

The large output is provided by *IC2* and transistors *Q4* through *Q7*. The actual output transistors (*Q6* and *Q7*) are generously overrated to ensure that the output overload fuse *F1* will always open before the transistors can be damaged.

Output current to *J3* is monitored by *IC3*. The voltage output of this op amp is proportional to the current flowing through *R12* and can be either ac or dc depending on the mode of operation.

Switch *S3* selects either the output of *IC3* or the actual output voltage at *J3*. One or the other is applied to the meter driver, *IC4*, which is connected so that the same polarity is applied to the meter whether the input is ac or dc. To avoid confusion in measuring dc outputs, lamp driver *Q3*, which responds only to negative dc, causes a front-panel lamp to come on when negative voltages or currents are being indicated.

A pair of voltage regulators (*Q1* and *Q2*) are also included. Constant current is applied to the base of each transistor by a FET connected as a constant-current diode. The voltage at each regulator base is determined by either *R23* or *R24*, which are selected to provide the desired output voltage. Capacitors *C17* and *C18* prevent oscillation in the regulator stages.

A well-regulated and temperature-stable positive or negative reference voltage is provided by zener diodes *D12* and *D13* and is used by *R32* to select any value of either voltage. This voltage is used in the POWER mode when Super-Op is functioning as a regulated power supply.

The main power supply is shown in Fig. 2. Note that *R7* and *R9* of Fig. 1 are also shown in Fig. 2.

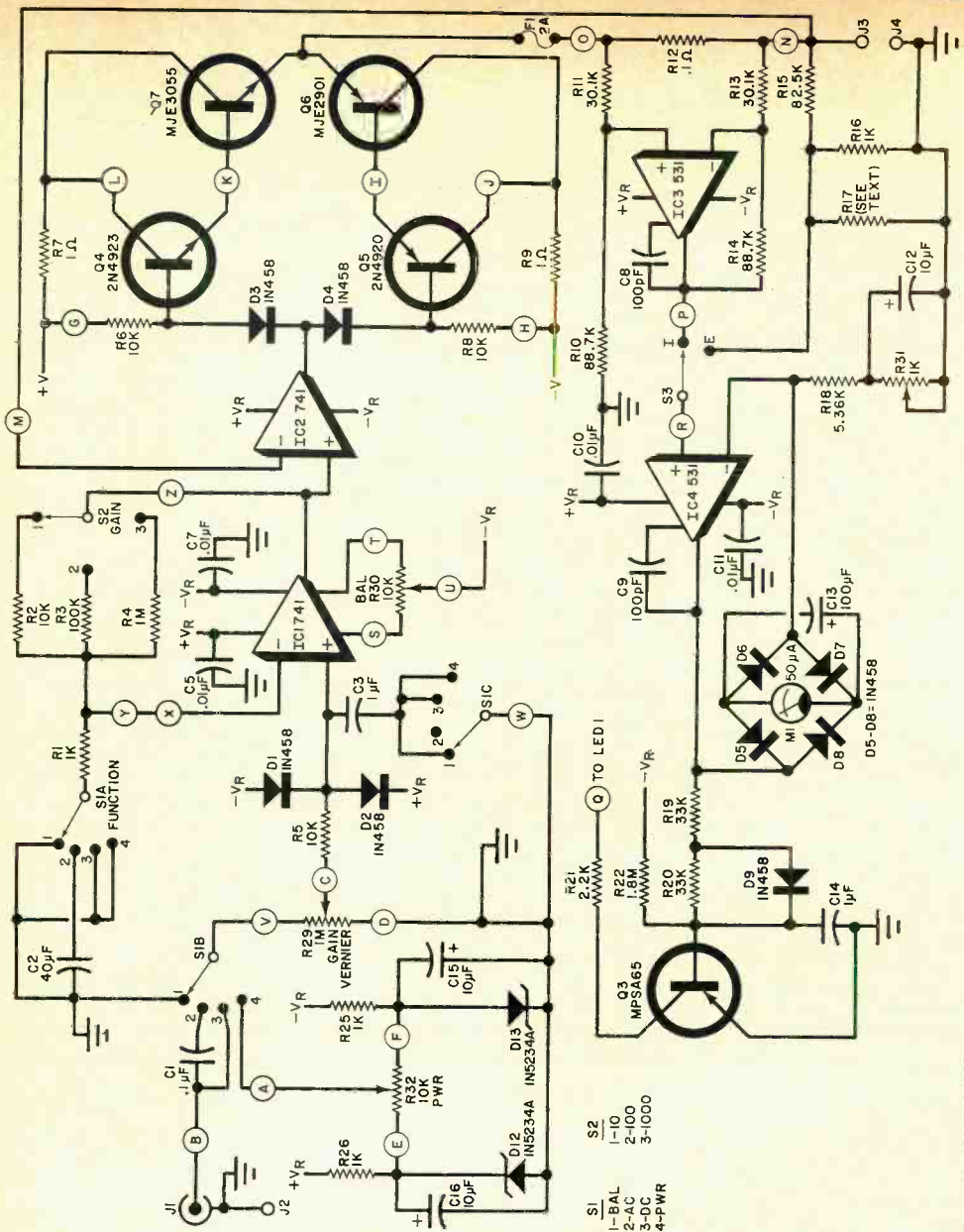

than 1% for load currents from zero to about 1 ampere.

With S3 on E, use an accurate voltmeter to monitor the voltage between J3 and J4. Adjust R17 to bring the indication of M1 to its correct value. The approximate value for R17 is 6000 ohms.

With S3 on I, use an accurate ammeter in series with a load that draws about 1

ampere. Adjust R31 to get similar readings between M1 and the external ammeter.

The common-mode rejection of IC3 can be adjusted to zero as follows. Set S3 in the 1 position and put an input of 100 Hz on the Super-Op, *without a load*. Connect a scope to monitor the output of IC3. Using a high-megohm resistor, shunt either R13 or R14 (but not both) until the scope

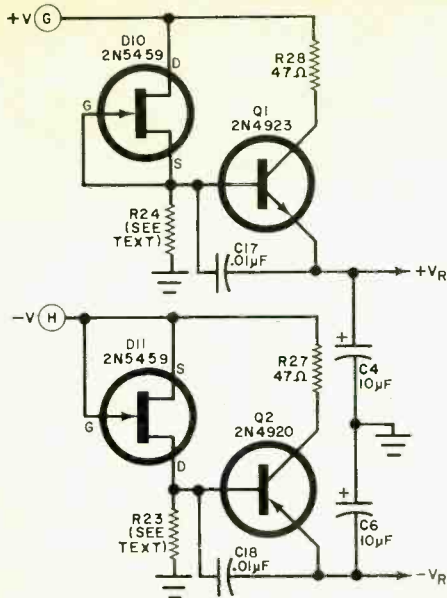

Fig. 1. The output of the basic op amp (IC1) is amplified by IC2 and Q4-Q7 to deliver 1 ampere. (Main circuit on opposite page.) The circuits above provide regulated voltages for the op amp.

#### PARTS LIST

- C1—0.1- $\mu$ F, 50-volt disc capacitor
- C2—40- $\mu$ F, 25-volt, non-polarized capacitor
- C3, C14—1- $\mu$ F, 25-volt, capacitor
- C4, C6, C12, C15, C16—10- $\mu$ F, 50-volt electrolytic capacitor
- C5, C7, C10, C11, C17, C18—0.01- $\mu$ F, 50-volt ceramic capacitor
- C8, C9—100- $\mu$ F, 50-volt ceramic capacitor

- C13—100- $\mu$ F, 30-volt, electrolytic capacitor
- D1-D9—1N458 diode
- D10, D11—1N5309 diode or 2N5459 FET
- D12, D13—1N5234A zener diode
- F1—8AG, 2-A fuse and holder
- IC1, IC2—741 op amp
- IC3, IC4—531 op amp
- J1—BNC connector
- J2-J4—5-way binding post
- M1—50- $\mu$ A meter (Monarch PMC1L or similar)
- Q1, Q4—2N4923 transistor
- Q2, Q5—2N4920 transistor
- Q3—MPS A65 transistor
- Q6—MJE2901 transistor
- Q7—MJE3055 transistor
- All resistors  $\frac{1}{4}$  watt, 10% unless otherwise specified
- R1—1000-ohm, 1% resistor
- R2—10,000-ohm, 1% resistor
- R3—100,000-ohm, 1% resistor
- R4—1-megohm, 1% resistor
- R5, R6, R8—10,000-ohm resistor
- R7, R9—1-ohm, 1-watt resistor
- R10, R14—88,700-ohm, 1% resistor
- R11, R13—30,100-ohm, 1% resistor
- R12—0.1-ohm, 1% resistor
- R15—82,500-ohm, 1% resistor
- R16, R25, R26—1000-ohm resistor
- R17—See text
- R18—5360-ohm, 1% resistor
- R19, R20—33,000-ohm resistor
- R21—2200-ohm resistor
- R22—1.8-megohm resistor
- R23, R24—See text
- R27, R28—47-ohm resistor
- R29—1-megohm potentiometer
- R30—10,000-ohm potentiometer
- R31—1000-ohm potentiometer
- R32—10,000-ohm, 10-turn potentiometer
- S1—3-pole, 4-position rotary switch
- S2—1-pole, 3-position, rotary switch
- S3—Spdt slide or toggle switch
- Misc.—Suitable chassis, heat sinks (2), mounting hardware, knobs, etc.

Fig. 2. Power supply is a full-wave rectifier. R7 and R9 are also shown in Fig. 1.

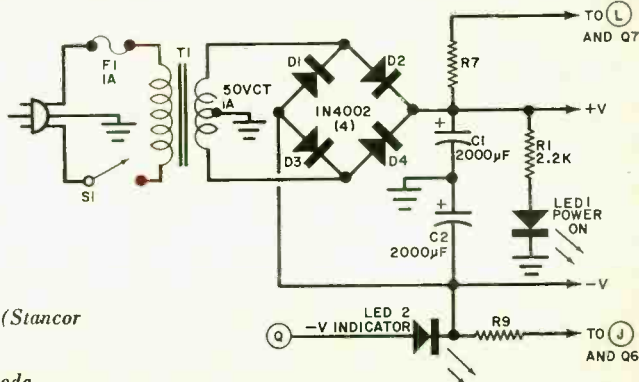

#### PARTS LIST

- C1, C2—2000- $\mu$ F, 50-volt electrolytic capacitor
- D1-D4—1-A, 100-V silicon rectifier
- F1—1-A fuse and holder
- S1—Spst slide or toggle switch
- T1—50-volt, CT, 1-A transformer (Stancor P8197 or similar)
- R1—2200-ohm,  $\frac{1}{2}$ -watt resistor
- LED1, LED2—Any light-emitting diode

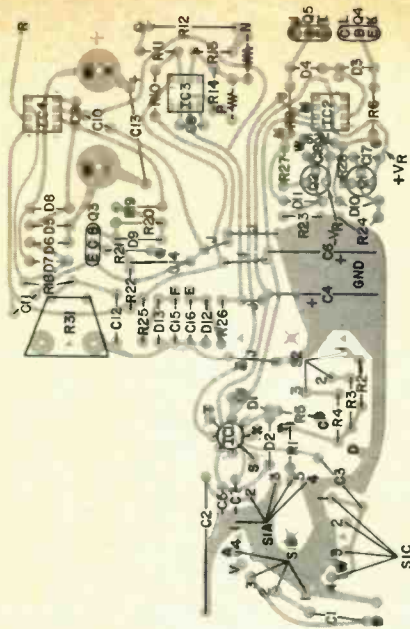

Fig. 3. Actual-size foil pattern for Super Op is below; component layout shown at left.



indicates a zero output. Once this resistor value is determined, it can be connected in its appropriate place on the board.

If the panel meter voltage indication changes significantly as the output current goes from zero to maximum, a ground loop may be present. In this case, the output

jack ground and the circuit-board common ground should be connected to the power supply ground through separate leads. If there is a slight residual hum voltage when the amplifier is at maximum gain, it may be due to magnetic induction from the power transformer. ♦



**CONSTRUCTION**

# FAST-ACTING **RESETTABLE** **ELECTRONIC FUSE**

PROVIDES ADJUSTABLE (1 TO 5 A) CIRCUIT-BREAKER ACTION

BY WILLIAM A. RUSSO

**F**OR THE protection of your own life and limb and that of your equipment, electronic apparatus should be protected by fuses or circuit breakers in their ac line inputs. But all too often, searching for the correct fuse and holder to use with a project and wiring them into place are chores that are dispensed with. While you can get away with doing things this way most of the time, sooner or later a puff of smoke or a nasty shock or burn are going to make you wish that you had taken the proper precautions in the first place.

The Electronic Fuse described here is designed to act as an adjustable *temporary* circuit breaker for projects undergoing tests or for any line-powered device rated at up to 600 watts while it is being tested or serviced at your workbench. Operating currents of from 1 to 5 amperes (in 1-A steps) can be selected. Detection of even a small overload

results in fast (less than 0.5 second) interruption of both lines feeding the load. Then, instead of replacing a blown fuse, you simply flip a switch to restore normal power —after remedying the overload problem, of course.

**Theory of Operation.** Referring to the schematic diagram (Fig. 1), load current flowing through *R1* and, depending upon the setting of *S2*, *R2* induces a voltage drop that is sensed at the gate of the triac *Q1* through the appropriate gate resistance (*R3-R11*). When sufficient gate current flows to turn on *Q1*, the triac energizes *K1* and indicator *I1*. The contacts of *K1* are wired in a latching arrangement, while at the same time isolating the load when the relay is energized. Interrupting power by opening *S1* resets the circuit.

Pushbutton switch *S3* and resistor *R11*

reduce the sensitivity of the sensing circuits to the turn-on transients of reactive or incandescent lamp loads. Potentiometers R4 through R8 are used for calibration.

**Construction.** Shown in Fig. 2 are the foil pattern and component placement diagram to be used when making the PC board and mounting components on it. Once the board is wired as shown (substitute heavy-duty perforated board if you wish), 1-in. spacers permit the board to be safely mount-

ed on the underside of the chassis box's top. Mount the board in place before making any external connections to it.

Next, mount and wire S2 and S3, followed by K1 and the remaining components, into the system. Use 18-gauge insulated wire for all leads carrying load current. When routing the power cord through a hole drilled in the chassis box, it is best to use a standard force-fit strain relief to hold it in place. However, lacking a standard strain relief, you can tie a figure-eight knot in the

### PARTS LIST

- F1—6-ampere fuse
  - K1—117-volt ac relay with 5-ampere dpdt contacts
  - PL1—Neon pilot lamp assembly
  - Q1—Triac (RCA 40529)
  - R1,R2—1-ohm, 10-watt power resistor
  - R3—47-ohm, 1/2-watt resistor
  - R4,R5—1500-ohm vertical-mounting trimmer potentiometer\*
  - R6,R7—3000-ohm vertical-mounting trimmer potentiometer\*
  - R8—5000-ohm vertical-mounting trimmer potentiometer\*
  - R9—1500-ohm, 1/2-watt resistor
  - R10—1800-ohm, 1/2-watt resistor
  - R11—12,000-ohm, 1/2-watt resistor
  - S1—10-ampere dpst toggle switch
  - S2—2-pole, 5-position non-shorting rotary switch (Mallory 173C or equivalent)
  - S3—Spst normally closed miniature push-button switch
  - SO1—3-conductor chassis-mounting ac receptacle
  - Misc.—Chassis-mounting fuse holder for F1; three-conductor ac line cord with plug; 6 3/4-in. by 5 1/4-in. by 2 1/4-in. Bakelite (or metal) chassis box with cover; hookup wire; solder; etc.
- \*Pots are Mallory Type MTC-1 or equivalent.

Fig. 1. In the fast-acting electronic fuse circuit, a triac is used to actuate the relay to cut off the power.

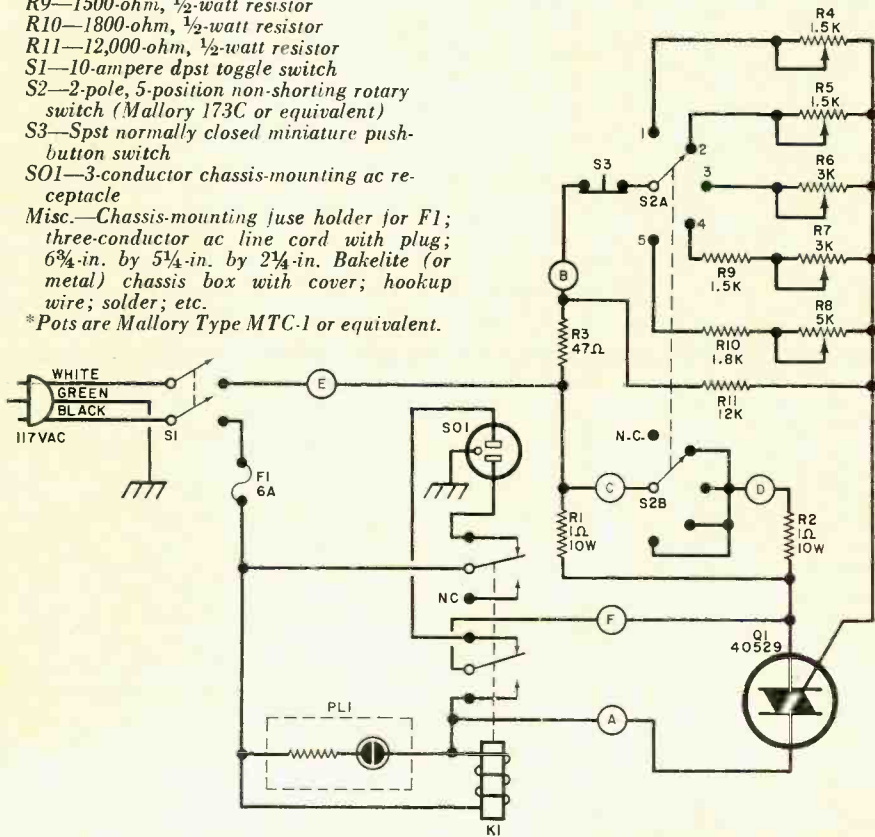

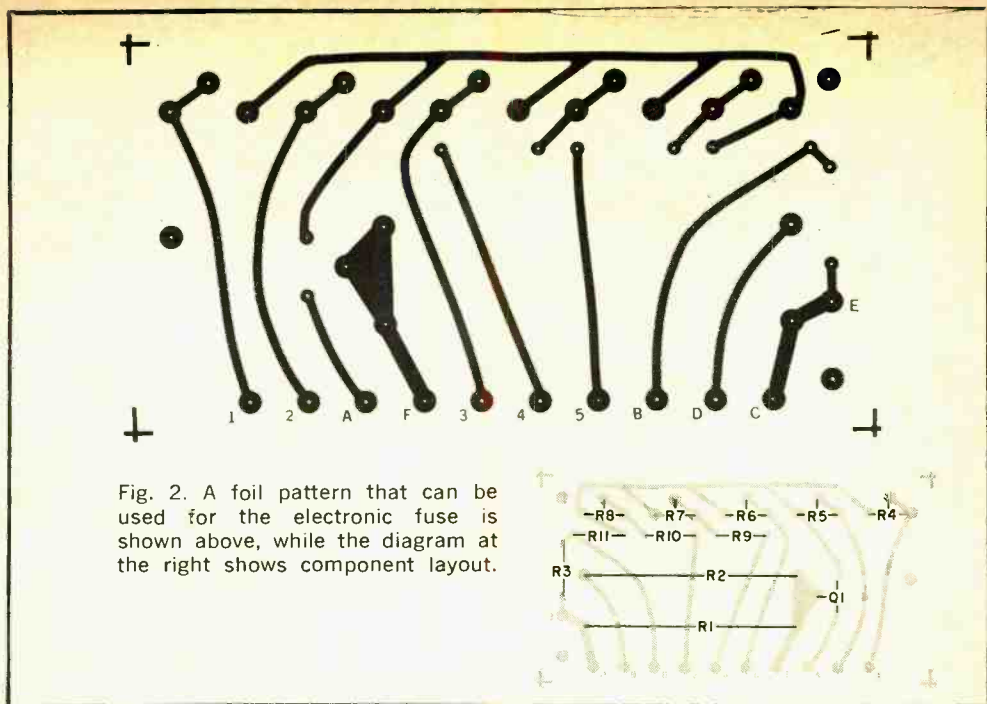

Fig. 2. A foil pattern that can be used for the electronic fuse is shown above, while the diagram at the right shows component layout.

cord after routing it through a hole with a rubber grommet.

Align and drill five 1/4-in. holes through the side of the chassis box to provide direct-in-line access to the adjustment slots of R4-R8 when the Electronic Fuse is fully assembled. Before finalizing the project, check to make certain that KI's armature operates freely when the chassis box is assembled. Then, use an ohmmeter and visual inspection techniques to make absolutely certain that no current-carrying portion of the circuit touches chassis ground. The only grounded items in the circuit should be the green (neutral) wire of the power cord and round contact of SO1. Sometimes this socket contact has a green-tinted screw for easy identification.

**Calibration and Use.** For calibration, you will need the following loads:

S2 SETTING (A)	OUTPUT LOAD (W)
1	150
2	275
3	375
4	500
5	650

Incandescent lamps connected in parallel can be used in conjunction with S3. For heavier loads, heating coils (hair dryer, toaster, etc.) are ideal. You will also need an *insulated* screwdriver to adjust R4-R8.

(Note: If you lack an insulated driver, you can slip over the shank of an ordinary metal driver a length of insulated tubing. Alternatively, you can drill the holes oversize and line them with rubber grommets.)

To calibrate each range, set S2 to the proper position and plug into SO1 the required load. Set the appropriate calibration pot to its maximum resistance setting and turn on the Fuse, using S3 as necessary during turn-on. If KI pulls in, check all settings and repeat the turn-on procedure.

With the load operating, slowly adjust the pot with the insulated screwdriver until the relay just pulls in. Turn off the project and repeat the above procedure for each setting of S2.

Now, with the Fuse plugged into an ac outlet, plug the device to be protected into SO1 and set the range switch for the proper fuse current. Turn on the Fuse, then the load. If the Fuse trips, reset it by turning off the power and then on again. Restart the system by momentarily pressing S3 while switching on the Fuse with the load turned on. If the Fuse's relay trips again, check the setting of S2 to verify whether or not it is switched to the correct current range, or look for a malfunctioning load. It should be noted that, if the load is incandescent lamps, it may require three or four starting attempts. ♦

# Design Your Own **BASS REFLEX HI-FI SPEAKER SYSTEMS**

## **PART 2. CONSTRUCTION DETAILS**

BY DAVID B. WEEMS

**I**N PART ONE of this article theoretical considerations in the design of bass reflex speaker systems were discussed in detail. In this second part, our discussion focuses on the practical construction details concerned with the reflex enclosure.

**Construction Details.** All speaker enclosures should be made from good-quality lumber and should be securely joined along all abutting edges. This is particularly important with such large enclosures as the floor-standing reflex. Large unsupported panels, such as the rear wall, should be braced with 1" X 2" or larger lumber that is glued and screwed on edge to the inside of the panel.

If a single brace is used on a panel, it should run along the panel's longer dimension (or diagonally) to divide the panel into two narrow strips that are more rigid than two square pieces. Opposing panels that are equal in size should theoretically be braced differently to stagger their resonances, but this is only for the purist. The speaker mounting board will always be braced differently from the rear panel owing to the speakers mounted on it.

Edges of the enclosure should be fitted together by means of internal glue blocks and screws. The back panel should be screwed down with a rubber-tape or caulking-compound gasket to eliminate leaks. The more carefully put together, the better the system will operate as a true reflex,

and the more accurate and predictable will be the tuning.

**Simple Vented Enclosures.** The classic bass reflex is a speaker box with a simple hole in the baffle. There is no tunnel behind the port. There are more variables and more design steps to the bass reflex than to the closed box system, but the procedure is similar. If the  $Cms/Cmb$  ratio is used, first measure the suspension compliance of the speaker (see "Closed Box Speaker System Design," Part 1, June 1973). Then choose a box compliance to yield the desired ratio.

Here is an example. Tests show that a 12-in. speaker has a 50-Hz free-air resonance and a  $0.7 \times 10^{-6}$  cm/dyne suspension compliance. If the  $Cms/Cmb$  ratio is to be 1.4, a box compliance of  $0.5 \times 10^{-6}$  cm/dyne would be chosen, obtained from:  $(0.7 \times 10^{-6})/1.4$ . From the box compliance chart in Fig. 1, locate the line for  $0.5 \times 10^{-6}$  and follow it up to the diagonal line for 12-in. speakers. From the junction of the lines, move to the left of the chart to find the optimum box volume: 6 cu ft.

Now refer to Fig. 2 to locate the curve for 50 Hz and follow it to where it crosses the 6 cu ft line on the vertical scale. Where the 50-Hz and 6 cu ft lines cross, the port area is 30 sq in., as shown along the bottom of the graph. It should be noted that Fig. 2 shows the values of port area for a rectangular port with a length-to-width



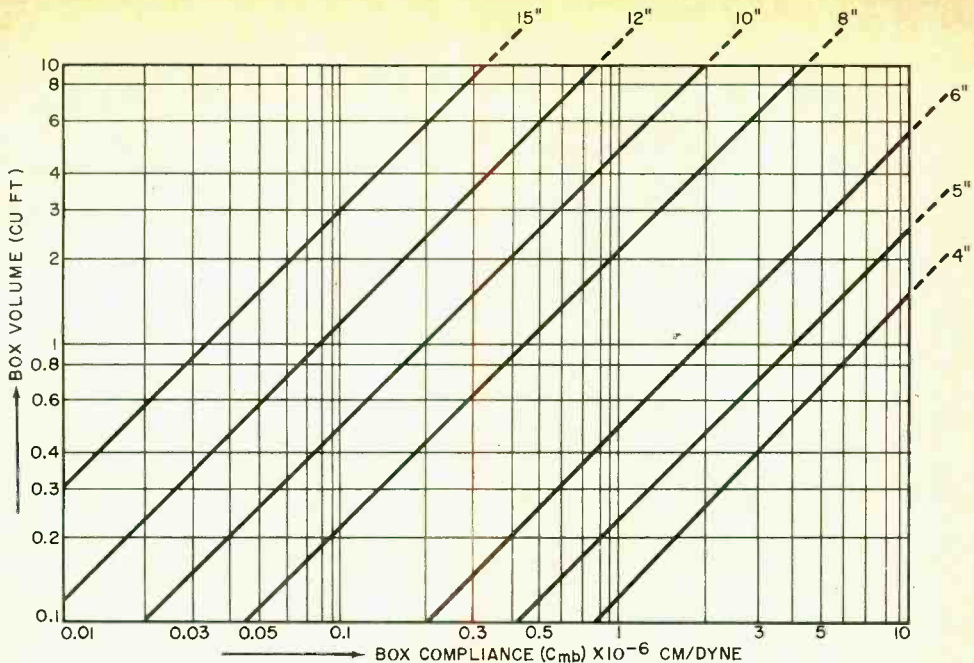

Fig. 1. Enclosure volumes for various values of box compliance and speaker size.

(aspect) ratio of 4:1, the shape usually found in large reflex boxes. If the port can be made square or round (1:1 aspect ratio), the area can be increased by about 33 percent. If possible, the aspect ratio should not be greater than 4. Long narrow slits add resistance to the vent; they should be avoided unless they are an integral part of a special design.

If the required port area is found to be very small—say 5 sq in.—it should be enlarged and a tunnel should be installed behind it.

**Simplified Method.** The builder with no test equipment can estimate the proper enclosure size for his speaker. From Fig. 2, he can choose a volume that will permit a port area of 30-100 percent of the speaker's effective cone area as follows:

NOMINAL SPKR DIA.	PORT AREA RANGE
8 in.	9-28 sq in.
10 in.	15-50 sq in.
12 in.	24-78 sq in.
15 in.	40-133 sq in.

For example, for an 8-in. speaker with a 70-Hz cone resonance, Fig. 2 shows that the largest volume, for a 28-sq-in. vent, is 3 cu ft. The smallest recommended volume, for a 9-sq-in. vent, is 1.8 cu ft. Because 70

Hz is a relatively high resonant frequency by today's standards, an enclosure volume at the upper end of the scale would be chosen to provide satisfactory bass response. If the resonant frequency were much lower, more latitude could be used in choosing an enclosure volume. For low-resonance speakers, the 30-percent-minimum rule can be violated, but the absolute minimum of 5 sq in. must be observed.

If possible, the vent should be located on the speaker board, about 3 or 4 in. from the speaker. The distance between vent and speaker can be greater than 4 in. but not less than 3 in. Where there is no room on the speaker board, the vent can be located on another board.

**Tuning Reflex Enclosures.** Perfect tuning is not required to obtain good results in a bass reflex system. The proper use of design charts will generally yield satisfactory performance, but the listener with test equipment will likely want to verify tuning accuracy. Most published instructions suggest adjusting the area of the vent until the two impedance peaks are equal in amplitude and equally spaced from the tuned frequency. These instructions are valid only if certain precautions are observed.

First, the specification that the peaks be equally spaced is correct only if the curves are graphed on the proper logarithmic scale. And the equal-amplitude requirement assumes the availability of accurate test equipment and little or no acoustical damping at either peak. The last requirement is subject to several variables, such as damping material and the type of lumber used in the box. Even without damping material, the wood walls of a speaker box will, by vibration, absorb a significant amount of energy at low frequencies. In a typical enclosure with 3 in. of damping material on the walls, the box will absorb about half as much energy as the damping material at 40 Hz; at 80 Hz, the damping material will absorb many times as much energy as does the box. These differences in energy absorption can upset tuning procedures, particularly if the damping material is changed during tuning.

The easiest way to avoid these problems

Fig. 2. Design chart to be employed for bass reflex enclosures with the simpler vents.

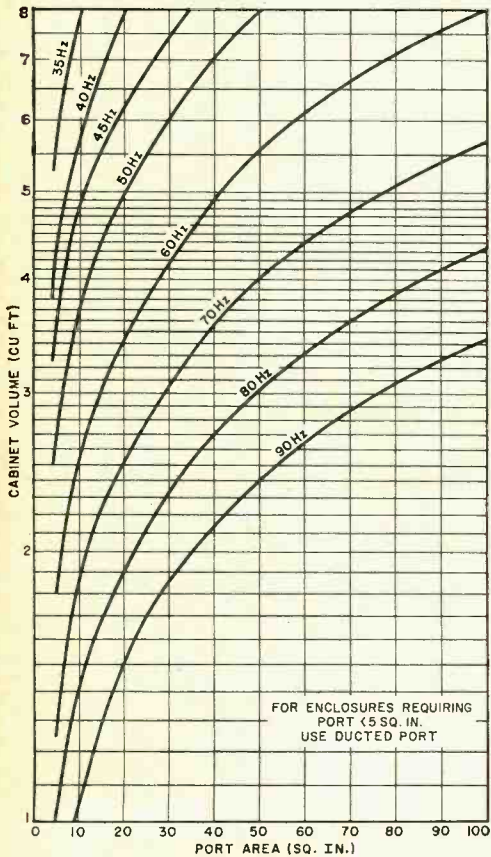

is to note the free-air resonance on the audio generator; then tune the enclosure for a minimum impedance at that frequency. Note that this method does not require an impedance curve, an accurately calibrated signal generator, or even knowledge of the exact tuning frequency.

To tune a reflex, the port should be made somewhat larger than the correct value as indicated on a design chart. Then a movable panel can be clamped across part of the port and adjusted until the trough of the impedance curve occurs at the same frequency as the free-air resonance of the speaker. While tuning, care should be taken to prevent rattles that can produce confusing results. If clamps are used to hold the panel, they should be very tight and their handles should be taped to prevent vibration. Air leaks also destroy tuning accuracy. So precautions to insure a sealed enclosure, except for the port, are advised.

Some manufacturers, notably JBL and Altec, do not recommend tuning the enclosure to the free-air resonance,  $f_r$ , of the speaker. They contend that optimum low-frequency response can be obtained only by extensive testing of a particular speaker/enclosure combination. These manufacturers furnish detailed cabinet plans that should be followed when using their loudspeakers. Unless such information is available, the enclosure should be tuned to the speaker's free-air resonance.

**Damping Material.** All speaker systems must be adequately damped to prevent the reflection of midrange and high frequencies within the cabinet and through the woofer's cone or port. The damping material should cover all walls except the speaker board. The proper thickness depends on the material's absorption characteristics and density, but 1-3 in. is typical. Fiberglass or rock wool batting are common damping materials.

In cases of excessive boom, home builders can often attempt to cure the problem with damping material. This step usually fails because most damping materials are not effective at low frequencies, particularly when they are applied to the box walls. But stuffing the enclosure can change the tuning volume by "expansion." The apparent increase in volume occurs because the stuffing decreases the velocity of sound by changing the operation of the enclosed air from adiabatic to isothermal. Stuffing

can also lower system  $Q$ , reducing the amplitude of the upper resonance while the volume expansion lowers its frequency. Care must be used to prevent overdamping and excessive bass loss, although slight overdamping can be compensated for by bass boost in the driving amplifier.

Sometimes damping material is put across the vent. This lowers the ability of the vent to damp the speaker and reduces efficiency, defeating two purposes of the ported enclosure. A better method of system damping is to staple a sheet of damping material over the back of the speaker itself. Damping material behind the speaker damps both the speaker and the enclosure without interfering with vent operation.

**Ducted-Port Reflex Enclosures.** There has always been a demand for small speaker systems, even when the sound from small systems was frequently bad. The advent of stereophonic sound (and, more recently, quadraphonics) put increasing pressure on manufacturers to decrease the sizes of their enclosures. One result of this pressure was the compact closed box. But with it came a new kind of reflex—new to the trade, although the principle had been

Candles in front of ported enclosure show relative cone and port air velocity at resonance. Lower flame is violently displaced at resonant frequency while upper is barely affected.

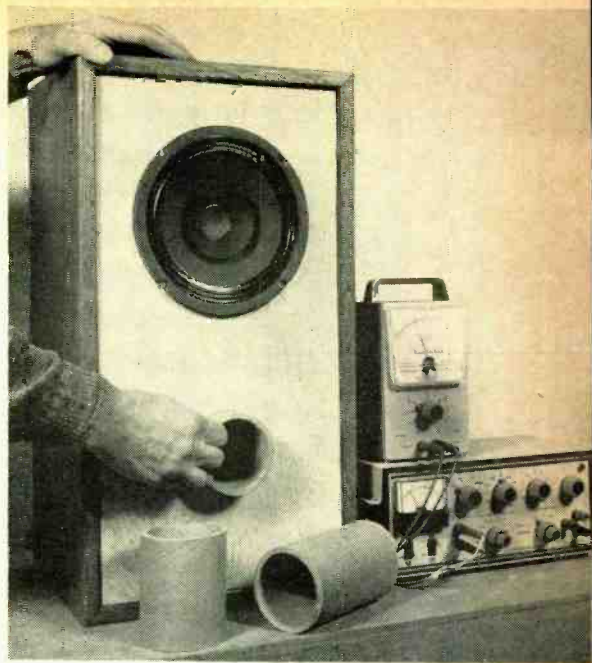

Method of tuning ducted port reflex with cardboard tubes. Various duct lengths are tried until proper tuning is achieved; then correct length tube is glued into speaker panel.

known for many years. This was the reflex with a duct behind the port.

Any increase in the thickness of a vent, either by using a thicker baffle or by a duct, increases the mass of vibrating air. Vibrating against the compliance of the trapped air in the box, this greater air mass lowers the resonant frequency of the system. A small enclosure can be tuned to a lower frequency with a duct than with a simple vent of the same area. A small box with a duct can have the same vent area as a large box without a duct tuned to the same frequency.

This does not mean that the small ducted enclosure will provide the same performance as the larger box. Important system characteristics, such as bass cutoff frequency, are determined by other factors like the  $Cms/Cmb$  ratio that is independent of the method of tuning. This fact is sometimes overlooked by enthusiastic experimenters and advertising men who claim that their small enclosures are the equal of much larger ones. It is true only if the volume of the smaller enclosure is about optimum for the specific speaker used in it.

Although modern loudspeakers require larger optimum-volume enclosures than past speakers did, they can be used with satisfactory results in smaller cabinets. This is due to their low resonances, a by-product of high compliance. It is especially true if the low resonance is obtained by increased cone mass, rather than by higher compliance alone. Small boxes raise the bass cutoff frequency above that of large enclosures. But if the speaker's free-air resonance is low enough, the combination will yield acceptable bass response. Thus, the development of low-resonance speakers not only made possible the modern compact closed-box system, but also the compact ducted-port reflex.

The same factors that determine the design of a simple vented enclosure apply to the ducted-port box. The inertance of a duct varies directly with its length and inversely with the cross-sectional area. So, to lower the tuning frequency, either the duct must be lengthened or its cross-sectional area must be reduced.

A duct must be used if tuning charts indicate a simple vent of less than about 5 sq in. Any enclosure that requires a vent of less than about one-third the effective

Tuning a large bass reflex. Tape on clamps prevents vibration from affecting the tuning.



cone area of the speaker is a candidate for a duct. Small vents produce increased air velocity through them, which can increase distortion and even add the spurious sound of rushing air. They can also add resistance that wastes energy and makes the enclosure operate like a leaky box instead of a tuned system.

For small vents, a cardboard tube or a plywood duct of square cross-section can be used. Heavy cardboard mailing tubes, when used, require that the hole in the baffle be cut to match the *outside* diameter of the tube. An extra advantage of the cardboard tube is the ease with which the system can be tuned. With other types of ducts it is necessary to remove the back panel to make changes in duct length.

If a cardboard tube is used, it is possible to permanently assemble the speaker system, except for the grille cloth, and then tune the enclosure. The duct hole must be carefully pre-cut to allow a snug fit when the tube is pressed into it. The audio generator and ac voltmeter are then connected

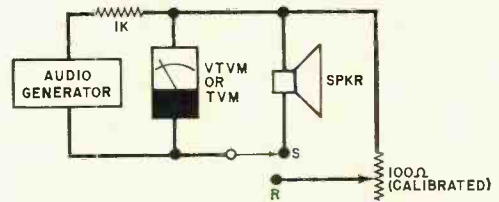

Fig. 3. Setup for running impedance curve. First calibrate variable resistor using ohmmeter and mark resistance at various settings of control knob. With equipment as shown, feed 200-Hz signal into speaker. Then, vary frequency downward, taking voltage readings at close frequency intervals. To read impedance at any frequency, note value of ac voltage on meter with switch in position S. Then switch to position R and vary knob setting to obtain the same meter reading. Record the resistance reading indicated by the exact frequencies of the peaks and valleys. Then plot the curve on a sheet of semilog paper.

to the speaker system as shown in Figure 3, and different lengths of tube are tried until the impedance trough occurs at the speaker's free-air resonance. The tube can protrude outside the box while testing because tuning is hardly affected by its position.

When the correct length of tube is prepared, glue it flush with the outside of

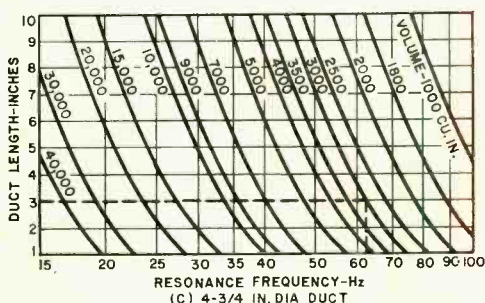
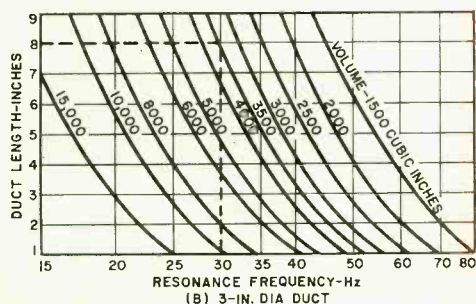
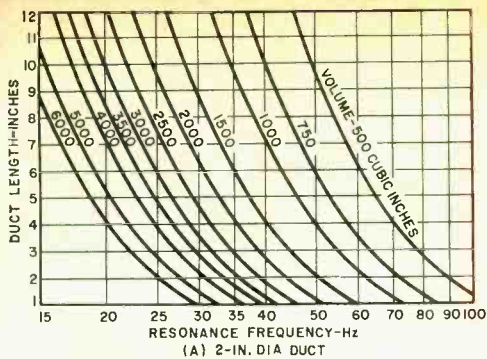

Fig. 4. Design charts for cardboard tube ducted enclosures developed by J. F. Novak, Chief Engineer, Jensen Sound Laboratories. Various tubing diameters are inside measurements; duct length is measured from cabinet front. Tubes can be obtained from business supply houses, stationery stores, or ordered from Service Manager, Jensen Sound Labs., 4310 Transworld Rd., Schiller Park, IL 60176.

the speaker board. All that remains to be done is to attach the grille cloth to the front of the cabinet.

Holes cut for square ducts should match the *inside* dimensions of the duct. The duct can then be glued and screwed to the front panel. Note that the effective duct length in this case will include the length of the duct and the thickness of the front panel.

No matter what kind of duct is used, a

free space of at least 1½ in. must be provided between its rear edge and the back wall of the enclosure. This will place a limit on the permissible duct length, which—together with the volume and desired tuning frequency—determines a useful cross-sectional area and length of duct for a given enclosure.

The effective length of any duct is slightly greater than the length of the tube itself due to the tendency of the air outside the end of the tube to vibrate with the moving air in the tube. This phenomenon would have to be accounted for if a formula were used to find the correct duct length for an enclosure. But when using design charts, this factor can be neglected; the correction has already been made by the chart maker.

To use James F. Novak's charts in Fig. 4, the largest possible duct should be selected to tune an enclosure to a speaker. For a speaker with a resonance of 62 Hz that will be used in a 3000-cu-in. box, a 3-in. length of 4¾-in. duct is correct as shown. But for a speaker with a free-air resonance of 30 Hz that is to be used in a 2-cu-ft. box (about 3500 cu in.), even a 10-in. long duct is far too short. For this speaker and box combination, it is necessary to go to the next smaller, 3-in., duct where an 8-in. length will properly tune the box to the speaker.

The duct can be made to any convenient shape if test equipment is used to assure proper tuning. But if the tuning charts are used without further testing, it is imperative that the cross-sectional shape of the duct be either round or square.

Some experimenters and speaker engineers advocate the use of damping material in the duct to improve transient response and smooth the impedance curve of the speaker. This is a controversial practice because, like simple resistive vents, it decreases cone damping in the octave above resonance and reduces efficiency. It does eliminate the possibility of midrange radiation from the port, but it is rarely necessary for that purpose. The naturally high reactance of the port to midrange and high frequencies, plus the judicious use of damping material inside the box, will usually take care of unwanted reflections through the port. Duct stuffing is useful only when accompanied by adequate testing to achieve a specific design goal. It should not be used indiscriminately. ♦

From Cleveland Institute of Electronics

# learn by doing!

Perform more than 200 exciting experiments  
with CIE's fascinating **ELECTRONICS  
LABORATORY PROGRAM!**

Put theory... into practice



# You get your own 161-piece electronics laboratory... with authentic electronic components used by industry!

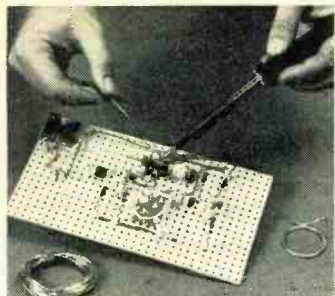

You learn how to construct circuits and connect them with a soldering iron, which is part of your CIE laboratory equipment. This "hands on" experience is extremely valuable in applying what you learn.

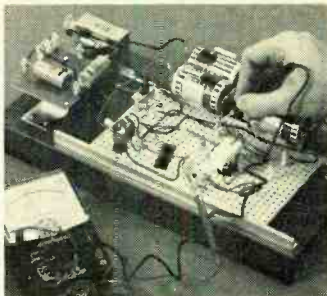

Testing and troubleshooting are an important part of your learning experience. Included in your laboratory is a precision "multimeter" to diagnose electrical and electronic troubles quickly and accurately.

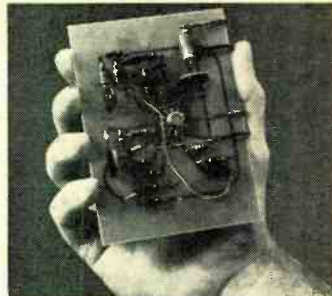

Modern space-age components like this IC (integrated circuit) are professional quality and can be used again and again in many of your projects. Lesson by lesson, piece by piece your knowledge grows!

## Prepare now for a high income career in Electronics...the Science of the Seventies.

Electronic miracles are changing today's world with breathtaking speed.

And with this growth in electronics technology has come a brand new need... a demand for thousands of electronics technicians, trained in theory and practice to build the products, operate them and service them during the Seventies.

Don't just wait for something to "happen" in your present job. Get ready now for a career you'll really enjoy with a good income and plenty of opportunity for advancement.

### Experience with experiments is your best teacher

"Hands on" experience helps to reinforce basic theory. When you learn by doing, you discover the "how" as well as the "why." You'll find out for yourself the right way as well as the wrong way to use electronic components. How to construct your own circuits, to discover trouble spots and learn how to fix them. And with CIE's special Auto-Programmed® Lessons, you learn faster and easier than you'd believe possible.

CIE's fascinating course, Electronics Technology with Laboratory, teaches you Electronics by making it work before your eyes. And you do it yourself, with your own hands.

### Importance of FCC License and our Money-Back Warranty

Many important jobs require an FCC License and you must pass a Government licensing exam to get one.

But, a recent survey of 787 CIE graduates reveals that better than 9 out of 10 CIE grads passed the FCC License exam.

That's why we can offer this famous Money-Back Warranty: when

you complete our Laboratory Course, which provides FCC License preparation, you'll be able to pass your FCC exam or be entitled to a full refund of all tuition paid. This warranty is valid during the completion time allowed for your course.

You get your FCC License — or your money back!

### You'll have high paying job opportunities

Electronics is still young and growing. In nearly every one of the new exciting fields of the Seventies you find electronics skills and knowledge are in demand. Computers and data processing. Air traffic control. Medical technology. Pollution control. Broadcasting and communications. With a CIE Diploma and an FCC License you can choose the career field you want... work for a big corporation, a small company or even go into business for yourself.

Here's how two outstanding CIE students carved out new careers: After his CIE training, Edward J. Dulaney, President of D & A Manu-

facturing, Inc., Scottsbluff, Nebraska, moved from TV repairman to lab technician to radio station chief engineer to manufacturer of electronic equipment with annual sales of more than \$500,000. Ed Dulaney says, "While studying with CIE, I learned the electronics theories that made my present business possible."

Marvin Hutchesn, Woodbridge, Virginia, says: "I was surprised at the relevancy of the CIE course to actual working conditions. I'm now servicing two-way radio systems in the Greater Washington area. My earnings have increased \$3,000. I bought a new home for my family and I feel more financially secure than ever before."

### Send now for 2 FREE BOOKS

Mail the reply card or coupon for our school catalog *plus* a special book on how to get your FCC License. For your convenience, we will try to have a representative call. If coupon is missing, write: Cleveland Institute of Electronics, Inc., 1776 E. 17th St., Cleveland, Ohio 44114. Do it now!



Approved under G. I. Bill

All CIE career courses are approved for educational benefits under the G. I. Bill. If you are a Veteran or in service now, check box for G. I. Bill information.

**CIE** Cleveland Institute of Electronics, Inc.  
1776 East 17th Street, Cleveland, Ohio 44114  
Accredited Member National Home Study Council

Please send me your two FREE books:

1. Your illustrated school catalog, "Succeed in Electronics."
2. Your book, "How to Get a Commercial FCC License."

I am especially interested in:  Electronics Technology with Laboratory  
 Electronics Technology  Industrial Electronics  
 Electronic Communications  First Class FCC License  
 Broadcast Engineering  Electronics Engineering

Name \_\_\_\_\_ Age \_\_\_\_\_  
(PLEASE PRINT)

Address \_\_\_\_\_

City \_\_\_\_\_ State \_\_\_\_\_ Zip \_\_\_\_\_

Veterans and Servicemen: Check here for G. I. Bill information.

PE-55

CIRCLE NO. 6 ON READER SERVICE CARD

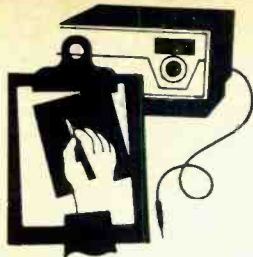

# Product Test Reports

## LAFAYETTE MODEL LR-221 4-CHANNEL RECEIVER (A Hirsch-Houck Labs Report)



**T**HE FULL directional effect of an SQ™ record can be heard only when the disc is played through a decoder that can sense the dominant direction at any instant and shift the relative channel gains to enhance the inherently limited front-to-rear directivity of the SQ system. The so-called "full-logic" (or wave-matching) system can yield the most effective separation in all directions with SQ discs. It is quite complex and, therefore, expensive. Until recently, the only 4-channel receiver to incorporate full-logic SQ decoding was the Lafayette Radio Electronics Model LR-4000. This receiver has now been joined by the lower cost (\$360) Model LR-221.

The LR-221's FM tuner section boasts performance specifications that are typical of many receivers in its price range—notably, 22  $\mu$ V IHF sensitivity, 0.25% distortion, 65 dB S/N ratio, 35 dB midrange stereo separation, and 40 dB alternate-channel selectivity. The 4 channel amplifier section is rated at 26 watts/channel into 4 ohms with one channel driven, while the THD at 1000 Hz is specified as less than 1 percent at full rated power and less than 0.125 percent at 1 watt output.

On the rear of the receiver are a HI/LO sensitivity switch for the magnetic phono inputs and two 4-channel AUX inputs. Two sets of speakers can be connected and driv-

en simultaneously or singly. The outputs for the REMOTE speakers are phono jacks, while screw-type terminals are used for the MAIN speakers. AM and FM antenna terminals (with provision for using the line cord as an FM antenna), a pivoted ferrite-rod AM antenna, an FM DET OUT jack for use with a future discrete 4-channel FM broadcasting system, and a single unswitched ac outlet are also on the rear apron. The tape recording and playback circuits, brought out through jacks on the rear of the receiver, are suitable for both 2- and 4-channel tape decks.

The front panel contains the tuning dial, tuning meter, an FM STEREO light, 2-channel TAPE OUT and separate front and rear headphone jacks, and all remaining controls and switches. The input selector has positions for AUX 1 and AUX 2, PHONO, AM, FM, and FM high-frequency blending (to reduce noise on weak signals). The FUNCTION SWITCH has positions for 2 CH (pairs both left and both right channels), COMPOSER A and COMPOSER B (matrices for decoding RM discs and synthesizing the rear channels

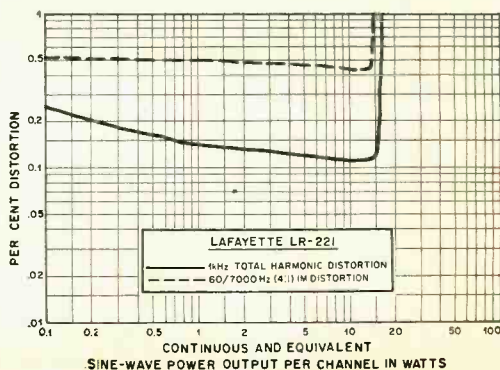



from 2-channel programs), SO FULL LOGIC, DISCRETE (for external tape source or a CD-4 demodulator), and REVERSE. The latter operates with discrete sources, reversing the left/right and front/rear positions to effectively turn the 4-channel array through 180°.

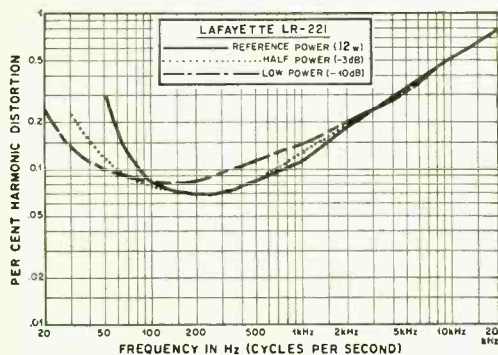

The BASS and TREBLE tone controls are concentric potentiometers, as is the L-R balance control for the front and rear channels. The master volume control is also concentric, slip clutched to permit adjusting the front-to-rear balance as well as overall volume. Pushbutton switches are used for TAPE MON, STEREO/MONO, LOUDNESS, HI FIL, and FM MUTE switching.

**Laboratory Tests.** With all four channels driven simultaneously at 1000 Hz into 8-ohm loads, the outputs clipped at 12.9 watts/channel. Driving only two channels increased the clipping output to 16 watts/channel. With 4-ohm loads and 16-ohm

loads, the figures were 16 watts/channel and 11.4 watts/channel respectively.

The 1000-Hz THD was below 0.25 percent from 0.1 to 16 watts, and was typically between 0.1 and 0.15 percent. The IM distortion was almost constant (0.4-0.6 percent) over the full range of power outputs from 10 mW to 12 watts. Using 12 watts as a reference full-power level, the THD at all power outputs from 1.2 to 12 watts was between 0.07 and 0.15 percent at frequencies from 65 Hz to more than 1000 Hz. The distortion increased with increasing frequency, to 0.5 percent at 10,000 Hz and 0.75 percent at 20,000 Hz. As with many receivers, the LR-221 had a limited low-frequency power capability so that its THD reached 0.25 percent at 20 Hz with a 1.2-watt output, at 30 Hz with 6 watts, and at 55 Hz with 12 watts output.

The tone control characteristics were good, with the bass inflection point sliding upward from 100 Hz to 500 Hz as the control was moved from center, and the treble slope hinged at about 2000 Hz. The m filter had a gradual 6-dB/octave slope, with the -3-dB point at 2700 Hz. The loudness compensation boosted both lows and highs moderately, and the RIAA phono equalization was within  $\pm 0.5$  dB from 70 Hz to 15,000 Hz (down less than 2 dB at 30 Hz).

The amplifiers could be driven to 10 watts output by a 180-mV AUX input or a 1.65-mV HI phono input or a 3.75-mV LO phono input. The corresponding phono overload levels were 22 mV and 50 mV. The former is too low for most cartridges; we recommend using the LO setting to avoid

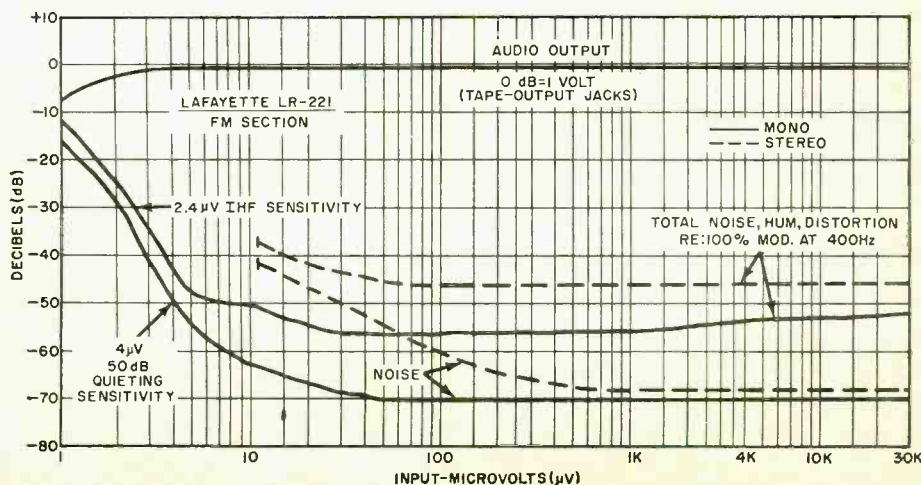

preamplifier overload distortion. The noise levels were very low,  $-75.5$  dB and  $-73$  dB for the aux and phono inputs respectively, referred to 10 watts output.

The FM tuner has a  $2.4\text{-}\mu\text{V}$  IHF sensitivity, with a 50-dB S/N ratio (mono) reached at only  $4\ \mu\text{V}$  input. The ultimate quieting in mono was 70 dB, with a residual distortion of only 0.17 percent. The automatic stereo threshold was  $11\ \mu\text{V}$ , and the ultimate stereo S/N ratio was 68 dB (with 0.5 percent distortion). The FM capture ratio was 1.6 dB, AM rejection was very good at 62.5 dB, and image rejection was an excellent 89.5 dB. Alternate-channel selectivity—55 to 59 dB on the two sides of the desired channel—was considerably better than the receiver's 40-dB rating.

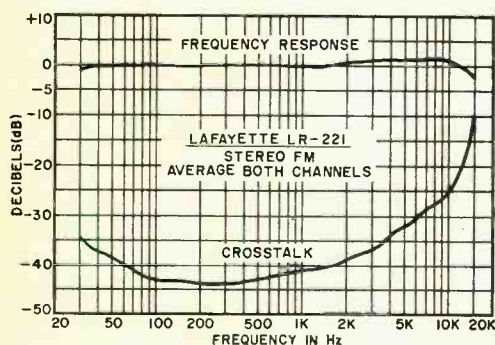

In stereo FM, the frequency response was flat within 1.5 dB overall from 30 Hz to 13,000 Hz. It was down 2.5 dB at 15,000 Hz. Channel separation was exceptionally good, exceeding 40 dB between 64 Hz and 1100 Hz, better than 30 dB from 30 Hz to 12,000 Hz, and still 10 dB at 15,000 Hz.

Circle No. 65 on Reader Service Card

The 19-kHz pilot carrier leakage in the audio outputs was 66 dB below full modulation.

The AM tuner, like many such, had limited high-frequency response.

**User Comment.** The FM tuner performance was comparable to what we have measured with many 2-channel receivers in the LR-221's price bracket. The tuning was not critical, and the muting allowed only a slight burst of noise to be heard when tuning through a station.

Although the audio amplifiers were much less powerful per channel than those of most 2-channel receivers, the total output of up to 64 watts at mid-frequencies from all four channels should be more than adequate for most listeners. Similarly, a comparison of the audio distortion in this receiver with that of a 2-channel receiver at the same price might seem to place the LR-221 at a disadvantage. However, under normal program conditions, the distortion is not likely to exceed 0.15 percent.

The SQ performance of the LR-221 is the receiver's most noteworthy feature, and it acquitted itself admirably. The center-front to center-rear separation was most impressive, as was the left-front to right-front separation. Between the rear channels and along the sides of the room, the separation was notably less, but distinct. Listening to a number of SQ discs, we were never in doubt as to the effectiveness of the full-logic decoder in this receiver. Compared to the vague directionality of a simple SQ matrix (used in almost all 4-channel receivers currently on the market, regardless of price), the quadrasonic performance of the LR-221 receiver was vastly superior.

## BANG & OLUFSEN MODEL 3000 TURNTABLE/TONEARM (A Hirsch-Houck Labs Report)

**T**HE Danish-made Bang & Olufsen Model 3000 is an integrated record playing system that is supplied on a wooden base to which is hinged a plastic dust cover. The system consists of a two-speed ( $33\ \frac{1}{3}$  and 45 rpm) belt-driven turntable and a slender tubular aluminum tonearm to which is fitted B&O's Model SP12A phono cartridge. The characteristics of the tonearm, phono cartridge, and turntable have been carefully matched for optimum performance, something not so easy to accomplish when as-

sembling a record player from its component parts.

**General Description.** The 11 $\frac{1}{4}$ -in. non-ferrous platter in the system is relatively light. It rests on a smaller internal turntable that is belt-driven by a 2750-rpm motor. The operating speed is adjustable over a nominal 6-percent range by a thumbwheel control located under the edge of the base. The tonearm mounting is rigidly coupled to the turntable system, and both are floated

from the motorboard on very compliant springs. The 4-Hz or so system resonance is low enough to avoid acoustic feedback problems but high enough to prevent undue susceptibility to jarring.

After the tonearm is balanced by an adjustable counterweight, the desired tracking force is set by a small knob on the pivot housing. The force calibrations cover a range of from 0 to 3 grams in 0.5-gram increments (B&O recommends a 1.2-gram force for their SP12A cartridge). Antiskating is applied by a non-adjustable system within the arm's pivot structure.



The cartridge supplied is identical in structure to the SP12 which B&O sells for installation in other tonearms. However, it is designed to simply plug into the end of the Model 3000's tonearm. It has a replaceable, polished,  $0.2 \times 0.7$ -mil elliptical diamond stylus.

The system has a uniquely simple control setup. A single LIFT button is concentric with the speed-select switch. The latter is used for selecting the standard turntable speed/arm index combination. When the selector is set for 10- or 12-in. discs, a touch of the button starts the turntable at 33 $\frac{1}{3}$  rpm, moves the arm over the lead-in groove, and gently lowers the arm to the disc's surface. The same thing happens in the 7-in. position except that the operating speed is 45 rpm. At the end of play, the arm returns to its rest position, safely supported clear of the motorboard (there is no rest post), and the motor shuts off.

At any time during play, pressing the LIFT button raises the pickup and shuts off the motor. A second push of the button starts the motor again and lowers the pick-up with no tendency for the arm to drift laterally.

There is also a MANUAL selector setting

that merely turns on the motor. The arm must be manually indexed (although its vertical motion is controlled by the LIFT button, and the automatic shut-off feature remains in effect at the end of play). Discs that do not fit the standard size/speed scheme, such as a 7-in. record designed to operate at 33 $\frac{1}{3}$  rpm, must be played using manual arm indexing.

The turntable platter has a retractable 45-rpm spindle built into its hub. A ring of stroboscopic markings on the platter facilitates easy initial speed adjustment.

The Model 3000 record player system, measures 17 $\frac{5}{8}$  in. by 13 in. by 4 $\frac{1}{2}$  in. and weighs 20 pounds. It retails for \$265.

**Laboratory Measurements.** On our test bench, wow and flutter tested out, respectively, at 0.05 and 0.04 percent on both speeds. Unweighted rumble was a very low -45 dB in the lateral plane and -38.5 dB when vertical rumble components were included. With RRL weighting, the rumble was -54.5 dB, typical of today's turntables. Speed was adjustable over a range of from +7.3 to -1.7 percent, relative to the correct speed.

Tonearm tracking error was very low, less than  $0.25^\circ$ /in. of radius from 3 to 6 in. It increased to a still good  $0.6^\circ$ /in. reading at a  $2\frac{1}{2}$ -in. radius. Balancing the arm according to instructions, we measured a tracking force slightly higher than the dial calibration indicated—by about 0.2 gram at a 1-gram setting. This small error is in a "safe" direction. But for maximum accuracy, an external pressure gauge could be used to check the force. Once set correctly at 1 gram, the dial error was less than 10 percent at any setting.

The cartridge had an output of 4.5 mV at 3.54 cm/s. Its frequency response was within  $\pm 2$  dB from 500 Hz to 20,000 Hz (the constant-velocity range of the CBS STR100 test record), and channel separation was 20 to 25 dB or more over most of the audible frequency range, decreasing to 10 to 15 dB beyond 15,000 Hz.

The 1000-Hz square wave of the CBS STR-111 disc was reproduced with a single over-shoot. We evaluated the "trackability" with the Shure TTR-103 disc which has special test signals for testing cartridge performance at high, middle, and low-middle frequencies. Although the numerical results could be used only to compare this cartridge with others tested in exactly the same man-

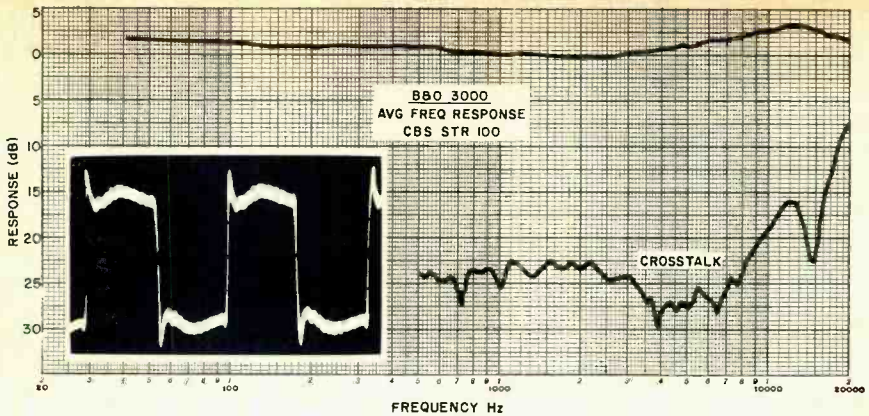

ner. Our studies showed that it has extremely good tracking capability—quite comparable, in fact, to what we have measured on the best cartridges previously tested.

**User Comment.** The Model 3000 player system is certainly one of the simplest players to operate with its control limited essentially to pushing a single button. Operation was smooth and flawless, with no undesirable characteristics.

The SP12A cartridge proved to be a superb performer. The most severe tracking tests to which we could subject it revealed that the SP12A cartridge could match the best we have yet tested for “trackability.” It would be safe to assume that any distortion heard when playing a disc with this unit would be in the record grooves.

The mass of the tonearm, which is somewhat lower than that of a typical general-purpose tonearm, enables the pickup to track severely warped discs that had proved previously to be unplayable with conventional arms. Since no antiskating adjustment was available, we could not judge its accuracy. But indications were that it was inoperative or too low on the test unit. Even without this aid to tracking, the Model 3000 system was able to outperform many players with full antiskating correction.

All in all, this is one of the most attractive and better performing record players we have seen. It is an excellent value, especially when one considers that it is a ready-to-play unit that requires only plugging into an amplifier and power line to put it into immediate service.

Circle No. 66 on Reader Service Card

## COURIER SPARTAN SSB CB TRANSCEIVER



**T**HE Courier Spartan SSB is a single-sideband CB transceiver with provisions for AM operation. It is a mobile, 23-channel solid-state rig that has most of the features incorporated in a combined AM/SSB unit.

A clarifier control allows the user to put both the receiver and the transmitter

right on frequency when operating SSB. There are an adjustable squelch for AM and SSB, a noise blanker that can be switched in or out, jacks for external receiving and for speaker hookup to the built-in PA system, and an r-f S/relative transmitter output power meter. Operation is from a nominal 13.8-volt dc, *negative-ground only* source. The microphone supplied is a push-to-talk dynamic noise-cancelling type.

Several of the functions are selected by miniature toggle switches, while others employ conventional rotary switches. The meter movement is an edgewise-mounting type. The rig measures 9½ in. by 7½ in. by 2 ¾ in. and weighs 6 pounds.

The Spartan SSB transceiver is list priced at \$330, including microphone and mobile mounting hardware.

**The Receiver.** The receiver section employs a front end that is common to both SSB and AM. It provides an excellent sensitivity figure of  $0.1 \mu\text{V}$  for 10 dB (S + N)/N on SSB and  $0.25 \mu\text{V}$  on AM with 30 percent modulation at 1000 Hz.

Many transceivers of this type use an r-f gain control to minimize overload by strong local signals, but the Spartan SSB has a LOCAL/DISTANCE switch; in the LOCAL position, it drops front-end gain by about 20 dB and reduces sensitivity to  $1.5 \mu\text{V}$  and  $3 \mu\text{V}$  on SSB and AM, respectively.

The 7.8-MHz i-f goes directly to the SSB section where USB or LSB selection is obtained with a 2.1-kHz bandpass crystal-lattice filter. The overall a-f response at the 6-dB points is 600-2700 Hz. Unwanted-sideband rejection with this setup was better than 70 dB at 1000 Hz.

Dual conversion is used on AM, with the 7.8-MHz i-f converted to 455 kHz. A ceramic filter in the i-f section provides a minimum of 30 dB of adjacent-channel rejection. The overall response of the a-f section was 550 to 2150 Hz, resulting in easily understood voice quality.

The receiver's image rejection was 80 dB. Other spurious signals were down a minimum of 60 dB.

A four-diode product detector is used for SSB, and dual diodes function as an envelope detector for AM. The a-f amplifying and output setup is switched between detectors and for PA operation. It was capable of producing more output than is usually the case, measuring 4.8 watts with a good sine wave distorted only 2.9 percent (1000 Hz into 8 ohms) and 6 watts with slight clipping and 4 percent distortion.

Individual agc systems are used for AM and SSB, with 14-dB a-f output change occurring with an 80-dB ( $1-10,000 \mu\text{V}$ ) r-f input change. The S meter was somewhat conservative, requiring a  $300\text{-}\mu\text{V}$  signal to produce an S9 reading. The squelch had a threshold sensitivity of  $0.1-500 \mu\text{V}$  on SSB and  $0.4-3000 \mu\text{V}$  with AM.

The noise blanker operates on AM and SSB. When used, a series-gate a-f noise limiter is simultaneously switched into the AM section. In either mode, the overall attenuation of impulse-noise peaks amounted to 20 dB. The system was quite effective

# Now Available!

The **Popular Electronics**  
INCLUDING Electronics World

# INDEX

**PUBLISHED FOR THE FIRST TIME**

NOW...you can find the information you want quickly and easily in these detailed and complete Indexes, each covering a full year of POPULAR ELECTRONICS Magazines (12 issues).

Hundreds of subjects, titles, and brand names arranged for clear, fast reference. An ideal companion to your magazine collection - and essential for the audiophile, gadgeteer, ham, and service technician.

Both the 1972 and 1973 Indexes have been prepared in cooperation with the Editors of POPULAR ELECTRONICS Including ELECTRONICS WORLD. Indexes for both 1972 and 1973 are available at only \$1.00 per copy, postpaid. Each Index covers a full year of 12 issues.

Order your copies of these valuable and informative Indexes now!

## INDEX

Box 2228, Falls Church, Virginia, 22042

Enclosed please find \$\_\_\_\_\_ for the following Indexes at \$1.00 each, postpaid: PE-274

\_\_\_\_\_ copies --- 1972 Index

\_\_\_\_\_ copies --- 1973 Index

Print Name: \_\_\_\_\_

Address: \_\_\_\_\_

City \_\_\_\_\_ State \_\_\_\_\_ Zip \_\_\_\_\_

Please enclose full payment with order. Make checks payable to INDEX.

in preventing receiver desensitization by noise pulses.

**The Transmitter.** A frequency synthesizer with 14 crystals provides a nominal 19-MHz output at a four-diode balanced mixer and provides the heterodyning signal for the receiver mixer. It also goes to an IC transmitter mixer where it is combined with a 7.8-MHz SSB signal that is generated in the usual manner with a balanced modulator and the crystal filter. This produces the on-channel signal that is amplified by two stages and drives the r-f power amplifier which contains the customary output-matching and filtering network. For AM, the on-channel carrier is produced by mixing the synthesizer's output and a 7.8-MHz signal. The power amplifier and driver are collector-modulated by the receiver's a-f system. A "power controller" holds the AM input voltage down at the r-f stages for operation within the legal power limit.

Automatic level control is provided for SSB. On AM, automatic modulation control takes over.

Operating from a 13.8-volt dc source, the transmitter's PEP output on SSB was almost 12 watts (rated 8 watts). The third-order distortion products at the automatic level control threshold were 26 dB below maximum output. Carrier suppression was 55 dB, and unwanted-sideband suppression was the same as on receive.

With AM, the carrier output was 3.75 watts. A full 100-percent modulation was attainable with a good waveform exhibiting only 2 percent distortion (with 1000 Hz) at the onset of complete modulation. With 6 dB of clipping, the distortion rose to 10 percent.

At the center position of the clarifier control, the frequency of any channel was within 100 Hz. The clarifier range was nominally  $\pm 500$  Hz.

The transceiver is designed for use only in negative-ground systems. Reverse-polarity protection is furnished by a diode that conducts and places a virtual short circuit across the supply line when the polarity is incorrect, blowing the line fuse. A filter in the supply line minimizes transient spikes and ignition-noise pulses.

Circle No. 67 on Reader Service Card

## BALLANTINE MODEL 3/24 DIGITAL MULTIMETER

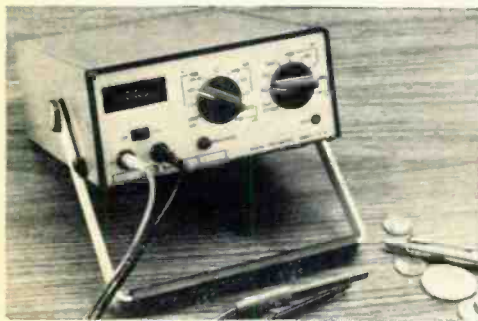

**U**NTIL fairly recently, some of the finest test equipment available for high-level scientific study and research and development was made by companies whose names were unknown to the majority of the people involved in electronics. Recently, however, a few of these companies have been producing test gear within the price range reachable by technicians, experimenters, and radio/TV-service shops.

One of the top-flight test instrument manufacturers that has established an impres-

sive reputation in engineering circles is Ballantine Laboratories, Inc. This company is currently making its debut into the low-cost test equipment market with the introduction of their Model 3/24 digital multimeter that retails for only \$195—this from a company whose wares in the past were priced nearer the thousands than the hundreds of dollars.

**General Description.** The Model 3/24 gets its designation from the fact that it is a three-function, 24-range instrument. It is designed to measure dc voltages to 1, 10, 100, and 1000 V full-scale with an accuracy of 0.5 percent or better. The same four ranges are available for measuring ac voltages to 1 percent accuracy. (On the 1- and 10-V ac ranges, the frequency response is 40 to 20,000 Hz, while on the 100- and 1000-V ranges, it is 40 to 1000 Hz.) Input resistance on dc V is 10 megohms, and on ac V the input impedance is 10 megohms shunted by 75 pF.

Five direct current ranges are provided,

going out to 100  $\mu$ A, 1 mA, 10 mA, 100 mA, and 1 A full-scale with an accuracy of 0.5 percent plus one digit. The voltage drop is approximately 1 volt. There are also five similar ac ranges, all with an accuracy of 1.5 percent plus two digits, approximately a 1-V drop, essentially infinite common-mode rejection (on battery operation), and a frequency response of 40 to 2000 Hz.

Six resistance ranges round out the instrument's functions, covering decade steps from 100 ohms to 10 megohms full-scale. Accuracy is 1 percent plus one digit. The test current is 10 mA on the 100-ohm range, decreasing in decade steps to 0.1  $\mu$ A on the 10-megohm range.

Among the other features to be found are automatic zero setting, automatic polarity indication, and a LED display BRIGHTNESS control that can be used to adjust the display to any brightness level within the instrument's range. Two front-panel controls are provided for selecting the function and range. The readout system is a cluster of 3½ LED displays. All displayed indications are made at a 3/second rate, producing an almost instantaneous updating of the measured parameter's value. In the event of an overrange, the most significant digit flashes on and off.

A front-panel ZERO control permits the

user to compensate for the resistance of the test leads when making very low resistance tests. The only other control on the front panel is the power ON/OFF switch.

**Evaluation Comments.** We were pleasantly surprised when we first unpacked the 7-in. by 5-in. by 2½-in. instrument. It weighed only 2 pounds with its single 9-volt battery installed. (The battery, it should be noted, is said to supply 300 hours of life when the instrument is put into normal use.) The carrying handle that comes affixed to the case of the DMM also doubles as a tilt stand for bench use.

Checking the DMM against our laboratory-standard dc voltage supply and our "standard" set of close-tolerance precision resistors revealed that the instrument functioned well within its published specifications, which was no surprise. Its small size and ac-line-independence made the DMM very useful on our workbench where it could be placed just about anywhere—even inside large TV receiver chassis. In field-service use, the instrument performed flawlessly.

We feel that the Model 3/24 DMM from Ballantine is an excellent buy. It is hoped that other OEM companies will follow this one into the consumer area.

Circle No. 68 on Reader Service Card

## BRANSON MODEL B-220 ULTRASONIC CLEANER

Sometimes we run into things that don't appear to fit any "electronic" category. But after using them for a while, we wonder how we ever got along without them. Just such a situation existed when we were handed a Branson ultrasonic cleaner to test. Frankly, we have to admit that we didn't have the faintest idea what to do with the thing (aside from cleaning jewelry, of course). The more we used it, the more uses we could see for the cleaner, especially in electronics work.

The Branson ultrasonic cleaners come in nine models that range in tank capacity from the 1-pint Model B-2 (\$55) to the 8-gallon Model B-92 (\$750). Looking for a convenient size for electronics applications, we decided to test the 3-quart (9" × 5" × 4" tank dimensions) Model B-220. This unit retails for \$115, which puts it into an attractive price range for repair shops that have to contend with component and assembly cleaning jobs.



**How It Works.** The theory behind ultrasonic cleaning is relatively simple. A high-power ultrasonic generator drives one or more transducers that couple the high-frequency energy into the liquid in the tank. Since the liquid (detergent solution or industrial solvent) does not heat up and the tank is made from stainless steel,

# PACE ((P)) GUARANTEES PERFORMANCE SERVICE



## Listen In

- WEATHER ALERTS
- POLICE MESSAGES
- FIRE ALARMS
- MARINE CALLS
- BUSINESS ACTION

## SCAN 10-4H

only **\$89.95**  
plus crystals

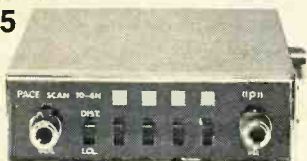

Works on AC or 12V Mobile, or Portable Pack. Monitors 4 VHF Channels simultaneously. Model 10-4H covers 144 to 174 MHz. Model 10-4U covers UHF.

Standard antenna fitting for Mobile or roof top antenna, temporary desk top antenna provided.

Low cost, but High in performance with lock out controls and exclusive local/distance function for city or country use.

WRITE PACE FOR FREE  
PACE SCAN MONITOR BOOKLET  
OR STOP BY YOUR LOCAL...

... SIGN OF QUALITY



PACE COMMUNICATIONS  
DIVISION OF PATHCOM INC.  
24049 S. FRAMPTON AVE., HARBOR CITY, CA 90710

Name \_\_\_\_\_

Street \_\_\_\_\_

City \_\_\_\_\_

Frequency or type of Monitor needed:

**CIRCLE NO. 32 ON READER SERVICE CARD**

almost any type of cleaner can be used.

The object to be cleaned is immersed in the solution in the tank. After power is turned on, the 50-60-kHz sound waves cause the solvent in the tank to undergo cavitation wherein millions of tiny bubbles form and collapse. The result is a "scrubbing" action on the immersed parts wherever the liquid contacts them. The cleaning action also goes around corners, into deep crevasses, and can even pass through some barriers. Hence, the insides of the immersed objects are cleaned simultaneously with their outside.

Although the bulk of the cleaning jobs can be accomplished with warm water and a little household detergent, other types of additives—such as ammonia and bleach—or solvents (kerosene, commercial cleaning fluids, degreasers, etc.) can be used. Selection of the cleaner to use depends on the job to be done.

**By the Numbers.** We had a crack at cleaning some noisy potentiometers and a couple of well-used, over-lubricated television tuners. The ultrasonic energy developed by the unit blasted them clean. We say "blasted" because the puffs of cloudy material leaving the items in the tank looked like they were blasted out. We noted afterward that because the cleaner does such a thorough job, cleaned switches or tuners require relubrication.

Because we build many projects, we used the ultrasonic cleaner to scrub the copper foil of PC boards. Soldering is no longer a problem, and items such as capacitors and resistors turn out so clean that no doubt is left as to their values by color code or number imprint. Knobs, especially those with grease-collecting knurled perimeters, really come clean.

Having used the ultrasonic cleaner for several weeks, we now find ourselves cleaning things electronic and non-electronic several times a day.

Circle No. 69 on Reader Service Card

### ERRATUM

In last month's Product Test Reports, the price of the EL Instruments Model DD1-K Digi-Designer was incorrectly listed as \$50. It should have been \$59.95.





# Servicing Without Service Data

By John T. Frye, W9EGV, KHD4167

**B**ARNEY had been working on a combination AM-stereo FM and 8-track tape player for half an hour, grumbling under his breath all the while. Finally Mac, his employer, switched off the sweep generator he had been using after replacing an i-f transformer in a TV receiver and asked, "OK, Irish, what's all the muttering in your beard about?"

"Aw, I'm sick and tired of having to work on foreign-made transistor equipment for which we have no service data. It's like fighting with one hand tied behind your back."

"I know," Mac sympathized. "More and more of this equipment comes into the shop every day: transistor radios, hi-fi's, tape players, and recorders, all bearing names we do not recognize. Almost no information is available on many of these units. If any helpful data came with the equipment, the owner threw it away or lost it long ago. The model number, and quite often the make itself, are not listed in the index of our service literature. If a rare wiring diagram is found on the chassis or in the cabinet, it's about the size of a credit card and of little help."

"Now servicing without service literature can be tedious and time-consuming; yet a diagnosis and repair of a piece of this maverick equipment must be made quickly to turn a profit. The owner simply will not pay for a great deal of time spent on it. Replacement cost—especially of the small radios—is low enough that the customer will buy a new receiver if the repair cost exceeds a few dollars."

"Yeah, I know," Barney chimed in. "Many smart technicians refuse to touch one of these 'Made in Japan, Hong Kong, Taiwan, etc.' electronic devices. They figure they will invest more time in flying-blind servicing than they will be able to recover in charges."

"I don't think that's so smart," Mac said. "Any time you see a service going begging because it has disagreeable features, you're staring an opportunity right in the face. Garbage collectors, plumbers, and undertakers have found this out, and they seldom die broke. The trick is to find ways to nullify the unattractive qualities of the work for you personally while these same qualities scare off your competition."

"Sounds good," Barney said dubiously, "but how are you going to take the blank, blank headaches out of servicing without service data?"

"By using your knowledge and experience to work out a diagnostic procedure that keeps unnecessary moves to a minimum, makes maximum use of generalized service data, and employs different techniques than the ones used with service data; then stick to that procedure religiously."

**Check the Easy Things First.** "Take that business about keeping unnecessary procedures to a minimum. Nothing is more frustrating than to remove a hard-to-get-out chassis for a lot of fruitless voltage testing only to discover the trouble was a broken antenna lead you could have repaired in a minute. Always check easily repaired possibilities first. Battery voltage and current drawn should be checked routinely even if the customer says the battery is brand new. It could have grown old on the shelf or the set could have a high current drain that exhausts the battery quickly. The milliammeter can be inserted in a snap-connector battery lead easily by removing one snap and using the meter leads to restore the connection. In case individual cells in series furnish the current, use a special jig made up of a couple of pieces of brass shim stock cemented to opposite sides of a piece of thin fish paper. When this is inserted between the end connector of one of the batteries

and its contact, milliammeter leads touched to the two pieces of shim stock will read the total current being consumed. Your experience will serve as a guide to normal current for the number of transistors used.

"Carefully look over the chassis with a pair of magnifying glasses for loose connections, broken wires or charred resistors. Look especially for dangling fine wires going to the antenna. These leads are often broken by the customer in changing batteries or in attempts at do-it-yourself servicing. With the volume full on, try gently moving resistors, capacitors and i-f cans, with an insulating diddle-stick. Be sure to wiggle the tuning capacitor. Quite often one of its solder connections to the board is broken when the radio is dropped or by rough handling of the tuning knob on direct-drive tuning capacitors. Gently flex the printed circuit board itself, especially along the edges. What you're hoping for, of course, is a sudden restoration of normal functioning, indicating a broken or loose connection has been temporarily corrected."

"If you can't find anything wrong that way, do you take the chassis out and do voltage checks on the back side?"

**Signal Injection and Signal Tracing.** "Not yet. The next thing to try is signal injection and/or signal tracing. With the proper equipment, even voltage checks can be made from the top of the PC board. Just listening for a click when the set is switched on will tell you if the output transistor is drawing collector current and if the output transformer and speaker voice coil are O.K. If you hear the click, they are; if not, something is wrong with one of these com-

ponents. Another crude signal-injection test is to touch the 'hot' or center lead of the volume control with the volume full on. If this produces a quite noticeable hum, you know a signal can pass from the volume control clear through the audio amplifier.

"But it is usually better to use signal generators for injection and a signal tracer to pick off the signal at various points 'down-wind' from where you put the test signal in. Look at this diagram I've drawn. If you know the audio amplifier is working, you can start right in by putting an r-f signal into the antenna and picking it off at the detector diode or as far forward as you need to go to pick up the signal. You can zero in on the defective component that is losing the signal from two directions."

"Yeah, but it's pretty tricky trying to work a signal-injection or signal-tracing probe into the proper points on top of the board without shorting out a couple of leads and possibly blowing a transistor," Barney pointed out.

"Not if you make up some special probes just for that purpose," Mac replied. "I solder two-inch lengths of fairly stiff, small diameter wire to pinjacks or banana jacks that will slip over the end of a test probe. The wire is covered with a piece of spaghetti tubing so that only about 1/16" of the end of the wire is exposed, and the spaghetti is cemented to the wire. The wire can be bent into any shape so that the end can reach in under a transistor case to contact a particular lead without fear of short circuits. These special extensions will slip over the probe tips of our VOM, VTVM, signal tracer, or signal generator. When not needed, they are quickly removed.

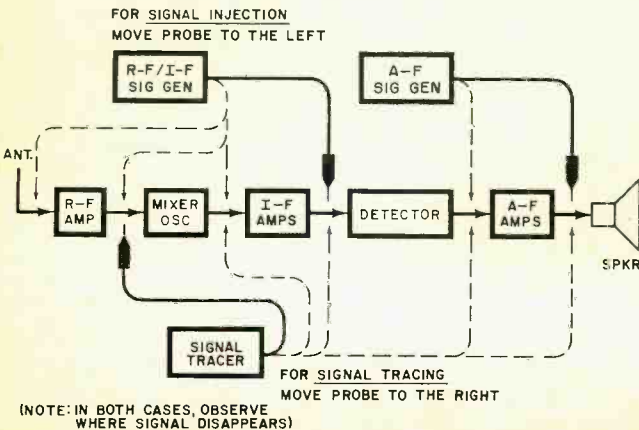

How to use signal generators and a signal tracer to check out an unfamiliar receiver.

"Once the loss of signal is cornered in a small portion of the circuit, you fall back on your technical knowledge and your generalized service data to pinpoint the bad component. By 'generalized service data,' I refer to such things as transistor and cross-reference manuals put out by many transistor manufacturers. The transistor and semiconductor manuals put out by RCA, General Electric, and Motorola and others contain not only characteristics of the devices they sell but also a wealth of theory, applications, and typical circuits of radios, TV receivers, CB transceivers, hi-fi amplifiers, mixers, and so on. By comparing the voltages you find in the circuit you suspect with typical voltages shown in the manual, you can quickly decide if everything is kosher. If a signal is present at the input of a transistor and its voltages are all within tolerance, but the signal is not present at the output, it doesn't take a whiz-kid to decide the transistor is very likely defective. A transistor tester can confirm this.

"I want to stress the value of such books as Sylvania's *ECG Replacement Guide and Catalog*, GE's *Entertainment Semiconductor Almanac*, Radio Shack's *Transistor Substitution Guide*, and Motorola's *HEP Semiconductor Cross-Reference Guide and Catalog*. These contain the manufacturers' substitutes for both domestic and foreign transistors, together with characteristics of the recommended substitute and installation hints. One of these books is the first thing I reach for when I suspect a transistor because it will tell me what voltages I can expect on that transistor, and, if need be, what easily available substitute to use. Also helpful are such catalogs as those from Lafayette Radio, Radio Shack and Callectro.

"If you've gotta change a component or repair a broken connection, you still have to remove the chassis board," Barney said.

"Not necessarily. In the case of a broken solder connection on a tuning capacitor lug, you can often apply heat to the top of the lug at the point where it goes down through the board and melt the solder on the other side of the board. In cases where the board is very difficult to remove because of the tuning mechanism or attachment to other components fastened to the case, I've even changed soldered-in transistors from the top of the board. I snip off the transistor leads with miniature diagonal cutters about an eighth inch or so above the top of the board, bend these over so they can't fall on through,

and solder the leads of the replacement transistor to these stubs with a miniature iron. You have to decide whether it will be quicker to remove the board or improvise a repair from the top."

**Other Suggestions.** "Here are some other helpful things I've learned: don't try transistor replacement—especially if they're soldered in—as a form of first aid. Neither should you blindly assume the fault can't be in a transistor. Three times in the last month I've encountered open collectors in Japanese line-operated output transistors. In two instances the owners were hard of hearing, and in the other case children were permitted to play with the radio. Probably operating these receivers at high volume for long periods of time overheated the output transistors in spite of their being heat-sinked. I used recommended U.S. replacements, and none of the sets has bounced yet.

"Another help is to keep a card file by make and model number on these data-less receivers. List the symptoms, the service procedure by which the difficulty was found, and how it was repaired. In my file I also put such things as a short article on reading code markings on Japanese resistors, capacitors, and inductors that appeared in the November, 1973, *QST*.

"But the thing that will really determine whether or not you succeed at this kind of servicing will be your attitude. If you're convinced servicing can't be done without diagrams and voltage data and pictures with callouts, and if you're going to waste your time whimpering about how difficult data-less servicing is and cursing the manufacturer, you'd better not tackle it. On the other hand, if you consider this kind of servicing a challenge to your technical ability and if you're willing to invest some low-return time in working out a procedure that best suits you and your instruments, you'll end up making money. On top of that, don't be at all surprised if you suddenly discover you've become a much more confident and competent service technician when working on sets for which you *do* have data because of what you've learned from taking on those non-pedigreed devices others are turning away. After all, any lubber can make a landfall when he has detailed charts, depth-sounders, loran, radar, and radio communication to lead him by the hand; but it takes an experienced and shrewd navigator to make port by dead reckoning!" ♦

# THE SHORTWAVE BROADCAST BANDS

## 120 meters—Tropical Band—2300-2500 kHz

Best reception: Evening to Central America; only few stations active. Frequencies in kHz; times in GMT.

**2390** Guatemala, La Voz de Atitlan, to 0345 sign-off; Spanish, Indian languages  
**2390** Mexico, Radio Huayacoctla, to 0300

sign-off; Spanish, Indian languages

**2446** Reunion, ORTF St.-Denis, rare at 0230 sign-on in French on East Coast of United States

**2500** U.S.A., WWV Fort Collins, time and frequency signals, during darkness

## 90 meters—Tropical Band—3200-3400 kHz

Best reception: Throughout hours of darkness to Latin America; your local dusk to Africa and Brazil; around local midnight, to Africa; before and just after dawn, to Asia, Pacific, and Central America.

**3200** China, Fukien Front Station People's Liberation Army; dawn

**3277** Kashmir (India), Srinagar, Kashmir, Urdu, some English; dawn

**3300** Burundi, Bujumbura, 0400 French and African languages

**3315** Martinique, ORTF, Fort-de-France, sign-on in French 1000

**3316** Sierra Leone, Freetown, sign-off

**2330** (on East Coast), sign-on 0600, English

**3325** Guatemala, Radio Maya, fine marimba music, evening and after dawn

**3330** Canada, CHU Ottawa, time signals in English and French, all day in Northeast

**3380** Guatemala, Radio Chortis, marimba music throughout the evening

## 75 meters—International Band (not assigned in Americas)—3900-4000 kHz

Best reception: Europe, Africa late afternoon until after midnight; Pacific midnight to dawn; Ecuador before dawn; Asia around dawn

**3910** Japan, Far East Network (U.S. Forces) pops and news, dawn

**3925** Japan, Nihon Shortwave Broadcasting,

late night until after dawn

**3952** Great Britain, BBC, European Service, many languages, around 0500

**3985** Ecuador, Escuelas Radiofonicas, Riobamba, 1000-1130

**3995** Solomon Islands, English and local languages, 0800-1000

## 60 meters—Tropical Band—4750-5060 kHz

Best reception: All hours of darkness, to Latin America; afternoon and around midnight, to Africa; midnight to dawn, to Pacific; late night to after dawn, to Asia; a few European stations active, times as for Africa

**4820** Honduras, La Voz Evangelica, Tegucigalpa, evenings and mornings, some English

**4820** Gambia, Bathurst, 0630 sign-on; 2300 sign-off on East Coast; English

**4845** Bolivia, Radio Fides, La Paz, early evening, 2300-0100; Catholic religious

**4877** South Vietnam, VTN Saigon, Viet-

namese until after dawn

**4890** Senegal, Dakar, sign-on 0600, sign-off 2300, native languages, French

**4955** Colombia, Radio Nacional; fine classical music, evenings, morning

**4970** Venezuela, Radio Rumbos; leading commercial station, a few English ID's; all night

**5000** U.S.A., WWV, Fort Collins, throughout hours of darkness

**5010** Dominican Republic, Radio Cristal, Santo Domingo; all night

## 49 meters—International Band—5950-6200 kHz

**5955** Guatemala, TGNA, missionary station, sermons often in English evenings

**5995** Vatican City, Vatican Radio, English to N. America daily 0100-0115

**6025** Portugal, Radio Portugal, English 0200-0245, 0345-0430 daily

**6040** United Arab Emirates, Saut-as-Sahil, Dubai, rarely 1300-1400

**6065** Spain, RNE Madrid, English to N. A. 0100-0145, 0200-0245, 0300-0345

**6070** Canada, CFRX, Toronto, 1 kW, day-time to Northeast, night everywhere

**6085** Canada, CBC relay of Deutsche Welle,

German 0155-0430, English 0435-0550

**6080** Luxembourg, Radio Luxembourg, English pop service to 0200 sign-off

**6100** West Germany, Deutsche Welle, German to N. A. 0000-0615

**6110** Great Britain, BBC, English to N. A. 2115-0415

**6115** Congo, LVRC, Brazzaville, partly in French 0400-0600. African music

**6140** Burundi, Bujumbura, French and Swahili, 0400 under good conditions

**6195** South Africa, Springbok Radio, English/Afrikaans commercials all night

# —AND WHAT TO FIND ON THEM

BY RICHARD E. WOOD

## 41 meters—International Band (not assigned in Americas)—7100-7300 kHz

**7130** Great Britain, BBC to Atlantic Islands  
2115-0330

**7150** U.S.S.R., Radio Moscow North American Service, 2300-0500

**7265** West Germany, Sudwestfunk, Baden-Baden, nighttime under good conditions

**7300** Albania, Radio Tirana, English to N.A., 0130-0200, 0230-0300, 0330-0400, 0430-0500

**7335** Canada, CHU, Ottawa, time signals all day / / 3330 kHz

## 31 meters—International Band—9500-9775 kHz

**9505** Japan, Radio Japan, English news on hour 0600-1400

**9510** Ascension Island, BBC relay, English to N. A. 0200-0330

**9515** Turkey, Radio Ankara, Turkish sign-on 0330

**9535** Switzerland, SBC, English to N. A. 0145-0215, 0430-0500

**9560** Ecuador, HCJB, Quito, missionary station, English to N. A. 0100-0600

**9570** Nigeria, Radio Kaduna, Koran chants, English, Hausa, sign-on 0430

**9570** Qatar, Radio Qatar, Doha, sign-on 0230, Arabic, rare catch

**9605** Vatican City, Vatican to N. A. / / 5995 above, English 0100-0115

**9615** Morocco, RTM Rabat, Arabic chants all night; 24-hour operation

**9645** Costa Rica, TIFC, Faro del Caribe, missionary, English sermons 0300

**9670** Portugal, Voice of Hope, Adventist World Radio, English Sunday 0830-0900

**9700** Bulgaria, Radio Sofia, nice Balkan music, English to N. A. 0400-0430

**9780** Albania, Radio Peking relay, Tirana, English 0100-0155, 0300-0355 (not from China!)

## 25 meters—International Band—11700-11975 kHz

**11705** Israel, IBA, English news 0500-0515 / / 9009, 11960 kHz

**11710** New Caledonia, ORTF, French 0600-1200

**11775** Spain, RNE Madrid, Spanish to Latin

America 2200-0400

**11800** Canary Islands, RNE Tenerife, often parallel above, same time

**11920** Ivory Coast, Abidjan, French, to sign-off 2400 and at sign-on 0600

## 19 meters—International Band—15100-15450 kHz

**15105** Japan, Radio Japan, English news on hour daytimes and early evening

**15110** New Zealand, NZBC, mostly home service, evenings.

**15170** Tahiti, ORTF, Papeete, English lesson 0230, Tahitian 0300-0500, French to 0800

**15245** Zaire, Kinshasa, 24-hour operation,

French, African languages

**15310** Guinea, Rep., Conakry, French, revolutionary music, sign-on 0600, to 1400

**15445** Japan, Radio Japan, English to N. A. 2345-0445

**15446** Brazil, Radio Nacional de Brasilia, international service, evenings

## 16 meters—International Band—17700-17900 kHz

**17720** Taiwan, Voice of Free China, English to N. A. 0200-0350, also 17780, 17890 kHz

**17770** New Zealand, NZBC, English, evenings / / 15110 kHz

**17810** Malagasy Rep., Radio Nederland re-

lay, 1400-1520 English

**17815** Sweden, Radio Sweden morning service to N. A. 1400-1530, English 1400-1430

**17895** Zambia, Radio Zambia, English 1700-2100, African music

## 13 meters—International Band—21450-21750 kHz

**21525** South Africa, Radio RSA, African service in English, mornings

**21605** Finland, FBC, 1 kW, 1400-1830 to Latin America, English 1400-1430, 1800-1830

**21640** Japan, Radio Japan, North & Latin American service 0100-0300

**21740** Australia, Radio Australia, N. A. service, English 0100-0300

## 11 meters—International Band—25600-26100 kHz

**25730** Norway, Radio Norway, 1100-1230 1300-1430, 1500-1630, English Sundays

**25790** South Africa, Radio RSA, English 0730-1500, heard under good conditions

# Train at home on NTS equipment like this:

## NTS Audio Electronics Servicing

Know tweeters, woofers and baffles — sound distortion, amplification and control — public address and music systems. Kits you build and keep include Heath 60-watt stereo receiver, twin speakers, Volt-Ohmmeter, digital meter, in-circuit transistor tester, solid-state pocket radio.

Digital Multimenter

AM-FM Solid-State  
60-Watt Stereo Receiver  
and Twin Speakers

## NTS color and b&w tv servicing

Build the largest and most advanced solid-state color TV. A 315 sq. in. ultra-rectangular matrix picture tube, Varactor Diode Tuner, Electronic Character Generator and more. Or build B&W TV with cabinet. Both TV's feature "instant on" Automatic Fine Tuning, solid-state design, and more. Other kits you build and keep: Solid-State Pocket Radio, Troubleshooter, AM/SW Radio, Volt-Ohmmeter, Color Bar/Dot Generator, Electronic Tube and Transistor Tester, TV Vector Monitor Scope and 5-inch Oscilloscope. Send card or coupon for all new color catalog and full details today.

NTS/GR2000  
solid-state color TV  
315 sq. in. picture

Solid-state  
B&W TV  
74 sq. in.  
picture

Electronic Tube  
and Transistor Tester

Signal  
Generator

Color Bar  
Generator

TV Vector  
Monitor Scope

FET  
Volt-Ohmmeter

Compu-Trainer

## NTS Automation and Computer Electronics

Master computer servicing technology as you build this solid-state Compu-Trainer — an NTS exclusive! Duplicates circuit technology of giant computers in industry, do your own wiring, patch-cording, assembly. Other kits you build and keep: 5-inch wide-band solid-state oscilloscope, FET Volt-Ohmmeter, Electro-Lab.

Solid-State  
Oscilloscope

Transceiver  
and  
Power Supply

## NTS Electronic Communications

Earn your FCC First-Class Radio-Telephone License. Prepare for the test by building your own amateur phone 2-Meter FM Transceiver. NTS gives you the exact skills the FCC requires. Other kits you build and keep: fully transistorized Volt-Ohmmeter and regulated power supply.

## Project Method Training — "heart" of the NTS system.

NTS Project Method Training is a better way to learn electronics. With easy-to-follow lessons, comprehensive kit manuals, large fold-out charts and more, you'll build advanced equipment while you learn electronics principles and applications. You'll learn how components work, why they work, what to do when they don't work. In short, you'll use your mind and your hands to develop ability and confidence. This is why the NTS Project Method is such an invaluable part of your program.

## NTS gives you confidence-building extras!

- Job Getting Manual
- Advice On Starting A Business
- Answers To On-The-Job Questions
- Illustrated Electronics Dictionary
- Mechanics & Science Bulletins

**NATIONAL TECHNICAL SCHOOLS**

Technical-Trade Training Since 1905  
Resident & Home Study Schools

4000 SOUTH FIGUEROA ST., LOS ANGELES, CA. 90037

# Feel at home on jobs like these:

**NTS builds your confidence with more solid training in Solid-State**

*NTS Training on professional solid-state equipment prepares you for many careers — in many consumer, commercial and industrial fields. If television is your chosen field, you could join a first class TV repair center, start a shop of your own, or specialize in industrial applications of television such as security system installation. And other electronic fields are continuing to grow, revolutionizing industry and communications, even reshaping our own lives. Opportunities are opening in home entertainment areas, commercial audio systems, mobile communications,*

*computer servicing, industrial controls and many other service technician areas. Yes, this is truly "The Age of Electronics." Your NTS training and the equipment you receive prepare you for these exciting careers wherever electronic technicians are needed. Start now! Build your confidence along with new skills in electronics. You may start earning extra money even before you graduate! Check your course on the card or coupon and mail today! No obligation. No salesman will call.*

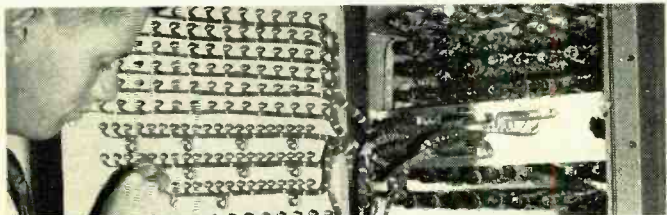

Master Technician: Communications Electronics



Master Technician:  
Industrial Electronics



Master Technician:  
Home Entertainment Electronics

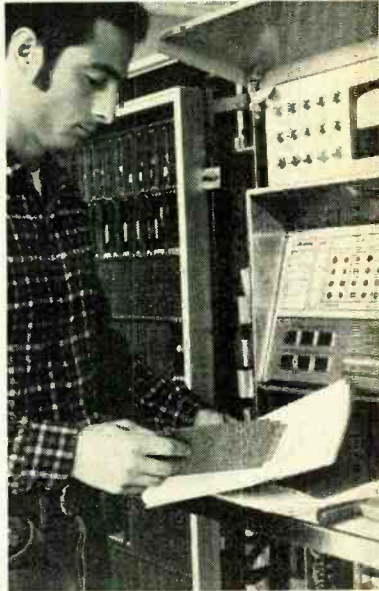

Master Technician:  
Computer Electronics

## Classroom training at Los Angeles

You can take classroom training at Los Angeles in sunny Southern California. NTS occupies a city block with over a million dollars in facilities devoted exclusively to technical training. Check box in coupon.

## Approved for Veteran Training

Accredited Member: National Association of Trade and Technical Schools; National Home Study Council.

Please rush Free Color NTS Guide To Careers in Electronics and Sample Lesson, plus information on course checked below. No obligation. No salesman will call.

NTS guide to careers in Electronics



**National Technical Schools**  
Technical-Trade Training Since 1905  
Resident & Home Study Schools  
4000 So. Figueroa St.  
Los Angeles, Ca. 90037

- Master Course in Color TV Servicing
- Color TV Servicing (For Qualified Technicians)
- Master Course in B&W TV & Radio Servicing
- Master Course in Electronic Communications
- Practical Radio Servicing
- FCC License Course
- Master Course in Electronics Technology
- Automation & Industrial Electronics
- Computer Electronics
- Basic Electronics
- Audio Electronics Servicing
- Audio Technology for Qualified Technicians

Dept. 205-024

NAME \_\_\_\_\_ AGE \_\_\_\_\_

ADDRESS \_\_\_\_\_

CITY \_\_\_\_\_

STATE \_\_\_\_\_ ZIP \_\_\_\_\_

Check if interested in Veteran Training under new G.I. bill.

Check if interested ONLY in Classroom Training at Los Angeles.



# PITCH GENERATORS for ELECTRONIC MUSIC

PART 1. SEPARATE VOICING AND VCO WITH SAMPLE-HOLD  
GENERATE NOTES ELECTRONICALLY

BY DON LANCASTER

**L**AST MONTH ("Electronic Music Pitch Standards") we discussed the frequencies wanted and stability needed in designing a useful electronic music pitch generator. In most cases, the equally tempered scale would be used, usually based on twelve notes per octave with each successive note 1.0595 (the twelfth root of 2) times higher in frequency than its neighbor below. To accompany some conventional musical instruments, it would probably be necessary to set the absolute pitch of A4 to 440.0 hertz. The overall stability should be within three cents of the desired pitch—one cent or better, if possible. (One-cent frequency stability is about 0.06% or 600 parts per million.)

The problem now is to determine what hardware should be used to generate all these notes; and the first thing to decide is whether or not more than one note at a time is needed. When working in a studio, with an elaborate tape recording setup, or when teaching or learning musical theory,

the flexibility of the monophonic or single-note systems can be a tremendous advantage. This is particularly true when it comes to envelope generation and special effects involving the interaction with time of pitch, timbre, and envelope. When playing along with other instruments, single notes might not be too bad—particularly if the voicing is unique or is a stunning imitation of some classical instrument.

About half of the single instruments generate only one tone at a time (trumpets, clarinets, trombones, etc), while the remainder (organs, pianos, guitars, violins, etc.) can and do generate more than one (or overlapping) notes at a time. The kicker here is that we rarely listen to just one single-voiced instrument. For instance, have you heard any good bassoon solos lately?

At this stage of the music game, the single-voiced monophonic circuits offer flexibility and low cost but are pretty much limited to the tape studio or to use with



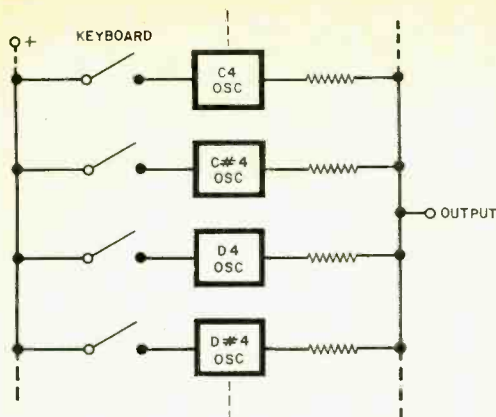

Fig. 1. Keying each oscillator individually is simple and eliminates crosstalk problems, but limits envelope characteristics.

other instrument ensembles. If the electronic music synthesizer is to stand by itself or be used in live concerts, then polyphonic, or multiple voicing is very desirable—almost essential. (An instrument with both polyphonic and monophonic capabilities is an interesting possibility, but more on that later.)

Another decision to be made is whether or not rock-stable notes are always needed. For many voices of medium pitch, the addition of vibrato or frequency modulation adds an interesting and potentially realistic quality to the tone. On the other hand, vibrato sounds very phony on notes of lower pitch, particularly in imitating organ pipes. (Vibrato can be introduced after the pitch is generated by phase-modulation or analog-delay effects.)

By rocking the pitch around a little, we can tune to match other instruments and achieve special effects such as the waa-waa of a Hawaiian guitar. To really move the notes around (as on a slide trombone), a portamento or glide capability is necessary.

Probably the best compromise is a stable reference system that can easily be adjusted in frequency, but which will readily return to absolute pitch on command. From a usage standpoint, either no pitch adjustments, one main adjustment, or a circuit that is exceptionally stable is wanted. One other reason for changing pitch is for transposition—playing in a different key.

With these basic needs in mind, we will consider four popular ways of generating

pitch electronically: separate voicing; vco (voltage-controlled oscillator) and sample hold; digital divider; and phase locked loop tracker. The first two are covered in this article; the last two next month.

**Separate Voicing.** In this type of pitch generation, an individual oscillator is used for each and every note and power is applied to only one oscillator at a time (Fig. 1); or a separate keyer is used for each note (Fig. 2). The first method has the advantages of using only dc voltage through the keyboard and the elimination of crosstalk since all the unused notes are off. Its disadvantages are that it is limited to very simple attack-sustain-decay shaping and it requires exceptionally good frequency-vs-supply-voltage performance during the rise and fall times.

Tuning is obviously difficult since one adjustment is needed for each oscillator. Free-running astable relaxation oscillators have traditionally been far too unstable for this sort of thing. So large inductors and Mylar capacitors were normally used in Hartley or Colpitts oscillators, with amplitudes held low enough that the active devices didn't cause serious problems. Typically, capacitor bridging was used for coarse tuning with a potentiometer for final adjustment.

With today's latest IC's, such as the Intersil 8038, it is possible to design a relaxation oscillator with a stability of 50 parts per million—eleven times better than needed—and it produces vibrato easily. This eliminates the need for the inductor and

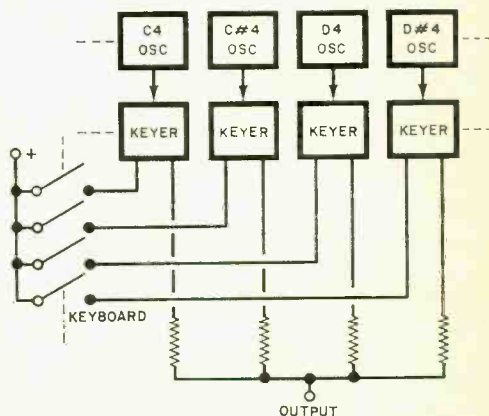

Fig. 2. Separate keying offers more flexible envelope control but adds complexity.

greatly eases tuning, but it still leaves a complex and expensive tone generation method.

The one place where separate voicing really shines is in faithful duplication of organ pipe ranks, particularly tibias, where a nearly perfect analog of the traditional pipe organ can be obtained with enough care. For any other system, the large number of parts and difficulty of tuning make the newer methods more attractive. Also, this approach is obviously polyphonic, and portamento is not easily introduced.

**The VCO and Sample-Hold.** The voltage-controlled oscillator (vco) pitch-generation technique is the one most often used today in "Moog-style" synthesizers. It is monophonic by itself, but there are tricks that can be played with the keyboard to get a two-note capability with a second vco and moderate additional complexity.

Figure 3 shows the vco technique. A vco produces a specified pitch in exchange for a fixed input voltage.

If a linear vco is used, the frequency output is linearly related to the input voltage, and the control or input voltage gets rather cramped at the low end where all the low notes have to be close together. This takes odd-ball precision or paralleled resistors of different values. It also severely restricts the stability and linearity of the vco.

A much better, but slightly more complicated, method is shown in Fig. 4. Here a logarithmic converter is used in front of the vco. A log converter exactly matches the ear's response capability, so a linear input can be used to generate the notes properly spread apart. For instance, a one-volt-per-octave system can be used, so that note C3 might require 3 volts, C4 would need 4 volts, and so on. This means a linear increase of  $\frac{1}{2}$  volt for each successive note on the scale.

The log converter then automatically spaces out the notes to get the right frequency separation. One popular type of log converter places a pn junction in the feedback loop of an op amp. The junction has the required logarithmic characteristic. Usually, a pair of matched transistors is used, with the second transistor handling offset and temperature problems.

With the log converter, it is still necessary to have precision resistors on the keyboard, but they are all identical. Usually, the keyboard is driven by a constant-current source, and a selected number of series-

connected resistors is shorted. The remaining voltage drop then equals the voltage needed for the note. This voltage is properly changed to a new voltage by the log converter; and the new voltage is converted to a frequency by the vco.

The basic vco method is low in cost, but it is single-voiced and extreme stability is needed for the keyboard controller, the log converter, and the vco. Pitch is easily changed by changing the current through the keyboard or the scale factor of the vco; and any number of notes per octave can be readily handled on a one-at-a-time basis.

One problem common to the vco and a number of the other single-voiced methods is the need for a memory of some sort. Whenever we release the key, we often would like the note to continue on and die out gradually. With the vco and log converter, releasing the key takes away the information (the input voltage) of what note is to be played. To overcome this, a sample-hold or analog storage system is added as shown in Fig. 4.

Pressing any key immediately changes the sample-hold to a new note. After the key is released, the sample-hold remembers what the note was until the decay cycle is complete and a new note is generated. In this way, the decay cycle of the envelope shaping can continue beyond key release.

One simple sample-hold circuit is a reed relay and a capacitor looking into a voltage follower. The relay is closed for sampling and the capacitor then holds this value.

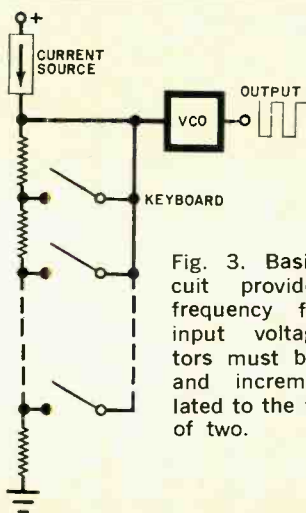

Fig. 3. Basic vco circuit provides output frequency for precise input voltage. Resistors must be precision and incrementally related to the twelfth root of two.

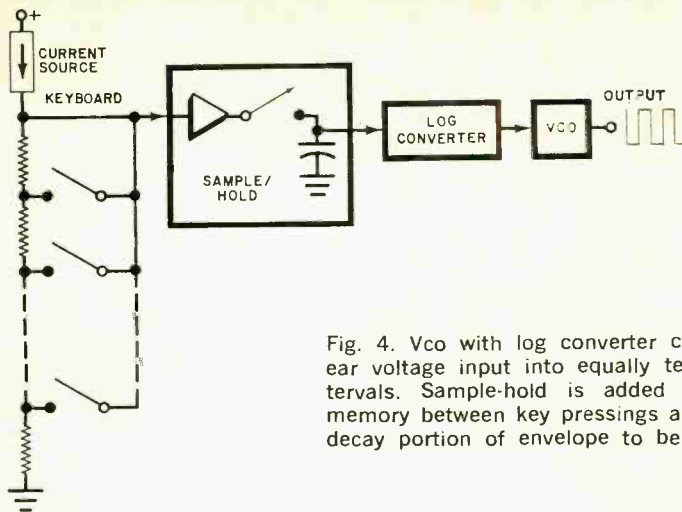

Fig. 4. Vco with log converter changes linear voltage input into equally tempered intervals. Sample-hold is added to provide memory between key pressings and to allow decay portion of envelope to be continued.

Other methods use an operational amplifier with a FET switch; or a CMOS analog multiplexer (such as the RCA CD4016) can be used directly.

The basic principle of most of the analog sample-hold circuits is to charge a capacitor rapidly when the key is pressed and then use the capacitor to hold the voltage as an analog memory after release. For the charge to be held without significant droop, a very high-quality capacitor and an absolute minimum of circuit loading are needed.

Glides and portamento effects are simply done by charging the capacitor somewhat more slowly. In this way, the notes glide from one to another in a trombone style rather than changing suddenly.

The major advantages of the vco system are the ease with which one can make glides, change pitch, introduce vibrato and waa-waa, or change the number of notes per octave. This approach can be used very inexpensively with the latest available components, but very careful attention to stability and accuracy is needed.

For instance, with a one-volt-per-octave control voltage, a voltage error, droop, offset, or crosstalk of only 2.5 millivolts will cause an objectionable pitch error. Extremely careful design is needed to get a good vco/log converter/sample-hold system going. On the other hand, this is certainly the simplest way to put together a low-cost system on an experimental basis. The results will be disappointing to a serious musician,

however, if careful control and good design are not used.

Note-to-note tuning is inherent in the selection of the precision resistors on the keyboard, while overall instrument tuning is controlled by a single reference voltage or current and the stability of the rest of the circuits.

Using two vco's will provide two-note capability and more vco's can be added as needed. The problem that immediately comes up is, "Which vco goes with which note?" The answer is to use very brief sample-hold intervals and properly assign each key being pressed to the right vco. One possible way of doing this is with a *scanning* keyboard where each key being pressed is sampled in either digital or analog form; and priority logic then assigns the right vco to a selected key. This adds considerably to the cost and complexity of the system.

At present, the vco/log converter/sample-hold pitch generation approach is the most popular in commercial synthesizer products. This is, however, probably only a temporary stopping place along the way to total digital pitch generation systems. Voltage-controlled pitch generation systems will probably go the way of most other analog systems, but right now vco methods are attractive and offer a lot in the way of simplicity and low-cost performance.

Next month, we will discuss digital dividers and phase locked loop methods of tone generation



# Solid-State

By Lou Garner

**I**F YOU'RE serious about electronics, whether as a ham, hi-fi enthusiast, R/C specialist, gadgeteer, experimenter, or student, you can look to the future with optimism and excitement. Comparatively recent changes in electronics manufacturing and marketing should, one day, permit the average hobbyist to tackle projects which, in the past, would have required a workbench full of components and a healthy wallet.

The situation is interesting not only for its potential effect on the hobbyist, but because it has resulted from an amazing change in the attitudes of a number of major manufacturers.

For years, consumer electronic product designers were considered as more or less the "black sheep" of the electronics engineering fraternity. Engineers working in such exotic fields as military electronics, aerospace, computers, industrial controls, medical electronics, instrument design, and communications felt that the consumer products field was less challenging and, therefore, tended to look down their sophisticated noses at their fellow engineers stuck with the (to them) unrewarding job of designing mass-produced products for the general public. Consumer product designers often were conspicuous by their absence at technical meetings and conventions, and exhibitors at technical shows paid them little attention.

There was, perhaps, a modicum of justification for the prevailing attitude. Faced with short lead times, consumer product designers could not afford the luxury of detailed and exhaustive mathematical analysis of their designs, nor of extensive precision tests of their prototypes. They couldn't afford to use expensive state-of-the-art devices in their circuits. Low production cost, consistent with acceptable performance, was the design criterion. Many circuit designs be-

came standardized, with relatively few changes, except in detail, from year to year.

Consumer product design engineers frequently were paid lower salaries than their counterparts in more exotic fields and there were fewer positions available. A medium-size factory producing several different products by the tens of thousands and employing hundreds of assembly workers might require only two or three design engineers. A firm manufacturing high-price military or communications electronic equipment, on the other hand, might have an engineer for every two or three production workers.

The advent of solid-state technology, the introduction of MSI and LSI devices suitable for consumer applications, and the public acceptance of high technology products, such as pocket calculators, digital electronic watches, and sophisticated TV and radio receivers have all combined to change the traditional attitude towards the consumer product design engineer. In fact, today such specialists are well on their way to becoming the "darlings" of industry.

Manufacturers who once looked upon the consumer field with disdain are now undergoing an agonizing reappraisal of their policies. Semiconductor manufacturers who once scorned the idea of assembling complete equipment are now entering the battle for the consumer market.

Fairchild's Semiconductor Components group (464 Ellis Street, MS 19-115, Moun-

# Consumer Products Engineering

tain View, CA 94042), for example, in a continuing bid for the automotive market, has recently announced a special pressure transducer designed specifically for automotive applications. This new thick-film, solid-state device for cars contains a single crystal diffused silicon strain gauge with a zero-pressure reference chamber, two linear operational amplifiers for temperature compensation, offset adjustment and scale factor control, and a single-chip voltage regulator. When connected to a pressure source, such as the intake manifold of an automobile engine, the module provides an accurate analog voltage output that is linearly proportional to the input. This signal voltage can serve as a control for electronic fuel injection, ignition advance and similar systems.

Looking ahead, we foresee a continued expansion of the high-technology consumer products market. As lucrative military and government contracts dwindle, as the advanced computer market becomes saturated,

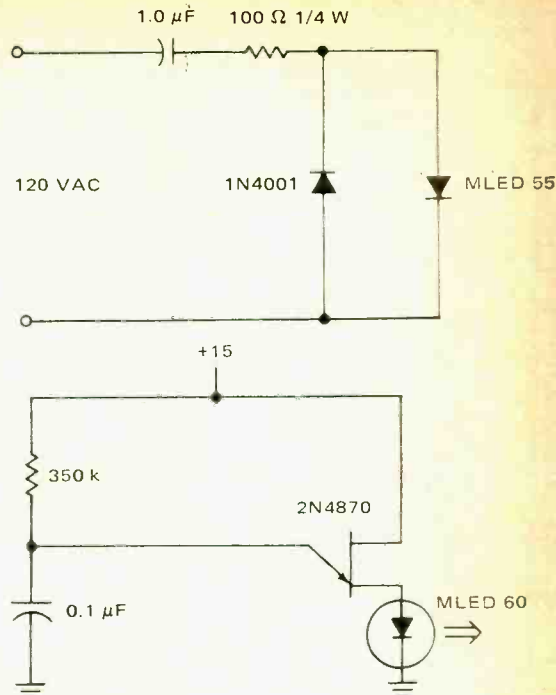

Fig. 1. Circuit (A), top, is LED line-voltage indicator; (B), bottom, is a pulser.

and as industry becomes fully automated, the really big electronics market will be the consumer.

All of this bodes well for the experimenter, for as sophisticated MSI and LSI devices are developed for the mass consumer market, they will filter gradually into the hands of local distributors, becoming available at reasonable prices to the average hobbyist.

**Circuit Potpourri.** Although relatively simple, the LED circuits illustrated in Fig.

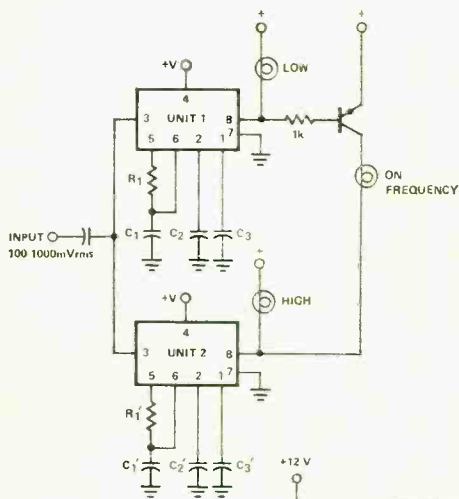
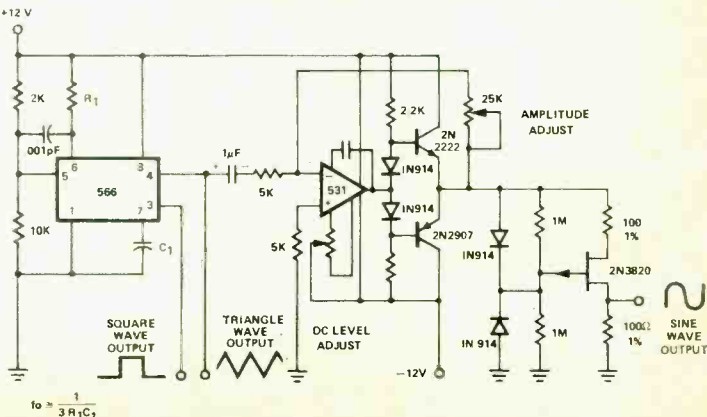

Fig. 2. Circuit (A), above, is a frequency indicator; (B), right, is function generator.



I can be used in a variety of experimenter and hobbyist projects. Both were abstracted from Motorola's Application Note AN-570, an 8-page brochure entitled "Introduction to Light Emitting Diodes."

The line-voltage indicator circuit shown in Fig. 1A can be used wherever a long-life, low-power ac pilot lamp is needed, as in amplifiers, transmitters, appliances, receivers, recorders, or power supplies. In operation, the capacitor's reactance serves to limit the LED current, with the result that real power consumption is virtually nil.

Featuring a unijunction transistor as a relaxation oscillator, the pulser circuit given in Fig. 1B operates at a repetition rate of approximately 30 Hz with a pulse width of 1.5  $\mu$ s. An infrared LED is specified, but other types may be substituted for the MLED 60. The circuit's output can be used as a light source for pulsed-beam burglar alarm systems and in similar applications.

Suitable for use in a number of instrument designs, the circuits shown in Fig. 2 are representative of the dozens of schematics described in an integrated circuit applications manual published by the Signetics Corporation (811 East Arques Ave., Sunnyvale, CA 94086).

Designed to monitor a single frequency tone, such as a control or test signal, the simple frequency indicator circuit illustrated in Fig. 2A utilizes a pair of type 567 tone decoder IC's in conjunction with a general-purpose pnp transistor and three low-power

incandescent lamps (or LED's). In operation, the tone decoders' RC values ( $R1C1$  and  $R1'C1'$ ) are selected to set one unit 6% above the desired sensing frequency and the other 6% below the desired frequency. If the applied signal is within 13% of the desired frequency, either unit 1 or unit 2 will deliver an output, activating its lamp. If both units are on, the incoming signal is within 1% of the desired frequency.

The basic function generator, Fig. 2B, employs a type SE/NE 566 voltage-controlled oscillator IC to supply square and triangular signals. The triangle signal, in turn, is shaped into a sinusoidal waveform with less than 2% distortion by using the nonlinear transfer characteristics of a 2N3820 p-channel JFET. The JFET's input is provided by a 531 operational amplifier, serving as a buffer, and a complementary driver.

**Device/Product News.** Five new optical couplers/isolators with Darlington output transistors have been introduced by Motorola Semiconductor Products, Inc. (P.O. Box 20924, Phoenix, AZ 85036). Intended for applications where relatively high speeds (to 30 kHz) and high collector currents are required, the new series, types 4N29 through 4N33, has isolation voltages as high as 2500 volts and collector currents of up to 50 mA (for 10 mA input). The new devices are suitable for use in a variety of experimenter projects, including solid-state relays, alarm systems, remote controls, and equipment interfacing.

Several new devices which should be of particular interest to the serious hobbyist

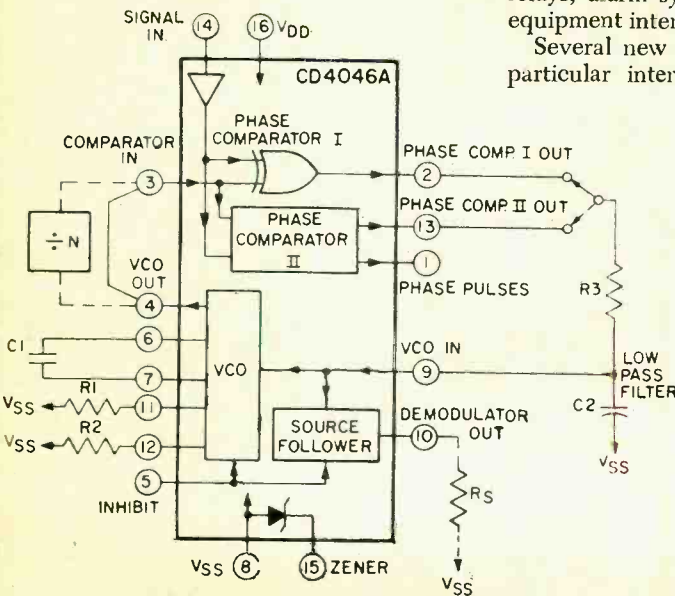

Fig. 3. Block diagram of RCA's new CD4046A COS/MOS micropower phase-locked loop IC device.

have been announced by RCA's Solid State Division (Route 202, Somerville, NJ 08876), including a COS/MOS micropower phase locked loop (PLL) IC, an inexpensive uhf oscillator transistor, a pair of medium-power transistors, and a COS/MOS dual complementary pair plus inverter IC.

Designated type CD4046A, RCA's new PLL consists of a low-power, linear voltage-controlled oscillator (vco) and two different phase comparators having a common signal-input amplifier and a common comparator input, as illustrated in Fig. 3. A 5.2-volt zener diode also is provided for supply regulation if necessary. Featuring very low power consumption (70  $\mu$ W), an operating frequency range up to 1.2 MHz, a wide supply voltage range (5 to 15 volts), and low frequency drift together with high vco linearity, the new device can be used for such applications as FM modulation and demodulation, frequency synthesis and multiplication, frequency discrimination, tone decoding, data synchronization and voltage-to-frequency conversion. It is offered in a 16-lead DIP.

RCA is soon coming out with a COS/MOS dual complementary pair plus inverter IC, which is functionally similar to the CD4007A, but operates on lower voltages (down to 1.1V). Available in a 14-lead DIP, it is recommended for breadboard designs of battery-powered watches, clocks, fuse timers, timing circuits, and oscillators with supplies of from 1.1 to 6 volts. The device is ideal for projects operated on a single-cell battery.

A new monolithic counter/timer capable of generating precise ultra-long time delays with an external RC setting has been introduced by Exar Integrated Systems, Inc. (750 Palomar, Sunnyvale, CA 94086). Identified as the XR-2240, the device comprises an analog time base oscillator with a programmable 8-bit counter on the same chip. It can be used to generate programmable time delays from microseconds up to 5 days with an accuracy of 0.5% and a temperature stability of 40 ppm/ $^{\circ}$ C. Two XR-2240 timers can be cascaded to generate programmable time delays of up to 3 years.

Litronix, Inc. (19000 Homestead Road, Cupertino, CA 95014) is now offering a new, inexpensive 0.6" high LED digit display, the Data-Lit 747. According to Litronix, the new device can be read clearly at distances of up to 20 feet. ♦

# HOW TO INCREASE YOUR EARNING CAPACITY IN JUST 6 WEEKS

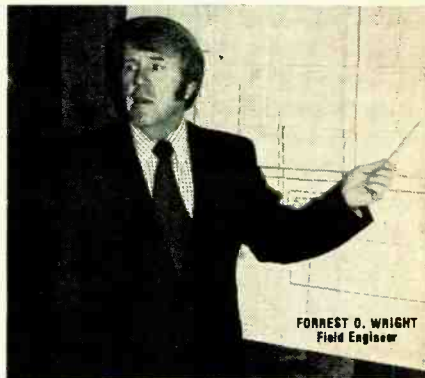

Here's how our Digital Circuit Design course helped Mr. Wright: "... your course helped me immeasurably. I recently applied for a new position and got it. Your special training is now helping me fulfill my responsibilities on the job."

**Learn advanced CIRCUIT THEORY  
in your spare time; without higher math!**

THE CENTER understands and anticipates your needs for working in electronics today. Our courses get results for you quickly, with convenient home study. All courses are 100% tax deductible. You take no risks. You receive everything on a 5 day FREE TRIAL basis. Decide your future, act today!

**SEND FOR FREE INFORMATION TODAY!**

Send me complete information on the following:

- Digital Circuit Design    IC Logic Design    Power Supply Design  
 MOS/FET & J/FET Circuit Design    UJT Circuit Design

Name \_\_\_\_\_ Age \_\_\_\_\_

Street \_\_\_\_\_

City \_\_\_\_\_ State \_\_\_\_\_ Zip \_\_\_\_\_



Dept: PE174

Phone: 513/296-1020  
2876 CULVER AVENUE  
DAYTON, OHIO 45429

**CIRCLE NO. 4 ON READER SERVICE CARD**



# Test Equipment Scene

By Leslie Solomon, Technical Editor

**S**EVERAL readers have asked what features they should look for in buying a particular piece of test equipment. Of course, I can't recommend specific products; but I would suggest that readers watch the Product Test Reports that appear every month in this magazine. They contain lots of information about the newest gear that we have seen and tested.

To get down to specifics on one item, let's consider a few things you should be aware of in choosing an oscilloscope—whether it is your first one or a replacement for an older model.

**Low-Cost and Expensive Models.** Prices of scopes vary over a wide range. Sometimes there is as much as \$100 difference between a low-cost model and an expensive one. However, keep in mind that, in many cases, the more expensive scope can prove to be cheaper in the long run since it may serve you longer, give you more accurate and repeatable results, and be much more versatile than the low-cost instrument. If you spread the price difference out over the years that you own the scope and consider the decent results you will be getting all that time, the difference may turn out to be only a few dollars per year. There are as many people who use the same good scope for 10 years or so as there are those who go through two or three low-cost units

in the same period—without having the benefit of good results over the years.

Remember that, like a good speaker (that doesn't add its own "color" to the reproduced audio), a scope must be as "transparent" as possible, not adding its own distortions to the displayed waveform. Since scope "honesty" seems to be a function of its price, get the best you can afford.

I do not mean to denigrate low-cost, ac-coupled audio scopes. With their limited bandwidth, poor rise times, and touchy free-running and hard-to-sync traces, they make excellent "first" scopes, and can be useful in non-critical applications. However, they leave a lot to be desired, especially when dealing with modern, high-speed circuits. If you are a beginner, remember that it will not be long before you advance to this type of circuit. If you are a long-time scope user, you will understand the problems involved with limited-band-width, free-running scopes.

**AC and DC Coupling.** The specifications for the vertical amplifier are of prime importance in determining what will be displayed. There are two major types: ac and dc coupled. (Usually the dc versions have ac-coupling provisions for the occasions when it might be needed.)

An ac-coupled scope responds only to an ac signal and the trace will do strange things when dc is applied (due to coupling capacitor charging). This ac response effectively removes all the dc component and one result is a "tilt" that distorts any waveform having flat tops or bottoms. Obviously, if you do any digital logic work, or square-wave testing, the ac-coupled scope is out.

Incidentally, the amount of tilt depends on the value of the coupling capacitor. Although some scopes use very large values to bring their ac response down to 2 to 5

## Oscilloscope Vertical Amplifiers



Hz, they are still ac coupled. Also, don't get the idea that all you have to do is remove the input capacitor to get a dc scope. It won't work because there are also coupling capacitors within the amplifier and removing them can change all biases drastically enough to prevent scope operation. A dc amplifier is designed as a dc amplifier, not as an ac amplifier without coupling capacitors.

On the other hand, a dc-coupled scope will respond from zero (dc) up, so that it produces square waves properly. Besides this, such a scope will also display an ac waveform superimposed on a dc component and the scope displays the actual signal present. This is nice to know when you are working on dc systems, as you are simultaneously looking at both the ac signal and the dc component, which may be the bias for the following stage. This also means that a dc scope (properly calibrated vertically) can act as a pretty good dc voltmeter with high input impedance. So you get this important function free.

Dc coupling, unfortunately, costs money because more transistors and associated components are used to create the balanced circuits needed to reduce drift (slow movement of the display across the CRT screen).

Of course, dc coupling in both horizontal and vertical amplifiers allows accurate phase-shift measurements. In most cases, the horizontal amplifier does not have the wide bandwidth of the vertical section because it is so seldom used for very high frequencies.

**Bandwidth and Transient Response.** The wider the vertical amplifier bandwidth, the better. So-called "narrow-band" scopes usually just span the audio range, while "broadband" units go out to several MHz.

The need to measure steep wave fronts determines just what bandwidth is required.

For example, the upper frequency limit should be at least 10 times higher than the fundamental frequency of the basic square-topped waveform if you want true reproduction. (Remember those high-frequency harmonics.) Keep in mind that this applies not only to square waves, but also to such things as sync pulses in TV equipment and tone bursts in audio systems. These signals have high repetition rates and steep leading and trailing edges, and you must be able to see these features as they actually exist before you can do any serious troubleshooting. You must also be sure that any distortion you see does not originate in your test equipment or you can waste many hours of searching for a non-existent fault. A scope that goes from dc out to a few MHz will suffice for most work.

As you start working on more advanced projects or more sophisticated commercial equipment (especially digital circuits), transient response is more and more important. Transient response determines just how fast the CRT beam (hence vertical amplifier) will deflect when following a steep wave-front. Most better scopes include rise time in their specifications.

If you are thinking of adding a front-end signal booster to your scope, remember that the transient response of a number of series-connected circuits is the square root of the sum of the squares of the individual responses. For example, an amplifier having a rise time of 3  $\mu$ s feeding a scope with a rise time of 4  $\mu$ s has an overall rise time of 5  $\mu$ s. So rise time is sacrificed (slowed down) in exchange for gain.

Rise time and bandwidth are closely related. The product of the two should produce a value of between 0.33 and 0.35 for best displayed results. Values greater than 0.35 will produce a "ringing" on steep transients, thus distorting the reproduced waveform. Ideally, the rise time should be

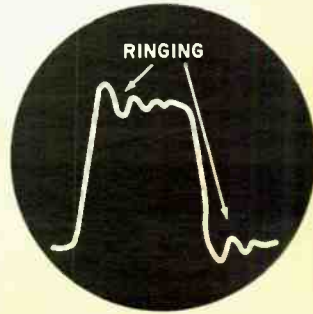
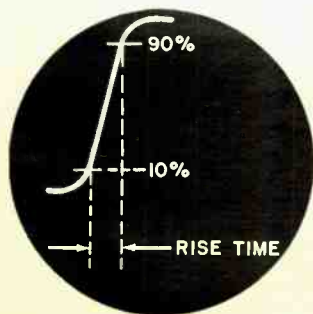



**FREE**

**1974 LAFAYETTE CATALOG 740**

*Ready Now!*

### Your Complete Electronics Buying Guide

- Stereo/Hi-Fi Components • CB Transceivers & Walkie-talkies • PA Systems • Tools & Test Equipment
- Police/Fire Monitor Receivers • Antennas • Photography Equipment • Ham Gear • Books, Parts, and More!

**Send Today!**

**Lafayette Radio Electronics**  
P.O. Box 10, Dept. 35024  
Syosset, L.I., N.Y. 11791

NAME \_\_\_\_\_ 35024

ADDRESS \_\_\_\_\_

CITY \_\_\_\_\_

STATE \_\_\_\_\_ ZIP \_\_\_\_\_

**CIRCLE NO. 19 ON READER SERVICE CARD**

## ABOUT YOUR SUBSCRIPTION

Your subscription to POPULAR ELECTRONICS is maintained on one of the world's most modern, efficient computer systems, and if you're like 99% of our subscribers, you'll never have any reason to complain about your subscription service.

We have found that when complaints do arise, the majority of them occur because people have written their names or addresses differently at different times. For example, if your subscription were listed under "William Jones, Cedar Lane, Middletown, Arizona," and you were to renew it as "Bill Jones, Cedar Lane, Middletown, Arizona," our computer would think that two separate subscriptions were involved, and it would start sending you two copies of POPULAR ELECTRONICS each month. Other examples of combinations of names that would confuse the computer would include: John Henry Smith and Henry Smith; and Mrs. Joseph Jones and Mary Jones. Minor differences in addresses can also lead to difficulties. For example, to the computer, 100 Second St. is not the same as 100 2nd St.

So, please, when you write us about your subscription, be sure to enclose the mailing label from the cover of the magazine—or else copy your name and address exactly as they appear on the mailing label. This will greatly reduce any chance of error, and we will be able to service your request much more quickly.

about  $\frac{1}{2}$  of the rise time expected from the signal to display the waveform with an error of less than 2%.

If you want to determine the bandwidth of your present scope, use the formula  $RT = K/B$ , where  $K$  is 0.35 and  $B$  is the upper -3-dB frequency limit in MHz and  $RT$  is the rise time in microseconds. For example, assume you have a 5-MHz scope. The value of  $RT$  is then  $0.35/5$  or  $0.07 \mu s$ . Multiply this by 5 to get 350 ns, which is the fastest rise time the scope can reproduce with an accuracy of 2%. If 5% is all that is required, then multiply by 3 to get a rise time of 210 ns.

**Dual-Channel Scopes.** Going toward more advanced projects or servicing, you may find that a single trace is not enough. Then you should consider a dual-channel or dual-trace scope. It may be a luxury, but it can also be worthwhile. Two independent traces, each with its own attenuator, amplifier, and positioning control on a single horizontal sweep can make a big difference between seeing all that is going on between two related signals and just guessing at it.

Most dual-channel scopes also have provisions for "chopped" or "alternate" modes. In the chopped mode, a built-in electronic switch (at about 100 kHz) alternates the single trace between the two independent inputs. This is fine for low-frequency work until you hit the higher sweep speeds, where the switching-frequency square waves become apparent and cause viewing interference. At this point, you can switch to the alternate mode. Here, one of the two inputs is displayed for one complete horizontal sweep, and during the CRT beam retrace time, the other channel is switched in to occupy one full sweep. Because of the high switching speeds (faster horizontal rate) and the persistence of the CRT phosphor, the two signals appear to be displayed simultaneously.

There is one other function usually attached to dual-channel scopes. This is the X-Y position of the dual-channel selector switch. The signal from channel A is displayed on the scope vertical axis, while input B forms the horizontal axis. This is useful for generating Lissajous figures, phase measurements, or any function where one input must be measured with respect to another (instead of against time as represented by the conventional horizontal sweep).



# CB Scene

By Len Buckwalter, KQA5012

**T**HE NEXT time you tune channel 10, you may hear talk of long-haul rigs, semi's and where to get the best chiliburger in the West. The reason: CB is enjoying a sudden surge in the trucking industry. Not only are the independents snapping up CB, fleet owners aren't far behind. Sales of equipment at truck stops are so good that CB manufacturers are starting to produce special models for the burgeoning market. One item by Antenna Specialists should delight the most grizzled trucker—a whip with its loading coil encased in a beer can.

How do the haulers use CB? They can talk to each other while highballing down the road and ease the boredom of a cross-country trip. (One manufacturer says CB may yet replace the tape deck on the dash.) Also, in an understandable spirit of comradery, truckers warn each other of highway hazards, especially the 4-wheel kind with flashing lights. To win good roadway communications the trend is to install dual antennas, one atop each side-view mirror. The whips are joined by a phasing unit to bulge the signal fore and aft, where other vehicles are most likely to be. Range is about 5 to 10 miles.

Stories about CB's boon to safety are starting to trickle in. Last winter one trucker rising over the crest of a long, icy hill in Pennsylvania had a remarkable experience. He was unaware that a jackknifed tractor rig blocked the road at the bottom. But he was monitoring channel 10. Warned by a voice on the speaker, he pulled the power, pumped the brakes—and slid to a halt within inches of disaster. He's convinced it would have ended differently without CB.

**Rising to New Heights.** After years of grumbling about limited range because of

low power and antenna height, CB'ers may soon enjoy official relief. The FCC is seriously considering raising the maximum antenna height to 60 feet. (See last month's "News Highlights.") Today's rule holds the top of an antenna 20 feet above any existing structure. In the new proposal, the antenna may rise to 60 feet above ground level. One important limit, though, is that you'll probably be prevented from using a "gain" type antenna—one that multiplies power, like a beam.

"What kind of improvement can we expect if the new rule becomes law?", I asked one antenna authority. He juggled his slide rule and came up with an enlightening figure. Increase height from 20 feet to 60 feet and you about double operating range. That may not sound dramatic, but remember that a widening circle puts your signal into hundreds more square miles. Most of the increase comes from peering over the earth's curve. CB mainly follows a straight-line path to the horizon and the loftier position enables the signal to "see" farther.

Greater height may also allow the antenna to clear more neighboring obstacles. Our antenna expert cautions that nearby obstructions are not usually critical if the antenna is an omnidirectional model. It's the beam antennas that are touchy because they're liable to be detuned by adjacent surfaces. The rule-of-thumb: if you're using

## Antennas & Towers

# NOW A PROFESSIONAL BURGLAR-FIRE ALARM SYSTEM YOU CAN INSTALL YOURSELF.



ONLY 139.95

Save hundreds of dollars in alarm installation and monthly service charges. The EICO SS-500 "install-it-yourself" burglar-fire alarm system offers you the kind of professional protection you have been looking for, at a price you can afford. The SS-500 has been designed on the EICO "Expandability Concept" that enables you to "add-on" protection to meet your own special needs. Before you purchase any security system, we suggest you read the EICO Security Handbook and see how easy EICO makes it to "Do-it-Yourself."

## FREE EICO CATALOG/SPECIAL OFFER!

Security handbook (Reg. \$2.95) only \$1.50 with this ad. Includes a catalog on EICO Security Systems, Test Instruments, Stereo, Hobby Kits and name of nearest distributor. For catalog only, check reader service card or send 25¢ for first class mail service.



EICO, 283 Malta Street, Brooklyn, N.Y. 11207

CIRCLE NO. 10 ON READER SERVICE CARD



We Stock What  
We Catalog

## Allied Electronics ENGINEERING MANUAL & PURCHASING GUIDE

**Special Offer!** \$5.00 VALUE Only \$1.00 to readers of Popular Electronics

**TECHNICAL INFORMATION:** Complete information on all items. Both electrical properties and physical dimensions. **ALL ITEMS IN STOCK:** Highest percentage of order filling in the country on standard and stock items. A guaranteed shipment program covering thousands of popular and hard-to-get items. **NEW FROM COVER TO COVER:** The only up to date annual in the electronics field. Allied has a reputation for delivery! Three key locations for immediate delivery. If you see it in our Engineering Manual & Purchasing Guide, it's because we've got it ready for your use! **THE MOST WIDELY USED BOOK IN THE COUNTRY!**

Enclosed is my \$1.00 to cover cost of shipping  
Cat. 910-9999-6  
Allied Electronics Corporation  
2400 W. Washington Blvd., Chicago, Ill. 60612

Name \_\_\_\_\_  
Address \_\_\_\_\_  
City \_\_\_\_\_ State \_\_\_\_\_ Zip \_\_\_\_\_

**ALLIED ELECTRONICS**

A DIVISION OF TANDY CORPORATION

a multi-element antenna, try to keep it one CB wavelength away from anything else—a distance of about 36 feet.

**Tower Power.** Let's say the 60-foot antenna rule is granted. Since the range benefits are attractive, there'd probably be a rush on masts, guy wires and longer transmission lines. What's more, the now-forbidden tower should become perfectly legal. And a tower may be the only practical way a low-lying or ranch home may thrust up an antenna all the way. A mast and guy-wire approach may take you 20 feet above the roof, but it's too unwieldy to go much higher. It takes a 40-foot tower planted on

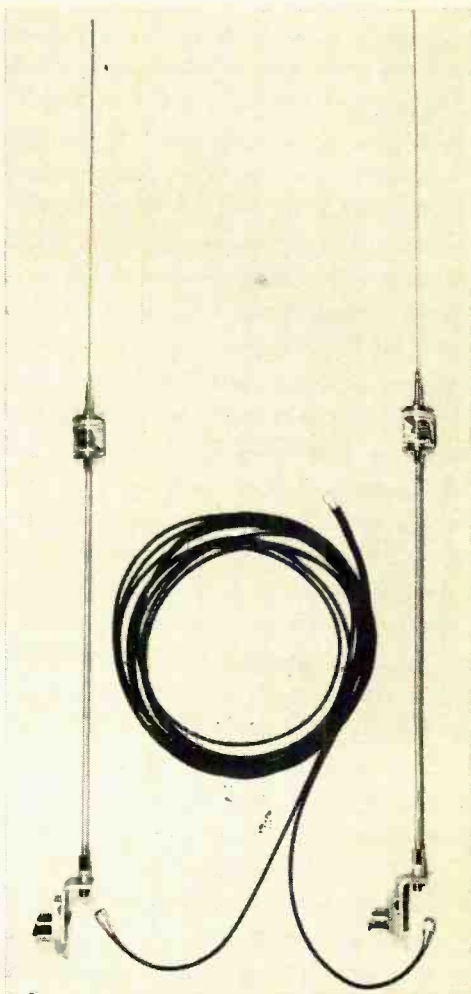

Dual whips that were designed for mounting on the side rear-view mirrors of a truck.

the ground to bring a 20-foot antenna to the maximum.

Raising a 40-footer isn't a major engineering feat. Much of the job is in the preparation if you choose the self-supporting type, with no guy wires splaying across the property to snag kid's feet. It doesn't need anchor points in the neighbor's lot, either. A typical 40-foot aluminum tower needs a hole in the ground 3 feet square and 4 feet deep. After the hole is filled with 1½ cubic yards of concrete, you level a metal base on its surface. To the base you bolt ten-foot tower sections lying horizontally along the ground. A friend or two can help you "walk" it up, antenna and all.

The cost of this elaborate skyhook is about \$200 including the 130-odd pounds of components and several hours of labor. But you could create a mighty CB signal that'll saturate the countryside and fill in those communication "holes".

**The Plugged-up PL.** CB equipment troubles are usually caused by sudden failures; a blown semiconductor, a ruptured mike lead, maybe a shorted capacitor. Silence is immediate. But in talking to one engineer in the field, I learned about a CB weakspot that usually goes unnoticed. It insidiously degrades the signal (on both receive and send) over a long period of time. The culprit is the PL-259, the coaxial connector found on the ends of most CB cables. It may work fine in the shelter of a car or home, but it often proves troublesome just under a base-station antenna. Not only is it difficult to inspect without ladderwork, it wasn't meant for outdoor service in the first place. An unprotected PL is an invitation to trouble because it's attacked by moisture, despite your efforts to tighten it.

There are several cures—preferably done when the antenna is on the ground, ready to be installed. Aerosol sprays, available from your local electronic distributor, give the plug a protective plastic coat. Spray *after* the plug is installed on the socket. A silicone rubber compound in a tube can also form a neat raincoat around a PL's vulnerable cracks. The final method uses material you might already have—black plastic electrical tape. Wrap overlapping layers around the whole connector, especially near any suspicious joints. These techniques prevent power loss that can creep into a system as little as six months after installation. ♦

# AUTO AIDS

Do-It-Yourself—Save Time, Money, Gas.



<p><b>EICO 1064</b> Dual purpose Battery Eliminator and Charger incorporating an extra low ripple filter circuit. Ideal for servicing, and powering 6-12 volt auto and marine equipment. <b>\$69.95 Kit \$89.95 Wired</b></p>	<p><b>EICO 888</b> Portable Universal Engine Analyzer. Keeps your car or boat engine in tip-top shape. Complete with "How-to-Use" tune-up and troubleshooting manual. <b>Kit \$59.95 Wired \$89.95</b></p>
<p><b>EICO 1080</b> 200 watt Solid State Power Inverter and Battery Charger. Converts 12 volts DC to 117V. AC current. For use in cars, mobile homes and boats to operate recorders, appliances, etc. <b>Kit \$49.95 Wired \$64.95</b></p>	<p><b>EICO 889</b> Solid State C-D Ignition System adds power to any engine. Boosts gas mileage up to 20%. Points and spark plugs last up to 5 times longer. Instant cold weather starting. <b>Kit \$34.95 Wired \$44.95</b></p>

**FREE 32 PAGE EICO CATALOG**

For latest catalog on EICO Test Instruments, Stereo, EICOCRAFT Projects, Environmental Lighting, Burglar/Fire Alarm Systems, and name of nearest EICO Distributor, check Reader Service Card or send 25c for First Class mail service.

**EICO**®

EICO, 283 Malta Street, Brooklyn, N.Y. 11207

**CIRCLE NO. 10 ON READER SERVICE CARD**



## Free!

*New 12th Edition of the Midwest Hifi Catalog!*

**Save on stereo!** Buy direct from us and you save money with our high-volume prices on more than 100 name brands. Order from the branch nearest you.

# Midwest Hifi

**Wholesale & MAIL ORDER DIVISION**

2455b Wisconsin Ave, 3309 E. J W Carpenter Frwy,  
Downers Grove, Ill 60515 Irving, Tex 75062

PE

NAME \_\_\_\_\_

ADDRESS \_\_\_\_\_

CITY/STATE \_\_\_\_\_ ZIP \_\_\_\_\_

**CIRCLE NO. 23 ON READER SERVICE CARD**

# DIGITAL COLOR

**Bell & Howell Schools introduces an amazing new color TV featuring channel numbers and digital clock that flash on the screen and automatic channel selector!**

**Now you can build and keep a color television that's ahead of its time!**

You've seen TV's that swivel, TV's with radios built in, TV's small enough to stuff in a suitcase and TV's that have remote control.

But now comes a color television with features you've never seen before. Features now possible as a result of the new technology of digital electronics... features that make Bell & Howell's new 25-inch diagonal digital color TV ahead of its time! Like...

Channel numbers that flash big and clear right on the screen. An on-screen digital clock that flashes the time in hours, minutes and seconds with just the push of a button. An automatic channel selector that you pre-set to skip over "dead" channels and go directly to the channels of your choice.

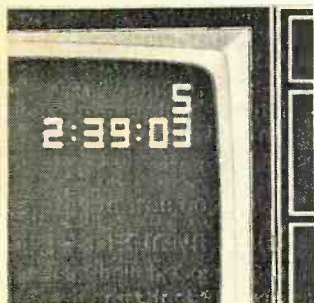

And, to insure highest quality performance, this new TV has all-electronic tuning, reliable integrated circuitry, and 100% solid-state chassis for a brighter, sharper picture with long life and dependability.

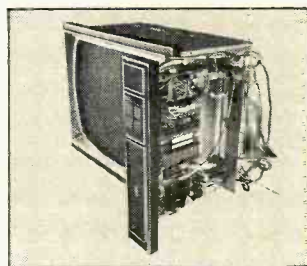

**Perform fascinating experiments... test your new TV as you build it... with the exclusive Electro-Lab, electronics training system. It's yours to build and keep!**

Designed exclusively for our students, this new Bell & Howell Electro-Lab features the most sophisticated and up-to-date "tools of the trade". In-

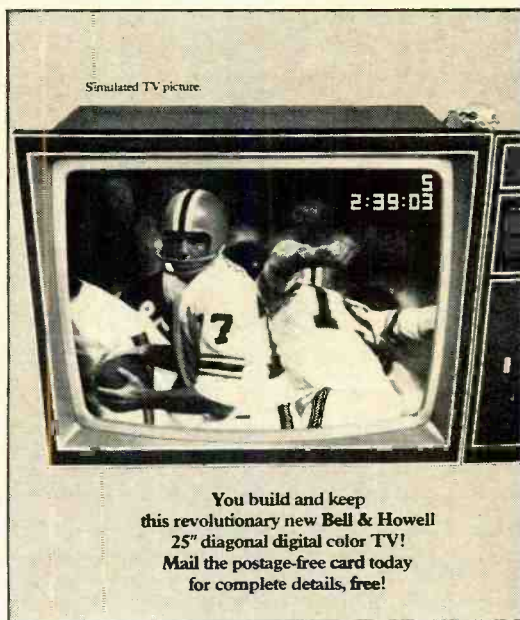

**You build and keep this revolutionary new Bell & Howell 25" diagonal digital color TV! Mail the postage-free card today for complete details, free!**

struments you can use professionally after you finish the program.

A new digital multimeter that measures voltage, current and resistance and displays its findings in big, clear numbers. Far more accurate and readable than conventional "needle pointer" meters that require guesswork and interpretation.



The solid-state "triggered sweep" oscilloscope is a "must" for accurate analysis of digital circuitry. With it you are able to make measurements of circuits in much the same way that heartbeats are measured on an electrocardiograph. Includes DC wide-band vertical amplifier and "triggered sweep" feature to lock in signals for easier observation.

The design console is a valuable device for setting up and examining circuits without soldering! Features patented modular connectors, AC power supply and transistorized dual range DC power supply.

# R TV IS HERE!

**Build it yourself... the perfect way to learn all about the exciting new field of digital electronics!**

**It's a fascinating spare-time project you can enjoy at home!**

Imagine spending your spare time actually building your own 25-inch diagonal digital color TV. It's a project you can enjoy working on right in your home. And you'll be amazed at the electronics knowledge you'll pick up in a relatively short period of time!

There's no travelling to classes, no lectures to attend, and you don't have to give up your job or paycheck just because you want to get ahead. When you finish this new Bell & Howell Schools program, you'll have the skills you need plus a great color TV to keep and enjoy for years!



**Digital electronics is changing our lives!**

There's a lot more to digital electronics than just the numbers! True, that's what you see on more and more products like digital calculators, clocks and watches. But behind the numbers lies a fantastic new technology that's creating higher standards of accuracy and dependability. The versatility of digital electronics has begun another industrial revolution. Its growth and applications are limitless, giving us new and better ways of doing things and spectacular products like this new Bell & Howell digital color TV!

**You don't have to be an electronics expert to build it... we help you every step of the way.**

One of the beauties of this TV is that you don't need previous electronics experience to build it! With a few simple household tools, our step-by-step instructions and the exclusive Electro-Lab<sup>®</sup>, you've got all the basics you need. Should you ever hit a "snag", you're just a toll-free call away from one of our expert instructors who can help you solve it. You can also take advantage of our in-person "help

sessions" held in major cities throughout the year where you can enjoy "talking shop" with instructors and fellow students.

**Pick up valuable skills in digital electronics that could lead to extra income full or part time... or a business of your own!**

Once you have your new TV, cash in on all that you learned from building it! This new Bell & Howell program employing digital electronics will help you gain valuable new skills that could easily lead to extra income, part time. A service or repair business of your own? Why not! We even show you how to get started with a complete volume on the basics of setting up a TV servicing business. Get the complete story on this exciting, learn-at-home program... the world's first color TV course employing digital electronics technology!

**Mail card today for full details, free!**

Electro-Lab is a registered trademark of the Bell & Howell Company.

**If card has been removed, write:**

597

An Electronics Home Study School  
DeVRY INSTITUTE OF TECHNOLOGY  
ONE OF THE  
**BELL & HOWELL SCHOOLS**  
41-11 Belmont, Chicago, Illinois 60641



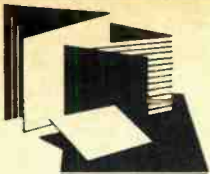

# New Literature

## GLADSTONE MAIL-ORDER CATALOG

The latest 64-page, cross-Canada, mail-order sales catalog is now available from Gladstone Electronics. With a special emphasis on high fidelity and kits, the catalog offers the Sinclair line of hi-fi amplifiers and tuner modules, as well as speaker kits by Philips Deforest, Marsland, Radio Speakers of Canada and Goodmans of England. Test equipment, hobbyist/experimenter parts and service components are also included. Address: Gladstone Electronics, 1736 Avenue Road, Toronto, Ontario, Canada, M5M 3Y7.

## SIMPSON METER/TEST EQUIPMENT CATALOG

A new, 40-page Catalog 4200 describes the complete line of Simpson test and measurement devices available as standard stock items from electrical/electronic distributors. It lists over 1500 types, styles, sizes and ranges of panel meters, more than 100 meter relays, and a wide variety of general and special-purpose test equipment. New products include reed frequency meters, pyrometers, percent-load meters, load meter relays, digital VOM's, photo tachometers, illumination level meters, insulation testers and a new general-purpose oscilloscope. The catalog can be obtained free from any Simpson distributor or from: Simpson Electric Co., 853 Dundee Ave., Elgin, IL 60120.

## AMPHENOL CONNECTOR CATALOG

An array of connector and socket devices designed for use in hobbyist equipment is de-

scribed in a full-color pocket-sized catalog published recently by Amphenol. The new 16-page catalog provides details on the company's microphone, hexagonal and r-f connector families, and on its chassis, dual-in-line, and TO-can socket lines. The catalog also furnishes advice on selecting the proper soldering tool and offers helpful solder usage tips. A complete list of schematic symbols and resistor color codes is included. For a free copy of the "Quality Crafted Component Handbook and Buying Guide" visit an Amphenol general line distributor.

## NORTRONICS RECORDER CARE MANUAL

The fifth edition of the company's popular Recorder Care Manual, which details proper maintenance of tape recording equipment, has been introduced. Designated Form #7310-E, the two-color 32-page illustrated manual includes information on the principles of magnetic recording, magnetic heads, recorder maintenance and a catalog section of the company's complete line of recorder care products. Also included is a bibliography for readers who want additional information, plus data on the company's replacement heads for more than 4400 foreign and domestic cassette, 8-track cartridge and reel-to-reel recorders and players. Copies can be obtained without charge from nationwide Nortronics dealers. A complete listing of dealers is available from: Nortronics Co., Inc., Recorder Care Division, 8101 Tenth Ave. North, Minneapolis, MN 55427.

## TEN-TEC INSTRUMENT ENCLOSURE BROCHURE

Two new series of instrument enclosures have been added to Ten-Tec's present product line. Series D enclosures, available in widths between 8" and 14", are 4 1/4" high and 10 1/4" deep. Construction is 0.62" aluminum with molded plastic end panels. Series T, with two-piece aluminum construction, are small enclosures in four basic sizes ranging from 2" x 4" x 4" to 3" x 4" x 6". Both of the new series are available in two finishes: walnut grain vinyl with

# FREE McIntosh CATALOG and FM DIRECTORY

McIntosh Laboratory, Inc.  
East Side Station P.O. Box 96  
Binghamton, N.Y. 13904  
Dept. 16-5

**SEND  
TODAY!**

NAME \_\_\_\_\_  
ADDRESS \_\_\_\_\_  
CITY \_\_\_\_\_ STATE \_\_\_\_\_ ZIP \_\_\_\_\_

Get all the news and latest information on the new McIntosh Solid State equipment in the McIntosh catalog. In addition you will receive an FM station directory that covers all of North America.



**MX 113**

AM FM/FM STEREO TUNER PREAMPLIFIER

**CIRCLE NO. 22 ON READER SERVICE CARD**



egg-shell white panel and black pebble vinyl with gray. A 4-page brochure on the enclosures is available from: Ten-Tec Inc., Highway 411 East, Sevierville, TN 37862.

#### RCA COS/MOS PRODUCT GUIDE

An up-to-date product guide on a broad line of COS/MOS IC's for low-voltage digital circuit design in industrial, commercial, and military applications is available from RCA. This 8-page designer's aid includes an easy-to-read wall-chart format permitting quick access to logic diagrams, functional diagrams, and applications for 58 COS/MOS types including: gates, flip-flops, latches, multivibrators, shift registers, counters, display counter/decoders/drivers, multiplexers, arithmetic circuits, memories and phase-locked loops. Copies of the guide may be obtained from: RCA Solid State Div., Box 3200, Somerville, NJ 08876.

#### SANSUI 4-CHANNEL BOOKLETS

Five booklets on 4-channel sound are being made available by Sansui for five specific groups from the novice audiophile to the electronics engineer. For the consumer, "A Non-Technical Guide to QS 4-channel Sound", which will be available to all QS licensees and distributed by dealers, describes the various formats of 4-channel, their advantages, disadvantages and availability of material. Other booklets are slanted toward the audio equipment dealer, the recording engineer, the electronics engineer and the FM broadcaster. For further information contact: Sansui Electronics Corp., 55-11 Queens Blvd., Woodside, NY 11377.

#### STAR-TRONICS CATALOG FLYER

The latest Catalog from Star-Tronics contains a number of items of interest to the surplus electronics enthusiast. Included are such items as switches, reed switches, keyboards, photo-multiplier tubes, coils, transformers, resistors and relays; also power supplies, semiconductor diodes, meters, knobs, hardware and capacitors. For a copy of the flyer write: Star-Tronics, P.O. Box 17127, Portland, OR 97217.

#### OLSON ELECTRONICS CATALOG FOR 1974

Hot off the presses is the 1974 catalog (No. 740) from Olson Electronics. Packed into its 244 pages are brand-name listings for hi-fi and communications gear, calculators, and digital wristwatches. Featured specialty items include alarms and security devices, automotive accessories, public address equipment, closed-circuit TV gear, telephones and accessories, etc. Separate listings are given for IC's, vacuum tubes, decimal readouts, resistors, capacitors, transformers, and other components. Tools and test equipment are also listed. Address: Olson Electronics, 260 S. Forge St., Akron, OH 44327.

FEBRUARY 1974

## 4 Money-saving reasons to buy EICO's Solid State Test Equipment.



**EICO 242 FET-TVOM.** Peak-to-peak measurements of AC volts and milliamps. 6½" meter 7 non-skip ranges. High input impedance. Low 1 volt scale. DC/AC Multi-Probe. AC or battery operated. Kit \$84.95, Wired \$119.95.

**EICO 379 Sine/Square Wave Generator.** Simultaneous sine and square wave outputs. Covers 20 Hz to MHz in five ranges. Low distortion sultzer feedback circuit. Square wave rise time better than 0.1 microseconds. Kit \$79.95. Wired \$119.95.

**EICO 330 RF Signal Generator.** 5 bands cover a range from 100 kHz to 54 MHz. Calibrated modulation adjustment control. 400 Hz audio output. Provision for modulating RF with internal or external signal source. Kit \$69.95, Wired \$109.95.

**EICO TR-410 Triggered Sweep Scope.** 100% solid state. DC to 10MHz bandwidth. Sweep synchronized gate output. Z-Axis input. Use as vectorscope for color TV servicing. One probe for direct and 10:1 measurements. Wired \$429.95.

### FREE 32 PAGE EICO CATALOG

For latest catalog on Eico Solid State Test Equipment, Automotive and Hobby Electronics, Burglar-Fire Alarm Systems, Stereo, and name of nearest EICO Distributor, check reader service card or send 25¢ for fast first class mail service.

EICO, 283 Malta Street, Brooklyn, N.Y. 11207



CIRCLE NO. 10 ON READER SERVICE CARD

## EVERYTHING YOU WANTED TO KNOW ABOUT CD IGNITION SYSTEMS BUT DIDN'T KNOW WHOM TO ASK.

Send for *FREE Tiger booklet* (20 pages) which answers all your questions.

Name \_\_\_\_\_

Address \_\_\_\_\_

City \_\_\_\_\_

State \_\_\_\_\_ Zip \_\_\_\_\_

CLIP OUT THIS AD AND SEND TO—

**TRI-STAR CORP.**

P. O. Box 1727 Dept. E  
Grand Junction, Colo. 81501

CIRCLE NO. 31 ON READER SERVICE CARD

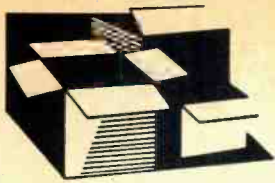

## New Products

Additional information on new products covered in this section is available from the manufacturers. Either circle the item's code number on the Reader Service Card inside the back cover or write to the manufacturer at the address given.

### HARMAN/KARDON CASSETTE DECK

The HK1000 cassette deck has a S/N of  $-75$  dB (weighted) with Dolby activated, a frequency response of 30 Hz to 16 kHz  $\pm 1.5$  dB and a 0.15 (weighted) wow and flutter. Functions include a three-position bias switch for standard, low-noise and chromium-dioxide tapes. The deck has a "memory" control that permits the listener to key special selections



and play them back without searching for their starting location, a built-in microphone preamp with its own level set controls, and two pro-

fessional-type VU meters that read peaks to prevent clipping of transients. It has a dc servo-controlled constant speed motor.

Circle No. 70 on Reader Service Card

### AIKENWOOD LOGIC PROBE

A new DP-6000 logic probe has been designed to simplify testing of digital systems. The probe not only displays logic states but also functions as a fast-pulse counter. As a high/low discriminator, the probe indicates logic states and identifies faults in IC's. When switched to the counting mode, it acts as a fast-pulse counter with display. Its self-contained pulse counting

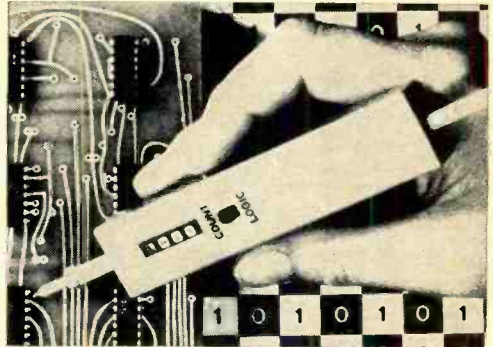

circuitry requires no accessories or options to detect multiple clock and trigger pulses, and it can indicate the presence of spurious oscillations. The three-bit counter is reset by a push button. The probe is suitable for any device using 5-volt DTL or TTL integrated circuits.

Circle No. 71 on Reader Service Card

### LEE AUTOMOTIVE CIRCUIT TESTER

The new Model E-A automotive circuit tester introduced by Lee Electronic Labs provides a continuity test that may be safely used to check all accessories such as lights, horns and wiring without disconnecting them from the circuit. The tester can be used for locating short circuits. It will not become damaged in the event

## NEW SPACE SAVING FORMULA

Save panel space on your next project. Mount the FCB in a  $\frac{1}{2}$ " hole and you have a fuse holder, pilot light and power switch in one neat package. Connect 3 terminals and you're in business. Uses 3AG type fast or slow blow fuse. UL listed. Send check or money order for \$5.00 each plus 50c shipping and handling to:

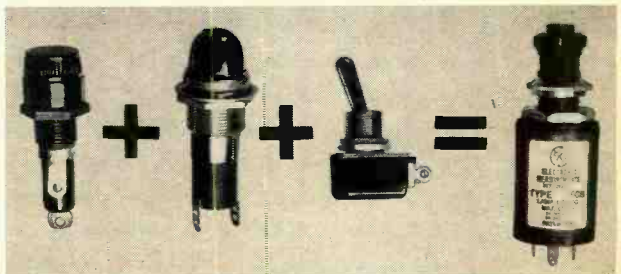

**ELECTRONIC MEASUREMENTS** ■ 405 Essex Road, Neptune, N. J. 07753

of accidental contact with hot battery leads or live wires. The tester can also be used as a handy portable spotlight.

Circle No. 72 on Reader Service Card

### AMERICAN TRADING CB TRANSCEIVER

A new Electronic 2000/Contact CB transceiver has just been announced by American Trading Corp. The Model CB-23CH uses a low-noise, double-conversion superhet with a series gate type of noise limiter. Incoming signal strength can be read by means of a combination S-meter/modulation indicator. A local/distance switch is used to allow maximum sensitivity in low noise areas. Power input is rated at 5 watts.

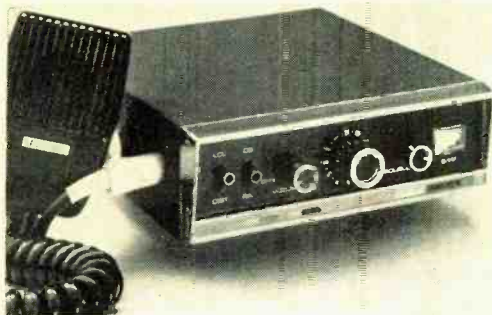

The unit is 6½" wide x 2" high x 7" deep and it weighs about 4 lb. The transceiver is budget-priced.

Circle No. 73 on Reader Service Card

### RUSSOUND 3-WAY AUDIO SWITCHER

A new tape recorder selector switch which expands the tape monitor facilities of amplifiers and receivers to accept up to three tape recorders or other line-level audio devices is available from Russound. The TMS-1W connects to

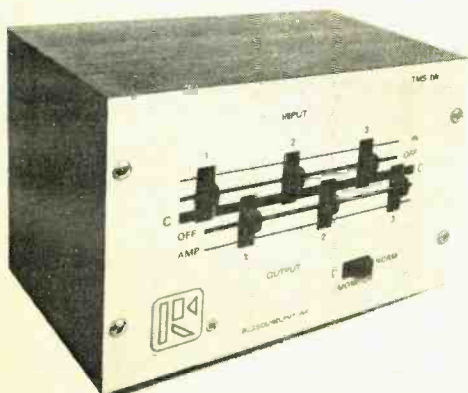

the tape monitor inputs and outputs of the amplifier or receiver and allows three recorders to be used simultaneously for recording, copying or editing. It can also be used to interface graphic equalizers, noise reduction units, syn-

# free BA 1974 catalog

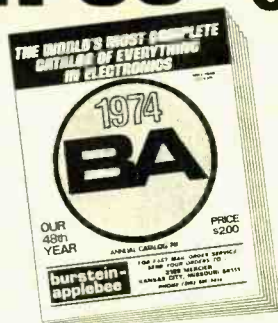

276 PAGE  
RADIO, TV &  
ELECTRONICS  
CATALOG

Your Buying Guide for  
Everything in Electronics  
... Stereo, Hi-Fi, TV's,  
Radios, Tape Recorders,  
CB, Kits, Tools, Books,  
and Electronic Parts.

WRITE FOR  
IT TODAY!

## burstein - applebee

DEPT. PE 3199 MERCIER ST.  
KANSAS CITY, MO. 64111

NAME \_\_\_\_\_

ADDRESS \_\_\_\_\_

CITY \_\_\_\_\_

STATE \_\_\_\_\_ ZIP \_\_\_\_\_



## NEW FREE CATALOG OF CIRCUIT DESIGN & BREADBOARDING EQUIPMENT!

NOW ... TEST NEW  
CIRCUIT IDEAS, I.C.'S,  
DISCRETE COMPONENTS WITH NO SOLDERING!

Circuit Design's new catalog has everything you need to take you from circuit concept to working hardware in minutes. Featured items include the great SK-10 socket for solderless circuit design and testing, the NEW SK-20 socket (only \$2.75) for smaller circuits, the versatile Digi Designer (in kit form or assembled), a new Op-Amp Designer, plus power supplies, pulse generators, digital logic courses, plug-in socket boards, and much more.

Write today for your free copy.

**CIRCUIT DESIGNS, INC.**

P.O. Box 24, Shelton, Conn. 06484

Exclusive mail order dist. for E&L Instruments.

CIRCLE NO. 12 ON READER SERVICE CARD

**QUALITY  
PERFORMANCE  
VALUE**



**CBS  
RADIO  
AM MOBILE**

**SBE CORTEZ—sweepingly new—brilliantly designed AM radio**

23 channels, no crystals to buy • Full 4 watts output • Advanced solid state w/FET's, I-C's • Sensitive, double conversion receiver • Panel metering: Power out/modulation; signal strength • "Anti-blast" AGC • Dynamic mic. w/plug/coil cord • Noise limiter with On-Off switch • Big audio—3W! • PA/Hailer provision • Operates 12VDC w/positive or negative ground • Compact!

Write for full line brochure



**LINEAR SYSTEMS, INC.**  
220 Airport Blvd. Watsonville, CA 95076

**CIRCLE NO. 21 ON READER SERVICE CARD**

thesizers and other signal processing equipment. The unit makes it possible to conveniently switch equipment in and out without the constant hooking and unhooking of audio cables usually required.

Circle No. 74 on Reader Service Card

**TECH SYSTEMS DIGITAL KEY**

The Digital Division of Tech Systems has introduced the Model 500 digital key. The key operates when the proper 5-digit code is punched into the unit; the proper sequence must be used or the key will not operate. Over 95,000 code combinations are available. The unit uses the latest IC's to produce a product that operates with any voltage from 5 to 30 volts dc. The entire device fits into a standard 2" x 3" electrical wall box and is available with either maintained or momentary relay contacts rated at 1 amp to provide compatibility with all types of alarm systems and electric door strikes.

Circle No. 75 on Reader Service Card

**LESLIE PLUS 2 SPEAKER SYSTEM**

Electro Music/CBS Musical Instruments has just entered the consumer market with its new Leslie Plus 2 speaker systems. Consisting of a pair of 2-way or 3-way speakers with a built-in pair of 50-watt solid-state power amplifiers, the system has some unique features that are said

to eliminate standing wave conditions in the listening room. A mechanical rotor is used with the low-frequency speaker to disperse the acoustic energy produced; another mechanical device which randomly varies the capacitance in the power amplifier input is used to disperse the middle and high-frequency energy to eliminate the standing-wave problem at those frequencies. The purpose of the overall effect is to create sound that is rich in ambience.

Circle No. 76 on Reader Service Card

**EDSYN HOT AIR TIP ATTACHMENT**

A hot air tip attachment, Part No. HA120, has been designed for Edsyn's Loner soldering instrument. With the attachment it is possible to produce a narrow jet of heated air that can be



*Planning to move?*

Let us know 6 to 8 weeks in advance so that you won't miss a single issue of **POPULAR ELECTRONICS INCLUDING ELECTRONICS WORLD**

Attach old label where indicated and print new address in space provided. Also include your mailing label whenever you write concerning your subscription. It helps us serve you promptly.

Write to: P.O. Box 2774, Boulder, Colo., 80302, giving the following information.

Change address only.

Extend subscription.  Enter new subscription.

(1)  5 yrs. \$21 (2)  3 yrs. \$15 (3)  1 year \$6

Payment enclosed (1 extra issue per yr. as a BONUS)

Bill me later.

If you have no label handy, print OLD address here.

name \_\_\_\_\_ please print \_\_\_\_\_

address \_\_\_\_\_

city \_\_\_\_\_

state \_\_\_\_\_ zip-code \_\_\_\_\_

AFFIX LABEL

name \_\_\_\_\_ please print \_\_\_\_\_ 0879

address \_\_\_\_\_

city \_\_\_\_\_ state \_\_\_\_\_ zip \_\_\_\_\_

Add'l postage: \$1 per year outside U.S., its possessions & Canada

directed at a small area. The hot air can be used to shrink plastic tubing, for fast drying of small wet areas on a PC board, for localized testing of components by fast heating, and for heat shaping of plastics. Routine soldering can also be done at the same time. To use the hot air attachment the technician merely blows into the mouthpiece supplied or connects it into his shop air supply.

Circle No. 77 on Reader Service Card

### ASCOM SPEECH PROCESSOR

A new microphone accessory for both mobile and base applications, the Model M-260 speech processor, is being offered by Ascom Electronic

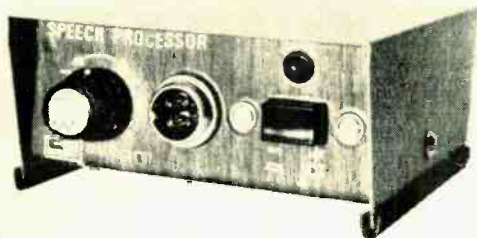

Products for amateur, CB, public address and similar communications systems. The unit provides high gain as well as effective speech compression to produce full modulation without distortion. The microphone may be held at arm's length or within  $\frac{1}{2}$ " of the mouth with no change in mike output. For mobile use, it is necessary only to provide 12 volts dc input to the speech processor and replace the microphone plug with the special plug furnished with the unit. Gain is adjustable to match the transmitter gain, and internal adjustment is set initially to provide a wide range of adjustment for the front panel control.

Circle No. 78 on Reader Service Card

### CHRISTIANSEN "MINI-MOUNT" BREADBOARD

A ground plane card with uncommitted gold-plated fingers is the latest feature in the Christiansen Radio, Inc., "Mini-Mount" breadboarding system. The double-sided, solder-coated cards—when used with the Mini-Mount pads—permit rapid assembly of all electronic components. Ready for testing in minutes, the breadboard can be plugged directly into the card cage. Packing density of the components will equal the final circuit. Pressure-sensitive adhesive on the back of the Mini-Mount holds it in place. The mounts are easily moved about or exchanged, yet will remain firmly in place in the finished assembly. Mini-Mounts come in different configurations to fit 14- and 16-pin DIP's, 6-12 pin TO-5 cans, etc.

Circle No. 79 on Reader Service Card

# free!

## 1974 Olson CATALOG



**SAVE ON THE BEST AND NEWEST IN ELECTRONICS**

- Stereo / 4 - Channel Systems
- Tape Recorders
- Radios
- Phonos
- Kits
- Amateur/Shortwave Gear
- CB
- Antennas
- Police/Fire Radios
- Calculators
- Timepieces
- Security
- Test Equip.
- Parts, Tubes, Batteries, Wire, Hardware

**Olson** Electronics Dept. IQ  
260 S. Forge St., Akron, Ohio 44327

Send My FREE 1974 Olson Catalog

Name \_\_\_\_\_

Address \_\_\_\_\_

City \_\_\_\_\_ State \_\_\_\_\_

Zip

**free!**  
**MAIL**  
**TODAY**

**CIRCLE NO. 24 ON READER SERVICE CARD**

# SAVE!

**MONEY • TIME • FREIGHT**

QUALITY STEREO EQUIPMENT AT LOWEST PRICES.

YOUR REQUEST FOR QUOTATION RETURNED SAME DAY.

FACTORY SEALED CARTONS—GUARANTEED AND INSURED.

SAVE ON NAME BRANDS LIKE

A.D.C.  
A.R.  
DYNACO  
FISHER  
KLH  
SHURE  
KOSS  
SONY

AND MORE THAN 50 OTHERS

BUY THE MODERN WAY  
BY MAIL—FROM

ia

illinois audio

Department B  
12 E. Delaware Place  
Chicago, Illinois 60611  
312-664-0020

**CIRCLE NO. 18 ON READER SERVICE CARD**

# ELECTRONICS MARKET PLACE

**NON-DISPLAY CLASSIFIED: COMMERCIAL RATE:** For firms or individuals offering commercial products or services, \$1.60 per word (including name and address). Minimum order \$16.00. Payment must accompany copy except when ads are placed by accredited advertising agencies. Frequency discount: 5% for 6 months; 10% for 12 months paid in advance. **READER RATE:** For individuals with a personal item to buy or sell, \$1.00 per word (including name and address.) No minimum! Payment must accompany copy. **DISPLAY CLASSIFIED:** 1" by 1 column (2 5/8" wide), \$200.00. 2" by 1 column, \$400.00. 3" by 1 column, \$600.00. Advertiser to supply cuts. For frequency rates, please inquire.

**GENERAL INFORMATION:** First word in all ads set in bold caps at no extra charge. All copy subject to publisher's approval. All advertisers using Post Office Boxes in their addresses **MUST** supply publisher with permanent address and telephone number before ad can be run. Advertisements will not be published which advertise or promote the use of devices for the surreptitious interception of communications. Closing Date: 1st of the 2nd month preceding cover date (for example, March issue closes January 1st. Send order and remittance to Hal Cymes, **POPULAR ELECTRONICS**, One Park Avenue, New York, New York 10016.

## FOR SALE

**FREE!** bargain catalog. Fiber optics. LED's, transistors, diodes, rectifiers. SCR's, triacs, parts. Poly Paks, Box 942, Lynnfield, Mass. 01940.

**GOVERNMENT** Surplus Receivers, Transmitters, Snooperscopes, Radios, Parts, Picture Catalog 25¢. Meshna, Nahant, Mass. 01908.

**LOWEST Prices** Electronic Parts. Confidential Catalog Free. KNAPP, 3174 8TH Ave. S.W., Largo, Fla. 33540.

**ELECTRONIC PARTS**, semiconductors, kits. **FREE FLYER.** Large catalog \$1.00 deposit. **BIGELOW ELECTRONICS**, Bluffton, Ohio 45817.

**RADIO—T.V. Tubes—36¢** each. Send for free catalog. Cornell, 4213 University, San Diego, Calif. 92105.

### TOUCH TONE ENCODER BOARD



Heavy duty board, made by Automatic Electric Co. Mfrs. of telephonestation equipment. In original factory cartons. 2 1/2" x 3"

STOCK NO. F5151 \$9.75 2/18.00

### 5 GANG PUSH BUTTON SWITCH RELAY CONTROLLED

Unique 5 section push button switch, each button controls a SPDT micro-switch. A 24 volt **MAGNACRAFT** relay is attached to the assembly in such a manner, that whenever the relay is activated, it locks all the push button in the position they were in. Ideal for electronic locks, fail safe devices, and other protective circuits. With data sheet and suggested applications. Mounting centers 3+

STOCK NO. F 9814 \$2.75 2/5.00

### COMPUTER GRADE CAPACITORS

40000 mfd. 10 volts	F2026	\$1.25	6/7.00
9000 mfd. 50 volts	F2350	\$2.75	4/10.00
3750 mfd. 75 volts	F2116	\$1.75	6/9.00
2200 mfd. 100 Volts	F2343	\$2.50	4/9.00

Include sufficient postage. Excess refunded. Send for new catalog. **MINIMUM ORDER \$5.00**



**DELTA ELECTRONICS CO.**

BOX 1, LYNN, MASSACHUSETTS 01903  
PHONE (617)-388-4705

**CIRCLE NO. 8 ON READER SERVICE CARD**

**CONVERT** any television to sensitive, big-screen oscilloscope. Only minor changes required. No electronic experience necessary. Illustrated plans. \$2.00. **Relco-A33**, Box 10563, Houston, Texas 77018.

**AMATEUR SCIENTISTS**, Electronics Experimenters, Science Fair Students . . . Construction Plans—Complete, including drawings, schematics, parts list with prices and sources . . . Robot Man — Psychedelic shows — Lasers — Emotion/Lie Detector — Touch Tone Dial—Quadrasonic Adapter—Transistorized Ignition — Burglar Alarm—Sound Meter . . . over 60 items. Send 25¢ coin (no stamps) for complete catalog. Technical Writers Group, Box 5994, University Station, Raleigh, N.C. 27607.

**METERS**—Surplus, new, used, panel or portable. Send for list. Hanchett, Box 5577, Riverside, CA 92507.

**PYROTECHNICAL** chemicals, casings, tools, supplies, fuse, literature. Giant, illustrated catalogue/handbook includes formulas, instructions—50¢, with samples—\$1.00. Westech, Box 593, Logan, Utah 84321.

**WE SELL CONSTRUCTION PLANS. TELEPHONE:** Answering Machine, Speakerphone, Carphone, Phonevision. Auto Dialer, Touch Button Dialer, Central Dial System. **TELEVISION:** \$35.00 Color Converter, Video Tape Recorder. \$25.00 Camera. **HOBBYIST:** Electron Microscope, 96 Hour Tape Music System, Ultrasonic Dishwasher, Radar-Oven. Plans \$4.95 each. **NEW ITEM:** \$75. Electronic Pocket Calculator, \$7.50. **COURSES:** Telephone Engineering \$39.50. Detective Electronics \$22.50, Integrated Circuit Engineering, \$49.50. **NEW SUPER HOBBY CATALOG** plus year's subscription to Electronic New Letter **AIRMAILED \$1.00.** Don Britton Enterprises, 6200 Wilshire Blvd., Los Angeles, Calif. 90048.

**JAPAN HONG KONG DIRECTORY.** World products information. \$1.00 today. World Trade Inquiries, Hillyard, Washington 99207.

**SCOPES**, meters, test equipment, military and industrial surplus. Write for free "Bargain Bulletins". Lawrence Instruments, P.O. Box 744, Sunbury, Pa. 17801.

**TEST EQUIPMENT**, Aerospace-Laboratory Grade. Request your needs; will mail appropriate catalogs (we have 24 catalog categories). Only for Engineers, Businesses, Schools and advanced Technicians. Goodheart, Box 1220PE, Beverly Hills, Calif. 90213.

### BUILD YOUR OWN SPACE-AGE TV CAMERA

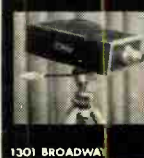

**ONLY KNOWN SOLID-STATE CAMERA KIT!** Ideal for experimenters, hobbyists, educators, students, etc. \* High quality \* Backed by over six years of field testing \* Fully Guaranteed \* Connects to any TV set without modification \* Step-by-step construction manual \* Model XT114 Series D complete with vidicon \$129.50 postpaid anywhere in USA & Canada (less vidicon tube \$116.99)

PHONE OR WRITE FOR CATALOG.  
DIAL 402-983-3771

Many other kits, parts and plans available including starter kits, focus-deflect coils, vidicon tubes, const. plans, audio subcarrier kit, etc.

1301 BROADWAY

**ATV Research**

DAKOTA CITY, NEBR. 68731

**MECHANICAL, ELECTRONIC** devices catalog 10¢. Greatest Values—Lowest Prices. Fertik's, 5249 "D", Philadelphia, Pa. 19120.

**FREE** Catalog lists resistors, tubes, transistors, rectifiers, condensers, tools, tuners, etc. Hytron Hudson, Dept. PE, 2818 Kennedy Blvd., Union City, N.J. 07087.

**SOUND SYNTHESIZER KITS**—Surf \$11.95, Wind \$11.95, Wind Chimes \$16.95, Electronic Songbird \$6.95, Musical Accessories, many more. Catalog free. PAIA Electronics, Box J14359, Oklahoma City, OK 73114.

**FREE CATALOG**  
**UP TO 50% OFF COMPARABLE KITS\***  
**• BUY DIRECT • SAVE \$\$\$**  
**FREE Catalog — Electronic Kits — Amplifiers —**  
**Preamps — Psychedelic Strobes — Burglar Alarms**  
**Digital Tachometer — More: Free Catalog.**  
**SWTPC, Box A32040, San Antonio, Tex. 78284.**

**DIGITAL ELECTRONICS:** Complete schematics, parts lists, theories — Discrete Component Digital Clock, \$3.00 — Sound Sensitive Switch, \$1.50. Increase technical competence, hobby skills — Complete Course in Digital Electronics is highly effective, \$10.00. Free literature. DYNASIGN, Box 60A7, Wayland, Mass. 01778.

**IGNITION SYSTEMS:** Capacitor, Transistor. Information 10¢. Anderson Engineering, Epsom, N.H. 03239.

**AUTHENTIC, INSTRUMENTED, FLYING ROCKETS** for casual or serious experimenters. Over 80 scale original, multi-stage or ready-to-fly models. Solid-propellant engines for safe, electric launch system liftoffs up to 2,500 feet. Measure altitude, temp. Inversions, more. Real telemetry, electronic tracking, aerial still and movie photography with super-miniaturized equipment. New, detailed tech manual and full-color catalog. 25¢ from ESTES INDUSTRIES Dept. 18T, Penrose, Colo. 81240.

**WE SELL CONSTRUCTION MANUALS**—GOLD Recovery Unit—SILVER Recovery Unit—Alternator Adapter—Infrared Scope—Inverter—Electronic Insect Trap—Burglar Alarm—X-Ray Fluoroscope—Chemical Formulary. Manuals \$5.00 each. HIGHLY PROFITABLE Business Courses!—"How To Start and Operate Your Own SILVER Recovery Business"—"The Manual of PRECIOUS Metals" courses \$9.95 each—illustrated color catalog, 25¢—Airmailed 50¢—Creative Products, 8415 Lofland, Dept. PE-274, Houston, Texas 77055.

**PAIA**



**MAKES THE ONLY**  
**SYNTHESIZER KITS**  
 models priced from \$139 — free brochure and catalog

**PAIA ELECTRONICS, INC.**  
**BOX P14359, OKLAHOMA CITY, OK 73114**

**WHOLESALE** Scanners, CB., Crystals, Directories, SSB/AM, Catalog 25¢. G—ENTERPRISES, Box 461P, Clearfield, Ut. 84015.

**LOGIC** Probe \$9.95. Free bargain catalog. Electro, 4201 Irving Park, Chicago, Illinois 60641.

**CD IGNITIONS,** VHF/UHF monitors, crystals, CB radios. Wholesale. Southland, Box 3591-B, Baytown, Texas 77520.

**WAVEFORM GENERATOR KIT 8038** Function Generator IC Producing Sine, Square, Triangular Waveforms, \$10.00. Write for catalog. Photolume Corporation, 118 East 28th Street, New York, N.Y. 10016.

**NEW FM Deviation Meters** \$75.00. Free Information. Write: ECM, 412A N. Winbach, Evansville, Indiana 47711.

**SURPLUS** electronic parts and pieces. Monthly picture flyer free. Startronics, Box 17127, Portland, Oregon 97217.

**BURGLAR-FIRE** alarm components, hardware. Free catalog—in-formation. Silmar, 133 S.W. 57 Ave., Miami, Florida 33144.

**INTRODUCTORY OFFER**

Led Readout Kit \$4.95 complete

You get:  
 1—Man—1 Type Led Readout  
 1—7490 1—7475 1—7447  
 + 8 Current Limiting Resistors  
 + Spec. Sheets



Compare this price!

\*\*\*

**SEMICONDUCTOR GRAB BAGS**

We bought over 20 million various semis and IC's direct from the factory. There are many useable devices, but we can not test them all. You can buy untested and save.

\*\*\*

**TTL AND LINEAR IC ASSORTMENT**

Contains 1/2 lb. (Approx. 200 pcs.) mixed TTL and linear IC's untested. In-cludes logic gates, flip flops, counter, FM detectors, chroma demod IC's, etc. Marked and unmarked. With some spec sheets. \$3.95

\*\*\*

**COMPUTER DIODE GRAB BAG**

IN914 and IN4148 type silicon diodes. Many good units. 1/2 lb. (Approx. 1,400 pcs.) \$3.95 untested

\*\*\*

**GERMANIUM DIODE ASSORTMENT**

1/2 lb. (Approx. 1,200 pcs.) like IN270 etc. Many useable devices. \$3.95 No test

\*\*\*

**TO-5 Linears** 709C — 29¢ 710C — 29¢ 711C — 29¢

**Stereo Audio Amps** Two — 2 watt amps on one ship. We bought too many to test. Untested but many useable units. With spec sheets. 3 for \$1.00

\*\*\*

**Motorola HEP 170 Rectifiers.** Rated a full 2 1/2 amps at 1,000 PIV. Miniature plastic.\* 4 for \$1.00 10 for \$2.00

**14 PIN IC Sockets** \*\*\* 3 for \$1.00

\*\*\*

**Reed Relay.** Sub min. size SPST N.O. Coil 500 ohm. Operates at 5 VDC 10 Ma. Compatible with TTL IC's — 95¢

\*\*\*

**Filter Cap Special.** Dual Section 1,000 + 1,000 Mfg. at 74 WVDC. Small Twist Lock Type 95¢

\*\*\*

**40 Watt Audio Output pair.** Plastic TO-220 Power transistors by GE. PNP and NPN. 95¢ pair

\*\*\*

**SPECIAL OFFER**

On every \$15.00 order, choose \$1.00 worth of free merchandise.

**ALTAJ ELECTRONICS**  
 P. O. BOX 28592  
 DALLAS, TEXAS 75228

Terms: Check or Money Order. No COD. Add 10% of order to help cover postage. Bargain flyer 10¢, free with order.

**CIRCLE NO. 1 ON READER SERVICE CARD**

**DISCOUNT PRICES**  
**B & K, SCORE, LEADER Test Equipment**  
 RAYTHEON, ICC/MULLARD Tubes  
 TELEMATIC Test Jigs

**Free Catalog**

**FORDHAM RADIO SUPPLY CO. INC.**  
 558 Morris Ave., Bronx, N.Y. 10451

**FREE CATALOG.** Parts, circuit boards for POPULAR ELECTRONICS projects. PAIA Electronics, Box C14359, Oklahoma City, OK 73114.

**YOU SAVE BIG MONEY!** Surplus, Clearouts, Bankruptcy, Inventory, Deals. Catalog \$1 (redeemable). ETCOA Electronics, Box 741, Montreal, H3C 2V2. U.S. Inquiries.

**ELECTRONIC Parts wholesale Free Catalog.** Donlyn Electronics, P.O. Box 15421, Phoenix, Arizona 85060.

**WHOLESALE** catalog electronic components—25 cents. National Electronic Supply, Box 15015, Long Beach, Calif. 90815.

**The Soft Touch : ELECTRONIC TOUCH SWITCH by ARM**



Completely Solid State · No Moving Parts  
 100 Watt Cp. · Great For Wall or Lamp Sw.  
 Contains: 5 Transistors, 1 Triac, 3 Diodes  
 12 Resistors, 4 Capacitors, 1 Face Plate  
 PC Board, Hardware, Complete Instr.  
 Kit - 7.95, Assembled - 9.95 postpaid · Pa.  
 Res. Add 6% Sales Tax · 60 day guarantee

**ARM ELECTRONICS, BOX 765, PITTSBURGH, PA. 15640**

**BURGLAR-FIRE** alarm supplies and information. Free catalog. Protecto Alarm Sales, Box 357-G, Birch Run, Michigan 48415.

**ELECTRONIC ORGAN KITS, KEYBOARDS** and many components. Independent audio amplifier tone generators. All diode keying. I.C. circuitry. Build any type or size organ desired. Supplement your Artisan Organ. 25¢ for catalog. **DEVTRONIX ORGAN PRODUCTS**, Dept. C, 5872 Amapola Drive, San Jose, Calif. 95129.

**BRAIN WAVE MONITOR** Biosone BF-20 Alpha Biofeedback Instrument. \$34.95 complete. Not a kit. Fully Guaranteed. For information write. **BIO-LOGIC DEVICES, INC.**, Dept. A, 888 Seventh Avenue, New York, New York 10019.

**DIGITAL** and analog computer modules. LED numeric display kits. **FREE LITERATURE**. Scientific Measurements, 2945 Central, Wilmette, Illinois 60091.

**BIOFEEDBACK**. Professional instruments: Electroencephalophone, Galvanic Skin Response. J&J, 8102-E, Bainbridge, WA. 98110.

**FREE!** Diodes and catalog. **BDJ Electronics**, 11 Revere, Tappan, New York 10983.

**ANTIQUE** and old tubes. Send self-addressed stamped envelope for free list and prices. **Arnie Electronics**, Livingston, New Jersey 07039.

**BARGAINS**—surplus electronics components. Eight-page catalog, 25¢. Refundable w/order. **Atlantis**, P.O. Box 12654P, Tucson, AZ. 85711.

**LEDS**, sample pack of 10, includes green and yellow, \$3.25, postpaid U.S.A. **East Coast Electronics**, 50 Scott St., Hamburg, New York 14075.

**NUMERICAL** readout projects: Plans Catalogue. **GBS**, Box 100E, Green Bank, West Virginia 24944.

**FREE CATALOG**. IC's, Puts, Transducers, Thermocouples, Led's, Transistors, Circuit Boards, parts. **Chaney's**, Box 15431, Lakewood, Colo. 80215.

**BURGLAR Alarm System**—Do It Yourself—Installed in Minutes. Free Literature. **Emerad Corporation**, P.O. Box 1341, Kokomo, Indiana 46901.

**COMPUTER LABORATORY!** New! Advanced Technology! Integrated circuits. Transistors. Dozens experiments. Free information. **Lindsay**, Box 12-U, Bradley, Illinois 60915.

**FREE CATALOG**—Tremendous electronic bargains. **Compukits**, Box 4192L, Mountain View, California 94040.

**KIT ORGANS**, Pipe and Electronic. New and used consoles. Accessories for all brands: Orchestra Bells, "Band Box", Portable Pipes. Send for R. Eby's book on organ building. \$3.50 post-paid. **NEWPORT ORGANS**, 846 Production Place, Newport Beach, CA 92660.

**ALPHA/THETA BRAINWAVE** biofeedback instruments. Analog instruments from \$125; digital processing systems from \$225. Free booklet "Technical Considerations for EEG Biofeedback Instrumentation". **BioScan**, Box 14168-E, Houston, Texas 77021.

**SAVE \$3**—complete set, 9 watch fobs, 3 belt buckles, 2 baseball caps featuring Caterpillar equipment, \$19.50. Today's Merchandising, Dept. PE, 1909 Cornell, Peoria, Illinois 61614.

**BRAIN WAVE Monitor/ANALYZER**. Send \$5.00 for professional quality plans including printed circuit layout. **AQUATRONICS**, P.O. Box 443, Cocoa Beach, Florida 32931.

**ATTENTION HOBBYISTS. PROFESSIONALS!** I-Tronics introduces lowest prices ever for all electronics parts. Free Catalog. **I-Tronics**, Box 29, East Rockaway, New York 11518.

**PROJECT TV** image life size! Construction plans: \$2.00. **Macrovision**, Box 14197, San Francisco, CA 94114.

**MAGNEPLANART™** Loudspeakers are extremely realistic sounding and they are only 1" thick. Contact us for information on all models. **Magneplan, Inc.**, Dept. E, 1124-1st Street, White Bear Lake, Mn. 55110.

**BUGGED???** New locator finds them fast. Write, Clifton, 11500-L N.W. 7th Avenue, Miami, Florida 33168.

**AUTOMATIC** telephone recording and debugging equipment. Electronic car ignition systems. Top quality. Lowest wholesale prices. **Viking International**, Box 632, Newhall, California 91321.

**KEYBOARDS**. Brand New. Full ASCII Decoder in Base, \$34.50. Intersil 8038 VCO Function Generator, \$5.75. Voltage Regulators 7805, 7812, 7815, 7912 or 7915, \$2.50 all ppd. Latest flyer for 8¢ stamp. **Tri-Tek, Inc.**, P. O. Box 14206, Phoenix, Arizona 85063.

**CALCULATOR OWNERS:** Use your  $+ - \times \div$  calculator to compute square roots, cube roots,  $\sin(x)$ ,  $\cos(x)$ ,  $\tan(x)$ ,  $\arcsin(x)$ ,  $\arccos(x)$ ,  $\arctan(x)$ , logarithms, exponentials, and more! Quickly, Accurately, Easily! Send today for the **IMPROVED AND EXPANDED EDITION** of the first and best calculator manual—now in use throughout the world . . . only \$2.00. Unconditional money-back guarantee—and **FAST** service! **Mallmann Optics and Electronics**, Dept. 12A, 836 South 113, West Allis, Wisconsin 53214.

## PLANS AND KITS

### FREE KIT CATALOG

Why does every major College, University, Technical School, Research & Development Center buy from us? Because we have the highest quality and lowest prices. Free Catalog. **SWTPC**, Box H32040, San Antonio, Tex. 78284.

**TESLA COIL—40" SPARKS!** Plans! \$7.50. Information 75¢. **Huntington Electronics**, Box 2009-P, Huntington, Conn. 06484.

**MUSIC** synthesizer printed circuit boards and kits. Free information. **Underwater Laboratories**, Box 25066, Northgate Station, Seattle, Washington 98125.

**ACUPUNCTURE** Electronic zone detector. Schematic, \$2.00. **ADZ**, Box 2422, San Rafael, CA 94901.

**NEW!** **CONVERT TV TO 6 FT. WIDE SCREEN!** 

**Easy Do-It-Yourself Kit**

Project a giant 5'x6' picture onto wall or screen. B&W/Color. Kit contains detailed plans, Inst., and Precision Lens System. Only \$12.95 ppd., or write for Free illustrated details.

**The Macrocoma Co., Dept. DCE**  
Washington Crossing, PA 18977

**Guaranteed to Work!**

## REPAIRS AND SERVICES

**CONSTRUCTS** electronic equipment to customer specifications. Write: **EEOC**, P. O. Box 64622, Baton Rouge, La. 70806.

**SPEAKER** Repairs Altec, EV, EMI, etc. **ALTEC** Diaphragm in stock. **AST**, 281 Church St., New York, N.Y. 10013.

## HIGH FIDELITY

**DIAMOND NEEDLES** and Stereo Cartridges at Discount prices for Shure, Pickering, Stanton, Empire, Grado and ADC. Send for free catalog. All merchandise brand new and factory sealed. **LYLE CARTRIDGES**, Dept. P, Box 69, Kensington Station, Brooklyn, New York 11218.

**SAVE 50%**. Build your own speaker systems featuring Norelco, Eminence and CTS. Famous brands from world's largest speaker factories at lowest wholesale prices. Write for 176 page catalog for speakers and electronic accessories. **McGee Radio Company**, 1901 McGee Street, Kansas City, Missouri 64108.



### SANKEN HYBRID AUDIO POWER AMPS

as Low as **\$8.88**

Output to 8 Ohms.  
Order by Stock No.

Used extensively in hi-fi systems, tape decks, FM tuners, record players, stereo components, musical instruments, P.A., etc. All amplifiers, flat within 1 db from 20 to 100,000. Each unit properly heat-sinked, with heavy-duty connecting tie lug connections. Single-ended pushpull output. Power supply required 24VDC.

Mfg's Type	Watts	Sale
SI-1010Y	10	\$ 8.88
SI-1025E	25	18.88
SI-1050E	50	29.95

### LED MITY DIGIT "DCM's"

Only **\$9.99**

Scientific Devices' "Digital Counting Modules" outperform any other DCM on the market today. More features than ever before! Not gaseous, not incandescents, not nixie but the modern LED. Choose from such famous manufacturers as Monsanto's MAN-1, MAN-4, Litronix 707 and 704, Opcoa's SLA-1 (the last 4 having character heights of 0.33 at no extra charge). Each kit includes 1/2" p.c. board with headers for a FREE edge connector, side-mounting dip socket, LED readout of your choice, resistors, IC's, and Mixer connectors (this PLIMMATES SOLDERING YOUR IC's) and 1/2" p.c. board INCLUDING P.C. EDGE CONNECTOR — FREE!

### WEST COAST MAKER OF LED'S

4-MV5054	Jumbo red lens, red lite	TO-18	\$1.00
1-MV5222	Jumbo green lens, green lite	TO-18	1.00
1-MV5322	Jumbo yellow lens, yellow lite	TO-18	1.98
4-MV5080	Micro red dome	red lite, TO-18	1.00

### LITRONIX-OPCOA-MAN "7-SEGMENT" LED Readouts

All fit 14-pin IC sockets. All 7-segments. Man Series "all LED" and made by well-known West Coast mfr. Others Reflective Bar type made by OPCOA and LITRONIX. The Reflective Bar type makes low-cost versions of the MAN's except .33 character height! If one LED blows you lose a segment. MAN's you DO NOT! All readouts 0-to-9 numerals, plus letters and decimal.

ALL LED READOUTS	CHARACTER TYPE	Size	Color Display	Decimal	Mils	Driver	Each	Special
MAN-1 equal	.27	Red	Yes	20	SN7447	\$3.95	3 for \$10.	
MAN-1A equal*	.27	Red	Yes	20	SN7447	3.95	3 for \$10.	
MAN-3 equal	.115	Red	Yes	10	SN7448	1.69	3 for 4.50	
MAN-3A equal*	.115	Red	Yes	10	SN7448	1.69	3 for 4.50	
MAN-3M equal*	.127	Red	Yes	10	SN7448	1.69	3 for 4.50	
MAN-3 equal	.115	Red	***	10	SN7448	1.50	3 for \$4.	
MAN-3M equal*	.127	Red	Yes***	10	SN7448	1.50	3 for \$4.	
MAN-4 equal*	.190	Red	Yes	15	SN7448	2.50	3 for \$6.	
MAN-4 equal*	.190	Red	Yes***	15	SN7448	2.25	3 for \$5.	

### "REFLECTIVE LITE BAR" (Segment LED Readouts)

707** (MAN-1)	.33	Red	Yes	20	SN7447	2.75	3 for \$6.
704** (MAN-4)	.33	Red	Yes	20	SN7448	2.75	3 for \$6.
SLA-1** (MAN-1)	.33	Red	Yes	20	SN7447	2.75	3 for \$6.
SLA-1** (MAN-1)	.33	Red	No	20	SN7447	2.25	3 for \$5.
SLA-2 + - 1	.33	Red	No	15	SN7447	2.75	3 for \$6.
SLA-3H Giant	.70	Red	Yes	20	SN7447	6.50	3 for \$18.
SLA-11C** (MAN-5.33)	Green	Yes	40	SN7447	4.95	3 for \$13.	
SLA-12** ± 1	.33	Green	No	40	SN7447	3.50	3 for \$ 9.

\* Red epoxy case, others clear. \*\* Litronix and Opcoa's pin-for-pin equal and electrical specs as MAN-1 or MAN-4. \*\*\* LED "dot" missing.

### Largest Selection TTL IC's

Lowest Prices

Type	Sale	Type	Sale	Type	Sale	Type	Sale
SN7400 \$0.30	SN7437 .50	SN7472 .50	SN74112 .95	SN74163 1.75			
SN7401 .30	SN7438 .50	SN7473 .55	SN74113 .95	SN74164 2.75			
SN7402 .30	SN7440 .30	SN7474 .49	SN74114 .95	SN74165 2.75			
SN7403 .30	SN7441 1.19	SN7475 1.00	SN74121 .60	SN74166 1.85			
SN7404 .35	SN7442 1.10	SN7476 .65	SN74122 .95	SN74173 3.20			
SN7405 .35	SN7443 1.19	SN7478 .95	SN74123 1.09	SN74174 3.20			
SN7406 .45	SN7444 .85	SN7479 1.25	SN74125 .71	SN74175 3.20			
SN7407 .55	SN7445 1.19	SN7481 1.25	SN74126 .71	SN74176 1.85			
SN7408 .35	SN7446 1.40	SN7482 .99	SN74139 1.25	SN74177 2.10			
SN7410 .30	SN7447 1.40	SN7483 1.25	SN74140 1.25	SN74178 1.85			
SN7411 .35	SN7448 1.45	SN7485 1.19	SN74145 1.55	SN74180 1.10			
SN7413 .85	SN7450 .30	SN7486 .50	SN74148 4.50	SN74181 4.25			
SN7415 .55	SN7451 .30	SN7489 3.25	SN74150 1.19	SN74182 1.05			
SN7416 .49	SN7452 .30	SN7490 1.25	SN74151 1.02	SN74183 2.50			
SN7417 .49	SN7453 .30	SN7491 1.35	SN74152 4.95	SN74192 1.62			
SN7420 .30	SN7454 .30	SN7492 1.02	SN74153 1.39	SN74193 1.85			
SN7421 .55	SN7455 .30	SN7493 1.02	SN74154 1.65	SN74194 1.85			
SN7422 .32	SN7456 .30	SN7494 1.05	SN74155 1.29	SN74195 1.10			
SN7425 .50	SN7457 .50	SN7495 1.02	SN74156 1.45	SN74196 1.95			
SN7426 .36	SN7460 .30	SN7496 1.05	SN74157 1.45	SN74197 1.95			
SN7430 .30	SN7465 .50	SN74105 .95	SN74158 1.55	SN74198 2.65			
SN7432 .35	SN7470 .50	SN74107 .70	SN74159 1.85				
	SN7471 .55	SN74108 .95	SN74161 1.55				

\* Factory Marked \* Money Back Guarantee

### GENERAL ELECTRIC 3-WATT AUDIO AMP \$2.50

Delivers 3 watts continuous, 10 watts peak, with best sinks; micro-mini size; 3 x 2 1/2" x 9 to 30V supply. High sensitivity, 8 to 16 ohms. For mono and stereo phonos, tape, FM, AM, TV, servo.

Buy 100 — Take 20%

### LINEAR Op Amps

Buy Any 3 — Take 10%

531	Hi slew rate op-amp (TO-5)	\$2.50
532	Micro power 741 (TO-5)	2.50
533	Micro power 709 (TO-5)	2.50
534	FET input op amp (TO-5)	2.95
556	5 Times faster than 741C	2.10
558	Dual 741 (TO-5)	1.00
560	Phase lock loops (DIP)	2.95
562	Phase lock loops (DIP)	2.95
565	Phase lock loops (DIP)	2.95
566	Function generator (TO-5)	2.95
567	Tone decoder (A)	2.95
703C	RF-IF, DC amp (TO-5)	2.95
704	TV sound IF system	.69
709C	90° phase shift amp (A)	1.50
709CV	Op amp (mini DIP)	.47
710C	Differential amp (A)	.47
711C	Dual diff. comp (A)	.47
723C	Voltage regulator (A)	.47
733	Diff. Video Amp	.75
741C	Frequency compensator 709 (A)	1.75
741CV	Freq. comp 709 (Mini DIP)	.49
748C	Freq. adj. 741C (A)	.95
753	Gain Block	.49
709-709	Dual 709C (DIP)	1.75
739-739	Dual stereo preamp	1.00
PA265	Dual 741C (A)	1.98
ULN2300M	5-watt voltage regulator	1.95
CA3065	Video Audio system	1.50
75451	Dual peripheral driver	1.05
75491	Quad seg driver for LED readouts	.88
75492	Hex driver w/col. out 250 ma. for LED readouts	1.65

(A) TO-5 or DIP dual in line pak

### NATIONAL EQUALS ON "DIGITAL CLOCK on a CHIP"

5311	28-pin, ceramic, any readout, 6-digits: A-B-D	\$8.88
5312	24-pin, ceramic, any readout, 4-digits: C-D	\$8.88
5313	28-pin, ceramic, any readout, 6-digits: A-C	\$8.88
5314	24-pin, plastic, LED and incandescent readouts, 6-digits: A-B	\$8.88
5316	40-pin, normal alarm, snooze alarm, sleep timer, 4-digits:	\$14.95

Code: A—Hold Count, C—1 PPS Output, B—Output Strobe, D—BCD

### 12-DIGIT "CALCULATOR CHIP"

CT5001 Chip 3 for \$18. **\$6.95**

Similar to Mostek 5001. Outperforms Texas N-digit, MN1802. A 10-pin DIP. Adds, multiplies, subtracts, and divides. Use with 7-segment readouts, Nixies, and LEDs. We include schematics, instructions to build calculator.

CT5002-9 Volt version of above — \$ 8.88  
CT5005-Same as above with MEMORY \$10.50

### 8-TRACK CAR RADIO STEREO TAPE TRANSPORT

8-Track tape transport with complete stereo playback system, less audio amplifier. Operates off 12 VDC Wov & flutter proof. Use 739 preamp & ready to go. Uses 8-track tape. **3 for \$24 8.88**

### INTEGRATED CIRCUIT SOCKETS

14-Pin, DIP	\$ .45
14-Pin, Wire Wrap	.59
14-Pin, Side Mount	1.00
16-Pin, DIP	.50
TO-5, 8 or 10-Pins	.29

Buy Any 3 Take 10% Discount!

Hi-Fi 1" SQUARE MINI METERS **\$1.49**  
3 for \$3.75

\* Plastic case \* Red needle indicators.  
\* Balancing, stereo, tape, amps.  
\* VI, side int., plus 3 minus 20 db.  
\* VI, front mt., plus 3 minus 20 db.

### POLY PAKS

Terms: add postage. Rated: net 30  
Phone Orders: Wakefield, Mass. (617) 245-3829  
Retail: 16-18 Del Carmine St., Wakefield, Mass. (off Water Street) C.O.D.'S MAY BE PHONED

P.O. BOX 942 E  
Lynnfield, Mass. 01940

## WANTED

**QUICKSILVER**, Platinum, Silver, Gold, Ores Analyzed. Free Circular. Mercury Terminal, Norwood, Mass. 02062.

## ELECTRICAL SUPPLIES AND EQUIPMENT

**PLATING** Equipment. Portable Platers. Supplies and "Know-How." Build your own tanks for nickel, chrome, etc. Easy-to-install PVC liners. Rectifier components—all sizes. Schematics, parts lists, formulas, operating instructions for all plating. Guaranteed to save you 25%-75%. Some good units for sale. Write for details. Platers Service Company, 1511-PE Esperanza, Los Angeles. Calif. 90023.

## TUBES

**RADIO & T.V. Tubes**—36¢ each. Send for free Catalog. Cornell, 4213 University, San Diego, Calif. 92105.

**RECEIVING & INDUSTRIAL TUBES, TRANSISTORS.** All Brands—Biggest Discounts. Technicians. Hobbyists. Experimenters—Request **FREE** Giant Catalog and **SAVE!** ZALYTRON, 469 Jericho Turnpike, Mineola, N.Y. 11501.

**TUBES "Oldies"**, latest. Lists free. Steinmetz, 7519 Maplewood, Hammond, Indiana 46324.

**SAVE** money on parts and transmitting-receiving tubes, foreign-domestic. Send 25¢ for giant catalog. Refunded first order. United Radio Company, 56-P Perry Street, Newark, N.J. 07105.

**TUBES** receiving. factory boxed. low prices. free price list. Translateronic, Inc., 1306 40th Street, Brooklyn, N.Y. 11218A, Telephone: 212-633-2800.

## TAPE AND RECORDERS

**RENT** 4-Track open reel tapes—all major labels—3,000 different—free brochure. Stereo-Parti, 55 St. James Drive, Santa Rosa, Ca. 95401.

### USED SCOTCH MAGNETIC TAPE

1800 FOOT, 7 INCH REEL, 1 MIL POLYESTER, 150, BULK ERASED (NO BOX), 99¢, PLUS 10% FOR SHIPPING & HANDLING (MINIMUM ORDER 10 REELS). "LIKE NEW" EMPTY 10½ INCH REELS; FIBERGLASS, 3/8" CENTER HOLE SOC. ALUMINUM, NAB 3" CENTER HOLE, \$1.00—BOTH CHEAPER IN LARGER QUANTITIES—ALL PLUS POSTAGE BY WEIGHT & ZONE. (INCREDIBLE BARGAINS ON NEW, FAMOUS BRAND TAPES & CASSETTES)



### SAXITONE TAPE SALES

1776 Columbia Rd., N.W. Washington, D.C. 20009

**1930-1962** Radio Programs. Reels, \$1.00 hour! Cassettes, \$2.00 hour! Send \$1.00 for mammoth catalog. AM Treasures, Box 192F, Babylon N.Y. 11702.

**SCOTCH TAPES.** Discounts! Catalog 10¢. Tower, Box 33098, District Heights, Md. 20028.

**16,000 OLD RADIO SHOWS** on Tape. Latest supplement 50¢, catalog \$2.00. Hart Enterprises, 1329 George Washington, Richland, WA 99352.

## PERSONALS

**MAKE FRIENDS WORLDWIDE** through international correspondence. Illustrated brochure free. Hermes, Berlin 11, Germany.

**BUGGED???** . . . Detectors locate hidden transmitters. Literature 25¢. Security, Box 671, Westwood, N. J. 07675.

## MOVIE FILMS

**8MM-SUPER 8-16MM MOVIES!** Biggest Selection! Lowest Prices! Free Catalog! Cinema Eight, Box PE, Chester, Connecticut 06412.

## INSTRUCTION

**LEARN ELECTRONIC ORGAN SERVICING** at home all makes including transistor. Experimental kit—trouble-shooting. Accredited NHSC, Free Booklet. **NILES BRYANT SCHOOL**, 3631 Stockton, Dept. A, Sacramento, Calif. 95820.

**LEARN WHILE ASLEEP**, Hypnotize! Strange catalog free. Auto-suggestion, Box 24-2D, Olympia, Washington 98501.

**DEGREE IN ELECTRONICS** through correspondence. Free catalog. Grantham, 2000 Stoner Avenue, Los Angeles, California 90025.

**INTENSIVE** 5 week course for Broadcast Engineers. F.C.C. First Class license. Radio Engineering Incorporated, 52 S. Palm Ave., Sarasota, Florida 33577.

**SHORTCUTS** To Success! Highly Effective, Profitable Short Courses. (75 Choices). Study At Home. Diploma Awarded. Our 27th Year. Free Literature. CIEE-D, Box 10634, Jackson, Miss. 39209.

### F.C.C. EXAM MANUAL

PASS FCC EXAMS! Memorize, study "Tests-Answers" for FCC 1st and 2nd class Radio-telephone licenses. Newly revised multiple-choice questions and diagrams cover all areas tested in FCC exams.—plus—"Self-Study Ability Test." \$9.95 postpaid. Moneyback Guarantee.

TESTS-ANSWERS FOR FCC First and Second Class Commercial Licenses

COMMAND PRODUCTIONS P.O. BOX 26348-P  
RADIO ENGINEERING DIVISION SAN FRANCISCO, CALIF. 94126

**DEGREE** Program in Electronics Engineering. Our 27th Year! Free Literature. Cook's Institute, Dept. 13, Box 10634, Jackson, Miss. 39209.

**KNOW** your electronics I.Q.# Self scoring exam. Rush \$3.00 guaranteed! Omicron, Dept. 1012, Box 10219, Albuquerque, New Mexico 87114.

DIGITAL:THEORY,DESIGN,  
CONSTRUCTION

## LOGIC NEWSLETTER

SAMPLE COPY \$1.00  
LOGIC NEWSLETTER  
POB 252  
WALDWICK,N.J. 07463

**SCORE** high on F.C.C. Exams . . . Over 300 questions and answers. Covers 3rd, 2nd, 1st and even Radar. Third and Second Test, \$14.50; First Class Test, \$15.00. All tests, \$26.50. R.E.I., Inc, Box 806, Sarasota, Fla. 33577.

**LICENSE-AID** formula chart. Formulas you should be able to work with before sitting for Second and First class FCC license exams. \$7.00 each. License-Aid, Box 1497, Moultrie, Georgia 31768.

**"DATA CONVERSION EXPERIMENTS"** Illustrated Electronics Lab Manual, \$3.00, postpaid. Experimenter Publications Catalog, 25¢. MP Publishing Co., Box 378, Belmont, Massachusetts 02178.

**COLLECT** Coins for Profit. Booklet tells How to Start, Where to Sell. Lists of valuable coins. Check your change! Send \$1.50. Aide to Shoppers, 2959 Singalong Way, Sunol, CA 94586.

**DRAFTING**—Blueprint Reading (Mechanical, Electronic, Architectural). Home Courses \$25.00. Send \$2.00 first lesson. Prior, Inc., 23-09 159th Street, Whitestone, New York 11357.

**FCC First Phone!** Pass! 3 Tests Guaranteed, \$5.00. Engineer, Drawer 570, Mars, PA 16046.

LIGHT EMITTING DIODES	
MRD 14B Photo Darlington	\$.75
MT2 Photo Transistor	\$.80
MCT-2 Opto. Isolator	\$.90
OSL-3 GaP WLS. LED	\$.59
MCD-2 Opto. Isolator	\$.90
MCA-2-30 Photo Relay	\$.90
ME4 IR LED's	\$.59
GREEN GaP OSL-16 LED	\$.59

7400	.28	7480	.70
7401	.28	7483	1.25
7402	.28	7486	.50
7403	.28	7489	1.50
7404	.33	7491	1.25
7405	.30	7492	1.30
7406	.50	7493	1.30
7407	.50	7494	1.30
7408	.32	7495	1.30
7410	.28	7496	1.30
7411	.32	74107	.75
7412	.40	74121	.70
7413	.85	74123	1.10
7416	.50	74125	1.50
7417	.50	74126	1.50
7420	.28	74145	1.00
7422	.32	74151	1.25
7426	.35	74154	1.95
7427	.57	74157	1.50
7430	.28	74164	2.20
7437	.60	74165	2.20
7438	.55	74176	1.95
7440	.28	74177	1.95
7441	1.50	74192	1.75
7442	.60	74193	1.75
7446	.50	74195	1.75
7447	1.50	75451	1.00
7450	1.50	75452	1.00
7451	.60	75491	1.10
7452	.30	8211	1.50
7453	.60	8220	1.50
7474	.50	8836	.95
7475	1.00	(SP380)	.95
7476	.75	LM351	1.00

**VERIPAX PC BOARD**  
This board is a 1/16" single sided paper epoxy board 4 1/2" x 6 1/2" (standard veripax) drilled and etched, which will hold 21 single 14 pin IC's, or 8,16 or LSI DIP IC's w/ push-on or power supply connections. It is also etched for a 22 pin connector. \$5.25 3/\$14.50

TRANSISTOR SPECIALS										
2N2222	NPN	Si	To-92	30V	.8A	5W	250MHZ	80HFE	5	\$1.00
2N3137	NPN	Si	To-5	.6	20	.5	70	500	4	\$1.00
2N1605	NPN	GE	To-5	15W	24V	JA	14	125	5	\$1.00
MPS3393	NPN	Si	To-106	25	1	3.2		200	4	\$1.00
2N2218A	NPN	Si	To-5	60	8	.8	250	70	4	\$1.00
2N3767	NPN	Si	To-66	80	4	20	10	80		.70
2N3772	NPN	Si	To-3	150W	60V	30A	2	30		\$1.25
2N3866	NPN	Si	To-5	5	30					RF Power \$ .75
2N6109	PNP	Si	To-220	36W	40V	4A	8	60		50c
2N5296	NPN	Si	To-220	36W	40V	4A	8	60		55c
2N4898	PNP	Si	To-66	25W	40V	4A	40	46		\$.60
MJ2251	NPN	Si	To-66	10W	225V	5A	10	40		\$.70
2N3055	NPN	Si	To-3	115W	100V	15A	2	44		\$1.00

SLA-3 7 Segment LED Readout 77" Num- bers 45 ma 1 Seg. \$7.95  
INJECTION LASER-A SINGLE DIODE 6W, 25A GAAs UNIT SIMILAR TO RCA 40B59 \$10.95

DATA LIT 707 READOUT \$3.25  
MAN-A LED READOUT \$3.50  
MAN-3 LED READOUT \$2.95

CAPACITORS	
6V 30 UF TANT	\$.5/1.00
20V 47 UF TANT	\$.5/1.00
12V 10 UF ELECT.	\$.5/1.00
50V 100 UF ELECT.	.40

1103 1024 Bit RAM \$ 7.25  
NEC6003 2048 Bit RAM 14.50  
1101 256 Bit RAM 3.25  
8225 64 Bit MEMORY 3.50  
8260 1024 Bit RAM \$7.25  
DUAL TAPERED CdS PHOTO CELL USED FOR OPTICAL ALIGNMENT WITH A SINGLE PLANE LENSE (Not Included) \$.95  
SIMILAR TO 8038C IC VOLT-AGE CONTROLLED OSCILLATOR AS FEATURED IN P.E. OCT 73. THEY HAVE SINE, SQUARE AND TRIANGULAR OUTPUT GOOD TO 1 MHz \$9.95

NIXIE TUBE RAYTHEON 8650 WITH SOCKET AND DATA SHEET \$2.25 3/\$6.00

FULL WAVE BRIDGES		
PRV	2A	6A
	200	.95 1.25
	400	1.15 1.50
	600	1.35 1.75

Silicon Power Rectifiers				
PRV	1A	3A	12A	50A
100	.06	.11	.30	.85
20C	.07	.16	.35	1.25
400	.09	.20	.45	1.50
600	.11	.30	.70	2.00
800	.15	.40	.85	2.30
1000	.20	.55	1.10	2.75

TRIACS		SCR's	
PRV	1A, 10A, 25A	1.5A	6A
100	.40	.70	1.30
200	.70	1.10	1.75
400	1.10	1.60	2.60
600	1.70	2.30	3.00

T15-73 N CHANNEL F.E.T. \$ .60  
2N 4891 UJT .50  
ER 900 TRIGGER DIODE 4/1.00

5311-Clock Chip featuring BCD, hold count and Output Strobe \$11.50  
5314-Clock Chip, 6 Digit readout hold count and Output Strobe \$0.50  
ASCII Encoded Terminal Keyboards \$60.00  
14 Pin IC Sockets \$.40  
Printed circuit board 4 1/2" x 6 1/2" double sided fiber glass board 1/16" thick, unetched. \$5 ea. \$2.50  
Miniature Trim Pots 5K, 10K, 20K, 25K, 50K, 100K \$.75 3/\$2.00

LM 309K SV  
1 Amp Regulator \$2.25  
741 OPER. AMP \$ .47  
709 OPER. AMP \$ .47  
723 Regulator \$ .75  
703RF 1/4 Amp \$1.80  
565 Phase Lock Loop \$2.95  
567 Tone Decoder \$2.95  
560 Phase Lock Loop \$2.95  
561 Phase Lock Loop \$2.95  
535 FEI Input Oper Amp \$2.95  
537 Precision 741 \$2.50  
747 Dual 741 \$1.25  
LM308 Oper Amp \$1.95  
101 Oper Amp \$ .75  
741A Oper Amp \$ .47  
320-SV Reg. \$1.75  
320-15V Reg. \$1.75  
748 Oper Amp \$ .90  
LM370 AGC Squelch Op. Amp \$1.25  
LM389 2 Watt Amp \$1.75  
2 Watt Stereo IC 14 Pin Dip \$3.95  
LM319 Dual HiSpeed Comparator \$1.99  
LM382 Stereo Preamp \$1.75  
CONDUCTIVE ELASTOMER LOW PROFILE CALCULATOR KEYBOARD A 2 3/4" x 3 3/4" x 1/2" FLEX KEY 19 SK-6 KEYBOARD HAVING 0-9, \*, /, K.C. BUTTONS WITH OFF, ON SWITCH. \$6.50

Terms: FOB Cambridge, Mass. Order. Include Postage. \$ .20 for our latest catalog featuring Transistors and Rectifiers

# SOLID STATE SALES

Post Office Box 74A Somerville, Mass. 02143 Tel. (617) 547-4005

CIRCLE NO. 28 ON READER SERVICE CARD

## GOVERNMENT SURPLUS

**GOVERNMENT Surplus.** How and Where to Buy in Your Area. Send \$2.00. Surplus Information, Headquarters Bldg., Box 30177-PE, Washington, D.C. 20014.

**ELECTRONIC Equipment and Parts.** Big 36 page Free Catalog. Send for your copy today! Fair Radio Sales, Box 1105-P, Lima, Ohio 45802.

**JEeps, TRUCKS, Cars** From \$31.50 . . . Airplanes, Typewriters, Clothing, Multimeters, Transceivers, Oscilloscopes, Photographic Electronics Equipment . . . 100,000 Surplus Bid Bargains Direct From Government Nationwide Typically Low as 2c on Dollar! Complete Sales Directory and Surplus Catalog \$1.00 (Deductible First \$10 Order From Included Catalog). U.S. Surplus Disposal, 2200 Fuller 601B-PEL, Ann Arbor, Michigan 48105.

**MANUALS** for Govt Surplus radios, test sets, scopes. List 50c (coin). Books, 7218 Roanne Drive, Washington, D.C. 20021.

**COMMUNICATIONS Catalog** 25c. Colonel Russell, 9410 Walhampton, Louisville, Kentucky 40222.

## INVENTIONS WANTED

**CASH-ROYALTIES** for patented, unpatented inventions. Global Marketing Service, 2420-P 77th, Oakland, California 94605.

**FREE "Directory of 500 Corporations Seeking New Products."** For information regarding development, sale, licensing of your patented/unpatented invention. Write: Raymond Lee Organization, 230-GR Park Avenue, New York City 10017.

**INVENTORS:** Protect your ideas! Free "Recommended Procedure". Washington Inventors Service, 422T Washington Building, Washington, D.C. 20005.

**PATENT** Searches including Maximum speed, full airmail report and closest patent copies. Quality searches expertly administered. Complete secrecy guaranteed. Free Invention Protection forms and "Patent Information." Write Dept. 9, Washington Patent Office Search Bureau, Benjamin Franklin Substation, P.O. Box 7167, Washington, D.C. 20044.

**FREE PAMPHLET:** "Tips on Safeguarding Your Invention." Write: United States Inventors Service Company, 708-T Carry Building, Washington, D.C. 20005.

**INVENTORS!** Either we will sell your Invention before you or anyone else does, or we will pay you a cash bonus. Get Free Invention Evaluation and information: Write Gilbert Adams Organization, Invention Brokerage, Dept. 20, 80 Wall St., New York, NY 10005.



**HOW** to prepare your own patent application. Simplified, complete. Details Free. Inventor's Guide, 468-K Goodspeed Road, Virginia Beach, Virginia 23451.

## PLASTICS

**CASTOLITE** pours like water, hardens like glass without heat. Crystal clear, colors. Embed flowers, seashells, moments, anything. Make fine gifts. Form flexible molds over any pattern, size. Reproduce your own designs in plastics, candle wax, metal, plaster, cement. Profitable. Illustrated Manual and Catalog Only 50c. CASTOLITE, Dept. 74B/PE, Woodstock, Ill. 60058.

## RESORTS AND TRAVEL

**BERTH & Partnership** in 155 ft. 3-masted Barquentine for \$10,700. Join in Europe, assist conversion then help sail on 2-year Adventure & Business World Voyage. Write: R. Bruderer, IYC, Box 149 Broadway, NSW Australia 2007.

<p><b>MAN4</b> Seven-segment, C-9 plus letters. Right-hand decimal point. Snaps in 14-pin DIP socket or Mexlec. Ideal for desk or pocket calculators. EACH...\$2.75 TEN OR MORE...\$25.00 EACH</p> 	<p><b>7400 DIP</b> 7400...\$ .25 7491...\$1.00 7401...\$ .25 7492...\$ .90 7402...\$ .35 7493...\$ 1.15 7403...\$ .35 7494...\$ 1.15 7404...\$ .30 7495...\$ 2.00 7405...\$ .35 7496...\$ 1.25 7406...\$ .35 74123...\$ 1.50 7407...\$ .28 74154...\$ 2.30 7408...\$ .70 74161...\$ 2.00 7409...\$ .35 74163...\$ 2.00 7410...\$ .35 74193...\$ 1.50 7408...\$ .35 74195...\$ 1.00 7410...\$ .25 7411...\$ .25 7411...\$ 1.25 NE555...\$1.50 7417...\$ .40 NE561...\$ 3.25 7420...\$ .25 NE565...\$ 3.25 7420...\$ .35 NE566...\$ 4.00 7420...\$ .35 NE567...\$ 4.00 7422...\$ .35 NE556...\$ 1.00 7430...\$ .25 NE558...\$ 1.00 7430...\$ .35 709...\$ .45 7430...\$ .40 710...\$ .75 7440...\$ .25 711...\$ .40 7440...\$ .35 723...\$ 1.00 7442...\$ .25 741...\$ .55 7442...\$ 1.20 747...\$ 1.00 7446...\$ 1.20 748...\$ 1.00 7447...\$ 1.20 CA3018...\$ 1.00 7448...\$ 1.00 CA3026...\$ 1.00 7450...\$ .25 CA3065...\$ 1.00 7450...\$ .35 LM100...\$ 1.00 7451...\$ .25 LM105...\$ 1.25 7451...\$ .30 LM302...\$ 1.25 7451...\$ .30 LM307...\$ .50 7451...\$ .20 LM308...\$ 2.00 7454...\$ .25 LM311...\$ 1.75 7454...\$ .35 LM370...\$ 2.00 7455...\$ .35 LM709...\$ 1.00 7460...\$ .20 LM3098...\$ 1.00 7471...\$ .30 LM309K...\$ 2.00 7472...\$ .40 LM3900...\$ 2.00 7472...\$ .50 LM195 4-quad 7473...\$ .60 mult...\$2.00 7473...\$ .75 7474...\$ .65 7474...\$ .80 CD401...\$ .75 7474...\$ .80 CD402...\$ .75 7475...\$ 1.40 CD4010...\$ 1.00 7475...\$ .60 CD4011...\$ .75 7478...\$ .80 CD4012...\$ .75 7480...\$ .65 CD4023...\$ .75 7483...\$ 1.00 74C00...\$ .75 7489...\$ 4.00 74C20...\$ .75 7490...\$ 1.20 74C160...\$ 3.25</p>												
<p><b>CD-2 Counter Kit</b> Unit includes board, 7490, 7415 quad latch, 7467 seven-segment driver, and RCA DR201D. COMPLETE KIT ONLY \$11.95 FULLY-ASSEMBLED \$13.95. Boards can be supplied separately at \$2.00 per digit.</p> 	<p><b>LINEARS</b> 7413...\$ 1.25 NE555...\$1.50 7417...\$ .40 NE561...\$ 3.25 7420...\$ .25 NE565...\$ 3.25 7420...\$ .35 NE566...\$ 4.00 7420...\$ .35 NE567...\$ 4.00 7422...\$ .35 NE556...\$ 1.00 7430...\$ .25 NE558...\$ 1.00 7430...\$ .35 709...\$ .45 7430...\$ .40 710...\$ .75 7440...\$ .25 711...\$ .40 7440...\$ .35 723...\$ 1.00 7442...\$ .25 741...\$ .55 7442...\$ 1.20 747...\$ 1.00 7446...\$ 1.20 748...\$ 1.00 7447...\$ 1.20 CA3018...\$ 1.00 7448...\$ 1.00 CA3026...\$ 1.00 7450...\$ .25 CA3065...\$ 1.00 7450...\$ .35 LM100...\$ 1.00 7451...\$ .25 LM105...\$ 1.25 7451...\$ .30 LM302...\$ 1.25 7451...\$ .30 LM307...\$ .50 7451...\$ .20 LM308...\$ 2.00 7454...\$ .25 LM311...\$ 1.75 7454...\$ .35 LM370...\$ 2.00 7455...\$ .35 LM709...\$ 1.00 7460...\$ .20 LM3098...\$ 1.00 7471...\$ .30 LM309K...\$ 2.00 7472...\$ .40 LM3900...\$ 2.00 7472...\$ .50 LM195 4-quad 7473...\$ .60 mult...\$2.00 7473...\$ .75 7474...\$ .65 7474...\$ .80 CD401...\$ .75 7474...\$ .80 CD402...\$ .75 7475...\$ 1.40 CD4010...\$ 1.00 7475...\$ .60 CD4011...\$ .75 7478...\$ .80 CD4012...\$ .75 7480...\$ .65 CD4023...\$ .75 7483...\$ 1.00 74C00...\$ .75 7489...\$ 4.00 74C20...\$ .75 7490...\$ 1.20 74C160...\$ 3.25</p>												
<p><b>CT5005 Calculator</b> A single MOS chip with all the logic necessary for a 12-digit, four-function calculator with an extra storage register for constant or memory application. #28 Lead DIL package #Automatic keyboard decapabilities (#, -, *, +) #True credit balance #Chain calculations #display #Single voltage supply is possible</p> <p>COMPLETE WITH DATA.....\$14.95 DATA ONLY (refundable with purchase of chip).....\$ 1.00</p>													
<p><b>5001 Calculator</b> Forty-pin calculator chip—will add, subtract, multiply, and divide. Complete data supplied with chip. CHIP AND DATA ONLY.....\$9.95 DATA ONLY (refundable).....\$ 1.00</p>													
<p><b>5002 Low power battery version.....\$12.95</b></p> <p><b>8038</b> Sine square triangle function generator. \$5.95</p>													
<p><b>3-Amp Power Silicon Rectifiers</b> Marked Epoxy Axial Package</p> <table border="1"> <tr> <td>PKW</td> <td>PRICE</td> <td>PKW</td> <td>PRICE</td> </tr> <tr> <td>100.....\$ .10</td> <td>800.....\$ .30</td> <td>200.....\$ .15</td> <td>1000.....\$ .40</td> </tr> <tr> <td>400.....\$ .18</td> <td>1200.....\$ .50</td> <td>600.....\$ .23</td> <td>1500.....\$ .65</td> </tr> </table> <p>All ICs are new and fully-tested; leads are plated with gold or solder. Orders for 55 or more will be shipped prepaid. Add 35c for smaller orders. Calif. residents add sales tax. 10 orders are shipped within 24 hrs. CDD orders may be phoned in—\$10 minimum. Money back guarantee. P. O. Box 3 BABYLON Ceramtech, CA 95608 ELECTRONICS (916) 334-2161</p>	PKW	PRICE	PKW	PRICE	100.....\$ .10	800.....\$ .30	200.....\$ .15	1000.....\$ .40	400.....\$ .18	1200.....\$ .50	600.....\$ .23	1500.....\$ .65	
PKW	PRICE	PKW	PRICE										
100.....\$ .10	800.....\$ .30	200.....\$ .15	1000.....\$ .40										
400.....\$ .18	1200.....\$ .50	600.....\$ .23	1500.....\$ .65										

CIRCLE NO. 2 ON READER SERVICE CARD

## BOOKS

FREE catalog aviation/electronic/space books. Aero Publishers, 329PE Aviation Road, Fallbrook, California 92028.

FREE book prophet Elijah coming before Christ. Wonderful bible evidence. Megiddo Mission, Dept. 64, 481 Thurston Rd., Rochester, N.Y. 14619.

UNUSUAL BOOKS! 40 for \$3.00! Catalog Free! International, Box 7798PE, Atlanta, Georgia 30309.

## RUBBER STAMPS

RUBBER address stamps. Free catalog. 45 type styles. Jackson's, Box 443G, Franklin Park, Ill. 60131.

## HYPNOTISM

SLEEP learning. Hypnotic method. 92% effective. Details free. ASR Foundation, Box 7566EG, Fort Lauderdale, Florida 33304.

FREE Hypnotism. Self-Hypnosis. Sleep Learning Catalog! Drawer H400, Ruidoso, New Mexico 88345.

AMAZING self-hypnosis record releases fantastic mental power. Instant results! Free trial. Write: Forum (AA2), 333 North Michigan, Chicago 60601.

## PRINTING

FREE literature, business cards, letterheads, labels, rubber stamps. Geer's, 111 North Drive, Ottawa, Ohio 45875.

## SPORTS ACTION FILMS

ORDER A COMPLETE SET of NFL SUPER BOWL Color Films, Standard 8 or Super 8. Start with 1967 & 1968 (Lombardi); then the glory years from 1969 thru 1973—each a separate 200' reel; \$15.95 each PPD, or \$7.95 each B&W. **BASEBALL SPECIAL:** includes '72 World Series and '72 All Star Game (just released) at \$14.95 each PPD Color; \$7.95 each B&W, Standard 8 or Super 8. Filmm Collectors' 24-page catalog, 25c. SPORTLITE FILMS, Elect. Dept., Box 500, Speedway, Indiana 46224.

## BUSINESS OPPORTUNITIES

I MADE \$40,000.00 Year by Mailorder! Helped others make money! Start with \$15.00—free Proof. Torrey, Box 318-N, Ypsilanti, Michigan 48197.

FREE CATALOGS. Repair air conditioning, refrigeration. Tools, supplies, full instructions. Doolin, 2016 Canton, Dallas, Texas 75201.

MAILORDER MILLIONAIRE helps beginners make \$500 weekly. Free report reveals secret plan! Executive (1K2), 333 North Michigan, Chicago 60601.

PIANO TUNING LEARNED QUICKLY AT HOME! Tremendous field! Musical knowledge unnecessary. GI approved. Information free. Empire School, Box 327, Miami 33145.

\$2000.00 MONTHLY selling information by mail. Ropchan, Box 161X, Saginaw, Oregon 97472.

FREE Secret Book "2042 Unique Proven Enterprises." Fabulous "Little Knowns." Work home! Haylins-BH, Carlsbad, California 92008.

**HIGHLY PROFITABLE**

## ONE-MAN ELECTRONIC FACTORY

Investment unnecessary, knowledge not required, sales handled by professionals. Postcard brings facts about this unusual opportunity. Write today!  
Barta-DB, Box 248, Walnut Creek, CA 94597.

START SMALL, highly profitable electronic production in your basement. Investment, knowledge unnecessary. Postcard brings facts. Barta-CB, Box 248, Walnut Creek, California 94597.

YOUR OWN ELECTRONICS BUSINESS. \$29,120/year. Detailed Program, \$2.00. Limited Time! Page-P1, Box 5146, Clearwater, Fla. 33518.

DO SIMPLE ADDRESSING—Mailing. Receive \$12.95 orders. Keep \$8.00 profit. Details Free. Quality, Box 9-Z, East Rockaway, N.Y. 11518.

IMPORT—MAILORDER opportunity free at our risk and expense for one full year. Earn \$15.00 or pay nothing. Details: Northeast Imports, World Trade Division, Box 111PE(2), Fremont, N.H. 03044.

## TREASURE FINDERS

FREE—Valuable Treasure Finder catalog sent by return mail. Find Coins, Rings, Gold, Silver, Metals, Relics. Write today. JETCO, Dept. CPE, Box 26669, El Paso, Texas 79926.

FREE FACT-FILLED CATALOG. World's largest line of metal detectors. Models as low as \$49.50 and up. Two year Guarantee. Three factory locations, U.S. and Canada, plus over 1,000 dealers and 35 Service Centers from coast to coast. No finer instruments made at any price. Budget terms. Write: White's Electronics, Inc., Rm# 391, 1011 Pleasant Valley Road, Sweet Home, Oregon 97386.

# Popular Electronics

FEBRUARY 1974

## ADVERTISERS INDEX

READER SERVICE No.	ADVERTISER	PAGE NO.	READER SERVICE No.	ADVERTISER	PAGE NO.
	Allied Electronics	110	33	Johnson Co., E.F.	15
1	Altaj	123	19	Lafayette Radio Electronics	103
2	Babylon Electronics	128	20	LaSalle Extension University	22, 23, 24, 25
	Bell & Howell Schools	112, 113, 114, 115	21	Linear Systems, Inc.	118
3	Bose	11	22	McIntosh Laboratory, Inc.	116
	Burstein-Applebee	119	15	MITS	19
	C'REI Capitol Radio Engineering Institute	58, 59, 60, 61	23	Midwest Hifi Wholesalers & Mail Order Division	111
4	Center for Technical Development Inc., The	105		National Radio Institute	SECOND COVER, 1, 2, 3
6	Cleveland Institute of Electronics	76, 77, 78, 79		National Technical Schools	94, 95, 96, 97
7	Cobra, Product of Dynascan Corporation	17	24	Olson Electronics	121
8	Delta Electronics Co	122	32	Pace Communications	68
9	Delta Products, Inc.	13	25	Pickering & Co., Inc.	28
10	EICO	110, 111, 117	26	Poly Paks	125
12	E & L Instruments Co	119	27	Radio Shack and Allied Radio Stores	27
13	Edmund Scientific Co	130	28	Solid State Sales	127
	Electronic Measurements	120	29	Southwest Technical Products Corporation	8
14	Electronics and Control Engineers' Book Club	7	30	Sylvania Technical School	131, 132
17	Grantham School of Engineering	9	16	Technics by Panasonic	FOURTH COVER
5	Health Company	40, 41, 42, 43	31	Tri-Star Corp	117
18	Illinois Audio	121		U.S. Navy	20, 21
CLASSIFIED ADVERTISING					122, 123, 124, 126, 127, 128, 129

**FAMILY FUN! OUTDOOR ADVENTURE!** Find valuable coins and treasure with world famous metal detectors. Free illustrated booklet. Detectron, Dept. PE, Box 243, San Gabriel, Calif. 91778.

**TREASURE FINDER** locates buried gold, silver, coins, treasures. 5 powerful models. \$19.95 up. Instant financing available. Free catalog. Relco, Dept. A-33, Box 10839, Houston, Texas 77018.

### MUSICAL INSTRUMENTS

**30% DISCOUNT** name brand musical instruments. Free Catalog. Freeport Music, 455N, Route 110, Melville, N.Y. 11746.

**WHOLESALE!** Professional Guitars, PA Systems, Altec Speakers, 240W RMS Amplifiers. Free Catalog, Carvin, Escondido, Calif. 92028.

**30% + DISCOUNT.** Name Brand Musical Instruments. Free Catalog. Continental Music, Dept. H, P.O. Box 3001, Garden City, New York 11530.

### STAMPS

**WDW! 110 All Different Germany 10¢.** Commemoratives, Airmails, High Values, Big Catalog, bargain lists. Also, fine stamps from our approval service, which you may return without purchases and cancel service at any time. Jamestown Stamp, Dept. A24EG, Jamestown, N.Y. 14701.

**FREE! Big Bargain Catalog—New Edition** listing thousands of bargains including U.S. & B.N.A. stamps, packets, albums, accessories and supplies. Also, fine stamps from our approval service which you may return without purchases and cancel service at any time. Jamestown Stamp, Dept. E24EG, Jamestown, N.Y. 14701.

### REAL ESTATE

**FREE . . . 264-PAGE . . . SPRING CATALOG!** Describes and pictures hundreds of farms, ranches, town and country homes, businesses coast to coast! Specify type property and location preferred. UNITED FARM AGENCY, 612-EP, West 47th St., Kansas City, Mo. 64112.

### EMPLOYMENT INFORMATION

**EXCITING** Overseas jobs. Directory \$1.00. Research Associates, Box 1167-E, Kailua, Hawaii 96734.

### EMPLOYMENT OPPORTUNITIES

**ELECTRONICS/AVIONICS EMPLOYMENT OPPORTUNITIES.** Report on jobs now open. Details FREE. Aviation Employment Information Service, Box 240E, Northport, New York 11768.

### MISCELLANEOUS

**WINEMAKERS:** Free illustrated catalog yeasts, equipment. Semplex, Box 12276P, Minneapolis, Minn. 55412.

**WIN AT DICE.** Free details on scientific method I use while winning 87% of the time. Write Sanders, Dept. B-17, Box 92102, Houston, Texas 77018.

### RETAIL DISPLAY PLAN

All magazine retailers in the United States and Canada interested in earning an allowance for the display and sale of a minimum of five publications of the Ziff-Davis Publishing Company, to be paid quarterly on the basis of ten per cent of the cover price of each sold copy, assuming that all terms and conditions of the contract are satisfied, are entitled to do so and are invited to write for full details and copies of the contract to Mr. J. Robert Gallicano, Single Copy Sales Director, Ziff-Davis Publishing Company, One Park Avenue, New York, New York 10016.

# LIVE IN THE WORLD OF TOMORROW... TODAY!

## A BETTER LIFE STARTS HERE



### SUPER GLUE! DROP HOLDS TON

Clear PermaBond obsoletes other adhesives! No mixing; sets in seconds—no solvents, catalysts, heat. Tensile strength to 5000 lb. in. Joints, welds, seals, mounts; bonds rubber, plastic, wood, etc. Use for assembly, repair. O.E.M. wks. Mend china; bond silicone chips to ceramics; metal to glass; fix parts to rivet. Impervious to most chemicals (fingers cracks others can't); non-water soluble; non-toxic.

No. 41,509AV ..... 1-OZ. BOTTLE ..... \$8.75 Ppd.  
No. P-4 107AV (5-AK 2 Gm. TUBES) \$7.95 Ppd.

### "FISH" WITH A GIANT MAGNET

Fascinating fun, and sometimes very profitable! Tie a line to our 3½-pound Magnet—drop it overboard in bay, river, lake or ocean. Tro. l it along the bottom. Your "treasured" haul can be outboard motors, anchors, other metal valuables. Five-pound Magnet is war surplus—Alnico V Type that cost the Government twice our price. It lifts over 40 pounds on land—much greater weights under water!



Stock No. 70,570AV 3½ lbs. \$11.50 Ppd.  
Stock No. 60,215AV 1½ lbs. \$ 6.50 Ppd.



### 130 EXPERIMENTS IN OPTICS

and photography! Optix® Experiments Kit is a complete optical & photography tab for 130 exciting experiments. Lets you recreate the periscope, telescope, microscope, kaleidoscope! Build a 35-mm reflex camera with interchangeable lens system! Make, develop photographic film! Enjoy the fun and fascination of having your own optics lab. Fully illustr 112-pg manual, 3½x11", clearly explains usage of this stimulating kit's 114 precision engineered components.

Stock No. 71,646AV

.....\$22.50 Ppd.

(And our FREE CATALOG is packed with exciting and unusual ecological & physical science items—plus 4,500 finds for fun, study or profit . . . for every member of the family.)

### KNOW YOUR ALPHA FROM THETA!

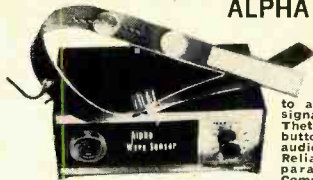

For greater relaxation, concentration, listen to your Alpha-Theta brainwaves. Ultra-sensitive electrode headband slips on/off in seconds—eliminates need for messy creams, etc. Attached to amplifier, filters brainwaves, signals beep for ea. Alpha or Theta wave passed. Monitoring button simulates Alpha sound; audio & visual (L.E.D.) feedback. Reliable, easy-to-use unit—comparable to costlier models. Completely safe. Comprehensive instruction booklet.

No. 1635AV ..... (8x3x4", 24 oz.) ..... \$124.50 Ppd.  
No. 71,809AV ..... (LOW COST "STARTER" UNIT) ..... \$49.95 Ppd.

### 3-CHANNEL COLOR ORGAN KIT

Easy to build low-cost kit needs no technical knowledge. Completed unit has 3 bands of audio frequencies to modulate 3 independent strings of colored lamps (i.e. "lows"—reds, "middles"—greens, "highs"—blues. Just connect hi-fi, radio, power lamp etc. & plug ea. lamp string into own channel (max. 300w ea.). Kit features 3 neon indicators, color intensity controls, controlled individ SCR circuits; isolation transformer; custom plastic housing; instr.



Stock No. 41,831AV ..... \$17.50 Ppd.

### NEW! KIRLIAN PHOTOGRAPHY KIT!



Experiment in the fascinating new field of "Kirlian" electrophotography—images obtained on film without camera or lens by direct recording of electric charge transmitted by animate & inanimate objects. Each "aura" differs from another—animate aura said to change corresponding to physical changes. \$50 kit gives everything needed except film including portable darkroom, double transformer isolated from power source; complete instructions.

Stock No. 71,938AV ..... \$49.95 Ppd.

### MAIL COUPON FOR GIANT FREE CATALOG!

180 PAGES • MORE THAN  
4,500 UNUSUAL BARGAINS!

Completely new '74 Catalog. Packed with huge selection of telescopes, microscopes, binoculars, magnets, magnifiers, prisms, photo components, ecology and Unique Lighting items, parts, kits, accessories—many hard-to-get surplus bargains. 100's of charts, illustration. For hobbyists, experimenters, schools, industry.

EDMUND SCIENTIFIC CO.  
300 Edscorp Building, Barrington, N. J. 08007  
Please rush Free Giant Catalog "AV"

Name \_\_\_\_\_  
Address \_\_\_\_\_  
City \_\_\_\_\_ State \_\_\_\_\_ Zip \_\_\_\_\_

### COMPLETE & MAIL WITH CHECK OR M.O.

EDMUND SCIENTIFIC CO.  
300 Edscorp Building, Barrington, N.J. 08007

How Many Stock No.	Description	Price Each	Total

PLEASE SEND  GIANT FREE CATALOG "AV"  MERCHANDISE Total

ADD HANDLING CHARGE: \$1.00 ON ORDERS UNDER \$5.00; 50c ON ORDERS OVER \$5.00

TOTAL \$ \_\_\_\_\_  
I enclose  check  
 money order for \$ \_\_\_\_\_



NAME \_\_\_\_\_  
ADDRESS \_\_\_\_\_  
CITY \_\_\_\_\_ STATE \_\_\_\_\_ ZIP \_\_\_\_\_

CIRCLE NO. 13 ON READER SERVICE CARD

CIRCLE NO. 30 ON READER SERVICE CARD

Printed in U.S.A.

POPULAR ELECTRONICS

# Why a Sylvania home training program may be your best investment for a rewarding career in electronics.

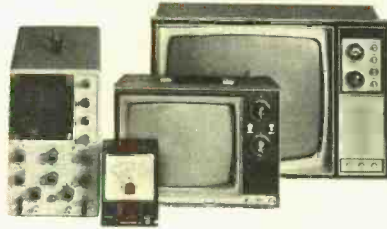

In the Master TV/Radio Servicing Program, you build and keep the all solid-state black and white TV set, the color TV set, the oscilloscope and multimeter shown.

- 1. LEADER IN ELECTRONICS TRAINING**  
Over the years, Sylvania Resident Schools have trained thousands of students for key positions in electronics. Now, through Sylvania Home Training, you can receive the same high-quality career training at home.
- 2. AUTOTEXT TEACHES YOU ELECTRONICS RAPIDLY, EASILY.**  
AUTOTEXT, offered exclusively by Sylvania, is the proven step-by-step method of home training that can help you learn electronics quickly and easily.
- 3. CASSETTE SYSTEM**  
This innovative learning-by-hearing approach is a special option that is almost like having an instructor in your own home. On cassette tapes, an instructor guides you through your AUTOTEXT lessons, explaining the material as you read it.
- 4. SPECIALIZED ADVANCED TRAINING**  
With our advanced courses, you can start on a higher level and skip work you know.
- 5. PERSONAL SUPERVISION THROUGHOUT**  
All during your program, your exams are

reviewed and your questions are answered by Sylvania instructors who become personally involved in your efforts and help you over any "rough spots" that may develop.

**6. HANDS-ON TRAINING**  
Many programs come with valuable kits to give practical application to your studies. In our Master TV Radio Servicing Program, for example, you actually build and keep an all solid-state black and white TV set, a color TV set, an oscilloscope, and a multimeter.

**7. FCC LICENSE TRAINING — MONEY BACK AGREEMENT**  
Take Sylvania's Communications Career Program — or enter with advanced standing and prepare immediately for your 1st, 2nd, or 3rd class FCC Radio Telephone License examinations. Our money-back agreement assures you of your money back if you take, and fail to pass, the FCC examination taken within 6 months after completing the course.

**8. CONVENIENT PAYMENT PLANS**  
You get a selection of tuition plans. And, there are never any interest charges.

LET SYLVANIA TRAIN YOU FOR A BIG FUTURE CAREER IN ELECTRONICS

Send for your FREE CATALOG right now!

Please rush me Free Illustrated Career CATALOG and more information about Sylvania's CASSETTE SYSTEM. I understand that I am under no obligation and that no salesman will call. I am interested in:

### HOME STUDY

- |   |  |
|---|--|
| <input type="checkbox"/> Television & Radio Servicing (including Color TV and CATV lessons) | <input type="checkbox"/> Fundamental Electronics |
| <input type="checkbox"/> Communications (including CATV lessons)                            | <input type="checkbox"/> Electronics Technology  |
| <input type="checkbox"/> FCC License Preparation  | <input type="checkbox"/> Solid State Electronics |
|   | <input type="checkbox"/> Digital Technology      |
|   | <input type="checkbox"/> Industrial Electronics  |
|   | <input type="checkbox"/> Instrumentation         |
|   | <input type="checkbox"/> Drafting                |

### CLASSROOM TRAINING

- Boston     New York     Philadelphia

**SYLVANIA TECHNICAL SCHOOL**

www.americanradiohistory.com

694-402-0

Name \_\_\_\_\_ Age \_\_\_\_\_

Address \_\_\_\_\_

City \_\_\_\_\_ State \_\_\_\_\_ Zip \_\_\_\_\_

Veterans & Servicemen: Check here for GI Bill information

# The Sylvania Cassette System

An exciting concept -  
new in electronics  
home training



**It's almost like having an instructor in your own home.**

This innovative learning-by-hearing approach is designed to get you started more quickly and easily towards an electronics career. The CASSETTE SYSTEM adds an extra dimension to AUTOTEXT, the step-by-step planned instruction which simplifies the mechanics of learning. As you play the cassette tapes, you'll have an instructor guiding you through your AUTOTEXT lessons. Explaining the material as you read it. And now the CASSETTE SYSTEM is available as an optional extra to all students enrolling in basic, fundamental, and career programs.

## "HANDS-ON" TRAINING

In addition, you get the all-important "Hands-On" training. You perform experiments and build a number of pieces of electronics test equipment that are yours to keep. In the Master TV/Radio Servicing

program you build and keep an all solid-state black & white TV set and a color TV set, oscilloscope and multimeter.

## CHOOSE FROM EXCITING CAREERS

Whether your career goal is radio/TV servicing, digital technology, communications or industrial electronics, Sylvania Home Study gets you started towards that career with the training you might have thought was too expensive, too drawn-out, or too hard to learn.

## NO SALESMAN WILL CALL

If you want an exciting, rewarding career in electronics, discover which Sylvania course or program is for you. Send the attached card today.

**SYLVANIA  
TECHNICAL SCHOOL**

**BUSINESS REPLY MAIL**

No Postage Stamp Necessary if Mailed in U.S.A.

FIRST CLASS  
PERMIT NO.  
48975  
NEW YORK, N.Y.

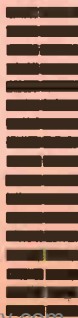

Postage will be paid by —  
**Sylvania Technical School**  
Home Study Division  
909 Third Avenue  
New York, N.Y. 10022

**FOR FREE  
ILLUSTRATED  
CAREER  
CATALOG**

and more  
information about  
Sylvania's  
CASSETTE SYSTEM  
send postage paid  
reply card  
TODAY!



# Popular Electronics

## READER SERVICE

Here's an easy and convenient way for you to get additional information about products advertised or mentioned editorially (if it has a reader service number) in this issue. Just follow the directions below... and the material will be sent to you promptly and free of charge.

**1**  
On the attached postage-free card, print or type your name and address in the lines indicated.

**2**  
Circle the number(s) that corresponds to the key number(s) at the bottom or next to the advertisement or editorial mention that is of interest to you. (Key numbers for advertised products also appear in the Advertisers' Index.)

**3**  
Simply cut out the card and mail. No postage required.

## FREE INFORMATION

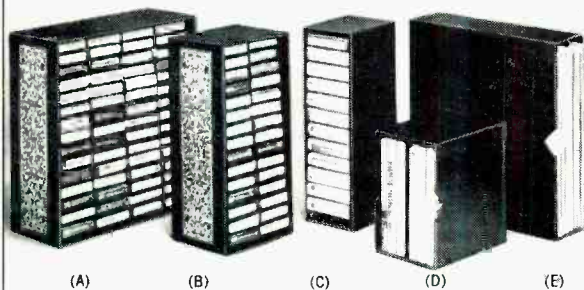

(A) 60-unit cassette case. 13½" high x 12⅝" deep x 5½" wide. \$15.95 each; 3 for \$45.00.  
(B) 30-unit cassette case. 13½" high x 6½" deep x 5½" wide. \$11.95 each; 3 for \$33.00.  
(C) 12-unit 8-track cartridge case. 13¼" high x 6½" deep x 4¼" wide. \$7.95 each; 3 for \$22.00.

Units A, B and C have titled compartments to prevent spillage and include pressure sensitive labels for titling.

(D) 6-unit 7" reel case. 8" high x 7½" deep x 5" wide. Holds reels in original boxes. \$5.25 each; 3 for \$15.00.

(E) 20-unit 12" record case. 13¼" high x 12½" deep x 3½" wide. Holds records in original jackets. \$5.95 each; 3 for \$17.00.

### A COMPLETE SET OF MATCHED STORAGE CASES

Here's the ideal solution to the problem of keeping all your records and tapes stored neatly, safely, conveniently and attractively. A complete set of matched storage cases, designed by the editors of STEREO REVIEW magazine, for your records and all your tapes: cassette, cartridge and 7" reel. Now you can keep them side-by-side on your bookshelf or cabinet, easy to identify and readily available.

These cases are sturdily constructed and covered in a handsome leatherette. The outer case is elegantly embossed in gold and comes in your choice of three popular decorator colors—black, brown and green—so that they blend themselves readily to the decor of any room.

STEREO REVIEW large capacity storage cases are just what you've been looking for—they're the ideal solution to keeping your records and tapes neatly stored for easy use.

### HERE'S HOW TO ORDER

Send your order to Ziff-Davis Publishing Co., Dept 23, One Park Ave., N.Y., N.Y. 10016. Be sure you identify the type of case ordered and indicate your color choice for the back of the case—black, green or brown (sides in black only). Print your name and address clearly and enclose the amount indicated above for the units being ordered PLUS an additional 50c per unit for postage and handling. Outside U.S.A. add \$1.00 per unit ordered.



CHARGE YOUR STORAGE CASE ORDERS TO YOUR AMERICAN EXPRESS OR BANKAMERICARD ACCOUNT



Mail your order, name, address and credit card number. You will be billed for the amount indicated above.

# The Technics SA-5400X. 4-amplifier 4-channel and 4-amplifier 2-channel.

Technics doesn't force you to choose between 2-channel or 4-channel. We give you both in one unit. The SA-5400X.

It's a very impressive 4-channel receiver. Each of its 4 amplifiers delivers 11 watts RMS, 8 $\Omega$ , each channel driven. And its full discrete capabilities include jacks for a CD-4 demodulator. Plus jacks for both 4-channel and 2-channel tape sources. And two tape monitor circuits.

There are also two different matrix decoding circuits that can handle all the popular matrix methods.

The SA-5400X is a great 2-channel receiver, too. Because it has Balanced Transformerless (BTL) circuitry. Our special way of strapping the front and rear amplifiers in tandem for 4-amplifier 2-channel. Which more than doubles the power per channel in stereo. Producing 25 watts RMS per channel (each channel driven) at 8 $\Omega$ .

The amplifiers all have direct-coupled circuitry which vastly improves their low-

frequency performance and power bandwidth. And a special phono-equalizer circuit so you can use virtually any kind of phono cartridge efficiently.

There's also a very potent FM section that boasts sensitivity of 2.0  $\mu$ V (IHF). With a 4-pole MOS FET and IF amplifiers whose ceramic filters yield 65 dB selectivity.

We knew you'd have a hard time trying to make up your mind about which kind of receiver to buy. So we put both 2-channel and 4-channel in one easy-to-afford unit.

The SA-5400X. The concept is simple. The execution is precise. The performance is outstanding. The name is Technics.

200 PARK AVE., NEW YORK, N.Y. 10017  
FOR YOUR NEAREST AUTHORIZED  
TECHNICS DEALER, CALL TOLL FREE  
800 447-4700. IN ILLINOIS, 800 322-4400.

## Technics

by Panasonic



CIRCLE NO. 15 ON READER SERVICE CARD