

# Popular Electronics

INCLUDING **Electronics World**

**Antennas for CB'ers and Hams**

**Bench Shock-Hazard Prevention**

**Julian Hirsch on the QS-4-Channel System**

**Electronics in Medicine**

**How to Build a:**

- Single-Digit Electronic Clock
- Linear-Scale Ohmmeter

**Test Reports:**

- Sherwood S-2400 Stereo FM/AM Tuner
- Johnson Messenger 120 CB Transceiver
- Turner "Super Sidekick" Microphone
- Wayne Model WT2 Transistor Tester
- Elextra "Jolly Roger" Monitor Receiver

**PE TESTED**

**Build a  
Thunderstorm  
Forecaster**

18101

561255 075 BC245M97 NOV73 6 1D  
 M DELSCLAGER 4  
 BX 242  
 BRDMNS MILLS NJ 08015

# NOW you can train at home building a NEW 25" DIAGONAL Solid State Color TV engineered by NRI for learning and trouble-shooting

*So much better for learning TV servicing than any hobby kit, because NRI designed and created it as an educational tool.*

Unlike hobby kits which are designed for creating a TV set as the end product, NRI built its exclusive 25" Diagonal Solid State Color TV kit as a real training kit. You can introduce and correct defects . . . for trouble-shooting and hands-on experience in circuitry and servicing. The kits include a wide-band oscilloscope, color bar crosshatch generator, transistorized volt-ohmmeter and other valuable equipment that can soon have you earning \$5 to \$7 an hour servicing color sets in your spare time.

**Handsome woodgrain cabinet, at no extra cost. (Offered only by NRI)**

**New square-cornered Sylvania picture tube**

**100% solid state chassis**

**6-position detented UHF channel selector**



**Modular construction with plug-in circuit boards**

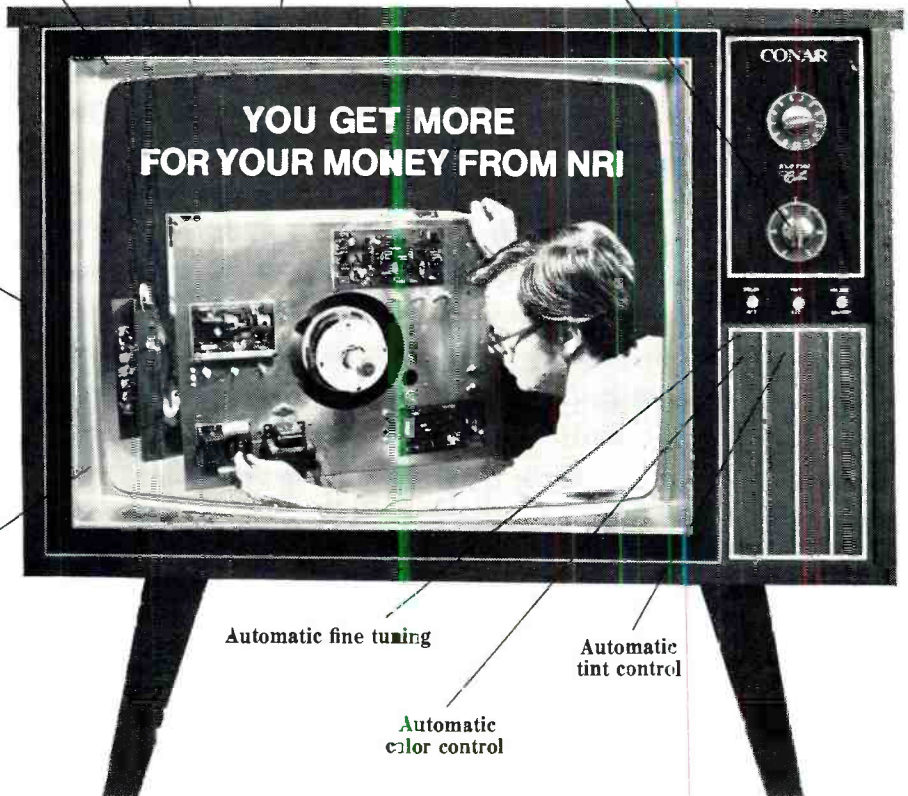

**Automatic degaussing**

**Automatic fine tuning**

**Automatic tint control**

**Automatic color control**



# NRI FIRSTS make learning Electronics fast and fascinating—to give you priceless confidence

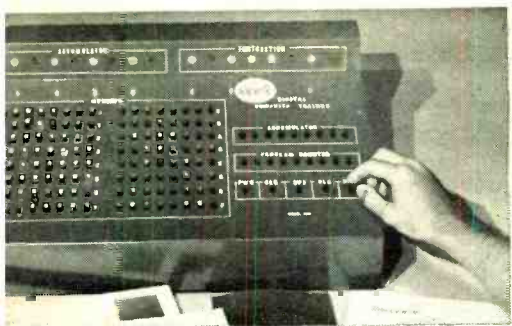

**FIRST** to give you a complete programmable digital computer, with memory, you build yourself... to learn organization, operation, trouble-shooting and programming. This remarkable computer is one of ten training kits you receive with the new NRI Complete Computer Electronics Course.



**FIRST** to give you true-to-life experiences as a Communications Technician. Every fascinating step you take in NRI Communications training, including circuit analysis of your own 15-watt, home/cw transmitter, is engineered to help you prove theory and later apply it on the job. Studio equipment operation and troubleshooting become a matter of easily remembered logic.



**FIRST** to give you completely specialized training kits engineered for business, industrial and military Electronics Technology. Shown is your own training center in solid-state motor control and analog computer servo-mechanisms. Telemetering circuits, solid-state multivibrators and the latest types of integrated circuits are included in your course.

The NRI color TV and digital computer kits are the latest in a long line of "firsts" for NRI. For more than fifty years, NRI has been providing unique 3-dimensional home-study training that has helped hundreds of thousands of students reach their goals quickly and easily.

What NRI provides is a combination of kits and bite-size texts that give you hands-on experience while you are learning. The texts average only 40 pages each, and they are fully illustrated. You are taken step-by-step from the first stages into the more advanced theory and techniques... with an expert instructor ready at all times to provide valuable guidance and personal attention. (The level of personal attention provided is more than you would receive in many classrooms.) Once you've grasped the fundamentals, you move with confidence and enthusiasm into new discoveries in the fascinating world of electronics.

You start out with NRI's exclusive Achievement Kit, containing everything you need to get moving fast. Lessons have been specifically written so that experiments build upon one another like stepping stones. You can perform a hundred experiments, build hundreds of circuits... as you learn to use the professional test equipment provided, building radios and TV sets, transmitter or computer circuits. It's the priceless "third dimension" in NRI training... practical experience.

## Train with the leader—NRI

Compare training kits, texts, techniques and overall training... and you'll find that you get more for your money from NRI. Whatever your reason for wanting more knowledge of Electronics, NRI has an instruction plan that will meet your needs. Choose from major programs in Advanced Color TV Servicing, Complete Computer Electronics, Industrial Electronics and the other special courses designed to meet specific needs. With NRI home training, you can learn new skills while you're still working at your present job... and turn yourself into the man in demand.

### GET FACTS ABOUT GI BILL

If you have served since January 31, 1955, or are in service now, check GI line on postage-free card.

## Send for free NRI catalog

MAIL THE POSTAGE-FREE CARD FOR THE FREE NRI CATALOG IN THE FIELD OF YOUR CHOICE. YOU WILL BE UNDER NO OBLIGATION. NO SALESMAN WILL CALL.

If the card has been used, write direct to:



**NRI TRAINING**

3939 Wisconsin Ave.  
Washington, D.C. 20016

# Popular Electronics

WORLD'S  
LARGEST-SELLING  
ELECTRONICS MAGAZINE

INCLUDING **Electronics World**

## FEATURE ARTICLES

- 44 QS DROPS THE GAUNTLET WITH ITS VARIO-MATRIX SYSTEM**  
*Julian Hirsch*
- 47 CHU—TIME SIGNALS FOR EVERYONE**
- 48 UNDERSTANDING NAB TAPE PLAYBACK EQUALIZATION**  
*Herman Burstein*
- 65 ELECTROMAGNETIC RADIATION IN MEDICINE** *Webb Garrison*
- 70 HOW TO AVOID WORKBENCH HAZARDS**  
*Don't be careless when working with electronics.*
- 86 ELECTRONICS IN AUTOMOBILES** *John T. Frye*  
*What the future may hold in store.*
- 91 DO YOU KNOW YOUR BIPOLAR TRANSISTORS?** *Lothar Stern*  
*Part 2 of a series on transistor fundamentals.*
- 95 ANTENNAS FOR CB'ERS AND HAMS** *Carl C. Drumeller*  
*What to look for in designing or buying.*

## CONSTRUCTION STORIES

- 31 EARLY WARNING STORM FORECASTER** *Thomas R. Fox*  
*Your own weather-watch alert.*
- 34 WELCOME BEACON PREVENTS STUMBLING IN THE DARK**
- 35 BUILD THE MONODIGICHRON** *Michael S. Robbins*  
*Unique electronic clock with sequential readout.*
- 51 LINEAR-SCALE OHMMETER FOR ACCURATE READING** *Dale Hileman*
- 56 ASSEMBLE A LOW-COST LOGIC PROBE** *Randall Glissman*

ZIFF-DAVIS PUBLISHING COMPANY  
Popular Electronics Including Electronics World  
Editorial and Executive Offices  
One Park Avenue, New York, New York 10016  
212 679-7200

William Ziff, President  
W. Bradford Briggs, Executive Vice President  
Hershel B. Sarbin, Senior Vice President, Secretary, and  
Treasurer  
Philip Sine, Senior Vice President  
Phillip T. Heffernan, Vice President, Marketing  
Frank Pomerantz, Vice President, Creative Services  
Arthur W. Butzow, Vice President, Production  
Edward D. Muhlfield, Vice President, Aviation Division  
Irwin Robinson, Vice President, Travel Division  
George Morrissey, Vice President  
Sydney H. Rogers, Vice President  
Sidney Holtz, Vice President  
Lawrence Sporn, Vice President, Circulation

POPULAR ELECTRONICS Including ELECTRONICS WORLD, September, 1973, Volume 4, Number 3. Published monthly at One Park Ave., New York, NY 10016. One year subscription rate for U.S., U.S. Possessions and Canada, \$6.00; all other countries, \$7.00. Second class postage paid at New York, N.Y. and at additional mailing offices. Authorized as second class mail by the Post Office Department, Ottawa, Canada and for payment of postage in cash. Subscription service and Forms 3579: P.O. Box 2774 Boulder, CO 80302. Editorial offices for manuscript contributions, reader inquiries, etc.: One Park Ave., New York, NY 10016.

POPULAR ELECTRONICS Including ELECTRONICS WORLD is indexed in the Reader's Guide to Periodical Literature.

Copyright © 1973 by ZIFF-DAVIS PUBLISHING COMPANY. All rights reserved.

POPULAR ELECTRONICS Including Electronics World



**EDGAR W. HOPPER**  
*Publisher*  
**ARTHUR P. SALSBERG**  
*Editorial Director*  
**MILTON S. SNITZER**  
*Editor*  
**LESLIE SOLOMON**  
*Technical Editor*  
**JOHN R. RIGGS**  
*Managing Editor*  
**EDWARD I. BUXBAUM**  
*Art Director*

**ALEXANDER W. BURAWA**  
*Associate Editor*  
**ANDRE DUZANT**  
*Technical Illustrator*  
**ELLEN S. FINKELSTEIN**  
*Editorial Assistant*  
**JOHN T. FRYE**  
**J. GORDON HOLT**  
**RICHARD HUMPHREY**  
**WALTER G. JUNG**  
**MATT P. SPINELLO**  
*Contributing Editors*

**JOSEPH E. HALLORAN**  
*Advertising Director*  
**JOHN J. CORTON**  
*Advertising Sales*  
**MADELEINE LITTMAN**  
*Advertising Service Manager*  
**STANLEY NEUFELD**  
*Associate Publisher*  
**FURMAN H. HEBB**  
*Group Vice President*  
*Electronics and Photographic*

## THE SCENES

- 10 STEREO SCENE** *J. Gordon Holt*
- 24 HOBBY SCENE**
- 62 TEST EQUIPMENT SCENE** *Leslie Solomon*
- 99 CB SCENE** *Matt P. Spinello*
- 102 SOLID-STATE SCENE** *Walter G. Jung*
- 119 SURPLUS SCENE** *Alexander W. Burawa*

## PRODUCT TEST REPORTS

- 80 TURNER SUPER SIDEKICK MICROPHONE**
- 81 SHERWOOD MODEL S-2400 AM/STEREO FM TUNER**
- 83 E. F. JOHNSON MESSENGER 120 CB TRANSCEIVER**
- 84 ELECTRA "JOLLY ROGER" SCANNING MONITOR RECEIVER**
- 85 WAYNE ELECTRONICS MODEL WT2 TRANSISTOR TESTER**

## DEPARTMENTS

- 6 EDITORIAL** *Milton S. Snitzer*  
*IC's and the Hobbyist*
- 8 LETTERS**
- 26 NEWS HIGHLIGHTS**
- 79 TIPS & TECHNIQUES**
- 106 NEW LITERATURE**
- 108 ELECTRONICS LIBRARY**
- 114 NEW PRODUCTS**

## COMING NEXT MONTH

*Build the PE Super Audio Sweeper*  
*Accessories for Your CB Rig*  
*Understanding Silicon Solar Cells*  
*Introduction to Electronic Music*

Midwestern Office  
The Pattis Group, 4761 West Touhy Ave.,  
Lincolnwood, Illinois 60644, 312 679-1100  
GERALD E. WOLFE, DICK POWELL  
DICK GOVATSKI, MANLEY LUDWIG

Western Office  
9025 Wilshire Boulevard, Beverly Hills, California 90211  
213 273-8050; Bradshaw 2-1161  
Western Advertising Manager, BUD DEAN

Japan: James Yagi  
Oji Palace Aoyama; 6-25, Minami Aoyama  
6 Chome, Minato-Ku, Tokyo 407-1930/6821

Ziff-Davis also publishes Boating, Car and Driver, Cycle, Flying, Modern Bride, Popular Photography, Skiing, and Stereo Review.

Forms 3579 and all subscription correspondence should be addressed to POPULAR ELECTRONICS including ELECTRONICS WORLD, Circulation Department, P.O. Box 2774, Boulder, CO 80302, Please allow at least eight weeks for change of address. Include your old address, as well as new—enclosing, if possible, an address label from a recent issue.

Editorial contributions must be accompanied by return postage and will be handled with reasonable care; however, publisher assumes no responsibility for return or safety of art work, photographs or manuscripts.

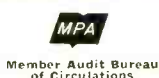



# Editorial

By Milton S. Snitzer, Editor

## IC'S AND THE HOBBYIST

Remember when we thought a circuit containing 3, 4 or 5 transistors was complex and daring? Prices for a single transistor were high and we considered the device primarily as a substitute for vacuum tubes—in circuits reflecting vacuum-tube thinking.

What a difference a few years can make!

Integrated circuits came on the scene and their advantages were quickly recognized. A natural evolution produced new and improved devices; prices dropped. RTL IC's gave way to TTL IC's. Close on the latter's heels, linear IC's emerged; and one in particular, the op amp, proved to be a near-universal device. Now, such marvelous linears as phase-locked loops, power supply regulators and other circuits have appeared at very low cost, enabling the experimenter to work with circuitry he never dreamed he could.

Proceeding one more step, we now have what is called MOS technology. Here, complexity has increased to where circuits for a complete digital calculator or digital clock can be deposited on a single chip. Despite the complexity of this IC, which may contain several thousand transistors, it makes construction of a project infinitely simpler than with discrete transistor circuits. After all, we need only be concerned with inputs and outputs, which has changed design from a one-stage-at-a-time approach to a systems concept using "black boxes" as the basic components. And serious projects can now be designed and built that are far superior to the best commercial equipment available only a few years ago.

As more and more of these sophisticated devices were used, component cost dropped. For example, EIA data reveals that the average unit value of total IC factory sales dropped from \$2.33 in 1968 to \$1.03 in 1972 (it was \$18.50 in 1964)! Unit sales of digital IC's rose from 298 million in 1971 to 481 million in 1972; linears went from the 65-million level in 1971 to 123 million in 1972; MOS jumped from 12.9-million units in 1971 to 26.4 million in 1972.

It's clear that integrated circuits have, indeed, contributed greatly to the enjoyment of our exciting electronics hobby. They make it possible for us to offer you practical, interesting projects that are more fulfilling than ever before.





## Get the whole kit and caboodle from RCA.

### RCA IC Project Kits, Experimenter Kits, and Devices

Type	Description	Type	Description
KC4000	I.C. Microphone Pre-Amplifier Kit	KD2100	Silicon Control Rectifier Assembly
KC4001	I.C. Two-Channel Mixer Kit	KD2105	SCR Experimenter Kit
KC4002	I.C. Audio Oscillator Kit	KD2106	Add on Light Sensor Kit
KC4003	I.C. Power Amplifier and Oscillator Kit	KD2110	Add on Heat Sensor Kit
KC4004	I.C. Regulated Power Supply Kit	KD2117	I.C. Experimenter Package
KC4005	I.C. Intruder Alarm Kit		Basic Kit Contains: 2-KD2114;
KC4006	I.C. Fire Alarm Kit		1-KD2115, 2-KD2116
KC4007A	I.C. Converter Kit: 118-136MHz Aircraft Band	KD2118	NPN Silicon Variety Pack (5 Units)
		KD2120	PNP Silicon Variety Pack (5 Units)
KC4008A	I.C. Converter Kit: 134-150MHz Ham, Government, Space Research Band	KD2123	PNP Germanium Variety Pack (5 Units)
		KD2124	NPN Germanium Variety Pack (5 Units)
KC4009A	I.C. Converter Kit: 148-164MHz Maritime Mobile, Police, Fire Band	KD2131	70-Watt IC Power Module
KC4010A	I.C. Converter Kit: 160-174MHz Police, Fire Band	3N128DP	MOS/FET Device in Display (Blister) Pack
KC4011	Digital/Readout IC Kit	40214DP	18 Amp. 1/4 in. Stud Silicon Rectifier Device in Display (Blister) Pack
KC4012	Digital/Counter IC Kit		
KC4500	Kit Enclosure for use with KC4000, KC4001, KC4002, includes Input & Output Jacks, On-Off Switch and Hardware		

CIRCLE NO. 26 ON READER SERVICE CARD

Now available from RCA ... a wide variety of solid-state components in convenient kit form to build interesting and useful projects.

And you can further expand your solid-state experience with RCA's popular hobby and experimenter's manuals. For example, the 368-page RCA Solid-State Hobby Circuits Manual (HM-91) has over 60 interesting circuits you can build.

See your RCA Distributor to buy the RCA Kits and Manuals of your choice.

RCA  
Electronic Components  
Harrison, N.J. 07029.

# RCA

## Electronic Components

**If You Work In Electronics:**

# Earn Your Electronics DEGREE by studying at home.

Your technical experience can be a valuable asset in advancing your electronics career to the engineering level. By adding college-level home training and a college degree to your experience, you can move up to greater opportunities.

## GRANTHAM School of Engineering

1505 N. Western Avenue  
Hollywood, CA 90027

is a college-level institution, specializing in teaching electronics and supporting subjects, mainly by correspondence. Grantham can prepare you to take advantage of advancement opportunities.

Grantham offers a correspondence program leading to the A.S.E.T. degree. After earning this degree, you may continue with additional correspondence plus a one-week residential seminar and certain transfer credits, to earn the B.S.E.T. degree. Then, the B.S.E.E. degree is available through further residential attendance.

The School was established in 1951 and is authorized under the laws of the State of California to grant academic degrees. G.I. Bill approved.

Mail the coupon below for free bulletin.

**Grantham School of Engineering** PE-9-73  
1505 N. Western Ave., Hollywood, CA 90027

I have been in electronics for \_\_\_\_\_ years. Please mail me your free bulletin which gives details concerning your electronics degree programs.

Name \_\_\_\_\_ Age \_\_\_\_\_

Address \_\_\_\_\_

City \_\_\_\_\_ State \_\_\_\_\_ Zip \_\_\_\_\_

**CIRCLE NO. 14 ON READER SERVICE CARD**

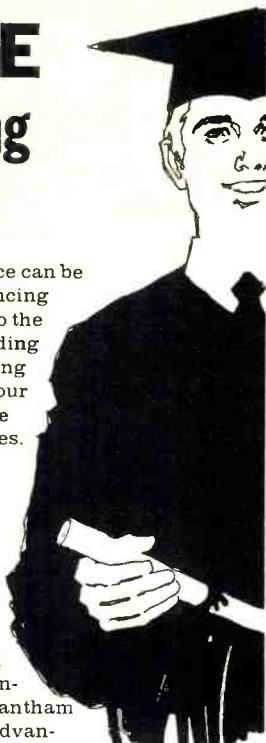

## MODIFIED GENERAL-PURPOSE ALARM

The article "Build A General-Purpose Alarm" (Sept. 1972) was just what I needed. However, not having the relay specified on hand, I decided to modify the circuit. The sche-

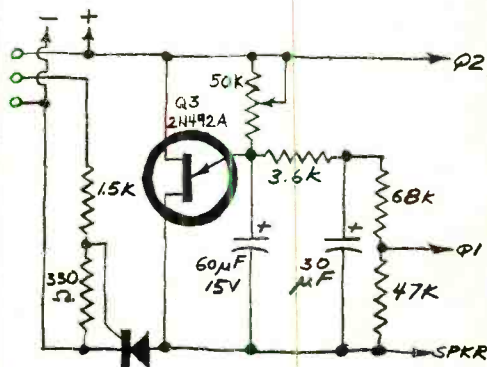

matic diagram shows the result of my modification. I eliminated a couple of components and juggled the values of a few more to accommodate the UJT I used.

ULRICH KREIDLER  
Spring Lake, N.C.

*A good solution to your problem. Thanks for passing your idea on to us and those readers who want to avoid using a relay.*

## HAZARDOUS FLASHLIGHT

I sincerely hope that the hazards of the rechargeable flashlight (April 1973) are evident to everyone and that no one would build it as indicated, with J1 and J2 being identical. If P1 were inadvertently plugged into J2, 117 volts ac would be applied to the batteries, which might then explode. Worse yet, if the flashlight body is made of metal, it might be placed at full line potential. Other problems concerned with an identical plug/jack arrangement also come to light. I suggest that different types of plug/jack setups be used for each circuit to eliminate the possibility of an incorrect hookup.

I would also like to point out that an even less excusable error in design exists in the project: A plug (P1) is used to deliver 117



volts ac to the flashlight. With this setup, if P1 were to be unplugged while the other end of the line remained plugged into the ac outlet, two live prongs would be hazardously exposed. I consider this irresponsibility on the part of POPULAR ELECTRONICS to allow such a design to be published. The plug should be on the flashlight for safety purposes.

JOSEPH M. NEWCOMER  
Pittsburgh, Pa.

Consider us properly reprimanded. You are, of course, correct on both accounts. Those plug/jack arrangements should definitely be different for each circuit—and reversed to maintain a modicum of safety. And you are also correct, as you point out elsewhere in your letter, that P2 (or J2 if rewiring is done properly) should never be left plugged into the flashlight during the recharge cycle.

### WHY SHOULD I BUILD IT?

After stimulating my interest with the title "Unique Digital Clock" (May 1973) and subtitle "Tells Time and Teaches Binary Arithmetic," the article leaves me high and dry. What does the finished project look like? More important, how does it teach binary arithmetic? The final question is: Why should I build it?

EUGENE A. WILLE, KH16EVX/W9EQU  
Honolulu, Hawaii

In order to get the entire story into the allotted space, we had to compromise and leave out the drawing (shown here) in favor of using the more important schematic diagram and PC drawings. With reference to your second question, the clock's readout system consists of a series of LED's, each of which is legended with its appropriate decimal equivalent. The on/off states of the LED's indicate the time in a binary format. So, by adding up the decimal no-

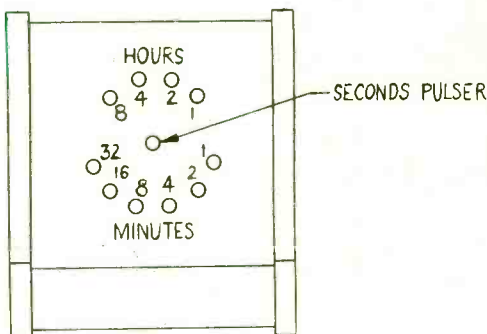

tations near each lighted LED, the time can be read in conventional notation—and you're learning binary arithmetic, to boot. The SECONDS PULSER LED simply pulses on and off to tick off the seconds and facilitate accurate time setting.



## A little Traveling Music, Please

Daily frustrations make a person want to get away from it all. And, the UTAH MP-3000 Speaker will take you there better, faster than any comparable unit. With the MP-3000, you **know** you are in Tahiti, Paris or even Kentucky. Your day becomes more pleasant, too, as the MP-3000 conquers the sound barriers.

MP-3000 combines the rare attributes of sound and styling. Clean, undistorted sound comes from this 4-speaker, 3-way speaker system. The oiled and hand-rubbed walnut veneer cabinets, and unique grille of sculptured foam are both acoustically and geometrically beautiful. The system contains a 15" high compliance woofer with a 2" voice coil, as well as two horn-loaded-dome-tweeters. It's a distinguished combination of well-defined, distortion-free sound reproduction. Size: 27" x 20½" x 14" deep, excluding base. Shipping weight: 70#.

Come travel with us. Get complete information about the exciting MP-3000 Speaker System.



**UTAH ELECTRONICS**  
Huntington, Ind. 46750

CIRCLE NO. 37 ON READER SERVICE CARD



# Stereo Scene

By J. Gordon Holt

**L**AST SPRING, near the end of the local concert season, I had an opportunity to compare a borrowed pair of Sony C-500 condenser microphones—among the best mikes money can buy—with my own, not-too-imperfect Sony C-37 condensers. Both are professional mikes priced respectively at around \$500 and \$400 each (without power supply); and their specifications indicated that there should be a small but audible difference between them. The comparisons were made using my Revox A-77 tape recorder and (merely for laughs) a \$150 cassette recorder that I had just overhauled for a friend.

I won't pretend that the resulting cassette and open-reel tapes were comparable. What surprised me, however, was that, even from the cassette, the more expensive mikes sounded smoother than the "cheaper" ones. Not conspicuously so—both are excellent mikes—but just enough so that there was no mistaking which were on at any given time.

Now if you think I'm going to try to persuade you to buy over \$1000 worth of mikes to feed a \$150 recorder, you're wrong. If you were that critical of your recordings, you'd own a top-notch, open-reel tape machine. What I am saying is that, given a recorder of above average quality, the better the mikes, the better the sound. You can't justify skimping on mikes with the excuse that you won't hear any improvement if you pay more than such-and-so dollars for them. You will. But if money means anything to you, you're probably going to

have to set your sights lower than the pinnacle of perfection and exercise a modicum of judgement in choosing your mikes. The following is offered in the hope of making the job easier.

If this is to be your first microphone purchase, you are probably in the market for a pair of mikes for stereo recording. This means you must think in terms of twice the per-mike prices I'll be quoting subsequently, for a stereo pair must be identical for best results. This doesn't mean you must buy them at once of course; but if you do go one at a time, make sure any accessory items (like power supplies for condenser mikes) are purchased in the stereo models so they can be used with the second mike when you get around to acquiring it. Special-purpose mikes (for solo highlighting, for instance), will be purchased singly as needed, and these need not be (in fact, should not be) identical to your main pair.

**Transducer Types.** Although as a user you are more interested in a mike's performance than in how it converts sounds into electrical signals, we can make some valid generalizations about the performance capabilities of each transducer type. Ceramic mikes are generally of poor quality and, since they are inherently high-impedance devices, are not usable anyway with the low-impedance mike inputs of solid-state recordings.

Moving-coil (dynamic) types range from cheap and dirty (\$10) to expensive and excellent, with a top price of around \$200. More money than that will buy you extra features like adjustable frequency response or extreme directionality (for spotlighting from a distance), but not extra audio quality.

Ribbon mikes range from modestly priced (\$45) and quite good to expensive (\$200) and sometimes a bit better than the

## How to Pick a Mike



# free

**OVER 93  
FAMOUS NAME  
ELECTRONICS  
PRODUCT LINES . . .  
MOST IN FULL COLOR**

**1974 VALUE PACKED**

## **Olson** CATALOG

YOUR COMPLETE ELECTRONICS BUYING GUIDE for home or business . . . over 8,000 quality-tested items clearly described and illustrated on big 8¼ x 10¾" pages. Shop leisurely in the comfort of your own home — order what you want by mail or through the catalog order station at your nearby Olson store. Any way you do it — you pay the same low Olson catalog price!

**FEATURING THE BEST OF THE NAME BRANDS  
PLUS EXCLUSIVE TELEDYNE AND OLSON PRODUCTS**

- Stereo and 4-Channel Sound Systems • Tape Recording Equipment • Car Stereo and Accessories • Easy-to-Build Electronic Kits • Citizens Band Radios • Police Receivers • Books • Amateur Radio Equipment • Antennas • Radios • PA • Test Equipment • Electronic Security Systems • Electronic Calculators and Timepieces • PLUS 1000's of PARTS, TUBES, BATTERIES, HARDWARE!

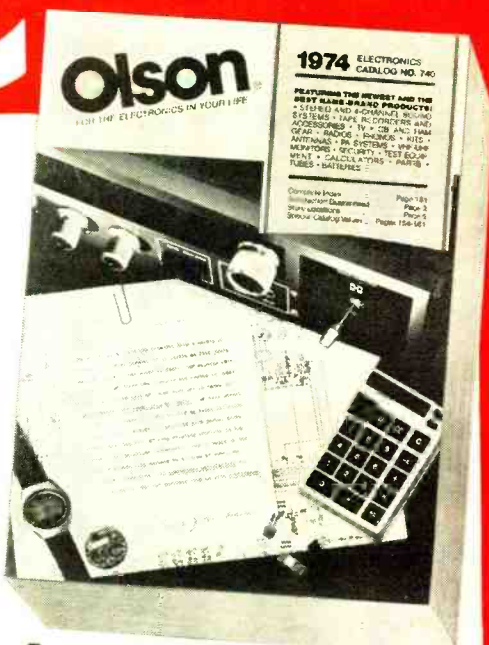

**SAVE ON "THE ELECTRONICS  
IN YOUR LIFE"  
— Buy with Confidence**

**FREE  
SEND  
TODAY!**

**Olson**  
for the electronics in your life

The VALUE Leader  
Since 1931

**STORES NATIONWIDE  
Check Your Yellow Pages  
or Shop by Mail**

**Olson. electronics** Dept. 1K  
260 S. Forge St., Akron, Ohio 44327

Rush me your free 1974 Electronics Catalog

Name \_\_\_\_\_ Apt. \_\_\_\_\_

Street \_\_\_\_\_

City \_\_\_\_\_ State \_\_\_\_\_ Zip \_\_\_\_\_

Send a 1974 Olson Electronics Catalog to my friend.

Name \_\_\_\_\_ Apt. \_\_\_\_\_

Street \_\_\_\_\_

City \_\_\_\_\_ State \_\_\_\_\_ Zip \_\_\_\_\_

**CIRCLE NO. 23 ON READER SERVICE CARD**

best dynamics. A ribbon can be made lighter than a coil and thus can have better transient response, but its very lightness tends to make some ribbon mikes fragile and susceptible to damage from wind (or close breaths). That this can be overcome is proved by at least one manufacturer (Beyer Dynamic), who is making ribbon mikes of very high quality that are as rugged as dynamics. So fragility is not necessarily a ribbon shortcoming, any longer.

The class of condenser mikes includes some of the best performers available (their diaphragms can be even lighter than ribbons) and also some mediocre ones. As a group, all are characterized by outstanding detail or "snap." But, whereas the \$400-and-up professional types (whose elements must be kept charged by a power supply) are generally extraordinarily good, the \$100 (and under) electret types, with permanently charged capacitor, have neither the smoothness nor frequency range of the very best ribbons or dynamics.

Oddly, there are only two condenser mikes (to my knowledge) in the wide price range from \$100 to \$400, and both are made by PML (through Ercona Corp.). The DC-20 and DC-21 are, respectively, omnidirectional and cardioid versions of the same mike; and a DC-21 plus stereo power supply costs \$200. With two DC-21's, the cost is \$350, which is a far cry from \$400 per mike. In performance, the PML's have much more in common with professional condensers than with the electret types.

**Impedance.** Although not as critical as loudspeaker amplifier matching, a mike's impedance range should suit the load impedance provided by the recorder's mike inputs. Solid-state recorders call for the use of low-impedance mikes, which means anything between 150 and 600 ohms. If possible, try to get a mike rated between 250 and 300 ohms impedance.

Tube-type recorders usually require a high-impedance mike, on the order of 10,000 ohms or more; but there are so many advantages to low-impedance interconnection (lower hum, greater permissible cable length) that it is best to buy low-Z mikes and use impedance-matching transformers at the recorder's inputs.

**Output.** Most currently available mikes produce roughly the same amount of audio signal voltage for a given sound level, and

most mike preamps are designed to handle optimally the kind of voltages a typical mike will deliver under typical conditions. The latter are considered to range from a speaking voice at a mike distance of 3 feet to a full chorus and orchestra at 10 feet. If you don't expect to use a mike closer than a few feet from a loud sound source or more than, say, six feet from a quiet sound (like normal speech), you need not be concerned about a mike's output. If you anticipate atypical conditions, be concerned.

The subject of output ratings is complex enough to warrant a separate article, which we will write at some future time. Suffice it to say here that a typical mike will be rated at around -56 dB relative to 1 mW/10  $\mu$ bar, -75 dB relative to 1 V/ $\mu$ bar, or -150 dB EIA G<sub>m</sub>. Any mike rated 5 dB or more above or below those figures may give you trouble, depending on the direction of the difference and your proposed use. Excessive mike output is easily remedied by adding an attenuator (available from Shure, E-V, and others) but inadequate output is not curable without replacing either the mike or the preamp.

**Directivity.** The sensitivity of some microphones is affected by the direction from which sounds reach them. Some are most sensitive to frontal sounds and least so at the rear (unidirectional or cardioid). Some are equally sensitive at front and rear (bidirectional or figure-8), and some are equally sensitive to sounds coming from all directions (nondirectional or omnidirectional).

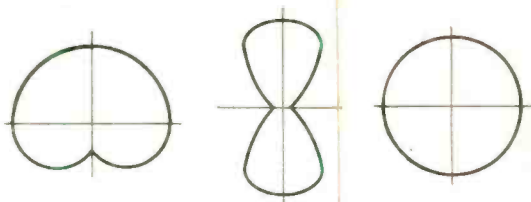

Fig. 1. Microphone directional characteristics: (from left) cardioid, bidirectional, and omnidirectional.

(See Fig. 1.) None of these directional characteristics is inherently superior to the other, but there are times when one will do a specific job better than anything else. For example, conference recording of a group of people around a table calls for an omnidirectional characteristic—as does recording a moving sound source from a fixed mike position. Bidirectional mikes are ex-



# It's old enough to vote. You haven't seen one like it since 1954. Now you've got to service it.



No sweat. PHOTOFAC<sup>®</sup> gives you complete service data on 92,000 different radio/TV circuits . . . including Rip Van Winkle, here.

Sams Photofact is the most comprehensive Radio/TV/Audio circuit source in the world. Photofact supplies complete service information on over 92,000 models produced since 1946 — color and b-w TV, AM and FM radios, stereos and record changers. Plus service data on auto radios and tape players, CB radios, modular hi-fi, tape recorders and scanner monitors. Quite a package!

And more data keeps coming. Every month, Photofact produces new Photofact data containing easy-to-follow service information on up to 100 of the latest chassis.

This data includes the manufacturers' own printed board callout numbers, detailed circuits, photos, standard notation schematics, replacement parts lists and descriptions, etc., etc., for each model. It'll save you hours of time and frustration.

And it's available in two ways: (1) Photofact-of-the-Month Club members receive regular monthly deliveries of the latest data; (2) or you can purchase whatever service data you need as you need it from your local electronic parts distributor.

The cost? A bargain either way. Photofact-of-the-Month Club members pay just \$15.75 a month—a \$88.20 a year saving for the entire service package. And if you need a Photofact on Rip Van Winkle, above, the price is only \$3.30.

1. Ask your Sams Distributor, or . . .
2. Fill out this coupon for membership in the Photofact-of-the-Month Club . . . get service data on up to 100 new chassis every month, delivered in 7 handy file folders . . . plus monthly "Bonus" certificate coupons toward a file cabinet of your choice.

HOWARD W. SAMS & CO., INC. 4300 West 62nd St.  
Indianapolis, Indiana 46268 PE193

Please enroll me as a new member of the Photofact-of-the-Month Club. I agree to pay \$15.75 per month for my membership and understand my subscription will begin with the 7 current Photofact Sets, plus the Photofact Index, free, to be delivered by my Sams Distributor.

Name \_\_\_\_\_  
Business name \_\_\_\_\_  
Address \_\_\_\_\_  
City \_\_\_\_\_ State \_\_\_\_\_ Zip \_\_\_\_\_  
My Sams Distributor Is \_\_\_\_\_  
Sign here \_\_\_\_\_

CIRCLE NO. 28 ON READER SERVICE CARD

cellent for spotlighting a soloist in the midst of other instruments. But for most purposes, the most versatile mike you can own is the so-called cardioid type.

Some directional mikes are more uniformly directional than others. Some cardioids are cardioid at middle frequencies only, becoming omnidirectional at low frequencies and increasingly "beamy" at high frequencies. This is why a directional mike that is reasonably uniform over the audio range often shows a family of polar patterns on its specifications sheet. Directional uniformity is in fact one of the things you pay for when you pay more for one of two mikes that appear to be identical performers in all other respects.

For advanced recordists with the scratch to pay for them, there are mikes with variable polar patterns and there are special-purpose long-reach mikes for spotlighting a single sound from a considerable distance. Both tend to be very costly and both have their places, but not usually as the first mikes you buy for cutting your teeth on stereo (or quadrasonic) taping.

**Frequency Response.** Basically, what your microphone dollar is going to buy is what you look for in a loudspeaker: frequency range and response smoothness. When you say to yourself, "that mike's too expensive for me," what you're actually saying is, "I have to give up some range or smoothness." Deciding just how much of what to give up is the serious recordist's most difficult decision.

The best condenser mikes have response curves that look like a perfectionist's flight of fancy. They go from 20 to 20,000 Hz, almost as straight as a ruler. Below that level of performance, though, you'll find some mikes that are deficient, to varying degrees at the low end but fine at the top; some that are peaky or down in response at the high end; and some whose major imperfections are irregularities in the middle range, causing honky or raucous colorations.

You can glean an idea of how good a microphone is in these respects from both its price and the manufacturer's claim for frequency range or response; but, in order to judge in advance how a mike is likely to sound, you must be able to get a look at its published frequency response curve. If you can't obtain a curve for a mike you're considering, don't buy it. When you do see a

curve, here's how to tell how it will probably sound. (See Fig. 2.)

First, mentally divide the audio spectrum between 50 and 10,000 Hz into two parts to the left and right of 1000 Hz on the published curve. If most of the curve through both segments is the same height (that is, if

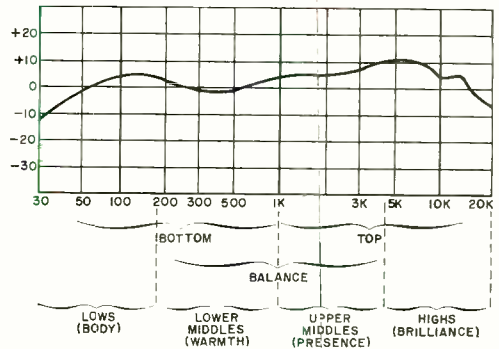

Fig. 2. How to break down a response curve to get interpretive analysis.

there is no visible tilt to the line), the mike will sound properly balanced with regard to highs and lows. If most of the right-hand segment rises progressively to around 10,000 Hz, the sound will be bright, somewhat sibilant, and rather forward. If it falls through that range, it will be dull. If the lower (left-hand) segment tapers downward the sound will be thin. If it rises down to around 50 Hz, it will be heavy and have a tendency to boom. A good ear can detect a response deviation of a bit more than 1 dB, and 3 dB is quite noticeable to anyone. A deviation of 5 dB is conspicuously evident, while 10 dB represents an apparent doubling or halving of level—a tremendous change. Read the vertical dB scale on the curve accordingly.

Next, split the audio spectrum into four equal-width (not equal-frequency) segments and compare their average heights. If the first (left-hand) segment is up, the sound will be bass-heavy; down and it will be sparse and tight at the bottom. If the second segment is up, the sound will be overly fat and a bit woolly; down and it will sound somewhat constricted. If the third segment is up, the sound will be forward and brassy; down and it will sound muted and lacking in life. If the fourth segment is up, the sound will be sizzly, sibilant and wiry; down and it will be dull, soft and lacking definition. The degrees to which these flaws are audible will, as before, depend on the extent of the

# Some of the reasons why other turntables don't perform quite like a Dual.

Because of the wide acceptance and acclaim Dual has earned over the years, especially among audio experts, many Dual features inevitably appear on competitive turntables.

To copy a Dual feature is one thing. To achieve Dual performance and reliability is quite another matter. The true measure of a turntable's quality is not its features alone, but how well the entire unit is designed and manufactured.

Following are just some of the ways in which Duals differ from other automatic turntables.

## Gyroscopic gimbal suspension.

The gyroscope is the best known scientific means for supporting a precision instrument that must remain perfectly balanced in all planes of motion. That is why the tonearms of the 1218 and 1229 are suspended in true, twin-ring gimbals.

Every Dual gimbal is hand-assembled and individually checked with gauges especially developed by Dual for this purpose. This assures that the horizontal bearing friction of the 1229 for example will be no greater than 0.015 gram, and vertical friction no greater than 0.007.

## True single-play automatic tonearm.

A turntable of the 1229's caliber is used primarily in its single play mode, so the tonearm is designed to parallel a single record on the platter. For multiple-play, the entire tonearm base is moved up to parallel the tonearm to the center of the stack.

The 1218 tonearm provides the single-play adjustment within the cartridge housing, and the cartridge pivots around the stylus tip to maintain the correct overhang.

## Stylus pressure around pivot.

Today's finest cartridges, designed to track at around one gram, have little margin for error. In the 1229, therefore, the tracking pressure scale is calibrated within 0.10 gram from 0 to 1.5 grams.

To maintain perfect balance on every Dual tonearm, stylus pressure is applied internally and around the pivot. This is accomplished by a very long spring coiled around the pivot. Only a small portion of the spring's length is needed to apply the required pressure, thus contributing greatly to the accuracy of the calibrations.

## Avoiding sounds that weren't recorded.

The rotor of every Dual motor is dynamically balanced in all planes of motion. Each motor pulley and drive wheel is also individually examined with special instruments to assure perfect concentricity.

Any residual vibration within the motor is isolated from the chassis by a three-point damped suspension. Finally, every assembled Dual chassis is "tuned" to a resonance frequency below 10 Hz.

## The best guarantee.

All these precision features and refinements don't mean that a Dual turntable must be handled with undue care. So we're not being rash when we include a full year guarantee covering both parts and labor for every Dual. That's up to four times the guarantee you'll find on other automatic units.

Now if you'd like to know what several independent test labs say about Dual, we'll send you complete reprints of their reports.

Better yet, just visit your franchised United Audio dealer. You'll see for yourself that only a Dual performs precisely like a Dual.



Dual 1214, \$109.50

Dual 1216, \$139.50

Dual 1218, \$159.50

Dual 1229, \$225.00

United Audio Products, Inc., 120 So. Columbus Ave., Mt. Vernon, N.Y. 10553

Exclusive U.S. Distribution Agency for Dual.

**CIRCLE NO. 36 ON READER SERVICE CARD**



deviations from flat, according to the dB scale.

Now, look for slight peaks or severe troughs in the curve. Low-end deviations will add heaviness or subtract certain notes from the sound. Lower-middle to upper-middle deviations will cause various kinds of colorations in the sound. Treble peaks above about 5000 Hz cause roughness, metallic edge, or excessive and spitty sibilance.

Finally, observe what the curve does above 8 kHz. If it rises, details will be enhanced but sibilance and hard transients will be exaggerated. If it falls above 8 kHz, the sound will be sweet, somewhat soft, and deficient in snap (transient information).

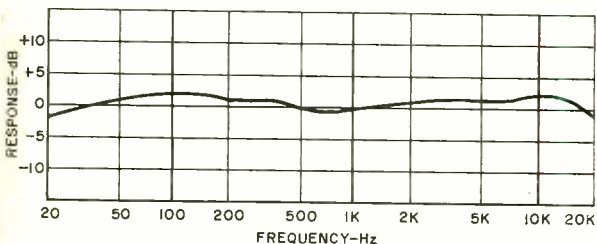
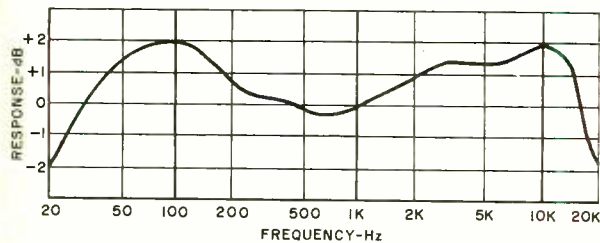

most extended high end you can afford, a mike that tapers off above 8 kHz rather than rising above there (if you can't find one that's flat to 15 kHz). For classical or quiet folk voice, the low end is unimportant, and a mike that rises slightly (3 dB or so) from 500 to 5000 Hz is ideal. For large choruses, low-end smoothness is secondary to high-end smoothness, and the range above 8 kHz should taper off rather than rise. For close voice or rock recording, extended low end is called for, as is a gradual rise from around 1000 to 8000 Hz, with a fall above that. A general rule of thumb is: for classical recording, you want the smoothest and most uniform response across the whole

Fig. 3. Which mike has smoothest response? Neither. They're identical curves but drawn with different scales for decibels.

Incidentally, when comparing mike curves, be sure you take into account the scale used for the curve (Fig. 3).

**The Choice.** Now it's decision time. Unless you feel you can justify a \$1000 mike setup, you are going to have to sacrifice some frequency range at the top or bottom, or both, and also some smoothness in between. Should you pick a mike that lacks 10 Hz or so of low-end range but has a smoother and more extended top than the competition? Or should you opt for the best low end you can afford and give up some assets at the high end? That's something only you can decide. However, here are a few pointers.

If your first love is organ music, you'll want all the low-end range you can get, but not low-end rise. If you expect to be doing a lot of recording of music in which strings play a major role, choose the smoothest and

audio range; for pop-type recording, good low end but a generally rising response above 1000 Hz.

Most home recordists, who aren't overly critical of sound but want something considerably better than just good, usually find what they are looking for in the range between \$45 and \$100 per mike. Picky recordists with better-than-average hi-fi systems at home usually find something in the range of \$90 to \$200 (per mike); while the real live-recording aficionados who have access to performing groups good enough to warrant top-notch recordings frequently jump in with both feet and invest in professional condenser mikes. The best mikes in the world won't assure a good recording if your technique is poor; but if your mikes don't have what it takes, it won't matter much how good your recording technique is, you won't wind up with a decent recording. ♦

# FREE BA 1974 ANNUAL CATALOG

WRITE FOR IT TODAY!

THE WORLD'S MOST COMPLETE  
CATALOG OF EVERYTHING  
IN ELECTRONICS

INDEX PAGES  
273 & 274



OUR  
48th  
YEAR

PRICE  
\$2.00

ANNUAL CATALOG 741

**burstein-  
applebee**

FOR FAST MAIL ORDER SERVICE  
SEND YOUR ORDERS TO...  
3199 MERCIER  
KANSAS CITY, MISSOURI 64111  
PHONE (816) 531-5614

## 276 PAGE RADIO, TV & ELECTRONICS CATALOG . . .

Containing the latest in . . . Stereo, Hi-Fi,  
TV's, Radios, Tape Recorders, CB, Kits,  
Tools and Books . . . PLUS 200 Pages of  
Electronic Parts.

BURSTEIN-APPLEBEE  
DEPT. PE 3199 MERCIER ST.  
KANSAS CITY, MO. 64111

NAME \_\_\_\_\_  
ADDRESS \_\_\_\_\_  
CITY \_\_\_\_\_  
STATE \_\_\_\_\_ ZIP \_\_\_\_\_

# CIE graduate builds two-way radio service business into \$1,000,000 electronics company!

How about YOU? Growth of two-way transmitters creates demand for new servicemen, field and system troubleshooters. Licensed experts can make big money. Be your own boss, build your own company. And you don't need a college education.

Two-way radio is booming. There are already nearly seven million two-way transmitters for police cars, fire department vehicles, taxis, trucks, boats, planes, etc., and Citizens Band uses. And the number keeps growing by the thousands every month. Who is going to service them? You can — if you've got the know-how!

## Why You'll Earn Top Pay

One reason is that the United States Government doesn't permit anyone to service two-way radio systems unless he's *licensed* by the FCC (Federal Communications Commission).

Another reason is that when two-way radio men are needed, they're *really* needed! A two-way radio *user* must keep those transmitters operating at all times. And, they *must* have their frequency modulation and plate power input checked at regular intervals by licensed personnel to meet FCC requirements.

As a licensed man, working by the hour, you would usually charge at least \$5.00 per hour, \$7.50 on evenings and Sundays, plus travel expenses.

Or you could set up a regular monthly retainer fee with each customer. Your fixed charge might be \$20 a month for the base station and \$7.50 for each mobile station. Studies show that one man can easily maintain at least 135 stations — averaging 15 base stations with 120 mobiles! This would add up to at least \$12,000 a year.



Edward J. Dulaney, Scottsbluff, Nebraska, (above and at right) earned his CIE Diploma in 1961, got his FCC License and moved from TV repairman to lab technician to radio station Chief Engineer. He then founded his own two-way radio business. Now, Mr. Dulaney is also President of D & A Manufacturing, Inc., a \$1,000,000 company building and distributing two-way radio equipment of his own design. Several of his 25 employees are taking CIE courses. He says: "While studying with CIE, I learned the electronics theories that made my present business possible."

## Be Your Own Boss

There are other advantages, too. You can become your own boss — work entirely by yourself or gradually build your own fully staffed service company. Of course, we can't promise that you will be as successful as Ed Dulaney, or guarantee that you'll establish a successful two-way radio business of your own, but the opportunities for success are available to qualified, licensed men in this expanding field.

## How To Get Started

How do you break in? This is probably the best way:

1. Without quitting your present job, learn enough about electronics fundamentals to pass the Government FCC exam and get your Commercial FCC License.
2. Then get a job in a two-way radio service shop and "learn the ropes" of the business.
3. As soon as you've earned a reputation as an expert, there are several ways you can go. You can move *out* and start signing up and servicing your own customers. You might become a franchised service representative of a big manufacturer and then start getting into two-way radio sales.

Cleveland Institute of Electronics has been successfully teaching Electronics for over 37 years. Right at home, in your spare time, you learn Electronics step by step.



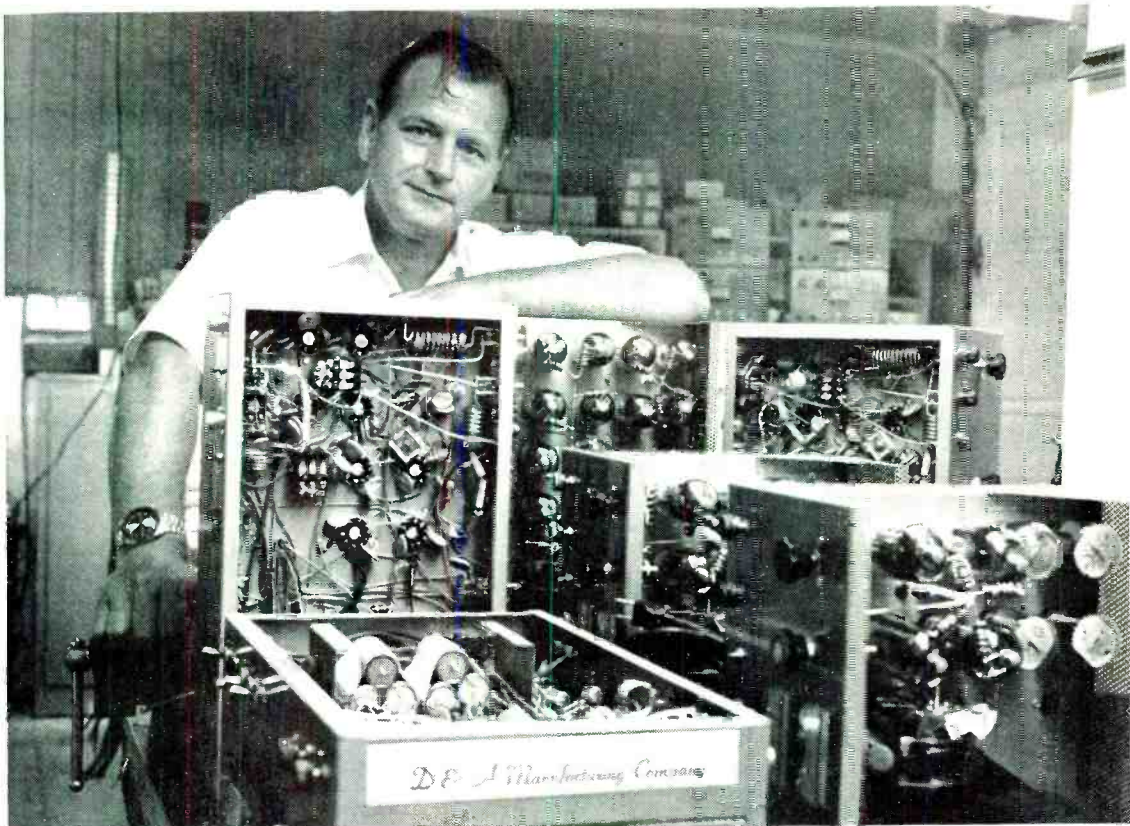

CIE's AUTO-PROGRAMMED® Lessons remove the roadblocks by using simple, concise examples. You learn in small, compact steps — each one building on the other!

You'll learn not only the fundamentals that apply to all electronics design and servicing, but also the specific procedures for installing, troubleshooting, and maintaining two-way mobile equipment.

### You Get Your FCC License... or Your Money Back!

By the time you've finished your CIE course, you'll be able to pass the FCC License exam. A recent survey of 787 CIE graduates reveals that better than 9 out of 10 CIE grads passed the FCC License exam. That's why we can offer our famous Money-Back Warranty: when you complete any CIE licensing course, you'll be able to pass your FCC exam or be entitled to a full refund of all tuition paid. This warranty is valid during the completion time allowed for your course. You get your FCC License — or your money back!

### It's Up To You

Mail the reply card for two FREE books, "Succeed in Electronics" and "How To Get A Commercial FCC License." For your convenience, we will try to have a representative call. If card has been removed, mail coupon or write: Cleveland Institute of Electronics, Inc., 1776 E. 17th St., Cleveland, Ohio 44114.

### APPROVED UNDER G. I. BILL

All CIE career courses are approved for educational benefits under the G.I. Bill. If you are a Veteran or in service now, check box for G.I. Bill information.

**Cleveland Institute of Electronics, Inc.**

1776 East 17th Street, Cleveland, Ohio 44114  
Accredited Member National Home Study Council

Please send me your two FREE books:  
1. Your book on "How To Get A Commercial FCC License."  
2. Your school catalog, "Succeed in Electronics."

I am especially interested in:

<input type="checkbox"/> Electronics Technology	<input type="checkbox"/> Electronic Communications
<input type="checkbox"/> Broadcast Engineering	<input type="checkbox"/> Industrial Electronics
<input type="checkbox"/> First Class FCC License	<input type="checkbox"/> Electronics Engineering
<input type="checkbox"/> Electronics Technology with Laboratory	

Name \_\_\_\_\_ (Please Print)  
Address \_\_\_\_\_  
City \_\_\_\_\_  
State \_\_\_\_\_ Zip \_\_\_\_\_ Age \_\_\_\_\_

Veterans & Servicemen: Check here for G. I. Bill information

PE 50

CIRCLE NO. 4 ON READER SERVICE CARD

**You were  
born smart.**



# Make it pay off in the Navy.

Get advanced technical training in electronics or nuclear power.

If you're a high school graduate who can meet our qualifications, the Navy will offer you over \$17,000 worth of advanced technical training in our Advanced Electronics or Nuclear Power Programs.

These are very special programs, and the academic schedule will be tough . . . calling for plenty of concentration and honest effort. It'll take more than a good mind to make it. You'll need a strong desire to learn and achieve. And a willingness to do your share of the house-keeping chores. But any man who learns to operate or

repair the Navy's sophisticated electronic systems or nuclear power plants, guarantees himself a firm foothold in the future, whether he stays in the Navy or not.

For more details, talk to your local Navy Recruiter. Or mail the coupon below. Or call toll-free, anytime, 800-841-8000.

**Be someone special  
in the New Navy.**

TO: Captain Robert W. Watkins, USN 352  
Building 157, Fourth Floor  
Washington Navy Yard  
Washington, D.C. 20374

Please send more information on  
 Advanced Electronics Program  
 Nuclear Power Program  
 Other Navy career opportunities.

If you really don't want to wait,  
call 800-841-8000 toll-free  
(24 hours a day, seven days a week).  
In Georgia, call 800-342-5855. Call collect  
in Alaska—272-9133, in Hawaii—533-1871.

Name \_\_\_\_\_ Age \_\_\_\_\_  
Address \_\_\_\_\_  
City \_\_\_\_\_ Phone \_\_\_\_\_  
State \_\_\_\_\_ Zip \_\_\_\_\_

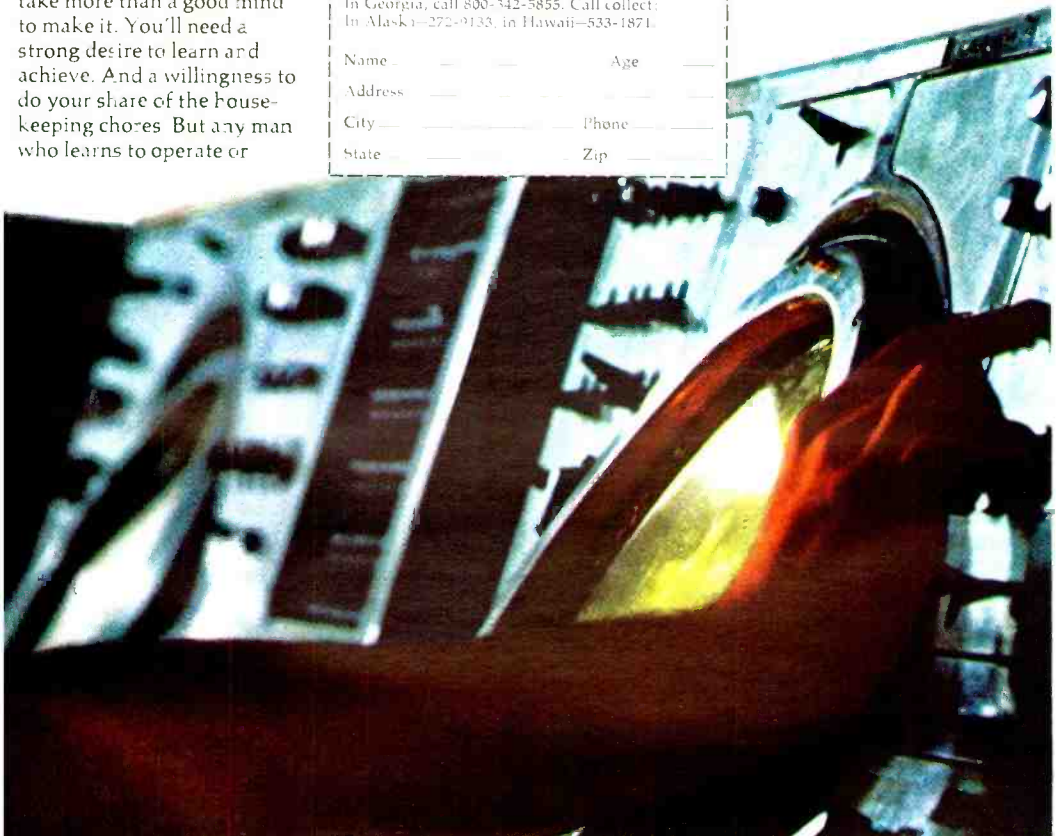



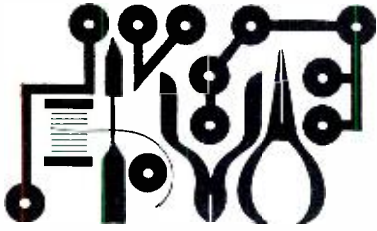

# Hobby Scene

## A "Bug" for the Ham

**Q.** I am studying for my ham ticket. Is there an easy way to make an electronic "bug" type of Morse key? At present I can copy almost 10 wpm and feel that a fast key would help me very much.

**A.** The circuit shown below is one of the simplest Morse bugs we have seen. The sensitive relay can be used to drive a code practice oscillator. Spacing is varied by changing the value of the transistor's collector resistor. Speed range is from about 10 to about 30 wpm. Once you get it working, you may have to "diddle" with the values of the various resistors to get a machine-like transmission. Just about any pnp transistor can be used.

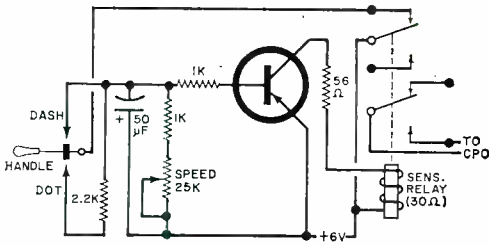

## Noise Limiter for SWL's

**Q.** As an avid SWL, I have often experienced tremendous hearing shocks when using headphones and listening to a weak shortwave station when either lightning starts up somewhere or a car with bad ignition drives past my house. Is there some way to save my ears, without making any changes to the receiver?

**A.** The circuit shown here is coupled to the audio output (speaker) of the receiver. The input resistor is about 10 ohms. Set *R1* so that the diodes just clip (produce distortion). Any signal or noise greater in ampli-

tude than this will be limited. This will not improve reception, but it will save your ears.

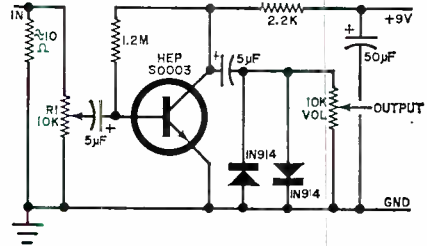

## Checking Unmarked Crystals

**Q.** I have a number of unmarked crystals. How can I determine what frequencies they are and whether or not they are good?

**A.** Shown here is a circuit using a conventional 10,000-ohms/volt (or better) dc voltmeter, preferably a VTVM or TVM, and a reasonably well calibrated r-f signal generator. Tune the signal generator until the voltmeter deflects sharply. At this point, the crystal is resonant with the generator frequency. You can check the overtone mode by changing the generator to the third, fifth, or higher harmonics. Some crystals perform better in the overtone mode. The diode used can be just about any signal type.

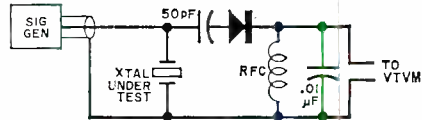

Have a problem or question on circuitry, components, parts availability, etc.? Send it to the Hobby Scene Editor, POPULAR ELECTRONICS Including Electronics World, One Park Ave., New York, NY 10016. Though all letters can't be answered individually, those with wide interest will be published.

A significant advance in the state-of-the-art

# THE PICKERING XV-15/1200E CARTRIDGE



unequaled for precision in design and performance.

"PRECISION" is the one word that best characterizes the extraordinary quality of the new Pickering XV-15/1200E cartridge, the culmination of Pickering's 25 years in contributing important technological advances to the manufacture of magnetic cartridges.

Its exceptional design and performance accords it a DCF

(Dynamic Coupling Factor) rating of 1200. Naturally, it delivers 100% Music Power.

This cartridge is for the sophisticate — one who possesses components of such superlative quality that the superiority of the XV-15/1200E is a requirement. \$79.95 audiophile net. Write Pickering & Co., Dept. E, 101 Sunnyside Blvd., Plainview, N.Y. 11803.

#### SPECIFICATIONS

Frequency Response:	10 Hz to 30 KHz
Nominal Output:	4.4 mV
Channel Separation:	
Nominal:	35 dB
Stylus Tip:	0.0002" x 0.0007" Elliptical Diamond
Tracking Force:	¾ gram, + ½ gram, - ¼ gram



*"For those who can hear the difference"*

All Pickering cartridges are designed for use with all 2 and 4-channel matrix derived compatible systems.

CIRCLE NO. 24 ON READER SERVICE CARD



# News Highlights

## Electronic Project Design Contest

Motorola HEP Semiconductors has announced the "Design-In," an electronic project design contest offering scholarship prizes totaling \$9000. Winners can use the scholarships at any school of their choice or transfer them to another individual. The contest will be divided into two categories: non-professional and professional engineers. It is open to students, hobbyists, experimenters, technicians, inventors, teachers, and professional engineers and will run from July 1 through Dec. 31, 1973. Contest entry blanks are available at more than 1500 HEP suppliers throughout the U. S., Canada, and the Caribbean area. Projects must have a total parts cost of less than \$100 and must use at least two HEP semiconductors.

## Notes on the Consumer Electronics Show

Possible hi-fi components trends observed at the recent Consumer Electronics Show included receivers with full provision for 4-channel record sources (SQ and QS matrices and CD-4). Superscope, announcing a new line of hi-fi products to be marketed under its brand name, displayed a stereo receiver which achieves 4-channel effect from both stereo and matrix-encoded sources and has an input to accommodate an outboard decoder or demodulator and an output jack for 4-channel FM to accept a decoder or adaptor. The key word here is "non-obsolescence" . . . Remember when the words, "record changer" were discarded in favor of "automatic turntable" to denote a high-quality changer that could be played in a manual mode? Now there are a host of automatic turntables that cannot play a stack of records. They are single-play units with automatic start, cue and stop (with arm return to rest). Dual (United Audio) exhibited one with an electronic drive system . . . In the tape area, Dolbyized cassette players were evident wherever one looked. TEAC even introduced a car stereo cassette player/stereo FM radio with built-in Dolby. Magnetic Video showed a cassette recorder and copier that compresses speech up to 2½ times normal speed with no change in pitch or tone and can be played back with a conventional cassette machine. JVC showed an 8-track, 4-channel cassette deck, breaking the quadraphonic ice. Can prerecorded 4-channel tapes be far behind? . . . A number of new and interesting loudspeakers were displayed at the Show. For example, British Industries demonstrated a new loudspeaker system that was small in size but able to produce full bass at high efficiency using a different bass reinforcement principle: the rear wave from the speaker passes through a "venturi" duct. Also novel, a thermistor sensor in the system effects a dynamic equalizer for Fletcher-Munson equal loudness characteristic curves by automatically adjusting bass and treble in accordance with the power fed into it. Several manufacturers exhibited vertical-column speakers in which the woofer radiates vertically to produce an omnidirectional sound source. Some of the woofers were especially designed for their systems. Examples include units made by Ohm Acoustics, RTR and Hegeman Labs . . . There were several electrostatic headphones at the show, too. One set (by



Janszen) was designed to "hover" over the ears rather than using a tight ear seal . . . There were a number of non-TV, non-hi-fi items at the Show. One example was a cordless, wireless extension telephone from Fonetron Inc. This unit, with a range of several hundred feet from its base unit, permits the user to make phone calls without being literally "tied to the phone cord." A myriad of electronic calculators was exhibited, too, indicating that 1974 is expected to be an even hotter sales year than 1973 for those devices.

### **Video Tape and Disc Unveilings**

A new type of color video projection system, from Sony Corp. of America, is being delivered to the company's network of audio-visual dealers throughout the U. S. and Canada. The complete system, priced at about \$3000 can project prerecorded programs from a video player, or it can project programs taken off the air with the aid of the TCV tuner/adaptor . . . AKAI America is displaying a new, compact, completely portable color video tape ( $\frac{1}{4}$  in.) recorder/camera system that features automatic editing. The system will sell for about \$5500 . . . The Disco-Vision video disc was demonstrated recently before a large audience in Chicago. The disc, developed by MCA Inc., played for a full 21 minutes; both video and audio were recorded on the disc.

### **Increase in Demand for Engineers**

Employment of engineers and scientists in industrial research organizations is growing again, according to a report from the Engineers Joint Council. Using employment as of January 1971 as a starting point, the number of engineers and scientists in nearly all categories declined through that year but had already begun to recover by the end of 1972. By the end of 1973 the number employed in industrial research should be about 4 percent higher than it was in 1971, and all sectors foresee further growth in the years immediately ahead.

### **Novel Use of Light Emitting Diodes**

An interesting use of LED's is being made in some of Zenith's new FM tuners in the company's high-power modular units. Three of these semiconductor devices located on the dial scale pointer are arranged in a red/green/red sequence. When the red diode on either side of the pointer is lighted, the station is not tuned properly. When the center green diode lights, the station is tuned dead center for the best possible signal reception.

### **Second Source for Sanyo Transistor**

Technicians and repair agencies have been looking for years for a domestic source of replacement for the widely used Sanyo 2SB464(G) transistor. Such a device is now being marketed by International Rectifier Corp. Semiconductor Division. IR's new IRTR94MP is an exact replacement for the Sanyo transistor because the pin spacing is slightly wider than the standard TO-66 configuration.

### **New FCC Exam Questions**

The Federal Communications Commission has issued revised study questions for the examinations for novice, general, conditional and technician licenses. Particularly for the novice license, the FCC test will be somewhat stiffer. For example, among the 34 non-regulatory questions, the applicant for a novice license will find eight that either require or are based on circuit diagrams.

# There are more low-cost Heathkit projects than ever...

starting for as little as \$5!

These low-cost Heathkit projects represent great values on electronic items you could pay up to twice as much for in assembled form. But they are also great kits for the first-time Heathkit builder, or the youngster who has been wanting to try a sophisticated electronics project. All the kits shown can be assembled in one or two evenings' time with conventional hand tools and a soldering iron. The assembly instructions begin with a quick course in soldering then take the builder into the famous Heathkit check-by-step assembly manual. After the kit is completed and working, the builder can go on to the circuit description sections which tell him how and why his kit works.

And finally, only Heath gives its customers this unique pledge: "We won't let you fail". If a Heathkit builder has any problem before, during or after assembly, he has a nation-wide technical consultant staff backing him up. These technicians, at the Benton Harbor plant and Heathkit Electronic Centers in major metropolitan areas are the "big brothers" of the Heathkit fraternity. They are always pleased to lend a helping hand... free. For as little as \$5, a Heathkit product could be the most worthwhile investment you'll ever make.

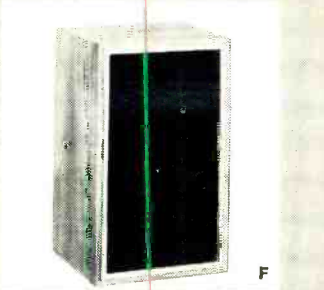
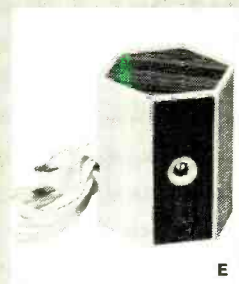
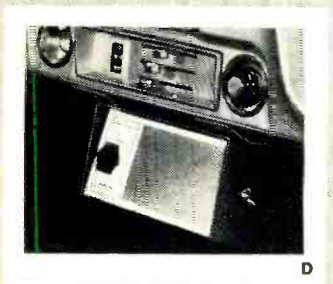
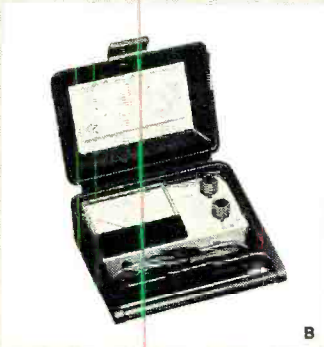
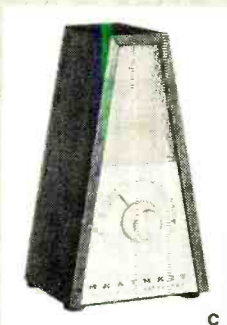
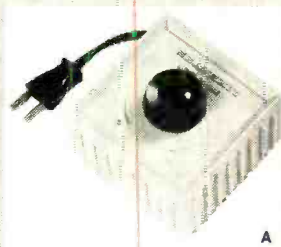

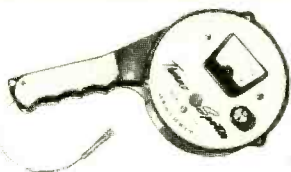

**A. Heathkit Lamp Dimmer** — lets you adjust brightness of table or floor lamps smoothly from full on to complete invisibility. A simple, useful kit, and an interesting introduction to Triac and Diac phase-controlled switches. Handles up to 300 watts.

Kit GD-1018, 2 lbs. .... 7.95\*

**B. Heathkit Tune-up Meter** — a 3-in-1 diagnostic instrument for 4-cycle, 3, 4, 6 and 8-cylinder engines having conventional (Kettering) ignition systems. Includes two-range tachometer to 4500 rpm, dwell meter, and voltmeter reading 0-15 volts. Completely portable.

Kit ID-29, 5 lbs. .... 29.95\*

**C. Heathkit Electronic Metronome** — provides professional accuracy in tempos from 40 to 210 beats per minute. Has adjustable volume control and includes chart relating tempos in time signatures to beats per minute. Uses two 9-volt batteries (not supplied).

Kit TD-17, 2 lbs. .... 9.95\*

**D. Heathkit Cab-to-Camper Intercom** — gives instant two-way communication between truck cab and cab-over camper or shell. Great for boats, too. Camper unit has switch position for listening to cab radio. Includes mounting brackets and 15' cable. 12-volt automotive system provides power.

Kit GD-160, 5 lbs. .... 25.95\*

**E. Heathkit Photoelectric Lamp Switch** — turns on a lamp when you're away. Adjustable sensitivity control lets you set unit to operate at various levels of darkness. No timers to set — electronic circuitry is fully automatic to compensate for changes in daylight hours during the year. Operates on 120 VAC household current.

Kit GD-600, 1 lb. .... 5.00\*

**F. Heathkit Bookshelf Speaker System** — excellent reproduction with any audio system having 4 watts or more per channel. Has 4 1/2" high-compliance cloth-suspension speaker with sealed acoustic suspension cabinet. Measures 12" H x 7" W x 6" D. Useful frequency response extends from 70 Hz to 16 kHz. Order a pair for stereo.

Kit AS-106, 10 lbs. .... 19.95\*

**G. Heathkit Code Practice Oscillator** — great for beginning and novice amateur radio operators. Has tone and volume controls, built-in speaker, headphone jack, blinker light. Includes key, phone plug, cord. Uses two 9-volt and one "C" battery (not supplied).

Kit HD-16, 3 lbs. .... 9.95\*

**H. Heathkit Thermo Fish Spotter** — an all-solid-state thermometer with self-contained reel and 100' cable so you can find the depth where your gamefish are likely to be feeding. Kit includes fish temperature preference charts, calibrating thermometer and line depth marking material. Uses one 9-volt battery (not supplied).

Kit MI-104, 3 lbs. .... 24.95\*

**I. Heathkit 4-Watt Monophonic Amplifier** — all solid-state. Excellent frequency response and low distortion. Has inputs for ceramic phono cartridge, mono AM or FM tuner or tape recorder, plus front-panel headphone jack. Drives 4 to 16 ohm speakers.

Kit AA-18, 4 lbs. .... 19.95\*

**J. Heathkit Portable AM Radio** — tuned-in to today's look, turns on to the sounds of AM. Has big 3 1/2" speaker, RF amplifier stage, automatic gain control — quality features not usually found on portables. Uses one 9-volt battery (not supplied).

Kit GR-1008, 2 lbs. .... 14.95\*

**K. Heathkit Telephone Amplifier** — lets you carry on conference calls or cook dinner while using the phone. And the special acoustic-coupled design means you can use it with virtually any telephone hand set. Amplifies incoming signal only. Includes speaker and 8' extension cord. Uses one 9-volt battery (not supplied).

Kit GD-1024, 2 lbs. .... 14.95\*

Visit your nearest Heathkit Electronic Center... or send for FREE catalog

**HEATHKIT ELECTRONIC CENTERS — ARIZ.:** Phoenix; **CALIF.:** Anaheim, El Cerrito, Los Angeles, Pomona, Redwood City, San Diego (La Mesa), Woodland Hills; **COLO.:** Denver; **CONN.:** Hartford (Avon); **FLA.:** Miami (Hialeah); **GA.:** Atlanta; **ILL.:** Chicago, Downers Grove; **IND.:** Indianapolis; **KANSAS:** Kansas City (Mission); **MD.:** Baltimore; **ROCKVILLE, MASS.:** Boston (Wellesley); **MICH.:** Detroit; **MINN.:** Minneapolis (Hopkins); **MO.:** St. Louis; **N.J.:** Fair Lawn; **N.Y.:** Buffalo (Amherst), New York City, Jericho; **L.I.:** Rochester; **OHIO:** Cincinnati (Woodlawn), Cleveland; **PA.:** Philadelphia, Pittsburgh; **R.I.:** Providence (Warwick); **TEXAS:** Dallas, Houston; **WASH.:** Seattle; **WIS.:** Milwaukee.



World's largest selection of electronic kits

HEATH COMPANY, Dept. 10-9  
Benton Harbor, Michigan 49022

HEATH

Slumberger

Please send FREE Heathkit Catalog.

Enclosed is \$ \_\_\_\_\_, plus shipping.

Please send model(s) \_\_\_\_\_

Name \_\_\_\_\_

Address \_\_\_\_\_

City \_\_\_\_\_

State \_\_\_\_\_

Zip \_\_\_\_\_

\*Mail order prices; F.O.B. factory.

CL-480R



# Technology must be confirmed by performance.

## Here are the judgments of the most respected critics and reviewers.

"After a time trial measured in months rather than weeks, this one can definitely proclaim Bose is best, big or small, high or low."  
Irving Kolodin  
SATURDAY REVIEW

"...If your response to it is like ours, you'll be reluctant to turn it off and go to bed."  
Norman Eisenberg,  
HIGH FIDELITY

"It is our opinion that this is the speaker system to own, regardless of price if one wants the ultimate in listening pleasure."  
e/e HIGH FIDELITY

"To hear a thunderous "low C" organ pedal..., or a clean, weighty impact of a bass drum is truly impressive... There is no doubt that the much abused and overworked term "break-through" applies to the Bose 901 and its bold new concepts."  
Bert Whyte — AUDIO

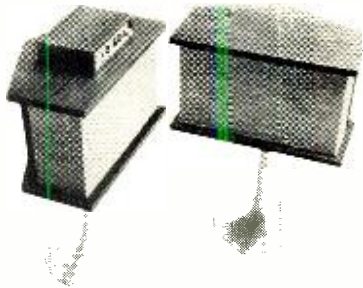

The most highly reviewed speaker regardless of size or price.

"...I must say that I have never heard a speaker system in my own home which could surpass, or even equal, the Bose 901 for overall 'realism' of sound."  
Hirsch-Houk Laboratories,  
STEREO REVIEW

"The Bose have replaced forever our bulky studio speakers with compact, handsome units. The only trouble is — our studio is beginning to look like a living room!"  
DOWNBEAT

"I urge that you listen for yourself. I think you will have to agree that Bose has, in a single giant step, produced one of the finest speaker systems ever made."  
AMERICAN RECORD GUIDE

"But these speakers provide a quality which is not to be matched."  
STEREO & HI FI TIMES

"The 901 is very possibly the only speaker to date to actually pour fourth in true concert hall fashion."  
HI -FI BUYER'S GUIDE

For complimentary copies of the reviews, circle your reader service card or write Dept. EP

The one review that really will convince you is your own. We invite you to compare the BOSE 901 Direct/Reflecting® Speaker with any conventional speaker, and hear the difference for yourself.

You can hear the difference now...

# BOSE®

The Mountain, Framingham, Mass. 01701

CIRCLE NO. 3 ON READER SERVICE CARD

BY THOMAS R. FOX

CONSTRUCTION

# EARLY WARNING STORM FORECASTER



*Thunderstorm detector alerts picnickers,  
golfers, fishermen with light and sound.*

**S**udden violent storms cause many millions of dollars worth of damage in the United States every year. Even worse, they sometimes cause the loss of human lives. In most cases, such storms are detected in advance by authorities and emergency announcements are made on local radio and TV broadcasts.

However, many times people are not listening to such broad-



casts. They may be sleeping, boating, camping out, golfing, or just sunning on the beach. If they can get sufficient warning, they can take steps to protect themselves and their property from the elements. That is the purpose of the Storm Forecaster.

The Forecaster uses the lightning flashes that often announce the approach of a storm to turn on a warning light or provide an audible alert signal. Since it is battery powered, the device can be used far from the commercial power line. The detection range can be preset to a value of a few miles to several hundred miles and when a storm comes within the detection range, the warning is given.

Lightning flashes create radio waves that can best be detected in the frequency range between 100 kHz and 1 MHz (long waves at the lower end of the conventional broadcast band). If you tune a conventional radio to the 550-kHz end of the broadcast band, weak lightning crashes as much as 100 miles away will cause static on the radio. The louder the static, the closer the storm.

Because of the avc (automatic volume control) action in most radios, and if you are listening to a station on the low end of the dial, the static will be louder on a radio tuned to a weak station than on one tuned to a strong station.

In addition to signalling the approach of a possibly dangerous thunderstorm, the Forecaster is useful indoors as a tornado warning device. There is a strong relationship between severe thunderstorms and the formation of a tornado. In fact, tornados are a form of thunderstorm but the exact mechanism is not known. The U.S. Weather Service issues Tornado Watches to inform the public that weather conditions may be ripe for the formation of tornados.

When there is a Tornado Watch called for your area, just turn on the Forecaster and go about your business. This is especially helpful if the warning is called late in the evening and you want to get as much sleep as possible. The loud acoustic warning signal generated by the Forecaster will wake you up.

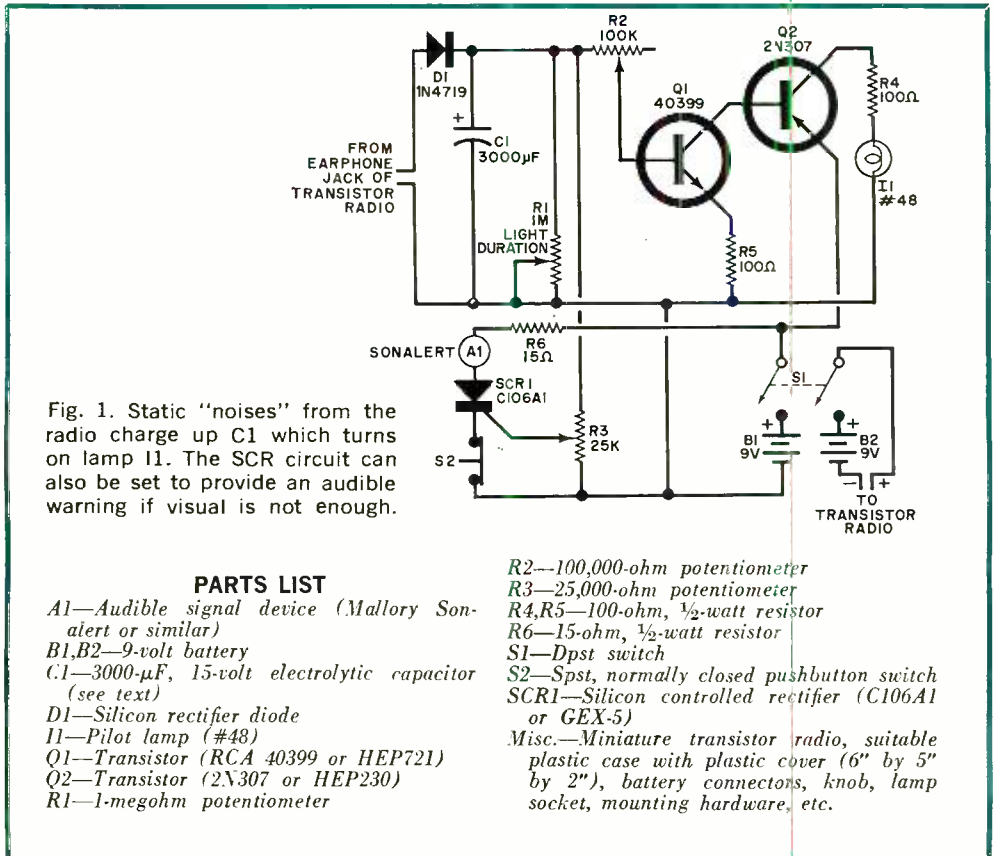



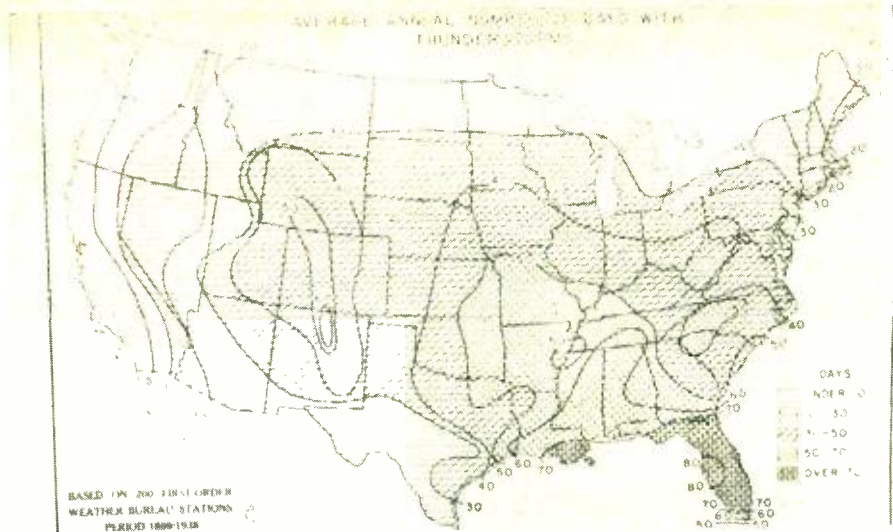

Map of U.S. shows average number of days in which thunderstorms occur in various areas.

**Construction.** The main element of the Forecaster is a small (shirt-pocket) solid-state radio. These can be purchased almost anywhere for a very low price and most are surprisingly sensitive. There are no changes to be made in the radio, except for the use of the earphone jack and cable. When not used in the Forecaster, the radio can operate quite conventionally.

The circuit shown in Fig. 1 can be assembled on a small piece of perf board or a PC board. In either case, the smaller the better. To avoid electromagnetic shielding, the outer case must be either plastic or Bakelite. Do not use a metal case. Pick a size that can accommodate the radio, the small board and two 9-volt batteries. Light duration control *R1*, the normally closed pushbutton reset switch *S2*, the thunderstorm light, the Son-alert, and the power switch are all mounted on the front (plastic) cover of the case.

Although a Sonalert is specified for the severe storm alert, you can substitute a low-current buzzer; or, if you live in a bad storm area, you can use a relay instead of the Sonalert. The relay can actuate a burglar alarm type of siren. It is also possible to substitute a sensitive relay for *R4* and *I1*, and use this relay to turn on either another audible warning device or power a much brighter (and hence more visible) light. The various modifications can be made to suit almost any condition.

The input to the circuit board is through a conventional headphone jack plugged into the transistor radio. Remove the earphone

and connect the two leads as shown in Fig. 1. This should also silence the radio.

**How It Works.** The input from the radio earphone jack is rectified by *D1* and places a charge on *C1*, which has a large capacitance value. When the charge on *C1* builds up to a sufficient value, it energizes two separate circuits. One circuit is a two-stage dc transistor amplifier (*Q1* and *Q2*) which is easily driven into saturation and whose output turns on *I1*. The second circuit consists of a sensitive SCR whose output drives the audible alert. Reset switch *S2*, when depressed, opens the cathode circuit of the SCR and turns off the alarm if *C1* is sufficiently discharged.

**Calibration.** The radio used should be tuned to the lowest frequency that is free of broadcast stations. It should be left in this position unless the Forecaster is moved to an area in which a station happens to be broadcasting at, or near, the frequency to which the radio is tuned.

Light-duration control *R1* does not have to be set at a specific point for the Forecaster to work. The purpose of the potentiometer is to provide an easy way of discharging *C1* (when desired) and a way of judging the intensity of an approaching storm by setting the potentiometer close to its minimum value. In that case, if the storm is weak, *I1* will go out periodically.

Controls *R2* and *R3* must be properly adjusted before the device can be used. Po-



Front panel of Forecaster holds warning light and a severe storm alert.

Potentiometer *R2* is basically a sensitivity control for the warning light, while *R3* controls the input current to *SCR1*. The former should be adjusted so that the thunderstorm warning light goes on at the desired amount of static. For example, you may want to be alerted if moderate thunderstorms are 100 miles (about 3 hours) away. By listening to the radar weather reports put out by the FAA on the longwave band or to a TV weather program, you can adjust *R2* so that the light just barely goes on when storms are that far away.

Potentiometer *R3* should be set so that the severe storm alert goes off when a bad storm is quite close (25 miles, for example).

The setting of this potentiometer is rather critical. Once you have adjusted *R3*, readjust *R2*.

Since thunderstorms appear when you least want them, you can give the Forecaster an initial test and adjustment by creating your own static. A soldering gun, when turned on and off rapidly, sends out a signal similar to that of a lightning flash. Corrections in this initial adjustment should, of course, be made when an actual thunderstorm appears.

If you want to be warned of the presence of a weak storm (with little lightning), use a smaller capacitance value for *C1* (2000- $\mu$ F or less). Since less current is required to charge a smaller capacitor, fewer pulses from the radio will be required to charge *C1*. With this modification, however, the thunderstorm warning light won't be on constantly during most storms and the increased sensitivity may be troublesome.

After it is checked out and adjusted, the Forecaster may falsely signal that a thunderstorm is near. In this case, some nearby electrical equipment is probably emitting pulses or electrical "hash." A faulty fluorescent light or motor may be to blame. The interference must be corrected or removed before Forecaster can function properly. ♦

## WELCOME BEACON PREVENTS STUMBLING IN THE DARK

**B**OATERS trying to find their lake-side docks or campers returning from a long hike in the woods and groping around in search of their campsites after dark will find the Welcome Beacon a handy device to have. The Welcome Beacon (see schematic) remains passive during daylight hours, drawing hardly any current at all from its power source. As dark approaches, the light falling on the *LDR* causes the light-dependent resistor's resistance to increase to a point where the circuit triggers and turns on the lamp. The entire process is automatic.

During the daylight hours, the current drain from the 12-volt dc power source (two 6-volt lantern batteries connected in series) is only a few milliamperes to conserve power. To further conserve power at night, it is

best to select a low-current 12-volt or 14-volt lamp for the beacon light. Also, use a heat sink for the output power transistor to prevent thermal runaway.

The 100-ohm potentiometer serves as a sensitivity control. It can be adjusted to permit circuit triggering under varying light conditions. ♦

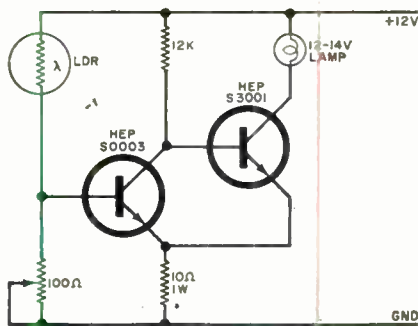

# BUILD THE MONODIGICHRON

*This unique electronic clock uses only a one-digit readout and displays hours and minutes in sequential form.*

BY MICHAEL S. ROBBINS

**T**HE Monodigichron is a true electronic digital clock featuring sequential display of tens of hours, hours, tens of minutes and minutes on one seven-segment readout device. Instead of displaying all four digits continuously in a static presentation, the Monodigichron dynamically flashes the hours and minutes in sequence at a rate of about fifteen times per minute.

The circuit uses the latest LS1-MOS integrated circuit for positive synchronization to the 60-Hz power line frequency. Two pushbuttons (fast and slow) are provided for initial time setting.

The large, bright, incandescent readout tube allows the Monodigichron to be read in total darkness as well as in brightly lit rooms. The display is all electronic and therefore completely silent. Because the readout is a bright filamentary type, any color filter may be used.

Power for the clock is supplied by a molded, plug-in transformer which is U. L. approved.

**Circuit Design.** A block diagram of the clock circuit is shown in Fig. 1, while the schematic is in Fig. 2. As in most ac digital clocks, the time base is the 60-Hz power-line frequency which is applied to a shaping circuit (*D10*, *D11*, *R9*, *R10*, and *C2*) for squaring and removal of transients. An array of flip-flops within *IC2* counts the 60-Hz input and provides one output pulse for every 60 input pulses (1 Hz). A binary coded decimal counter (BCD) totals the 1-Hz pulses and provides four output lines for display of the seconds count. (Though the seconds are not displayed in the clock described here, they are counted in the IC.) A fifth line provides one pulse every 10 seconds for the tens-of-seconds BCD count-



SEPTEMBER 1973





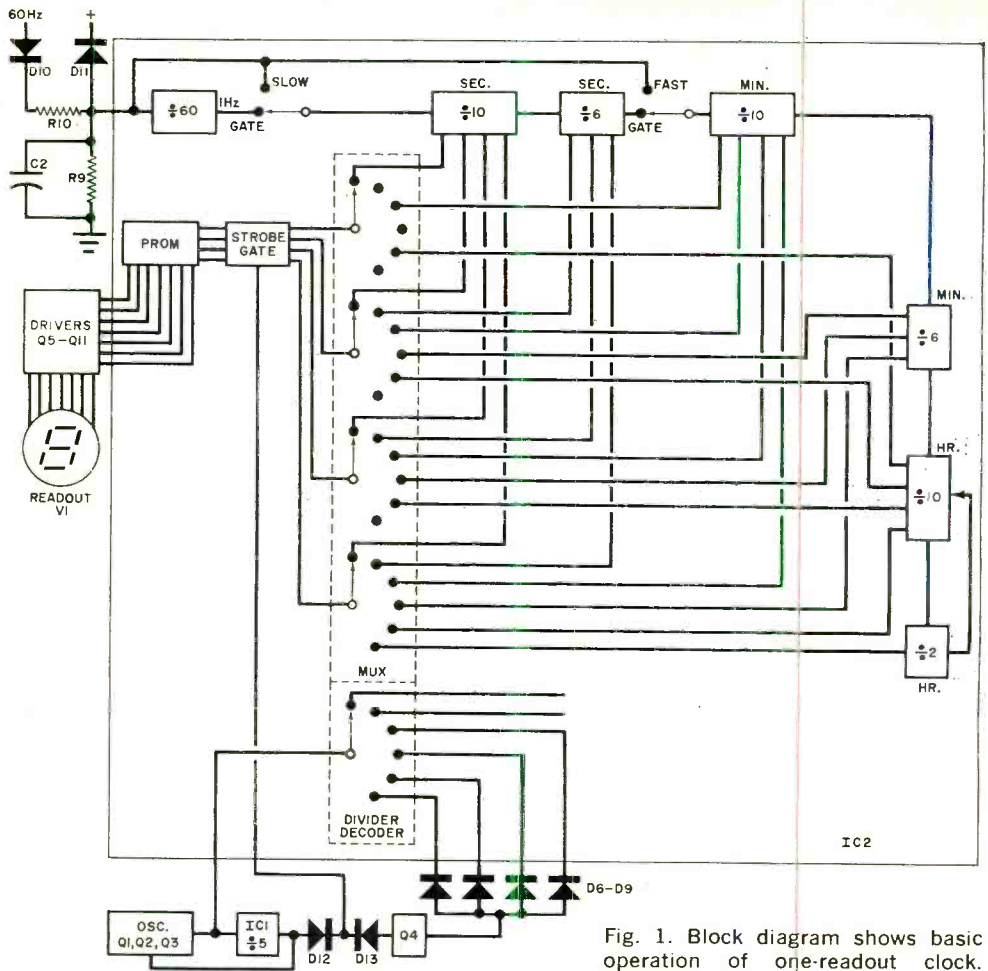

Fig. 1. Block diagram shows basic operation of one-readout clock.

er. An output and reset are incorporated to return these counters to zero on the next pulse after counting to 59 seconds. This output line also provides a one-pulse-per-minute signal for the minutes counter.

A third BCD counter counts and decodes the minutes and provides a one-pulse-per-ten-minutes output for the fourth counter. The tens-of-minutes counter provides an output pulse (one per hour) and resets on the next pulse after counting to 59 minutes.

The one-per-hour pulse is applied to a fifth BCD counter for counting and decoding. The output of this counter operates a flip-flop for the tens-of-hours count. Gating is built into these last two counters so that they will reset to one o'clock after twelve. High order zero blanking is incorporated to display 1:00 instead of 01:00.

Fig. 2. Most of the circuit is contained in the IC's and 7 driver units.

## PARTS LIST

- C1—1- $\mu$ F, 15-volt electrolytic capacitor (low-leakage type)
- C2, C4—0.01- $\mu$ F, 16-volt disc ceramic capacitor
- C3—2000- $\mu$ F, 15-volt electrolytic capacitor
- D1—5.1-volt, 1-watt zener diode
- D2-D5, D14—Rectifier diode (1N4001 or similar)
- D6-D13—Switching diode (1N914 or similar)
- IC1—7490 TTL decade counter
- IC2—Digital clock IC (National Semiconductor MM5314N)
- Q1, Q5-Q11—Npn transistor (MPS5172 or similar)
- Q2—JFET (MPF102)

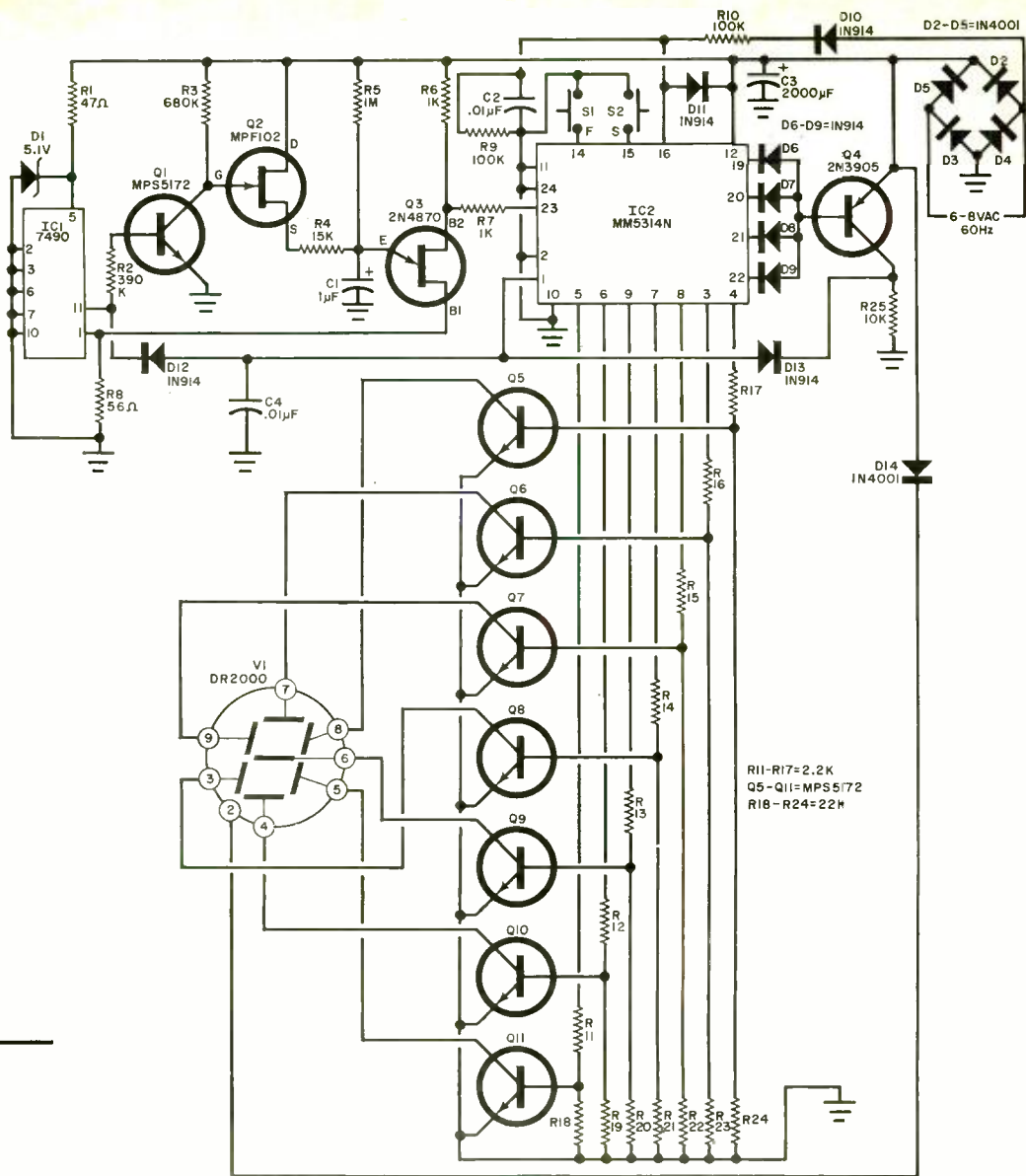

- Q3—Unijunction transistor (2N4870, 2N4871 or MU10)  
 Q4—Pnp transistor (2N3905 or similar)  
 R1—47-ohm, 1/2-watt resistor  
 R2—390,000-ohm, 1/2-watt resistor  
 R3—680,000-ohm, 1/2-watt resistor  
 R4—15,000-ohm, 1/2-watt resistor  
 R5—1-megohm, 1/2-watt resistor  
 R6, R7—1000-ohm, 1/2-watt resistor  
 R8—56-ohm, 1/2-watt resistor  
 R9, R10—100,000-ohm, 1/2-watt resistor  
 R11-R17—2200-ohm, 1/2-watt resistor  
 R18-R24—22,000-ohm, 1/2-watt resistor  
 R25—10,000-ohm, 1/2-watt resistor  
 S1, S2—Spst, normally open pushbutton switch  
 T1—External transformer; secondary: 6-8 V

at 1.75 VA (plug-in telephone dial-light type, available from most telephone equipment distributors)  
 V1—9-pin, seven-segment readout tube (RCA DR2000 or similar)  
 Misc.—Printed circuit board, Molex pins, 9-pin tube socket, cabinet, etc.  
 Note—The following are available from Caringella Electronics, Inc., Box 327, Upland, CA 91786: PC board #SDC-1PC, drilled and etched, at \$6.95, postpaid in USA; complete kit including cabinet, all parts, ac power pack, hardware, wire solder, and instructions, at \$37.50 plus \$1.50 for handling and shipping. California residents, please add 6% sales tax.

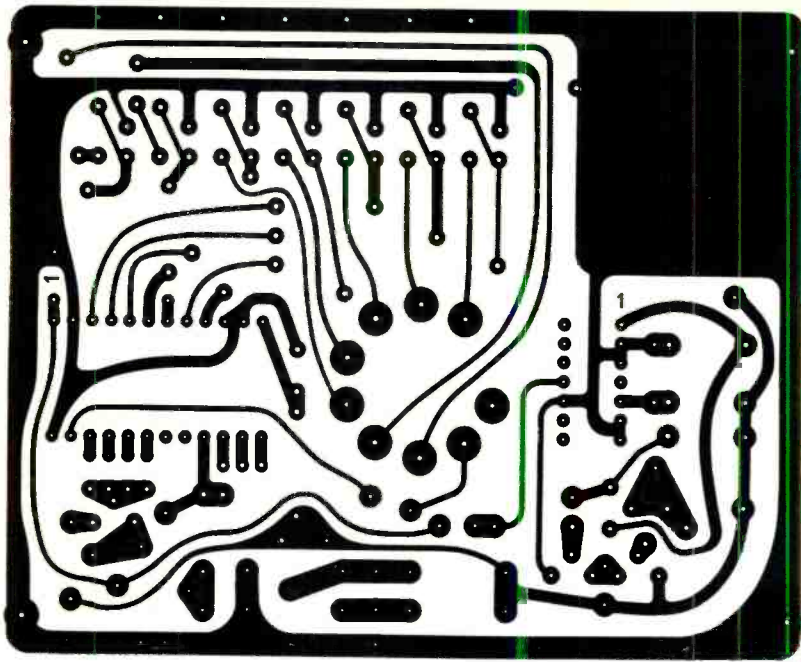
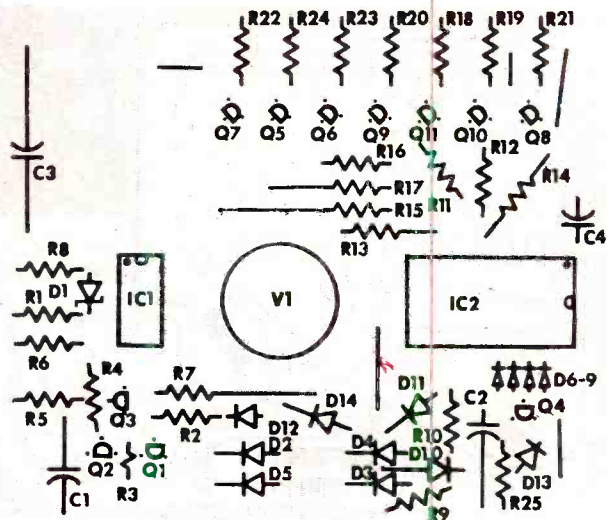

Fig. 3. The actual-size foil pattern above can be used to make a printed circuit board with parts placed as at right.



"Hurry-up" logic is built into the circuit to speed up the counting process when it is necessary to set the time. An externally operated switch (S2) bypasses the first divide-by-60 divider, increasing the count speed by a factor of 60. Another switch (S1) bypasses the first three dividers, increasing the count speed by a factor of 3600. These two switches are used to set the clock.

Since only one digit is displayed at a time, some means is required to sequentially switch the hours and minutes lines to

the display tube. This is accomplished by feeding the count outputs of all six counters to an internal output multiplexer (MUX). The MUX is essentially an electronic four-pole, six-position switch, which is continuously being operated through its six positions in the following order: seconds, tens of seconds, minutes, tens of minutes, hours, and tens of hours.

The speed and position of the MUX are controlled by its associated multiplex divider/decoder and an external oscillator



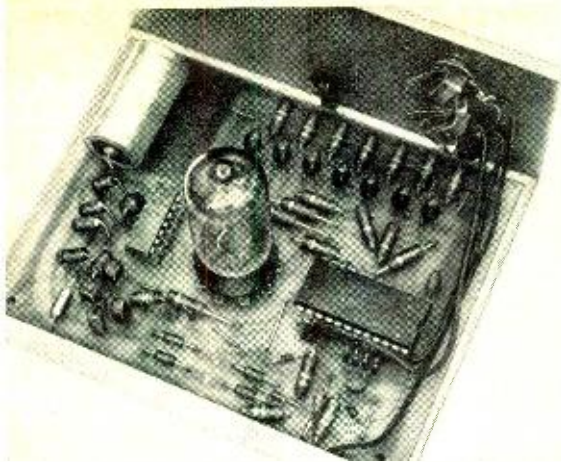

This photo shows how the parts were assembled in the author's prototype.

connected to its input. The BCD output of the MUX is fed to an on-off (output strobe) gate and then to a programmable read-only memory (PROM). The PROM is programmed during manufacture of the IC to translate the various BCD data into the seven-segment code required by the display tube.

The outputs of the MUX decoder (six but only four are used here) can be used to find out what position the MUX is in. Only one of the six is on at a time.

From the preceding description of the LSI-MOS integrated circuit, it will be noted that the multiplexer operates backwards from the desired sequential display order. Instead of going from tens of hours down to seconds, it sequences from seconds up to tens of hours. It also has the ability to display six digits, and we want only four. In this clock, the circuits external to the IC reverse the apparent direction of the MUX and eliminate the seconds and tens-of-seconds displays.

Unijunction transistor Q3 operates as a free-running relaxation oscillator providing pulses about 12 milliseconds apart to drive the multiplex divider/decoder. The period of this oscillator is determined by C1 and the parallel combination of R4 and R5. These pulses are also fed to IC1, operating as a divide-by-five circuit. On every fifth pulse, FET Q2 disconnects R4, leaving only R5 to charge capacitor C1. This increases the length of the interval between pulses 5 and 6 from about 12 milliseconds to about 750 milliseconds. The time periods or in-

tervals between oscillator pulses are the times when the BCD outputs of the MUX have information to display.

By gating the outputs through Q4 with the MUX output from the individual switches, the strobe gate blanks the seconds and tens-of-seconds displays. Additional gating (D12) is employed to blank the display during the short intervals between 5 and 10, 10 and 15, 15 and 20, etc.

Transistors Q5 to Q11 are display drivers for the individual incandescent filaments of the readout tube. The common end of all seven filaments (pin 2) is connected to the positive side of the power supply through D14.

The power supply consists of a plug-in power transformer, four silicon rectifier diodes (D2 through D5) in a bridge configuration and filter capacitor C3.

**Construction.** Although the Monodigichron can be built on a piece of perf board, a printed circuit greatly simplifies construction and reduces errors. A foil pattern is shown in Fig. 3, with a parts placement diagram. Normal precautions should be taken with the close conductor spacing on the PC board. A low-power soldering iron and fine solder should be used. If a large iron must be used, a small tip made out of #14 or #12 bare copper wire should be used. Observe the polarities of diodes, capacitors, and transistors.

Although IC2 is relatively rugged, it is recommended that no soldering be done directly to the IC pins or to the board after the IC has been installed. Molex pins are suggested to form sockets for the two IC's. Do not apply power to the board until the IC's have been installed.

The cabinet for the Monodigichron can be of any size and shape. The prototype cabinet is made of 3/4" walnut with 1/16" smoked grey plexiglass and brushed aluminum.

**Operation.** A final check should be made of the circuit and construction before plugging the transformer into an ac outlet. If everything is OK, plug in the transformer. The clock will immediately start doing strange things. Ignore them. Depress the fast set button (S1) and hold it for a full minute. Release the button and observe the display for a few minutes. Depress S1 and S2 one at a time for short periods to get a feel for their operation. Then use them to set the clock and let it run. ♦

# CREI—the only home-study college-level training

## and now

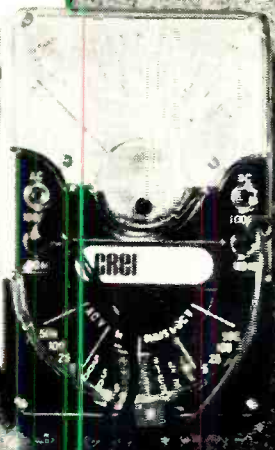
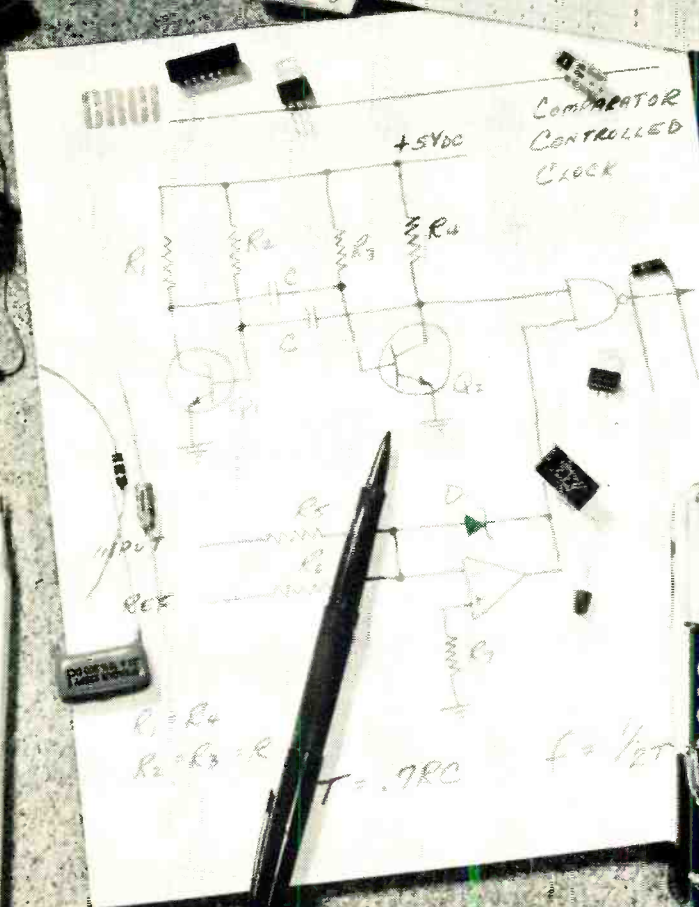
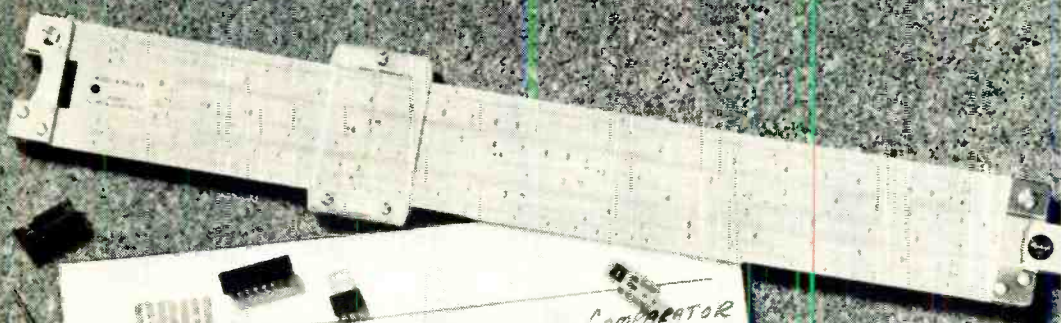



# rogram which gives you n electronic circuit design

## only CREI offers you a complete college-level Electronic Design laboratory to speed your learning

**Electronic circuit design**—source of all new development in the application of electronics to new products and services. Without this skill, we would be unable to monitor the heartbeat of men in space. Without it, the computer revolution would never have occurred. And we would have to see our first TV show. *Yet, only CREI teaches electronic circuit design at home.*

### ELECTRONIC CIRCUIT DESIGN

A key skill which paces our nation's progress in countless fields—from pollution control to satellite tracking to modern medicine to exploring the ocean's depths. And beyond. A skill which *you* must have to move to the top in advanced electronics.

### Electronics programs open up new worlds of opportunity for you.

In addition to electronic circuit design, CREI provides you with a full advanced electronics education in any of a dozen fields of specialization you choose. Communications, computers, space operations, television, nuclear power, industrial electronics—to mention just a few of the career fields for which CREI training is qualifying. With such preparation, you will have the background for a career which can take you to the frontiers of the nation's most exciting new developments. And around the world.

### This free book can change your life. Send for it.

If you are a high-school graduate (or equivalent) and have previous training or experience in electronics, then you are qualified to enroll in a CREI program to move you ahead in advanced electronics.



Send now for our full-color, eighty page book on careers in advanced electronics. In it, you will find full facts on the exciting kinds of work which CREI programs open up to you. And full facts on the comprehensive courses of instruction, the strong *personal* help, and the professional laboratory equipment which CREI makes available to you. All at a surprisingly low tuition cost.

### And when you have it, talk with your employer about it.

Tell him you're considering enrolling with CREI. He'll undoubtedly be happy to know you are planning to increase your value to him. *And he may offer to pay all or part of your tuition cost.* Hundreds of employers and government agencies do. Large and small. Including some of the giants in electronics. *If they are willing to pay for CREI training for their employees, you know it must be good.*

**Send for Advanced Electronics today. You'll be glad you did.**

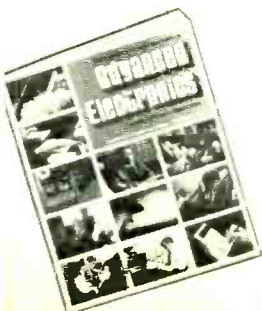

CREI Dept. E1209D  
3939 Wisconsin Avenue  
Washington, D.C. 20016

Rush me your FREE book describing my opportunities in advanced electronics. I am a high school graduate.

Name \_\_\_\_\_ Age \_\_\_\_\_

Address \_\_\_\_\_

City \_\_\_\_\_ State \_\_\_\_\_ ZIP \_\_\_\_\_

If you have previous training in electronics, check here

Employed by \_\_\_\_\_

Type of Present Work \_\_\_\_\_

Veterans and servicemen, check here for G. I. Bill information

# CREI

**CAPITOL  
RADIO  
ENGINEERING  
INSTITUTE**

WASHINGTON, D.C. 20016



# QS

## *Drops the Gauntlet with its "Vario-Matrix" System*

HOW THE LATEST QS MATRIX SYSTEM  
MINIMIZES SEPARATION SHORTCOMINGS

BY JULIAN D. HIRSCH, Hirsch-Houck Laboratories

**E**ACH of the several matrixing systems that have been proposed for 4-channel disc recordings represents certain compromises in channel separation and ability to reproduce signals in their correct amplitude and spatial relationships around a full 360° circle. The compromises extend to compatibility between 4-channel and 2-channel stereo as well as monophonic reproduction. (For example, with certain matrices, an instrument located at center rear may be heard at reduced level in stereo and possibly not at all in mono.)

The controversy over "optimum" matrix coefficients continues unabated, principally between two major competitors: CBS, developer of the SQ matrix, and Sansui, who originated the QS matrix (also identified by Japanese industry standards as the RM, or regular matrix). One point of agreement

seems to be that, with either system, a basic decoding matrix cannot match the channel separation of the original 4-channel master tapes. But each matrix system has been improved. Whereas the original SQ matrix had only 3 dB of front-to-rear separation, there are now SQ and QS decoders that can achieve as much as 20 dB separation. Matrices incorporated into receivers are not as sophisticated, though, doubtlessly due to the high cost of complex circuitry.

To some degree, the separation shortcoming can be overcome by exploiting the psychoacoustic effects which allow the human listener to recognize directionality even when the electrical channel separation is poor. As a further aid, the full potential of the SQ system can be realized by using a gain-riding logic circuit that constantly compares the four channels and shifts their

Function switch of a Sansui receiver which uses the Vario-Matrix system in its QS regular matrix decoder.

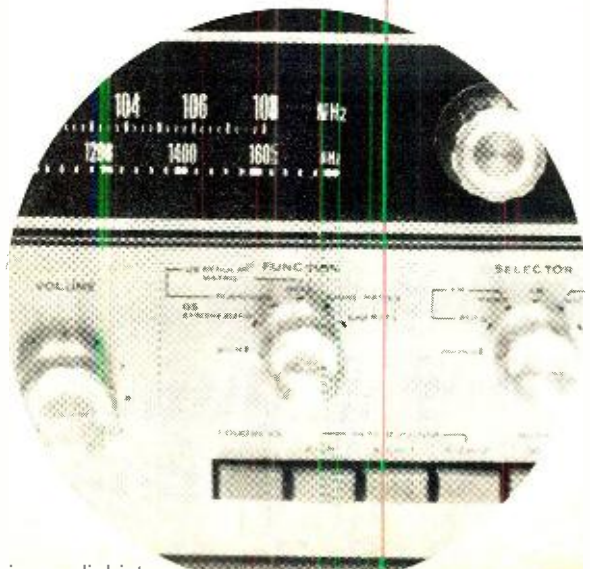

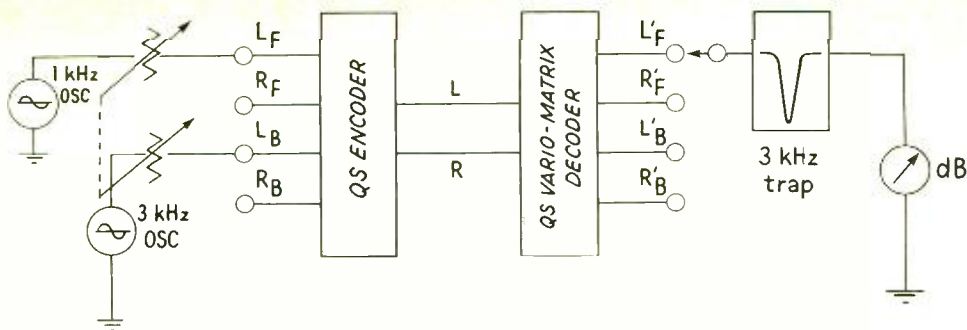

Fig. 1. Test setup used to demonstrate the separation of the Vario-Matrix system.

gains to enhance the apparent separation. Although this technique can be very effective, it is possible under certain conditions to hear the sudden level drop in sound from one speaker as the dominant sound shifts to another speaker. Again, technology will likely find a solution to eliminate this presently annoying problem.

The most advanced form of SQ uses wave-matrix logic and variable blending. The QS "Vario-Matrix" system's operation follows.

**Sansui's Investigations.** Recently, Sansui has been investigating the psychoacoustic effects underlying the detection of sound source direction detected by the human ear, with the goal of optimizing the performance of their matrix system. A paper by Mr. R. Itoh (developer of the original QS matrix) and Mr. S. Takahashi of Sansui, presented in September 1972 at the Audio Engineering Society Convention (from which our illustrations were taken), summarized their findings and offered some thought-provoking conclusions.

The emphasis was on the phenomenon of "masking," in which one sound dominates or is heard to the exclusion of another because of their relative levels and arrival times at the listening point. Perhaps the most widely known masking effect is ordinary *loudness masking* which occurs when there is a large difference (30 dB or more) between two sounds. The weaker sound is not heard at all. A common example of this is the effect of program material on background noises such as hiss and hum. The noise may be plainly heard in the absence of a program but is completely inaudible at normal program levels.

One of the basic effects responsible for directional localization in both 2- and 4-channel listening is *forward masking*. The

first sound to reach the listener's ear establishes the apparent direction of the source—so long as the second arrival occurs within 25 milliseconds. If the time interval is greater, the second sound is heard as an echo or as coming from a distinctly different sound source. According to the Sansui paper, forward masking can occur even when both sounds are of the same loudness level.

Another phenomenon is that of *backward masking*. Here, the observed direction is established by the *second* sound to arrive at the listener's ear. This has been found to happen when the second arrival occurs at least 25 milliseconds after the first if the second is 10 dB louder than the first. If the time interval is less than 25 milliseconds, the directionality of both sounds is obscured. It was also observed that a second arrival 20 dB stronger than the first would establish the apparent direction of the source with a time difference as small as 10 milliseconds.

Based on these masking effects, Sansui reasoned that a 4-channel matrix system could produce effects equivalent to a discrete system if it compared the loudness levels of the four channels and emphasized the loudest channel to produce the clearest directionality by masking. It was expected that weaker sounds occurring within certain time intervals, both preceding and following the loudest sound, would still be heard at the approximately correct levels, though with reduced directionality (unless, of course, they were so weak as to be obscured by loudness masking). Since these masking effects are always present during 4-channel listening, the question was raised as to the actual necessity of transmitting the masked channels through a fully discrete system.

**The Vario-Matrix System.** This is the principle of the Sansui QS "Vario-Matrix" sys-

tem. It continuously scans the phase and amplitude relationships between the total left and right signals, sensing their levels and timing the dominant sound source direction on a 4-channel basis, and uses this information to modify its own matrix coefficients. The system utilizes a time constant of less than 10 milliseconds to improve channel separation in all directions without changing the total output level or that of any of the four individual channel outputs.

A test setup used by Sansui to demonstrate the separation of the Vario-Matrix system is shown in Fig. 1. A 1000-Hz signal was fed to the  $L_F$  input and a 3000-Hz signal to the  $L_B$  input of a QS encoder. The other channels were undriven. The encoded signal, in 2-channel form, was then decoded by a QS Vario-Matrix decoder, and the 1000-Hz signal at each of its outputs was measured. A trap was used to remove the 3000-Hz components.

The purpose of the test was to determine how much of the 1000-Hz signal appeared in each channel output in the presence of varying amounts of the 3000-Hz signal. The 3000-Hz level was not monitored, except to establish its level relative to that of the 1000-Hz input. Since the QS matrix is

symmetrical, the same results would be obtained if the 3000-Hz signal were measured and the 1000-Hz signal were used as a control.

A plot of the four outputs is shown in Fig. 2, where the separation of the Vario-Matrix is shown against two simultaneous input signals. To interpret these curves, bear in mind that they pertain only to the measured 1000-Hz output. The relative levels of the four outputs are plotted on the vertical scale in decibels (dB), and the horizontal scale shows the ratio between the  $L_F$  (1000-Hz) and  $L_B$  (3000-Hz) input levels, also in dB. Nothing else on the graph pertains to the 3000-Hz signal. At the center,  $L_F$  equals  $L_B$ ; in the left half of the graph,  $L_B$  is larger than  $L_F$ , and in the right half,  $L_F$  is larger than  $L_B$ .

Starting at the right side of the graph, when  $L_F$  is 10 or 20 dB stronger than  $L_B$ , the 1000-Hz levels in the  $L_B$ ,  $R_F$ , and  $R_B$  outputs are 20 to 25 dB lower than the  $L_F$  output. As the 3000-Hz level is increased, there is little change in the 1000-Hz distribution until the  $L_B$  input is only about 3 dB lower than the  $L_F$  input. When the two are equal, the desired signal in the  $L_F$  output has dropped about 2 dB, but the  $L_B$  and  $R_F$

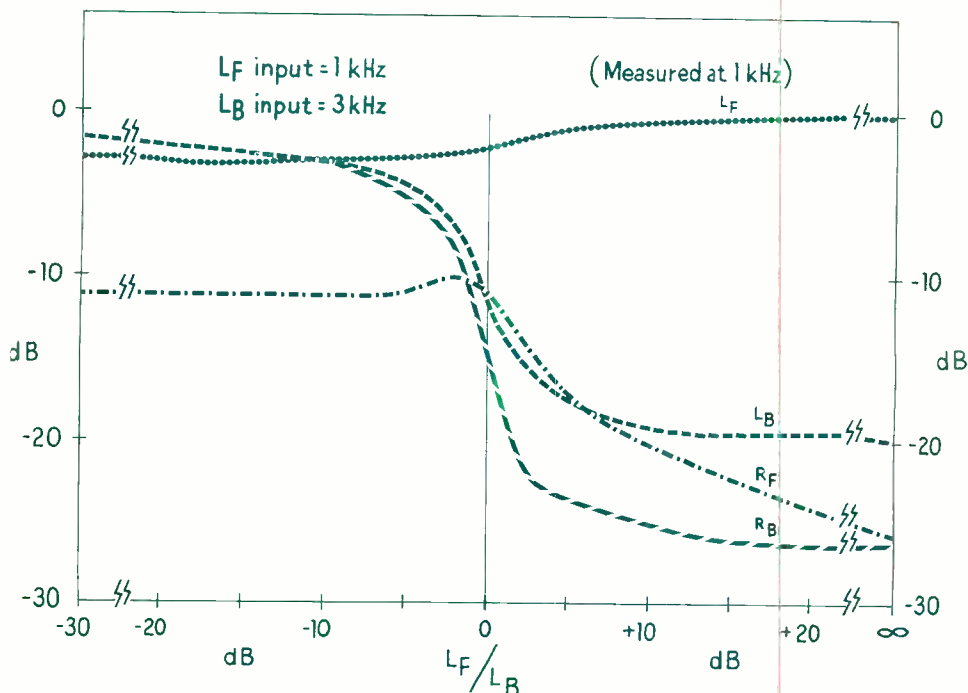

Fig. 2. Graph showing the four outputs as a function of left-front to left-back ratio.



outputs are about 10 dB below that level, and the  $R_B$  separation is about 13 dB.

As the  $L_B$  input exceeds the  $L_F$  input, we move to the left half of the graph. The  $L_F$  output remains essentially constant, at a level of  $-2$  to  $-3$  dB, and the  $R_B$  and  $L_B$  outputs are also at the same level when the 3000-Hz  $L_B$  input is at least 10 dB greater than the  $L_F$  input. The  $R_F$  output still shows a good separation of about 8 dB (across the front of the listening area) relative to the  $L_F$  output.

It must be appreciated that under these circumstances the 3000-Hz  $L_B$  input becomes the dominant signal. And, since it appears in the  $L_B$  output at a level at least 10 dB higher than that of the 1000-Hz crosstalk from  $L_F$ , the audible separation of the two signals is maintained. The low-level 1000-Hz outputs of the other channels are not suppressed; they contribute to the total sound output, though not to the apparent source of the sound since they are heard essentially as monophonic sounds.

This is the most noteworthy feature of the Vario-Matrix system—the low-level  $L_F$  signal, in the presence of a stronger  $L_B$  input, is still heard at its normal level instead of being suppressed as would happen with gain-riding logic systems. Nevertheless, the apparent direction of the sound source is always determined by the dominant signal.

As a further refinement, Sansui splits the audio spectrum into two frequency bands and processes them through two separate Vario-Matrices for the most effective control action.

The QS Vario-Matrix is applicable to the playback of recordings originally encoded for the standard QS matrix. There is an implication that newer recording techniques can produce even more channel separation with the Vario-Matrix.

As this article was written, the Vario-Matrix was available only in the Sansui QRX series of 4-channel receivers. However, since this system is now available on a licensing basis to all interested manufacturers world-wide, we expect to see it included in other Sansui receivers in the future and possibly as an add-on accessory for other 4-channel systems, the latter possibly by the time you read this.

Having listened to a demonstration of the system in operation both at the Audio Engineering Society N.Y. convention and elsewhere, we can testify that the Sansui QS Vario-Matrix appears to provide a fully "discrete" sound character, with no evidence of the side effects sometimes experienced with gain-controlled matrices. Clearly, in the three-way battle between the two major matrix systems and discrete discs, the issue is far from decided. ♦

---

## CHU—TIME SIGNALS FOR EVERYONE

**R**ADIO station CHU, geographically located in Canada and frequency spotted at 3330, 7335, and 14,670 kHz on the dial, has long been a favorite of hams, SWL's, and sportsmen. CHU announces EST (Eastern Standard Time) in French and English every minute. In addition to giving time signals, the CHU frequencies also provide a convenient reference standard for hams due to their proximity to the 80-, 40-, and 20-meter bands.

The basic signal format is a pulse each second, except for the 29th which is skipped to identify the half-minute mark and the 51st through 59th which are replaced by the voice announcement. During the first quarter of each minute, some of the pulses may be split; the number and positions of these pulses indicate the error between

Universal Time (based on the Earth's rotation; it varies) and Atomic Time (a constant). This error is always less than one second.

The staff of CHU welcomes reception reports. They ask that when making reports you include details of readability and interference, if any. All reports are acknowledged with the station's distinctive QSL card. Reports should be sent to: National Research Council of Canada, Ottawa, Ontario, Canada, K1A 0S1, marked for the attention of the Time & Frequency Section.

If you would like more information about CHU, write to the same address and request a free copy of Time Service Bulletin No. B-27. This handy bulletin explains Universal Time and the Atomic Time relationship.

—D.J. Holford

# UNDERSTANDING NAB TAPE PLAYBACK EQUALIZATION

**WE** HAVE received a number of inquiries referring to what appears to be a disturbing contradiction with respect to the nature of NAB tape playback equalization. The seeming contradiction can be seen by referring to the curves in Fig. 1 and Fig. 2, both of which pertain to tape speeds of  $7\frac{1}{2}$  and 15 ips.

The curve in Fig. 1 shows that playback equalization consists of bass boost, commencing (3 dB up) at 3180 Hz and leveling off (3 dB below maximum) at 50 Hz. However, the NAB standard curve shown in Fig. 2 (published in April 1965) appears to state that playback equalization

consists largely of what appears to be treble boost.

As a result of the apparent contradiction, some audio literature contains statements to the effect that there is a large amount of treble boost when playing back a tape at  $7\frac{1}{2}$  or 15 ips (and at  $3\frac{3}{4}$  and 1 $\frac{1}{2}$  ips as well). Understandably, many audio enthusiasts are confused, particularly those who wish to understand the inner workings of audio equipment.

**A Clearer Picture.** The curves shown in Fig. 3 will explain and reconcile the contradiction. Curve I illustrates the response

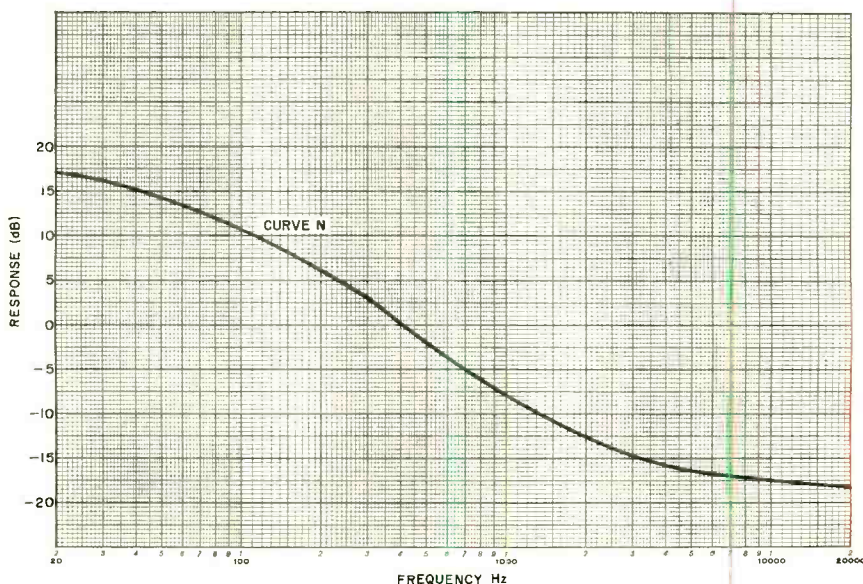

Fig. 1. NAB playback characteristic for  $7\frac{1}{2}$  and 15 ips tape. Curve is due to equalization provided by playback amplifier and tape head irregularities.

BY HERMAN BURSTEIN

## Answers to common questions on boost required to play back NAB equalized tapes

of an ideal playback head, one with neither losses nor irregularities, if the tape is recorded flat at all frequencies and if constant flux appears in the core of the head. This curve rises steadily at a rate of 6 dB/octave (or 20 dB/decade).

Curve A, the NAB playback standard, does not require the playback amplifier to supply the same 6-dB/octave rise in output. Instead, the requirement is that the amplifier produce a much smaller rise in output as the frequency increases. Consequently, the amplifier must supply some kind of equalization to prevent the output from rising by 6 dB/octave. The nature of this

equalization is *essentially* the difference between the ideal output of curve I and the stipulated output of curve A. If we subtract curve I from curve A, we obtain curve N—the familiar playback equalization characteristic.

To illustrate, consider what happens at frequencies of 400, 50, and 5000 Hz. We have arbitrarily drawn curve I so that it is at the 0-dB reference level at 400 Hz because curve A is also at 0 dB at 400 Hz. At 50 Hz, an ideal tape head's response would be 18 dB down according to curve I. But according to NAB curve A, the amplifier's output is only 3 dB down—a difference

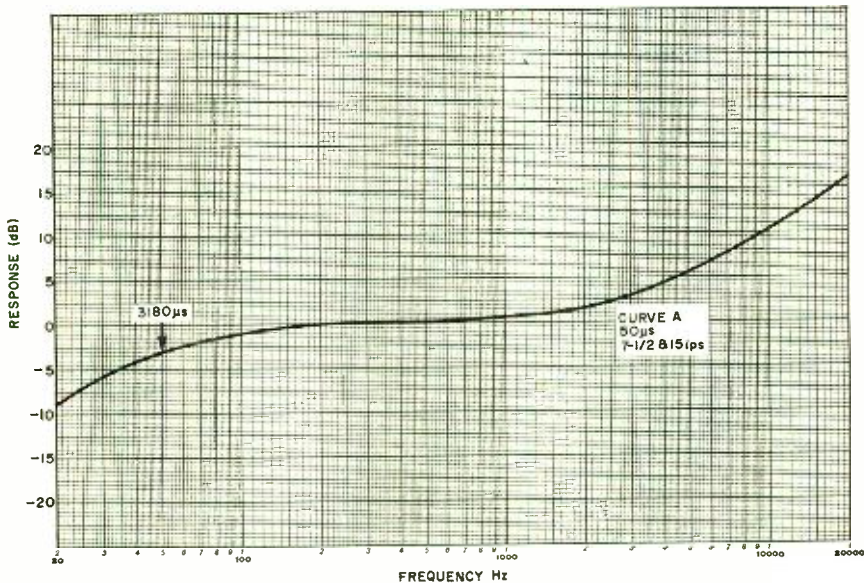

Fig. 2. NAB standard reproducing characteristic. This is the reproducing amplifier output for constant flux in the core of an ideal reproducing head.



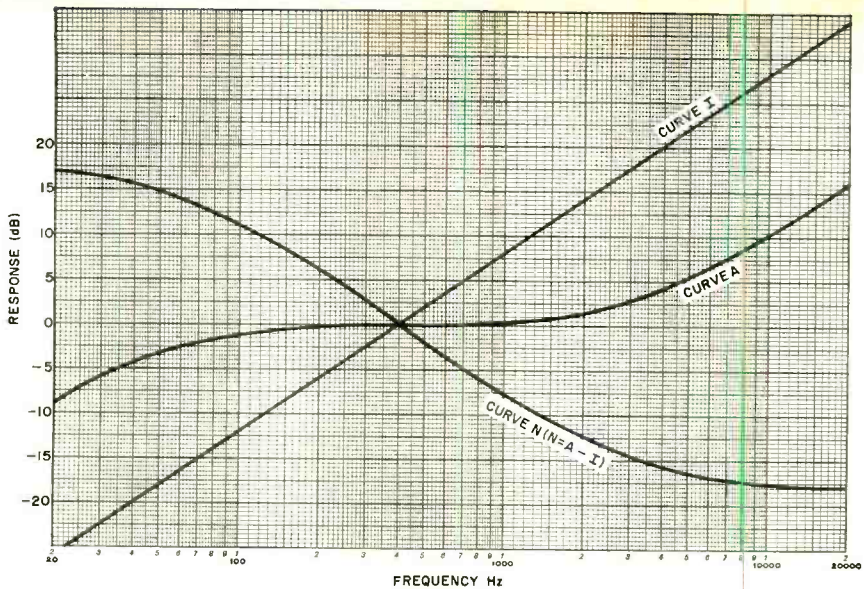

Fig. 3. Transformation of the NAB standard playback characteristic for  $7\frac{1}{2}$  and 15 ips tape. Curve I is the response of an ideal head to constant head flux. Curve A is the NAB playback standard amplifier output for constant head flux shown in Fig. 2; and curve N is the playback characteristic shown in Fig. 1.

of 15 dB. Therefore, at 50 Hz, the amplifier must supply 15 dB of boost relative to 400 Hz as shown in curve N.

At 5000 Hz, an ideal head would have a response 22 dB up according to curve I. But according to curve A, the amplifier is only 5.5 dB up—a difference of 16.5 dB. So, at 5000 Hz, the amplifier must supply 16.5 dB of cut relative to 400 Hz, which is the same as saying that 400 Hz is boosted 16.5 dB relative to 5000 Hz.

When all things are considered, the playback equalization characteristic supplied by the amplifier is *essentially* that of curve N in Fig. 3.

We have twice emphasized the word “essentially” because the playback characteristic is produced by both the playback amplifier *and* the irregularities of the playback head. To the extent that the actual playback head departs from the behavior of an ideal head, resulting in bass or treble irregularities, the playback amplifier must provide compensation.

For example, if the head demonstrates a 2-dB loss at 15,000 Hz, the equalization curve produced by the amplifier must be 2 dB higher at 15,000 Hz than is shown in curve N. Likewise, if the head produces 3 dB greater output than an ideal head at 50 Hz (owing to the “contour” effect), the am-

plifier must supply 3 dB less boost at 50 Hz. Hence, the amplifier *and* the playback head are required to provide curve N.

**The NAB Choice.** Why has NAB chosen to present the playback standard in the sophisticated form of curve A, rather than in the more comprehensible form of curve N? The answer, given us by one of the people who helped to write the standard, lies in the paragraph immediately above. Writers of the standard wanted to guard against the assumption that the playback amplifier alone would provide the required playback characteristic. They wanted to make certain that the playback head’s deviation from the ideal response would also be responsible for the characteristic. They felt that they could achieve this aim by presenting the standard in the form of curve A. The reader can judge for himself whether the NAB has clarified more than it has obscured by so doing.

In any event, rest assured that the playback characteristic is really that shown as curve N, supplied jointly by the playback amplifier’s equalization circuit and the head’s deviation from the ideal response. Inasmuch as modern playback heads behave nearly like ideal heads at a tape speed such as  $7\frac{1}{2}$  ips, the characteristic of curve N is mainly produced by the playback amplifier. ♦

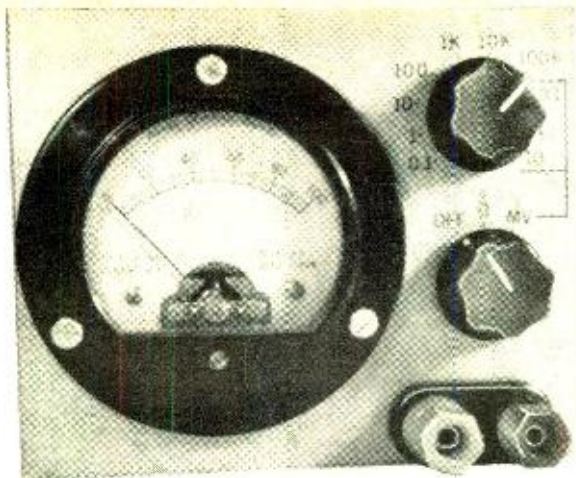

# LINEAR-SCALE OHMMETER for ACCURATE READINGS

*Zero to 10 megohms in seven ranges  
plus three ranges of dc millivolts*

BY DALE HILEMAN

**H**ANDY as it is, the ohmmeter portion of a typical VOM has four major drawbacks: the nonlinear scale makes accurate readings difficult; it can apply too much current or voltage to the circuit being tested, thus damaging semiconductors or delicate filaments; the zero ohms control has to be adjusted separately for each range; and battery life may be short.

If any of these problems are bothering you or if you are looking for a handy 0-to-10-megohm meter with seven ranges, plus three ranges of dc millivolts (10, 100, and 1 V) at 10 megohms per volt (very useful for semiconductor circuits), try the circuit shown in Fig. 1. The maximum test current is 1 mA, and test voltage at full-scale deflection is only 1 V. The meter zero is so stable that no external zero control is needed. Both voltage and resistance indications are stable over a wide temperature range.

The instrument is powered by two 8.4-volt mercury batteries rated at 500 mA-hr each. Since maximum drain on either bat-

tery is under 5 mA, they can be expected to provide at least 100 hours of service. Conventional 9-volt batteries can be used, with shorter life and only a slight loss in accuracy.

**How It Works.** As shown in Fig. 1, the linear ohmmeter contains two sections: a constant-current source ( $Q1, Q2$ ) and a meter driven by  $IC1$ . The output of the constant-current source is applied to the unknown resistance through  $J1$  and  $J2$  and the resulting voltage drop is applied to the meter through  $IC1$ .

Except for the input connection, the two circuits are independent. (Note that they do not even share a common ground, for reasons given later.) A position is provided on power switch  $S1$  to disable the constant-current source so that the instrument can be used as a millivoltmeter. With the switch in position 1 (off), both batteries are disconnected. In position 2, battery power is applied to both the constant-current source and the millivoltmeter. Also in position 2,

section *S1B* applies the output of the constant-current source to the test terminals (*J1* and *J2*). In position 3, only the millivoltmeter is energized.

The constant-current source consists of a voltage regulator and a constant-current generator. The voltage regulator itself uses another constant-current generator. The voltage regulator is made up of transistor *Q1*, resistors *R1* and *R2*, and zener diodes *D1* and *D2*. To conserve battery power, the zeners are operated at less than their rated current so that their operating potential is lower than the rated 2.6 volts. Diode *D1* provides about 1.5 volts as a reference for constant-current generator *Q1*. A constant current of about 2.5 mA, developed through *R2*, is applied from the collector of *Q1* to diode *D2*. The latter diode develops a reference voltage of about 2 volts, which is used by constant-current source *Q2* to develop a test current for the instrument. Capacitor *C1* suppresses a tendency of *Q2* to oscillate.

Resistors *R3* through *R7* are selected to provide five test currents in decade, from 1 mA to 0.1  $\mu$ A, respectively, as range switch *S2* is advanced from position 3 to position 7. To conserve battery power and keep the test current low, the value for positions 1 and 2 is held to 1 mA, but the sensitivity of the millivoltmeter is increased 10 times (via *R21*) or 100 times (via *R22*) respectively.

Why is it necessary for the test current to be so incredibly small on the higher resistance ranges? Why not keep the test current at 1 mA and simply reduce the sensitivity of the millivoltmeter by decade steps? The reason is to keep the full-scale voltage at a reasonable 1-volt value. Across 10 megohms, a test current of 1 mA would develop 10,000 volts.

The effect of rising ambient temperature on *D1* and *D2* is to decrease the test current; but the effect on *Q1* and *Q2* is to increase it. The net effect is that the test current remains constant over a wide temperature range.

The total current drain on battery *B1* is 3.5 mA to 4.5 mA, depending on the resistance being tested.

The MC1458G is an inexpensive integrated circuit containing two operational amplifiers in a single case. It is similar to the popular type 741, without offset adjustment. One of the op amps, *IC1A*, is used as a very-high-resistance voltage fol-

## PARTS LIST

- B1,B2*—8.4-volt mercury battery  
*C1,C2*—0.01- $\mu$ F ceramic or Mylar capacitor  
*D1,D2*—1N702 zener diode  
*IC1*—Dual op amp IC (Motorola MC1458G or similar)  
*J1,J2*—Binding post (black, red)  
*M1*—100- $\mu$ A meter  
*Q1*—2N1132 transistor  
*Q2*—2N697 transistor  
*R1,R13*—6800-ohm,  $\frac{1}{4}$ -watt, 5% resistor  
*R2*—330-ohm,  $\frac{1}{4}$ -watt, 5% resistor  
*R3*—1300-ohm,  $\frac{1}{4}$ -watt, 5% resistor\*  
*R4*—13,000-ohm,  $\frac{1}{4}$ -watt, 5% resistor\*  
*R5*—130,000-ohm,  $\frac{1}{4}$ -watt, 5% resistor\*  
*R6*—1.3-megohm,  $\frac{1}{4}$ -watt, 5% resistor\*  
*R7*—13-megohm,  $\frac{1}{4}$ -watt, 5% resistor\*  
*R8*—10-megohm,  $\frac{1}{4}$ -watt, 10% resistor  
*R9*—1-megohm,  $\frac{1}{4}$ -watt, 10% resistor  
*R10,R16*—100,000-ohm,  $\frac{1}{4}$ -watt, 10% resistor  
*R11*—3300-ohm,  $\frac{1}{4}$ -watt, 5% resistor  
*R12*—500-ohm potentiometer (Mallory MTC-52-L1)  
*R14,R15*—470-ohm,  $\frac{1}{4}$ -watt, 5% resistor  
*R17*—180,000-ohm potentiometer, (Mallory MTC-184-L1)  
*R18,R20*—1000-ohm,  $\frac{1}{4}$ -watt, 1% resistor  
*R19*—50,000-ohm potentiometer (Mallory MTC-54-L1)  
*R21*—10,000-ohm,  $\frac{1}{4}$ -watt, 1% resistor  
*R22*—100,000-ohm,  $\frac{1}{4}$ -watt, 1% resistor  
*R23*—4700-ohm,  $\frac{1}{4}$ -watt, 10% resistor  
*R24*—10,000-ohm potentiometer (Mallory MTC-14-L1)  
*S1*—3-pole, 3-position rotary switch  
*S2*—3-pole, 10-position rotary switch  
 \*Selected component (see text).  
 Misc.—Battery connectors (2), perf board with clips, knobs with indices (2), socket for 8-lead TO-5 can, suitable chassis, mounting hardware, etc.  
 Note: For calibration,  $\frac{1}{4}$ -watt, 1% resistors of 1000, 10,000, 100,000 ohms and 1 and 10 megohms are required. (Since 10-megohm resistors are rare, two 5-megohm units in series can be used.)

Fig. 1. Circuit (opposite) consists of a constant-current generator and a very stable dc millivoltmeter. The latter can be used as separate meter.

lower, while the other, *IC1B*, is connected as an inverting dc amplifier.

The usual practice is to use a plus-and-minus supply to power an op amp. To avoid the need for another battery, however, an "artificial ground" is created for *IC1* by the voltage divider made up of *R11* through *R15*. Resistor *R11* was made smaller in value than *R13* because this particular op amp works better if the plus supply voltage is slightly less than the minus.

Zero potentiometer *R12* is provided to



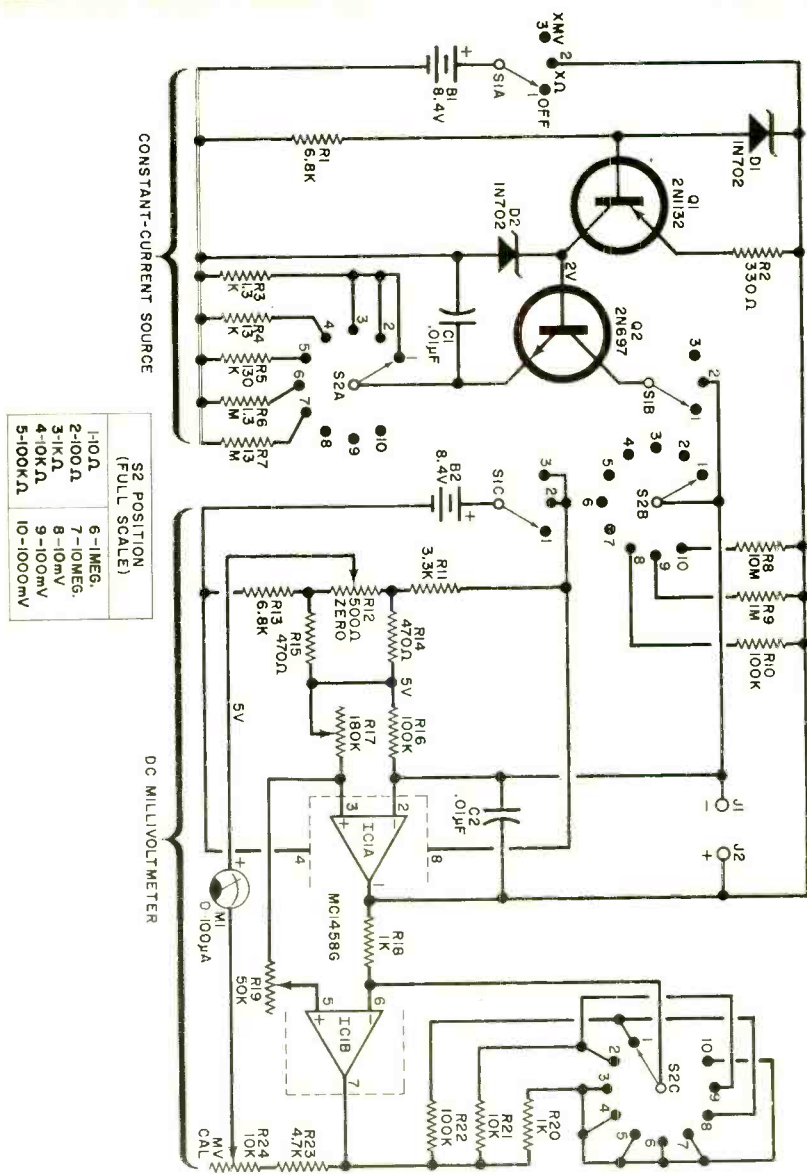

compensate for offsets of the IC. It forms a bridge with resistors  $R_{14}$  and  $R_{15}$  so that the positive terminal of meter  $M_1$  can be set slightly above or below the artificial ground potential at the junction of  $R_{14}$  and  $R_{15}$ .

On the higher resistance ranges of the instrument, accuracy would be severely degraded if the millivoltmeter measurably loaded the constant-current source because the instrument would then be measuring the input resistance of the millivoltmeter in

parallel with the unknown resistance. Therefore, op amp  $IC_{1A}$  is connected as a voltage follower with very high input resistance, coupling the voltage developed across the unknown to the relatively low input resistance of the inverter.

The input to a more conventional op amp voltage follower is applied between common (or ground) and the plus (non-inverting) input. With a typical inexpensive op amp, however, the input resistance of this arrangement is about 2 megohms—far

too low for our purposes. In the high-impedance follower circuit of *IC1A*, the input is applied between the output (terminal 1) and minus input (terminal 2). This arrangement provides a very high input resistance because the input voltage is matched (or bucked out) by the action of *IC1A*. The disadvantage is that the millivoltmeter can't share a common ground with its input, so two batteries are required. But the

are selected to yield a full-scale meter sensitivity of 1 volt.

The input polarity to the millivoltmeter and the connection of the meter were arranged to give up-scale deflection for a negative-going output from *IC1B*. With the obverse connection (positive for up-scale deflection), the IC has a tendency to lock up like a flip-flop.

Potentiometers *R17* and *R19* are con-

VOLTAGE AND RESISTANCE RELATIONSHIPS						
S1	S2	Test R Full Scale (ohms)	Test I Full Scale ( $\mu$ A)	Test E Full Scale (mV)	IC1A Input Load (ohms)	IC1B Gain
2	1	10	1000	10	open	100
	2	100	1000	100		10
	3	1000	1000	1000		1
	4	10,000	100	1000		1
	5	100,000	10	1000		1
	6	1 meg	1	1000		1
	7	10 meg	0.1	1000		1
3	8	—	—	10	100,000	100
	9	—	—	100	1 meg	10
	10	—	—	1000	10 meg	1

input resistance of the millivoltmeter is in the hundreds of megohms.

Capacitor *C2* bypasses any 60 Hz or other noise pickup on the input leads that might overload the op amp. The capacitor may be made larger for severe noise but increasing its value will also slow the response of the instrument on the high resistance ranges.

On the millivolt ranges, section B of range switch *S2* bridges the input with resistors *R8*, *R9*, or *R10* to enhance the stability of open-circuit meter zero. The values of these resistors are arbitrarily chosen to provide an input resistance of 10 megohms per volt, but they can be increased if you have good luck in selecting the op amp or if you are satisfied with some instability of meter zero on the millivolt ranges.

The effect of bias current flowing in the plus and minus input leads of *IC1A* is balanced by the adjustment of potentiometer *R17*. This potentiometer is set to equalize the quiescent dc level on these inputs.

The second part of *IC1* is connected as a conventional inverting dc amplifier. Gain is determined by the ratio of resistors *R20* through *R22* to input resistor *R18*. These values are selected to provide gains of 1, 10 and 100, respectively. The resistances of *R23* and *R24*, in series with the meter

connected to the plus inputs of the op amps to avoid biasing complications. The adjustments of *R17* and *R19* are slightly interacting, but they provide good stability. Nevertheless, for best results, it may be necessary to select *IC1*.

New voltage and resistance ranges can be gained by added switching to alter the sensitivity of the millivoltmeter. For instance, *S2* could have more positions so that different feedback resistors could be selected by *S2C*. However, the value of *R18* should not be changed because doing so will upset the balance of bias currents at the input to *IC1B*.

Another way of getting more meter scales might be to switch different values of series resistance in the places of *R23* and *R24*. This approach has economic appeal because, in one easy step, it provides seven new resistance ranges and three new voltage ranges.

It is also possible to use a meter with higher sensitivity (50 or 20 microamperes full scale) selecting values for the meter series resistors (*R23* and *R24*) that give the desired full-scale deflection. However, it is not a good idea to use a meter with less sensitivity than 100 microamperes because full-scale deflection would necessitate excessive current in the artificial ground voltage divider, which might possibly un-

balance the millivoltmeter biasing network.

At the risk of getting a slight instability, you can get another full decade step of sensitivity (1 millivolt or 1 ohm, full scale) by using one of the foregoing three methods, or some combination thereof. For a 1-mV sensitivity range, however, you should arrange for S2B to select a 10,000-ohm load.

In the prototype, potentiometer R12 is an internal adjustment. Depending on the stability and sensitivity of your version, you may want to make R12 an external control. This is especially true if you use long test leads because, on the lower resistance ranges, you will then have to contend with zero shift caused by the resistance of the leads.

Total current drain on B2 is 1.7 to 2.7 mA, except when the meter is pegged, in which case, it is 4 mA.

The accompanying table summarizes the voltage and resistance relationships in the ohmmeter.

**Construction.** The prototype, except for the meter and the various switches, was assembled on perf board, with the final mounting in a small metal enclosure. The batteries were mounted on clips on the rear cover.

Due to differences in bias currents, it is possible that the first dual op amp you try might not perform satisfactorily. So it is best to have on hand two or three of these units. We tested 12 specimens consisting of an approximately equal mix of Motorola's MC1458G and MC1458CG and Texas Instruments' SN72558L. Judging by this test and the published data, just about any of the dual 741-type op amps can be used, but 25 percent of any given type may not work properly. Those you can't use in this project may work well in less critical applications.

To facilitate the selection or replacement of ICI, it is recommended that a socket be used for mounting it. Also, get a couple of extra IN702 zener diodes since D1 and D2 should be selected to provide an optimum reference voltage for the constant-current source. It is essential that capacitors C1 and C2 not leak—use ceramic or Mylar types.

Carbon or alkaline 9-volt batteries are perfectly suitable for B2. They can also be used for B1, but their greater range of terminal voltage will cause a slight long-term drift in resistance readings.

Resistors R3 through R7 must be selected to provide proper full-scale deflection on each of the resistance ranges. You may want to use potentiometers instead. If so, for R3, use 1000 ohms in series with a 500-ohm potentiometer; for R4 use 10,000 ohms in series with a 5000-ohm potentiometer, and so forth.

Don't solder resistors R3 through R7 in place since the heat may change the resistances. The lead of a ¼-watt resistor can be snapped neatly into the bottom of the slot in a Vector T-28 perf board terminal, making a firm, permanent contact without the need for solder. A connecting lead can be soldered to the tip of the terminal sticking out the other side of the board.

Don't solder D1 and D2 into the circuit until you are completing the calibration process as described below.

**Calibration.** The millivoltmeter section must be adjusted before the constant-current source is calibrated. To adjust the meter, you will need an accurate dc source of 1 volt. If the meter circuit fails to respond as indicated, replace ICI and start over. Resistors needed to calibrate the constant-current source are given in the Parts List.

Install both batteries, place test leads in J1 and J2 and proceed as follows:

1. Set R12 with the wiper at its maximum positive. Set R24 at mid-position.
2. Turn S2 to position 10 and S1 to position 3.
3. Alternately short together and open the test leads, watching meter M1. Adjust R17 so that the meter reading does not change as a result of this action. Proper adjustment should occur with the meter reading somewhat above zero.
4. Leaving the test leads open, switch S2 from position 10 to position 8 and then back to 10, watching the meter. Adjust R19 so that the meter reading does not change as a result of this action. Again, proper adjustment should occur with the meter reading just above zero.
5. Repeat steps 3 and 4 until the meter reading is stable and no interaction occurs.
6. Adjust R12 to zero the meter.
7. Put S2 on position 10, and connect the test leads to a 1-volt dc source (observing polarity). Adjust R24 for full-scale deflection. This completes calibration of the millivoltmeter section.
8. Turn S1 to position 2 and measure the



voltage across *D2*. If it is between 1.8 and 2.0 volts, proceed to step 11. If it is not, interchange *D1* and *D2* or try different diodes. Solder *D1* and *D2* in place.

9. Set *S2* to position 3 and connect the test leads to a 1000-ohm calibration resistor. Select (or adjust) *R3* to obtain full-scale deflection.

10. Set *S2* to position 4 and connect the test leads to a 10,000-ohm calibration resistor. Select (or adjust) *R4* to obtain full-scale deflection.

11. Successively calibrate the remaining ohmmeter scales as in steps 11 and 12.

**In Case of Trouble.** As we have indicated, the most likely trouble spot is in the IC, and the symptom is instability or difficulty in adjusting the millivoltmeter. You should suspect a marginal op amp if it proves necessary to set *R12*, *R17*, or *R19* to one extreme or if there is considerable interaction between the adjustment of *R17* and *R19*.

If, however, the trouble is merely a slight upscale reading of the meter on the 10-ohm scale with test leads shorted, the first thing

you should suspect is that you are really reading the resistance of the leads. If shorting directly across *J1* and *J2* with a screwdriver still doesn't drop the reading to zero, try repeating steps 2 through 6 of the adjustment procedure, but be more careful this time. With *J1* and *J2* shorted together, there should be absolutely no shift of meter zero as *S2* is switched through its ohmmeter ranges.

If you get unexpected resistance readings while using the ohmmeter for its intended purpose, don't blame the instrument until you can check its linearity against a known precision resistor. Composition resistors—even brand new ones—sometimes fail outside their own rated tolerances.

If, on a cold winter day, you notice intermittent jumping of the meter needle, you are probably the victim of static electricity. To preclude certain leakage problems, we have shown no connection from the circuits to the chassis. In case of static, however, you might try grounding one of the negative battery terminals or the plus terminal of meter *M1*. ♦

## ASSEMBLE A LOW-COST LOGIC PROBE

BY RANDALL GLISSMAN

**D**igital circuit experimenters usually use a dc scope or some type of voltmeter to determine the logic states at various points of a circuit. Now, for an investment of only a few dollars, they can fabricate a logic probe with its own readout. It is the equal of many commercial probes costing more.

As shown, the circuit uses a low-cost TTL logic chip and three LED diodes. The

presence of a logic 0 or 1 is indicated by their respective LED, while the presence of a high-speed pulse, which may be far too fast for the logic circuits to catch, turns on the third LED. The latter will also light when a pulse train is probed.

With sufficient care, the complete circuit can be built in an ordinary metal cigar tube, with the insulated probe tip protruding from one end, and the two power leads (one for the 5-volt supply and the other for ground) coming out the other end.

A small PC board can be fabricated to fit in the tube, and the smallest available resistors should be used. The three LED's are mounted so that they can be viewed through holes cut in the appropriate places on the tube wall.

Power for the probe is taken from the TTL board being tested. Connect the +5-volt and ground leads from the probe to the board. To test the probe, before installing the board in the tube, touch the probe tip to the +5-volt line and note that the proper LED is lit. Touching the tip to ground should cause the 0 LED to glow. The pulse-catching LED can be switched. ♦

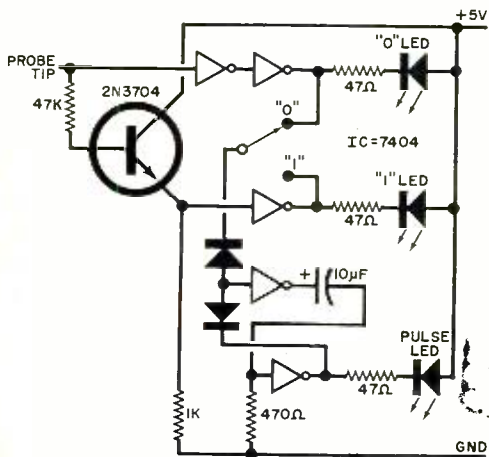

# DURATAPE® Cassettes.

## They hand you the right sound at the right price.

With Mallory DURATAPE® Cassettes, you can always get a tape that's right for both you and your wallet. Because we have a full line of tape to cover the full range of recording needs.

See what we have below. Then see your Mallory distributor.

**DURATAPE®:** When you want clean sound from a clean machine, here's the tape for you! It comes with a nonabrasive, built-in head-cleaner leader that cleans every time you record or play.

**FLIPTAPE™:** If you like lots and lots of music but don't have a bundle of money, this is the recording tape for you.

**PROFESSIONAL DURATAPE™:** If you are an audiophile, this is the recording tape for you. It's cobalt-energized. And has phenomenal fidelity. Hearing is believing.

**VOICETAPE™:** "To whom it may concern..." Dictation tapes are the newest shortcut around shorthand. And this tape doesn't miss a comma. Period.

**DURATAPE 8-TRACK:**  
We've got it in 40-minute and 80-minute lengths. Your stereo recorder will love it almost as much as you do.

**PROFESSIONAL REEL-TO-REEL RECORDING TAPE:** This professional-quality tape is an attractive value in all popular lengths. It gives you beautiful fidelity at a beautiful price.



**MALLORY**

**MALLORY DISTRIBUTOR PRODUCTS COMPANY**

a division of P. R. MALLORY & CO. INC.

Box 1284, Indianapolis, Indiana 46206; Telephone: 317-636-6353

Batteries • Capacitors • Controls • Security Products • DURATAPE® • Recorders • Resistors • Semiconductors • SONALERT® • Switches • Timers

©DURATAPE is a registered trademark of P. R. Mallory & Co., Inc.

**CIRCLE NO. 21 ON READER SERVICE CARD**

**Let ICS mail  
you a FREE  
demonstration  
lesson without  
obligation...  
to prove that  
you can learn  
TV Servicing  
at home.**

Credit towards a Certified Electronic Technician (C.E.T.) rating will be granted by the National Electronics Association to ICS students upon completion of the ICS Career Program in TV Service/Repair.





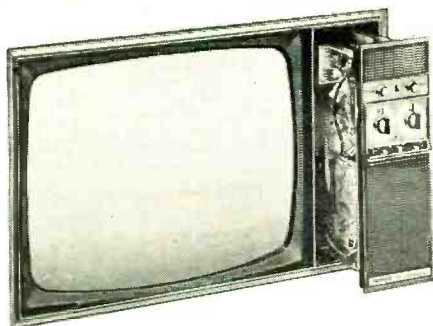

## Practice on a new 25" MOTOROLA QUASAR II® chassis.

TV Servicing is a satisfying career . . . and the pay is great. Qualified men are needed now to maintain the 93 million sets in U.S. homes. And prospects for the future are even brighter.

Now . . . here's an opportunity for you to prove to yourself that *you* can learn TV Servicing . . . at home, in your spare time. ICS, the world's most experienced home-study school, will send you a **FREE** Demonstration Lesson (complete with sample questions) if you will merely fill out the coupon below and mail it to us.

In addition to your free demonstration lesson, we'll send you . . . also **FREE** . . . a brochure that describes the 25" (diagonally measured screen) MOTOROLA QUASAR II® Color TV chassis that we include in our TV Service Training Program.

This chassis with automatic fine tuning control is ideal for training purposes because it combines solid state devices with vacuum tubes to give you both kinds of practical experience. All parts carry Motorola's two year replacement guarantee!

The QUASAR II chassis comes to you in three basic sub-assemblies . . . **NOT AS A KIT** . . . because we want you to learn how to *repair* TV sets, not build them.

Our free literature also describes the fully assembled test equipment you receive such as the Deluxe 5" Solid State Oscilloscope, the tools and the learn-by-doing kits, all of the finest quality.

And we're going to tell you about eight other career opportunities in Electronics and the ICS Career Programs that can help prepare you for them. All you've got to do is mail the attached postpaid card or coupon—today!

# ICS

International Correspondence Schools  
Since 1890  
School of Electronics  
Scranton, Pa. 18515

Approved for Veterans' Training. Eligible Institution under the Guaranteed Student Loan Program. Accredited Member National Home Study Council. Canadian residents use coupon address for service from ICS Canadian, Ltd. In Hawaii: 931 University Ave., Honolulu, Hawaii 96814

### ICS School of Electronics International Correspondence Schools Scranton, Pa. 18515

YES, I want you to mail to me without obligation, the **FREE** DEMONSTRATION LESSON and complete literature on the career program checked below. (Please check one.)

- |  |  |
|--|--|
| <input type="checkbox"/> Color TV Servicing & Repair | <input type="checkbox"/> FCC Licensing                   |
| <input type="checkbox"/> Computer Maintenance        | <input type="checkbox"/> Communications/<br>Broadcasting |
| <input type="checkbox"/> CATV/MATV Technician        | <input type="checkbox"/> Hi-Fi Sound Systems             |
| <input type="checkbox"/> Telephony                   | <input type="checkbox"/> Industrial Electronics          |
| <input type="checkbox"/> Electrician                 |  |

AA640U

Name \_\_\_\_\_ Age \_\_\_\_\_  
Address \_\_\_\_\_  
City \_\_\_\_\_  
State \_\_\_\_\_ Zip \_\_\_\_\_



# Test Equipment Scene

By Leslie Solomon, Technical Editor

**W**HEN the term test equipment is mentioned, most of us think of multimeters, scopes, signal generators, and the like. However, there are a number of pieces of test gear that may not be as "scientific" looking, but are extremely useful in a typical service shop or on an experimenter's or hobbyist's workbench.

**Component Substitution.** Let's start with component (*R* and *C*) substitution. There are many switch-operated decade boxes made by several manufacturers. These devices are real time savers in determining just what value of resistor or capacitor is needed in a particular circuit. Decade boxes can be found in the catalogs of the various mail-order houses. Some of them are capacitance only, with as many as three switches to enable the user to create a value from a few picofarads up to several microfarads. Usually the voltage rating is high enough to handle anything found in semiconductor circuits. For capacitances under 1  $\mu\text{F}$ , the decade boxes can usually handle vacuum-tube circuits.

Other decade units are for resistances only and can provide values from a few ohms to many megohms. Usually, these are made up from a collection of individual 1-watt resistors.

Then, of course, there are several combination boxes on the market. Here, resistance and capacitance switching is com-

bined in one case; and some units even have extra switches, so that resistance and capacitance can be switched in series or parallel, as desired. There are also some units with small drawers that can be used to store the most-used values. At least one of these handy instruments should be part of every test bench; and, if you are strapped for room, look for those that can be mounted under shelves with woodscrews. A pair of test leads is then all you need to use these substitutes at your workbench.

**Temperature.** We have all heard the complaint about a piece of equipment that, "It gets hot." There is no reference as to how hot is hot—it's just hot. This occurs in ac-de radios, audio amplifiers, some TV's, various appliances, etc. Since the human hand makes a poor thermometer, why not take advantage of the various reasonably priced temperature indicators that are on the market? They range in types from chemically treated stick-on tabs that change color when exposed to a higher-than-rated temperature, through variable-resistance devices that change with temperature and must be used with an external ohmmeter, to complete metering systems using thermistors on long test leads and the like.

Depending on the application with which you are most involved (high-current appliances, air conditioners, etc.), you can get the temperature-measuring instruments for ranges from about  $-50^{\circ}\text{F}$  to a couple of hundred degrees F.

We have used such devices to make temperature measurements on the heat sinks of popular audio amplifiers (after they have been running for some predetermined time so that their temperature is stabilized). We then mark the temperatures on the sche-

## Different Testers

Your electronic project may be the winner of one of ten scholarship awards! Pick-up your entry blank from any Motorola HEP Semiconductor Supplier!



**10 WINNERS**

<b>2 CATEGORIES—ENGINEERING OR HOBBYIST</b>		
GRAND PRIZE . . . . .	\$2,500.00 . . . . .	SCHOLARSHIP
FIRST PRIZE . . . . .	\$1,000.00 . . . . .	SCHOLARSHIP
SECOND PRIZE . . . . .	\$ 500.00 . . . . .	SCHOLARSHIP
2 THIRD PRIZES . . . . .	\$ 250.00 . . . . .	SCHOLARSHIPS

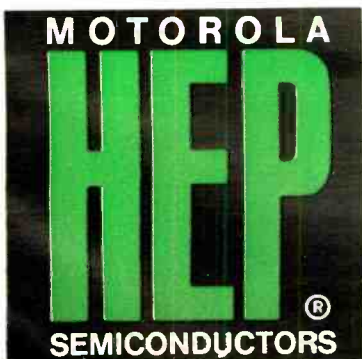

ORIGINAL ELECTRONIC PROJECT

**“Design-In” Contest**



**OPEN TO ALL AGES**

- Students • Technicians • Teachers • Experimenters
- Radio/TV Service Dealers • Electronic Repairmen
- Hobbyists • Inventors • Military Personnel • Engineers

**Enter Before December 31, 1973**



matic and this helps in future diagnoses. Our temperature meter does double duty by having an extra probe mounted on the outside wall so that we can find out the outside temperature if desired. Although we do no air conditioner servicing, we can see how such a meter could really be handy in determining the cooling power of a particular system.

**Automotive.** In another area, we take advantage of our electronics know-how to service our own trucks and cars electronically. There are many pieces of test equipment available for such jobs.

The most important piece of test gear in this area is the CRT ignition analyzer. (We use a Heath unit.) Using this scope-like device is like having a "window" in the ignition system. If you check the specs on any of these units, you will find that using one of them and your electronics know-how can really make your vehicle hum along, saving both garage fees and gas (which can really add up if you do a lot of driving). When you couple this with a solid-state metering system and a timing light, you have a complete set of automotive test gear; and, aside from major repairs, you can save a lot of money.

**Citizens Band.** If your neighborhood is like ours, CB'ers grow like mushrooms, and quite a number of them are in need of help in keeping their gear operating. We have invested in a low-cost CB transceiver multi-tester which can measure r-f power output, modulation percentage, and SWR. It can also be used as a field strength meter for checking antennas (especially in mobile installations). The meter has a built-in crystal-controlled r-f signal and an audio tone generator. Altogether, our little CB tester has 14 functions, and most of them are used. Because most CB'ers do not have such test gear, take a look around the catalogs and find yourself one. You'll discover you can have a profitable sideline in CB radio servicing and repair.

**Tape.** Why not look into the tape market? After numerous user complaints that their tapes that had been used over and over were noisy, we looked into bulk erasers. (It seems some people have a compulsion to tape all manner of strange sounds, erase them, and then have another go at it—all on the same cassette or cartridge.) We decided on a bulk

eraser that seems to do the job properly; and now the user can bring in his well-worn tapes, place them on the eraser, push the button, and go away with clean tapes to have another go at taping.

**Mobile Power.** Our town, like many others, has several parades or other outdoor community activities during the summer. A number of floats need music or other amplified sounds. Since everyone seems to have 117-volt audio equipment and most inverters tend to run down car batteries, we have a couple of gas-driven alternators that are busily occupied through most of the summer. Parades and picnics usually take place where power lines are not easily accessible so the portable power really comes in handy.

**Audio Sweep Generator.** After all our squawking about finding a decent audio sweep generator, we finally got our wish. Next month, in this magazine, there will be a construction article covering a sweep generator with five ranges from 1 Hz to 100 kHz, a choice of linear or logarithmic sweep and the capability of delivering either swept sine, triangle, or square waves. Besides the sweep function, the generator will provide fixed frequency operation (CW) at any selected frequency within its range and a sync pulse to lock an oscilloscope.

The generator uses several IC's and will be available in kit form for about \$100 (our present estimate). If you decide to build this instrument, you can look forward to having a fine piece of test equipment that can be used to check various types of audio amplifiers, crossover networks, speakers, etc. We will also show you how to set up a tape recorder so you can really get the best out of it. We have been using the sweeper for a couple of weeks now, and we can assure you it is a first-class piece of test gear that can really do a job on audio equipment. By the way, if there is any piece of gear that you feel is needed in the area of test equipment and there is nothing available either commercially at a reasonable price or in kit form, drop me a line in care of the magazine. We have a number of excellent design engineers champing at the bit to design some new equipment. Just spell out what type of tester you feel is needed, why you need it, what price you think would be right, and what is the nearest commercial equivalent. We will give it a try. ♦

Main Bevatron control room at the Lawrence Radiation Laboratory where high-energy particle experiments are conducted. Radioactive elements are produced here for possible use in various areas in the field of medicine.



# ELECTROMAGNETIC RADIATION in MEDICINE

ONE OF OUR BEST WEAPONS IN THE WAR AGAINST ILLNESS

BY WEBB GARRISON

**T**HE USE of electromagnetic radiation in medical diagnosis and therapy began about 80 years ago. Launched by accident, it took off like a rocket. In the twentieth century, no other branch of medicine, not even surgery or chemotherapy, has developed as rapidly as EM research.

Today, most bands of the EM spectrum are being used in the war against illness and disease. Yet, only the surface has been scratched. All signs point to continued acceleration in highly specialized uses of specific wavelengths that will eventually play important medical roles in the future.

**How It Began.** German physicist Wilhelm Conrad Roentgen started the whole business. His meager equipment included a Crookes tube already known to emit cathode rays. While experimenting in November 1895 with his tube, Roentgen was astonished to notice a clear fluorescent effect on a screen of barium platinocyanide that hap-

pened to be nearby. Other users of the tube, including Crookes himself, had observed similar phenomena without paying heed. But Roentgen quickly grasped the fact that in addition to the radiation he was investigating, the tube was emitting mysterious rays. What is more, they had penetrated the black cardboard cover that was placed over the tube during the experiment.

Dubbed X-rays ( $x$  is the common mathematical symbol for "unknown"), the newly discovered waves were almost immediately put to practical use in medicine. With them, Roentgen peered inside his own hand. Soon, scientists were beating a path to his door. Drs. Oudin and Barthelemy came all the way from Paris. They submitted "a photograph of the bones of the hand taken by means of Prof. Roentgen's X-rays" to the Paris *Academie des Sciences* on January 20, 1896.

This first published medical X-ray photo created intense interest in the generation





Copy of first X-ray picture of hand. Though of poor quality due to crude equipment, this led to wide X-ray use.

and control of waves whose frequencies range upward from about  $10^{16}$  Hz. Since the longest X-rays have a wavelength of about  $10^{-6}$  cm, the band that includes them overlaps part of the ultraviolet band on the low end and the gamma-ray band on the high end.

It is a rule of thumb that since 1896 medical applications of man-controlled EM radiation have quickly followed perfection of techniques and instruments for production, control, and measurement of particular kinds of waves. In the United States, Dr. Walter B. Cannon extended and amplified the use of X-rays by placing patients before fluorescent screens. A subject given an opaque substance (often barium) takes on a new dimension. As a result, "soft" regions like the throat, stomach, and gastro-intestinal tract can be examined without resorting to surgery.

The therapeutic use of X-rays followed the discovery that this form of EM radiation has different effects on normal and malignant tissue. Toward the short end of the X-ray band, effects are much like those produced by radiation in the long end of the gamma-ray band.

Use of instruments and techniques has proliferated so widely that established procedures involving X-rays in medicine are now numbered in the hundreds. Exact fig-

ures are not available, but one industry spokesman estimates that X-ray film used by hospitals, clinics, and private physicians in the U.S. exceeds the quantity of light-sensitive film used by photographers.

**Diathermy Devices.** French scientist Jacques Arsene d'Arsonval reasoned that high-frequency waves should have specific therapeutic effects. He tried them on humans, but his equipment was too primitive to produce uniform results. German physician Carl F. Nagelschmidt coined the term *diathermy* in 1907. But another 21 years passed before General Electric's Dr. Willis Rodney Whitney developed a practical diathermy machine. The first patient was physician Charles M. Carpenter, treated on February 23, 1929 in Schenectady, New York.

Today, diathermy machines are in such wide use that they contribute to the growth of electromagnetic radiation pollution. Spurred by this threat to health by EM therapy, funds from the National Institutes of Health were used to create a digital glow curve analyzer to measure microwave exposure. Basic to the design is a special thermoluminescent dosimeter (TLD) reader.

Also being studied, at Philadelphia's Jefferson Medical College, is the use of EM radiation for abortion. It has been discovered that microwaves of 2450 MHz (2.45 GHz) cause pregnant rats to reabsorb embryos. Years of testing and research will be necessary to determine whether or not the

Varian's Clinic® 4, already in use in more than 40 hospitals, is a megavolt linear accelerator for radiotherapy.

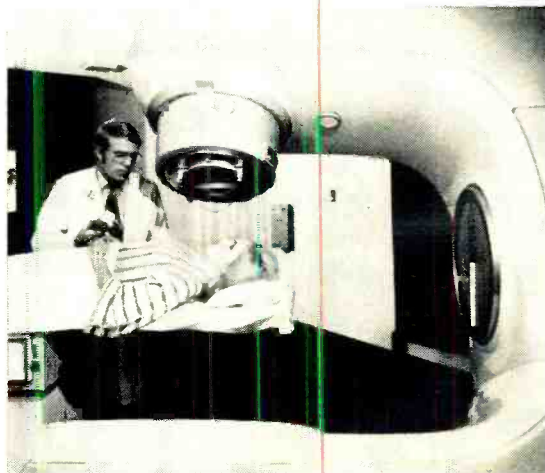



procedure can be applied to human beings.

Meanwhile, microwave experimentation is proceeding at such a pace that special controlled environmental facilities have had to be built. The control console of such a facility is so elaborate that one glance at it gives proof positive that modern medicine shows increasing dependence upon electronics.

Shortwave diathermy, tried at least 30 years ago, remained in the Model-T stage until advanced instrumentation came along. One U.S. manufacturer has received three patents on a new device with "automatic-demand control" and helical induction-coil drum applicator. Federal law restricts the sale of this device to physicians, dentists, veterinarians, and other state-licensed practitioners. But the therapist need not be versed in electronics to use it; he simply sets controls and turns on the machine.

This does not mean that the use of any form of EM radiation is simple or fully understood. The complex that includes living organisms plus radiation is so elaborate that every variable has potential for far-reaching influence.

In the case of microwaves, pulsed energy has effects quite different from those of constant radiation of the same type. This effect has led to the development of the Diapulse® machine. Energy waves from it typically last 65 microseconds and can be administered at a frequency of 80 to 600 pulses per second. The assigned frequency is 27.12 MHz.

Diapulse treatments have produced dramatic accelerations in wound healing, germination of seeds, and peripheral blood flow. Some investigators think it even offers hope in medicine's perennially "incurable" condition known as arthritis.

**Light & Atomic Energy.** Coherent radiation that is both directional and highly monochromatic was not available until 1960. Within five years after a pioneer laboratory development program in the laser field, this type of controlled radiation was being used in delicate eye surgery and treatment.

Already, the proliferation of laser types has led to recognition that equipment to produce simulated emission will be as closely identified with the hospital of the future as were the scalpel and saw in the hospital of the past.

Rather strangely, visible light that lies in the narrow band limited at one end by



Diathermy machine, made by Burdick, operates on frequency of 27.120 MHz.

$10^{-4}$  cm and at the other end by  $10^{-5}$  cm wavelength was one of the last kinds of EM radiation to find controlled use in medicine.

Under ordinary circumstances, practically all humans get enough of this radiation without seeking it. But infants born with jaundice need continuous treatment at a level of 200 to 300 footcandles. This need was accidentally discovered in England when a nurse noticed that jaundiced infants improved faster when their cribs were placed near windows. In almost any hospital, day or night, you will find at least one infant, with eyes bandaged to prevent damage, lying continuously under ordinary visible light.

**Gamma Rays.** Invisible radiation of very high frequency (beyond  $10^{18}$  Hz) and correspondingly short wavelength ( $10^{-7}$  cm or less) attracted medical interest long before visible light was known to have therapeutic value. Just three years after X-rays were discovered, Pierre and Marie Curie announced their discovery of a new element that they called radium. Gamma rays produced by this material found applications ranging from treatment of cancer and tumors to the control of infected tonsils.

Harmful and even lethal side effects of radium treatment emerged quite early. So much of the radioactive element was being used in medicine, with inevitable losses of small quantities, that it became necessary to develop a device with which to locate it. The Geiger counter came into existence as a result.

In the aftermath of the atom bomb, radio isotopes have been spawned in bewildering numbers and varieties. EM radiation from these man-made isotopes in the form of gamma rays that can be like those of radium, or radically different from radium, are in widespread use in the developed nations. A spokesman for the American Medical Association has made an "educated guess" according to which this form of EM radiation "has already saved more lives than have been taken by all the wars of history."

The clinical use of radio isotopes has spurred development of highly sophisticated devices for regulation of dosage. Newly developed counting systems seem equally efficient with low-energy and high-energy radio isotopes.

From the beginning of high-energy physics, medical applications have been major goals of scientists working with particle acceleration. Only now, however, with the "new generation" of super accelerators, have man-controlled particles come close to duplicating heavy components of cosmic rays. This development was predicted in 1951 when E.O. Lawrence made his acceptance speech at the Nobel Prize ceremonies. Then in 1971 at the Lawrence Radiation Laboratory, the predicted breakthrough came—heavy ions were accelerated to an energy level of 36 billion electron volts (BeV).

Such high-energy particles, closely equiv-

alent to cosmic waves with frequencies in the range of  $10^{24}$  Hz. give modern medicine a tool never before available. Like cosmic rays, high-energy particles have qualities that differ from those of X-rays and gamma rays. At least in theory, their potential for destroying tumor cells is much greater.

Except for very long waves of low frequency in the audio band, the whole EM spectrum now wears a white coat at least part of the time. Long-standing distinctions between "therapeutic" and "damaging" radiation are no longer valid. Both terms are now recognized to be relative, with most or all kinds of EM radiation having potential for effects of both kinds. Generalizations about such things as microwaves and r-f radiation are already on the way out.

Medicine of the immediate future will deal with EM radiation that is precisely oriented for particular effects upon specific biosystems. This means more complex instrumentation plus control within diminishing tolerances.

The past 80 years represent no more than a beginning. New techniques and increasingly refined instruments point to a continuing surge in use of EM radiation for both diagnosis and therapy.

Nothing in the history of medicine can be compared with this growth. Before the end of this century, radiation may make the knife and the pill obsolete in many cases. ♦

Photo of a whole-body counter for measuring gamma rays from cats treated with strontium 85 and 89. The lead shielding cylinders are 8 inches thick.

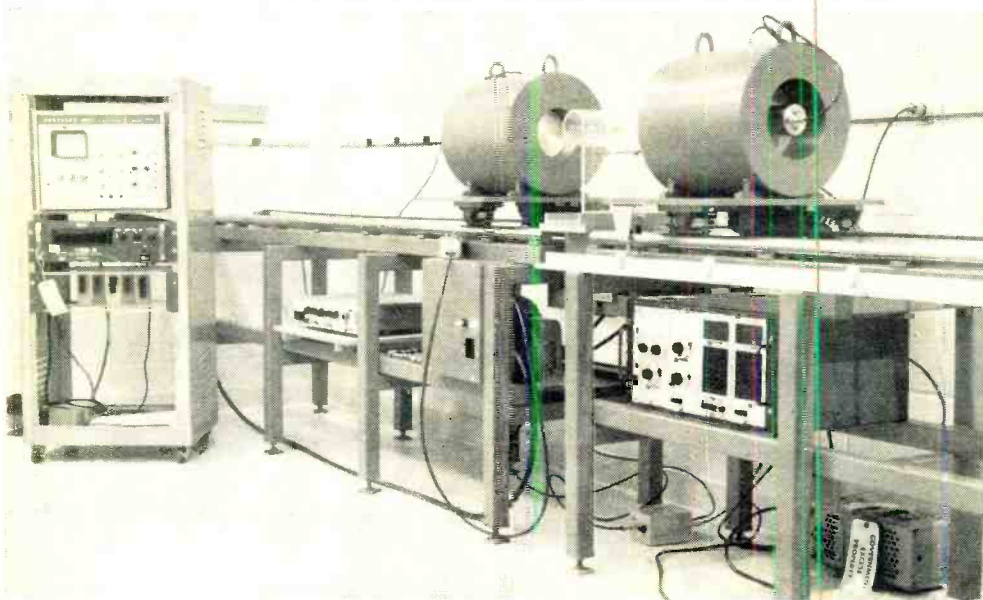

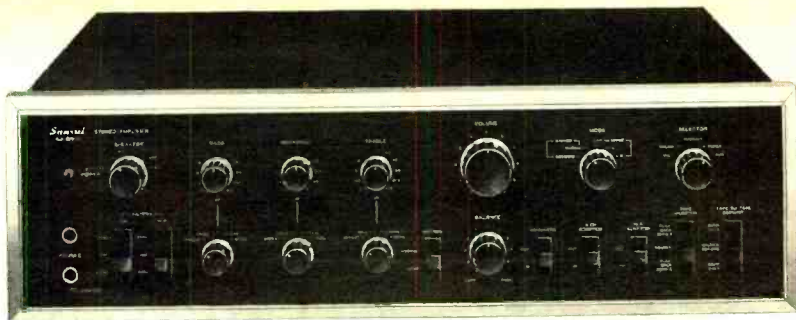

# *the Sansui AU9500: hottest-selling integrated amplifier in the field.*

Here's the power amplifier that not only boasts 85 hefty wats per channel, but also boasts a host of other fantastic features. It's designed and made for people who want only the best—and are willing to pay for it. And, judging by the way the AU9500 is selling, there must be a lot of those folks around.

The new Sansui AU9500 is the most advanced stereo product we make. It's superior performance characteristics include total harmonic distortion and intermodulation distortion below 0.1% throughout the entire audio spectrum and well beyond. Power bandwidth is extremely wide (5-40,000Hz) and RMS true power, conservatively rated, is 85 watts per channel into 8 ohms.

Among the many exciting features of the AU9500 are a wide variety of conveniences, such as a 4-channel adaptor switch, for QS, SQ, or CD-4 add-on units, the ability to handle up to four tape decks, and provision for tape-to-tape dubbing. Triple tone controls allow even the fussiest listener to adjust the AU9500's response to his taste.

As eye-catching as it is functional, the AU9500's elegant front-panel styling is a standout in any audio display. And it has two counterparts, the AU7500 and AU6500, which offer many of the same features, the same quality engineering and manufacturing, but slightly less power. All three are powerful, quality units that are unequalled for fine high fidelity reproduction.



## **SANSUI ELECTRONICS CORP.**

Woodside, New York 11377 • Gardena, California 90247

SANSUI ELECTRIC CO., LTD., Tokyo, Japan • Sansui Audio Europe S. A., Antwerp, Belgium

**CIRCLE NO. 30 ON READER SERVICE CARD**



# HOW TO AVOID WORKBENCH HAZARDS

DON'T BE CARELESS WHEN WORKING WITH ELECTRONICS

**E**VERY YEAR, thousands of electronics professionals and hobbyists suffer the painful and sometimes lethal effects of electrical shock while at their workbenches. Most are lucky enough to come away from the experience with a bruise, a broken bone or a painful memory and a new respect for the power of electricity. Those who fail to come away from it become statistics.

These accidents need never have occurred if the victims had adopted a sensible work plan and geared themselves physically and mentally to avoid multiplying the shock hazard. You can minimize the shock hazard on your workbench by using a few simple expedients and exercising good common sense.

In this article we will be discussing some of the practices you should adopt whenever you work on line-powered and high-voltage circuits and equipment. We will detail the conditions under which you should avoid working near potentially dangerous voltages and describe what you can do to make your working environment a safer place in which to work.

**Safety Practices.** Let us begin with the common denominator—you. You can do everything possible to make your shop really safe, but if you are a “walking disaster,” accidents will follow you on the job.

First, never go to work on an electronic device—powered or not—while wearing jewelry such as a wristwatch, ring, etc. The workbench is no place for jewelry or other items like ties and dangling laces that can

get hung up on the equipment in an emergency or even be the cause of an emergency.

Be practical about what you wear on the job. You are at your best when comfortably dressed. So, wear a long-sleeved shirt, buttoned at the wrists and open at the collar, and rubber-soled shoes.

Whenever you are working on a circuit or chassis where high voltages are present, keep your mind and eyes on what you are doing. Don't look away to observe a meter reading or a scope waveform if you are touching a test prod to a point in a powered circuit. Do your job the way a professional would: With the power to the equipment under test turned off, connect the test leads. Turn on the power, take your reading, and turn off the power. Only after the power has been turned off should you remove the test leads from the equipment. If you do the job the unsafe way, your eyes have to leave the work to take the reading, in which case the probe tip might slip.

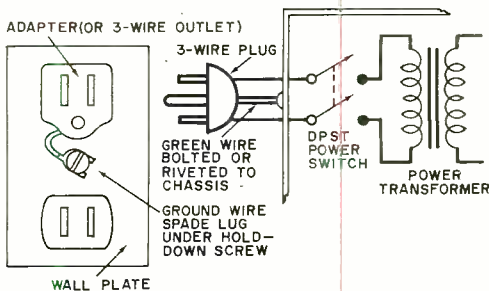
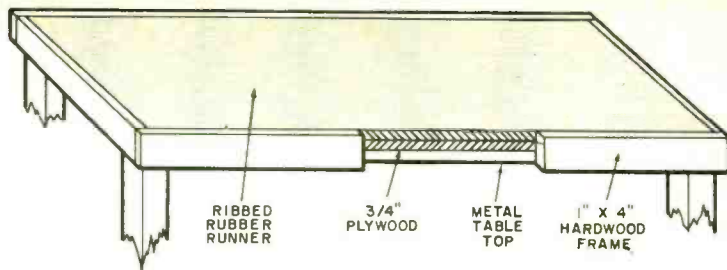

Fig. 1. Recommended method of wiring cords and switches on electronic gear.

Fig. 2. How to make a workbench with a metal top safe by addition of insulation.



Chances are that you will overreact and get yourself into more trouble.

It takes only about 10-20  $\mu\text{A}$  of current coursing through the heart to cause ventricular fibrillation, a usually fatal condition unless help and special equipment are immediately available. Currents as low as 100 mA entering a hand and leaving the body via the other hand or a foot can generate the fibrillatory current in the heart. So, never reach into a high-voltage circuit with both hands, and never rest one hand on the chassis while reaching into the circuit with the other hand. To avoid temptation, keep your free hand in a pocket or behind your back.

If you plan to work on unpowered equipment in which high voltages are developed, make certain that the line cord is unplugged and that you discharge all electrolytic capacitors in the high-voltage circuits. Electrolytic capacitors can hold a potent charge long after power is shut off; so, don't take chances. (Remember that charges too small to be lethal can inflict secondary injuries like bruises, lacerations, and broken bones as muscles violently and involuntarily contract upon contact. This can be a life-saving move on the part of nature, by interrupting the through-the-body circuit, but it doesn't help if you crack your skull against a shelf or tear your flesh on a chassis.)

**When Not To Work.** Many electronics men go to work on circuits or equipment when they should be doing something else—like resting. There are definitely times when you should avoid going near electronic gear if you plan to stay healthy.

Hot, muggy environments cause a worker to perspire profusely and sap energy. A body covered with high-salinity perspiration becomes a fairly good conductor of electricity. Not only is the resistance over the surface of the skin reduced by perspiration, it provides a more direct current path between the skin and the interior of the body.

Cold environments can be equally hazardous. Cold has a numbing effect on the body, particularly in the extremities—like the fingers that hold test probes. Fingers that lose their normally acute sense of touch can easily make mistakes and do so all too often. Either heat the area or stay away.

Never approach a job if you are tired, angered, or emotionally upset. And don't try to work off excess energy at your workbench. (Go lift weights or do some jogging; it's safer.) Under these conditions, your concentration is apt to wander—which is as bad as your eyes wandering.

The best time to go to work is when you are relaxed and alert. Stop working when you become fatigued or bored, and take frequent rest breaks.

**Your Equipment And Workshop.** Many electronics men who practice proper safety measures give little thought to their test equipment and workshops. This is particularly true of the hobbyist who works in a basement or attic where environmental conditions are hardly conducive to safety.

Line-powered test gear is a particularly sore point. Under no circumstances can a line-powered instrument be considered safe if it is equipped with a two-conductor line cord. It is even less safe if only a single-pole, single-throw power switch is used. All two-conductor line cords should be replaced with three-conductor cords, and all instruments should be equipped with double-pole single-throw switches. The recommended method for wiring the cords and switches into your gear is shown in Fig. 1. While you are at it, carefully inspect all power cords and plugs, replacing any that are frayed, loose, or worn.

Plug three-prong plugs into appropriate sockets or into adapters to mate them to two-conductor house wiring systems. If you use adapters, slip the spade lugs on the grounding wire under the outlets' wall-plate mounting screw and tighten down. When

# WOW

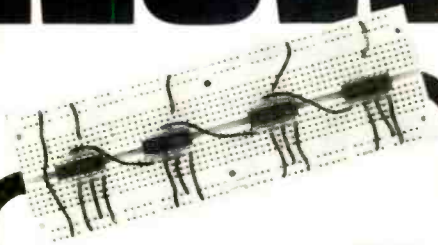

## ... TEST NEW CIRCUIT IDEAS, I.C.'s, DISCRETE COMPONENTS WITH NO SOLDERING!

Only **\$17.75** The E&L SK-10 SOCKET

Just plug in ¼ watt resistors, ceramic capacitors, diodes, I.C.'s, transistors and more, and your circuit is built! No soldering! No special patch cords needed. All components reusable! Interconnect with any solid #22 gage wire.

- Nickel/silver terminals — low contact resistance
- Low insertion force
- Initial contact characteristics beyond 10M insertions
- Vertical and horizontal interconnecting matrices
- Handles wide range of wire leads from .015" to .032"

### MONEY-BACK GUARANTEE

Try it with absolutely no risk for 5 days. If not satisfied, return your SK-10 socket and get a full refund. Trying is believing. How can you go wrong? Send check or M.O. today!

- Add 50¢ for postage and handling
- 25% deposit for C.O.D.'s

Ask for FREE IDEA-PACKED,  
ILLUSTRATED CIRCUIT DESIGN  
CATALOG.



**E&L INSTRUMENTS, INCORPORATED**  
61 First Street, Derby, Conn. 06418

CIRCLE NO. 10 ON READER SERVICE CARD

you have several instruments that have to be used simultaneously, your best bet is to use a circuit-breaker or fuse-protected heavy-duty powerline outlet box. In this event, you need only one adapter in a two conductor house wiring system.

If you want to be really safe at your workbench, consider installing a ground-fault interrupter (GFI) in the bench's power system. The GFI is a fast-response device that disconnects power from the load whenever leakage current exceeds a specific amount (typically 5 mA). Don't install the GFI into the room's entire electrical system, or it might extinguish the lighting when it trips—a safety hazard in itself as you grope around in the dark and trip over things.

Finally, make your work area safe and livable. In a damp basement where the floor is of raw concrete or in an attic where the floor is of unfinished lumber, lay vinyl flooring. Both areas will benefit enormously from a few sheets of hardboard nailed over exposed studs and rafters. Before installing the hardboard, however, make sure that there is adequate weather insulation between the exposed studs and rafters. A casement vent in the basement or a through-the-wall vent, each equipped with an exhaust fan, to allow free circulation of air will keep either area relatively dry and odor-free. While you are about fixing up your work area, install adequate lighting. Any good book on home improvements will tell you how to do these things.

Wood is the best material for an electronics workbench, but if you must use a table with a metal top, it will have to be made safe. You will need two sheets of ¾-inch plywood cut to ¼ inch longer and wider than the dimensions of the table top. Cement the plywood sheets together and clamp overnight. Then top them with a ribbed synthetic rubber runner, held in place with contact cement, to provide a durable non-skid work surface. Finally, glue and nail a hardwood frame around this assembly as shown in Fig. 2. When finished, the worktable surface should slip over the metal table top. Do not fasten the work surface to the top of the table.

If you do everything we have outlined above, your chances of being injured or worse in your workshop will be very remote. But, again, we must caution you. Don't relax your guard or take shortcuts. To do so, you are only inviting trouble. ♦



# MIT'S Presents The New 150 Series Handheld Calculator

...8 Functions Mean a Handful of Features!

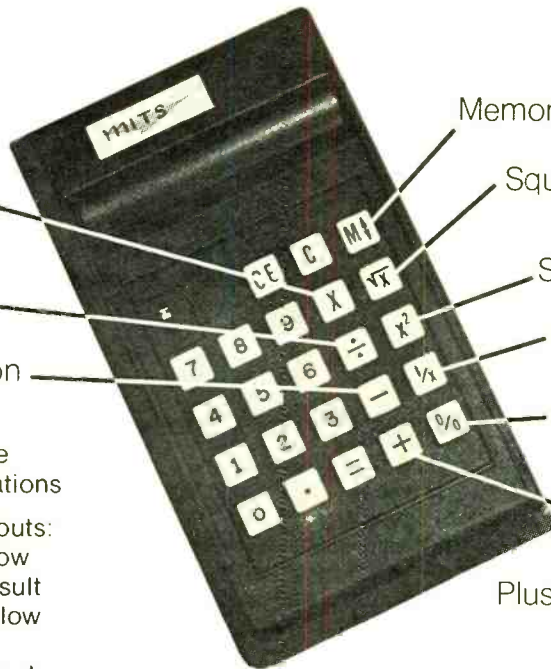

Multiplication

Division

Subtraction

Memory

Square Roots

Squaring

Reciprocals

Percentages

Addition

100% American Made  
Chain & Mixed Operations

Special Readouts:

- Entry Overflow
- Negative Result
- Result Overflow
- Low Battery
- 8 Digit Readout  
(Always the most significant digits)
- Bright Led Display

Plus: •Floating &  
Fixed Decimal  
•Algebraic Logic

PRICES\* \$129.95 Assembled

\$ 99.95 Kit

Full 1 Year Warranty

AC Adapter for 110VAC Operation \$6.95

Carrying Case (leatherette) \$5.95

\*Prices subject to change without notice.

SIZE: 5-3/4" x 3-1/4" x 1-1/2"

Hi-Impact ABS Case

## MIT'S®

### Micro Instrumentation & Telemetry Systems, Inc.

6328 Linn, N.E., Albuquerque, New Mexico 87108  
505/265-7553 Telex Number 660401

Enclosed is a Check for \$ \_\_\_\_\_  
or  BankAmericard # \_\_\_\_\_  
or  Master Charge # \_\_\_\_\_  
or  Purchase Order # \_\_\_\_\_

Include \$5.00 for Postage and Handling

Kit  Assembled

Please Send Information on Entire MIT'S Line.

NAME \_\_\_\_\_

ADDRESS \_\_\_\_\_

CITY \_\_\_\_\_

STATE & ZIP \_\_\_\_\_

MIT'S/ 6328 Linn, N.E., Albuquerque, New Mexico 87108 505/265-7553 Telex # 660401

CIRCLE NO. 20 ON READER SERVICE CARD



# Tips & Techniques

## REPLACE A BROKEN GUY WIRE WITHOUT TAKING DOWN MAST

To replace a broken guy wire without having to take down the antenna mast or tower, you will need a new insulator and an extra-long new guy wire. First, estimate how much wire is needed for forming a slip loop, permitting a few turns around the mast, and attaching the

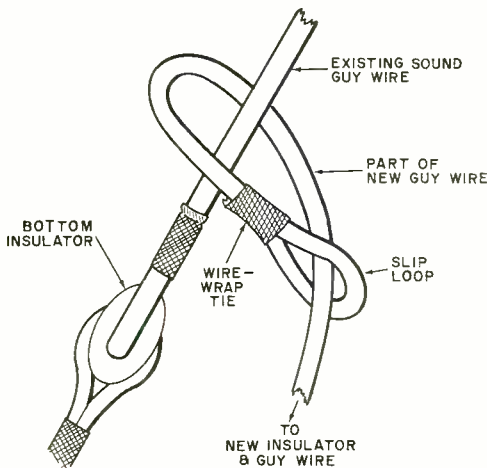

new insulator. Cut this length from the new guy wire and form a small loop at one end of it. Thread the free end through the loop around one of the sound guy wires that flank the broken one (see drawing) and attach the insulator and new guy wire. Throw the new wire around the next sound guy wire and pull the loose end to raise it to the top of the mast. Holding the wire taut, make three or four circuits of the mast to assure a firm anchor. Then securely fasten the free end to the bottom insulator.

—Jack Pulford, VE3AWL

## PLASTIC MACHINE SCREWS AND NUTS RESIST LOOSENING DUE TO VIBRATION

Many hardware stores stock machine hardware made from a resilient plastic (Nylon or polyethylene) that builders of automotive and marine projects will welcome. Unlike ordinary

steel and brass hardware, the plastic nuts and screws "give" with vibration to resist working loose. Even lockwashers used with ordinary machine hardware don't provide as much staying power as the plastic hardware.

—Tom Dunning

## MAILING TUBE SAVES WEAR AND TEAR ON SOLDERING IRON IN TOOL BOX

A soldering iron can be a handy tool to take along on a service trip, to make on-the-spot repairs, etc. However, to carry a small iron safely in a tool box along with heavier, more

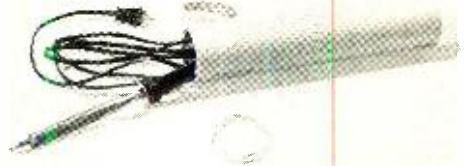

rugged tools, special precautions must be taken to prevent it from becoming damaged. No need to be fancy. Just obtain a relatively heavy cardboard mailing tube. Close one end with a piece of heavy cardboard and some tape and find or fashion a cap for the other end. When you pack away the soldering iron, be sure to include some turns of solder.

—Marshall Lincoln

## BREAD SEALER TABS MAKE NO-COST CABLE IDENTIFIER TAGS

Most of us who have an electronics interest are familiar with the problem of keeping tabs on what cable comes from or goes to where. We are resigned to being cable users, whether in a hi-fi system, on a testbench, or whatever. Ingenious devices—from adhesive tags that become tacky and discolored to paper tags in metal rings that attach via strings—have come along to help us out of the cable dilemma. Perhaps the most ingenious device to come our way for identifying cables in a system can be found on the open ends of most bread wrappers: those plastic tabs you've been throwing away all these years. They make excellent cable tags that won't get in the way when slipped over the cable leads. And they can be permanently marked with a Magic Marker.

—J. Leeds

### TIPS WANTED

Do you have a "tip" or "technique" that might help your fellow readers? It may be worth money to you. Send it in (about 100 words, with a rough drawing and/or clear photograph, if needed) and you'll receive payment if accepted. Amount depends on originality and practicality. Material not accepted will be returned if accompanied by a stamped, self-addressed envelope. Send material to: Tips and Techniques Editor, POPULAR ELECTRONICS Including Electronics World, 1 Park Ave., New York, NY 10016.

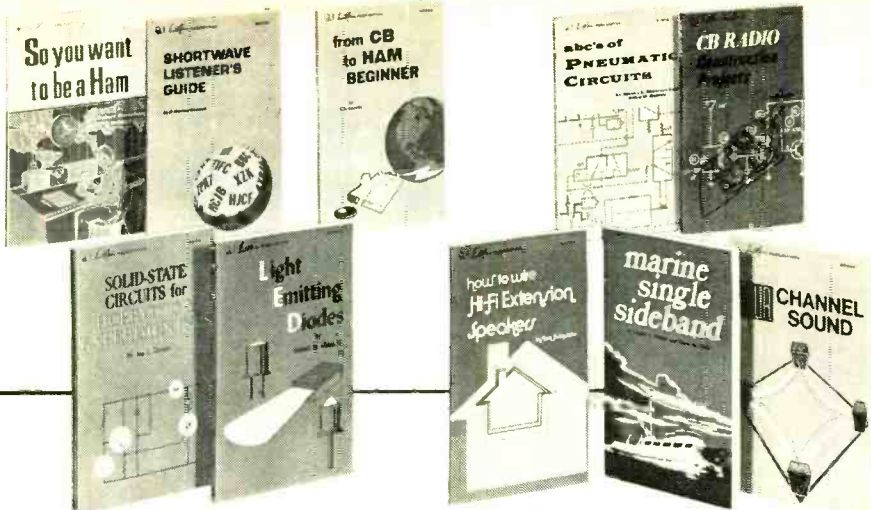

## There's a Sams book here that can help you.

You are almost sure to discover here one or more handbooks that will instruct you and help you advance in a favorite field of electronics. Without exception, they are authoritative, clear and easy to follow.

### SO YOU WANT TO BE A HAM—6th Edition by Robert Hertzberg W2DJJ

Starts beginners in a fascinating hobby; serves as an invaluable reference for old-timers. Covers license requirements, receivers, transmitters, mobile equipment, test equipment, antenna systems; also explains operating procedures, how and where to buy equipment, guidance on passing the FCC exam. No. 20977—\$5.50

### SHORTWAVE LISTENER'S GUIDE—5th Edition by H. Charles Woodruff

A practical guide listing short-wave stations by country, city, call letters, frequency, power, and transmission time. Includes many Voice of America, Radio Free Europe, and Iron Curtain stations, time zone conversion charts, and a handy log for recording stations received. No. 20934—\$2.95

### FROM CB TO HAM BEGINNER by J. A. Stanley

Tells and shows how to enter the world of the "ham," how to select and tune a communications receiver, listen in on ham bands, send and receive code, pass the novice license exam, build or buy an amateur transmitter, erect an antenna, put a ham station on the air. No. 20920—\$4.25

### ABC'S OF PNEUMATIC CIRCUITS by Harry L. Stewart and John M. Storer

Provides an excellent understanding of the fundamentals of pneumatic control circuits. Starting with a coverage of basic symbols and symbology, the book progresses through increasing difficult arrangements and explains the operation of performance tested circuits in step-by-step detail. No. 20970—\$4.50

### CB RADIO CONSTRUCTION PROJECTS—2nd Edition by Len Buckwalter

You can know little or nothing about electronics and still understand the how-to instructions in this book. The result: you'll build valuable CB devices at a fraction of the cost of commercial models. No other book like it. No. 20952—\$3.95

### SOLID-STATE CIRCUITS FOR HOBBYISTS & EXPERIMENTERS by Jon L. Turino

A most practical book for the serious hobbyist who wants to design his own circuits or modify existing designs. Explains the "how" and "why" steps that enable you to think through a project to the desired end. No. 20949—\$5.95

### LIGHT EMITTING DIODES by Forrest M. Mims, III

Here is thorough coverage of a fascinating subject, starting with the theory of semiconductor emission, and covering infrared-emitting diodes, visible-light-emitting diodes, and their growing number of commercial applications. No. 20964—\$4.50

### HOW TO WIRE HI-FI EXTENSION SPEAKERS by Len Buckwalter

Follow the step-by-step instructions in this book and you can design and install an extension speaker system to fit your precise needs. Covers design, installation and troubleshooting in full detail. No. 20935—\$3.95

### MARINE SINGLE SIDEBAND

by Donald L. Stoner and Pierre B. Goral

Covers the "how" and "why" of single sideband; interpreting specifications, alignment tests and measurements, installations, securing a limited coastal license, high-seas telephone service, marine radio terminology. No. 24029—\$5.95

### FOUR-CHANNEL SOUND

by Leonard Feldman

If you are thinking about buying a four-channel set, converting to one, or you just want to learn more about this newest development in sound recording and listening—this book contains the information you need. No. 20966—\$4.50



HOWARD W. SAMS & CO., INC.

PE-093

4300 West 62nd Street, Indianapolis, Indiana 46268

Order from your electronic parts distributor, or mail to Howard W. Sams & Co., Inc.

Send books checked at right. \$\_\_\_\_\_ enclosed. Please include sales tax where applicable.

Send FREE 1973 Sams Book Catalog

Name \_\_\_\_\_

Address \_\_\_\_\_

City \_\_\_\_\_ State \_\_\_\_\_ Zip \_\_\_\_\_

- 20977
- 20934
- 20920
- 20970
- 20952
- 20949
- 20964
- 20935
- 24029
- 20966

CIRCLE NO. 29 ON READER SERVICE CARD



# Great careers

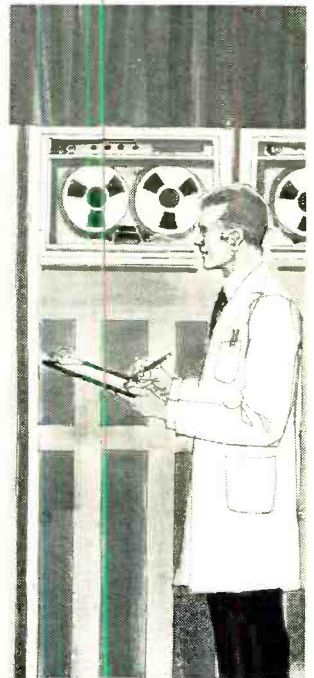
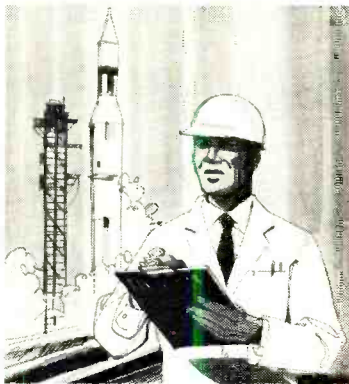
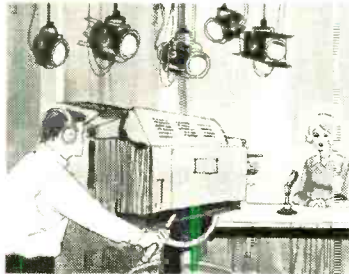

## Join the high-paid electronics technicians who got their start through NTS Home Training.

Your home can become your own private classroom-workshop. NTS sends you everything you need to learn valuable technical skills in electronics. You get easy-to-grasp lessons, comprehensive kit manuals, large fold-out charts, and more. Plus the finest professional equipment available today. It's all included in your tuition, yours to keep.

You'll work with commercially-designed equipment, and school training material. Cash in on the tremendous opportunities in the expanding, exciting world of electronics.

If your field is television, you might decide to join a first-class TV repair center. Or start a shop of your own. Or specialize in industrial applications of television. Once you master an area of electronics, the direction you take is really up to you. And you'll be able to use the test instruments you built yourself.

It all begins at home, with NTS Project Method Training. Check card or coupon today for free full-color NTS Catalog and complete details. No obligation. No salesman will call.

### NTS COLOR AND B&W TV SERVICING

Build the largest most advanced color TV made! It's a Heath! Over-all solid-state design, 315 sq. in. ultra-rectangular screen, 24 channel detent UHF/VHF power tuning, matrix picture tube, built-in self-servicing features, "Instant On," A.F.T., solid-state VHF tuner, and much more! This is a commercial set, the kind you'll encounter in the field — and not for training purposes only. Also build and keep AM-SW Radio, Solid-State Radio, FET Volt-Ohmmeter, and Electronic Tube Tester. Learn trouble-shooting, stereo multiplex systems, radio, color and B&W TV servicing.

**Solid-state B&W TV**  
74 sq. in. picture (cabinet included)



Learn advanced solid-state circuitry as you build this B&W TV receiver. Course covers the full range of home entertainment electronics.

### NTS AUDIO ELECTRONICS SERVICING



**Solid-state Heath Stereo Receiver and Speakers**

Learn sound theory — how it works in home radio, 4-channel, and more! Set up a spectacular music system. Learn about sound distortion, amplification and control, loud-speaker baffles, problems of system installation, etc. Included is Volt-Ohmmeter, In-Circuit Transistor Tester and solid-state Radio. Prepare yourself for great opportunities in the Home Entertainment Industry!

# begin at home.



**New solid-state  
315 sq. in. color TV**



**The exclusive  
NTS Compu-Trainer**

## NTS COMPUTER ELECTRONICS

Build and operate the exclusive NTS Compu-Trainer! Loaded with integrated circuits, it teaches you the how, what, and why of computers — faster, more thoroughly. You perform all wiring and patch-cording. No shortcuts! No pre-wired circuit boards. Also receive an FET Volt-Ohmmeter and a 5" wide-band Solid State Oscilloscope.

## NTS ELECTRONIC COMMUNICATIONS

Gain the prestige and earning power of owning an FCC First Class Radio Telephone License! Two exciting courses in the fields of transmitting and receiving. Experiment with an amateur phone 6-meter VHF transceiver, NTS exclusive 6-transistor solid-state radio and a fully transistorized volt-ohmmeter.

**5-watt AM  
transmitter/  
receiver.**



## NTS AUTOMATION/ INDUSTRIAL ELECTRONICS

Systems automation is the future of the industry — and you can play an important role! Enter the age of electronic controls by training on the NTS Electro-Lab — a complete workshop. Also receive a Solid State 5" wide-band professionally rated Oscilloscope. Build five industrial controls to regulate motor speed, temperatures, pressure, liquid level and much more.

**5" Solid State  
Oscilloscope**



## CLASSROOM TRAINING AT LOS ANGELES

You can take classroom training at Los Angeles in sunny Southern California. NTS occupies a city block with over a million dollars in facilities devoted exclusively to technical training. Check box in coupon.

## APPROVED FOR VETERANS

Accredited Member: National Association of Trade and Technical Schools; National Home Study Council.

## NATIONAL TECHNICAL SCHOOLS

Resident & Home Study Schools  
World-Wide Training Since 1905  
4000 S. Figueroa St., Los Angeles, CA 90037

**Please rush Free Color  
Catalog and Sample  
Lesson, plus information  
on course  
checked below. No  
obligation. No sales-  
man will call.**



### National Technical Schools

Resident & Home Study Schools  
World-Wide Training Since 1905  
4000 S. Figueroa St., Los Angeles, CA 90037

- Master Course in Color TV Servicing
- Color TV Servicing (For Advanced Technicians)
- Master Course in B&W TV & Radio Servicing
- Master Course in Electronic Communications
- Practical Radio Servicing
- FCC License Course
- Master Course in Electronics Technology
- Automation & Industrial Electronics
- Computer Electronics
- Basic Electronics
- Audio Electronics Servicing Dept. 205-093

Name \_\_\_\_\_ Age \_\_\_\_\_  
Address \_\_\_\_\_  
City \_\_\_\_\_ State \_\_\_\_\_ Zip \_\_\_\_\_

- Check if interested in Veteran Training under new G.I. bill.
- Check if interested ONLY in Classroom Training at Los Angeles.





# Product Test Reports

## TURNER SUPER SIDEKICK MICROPHONE (A Hirsch-Houck Labs Report)



**T**HE TURNER "Super Sidekick" base station communications microphone can be used with virtually any transmitter designed for CB, business band, amateur, or general communications service. Its built-in amplifier employs a transistor and an IC that boost the output of the dynamic microphone element to a level suitable for any solid-state or vacuum tube transmitter.

The die-cast base of the microphone serves as a desk stand and a housing for the electronics package and its 9-volt battery. A plastic bar across the front edge of the base provides a convenient means of activating the microphone and amplifier and energizes the transmitter control circuits. A slide switch on the underside of the base adapts the push-to-talk control to relay-operated transmitters (by joining the two control wires) or to electronically switched transmitters (requires a grounding wire). The spring-loaded bar releases when pressure is removed; but it can be locked in place for extended periods by a lock-on switch on the base.

A gain control in the microphone amplifier's negative feedback circuit is accessible,

by screwdriver, through a hole in the underside of the base. A knob on the top of the base permits adjustment of the output voltage from the amplifier. A three-conductor, coiled-cord cable that extends 4 to 5 ft carries the audio and control outputs to the transmitter.

The maximum output level from the amplifier is 25 dB below 1 volt/microbar. Output impedance is 100 ohms. The 3-mA current drain yields a battery life of about six months in normal use.

The Super Sidekick weighs 2 pounds. It is list priced at \$80, including the battery.

**Laboratory Tests.** We plotted the output of the microphone on the same chart with that of our calibrated laboratory microphone. The microphones were in the same position relative to a wide-range loud-speaker system. The difference between the two curves is an approximate indication of the frequency response of the Super Sidekick, since the calibrated reference microphone is flat within a fraction of a decibel over the frequency range of interest.

The response of the Super Sidekick fell off at about 6 dB/octave below 500 Hz and more steeply below 100 Hz. There was considerable output, with some irregularity, between 500 Hz and 6000 Hz. The response dropped rapidly beyond 6000 Hz. As one would expect from a communications microphone, the Super Sidekick operates most effectively at voice frequencies, discriminating against unnecessary high frequencies and the power-wasting lower frequencies which do not contribute to intelligibility.

The maximum undistorted output from the microphone was about 22 mV. Since most transmitters are designed to accept much lower microphone inputs, the Super Sidekick's volume control can be adjusted as required. The gain control does not af-



fect the maximum available output. (The instructions suggest leaving it at its minimum setting unless this is inadequate; it can be increased by about 24 dB if needed.)

**User Comments.** We used the Super Sidekick in two ways—on-the-air in amateur SSB service and into a high-quality tape recorder—to judge its sound quality. The on-the-air tests were completely successful. Many receiving stations were unable to distinguish between the sound from this mike and that of a popular dynamic mike in the same price range. There were no problems with r-f feedback, even at a 1-kW power level. Hence, CB and business-band radio

users should have no troubles from this source.

When we listened to the tape recordings made with this microphone, we immediately noted a crisp “punch.” There is a subjective emphasis on the upper speech frequencies—which would aid intelligibility under less-than-ideal receiving conditions. The gain and output of the microphone are enormous when compared with most non-amplified mikes; we suggest care in the use of the gain control to avoid overmodulation. At moderate volume control settings, the mike can pick up speech from several feet away, while in close talking there is no “blasting” or loss of intelligibility.

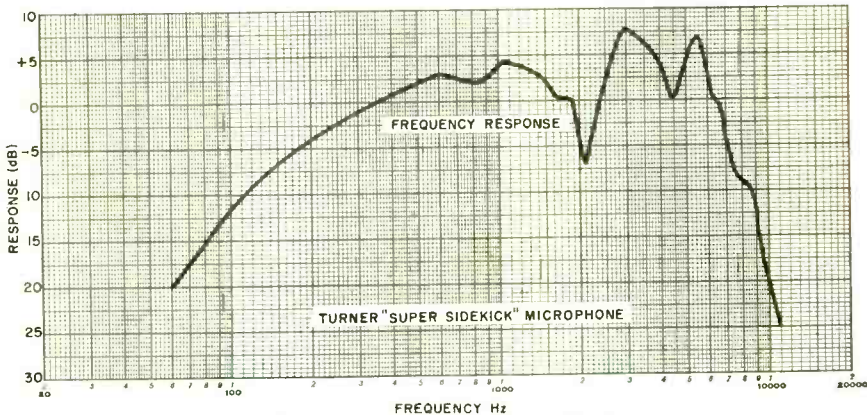

Circle No. 65 on Reader Service Card

### SHERWOOD MODEL S-2400 AM/STEREO FM TUNER (A Hirsch-Houck Labs Report)

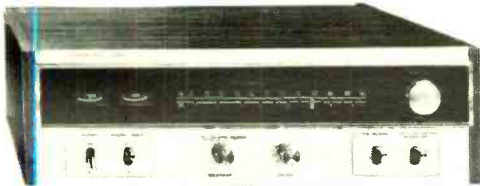

**S**HERWOOD'S Model S-9400 integrated amplifier now has a companion in the company's new Model S-2400 AM/stereo FM tuner. The two complement each other both cosmetically and in size.

A “blackout” dial, two tuning meters (zero-center for FM and relative signal strength for FM and AM), and a large tuning knob occupy the upper half of the tuner's front panel. Above the dial scales are AM, FM, and STEREO indicators that tell

at a glance to which mode of operation the tuner is switched.

Below the dial are the POWER and STEREO ONLY switches. The STEREO ONLY switch allows the tuner to receive only stereo broadcasts. Switches are also provided for FM MUTING and MPX noise cancelling. The latter switch reduces background noise during reception of weak stereo broadcasts, without loss of high-frequency response, by partially blending the two channels at high frequencies. A knob in the lower center of the panel is used for selecting between the AM, FM, and FM MONO modes of operation, while a final knob permits adjustment of the audio volume levels at the VARIABLE tuner output jacks.

Two pairs of audio outputs are provided at the rear of the tuner. Their 600-ohm impedances permit the use of connecting

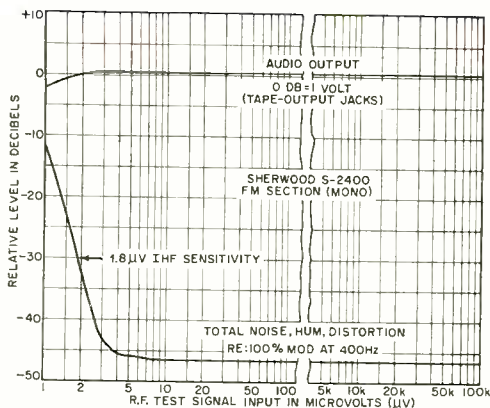

cables up to 200 ft long without loss of high-frequency response. One pair of outputs delivers a fixed-level signal, while the other—VARIABLE—is controlled by the knob on the front panel. Terminals are also provided for external AM and FM antennas. A built-in pivoting ferrite AM antenna obviates the need for an external antenna in many areas.

Anticipating the possible development of a discrete 4-channel broadcasting system, Sherwood has provided a 4 CH OUT jack that carries the FM detector output before deemphasis, at a 3300-ohm impedance. Presumably, any possible system for discrete 4-channel FM broadcasting will be able to operate on that signal. Another feature of the tuner is the provision for connecting to it an external multipath display, either the type currently being sold as a hi-fi accessory

or a service-type oscilloscope. The display provides the most effective way to orient an antenna for lowest distortion.

The key FM performance specifications of the S-2400 tuner include: a 1.8- $\mu$ V IHF sensitivity, a 0.25-percent distortion at 100 percent modulation, a 1.5-dB capture ratio, a 70-dB S/N ratio, an 85-dB image rejection, a 60-dB AM suppression figure and a 65-dB alternate-channel selectivity.

The FM "front end" employs two FET r-f amplifiers, while the i-f strip contains an IC, three transistor stages, and three groups of ceramic filters for selectivity. The AM tuner is quite basic, with selectivity aided by a ceramic filter. There is no "whistle" filter in the AM audio output.

The S-2400 tuner is supplied with a wood cabinet, walnut finished and measuring 17½ in. by 5½ in. by 14 in. deep. The list price for the tuner is \$230.

**Laboratory Measurements.** The measured IHF sensitivity was 1.8  $\mu$ V, exactly as rated. Only 2.4  $\mu$ V was needed for a 50-dB S/N ratio in mono, and 17  $\mu$ V in stereo. The measured distortion was 0.5 percent (the residual level of our signal generator), and the final mono quieting for inputs exceeding 100  $\mu$ V was 74 dB. In stereo, the full quieting of 72-73 dB was attained at about 2000  $\mu$ V.

The stereo frequency response on FM was within +15/-2 dB from 30 Hz to 15,000 Hz. An effective low-pass filter reduced the 19-kHz leakage to a low -76.5 dB. Stereo

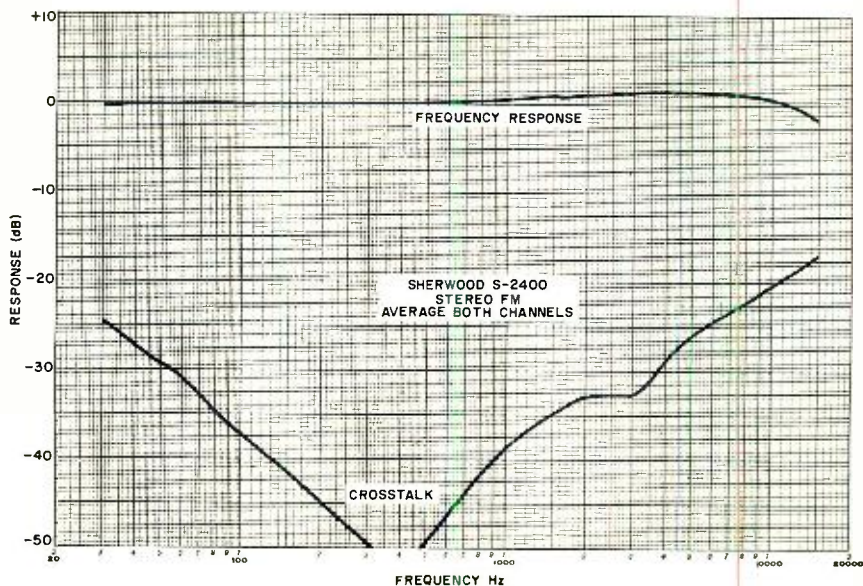

channel separation was better than 25 dB from 30 Hz to 5500 Hz, reducing to 17.5 dB at 15,000 Hz.

The capture ratio was 2 dB at 1000  $\mu$ V. The AM rejection was 50 dB, and image rejection was 73 dB. Both are quite satisfactory, though falling a bit short of the published ratings. Alternate-channel selectivity, on the other hand, was 72 dB, exceeding the published specification. The muting and automatic stereo switching thresholds were each 6.5  $\mu$ V. The AM tuner had a flat response from 20 Hz to beyond 2000 Hz, falling to -6 dB at 4200 Hz.

**User Comments.** The tuner proved to be

Circle No. 66 on Reader Service Card

a first-rate unit, meeting or exceeding all of its important performance specifications in our tests. Equally important, it had a smooth tuning "feel" and an ideal FM interstation muting system that operates with neither thumps nor noise bursts.

The AM tuner was somewhat better than average, with notable freedom from distortion, as well as good sensitivity and selectivity. However, there were audible 10,000 Hz "whistles" on a number of stations due to adjacent-channel interference.

All in all, this is an excellent companion to the S-9400 stereo amplifier. The two make an attractive, compatible, highly flexible, and fine sounding system.

## E.F. JOHNSON MESSENGER 120 CB TRANSCEIVER

**T**HE E.F. Johnson Messenger Model 120 is a five-channel AM CB transceiver that features the company's "Tone-Alert V" selective calling, a system that quiets the receiver until a call is received from a similarly equipped station. The receiver output at the called station is otherwise deactivated; so, signals from other stations not equipped with the alert feature are not detected.

When a station equipped with the alert system is to be called, the caller presses a button for four or more seconds to transmit a tone of a specific frequency ( $\pm 50$  Hz) on the channel prearranged for such use. The signal is picked up at the distant station and used to generate the "alert" tone. The alerted listener then releases a **STANDBY** button (previously depressed to lock out unwanted signals) in preparation for two-way communication with the caller.

In addition to generating an audible signal at the receiving end, the transmitted tone also turns on a **CALL** lamp which remains on until the call is answered. Hence, if the receiving station is unattended when a call comes in, the operator is informed of the fact upon his return.

The Model 120 transceiver is equipped for operation with one specific tone of a choice of ten tones ranging from 750 Hz to 1615 Hz. While it comes with crystals for channel 11 only, up to four other crystals (\$2.50 each) can be installed to provide flexibility in heavy-traffic areas. (If a receiver equipped with tone alert has been preset for a channel not agreed upon with the calling operator, the latter can still alert



the receiver. All he has to do is put in a call on each of the five channels until he receives a response.)

An advantage of the tone-alert system is that the squelch can be left at full sensitivity, without activating the receiver output, to allow a call to be detected from even a weak signal that might not otherwise be able to unsquelch the receiver.

Aside from the alert system, the Model 120 is a standard CB transceiver. Designed primarily for mobile use, it can also be used as a base station with the optional No. 239-0125-001 ac power supply (\$33). When used in mobile service, an external speaker (\$13) is available for PA capability. The Model 120 transceiver retails for \$150.

**Test Results.** The single-conversion receiver section employs a 455-kHz i-f with a ceramic-filter bandpass circuit. Its measured sensitivity was 0.4  $\mu$ V for 10-dB (S+N)/N with 30 percent modulation at 1000 Hz. The adjacent channel rejection was down 40 to 45 dB, while the image rejection was down 11 dB. Squelch threshold was adjustable from 0.3  $\mu$ V to 100  $\mu$ V, and



age action produced a -7-dB audio output change with 86-dB r-f input change (5-100,000  $\mu$ V). The audio output power was 2.5 watts at 1000 Hz with 10 percent distortion into 8 ohms. The noise silencing action was extremely effective with a series-gate noise limiter and i-f clipping.

The receiver could be alerted by a signal as low in intensity as 0.3  $\mu$ V when called by a similar unit. However, when another signal was present, the calling signal level had to be greater to "punch through." The output tone from the receiver is fixed at a good level that is independent of the volume control setting.

The transmitter delivered 4 watts of carrier output while operating from a 13.8-volt dc source. The modulation—for which speech compression, audio clipping,

and filtering were engaged—was very clean with normal speech levels. Measured distortion at 100 percent modulation with a 1000-Hz signal was 7.5 percent. Response below 400 Hz rolled off to 8 dB down at 250 Hz, while above 1800 Hz it rolled off to 7 dB down at 3000 Hz. The latter was probably due to the a-f filtering used to minimize distortion products. All in all, a fine sounding signal was produced with a well-maintained punch without creating adverse splatter.

**Comments.** The Messenger 120 CB transceiver is a high-quality rig that is well suited for either normal CB use or for selective calling. Its 9.3 in. by 6.2 in. by 2 in. dimensions, 2 $\frac{1}{2}$  pound weight, and lack of projecting knobs make it ideal for mobile use.

Circle No. 67 on Reader Service Card

## ELECTRA "JOLLY ROGER" SCANNING MONITOR RECEIVER



IF DISTRIBUTOR sales figures and reader mail are any indication, listening in on police, fire, and other public service broadcasts on the uhf and vhf bands seems to have blossomed into quite a hobby. If you check the various consumer electronics catalogs, you will see a goodly array of uhf/vhf monitor receivers employing either manually-operated tuning dials, a selection of switchable channels, or even automatic multi-channel scanning.

The latest monitor receiver to come our way was the "Jolly Roger" made by Electra Company and retailing for \$80. It is designed to operate from either four 1.5-volt D cells or line power from a module supplied with the receiver. The 8 in. by 6 in. by 3 $\frac{1}{4}$  in. receiver weighs 2 $\frac{1}{2}$  pounds with the batteries installed.

The Jolly Roger features coverage of the standard 535-1620-kHz AM broadcast band, plus a selection of any one or two crystal-controlled uhf or vhf channels. The Model JR-1H receiver covers the vhf band from 150-174 MHz and accepts any two channels within a 12-MHz spread. The Model JR-1U covers the uhf band from 450-470 MHz and accepts a selection of any two crystal-controlled channels within this band. Crystals for the desired vhf and uhf channels are available at \$5 each.

The receiver can be operated in any of five modes: two-channel uhf/vhf scanning with automatic switching to the broadcast band; channel A or channel B only with automatic switching to the broadcast band; automatic scanning of channels A and B without the broadcast band; continuous operation on channel A or channel B only; or broadcast band only. A telescoping whip antenna is used for the uhf/vhf bands, while a ferrite antenna serves for the broadcast band. Sensitivity is 1  $\mu$ V for vhf and 2  $\mu$ V for uhf. A squelch control is provided. A light-emitting diode channel indicator lights up when a channel is being scanned.

The cabinet of the receiver is molded of textured break-and-mar-resistant ABS plastic—that incredibly tough material used to house the guts of home (and many commercial) telephone sets.

If the monitor receiver is operated from the ac power line, and the batteries are in-

stalled, it will automatically switch over to battery operation should a line power outage occur. Provisions are also made for ear-

phone operation, for which the earphone is supplied with the purchase of the Jolly Roger monitor receiver.

Circle No. 68 on Reader Service Card

## WAYNE ELECTRONICS MODEL WT2 TRANSISTOR TESTER

LATELY, we have been reporting in this column on quite a few semiconductor testers that do good jobs and have interesting features (electronic or economical). The latest semiconductor tester to appear on our testbench is the Wayne Electronics Model WT2 which sells for \$80.

This instrument employs a large zero-center meter movement as its readout system. One of the interesting byproducts of the use of this movement is that, on a pc board containing a mixture of pnp and npn transistors, it will indicate which type is under test at any given moment.

The WT2 does not measure actual values of either gain or leakage. What it does is test for: leakage; emitter-to-base and base-to-collector diode characteristics; emitter-to-collector shorts; and transistor types (npn or pnp and germanium or silicon). It does all of this as fast as the user can make electrical contact and flip a switch. And it works either in-circuit or out-of-circuit.

Although there are occasions when the parameters of a given transistor must be known, we found that the basic meter indications given by the WT2 are sufficient for most of our needs. After all, when checking a pc assembly loaded with transistors and diodes, our main concern is the good/bad condition of each device.

On the front panel of the instrument is a conventional TO-5 transistor socket for out-of-circuit tests. The socket is paralleled by a unique six-conductor test cable. The cable is divided into two groups of three conduc-

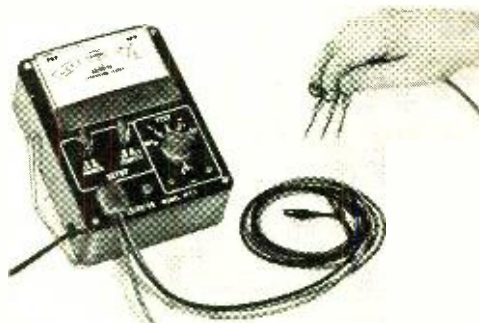

tors each. One group is terminated in insulated alligator clips; it is used for all out-of-circuit tests on transistors not based on the TO-5 configuration and on all in-circuit tests where transistors and diodes are either mounted on lugs or on heat sinks. The second group of three conductors is terminated in a trio of "finger-tip" clips fitted with needle-sharp prods; this group is designed expressly for in-circuit tests on pc assemblies. Using the needle-prod assemblies is simple. The user simply slips the clips onto the three middle fingers of one hand and pushes the points into the solder pads of the transistor to be tested. The points will penetrate into the solder or copper foil to provide a nonslip grip.

Using another transistor tester known to be in good shape as a reference, we tested a number of transistors and diodes. When we retested these devices with the WT2, the results were substantially the same—but the tests went faster.

Circle No. 69 on Reader Service Card

## Planning to move?

Let us know 6 to 8 weeks in advance so that you won't miss a single issue of **POPULAR ELECTRONICS INCLUDING ELECTRONICS WORLD**

Attach old label where indicated and print new address in space provided. Also include your mailing label whenever you write concerning your subscription. It helps us serve you promptly.

Write to: P.O. Box 2774, Boulder, Colo., 80302, giving the following information.

Change address only.

Extend subscription.  Enter new subscription.

(1)  5 yrs. \$21 (2)  3 yrs. \$15 (3)  1 year \$6

Payment enclosed (1 extra issue per yr. as a BONUS)

Bill me later.

If you have no label handy, print OLD address here.

name \_\_\_\_\_ please print

address \_\_\_\_\_

city \_\_\_\_\_

state \_\_\_\_\_ zip-code \_\_\_\_\_

AFFIX LABEL

name \_\_\_\_\_ please print 0780

address \_\_\_\_\_

city \_\_\_\_\_ state \_\_\_\_\_ zip \_\_\_\_\_

Add'l postage: \$1 per year outside U.S., its possessions & Canada.



# Electronics in Automobiles

By John T. Frye, W9EGV, KHD4167

"MAC," Barney said to his boss working at the bench beside him, "what will cars be like twenty years from now?"

Mac finished a delicate job of desoldering an i-f can from a printed circuit board before he answered, "No one knows for sure what those cars will look like or how they will be powered, but this much is certain: they will involve a lot more electronics than cars do today. Several months ago the American big three automobile manufacturers forecast that \$5 billion annually might be spent on automotive electronics by 1980, and European manufacturers are talking about 12 percent of car costs going for electronics by 1982."

"That's not what you're talking about," Barney reminded him. "I was just reading that last year we spent \$49 billion on autos and parts. Then we spent another \$41 billion on gas and oil, repairs, insurance, and other charges. That made a neat total of \$90 billion, or about 11% of our after-tax income. Only food, about 17%, and housing, about 13%, get a larger share of the American's after-tax dollar. To top the cake, consumer sales of autos and parts in the first three months of this year were up 20% over the same three months of 1972. Some think an unprecedented fifteen million cars and trucks may be sold this year."

"That's all the more reason why a young fellow like you, who expects to make his living from electronics, would do well to take a keen interest in this automotive-electronic field that is just starting to boom. You may be able to get yourself a piece of the action."

"Why are car people discovering electronics now?" Barney asked. "In the past we've only received pin money from the auto people. Radio, headlamp dimmer, voltage regulator, sequential turn signals, alternator diodes—that was about it."

"There are several hard-headed reasons. In the past, auto design was dominated by mechanical engineers who were very reluctant to allow outsiders to play a part in designing the car. But now they need electronic help to meet government-dictated deadlines for reducing pollution. Only solid-state compactness can provide room in the already crowded car for new safety and comfort equipment. Modern high-speed, heavy-traffic driving imposes demands on the average driver that exceed the limitations of his unaided senses and reaction time; only lightning-fast electronics can amplify those senses and stretch time for him. Space exploration, by fully demonstrating the reliability, precision, and space-saving of electronics under extreme conditions has destroyed many arguments against such use in the car, and plummeting solid-state costs have undercut others. Finally, the ranks of automotive engineers, historically trained to think in terms of mechanics, are being infiltrated by space age electronics engineers. Their influence promises to snowball."

"How about getting out your crystal ball and showing me some of the coming electronic applications to cars?"

**New and Future Applications.** "Okay. First I'll switch the crystal ball to 'local' and talk about applications right at hand. Electronic ignition is one. Chrysler engineers estimate 15% of the cars on the road have one or more plugs misfiring, increasing hydrocarbon emission 300 to 1000 per cent. Their electronic ignition system, now standard on all their cars, is designed to prevent such misfiring. A toothed reluctor and a magnetic pickup coil replace conventional breaker points, cam, and 'condenser' inside the distributor. Each time a reluctor tooth passes the pole piece of the



pickup coil, this induces a pulse in the coil that causes a switching transistor to interrupt the primary current of the induction coil, just as happened when the old breaker points were nudged open by the cam. The rest of the ignition operation is normal, but notice there are no points and no cam to wear and pit and corrode so as to degrade the spark and change the timing. Ignition time set at the factory remains adjusted as long as the distributor is left alone.

"Car theft is another challenge electronics is meeting. Almost a million cars were stolen in 1971, twice as many as were stolen six years previously. Starting this year Chrysler offers a new security system built right into the car's basic electrical system. An attempt to force open the passenger, trunk, or engine compartment or an unauthorized attempt to start the car causes the horn to start beeping and the headlights, tail lights, and parking lights to flash on and off.

The same system serves as an occupant distress alarm and provides instant protective locking. When an emergency button on the instrument panel is pushed, all doors are instantly locked, the hood latch is blocked, and the visual and audible alarm signals start and run for three minutes and then stop, but the doors remain locked. This

feature is considered essential because as unoccupied-car protection becomes better, the frustrated thief may feel the best way to steal a car is to take the key away from the driver; so chance of assault is mounting. Naturally, details of the system are not broadcast, but the heart is a well-concealed control box equipped with IC's, transistors, resistors, power relay, and a capacitor. This box receives a message from any sensor, interprets the message, decides which of several courses of action is most appropriate, and initiates the proper action.

"But with more than 55,000 killed and five million injured on the highways annually automobile safety commands a high priority on the services of electrons, and they promise to meet the challenge. To help avoid collisions we already have in production electronic anti-skid brakes, sequential turn signals, engine speed limiters, intermittent windshield wipers, and headlamp dimmers. If radars can be built cheaply enough, there are innumerable anti-collision uses for them on cars. Bendix has developed and Ford is testing an adaptive speed-control system that uses a CW doppler radar and a computer that computes range and range-change-rate between one car and another in front. Connected to the accelerator and brakes, it automatically slows a car when it is getting

RCA's version of car of the future, showing where solid-state electronics will be used.

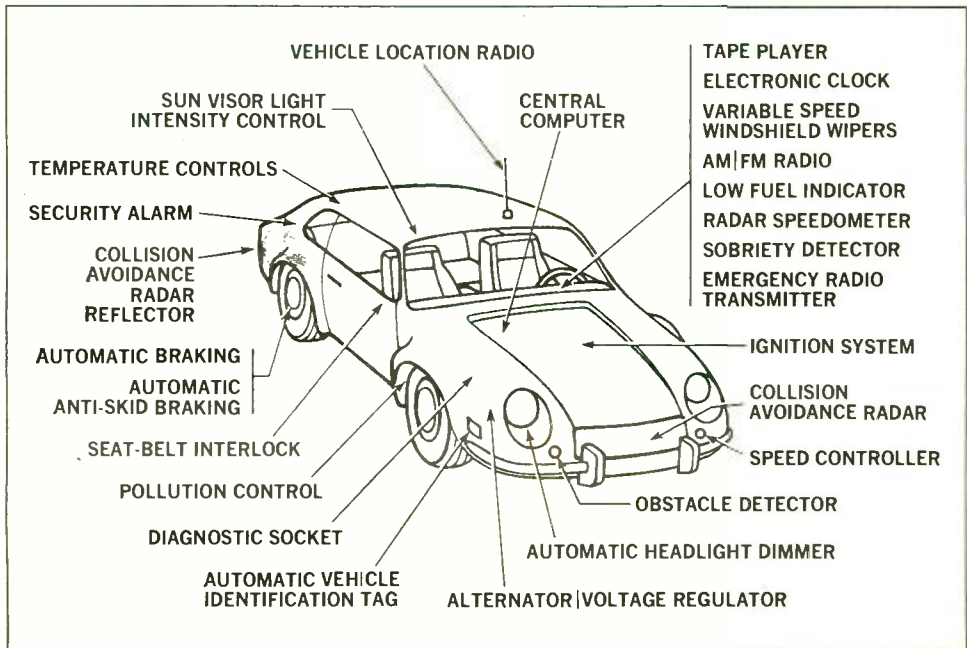

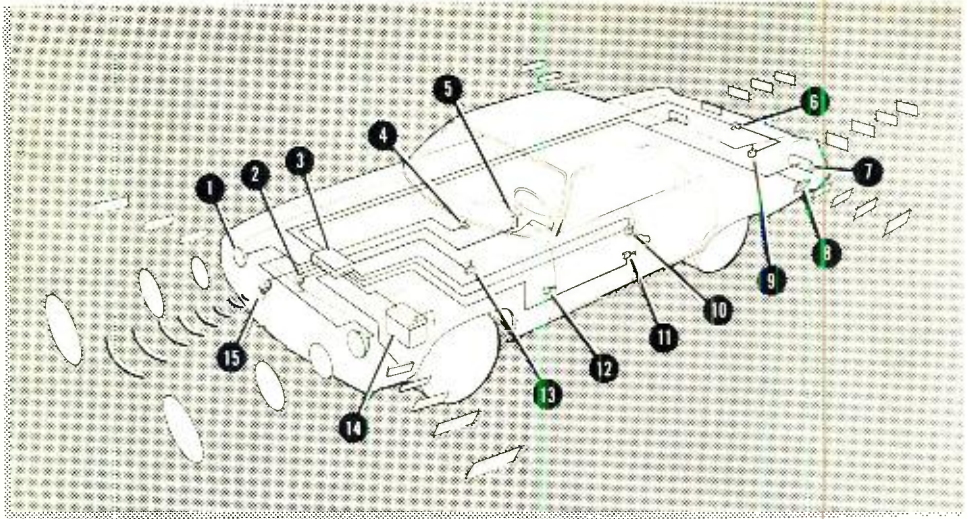

- |                           |                         |                        |                           |                      |
|---------------------------|-------------------------|------------------------|---------------------------|----------------------|
| 1 HEAD LAMP               | 4 LOCK-ALARM SWITCH     | 7 TAIL LAMP            | 10 ARM-DISARM SWITCH      | 13 HOOD LATCH SWITCH |
| 2 HOOD LATCH SOLENOID     | 5 IGNITION SWITCH       | 8 REAR SIDE MARKER     | 11 REAR DOOR JAMB SWITCH  | 14 BATTERY           |
| 3 ELECTRONIC CONTROL UNIT | 6 DECK LID LATCH SWITCH | 9 DECK LID AJAR SWITCH | 12 FRONT DOOR JAMB SWITCH | 15 HORN              |

Numbered callouts show locations of components in Chrysler's electronic security system.

too close to the car in front; and if a marked deceleration is noted in the car ahead, the brakes of the trailing car are applied. To prevent false readings from cars in adjacent lanes, the doppler beam is restricted to about 4 degrees, which is lane width at 200 to 250 feet. Responders on the rears of cars return the sensing signals in some systems.

"Cheap radars will be used in the rear and sides of the car to warn the driver of other cars approaching from behind in adjacent lane blind spots or of objects behind him when he is backing. Here a wide beam, up to 180 degrees, will be used. In tests Bendix has detected a one-pound coffee can at 15 feet. Other collision-avoiding electronic devices of the future include a light-amplifying TV-type viewer for better vision in fog and rain, a decelerator indicator that warns the driver behind you the instant you ease up on the accelerator, a highway condition sensor that gives notice of ice forming on the pavement, and an audible warning when you drift out of your lane. Four new solid-state devices—the Gunn oscillator, the LSA diode, the IMPATT diode, and the TRAPATT diode—promise to make available the cheaper radar."

"Yeah, and I've read that a radar trigger can yield the extra fraction of a second needed to prevent explosive accelerometer-trig-

gered airbag inflation in an accident," Barney offered.

**Computer-Controlled Autos.** "Right," Mac agreed. "You probably noticed several of the electronic devices mentioned require separate signal processing and control units. Trevor Jones, head of GM's Electronic Control Systems Group, considers this duplication wasteful and is doing something about it. That 'something' is the Alpha series of computer-controlled experimental autos. An automobile computer such as that in Alpha-1 should, according to Jones, be capable of performing a number of functions common in a universal control system: add, subtract, remember things, perform go/no-go logic, and switch. Time sharing in such a computer can justify its cost by bringing the cost of add-on functions down to a low level.

"For example, in Alpha-1 the computer controls an electronic ignition lock, a seat belt warning, a 'Phytester,' or drunken driver tester, a digital gas gauge, a digital speedometer, a digital clock, automatic windshield wipers, headlamp switching, heater and air-conditioning, turn signals, anti-skid braking control, a fuel economy computer, electronic fuel injection and ignition, gear shifting, emission monitoring and control, locking of the doors at 5 mph, and air-bag

firing. In addition, many systems and sub-systems are constantly monitored, and any trouble produces a display that tells the driver what is wrong and what to do about it.

"The digital logic speed is high enough to make control operations appear simultaneous. For example, quantity of fuel injected and spark timing are calculated for each cycle, but free intervals remain between these calculations for use by other functions. Priorities are assigned to all functions, and in an emergency the computer works from the top of the list so that the most essential override the less important ones. Air-bag firing, for example, overrides everything else.

"The proliferation of electronic components, however, cannot be permitted to add to the mile-long rat's nest of wire used in present cars. The answer being built into Alpha-2 and under development by all three major manufacturers and some independent firms is the so-called 'one-wire' system. 'One cable' system would be more accurate, for actually three to six conductors are run in a single cable to all sensors and all actuators of the car. Information and control signals are multiplexed onto this cable in the form of serial pulse code modulation (PCM). While all receivers are exposed to all control signals, only those pulse-coded for a particular receiver can enter it and initiate the desired action.

"Before the Automotive Central Processor can effectively communicate with all encode and decode stations throughout the car, two major problems must be overcome: reliable digital transducers must be developed, and suitable 'muscles' for doing the actual work must be worked out and subjugated to the electronic controls. We have good analog transducers, but if a single computer is going to receive and display information from several transducers, that information must be in digital form. Analog-to-digital transducers would add an extra step. At present, there are very few accurate, inexpensive digital transducers. A computer can receive and process information, but it cannot do major physical work. In a car, such work is usually done by electricity, hydraulics, or vacuum power. It would seem hydraulic power possibly generated by the power steering pump, with a fluidics interface between the electronic control and the powered unit would be the best solution.

"Cars of the future will still require service, and electronics will perform the diag-

# exactly what you need

**LARGEST SELECTION  
ANYWHERE**

Xcelite, first with color-coded nutdrivers, offers you a size and type to drive any hex head screw or nut. Yes, metrics, too.

- hex sizes from  $\frac{3}{32}$ " to  $\frac{3}{4}$ " and 3 mm to 17 mm
- $3\frac{1}{2}$ " Midgets to 21" "Super Longs"
- nickel chrome plated or plastic-dip-insulated shanks
- with clearance hole or full hollow shafts
- tough, cold drawn, accurately formed sockets, regular or magnetic
- fixed-handle or interchangeable shanks
- straight and tee handles—regular or ratcheting types
- available individually or in handy kits and sets

Made in U.S.A. to highest standards.

REQUEST FREE  
TOOL CATALOG 171

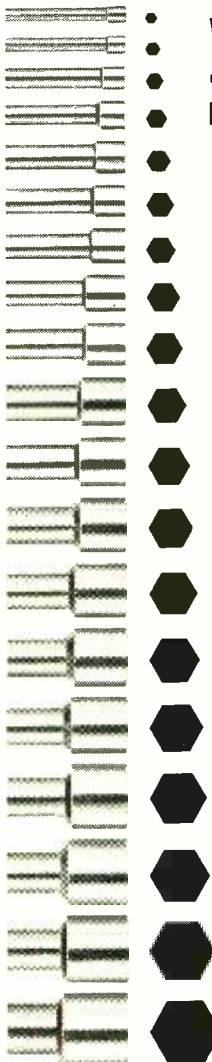

*nationwide  
availability through  
local distributors*

## XCELITE

### professional nutdrivers

XCELITE, INC. • 20 BANK ST., ORCHARD PARK, N.Y. 14127

Send complete tool catalog, which includes information on all Xcelite nutdrivers.

name \_\_\_\_\_

address \_\_\_\_\_

city \_\_\_\_\_ state & zip \_\_\_\_\_

In Canada contact Charles W. Pointon, Ltd.

**CIRCLE NO. 39 ON READER SERVICE CARD**



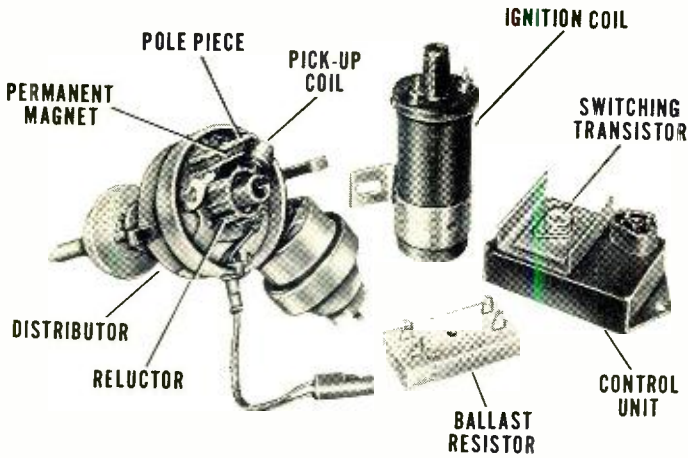

These are the components that are used in the electronic ignition system proposed by Chrysler.

nostic work. Alpha-1, as already mentioned, does basic trouble-shooting with its on-board computer; but a more elaborate system is already in use by Volkswagen. Many sensors located throughout every 1972 and later Volkswagen connect to a socket in the engine compartment. A computer at Volkswagen service stations, when plugged into this socket, rapidly checks 60 vital points including such things as front wheel alignment, compression of each cylinder, dwell angle, ignition performance, generator output, battery water level, and even the condition of the rear window heater. At the same time the computer prints out in plain English what's right and wrong with the car. Other manufacturers are likely to follow this lead."

"I'm disappointed," Barney complained. "You've said nothing about a completely automatic car that drives itself at 100 mph while the owner plays bridge with his friends."

Mac grinned. "Don't forget I grew up in a garage, and I agree with the auto manufacturers that the fully automatic car of the Sunday supplements is many years away. Space engineers who have gone into automobile engineering have discovered there is one big difference in the two engineering philosophies: cost! In space, if something *can* be done it *must* be done. In auto manufacturing, you don't do it unless it's better and at least as cheap. Trevor Jones points out, 'It takes \$10,000 just to insert a new part number in the GM system.'"

"Okay," Barney said, laying down his soldering iron, "but electronics *can* do things better and cheaper. With Uncle Sam holding the double-barrelled shotgun of pollution control and energy conservation, and with foreign competition lurking just outside the church door, the marriage between automobiles and electronics is going to take place *muy pronto*." ♦

Experimental Alpha-1 auto, by General Motors, uses a digital instrument panel in front of driver along with the sobriety keyboard located to the right.

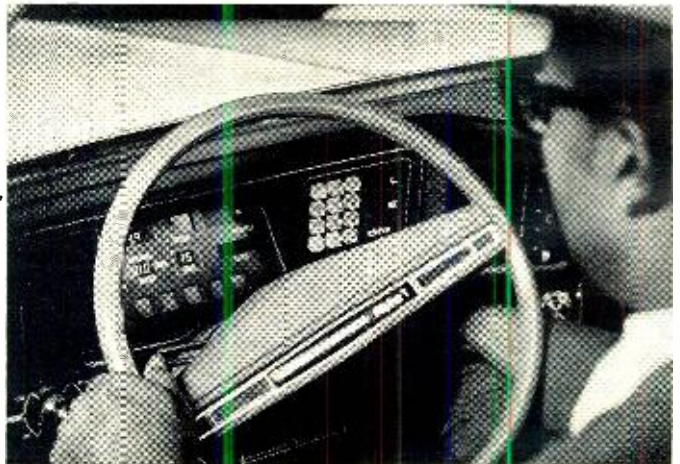

# DO YOU KNOW YOUR BIPOLAR TRANSISTORS?

## PART 2 OF A SERIES ON BASIC TRANSISTOR THEORY

BY LOTHAR STERN, Motorola Semiconductor Products Inc.

**Biasing.** When operated as an amplifier, the transistor must first be biased to some quiescent value of collector current, so that both positive- and negative-going input voltage excursions will cause corresponding changes in output voltage and current. The ideal bias point is represented by Q on the loadline because this permits approximately equal excursions in  $I_c$  and  $V_{ce}$  in both directions along the load line without signal clipping. The bias point is established by a quiescent base current that results in a dc collector current of approximately  $I_{c(sat)}/2$ .

Several circuits are used for establishing the bias point. Among the most familiar are those in Fig. 5. The basic performance difference is in the bias-point stability. At point Q on the load line in Fig. 4, the transistor has a beta of approximately 20. If a transistor with

a beta of 40 were substituted (simulated by dividing all  $I_b$  values by 2), and if  $I_b$  were held by the bias circuit to 2.5 mA, as before, the operating point would move up the load line to point Q', a much higher value of  $I_c$ . As a result, considerable distortion would occur for high-value input signals.

The bias point stability factor ( $S$ ) is defined as the percent-change in  $I_c$  for a percent-change in  $\beta$ , or  $\Delta I_c/I_c = S \Delta \beta/\beta$ . If a percent-change of  $\beta$  causes a corresponding percent-change in  $I_c$ , the least desirable condition, then  $S = 1$ . If  $I_c$  is independent of  $\beta$  (corresponding to a zero change in  $I_c$  when  $\beta$  is varied), then  $S = 0$ . The formulas accompanying Fig. 5 give  $I_c$  and  $S$  as functions of  $\beta$  and assign values for  $S$  under specific operating conditions. The bias arrangements in Fig. 5c and 5d using emitter degeneration are pre-

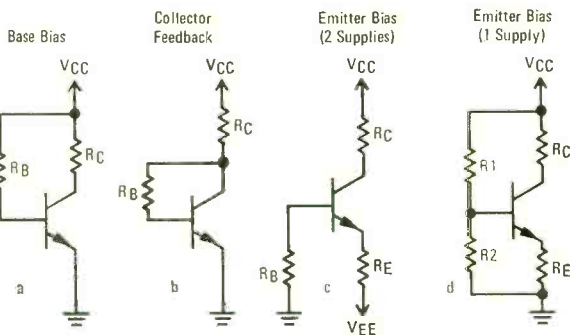
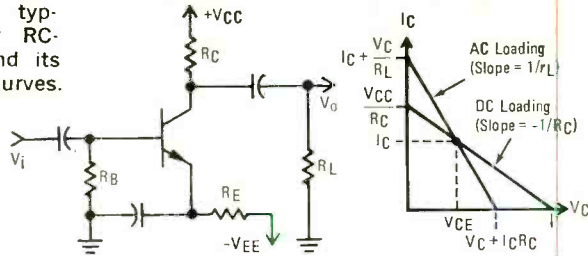

Fig. 5. Conventional common-emitter bias circuits. Table gives approximate characteristic expressions.

$I_c \rightarrow$	$\beta \frac{V_{CC}}{R_B}$	$\frac{V_{CC}}{R_C + R_B/\beta}$	$\frac{V_{EE} - V_{BE}}{R_E + R_B/\beta}$	$\frac{R_2}{R_1 + R_2} \times \frac{V_{CC}}{R_C}$
$S \rightarrow$	1	$\frac{1}{1 + \beta R_C/R_B}$ for $R_B = \beta R_C$ $S \approx 0.5$	$\frac{1}{1 + \beta R_E/R_B}$ for $R_B = R_C$ $S \approx 1/\beta$	$\frac{1}{1 + \beta R_E} \times \frac{R_1 R_2}{R_1 + R_2}$
To Make $I_c = \frac{I_{C(sat)}}{2}$	$R_B = 2\beta R_C$	$R_B = \beta R_C$	$R_E = 2 \frac{V_{EE}}{V_{CC}} R_C$	$\frac{R_1}{R_2} = 1 + 2 \frac{R_C}{R_E}$

Fig. 6. Circuit of a typical common-emitter RC-coupled amplifier and its ac and dc loading curves.



ferred because, by proper choice of resistor values, the effect of  $\beta$  on  $I_c$  can be made almost negligible. This prescribes a large value of  $R_b$ , so that the voltage,  $I_b R_b$ , at the emitter is much larger than  $V_{BE}$  or  $I_b R_b$ . To prevent degenerative ac feedback,  $R_E$  is normally bypassed by a large-value capacitor. (Figure 5c is used when a positive and negative power supply is available. For single-supply operation, Fig. 5d is preferred.)

In practical transistor amplifiers (RC coupled amplifier, for example) the operating point is influenced by both dc and ac conditions. Figure 6 shows a typical RC-coupled amplifier and its representative loadline plot. Note that there are two loadlines—a dc loadline whose slope is affected only by the value of  $R_c$  and an ac loadline whose slope is determined by  $r_c$ , the equivalent resistance of  $R_c$  and  $R_L$  in parallel. The dc loadline represents the path along which the operating point can be established. The ac loadline intersects the dc loadline at the operating point, and the actual signal varies along the ac loadline, which sets the  $V$  and  $I$  output limits.

The ac performance of the circuit in Fig. 6 can be established from the high-frequency equivalent circuit in Fig. 7a. (For this approximation, it is assumed

that the signal frequencies are high enough that all capacitive reactances of Fig. 6 are negligibly small.)

Each transistor junction has an associated junction capacitance. These are quite small (on the order of a few picofarads), but they do affect transistor action at high frequencies. A typical transistor frequency response plot is shown in Fig. 7b. At the frequency where the reactance of the parasitic input capacitance equals the input resistance,  $\beta r_i$ , the current to the input resistance is bypassed through the capacitance to the point where the effective  $\beta$  is down 3 dB from its low-frequency value. This is called the  $\beta$ -cutoff frequency,  $f_{\beta}$ . If the frequency is further increased,  $\beta$  continues to decrease at a rate of 6 dB per octave. The frequency at which  $\beta$  equals unity is specified on data sheets as  $f_T$ , the current-gain/bandwidth product. Given  $f_T$ , it is possible to determine transistor  $\beta$  for any frequency between  $f_{\beta}$  and  $f_T$  from the relation  $\beta = f_T / f$ .

**Negative Feedback.** While the dc degenerative feedback associated with  $R_E$  of Fig. 6 stabilizes the operating point, making it independent of changes in beta and other temperature-dependent parameters, the bypass capacitor keeps it from compensating for the del-

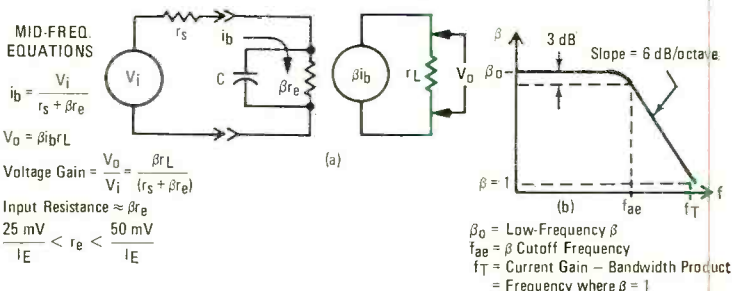
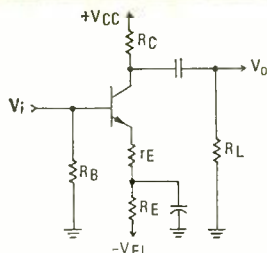

Fig. 7. Equivalent high-frequency common-emitter circuit (a) and its response (b).





Voltage Gain with  $r_E = 0$   
 $A = r_L / r_e \quad r_L = \frac{R_C R_L}{R_C + R_L} \quad r_e \approx \frac{25 \text{ mV}}{I_E}$

Feedback Factor =  $F = \frac{r_E}{r_L}$

Effect of negative feedback on gain:

$A(f) = \frac{A}{1 + AF} = \frac{1}{F}$  (when  $AF \gg 1$ )

Effect of negative feedback on amplitude distortion:

$D(f) = \frac{D}{1 + AF}$

Effect of negative feedback on frequency response:

$f_{ae}(f) = f_{ae} (1 + AF)$

Effect of negative feedback on input resistance:

$R_i(f) = R_i (1 + AF)$

Fig. 8. One-stage amplifier and equations for feedback effects.

eterious effects of these changes on the ac signal. Moreover, while proper placement of the operating point can reduce non-symmetrical signal clipping, it cannot reduce the distortion for large signal swings caused by nonlinearity of the  $I_c/I_b$  characteristics (Fig. 4). These characteristics can be greatly improved by means of negative signal feedback, which requires a small unbypassed resistor,  $r_E$ , in series with  $R_E$  as shown in Fig. 8. (This is only one of many possible feedback arrangements.) In addition, negative feedback improves frequency response and compensates for changes in output voltage (and gain) due to variations in temperature-sensitive parameters such as  $r$ , and  $\beta_{ac}$ .

The equations accompanying Fig. 8 describe the basic advantages achieved through negative feedback, as well as the price paid for them in terms of voltage gain. However, since feedback increases input resistance, the loss of gain can partly be recovered because of an increase in the gain of a previous stage caused by the increase in input resistance.

**Darlington Transistors.** Modern semiconductor technology not only has led

to complete circuits on a single chip of silicon (integrated circuits) but also to compound-connected transistors. For the circuit designer, the latter provides some cost and space savings, while still permitting unrestricted circuit design freedom. One of these devices is the Darlington pair shown in Fig. 9.

Though consisting of two interconnected transistors, the device can actually be treated as a single transistor with extremely high current gain and

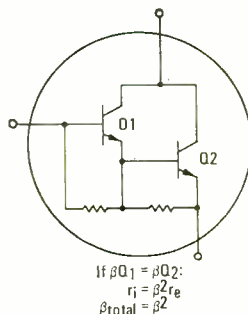

If  $\beta_{Q1} = \beta_{Q2}$ :  
 $r_i = \beta^2 r_e$   
 $\beta_{total} = \beta^2$

Fig. 9. Darlington transistor pair.

input resistance. Normally, Darlington pairs are employed in the grounded collector configuration. Commercially, they are available as small-signal and power devices, in both npn and pnp polarities and with betas ranging from several 100 to several 1000.

**Differential Amplifiers.** With the advent of integrated circuits, the circuit in Fig. 10 has become increasingly

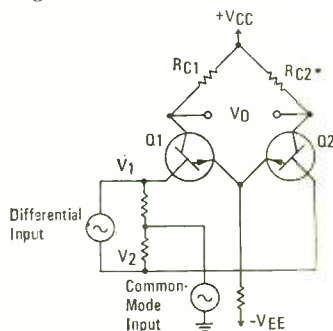

Characteristics, if Q1 and Q2 are perfectly matched and  $R_{C1} = R_{C2}$ :

$V_1 = V_1 - V_2$	For differential input:	$V_1 = -V_2$
$V_0 = \frac{R_C}{r_e} (V_1 - V_2)$	For common-mode input:	$V_1 = V_2$
$r_{in} = 2\beta r_e$		

Fig. 10. Basic differential amplifier.

important. Being dc coupled through a common emitter resistor, it has no low-frequency limit; but, unlike other types of dc-coupled amplifiers, it exhibits excellent stability and drift-free operation without requiring elaborate compensating circuitry. This is its most important characteristic. Operated in the differential mode, as shown, the output voltage responds only to difference inputs to the two bases. If a common-mode signal were applied (as in the case of ground line or power supply noise) or if the characteristics of the transistors were to change in response to a change in temperature, the collector current of both transistors would be affected equally. As a result, the output voltage between the collectors would remain constant.

**Transistor Fabrication Processes.**

Over the years, many processes and structures have been used in transistor fabrication. Most of them are still being used, though the older processes no

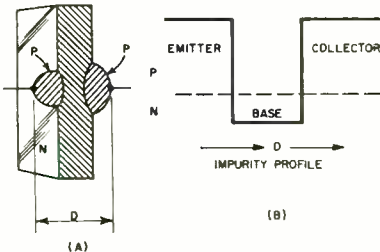

Fig. 11. Typical alloy transistor.

longer offer the best obtainable performance. The major sequential developments in the processing of the bipolar transistor are shown in Figs. 11 through 15.

In Fig. 11A is a typical alloy transistor, while Fig. 11B shows its im-

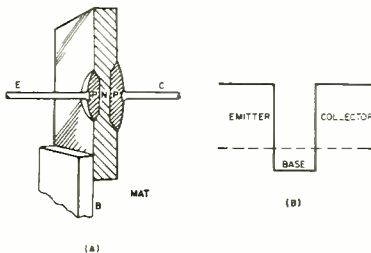

Fig. 12. The microalloy structure.

purity profile. It is simple and inexpensive to build. It provides excellent low-frequency beta and can operate at high currents and power levels, but not at high frequencies or high voltages.

Figure 12 shows the construction detail and impurity profile of a typical microalloy (MAT) structure. It is similar to the technique shown in Fig. 11

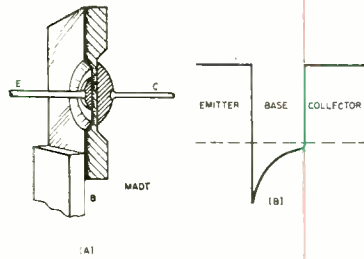

Fig. 13. Microalloy diffused type.

except that shallow pits are etched into the base substrate prior to collector and emitter alloying. The thinner base improves the frequency response

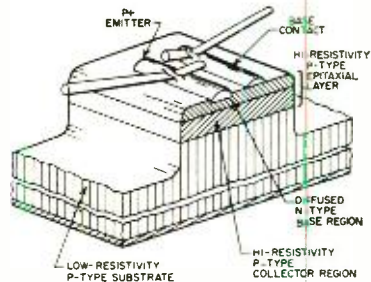

Fig. 14. Epitaxial mesa structure.

but results in a fragile structure and further reduces breakdown voltage.

The process shown in Fig. 13 uses diffusion of impurities into a thin base membrane prior to alloying to permit a closely controlled, graded impurity profile. This technique offers frequency responses up to 100 MHz.

The process shown in Fig. 14, with extremely thin collector and base regions and unrestricted use of different material resistivities, provides high-frequency performance up to a gigahertz. It also provides high gain and high breakdown voltage. However, sensitive pn junctions are exposed to the atmosphere, resulting in high leakage current.

*(To be concluded)*

# ANTENNAS FOR CB'ers & HAMS

## PART 1

### *Clearing away half truths and superstitions*

BY CARL C. DRUMELLER, W5JJ

IF RADIO amateurs and CB'ers devoted as much thought, time, and money to their (largely) nondirectional high-frequency antennas as they do to their directional beams, there might be a much wider variety of both single- and multi-band antennas. Most of us, though, are content to use purely conventional horizontal dipoles, inverted V's, or ground-plane, quarter-wave verticals. These, as a rule, give satisfying results—perhaps because we've been conditioned to think of such antennas as standards of comparison.

Once in a while, however, some adventurous soul chooses a rhombic or a long-wire V—some even try disc-cones or fat monopoles. Such departures from the norm often are quite rewarding. Their users discover the convenience of having an antenna that's truly effective over a wide band of frequencies, one that achieves this advantage without tuned feeders or other auxiliaries.

Then there are those who, by force of circumstance, are driven to the use of restricted-space antennas. These antennas are approached with trepidation since both theory and popular supposition hold them to be nearly useless because of low efficiency or narrow bandwidth.

Portable and emergency operations present another set of problems. Just how much like the "ideal" antenna must a radiator be to put out an effective signal? Is there danger of damage to one's transmitter from using unconventional antennas?

**Questions.** What are the facts? Is it true that there is no radiating system that combines good efficiency, wide bandwidth, and

reasonable space? How vital to acceptable operation are such factors as careful design, meticulous attention to the impedance match between feeder and antenna, and supporting the antenna as high as possible? Does a choice transmitting antenna always constitute the best receiving antenna? Is the buried wire antenna a myth or a reality? What about loop antennas for receiving and for transmitting? How do the small ones compare with the large ones? How important is capture space? Does a wire have to be stretched out, or can it be coiled and still retain good radiation characteristics? Just how vital is a good ground to the performance of a Hertz antenna? A Fuchs? A Marconi?

What about feedline losses in h-f antenna systems? How does one use a counterpoise? Does it have to be under the antenna? Does one use a single wire or many? How high above ground should it be? Should a ground connection be used in conjunction with a counterpoise? If so, how should it be connected? And what do you do when you're caught in a situation where you can't use one of the conventional antennas? Just what can you use as a substitute? Can you expect any truly useful radiation from unconventional radiators?

Well, we are not going to provide full answers to all of these questions. But we will review the opinions of some of the better authorities on the subject and hopefully, we will stimulate your thinking about some ideas that deviate from the humdrum and timeworn traditions.

Let's think first about that ideal com-



bination: good efficiency, wide bandwidth, and small size. No really good solution exists to the simultaneous achievement of all three of these goals. However there are some ways of approaching the ideal.

**Normal Mode Helix.** One approach, which lies within the constructional abilities of the average amateur, is the "normal mode helix" (from *Sylvania Antenna Reference Index*, Sylvania Electronic Systems). Used as a vertical radiator and worked against a ground plane or a good ground, it has a nondirectional horizontal radiation pattern, and the vertical pattern is of a reasonably low angle. By varying the dimensions, the polarization can be made either elliptical or circular. As compared with an isotropic radiator, the gain is 4.76 dB. Bear in mind that a conventional dipole has only 2.15 dB gain. The bandwidth of 5% is not too impressive, but the helix is easily resonated by external tuning units. This gives promise of extending the bandwidth substantially without too much drop in efficiency.

There are whispers to the effect that the use of a ferrite core in the helix performs wonders in retaining efficiency while making possible drastic reductions in overall dimensions. Other whispers say that getting a type of ferrite usable for high power and high frequency poses limitations. In each case, the probable definitions of high power and high frequency are such that a kilowatt of dc input power and a frequency range of 1.8 MHz to 30 MHz are wholly feasible. Why do we say whispers? There is reason to believe that the findings of research in this field are classified—after initial and excited announcements, all reference to the subject disappeared from the technical literature.

Figure 1 shows the form and dimensions of the normal mode helix. The wire or tubing used to make the helix should be heavy enough to hold its form with a minimum of support. Of course, it should also have a low skin resistance. Polished copper protected from corrosion by some type of weather-proof varnish is quite acceptable.

**Broadband Dipole.** Although they take a lot of space, variants of the prosaic half-wave dipole offer exciting possibilities. They can be really broadband if you get rid of the concept of a thin-wire radiator. Figure 2 shows one broadbanding possibility. The

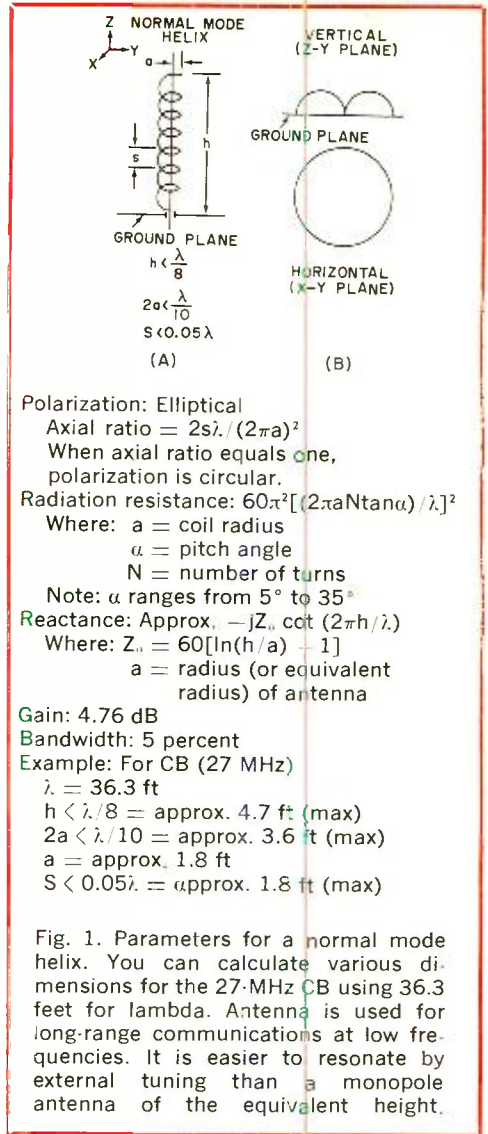

Fig. 1. Parameters for a normal mode helix. You can calculate various dimensions for the 27-MHz CB using 36.3 feet for lambda. Antenna is used for long-range communications at low frequencies. It is easier to resonate by external tuning than a monopole antenna of the equivalent height.

use of the multi-wire radiator transforms the dipole from a narrowband device to one that is good for at least two adjacent bands plus everything in between.

The multi-wire flat-top, flared from a common feedpoint, is easy to build but a bit awkward to keep in position in order to maintain a constant capacitance to ground. This may require as many as five supports—one at the center and one at each end of the two spreaders. Research indicates that, for the greatest bandwidth, the wires of the flat-top should be of unequal length, approaching a quarter-wave (per half of

the dipole) for the lowest and the highest frequency included in the design. In all cases, the wires must terminate in an insulator; do not interconnect them at the far end.

Although it is more trouble to construct, the cage antenna, another old but sadly neglected design, presents no problem in maintaining a constant capacitance to ground. Usually, it is built with conductive circular spreaders every few feet of its length, with the middle (at the feed-point) and the far ends tapered to a point for ease in attaching to an insulator. There is no verified opinion as to whether better performance would be obtained by using nonconductive spreaders and terminating each wire with an insulator. Such a practice, however, is employed in the "fat" monopoles used extensively by the military (Fig. 3). This type of monopole has a diameter at its broadest point that is an appreciable fraction of its height. In this configuration, the bandwidth is slightly over three to one! Centered at 7 MHz, it would be quite effective at 3.5 MHz and 14 MHz, as well as every frequency between.

In such applications, using a "fat" conductor (usually multi-wire) has an effect on the antenna's radiation resistance, reactance, length for a given frequency, and ohmic resistance. Each of these effects is a desirable one! The total effect on the feedpoint impedance is not so drastic as to interdict the use of the popular 52-ohm coaxial cable as a feeder; it really more nearly approaches a true match (not that this is of any great importance). The amount of reduction, from the formula  $492/f$  (where  $f$  is in megahertz) for computing the length of a dipole, depends on so many factors that it is best arrived at by experimentation. Fortunately, the antenna is so broadband that a near-miss approximation probably will suffice. In the matter of reduction of ohmic resistance, a small improvement in overall efficiency will be obtained. Other than in exceptional instances, the ohmic

resistance of an antenna is not of paramount importance.

**Impedance Matching.** Impedance matching, that interest-provoking interface between feeder and antenna feedpoint, is so hedged in by what is half truth and half superstition that one hesitates to discuss it for fear of affronting the pietistic convictions of some devotee of a particular school of belief.

Really, though, it is a simple matter. Basically, any generator delivers maximum power to its load when that load matches the internal impedance of the generator. If they are not matched initially, we make them match by some means of impedance transformation. Take the audio output of a receiver as an example. If the amplifier is a vacuum tube, it may need a load of 4000 ohms. The speaker offers only eight ohms. So, we use a transformer to effect the impedance transformation. There is no sacrosanct law that says the matching transformer has to be mounted on the speaker; it may be in the receiver. Now, have you ever heard of an audiophile demanding an eight-ohm cable to feed the audio from the receiver to the speaker?

The very same situation and considerations are involved in feeding r-f energy from the active device (vacuum tube, transistor, Gunn diode, or what-have-you) in a radio transmitter to its load, the antenna. As it's highly improbable that there is a natural impedance match, you use some form of impedance transformation. A bit of this is built into the transmitter. Because of cost considerations, manufacturers make a sharp limitation in the flexibility of this built-in feature; so you may have to supplement it with an external device.

For example, suppose that you have an antenna operating in the high-frequency range (3 MHz to 30 MHz) and you are feeding it with RG-8/U cable. The antenna is constructed so that its feedpoint impedance is 12.8 ohms. This would result in a 4:1 VSWR on the feedline if no corrective measures were taken. But corrective measures can be taken: such as, using an impedance matching device similar to the Drake MN-4 or the Johnson Matchbox on the tower supporting the feedpoint. The device can be adjusted to transform the 12.8-ohm impedance into a resistive load of 52 ohms. Then the RG-8/U will have no standing waves along its length and the



Fig. 2. Cage type of multi-wire dipole. Though a two-wire feeder is shown, this antenna can be adapted to conventional 52-ohm coaxial feedline.

transmitter will load into it quite readily.

But suppose you don't like the idea of climbing the tower every time you want to shift operations to another band? You can connect the RG-8/U directly to the dipole (using a 1:1 balun if you like) and move the impedance-matching device next to the transmitter. The transmitter will not know the difference because it is still working into a 52-ohm load. But what about that length of RG-8/U, which now has a 4:1 VSWR? This is no problem since the only thing bad about it is that a very tiny portion of your r-f power will be dissipated in heating parts of the coaxial cable. Since you're operating in the h-f band, these heated spots will be at the current maximums. On the 3.5-MHz band, these would be only at 132-ft intervals; and how long is your feeder? Even on the 29-MHz band, you'd probably have only two or three spots where a few milliwatts would be wasted in heat.

It's very difficult to convince many people of these simple facts. They have been brainwashed by those who have not made a careful study of the subject. Collins Radio Company, in its publication "Engineering Compendium, High Frequency Antennas," (which we recommend) states, with regard to reflected power, "It is important to appreciate the fact that reflected power does not constitute a system loss." Similar statements appear in other well-edited and authoritative publications, yet the myth of reflected power loss dies slowly.

To ascertain the nature of power in the reflected wave and its relation to power in the incident wave in a mismatched transmission line, an experiment was conducted. A transmitter operating on 7 MHz was connected through an r-f wattmeter and a length of RG-8/U cable to a 52-ohm resistive load. The transmitter was adjusted to provide a measured output of 100 watts; its dc power input was noted and logged. Then the transmitter was connected through an r-f wattmeter to an impedance-matching network, through it to a forward-and-reflected-power meter, and on through RG-8/U cable to a 12.8-ohm load made up of four 52-ohm resistive loads in parallel.

The transmitter was loaded to 100 watts power output, indicated both by the r-f wattmeter and by the same dc power input as before. As this loading was being done, the impedance-matching device was adjusted to reflect a 52 ohm resistive load to the

**Polarization: Linear vertical**  
**Radiation resistance: approx. 73 ohms,**  
**for thin cylindrical dipole.**  
**Radiation resistance: approx. 73 ohms, for**  
**thin cylindrical dipole.**  
**For other thicknesses:**

$\lambda/2a$	R
40,000	69
4000	67
400	63.6

**For monopole where  $h = \lambda/4$ , R is**  
**approx. 37 ohms.**  
**Reactance: Resonant**  
**Resonance actually occurs for h**  
**slightly less than  $\lambda/2$ .**  
**For  $h = \lambda/2$ ,  $X = j42$**   
**Gain: 2.15 dB**  
**Bandwidth: 5 to 40 percent**

**Fig. 3. Shown here as a vertical, rotating the dipole to horizontal plane swaps the radiation patterns and changes polarization to linear horizontal. Structure need not be solid as a cage retains same characteristics. Note small change in radiation resistance for large change in diameter.**

transmitter. Between the impedance-matching device and the cable, the forward r-f power meter indicated 120 watts of forward power. This would make it appear that a purely passive device was generating 20 watts of r-f power. Switching the meter to read reflected power resulted in an indication of 20 watts, precisely the amount of the extra forward power. If stronger proof were needed of the fact that reflected power does not constitute a system loss, one could insert an r-f ammeter in series with the feedline at the junction with the 12.8-ohm load. Its reading, squared and multiplied by 12.8, would indicate a full 100 watts of r-f power delivered to the load. Such verification was made in a prior experiment.

In the second and concluding part of this article we will discuss other antenna types and related topics. ♦



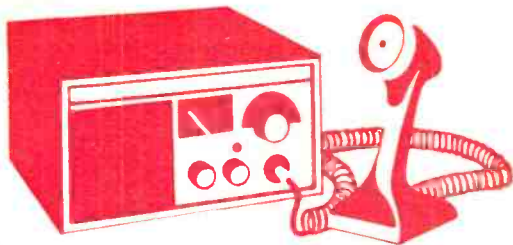

# CB Scene

By Matt P. Spinello, KHC2060

**E**IGHTY-NINE percent of CB'ers make trash of the 11-meter band . . . The FCC has a proposed ruling to take effect January 1, 1974 terminating the use of 11 meters . . . The ruling supposedly was drawn as a result of illegal actions by CB'ers in excess of 27%." All of these comments were reported to us by an amateur radio operator in Birmingham, Michigan, who thinks the FCC is planning to have hams squeal on illegal CB operators after the ruling takes effect, or that the Commission will ask hams "to monitor the band."

The tallies don't exactly jibe. One might question, for example, how a lone amateur arrives at an 89% statistic of flagrant misuse of the CB frequencies and, at the same time, indicates that the FCC will close the band as a result of 27% illegal operation. Is there a worn cog in the Commission's adding machine; has their digital calculator winked its totals once too often to tally the score correctly; or is our self-appointed statistician pulling our 11-meter leg?

The FCC's General Council, Richard Everett, confirmed to us that the Commission has no knowledge of such a proposal. It has, however, been examining a number of various proposals directed toward promoting the effective use of the Citizens Radio Service or reducing widespread rules violations.

The moral is: know the source of information from which rumor may develop—on the air or in print. If in doubt, call or write for verification to the nearest FCC district office or directly to the Commission in Washington, D.C. Unless a claim received through the mails is accompanied by a full signature and address for response, don't bother to pass the information on to others.

**New FCC Docket.** The 20th of September is the deadline for interested parties to file

comments relative to FCC Docket 19759, which proposes 40 channels in the 224-225-MHz band as a fixed and mobile service, commonly referred to as Class E Citizens Radio.

The Commission's Notice of Inquiry and Proposed Rule Making was released June 12, 1973, and was captioned "The creation of a new class of Citizens Radio Service and the reallocation of frequencies between 224 MHz and 225 Mhz in the band from 220 to 225 MHz now allocated for shared use by stations in the Amateur Radio Service and Government Radiolocation Stations for that purpose." The proposed use of a portion of the 220-225-MHz band for Class E radio might meet with objections from Mexico and Canada that might require a prohibition against any other operations in some border areas.

Six petitions applicable to the creation of a new class of CRS were received by the Commission:

1. RM-1633 (Wayne Green petition) filed May 25, 1970, proposed to make part of the 220-MHz amateur band available for "Hobby Class" amateurs and to limit 27-MHz Citizens Band operations to "business and personal business" use.

2. RM-1656 (Reed Electronics School petition) filed June 24, 1970, proposed to move Citizens Band from 27 MHz to the

## Class E: Closer to Reality

220-MHz amateur band and to return 27-MHz frequencies to the U. S. Government.

3. RM-1747 (EIA petition) filed February 5, 1971, proposed a new "Class E" Citizens Band service between 220 and 222 MHz; 80 channels; 25-kHz channels; 100 watts maximum power. Would not alter rules for 27-MHz Citizens Band.

4. RM-1761 (F. C. Hervey petition) received February 26, 1971, proposed to shut down 27-MHz Class D Citizens Band as now provided in "Parts 95 and 15" temporarily and reassign frequencies "to those mobile Radio Services in greatest need"; and to create a new "Hobby/Personal Radio Service" in parts of the 220-225-MHz band as a substitute for present Class D Citizens Band.

5. RM-1793 (George Jacobs and Stewart Meyer petition) filed May 10, 1971, proposed to establish a new "VHF Radiotelephone License" in the Amateur Radio Service anywhere above 144 MHz (suggested 221-224 MHz); phone only; 100 watts maximum power; no code test. Would not change Citizens Band rules.

6. RM-1841 (United CB'ers of America) filed July 1, 1971, proposed to use 27 MHz for "Hobby (Class H)" use only; transfer "all emergency and call channel operations" to 220 MHz.

(UCBA and its president George Bennett were charged in an 11-count indictment returned May 1973, by a Federal Grand Jury in Detroit, Michigan, with violating various provisions of the U. S. Code by distributing counterfeit radio station licenses purportedly issued by the FCC.)

The most detailed petition was submitted by the Electronics Industries Association (EIA). Proposed by EIA in RM-1747 was a new Class E category of use now authorized to Class D category stations. The Class E category would provide 80 FM channels occupying 2 MHz within the 220-225-MHz band. Channels would be allocated for specific types of communications: for example, intra-station, inter-station, business, weather advisory, emergency, marine, in-plant, traffic control, etc. Most Class E stations would be authorized 25 watts power output. A small number of channels would be reserved for one-watt, local-use stations. Certain public safety agencies would be licensed to operate Class E stations at 100 watts for use in emergencies.

**Pro and Con.** The Commission has also

received a great deal of correspondence both in favor of and in opposition to the reallocation of the band for any uses other than are now authorized. The American Radio Relay League, Inc. (ARRL) has filed a petition in opposition to that of EIA (RM-1747) requesting denial of the EIA petition and that the Commission issue a notice of inquiry inviting suggestions and proposals for increasing the efficiency and effectiveness of the Citizens Radio Service.

The Commission, in considering any schedule for implementing the new radio service operations at 224-225 MHz states that it will have to consider the availability to the Commission of budget allocations in order to provide for the additional administration and enforcement of Rules. The EIA has estimated that the proposed Class E Service could produce 10 million licensees. The Commission solicits comments on this and other estimates of total licensee impact as well as the methodology and/or calculations that support such estimates. Comments are also requested regarding possible procedures for licensing and enforcement which would minimize the administrative burdens resulting from such a large number of users.

Eligibility to operate on the new Class E band would be similar to that for the present Class D service: Any person 18 years and older who meets the basic criteria for licensing would be eligible. To avoid the abuses of its Class D rules and associated enforcement problems, the FCC said that it would establish enforcement procedures before the service is permitted to begin operations.

In addition to detailed amendments to the rules governing all services involved, in the event that a portion of the 220-225-MHz amateur band is reallocated to other services, manufacturers, CB'ers, and amateur radio operators all have their own considerations and axes to grind. One question for which they all undoubtedly await an answer is: With the experiences from nearly a million operators with 23 channels on 27 MHz through a 15-year period, can 40 new channels in the 220-225-MHz band effectively serve 10 million licensees? Should Class D remain operable as is, but with more stringent rules, and Class E launched with 80 channels as originally proposed by EIA?

More to come; soon no doubt. In the meantime, I'll CB'ing you. ♦

# 1973 ELECTRONIC EXPERIMENTER'S HANDBOOK

## SPRING EDITION

### Helps you get it together...

### with a score of

### build-it-

Are you ready to tackle assembling your own four-channel decoder? Yes! with our full instructions on how to build this basic CBS/Columbia "SQ" unit.

...about puzzle solving? Here's the Princeps toughie, with eight lights and as

...LASERS.

**SPECIAL ANNOUNCEMENT FOR READERS OF POPULAR ELECTRONICS** The all-new, 1974 ELECTRONIC EXPERIMENTER'S HANDBOOK WINTER EDITION is scheduled to go on sale nationally September 20, 1973. **IT WILL AGAIN FEATURE**

Lab-tested projects by the editors of Popular Electronics, complete with parts list, easy "how-to-do-it", "how-it-works" instructions. All features and articles guarantee successful

hours and months of mind-absorbing projects for fun and practicality.

**YOU CAN RESERVE YOUR COPY NOW AT THE SPECIAL PRE-PUBLICATION PRICE OF ONLY \$1.00 POSTPAID**

This offer is being made to readers of POPULAR ELECTRONICS Magazine only. Regular price is \$1.25. Copies will also be available by mail for \$1.60, which includes shipping and handling charges. **YOU CAN RESERVE YOUR COPY NOW AT THE SPECIAL PRE-PUBLICATION PRICE OF ONLY \$1.00.**

POSTPAID, by completing the Reservation Form and returning it promptly along with your remittance. ELECTRONIC EXPERIMENTER'S HANDBOOK will be mailed to you on or before September 20 from first-off-the-press copies.

- Under-State Tuner
- Solid-State Tuner
- Metal Locator
- Five-Forty Power Amp

- PLUS...**
- Ten Hi-Fi Fallacies
  - Know Your Phono Cartridges
  - Chemicals for Electronics
  - 55B Ion Chromes Board
  - Color Codes Chart
  - Decibel Table
  - Reactance Chart



hours practicality. Don't miss a minute of it. coupon. Only \$1.25.

## PRE-PUBLICATION RESERVATION FORM

ELECTRONIC EXPERIMENTER'S HANDBOOK  
Ziff-Davis Service Division  
595 Broadway  
New York, N.Y. 10012 Dept PE-973

Print Name \_\_\_\_\_

Address \_\_\_\_\_

State \_\_\_\_\_

City \_\_\_\_\_ Zip \_\_\_\_\_

Enclosed is \$\_\_\_\_\_ Please reserve \_\_\_\_\_ copies of ELECTRONIC EXPERIMENTER'S HANDBOOK 1974 WINTER EDITION at the special pre-publication price of \$1.00 per copy, postpaid, to be mailed to me from first-off-the-press copies on or before September 20, 1973.

PLEASE ENCLOSE PAYMENT WITH ORDER.





# Solid-State Scene

By Walter G. Jung

**T**HIS MONTH, we will take a look at some new devices, as well as some that have been around for a while. Among the latter there is a trend toward increasing popularity of the power Darlington transistor—a handy device which can save a great deal of time, space and money.

The power Darlington transistor cannot be represented by any single "2N" number since the technology encompasses a wide variety of type numbers with various capabilities. Specifications include  $I_c$  ranges of 100 mA to 20 A,  $V_{CE}$  ranges up to hundreds of volts, power dissipations of 150 W or more, and, most significantly, current gains of several thousand, making control of amperes by milliamperes inputs an everyday thing. One might question the interest in the Darlington transistor connection since it has been around for years. The answer is that only recently has it come completely of age, maturing into a monolithic structure which is specified as a single component and, through simplified processing, is now available at highly attractive prices in a variety of packages.

A schematic of a typical monolithic power Darlington is shown in Fig. 1. Integrated into the structure, in addition to the two transistors, are a clamping diode and base-emitter shunt resistors  $R1$  and

$R2$ . The diode is back-biased in normal use. Resistors  $R1$  and  $R2$  serve the important function of speeding turnoff and shunting dc leakage which could be troublesome since the composite beta of the pair is several thousand. The exact values for  $R1$  and  $R2$  will vary somewhat for different devices, but their function is the same. Considered as an integral unit then, this package can be used as a single, high-gain transistor, which is, in fact, the manner in which it is specified. Although Fig. 1 illustrates an npn type, complementary pnp types are also available, and the same general considerations apply with regard to gain and application.

A good way to gain a better appreciation of power Darlington versatility is to consider some typical device characteristics. Motorola Semiconductor, a pioneer in monolithic power Darlington, has a broad range of complementary devices available in various packages. For instance, in plastic, the 2N6034/2N6037 pnp/npn families provide 4 A and 40 W of power and have a gain of 2000 at 2 A with a 25-MHz cut-off frequency. Jumping up in current, power and voltage (still plastic packaged), the 2N6040/MJE6043 pnp/npn families are capable of 8 A and 75 W at voltages up to 100 V. Gain is specified at 2500 at 4 A, but the cutoff frequency is lower—4 MHz. For 100 W of dissipation, the 2N6053/2N6055 families are very similar, in a TO-3 metal package.

For high voltage and current, power Darlington are in metal packages. At 12 A and 150 W, the 2N6050/2N6057 pnp/npn family has voltage ratings to 100 V with gains of 3500 at 5 A, while the cutoff frequency is 4 MHz. And, in the 2N6282/2N6285 npn/pnp families, 20 A and 160 W are achieved at voltages up to 100 V

## Power Darlington

and gains of 2400 or more at a current of 10 amperes.

RCA's Solid State Division is also supplying power Darlington's with various volt-

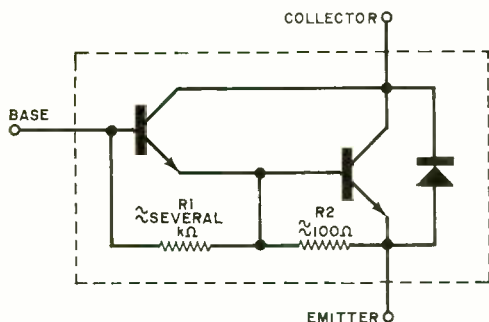

Fig. 1. Schematic of a typical monolithic power Darlington. Integrated into structure with the two transistors are a clamping diode as well as the two base-emitter shunt resistors.

age/current/power capabilities. One interesting device family is the 2N6386-88 npn group, featuring 40 W at 10 A with voltage ratings up to 80 V and gains of 1000 at 2 A. One outstanding feature of these transistors is their frequency response of 20 MHz, about 10 times better than average capability. For applications which demand greater dissipation the similar 2N6383-85 group offers 100 W of power.

It is interesting to consider what new opportunities are provided by the features of a power Darlington. Generally, IC's do not provide much current output (A few milliamperes being typical) but a few mA into a power Darlington can control 10 A or more! So logic gates or op amps can be souped up to drive high-power loads with ease, with the desirable simplicity of a single power package and low overall complexity.

We have discussed just a few of the many devices available, and new types are being developed. We suspect that once you have tried a power Darlington or two, you will be favorably impressed with their performance, simplicity and economy.

**High-Voltage Op Amps.** To take full advantage of the muscle provided by the high-gain power Darlington, a useful driver would be a high-voltage op amp. But, have you ever been stymied by the relatively low supply voltage of conventional op amps? There's an answer: the high-voltage MC1536G/

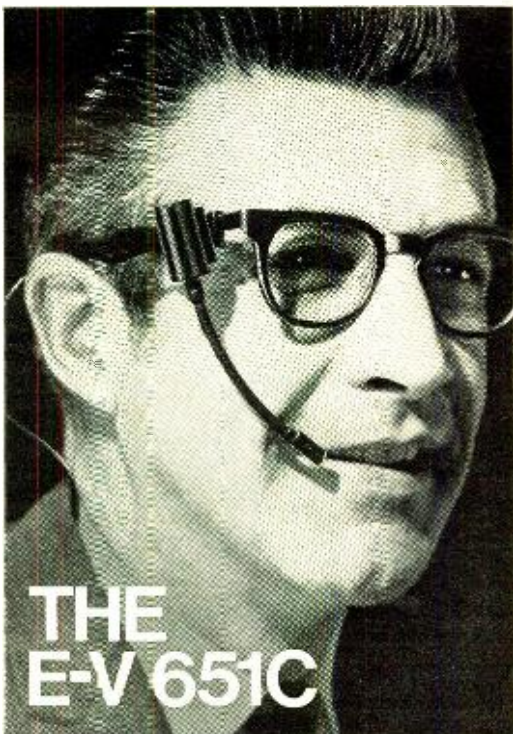

## Never be "off-mike" again!

Now a microphone you wear, just like the astronauts, and major TV sports commentators. This ½-ounce dynamic communications microphone fits on its own headband, your glasses, or headphones. The adjustable pickup tube stays at your mouth to provide constant volume and maximum noise cancelling.

A transistorized preamp, either mounted on your belt or on its accessory desk stand, provides push-to-talk or VOX operation into any input with up to 2.5 volts output (adjustable). Response from 200 to 4,500 Hz for best communications (other models for broadcast, paging and aircraft).

The new E-V Model 651C... that recognizes you may have something better to do than hold a microphone!

Model 651C \$69.00 net, complete.  
Model 451 Preamp table base  
(not illus.) \$9.75 net.



ELECTRO-VOICE, INC., Dept. 932P,  
630 Cecil Street, Buchanan, Michigan 49107  
In Europe: Electro-Voice S.A., Römerstrasse 49, 2560 Nidau, Switzerland  
In Canada: EV of Canada, Ltd., Gananoque, Ontario

**Electro-Voice®**

a **Gulton**  
COMPANY

CIRCLE NO. 12 ON READER SERVICE CARD

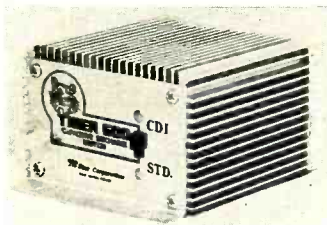

## 12 REASONS YOUR CAR NEEDS TIGER CDI

Instant starting in any weather - Eliminates tune-ups - Increases gas mileage - Increases horsepower 15% - Improves acceleration and performance - Spark plugs last up to 70,000 miles - Reduces engine maintenance expense - Amplifies spark plug voltage to 45,000 volts - Maintains spark plug voltage to 10,000 RPM - Reduces exhaust emissions - Dual ignition switch - An Unconditional LIFETIME GUARANTEE - Installs in 10 minutes on any car with 12 volt negative ground - No rewiring - Most powerful, efficient and reliable Solid State Ignition made.

SATISFACTION GUARANTEED or money back.  
**TIGER 500** assembled ..... **\$49.95**  
**TIGER SST** assembled ..... **39.95**  
**TIGER SST Simpli-Kit** ..... **29.95**  
 Post Paid in U.S.A.

Send check or money order with order to:

**Tri-Star Corporation**

Dept. W, P. O. Box 1946  
 Grand Junction, Colorado 81501  
 DEALER INQUIRIES INVITED

**CIRCLE NO. 35 ON READER SERVICE CARD**

**Free!**  
**1973**  
**Eico catalog**  
**OVER 200 INSTRUMENTS • KIT & WIRED!**

**NEW! TR 410** Solid State Triggered Sweep Scope  
**NEW! 300C** "Clamp-On" Current Tester  
**NEW! TD-8 B** Track Stereo Tape Deck  
**NEW! SS-200** "Time Delay" Burglar Alarm System  
**NEW! ASA-300** Electronic Siren Auto Alarm

Build all-professional Eico Kits and save up to 50%. The more you know about electronics, the more you'll appreciate Eico. Over 2500 local Eico dealers offer you all the top brands, personal technical counsel, fast off-the-shelf service. Free catalog includes Test Equipment, Stereo, Eico-craft Projects, Burglar/Fire Alarm Systems and name of nearest Eico distributor, check reader service card or send 25¢ for first class mail service.

EICO, 283 Malta St., Brooklyn, N.Y. 11207  
 Leadership in creative electronics since 1945

**EICO®**

**CIRCLE NO. 9 ON READER SERVICE CARD**

1436G/1436CG op amp, made by Motorola. The MC1536G is capable of  $\pm 40$ -V supply operation, while commercial versions, MC1436G and MC1436CG, operate from  $\pm 34$  V and  $\pm 30$  V, respectively. All devices in the family are internally compensated for ease of application. They have typical gains of 114 dB and input currents of 8 to 25 nA, depending upon type.

The 1536/1436 series has been available for some time from Motorola, but it also has recently been introduced by Silicon General as the SG1536T/1436T/1436CT. These devices are pin-for-pin and electrical equivalents and come in TO-99 8-pin packages. Silicon General prices begin at \$3.75 each for the SG1436CT.

**Quad 741 Op Amp.** As electronic systems become increasingly more sophisticated and complex, packaging techniques are developed to minimize component count and size. This is evident in a number of IC types, some discussed here in recent months. Among op amps, we have had dual 741 types for some time. Now, there is a quad 741 op amp—the RM4136/RC4136 from Raytheon. This device contains, within a single, 14-pin dual inline package, 4 op amps with 741 characteristics. In fact, in some instances, the specifications exceed standard 741 specifications. This, plus the fact that the 4 amplifiers are matched for gain, input current, and offset voltage and have channel separation, makes an RC4136 (commercial version) an attractive combination. In addition, the RC4136 has the same low-noise characteristic as the quiet RC4739. Audio enthusiasts will be attracted to the RC4136 since, with this single device, an entire stereo preamp with tone controls can be constructed. Other applications for which it is well-suited are matched low-level dc preamps, multiple-stage filters, ac/dc converters, function generators, and other signal conditioning or generating circuits which require multiple op amps. The RCA4136P op amp unit is priced at \$2.08.

**IC Tachometer.** A development by Stewart-Warner Microcircuits should catch the fancy of readers who are also automotive buffs. Recently introduced is the SW781, a monostable multivibrator specifically designed for driving a meter in response to an input pulse rate, thus providing a tachometer function.

In operation, the SW781 is connected as



shown in Fig. 2, requiring few external components. Trigger pulses from either ignition points or ballast resistor are applied to  $R_1$ ,  $R_2$ , and  $C_1$ , which serve as an attenuator/noise filter. The trigger pulses fire the multivibrator, which generates a pulse with a width determined by  $R_T$  and  $C_T$ . The pulse is applied to the meter, with calibration current set by  $R_3$ . The temperature compensation in the SW781 keeps the meter calibration stable within a few percent.

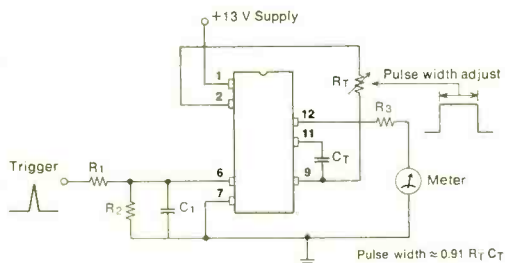

Fig. 2. Schematic shows how a monostable multivibrator can be connected with a few external components to be used as a tachometer. Trigger pulses can be from ignition or ballast unit.

Though the SW781 is offered as a tachometer, we can think of a few other uses to which it might be applied. Since a tach is essentially a frequency measuring device, you could easily construct a circuit to measure frequency over a 10/1 range, using an SW781 and switching the values of  $C_T$ . This would yield a simple, low-cost frequency meter.

For further details, see the SW781 data sheet, which gives a good explanation of the circuit and instructions on how to set it up. The SW781 is supplied in a  $-30$  to  $+75^\circ\text{C}$ , 14-pin dual in-line package at \$5.25 each.

**Further Information.** For more about these devices, write to:

Motorola Semiconductor Products

Technical Information Center

Box 20924

Phoenix, AZ 85036

Raytheon Semiconductor

350 Ellis St.

Mountain View, CA 94040

Silicon General Inc.

7382 Bolsa Ave.

Westminster, CA 92683

Stewart-Warner Microcircuits

730 E. Evelyn Ave.

Sunnyvale, CA 94086



# All New

**Includes FREE Ohms Calculator**

72 pages of products, projects, tips, formulas, tables, etc. from your local CALECTRO Electronics Distributor!

**Includes 20" x 30" Wall Chart**

**GC ELECTRONICS**  
DIVISION OF HYDROMETALS, INC.  
ROCKFORD, ILLINOIS 61101 U.S.A.

**CIRCLE NO. 13 ON READER SERVICE CARD**

## PRINTED CIRCUITS

**FAST — EASY**  
with **DATAK's**

## DIRECT ETCH SET

**EASY**—patterns rub down directly on the copper board and connect with rub-down lines or tapes supplied.

**FAST**—safe new etchants will etch a 2 oz. copper board in 30 minutes.

**ACCURATE**— $\pm .002$ " print tolerance so parts and connectors mate with no errors.

Circuit Made With ER-1

**COMPLETE ER-1 SET** contains hundreds of dry transfer DIP, flatpack, TO-5, IC, and transistor patterns:  $\frac{1}{16}$ " and  $\frac{1}{32}$ " etch resist tapes; 4 copper clad boards:  $\frac{1}{4}$  lb. dry etch; tray and instructions, \$4.95 p.p.d.

**IN STOCK AT ALLIED AND OTHER DISTRIBUTORS**  
WRITE FOR FREE CATALOG listing this and many other dry transfer marking sets.

**The DATAK Corporation**

65 Seventy-first Street • Guttenberg, New Jersey 07093  
**CIRCLE NO. 6 ON READER SERVICE CARD**

# SAVE!

MONEY • TIME • FREIGHT

- ♪ QUALITY STEREO EQUIPMENT AT LOWEST PRICES.
- ♪ YOUR REQUEST FOR QUOTATION RETURNED SAME DAY.
- ♪ FACTORY SEALED CARTONS—GUARANTEED AND INSURED.
- ♪ SAVE ON NAME BRANDS LIKE:  
A.D.C. KOSS KLH DYNACO  
A.R. FISHER SHURE SONY

AND MORE THAN 50 OTHERS

BUY THE MODERN WAY BY MAIL—  
FROM

## ia illinois audio

Department 873 12 East Delaware  
Chicago, Illinois 60611 312-664-0020

CIRCLE NO. 40 ON READER SERVICE CARD



greatest advance in soldering  
since electricity!

## WAHL® Cordless SOLDERING IRON

Wahl "Iso-Tip" gives soldering heat in 5 seconds. Lets you solder up to 100 joints\* unhindered by cord and plug anywhere! Recharger/converter plugs into 12V cigarette lighter. Safe to use on sensitive components. See your dealer or order direct.

7565 Kit with 12V Auto Charger ..... \$18.95

7500 Kit with 120V AC Charger ..... \$19.95

(\*Depending upon wire size, temperature and atmospheric conditions.)

**WAHL®** CLIPPER CORPORATION Dept. 2  
2902 Locust St. • Sterling, Ill. 61081 (815) 625-6525  
CIRCLE NO. 38 ON READER SERVICE CARD

106



## New Literature

### RCA POWER TRANSISTOR BROCHURE

A new 30-page publication on their power transistors is available from RCA Solid State Division. Publication No. PSP-704 is arranged in three sections: a foldout chart that displays total power-transistor capability at a glance; specific transistor family capability charts arranged by power areas; and a data section arranged by power areas showing the transistor families and the transistors in each family. Information is also given on hardware, shipping containers, and the plastic-package leadforms available from RCA. Address: RCA Solid State Div., Box 3200, Somerville, NJ 08876.

### LITTELFUSE CROSS REFERENCE GUIDE

A new 8-page Cross Reference Catalog (Form CR 173) that lists the comparable Littelfuse and Bussman parts numbers for hundreds of standard fuses, fuse holders, fuse clips, and fuse blocks is available from Littelfuse. The guide makes it convenient for the user to specify the proper fuse from either manufacturer if he has one or the other's part numbers on hand. A comprehensive array of voltages, currents, and fuse types is identified and cross-referenced. Address: Littelfuse, Inc., Dept. PR, 800 East Northwest Hwy., Des Plaines, IL 60016.

### MOTOROLA TEST EQUIPMENT CATALOG

A new full-line catalog on "Motorola Test Equipment" is now available from the firm's Communications Division Parts Department. Covering a variety of test equipment products ranging from service monitors to tone generators and wattmeters, the 36-page catalog includes photos and complete listings of features, specifications, and model nomenclatures for available test equipment. Address: Barbara Bennett, Motorola, Inc., Communications Division Parts Dept., 1301 E. Algonquin Rd., Schaumburg, IL 60172.

### HICKOCK SHORT FORM CATALOG

The new Hickock Product Selection Guide describes, illustrates, and lists principal specifications (including prices) for all current Hickock products. Among the items listed are lines of 3½- and 4½-digit multimeters, oscilloscopes, a true rms multimeter, tube and transistor test-

POPULAR ELECTRONICS Including Electronics World

ers, industrial card readers, etc. Address: Instrumentation & Controls Div., The Hickock Electrical Instrument Co., 10514 Dupont Ave., Cleveland, OH 44108.

### TANGENT TEMPLATE DRAFTING AIDS

A short-form catalog that gives quick reference to the most comprehensive line of templates available for printed circuit designing and drafting is being offered by Tangent Template, Inc. Fourteen different templates are described and illustrated in the catalog. Address: Tangent Template, Inc., P.O. Box 20704, San Diego, CA 92120.

### HALSTED PRESS TECHNICAL BOOK LIST

Current and forthcoming titles in electronics and electrical engineering books are listed and described in a new brochure available from Halsted Press. Listed are books on general electronics; computer technology; fields, waves, and antennas; and power. Address: Halsted Press, 605 Third Ave., New York, NY 10016.

### SWITCHCRAFT TERMINOLOGY DICTIONARY

The "Switchcraft Dictionary of Switching and Connecting Terminology" gives comprehensive definitions of switching and connecting terminology widely used and generally accepted throughout the electronics industry. The 12-

page publication's explanations are recommended as a technical guide in understanding the technical complexities of electronic and electro-mechanical components by engineers, technicians, and purchasing agents. Address: Switchcraft, Inc., 5555 N. Elston Ave., Chicago, IL 60630.

### PAIA MUSIC SYNTHESIZER BROCHURE

Listed and described in full detail (including prices) in Bulletin No. 573 available from PAIA Electronics is the full line of modules and keyboards that make up the company's 2720 series synthesizer. Two keyboards are described: one is for the beginner and non-professional, and the other is designed for the professional. Among the modules listed are a vca, vco, vcf, function generator, control oscillator/noise source, power supply, envelope follower/trigger, inverter buffer, and sine converter/pwm. Address: PAIA Electronics, Inc., P.O. Box 14359, Oklahoma City, OK 37411.

### RCA APPLICATION NOTE

Enhancing the visibility of the Numitron display in sunlight is the topic of Application Note AN-4920 available from RCA. It details seven steps that can be taken to enhance display visibility. Address: RCA Electronic Components, Harrison, NJ 07029.

# SAVE MONEY!

## A Delta Mark Ten Capacitive Discharge Ignition (CDI) System On Your Car Slashes Maintenance Costs And Increases Performance.

Put a Mark Ten on your car and save by eliminating 3 out of 4 tune-ups. Save as gasoline mileage increases (up to 20%). The Mark Ten CDI system also extends spark plug life, promotes more complete combustion and assures instant starts in all weather. It operates on any 6 or 12 volt negative or positive ground system.

The Mark Ten B affords additional money saving advantages by drastically reducing combustion contaminants and restoring power lost by the use of smog control devices. Equipped with handy switch for instant return to standard ignition, the Mark Ten B works with ANY 12 volt negative ground engine. Both systems install in ten minutes without rewiring.

Order your Mark Ten or Mark Ten B today. Save money while you enjoy low maintenance and increased performance.

**Mark Ten (Assembled) \$44.95 ppd.**

**Mark Ten (Deltakit) \$29.95 ppd.**  
(Kits available in 12 volt only,  
positive or negative ground)

**Mark Ten B \$59.95 ppd.**  
(12 volt negative ground only)

**Superior Products at Sensible Prices**  
Mfg. in U.S.A.



Dept. PE



## DELTA PRODUCTS, INC.

P.O. BOX 1147 • GRAND JUNCTION, COLORADO 81501  
PHONE (303) 242-9000

Please send me literature immediately:

Enclosed is \$ \_\_\_\_\_

Ship ppd.     Ship C.O.D.

Please send: \_\_\_\_\_ Mark Ten B @ \$59.95 ppd.

\_\_\_ Standard Mark Ten (Assembled) @ \$44.95 ppd.

\_\_\_ 6 Volt: Neg. Ground Only    \_\_\_ Positive Ground

\_\_\_ 12 Volt: Specify \_\_\_\_\_ Negative Ground

\_\_\_ Standard Mark Ten (Deltakit\*) @ \$29.95 ppd.

          (12 Volt Positive Or Negative Ground Only)

Car Year \_\_\_\_\_ Make \_\_\_\_\_

Name \_\_\_\_\_

Address \_\_\_\_\_

City/State \_\_\_\_\_ Zip \_\_\_\_\_

**CIRCLE NO. 8 ON READER SERVICE CARD**





## Electronics Library

### 4-CHANNEL STEREO—FROM SOURCE TO SOUND

by Ken W. Sessions, Jr.

This eye-opening book discusses the advantages and disadvantages of the various techniques currently being used to deliver four channels of sound to a music-oriented public. It contains complete descriptions of the various approaches to quadraphonics, along with facts to let you know what to expect from each approach. Explained are the evolutionary developments of sound, including the fine differences between stereo and binaural listening, laying the groundwork for quadraphonics by describing the ear's faculty for localizing sound sources. The differences between discrete, matrix, and derived 4-channel sound are given in depth.

Published by Tab Books, Blue Ridge Summit, PA 17214. 176 pages. \$6.95 hard cover; \$3.95 soft cover.

### ELECTRICAL REPAIRS AND PROJECTS FOR THE HANDYMAN

This book begins with basic electrical fix-it information and includes a wide variety of interesting, useful electronic projects. The special section on color TV receivers can save the reader a bundle of money. Another potential money saver is an alarm system that signals when the power is interrupted from a home freezer. There are ideas for burglar alarm installation, speaker systems for every budget, a household intercom system, and scores of other projects. Well-thought-out diagrams, photos, charts, and text make the book especially easy to follow.

Published by Arco Publishing Co., 219 Park Ave. South, New York, NY 10003. Hard cover. 112 pages. \$3.95.

### SOLID-STATE CIRCUITS FOR HOBBYISTS & EXPERIMENTERS

by John L. Turino

If you are a serious hobbyist or experimenter who is interested in the "why" and "how to" of solid-state circuit design, this book is for you. It provides practical assistance for designing circuitry for a great many useful projects or adapting and modifying existing circuit de-

signs to suit specific purposes. Procedures of design are presented with "how" to explain an idea in block diagram form. The design procedures then progress from developing a single stage to combining several stages, adding a voltage source for power, and finally connecting an input.

Published by Howard W. Sams & Co., Inc., 4300 West 62 St., Indianapolis, IN 46268. Soft cover. 208 pages. \$5.95.

### ESSENTIALS OF COMMUNICATION ELECTRONICS, Third Edition

by Slurzburg & Osterheld

Solid-state devices and vacuum tubes, their basic circuitry, and their applications to electronic communication systems are presented in this book. Written at an intermediate level, most of the required mathematics is limited to simple arithmetic. Any examples that use algebra, trigonometry, or logarithms are explained step by step. This new edition contains a host of review problems and questions, as well as 300 new illustrations. The prerequisite for understanding the material presented is a course in electrical fundamentals.

Published by McGraw-Hill Book Co., 1221 Avenue of the Americas, New York, NY 10020. Hard cover. 800 pages. \$11.95.

### FM AND REPEATERS FOR THE RADIO AMATEUR

This manual is written from the experience of radio amateurs who have been active in the designing, building, and using of repeaters. It covers a diversity of topics: FM transmitters and receivers, antennas for mobile and base stations, mobile equipment installation, portable equipment, test equipment and techniques, using surplus equipment, what to look for when buying a rig, tone encoders and decoders, auto-patch equipment, and repeater technical problems and cures. There is also a section on operating under the new regulations and on organizing a repeater club.

Published by The American Radio Relay League, Inc., Newington, CT 06111. Soft cover. 232 pages. \$3.00.

### TELEVISION SERVICING, Seventh Edition

by Kiver & Kaufman

In simple and clear terms, this book analyzes all types of TV receivers, both color and monochrome, now in service, from the standpoint of theory, operation, trouble-shooting, and alignment. While the emphasis is on solid-state and IC designs, the text also covers vacuum-tube designs wherever applicable. In addition, information is provided on transmission and transmitters for a fuller understanding of the overall TV system. Expanding its coverage to 24 chapters (the previous edition had only

197), this new edition devotes separate chapters to the more important concepts currently in use in modern receivers.

Published by Van Nostrand Reinhold Co., 450 West 33 St., New York, NY 10001. Hard cover. 612 pages. \$15.95.

## FUNDAMENTALS OF ELECTRONICS, Third Edition

by Matthew Mandl

This up-to-date and comprehensive volume provides broad and deep coverage of circuits, signals, and complete systems. Basic circuitry is illustrated and discussed from the standpoint of operational characteristics and applications to overall systems. This latest edition treats signals and spectra, modulation and sidebands, signal generation and shaping, r-f and i-f amplification, a-f and video amplification, AM and FM detection, monochrome and color TV modulation, filters and transmission lines, microwave principles, and antenna systems. Updated material includes MOSFET's and Y-paramater discussions, among other things.

Published by Prentice-Hall, Inc., Englewood Cliffs, NJ 07632. Hard cover. 628 pages. \$13.95.

## BASIC PRINCIPLES OF ELECTRICITY

by Vester Robinson

Even if the reader does not have a science background, this book can guide him to a sound understanding of ac/dc circuits. Using an approach designed to help the reader clearly visualize electric action in the circuit, each basic principle and its practical application is explained in the text. Where necessary, the principles are analyzed mathematically. In this step-by-step approach, more than 450 drawings and photos illustrate the text material.

Published by Reston Publishing Co., Inc., Box 547, Reston, VA 22090. Hard cover. 414 pages. \$12.95.

## PRACTICAL APPLICATIONS OF DIGITAL INTEGRATED CIRCUITS, Parts I-IV

Anyone who wishes to master both the theory and practical aspects of digital techniques will do well to purchase this set of books. The four-volume set is actually a complete digital "course," complete with theory discussions and practical laboratory projects the reader can use to obtain a rounded education in digital techniques. Although the lab experiments are based on the publisher's Digi-Kit logic breadboard, they can be accomplished with a home-made breadboard and the appropriate IC's. The course covers everything from basic logic gates through hybrid digital IC's.

Published by General Electronics Associates, Inc., Box 156, Northfield, OH 44067. Soft cover. \$19.95 for 4-volume set.

## ABOUT YOUR SUBSCRIPTION

Your subscription to POPULAR ELECTRONICS is maintained on one of the world's most modern, efficient computer systems, and if you're like 99% of our subscribers, you'll never have any reason to complain about your subscription service.

We have found that when complaints do arise, the majority of them occur because people have written their names or addresses differently at different times. For example, if your subscription were listed under "William Jones, Cedar Lane, Middletown, Arizona," and you were to renew it as "Bill Jones, Cedar Lane, Middletown, Arizona," our computer would think that two separate subscriptions were involved, and it would start sending you two copies of POPULAR ELECTRONICS each month. Other examples of combinations of names that would confuse the computer would include: John Henry Smith and Henry Smith; and Mrs. Joseph Jones and Mary Jones. Minor differences in addresses can also lead to difficulties. For example, to the computer, 100 Second St. is not the same as 100 2nd St.

So, please, when you write us about your subscription, be sure to enclose the mailing label from the cover of the magazine—or else copy your name and address exactly as they appear on the mailing label. This will greatly reduce any chance of error, and we will be able to service your request much more quickly.

**NEW**  
... for the sound buff  
**HYBRID POWER AMPLIFIERS**

With the addition of a few off-the-shelf components, you can easily build your own quality amplifier for record player, tape deck, tuner, P.A. (musical instruments) or intercom system.

**USED BY LEADING MANUFACTURERS • 2 YEAR WARRANTY**

AVAILABLE IN 3 MODELS:			CHARACTERISTICS:	
Power	RMS	IHF	• Harmonic Distortion	< .05%
1. SI-1010Y	10W	25W	• Bandwidth	20 Hz — 100K Hz
2. SI-1025E	25W	65W	• Flat response	within 1/2dB
3. SI-1050E	50W	120W	• Input sensitivity	500 mV

Contact your local electronic component distributor!

**AIRPAX**™ INTERNATIONAL DIVISION  
P.O. Box 8488  
Ft. Lauderdale, Fla. 33310  
CIRCLE NO. 41 ON READER SERVICE CARD

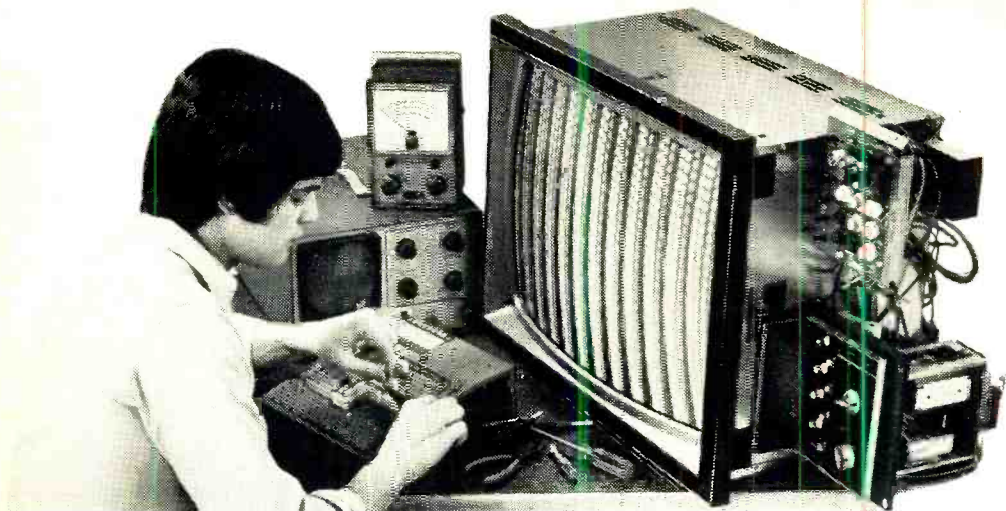

# **BUILD YOUR OWN BELL & HOWELL SOLID-STATE 25-INCH DIAGONAL COLOR TV!**

**It's an enjoyable way to learn new skills that could launch you on a brand-new career in electronics!**

**For free information, mail postage-free card today!**



# A complete at-home learning program in home entertainment electronics!

Send for free information now about this complete, learn-at-home program. Our Bell & Howell Schools representative is ready to bring you all the facts you need.

## Work on this exciting "hands on" project integrated into your learn-at-home program!

As part of your program, you build yourself a Bell & Howell solid-state color television set. This important project gives you "hands on" experience with solid-state circuitry—the kind of *practical* experience you'll need to build a successful career.

## Attend special "help sessions" . . . talk to your instructors in person!

If you'd like some personal advice at any point in your program, you can arrange to attend a special "help session" and talk over special problems with a qualified Bell & Howell Schools instructor.

## Master the most up-to-date solid-state circuitry

As color TV moves more and more in the direction of *total* solid-state circuitry, you'll be thoroughly familiar with the most advanced "trouble-shooting" techniques for these sophisticated circuits.

## Fix stereo systems . . . FM-AM radios . . . phonographs . . . tape recorders

The thorough knowledge of electronics you gain from completing this course and building your own color TV set will be enough to service almost *any* type of home entertainment electronic device—even some that aren't on the market yet!

## Earn extra part time income—or start a business of your own!

The skills you acquire through this unique program can help you earn extra money—or start a business of your own in color TV servicing. We've helped many people start new careers or businesses of their own in electronics.

## Exclusive Electro-Lab® electronics training system—yours to keep!

To make sure you get practical experience with instruments used daily by professionals, we've integrated into your program three precision instruments you assemble yourself: a Design Console, an Oscilloscope and a Transistorized Meter. (See details at right.)

## For Free Information, Mail Card Today!

Electro-Lab® is a registered trademark of the Bell & Howell Company



25-inch picture (measured diagonally)

**Detach postage-paid reply card and mail today for free information about . . .**

### ■ Bell & Howell Solid-State 25-inch Diagonal Color TV:

Ultra-rectangular tube • 25-inch picture measured diagonally • full 315 sq inch viewing area • solid-state modular circuitry • 4 advanced IC's • 100 transistors • 72 diodes • individual plug-in circuit boards • special UHF/VHF tuning features • built-in self-service components.

■ **Design Console:** "Breadboard" circuits without soldering for both solid-state and vacuum tube experiments • patented modular connectors • transistorized dual-range regulated DC power supply • 12.6 volt center tapped AC power supply • sine and square wave signal generator • test speaker.

■ **Oscilloscope:** Professional technician's diagnostic instrument • 5-inch screen • wide-band • sharp screen images • calibrated for peak-to-peak voltage and time measurements • 3-way jacks for leads, plugs, wires.

■ **Transistorized Voltmeter:** Measures current, voltage, resistance on large dial • combines vacuum-tube voltmeter with multimeter • sensitive, 4-inch, jewel-bearing d'Arsonval movement.

**NEW . . .** with your first lesson, you get the brand-new Laboratory Starter Kit: A volt-ohm meter (VOM) with design panels • modular connectors • experimental parts • battery power source. Gives you *immediate* "hands on" experience with your very first lesson.

If card has been removed, write:  
An Electronics Home Study School  
DEVRY INSTITUTE OF TECHNOLOGY

ONE OF THE  
**BELL & HOWELL SCHOOLS**  
4141 Belmont, Chicago, Illinois 60641

523

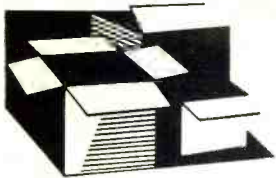

## New Products

### DUAL SINGLE-PLAY AUTOMATIC TURNTABLE

Dual's first single-play automatic turntable, the Model 701, features an all-electronic low-speed, direct-drive dc motor and two mechanical filters that cancel out resonant energies originating in the tonearm/cartridge system and in the chassis. The motor rotates at 33 $\frac{1}{3}$  or 45 rpm,



and the platter is directly driven by the motor. Speed is controlled by a regulated power supply and monitored by two Hall-effect generators. The two anti-resonance filters, designed into the tonearm counterbalance, are claimed to provide smoother frequency response and to isolate the stylus from such external sources of mechanical disturbances as record warp, acoustic feedback, and room vibration.

Circle No. 70 on Reader Service Card

### METROTEC TELEPHONE ANSWERING SERVICE

The Phone Butler, a telephone answering device and home message center has been intro-

duced by Metrotec Electronics, Inc., a subsidiary of BSR (USA) Ltd. It is the first electronic phone answerer designed for the home as well as the office. The ac-powered device meets all applicable telephone company regulations and can be used with or without a telephone company coupler. All functions are activated by pushbutton switches for simple and fool-proof operation. The Phone Butler can record up to 30 messages on a special cassette. A Message Waiting indicator lamp lights whenever a call has been taped.

Circle No. 71 on Reader Service Card

### ARCHERKIT TREASURE FINDER KIT

The Archerkit Treasure Finder, in a build-it-yourself kit, detects metal objects buried up to 6" deep. Available from Radio Shack, it features a calibrated meter and a built-in 2 $\frac{1}{2}$ " speaker to provide a choice of visual or audible indication when approaching a metal object. The lightweight unit features a sealed 6 $\frac{1}{2}$ " circular detector coil with a special Faraday shield that is said to provide maximum sensitivity. The 36" collapsible shaft has a pistol-grip handle. Other features include a headphone jack, on-off/volume control, and sensitivity control.

Circle No. 72 on Reader Service Card

### KOSS "POCKET" STEREO HEADPHONES

Koss Corp. has introduced the industry's first pocket-sized stereo headphones. Named the "Traveler," it transforms from a full-size set

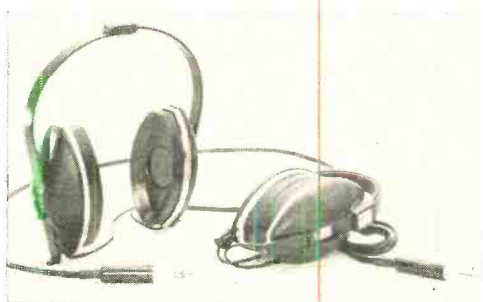

# FREE McIntosh CATALOG and FM DIRECTORY

McIntosh Laboratory, Inc.  
East Side Station P.O. Box 96  
Binghamton, N.Y. 13904  
Dept. 16-5

**SEND  
TODAY!**

NAME \_\_\_\_\_

ADDRESS \_\_\_\_\_

CITY \_\_\_\_\_ STATE \_\_\_\_\_ ZIP \_\_\_\_\_

Get all the news and latest information on the new McIntosh Solid State equipment in the McIntosh catalog. In addition you will receive an FM station directory that covers all of North America.



**MX 113**

AM FM/FM STEREO TUNER PREAMPLIFIER  
CIRCLE NO. 19 ON READER SERVICE CARD

POPULAR ELECTRONICS Including Electronics World

into a compact, palm-sized unit for storage or traveling. The unique feature of the Traveler is its telescoping headband. The reproducers are high-quality driver elements similar to those used in the company's top-of-the-line headphones. They feature a 1½" Mylar diaphragm, a light-weight, stiff material that is resistant to moisture and temperature changes. The Traveler weighs just 9 ounces and comes with an 8' cord.

Circle No. 73 on Reader Service Card

#### HEATHKIT 4-CHANNEL R/C SYSTEM

With the new Heathkit Model GDA-1057 system, the Heath Company offers radio control buffs a low-cost, kit-form 3-channel rig that quickly converts to a complete 4-channel system simply by adding an optional modification



kit. The transmitter is available on all R/C frequencies and is housed in a new slim-line case that permits one-hand action during launch or engine adjustment. The 3-channel receiver (also convertible to 4-channel operation with the optional modification kit) has a connector block for servos and battery pack. Available with a choice of servos, the GDA-1057 system becomes a 4-channel system with the addition of the Model GDA-1057-4 modification pack.

Circle No. 74 on Reader Service Card

#### CONCORD CARTRIDGE TAPE DECKS

Two new cartridge tape decks are now available from Concord Division of Benjamin Electronic Sound Co. The Model CD-8 is an 8-track deck equipped to easily and inexpensively increase the scope of any home entertainment system. It features a preamplifier level output control that allows adjustment of a level to that of the other input sources in the audio system. The Model CD-8-4 is a 2/4-channel deck that incorporates the most advanced engineering concepts as exemplified by a computer-type readout of channel and program selection. It is

The great new  
**Super Scanner**  
It scans 360° in milliseconds with 575 dB gain. Or beams an 875 dB gain signal where and when you want it—**instantaneously.** (Otherwise, it's just another beautiful base antenna.)

MODEL MS-119 Super Scanner electronic beam, incl. control console — sugg. price, \$99.95



© 57 Stripes of Quality

**the antenna specialists co.**

Division of ORION INDUSTRIES, INC.  
12435 Euclid Ave., Cleveland, Ohio 44106  
Export: 2200 Shames Dr.,  
Westbury, L.I., New York 11590  
Canada: A. C. Simmonds & Sons, Ltd.

CIRCLE NO. 1 ON READER SERVICE CARD

## Why pay retail for hifi?

Buy direct from us, and you save money with our high-volume prices on more than 100 name brands.

Order from the branch nearest you to save time and money on freight.

Send for our free catalog.



## Midwest Hifi

Wholesale & MAIL ORDER DIVISION

2455b Wisconsin Ave. 3309 E. J W Carpenter Frwy.  
Downers Grove, Ill 60515 Irving, Tex 75062

CIRCLE NO. 22 ON READER SERVICE CARD



programmed to differentiate between 2- and 4-channel cartridges, automatically switching to the proper mode.

Circle No. 75 on Reader Service Card

### TECHNICS 2/4-CHANNEL AM/FM RECEIVER

The Technics Model SA-8000X 4/2-channel AM/stereo FM receiver by Panasonic has a built-in CD-4 demodulator, plus AFD matrix circuitry for direct demodulating or decoding of every 4-channel medium in use today, without the need for external accessories. The receiver also has direct plug-in adaptability for the discrete 4-channel FM broadcasts of the future. The SA-8000X features 64 watts of total continuous rms output power, all four channels driven into 8 ohms, and 84 watts of total continuous rms power with both channels driven at 8 ohms in the 2-channel mode. The total IHF output power is 160 watts.

Circle No. 76 on Reader Service Card

### KENWOOD 4-CHANNEL AM/STEREO FM RECEIVER

The 2/4-channel Kenwood Model KR-6340 AM/stereo FM receiver features a new strapping circuit that switches the full power of the amplifier to the front channels during 2-channel

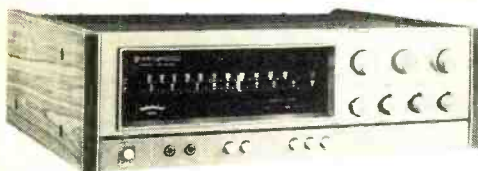

operation. This gives the user full power output in either 2- or 4-channel modes. The receiver incorporates SQ and RM decoders, plus provisions to play and record discrete 4-channel tapes, and accepts an optional CD-4 plug-in adapter. The 4-channel controls for front and rear balance, tone, and volume provide optimum flexibility for a full 4-channel control center, with ample provision for a complete 4-channel system including two 4-channel speaker systems.

Circle No. 77 on Reader Service Card

### IMPROVED SHURE-SME TONEARMS

Shure Brothers has announced the Shure-SME Model 3009 Series II Improved tonearm featuring significant reduction in the effective tonearm mass and improved antiskating control. Other improvements in the tonearm include less overhang of the counterweight and

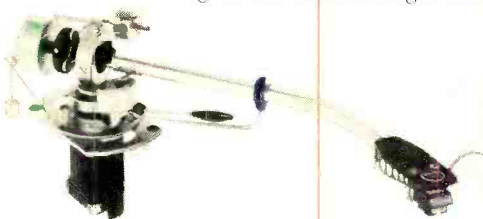

easier balance adjustment incorporating a rotating counterweight at the rear of the tonearm. By reducing effective mass, the resultant resonant frequency of the tonearm/cartridge combination has been increased, resulting in more positive tracking of warped records and less susceptibility to vibration. This was accomplished by reducing the counterweight mass and incorporating a permanent cartridge shell. For those who prefer a removable shell, there is the Model 3009/S2 Improved, with a slightly higher effective mass than the 3009 Improved.

Circle No. 78 on Reader Service Card

### EV-GAME WIRELESS MICROPHONE

A new FCC-approved FM wireless electret microphone that transmits voice and music through any broadcast FM receiver or tuner is available from EV-Game Inc. The distinctly styled Model WM-10 mike has a maximum transmitting range of 100 feet, depending upon the receiver's sensitivity and the nature of the obstructions between receiver and mike. The WM-10 incorporates a highly efficient electret microphone element with advanced circuitry to achieve a lightweight, reliable, compact, and easy-to-use mike. The cordless WM-10's antenna is a short length of insulated wire that hangs from behind the unit.

Circle No. 79 on Reader Service Card

SEE...  
COMPARE...  
SELECT!!!

**SBE**

SCANNING  
MONITOR  
RECEIVERS

"Sentinel"



Advanced features—superior operation  
Models for HF, VHF, UHF • 8 channels • Priority  
channel feature • 12VDC - 115VAC • Squelch  
Built-in speaker • plug-in antenna • Small

Monitor:  
Police  
Fire  
Marine  
Weather  
Emergency  
Traffic  
Business  
Taxi

WRITE FOR  
BROCHURE

SBE 220 Airport Blvd., Watsonville, CA 95076

### EDMUND SCIENTIFIC ELECTRONIC THERMOMETER

At the push of a button, temperatures in three different areas from inches to 1000 ft away can be monitored with an ingenious electronic thermometer (No. 71,741) available from Edmund Scientific Co. The unit accepts three plug-in temperature probes and provides instant readings from  $-22$  to  $+122^{\circ}\text{F}$  and  $-30$  to  $+50^{\circ}\text{C}$ , accurate to within  $\pm 1$  percent. The electronic thermometer comes with two solid-state waterproof probes. Additional probes are available separately.

Circle No. 80 on Reader Service Card

### REGENCY LOW-BAND TRANSCEIVER

Regency Electronics, Inc., has announced the availability of a new two-way radio for use in the low-band (29-50-MHz) business radio spectrum. The new Model BTL-301 radio features a 30-watt power output,  $0.35\text{-}\mu\text{V}$  sensitivity on



receive, receiver selectivity of  $6\text{ dB} \pm 7500\text{ Hz}$  ( $70\text{ dB} \pm 15,000\text{ Hz}$ ), and an audio output of 5 watts. The i-f system is double conversion ( $10.7\text{ MHz}/455\text{ kHz}$ ), while a noise-operated squelch is adjustable by a control on the front panel. The transmitter section is protected by a VSWR bridge limiter circuit.

Circle No. 81 on Reader Service Card

### LAMB LOW-COST BENCH POWER SUPPLIES

The compact LPS-10-Series power supplies made by Lamb Laboratories provide short-circuit protection with fixed output voltages at tolerances of  $\pm 5$  percent. Five models are available: LPS10-5A (5 V at 1.2 A), LPS10-6A (6 V at 1 A), LPS10-12A (12 V at 650 mA), LPS10-24A (24 V at 500 mA), and LPS10-1515A dual tracking  $\pm 15\text{ V}$  at 300 mA). The 12-V and 24-V supplies have less than  $600\text{-}\mu\text{V}$  rms ripple. All supplies operate from inputs of 105-130 V ac, 47-63 Hz. Specialized units with remote sensing and over-voltage protection are also available.

Circle No. 82 on Reader Service Card

### BLACK & DECKER SOLDER CRAFT KIT

A solder craft kit that contains interchangeable tips for soldering, hot-knife cutting, leathercraft, wood burning, and foil writing has been introduced by The Black & Decker Manufacturing Co. The soldering tip is ideal for electrical and electronics work; the 27-watt heating element provides a tip temperature of about

## Now... the most enjoyable, do-it-yourself project of your life—a Schober Electronic Organ!



You'll never reap greater reward, more fun and proud accomplishment, more benefit for the whole family than by assembling your own Schober Electronic Organ.

You need no knowledge of electronics, woodwork or music. Schober's complete kits and crystal-clear instructions show you — whoever you are, whatever your skill (or lack of it) — how to turn the hundreds of quality parts into one of the world's most beautiful, most musical organs, worth up to twice the cost of the kit.

Five superb models, with kit prices from \$500 to around \$2,000, each an authentic musical instrument actually superior to most you see in stores.

Get the full story FREE by mailing the coupon TODAY for the big Schober color catalog, with all the fascinating details!

The Schober Organ Corp., Dept. PE-51  
43 West 61st Street, New York, N. Y. 10023

- Please send me Schober Organ Catalog.  
 Enclosed please find \$1.00 for 12-inch L.P. record of Schober Organ music.

NAME \_\_\_\_\_

ADDRESS \_\_\_\_\_

CITY \_\_\_\_\_ STATE \_\_\_\_\_ ZIP \_\_\_\_\_

CIRCLE NO. 31 ON READER SERVICE CARD

**DELUXE**  
**MAGAZINE CASES**  
*Designed Exclusively for*  
**POPULAR ELECTRONICS**

● The ideal way to save your valuable copies, keep them well protected and make it easy for you to refer to any issue at any time. Both decorative and attractive enough to enhance the decor of any room, each case holds a full year's copies. Constructed of reinforced fiberboard, these durable cases are covered in a rich-textured leatherette. The gold embossed back adds to its elegance and makes each case a welcome addition to your bookshelf or cabinet.

Magazine cases are available for any of your favorite magazines. They're only \$4.50 each, 3 for \$12.50, in any combination of titles ordered. Add 50¢ per case for postage and handling. Outside U.S.A. add \$1.00 per case ordered.

**CHARGE YOUR AMERICAN EXPRESS OR UNI-CARD ACCOUNT.**

Ziff-Davis Pub. Co., Dept. 23, 1 Park Avenue, New York 10016

My remittance in the amount of \$ \_\_\_\_\_ is enclosed. Please send magazine cases for the titles indicated below.

CHARGE:  American Express  Uni-Card PE-1073

Account # \_\_\_\_\_

Signature \_\_\_\_\_

	TITLE	QUANTITY

Check One:  All Black  Maroon Back, Black Sides

Print Name \_\_\_\_\_

Address \_\_\_\_\_

City \_\_\_\_\_ State \_\_\_\_\_ Zip \_\_\_\_\_

**PAYMENT MUST ACCOMPANY ORDER**

700°F. For cutting and trimming plastics, rubber, and synthetics and for sealing the edges of man-made fabrics and materials, the hot-knife tip comes in handy. The other tips in the kit can be used for any number of hobby and craft projects.

Circle No. 83 on Reader Service Card

#### JEFFERSON MARINE DEPTH FINDER

The Model 410 depth finder manufactured by Ray Jefferson is a completely solid-state, two-range meter-type unit that can operate on its own 12-volt battery system or from a boat's 12-volt electrical system. It reads a shallow range of from 0 to 24 ft and a deep range of from



0 to 240 ft with high precision. The Model 410 features a bright, easy-to-read meter that is shielded to reduce compass deviation. It can be used on all boats from small dinghies to heavy cruisers. Its one-piece bronze transducer, treated with anti-fouling inhibitors, mounts either through the hull or off the transom.

Circle No. 84 on Reader Service Card

#### ASTATIC TRANSISTORIZED MICROPHONE

A new transistorized mobile (or base station) microphone for CB use is available from Astatic. Designated the Model TMD-107, it features a field-effect-type amplifier, press-to-talk switch, high-impact Cyclocac housing, coiled cord with strain relief bushing, and rugged metal hang-up button. A screwdriver-adjustable gain control prevents accidental changes in gain setting. Output impedance is less than 5000 ohms.

Circle No. 85 on Reader Service Card

#### GC IC REMOVAL TOOL KIT

Fast, easy removal or replacement of IC's is promised with a new integrated circuit removal tool kit (Cat. No. 9228 from GC Electronics). The kit contains two IC removal tools in a convenient plastic case. The flat IC tool removes or replaces DIP IC's with up to 18 pins by hooking under diagonal terminals and lifting them out. The round TO-5 tool removes or replaces JEDEC 99-100 and TO-5 outline IC's.

Circle No. 86 on Reader Service Card

# YOU CAN CREATE ALMOST ANYTHING WITH QT SOCKETS™

No matter what kind of circuits you're designing, it's easy testing them with QT (quick-test) SOCKETS™. ICs, transistors, resistors, capacitors, etc., are simply plugged in and interconnected with solid No. 22 AWG hookup wire. There is no soldering required. And components and sockets can be re-used thousands of times. What's more, QT SOCKETS – featuring an exclusive snap/lock construction – can be assembled in any size combination of sockets and bussing strips. Prices start at \$2.00.

QT SOCKETS – just the thing for bringing new ideas to life.

## FREE SELECTION GUIDE

Check and return the reader service card for additional information, including application and product photos, drawings, specifications, socket sizes and ordering information.

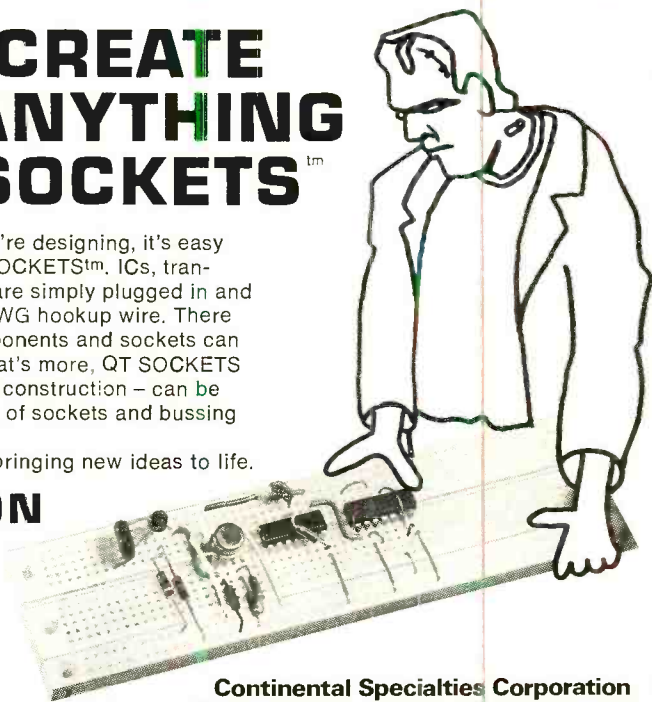

**Continental Specialties Corporation**

325 East St., New Haven, Conn. 06511 Tel: 203 624 1811

**CIRCLE NO. 5 ON READER SERVICE CARD**





# Surplus Scene

By Alexander W. Burawa, Associate Editor

## POLY-PAKS, INC.—A DEALER PROFILE

**T**O MOST of us who have been in the experimenter/hobby end of electronics for several years or more, the name Poly-Paks, Inc. (16-18 Del Camino St., Wakefield, MA 01880) is a familiar one. The company is not new, predating by a considerable margin the current surplus "range" brought about by inflation and sundry other reasons. Begun some 20 years ago in a basement as Lektron, Inc., Poly-Paks has become one of the biggest and most competitive among the electronics dealers catering primarily to consumer interests.

About 12 years ago, the company became known by its present name. Continuous growth forced it, in the latter part of last year, to relocate to newly built quarters where the company occupies 100,000 square feet of warehouse and operating space.

Poly-Paks has built its business and reputation around one very important maxim: economy for the consumer in the form of low-cost, high-quality items. This is evidenced by the company's policy of offering a "double bonus" through which the buyer receives a \$25-value package of components for only 25¢, plus any \$1 item in stock for free whenever his order exceeds \$10.

Long famous as the originator of the economy or bargain package, Poly-Paks continues to do a considerable business in their "Dollar Paks" which contain assortments of parts and components at a considerably lower cost than the buyer could obtain them elsewhere or in unit quantities. While the company has doggedly pursued a policy of specializing in only those small items, both commonplace and exotic, that can reasonably return a good investment to the buyer, they have by no means limited their scope.

Back when fiber optics, opto-couplers, and LED's were new to the consumer scene,

Poly-Paks was heavily into their promotion. Diodes and transistors have almost always figured prominently in their inventory. Later, when digital and linear IC's and numeric readouts became available, the company plunged right in. And now that CMOS has become a practical reality, they handle a nicely rounded line of these IC's. All-in-one MOS LSI chips for digital electronic clocks and calculators supplement the standard "function" series of IC's you see everywhere, while Sperry 332 two-digit neon-glow readouts (similar to the Panaplex) and three digits on a DIP chip (similar to the ones Hewlett-Packard is currently selling to OEM customers) have recently been added to the lineup. Incidentally, specifications sheets for all solid-state devices sold are available on demand.

Another relatively new addition to the lineup of offerings is the Poly-Paks "Kronos" electronic clock kit that sells for \$47. Normally available with the MAN-1 type LED readouts, it can be had with the new Litronix high-visibility 707 and 704 seven-segment readouts. Soon to be announced will be a conversion that will allow the clock to be used on battery power (in a car or boat) while operating from a crystal-controlled time base. Another item to be announced soon will be a 12-digit, four-function digital electronic calculator with memory, constant function, and full floating decimal system in kit form for about \$60.

Poly-Paks is primarily a mail-order house, doing business domestically and internationally, but they also take many telephone orders. All orders will be given rush treatment if requested. And orders are processed immediately upon arrival; for items out of stock, the buyer is notified of the fact without delay. This makes for good customer relations—if you need more of an incentive than just saving money. ♦

# ELECTRONICS MARKET PLACE

**NON-DISPLAY CLASSIFIED: COMMERCIAL RATE:** For firms or individuals offering commercial products or services, \$1.60 per word (including name and address). Minimum order \$16.00. Payment must accompany copy except when ads are placed by accredited advertising agencies. Frequency discount: 5% for 6 months; 10% for 12 months paid in advance. **READER RATE:** For individuals with a personal item to buy or sell, \$1.00 per word (including name and address.) No minimum! Payment must accompany copy. **DISPLAY CLASSIFIED:** 1" by 1 column (2 5/8" wide), \$200.00. 2" by 1 column, \$400.00. 3" by 1 column, \$600.00. Advertiser to supply cuts. For frequency rates, please inquire.

**GENERAL INFORMATION:** First word in all ads set in bold caps at no extra charge. All copy subject to publisher's approval. All advertisers using Post Office Boxes in their addresses **MUST** supply publisher with permanent address and telephone number before ad can be run. Advertisements will not be published which advertise or promote the use of devices for the surreptitious interception of communications. Closing Date: 1st of the 2nd month preceding cover date (for example, March issue closes January 1st. Send order and remittance to Hal Cymes. **POPULAR ELECTRONICS** Including **ELECTRONICS WORLD**, One Park Avenue, New York, New York 10016.

## FOR SALE

**FREE!** bargain catalog. Fiber optics, LED's, transistors, diodes, rectifiers, SCR's, triacs, parts. Poly Paks, Box 942, Lynnfield, Mass. 01940.

**GOVERNMENT** Surplus Receivers, Transmitters, Snooperscopes, Radios, Parts, Picture Catalog 25¢. Meshna, Nahant, Mass. 01908.

**LOWEST Prices** Electronic Parts. Confidential Catalog Free. **KNAPP**, 3174 8TH Ave. S.W., Largo, Fla. 33540.

**ELECTRONIC PARTS**, semiconductors, kits. **FREE FLYER**. Large catalog \$1.00 deposit. **BIGELOW ELECTRONICS**, Bluffton, Ohio 45817.

**CONVERT** any television to sensitive, big-screen oscilloscope. Only minor changes required. No electronic experience necessary. Illustrated plans. \$2.00. **Relco-A33**, Box 10563, Houston, Texas 77018.

## RCA COMPUTER BOARDS



New glass epoxy boards, from last computers made by RCA. All kinds of semiconductors, trim pots, resistors, capacitors, time delays etc. **STOCK NO. F9662** 6/5.00, 14/10.00, 22/15.00, all different.

## HEAVY DUTY MULTIPLE VOLTAGE REGULATED TRANSFORMER

7 voltages, 15 volts @ 10 A., 36 volts @ 5 A., 10 volts @ 5 A., 20 volts ct @ 2 A., 36 volts @ 5 A., 42 volts @ 5 A., 36 volts @ 4 A. Resonant primary regulated, (no change in output voltages for up to 20% change in primary). 5 1/4" x 4 1/2" x 6". Complete with regulating capacitor and data for many more uses and voltage combinations.

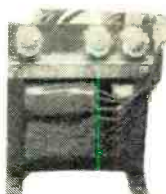

**STOCK NO. F9584** 20 lbs. 12.50 ea. 2/22.00

OUR NEW 56 PAGE CATALOG JUST OUT, LOADED WITH NEW AND DIFFERENT ITEMS, NEVER BEFORE AVAILABLE.

Include postage. Excess refunded. **MINIMUM ORDER, \$3.00.** Write for new 56 page catalog.



**DELTA ELECTRONICS CO.**

BOX 1, LYNN, MASSACHUSETTS 01903  
617-388-4705

**CIRCLE NO. 7 ON READER SERVICE CARD**

**AMATEUR SCIENTISTS**, Electronics Experimenters, Science Fair Students . . . Construction Plans—Complete, including drawings, schematics, parts list with prices and sources . . . Robot Man — Psychedelic shows — Lasers — Emotion/Lie Detector — Touch Tone Dial—Quadrasonic Adapter—Transistorized Ignition — Burglar Alarm—Sound Meter . . . over 60 items. Send 25¢ coin (no stamps) for complete catalog. **Technical Writers Group**, Box 5994, University Station, Raleigh, N.C. 27607.

**RADIO—T.V. Tubes**—36¢ each. Send for free catalog. **Cornell**, 4213 University, San Diego, Calif. 92105.

**METERS**—Surplus, new, used, panel or portable. Send for list. **Hanchett**, Box 5577, Riverside, CA 92507.

**PYROTECHNICAL** chemicals, casings, tools, supplies, fuse, literature. Giant, illustrated catalogue/handbook includes formulas, instructions—50¢, with samples—\$1.00. **Westech**, Box 593, Logan, Utah 84321.

**WE SELL CONSTRUCTION PLANS. TELEPHONE:** Answering Machine, Speakerphone, Carphone, Planavision, Auto Dialer, Touch Button Dialer, Central Dial System. **TELEVISION:** \$35.00 Color Converter, Video Tape Recorder. \$25.00 Camera. **HOBBYIST:** Electron Microscope, 96 Hour Tape Music System, Ultrasonic Dishwasher, Radar-Oven. Plans \$4.95 each. **NEW ITEM:** \$75. Electronic Pocket Calculator, \$7.50. **COURSES:** Telephone Engineering \$39.50. Detective Electronics \$22.50. Integrated Circuit Engineering, \$49.50. **NEW SUPER HOBBY CATALOG** plus year's subscription to Electronic New Letter **AIRMAILED \$1.00.** **Don Britton Enterprises**, 6200 Wilshire Blvd., Los Angeles, Calif. 90048.

**ANTIGRAVITY**, experiment and theory, **Rushed—\$2.00.** U.S. inquiries. **Intertech 7A11**, Box 5373, Station F, Ottawa, Canada.

**JAPAN HONG KONG DIRECTORY.** World products information. \$1.00 today. **World Trade Inquiries**, Hillyard, Washington 99207.

**TEST EQUIPMENT**, Aerospace-Laboratory Grade. Request your needs; will mail appropriate catalogs (we have 24 catalog categories). Only for Engineers, Businesses, Schools and advanced Technicians. **Goodheart**, Box 1220PE, Beverly Hills, Calif. 90213.

## BUILD YOUR OWN SPACE-AGE TV CAMERA



**ONLY KNOWN SOLIDSTATE CAMERA KIT!** Ideal for experiments, home, education, industry, etc. High quality. Backed by over six years of lab & field testing. Fully Guaranteed. Components fit any TV set without modification. Step-by-step construction manual. Model KT-1A, Series D complete with vidicon \$149.50. postpaid. Inquiries in USA & Canada (less vidicon tube \$1 6.95pp)

PHONE OR WRITE FOR CATALOG

DIAL 402-867-3779

Many other kits, parts and plans available including starter kits, focus-lets, coils, vidicon tubes, control plans, audio subcarrier kit, etc.  
**1301 BROADWAY ATV Research DAKOTA CITY, NEBR. 68731**

**SCOPES**, meters, test equipment, military and industrial surplus. Write for free "Bargain Bulletins". **Lawrence Instruments**, P.O. Box 744, Sunbury, Pa. 17801.

**MECHANICAL, ELECTRONIC** devices catalog 10¢. Greatest Values —Lowest Prices. **Fertik's**, 5249 "D", Philadelphia, Pa. 19120.

**SURPLUS** electronics for everyone. Free catalog. U.S. inquiries. **ETCO**, 464 McGill, Montreal, Canada.



**DIGITAL ELECTRONICS:** Complete schematics, parts lists, theories—Discrete Component Digital Clock, \$3.00—Sound Sensitive Switch, \$1.50. Increase technical competence, hobby skills—Complete Course in Digital Electronics is highly effective, \$10.00. Free literature. DYNASIGN, Box 60A7, Wayland, Mass. 01778.

**FREE** Catalog lists resistors, tubes, transistors, rectifiers, condensers, tools, tuners, etc. Hytron Hudson, Dept. PE, 2218 Kennedy Blvd., Union City, N.J. 07087.

**CONSTRUCTION PLANS:** Laser . . . \$2.00. Missile Tracker . . . \$2.00, Free Catalog. Quadraphonic Adaptor—Assembled . . . \$8.95. Howard, P.O. Box 35271, Detroit, Michigan 48235.

**PRINTED** circuits made. Free details. Reed Engineering, 1140-C N. Lemon, Orange, Calif. 92667

**WHOLESALE** Scanners, CB., Crystals, Directories, SSB/AM, Catalog 25¢. G—ENTERPRISES, Box 461P, Clearfield, Ut. 84015.

**WE SELL CONSTRUCTION PLANS**—gold recovery unit!—silver recovery unit—infra-red scope—x-ray fluoroscope—alternator adapter—200 watt inverter—electronic insect tap—burglar alarm system—chemical formulary—plans \$5.00—plus many more!—ask for complete catalog 25¢—Airmailed 50¢. Creative Product, 8415 Loffland, Dept. E-973, Houston, Texas 77055.

+ - × ÷ **CALCULATOR OWNERS:** Compute **SQUARE ROOTS**, trigonometric functions, logarithms, exponentials, and more! Quickly, accurately, easily! Manual \$2.00. Send today—Unconditional money-back guarantee! Mallmann Optics and Electronics, Dept.-7A, 836 South 113, West Allis, Wisconsin 53214.

**FREE!** Diodes and catalog. BDJ Electronics, 11 Revere, Tappan, New York 10983.

**FIREWORKS NEWS** Magazine Covers Commercial-Display Fireworks, Sources, Construction, Literature, Pyrotechnical Supplies. Free Catalog! Pyro Press, Box 12010(N93), Lexington, Kentucky 40511.

**FREE** Catalog. Reeds, Tantalums, Transistors, PUTS, LEDs, Parts. Chaney, Box 15431, Lakewood, Colo. 80215.

**FREQUENCY COUNTERS**—Hewlett-Packard FR-38 same as 524B. With 525A plug-in range: 10Hz-100MHz. 8 place readout, 1ppm stability. Used repairable—\$125.00, checked for operation—\$150.00, check and calibrated—\$195.00. J. Hartley, 9514 Timberlake Rd., Lynchburg, Virginia 24502.

**FREE CATALOG**—Tremendous electronic bargains. American, Box 4188C, Mountain View, California 94040.

**TRIGGERED OSCILLOSCOPE**  
**\$129.00** Wired, calibrated and tested. Postpaid in U.S.A.  
 Measure AC, DC voltage, time, and frequency directly. Triggered sweep is always rock-stable without adjustment.  
 • DC to 1.5 MHz bandwidth • All solid state  
 • Sensitivity to 10mV/div. • 10 lbs. 12 in deep  
**BEDFORD ELECTRONICS**  
 7741 Fir Dr., Toledo, Ohio 43612



**RADIO-TELEVISION** Diagrams, Service Information. Give description, request quotation. Beitman, 1760 Balsam, Highland Park, Illinois 60035.

**"ELECTRONIC MOUSETRAP."** Unique! Fun to Build! Plans \$2.50. DYNAMIC BATTERY TESTER Plans \$2.00. Frost Electronics, Box 12932, Fort Worth, Texas 76116.

**AUTOMATIC** Telephone Recording Monitors. Starts and stops recording automatically and unattended. Catalog \$1.00. Jack, Box 19422, Sacramento, Calif. 95819.

**HILARIOUS** SWL Satire Tape: Radio Morania! Hour Reel, \$3.85. DX'ers Must! Custom Production Studios, Box 146, Ishpeming, Michigan 49849.

**JAPANESE TRANSISTORS**, Wholesale Prices, Free Catalog. West Pacific Electronics, Box 25837, W. Los Angeles, CA 90025.

**FREE CATALOG**  
**UP TO 50% OFF COMPARABLE KITS\***  
**• BUY DIRECT • SAVE \$\$\$**  
**FREE** Catalog — Electronic Kits — Amplifiers — Preamps — Psychedelic Strobes — Burglar Alarms Digital Tachometer — More: **Free** Catalog. SWTPC, Box A32040, San Antonio, Tex. 78284.

**IGNITION SYSTEMS:** Capacitor, Transistor. Information 10¢. Anderson Engineering, Epsom, N.H. 03239.

**AUTHENTIC, INSTRUMENTED, FLYING ROCKETS** for casual or serious experimenters. Over 80 scale original, multi-stage or ready-to-fly models. Solid-propellant engines for safe, electric launch system liftoffs up to 2,500 feet. Measure altitude, temp. inversions, more. Real telemetry, electronic tracking, aerial still and movie photography with super-miniaturized equipment. New, detailed tech manual and full-color catalog, 25¢ from ESTES INDUSTRIES, Dept. 18N, Penrose, Colo. 81240.

**ALPHA/THETA** feedback instruments—\$25. Sensitive circuit of \$75 unit. Ultimate ease of use. Inner Space Electronics, Box 308PE, Berkeley, CA 94701.

**ELECTRONIC** CDI Ignitions, VHF/UHF monitors, CB radios. Wholesale. Southland, Box 3591, Baytown, Texas 77520.

**FREE CATALOG.** Parts, circuit boards for Popular Electronics projects. PAIA Electronics, Box C14359, Oklahoma City, OK 73114.

**BURGLAR-FIRE** alarm supplies and information. Free catalog. Protecto Alarm Sales, Box 357-G, Birch Run, Michigan 48415.

**SOUND SYNTHESIZER KITS**—Surf \$11.95, Wind \$11.95, Wind Chimes \$16.95, Electronic Songbird \$6.95, Musical Accessories, many more. Catalog free. PAIA Electronics, Box J14359, Oklahoma City, OK 73114

**WAVEFORM** Generator Kit \$10.00. Stereo Multiplex Kit \$19.95. Free Kit Catalog. Photolume Corp., Box 139, N.Y., N.Y. 10016.

**TTL IC**, Semiconductors, parts discount. Price List, 10¢. Totelek, Box 222, Goodyear, Arizona 85338.

**DIGITAL SPEEDOMETER** with numeric readout. Plans \$7.50. KIMTRON, Box 80134, Chamblee, Georgia 30341.

**ELECTRONIC GOODIES.** Sorensen Voltage Stabilizer Input 95-130V/24A; Output 110-120V, 2000VA New \$150.00. F.O.B. Houston; Write list; Madison Electronics, 1508 McKinney, Houston, Texas 77002. (713) 224-2668.

**ALPHA/THETA** brainwave biofeedback instruments with digital processing. BioScan, Box 14168E, Houston, Texas 77021.

**POLICE—FIRE** Frequency Directories \$2.00. Monitor Crystals \$4.95. 25¢ extra for airmail. Crystal Service, P.O. Box 612, East Moline, Illinois 61244.

**BRAINWAVE** feedback. Professional biofeedback instruments: Electroencephalophone, Electromyometer. J&J, 8102-E, Bainbridge, Wa. 98110.

**ELECTRONIC ORGAN KITS, KEYBOARDS** and many components. Independent and divider tone generators. All diode keying. I.C. circuitry. With our kits you can build any type or size organ desired. 25¢ for catalog. DEVTRONIX ORGAN PRODUCTS, Dept. C, 5872 Amapola Dr., San Jose, Calif. 95129.

**DISCOUNT PRICES**  
**B & K, SENCORE, LEADER** Test Equipment  
 RAYTHEON, ICC/MULLARD Tubes  
 TELEMETRIC Test Jigs  
**Free Catalog**  
**FORDHAM RADIO SUPPLY CO. INC.**  
 558 Morris Ave., Bronx, N.Y. 10451





## WANTED

**QUICKSILVER**, Platinum, Silver, Gold, Ores Analyzed. Free Circular. Mercury Terminal, Norwood, Mass. 02062.

**MILITARY SURPLUS EQUIPMENT WANTED.** ARC-34C, ARC-51BX, ARC-73, ARC-102, ARC-109, ARC-131, ARC-134, ARN-21C, ARN-52, ARN-65, GRC-106, VRC-12, URC-24, 618T, Also Bendix, Collins GR, HP, Tektronix needed, plus military test sets. We Buy or Trade. Slep Electronics, 2412 Highway 301, Ellenton, Florida 33532.

## ELECTRICAL SUPPLIES AND EQUIPMENT

**PLATING Equipment.** Portable Platers. Supplies and "Know-How." Build your own tanks for nickel, chrome, etc. Easy-to-install PVC liners. Rectifier components—all sizes. Schematics, parts lists, formulas, operating instructions for all plating. Guaranteed to save you 25%-75%. Some good units for sale. Write for details. Platers Service Company, 1511-PE Esperanza, Los Angeles, Calif. 90023.

**INEXPENSIVE** home burglar alarm. No wires. Wholesale: Centron Communications, PO Box 4716. Chicago 60680.

## TUBES

**RADIO & T.V. Tubes**—36c each. Send for free Catalog. Cornell, 4213 University, San Diego, Calif. 92105.

**RECEIVING & INDUSTRIAL TUBES. TRANSISTORS.** All Brands—Biggest Discounts. Technicians. Hobbyists. Experimenters—Request **FREE** Giant Catalog and **SAVE!** ZALYTRON, 469 Jericho Turnpike, Mineola, N.Y. 11501.

**SAVE** money on parts and transmitting-receiving tubes, foreign-domestic. Send 25c for giant catalog. Refunded first order. United Radio Company, 56-P Perry Street, Newark, N.J. 07105.

**TUBES "Oldies"**, latest. Lists free. Steinmetz, 7519 Maplewood, Hammond, Indiana 46324.

**TUBES** receiving, factory boxed, low prices, free price list Translateronic, Inc., 1306 40th Street, Brooklyn, N.Y. 11218A, Telephone: 212-633-2800.

## DO-IT-YOURSELF

**PROFESSIONAL ELECTRONIC PROJECTS**—\$1.00 up. Catalog 35¢. PARKS, Box 15201A, Seattle, Wash. 98115.

**CONVERT TV** to 6-ft. wide screen! B&W/Color. Do-It-Yourself—easy! Kit, instructions, lens, \$12.95 ppd. Free illustrated details. MACROCOMA, PE-9, Washington Crossing, Penna. 18977.

## PERSONALS

**MAKE FRIENDS WORLDWIDE** through international correspondence. Illustrated brochure free. Hermes, Berlin 11, Germany.

## INSTRUCTION

**LEARN ELECTRONIC ORGAN SERVICING** at home all makes including transistor. Experimental kit—trouble-shooting. Accredited NHSC, Free Booklet. NILES BRYANT SCHOOL, 3631 Stockton, Dept. A, Sacramento, Calif. 95820.

**LEARN WHILE ASLEEP**, Hypnotize! Strange catalog free. Auto-suggestion, Box 24-ZD, Olympia, Washington 98501.

**ASSOCIATE DEGREE IN ELECTRONICS** through correspondence instruction. G.I. Bill approved. Free catalog. Grantham, 1509 N. Western, Hollywood, California 90027.

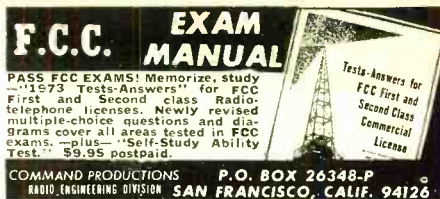

**F.C.C. EXAM MANUAL**  
PASS FCC EXAMS! Memorize, study —1973 Tests-Answers\* for FCC First and Second class Radio-telephone licenses. Newly revised multiple-choice questions and diagrams cover all areas tested in FCC exams, —plus— "Self-Study Ability Test" — \$9.95 postpaid.  
COMMAND PRODUCTIONS RADIO ENGINEERING DIVISION P.O. BOX 26348-P SAN FRANCISCO, CALIF. 94126

**FCC First and Second Tests.** \$8.95. Electronic Tutoring, Box 24190, Cleveland, Ohio 44124.

**INTENSIVE** 5 week course for Broadcast Engineers. F.C.C. First Class license. Radio Engineering Incorporated, 52 S. Palm Ave., Sarasota, Florida 33577.

**SHORTCUTS To Success!** Highly Effective, Profitable Short Courses. (75 Choices). Study At Home. Diploma Awarded. Our 27th Year. Free Literature. CIEE-D, Box 10634, Jackson, Miss. 39209.

**TAPE RECORDING COURSE:** Taught by studio engineers. Free information. NNA, Box 721R, Rye, New York 10580.

DIGITAL: THEORY, DESIGN,  
CONSTRUCTION

## LOGIC NEWSLETTER<sup>®</sup>

SAMPLE COPY \$ 1.00  
LOGIC NEWSLETTER  
POB 252  
WALDWICK, N.J. 07463

**ENGINEERS**—Technicians, Update Yourself. Refresher/Review Course complete—\$20.00, Reference Digest only—\$10.00. Computer Sciences; Digital Electronics; Circuits/Systems Design; Drafting/Designing; Semiconductor Design; Biomedical/Bionics; Business/Manufacturing; Electronics Design Technician; others. Catalog \$1.00 refundable. DA-Tronix Company, 13622 Hope Street, Garden Grove, Calif. 92643.

**SCORE** high on F.C.C. Exams . . . Over 300 questions and answers. Covers 3rd, 2nd, 1st and even Radar. Third and Second Test, \$14.50; First Class Test, \$15.00. All tests, \$26.50. R.E.I., Inc, Box 806, Sarasota, Fla. 33577.

**DRAFTING**—Blueprint Reading (Mechanical, Electronic, Architectural). Home Courses \$25.00. Send \$2.00 first lesson. Prior, Inc., 23-09 169th Street, Whitestone, New York 11357.

**NEW!** "Revised 1973" Basic, Third, Second; Advanced, Radar, First; Phone Exams. "1000" Questions, Answers, Diagrams, Formulas; Taken from actual FCC material. \$7.75. Frustration Resreach Hill, Dept 3-R, Box 19A56; Ahsokie, N. Carolina 27910.

## INSTRUCTION

**FCC First Phone!** Pass! 3 Tests Guaranteed, \$5.00. Engineer, Drawer 570, Mars, Pa. 16046.



## GOVERNMENT SURPLUS

**GOVERNMENT Surplus.** How and Where to Buy in Your Area. Send \$2.00. Surplus Information, Headquarters Bldg., Box 30177-PE, Washington, D.C. 20014.

**ELECTRONIC** Equipment and Parts. Big 36 page Free Catalog. Send for your copy today! Fair Radio Sales, Box 1105-P, Lima, Ohio 45802.

**JEEPS** Typically from \$53.90 . . . Trucks from \$78.40 . . . Boats, Typewriters, Knives, Airplanes, Clothing, Multimeters, Oscilloscopes, Transceivers, Photographic, Electronics Equipment. Wide-variety, condition. 100,000 Bid Bargains direct from government nationwide. Complete sales directory and surplus categories catalog \$1.00 (Deductible on orders from separate included catalog). Surplus Service, Box 820-J, Holland, Michigan 49423.

**GOVERNMENT SURPLUS.** Complete sales directory \$1.00. Surplus Publications, Box 26062Z, Los Angeles, Calif. 90026.

<b>NATIONAL MOS</b> DYNAMIC shift registers MM502 dual 50 bit 1.25 MM505 dual 100 bit 1.50 MM506 dual 100 bit 1.50 MM5013 1024 bit 2.00 MM5016 512 bit 1.50 STATIC shift registers MM504 dual 16 bit 1.50 MM505 dual 32 bit 1.75 MM550 dual differential analog switch 2.50	<b>CT5005</b> CALCULATOR ON A CHIP This chip has a full four function memory. Memory is controlled by four keys, AM (adds entry to memory), CM (subtract entry from memory), CM (clear memory—without clearing rest of registers), RM (read memory or use as entry).  ·12 DIGIT DISPLAY AND CALC. ·FIXED DECIMAL AT 0.1,2,3,4 OR 5 ·LEADING ZERO SUPPRESSION ·SEVEN SEGMENT MULTIPLEXED OUTPUT ·TRUE CREDIT SIGN DISPLAY ·SINGLE 28 PIN CHIP Chip and data—\$14.95 Data only—1.00 (refundable)	<b>7400 TTL DIP</b> 7400-----\$.35 7401-----.35 7402-----.35 7403-----.35 7404-----.35 7405-----.35 7410-----1.75 7411-----.35 7412-----.50 7420-----.35 7430-----.35 7440-----1.60 7441-----1.60 7442-----1.30 7443-----1.75 7448-----1.15 7450-----.35 7451-----.35 7452-----.35 7453-----.35 7454-----.35 7455-----.50 7472-----.50 7473-----.65 7474-----.65 7475-----.70 7480-----.65 7481-----1.30 7486-----.80 7491-----1.15 7492-----1.15 7493-----1.15 7495-----1.25 74107-----.70 74154-----2.50 74192-----2.50 74193-----1.50 74195-----1.10
<b>KEYBOARD General Telephone</b> Ten push buttons (0-9) touch-tone, encoding, programming devices. Easy for panel mounting.  \$5.95 Size: 3K2xY1	<b>MANI</b> Popular 7 segment diffused LED. Dual in line 14 pin capable of displaying all digits and nine distinct letters.  \$4.00 each	<b>7400 TTL DIP</b> (continued) 7476-----1.30 7491-----1.15 7492-----1.15 7493-----1.15 7495-----1.25 74107-----.70 74154-----2.50 74192-----2.50 74193-----1.50 74195-----1.10
MV-50 red emitting 10-40ma @ 2V .39 MV5020 red LED .45 MV-108 Visible red 5-70ma @ 2V .45	<b>TRIAC 2N6344</b> 600V 1A TO-220 \$1.00 NE531 op amp TO-5 \$2.00 NE561 phase lock loop DIP 3.25 NE565 phase lock loop TO-5 3.25 NE566 function generator TO-5 4.00 NE567 tone decoder TO-5 4.00	<b>LINEARS</b> LM100-----\$ 1.00 LM309H-----.75 LM309K-----2.00 NE5556-----1.00 NE560-----3.25 741(MINI DIP)--.45 747-----1.10 709-----.45 710-----.40 711-----.40 723-----1.00 LM380(audio amp) 1.75
<b>DM8890 (Sperry D0703 202)</b> 7 segment high voltage nixie driver-----\$1.75 All IC's are new and fully tested. Leads are plated with gold or solder. Orders for \$5 or more will be shipped prepaid. Add 35¢ for smaller orders. California residents add sales tax. IC orders are shipped with 24 hrs. COD's will be phoned in 310. Minimum money back guarantee. P.O. Box 3, Carmichael, California 95608 <b>BABYLON ELECTRONICS</b> (916) 966-2111	<b>LED FL 100</b> special !!! .39 each 3.50 for ten 29.95 for 100 <b>MANE M</b> Each \$3.00 Ten or more 2.50	<b>CMOS</b> CD4001-----\$.75 CD4002-----.75 74C00-----.75 CD4012-----.75 CD4023-----.75

CIRCLE NO. 2 ON READER SERVICE CARD

## TAPE AND RECORDERS

RENT 4-Track open reel tapes—all major labels—3,000 different—free brochure. Stereo-Parti, 55 St. James Drive, Santa Rosa, Ca. 95401.

<b>SCOTCH MAGNETIC TAPE (USED)</b> —150, 1800 FT. 7 INCH REEL, 1 MIL POLYESTER, RECORDED ONCE, BULK ERASED (NO. BOX), PLUS 1.00¢ SHIPPING & HANDLING (MIN. ORDER \$10.00); SLIGHTLY USED 10% INCH FIBERGLASS REELS, 3/8" HOLE, 50¢ EACH, PLUS SHIPPING BY WEIGHT AND ZONE. <b>SAXITONE TAPE SALES</b> 1776 Columbia Rd., N.W. Washington, D.C. 20009	
---	---

RECORD 8TRK cartridges with any player. Instructions, \$2.00. C. Faust, Rancocas, New Jersey 08073.

1930-1962 Radio Programs on reels, \$1.00 hour! Wholesale Cassettes, \$2.00 hour! Send \$1.24 for huge catalog and hour samples. AM Treasures, Box 192, Babylon, N.Y. 11702

SCOTCH RECORDING TAPES. Biggest discounts! Catalog 10¢. Tower, Lafayette Hill, Pa. 19444.

## INVENTIONS WANTED

CASH-ROYALTIES for patented, unpatented inventions. Global Marketing Service, 2420-P 77th, Oakland, California 94605.

FREE "Directory of 500 Corporations Seeking New Products." For information regarding development, sale, licensing of your patented/unpatented invention. Write: Raymond Lee Organization, 230-GR Park Avenue, New York City 10017.

PATENT Searches including Maximum speed, full airmail report and closest patent copies. Quality searches expertly administered. Complete secrecy guaranteed. Free Invention Protection forms and "Patent Information," Write Dept. 9, Washington Patent Office Search Bureau, Benjamin Franklin Substation, P.O. Box 7167, Washington, D.C. 20044.

INVENTORS: Protect your ideas! Free "Recommended Procedure". Washington Inventors Service, 422T Washington Building, Washington, D.C. 20005.

NEW PRODUCTS—INVENTIONS—IDEAS Developed/Marketed by professional organization. FREE INFORMATION "How to Market Inventions To Industry". Lawrence Peska Associates, 500-PE Fifth Avenue, New York City 10036.

FREE PAMPHLET: "Tips on Safeguarding Your Invention." Write: United States Inventors Service Company, 708-T Carry Building, Washington, D.C. 20005.

INVENTORS! Either we will sell your Invention before you or anyone else does, or we will pay you a cash bonus. Get Free Invention Evaluation and information: Write Gilbert Adams Organization, Invention Brokerage, Dept. 20, 81 Wall St., New York, NY 10005.

INVENTORS are invited to join the INTERNATIONAL SOCIETY OF INVENTORS, Rosenstrasse 1 Thalwil 8800, Zurich, Switzerland.

## BOOKS

FREE catalog aviation/electronic/space books. Aero Publishers, 329PE Aviation Road, Fallbrook, California 92028.

FREE book prophet Elijah coming before Christ. Wonderful bible evidence. Megiddo Mission, Dept. 64, 481 Thurston Rd., Rochester, N.Y. 14619.

## PLASTICS

CASTOLITE pours like water, hardens like glass without heat. Crystal clear, colors. Embed natural flowers, seashells, momentos, anything. Make fine gifts. Form flexible molds over any pattern, size. Reproduce your own designs in plastics, candle wax, metal, plaster, cement. Profitable. Illustrated Manual and Catalog Only \$1.00. CASTOLITE, Dept. 73K/PE, Woodstock, Ill. 60098.

## HYPNOTISM

SLEEP learning. Hypnotic method. 92% effective. Details free. ASR Foundation, Box 7566EG, Fort Lauderdale, Florida 33304.

FREE Hypnotism. Self-Hypnosis. Sleep Learning Catalog! Drawer H-00, Ruidoso, New Mexico 88345.

## RUBBER STAMPS

RUBBER address stamps. Free catalog. 45 type styles. Jackson's, Box 443G, Franklin Park, Ill. 60131.

## EMPLOYMENT INFORMATION

EXCITING Overseas jobs. Directory \$1.00. Research Associates, Box 889-E, Belmont, California 94002.

## EMPLOYMENT OPPORTUNITIES

ELECTRONICS/AVIONICS EMPLOYMENT OPPORTUNITIES. Report on jobs now open. Details FREE. Aviation Employment Information Service, Box 240E, Northport, New York 11768.



# Opto Electronics

## LED GaAs INDICATORS

- 2-MV1\*, Amber, visible jumbo epoxy lens upright ..... \$1.00
- 1-MV2\*, TO-18, Dome, green, visible ..... 1.19
- 3-MV3\*, visible, "coax pin pak", red, mini dome lens ..... 1.00
- 1-MV4\*, stud, high power, red, 2-watts ..... 3.95
- 1-MV4M\*, stud, high power, hi-dome, red, 2-watts ..... 3.95
- 3-MV10B, visible, red, clear, dome lens, TO-18 ..... 1.00
- 2-MV10C, visible, red, diffused, dome lens, TO-18 ..... 1.00
- 3-MV50\*, axial leads, micro-mini dome, clear, red ..... 1.00
- 3-MV5012\*, visible, red, small dome lens ..... 1.00
- 2-MV5022\*, jumbo red dome, TO-18, visible ..... 1.00
- 2-MV5020\*, jumbo clear dome, TO-18, visible, red ..... 1.00
- 1-MV5040\*, 4-LED red array, with 5-lead pak ..... 1.49
- 3-MV5040\*, visible, red, jumbo dome lens, upright ..... 1.00
- 2-MV5080\*, TO-18, micro-mini, clear dome, red ..... 1.00
- 4-MV5082, visible, red, clear flat lens, TO-18 ..... 1.00
- 1-MV5222\*, jumbo dome, green, panel snap-in ..... 1.98
- 1-MV5322\*, jumbo dome, GaAsp, panel snap-in yellow ..... 1.98
- 1-MV9000\*, cartridge panel lamp, sealed, red, clear lens ..... 1.49
- 2-MT-2\*, Photo Transistor, light sensor, TO-18 ..... 1.00
- 1-ME-1\*, infra-red, parabolic lens, pin type ..... 1.19
- 2-ME-4\*, infra-red, "invisible", TO-18, diff. dome ..... 1.19
- 2-ME60\*, infra-red, "invisible", axial, micro-mini ..... 1.00

## OPTO-COUPLEDERS \* Monsanto Equivalent

- MCA2-30\* 1500V Photo Darlington Relay ..... \$1.00
- MCD1-1 4000V Isolation Photo Transistor ..... 4.95
- MCD2-1 1500V Isolation Photo Diode ..... 1.00
- MCT-1 4000V Isolation Photo Transistor ..... 4.95
- MCT2-1 1500V Isolation Photo Transistor ..... 1.00
- MCT2-D 1500V Isolation Twin Photo Transistor ..... 1.98
- MCT5-10\* 10,000V Isolation Photo Transistor ..... 4.95
- MCT5-25\* 25,000V Isolation Photo Transistor ..... 5.95

## LED MITY DIGITS "DCM'S"

Digital Counting Modules **\$9.99** INCLUDES P.C. EDGE CONNECTOR — FREE!

Will outperform any other DCM on the market today, not expensive nor incandescent, but a device that will READ almost for life. MAN-7, 7-48, 7-48, 7-49, booklet.

## LITRONICS-MONSANTO-OPCOA

# LED Readouts

All fit 14-pin IC sockets, 5V 10 to 20 mA, 0-to-9 numerals, plus letters and decimal. With spec sheets. \* Monsanto Equal. \* MAN-1 Specs. \* 135-Diode Array.

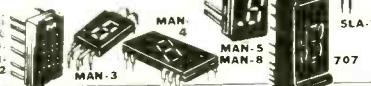

Type	Character size	Color	Display	Decimal	Driver	Each	Special
<input type="checkbox"/> MAN-1*	.27	Red	Yes	SN7447	4.50	3 for \$12.	
<input type="checkbox"/> MAN-2*	.32†	Red	Yes	2513	8.88	3 for \$24.	
<input type="checkbox"/> MAN-3*	.115	Red	Yes	SN7448	2.25	3 for \$6.	
<input type="checkbox"/> MAN-3*	.115	Red	No	SN7448	1.49	3 for \$3.	
<input type="checkbox"/> MAN-4*	.190	Red	Yes	SN7448	2.95	3 for \$8.	
<input type="checkbox"/> MAN-4*	.190	Red	No	SN7448	1.79	3 for \$5.	
<input type="checkbox"/> MAN-5*	.27	Green	Yes	SN7447	8.88	3 for \$24.	
<input type="checkbox"/> MAN-8*	.27	Yellow	Yes	SN7447	8.88	3 for \$24.	
<input type="checkbox"/> LITRONICS 707* (MAN-1)	.33	Red	Yes	SN7447	3.50	3 for \$9.	
<input type="checkbox"/> OPCOA** (SLA-7 (MAN-1))	.33	Red	Yes	SN7447	3.50	3 for \$9.	
<input type="checkbox"/> OPCOA** (SLA-7 (MAN-1))	.33	Red	No	SN7447	1.95	3 for \$5.	

## HOBBY EXPERIMENTAL "LED" KORNER

- 5-MAN-3\* The claw — some segments missing, hobby use, readout ..... \$1.00
- 1-MAN-4\* some segments missing, hobby use, readout ..... \$1.00
- 1-SLA-7 Opcoa's MAN-1, 1-segment missing ..... \$1.49
- 1-SLA-7 Opcoa's MAN-1, hobby, some segments missing ..... \$1.00
- 10-LED HOBBY SURPRISE! 10-seg. no test ..... \$1.00
- 5-MONSANTO'S Opto-Coupler surprise, asst. no test ..... \$1.00
- 3-PC. KIT, MAN-1, MAN-3, MAN-1, some segments missing ..... \$1.49

# Lowest Prices Largest Selection TTL IC's

Brand New \* DIP Packages Order by type number. Ship. Ins. on request. USA

<input type="checkbox"/> SN7400 \$0.30	<input type="checkbox"/> SN7432 1.25	<input type="checkbox"/> SN7483 1.50	<input type="checkbox"/> SN74151 1.25
<input type="checkbox"/> SN7401 .30	<input type="checkbox"/> SN7433 1.25	<input type="checkbox"/> SN7484 1.50	<input type="checkbox"/> SN74152 1.25
<input type="checkbox"/> SN7402 .30	<input type="checkbox"/> SN7434 1.25	<input type="checkbox"/> SN7485 .55	<input type="checkbox"/> SN74153 1.60
<input type="checkbox"/> SN7403 .30	<input type="checkbox"/> SN7435 1.25	<input type="checkbox"/> SN7486 .55	<input type="checkbox"/> SN74154 2.10
<input type="checkbox"/> SN7404 .35	<input type="checkbox"/> SN7436 1.25	<input type="checkbox"/> SN7489 3.75	<input type="checkbox"/> SN74155 1.55
<input type="checkbox"/> SN7405 .35	<input type="checkbox"/> SN7437 1.25	<input type="checkbox"/> SN7490 1.50	<input type="checkbox"/> SN74156 1.55
<input type="checkbox"/> SN7406 .55	<input type="checkbox"/> SN7437 1.65	<input type="checkbox"/> SN7491 1.50	<input type="checkbox"/> SN74157 1.55
<input type="checkbox"/> SN7407 .55	<input type="checkbox"/> SN7438 1.50	<input type="checkbox"/> SN7492 1.10	<input type="checkbox"/> SN74160 1.55
<input type="checkbox"/> SN7408 .35	<input type="checkbox"/> SN7439 1.35	<input type="checkbox"/> SN7493 1.10	<input type="checkbox"/> SN74161 1.95
<input type="checkbox"/> SN7409 .35	<input type="checkbox"/> SN7440 1.35	<input type="checkbox"/> SN7494 1.10	<input type="checkbox"/> SN74162 1.95
<input type="checkbox"/> SN7410 .35	<input type="checkbox"/> SN7441 1.35	<input type="checkbox"/> SN7495 1.10	<input type="checkbox"/> SN74163 1.95
<input type="checkbox"/> SN7411 .35	<input type="checkbox"/> SN7442 1.35	<input type="checkbox"/> SN7496 1.10	<input type="checkbox"/> SN74164 3.50
<input type="checkbox"/> SN7413 .35	<input type="checkbox"/> SN7443 1.35	<input type="checkbox"/> SN7497 1.10	<input type="checkbox"/> SN74165 3.50
<input type="checkbox"/> SN7415 .35	<input type="checkbox"/> SN7444 1.35	<input type="checkbox"/> SN7498 1.10	<input type="checkbox"/> SN74166 3.50
<input type="checkbox"/> SN7416 .35	<input type="checkbox"/> SN7445 1.35	<input type="checkbox"/> SN7499 1.10	<input type="checkbox"/> SN74167 3.50
<input type="checkbox"/> SN7417 .35	<input type="checkbox"/> SN7446 1.35	<input type="checkbox"/> SN7500 1.10	<input type="checkbox"/> SN74168 3.50
<input type="checkbox"/> SN7418 .35	<input type="checkbox"/> SN7447 1.35	<input type="checkbox"/> SN7501 1.10	<input type="checkbox"/> SN74169 3.50
<input type="checkbox"/> SN7419 .35	<input type="checkbox"/> SN7448 1.35	<input type="checkbox"/> SN7502 1.10	<input type="checkbox"/> SN74170 3.50
<input type="checkbox"/> SN7420 .35	<input type="checkbox"/> SN7449 1.35	<input type="checkbox"/> SN7503 1.10	<input type="checkbox"/> SN74171 3.50
<input type="checkbox"/> SN7421 .35	<input type="checkbox"/> SN7450 1.35	<input type="checkbox"/> SN7504 1.10	<input type="checkbox"/> SN74172 3.50
<input type="checkbox"/> SN7422 .35	<input type="checkbox"/> SN7451 1.35	<input type="checkbox"/> SN7505 1.10	<input type="checkbox"/> SN74173 3.50
<input type="checkbox"/> SN7423 .35	<input type="checkbox"/> SN7452 1.35	<input type="checkbox"/> SN7506 1.10	<input type="checkbox"/> SN74174 3.50
<input type="checkbox"/> SN7424 .35	<input type="checkbox"/> SN7453 1.35	<input type="checkbox"/> SN7507 1.10	<input type="checkbox"/> SN74175 3.50
<input type="checkbox"/> SN7425 .35	<input type="checkbox"/> SN7454 1.35	<input type="checkbox"/> SN7508 1.10	<input type="checkbox"/> SN74176 3.50
<input type="checkbox"/> SN7426 .37	<input type="checkbox"/> SN7455 1.35	<input type="checkbox"/> SN7509 1.10	<input type="checkbox"/> SN74177 3.50
<input type="checkbox"/> SN7427 .37	<input type="checkbox"/> SN7456 1.35	<input type="checkbox"/> SN7510 1.10	<input type="checkbox"/> SN74178 3.50
<input type="checkbox"/> SN7428 .37	<input type="checkbox"/> SN7457 1.35	<input type="checkbox"/> SN7511 1.10	<input type="checkbox"/> SN74179 3.50
<input type="checkbox"/> SN7429 .37	<input type="checkbox"/> SN7458 1.35	<input type="checkbox"/> SN7512 1.10	<input type="checkbox"/> SN74180 3.50
<input type="checkbox"/> SN7430 .37	<input type="checkbox"/> SN7459 1.35	<input type="checkbox"/> SN7513 1.10	<input type="checkbox"/> SN74181 3.50
<input type="checkbox"/> SN7431 .37	<input type="checkbox"/> SN7460 1.35	<input type="checkbox"/> SN7514 1.10	<input type="checkbox"/> SN74182 3.50
<input type="checkbox"/> SN7432 .37	<input type="checkbox"/> SN7461 1.35	<input type="checkbox"/> SN7515 1.10	<input type="checkbox"/> SN74183 3.50
<input type="checkbox"/> SN7433 .37	<input type="checkbox"/> SN7462 1.35	<input type="checkbox"/> SN7516 1.10	<input type="checkbox"/> SN74184 3.50
<input type="checkbox"/> SN7434 .37	<input type="checkbox"/> SN7463 1.35	<input type="checkbox"/> SN7517 1.10	<input type="checkbox"/> SN74185 3.50
<input type="checkbox"/> SN7435 .37	<input type="checkbox"/> SN7464 1.35	<input type="checkbox"/> SN7518 1.10	<input type="checkbox"/> SN74186 3.50
<input type="checkbox"/> SN7436 .37	<input type="checkbox"/> SN7465 1.35	<input type="checkbox"/> SN7519 1.10	<input type="checkbox"/> SN74187 3.50
<input type="checkbox"/> SN7437 .37	<input type="checkbox"/> SN7466 1.35	<input type="checkbox"/> SN7520 1.10	<input type="checkbox"/> SN74188 3.50
<input type="checkbox"/> SN7438 .37	<input type="checkbox"/> SN7467 1.35	<input type="checkbox"/> SN7521 1.10	<input type="checkbox"/> SN74189 3.50
<input type="checkbox"/> SN7439 .37	<input type="checkbox"/> SN7468 1.35	<input type="checkbox"/> SN7522 1.10	<input type="checkbox"/> SN74190 3.50
<input type="checkbox"/> SN7440 .37	<input type="checkbox"/> SN7469 1.35	<input type="checkbox"/> SN7523 1.10	<input type="checkbox"/> SN74191 3.50
<input type="checkbox"/> SN7441 .37	<input type="checkbox"/> SN7470 1.35	<input type="checkbox"/> SN7524 1.10	<input type="checkbox"/> SN74192 3.50
<input type="checkbox"/> SN7442 .37	<input type="checkbox"/> SN7471 1.35	<input type="checkbox"/> SN7525 1.10	<input type="checkbox"/> SN74193 3.50
<input type="checkbox"/> SN7443 .37	<input type="checkbox"/> SN7472 1.35	<input type="checkbox"/> SN7526 1.10	<input type="checkbox"/> SN74194 3.50
<input type="checkbox"/> SN7444 .37	<input type="checkbox"/> SN7473 1.35	<input type="checkbox"/> SN7527 1.10	<input type="checkbox"/> SN74195 3.50
<input type="checkbox"/> SN7445 .37	<input type="checkbox"/> SN7474 1.35	<input type="checkbox"/> SN7528 1.10	<input type="checkbox"/> SN74196 3.50
<input type="checkbox"/> SN7446 .37	<input type="checkbox"/> SN7475 1.35	<input type="checkbox"/> SN7529 1.10	<input type="checkbox"/> SN74197 3.50
<input type="checkbox"/> SN7447 .37	<input type="checkbox"/> SN7476 1.35	<input type="checkbox"/> SN7530 1.10	<input type="checkbox"/> SN74198 3.50
<input type="checkbox"/> SN7448 .37	<input type="checkbox"/> SN7477 1.35	<input type="checkbox"/> SN7531 1.10	<input type="checkbox"/> SN74199 3.50
<input type="checkbox"/> SN7449 .37	<input type="checkbox"/> SN7478 1.35	<input type="checkbox"/> SN7532 1.10	<input type="checkbox"/> SN74200 3.50
<input type="checkbox"/> SN7450 .37	<input type="checkbox"/> SN7479 1.35	<input type="checkbox"/> SN7533 1.10	<input type="checkbox"/> SN74201 3.50
<input type="checkbox"/> SN7451 .37	<input type="checkbox"/> SN7480 1.35	<input type="checkbox"/> SN7534 1.10	<input type="checkbox"/> SN74202 3.50
<input type="checkbox"/> SN7452 .37	<input type="checkbox"/> SN7481 1.35	<input type="checkbox"/> SN7535 1.10	<input type="checkbox"/> SN74203 3.50
<input type="checkbox"/> SN7453 .37	<input type="checkbox"/> SN7482 1.35	<input type="checkbox"/> SN7536 1.10	<input type="checkbox"/> SN74204 3.50
<input type="checkbox"/> SN7454 .37	<input type="checkbox"/> SN7483 1.35	<input type="checkbox"/> SN7537 1.10	<input type="checkbox"/> SN74205 3.50
<input type="checkbox"/> SN7455 .37	<input type="checkbox"/> SN7484 1.35	<input type="checkbox"/> SN7538 1.10	<input type="checkbox"/> SN74206 3.50
<input type="checkbox"/> SN7456 .37	<input type="checkbox"/> SN7485 1.35	<input type="checkbox"/> SN7539 1.10	<input type="checkbox"/> SN74207 3.50
<input type="checkbox"/> SN7457 .37	<input type="checkbox"/> SN7486 1.35	<input type="checkbox"/> SN7540 1.10	<input type="checkbox"/> SN74208 3.50
<input type="checkbox"/> SN7458 .37	<input type="checkbox"/> SN7487 1.35	<input type="checkbox"/> SN7541 1.10	<input type="checkbox"/> SN74209 3.50
<input type="checkbox"/> SN7459 .37	<input type="checkbox"/> SN7488 1.35	<input type="checkbox"/> SN7542 1.10	<input type="checkbox"/> SN74210 3.50
<input type="checkbox"/> SN7460 .37	<input type="checkbox"/> SN7489 1.35	<input type="checkbox"/> SN7543 1.10	<input type="checkbox"/> SN74211 3.50
<input type="checkbox"/> SN7461 .37	<input type="checkbox"/> SN7490 1.35	<input type="checkbox"/> SN7544 1.10	<input type="checkbox"/> SN74212 3.50
<input type="checkbox"/> SN7462 .37	<input type="checkbox"/> SN7491 1.35	<input type="checkbox"/> SN7545 1.10	<input type="checkbox"/> SN74213 3.50
<input type="checkbox"/> SN7463 .37	<input type="checkbox"/> SN7492 1.35	<input type="checkbox"/> SN7546 1.10	<input type="checkbox"/> SN74214 3.50
<input type="checkbox"/> SN7464 .37	<input type="checkbox"/> SN7493 1.35	<input type="checkbox"/> SN7547 1.10	<input type="checkbox"/> SN74215 3.50
<input type="checkbox"/> SN7465 .37	<input type="checkbox"/> SN7494 1.35	<input type="checkbox"/> SN7548 1.10	<input type="checkbox"/> SN74216 3.50
<input type="checkbox"/> SN7466 .37	<input type="checkbox"/> SN7495 1.35	<input type="checkbox"/> SN7549 1.10	<input type="checkbox"/> SN74217 3.50
<input type="checkbox"/> SN7467 .37	<input type="checkbox"/> SN7496 1.35	<input type="checkbox"/> SN7550 1.10	<input type="checkbox"/> SN74218 3.50
<input type="checkbox"/> SN7468 .37	<input type="checkbox"/> SN7497 1.35	<input type="checkbox"/> SN7551 1.10	<input type="checkbox"/> SN74219 3.50
<input type="checkbox"/> SN7469 .37	<input type="checkbox"/> SN7498 1.35	<input type="checkbox"/> SN7552 1.10	<input type="checkbox"/> SN74220 3.50
<input type="checkbox"/> SN7470 .37	<input type="checkbox"/> SN7499 1.35	<input type="checkbox"/> SN7553 1.10	<input type="checkbox"/> SN74221 3.50
<input type="checkbox"/> SN7471 .37	<input type="checkbox"/> SN7500 1.35	<input type="checkbox"/> SN7554 1.10	<input type="checkbox"/> SN74222 3.50
<input type="checkbox"/> SN7472 .37	<input type="checkbox"/> SN7501 1.35	<input type="checkbox"/> SN7555 1.10	<input type="checkbox"/> SN74223 3.50
<input type="checkbox"/> SN7473 .37	<input type="checkbox"/> SN7502 1.35	<input type="checkbox"/> SN7556 1.10	<input type="checkbox"/> SN74224 3.50
<input type="checkbox"/> SN7474 .37	<input type="checkbox"/> SN7503 1.35	<input type="checkbox"/> SN7557 1.10	<input type="checkbox"/> SN74225 3.50
<input type="checkbox"/> SN7475 .37	<input type="checkbox"/> SN7504 1.35	<input type="checkbox"/> SN7558 1.10	<input type="checkbox"/> SN74226 3.50
<input type="checkbox"/> SN7476 .37	<input type="checkbox"/> SN7505 1.35	<input type="checkbox"/> SN7559 1.10	<input type="checkbox"/> SN74227 3.50
<input type="checkbox"/> SN7477 .37	<input type="checkbox"/> SN7506 1.35	<input type="checkbox"/> SN7560 1.10	<input type="checkbox"/> SN74228 3.50
<input type="checkbox"/> SN7478 .37	<input type="checkbox"/> SN7507 1.35	<input type="checkbox"/> SN7561 1.10	<input type="checkbox"/> SN74229 3.50
<input type="checkbox"/> SN7479 .37	<input type="checkbox"/> SN7508 1.35	<input type="checkbox"/> SN7562 1.10	<input type="checkbox"/> SN74230 3.50
<input type="checkbox"/> SN7480 .37	<input type="checkbox"/> SN7509 1.35	<input type="checkbox"/> SN7563 1.10	<input type="checkbox"/> SN74231 3.50
<input type="checkbox"/> SN7481 .37	<input type="checkbox"/> SN7510 1.35	<input type="checkbox"/> SN7564 1.10	<input type="checkbox"/> SN74232 3.50
<input type="checkbox"/> SN7482 .37	<input type="checkbox"/> SN7511 1.35	<input type="checkbox"/> SN7565 1.10	<input type="checkbox"/> SN74233 3.50
<input type="checkbox"/> SN7483 .37	<input type="checkbox"/> SN7512 1.35	<input type="checkbox"/> SN7566 1.10	<input type="checkbox"/> SN74234 3.50
<input type="checkbox"/> SN7484 .37	<input type="checkbox"/> SN7513 1.35	<input type="checkbox"/> SN7567 1.10	<input type="checkbox"/> SN74235 3.50
<input type="checkbox"/> SN7485 .37	<input type="checkbox"/> SN7514 1.35	<input type="checkbox"/> SN7568 1.10	<input type="checkbox"/> SN74236 3.50
<input type="checkbox"/> SN7486 .37	<input type="checkbox"/> SN7515 1.35	<input type="checkbox"/> SN7569 1.10	<input type="checkbox"/> SN74237 3.50
<input type="checkbox"/> SN7487 .37	<input type="checkbox"/> SN7516 1.35	<input type="checkbox"/> SN7570 1.10	<input type="checkbox"/> SN74238 3.50
<input type="checkbox"/> SN7488 .37	<input type="checkbox"/> SN7517 1.35	<input type="checkbox"/> SN7571 1.10	<input type="checkbox"/> SN74239 3.50
<input type="checkbox"/> SN7489 .37	<input type="checkbox"/> SN7518 1.35	<input type="checkbox"/> SN7572 1.10	<input type="checkbox"/> SN74240 3.50
<input type="checkbox"/> SN7490 .37	<input type="checkbox"/> SN7519 1.35	<input type="checkbox"/> SN7573 1.10	<input type="checkbox"/> SN74241 3.50
<input type="checkbox"/> SN7491 .37	<input type="checkbox"/> SN7520 1.35	<input type="checkbox"/> SN7574 1.10	<input type="checkbox"/> SN74242 3.50
<input type="checkbox"/> SN7492 .37	<input type="checkbox"/> SN7521 1.35	<input type="checkbox"/> SN7575 1.10	<input type="checkbox"/> SN74243 3.50
<input type="checkbox"/> SN7493 .37	<input type="checkbox"/> SN7522 1.35	<input type="checkbox"/> SN7576 1.10	<input type="checkbox"/> SN74244 3.50
<input type="checkbox"/> SN7494 .37	<input type="checkbox"/> SN7523 1.35	<input type="checkbox"/> SN7577 1.10	<input type="checkbox"/> SN74245 3.50
<input type="checkbox"/> SN7495 .37	<input type="checkbox"/> SN7524 1.35	<input type="checkbox"/> SN7578 1.10	<input type="checkbox"/> SN74246 3.50
<input type="checkbox"/> SN7496 .37	<input type="checkbox"/> SN7525 1.35	<input type="checkbox"/> SN7579 1.10	<input type="checkbox"/> SN74247 3.50
<input type="checkbox"/> SN7497 .37	<input type="checkbox"/> SN7526 1.35	<input type="checkbox"/> SN7580 1.10	<input type="checkbox"/> SN74248 3.50
<input type="checkbox"/> SN7498 .37	<input type="checkbox"/> SN7527 1.35	<input type="checkbox"/> SN7581 1.10	<input type="checkbox"/> SN74249 3.50
<input type="checkbox"/> SN7499 .37	<input type="checkbox"/> SN7528 1.35	<input type="checkbox"/> SN7582 1.10	<input type="checkbox"/> SN74250 3.50
<input type="checkbox"/> SN7500 .37	<input type="checkbox"/> SN7529 1.35	<input type="checkbox"/> SN7583 1.10	<input type="checkbox"/> SN74251 3.50
<input type="checkbox"/> SN7501 .37	<input type="checkbox"/> SN7530 1.35	<input type="checkbox"/> SN7584 1.10	<input type="checkbox"/> SN74252 3.50
<input type="checkbox"/> SN7502 .37	<input type="checkbox"/> SN7531 1.35	<input type="checkbox"/> SN7585 1.10	<input type="checkbox"/> SN74253 3.50
<input type="checkbox"/> SN7503 .37	<input type="checkbox"/> SN7532 1.35	<input type="checkbox"/> SN7586 1.10	<input type="checkbox"/> SN74254 3.50



**GREGORY ELECTRONICS**  
Reconditioned & Used  
**FM 2-WAY RADIO SAVINGS**

Partial List—Send for New Catalog

The General Electric

**Message Mate**

personal pocket  
voice receiver  
with sel-call

• Fully transistorized. 100% solid state for ultimate in reliability and performance.

• Selective signaling options for individual messages inside & outside of buildings.



150-162 MHz, 162-174 MHz  
Specify freq. with order

Charger inc. with nickel-cadmium model. Ask about low band.

Lots of 5, less 10% . . ea. \$88.20  
Lots of 10, less 15% . . ea. \$83.30

**\$98.**

less reeds



**GREGORY ELECTRONICS CORP.**

249-F Rt. 46, Saddle Brook, N.J. 07662  
Phone: (201) 489-9000

**CIRCLE NO. 15 ON READER SERVICE CARD**

**SPORTS ACTION FILMS**

**FALL SPORTS SPECIAL**—1972 or 1971 World Series. 1972 or 1973 Super Bowl Films, Super 8 or Reg. 8, \$13.95 ea. ppd., in Eastman Color; \$6.95 each B&W (you save \$1.00 on every 20' reel you buy). All sports Catalog, \$25¢. SPORTLITE, Elect Dept., Box 500, Speedway, Indiana 46224.

**MOVIE FILMS**

**8MM-SUPER 8-16MM MOVIES!** Biggest Selection! Lowest Prices! Free Catalog! Cinema Eight, Box PE, Chester, Connecticut 06412.

**BUSINESS OPPORTUNITIES**

**I MADE \$40,000.00 Year by Mailorder!** Helped others make money! Start with \$15.00—Free Proof. Torrey, Box 318-N, Ypsilanti, Michigan 48197.

**\$200.00 DAILY** In Your Mailbox! Your opportunity to do what mail-order experts do. Free details. Associates, Box 136-J, Holland, Michigan 49423.

**FREE CATALOGS.** Repair air conditioning, refrigeration. Tools, supplies, full instructions. Doolin, 2016 Canton, Dallas, Texas 75201.

**MAILORDER MILLIONAIRE** helps beginners make \$500 weekly. Free report reveals secret plan! Executive (1K9), 333 North Michigan, Chicago 60601.

**PIANO TUNING LEARNED QUICKLY AT HOME!** Tremendous field! Musical knowledge unnecessary. GI approved. Information free. Empire School, Box 327, Miami 33145.

**FREE SECRET BOOK** "2042 Unique, Proven Enterprises." Beat inflation with fabulous, successful "Little Knowns." Work home! Haylings-B1, Carlsbad, Calif. 92008.

**HIGHLY PROFITABLE ONE-MAN ELECTRONIC FACTORY**

Investment unnecessary, knowledge not required, sales handled by professionals. Postcard brings facts about this unusual opportunity. Write today! Barta-DEPI, Box 248, Walnut Creek, CA 94597.

**START SMALL,** highly profitable electronic production in your basement. Investment, knowledge unnecessary. Postcard brings facts. Barta-PEM, Box 248, Walnut Creek, California 94597.

**POLICE SCANNERS!** Fast sales, big profits. Best Crystal Service, P.O. Box 6122, East Moline, Illinois 61244.

**\$2000.00 MONTHLY** selling information by mail. Ropchan, Box 5341X, Sherman Oaks, Calif. 91413.

**BECOME** our Mail Order Distributor with \$150 investment. Free brochure. Audit Controls, 141 Brookside Ave., Fair Lawn, NJ 07410.

**MAILORDER:** How to prepare your own catalog for pennies! Free Catalog! Obie-Q9, Brooklyn, New York 11219.

**AGENTS WANTED**—Sell car electricity adapter. Quick seller. Outstanding profits. RLH Enterprises, Box 8908, Shreveport, LA 71108.

**BUSINESS OPPORTUNITIES**

**YOUR IDEA** and \$5.55 could make you rich. "Ideas, Inventions and Patents" tells you in plain language how to develop your idea and make money. Send \$4.95 plus 60¢ handling to Pioneer Press, Dept. PE, P. O. Box 76025, Atlanta, Georgia 30328.

**STAMPS**

**88 COUNTRIES—ONLY 10¢!** Worth \$5.00 at catalog prices!! Incredible collection of genuine postage stamps from 88 different countries—from Afghanistan to Zambia, North to South Pole! British, French, Portuguese, Spanish Colonies. Old 19th Century, New Issues, Moon and Outer Space stamps, etc. All for only 10¢! Also, other exciting stamps to examine free. Buy any or none; return balance, cancel service anytime. Plus Wonderful Free Catalog. H. E. HARRIS, Dept. SS-62, Boston, Mass. 02117.

**TREASURE FINDERS**

**FREE**—Valuable Treasure Finder catalog sent by return mail. Find Coins, Rings, Gold, Silver, Metals, Relics. Write today. JETCO, Dept. CPE, Box 26669, El Paso, Texas 79926.

**TREASURE FINDER** locates buried gold, silver, coins, treasures. 6 powerful models. \$19.95 up. Instant financing available. Write or call for free catalog. Phone (713) 682-2728 day or night. Dealer inquiries invited. Relco, Dept. A-33, Box 10839, Houston, Texas 77018.

**FREE FACT-FILLED CATALOG.** World's largest line of metal detectors. Models as low as \$49.50 and up. Two year Guarantee. Three factory locations. U.S. and Canada, plus over 1,000 dealers and 35 Service Centers from coast to coast. No finer instruments made at any price. Budget terms. Write: White's Electronics, Inc., Rm# 391, 1011 Pleasant Valley Road, Sweet Home, Oregon 97386.

**METAL DETECTORS.** Save \$\$\$! Catalog; Detector, Room 965-W, 102 W. Arrellaga St., Santa Barbara, Calif. 93101.

**FIND BURIED TREASURE** eight transistorized models \$19.95 to \$11.95, modular interchangeable heads, full view motors, FREE Catalog, Solidtronics Corporation-PE 36, Tennent, N.J. 07763.

# Popular Electronics

INCLUDING **Electronics World**

SEPTEMBER 1973

## ADVERTISERS INDEX

READER SERVICE NO.	ADVERTISER	PAGE NO.	READER SERVICE NO.	ADVERTISER	PAGE NO.
41	Airpax International Division	109	19	McIntosh Laboratory, Inc.	114
1	Antenna Specialists Co., The	115	20	MITS Micro Instrumentation & Telemetry Systems, Inc.	73
22	Babylon Electronics	124	21	Mallory Distributor Products Company	57
	Bell & Howell Schools	110, 111, 112, 113	22	Midwest HiFi Wholesale & Mail Order Division	115
3	Bose	30		Motorola HEP	63
	Burstein-Applebee	17		NRI Training	SECOND COVER, 1, 2, 3
	CREI Capitol Radio Engineering Institute	40, 41, 42, 43		National Technical Schools	76, 77, 78, 79
4	Cleveland Institute of Electronics	18, 19, 20, 21	23	Olson Electronics	11
5	Continental Specialties Corporation	118	24	Pickering	25
6	Datak Corporation, The	105	25	Poly Paks	125
7	Delta Electronics Co.	120	26	RCA Electronics Components	7
8	Delta Products, Inc.	107	27	SBE	116
9	EICO	104	28	Sams & Co., Inc., Howard W.	13
10	E & L Instruments, Incorporated	72	29	Sams & Co., Inc., Howard W.	75
11	Edmund Scientific Co.	128	30	Sansui Electronics Corp.	69
12	Electro-Voice, Inc.	103	31	Schober Organ Corp., The	117
13	G C Electronics	105	32	Shure Brothers Inc.	FOURTH COVER
14	Grantham School of Engineering	8	33	Solid State Sales	122
15	Gregory Electronics Corp.	126	35	Tri-Star Corporation	104
16	Heath Company	28, 29		U.S. Navy	22, 23
	ICS School of Electronics	58, 59, 60, 61	36	United Audio Products, Inc.	15
40	Illinois Audio	106	37	Utah Electronics	9
18	Lafayette Radio Electronics	129, 130	38	Wahl Clipper Corporation	106
	CLASSIFIED ADVERTISING		39	Xcelite, Inc.	91
					120, 121, 122, 123, 124, 126, 127

### MAGNETS

**MAGNETS.** All types. Specials—20 disc magnets, or 2 stick magnets, or 10 small bar magnets, or 8 assorted magnets, \$1.00. Maryland Magnet Company, Box 192H, Randallstown, Maryland 21133.

### REAL ESTATE

**FREE . . . NEW . . . BIG . . . FALL CATALOG!** Describes and pictures hundreds of farms, ranches, town and country homes, businesses coast to coast! Specify type property and location preferred. UNITED FARM AGENCY, 612-EP West 47th St., Kansas City, Mo. 64112.

### MUSICAL INSTRUMENTS

**30% DISCOUNT** name brand musical instruments. Free Catalog. Freeport Music, 455N, Route 110, Melville, N.Y. 11746.

**WHOLESALE!** Professional Guitars, PA Systems, Altec Speakers. 240W RMS Amplifiers. Free Catalog, Carvin, Escondido, Calif. 92028.

### MISCELLANEOUS

**WINEMAKERS:** Free illustrated catalog yeasts, equipment. Semplex, Box 12276P, Minneapolis, Minn. 55412.



# LIVE IN THE WORLD OF TOMORROW...TODAY!

## A BETTER LIFE STARTS HERE

### CREATIVE AERONAUTICS FUN KIT



Complete aeronautics lab provides 100 experiments for ages 12 to 90. Learn about air convection, aerody- namics, rel. density, drag, altitude determination. Easily make glider, rubber-powered, aileron-controlled plane; 27" wingspan plane w/ wkg. ailerons & elevators, rudder; helium balloon w/ passenger transport; heli- copter; air-driven land vehicle; rocket & learning incl 159-pg instr book!

w/ automat. chute recovery. Everything you need for weeks of fun  
Stock No. 71,840AV ..... \$15.95 Ppd.

### "FISH" WITH A GIANT MAGNET

**Go Treasure Hunting On The Bottom!** Fascinating fun, and sometimes very profit- able! Tie a line to our 5-pound Magnet— drop it overboard in bay, river, lake or ocean. Troll it along the bottom. Your "treasured" haul can be outboard motors, anchors, other metal valuables. Five-pound Magnet is war surplus—Alnico V Type that cost the Government \$50. It lifts over 150 pounds on land—much greater weights under water.



Stock No. 70,571AV ..... \$14.00 Ppd.  
Stock No. 70,570AV 3 1/2 lbs. .... \$8.75 Ppd.  
Stock No. 60,215AV 1 1/2 lbs. .... \$5.75 Ppd.

### NEW! FORD TURBINE ENGINE KIT



Think Wankel's great? Build a 1/8 scale model of Ford's revolutionary, "better" answer for a clean-burning economy engine! Harnesses power prev. used in jets w/ ingenious engineering like exhaust re- generator, variable power turbine nozzle, electronic control system. Exact detail model shows actual working compressor, gears, turbine, regenerator, power output shaft, glowing combustion chamber. Batt. oper. (2 "AA" not incl). Instructions.

Stock No. 71,851AV ..... \$12.95 Ppd.

(And our FREE CATALOG is packed with exciting and unusual ecological & physical science items—plus 4,500 finds for fun, study or profit... for every member of the family.)

### KNOW YOUR ALPHA FROM THETA!

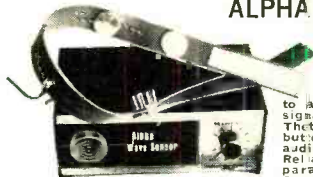

For greater relaxation, con- centration, listen to your Alpha-Theta or brainwaves. Ultra-sensitive electrode headband slips on/off in seconds—eliminates need for messy creams, etc. Atch'd to amplifier, filters brainwaves, signals beep for ea. Alpha or Theta wave passed. Monitoring button simulates Alpha sound; audio & visual (L.E.D.) feedback. Reliable, easy-to-use unit—com- parable to costlier models. Completely safe. Comprehensive instruction booklet.

No. 1635AV ..... (8x3x4"); 24 op. .... \$124.50 Ppd.

### 3-CHANNEL COLOR ORGAN KIT

Easy to build low-cost kit needs no technical knowledge. Com- pleted unit has 3 bands of audio frequencies to modulate 3 inde- pendent strings of colored lamps (i.e. "lows"—reds, "middles"— greens, "highs"—blues. Just connect hi-fi, radio, power lamp etc. & plug ea. lamp string into own channel (max. 300W ea.). Kit features 3 neon indicators, color intensity controls, con- trolled individ SCR circuits; isolation transformer; custom plastic housing; instr.



Stock No. 41,831AV ..... \$15.75 Ppd.

### 130 EXPERIMENTS IN OPTICS

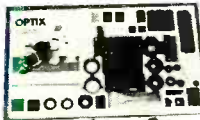

and photography! Optix® Experiments Kit is a complete optical & photography lab for 130 exciting experiments. Lets you recreate the periscope, telescope, microscope, kaleidoscope! Build a 35- mm reflex camera with interchangeable lens system! Make, develop photo- graphic film! Enjoy the fun and fasci- nation of having your own optics lab. Fully illust' 112-pg manual, 8 1/2 x 11", clearly explains usage of this stimulating kit's 114 precision engineered components.

Stock No. 71,646AV ..... \$21.00 Ppd.

### MAIL COUPON FOR GIANT FREE CATALOG!

164 PAGES • MORE THAN 4,500 UNUSUAL BARGAINS!

Completely new '74 Catalog. Packed with huge selection of telescopes, microscopes, binoculars, magnets, magnifiers, prisms, photo components, ecology and Unique Lighting items, parts, kits, accessories—many hard-to-get surplus bargains. 100's of charts, illustration. For hobbyists, experi- menters, schools, industry.

**EDMUND SCIENTIFIC CO.**  
300 Edscorp Building, Barrington, N.J. 08007  
Please rush Free Giant Catalog "AV"

Name \_\_\_\_\_  
Address \_\_\_\_\_  
City \_\_\_\_\_ State \_\_\_\_\_ Zip \_\_\_\_\_

### COMPLETE & MAIL WITH CHECK OR M.O.

**EDMUND SCIENTIFIC CO.**  
300 Edscorp Building, Barrington, N.J. 08007

How Many	Stock No.	Description	Price Each	Total

PLEASE SEND  GIANT FREE CATALOG "AV"  MERCHANDISE Total  HANGLING CHARGE \$1.00\*  
TOTAL \$ \_\_\_\_\_



I enclose  check  money order for \$ \_\_\_\_\_ \*50¢ ON ORDERS OVER \$5.00

NAME \_\_\_\_\_  
ADDRESS \_\_\_\_\_  
CITY \_\_\_\_\_ STATE \_\_\_\_\_ ZIP \_\_\_\_\_

CIRCLE NO. 11 ON READER SERVICE CARD CIRCLE NO. 18 ON READER SERVICE CARD

Printed in U.S.A.

# Popular Electronics

INCLUDING **Electronics World**

## READER SERVICE

Here's an easy and convenient way for you to get additional information about products advertised or mentioned editorially (if it has a reader service number) in this issue. Just follow the directions below... and the material will be sent to you promptly and free of charge.

# 1

On the attached postage-free card, print or type your name and address on the lines indicated.

# 2

Circle the number(s) that corresponds to the key number(s) at the bottom or next to the advertisement or editorial mention that is of interest to you. (Key numbers for advertised products also appear in the Advertisers' Index.)

# 3

Simply cut out the card and mail. No postage required.

## FREE INFORMATION



the **NEW STANDARD** in Stereo Testing!

### Model SR12 STEREO TEST RECORD

The most complete...most sophisticated...  
most versatile Test Disc available today.

Whether you're an avid audiophile, a casual listener or a professional technician... the new MODEL SR12 will be the most important disc in your entire collection.

DEL SR12 has been produced by Stereo Review Magazine music lovers who want immediate answers to questions about the performance of their stereo systems and how to get the best possible sound reproduction.

It's the most complete test record of its kind - containing the widest range of checks ever included on one test disc.

**Make these important stereo checks BY EAR... (no test instruments required)**

**Frequency response**—a direct warble-tone check of nineteen sections of the frequency spectrum, from 20 to 20,840 Hz, which will pinpoint any frequency response defects in your system.

**Separation**—an ingenious test which indicates whether you have adequate separation for good stereo.

**Cartridge tracking**—the most sophisticated tests ever devised for checking the performance of your cartridge, stylus and tone arm.

**Channel balance**—two broad-band, random-noise signals which permit you to eliminate any imbalances originating in cartridge, amplifier, speakers or room acoustics.

**Hum and rumble**—loopproof tests that help you evaluate the actual audible levels of rumble and hum in your system.

**Flutter**—a sensitive "musical" test to check whether your turntable's flutter is low, moderate, or high.

**US!** ● Cartridge and Speaker Phasing ● Anti-tuning Adjustment ● "Gun Shot Test" for Stereo Spread ● All-purpose Musician's "A" ● Equal-tempered Chromatic Scale ● Guitar-tuning Tones

**Attention Professionals** . . . . . Model SR12 is also designed to be used as a highly efficient design and measurement tool. Tests below have been controlled to laboratory tolerances—affording accurate numerical evaluation when used with oscilloscope, chart recorder, output meter, intermodulation-distortion meter and flutter meter.

- 1,000-Hz square waves to test transient and high-frequency response of phono pickups.
- 500 to 20,000 Hz frequency-response sweep.
- Sine-wave tone-bursts to test transient response of pickup.
- Intermodulation test using simultaneous 400-Hz and 4,000-Hz signals.
- Intermodulation sweep to show distortion caused by excessive resonances in tone arm and cartridge.
- 1,000-Hz reference tones to determine groove velocity.
- 3,000-Hz tone for flutter and speed tests.

Sample waveforms—illustrating both accurate and faulty responses are provided in the Instruction Manual for comparison with the patterns appearing on your own oscilloscope screen.

**FREE** Instruction Manual Includes Detailed Instructions, Charts, Tables and Diagrams

**CASH:** Mail your order along with your name, address and remittance in the amount of \$5.98, postpaid.

**CHARGE:** Your American Express or Bank Americard account! Mail your order, name, address and credit card number. You will be billed at \$5.98, postpaid.

**MAIL ALL ORDERS TO:** RECORDS, ZIFF-DAVIS SERVICE DIVISION, 595 BROADWAY, NEW YORK, N.Y. 10012 OUTSIDE U.S.A. RECORDS ARE \$8.00, POSTPAID.





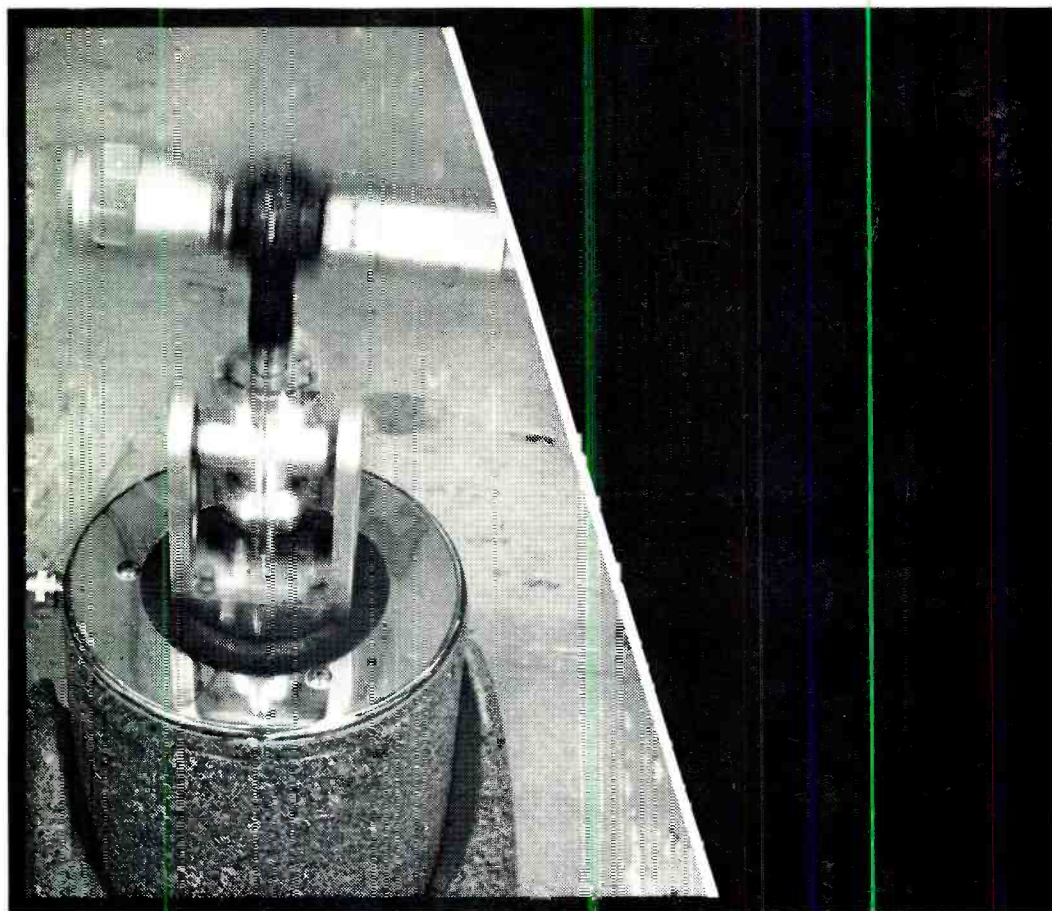

## Shake, rattle & roll.



Welcome to our chamber of horrors. Inside the Shure Quality Control laboratory some of the most brutal product tests ever devised are administered to Shure microphones. The illustration above shows a "shaking" machine at work on a Shure microphone and noise-isolation mount. It's only one in a battery of torturous tests that shake, rattle, roll, drop, heat, chill, dampen, bend, twist, and generally commit mechanical, electrical and acoustical mayhem on off-the-production-line samples of all Shure microphones. It's a treatment that could cause lesser microphones to become inoperative in minutes. This kind of continuing quality control makes ordinary "spot checks" pale by comparison. The point is that if Shure microphones can survive our chamber of horrors, they can survive the roughest in-the-field treatment you can give them! For your catalog, write:

Shure Brothers Inc.  
222 Hartrey Ave., Evanston, Ill. 60204  
In Canada, A. C. Simmonds & Sons Ltd.



CIRCLE NO. 32 ON READER SERVICE CARD