

Popular Electronics

INCLUDING **Electronics World**

How to
Become a
**RADIO
AMATEUR**

HOW TO BUILD:

- An SQ 4-Channel Decoder
- A Tester for SCR's & Triacs

SEEING INSIDE
WITH
**ACOUSTICAL
HOLOGRAPHY**

**NOISE
REDUCING
SYSTEMS
FOR
CASSETTES**

TEST REPORTS:

- Shure V15 Type III Phono Cartridge
- BSR 810X Automatic Turntable
- Harman-Kardon HK-1000 Cassette Deck
- Heath IB-1100 Frequency Counter
- Regency TME-16
FM Monitor Receiver
- Fanon Fanfare 700
CB Transceiver

**ELECTRONICS
AND
BRAIN
CONTROL**



561256 2LS B0245M97 NOV73 6 1D
M DELS:HLAGER
BX 245
BROWNS HILLS NJ 08015
4
07

NOW you can train at home building a NEW 25" DIAGONAL Solid State Color TV engineered by NRI for learning and trouble-shooting

So much better for learning TV servicing than any hobby kit, because NRI designed and created it as an educational tool.

Unlike hobby kits which are designed for creating a TV set as the end product, NRI built its exclusive 25" Diagonal Solid State Color TV kit as a real training kit. You can introduce and correct defects . . . for trouble-shooting and hands-on experience in circuitry and servicing. The kits include a wide-band oscilloscope, color bar crosshatch generator, transistorized volt-ohmmeter and other valuable equipment that can soon have you earning \$5 to \$7 an hour servicing color sets in your spare time.

Handsome woodgrain cabinet, at no extra cost. (Offered only by NRI)

New square-cornered Sylvania picture tube

100% solid state chassis

6-position detented UHF channel selector



Modular construction with plug-in circuit boards

Automatic degaussing

Automatic fine tuning

Automatic color control

Automatic tint control

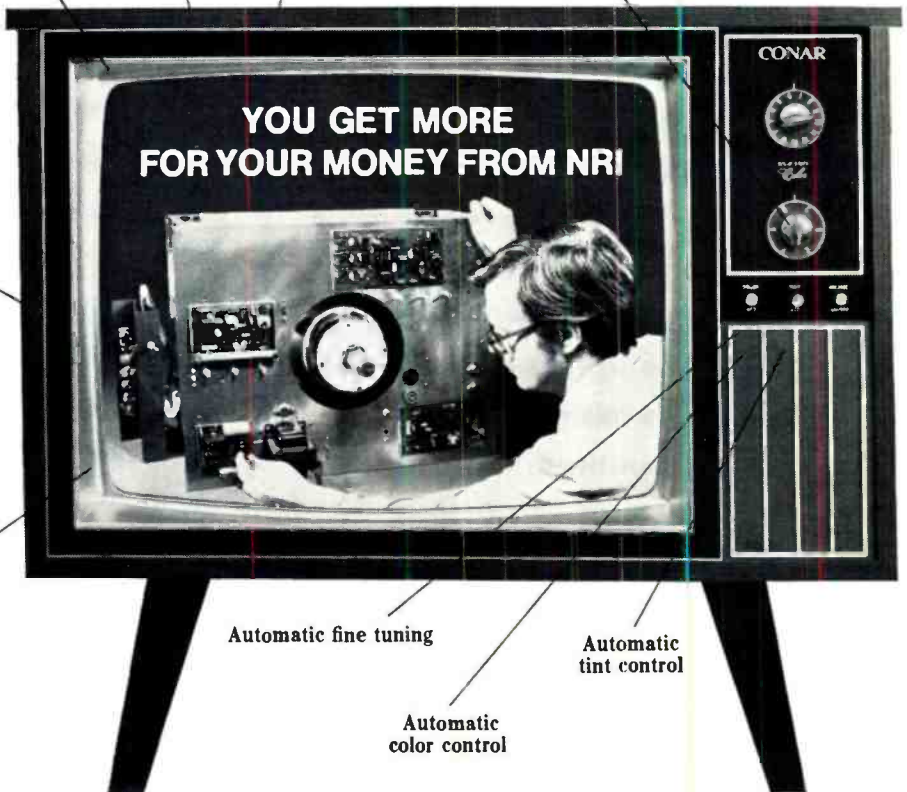

NRI FIRSTS make learning Electronics fast and fascinating—to give you priceless confidence

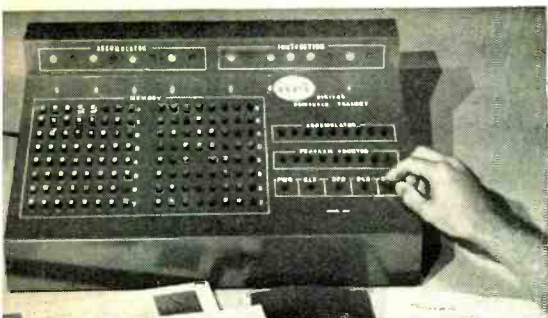

FIRST to give you a complete programmable digital computer, with memory, you build yourself... to learn organization, operation, trouble-shooting and programming. This remarkable computer is one of ten training kits you receive with the new NRI Complete Computer Electronics Course.



FIRST to give you true-to-life experiences as a Communications Technician. Every fascinating step you take in NRI Communications training, including circuit analysis of your own 15-watt, phone/cw transmitter, is engineered to help you prove theory and later apply it on the job. Studio equipment operation and trouble shooting become a matter of easily remembered logic.



FIRST to give you completely specialized training kits engineered for business, industrial and military Electronics Technology. Shown is your own training center in solid-state motor control and analog computer servo-mechanisms. Telemetering circuits, solid-state multivibrators and the latest types of integrated circuits are included in your course.

The NRI color TV and digital computer kits are the latest in a long line of "firsts" for NRI. For more than fifty years, NRI has been providing unique 3-dimensional home-study training that has helped hundreds of thousands of students reach their goals quickly and easily.

What NRI provides is a combination of kits and bite-size texts that give you hands-on experience while you are learning. The texts average only 40 pages each, and they are fully illustrated. You are taken step-by-step from the first stages into the more advanced theory and techniques... with an expert instructor ready at all times to provide valuable guidance and personal attention. (The level of personal attention provided is more than you would receive in many classrooms.) Once you've grasped the fundamentals, you move with confidence and enthusiasm into new discoveries in the fascinating world of electronics.

You start out with NRI's exclusive Achievement Kit, containing everything you need to get moving fast. Lessons have been specifically written so that experiments build upon one another like stepping stones. You can perform a hundred experiments, build hundreds of circuits... as you learn to use the professional test equipment provided, building radios and TV sets, transmitter or computer circuits. It's the priceless "third dimension" in NRI training... practical experience.

Train with the leader—NRI

Compare training kits, texts, techniques and overall training... and you'll find that you get more for your money from NRI. Whatever your reason for wanting more knowledge of Electronics, NRI has an instruction plan that will meet your needs. Choose from major programs in Advanced Color TV Servicing, Complete Computer Electronics, Industrial Electronics and the other special courses designed to meet specific needs. With NRI home training, you can learn new skills while you're still working at your present job... and turn yourself into the man in demand.

GET FACTS ABOUT GI BILL

If you have served since January 31, 1955, or are in service now, check GI line on postage-free card.

Send for free NRI catalog

MAIL THE POSTAGE-FREE CARD FOR THE FREE NRI CATALOG IN THE FIELD OF YOUR CHOICE. YOU WILL BE UNDER NO OBLIGATION. NO SALESMAN WILL CALL.

If the card has been used, write direct to:



NRI TRAINING

3939 Wisconsin Ave.
Washington, D.C. 20016

Popular Electronics

WORLD'S
LARGEST-SELLING
ELECTRONICS MAGAZINE

INCLUDING **Electronics World**

FEATURE ARTICLES

- 32 NOISE REDUCING SYSTEMS FOR CASSETTES** *Julian D. Hirsch*
- 40 THE ZENER DIODE, THEORY AND APPLICATIONS** *Adolph A. Mangieri*
- 49 HOW TO BECOME A RADIO AMATEUR**
Requirements needed to enjoy a fascinating hobby.
- 58 NEW RCA IN-LINE COLOR TUBE**
- 59 SEEING INSIDE WITH ACOUSTICAL HOLOGRAPHY** *Fred W. Holder*
Three-dimensional pictures with ultrasonic energy.
- 65 ELECTRONICS & BRAIN CONTROL** *L. George Lawrence*
Learning more about the gray matter.
- 85 GAS AND SMOKE ALARMS** *John T. Frye*
- 88 DO YOU KNOW YOUR DC CIRCUITS? PART 3** *Arthur H. Seidman*
- 102 CLOSED BOX SPEAKER SYSTEM DESIGN, PART 2** *David B. Weems*
Useful charts for building enclosures.

CONSTRUCTION STORIES

- 26 SQ FOUR-CHANNEL DECODER** *Murray Esformes*
High-performance unit using one IC.
- 45 BUILD A THYRISTOR TESTER** *Michael S. Robbins*
Check operation of SCR's and triacs.
- 69 TV COMMERCIAL KILLER**
- 98 VERSATILE IC TIMER** *Walter W. Schopp*

ZIFF-DAVIS PUBLISHING COMPANY
Popular Electronics Including Electronics World
Editorial and Executive Offices
One Park Avenue, New York, New York 10016
212 679-7200

William Ziff, President
W. Bradford Briggs, Executive Vice President
Hershel B. Sarbin, Senior Vice President and Secretary
Philip Sine, Financial Vice President and Treasurer
Phillip T. Heffernan, Vice President, Marketing
Frank Pomerantz, Vice President, Creative Services
Arthur W. Butzow, Vice President, Production
Edward D. Muhlfeld, Vice President, Aviation Division
Irwin Robinson, Vice President, Travel Division
George Morrissey, Vice President
Sydney H. Rogers, Vice President
Staver Hertz, Vice President
Lawrence Sporn, Vice President, Circulation

POPULAR ELECTRONICS Including ELECTRONICS WORLD, July, 1973, Volume 4, Number 1. Published monthly at One Park Ave., New York, NY 10016. One year subscription rate for U.S., U.S. Possessions and Canada, \$6.00; all other countries, \$7.00. Second class postage paid at New York, N.Y. and at additional mailing offices. Authorized as second class mail by the Post Office Department, Ottawa, Canada and for payment of postage in cash. Subscription service and Forms 3579: P.O. Box 2774, Boulder, CO 80302. Editorial offices for manuscript contributions, reader inquiries, etc.: One Park Ave., New York, NY 10016.

POPULAR ELECTRONICS Including ELECTRONICS WORLD is indexed in the Reader's Guide to Periodical Literature.

Copyright © 1973 by ZIFF-DAVIS PUBLISHING COMPANY. All rights reserved.

POPULAR ELECTRONICS Including Electronics World

EDGAR W. HOPPER
Publisher
ARTHUR P. SALSBERG
Editorial Director
MILTON S. SNITZER
Editor
LESLIE SOLOMON
Technical Editor
JOHN R. RIGGS
Managing Editor
EDWARD I. BUxbaUM
Art Director

ALEXANDER W. BURAWA
Associate Editor
ANDRE DUZANT
Technical Illustrator
ELLEN S. FINKELSTEIN
Editorial Assistant
JOHN T. FRYE
J. GORDON HOLT
RICHARD HUMPHREY
WALTER G. JUNG
MATT P. SPINELLO
Contributing Editors

JOSEPH E. HALLORAN
Advertising Director
JOHN J. CORTON
Advertising Sales
MADELEINE LITTMAN
Advertising Service Manager
STANLEY NEUFELD
Associate Publisher
FURMAN H. HEBB
Group Vice President
Electronics and Photographic

THE SCENES

- 12 STEREO SCENE** *J. Gordon Holt*
- 70 TEST EQUIPMENT SCENE** *Leslie Solomon*
- 91 HOBBY SCENE**
- 92 CB SCENE** *Matt P. Spinello*
- 94 SOLID-STATE SCENE** *Walter G. Jung*
- 115 SURPLUS SCENE** *Alexander W. Burawa*

PRODUCT TEST REPORTS

- 76 SHURE V-15 TYPE III STEREO PHONO CARTRIDGE**
- 78 HARMAN-KARDON MODEL HK-1000 CASSETTE DECK**
- 80 HEATH MODEL IB-1100 FREQUENCY COUNTER**
- 81 REGENCY MODEL TME-16HLU FM MONITOR RECEIVER**
- 82 BSR/McDONALD MODEL 810/X AUTOMATIC TURNTABLE**
- 84 FANON/COURIER FANFARE 700 CB TRANSCEIVER**

DEPARTMENTS

- 6 EDITORIAL** *Milton S. Snitzer*
An Advance in Personal Communications
- 8 LETTERS**
- 23 NEWS HIGHLIGHTS**
- 100 NEW LITERATURE**
- 101 ELECTRONICS LIBRARY**
- 110 NEW PRODUCTS**

COMING NEXT MONTH

What's New in SSB CB Transceivers
Discrete Quadraphonic Discs
Controlling Insects with Electronics
Build a Convergence Generator

Midwestern Office
The Pattis Group, 4761 West Touhy Ave.,
Lincolnwood, Illinois 60644, 312 679-1100
GERALD E. WOLFE, DICK POWELL
DICK GOVATSKI, MANLEY LUDWIG

Western Office
9025 Wilshire Boulevard, Beverly Hills, California 90211
213 273-8050; BRADSHAW 2-1161
Western Advertising Manager, BUD DEAN

Japan: James Yagi
Oji Palace Aoyama; 6-25, Minami Aoyama
6 Chome, Minato-Ku, Tokyo 407-1930/6821

Ziff-Davis also publishes Boating, Car and Driver, Cycle, Flying, Modern Bride, Popular Photography, Skiing, and Stereo Review.

Forms 3579 and all subscription correspondence should be addressed to POPULAR ELECTRONICS Including ELECTRONICS WORLD, Circulation Department, P.O. Box 2774, Boulder, CO 80302, Please allow at least eight weeks for change of address. Include your old address, as well as new—enclosing, if possible, an address label from a recent issue.

Editorial contributions must be accompanied by return postage and will be handled with reasonable care; however, publisher assumes no responsibility for return or safety of art work, photographs or manuscripts.



Member Audit Bureau of Circulations



By Milton S. Snitzer, Editor

AN ADVANCE IN PERSONAL COMMUNICATIONS

Just imagine that you have one of those new compact telephones with pushbutton dialing with the buttons mounted right on the handset. Imagine further that this handset has no connecting wire to the base of the phone and that it could be put into your coat pocket or briefcase and taken with you in your car, boat, taxi, and kept with you throughout the day in your travels in the city. Finally, imagine that you could use this handset wherever you were just as though it were connected to its base at your home, office, or store. What a convenience this wireless telephone would be if you were riding in a car or taxi, walking down the city's streets, sitting in a restaurant, or were anywhere that conventional "tied to the wall" phones were not available.

Well, this can now be done with a new hand-held radiotelephone that is part of Motorola's presently experimental Dynatac™ system.

Hams, CB'ers, and other communicators have been using hand-held transmitter/receivers for some time. Hams and others have also been getting increased range and coverage from their low-power hand-held rigs by using remote repeaters that amplify and rebroadcast their weak signals to other similar rigs within range of the repeater (see "Amateur 2-meter FM Repeaters" in our May issue).

But this new hand-held Motorola rig does much more, thanks to the use of large scale integrated circuits. Circuits for the dialing pushbuttons are included along with circuitry for full duplex operation. This means that two channels are used at a time so that one party can interrupt the other and need not wait until the other party stops talking as is the case with the ham rigs and simpler radiotelephones. Repeater stations will be required throughout the area that is to be serviced by the new system, and these stations will be able to be automatically patched into the world-wide telephone network.

The FCC is currently trying to encourage some more action in the upper uhf TV channels from channel 70 (806 MHz) through 83 (890 MHz); they are encouraging industry to come forward with new two-way radio uses for this band. This new portable radiotelephone system is one answer to the FCC's request.

After the company gets the FCC's approval to go ahead, they plan to spend about \$5 million setting up repeaters all over the island of Manhattan and then expand into the city's other four boroughs. Regular commercial use of the system is not expected before 1976 and the initial user costs will run about \$60 to \$100 per month. At these rates only those who really can use the system will have it. Business executives, salesmen, doctors are just some of these. But equipment costs and prices are expected to drop soon so that other users will be able to be served.

And for those who don't want to be disturbed by the phone bell when they are away from home or the office, they can either hide in a subbasement or elevator where radio waves can't reach them, or they can simply switch the unit off.

You get more "security" from Mallory. And it's all do-it-yourself.



The Mallory line of security products is not only the most complete line you can get anywhere, it's also just about the easiest to hook up. It's genuinely a do-it-yourself line.

Especially the complete systems. From complete home intrusion alarm systems (plug-in or wire-in) to smoke alarms and car alarms.

And we have all the accessories you need to expand and adapt any of these systems to your specific security needs.

Look for our security systems and accessories on display in their bright, new packages (with installation directions printed right on each package). It's all at your Mallory distributor's now.

**Send for our new Security Systems Catalog 9-654.
It describes and explains how to use every item we have.**

MALLORY

MALLORY DISTRIBUTOR PRODUCTS COMPANY

a division of P. R. MALLORY & CO. INC.
Box 1284, Indianapolis, Indiana 46206; Telephone: 317-636-6363

CIRCLE NO. 22 ON READER SERVICE CARD

**NOW, FOR ANY
ASSIGNMENT...**

2 attache tool cases

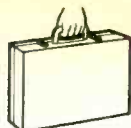

Model TC-100/ST

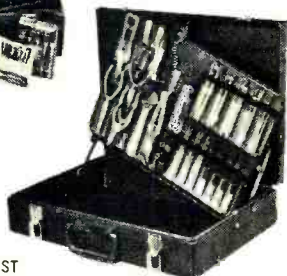

Model TC-200/ST

**with different
tool selections**

Technicians, servicemen, field engineers: Here's the ideal combination—Xcelite professional hand tools made to highest standards for any job... all housed in a rugged, attractive attaché style case personalized with your initials. Tools neatly mounted in see-thru pockets on removable pallets and trays... plus generous space for individualized selection of test instruments, parts boxes, soldering gun and other tools.

Your choice of two: Model TC-100/ST provides a larger, yet compact case containing an extensive selection of 41 individual and 13 interchangeable tools with 3 handles, and 5 separately cased sets of specialized drivers. Model TC-200/ST offers an economical but extremely versatile selection of 10 individual and 28 interchangeable tools and handles for less demanding work.

WRITE FOR
BULLETIN N273.

*nationwide availability through
local distributors*

XCELITE

XCELITE, INC. • 20 BANK ST., ORCHARD PARK, N.Y. 14127
Send Bulletin N273 on Attaché Tool Cases.

name _____

address _____

city _____

state & zone _____

CIRCLE NO. 32 ON READER SERVICE CARD



Letters

EIA DOESN'T MAKE OR SELL AUDIO TAPE

We wish to thank you very much for announcing the availability of a new EIA Test Tape Standard, RS-400, in New Products (April 1973). The Electronics Industry Association does not market an audio test tape. EIA Standard RS-400 is a detailed voluntary industry standard of how audio test tape should be produced. To clear up this confusion, we are returning all orders for EIA RS-400 which reference the POPULAR ELECTRONICS announcement, along with an explanation of exactly what the Standard contains.

A.M. WILSON, Manager
Engineering Department
Electronic Industries Assn.
Washington, D.C.

"MUSCLE WHISTLER" WINS FIRST PRIZE

A while back, I decided to build the "Muscle Whistler" (November 1971) for my science fair project. With this project I won first prize in the individual competition in the science fair. I was awarded \$15 and a plaque, and my photo was published in our local newspaper, accompanied by a few short paragraphs regarding the project.

BILL MERLEVEDE
Oakville, Ontario, Canada

Congratulations, Bill. We note from the newspaper account that you're a seventh grader. This leads us to wonder what types of projects you will be tackling when you get into high school.

WE TAKE EXCEPTION TO . . .

We read with interest "Cassettes For Perfectionists" (Stereo Scene, March 1973). While a considerable amount of enlightening information was given, certain segments of the article—particularly as to life expectancy—are matters to which we wish to take exception. While some companies have found that their products lose more than 2 dB of output at 15,000 Hz after only five plays, this information is misleading since it seems to imply that all cassettes are subject to this phenomenon.

We keep a daily analytical record of every batch of tape we manufacture. In the last 2½

years of production, on both our UD and LN cassettes, we have never observed this exceedingly severe loss. As a matter of fact, our tests indicate less than 1.4 dB of loss at 18,000 Hz after ten plays, with a stabilization at 1.9 dB after 35 plays. This kind of loss is inaudible and represents less quality degradation per play than successive plays of an LP record or any other commonly used recording medium.

DAVID B. MONSON, Pres.
Marketing World, Ltd.
Technical Consultants to
Maxell Corp. of America

ANOTHER ELECTRONIC POLLUTION WRINKLE

"Electronic Pollution" (April 1973) set me to thinking about a tunable pulse I had been picking up on the BCB at around 1490 kHz all winter long. I live way out on the prairie, 45 miles from a city of any size. So, I began to look around the ranch for the source of the pulse. I found nothing to blame it on, not even an omni-range station some 12 miles away.

At first, I thought my receiver had a faulty capacitor in it. But before tearing into it, I tried out two more receivers; they both picked up the pulse. Then, after reading your article, I rigged up a transistor receiver with a loopstick antenna as a direction finder. Imagine my surprise when, about two miles from home, I pinpointed the source. It was my neighbor's

electric fence. So, author Webb Garrison can add one more source of electronic pollution (at least to rural people) to his list: Electric Fence Interference.

JESS W. SPEER
Arnett, Okla.

A "SEIZURE" IS NOT A "FIT"

In "Flash Tubes: Operation & Applications" (January 1973) an epileptic "seizure" is erroneously referred to as a "fit." The word "fit" is a throwback to the times when epileptics were considered to be "possessed" by demons. In the future, I hope that you will refer to epileptic seizures as such. The word "fit" is hardly proper in these enlightened times.

TERRY FUGATE
Lexington, Ky.

Please excuse us for the unfortunate use of an archaic term.

QUALITATIVE FEEDBACK

I read with interest "Rock Music & Noise Pollution" and "How We Hear the Way We Do." With the high sophistication and often staggering investment that are found in electronic reproduction systems, the public is woefully ignorant of hearing and the man-machine interface. I'll soon receive my doctorate in

SAVE MONEY!

A Delta Mark Ten Capacitive Discharge Ignition (CDI) System On Your Car Slashes Maintenance Costs And Increases Performance.

Put a Mark Ten on your car and save by eliminating 3 out of 4 tune-ups. Save as gasoline mileage increases (up to 20%). The Mark Ten CDI system also extends spark plug life, promotes more complete combustion and assures instant starts in all weather. It operates on any 6 or 12 volt negative or positive ground system.

The Mark Ten B affords additional money saving advantages by drastically reducing combustion contaminants and restoring power lost by the use of smog control devices. Equipped with handy switch for instant return to standard ignition, the Mark Ten B works with ANY 12 volt negative ground engine. Both systems install in ten minutes without rewiring.

Order your Mark Ten or Mark Ten B today. Save money while you enjoy low maintenance and increased performance.

Mark Ten (Assembled) \$44.95 ppd.

Mark Ten (Deltakit) \$29.95 ppd. **Mark Ten B \$59.95 ppd.**
(Kits available in 12 volt only. (12 volt negative ground only)
positive or negative ground)

Superior Products at Sensible Prices

Mfg. in U.S.A.



Dept. PE



DELTA PRODUCTS, INC.

P.O. BOX 1147 • GRAND JUNCTION, COLORADO 81501
PHONE: (303) 242-9500

Please send me literature immediately:
Enclosed is \$ _____

Ship ppd. Ship C.O.D.

Please send: _____ Mark Ten B @ \$59.95 ppd.
 ___ Standard Mark Ten (Assembled) @ \$44.95 ppd.
 ___ 6 Volt: Neg. Ground Only ___ Positive Ground
 ___ 12 Volt: Specify _____ Negative Ground
 ___ Standard Mark Ten (Deltakit®) @ \$29.95 ppd.
 (12 Volt Positive Or Negative Ground Only)

Car Year _____ Make _____
 Name _____
 Address _____
 City/State _____ Zip _____

CIRCLE NO. 7 ON READER SERVICE CARD

Dreaming about a pair of \$300 condenser microphones? Think seriously about these: \$39.75* each!



All of the great condenser advantages are here without compromise. Flat, extended range, excellent transient response, high output, low noise, and ultra-clean sound. But the new E-V electret condenser microphones need no high voltage power supply. Just an AA penlite battery to operate the built-in FET impedance converter. The result is studio performance without complications and at a dramatically lower price.

There are 4 new E-V electret microphones, including cardioid models, from \$39.75 to just \$75.00, audiophile net. Second-generation designs with unusually high resistance to heat and humidity. Hear them today at your nearby Electro-Voice sound-room. Or write for details.

More U. S. recording studios use Electro-Voice microphones than any other brand.

*Suggested retail price. Microphones shown on Model 421 Desk Stand. \$12.00 each.

Electro-Voice® a Gulton
COMPANY

ELECTRO-VOICE, INC., Dept. 732P
630 Cecil Street, Buchanan, Michigan 49107
In Europe: Electro-Voice, S.A., R mmerstrasse 49,
2560 Nidau, Switzerland

CIRCLE NO. 13 ON READER SERVICE CARD

sensory psychology with a specialty in audition. As such, I feel that I have some obligation to provide a little qualitative feedback for your commendable publication efforts.

Mr. Silver's article ("Rock Music . . .") is good. It is a basic presentation of the "facts" as we now know them. It is especially good because Mr. Silver did not go beyond the facts to incorrect generalizations. Mr. Kenney's article ("How We Hear . . .") is not as good, but it attempts to cover more difficult material. His conclusion that "the factor of prime importance in sound localization is intensity difference, with phase difference a secondary factor" is simply incorrect. Our laboratory has shown just the reverse. The article presents an assortment of existing evidence, yet it blunders on several points. However, it is a difficult subject to cover in simple words.

JOHN R. LAKEY
Austin, Tex.

MORE ON P.C. VERSUS "PERF" BOARDS

In the April 1973 Letters column there was a letter concerning the distinctions between printed circuit and perforated boards. I agree with reader Walkup's comments 100 percent. I disagree with the justifications you gave for PC etching and drilling guides in your answer to Mr. Walkup's letter. I feel that you should provide both PC and perf board diagrams in your construction articles. Also, I see nothing wrong with hand wiring.

NOEL CORNMAN
Los Angeles, Calif.

There is no need to publish two types of diagrams because in either case the components would be laid out in the same manner. The PC etching guide can simply be used as the wiring guide for perf board assemblies. Nor do we have any prejudice toward hand wiring. In any event, we only suggest a method of assembly; the reader is free to choose any alternate method he desires.

FORGET THE DIODE—TUNE YOUR ENGINE

The suggestion of installing a diode between the ignition switch and alternator lamp in a car ("Stopping Engine Run-On," March 1973) to stop dieseling is only a compromise solution to the problem. The best way to really solve the problem is to get the engine idle properly set, since the most common cause of engine run-on is too fast an idle set.

W. ARTHUR
Birmingham, Mich.

Agreed, but most of us can barely tell the difference between the ignition and the trunk keys on a car without first trying them. For us, then, a 50¢ diode installation is a whole lot cheaper than \$15 or more for a tuneup.

Hobbyists-Experimenters...for the

FIRST TIME EVER

from MOTOROLA HEP

LED 7-Segment Numerical

READOUTS

FOR
LESS THAN

\$2.50
ea.

Your local Motorola HEP supplier currently has a limited quantity of HEP's HEK-5 red solid-state readout kits available. Now, at a price you can afford, you can experiment with the same reliable, high quality readouts that are used extensively in test instruments, computer peripheral equipment and calculators. The devices read from 0 to 9, each incorporate a decimal point and are 100% functional.

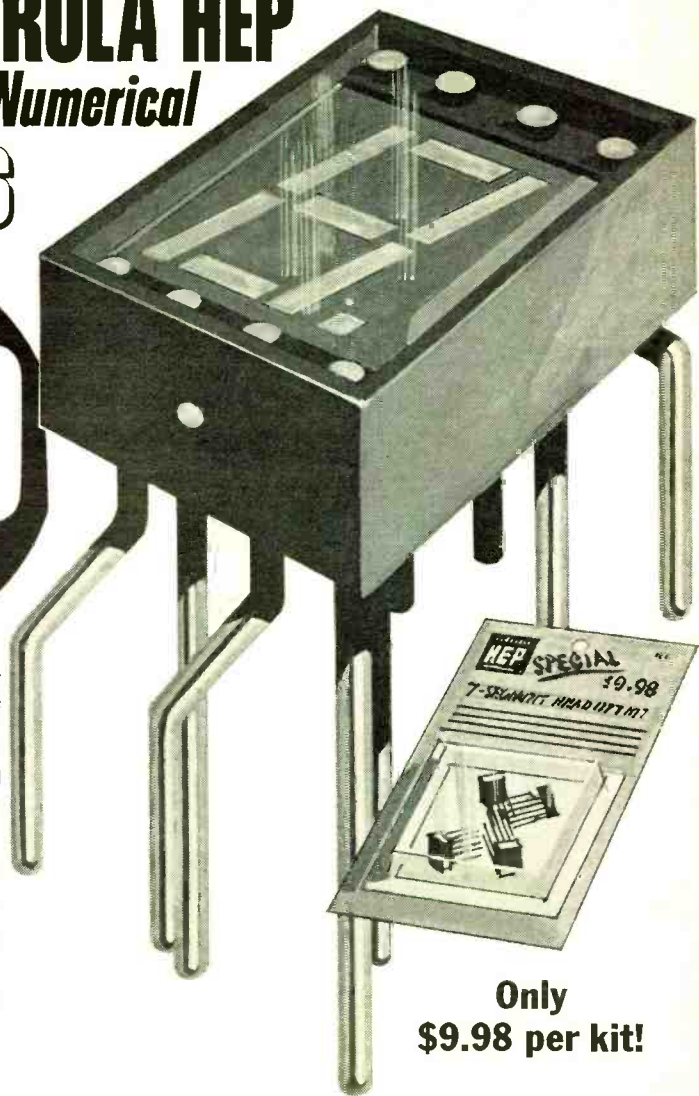

Only
\$9.98 per kit!

In addition to four readouts, the HEK-5 kits include custom circuit designs and parts lists for a digital clock, a voltage converter and a digital stop watch. All of this for \$9.98 per kit.

SEE YOUR NEAREST HEP SUPPLIER TODAY
for a de-lightful surprise.



Stereo Scene

By J. Gordon Holt

A TAPE recorder is a very versatile device. Its versatility has, in fact, been illustrated many times in those booklets and magazine articles describing fifty (or one or two hundred) tape recorder applications that you never would have thought of by yourself. Let's face it, though, for every tape-recorder owner who uses his machine for playing party games, brushing up his conversational Spanish or recording his own home-movie sound effects, there are thousands who use theirs for one thing: taping, off the air, music from commercial recordings which for one reason or another they would rather not buy. This is on the edge of being unethical, but it is not illegal, and since it will be done anyway, I am doing no one any disservice by explaining herein how it can be done better.

What to Record. First, what are you going to record? If you just want to reel off an hour of background listening, you may get better results by reading this, but since nobody *listens* to background music anyway, it doesn't really matter. So I will assume that, instead of just taping some deejay's afternoon show, you are interested in getting some specific musical selections. The second question, then, is: "When will the music you wish to record be broadcast?" This is not always easy to determine.

Taping Off the Air

If you're after classical works, it is likely that most of your listening is to a classical-music station or a so-called "cultural affairs" station, and both types usually issue their own monthly program guides. If you're not already subscribing, do so.

Newspapers, which used to publish detailed radio schedules, generally limit themselves to TV schedules these days, and the few that still acknowledge that radio does indeed exist are of little help to the off-the-air recordist, for they rarely specify which selections will be played on a particular program. They figure it is enough for you to know that on Thursday night at 8 p.m. there will be a Boston Symphony Orchestra broadcast. Short works like overtures, intermezzos and so on are seldom listed in program guides, so if you're after some of these, your best bet is to keep the recorder loaded and all ready to go (with levels and balances pre-set) so that, as soon as you hear the announcer introduce something you want, you can leap up and start things running in time to catch the first note.

For the pops collector, things are more difficult. Program schedules rarely list specific pop selections—the best you can ascertain as a rule is that such-and-so performing group will be featured at a certain time. If you want to copy pops, you're better off doing it from borrowed discs. If you must do it from FM, then the standby approach mentioned previously is probably the best way. On the other hand, you can use a scatter-gun approach, which involves loading the recorder with as much tape as it will accept, and just letting it run for the duration of each program that is *likely* to broadcast what you're after. You then have the option of editing out the desired take (assuming you get it) or copying it off onto another machine. If you want to get a selection complete from start to finish, though,



'73 Heathkit® Catalog

Shown below are only a few of the more than 350 kits fully described in the 1973 Heathkit catalog. Kits for every interest, every budget...including color TV; stereo systems; electronic organs; marine equipment; a kitchen waste compactor; home intercoms and protection systems, garage door openers; table radios; portable radios and phonographs; guitar amplifiers and accessories; educational electronic workshops for youngsters and adults; tool sets; electronic test instruments; amateur and shortwave radio gear; radio-control equipment; metal locators.

Can you build a Heathkit? For 25 years people just like you have been doing it - armed with no more than a soldering iron and a few conventional hand tools.

No matter how complex the kit, the manual reduces assembly to a simple step-by-step operation. Add to that the availability of the technical correspondence department here in Benton Harbor, and service people in 36 retail stores across the country, and you see why we say "we won't let you fail." And finally, building a Heathkit is fun, pure and simple. The coupon below gets you started.

Here are just a few of the new kits in this new '73 edition

					
Heathkit 50-watt Stereo Receiver. \$169.95*	Heathkit Deluxe Metal Locator has submersible sensing head. \$89.95*	Heathkit VHF/FM Band-Scanning 8 channel Receiver. \$119.95*	Heathkit Cassette Deck, Dolby Circuit. \$249.95*	Heathkit 6-Digit Electronic Clock-Alarm. \$54.95*	Heathkit 25V Solid-state Color TV with detent power tuning. \$599.95*
					
NEW Heathkit Ultrasonic Intrusion Alarm. \$49.95*	NEW Heathkit 8-transistor AM Radio for first-time kit-builders. \$14.95*	Heathkit 2 1/2 Digit VOM. \$79.95*	NEW Heathkit 8-digit Pocket Calculator. \$92.50*	NEW Heathkit 8-digit desktop Calculator. \$79.95*	NEW Heathkit Small-engine Tune-up Meter for 2- and 4-cycles, all ignitions. \$39.95*
					
					NEW Heathkit 2-Meter Amateur Transceiver. \$179.95*

Send Today for Your Free '73 Heathkit Catalog

HEATHKIT ELECTRONIC CENTERS

ARIZ.: Phoenix, 2727 W. Indian School Rd.; CALIF.: Anaheim, 330 E. Ball Rd.; El Cerrito, 6000 Potrero Ave.; Los Angeles, 2309 S. Flower St.; Pomona, 1555 Orange Grove Ave. N.; Redwood City, 2001 Middlefield Rd.; San Diego (La Mesa), 8363 Center Dr.; Woodland Hills, 22504 Ventura Blvd.; COLO.: Denver, 5940 W. 38th Ave.; CONN.: Hartford (Avon), 395 W. Main St. (Rte. 44); FLA.: Miami (Hialeah), 4705 W. 16th Ave.; GA.: Atlanta, 5285 Roswell Rd.; ILL.: Chicago, 3462-66 W. Devon Ave.; Downers Grove, 224 Ogden Ave.; IND.: Indianapolis, 2112 E. 62nd Ave.; KANSAS: Kansas City (Mission), 5960 Lamar Ave.; MD.: Baltimore, 1713 E. Joppa Rd.; Rockville, 5542 Nicholson Lane; MASS.: Boston (Wellesley), 165 Worcester St.; MICH.: Detroit, 18645 W. Eight Mile Rd. & 18149 E. Eight Mile Rd.; MINN.: Minneapolis (Hopkins), 101 Shady Oak Rd.; MO.: St. Louis, 9296 Gravois Ave.; N.J.: Fair Lawn, 35-07 Broadway (Rte. 4); N.Y.: Buffalo (Amherst), 3476 Sheridan Dr.; New York City, 35 W. 45th St.; Jericho, L.I., 15 Jericho Turnpike; Rochester, Long Ridge Plaza; OHIO: Cincinnati (Woodlawn), 10133 Springfield Pike; Cleveland, 5444 Pearl Rd.; PA.: Philadelphia, 6318 Roosevelt Blvd.; Pittsburgh, 3482 Wm. Penn Hwy.; TEXAS: Dallas, 2715 Ross Ave.; Houston, 3705 Westheimer; WASH.: Seattle, 221 Third Ave.; WIS.: Milwaukee, 5215 Fond du Lac.

HEATH COMPANY, Dept. 10-7 Benton Harbor, Michigan 49022	HEATH Schlumberger
<input type="checkbox"/> Please send FREE Heathkit Catalog.	
Name _____	
Address _____	
City _____	State _____ Zip _____
*Mail order prices; F.O.B. factory. CL-470R	

CIRCLE NO. 15 ON READER SERVICE CARD

avoid deejay shows. The “hosts” for these generally feel it is part of their function to babble over the first and last notes, and may even interject “cute” noises during the selection.

How Much Tape? For short selections—10 minutes or less—you must decide for yourself whether to aim for one or two per tape side, or use the longest possible length of tape and fill it up with shorties, using the index counter for locating desired selections later on. The short tape has the advantage of fast cueing of a desired work, but it also has the disadvantage of short program time. The long tape has the advantage of uninterrupted listening, but the disadvantages are that you may not want to hear the selections in that sequence, and it is difficult to replace one selection with another. If the new recording runs shorter than the one you erase, you’ll have a long gap in the program. If it runs longer, of course, you’ll erase part of the next one on the tape that you presumably want to keep. Also, digital counter readings that you write down as an aid to locating selections will be worthless if you ever change tape machines. Different recorders show different counter readings for identical elapsed footage.

The most crucial aspect of off-the-air taping is choosing *adequate* tape length, for there are few greater frustrations than sitting helplessly by while the tape runs out five seconds short of the last note. So, before you start taping, make sure you have *more* than enough tape on the recorder to last through the selection.

There are several ways of doing this. For classics, get a copy of the Schwann record catalog, look up the work you plan to record, and estimate as follows: Most disc sides are 25 minutes long, maximum. (Some monos, a very rare stereo, and *no* quadraphonic discs, run for 30 minutes.) The Schwann catalog will tell you what else is on the disc, and if there are only two works, chances are they are neatly divided, one per side. A ½-hour tape will suffice. Use common sense, though. If one is a symphony and the other an overture or prelude, figure on 1½ sides for the longer work, and don’t depend on there being a break while the broadcaster flips sides. Many stations have two copies of each disc, or have the discs pre-taped, so that they can run continuously. Figure on around 45 minutes or, to be very safe, one hour of continuous recording capability. You

can always fill in the leftover with something else.

Four or more works on a disc are usually of approximately equal length, while a “collection” (Schwann’s classification) is typically five or six works on one disc. “Suites” can vary widely in length, depending on how many excerpts the conductor chose to include, so try to judge length from the other works on the disc. Two “suites” are probably one per side.

Operas are treacherous to tape, as they nearly all outlast any tape (on a 7-inch reel recorder), and they may have act breaks in the middle of sides. The safest thing here is to use a 45-minute tape for each act, unless your familiarity with things like Wagnerian epics suggests you need an hour per act.

Estimating the tape needed for a pop selection may be harder because, while Schwann does list current pops, they list them only by album title. Program guides aren’t usually much help, either, for the same reason: they may list the performing group that will be featured during a given program, but they rarely list the selections to be played. And you can’t make generalizations, either. A pop selection may run anywhere from 6 minutes or less up to a full disc side, but rarely longer. If you’ve ever heard the piece, you should have some idea how long it is. If you don’t, use a ½-hour tape just to be safe.

Setting Up. I will assume that you already have the recorder connected properly to the rest of your system (if not, read the recorder’s instructions) and are ready to set recording level and balance. Both should be pre-set for the station from which you’re going to record, and the simplest and easiest way is to use a *mono* signal source. Set the *tuner* for mono reception—a preamp’s mono stereo switch does not affect signals going to the tape recorder—and adjust both VU meters for identical readings up to (but not beyond) zero level (100%) on the loudest musical passages of the preceding program. Then restore the tuner to stereo mode, and *don’t touch your recording levels thereafter*. FM broadcasts, unlike the discs they play, have a very definite maximum output level which it is illegal to exceed, so most stations use limiters and compressors to ensure that occasionally excessive levels won’t go out over the air. If you note that the levels are too high or too low when you start taping, keep your hands off. Given a

Are you playing your records or ruining them?

If you're like most music listeners, you never think about your records after putting them on your record player.

You just sit back and enjoy the music.

Chances are you'd be less relaxed if you knew that your records might be losing something with every play.

Like the high notes.

It's something to think about. Especially when you consider how many hundreds or even thousands of dollars you have invested in your record collection. And will be investing in the future.

What happens during play.

Even the cheapest record changer can bring its tonearm to the record and lift it off again. But what happens during the twenty minutes or so of playing time is something else.

The stylus is responding with incredible speed to the roller-coaster contour of the stereo grooves. This action recreates all the music you hear, whether it's the wall-shaking cacophony of a rock band or the richness of a symphony orchestra.

The higher the frequency of the music, the more rapidly the contours change, and the sharper the peaks the stylus has to trace. If the stylus bears down too heavily, it won't go around those soft vinyl peaks. Instead, it will lop them off. The record will look unchanged, but your piccolos will never sound quite the same. Nor will Jascha Heifitz.

It's all up to the tonearm.

What does it take for the stylus

to travel the obstacle course of the stereo groove without a trace that it's been there? It takes a precision tonearm. One that can allow today's finest cartridges to track optimally at low pressures of one gram or less. For flawless tracking, the tonearm should be perfectly balanced with the weight of the cartridge, and must maintain the stylus pressure equally on each side wall of the stereo groove. And in order to maintain this equal pressure during play, the tonearm must not introduce any drag. This requires extremely low friction pivot bearings.

There is much more to the design and engineering of tonearms and turntables. But this should be sufficient to give you the idea.

Dual: the music lovers' preference.

By now you probably understand why serious music lovers won't play their precious records on anything but a precision turntable. And the most serious of these people, the readers of the leading music magazines, buy more Duals than any other make of quality turntable.

If you would like to know more about Dual turntables, we'll send you lots of interesting literature, including an article on how to buy a turntable, and reports by independent test labs. Or better yet, just visit your franchised United Audio dealer and ask for a Dual demonstration. You will never have to worry about your records again.



United Audio Products, Inc., 120 So. Columbus Ave., Mt. Vernon, N.Y. 10553
Exclusive U.S. Distribution Agency for Dual.

CIRCLE NO. 30 ON READER SERVICE CARD

few seconds, you will almost certainly see the error corrected at the transmitting end.

You may also notice that the stereo transmission does not usually give identical readings on your VU meters. This is normal, for stereo directionality is predicated upon imbalances between the channels. Again, keep your hands off the controls. Stereocasts are frequently out of balance by a dB or two, but this is well within the range of your playback balance control, and if a tape is imbalanced, it is best that it stay that way for the duration of the recording, so that any correction you make during playback will remain correct. If you adjust balance while recording, you'll have to do it *several* times during each playback of the tape.

Editing on the Recorder. It does not pay to try to start your recording between the end of the introductory announcement and the beginning of the music. Usually, you will succeed only in chopping off the first note of the music, or in laying a half second or so of flutter through the opening measures. It's best to start recording *during* the announcement, and then go back later on and erase the unwanted lead-in. This is easily done in the copying if you're scatter-gunning. If you're not, you can usually accomplish the same thing via your index counter and pause control.

Rewind the tape to well ahead of the unwanted announcement, press the zero-reset button on the digital counter, then play forward until the end of the announcement and note the counter reading. Let the tape continue to run until the music starts, and note the counter reading again. If there's more than half a digital space between them, you're in the clear. Return the tape to the zero point and repeat the preceding run-through. If the two previously noted points give slightly different counter readings this time, use the *second* set of readings for your "editing." Now, rewind to zero again, turn the recorder's record-level controls all the way down, and start recording (or, rather, erasing) until you reach the first of the counter points. Say the words "Very well done!" to yourself as fast as you possibly can, then hit the pause switch and take the recorder out of its record mode. The result should be a clean lead-in to the music.

If you found you had less than a half a digital space in which to shut off the erasing recorder, you'd best do your "editing" by trial and error, listening to the result each

time, and repeating the operation by running just a bit farther past the first counter point with each swipe until the last vestige of the announcement has been shaved off. It is tedious, but effective.

Actual editing, with a splicer and appropriate sticky tape, is of course possible here, but since most off-the-air tape collections are bi-directional—recorded in both directions on 4-track tapes—splicing is not practical because it chops up the reverse tracks.

Quad Off the Air. Increasing numbers of FM stations are scheduling 4-channel transmissions. Most, thus far, are of matrixed recordings, which means they are broadcast and can be recorded via two stereo channels, for subsequent decoding in playback. Taping these is exactly like taping conventional stereo material. The front/rear information from RCA's discrete discs is irrevocably lost in stereo transmission, and discrete 4-channel broadcasting is not yet possible (without an FCC ruling, still forthcoming). Some FM stereo stations, though, are cooperating on *discrete* 4-channel transmissions of RCA discs and some 4-channel tapes, and these can be taped on any 4-channel recorder in much the same way as you would tape stereo material. Here, though, it is even more important that you leave recording levels alone, once they've been set up on preceding broadcasts from the two stations, for level-diddling in four channels creates chaos in playback. Treat each pair of channels as a stereo pair, and set them up as described previously.

A potential problem here is that there's a 50-50 chance that the front and rear channels may be out of phase with one another, and since few tuners or recorders have phase-reversal facilities, there is no way of correcting this while recording. The simplest solution is to equip the two rear speakers with phase-reverse switches, that can be flipped back and forth in playback to provide the best low end and best localization of side-placed sound sources.

Discrete 4-channel tapes will of course play directly into your 4-channel system. Tapes of matrixed 4-channel broadcasts will need decoding in playback, just as though you were playing the original discs, and the same stricture applies: the better the decoder, the better the 4-channel performance. Come to think of it, isn't that true of everything? ♦

When you want the very best stereo without paying the highest price

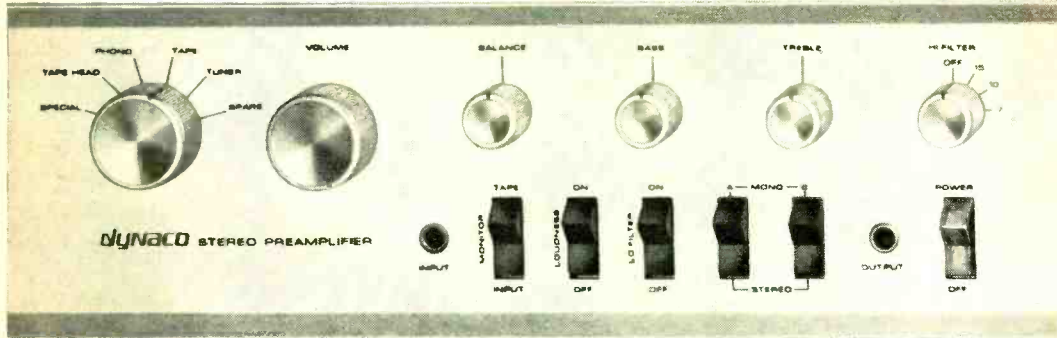

PAT-4 Preamplifier

BUILD A DYNAKIT

The experts agree that Dynakits deliver pure performance that match the most costly components. A few evenings of your time brings you substantial savings with unparalleled listening satisfaction. It's easy, fun and educational. Advanced engineering, with functional simplicity which is a hallmark of Dynaco's designs, add a special satisfaction for you who appreciate excellence.

It's much easier to build a Dynakit. Thoroughly proven circuits, supplied preassembled and tested on fiberglass etched circuit boards, leave only the mechanical assembly and interconnection to you. Detailed step-by-step instructions with easy-to-follow pictorial diagrams clearly show every connection. In high fidelity stereo or 4-channel sound there is no match for Dynakit value.



A-25
Loudspeakers



SCA-80Q
Amplifier



AF-6
AM-FM Tuner

dynaco inc. Division Tyco
3060 Jefferson St., Phila., Pa. 19121
Also available in Canada
from Dynaco of Canada, Ltd.

PE

Gentlemen:

Please send new 1973 full color catalog.

Name _____

Address _____

City _____ State _____ Zip _____

CIRCLE NO. 9 ON READER SERVICE CARD

IF YOU CAN USE ANY OF THESE TOOLS...

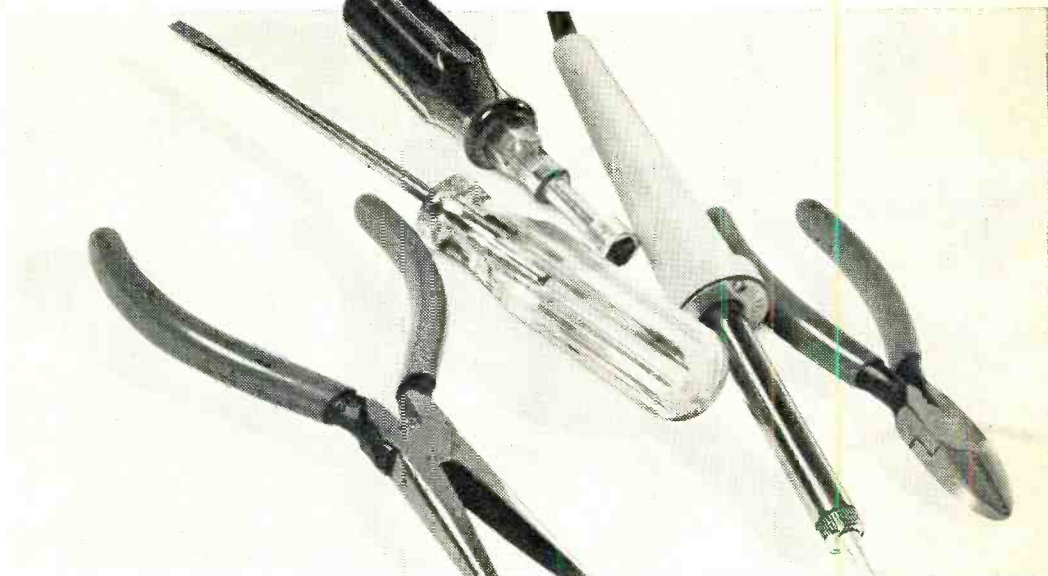

...you could build a whole new future...

and build
yourself
a Bell & Howell
solid state
color TV while
you're at it!



If you're already handy with a set of tools, here's a way to pick up a pretty thorough knowledge of electronics, build yourself a solid state color TV as part of a complete learn-at-home program from Bell & Howell Schools.

This important project gives you valuable "hands on" experience with solid state circuitry—the kind of *practical* experience you'll need to build a successful career. It's a vital part of your total electronics education.

Once you've completed your program, you could be ready to build a new career—or start a business of your own—in home entertainment electronics.

Fix stereo systems . . . FM-AM radios . . . phonographs . . . tape recorders

With your new skills, you can build and service stereo-hi-fi systems—including FM-AM radios . . . phonographs . . . open reel tape recorders and cassette or cartridge player/recorders. You could even build yourself a complete "home entertainment communications center"—complete with the new gadgetry of cartridge television when it comes out. The skills you build up by following this brand-new program are more than enough to service almost any type of home entertainment electronic device.

A complete at-home learning program in home entertainment electronics

Don't confuse this program with an ordinary hobby kit. It's much more than that. It's a complete at-home learning program prepared by skilled instructors at Bell & Howell Schools.

It doesn't matter if you've never had any training in electronics before. Nobody's going to start throwing "diodes" and "capacitors" at you right off. You start with the basics. You take it one step at a time. You walk before you run. And you'll be amazed at how quickly you start to feel comfortable with things that seemed complicated at the beginning.

Attend special "help sessions" if you like

In case you should run into a sticky problem or two—one that you can't handle on your own—come in and see us. We've scheduled help sessions every few Saturdays at the Bell & Howell Schools and in many other cities throughout the U.S. and Canada. Drop by. Meet an expert instructor in person. Talk over any rough spots with him—and with other students. You'll enjoy the chance to "talk shop."

Master the most up-to-date solid state circuitry

Solid state is here to stay. Not just color TV but almost every type of electronic device will eventually move farther and farther in the direction of *total* solid state circuitry. Get to know the most advanced "trouble-shooting" techniques for these sophisticated circuits. You'll find an almost irresistible demand for your skills.

Why you should know electronics

No matter where you look, the amazing

technology of electronics is becoming a bigger and bigger part of the picture. More and more automotive parts and diagnostic instruments are electronic. Many large manufacturing plants use sophisticated electronic systems—controlled by a few skilled electronics technicians. The increasing use of two-way radio . . . the huge promise of cable television . . . the astonishing growth of electronic data processing all open doors to exciting new career opportunities for the man with thorough training in electronics. In fact, the day may come when the man who does *not* have electronic skills will be severely handicapped in many industries.

Why you should get your training from Bell & Howell Schools

Skilled instructors at Bell & Howell Schools—carefully selected for their knowledge, experience and teaching ability—plan each program with the utmost care and attention. Each year, they spend about \$200,000.00 improving programs and materials and keeping them in step with new developments in electronics. Thousands of people have used their Bell & Howell Schools training as the foundation for new careers and businesses of their own in electronics.

You build and keep the exclusive Bell & Howell Schools Electro-Lab®—a complete laboratory-in-the-home

To make sure you get practical experience with instruments used daily by professionals, you build and keep a Design Console, an Oscilloscope and a Transistorized Meter (see details at right). These are the three instruments you'll work with constantly—both during your program and thereafter.

CONSIDER THESE ADVANTAGES:

Help Sessions We've scheduled "help sessions" every few Saturdays at the Bell & Howell Schools and in many other cities throughout the U.S. and Canada. Top instructors give you expert guidance and you meet other students, too.

Resident Study After you complete your program, you can transfer to any of the resident schools for more advanced study, if you wish.

Lifetime National Placement Assistance When you complete your course, we help you locate a position in the field of Electronics that fits your background and interests. This unique service is available at any time after you graduate.

Veterans' Benefits We are approved by the state approval agency for Veterans' Benefits. Check the box for details.

Student Financial Aid We are an eligible institution under the Federally Insured Student Loan Program. Check the box for details.

Detach postage-paid reply card and mail today for free information

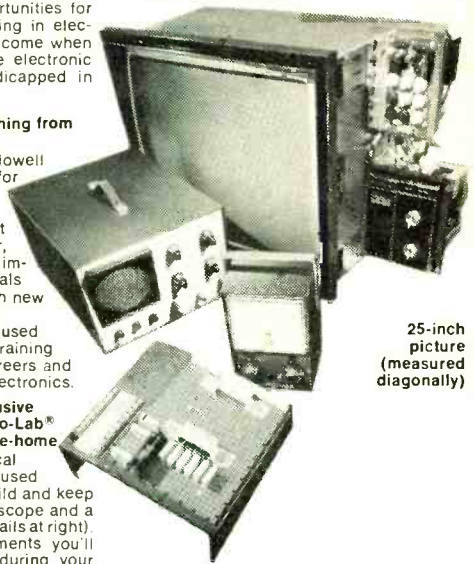

25-inch picture (measured diagonally)

■ **Bell & Howell Solid State Color TV.** Ultra-rectangular tube . . . 25-inch picture measured diagonally . . . full 315 sq. inch viewing area. Solid state modular circuitry . . . 4 advanced IC's . . . 100 transistors . . . 72 diodes . . . individual plug-in circuit boards. Special UHF/VHF tuning features . . . built-in self-service components.

■ **Design Console** Use this to rapidly "breadboard" circuits without soldering. Equipped with built-in power supply . . . test light . . . speaker . . . patented plug-in modular connectors.

■ **Oscilloscope** Portable 5-inch wide-band oscilloscope offers bright, sharp screen images . . . calibrated for peak-to-peak voltage and time measurements . . . 3-way jacks for leads, plugs, wires.

■ **Transistorized Meter** Combines most desired features of vacuum-tube voltmeter and quality multimeter. Registers current, voltage and resistance measurements on a large, easily-read dial. Features sensitive, 4-inch, jewel-bearing d'Arsonval meter movement.

For Free Information, Mail Card Today!

If card has been removed, write:

An Electronics Home Study School
DEVRY INSTITUTE OF TECHNOLOGY

ONE OF THE
BELL & HOWELL SCHOOLS
4141 Belmont, Chicago, Illinois 60641

347R2

QRX-3500

the Sansui all-in-one 4-channel receiver



The trouble with most four-channel components available today is that many of them aren't capable of handling all kinds of four-channel program material.

Not so with the new Sansui QRX3500. This versatile unit:

- decodes records, tapes and broadcasts made with the superior Sansui QS matrix encoding process;
- decoded SQ program material (and does it better than many other competitive units).
- creates magnificent four-channel sound from regular two-channel sources (rather than just offering you two-channel amplifier sections strapped together for "double stereo" which sounds phony).
- accepts the output of any discrete demodulator via its "discrete" input position;
- handles two four-channel and one two-channel tape decks;
- has extremely low distortion figures (less than 0.5%) and is conservatively rated at 180 watts (IHF), coupled with wide frequency response for brilliant, clean reproduction.

Sansui's new vario matrix is the main reason for the QRX 3500's great versatility. It decodes better and it synthesizes better than any other quadrasonic circuitry available. And the QRX 3500 has a host of other features including individual bass and treble controls for each channel, sensitive FM/AM tuning section and provision for an optional "joystick" remote control.

See the QRX 3500 at your nearest franchised Sansui dealer soon and hear what it can do.



SANSUI ELECTRONICS CORP.

Woodside, New York 11377 • Gardena, California 90247

SANSUI ELECTRIC CO., LTD., Tokyo, Japan • Sansui Audio Europe S. A., Antwerp, Belgium

CIRCLE NO. 27 ON READER SERVICE CARD



News Highlights

Liquid Crystal Displays to be Commercially Produced

A full-scale commitment to the manufacture of liquid crystal displays for use in watches, clocks, calculators and test and lab instruments has been announced by RCA. Liquid crystals are flat, low-power devices which display any graphic data electronically. The displays can be controlled and operated by solid-state integrated circuits. Basically, the display consists of two clear glass plates with conductive coatings, separated by a thin layer of liquid crystal material.

World's Largest Cathode Ray Tube

The world's largest CRT has been developed by Thomas Electronics (Wayne, N. J.) for use by the Air Force. The complete tube, weighing 226 lb, including implosion panel, magnetic shield and mounting flanges, will be used in an advanced simulator during undergraduate pilot training research to produce images of flight situations. Seven CRT's are combined to provide a panoramic field of view for student pilots. The tube screen diameter is 36 inches.

Engineering Enrollments Down

Enrollments in engineering dropped sharply last fall, according to statistics just compiled by the Engineering Manpower Commission of Engineers Joint Council. The freshman class numbered 52,000, down 11 percent from the previous year. On the other hand, enrollments in 2-year technology programs were about 4 percent higher than in 1971. Despite the overall reduction in engineering enrollments, the numbers of blacks and women reported in the totals increased both in absolute numbers and as a percentage of the total.

On the other side of the coin, the Carnegie Commission on Higher Education reported that the job outlook for this June's college graduates is the best in four years in most fields. The upturn in demand for new engineers is tied to a better economic situation and the fact that younger men and women can be hired more cheaply than more experienced West Coast aerospace engineers. On the other hand, persons with new Ph.D.'s and degrees in education will continue to have the slimmest pickings.

Laser Items Found in the News

A laser is to be used as a scanner to transmit photos by wire. The system will be employed by Associated Press which will also use electronic darkrooms, where pictures will be stored in computers, edited on video screens, and transmitted at high speeds.

A laser has also been used recently in the Soviet Union in the successful treatment of glaucoma, a leading cause of blindness. The treatment has been used successfully to control the disorder in 88 out of 94 patients. Although the treatment must be repeated about every six months, it can be done in about 10 minutes in the doctor's office.

Finally, a laser system that can record color images on black and white film has been developed by RCA. The system could be used

to display and interpret multispectral information generated by sensors in airplanes and spacecraft. It could also be used with color scanners in facsimile systems.

Zenith Color TV Passes 10 Million Mark

Zenith Radio Corporation produced its 10 millionth color TV set in Chicago recently. All 10 million color receivers have been made in the United States. The company and its employees presented the color receiver to President Nixon who in turn requested that it be contributed to the Veteran's Administration for use in a new V.A. hospital.

U.S. Computer Company Joins with Rumanians

The first manufacturing joint-venture company between a Rumanian company and a U.S. corporation has been announced. The American company is Control Data Corp. The new company, located in Bucharest, will make computer peripheral equipment, including card-readers, card punches, and printers used in computer terminals. Control Data will have a 45 percent interest in the joint company and the Rumanian industrial group will have a 55 percent share.

IC Maker to Enter Transistor Business

Most semiconductor manufacturers went from transistors to IC's but here is one that is taking the opposite route. Signetics Corp., the fifth largest manufacturer of IC's has just formed a new department to manufacture discrete, high-performance transistors for use in consumer products and communications equipment. Until now, the 12-year old firm has specialized in the development and production of complex semiconductor IC's. Using the D-MOST (Double-diffused Metal-Oxide Semiconductor Technology) fabrication method, the new technique is said to be highly precise and yet relatively simple.

Total Number of CET's Nears 5000

The number of electronics technicians who have successfully passed the written Certified Electronic Technicians examination now totals 4875. Of this total, 4551 are certified for radio-TV and consumer electronics. The remainder are industrial technicians and associates, who have passed the exam but do not yet have the necessary 4 years of experience. The exams are promoted by NEA, the National Electronic Associations, an organization comprising radio-TV service technicians.

COMSAT Files to Proceed with Maritime Satellite

Communications Satellite Corp. has asked the FCC for authority to proceed promptly with a maritime satellite system. The system would provide communications to the Navy and would offer separate services to the commercial shipping industry. Service is planned to start in September, 1974. The system would consist of two multi-frequency satellites stationed in geostationary orbits, one over the Atlantic and one over the Pacific, and related ground control facilities in Connecticut and California.

Home Study School Uses Cassettes

A new system using pre-recorded cassette tapes to help teach the basic principles and theories of electronics was announced by RCA Institutes. The cassette system is geared to the Institutes' Home Study School introductory electronics lessons for basic courses. The instructor whose voice is on the tape explains material and describes the schematic illustrations in easily understood terms as the student reads the text.

The most frequently asked question about loudspeakers:

Does the sound of a speaker depend upon the method by which the air is moved?

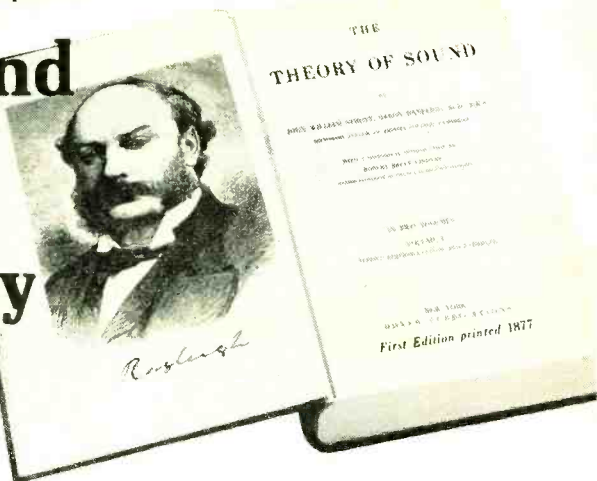

All speakers sound different from each other and when you hear a difference between two speakers that employ different principles of moving the air, it is only natural to wonder whether the variance in sounds is a consequence of the principles involved. After all, moving the air is what produces the sound.

Back in the 1950's, when electrostatic speakers reached a peak of popularity, some people thought that they might have a fundamental advantage because of the lower mass of the moving element compared to that of a cone speaker. Then, in the 1960's, ionic speakers were developed with no moving parts at all, and therefore, zero moving mass. Today, in the 1970's, a wide variety of transducers exists using principles ranging from piezoelectric to magnetostrictive, which either push the air with a diaphragm or squeeze the air out between moving surfaces.

Indeed, some of the principles of moving the air do have advantages over others in terms of size, weight, efficiency, and cost. But there is absolutely no advantage of any particular method of moving the air in terms of the potential quality of the sound that can be produced.

Let's see why this is so. We experience sound through the medium of acoustic waves traveling in air. It has long been known¹ that once the air is set into motion, it moves by the laws of acoustic wave propagation which are totally independent of the method by which the air was set into motion.

Therefore, a source (speaker) influences the sound field only through the amount of air it moves at each frequency and through the directions that the speaker moves the air. The method of moving the air in no way affects the sound that you hear.

In a basic experiment presented at a meeting of the I.E.E.E. professional group on Electroacoustics in 1964, it was demonstrated² that a multiplicity of full-range cone speakers can produce music that is subjectively identical to that produced (with the aid of computer simulation) by an ideal massless membrane free of all resonances and distortion. While this very basic result was proved only for full-range cone type speakers, the above discussion indicates that the same result could be obtained by the use of other types of full-range speakers as well. Thus, the secret of excellent performance doesn't lie in the type of speaker used (i.e. the way the air is moved). It lies in the use of a multiplicity of full-range speakers in one enclosure, in the exact proportioning of the ratio and the directions of direct and reflected sound radiated by the total enclosure, in the precise equalization of the speakers to radiate the correct balance of frequencies, and in extreme quality control measures that select and match all the speakers in the enclosure.

To fully appreciate the effect of a multiplicity of full-range speakers, with precise equalization and the optimum combination of direct and reflected sound, simply A-B the BOSE 901 Direct/Reflecting[®] speaker with any other speaker. Hear why the BOSE 901 is the most highly reviewed speaker regardless of size, price, or type of speakers.

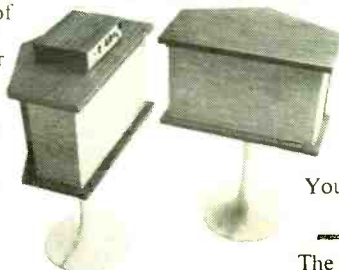

References

1. The Theory of Sound, Vol. 1. By J.W.S. Rayleigh, 1877.
2. The results are documented in the Audio Engineering Society Paper, ON THE DESIGN, MEASUREMENT AND EVALUATION OF LOUSPEAKERS, by Dr. A. G. Bose. Copies are available from the Bose Corporation for fifty cents.

For complimentary copies of the reviews, circle your reader service card or write Dept. EP

You can hear the difference now.

BOSE[®]

The Mountain, Framingham Mass.

CIRCLE NO. 2 ON READER SERVICE CARD

The SQ decoder with cover removed to show PC board and the wiring. Two enclosures at right are the Ten-Tec (top) and the Instruteck (bottom). See article for details on both cabinets.



SQ FOUR-CHANNEL DECODER

BY MURRAY ESFORMES

Vice-President, Engineering, Instruteck Corporation

Build this decoder, using an IC chip, that offers performance equal to or exceeding that of some commercially available units.

FOUR-CHANNEL sound offers the promise of a new creative medium for the recording artist and an expanded spatial perspective for the listener. Investigation by CBS of the various possible methods of recording four channels on a two-channel disc has led to the development of the stereophonic-quadrasonic (SQ) matrix system. Through a suitable encoding matrix, it can be used to produce a 2-channel stereo record that can be played on a conventional phonograph and then it can be decoded back to four channels by means of an inverse matrix.

The SQ matrix decoder described in this article has been specifically designed, through the joint efforts of CBS Labs, Motorola, and Instruteck, to reproduce SQ Quadrasonic records: CBS Labs setting the standards of performance; Motorola supplying the integrated circuit; and Instruteck fulfilling the equipment requirements for the decoder.

The SQ Code. To understand how the decoder operates, a bit of basic knowledge about how the signals are encoded onto the record is required. When the record is cut,

the basic SQ code calls for the two front quadraphonic channels, L_F and R_F , to be recorded in precisely the same mode as the L and R channels of a conventional stereo disc, thus retaining full front-channel separation.

The back channels, L_B and R_B , are superimposed on the front channels so that the quadrature image is described by the relative phase and amplitude of the signals in the grooves. The left total signal, L_T , is a combination of three signals: the left back, L_B , the right back, R_B , and the left front, L_F . The right total signal, R_T , is also composed of three signals: right back, R_B , left back, L_B , and right front, R_F . It then remains to separate the back and front signals from the total signals.

Theory of Operation. The inputs, L_T and R_T , are derived from the outputs of a standard stereo cartridge or the outputs of a preamplifier. Most popular cartridges possess reasonably well-matched amplitude and phase characteristics and can be used with this decoder.

As shown in Fig. 1, the L_T/R_T signals are applied to input amplifiers whose function is to provide an impedance transformation with high impedance on the input so as not to load the incoming signals and low impedance on the output to drive the phase-shift networks. The signal is then split into two branches containing a reference psi-network ($\psi-0^\circ$) and a psi-plus quadrature network ($\psi-90^\circ$), respectively. The psi networks have been computed to provide a constant phase shift of 90° across a band of frequencies from 100 to 10,000 Hz. The merging L_T and R_T signals are fed to the output terminals, unaltered, to form the L_F and R_F outputs, while an appropriate combination of the four phase-shifted signals produces the L_B and R_B outputs. The first pair of outputs, pins 1 and 10, contains dominant L_F and R_F components which are completely isolated from each other and therefore have infinite channel separation. The second pair of outputs, pins 4 and 13, contains dominant L_B and R_B signals which are also completely isolated from each other and thus exhibit infinite channel separation as well.

Portions of signals from the front channels are combined with the back channels of the opposite side (the precise magnitude of the combining signals being indicated by

numerical values at the input to the output amplifiers). The previously described circuit characterizes the basic SQ decoding function; it provides completely discrete front and back channel performance with partial signal transfer between front and back pairs. On the output lines of the decoder, resistors $R9$ and $R10$ are connected across the front and back channels, respectively, through switch $S2$. When the switch is placed in the "Blend" position, cross-channel contamination yields a 10%-40% blend recommended by CBS for matrix operation. It is largely a matter of preference to the listener if the "Blend" mode of operation is desired, since in the unblended mode the left/right channel separation, both front and rear, is the greatest.

Construction. The entire decoder has been reduced to an integrated circuit which operates in conjunction with external phase-shift networks. See Fig. 2.

The integrated circuit assures a high standard of performance when used in conjunction with the specified components, not always attainable with its discrete component counterpart. A foil pattern and component installation are shown in Fig. 3.

The "SQ" decoder described may be used as a separate unit, or the decoder circuitry can be incorporated into existing equipment. The integrated circuit with its precision phase-shift components is available from Instruteck as well as a more complete set of specialized parts, including an etched-circuit board.

The custom cabinet, as supplied by Instruteck, is of wood-pulp flakeboard construction with a vinyl walnut-veneer finish. It is supplied as a flat board and will have to be folded and glued.

Another alternative is a fully assembled, decorator-type cabinet supplied by Ten-Tec as the No. JW-10. For details as to the nearest dealer in your area, write to Ten-Tec, Sevierville, Tenn. 37862. This particular cabinet is just slightly smaller than the Instruteck enclosure. A chassis is also available from them, but is not required as the printed-circuit board can be mounted on the cabinet itself. With this particular enclosure, you can dress up the front panel by using press-on type.

In the case of the cabinets supplied by Instruteck, you will have to obtain a Bud #AC406 chassis, or if you are handy with

PERFORMANCE VERIFICATION

For those with access to an audio oscillator and ac voltmeter, the final performance of this decoder should be checked, using the simple procedure outlined below. Note: This test should be done with the decoder disconnected from all other equipment in your audio system.

1. Equipment required: (a) an audio oscillator capable of 1.5-V rms output at 2200 Hz; (b) an ac voltmeter with 1-megohm input impedance.

2. Set the audio oscillator to 2200 Hz, connect the oscillator to the "L" input jack (J4) of the decoder; set the output of the oscillator to 1.0 V rms as measured with the ac voltmeter.

3. Place the decoder "Mode" switch in the "Phono/Tuner" position and set the "Master Gain" control to its maximum clockwise position. Set the "Blend" switch to "Blend" position (R9 and R10 in the circuit).

4. With the ac voltmeter connected to the left-front output jack (J10), adjust the audio oscillator until the voltmeter reads precisely 1.0 volt rms (the audio oscillator output may have to be increased slightly). This is the reference setting.

5. Measure the outputs with the ac voltmeter: J9, left-back, 630 mV \pm 80 mV; J8, right back, 630 mV \pm 80 mV; J7, right front, between 50 and 100 mV.

6. Repeat steps 2, 3, 4, and 5; this time using J3, the right input jack, and J7, the right front, for the reference setting. Look for the following results: J8, right back, 630 mV \pm 80 mV; J9, left back, 630 mV \pm 80 mV; and J10, left front, between 50 and 100 mV.

7. If the results of steps 5 and 6 are not attainable, it might be wise to examine the phase shifters on the circuit board for wrong component insertion.

tools, you could bend a piece of aluminum or sheet metal into a "U" shape, 9 $\frac{1}{4}$ " wide \times 6 $\frac{3}{4}$ " deep \times 2 $\frac{3}{8}$ " high. Instruteck will also make available a very impressive metallic decal that can be pressed onto the front panel of the chassis.

One point should be mentioned and that is the "on-off" switch which is shown in the secondary of the power transformer. Obviously, the primary of the transformer will always be connected to the power line with this particular arrangement. The wattage is

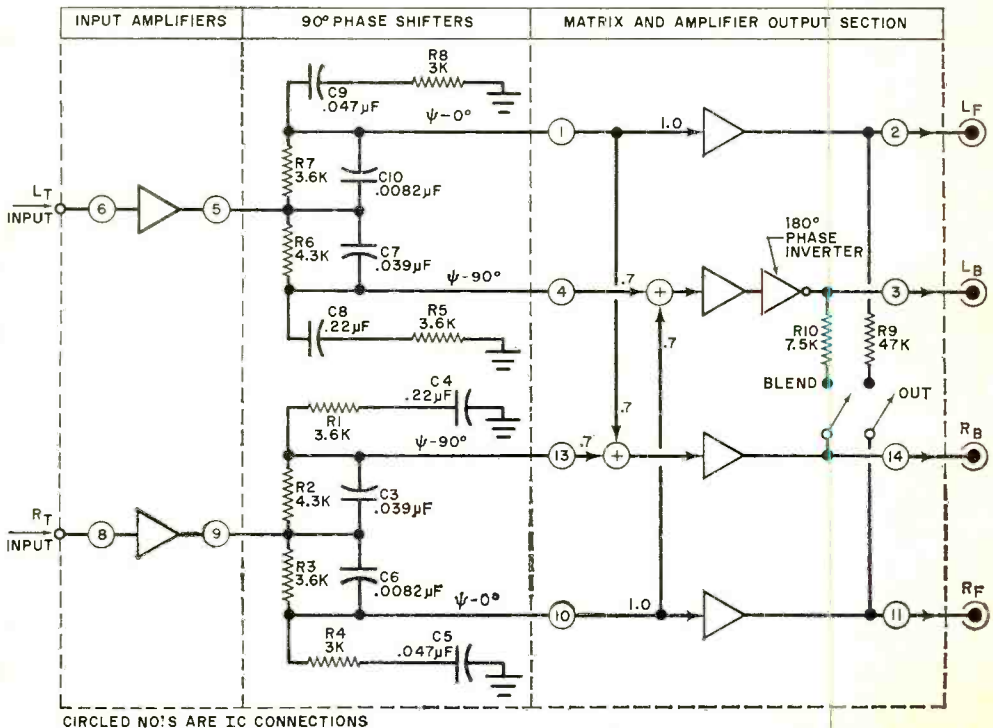
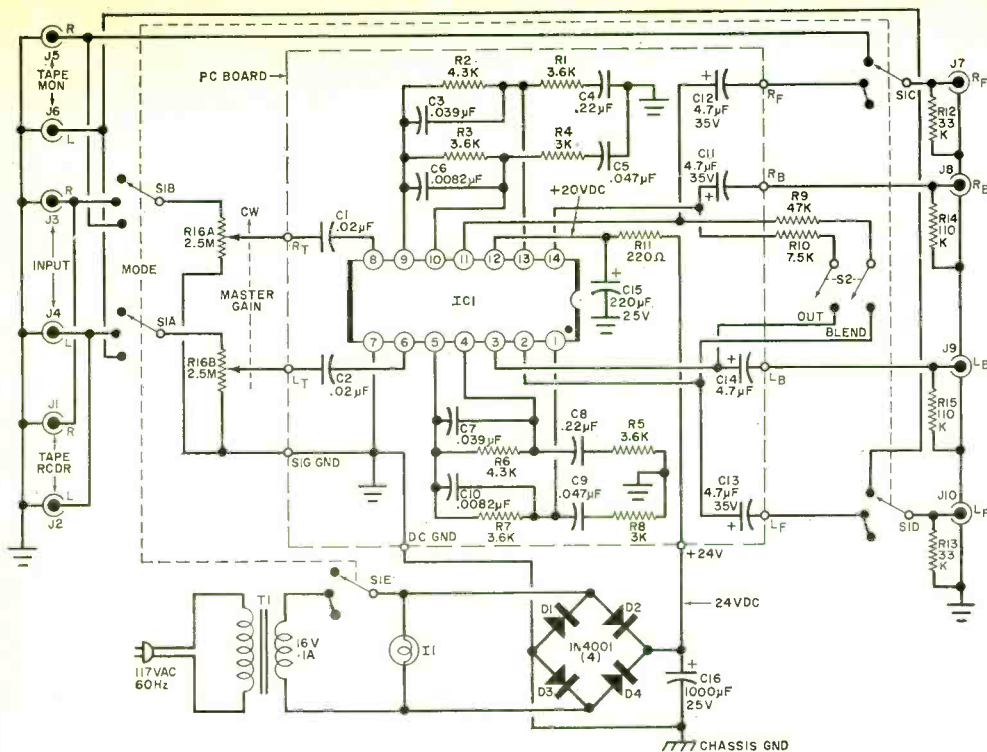

Fig. 1. Block diagram of SQ decoder. Circled numbers are IC connections.



PARTS LIST

- C1, C2*—0.02- μ F, 100-volt disc ceramic capacitor
**C3, C7*—0.039- μ F, 100-volt 10% Mylar capacitor
**C4, C8*—0.22- μ F, 100-volt 10% Mylar capacitor
**C5, C9*—0.047- μ F, 100-volt 10% Mylar capacitor
**C6, C10*—0.0082- μ F, 100-volt 10% Mylar capacitor
C11-C14—4.7- μ F, 35-volt electrolytic capacitor
C15—220- μ F, 25-volt electrolytic capacitor
C16—1000- μ F, 25-volt electrolytic capacitor
D1-D4—1N4001 diode
I1—18V, 0.04A light (#346 or similar)
IC1—Integrated circuit (Motorola MC1312P)
J1-J10—Phono jack
**R1, R3, R5, R7*—3600-ohm, $\frac{1}{2}$ -watt 5% resistor
**R2, R6*—4300-ohm, $\frac{1}{2}$ -watt 5% resistor
**R4, R8*—3000-ohm, $\frac{1}{2}$ -watt 5% resistor
R9—47,000-ohm, $\frac{1}{2}$ -watt 5% resistor

- R10*—7500-ohm, $\frac{1}{2}$ -watt 5% resistor
R11—220-ohm, $\frac{1}{2}$ -watt 5% resistor
R12, R13—33,000-ohm, $\frac{1}{2}$ -watt 5% resistor
R14, R15—110,000-ohm, $\frac{1}{2}$ -watt 5% resistor
R16A, R16B—2.5-megohm tandem, audio taper potentiometer
S1—5-pole, 3-position selector switch
S2—Dpdt slide switch (R9 and R10 mounted on unused throw)
T1—Power transformer; secondary: 16V at 0.1A (Stancor P-8611. Use half of secondary.)

**Close-tolerance, phase-shift components. Do not substitute.*
Misc.—Chassis (Bud #AC406), line cord, grommet, mounting hardware, etc.

Note: The following are available from Instrutek Corp., 168 Yantic St., Norwich, CT 06360: etched and drilled PC board at \$2.95; complete set of phase-shift components (marked with * above) with IC1 at \$13.35; etched and drilled PC board and all parts mounted thereon, including R9 through R15 and IC1 at \$19.95; cabinet at \$10.50; decal for front panel at \$2.00.

Fig. 2. Schematic and parts list for the SQ decoder. See text and parts list for details on obtaining the etched circuit board or kit of certain components.

extremely low and is less than that drawn by an ordinary electric clock. For those who feel that they would prefer an "on-off" switch in the primary, there is no problem

in adding it to the circuit and on the front panel.

It is recommended that the copper foil side of the printed-circuit card be tinned

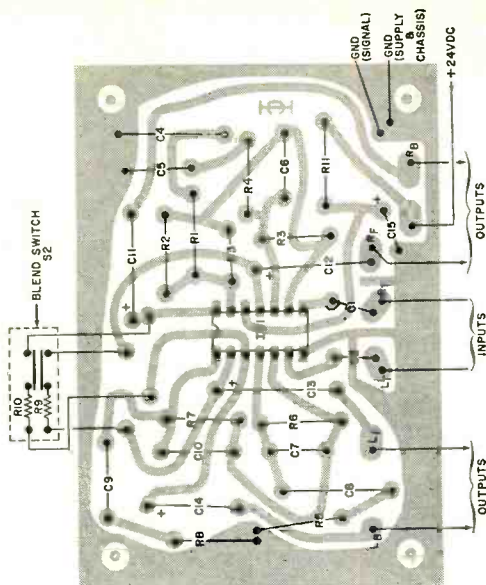
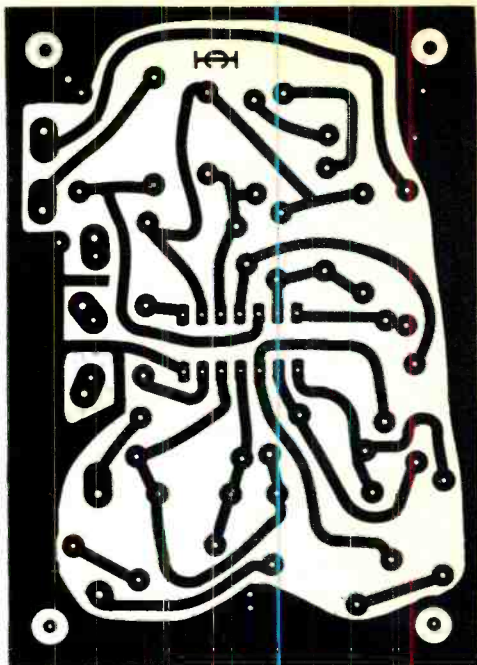

Fig. 3. Actual size foil pattern, right, and component installation for decoder.



prior to component insertion. Use a low-wattage soldering iron and small diameter, high-quality rosin-core solder. Make certain not to obstruct the holes in the printed-circuit card, especially the integrated circuit. It is also recommended that the integrated circuit be soldered in last to avoid overexposure to soldering heat.

The printed-circuit board is mounted on four plastic stand-offs in the horizontal plane but could be mounted vertically with no effect on its operation.

The ten phono jacks, providing the various inputs and outputs, should be mounted on the back vertical wall of the chassis. Insulated jacks are recommended so as to minimize ground-loop hum-inducing effects.

TECHNICAL SPECIFICATIONS

Input Voltage: 0.1 to 1.0 rms
Gain: Front channels, 1.0 (typical)
 Rear channels, 0.7 (typical)
Frequency Response (normalized):
 30 to 20,000 Hz within 2 dB (± 1 dB)
Input Impedance: 2 megohms (typical)
Output Impedance: 5000 ohms (max)
Hum and Noise: -60 dB
Phase Linearity (for any back-channel output referred to the front-channel output): $\pm 5^\circ$ from 100 to 10,000 Hz
Maximum Output Voltage: 2.0 rms

Connections. Normally a set of "tape-monitor" connections on the existing stereo amplifier/receiver provide the proper signal source, plus a way to return the decoded front signals to the existing amplifiers. The rear-channel signals may then be connected to an additional stereo amplifier which, in turn, is connected to a set of rear speakers, as shown in Fig. 4.

On systems lacking a tape-monitor function, minor modifications are required on the existing equipment to introduce the decoder between the program material and the amplifiers for proper decoding of the signals.

Operation. After the decoder is connected as shown in Fig. 4, power may be applied by placing the mode selector switch, S1A and S1B, in the "Phono/Tuner" position. In this mode, dc power is applied to the decoder and any program material appearing on the input terminals will be decoded. The "Master Gain" control will set the overall level of the decoded material appearing at jacks J7, J8, J9, and J10.

If it is desired to play a pre-recorded tape through the decoder, place the "Mode" switch in the "Tape" position and start up the player. If direct stereo operation is desired, without going through the matrix circuit, turn the decoder "Mode" switch to

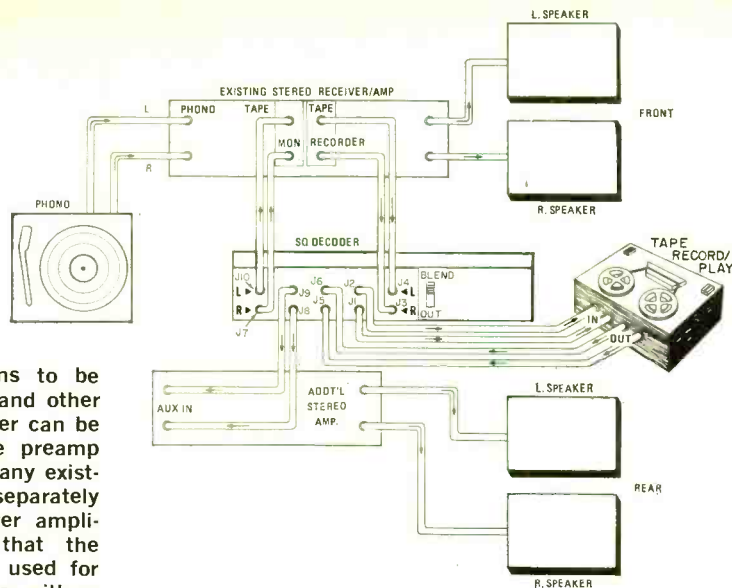

Fig. 4. Inter-connections to be used between decoder and other parts of system. Decoder can be connected between the preamp and power amplifier of any existing hi-fi receiver or any separately housed tuner and power amplifier. It is assumed that the present hi-fi system is used for the two front speakers with a second stereo amplifier and its two speakers added for the back.

"Off" and normal stereo operation will result.

Note: To introduce the decoder into the front channels, the tape-monitor function of the existing stereo must be on.

The decoder can also be used in a variety of other applications, including: (1) de-

code FM stereo transmissions when quadrasonic matrix program material is being broadcast; (2) play back tapes that have been recorded from quadrasonic broadcasts and/or records; (3) synthesize 4-channel operation from stereo discs, tapes, or FM transmissions. ♦

Editor's Note: There are now two main companies, CBS/Columbia and Sansui which have independently developed and are marketing decoders for developing four-channel sound from especially produced four-channel matrix discs.

The most publicized system is the CBS/Columbia SQ design. There are actually three SQ versions being marketed today. The one described in this article is the simplest and, obviously, the least expensive of the three. It does provide maximum separation (limited only by your program source) across the two front speakers and across the rear speakers. It provides approximately 3-dB separation from front to back. The second version, referred to as an SQ decoder with front-to-back logic, reduces the front and rear separation to about 14-15 dB but does increase the front-to-back separation to about 6-9 dB. The third system, and obviously the most sophisticated, is referred to as an SQ matrix decoder with full logic. This system will provide chan-

nel separation of 14-15 dB in all four directions—across the front and back and from front to back. Both the logic designs are produced today using discrete components. The circuits are quite complicated and critical to adjust and we do not think, at the moment, that they are quite suitable for home construction.

Circuit designs have been developed, based on two new integrated circuits; and Motorola, the semiconductor manufacturer, hopes to have samples in the hands of manufacturers some time this year. We hope, when these chips are available in quantity, to work up an article on the design and home-construction of a full-logic SQ decoder. In the meantime, this simpler design is an ideal project to tackle and is an excellent way of getting involved with four-channel reproduction. This SQ decoder, when completed, does not require any adjustments. All of the individual component circuits are so designed that they provide the proper performance.

NOISE REDUCING

Descriptions of the Dolby, JVC ANRS, Philips DNL, dbx,

IMPRESSIVE advances have been made in magnetic tape technology. Narrow-gap tape heads and low-noise electronics have become almost commonplace. Even so, cassette recorders continue to suffer from relatively poor signal-to-noise ratio (S/N) figures when compared to standard open-reel tapes and phonograph records.

The S/N problem stems basically from the very narrow track width (about 0.020 in.) that severely limits the amount of energy that can be stored on the tape; and, therefore, the playback output voltage is low. Both theoretical and practical considerations set a lower limit on the amount of noise present in the tape and electronic circuits. Consequently, the S/N ratio is necessarily lower than in open-reel recorders with their wider tape tracks.

Random noise, predominantly at the higher frequencies, commonly known as "hiss," is the most audible and objectionable cassette noise. A low-pass filter could be used to attenuate the cassette system's output above a certain frequency (typically in the 3000-7000-Hz range) to eliminate or vastly reduce hiss. However, this approach inevitably sacrifices some high-frequency program content along with the ridding of the hiss; so, it is unacceptable for high-fidelity applications.

It is possible to reduce noise, or more accurately improve S/N, without audibly affecting the reproduction of high-frequency signals. To do this, one of two basically successful approaches can be used. In an open-ended system, the noise reduction occurs entirely during playback and requires no special processing of the recorded program. On the other hand, in a closed system, the original program is modified in a predeter-

mined manner and complementary modification is used during playback.

Compressor/Expanders. The combination of a compressor and an expander form a typical closed noise reduction system. Low-level signals are amplified more than stronger signals so that they are not lost in the tape noise during recording. For example, a re-



The dbx 117 compressor/expander unit.

order with a 50-dB dynamic range—the ratio between the noise level and the maximum signal level that can be recorded without excessive distortion—cannot handle a program with a 70-dB dynamic range. The lowest 20 dB of the program will be submerged in the noise and be irretrievably lost. By compressing the recording so that the weakest signals are amplified 20 dB more than the strongest, the program's dynamic range can be reduced to 50 dB so that weak signals are not below noise level.

It is necessary to expand during playback to restore the dynamics of the original program. The expander reduces the playback gain for low-level signals so that (in the example cited) the weakest signals are returned to a level 70 dB below the strongest signals. In the process, any noise introduced during

SYSTEMS FOR CASSETTES

and Kenwood De-Noiser

BY JULIAN D. HIRSCH, Hirsch-Houck Laboratories

recording and playback is reduced by 20 dB. Hence, the recorder has not added any noise to the program.

At first glance, the compressor/expander system appears to be an excellent solution to the noise problem. A closer look, however, will reveal several serious drawbacks. For example, compression and expansion occur at *all* program levels even though the degree varies with level. Also, the actions do not occur instantaneously. And whatever the time constants used, the compressor and expander must have exactly the same values and exactly inverse input/output characteristics.

The results can be excellent when all conditions are satisfied. But even a slight difference between the two processes can result in a "breathing" or "pumping" effect that can be as disturbing as the original noise problem because it can occur even at full program levels. Also, a compressed program often sounds rather unnatural when played through a linear, or non-expanding, system. This means that a compressed recording must be played through the proper expander.

On occasion, compressor/expanders have been offered to the high-fidelity tape record-

ing enthusiast even though most have not met with commercial success. One such unit currently available is the dbx 117 made by dbx, Inc., of Waltham, Mass. It has a wide-range, continuously adjustable compression/expansion slope. Though it can be used as part of a closed system, it can also be used as an "open-ended" compressor or expander. Our tests revealed the dbx 117 to be effective in tape recording noise reduction, but careful adjustment of the two characteristic slopes is required to avoid the "pumping" effect.

Dolby "B" System. The well-known Dolby "B" Noise Reduction System, probably the most popular system extant, is similar in some respects to the compressor/expander system. It does, however, have some very important and basic differences. Although it is a closed system, it is in wide use, offered as a built-in feature in many high-quality cassette recorders. Many commercial cassettes are now recorded with the Dolby process.

The unique operating characteristics of the Dolby "B" Noise Reduction System are:

1. It affects only the high frequencies, in accordance with the frequency content of

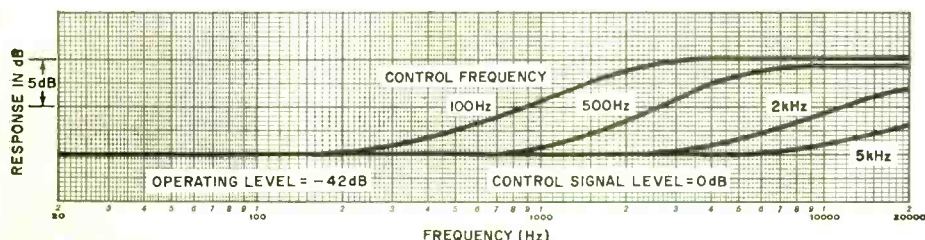

Fig. 1. Frequency response during a Dolby "B" recording. The control frequency moves up and down, depending on the high-frequency content of original program material.

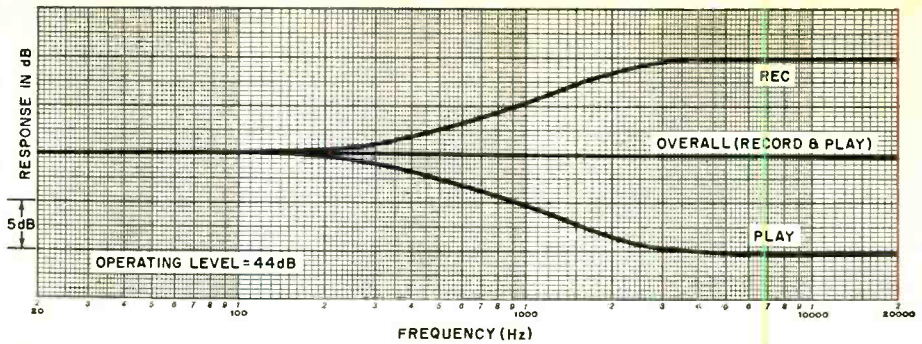
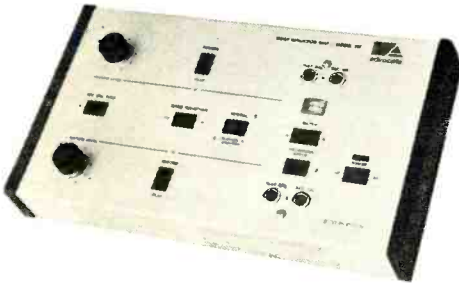

Fig. 2. Recording and playback response for Dolby "B" material. Overall response is flat. If Dolby system is not used for playback, response will rise at high end.

the program material. When highs are present, the Dolby action is inhibited because the program will then mask the hiss. If no highs are present, the Dolby action (a high-frequency boost during record and a high-frequency cut during play) starts at about 500 Hz. When higher frequencies are present, the Dolby operating frequency shifts upward to affect only the noise that is higher in frequency than the signal. This is illustrated in Fig. 1 which was prepared from data furnished by Dolby Laboratories. In Fig. 2 is illustrated the complementary recording and playback response characteristics that together produce a flat overall frequency response at any level.

2. It functions only at low program levels



Advent 101 Dolby "B" Noise Reduction Unit.

(-15 dB and down). The degree of compression and expansion is an inverse function of the level. Therefore, any side effects due to attack or decay time constants occur at low levels that are inaudible.

The levels and operating characteristics of the Dolby system are tightly controlled and adhered to by all Dolby licensees. As a result, a recording made on any Dolby-equipped deck can be played back on any other similarly equipped deck, with a flat overall frequency response and a noise

reduction of 6 to 10 dB. A Dolby tape can also be played through a deck not equipped with the Dolby Noise Reduction System. It will sound "bright" and somewhat noisy, but it can be made listenable with amplifier tone controls.

JVC ANRS System. Similar in some respects to the Dolby system is a closed noise reduction system developed by the Victor Company of Japan. It is known as the Automatic Noise Reduction System (ANRS). In addition to a completely different circuit approach, the ANRS controls the response at high frequencies starting at a fixed frequency of about 500 Hz. Although the "hinge" frequency is not controlled by the frequency content of the program, the response curves vary in accordance with program level and frequency characteristics.

An attempt has been made to make the ANRS characteristics resemble those of the Dolby system as much as possible. Since they are not identical to the Dolby characteristics, a Dolby recording will not play back with a flat response on an ANRS deck. The differences are not great, typically about 5 dB at the higher frequencies. It is often possible to hear a noise "swish" when playing a Dolby recording or a solo instrument or voice through an ANRS setup. Generally, though, the ANRS can yield satisfactory results when playing Dolby material, and it affords about the same degree of noise reduction. As with the Dolby Noise Reduction System, an ANRS-processed tape can be played through a deck not equipped with ANRS circuitry, but it will sound bright and noisy.

Philips DNL. Open-ended noise reduction systems are essentially dynamic low-pass fil-

ters whose cut-off frequencies and/or attenuations are controlled by the level, and sometimes the frequency content, of the program material. They have the advantage of being usable with any program source, owing to the fact that they do not depend on complementary recording and playback characteristics.

Currently, the most widely used open-ended system is the Philips Dynamic Noise Limiter (DNL) that is used in some Norelco cassette decks. It employs a cancellation circuit that produces the effect of a very sharp cut-off filter with an 18-dB/octave characteristic at very low signal levels. It takes effect at frequencies above 4000 Hz. The amount of noise reduction increases with frequency, ranging from about 10 dB at 600 Hz to about 20 dB at 10,000 Hz (with no signal present). The action is controlled to some extent by the high-frequency content of the program material.

As is common with all open-ended noise reduction systems, the DNL system can generate audible side effects, usually a "swish" of noise as it goes into and out of operation on a solo instrument or voice. With more complex material, its action is less noticeable.

Kenwood "De-Noiser." Similar to but more sophisticated than the Philips DNL system is the approach used in the Kenwood Model KF-8011 "De-Noiser." An add-on



Kenwood KF-8011 De-Noiser accessory.

accessory, it connects to the recorder's inputs and the outputs of an amplifier or receiver. It contains four band-rejection filters that cover the ranges of 3000-4500, 4500-6500, 6500-10,000, and 10,000-15,000 Hz. Rejection in each band is controlled by the program content in that band so that the action of the De-Noiser has a minimal effect on high-frequency signal components. The filters can be switched in or out by individual pushbuttons, and the threshold level, below which they operate, can be varied over wide limits.

The KF-8011 can reduce hiss by 6 to 15 dB. When properly adjusted, it goes into



Norelco 2100 cassette deck with DNL.

action only at levels of -35 dB and below and has almost no effect on program content. However, it exhibits the same "swish" characteristic of the DNL, especially when the program contains an appreciable amount of noise.

Concluding Remarks. From our experience, we judge the Dolby "B" Noise Reduction System to be the most effective approach to reducing noise in cassette systems, mainly because its operation is never audible to the listener. The widespread use of the Dolby system also allows interchangeability of recording and playback equipment and the playing of commercial cassettes with the benefits of noise reduction.

For most practical purposes, JVC's ANRS is about as effective as the Dolby system in noise reduction and is "quasi-compatible" with it. But no commercially recorded ANRS material is available. Hence, its value lies chiefly in making and playing home recordings.

The dbx 117, at least potentially, can provide more noise reduction than any of the other systems (about 20 dB). It is also effective at all frequencies and can therefore reduce recorder hum and other low-frequency noises ignored by the other systems. However, tapes made with it cannot be properly played without the use of the same device, and it requires more care in setup and adjustment to yield the best results.

The Philips DNL and Kenwood KF-8011 systems are less ideal than the closed systems since under certain conditions their action can be heard. However, the rather expensive (\$220) KF-8011 can "De-Noise" FM programs and can be switched to reduce noise in a signal *before* it is recorded as well as during playback.

Each of these systems can make a worthwhile contribution to cassette recording. Once you have discovered how quiet a processed cassette can be, it is not easy to accept "hissy" recordings. ♦

14 ways to help you earn more money



TV Servicing



Air Condition-
ing/Heating



Automotive



Computer
Programming



Accounting



Engineering



Electrician



Interior
Decorating



Business
Management



Hotel, Motel
Management



Airline/Travel



Secretarial



Drafting



Electronics

Take one of these 14 Career Guidance Booklets and "Demonstration Lessons"—free—and find out how you can now start developing the skills you need to succeed in a better-paying career.

In today's fast-moving world, you can move up to a better-paying career in less time than you may think. If you choose a career field that's right for you. And if you can get the kind of career training that today's employers are willing to pay big money for.

To help you choose the right career field, we have listed 14 opportunities on the attached postpaid card and in the coupon below. You are invited to discover everything you want to know about the field you like best, by simply mailing the card (or coupon) for a free Career Guidance Booklet.

Your free booklet will describe the opportunities, income and job security you might expect in your newly chosen field. It will also explain how ICS can help you prepare for this—in your spare time...in your own home...regardless of your past experience.

In addition, you'll receive a free "Demonstration Lesson" that lets you see for yourself why you can prepare for your new career—the ICS way—in much less time than you may think.

Major corporations use ICS career training

Please bear in mind, as you fill in the attached postpaid card, that more than 8,500,000 men and women have turned to ICS for career training, since 1890. Some 2,000 American firms and government agencies are also using ICS training programs to upgrade and update their employees. Among these firms are such names as Ford, U.S. Steel, Chrysler, Mobil, DuPont, ITT, IBM, General Motors, 3M Company, Alcoa, Pan Am, GE, Motorola, and RCA.

ICS career training is Approved for Veterans, and is Accredited by the Accrediting Commission of the National Home Study Council. Now it's *your* turn to discover how ICS can start *you* in a rewarding new career. Just mail the attached postpaid card today.



(If card is missing, please fill in the coupon below and mail it to: ICS, Scranton, Pennsylvania 18515.)

Take one of these Career Guidance Booklets—free!

ICS International Correspondence Schools
Scranton, Pennsylvania 18515

Please send me free booklets and a free "Demonstration Lesson" for the field I have checked below. I understand that I am under no obligation.

1. ACCOUNTING

- Business Accounting
- Bookkeeping
- CPA Training
- Income Tax Specialist

2. BUSINESS MANAGEMENT

- Business Administration
- Executive Management
- Industrial/Production Management
- Marketing/Advertising/Sales Management

3. COMPUTER PROGRAMMING

- Programming Concepts
- COBOL System 360
- Fortran IV

4. SECRETARIAL

- Medical
- Legal
- Executive

5. MOTEL/HOTEL MANAGEMENT

- Motel Management
- Club/Restaurant Management
- Resort Manager
- Hotel Executive

6. INTERIOR DECORATING & DESIGN

- Interior Decorator
- Interior Designer
- Advanced Interior Designer

7. ELECTRICIAN

- Master Electrician
- Practical Electrician

8. DRAFTING

- General Drafting
- Specialized Training (Arch., Mech., Struct., Electrical, Aircraft, Electronics)

9. AUTOMOTIVE

- Master Mechanic
- Air Conditioning Specialist
- Body Rebuilding Specialist
- Diesel/Gas Mechanic

10. ENGINEERING

- Mechanical Civil
- Chemical Industrial
- Electrical-Electronics
- Surveying & Mapping

11. AIRLINE/TRAVEL

- Reservation and Communication Specialists
- Ticket Agent
- Travel Agent

HIGH SCHOOL. (Earn a High School Diploma.)

- Check here for special information, if age 16 or under.

Miss _____ XA 685 W
Mrs. _____
Mr. _____ Age _____

Address _____ Apt. _____

City _____ State _____ Zip _____

Approved for Veterans Training. Eligible Institution under the Guaranteed Student Loan Program. Accredited Member National Home Study Council. Canadian residents use coupon address for service from ICS Canadian, Ltd. In Hawaii: 931 University Ave., Honolulu, Hawaii 96814.

The Zener Diode

Theory and Applications

HOW A ZENER DIODE WORKS AND

HOW TO PUT IT TO WORK FOR YOU

ZENER diodes, solid-state's answers to voltage regulators, are versatile semiconductors with many applications. Used alone or in combination with other semiconductors, the zener diode provides stable and accurate control and instrumentation, high-performance regulated voltage and current supplies, and many other functions in today's circuits.

Available in voltage ratings from several to several hundred volts and power ratings from a fraction of a watt to fifty watts or more, the devices provide a wide choice for the experimenter working with many different types of circuits. Here is an introduction to the internal operation of the diode and its terminal characteristics, plus a description of some of its many applications.

Diode Physics. The zener diode is a silicon pn junction. A silicon crystal is practically nonconductive at room temperatures because it lacks appreciable numbers of free

electrons. However, the addition of controlled amounts of specific impurities to the crystal imparts conductivity and creates the pn junction. Adding phosphorus atoms to the crystal forms n-type material having a number of free electrons serving as current carriers. Adding boron forms p-type material having movable holes which assist electron conduction by movement of holes. Figures 1A and 1B show the crystal atoms of n and p material formed within the crystal.

A zener diode is operated in reverse bias with positive voltage on the n side. Figure 2A shows the diode under reverse bias but below the diode breakdown or zener voltage. The n-type side is heavily doped with phosphorus, imparting a high population of free electrons (-) and the p side is lightly doped with boron to give a sparse population of movable holes (+). By repelling action of like charges, the applied voltage has cleared or depleted a zone of all

movable current carriers. The depletion zone now contains fixed plus charges (ionized atoms) on the n side of the barrier and fixed minus charges (filled holes) on the p side.

The fixed charges set up an electric field, E , directed from (+) to (-). An electric field always has an associated potential or voltage with plus on the positive charges and minus on the negative charges. This is designated as V_i , the internal voltage developed in the depletion zone. Note, in particular, that V_i bucks or opposes the applied reverse bias voltage. With only a momentary flow of current from V_R , the depletion zone rapidly widens until enough space charges are developed to produce an internal voltage just large enough to buck out V_R . Current ceases but for a slight leakage current.

When V_R is increased, the zone widens, especially into the lightly doped p side, uncovering equal numbers of plus and minus fixed charges. But this process cannot continue without limit. At a sufficiently high

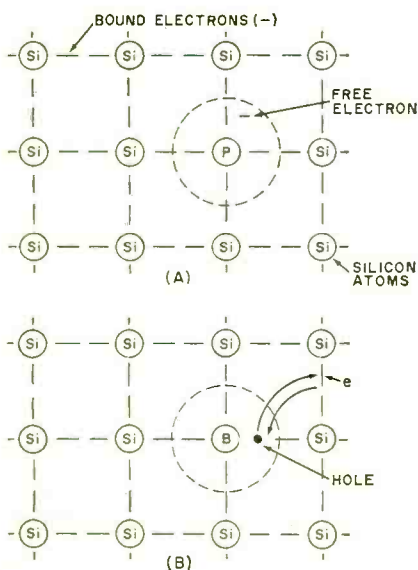

Fig. 1. (A) Phosphorus has five outer electrons and one is free. The electric field set up by a voltage moves this electron away leaving a fixed plus charge. (B) Boron has 3 outer electrons, one short of filling lattice, leaving a hole. A nearby electron can fill hole leaving fixed minus charge. New hole is considered a movable plus charge. Current flows by succession of electron-hole interchanges.

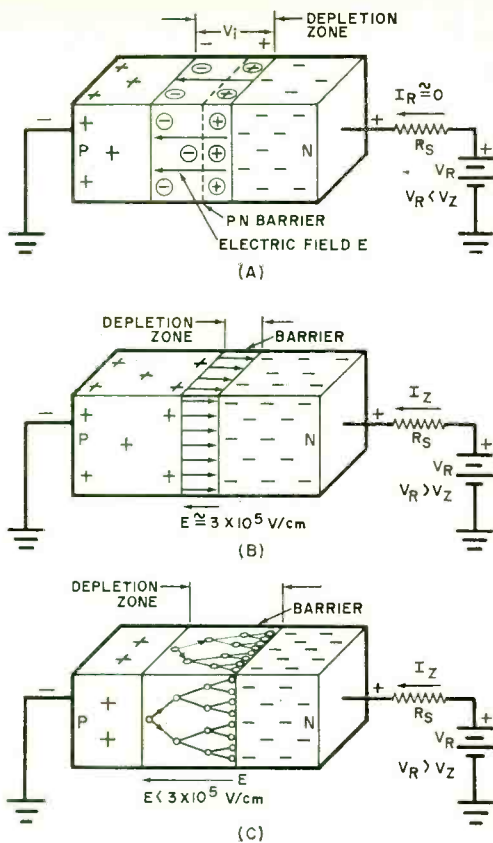

Fig. 2. (A) Electric field has cleared depletion zone of movable electrons and hole carriers. Only slight leakage current flows due to residual carriers. Depletion zone extends mostly into lightly doped p side. (B) Diode in zener breakdown. Moderate doping on p side results in narrow zone. High field tears away bound electrons generating electron-hole carriers. Electrons move toward plus terminal and holes to minus. (C) Diode in avalanche breakdown. Light doping on p side holds field below zener level. But stray carriers in lower field dislodge electrons by collision. Each dislodging collision produces electron-hole pairs which in turn dislodge additional carriers causing an avalanche of the carriers by collision.

reverse voltage, the zone suddenly breaks down and results in high current flow. Breakdown is either by the zener mechanism or by the avalanche mechanism—depending on doping levels and zone widths.

Zener breakdown occurs in diodes rated at below five volts. The diode is heavily

doped on the n side and moderately doped on the p side. As a result, the required zone width to buck out V_R is narrow. In the narrow zone, heavily populated with fixed charges, electric field E can reach sufficient strength to tear away bound electrons of the atoms thereby generating great numbers of electron-hole pairs. This causes a high current flow which can destroy the diode unless limited by R_s to safe values. Figure 2B illustrates zener breakdown in a narrow zone. Arrows symbolize the sudden release of many bound electrons flowing to plus terminals. Holes, not shown, flow to negative terminals. Because bound electrons of atoms are less strongly held in place with increasing temperature, the zener breakdown voltage drops at higher temperatures, imparting a negative temperature coefficient to the zener voltage.

Avalanche breakdown predominates in diodes breaking down above 7 or 8 volts. In such diodes, the n side is heavily doped but the p side is lightly doped. As a result, the depletion zone spreads much farther into the p side with applied reverse bias. In the wide depletion zone, electric field E fails to reach zener field strength levels by the onset of avalanching at lower field strengths. As field E builds up with increasing V_r , residual current carriers within the zone pick up more velocity and energy. In

carriers (carrier multiplication). Figure 2C depicts carrier multiplication by avalanching in the wide zone. The avalanche mechanism has a positive temperature coefficient on V_z . This is the result of the delay in velocity buildup of carriers caused by more frequent nondislodging collisions occurring at high temperatures.

Diodes in the range of 5 to 8 volts involve both breakdown mechanisms. These diodes can have a temperature coefficient near zero at a particular operating current. Both breakdown mechanisms, once initiated, are self-sustaining, drawing electrons from the voltage source. The diode exhibits positive resistance in the breakdown region and is inherently stable.

Terminal Characteristics. Biased in the forward direction, the diode performs much like the ordinary rectifier diode having a forward voltage drop of 0.75 to 1.0 volt. The diode is normally operated in the reverse bias region shown in Fig. 3. Specified characteristics include zener voltage V_{ZT} at test current I_{ZT} , dynamic impedance Z_{ZT} at test current I_{ZT} , maximum allowable current I_{ZM} , minimum operating current I_{ZK} , and reverse leakage current at voltage V_R .

Zener impedance largely determines how well the diode regulates voltage; Z_{ZT} is the small change in V_z divided by the corresponding change in I_z centered on test current I_{ZT} . Diode operation in or near the knee region at high dynamic impedance results in poor voltage regulation.

The effect of temperature on voltage V_z is a critical factor when the diode is used as a precision voltage reference in control systems, digital voltmeters, frequency standards, precision power supplies, and other high-accuracy applications. Diodes rated near five volts may have a coefficient near zero. Unfortunately, diodes rated under eight volts have a temperature coefficient which depends on the operating current. Thus, a five-volt diode can have a negative coefficient at low current, a zero value at an intermediate current, and a positive coefficient at high current. For this reason, precision reference diodes are operated at a specified current.

An avalanche diode can be temperature compensated by adding one or more forward-operated diodes as shown in Fig. 4. A forward-biased diode has a negative temperature coefficient of about $-2 \text{ mV}/^\circ\text{C}$, permitting compensation of avalanche types.

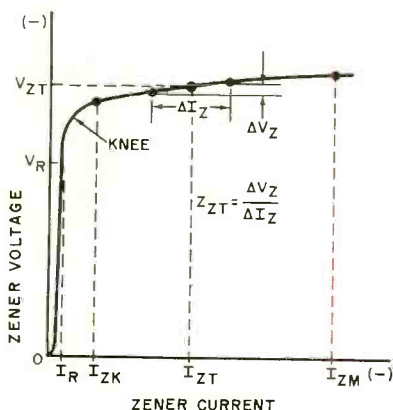

Fig. 3. Reverse zener characteristics.

the wide zone, the chances of a collision between a fast-moving carrier and an atom are high. At a particular field strength, a fast-moving electron can collide with and dislodge a bound electron from an atom, thereby creating another electron-hole pair. A veritable avalanche of carriers is generated in a rapid geometric multiplication of

Zener diodes, being comparatively large-area junctions have large junction capacitances. A 1-W, 10-V diode may have about $0.003 \mu\text{F}$, with a 1-V reverse bias and about $0.001 \mu\text{F}$ in the breakdown region. For this

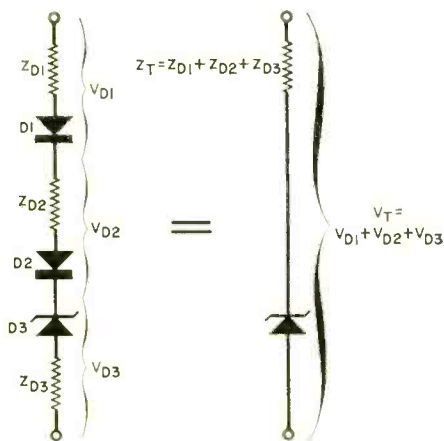

Fig. 4. Stacking one or more forward-biased diodes in series with avalanche diode produces temperature compensation. Terminal voltage is increased by 0.7 V per diode. Dynamic impedance is slightly increased and the diode is operated at specific current flow.

reason, the diode is not used in switching circuits above 100 kHz without special compensating circuits. However, the diode may be used as a dc blocking and coupling capacitor.

Figure 5 shows the basic zener diode regulator circuit. In operation, diode *D1* maintains output voltage V_o nearly constant for changes in both load current I_L and input voltage V_i . Assuming a decrease only in I_L , current I_z increases by a similar amount and the voltage across R_s remains fixed. If only V_i changes (say an increase), I_L remains fixed and I_z increases until the voltage across R_s increases by the amount of the input voltage increase.

Actually, the output voltage does vary somewhat due to impedance Z_z of *D1*. The change in output voltage V_o is equal to the change in zener current I_z multiplied by the average diode impedance at the operating currents. To obtain best results, the diode should be operated in the low-impedance region at higher diode currents (within diode ratings). Additionally, the minimum input voltage should be well above V_o to avoid very low R_s values. Circuit calcula-

tions may be found in many manuals including the *Zener Diode Handbook*, published by Motorola, Inc.

Zener Diode Applications. Cascaded regulators (Fig. 6A) include a pre-regulator diode *D1* serving to regulate the input voltage to diode *D2*. Output voltage regulation depends mostly on the dynamic impedance of *D2* and on load current changes. This circuit is practical for low voltage, low power applications if appreciable power losses are to be avoided.

Reference diodes are advantageously biased by the constant current diode (Fig. 6B) to avoid output voltage changes due to input variations. Similarly, the FET constant current source (Fig. 6C) provides a range of constant current levels by adjusting source potentiometer *R1*.

High-power zener diodes are comparatively costly. To boost the power handling ability of a low-power diode, one may use a power transistor as shown in the shunt voltage regulator in Fig. 6D. In operation, an increase in V_o causes an increase in voltage across sensing resistor R_B . This increases base drive to *Q1*, causing a larger collector current in *Q1* and a larger drop across R_s thereby reducing V_o to the desired value. Because *D1* is biased by a regulated voltage, and because *Q1* can effect high gain when using large R_s values, the circuit is very effective as a regulator but has the disadvantage of high power consumption.

To avoid high power losses, the simple series-pass regulator in Fig. 6E places the power transistor in series with the load and omits R_s . Resistor *R1* biases diode *D1*. The output voltage is equal to the diode voltage minus the base-emitter drop (0.75 V) of *Q1*. Regulation is somewhat impaired because *D1* is biased from an unregulated source and because the base-emitter drop of *Q1* varies with load current. Replacing *R1* by a constant current source improves the regulation. Input voltage changes merely alter the collector voltage of *Q1* with little change in output voltage. Because the circuit draws little power at no load, the

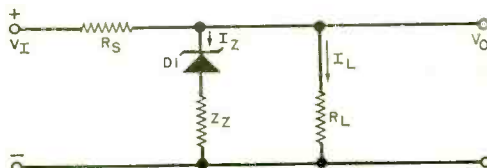

Fig. 5. Basic zener regulator circuit.

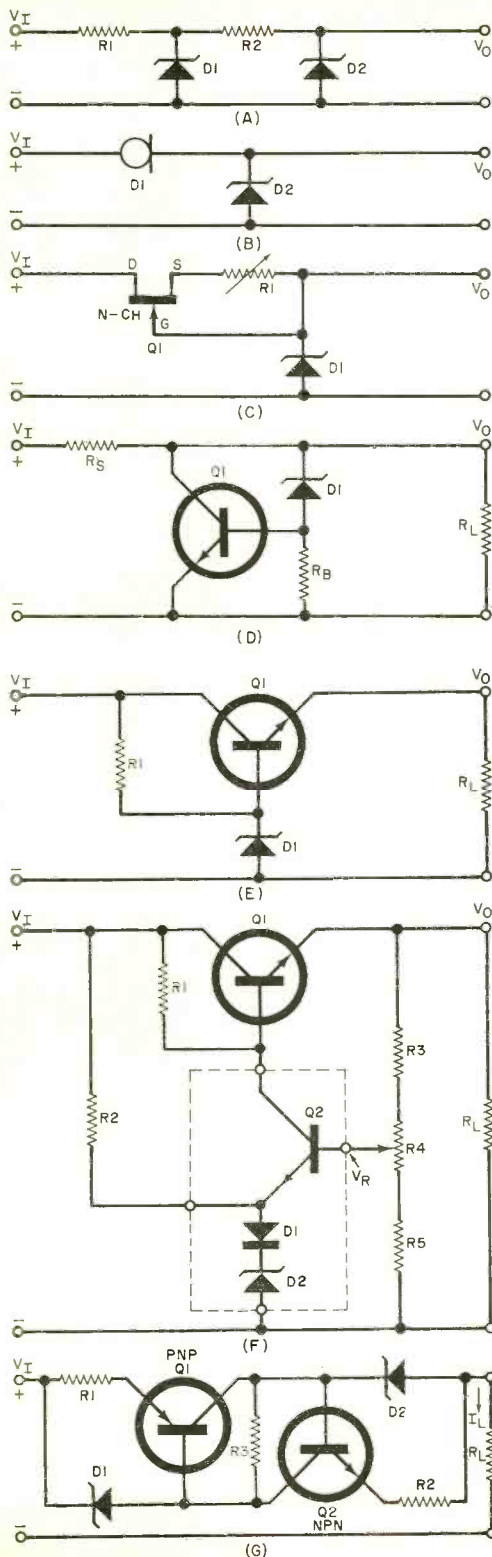

Fig. 6. (A) Cascaded regulators. (B) Constant-current biasing using a CC diode. (C) Adjustable CC biasing using a FET as the CC source. (D) Basic shunt regulator boosts power handling by using a power transistor. (E) Simple series-pass circuit boosts power with less loss. (F) Packaged reference amplifier with temperature compensation further improves regulation. (G) This two-terminal CC supply uses two zeners to get closer regulation.

series-pass regulator is widely applied in regulated power supplies. The addition of an external feedback loop including a reference amplifier permits very close regulation of output voltage.

Figure 6F shows an improved series-pass regulator using a pre-packaged voltage reference and amplifier. The reference amplifier includes zener diode D_2 , compensating diode D_1 and amplifier Q_2 . In operation, reference voltage V_R is compared with the voltage across R_5 and the lower portion of R_4 . Any voltage error is amplified by Q_2 and Q_1 , resulting in correction of the output voltage. This circuit not only permits output voltage adjustments but also corrects for variable base-emitter voltage drop in Q_1 .

Although usually applied as voltage regulators, zener diodes are also used to regulate current indirectly. Figure 6G shows a two-terminal constant current source using a pair of series-pass regulators. Zener diode D_1 regulates the voltage across R_1 at one base-emitter drop below the zener voltage of D_1 . Hence, the current through R_1 , collector of Q_1 , and D_2 is regulated and nearly equal. Similarly, D_2 regulates the voltage across R_2 and, hence, the current in R_2 , Q_2 , and D_1 . Thus, load current I_L is very closely regulated to both input voltage and load resistance changes. Resistor R_3 (in the megohm range) neutralizes collector voltages.

We have described only a few of the many applications of the zener diode. Others include diode clippers which convert low and middle frequencies to square waves, pulse clipping and limiting, noise generation by operation in the knee region, dc voltage-level shifting, transient voltage suppression, voltage clamping, and many others. Although the zener diode is no longer regarded as an exotic semiconductor, it remains a valuable and versatile member of the semiconductor family. ♦

BUILD A

THYRISTOR

TESTER

Check those SCR's and triacs for operation, and determine gate characteristics

BY MICHAEL S. ROBBINS

WE HAVE been using SCR's and triacs (generically called thyristors) for a few years now; but reliable equipment for testing, matching, and classifying these devices tends to be exotic, expensive, or unavailable. The thyristor tester described here will satisfy the needs of most hobbyists, technicians, and engineers who need an accurate and reliable piece of equipment for measuring gate characteristics of SCR's and triacs and the zener voltage of low voltage zener diodes.

The circuit of the tester is shown in Fig. 1. It consists of a power supply, light emitting diodes (LED's) to indicate conduction, and a gate metering circuit. The power supply delivers positive and negative 12-volt dc for the gate of the device being tested and the two op amps of the metering circuits. The supply also provides positive and negative pulsating 12-volt dc for the anode of the device being tested.

The two LED's indicate conduction in the forward and reverse directions. A good SCR conducts in the forward direction only and causes LED2 to glow when a positive voltage is applied to the gate. A shorted SCR lights both with no gate voltage.

Gate voltage and current are determined by the setting of R4.

A differential amplifier with unity gain is used in the metering circuit to reduce the effects of the characteristics of the meter on the actual measurement. Its use makes possible a 100-microampere range with a 1-mA meter movement and a 5-megohm input resistance for voltage measurements. Current is measured by reading the voltage drop across shunt resistors R6 through R9. The maximum drop on each range is 0.1 volt.

Construction. The passive components and the two 741 IC op amps are mounted on the printed circuit board as shown in Fig. 2.

The polarities of the eight silicon diodes and the electrolytic capacitors should be observed. The two IC's are oriented by observing the metal tab adjacent to pin 8. Use a small pencil iron and good-quality 60-40 rosin-core solder.

Components are mounted on the panel as shown in the photo. Be careful when soldering the LED's. Interconnections between the printed circuit board and the

PARTS LIST

- C1, C2—470- μ F, 16-volt PC-type electrolytic capacitor*
D1-D8—1N4001, HEP154 or equivalent silicon rectifier
IC1, IC2—741 op amp IC (Motorola MC1741-CG, RCA3741CT, National LM741CM, Fairchild U5B7741393, or similar)
J1-J3—Binding post (red, black and blue)
LED1, LED2—Light-emitting diode with mounting clip (Monsanto MV-5020 or similar)
M1—1.0-1-mA meter (up to 5.0-5-mA can be used by selecting R13)
R1, R2—100-ohm, 1-watt 10% resistor
R3, R5—100-ohm, $\frac{1}{2}$ -watt 10% resistor
R4—10,000-ohm, 5-watt wirewound potentiometer
R6—1-ohm, $\frac{1}{2}$ -watt, 5% resistor
R7—10-ohm, $\frac{1}{2}$ -watt 5% resistor
R8—100-ohm, $\frac{1}{2}$ -watt 5% resistor
R9—1000-ohm, $\frac{1}{2}$ -watt 5% resistor
R10—47,000-ohm, $\frac{1}{2}$ -watt 5% resistor
R11—430,000-ohm, $\frac{1}{2}$ -watt 5% resistor
R12—4.7-megohm, $\frac{1}{2}$ -watt 5% resistor
R13—68-ohm, $\frac{1}{2}$ -watt 5% resistor (use miniature 100-ohm potentiometer for different meters)
S1—Dpdt miniature toggle switch (JBT JMT-223 or similar)
S2, S3—Spdt pushbutton switch (Switchcraft 953 or similar)
S4—Single-pole, four-position, shorting-type rotary switch (Oak 399 418K or Centralab PA-1000 with stop set for 4 positions)
S5—Single-pole, three position, shorting-type rotary switch (same as S4, set for 3 positions)
T1—Power transformer; secondary: 25.2 VCT at 500 mA (Calctro DI-752)
Misc.—Cabinet with handle, line cord, knobs, mounting hardware, etc.
Note—The following are available from Caringella Electronics, Inc., PO Box 327, Upland, CA 91786: PC board, No. STT-IPC, drilled and printed with part numbers, at \$5.95, postpaid; meter, No. STT-1M at \$15.00, postpaid; complete kit, No. STT-1K, including cabinet with printed panel, all parts, and instructions at \$59.95, plus \$1.50 for handling and shipping in USA. California residents, add 5% sales tax.

is too low, switch to the 1-volt range.

Typical low-current SCR's, such as the GE C103, will trigger with gate currents as low as 10 μ A and voltages of 0.6 volt. Large industrial SCR's may require 30 mA at 2 volts.

Testing Triacs. Four modes of conduction are possible with triacs:

Fig. 2. Actual size foil pattern (top) and component layout for the tester.

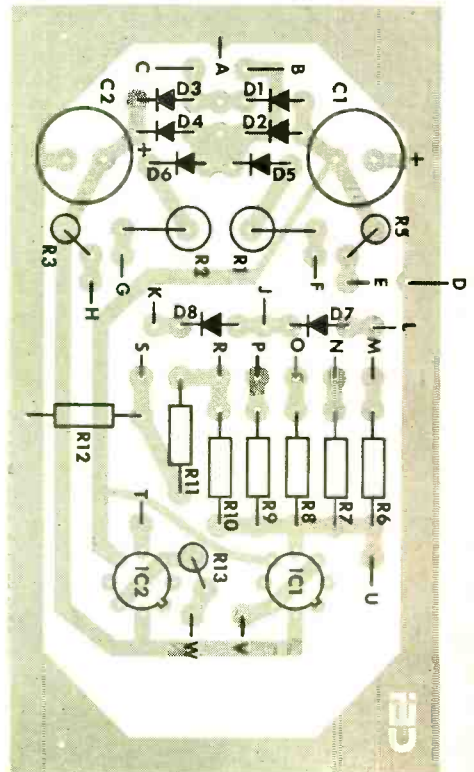
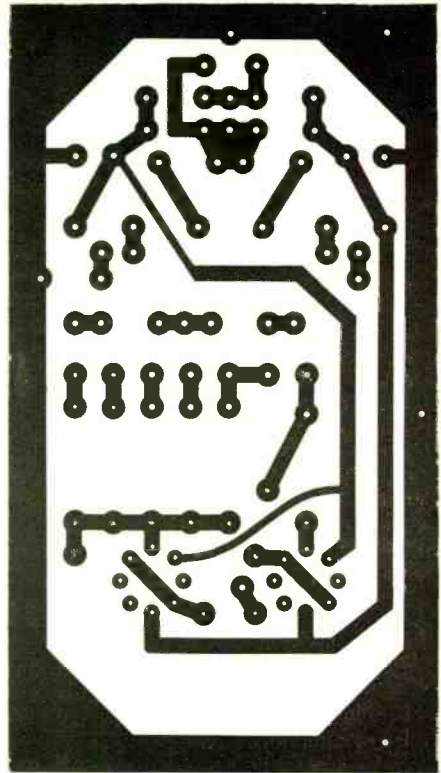



Front panel arrangement of prototype. LED's are mounted in rubber grommets.

Mode	Gate Polarity*	Main Terminal 2* Polarity
I+	Positive	Positive
I-	Negative	Positive
III+	Positive	Negative
III-	Negative	Negative

*with respect to MT1.

Each mode is checked independently by pressing either S2 or S3 and observing the LED indicators. A shorted triac will cause both indicators to glow with zero gate voltage.

Triacs are tested in the same manner as SCR's, except that the test results provide four pairs of gate measurements instead of one. SCR action is similar to the I+ triac mode. Set the METER switch to mA and the mA switch to 100. Connect Main Terminal 2 of the triac to the red binding post and Main Terminal 1 to the black, with the gate connected to the blue post.

If either LED glows, the triac is defective. Press the (+) pushbutton and rotate R4 clockwise until the positive LED glows. Record the current and voltage readings. This is the I+ mode.

Return the switches to their original SCR settings. Press the (-) pushbutton and rotate R4 counterclockwise until the negative LED glows. The meter will swing to

the right for current measurements and to the left for voltage measurements. This is the III- mode.

Triacs used in most ac circuits operate in the I+ and III- modes: during the half of the cycle when MT2 is positive with respect to MT1, the gate is positive; and during the half of the cycle when MT2 is negative with respect to MT1, the gate is negative.

The gate characteristics of the I- mode can be checked by pressing the (-) pushbutton and rotating R4 counterclockwise until the positive LED glows. The gate current and voltage are measured as before. Gate characteristics for III+ mode are measured by pressing the (+) pushbutton, rotating R4 clockwise and observing the negative LED indicator.

Testing Zener Diodes. Low-voltage (under 10) zener diodes can be checked as follows: Connect the anode to the black

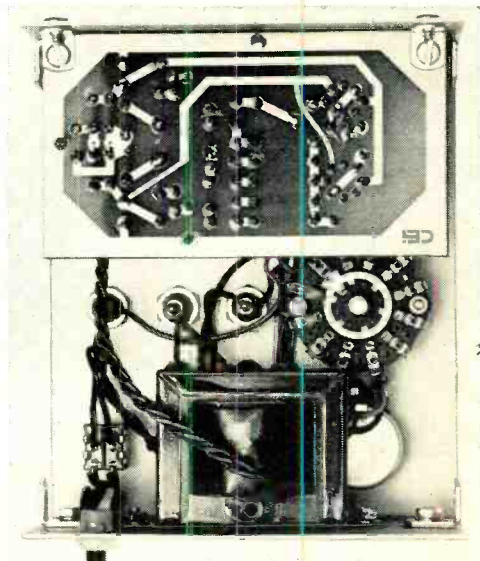

Internal view of tester showing how the printed circuit board is mounted.

binding post (the reverse of the SCR connections) and the cathode to the blue binding post. The red binding post is not used. Set the METER switch to the 10-volt range and the mA switch to 1.0.

Press the (+) pushbutton and rotate R4 to full clockwise. The meter will then read the zener voltage on the left side of the scale. ♦

How To Become A Radio Amateur

TESTS AND BASIC REQUIREMENTS FOR OBTAINING AN OPERATOR'S LICENSE WITH EMPHASIS ON THE NOVICE CLASS

EACH YEAR some 20,000 U.S. and Canadian citizens become licensed radio amateurs, or "hams," one-half of them in the under-21 age group. There are now almost three-quarters of a million hams worldwide—more than one-third of them in the U.S. alone. They range in age from 7 to eighty and, literally, come from every walk of life. The lure is a fascinating new world that involves participation in a remarkable international fellowship.

The first time you use your own call letters on the air is a day you will long remember. It will mark the beginning of your QSL card collection (the personal postcards every ham uses to exchange confirmations of on-the-air contacts). In a fairly short time, you may have QSL cards from countries all over the world and will have

established personal friendships that know no geographic, economic, or political boundaries. One day you might talk to a ham across your state; another evening your contact might be from England, Japan, Australia, or Madagascar. When you send out your "CQ," or invitation to reply, you never know who will answer or from where. That is the fascination of ham radio.

One day you might answer a call from KTUGA (Senator Barry Goldwater) or VK2KB (Sir Allen Fairhall, Australia's Minister of Defense). Other well-known figures who hold ham licenses include: Arthur Godfrey, K4LIB; King Hussein of Jordan, JY1; Andy Devine, WB6RER; General Curtis LeMay, W6EZV; Astronauts Owen Garriott, W5LFL, and Tony England, W5RAP; and Alvino Rey, W6UK—to name a few.

Classes of Licenses. Every radio operator must have a government license to transmit over the air. In the U.S., licenses are issued by the Federal Communications Commission (FCC). An amateur license consists of two parts, one for the station and the other the actual license that permits an individual to operate any station within the license's limitations.

The station license is an official registration that permits a transmitter to be operated on the amateur bands. No examination is required, but station authorizations are issued only to individuals who have qualified for an operator's license. The operator's portion of the license permits you to operate any amateur station within your legal limits. Only citizens and immigrants who have filed declarations of intent to become citizens are eligible to hold station and operator licenses in the U.S.

There are six classes of amateur licenses.

Novice License. This is the simplest of all amateur licenses. To qualify, you must pass a code test of 5 words per minute (wpm) and a very simple written exam. Operation is limited to the use of code (CW) only, while maximum power into the transmitter's final is specified at 75 watts. As a Novice you will be permitted to operate only on these specific bands:

80 meters	3700-3750 kHz
40 meters	7100-7150 kHz
15 meters	21,100-21,200 kHz
10 meters	28,100-28,200 kHz

The Novice license is good for two years and is not renewable, except after a lapse of at least a year. It is a "beginner's permit," designed specifically to encourage you to increase your proficiency as soon as possible so that you can go on to a higher class of license.

There is no charge for the Novice exam, and it can be repeated in 30 days if you fail the first time out. (There is no age limit for any ham license.)

When you receive your license, your call letters will be coded to reflect your status. An "N" between the first letter and first number, as in WN1ZIU, indicates a Novice class. As the licensee advances to higher grades, the N is replaced by an A or a B.

Once you have passed the code test, you will be required to pass the written exam that consists of 20 rather easy multiple-choice questions for which a choice of four or five possible answers is given. "The Radio Amateur's License Manual," published by the ARRL, will be of tremendous help in preparing you to pass the written exam. Once preparation is made for taking the exam, you can write to the FCC Licensing Unit, Gettysburg, PA 17325, or your

A ●●	N ●●●	1 ●●●●●●●●
B ●●●●	O ●●●●●	2 ●●●●●●●●
C ●●●●●●	P ●●●●●●●	3 ●●●●●●●●
D ●●●●	Q ●●●●●●●●	4 ●●●●●●●●
E ●	R ●●●●	5 ●●●●●●●●
F ●●●●●	S ●●●●	6 ●●●●●●●●
G ●●●●●●	T ●●	7 ●●●●●●●●
H ●●●●●	U ●●●●●	8 ●●●●●●●●
I ●●	V ●●●●●	9 ●●●●●●●●
J ●●●●●●●	W ●●●●●	ø ●●●●●●●●
K ●●●●●●	X ●●●●●●●	
L ●●●●●●	Y ●●●●●●●●	
M ●●●●	Z ●●●●●●●●	
WAIT (AS) ●●●●●●●●	QUESTION MARK ●●●●●●●●	
PERIOD ●●●●●●●●	DOUBLE DASH (BREAK) ●●●●●●●●	
COMMA ●●●●●●●●	END OF MESSAGE (AR) ●●●●●●●●	
FRACTION BAR (/) ●●●●●●●●	INVITATION TO TRANSMIT ●●●●●●●●	
ERROR ●●●●●●●●	END OF TRANSMISSION (SK) ●●●●●●●●	

International Morse code is not as fearsome as it looks. Special letter groups such as AS and SK are transmitted without spacing between letters; when printed, they are identified by a bar over the two letters. See text for pronunciation.

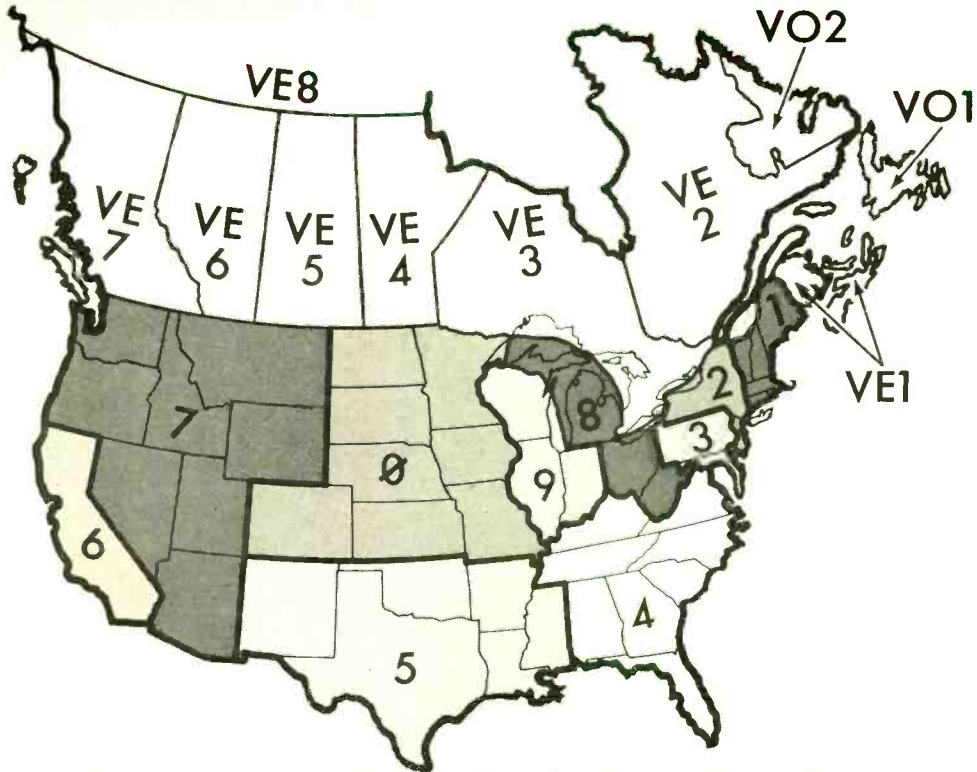

The various amateur radio call areas in the United States and Canada.

local district office and request Amateur License Form 610. When the form arrives, fill it in. Then seek out a volunteer examiner. He (or she) must be 21 years of age or older and the holder of a General, Advanced, or Advanced Extra Class license, a commercial radiotelegraph license, or be employed in the service of the U.S. as an operator of a manual telegraph station.

You should not encounter any problems in locating a qualified examiner. But if you do, check with your local radio and TV service technician; he is likely to know some of the ham stations operating in your area.

The volunteer examiner must fill in the back of Form 610. Then, after he is certain that you can pass the code test, he will send it to the FCC and request a set of exam papers. After the FCC accepts his qualifications as an examiner, they will mail to him the exam papers. The examiner is then responsible for conducting the exam and for returning the completed papers to the FCC. There is a time limit for taking the exam, usually within 30 days of the

time that the application was mailed to the FCC.

At the beginning of the exam, the examiner will pass on to you the sealed envelope containing the FCC-supplied papers. After you complete the exam, the examiner will return the papers to the FCC. If you passed the exam, your call letters will be assigned within a month or two.

No matter at what level you start in ham radio, you must resign yourself to the fact that you will have to learn International Morse Code. Obviously, the first step is to memorize the code so that each character can instantly be associated with "dits" and "dahs." A dot is a "dit" and a dash is a "dah." When "speaking" code, the T in dit is not pronounced unless it comes at the end of a group. Thus, the letter F is pronounced "dididahdit."

Any licensed ham will be glad to help you practice code, or you can use one of the many instruction tapes and records available. Also, various organizations periodically conduct free code courses for Novices. But

SOME HAM ABBREVIATIONS

ABT	About	NIL	Nothing
AGN	Again	NR	Number, near
AMP	Ampere	NW	Now
ANI	Any	OB	Old Boy
BCNU	I'll be seeing you	OM	Old Man (all male hams are "OM's" regardless of age!)
BK	Break	OP	Operator
BTR	Better	PSE	Please
CRD	Card	RCVR, RX	Receiver
CUD	Could	SED, SEZ	Said, says
CUL	See you later	SKED	Schedule
DX	Distance	SIGS	Signals
ES	"&"	SRI	Sorry
FB	Fine business, excellent	TKS, TNX	Thanks
FM	From	TMW	Tomorrow
FR	For	TT	That
GA	Go ahead, good afternoon	TU	Thank you
GE	Good evening	U, UR	You, your, and you're
GC	Going	VY	Very
GM	Good morning	WL	Well, will
GN	Good night	WX	Weather
GUD	Good	XMTR, TX	Transmitter
HAM	Amateur	XYL	(Ex-Young-Lady) Wife or married woman operator
HI	Laughter	YL	(Young lady) An unmarried or girl operator
HR	Hear, here		
HRD	Heard		
HV	Have		
HW	How		

73

Best regards

the quickest way to learn code is to tune in on one of the code practice transmissions. The ARRL's WIAW station transmits code at various speeds on 1.805, 3.580, 7.080, 14.080, 21.080, 50.080, and 145.588 MHz on the following schedule:

SPEED (wpm)	DAYS & TIMES
10,13,15	Daily, 7:30 p.m.
5,7½,10,13,20,25	Sun/Tue/Thu/Sat, 9:30 p.m.
5,7½,10,13,20,25	Mon/Wed/Fri, 9:00 a.m.
35,30,25,20,15	Mon/Wed/Fri, 9:30 a.m.
35,30,25,20,15	Tue/Thu, 9:30 a.m.

The TIMES are EST, except in the summer when they are EDT.

On the West Coast, W6QIE transmits code at various speeds every day except Monday between the hours of 8:00 p.m. and 9:30 p.m. PST. The schedule can be heard on 3.590 MHz. On Tuesdays and Thursdays, they have classes for all levels of amateur licenses.

As is the case with the written exam, the code test must be administered and approved by a volunteer examiner. You must pass the code test *before* you can take the written exam. Transmitter power is limited to 75 watts.

Technician License. This is a "mail-order" test similar to that given for the Novice license. It requires a code proficiency of 5 wpm and successful completion of a written exam consisting of some 50 multiple-choice questions. This license is ideally suited to those who want to operate in the vhf or higher bands beginning at 50.1 MHz (6 meters). Operation is strictly limited to the 6-meter band and frequencies beyond, including uhf and even some microwave channels.

License holders are authorized to operate at up to 1000 watts (unless otherwise specified) of input power to the transmitter's final. The license can be retained indefinitely and is renewable every five years. License holders can operate in all common modes of transmission, including television, phone, and facsimile.

General Class License. This most popular ham license permits operation on many ham bands. It is good for life but must be renewed every five years. Power is limited to 1000 watts maximum (unless otherwise specified) into the final in any operational mode allocated by the FCC rules. The

exam consists of a code test of 13 wpm and some 50 multiple-choice questions. Exams must be taken at a specifically designated FCC examination point.

Conditional Class License. This is identical to the General Class license in that it provides the same privileges. The exams are also identical. The only difference is that this test is conducted by mail through a volunteer examiner. To qualify for this type of license, you must meet one of these conditions: (1) reside outside the continental limits of the U.S., including U.S. Possessions and Territories, for at least 12 months; (2) be in the Armed Forces of the U.S. and unable to appear in person for the exam; (3) be physically unable to travel and have a physician's certificate or letter to prove it (special FCC consideration is given to the blind); or (4) live more than 175 air-line miles from the nearest FCC examination point.

Advanced Class License. Reinstated in 1967, this license is slightly more difficult to obtain than is the General Class license. With it, you are permitted to operate on specially reserved frequencies which only Advanced and Extra Class licensees can use. Although power limitations are the same as for the General Class license, operating privileges are slightly improved. The exam, which consists of a code proficiency test of 13 wpm and 50 multiple-choice

questions, must be taken in person at an FCC testing location. The license is held for life, renewable every five years.

Extra-Class License. This is the highest rank to which an amateur radio operator can aspire. These licensees are an exclusive group, considered to be true "experts" in electronic communications. They have the privilege of operating on several "reserved" ham frequencies set aside especially for their use. To qualify, you must be the holder of another class of ham license (other than Novice) for one year or more prior to taking the final examination. The exam has a 20-wpm code proficiency test and 100 multiple-choice questions. Tests must be taken in person at an FCC examination point.

The Novice Station. The basic elements of any amateur radio station are the transmitter, the receiver, and the antenna. The cost of the station can run from less than \$100 to several thousand dollars and can range in complexity from a small tabletop unit to a room full of gear. Part of the fun of being a ham is in building your own equipment.

Since they are restricted to specific frequencies and are designed for a maximum of 75 watts of input power, Novice transmitters are fairly simple to construct. Circuit diagrams and complete construction details are available from the ARRL and a number of publications.

The receiver could also be home-built, but it is a more complex project. A commercial receiver, capable of tuning in on all the ham bands, is recommended. It must, however, be capable of receiving CW (continuous-wave) signals. The most expensive models are usually the most sensitive, but less expensive receivers—either factory wired or in kit form—will also suffice if care is taken in their selection.

The antenna you start off with can be as simple as a wire hung out of a window. In many city apartments, hams have been known to use bed springs and window screens as improvised, but workable, antennas.

It does not really take much money, equipment, knowledge, or effort to get a first license and be on the air. A ham can also move as rapidly up the ladder as he chooses because he does not have to wait for his Novice license to expire before taking the next license exam. ♦

SOME Q SIGNALS

Note: Q abbreviations become questions only when followed by question marks.

QRM—Am I being interfered with? You are being interfered with.

QRN—Are you troubled by static? I am being troubled by static.

QRQ—Shall I send faster? Send faster (. . . words per minute).

QRS—Shall I send more slowly? Send more slowly (. . . words per minute).

QRT—Shall I stop sending? Stop sending.

QRU—Have you anything for me? I have nothing for you.

QRZ—Who is calling me? You are being called by . . . (on . . . kHz).

QSL—Can you acknowledge receipt? I am acknowledging receipt.

QSY—Shall I change to transmission on another frequency? Change to transmission on another frequency (or on . . . kHz).

Changes come fast in electronics.

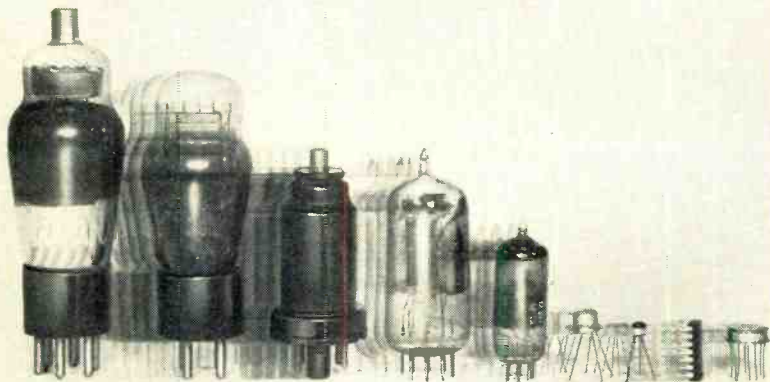

From
tube
to
LSI



Take a look at the race in circuit technology. In the 1960's the tubes at the left made way for the transistors at the right. Today, transistors are surpassed by the large scale integrated circuit (LSI) at the far right. This circuit, less than a quarter inch square, replaces over 6000 transistors!

There's big money to be made by the men who stay ahead of this technology race. Put yourself

ahead with NTS Home Training! You get the latest, most advanced equipment (at no extra cost). More solid-state units, and more advanced technology. Plenty of training with integrated circuits, too! As an NTS graduate, you enter a world of electronics you're familiar with. You have a thorough working knowledge of solid-state circuitry. You're ready to tackle bigger jobs at higher pay!

NTS COLOR AND B & W TV SERVICING

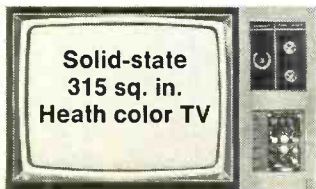

Build and keep the largest, most advanced color TV made! Over-all solid-state design, ultra-rectangular screen, matrix picture tube, built-in self-servicing features, "Instant On," A.F.T., solid-state, 24-channel detent UHF/VHF power tuning, and much more! Also build and keep AM-SW Radio, Solid-State Radio, FET Volt-Ohmmeter, and Electronic Tube Tester. Learn trouble-shooting, hi-fi, stereo, multiplex systems, radio, color and B & W TV servicing.

Learn sophisticated solid-state circuitry as you build this B & W TV receiver. Lo-Silho "Superhet" Radio, FET Volt-Ohmmeter, Solid-State Radio, Electronic Tube Checker, and Signal Generator. TV

and all other equipment are yours to keep.

Solid-state B & W TV, 74 sq. in. picture (cabinet included)



NTS ELECTRONICS & COMPUTER TECHNOLOGY

Build and keep this exclusive NTS Compu-Trainer. It teaches you the

Solid-state Compu-Trainer 14 integrated circuits replace 198 transistors!



same principles used in million-dollar systems. Contains 14 inte-

grated circuits! All Solid-State! You perform all wiring and patchcording. No shortcuts. No pre-wired circuit boards. Your training is complete! Also receive an FET Volt-Ohmmeter and a 5" wide-band Solid-State Oscilloscope.

NTS ELECTRONICS COMMUNICATIONS

Gain the prestige and earning power of owning an F.C.C. First Class Radio-Telephone License. Two comprehensive NTS courses cover the big opportunity field of transmitting and receiving.

You build and keep 14 kits, including this amateur phone 6-meter VHF Transceiver, NTS's exclusive 6-transistor Solid-State Radio, and a fully transistorized Volt-Ohmmeter. Also, learn 2-way radio, Citizens Band microwaves, and radar.

5-watt AM transmitter/receiver



NTS Home Training puts you in the lead.

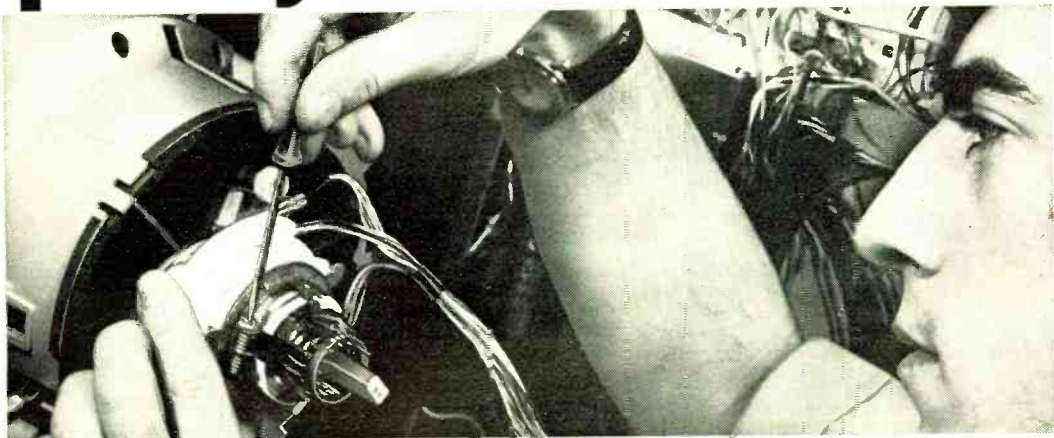

NTS INDUSTRIAL & AUTOMATION ELECTRONICS

Automation is the future of industry and you can play an important part! Learn industrial controls by training on the NTS Electro-Lab (a complete workshop). You also build and operate this 5" Solid-State oscilloscope. And you perform experiments that involve regulating motor speeds, temperature, pressure, liquid level, and much more. All equipment is yours to keep.

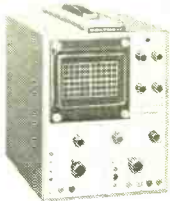

NTS AUDIO ELECTRONICS SERVICING

Learn basic sound theory—how it works in home radio, car tape

decks, stereo multiplex component systems, and more! Set up a spectacular music system. Learn about



Build and keep this famous Heath Stereo Receiver and Speakers.

sound distortion, amplification and control, loud-speaker baffles, problems of system installation, etc. Included is Volt-Ohmmeter, In-Circuit Transistor Tester, and Solid-State

Radio. Prepare yourself for great opportunities in the Home Entertainment Industry!

CLASSROOM TRAINING AT LOS ANGELES

You can take classroom training at Los Angeles in sunny Southern California. NTS occupies a city block with over a million dollars in technical facilities. Check box in coupon below.

NATIONAL TECHNICAL SCHOOLS

WORLD-WIDE TRAINING SINCE 1905
Resident & Home Study Schools
4000 S. Figueroa Street
Los Angeles, California 90037

APPROVED FOR VETERAN TRAINING

Accredited Member: National Association of Trade and Technical Schools; National Home Study Council.

Big, Colorful NTS Guide to new opportunities in Electronics. Yours FREE!



NATIONAL TECHNICAL SCHOOLS
4000 S. Figueroa Street
Los Angeles, California 90037

Please rush me FREE Color NTS Electronics Guide & FREE lesson, plus information on course checked at right. No obligation. No salesman will call.

- MASTER COURSE IN COLOR TV SERVICING
- COLOR TV SERVICING (FOR ADVANCED TECHNICIANS)
- MASTER COURSE IN B&W TV & RADIO SERVICING
- MASTER COURSE IN ELECTRONIC COMMUNICATIONS
- PRACTICAL RADIO SERVICING
- FCC LICENSE COURSE
- MASTER COURSE IN ELECTRONICS TECHNOLOGY
- AUTOMATION & INDUSTRIAL ELECTRONICS
- COMPUTER ELECTRONICS
- BASIC ELECTRONICS
- AUDIO ELECTRONICS SERVICING

Dept. 205-073

NAME _____ AGE _____

ADDRESS _____

CITY _____

STATE _____ ZIP _____

- Check if interested in Veterans Training under new G.I. Bill.
- Check if interested ONLY in Classroom Training at Los Angeles

NEW RCA IN-LINE COLOR TUBE

A NEW color-TV picture tube, announced by RCA uses a unitized, in-line, triple-beam gun structure and a shadow mask having vertically oriented slit-shaped apertures as shown below. The phosphor array is applied in continuous vertical lines.

Converging magnetic pole pieces and the electromagnetic pole-piece exciters and associated convergence circuits are no longer required.

The three electron beams are arranged in a horizontal line, and the cathodes are electrically isolated so that they can be driven

by both the video and chroma signals.

The static toroidal deflection yoke coils are precisely placed in winding grooves molded in plastic rings, and a permanent magnet convergence and purity device is included in the system which is factory adjusted for optimum performance. The yoke is permanently bonded to the neck of the CRT to form an integral assembly.

It is claimed that this new approach permits installation and setup of a color tube assembly with a simplicity approaching that of a black-and-white tube. ♦

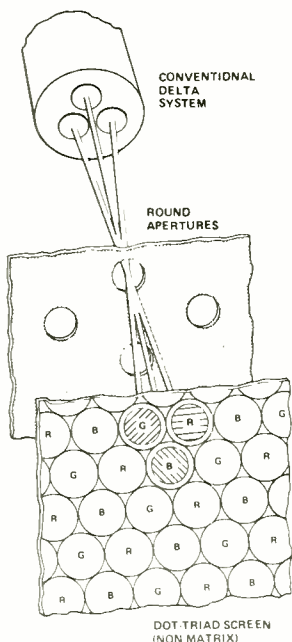
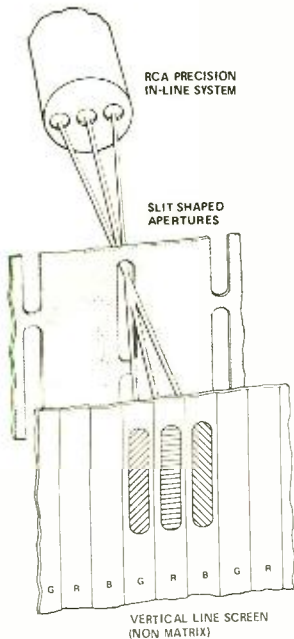

The new tube is 1.8 inches shorter than the present 90-degree type, and about 2.5 pounds lighter. The line-type screen reduces beam-to-phosphor register problems providing superior color pictures.

The 15" 15VADP22 tube has an overall length of 14.2" and has a 9.5" by 12.7" usable screen. The area is 117 square inches. The weight, with all neck components installed, is close to twenty pounds.

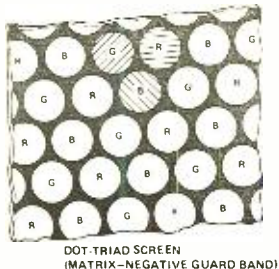
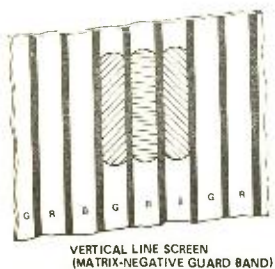

Seeing Inside with Acoustical Holography

Three-dimensional pictures made with ultrasonic energy have many applications.

A HOLOGRAM is a recording of the interference pattern formed when two single-frequency beams intercept each other in a plane. If an object is placed in the path of one of the beams, it modifies the interference pattern to include its image.

In optical holography, the beams are laser-generated, and the recording medium is a photographic plate or film. The hologram, when viewed in ordinary light, appears to contain nothing more than an unintelligible pattern of lines, swirls, and dots. But when it is illuminated by another laser beam, it becomes a "window" through which an observer can see the reconstructed three-dimensional image of the object.

A hologram can be constructed from almost any form of single-frequency radiation, including sound and radio-frequency beams. This article investigates the use of sound waves to construct *acoustical* holograms, a new technology just emerging from the laboratory. The use of sound beams brings a new dimension to holography because, unlike light, sound penetrates solid objects to provide a three-dimensional "interior-view" of the object.

Perhaps the most useful application of acoustical holography will be in the field

of medicine as a diagnostic tool. It would permit the physician to "see" inside his patients' bodies to view bones, muscle tissue, blood vessels, tumors, and other soft tissue—all in three vivid dimensions without the dangers attendant to surgery and X-ray diagnoses.

The biological scientist might use the acoustical hologram to obtain an interior view of microscopic objects. Industry might use it to conduct non-destructive testing to uncover flaws in castings, welds, etc., in their efforts to make better and stronger products. And the oil industry might use it to see deep inside the earth to seek out new deposits of oil that cannot be detected by other methods.

Acoustical holography presents two significant problems not encountered in optical holography, however. First, a good method must be developed to record the hologram. Second, the size of the reconstructed object image is smaller than the object itself. The latter problem occurs because the size of the reconstructed image is proportional to the ratio of the recording and reconstructing beam wavelengths. For example, in one experiment, a 7-MHz sound wave with a wavelength of 2×10^{-4} meter was

used to construct the hologram. Reconstruction was made with a 63×10^{-8} meter wavelength laser beam. With this 317:1 ratio, the reconstructed image was so small that it had to be viewed through a telescope. (This problem does not exist in optical holography where the wavelengths of the two beams are very close to being identical.)

To resolve the first problem, several methods have been developed to generate the acoustical hologram: liquid-surface levitation, mechanical scanning, electronic

in three dimensions. However, the reconstructed image will be smaller than the object by the ratio of the sound beam and laser beam wavelengths so that a telescope will be required to view the image. The surface of the water can also be photographed to provide a permanent record of the hologram, which can be reconstructed by illuminating it with laser light.

According to A.F. Metherell in his Society of Photo-Optical Instrumentation Engineers paper "The Present Status of Acoustical Holography," there are two basic

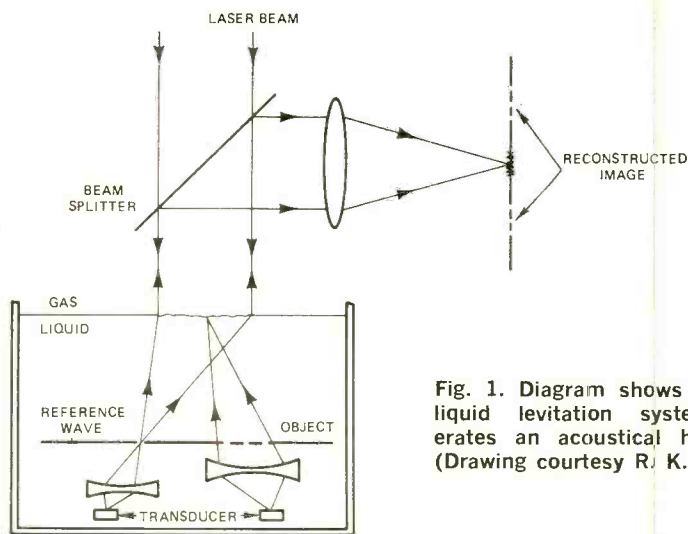

Fig. 1. Diagram shows how the liquid levitation system generates an acoustical hologram. (Drawing courtesy R. K. Mueller)

scanning, and optical scanning. The simplest of these to implement is the first.

Liquid-Surface Levitation. The liquid-surface levitation technique of constructing a hologram is based on a discovery made by Soklov during the 1930's. He discovered that, when a sound beam is directed upward toward the surface of water, the surface is pushed upward until the increase in the height of the water plus the surface tension exactly cancel the vertical component of the sound pressure. If two sound beams are directed upward so that they intersect at the surface, a stationary ripple pattern will form on the water's surface. The ripple pattern represents the interference of the two beams.

If an object is placed in one of the beams, the ripple pattern is modified to include the image of the object. Then, by illuminating the ripple pattern with a laser beam (Fig. 1), the image of the object is reconstructed

problems encountered in the use of surface levitation. One is that the surface of the liquid is very sensitive to vibrations. The other is that the two beams of acoustical energy must be very carefully balanced to prevent surface streaming. Both of these problems break up the fine ripple pattern of the acoustical hologram formed on the water's surface.

In his paper, Metherell describes a method for tackling the problems (Fig. 2) developed by Byron Brenden. Brenden placed a small tank, with an acoustically transparent membrane stretched across its bottom, at the liquid surface. A 2-3-mm layer of oil placed on the membrane reduced the surface streaming effect and decreased the surface sensitivity to vibration. He also used an acoustic lens to project the acoustic image of the object onto the liquid surface—the hologram plane—to form an in-focus acoustical hologram in the liquid surface. Thus, the reconstructed image of the object

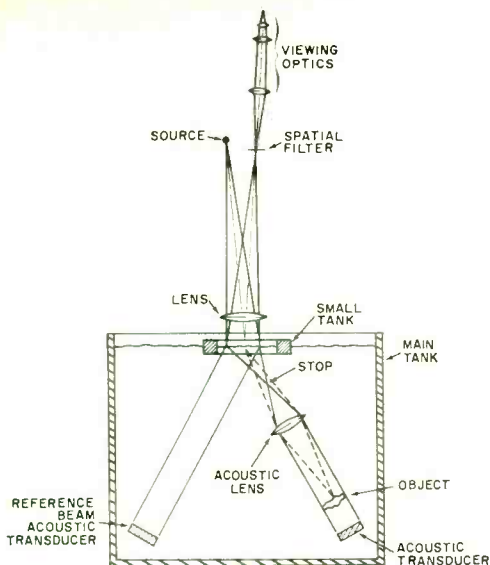

Fig. 2. Surface levitation using Brenden technique. (Courtesy B.B. Brenden)

is viewed in the plane of the liquid surface rather than at a distance below the surface. This compensates for the differences in the wavelength of the sound used to form the hologram and the laser light used to reconstruct the image.

The first commercially available acoustical hologram system is called the Holosonic Ultrasonic Imager. Made by Holosonics, Inc., it employs Brenden's process to develop and reconstruct the holographic image. The sound source is cycled on and off 300 to 400 times a second, with an on-time duration of roughly 80 μ s. The acoustical pattern builds up and dies down with each sound pulse. When the acoustical hologram reaches its optimum shape, a pulsed argon laser illuminates it for a few microseconds so that the reconstructed image can be viewed. The images are reflected onto ground glass or picked up and displayed on a TV monitor.

A real-time image of a honeycomb structure made by the Holosonic Model GP-3 Ultrasonic Imager is shown in Fig. 3. The hologram for this image was constructed using 5-MHz sound. In discussing the Imager, Byron Brenden, Vice President of Engineering at Holosonics, points out that the system can be used for non-destructive testing of metal and plastic structures. He also indicated that it can be used in medical applications.

To date, most of the medical applications

of acoustical holography have been confined to research. It has not been accepted as a diagnostic tool at this time because fast and highly sensitive systems that can accommodate larger viewing apertures are needed before it can be placed into general use by the medical profession. Also, the need for a coupling agent, such as water, between the patient and the transducers, will make such a system large and rather cumbersome.

The primary advantages that acoustical holography has to offer medicine are its ability to show the soft tissue and the minimal damaging effects of sound waves on living tissue. However, A.F. Metherell points out that there is no doubt that ultrasound of sufficient intensity applied for a sufficient period of time will destroy tissue. The obvious question is, at what level of ultrasound is there *no* damage to tissue? This and many other questions must be resolved before acoustical holography will find widespread use in the medical profession.

Although Brenden's techniques used in the GP-3 solve the first of the problems indicated by Metherell, it still uses a reference beam that must be carefully balanced with the object beam. P.S. Green of the Stanford Research Institute has demonstrated, however, that liquid surface levitation can be accomplished without the use of a reference sound beam. This is accomplished by placing a wire grating just below the surface of the water in the path of a focused object beam. When the acoustical object image forms on the surface, it has a grating pattern superimposed upon it. This permits the acoustical image to be reconstructed in the conventional manner. Metherell points out, however, that this is

Fig. 3. Image of honeycomb structure made by Holosonic Ultrasonic Imager.

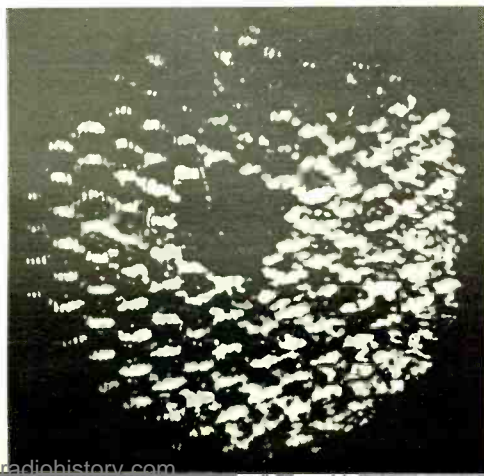

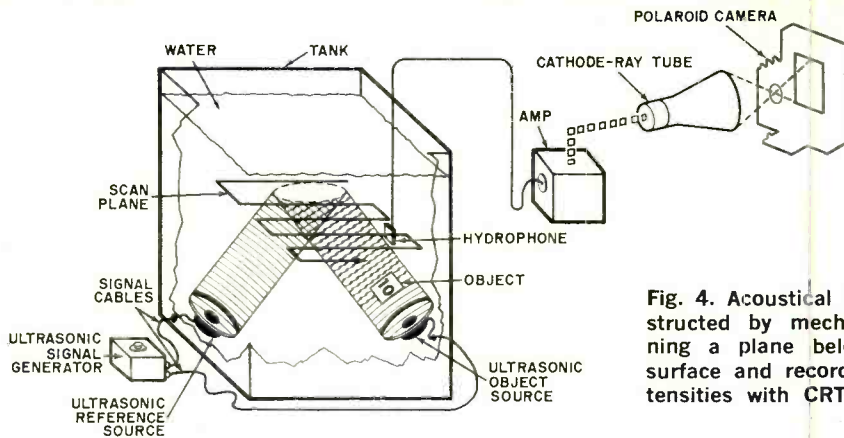

Fig. 4. Acoustical hologram constructed by mechanically scanning a plane below the liquid surface and recording sound intensities with CRT and camera.

not an acoustical hologram, even though the results are the same.

Mechanical Scanning. The preceding methods of constructing the hologram have utilized the surface of a liquid as the holographic plane. This plane could just as well have been located below the surface if some means were available to detect the sound. As shown in Fig. 4, for example, a mechanical scanning device can scan a plane below the surface where the beams intersect. The sonic signal intensity detected at each point is used to modulate the beam of a cathode-ray tube (CRT) which is synchronized with the mechanically scanned hydrophone. Through time exposure, the image is recorded on film. The object image is then reconstructed in the conventional manner using a laser to illuminate the photograph.

It is interesting to note that, when using mechanical scanning for constructing the hologram, it is possible to use only one sound beam. The reference beam can be simulated electronically by mixing it with the sonic signal gathered from the hydrophone. This method's disadvantage is that it is slow, not to mention that the result is a composite sampling of many different sonic waves. It will be unsatisfactory if the object is not stationary.

In "Acoustic Holography" (*Proceedings of the IEEE*, 1971), R.K. Mueller of Bendix Research Laboratories notes that industry has been seeking application of acoustical holography for non-destructive testing ever since it became a technical reality. He adds that mechanical scanning methods have received considerable study and have produced some high quality re-

sults. In this application, mechanical scanning can be very effective because the object under test is immobile and real-time construction is not necessary. It also permits scanning over larger areas than is possible with most other methods.

Mueller points out that the holographic approach is not limited to simple imaging. With proper signal processing, it would be possible to acoustically compare mass-produced parts with a master part. In any case, the end result would be increased quality and improved reliability.

Electronic Scanning. The same general results obtained from mechanical scanning can be obtained with a matrix of hydrophones that can be electronically scanned at a rapid rate. The sound intensity at each hydrophone can be sampled momentarily and used to intensify the beam of a CRT or other imaging device. In this case, the scan would be rapid enough that the holographic image could be photographed directly.

An acoustic underwater viewer based on this technique has been developed by Bendix. This system offers much potential for undersea use because direct optical viewing is limited to very short ranges and sonar cannot provide a recognizable image for accurate identification and classification of the target. Acoustical holography, on the other hand, is capable of producing good images over a comparatively large field of view.

The major components of the Bendix system are the sound transmitter, receiving array, electronic signal processor, and real-time image reconstruction device. The transmitter is a small spherical shell of

piezoelectric ceramic that vibrates in a radial mode. The receiver array is made up of lead-zirconate-titanate slugs mounted in an acoustically soft baffle to form a planar matrix. These elements are spaced 4.5 wavelengths apart to provide the proper viewing aperture.

The signal processor electronically generates all of the holographic data simultaneously. The signals received at each element are mixed with a reference signal, integrated for a predetermined length of time, and stored as a voltage level that is proportional to both the amplitude and phase of the detected signal at that point. When all of these points are displayed on a CRT, they make up the complete hologram.

The image can be reconstructed in real-time if the CRT is replaced with an electro-optical light modulator tube such as that shown in Fig. 5. The image can then be reconstructed directly in real-time by illuminating the face of the tube with a laser beam. Though the electro-optical modulator is still in the development stage, it can handle up to 400 resolved points per line—well within the requirements of ultrasonic holography in the 100-kHz to 1-MHz range.

As a third alternative, the data can simply be recorded on magnetic tape for later processing and refining by an analog or digital computer. Use of the digital computer seems to offer considerable promise as refinements are made in the technology. For example, the photographic enhancement techniques being developed for NASA at the Jet Propulsion Laboratory might well be adapted to enhance acoustical holograms. These techniques were used very successfully to enhance similar data pictures of Mars and the moon that were

recorded and returned by deep-space probes.

Computer reconstruction has considerable advantages over other methods of reconstruction. For example, all non-random image degradation can be corrected easily and complex image processing can be accomplished when desired during the reconstruction. Too, it is not necessary to carry the conjugate image through the reconstruction process. The result is less complexity and noise at the image plane.

Computer reconstruction is used very effectively in seismic applications. R.A. Peterson of Bendix United Geophysical Corp. indicates that his company performs image field reconstructions by suitable operations in a high-speed digital computer, with final graphical display of the reconstructions of the geological subsurface. The image is constructed directly with the computer, bypassing the need of reconstructing a holographic image with a laser.

Peterson points out that holography is "state-of-the-art" in seismic operations. However, unlike other acoustical holography operations, they use wideband sound (20-60 Hz) because of the poor vertical depth resolution that can be obtained with single-frequency sound. The data is gathered using "linear-slot" receivers that give two-dimensional cross-sections rather than three-dimensional volume reconstructions. This is done to keep down the staggering cost of equipment to construct three-dimensional images in seismic operations.

The data obtained by the receivers are recorded as a multi-channel time-history record on digital tape rather than as an optical interference pattern on a photographic plate. The data are then reconstructed directly through computer operations and plotted as a graphical output.

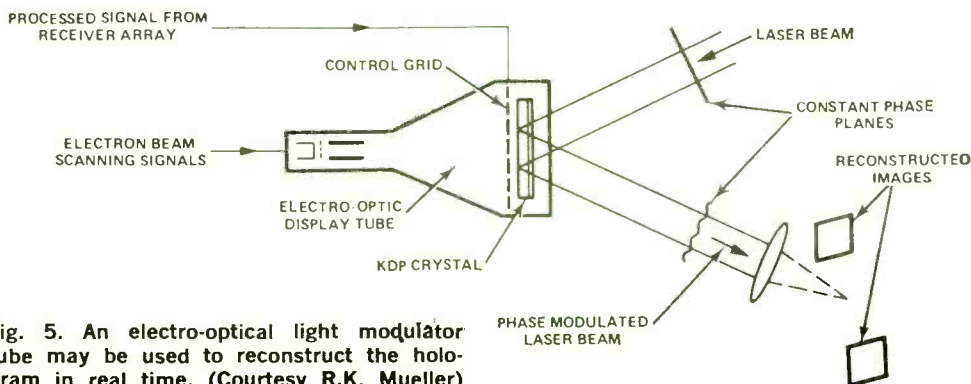

Fig. 5. An electro-optical light modulator tube may be used to reconstruct the hologram in real time. (Courtesy R.K. Mueller)

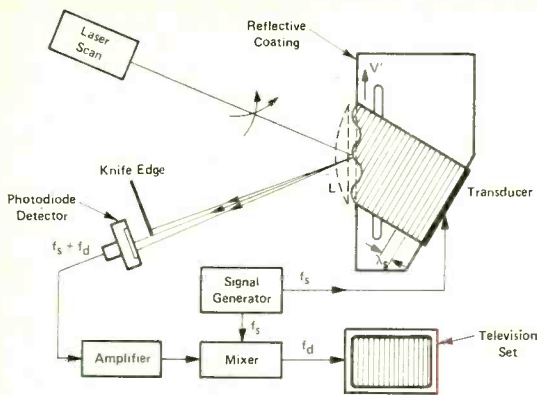

Fig. 6. Laser scanning of acoustically excited reflective coating may be used to construct holograms. (By R. K. Mueller)

Active in acoustical holography from the very beginning, Bendix Research Labs have developed another form of electronic scanning using an electron-beam-scanned piezoelectric area detector. This "Sokolov tube" serves as an ultrasonic camera for detecting acoustic waves. It is basically a modified TV camera tube with a thin resonant piezoelectric (quartz) crystal faceplate. The crystal plate is designed to resonate at the sound frequency being used. Sound waves striking the surface cause the crystal's surface to vibrate locally to generate a piezoelectric voltage proportional to the strength of the sound wave at that point. As the electron beam scans through its cycle, the secondary emission from the faceplate is modulated by this voltage. The modulated secondary emission signal is combined with the ultrasonic reference signal to generate the necessary interference signal and is used to intensify the beam of a television monitor.

Optical Scanning. Mueller describes another method of producing the hologram that was suggested by Dennis Gabor, a British scientist who first thought of the concept of holography. It is one of the most promising candidates for use in an ultrasonic microscope. This concept has been implemented by Korpel and Desmares into the system shown in Fig. 6. Here, the sound beam is directed into an acoustic medium so that it strikes the front surface at an angle. The front surface is a thin film that is completely transparent to sound but is reflective to light. The object to be recorded as a hologram is inserted into the

sound path inside the acoustic medium where the ultrasonic waves strike its surface and cause a ripple to move up the front surface.

A laser beam scanned over the surface is reflected by the ripple, modulating the light beam. The variations in reflected light are converted to a modulated voltage by means of a knife-edge and photodetector. The modulated voltage signal is then mixed with the reference signal and displayed on a TV monitor as a hologram. In concept, this is similar to the piezoelectric method, but it is less limited in resolution and is especially suitable for high-frequency imaging.

Another method considered applicable to the ultrasonic microscope is Bragg diffraction imaging. As demonstrated by Korpel, it is based on the principle that, when light and sound beams pass through the same space, the light is modulated by the sound waves. Hence, it is possible to obtain an optical image of the sound source or of an object if it is placed in the sound beam. Figure 7 is a diagram of the original experimental setup Korpel used to obtain Bragg diffraction holography in two dimensions. According to Mueller, Korpel later obtained full holographic imaging using this method.

Mueller states that both of these methods are applicable to ultrasonic microscopes because acoustic waves in the frequency range of 0.1 to 3.0 GHz have wavelengths in water ranging from 15 μm to 0.5 μm (μm = micrometers). Therefore, it is quite conceivable that sound waves can provide a means of viewing microscopic objects with a resolution approaching that of optical microscopes. Such microscopes would be of great value to the biological scientist because they use the mechanical properties of the object rather than its optical properties. ♦

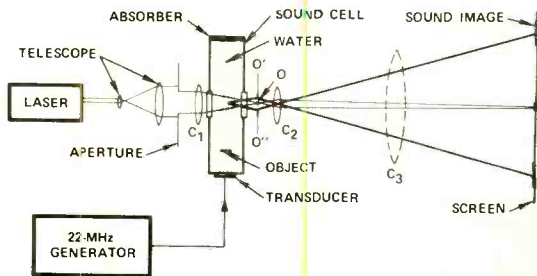

Fig. 7. Bragg diffraction imaging uses sonic beam to modulate laser and generate image on a screen. (By R. K. Mueller)

ELECTRONICS & BRAIN CONTROL

*We are learning more about
our gray-matter computers*

BY L. GEORGE LAWRENCE

IT IS TIME that we closely examined brain control, now that scientists are actively seeking to unravel the mysteries that shroud that miniature bioelectric giant known as the human brain. Elements of brain control can already be found in anti-collision radar technology involving birds. It has also been substantiated that, by pumping energy in the gigahertz range of frequencies through human heads, subjects can suddenly "hear" without using their ears.

Much remains to be done to correlate and sift out concealed facts. We still know very little about the all-important coding events that take place in the brain's neuron-synaptic complex. How can we measure and reinforce such significant human capacities as love, will, and character? Does uncontrolled electromagnetic pollution affect the brain? These and other questions remain to be answered as scientists delve deeper and deeper into the human brain with the help of electronics.

What Is the Brain? The theory that the brain is a true electronic machine has often been proposed. To a point, the theory is true. As Dr. Wilder Penfield demonstrated some years ago, the electrical stimulation of brain tissue during skull surgery triggers

lucid audio-visual recalls of past events in patients. The patient "sees" and "hears" complete increments of true life experiences, all in correct sequence.

But consider Fig. 1. Studies are enormously complicated by the fact that the human brain contains an estimated 10 billion nerve cells called "neurons" and another 100 billion of a second type called "glial" cells. The fluid bath in which these cells are suspended is a vital element in their electrochemical interactions. Is it here where emotional components and memory are stored and where we have susceptance to microwave and other electromagnetic frequencies?

Such questions guide us into the subject of "synaptic" transmission. The term "synapse" is derived from the Greek phrase "to clasp" and was introduced in 1897 by a Dr. Sherrington who used it to describe the junctional region between two nerve cells. In many cases there is a gap or cleft across a synapse. (In other cases, as in fish, a synapse is a real physical joint.)

One big neuron might have on its surface as many as 10,000 points of contact (synaptic knobs) with other neurons. When the latter are stimulated, some of the millions of ribonucleic acid (RNA) molecules inside them give orders to the glial cells to manu-

facture new proteins. The nature and pattern of these proteins contain an imprint of something that has been perceived and apparently gives rise to a molecular "en-gram."

We also find electrical dipoles in synaptic mechanisms which, when oriented and arranged in a large array, apparently can produce an electric field strong enough to drive positive ions over the junction barrier of the postsynaptic membrane (in a manner similar to that in a transistor) and thereby initiate excitation or produce depolarization. So, one comes to believe that the nature of synaptic transmission is essentially electrical, be it mediated by electrical or chemical transmitters.

By inference, then, the possibility arises of human brain control by electromagnetic forces directed at it from the outside. If such radiations can be suitably coded to elicit a synchronous response in the neuron-synaptic complex, the brain will trigger motor functions which, in turn, cause man or animal to execute a programmed act. Here we have some fascinating experiments that hold great hopes for the immediate future.

In the case of hearing, for example, we have been taught that our auditory system can respond only to acoustic energy. This "fact" is far from correct. Experiments con-

ducted by Dr. Frey and others clearly indicate that the audio sense in man—and probably in animals, too—can respond to electromagnetic energy in at least a portion of the r-f spectrum. Data shows that, at very low power levels (to preclude biological damage) in tests like that shown in Fig. 2, there are audio sensations at frequencies as low as 200 MHz and at least as high as 3 GHz. When low-level energy was directed at them, the test subjects reported "hearing" a buzzing sound. However, they found it almost impossible to match r-f sounds to a sine wave. The apparent source of the buzzing, clicking, knocking, or hissing sounds is described as being within or immediately behind their heads. This localization persists no matter how a person rotates or twists his head in the r-f field.

It was during these studies that a profoundly important discovery was made: deaf subjects often had the ability to *hear* r-f sound. The clinical criterion was that, if a given person could hear audio above 5 kHz either by bone or air conduction, then r-f sound could be heard as well. This and related work has resulted in the manufacture of r-f type hearing aids for the deaf, one of which is made by Listening, Inc., 6 Garden St., Arlington, Mass., and is known as the Neurophone Model GPF-1. It operates at 100 kHz and employs crystal control.

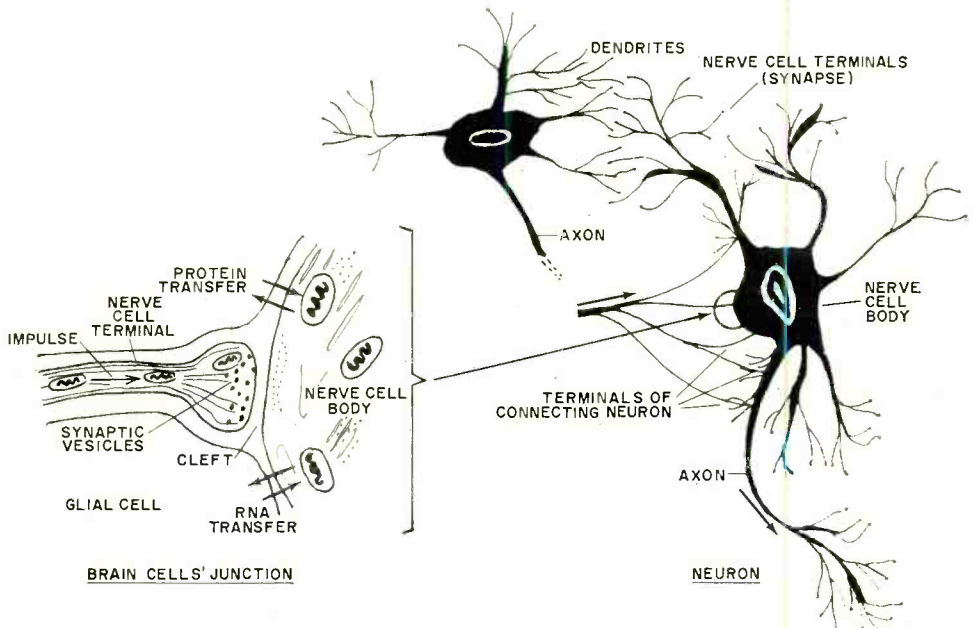

Fig. 1. Neuron/synaptic mechanism in the human nervous system.

These observations tie in with the fact that some individuals can detect radio programs through the fillings in their teeth. This phenomenon was technically verified by interposing shields between respective people who exhibited it and the modulated r-f sources. When the lower half of the head was covered, including the maxillary dental area, the r-f sound was perceived. The sound ceased upon covering the top half of the head. While the mechanism responsible for this phenomenon is only imperfectly understood, it can be assumed to be the result of direct cortical nerve fiber stimulation.

We also have another form of hearing sensations that come about when the human head is placed between two large capacitor plates that are excited by varying electrostatic potentials. "Electrophonic hearing," as it is called, apparently acts on the ear's tympanic membranes in a quasi-mechanical manner. It is useful as a new research tool in specialized psycho-physiological studies on the auditory or vibrotactile system.

Unavoidably, data of this sort begs application. Pilot studies are under way to apply effective electrodynamic brain control to animals and man himself. Consider, for example, the brain-wave proposal based on ideas put forth by the late Dr. Norbert Wiener, the acknowledged father of cybernetics.

According to Wiener, a sheet of tin suspended from the ceiling of a room and connected to a 10-Hz electrostatic generator can cause unpleasant sensations in human subjects. With a field strength of 1 or 2 volts per sq cm, the oscillating field roughly coincides with the human brain's alpha-rhythm frequency but attempts to lock it to a *fixed* frequency—that of the generator. Electronic sleep machines employ similar principles, with currents of fixed amplitude and pulse width (usually square waves) being fed by conductive face masks through the cranium and brain.

Brain Control of Birds. Radar technology is now being used to deal with the problem of birds getting in the way of fast flying aircraft. The idea is to trigger a flying bird's (or a whole flock's) brain into motor functions to initiate collision avoidance by having the bird(s) veer off the flight path of the plane. This area of research was triggered by the staggering incidence of plane/bird collisions that result in equipment damage estimated to be in the millions of

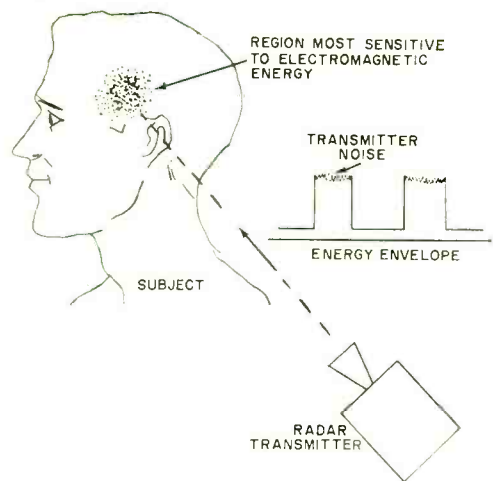

Fig. 2. Microwave susceptance area in brain.

dollars each year and the human lives that continue to be lost as a result of such collisions.

The work being carried out by the National Research Council of Canada bears much promise in bird-brain control. The NRC's test system takes the form of a carousel of bird cages containing live chickens. (Fig. 3) Only one of the many cones suspended above the cages contains a microwave antenna. The program, headed by Dr. Alan Tanner, aims to evolve microwave brain-control systems that will have the greatest possible effect on birds while at the same time deploying the least amount of power.

When exposed to microwave radiation, birds in general exhibit escape reactions. This fact became clear during World War II. Investigators also found that in each case the microwave field through which birds were flying was of very low intensity—too low, in fact, to account for confusion and escape reactions on the basis of heat generated in the animals' bodies.

Different species of birds have different behavioral patterns. In the laboratory, a few seconds after the microwave field has been initiated, the given bird's wing outside the field of radiation became collapsed and the opposite wing became extended. Similar phenomena were observed with the legs. Sometimes the birds heeled over to the outside of the field. In the turning reaction, the outer side of the bird becomes paralyzed. In short, the microwave beam interacts with the nervous system of the test birds. Seagulls and pigeons reacted similarly,

though the gulls are more inclined to initiate flight.

It is interesting to note that a bird's feathers appear to play a much greater role in the sensory complex than has been realized before. Defeathered chickens, for example, give little or no reactions to microwave fields until the twelfth day, at which time new feathers start to grow and tips protrude from the surface of the skin. In the case of fully feathered chickens whose tail feathers were exposed to microwave radiation, the birds immediately ceased exploration of their cages and exhibited mounting signs of distress after a period of 10-20 seconds. When the microwave field was switched off, the birds responded by fluffing their body feathers and active preening.

The Canadians believe that the physical properties of quill tissue—particularly the piezoelectric properties that are fundamental to living tissue—suggest mechanisms that have heretofore been overlooked. However, work carried on by Dr. Tanner and his staff as well as research conducted elsewhere should in time yield a microwave beam of the proper wavelength and modulation to cause birds to activate collision avoidance with all possible haste.

Brain-Wave Detection. Some 40-odd years ago, university professor F. Cazzamalli

started publishing papers on the subject of brain-wave detection and implied that he had detected radiations from the mind. As shown in Fig. 4, he placed subjects in a shielded room (or Faraday cage), emanated vhf radiowaves through their heads, and claimed to have recorded "beat frequencies" obtained with an untuned receiver consisting of a galena crystal or diode tube, a fixed capacitor, an antenna, and a sensitive light-beam galvanometer.

The trouble is that Cazzamalli never mentioned transmitter power in his somewhat unprofessional papers. His oscillograms meant to show variations of the "beat" when his subjects were emotionally aroused or engaged in creative tasks when they were in the Faraday cage. Later, he told an astounded world that his subjects would hallucinate when under the influence of his "oscillatori telegrafica," its frequency being about 300 MHz at the time.

Tom Jaski, a noted science writer and engineer, duplicated some of Cazzamalli's work with a modern low-power oscillator that was swept from 300 MHz to 600 MHz. His subjects could not see the dial. They were told to sound off as soon as they felt something unusual. At a certain frequency range—varying between 380 MHz and 500 MHz—the subjects repeatedly indicated points with exact accuracy in as many as 14 out of 15 trials. At these "individual"

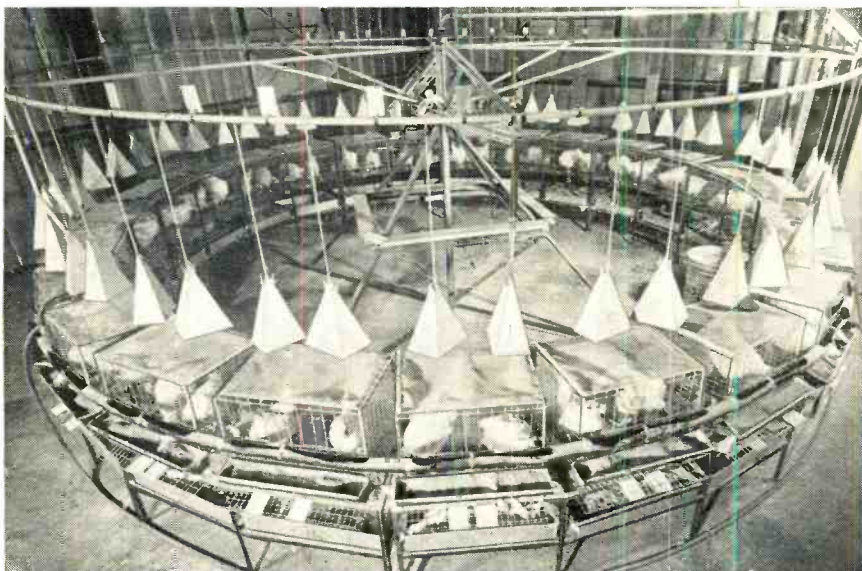

Fig. 3. Microwave test carousel to determine reactions in live birds. Only one cone is active; all others are dummies. (Courtesy National Research Council of Canada)

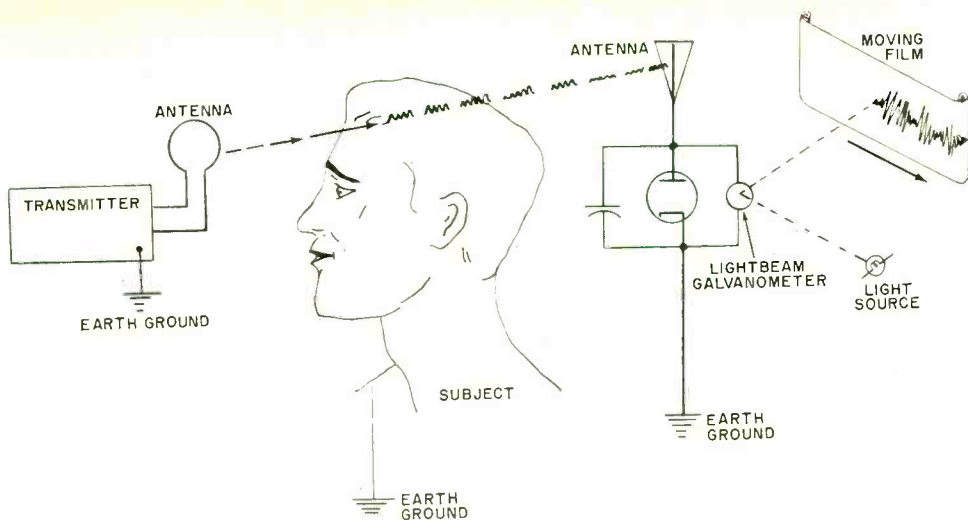

Fig. 4. Cazzamalli's brain-wave detector of some years ago is illustrated here.

frequencies, the same subjects announced having experienced pulsing sensations in the brain, ringing in the ears, and an odd desire to *bite* the experimenters. The oscillator's output power was only a few milliwatts, while the oscillator itself was located several feet away from the subjects.

The Conclusions. Considering the ingredients of the few sample discussions presented above, it appears that both humans and animals have brains sensitive to r-f energy. The correlating mechanisms are only imperfectly known, but they apparently reside within the neuron-synaptic complex. Nor will we know how this susceptibility

affects our longevity without proceeding with a great deal more research.

Just how electromagnetic radiation affects our social structure has led to a great deal of speculation in the past. For example, the late Dr. Goldman once insisted that r-f energy allows the id, or primitive brain, to take control over human affairs. Such considerations might open a Pandora's box when applied to an explanation of our sharply increasing crime rates and decline of social fidelity. So, before we rush pell-mell into electromagnetically contaminating our environment, it would serve us well once and for all to discover what adverse effects, if any, it will have on our lives. ♦

TV COMMERCIAL KILLER

- FEATURES:
- No interconnecting wires—use a flashlight to key relay
 - Low battery drain
 - Auto reset

PARTS LIST:

- 1 HEP 312
- 1 HEP 156
- 1 HEP 55
- 1 Resistor, 1.5K, 1/2 Watt
- 1 Relay, Potter-Brumfield RS5D, 6VDC
- 1 Battery, 9VDC

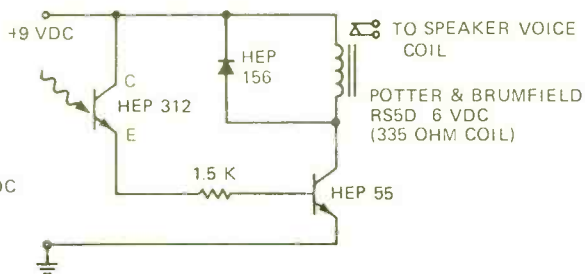



Test Equipment Scene

By Leslie Solomon, Technical Editor

A FEW MONTHS ago, in this column, we were discussing audio generators and the statement was made that sine waves leave a lot to be desired when it comes to audio testing. We also noted that very few people had ever seen a real sine wave—most of us having been looking at “almost sine” waves (via a scope of course) for most of our electronic lives. It was pointed out that tests showed that most of us could observe a sine wave having 3 to 5% distortion (in some cases much more) and never know it. Yet, we didn’t object to using this waveform for audio testing.

A listening test made by *Stereo Review* (May 1973) had interesting results. It was demonstrated that only 0.15% distortion was perceptible on a single-frequency tone. Mixing two tones raised the perception threshold to about 2%, while three simultaneous tones resulted in 4%. When listening to normally complex music, it was necessary to raise the distortion to a whopping 6% before it became perceptible. In light of these tests, it appears that a sine-wave generator (or any other source of a single-frequency signal being used as the test tone) should have distortion of less than 0.1% to be on the safe side. Actually, good engineering practice dictates that it should be one decade better than the equipment being tested, so we should shoot for 0.01%.

Of course, test equipment manufacturers are aware of the distortion problem and are

doing their utmost to make a perfect non-distorting sine wave. Unfortunately, most homemade units and many older commercial generators still have the distortion figure of 2 or 3%.

In the following discussion, it is not our intent to denigrate the use of sine waves; rather it is to give the thinking reader some ideas about other—possibly better—approaches to audio test gear, in the interest of furthering his audio electronics education. The possible result of all of this of course would be better audio test equipment and, thus, better audio systems.

The sine wave is one of the easiest waveforms to generate electronically and was one of the first types of waves used in audio work. All it takes is an amplifier, some frequency selective feedback, and—*voila!*—an “almost sine.” Feed this through a Schmitt trigger (for example) and you have a square wave.

Consider the Triangle. Although sine waves are still used for frequency response and distortion testing, and square waves are used for testing transient response, stability (damping), and relative frequency response, let us take a look at an almost unknown waveform—the triangle (not sawtooth, but triangle).

This unique waveform can be used in all of the operations for which the sine and square waves are used; and it also has a couple of useful features of its own. Why the sudden interest in the triangle wave? Probably, it is due to the introduction of low-cost monolithic op amps. Just two of these devices can be used to make a dandy triangle-square generator.

First, let’s take a close look at the triangle waveform (Fig. 1A). No doubt we all agree on what a straight line looks like, and the sharp tips are easy to see.

Observing the exact clipping point of an amplifier with a sine wave is not that easy

Triangle Waves For Testing

since the top of a sine wave is "almost flat" and the signal has to be "diddled" with in order for us to see the exact clipping point. However, with a triangle, there is no doubt about clipping since those sharp points blunt very rapidly (Fig. 1B).

Crossover distortion (Fig. 1C) is also very easy to detect—as it is in a sine wave, though it shows up a little more clearly on the triangle.

The importance of the straight lines of the triangle waveform really shows up when we are measuring the constancy of gain of an amplifier. Parasitic oscillations may take place in an amplifier at certain levels of gain and not at others. Even though these gain variations may be so high in frequency and of such short duration that they are not apparent using conventional techniques, they almost always cause a change in gain which appears as slow variations in the triangle waveform (Fig. 1D).

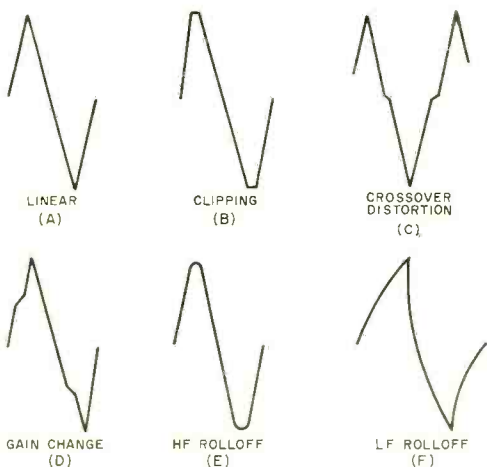

Fig. 1. Effects of distortion on triangle.

Waveforms in Figs. 1E and 1F show the effects of high- and low-frequency rolloff. Note that only one triangle frequency is needed to show these effects.

Active Differentiation. Back in November of 1972, we discussed the use of active differentiation in audio testing. Now, assume that you inject a clean triangle waveform into an amplifier as shown in Fig. 2. Also assume that the amplifier being tested has some slight distortion. By passing the output of the amplifier through the active differentiator, a square wave is produced on the scope. There will be a clearly visible "notch" on the square wave if there is any

distortion in the triangle wave. The depth of the notch is a function of the amount of distortion and the position of the notch shows where (at what amplitude) on the triangle the distortion is occurring. This method of finding distortion is far more sensitive than others more widely used.

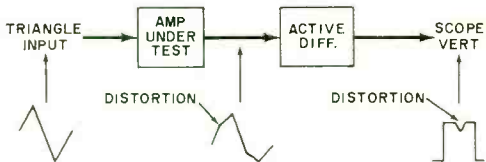

Fig. 2. Differentiated wave shows distortion.

For those who are mathematically inclined and are looking for proof of our argument, here is a mathematical explanation of how a differentiator connected in series with an audio signal emphasizes harmonic distortion. We will use a simple series RC circuit to ground.

The current through R is determined by the reactance of C and $i = C(de/dt)$ where e is the voltage across C and de/dt is the change in voltage with time. Since X_c is large compared to R , the voltage across R is negligible and e is effectively the total voltage applied to the network. The voltage across R is the product of the current through the network and the resistance or $e_o = RC(de/dt)$. The output voltage is then the derivative of the voltage at the input of the circuit.

Assume that a distorted signal is applied to the network from an amplifier. The signal is represented by $e = E_1 \cos \omega t + E_2 \cos 2\omega t + E_3 \cos 3\omega t$, where E_1 , E_2 , and E_3 are the maximum voltages of the three signal components; $\cos \omega t$ represents the sinusoidal excursions of the fundamental; $\cos 2\omega t$ and $\cos 3\omega t$ are the sinusoidal excursions of the second and third harmonics, respectively; ω is the angular frequency equal to $2\pi f$.

When the composite signal is applied to the differentiator, the output is

$$\begin{aligned} de/dt &= d(E_1 \cos \omega t)/dt + d(E_2 \cos 2\omega t)/dt \\ &\quad + d(E_3 \cos 3\omega t)/dt \\ &= -\omega E_1 \sin \omega t - 2\omega E_2 \sin 2\omega t - \\ &\quad 3\omega E_3 \sin 3\omega t \end{aligned}$$

Note that the relative size of the second harmonic is doubled and the third harmonic is tripled. Thus, with respect to the fundamental, the sizes of the harmonics are increased. An excellent coverage of such measurements can be found in *Measuring Hi Fi Amplifiers*, by Mannie Horowitz, published by Howard W. Sams & Co., Inc. ♦

From Cleveland Institute of Electronics

learn by doing!

Perform more than 200 exciting experiments with CIE's fascinating **ELECTRONICS LABORATORY PROGRAM!**

Put theory... into practice

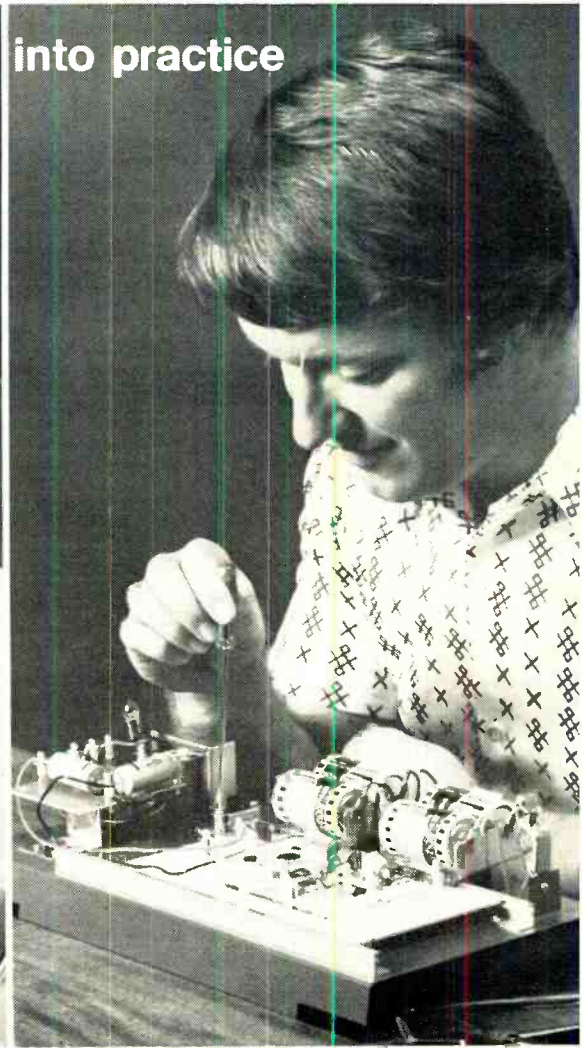

You get your own 161-piece electronics laboratory... with authentic electronic components used by industry!

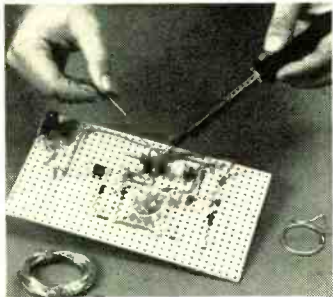

You learn how to construct circuits and connect them with a soldering iron, which is part of your CIE laboratory equipment. This "hands on" experience is extremely valuable in applying what you learn.

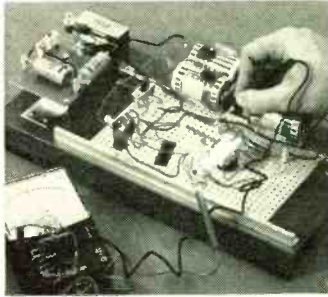

Testing and troubleshooting are an important part of your learning experience. Included in your laboratory is a precision "multimeter" to diagnose electrical and electronic troubles quickly and accurately.

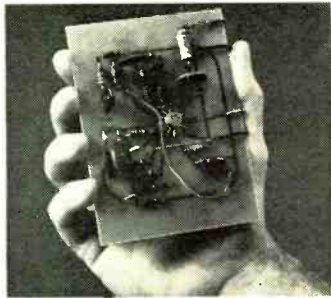

Modern space-age components like this IC (integrated circuit) are professional quality and can be used again and again in many of your projects. Lesson by lesson, piece by piece your knowledge grows!

Prepare now for a high income career in Electronics...the Science of the Seventies.

Electronic miracles are changing today's world with breathtaking speed.

And with this growth in electronics technology has come a brand new need... a demand for thousands of electronics technicians, trained in theory and practice to build the products, operate them and service them during the Seventies.

Don't just wait for something to "happen" in your present job. Get ready now for a career you'll really enjoy with a good income and plenty of opportunity for advancement.

Experience with experiments is your best teacher

"Hands on" experience helps to reinforce basic theory. When you learn by doing, you discover the "how" as well as the "why." You'll find out for yourself the right way as well as the wrong way to use electronic components. How to construct your own circuits, to discover trouble spots and learn how to fix them. And with CIE's special Auto-Programmed[®] Lessons, you learn faster and easier than you'd believe possible.

CIE's fascinating course, Electronics Technology with Laboratory, teaches you Electronics by making it work before your eyes. And you do it yourself, with your own hands.

Importance of FCC License and our Money-Back Warranty

Many important jobs require an FCC License and you must pass a Government licensing exam to get one.

But, a recent survey of 787 CIE graduates reveals that better than 9 out of 10 CIE grads passed the FCC License exam.

That's why we can offer this famous Money-Back Warranty: when

you complete our Laboratory Course, which provides FCC License preparation, you'll be able to pass your FCC exam or be entitled to a full refund of all tuition paid. This warranty is valid during the completion time allowed for your course.

You get your FCC License — or your money back!

You'll have high paying job opportunities

Electronics is still young and growing. In nearly every one of the new exciting fields of the Seventies you find electronics skills and knowledge are in demand. Computers and data processing. Air traffic control. Medical technology. Pollution control. Broadcasting and communications. With a CIE Diploma and an FCC License you can choose the career field you want... work for a big corporation, a small company or even go into business for yourself.

Here's how two outstanding CIE students carved out new careers: After his CIE training, Edward J. Dulaney, President of D & A Manu-

facturing, Inc., Scottsbluff, Nebraska, moved from TV repairman to lab technician to radio station chief engineer to manufacturer of electronic equipment with annual sales of more than \$500,000. Ed Dulaney says, "While studying with CIE, I learned the electronics theories that made my present business possible." Marvin Hutchens, Woodbridge, Virginia, says: "I was surprised at the relevancy of the CIE course to actual working conditions. I'm now servicing two-way radio systems in the Greater Washington area. My earnings have increased \$3,000. I bought a new home for my family and I feel more financially secure than ever before."

Send now for 2 FREE BOOKS

Mail the reply card or coupon for our school catalog *plus* a special book on how to get your FCC License. For your convenience, we will try to have a representative call. If coupon is missing, write: Cleveland Institute of Electronics, Inc., 1776 E. 17th St., Cleveland, Ohio 44114. Do it now!



Approved
under
G. I. Bill

All CIE career courses are approved for educational benefits under the G. I. Bill. If you are a Veteran or in service now, check box for G. I. Bill information.

CIE Cleveland Institute of Electronics, Inc.
1776 East 17th Street, Cleveland, Ohio 44114
Accredited Member National Home Study Council

Please send me your two FREE books:

1. Your illustrated school catalog, "Succeed in Electronics."
2. Your book, "How to Get a Commercial FCC License."

I am especially interested in: Electronics Technology with Laboratory
 Electronics Technology Industrial Electronics
 Electronic Communications First Class FCC License
 Broadcast Engineering Electronics Engineering

Name _____ Age _____
(PLEASE PRINT)

Address _____

City _____ State _____ Zip _____

Veterans and Servicemen: Check here for G. I. Bill information.

PE-4B

CIRCLE NO. 5 ON READER SERVICE CARD

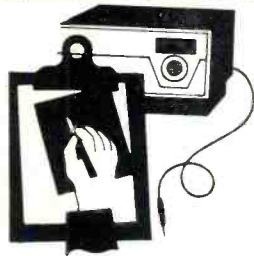

Product Test Reports

SHURE V-15 TYPE III STEREO PHONO CARTRIDGE (A Hirsch-Houck Labs Report)



THE SHURE BROTHERS V-15 series of stereo phono cartridges, especially the recent Type II (Improved), has established a reputation for tracking ability that has only rarely been challenged by competitive cartridges. In the company's newly announced V-15 Type III cartridge, they have somehow managed to make substantial improvements in what was already one of the two or three top-ranking cartridges in the world.

Trackability, the manufacturer's name for tracking ability, refers to the ability of the cartridge to follow the highest velocities found on commercial records over the entire audio frequency range without significant distortion. Mistracking is heard, depending on the frequency involved, as a "shattering" or harshness, as a "sandpapery" sound on vocal sibilants, or in severe cases as a complete loss of contact between stylus and groove on high-level low-frequency signals such as those of a bass drum.

A study by Shure engineers revealed that the most severe tracking problems could be expected at the higher frequencies where many records have recorded velocities that exceed the capability of even the V-15 Type II (Improved) cartridge. High-frequency

trackability can be improved by lowering stylus mass, which raises the frequency of resonance between the moving mass and the record material's compliance. In the V-15 Type III cartridge, the mass was reduced by 25 percent (to only 0.33 milligram). This shifted the high-frequency resonance from 20,000 Hz to 23,000 Hz, improving tracking ability in the highest audible octave.

Low-frequency trackability is a function of stylus compliance. However, excessive stylus compliance can lead to problems when playing warped or eccentric records if the resonance with the tonearm's mass lies below about 5 Hz. Fortunately, the compliance needed to resonate the V-15 Type III's stylus with the mass of the cartridge plus that of a good tonearm (such as the latest version of Shure's SME-3009) in the safe region between 7 Hz and 15 Hz is also adequate to track any low-frequency recorded material.

To compensate for the loss of output voltage that would normally result from the new stylus design, the internal magnetic structure of the cartridge was redesigned. Special laminated pole pieces provide higher magnetic efficiency so that the output of the new Type III is the same as that from the Type II (Improved).

Another improvement has been the flattening of the cartridge's response curve, eliminating the slight dip in the upper mid-range that characterized the Type II (Improved). Like the latter, the Type III is designed to be loaded with a fairly high capacitance—400-500 pF—in shunt with 47,000 ohms for flattest response. However, the capacitance effect is not as critical in the Type III.

The V-15 Type III cartridge is normally supplied with a 0.2×0.7 -mil elliptical dia-

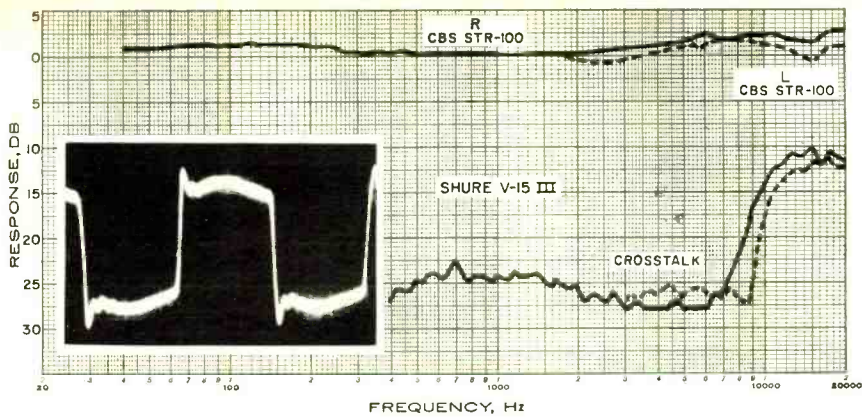

mond stylus and sells for \$72.50. It can also be had with a 0.6-mil conical stylus as the V-15 Type III-G for the same price. For those people with collections of 78-rpm discs, a new *elliptical* stylus, the VN-78E, is offered as an optional accessory. The 2.5 × 5-mil stylus is designed to track at between 1.5 and 3 grams as opposed to the recommended tracking force of 0.75 to 1.25 grams for the long-play styli.

Laboratory Measurements. The very-high-level low-frequency bands of our Cook 60 and Fairchild 101 test records were tracked with ease at 0.75 gram, the latter with no significant distortion, a characteristic not common with most other cartridges. The output from the 1000-Hz, 3.54-cm/s bands of the CBS STR100 record was 3.8 mV. The hum shielding of the Type III was better than found in most cartridges we have tested. The square-wave response was good, characterized by a single moderate overshoot.

We checked the frequency response with capacitive loads of 350 pF and 600 pF.

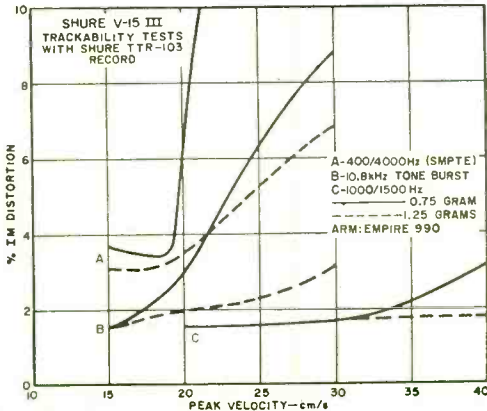

Both yielded very good results, but the flattest response was obtained with the higher value. It was within ± 1.25 dB over the full frequency range up to 20,000 Hz. Channel separation was about 30 dB up to 8000 Hz and 15 dB in the 10,000-20,000-Hz range.

To measure trackability, we used the new Shure TTR-103 test record. This provides IM distortion measurements in three frequency ranges at velocities ranging from 15 cm/s to 40 cm/s. Although the numerical results cannot be compared directly to those obtained with any other type of test record, they essentially confirmed the company's specifications for the V-15 Type III cartridge. They were also considerably superior to our test results with other fine cartridges, including the Type II (Improved).

When the company introduced the Type II (Improved), they also issued a test record titled the "Audio Obstacle Course" which contained musical recordings at successively higher levels to reveal the tracking limitations of cartridges without the use of any test instruments. Since this recording is not much of an "obstacle" to the V-15 Type III, the company has prepared a new version which they call "Audio Obstacle Course—Era III." The new cartridge handled the Era III with ease.

Wondering if the Era III was really as severe a test as was implied, we tried the best cartridges previously available and found that none of them was able to track the highest levels on the record without distortion. (Each purchaser of a V-15 Type III cartridge can obtain a free copy of the Era III simply by filling in and mailing the request card packaged with the cartridge. If one has any doubts about the superiority of the Type III, this test will soon dispel them.)

User Comments. As might be expected, the sound using the V-15 Type III cartridge is as uncolored and free from strain as could be desired. On most records, it does not sound any different from some of the other top-quality cartridges available, some of which have a very similar frequency response characteristic. However, a record that seems to have distorted sections will

almost always sound clean with the Type III, proving that a large part of the distortion we hear from discs is actually due to cartridge mistracking. We were impressed with the fact that at 0.75 gram the Type III will outperform other cartridges that operate in the 1.0-1.5-gram range.

As Shure states in their ads, "anything II could do, III can do better."

Circle No. 65 on Reader Service Card

HARMAN-KARDON MODEL HK-1000 CASSETTE DECK (A Hirsch-Houck Labs Report)



BIAS AND EQUALIZATION switching for both "standard" and "low-noise" ferric oxide as well as for chromium dioxide tape formulations are featured in Harman-Kardon's new Model HK-1000 cassette deck with built-in Dolby noise reduction circuits. There is also a "memory" switch used in conjunction with the index counter to stop the tape accurately at the "000" count during high-speed rewind. Other switches activate the Dolby system and parallel the inputs for monophonic recording using both channels.

Recording and playback levels are controlled by four slide-type potentiometers. Recessed into the rear of the walnut base are two pairs of line inputs, one pair each for high- and low-level program sources, obviating the possibility of having to operate the recording level controls near their limits where adjustment might prove difficult. Also on the rear of the recorder are the line outputs and a screwdriver-adjustable tape-speed control that is factory set and should not be touched without having adequate test facilities on hand.

A pair of standard phone jacks on the front panel accept inputs from low-impedance dynamic microphones, while small knobs near the jacks are used to adjust micro-

phone gain (in conjunction with the regular recording level controls). Plugging a microphone into either channel input disconnects the corresponding line input.

Two illuminated meters indicate peak signal levels during record and playback, while red and amber lights come on when the controls are set to the RECORD and DOLBY modes, respectively. Below the meters are four recessed screwdriver controls for the Dolby system and a test pushbutton that records a 400-Hz standard Dolby level tone (0 dB) on the tape. The playback calibration for the Dolby system is factory set and must not be disturbed unless a special cassette (supplied by Harman-Kardon) is used. The Dolby recording calibration might require readjustment to accommodate different types of tape, a task simplified with the built-in test tone facility.

The HK-1000 cassette deck measures 15½ in. wide by 10¼ in. deep by 5 in. high and weighs 12½ pounds. Its retail price is \$330.

Laboratory Measurements. The playback frequency response of the HK-1000, using a Nortronics AT200 test tape, was +2/-4 dB from 31.5 to 10,000 Hz. An input of 0.18 mV, 30 mV, or 240 mV at the microphone, low-level line, and high-level line inputs respectively produced a 0-dB recording level. The corresponding line output during playback was 0.53 V.

Harman-Kardon provides no indication of what they consider to be "standard" or "low-noise" tape. Unfortunately, few major tape manufacturers admit to making a "standard" tape, and even the most undistinguished products are sometimes designated as "low-noise" types.

Prior experience has demonstrated to us that Memorex tape is typical of the formulations that yield optimum results in most good recorders. Because of its wide com-

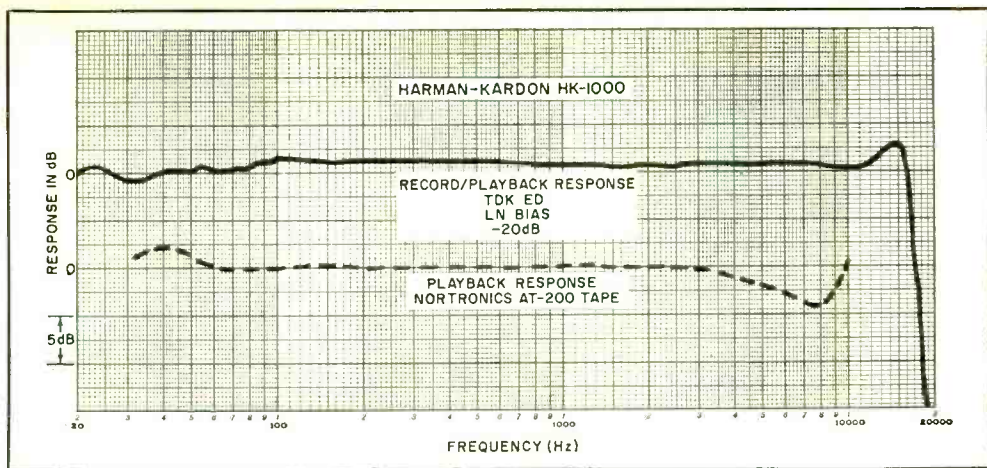

patibility with moderate bias levels and commonly used equalization characteristics, we have chosen to label it as "standard" (Memorex calls it "Low Noise, High Output"). Perhaps coincidentally, the factory settings for Dolby recording calibration were correct for the Memorex tape.

When we measured the overall record/playback response, the combination of STD bias setting and Memorex tape produced a falling high-end response, about -8 dB at 13,000 Hz, relative to the 400-Hz level. When used with the LN bias, a considerable improvement was noted; the highest frequencies were only about 5 dB below the midrange levels.

Most "low-noise" cassette tapes gave a roughly similar response. The best performance came from the latest "extended-range" tapes, such as TDK's ED which yielded an excellent, flat overall response within ± 1 dB, 20-13,000 Hz, and a slight rise of 2.5 dB at 15,000 Hz before dropping to -1 dB at 16,500 Hz. LN bias was used for this tape.

With CrO_2 tape and the appropriate bias setting, there was a gentle high-frequency rolloff with the same small peak at 15,000 Hz. Overall, the frequency response was a very good ± 2.5 dB from 20 to 16,500 Hz. This is one of the few cassette recorders that permits the playback equalization to be changed for CrO_2 tape, thereby opting for lower noise instead of a less useful extension of the frequency response beyond 15,000 Hz. As a result, there is no significant difference between a good ferric-oxide tape and a CrO_2 tape, although there is an appreciable improvement in the signal-to-noise ratio when CrO_2 tape is used.

With ferric oxide tapes, the 3-percent dis-

tortion level appeared at between 0 and $+1.5$ dB. Using CrO_2 tape, the same distortion occurred at a level of -1 dB. The unweighted S/N ratio, referred to the 3-percent distortion recording level, was 53.7 dB with Memorex (STD) and 53.9 dB with TDK SD (LN) tape. TDK KR (CrO_2) tape produced a 57.2-dB S/N ratio. All of these measurements were obtained with the Dolby system out of the circuit. The Dolby circuits improved the S/N ratios by 8 dB with ferric oxide and 6.5 dB with CrO_2 tapes. We measured a 6-dB greater noise level through the microphone inputs than we did through the line inputs at maximum gain.

The tape transport operated very smoothly and quietly, with wow and flutter (unweighted) respectively 0.04 and 0.16 percent. In fast forward and rewind, a C-60 cassette was run through from end to end in about 70 seconds.

User Comments. The HK-1000 cassette recorder performed as well as its bench measurements suggested. We could not fault its performance in any respect. Especially impressive was its flat low-bass response, all the way down to 20 Hz. Almost every other cassette recorder we have tested had considerable low-frequency irregularity or an attenuated response due to head gap fringing effects. In contrast, the HK-1000's bass response compares favorably with that of the best open-reel recorders.

We were surprised to note that microphone mixing was not possible, in spite of the recorder's having separate gain controls for the microphone inputs. In any event, the best S/N ratio when using microphones required that these controls be set at their

maximum positions and the regular recording level controls be set to the operating level required.

Judging from our experience with this recorder, the LN bias should be used with *all* ferric oxide tapes. We know of no tape with quality worthy of this machine that will not perform at its best with the LN bias.

Circle No. 66 on Reader Service Card

HEATH MODEL IB-1100 FREQUENCY COUNTER



TODAY'S DIGITAL frequency counters are rapidly becoming as indispensable to electronic engineers, technicians, and experimenters as are oscilloscopes and high input resistance meters. It seems that, every month or so, one manufacturer or another introduces a new counter model. One of the new entries is the Model IB-1100 counter kit being sold by the Heath Company for \$170.

The IB-1100 is actually Heath's lowest cost digital frequency counter. Nevertheless, its published specifications are really quite good. The frequency range of the new instrument is specified at 1 Hz to 30 MHz. Working into a diode-protected FET input, the sensitivity is 100 mV to 150 V (both rms) maximum. Beyond 100 kHz, the maximum input potential is derated by 48 volts per decade, but since the bulk of conventional measurements is usually in the low-voltage range, these ratings should suffice for all but those very rare occasions when an attenuator must be used. With an input impedance of 1 megohm and 20 pF, the IB-1100 is essentially a non-loading instrument.

The crystal-controlled time base has a quoted stability of less than 3 parts per million (ppm) between 22° C and 37° C and less than 20 ppm between 10° C and 40° C. This stability improves to less than 1 ppm per month after 30 days of operation.

The readout display consists of five gas-

The HK-1000 is a foolproof machine to use from a mechanical standpoint. The transport controls are cleverly interlocked to prevent damage to tapes yet provide a minimum of inconvenience to the user. All in all, this is a first-rate recorder, "high fidelity" in every respect, and versatile enough to satisfy the critical audio buff.

discharge cold-cathode tubes. These are backed up by a neon lamp overrange indicator.

The front panel of the IB-1100 features a very simple layout. There are only two slide-type switches: one is for power ON/OFF, while the other is for range selecting between kHz and MHz. Below the switches is located a single BNC input connector. Aside from the readout system, that is it.

The rear panel contains facilities for trimming the time base oscillator, a test point output connector, and a test point level control. The crystal oscillator can be trimmed to zero beat with WWV using any short-wave receiver and the instructions provided in the assembly/operating manual.

Owing to the fact that most of the components that make up the counter mount on one large double-sided epoxy printed circuit board, assembling the IB-1100 was very easy. Our instrument went together in about 7½ hours. And it functioned well right from the very first test.

Using the Instrument. From the layout of the front panel, it was fairly obvious that operating the instrument would be a snap—and it was. All one has to do is connect the input cable to the circuit under test, slide the power switch to ON, set the range switch to the appropriate position, and read the frequency. Although the instrument uses only five display tubes, if measurements are made in the MHz range, an eight-digit capability can be obtained merely by reading the figures displayed with the range switch in the MHz position. Then by flipping to the kHz position, the display will fill in the remaining figures right down to the nearest hertz. In the event that the capacity of the instrument is exceeded, the overrange (OVER) lamp will come on.

Unlike many other low-cost frequency counters, the IB-1100 employs a latch between the counter stages and the readout

decoder. This means that the readouts do not ripple through their count. They simply display the final count, changing only to reflect the count for the updated frequency, if any.

We ran a number of frequency tests, using our crystal-controlled signal generator (accurately set to WWV) in conjunction

with our other, more expensive, Heath frequency counter. The IB-1100 acquitted itself quite well both in frequency accuracy and sensitivity. During the test, we also discovered that the 30 MHz specified top end was really quite conservative. Our instrument ran quite well out to about 50 MHz.

Circle No. 67 on Reader Service Card

REGENCY MODEL TME-16HLU FM MONITOR RECEIVER (A Hirsch-Houck Labs Report)

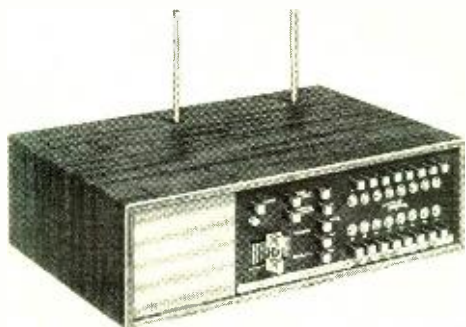

THE REGENCY ELECTRONICS Model TME-16HLU is a versatile 16-channel, crystal-controlled, double-conversion FM monitor receiver. It covers the 30-50-MHz, 148-174-MHz, and 450-470-MHz public service bands via a battery of 16 pushbutton switches located on the control panel.

The receiver can be internally programmed for reception of any eight channels in the two vhf bands, plus eight more channels in the uhf band. A quartz crystal of the proper frequency must be used for each channel desired. (The receiver is shipped from the factory programmed for four LO and four HI band channels in the vhf ranges. However, internal jumper wires can be shifted to group the programmed channels differently.)

Several reception modes are possible. In MANUAL, any of the 16 pushbutton selector switches can be pressed to provide single-channel monitoring. Pressing the momentary-contact CHANNEL SELECTOR button causes the receiver to scan sequentially through all selected channels (buttons pushed in) at a rate of about one channel per second. Channel identification lights adjacent to the buttons glow as the scan passes through each channel. Releasing the CHANNEL SELECTOR when the scan reaches the desired channel leaves the receiver tuned to

that channel. The receiver can also be set up to scan automatically through all selected channels at a rate of approximately 15 channels per second.

Five pushbutton switches are used to select the scanning range: HI covers the 148-174-MHz band; LO covers the 30-50-MHz band; and HI/LO covers both vhf bands. UHF covers the 450-470-MHz band. The fifth button, marked ALL, sets up the receiver to scan all bands. To use the scan mode, the squelch circuit must be in operation and the SCAN/MANUAL button must be depressed.

A pair of slide-type potentiometers is provided for volume and squelch adjustment. In the rear of the receiver are separate standard Motorola auto radio coaxial jacks that accommodate the external vhf and uhf antennas. Telescoping vhf and uhf antennas are provided for use when external antennas are either not feasible or not required; inserted through the top of the cabinet, they screw into the "front-end" section of the receiver. The receiver develops 3 watts of audio output power that drives a small built-in speaker. This output power is also delivered to a terminal block located on the receiver's rear apron for driving an external speaker.

Housed in a wood-grain-finished metal cabinet, the receiver measures 13 in. wide by 8 $\frac{3}{4}$ in. deep by 4 $\frac{1}{2}$ in. high. At its retail price of \$219, the receiver is supplied less crystals. The crystals are supplied separately, their frequencies specified by the buyer.

Laboratory Measurements. The Regency TME-16HLU monitor receiver was evaluated on our test bench with local police and other mobile services crystals installed in all three bands. Sensitivity was measured with a signal deviated ± 7000 Hz at 400 Hz. The r-f level was adjusted until the

background noise without modulation was 20 dB lower than the fully modulated audio output.

At the factory, the receiver's r-f circuits are aligned for maximum sensitivity at 40 MHz, 156 MHz, and 458 MHz. It is recommended that the operating frequencies be within about 3-5 MHz of these points if best sensitivity (rated at 0.5-0.7 μV on the different bands) is to be achieved. Our test channel frequencies on the vhf LO band were far outside these limits (46.3 MHz), yielding a measured sensitivity of only about 4.5 μV . On the m band where we used 154.8 MHz, the sensitivity was 1.2 μV . No measurements could be made at 453 MHz, but local police car transmissions came in loud and clear to our basement listening post while using the short 5-in. vertical antenna supplied with the receiver. For optimum performance on frequencies far removed from the factory alignment points,

Circle No. 68 on Reader Service Card

BSR/McDONALD MODEL 810/X AUTOMATIC TURNTABLE (A Hirsch-Houck Labs Report)

THE TOP-OF-THE-LINE Model 810/X record player is aptly titled a "Total Turntable" by its manufacturer, BSR/McDonald. It consists of a Model 810 automatic player-and-tonearm combination, a Shure M91E phono cartridge, a walnut base, and a tinted plastic dust cover. To set up the player, one has only to set the platter in place, plug into the tonearm the preassembled cartridge shell, and take a few moments to balance the tonearm and set stylus force. After this, the 810/X is ready to plug into an amplifier for immediate play.

Two speeds are provided (33 $\frac{1}{3}$ and 45 rpm), selectable through a rocker switch that mechanically shifts the idler wheel to the appropriate step on the motor shaft. Concentric with the speed selector is a vernier control that permits adjustment of the platter speed by about 3 percent above and below each nominal speed. A stroboscope disc forms the center insert of the ribbed anti-static turntable mat.

The 12-in. cast aluminum platter (weighing over 6 lb.) is driven by a synchronous motor that can be operated from either a 117-volt or a 220-volt ac line. Interchangeable motor shaft bushings are supplied for operating on either 50 Hz or 60 Hz.

The square cross-section aluminum tonearm is mounted on gimbal pivots via four

the "front end" of the receiver must be realigned.

The squelch threshold must be adjusted for full quieting in order for the automatic scan feature to operate. In this condition, a signal equal to that producing a 20-dB (S + N)/N ratio was sufficient to activate the receiver.

The selectivity of the receiver (which uses ceramic filters in its 455-kHz second i-f amplifier) was appreciably better than rated by the manufacturer. We measured a ± 5000 -Hz selectivity at -6 dB and ± 9000 Hz at -50 dB (rated figures were ± 7000 Hz and $\pm 15,000$ Hz).

The Regency Model TME-16HLU monitor receiver is clearly an exceptionally versatile high-performance unit. Although no schematic diagrams were supplied with it, the fact that the receiver contains ten IC's and a number of silicon transistors suggests its thoroughly up-to-date design.



miniature ball-bearing assemblies. It has a knob-adjustable counterweight on its side. After balancing, a calibrated scale on one of the gimbal rings is used to set any stylus force between 0 and 6 grams. Stylus overhang is adjustable for minimum tracking error (not required in the preadjusted 810/X) with the aid of a removable index post on the motorboard. Afterward, a soft brush is fitted to the post, where it removes lint from the stylus each time the arm returns to its rest. The arm rest has a built-in lock that automatically closes on the arm a short while after the turntable shuts itself off.

The anti-skate control has separate scales for conical and elliptical styli (normally set to match the tracking force). A cueing lever is used to lift up the pick-up gently from the

record and lower it when desired. During the lifting and lowering operations, the cart-ridge outputs are muted. The arm indexing point, customarily set by a screwdriver on automatic turntables, is controlled by a knob on the motorboard.

The system comes with interchangeable spindles for manual and automatic operation. A knob is used to select either mode, and punching either the 7-in., 10-in., or 12-in. button initiates the operating cycle and indexes the tonearm for the selected record size. The short manual spindle rotates with the disc to prevent center hole wear. Up to six discs of the same size and speed can be played automatically. The spindle must be lifted from the turntable to remove the discs when play is done.

With the manual spindle inserted, setting the MODE switch to AUTO allows the disc to be repeated indefinitely. It will continue to repeat until the STOP button is pressed.

The 810/X "Total Turntable" measures 17½ in. wide by 12¾ in. deep by 9¾ in. high, including dust cover, and weighs 22 pounds. Its suggested retail price is \$239.

Laboratory Measurements. The range of the vernier speed adjustment checked out to be +2.3/-2.7 percent around the center speeds. Wow and flutter were very low, 0.04 and 0.06 percent at 33½ rpm and 0.04 and 0.03 percent at 45 rpm. The unweighted rumble was down 38.5 dB in the lateral plane and -34 dB when vertical and lateral

components were included. With CBS RRL weighting, which correlates the measurements with their audible effects, rumble was a low -54 dB. The automatic change cycle time was 14.5 seconds at 33½ rpm.

The tracking error of the tonearm was less than 0.5°/in. for disc radii of 2.5 to 6 in. (typical of a well-designed tonearm of this size). When the tracking force dial was exactly correct at 1 gram, the actual forces we measured were from 0.25 to 0.35 gram higher at settings between 2 and 4 grams. At a 1-gram setting, the force increased by 0.35 gram at the top of a stack of six discs. As with most anti-skating systems we have used, the optimum settings for equal tracking distortion in both channels were slightly higher than indicated, about 1.5 grams for a 1-gram tracking force.

User Comments. The BSR 810/X total turntable proved to be an exceptionally quiet and smoothly operating system. The controls move with ease and, during extended periods of use, the mechanism operated flawlessly. The operating characteristics of the system, including its speed stability, low wow and flutter, and inaudible rumble, were on a par with some of the best automatic players we have tested, most of the latter being considerably more expensive than the 810/X.

In conclusion, we feel that the 810/X "Total Turntable" package is unquestionably one of the best values in high-quality record playing equipment available today.

Circle No. 69 on Reader Service Card

FANON/COURIER FANFARE 700 CB TRANSCEIVER



IT IS NOT OFTEN that we find a piece of CB gear that departs from convention and makes us sit up and take notice. The Fanon/Courier Fanfare 700 is a rarity. It is a 23-channel, crystal-synthesized AM rig. Designed to be a base station, it can also be used in mobile or emergency service with a 12-14-volt dc negative-ground electrical system.

The rig has the usual adjustable squelch, delta tune, noise limiter, PA facilities, meter, and performance at the full legal input power of 5 watts. Additionally, it has an ANL on/off switch, tone control, headphone jack, detachable push-to-talk dynamic microphone, compressor for modulation limiting, ac circuit breaker, and a digital-readout clock that can be set to turn on the transceiver or actuate an alarm buzzer on cue.

To top it all off, the rig is exceptionally attractive, designed more along the lines of a high-quality stereo receiver than a CB rig. Instead of a rotating channel selector dial, a linear-type scale is employed with all the channel numbers softly illuminated in green on a black background. Channel identifica-

tion is accomplished with the aid of a red pointer that is positioned in much the same manner as with a slide-rule dialing system.

The Fanfare 700 measures 12 $\frac{1}{2}$ in. wide by 8 $\frac{1}{2}$ in. deep by 4 $\frac{3}{16}$ in. high and weighs 10 pounds. Its retail price is \$323.15.

Receiver. Double-conversion starting off with a FET r-f amplifier permits an input-signal sensitivity of 0.5 μ V for 10 dB (S + N)/N. Conversion frequencies are at 10.65 MHz and 455 kHz. A ceramic filter at the first i-f minimizes certain spurious-signal responses, while two ceramic filters at the second i-f provide the necessary selectivity for an adjacent-channel rejection of at least 50 dB.

The high first i-f and the front-end circuitry maintain a 90-dB image rejection, while a 10.6-MHz trap at the antenna helps to improve the i-f signal rejection which we measured to be 60 dB. Two 455-kHz i-f stages are incorporated into a single IC.

Diodes are used for the detector/age, S-meter setup, and a series-gate noise limiter. The latter is extremely effective, attenuating impulse noise by 35 or 40 dB without distorting or dropping the level of the output signal. With an r-f input change of 1 to 10 μ V (20 dB), the a-f output rose 13 dB. A 10-10,000- μ V change (60 dB) caused the output to rise only 5 dB. An S-9 meter indication was obtained with a 30- μ V input signal. The squelch, triggered from an age-controlled stage, can be adjusted for a threshold sensitivity of between 0.4 μ V and 10,000 μ V. A slight "plop" is heard when the squelch opens and closes.

The a-f amplifier engages an IC and a push-pull class-B output stage. At the a-f output, 2 watts of power at 6 percent distortion into 16 ohms are developed for receiver or PA service. A headphone jack can also be used for an external speaker.

Frequency Synthesizer. Six different crystals cut to frequencies near 37 MHz are used in the synthesizer in conjunction with four crystals cut to near 10.15 MHz. Each group, respectively, provides heterodyning signals for the first and second mixers. The delta tune is obtained by "rubbering" capacitors in the 10.15-MHz crystal group. There are only two fixed positions to either side of center, allowing a change of \pm 1500 Hz. Since this change is greater than the 0.005 percent legal tolerance for transmit-

ters, and considering the transceiver tolerance, a shift by the delta tune system of only \pm 1000 might have been more realistic.

Transmitter. On transmit, the 10.15-MHz crystal group of synthesizer crystals is substituted by a group near 10.6 MHz. By combining these with the 37-MHz crystals at a transmitter mixer, the on-channel signal is developed. A four-section bandpass network here minimizes spurious frequencies, as does the 10.6-MHz antenna trap. The frequency tolerance on all channels was within 0.002 percent at 75° F.

There are two r-f amplifiers. These are followed by the power amplifier, which has a triple-section output network for matching to 50 ohms. The network also minimizes spurious responses with TVI reduction further enhanced by a 54-MHz trap (at the antenna) that can also minimize receiver overload by a nearby TV station.

A carrier output of 3.75 watts was obtained with operation from 117-volt ac and 13.8-volt dc sources. A solid-state voltage regulator maintains a constant supply potential from either type of power source.

Modulation, as usual, is obtained from the receiver section's output amplifier where a feedback circuit is switched in to furnish a control bias at the a-f IC to provide limiting-compression. An excellent modulation waveform was observed, with distortion measuring only 7.5 percent with 10 dB of compression at 100 percent modulation at 1000 Hz.

Comments. During receive, a panel lamp glows. On transmit, it extinguishes and another lamp comes on and changes in brilliance according to the modulation. The meter at this time indicates relative output power; during receive, it indicates relative signal strength in S units.

Panel controls are furnished for setting the clock (includes seconds indicators) to turn on the transceiver or to actuate the alarm buzzer at the desired time. The clock, of course, does not operate when the rig is powered from a dc source.

Unlike slide-rule-type dials, operation of the channel selector in the Fanfare 700 is positive. It still employs ball-and-detent tuning to assure on-channel operation, but without the less aesthetic appearance of a traditional circular dial arrangement.

Circle No. 70 on Reader Service Card



Gas and Smoke Alarms

By John T. Frye, W9EGV, KHD4167

This morning, Barney parked the service truck behind the shop because he knew he had several repaired sets to deliver. When he came in the rear door, he stopped short at the sight of Mac, his employer, waving a lighted match beneath a little white box fastened to the wall above the "cooking bench." This was a bench on which electronic "dogs" were allowed to run continuously until the intermittent conditions that brought them into the shop surfaced.

"Blow out your lantern, Diogenes!" Barney said. "Here's the honest man you're looking for."

"Some of our customers might give you an argument about that," Mac answered, looking over his shoulder with a wry grin.

But he did blow out the match and then held it so the little curl of white smoke from it rose and entered three rectangular holes in the bottom of the white box and emerged from similar holes in the top. Almost instantly there was a raucous roar from the box. Mac stopped the noise by moving a little black lever protruding from one of the openings on the bottom of the box to

the right, but the noise started again when he released the lever. He moved the lever over again and blew up into the rectangular openings. This time when the lever was released the box remained silent.

"What the heck is that?" Barney demanded. "That thing makes a noise like the emergency dive warning on a submarine. It certainly can bellow for such a small thing. It can't be more than 2" x 8" x 4"."

"The long dimension is only 7", so you've got a pretty good eye," Mac replied. "It's Radio Shack's new Disaster Alarm, offered in kit form for \$19.95. They claim it uses the world's first gas and smoke sensing semiconductor to activate an alarm buzzer in the presence of gas concentration."

"But that was *smoke* from the extinguished match you were using to trip it."

"Right; but smoke contains gaseous components. In addition to smoke this thing will detect butane, propane, carbon monoxide, and natural or cooking gas. While it is not equally sensitive to all of these, it is plenty sensitive to sound an alarm before the concentration of any one of them would

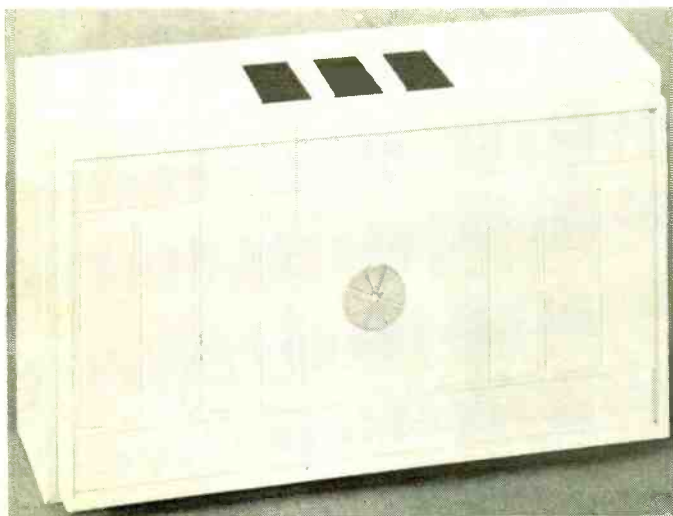

Disaster Alarm measures 2" x 7" x 4" with holes in bottom and top to allow smoke or gas to pass through and sound alarm.

be considered lethal. The claimed sensitivity is 100 ppm for propane, 120 ppm for isobutane, 500 ppm for carbon monoxide, 5000 ppm for methane, and about a 2-4% concentration for smoke. The variation in sensitivity for smoke is a function of the variety in the burning substances producing smoke and alarm-tripping gas."

"How does it work?"

"All I can tell you is what the manufacturer told me. Take a look at this diagram. The heart of the whole thing is the

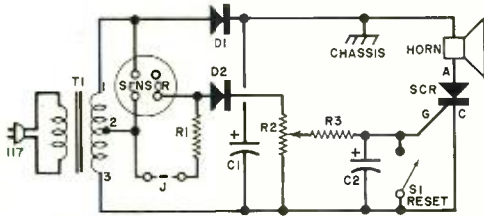

Circuit uses gas-sensing semiconductor.

TGS gas sensing n-type semiconductor. The voltage from T1 is fed through the sensor to D2. The electrical conductivity of the sensor varies with the adsorption of ambient gases. This variation of conductivity can be taken as associated with the mode of adsorption on a specific site on the semiconductor surface contributing to the conduction process. The adsorption of gaseous components occurs on specially active surface areas, which may consist of positive hole and/or free electrons resulting from lattice defects of the semiconductor crystal."

Mac stopped for breath and then continued. "The rise in conductivity on adsorption of carbon monoxide, for instance, may be due to the adsorption of CO₂ as a positive ion by electron donation to the positive hole in the lattice; and, in order to maintain electrical neutrality, a free electron is created at the same time. On the other hand, oxygen may be adsorbed as a negative ion by accepting a free electron from the lattice, giving rise to a decrease in conductivity of the adsorbent. Is that crystal clear?"

"I reckon, if you say so," Barney mumbled. "Why did the alarm keep sounding after you reset it?"

"Because some gas still lingered in the vicinity of the detector. That's why I blew through the protective fine mesh screen that fits down over the sensor to clear away the gas."

"I see," Barney said, studying the diagram, "that the increasing voltage delivered to D2

in the presence of gas is rectified and delivered to the gate of the silicon controlled rectifier. Once tripped, the SCR keeps sounding the horn in its anode circuit until reset. Potentiometer R2 is obviously a sensitivity control."

Easy Kit Assembly. "You've got the picture. The circuit is simple and the kit is easy to assemble. The printed circuit board is only 5" X 1", and even an inexperienced person should be able to assemble it in an hour or so. I've proved to myself it trips on only a small amount of cooking gas and butane gas, and I've tried it with wood smoke, cigar smoke, cigarette smoke, burning wool, burning cotton, burning plastic, and burning rubber."

"Why so many different kinds of smoke?"

"Because some smoke sensors are very fussy about the kind of smoke they detect. One type shines a light onto a photocell and depends on the presence of smoke in this light path to trip the alarm by reducing the amount of light falling on the cell. Another type does not shine the light directly onto the cell but depends on the presence of smoke to reflect the light onto the cell. The first type works best with dark-colored smoke; the second, with light-colored smoke. I wanted to make sure this one would trip with smoke produced by the burning of all substances normally ignited in home fires, and I found it did."

"Now," he said, lifting the alarm from its mounting screws, "I have just one more test to make. You fire up the truck while I plug this thing into an extension cord. Let's see what it does with carbon monoxide from the exhaust."

Barney started the truck and let it idle. When Mac held the alarm a foot or so above and behind the exhaust pipe, the alarm blared its warning.

"Man, that thing surely hates gas!" Barney exclaimed. "I suppose it will be used mostly in the home."

"That's what it's designed for," Mac agreed, "but I'll wager it will find lots of other uses. For example, you will notice I've mounted it over our 'cooking bench.' Quite often one of the sets on this bench starts to smoke from an overloaded resistor or transformer. I think we can depend on this little jewel to call our attention to the fact."

Many Uses. "It would be pretty handy

in the kitchen, too," Barney suggested. "If someone carelessly left a burner on when the pilot was out, the Disaster Alarm would certainly let you know about it. It would also tell you if the roast were burning."

"The garage would be another place where it could serve a vital function," Mac said. "Properly mounted, away from the exhaust, it would remain silent until the concentration of carbon monoxide rose to a dangerous level; but if you left the engine running very long with the doors closed, it would tell you in no uncertain terms that carbon monoxide is an insidious and deadly poison gas."

"Hey!" Barney interrupted, "I have another idea. Why wouldn't that be a fine thing to mount in a camper or trailer? I'm always reading where hunters are being asphyxiated while sleeping in their campers. Of course the Disaster Alarm would only work when 120-volt ac was connected to the mobile vehicle, but that is pretty often the case when these vehicles are tied up for the night."

"Sounds good," Mac agreed. "One thing I want to warn you against is careless testing of the alarm. The sensor is extremely sensitive, and like all sensitive devices can be damaged by over-exposure to the substance it is designed to detect. For example, one fellow I know wanted to see if the device would detect the gas used to pressurize aerosol cans; so he sprayed some of the can's contents directly on the sensor. The alarm sounded, all right, but that was its swan song. It was paralyzed, and the fellow had to buy a new sensor. At about six dollars each for sensors, this lesson is quickly learned."

"I don't suppose the thing has a fail-safe feature is which the alarm sounds if the power goes off."

"Not exactly, but, if the current stays off for approximately an hour, the alarm will sound when the current comes back on. Then you have to reset it. This has some value in that it warns you not to believe what your electric clocks say."

"Well, as the young husband said when his mother complained that his beautiful wife was not too good a cook: 'You don't expect a sunset to fry eggs.' That Disaster Alarm obviously does a bang-up job of gas and smoke detection at a very reasonable price, and that's enough," Barney concluded as he started carrying chassis out to the truck. ♦

NOW

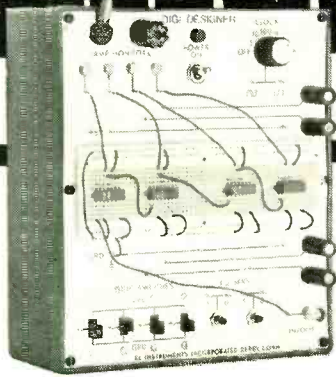

... BUILD YOUR OWN CIRCUIT DESIGNER, WITH ALL THE OUTSTANDING FEATURES OF EXPENSIVE MODELS . . . AT A LOW BUDGET PRICE.

THE DIGI DESIGNER

This compact package contains a regulated 5VDC supply, selectable frequency clock, E&L-socket, dual bounce-free pushbuttons (pulsers), 4 slide switches for voltage/ground, plus 4 independent "logic lights" for on/off states of various logic circuitry. Exclusive Breadboarding Pins offer input/output connections to socket, eliminating all soldering. All your circuit components are reusable. Use any #22 gage solid wire. Send check or M.O. today for your choice of two models.

DD1-K, Kit Form (incl. p.c. boards, all components, instruction manual) **\$59.95**

DD1-A, Assembled, ready for use **\$95.00**

- Add \$1 postage, handling
- 25% deposit on C.O.D.'s

Ask for FREE IDEA-PACKED, ILLUSTRATED CIRCUIT DESIGN CATALOG.



E&I INSTRUMENTS, INCORPORATED
61 First St., Derby, Conn. 06418
Telephone: 203/735-8774

CIRCLE NO. 11 ON READER SERVICE CARD

DO YOU KNOW YOUR DC CIRCUITS?

CONCLUSION OF A SERIES COVERING DC CIRCUIT ANALYSIS

BY ARTHUR H. SEIDMAN, Prof. of Elect. Eng., Pratt Institute

13. Network Topology.

In complex networks it is sometimes difficult to determine whether to use mesh or nodal equations, or to determine the minimum number of independent equations needed. By borrowing from a branch of mathematics

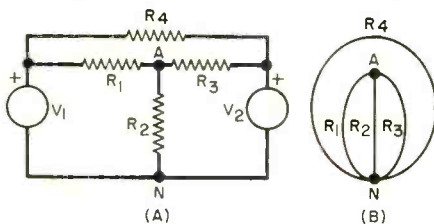

Fig. 24

called topology, it is relatively simple to find answers to these questions. Here is the procedure:

(1) Set all independent (or dependent) sources to zero. Setting a voltage source to zero means that it is shorted out of the network; setting a current source to zero means that it is removed, or open circuited, from the network.

(2) All elements, such as resistors, are replaced by line segments, called

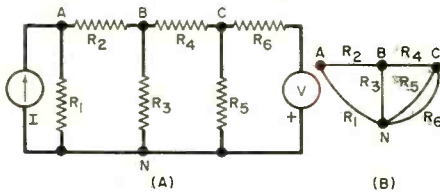

Fig. 25

branches. The resulting configuration is referred to as a graph.

(3) Let the number of nodes of the graph equal N and the number of branches equal B .

(4) The number of independent nodal equations required is $N - 1$.

(5) The number of independent mesh equations required is $B - N + 1$.

Ex. 22. For the network in Fig. 24A draw its graph and determine the minimum number of independent nodal and mesh equations. *Sol.* The graph is shown in Fig. 24B. Nodal equations: $N - 1 = 2 - 1 = 1$. Mesh equations: $B - N + 1 = 4 - 2 + 1 = 3$.

Ex. 23. Repeat Ex. 22 for the network in Fig. 25A. *Sol.* The graph is shown in Fig. 25B. Nodal equations: $N - 1 = 4 - 1 = 3$. Mesh equations: $B - N + 1 = 6 - 4 + 1 = 3$.

14. Superposition Theorem.

The superposition theorem states that the response of a linear circuit to more than one independent source is equal to the sum of the responses to each

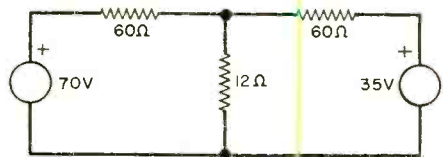

Fig. 26

source with the remaining sources set to zero. It must be remembered that this theorem applies only to linear circuits. If the circuit contains dependent, as well as independent sources, the dependent sources are not set to zero. Only independent sources are set to zero.

Ex. 24. Applying the superposition theorem, determine the current in the 12-ohm resistor in Fig. 26. *Sol.* Setting

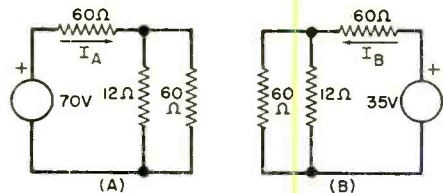

Fig. 27

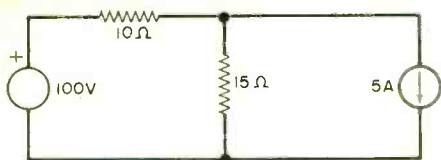

Fig. 28

the 35-volt source to zero yields Fig. 27A. Current $I_A = 70 / (60 + 60 // 12) = 1$ A. $I_{A(12)}$ due to the 70-volt source $= 1 \times 60 / (60 + 12) = 0.83$ A. Setting the 70-volt source to zero yields Fig. 27B. $I_B = 35 / (60 + 60 // 12) = 0.5$ A. The current $I_{B(12)}$ due to the 35-volt source is $0.5 \times 60 / 72 = 0.42$ A. Hence, $I_{12} = I_{A(12)} + I_{B(12)} = 0.83 + 0.42 = 1.25$ A.

Ex. 25. Using superposition, find the current in the 10-ohm resistor in Fig. 28. Sol. Setting the 5-A source to zero results in Fig. 29A. Current $I_A(10) =$

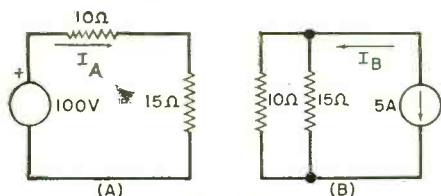

Fig. 29

$100 / (10 + 15) = 4$ A. Setting the 100-volt source to zero yields Fig. 29B. $I_B(10) = -5 \times 15 / (10 + 15) = -3$ A. Therefore, $I_{10} = 4 - 3 = 1$ A.

Ex. 26. Find I_2 in Fig. 30. Note the presence of a current dependent source, $3I_1$, in the circuit. Sol. Setting the 5-A source to zero yields Fig. 31A. $I_1 = 10 / 5 = 2$ A and $3I_1 = I_2 = 3 \times 2 = 6$ A. Setting the 10-volt source to zero yields Fig. 31B. Because there is a short circuit across the 5-ohm resistor, $I_1 = 0$ and I_2 , due to the 5-A source, is 5 A. Therefore, $I_2 = 6 + 5 = 11$ A.

15. Thevenin's Theorem.

A linear two-terminal network (Fig.

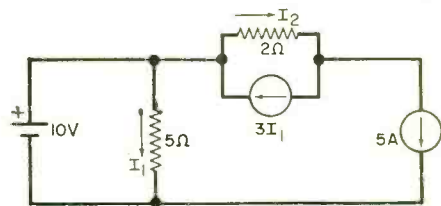

Fig. 30

32A) containing independent and/or dependent sources, can be represented by the Thevenin equivalent circuit of Fig. 32B, consisting of a voltage source V_{oc} in series with resistor R_{TH} , when calculating the external behavior of the circuit. Voltage V_{oc} is the Thevenin, or open circuit, voltage across terminals a-b. Resistance R_{TH} is the Thevenin, or equivalent, resistance across a-b. If

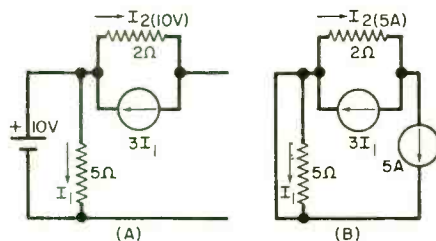

Fig. 31

the network contains only independent sources, R_{TH} is equal to the resistance across a-b with all independent sources in the network set to zero. To obtain R_{TH} in a network which also contains dependent sources, the procedure is to short terminals a and b and determine the short circuit current, I_{sc} , flowing through a-b. Then, $R_{TH} = V_{oc} / I_{sc}$. This

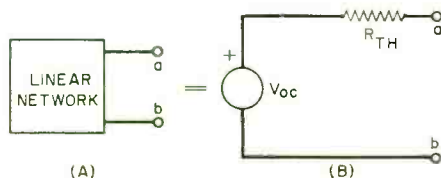

Fig. 32

procedure may also be used for networks containing only independent sources.

Ex. 27. Determine the Thevenin equivalent for the network of Fig. 33A by finding (a) R_{TH} directly and (b) $R_{TH} = V_{oc} / I_{sc}$. Sol. (a) $V_{oc} = 30 \times 10 / (10 + 10) = 15$ V. Setting the 30-V source to zero, $R_{ab} = R_{TH} =$

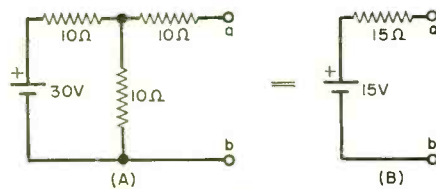

Fig. 33

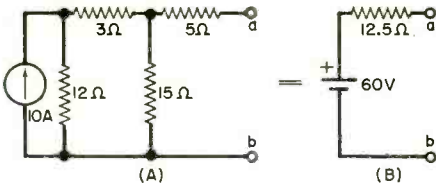

Fig. 34

$10//10 + 10 = 15$ ohms. The Thevenin equivalent circuit is drawn in Fig. 33B. (b) Shorting a to b in Fig. 33A, the total current from the 30-V source is $I_T = 30/(10 + 10//10) = 2$ A. Hence, $I_{sc} = 2 \times 10/(10 + 10) = 1$ A. $R_{TH} = V_{oc}/I_{sc} = 15/1 = 15$ ohms. This is the same value found in part (a).

Ex. 28. Find the Thevenin equivalent for the network of Fig. 34A. Sol. The current flowing in the 15-ohm resistor

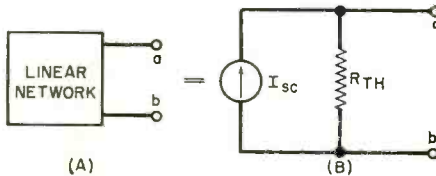

Fig. 35

is $10 \times 12/(12 + 3 + 15) = 4$ A. Hence, $V_{oc} = 4 \times 15 = 60$ V. Setting the 10-A source to zero, $R_{TH} = (12 + 3)//15 + 5 = 7.5 + 5 = 12.5$ ohms. The Thevenin equivalent circuit is shown in Fig. 34B.

16. Norton's Theorem.

A linear two-terminal network (Fig. 35A), containing independent and/or dependent sources, can be represented by the Norton equivalent circuit of Fig.

35B, consisting of a current source, I_{sc} , in parallel with a resistor, R_{TH} , when calculating the external behavior of the circuit. The procedures for finding I_{sc} and R_{TH} are identical to those for the Thevenin equivalent circuit.

Ex. 29. Draw the Norton equivalent circuits for the networks of (a) Ex. 27 and (b) Ex. 28. Sol. (a) Referring to Fig. 33B, $I_{sc} = V_{oc}/R_{TH} = 15/15 =$

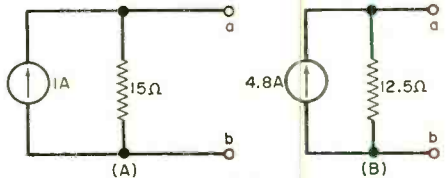

Fig. 36

1 A. The Norton equivalent is shown in Fig. 36A. (b) Referring to Fig. 34B, $I_{sc} = 60/12.5 = 4.8$ A. The Norton equivalent is given in Fig. 36B.

Ex. 30. For the circuit in Fig. 37A, draw the Norton equivalent by finding I_{sc} directly. Sol. Shorting terminals a and b, the total current is $60/(10 +$

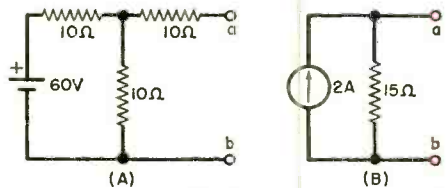

Fig. 37

$10//10) = 4$ A. $I_{sc} = 4 \times 10/(10 + 10) = 2$ A. Setting the 60-V source to zero, $R_{TH} = 10//10 + 10 = 5 + 10 = 15$ ohms. The Norton equivalent circuit is shown in Fig. 37B. ♦

FREE McIntosh CATALOG and FM DIRECTORY

McIntosh Laboratory, Inc.
East Side Station P.O. Box 96
Binghamton, N.Y. 13904
Dept. 16-5

SEND TODAY!

NAME _____
ADDRESS _____
CITY _____ STATE _____ ZIP _____

CIRCLE NO. 19 ON READER SERVICE CARD

Get all the news and latest information on the new McIntosh Solid State equipment in the McIntosh catalog. In addition you will receive an FM station directory that covers all of North America.

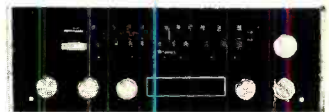

MX 113

AM FM/FM STEREO TUNER PREAMPLIFIER
SERVICE CARD

POPULAR ELECTRONICS Including Electronics World

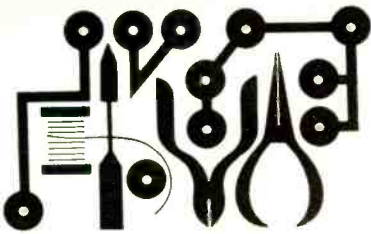

Hobby Scene

Diode Meter Protectors

Q. I have often wondered how those "meter protectors" work. Can you clarify?

A. The basic circuit is shown here. Any type of low-voltage silicon diode can be connected across the meter terminals as shown. The diodes will not affect meter operation until the voltage across the meter exceeds the diode junction voltage—about 0.5 or 0.7 volt for silicon diodes. At this point, the diode conducts, essentially shunting the meter movement. For a typical meter resistance of 1200 ohms and a full-scale rating of 50 μ A, the diodes introduce less than 1% error. Meter movement current is limited to less than 1 mA for a 1-A fault current.

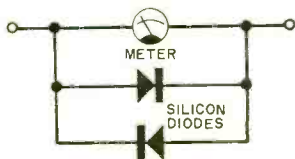

Winding a Coil Accurately

Q. Quite often, in my experiments, I have to wind a coil for a particular frequency. Since I have no sophisticated test gear, is there some easy way I can wind a coil to hit the frequency "on the head"?

A. Use the variable-capacitance circuit shown below. The "trick" is to calibrate reasonably accurately the variable capacitor. Use a pointer knob and mark the fully open (minimum capacitance) point at the minimum specified for the type of capacitor used. Also mark the fully meshed (maximum capacitance) point. Intermediate points may be guessed at and will be sufficiently accurate for most applications. Connect the coil across the variable capacitor

and connect the "hot" lead of your r-f signal generator as shown. Set the variable capacitor to the value you intend to use in the final circuit. Then sweep the generator across the band until the meter indicates a peak. The generator frequency is then the tuned frequency of the LC combination. You can substitute a fixed capacitor (as used in the final circuit) for the variable and trim the coil turns to obtain exact peaking. You can also check what value of capacitor is needed for a particular frequency if you have a finished coil that you don't want to damage.

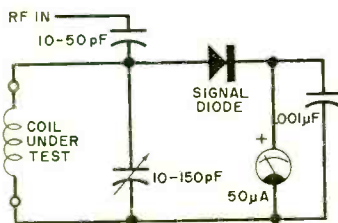

Electric Razor on DC

Q. I have heard that there is an electronic method of improving the "zip" of an electric razor. Any truth in that; and if there is, can you tell me how it is done?

A. It appears that many ac/dc electric razors operate better on dc than ac. To try yours out, build the simple circuit shown here. Make sure that all the components are enclosed in a small insulated box with the line cord coming out through a rubber grommet at one end and the socket mounted on the other end.

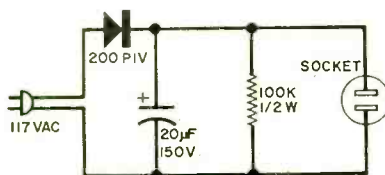

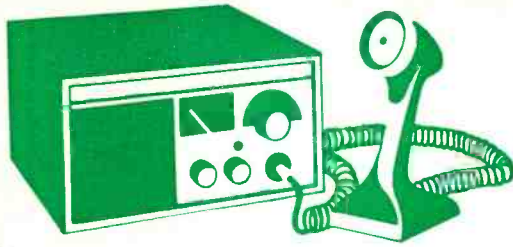

CB Scene

By Matt P. Spinello, KHC2060

CITIZENS Radio operators took their problems directly to the Federal Communications Commission in Washington, DC, recently and returned victorious—at least in the knowledge that Commission Chairman Dean Burch is in agreement with legally operating CB'ers that "there is nothing sillier than having an unenforceable rule, particularly one that could be changed and not hurt anybody. . ." The CB entourage also learned that FCC personnel (contrary to belief and some rumors) can be very understanding, sympathetic, and objective about the conditions that exist on Citizens Radio channels and what should be done about them.

The United States Citizens Radio Council (USCRC) is a 3-year-old national CB organization concerned with "improving the CB service to make it more valuable to the community and the individual CB'er." Armed with a list of questions, recommendations, and proposals, representatives of the USCRC met with members of the Commission, at a hearing granted by the Commission in Washington.

In attendance for the USCRC were George Martin from Alabama, Chairman on National Rules and Legislation and spokesman for the group; John Johnson, West Virginia; Dorsey Jordan, Florida; Fred Blackwell, N. Carolina; and Robert Thompson, Washington, DC. Representing the Commission were Chairman Dean Burch; Commissioner Richard Wiley; General

Council James Barr and Richard Everett; and Assistant to the Chairman Anthony Thompson. Also in attendance were 13 individuals representing Congressional offices from the states of W. Virginia, Alabama, N. Carolina, S. Carolina, Texas, and Florida.

Following introductions, the meeting turned quickly to the problems at hand.

Concerning antenna height limitations (20 feet above existing structures for CB), Martin commented that the USCRC has entered a petition that the rule be changed to conform with the FAA regulation which limits antenna height by 1 foot per 100 feet from the end of the nearest airport runway. "We would like 80 feet, providing it does not conflict with the FAA rules and regulations in the area in which we live," Martin stated. To which, Commissioner Burch replied, "This doesn't seem very harsh to me. . . If there's a justification for (higher antennas) I have no squawk. I fly airplanes and if I have to worry about an 80-foot antenna, then I am not on the right course; so I'll look into that. . ."

In a discussion regarding the obscenity problem, Mr. Burch emphasized that the ruling would not be changed; that it would be enforced to the fullest extent. As of last April, three FCC enforcement teams were put into service, strategically stationed to handle problems on the East Coast, in the Midwest, and in the Far West. Each team consists of 8 engineers equipped with 4 vehicles: 3 to handle DF'ing and location of rules violators and the fourth to carry the equipment. The vehicles have license plates for all states and are unmarked to avoid detection.

Service in General. As for the CB service in general, Commissioner Burch indicated that he is personally very interested (and has been for some time) in extending the Citizens Service, rather than constricting

CB Goes to Washington

it. . . This is the largest single service that we have in the Agency, and it could be a lot larger, obviously, because there is great interest in it. . . From the point of view of the gross natural product and our own manufacturers, it would be a marvelous thing if we could sell another 3 or 4 million radio sets and say that 5% or 6% of them were American made. It would be wonderful." (The remark drew laughter from those in attendance.)

In answer to George Martin's statements regarding the class E proposal, Mr. Burch commented, "Well, it certainly has some advantages. We are all surprised at how popular Citizens D became and . . . I must confess the hobbling thing has never really been one of my big hang-ups, and yet it does seem kind of foolish in a way to say in one breath that we are out of channels and we don't have enough space and there is no chance to talk, and then suggest that we change the rules to encourage or at least legitimize talk, which, although convenient and maybe pleasant, is certainly not a requirement for carrying on business or family situations.

"Yet, my main experience with radio has been with Senator Goldwater, who is one of the great avid radio men of the world. I don't know what is so . . . interesting about finding out what kind of outfit a guy has or is listening to, but he seems to get a big pleasure out of it and it's all right with me if they sit there and exchange brand names and whatnot, and so, we are prepared to look at that and I think Dick Wiley and the other Commissioners feel the same way. We are not prepared to give up on Citizens Radio, and we shouldn't."

In a conclusion to the meeting, Mr. Everett remarked, "I will state here, as I have before to your organization (USCRC)

on many occasions, that I think the Commission endorses the idea and likes the idea of having a national organization of CB'ers (with) which it can have public relations and educational process and exchange of ideas. . . We are working with your organization certainly because you are the only one that I know of that is anywhere cognizant at all with the kind of ideas that we are trying to establish. . . You represent the largest group of CB'ers that I am aware of. I don't know of any other organization that probably represents anywhere near the total that you do."

Having covered antenna height, types of conversation that the USCRC would like to be permitted to air, requests for more channel allocations, the class E proposal, rules violators, and the organization's position on license fee increases, George Martin thanked those in attendance for allowing the USCRC to present its opinions, objections, and recommendations, with an offer to help the Commission as a national organization in any way possible. Commissioner Burch agreed that it would be useful if FCC personnel could meet with CB'ers in various parts of the country in an exchange of questions and answers.

The representatives from USCRC came away from the meeting with the feeling that the Commission will take bold and positive strokes at rule changing to benefit the legally operating CB'ers; that the FCC will impose (with the help of other governmental agencies) stiff and rapid penalties to unlicensed operators and licensed law-breakers; and that the Commission will, even more closely than in the past, work with and place confidence in national CB organizations and public service assistance teams.

I'll CB'ing you!

Planning to move?

Let us know **6 to 8 weeks in advance** so that you won't miss a single issue of **POPULAR ELECTRONICS INCLUDING ELECTRONICS WORLD**

Attach old label where indicated and print new address in space provided. Also include your mailing label whenever you write concerning your subscription. It helps us serve you promptly.

Write to: P.O. Box 2774, Boulder, Colo., 80302, giving the following information.

- Change address only.
- Extend subscription. Enter new subscription.
- (1) 5 yrs. \$21 (2) 3 yrs. \$15 (3) 1 year \$6
- Payment enclosed (1 extra issue per yr. as a BONUS)
- Bill me later.

If you have no label handy, print OLD address here.

name _____ please print

address _____

city _____

state _____ zip-code _____

name _____ please print 0778

address _____

city _____ state _____ zip _____

Add'l postage: \$1 per year outside U.S., its possessions & Canada.

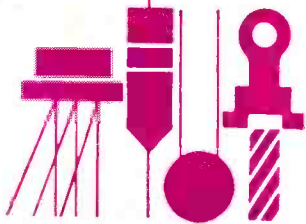

Solid-State Scene

By Walter G. Jung

REGULAR readers of this column may have noted our enthusiasm for CMOS technology and the advantages it offers in digital IC's. Now, MOS technology has also been introduced to the world of linear IC's, bringing with it the promise of interesting new dimensions in performance.

PMOS High-Speed Op Amp. One consistent performance limitation of IC op amps since the early days of IC's is their speed capability. Due to manufacturing process incompatibility, good high-frequency pnp transistors have been virtually nonexistent in IC op amps. As an example, such standard chips as the 741 have a bandwidth of only 1 MHz. Now, RCA has taken a bold step forward with an entirely new type of op amp, their CA3100, designed to solve the speed problem by a new method. The CA3100 uses p-channel MOS (PMOS) transistors as functional substitutes for pnp's and, in doing so, achieves a bandwidth of 38 MHz.

The CA3100 does not have the very high dc gain typical of general purpose op amps, its gain being only slightly more than 60 dB. This factor must be taken with a grain of salt however, because it is at high frequencies that the CA3100 shines. It can achieve a gain of 42 dB at 1 MHz open loop, whereas most other op amps have long since expired at this frequency. Another asset of the CA3100 over standard op

amps is its healthier output current—30 mA p-p. This new chip operates from supplies of 14 to 36 volts (or ± 7 to ± 18 V), is compensated with a single capacitor, has provision for input offset adjustment, and uses the standard TO-5 8-pin op amp arrangement.

With the speed capability the CA3100 offers and the ease of designing that the versatility of the op amp configuration affords, a host of new applications are possible—video amplifiers, fast-response detectors, high-frequency oscillators and multi-vibrators, high-speed drivers, etc. Considering the bandwidth improvement (a factor of 40) of the CA3100, it can be used to speed up many a sluggish op amp circuit using devices with lower speeds. If you've ever run into problems with speed in an op amp circuit, you just might find this device to be the answer.

The CA3100T (\$5.95) is in the standard 8-lead (round) TO-5 package, while a CA3100S is also available in a TO-5 package with "dual inline" formed leads.

Marriage of Linear and CMOS. RCA, which originally pioneered the digital CMOS line, has now extended the virtues of CMOS transistor circuitry to the linear domain—thus leading to a new term: LCMOS. The first of these new devices is the CA3600E, an array of complementary p- and n-channel MOS transistors in a single package, connected as shown in Fig. 1. The CA3600E transistors have many of the characteristics that we have become familiar with in digital CMOS. They can be used with supply voltages from +3 to +15 V; they have input resistances of 100 gigohms and virtually zero input current; and they have low, symmetrical output resistance. The devices may be used singly, differentially, in parallel, or in series, allowing a variety of functions to be implemented.

New MOS Linear IC's

One of the neatest features of a CMOS stage is the absolute minimum of biasing complexity required. This takes a little getting used to compared to bipolar transistor amplifiers. Regarding Fig. 2, for instance, would you believe that, with pins 11

“floating” bias. Voltage gain and bandwidth vary with supply voltage—typical figures at +10 V being 32 dB and 800 kHz or 42 dB and 60 kHz at +5 V. Another interesting feature of this LCMOS stage is the fact that the bias stays “class A centered” for any supply voltage, and the output can swing to

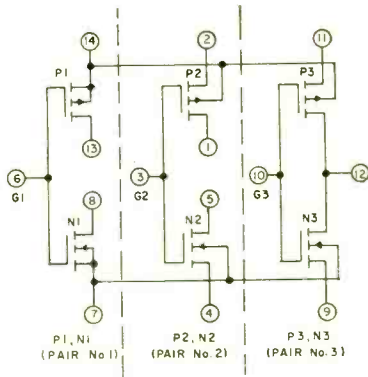

Fig. 1. Schematic of CA3600E LCMOS array.

and 14 tied to a positive voltage and 7 and 9 tied to ground, transistors P3 and N3 constitute a linear amplifier? They do. Resistor R_b is a high-value feedback resistor (22 megohms) which establishes a class A

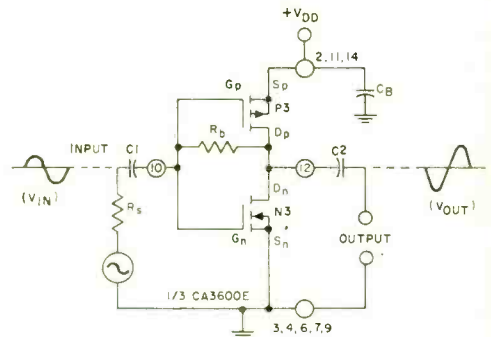
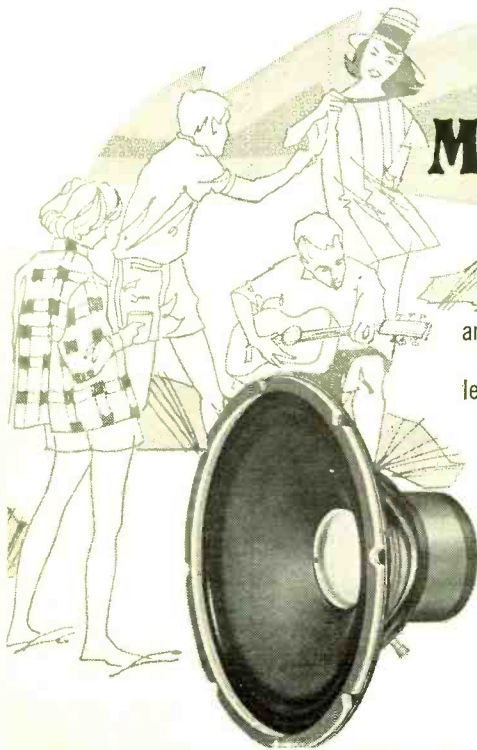

Fig. 2. CA3600E biased for linear mode.

within a few millivolts of either supply. Thus it is simple, stable, and efficient in addition to having good gain and bandwidth characteristics. A cascade triplet of these stages can achieve a gain of 110 dB with a 100-kHz bandwidth!



MAKING "WAVES"

CADENCE—the musical instrument speakers

Making better, clearer, amplified sound waves is the THING Cadence does... better than anything else in the industry. Cadence Speakers are built to withstand heat from sustained notes at a high power level and the vibrations and stresses which are continually placed upon them. Cadence is guaranteed **one full year** at the power level specified. This proven speaker family has been selected by the manufacturers of most of the world's fine amplified music instruments.

If making beautiful, clear sound waves is your thing, ask for CADENCE SPEAKERS. For complete information and the name of your Cadence Dealer, write:



UTAH ELECTRONICS DIVISION
Utah-American Corporation
1124 East Franklin Street
Huntington, Indiana 46750

The CA3600E data sheet shows a number of additional possible hookups: comparators, op amp buffers, oscillators, multivibrators, threshold detectors, etc. One of the most interesting of these is a combination CA3600E and CA3046 (bipolar transistor array) op amp. This circuit shows by example how PMOS devices can replace normal pnp transistors in op amp circuits. The CA3600E data sheet has a great deal of valuable information on how CMOS devices in general operate (and LCMOS in particular).

The CA3600E comes in a 14-pin dual inline plastic package and is \$2.35.

MOS technology potentially has a great deal to offer in linear circuits, and we suspect that these two new devices are the beginning of further useful developments. The technology (at least as applied to linear IC's) is brand new, so the future could indeed be interesting.

Hybrid, Low-Distortion Op Amp. As opposed to the more conventional monolithic IC, there is also a form of miniature circuit construction known as "hybrid." This in-

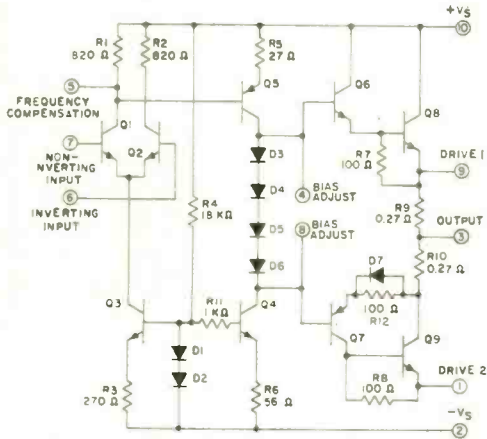

Fig. 3. Schematic diagram of an RCA type TA8651A operational amplifier.

volves a process in which a number of unencapsulated semiconductor chips and other components are assembled on a common substrate. Hybrid construction is generally more expensive than monolithic, but it offers more design flexibility and greater power capability. A good example of what hybrid construction can do is RCA's new power op amp, developmental type TA8651A.

This is a two-stage, direct coupled circuit

(Fig. 3) which includes an input differential pair (Q1 and Q2) and class A output stage driver, Q5. Transistor Q4 biases Q5 at a constant collector current, and the diode string, D3-D6, provides forward bias for the class AB output. This floating bias is adjusted externally through pins 4 and 8 to set the idle current in Q8 and Q9 for low distortion. Since all the components are in intimate thermal contact in a hybrid circuit, the bias developed by D3-D6 tracks the base-emitter voltage required by the output stage, providing stability at high temperatures. Overall bandwidth is controlled by an external capacitor connected across Q5 (pins 4 and 5). Open loop gain of the circuit is 60 dB, and the amplifier is contained in a sealed module, which is about 2 inches square. However, the size may be deceptive since the unit can develop an output of 100 watts into 4 ohms or 60 watts into 8 ohms with a ± 35 -V supply. Maximum supply rating is ± 37.5 V and peak current rating is 7 amperes.

A big key to the performance of the TA8651A is the adjustable idle current

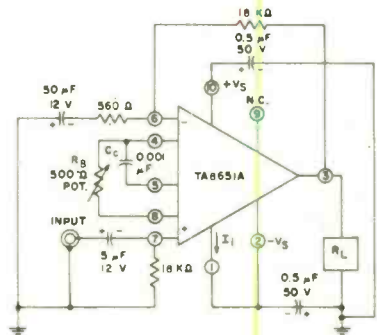

Fig. 4. Test circuit using TA8651A.

which allows crossover distortion to be minimized. This preserves both low- and high-level linearity. For instance, with an idle current of 50 mA, the 50-mW IM distortion is typically 0.05%, when used in the circuit in Fig. 4. This is a closed loop configuration with a gain of about 30 dB, established by the upper 18-kilohm and the 560-ohm resistors. The 500-ohm potentiometer adjusts the idle current and the 0.001-microfarad capacitor controls bandwidth. The circuit has direct coupling to the load, providing optimum low-frequency damping.

This circuit can be used as a very simple audio power amplifier which provides high performance. For power outputs less than

the module's maximum capability, the same circuit may just as easily be used at lower supply voltages with comparable characteristics—due to the versatility of the op amp design. Other possible applications include voltage regulators, servo amplifiers, power inverters, etc. Extra terminals are available on the package to permit the connection of booster transistors for current outputs higher than the rated peak current (or for current limiting).



The TA8651A is in a bolt-down package.

No doubt, you will find many uses for this little module with the powerful punch. The TA8651A (\$18.50) is in a 10-lead bolt-down power package.

Recommended Reading. A truly remarkable publication available to engineers for the asking from Teledyne Semiconductor is *JFET Applications and Specifications*, a 160-page handbook of junction FET theory, terminology, specifications, and applications. Parameters are defined and discussed, with cross references, selection guides and device specifications. Also included are applications such as analog switching, low-noise circuits, differential amplifiers, r-f amplifiers, source followers of various types, current regulators, oscillators, active filters, and voltage controlled resistors. In short, there is something for everyone interested in JFET's. A worthwhile addition to your solid-state library.

For More Information. Write:
 RCA Solid State Division
 Box 3200
 Somerville, NJ 08876
 Teledyne Semiconductor
 1300 Terra Bella Ave.
 Mountain View, CA 94040.

DEEP DOWN INSIDE, THE MITS 1200 SERIES POCKET CALCULATOR IS...



PRICES:

- Model 1212 (12 digit)
Kit \$89.95
We Assemble . . \$99.95
- Model 1209 (9 digit)
Kit \$69.95
We Assemble . . \$79.95
- Model 1206 (6 digit)
Kit \$49.95
We Assemble . . \$59.95

AC ADAPTER

Equips any MITS 1200 series pocket calculator for operation from 110 VAC
 \$6.95

CARRYING CASE
 leatherette \$5.95

MITS®
**Micro Instrumentation &
 Telemetry Systems, Inc.**



Enclosed is check for _____ KIT
 1200 Series/Model # _____ ASSEMBLED
 AMOUNT OF CHECK \$ _____
 Include \$5.00 for postage and handling. P7
 Please send information on entire MITS line.
 NAME _____
 ADDRESS _____
 CITY _____
 STATE & ZIP _____
 5404 Coal Ave., S.E., Albuquerque, New Mexico 87108 505/265-7553

CIRCLE NO. 20 ON READER SERVICE CARD

Versatile IC Timer

*From 10 microseconds to 1000 seconds
using one IC and four components*

BY WALTER W. SCHOPP

THERE are timers that are initiated by the closing of a switch and there are timers whose cycles are started by the opening of a switch. There are circuits that energize a relay to close contacts and circuits to de-energize a relay—sometimes during the same timing cycle. Described here are circuits that perform many of these basic timing functions, all using a low-cost easy-to-apply integrated circuit. Some of the circuits are operated by switches, some by touch plates. In all cases, once the cycle has been started the timing can not be affected by further

triggering until the cycle has been completed.

The integrated circuit is a Signetics type 555. It is available from suppliers such as Poly-Paks, Solid-States Sales, etc. The power supply for the timers can be obtained from a battery or an unregulated supply of 10 to 18 volts.

The accuracy of most timing circuits is affected by voltage variations in the supply because the charging rate of the timing capacitor varies with respect to the fixed trigger point of the device (transistor or FET) used

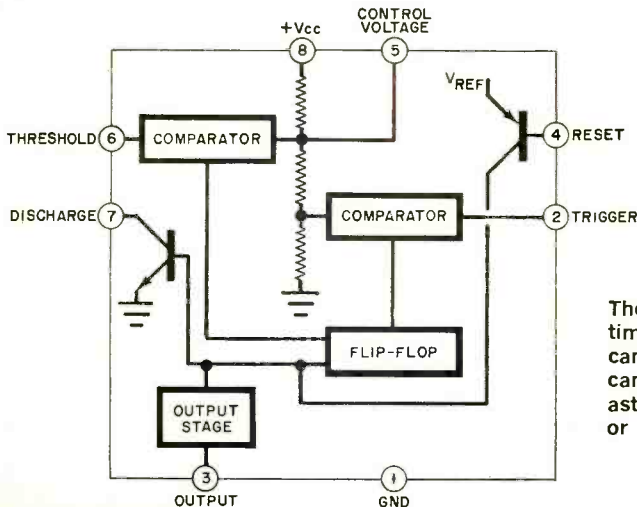

The internal circuitry of the 555 timer IC. Besides timing, the IC can be used as an oscillator and can operate in both monostable and astable modes. The output can sink or source 200 mA or drive TTL.

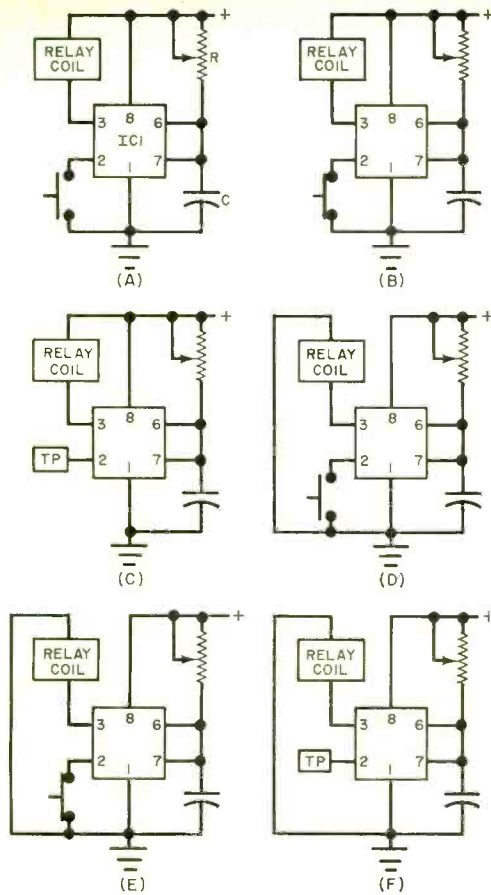

Typical timing circuits: (A) Relay normally energized. Time cycle initiated by closing normally open switch. Relay de-energized during time cycle. (B) Relay normally energized. Time cycle energized. Relay de-energized during time cycle. (C) Relay normally energized. Time cycle initiated by contact on touch plate. Relay de-energized during time cycle. (D) Relay normally de-energized. Time cycle initiated by closing a normally open switch. Relay energized during time cycle. (E) Relay normally de-energized. Timing initiated by opening switch. Relay energized during time cycle. (F) Relay normally de-energized. Time cycle initiated by touch plate. Relay energized during cycle.

at the input of the timer. In the circuits presented here, the charging rate of the timing capacitor and the threshold trigger point of the comparator are both directly proportional to the supply voltage. This means that the power supply voltage has little effect on the timing accuracy.

Timing cycles varying from microseconds to hours can be obtained by changing the time constant of the resistor/capacitor circuit. The chart shows the values to use for R and C for different time delays.

The relay used in these circuits can be any low-current sensitive relay such as Sigma 4F-5000 or 11F-2300-G-SIL. ♦

Required R and C for timing intervals from 10 microseconds to 1000 seconds.

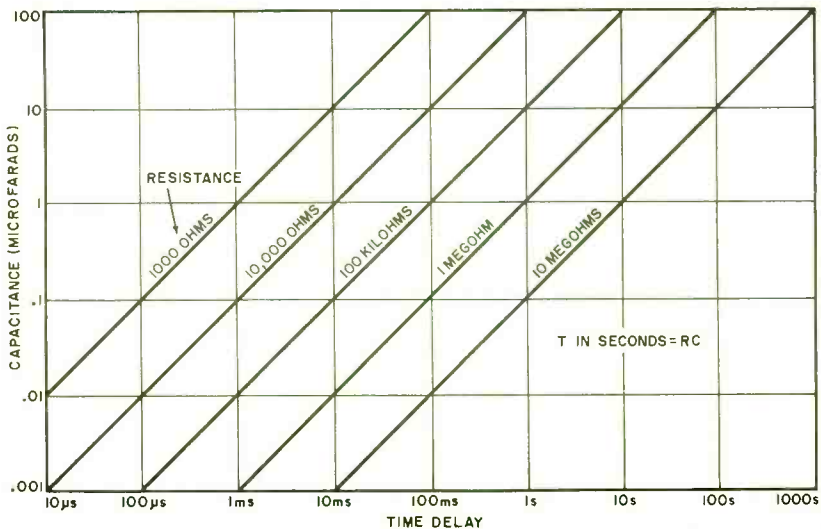

AVAILABLE NOW

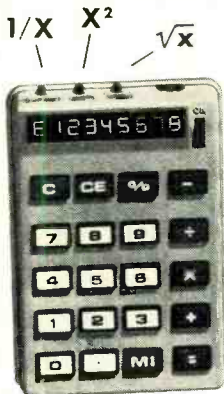

Electronic calculator
2 3/4" x 4" x 1 1/8" with
built in NiCad batteries.

8

FUNCTION —Plus— MEMORY

Only \$**169**⁵⁰

- Square Root
- Square
- Reciprocal
- Percentage
- Add
- Subtract
- Multiply
- Divide

SUMMIT



INTERNATIONAL CORPORATION
180 West 2950 South
Salt Lake City, Utah 84115
Telex: 388 443 Summit SLC

CIRCLE NO. 33 ON READER SERVICE CARD

DELUXE
MAGAZINE CASES

Designed Exclusively for
POPULAR ELECTRONICS

● The ideal way to save your valuable copies, keep them well protected and make it easy for you to refer to any issue at any time. Both decorative and attractive enough to enhance the decor of any room, each case holds a full year's copies. Constructed of reinforced fiberboard, these durable cases are covered in a rich-textured leatherette. The gold embossed back adds to its elegance and makes each case a welcome addition to your bookshelf or cabinet.

Magazine cases are available for any of your favorite magazines. They're only \$4.50 each, 3 for \$12.50, in any combination of titles ordered. Add 50¢ per case for postage and handling. Outside U.S.A. add \$1.00 per case ordered.



**CHARGE YOUR AMERICAN EXPRESS
OR UNI-CARD ACCOUNT.**



Ziff-Davis Pub. Co., Dept. 23, 1 Park Avenue, New York 10016

My remittance in the amount of \$_____ is enclosed.
Please send magazine cases for the titles indicated below.

CHARGE: American Exprss Uni-Card PE-773

Account # _____

Signature _____

TITLE	QUANTITY

Check One: All Black Maroon Back, Black Sides

Print Name _____

Address _____

City _____ State _____ Zip _____

PAYMENT MUST ACCOMPANY ORDER

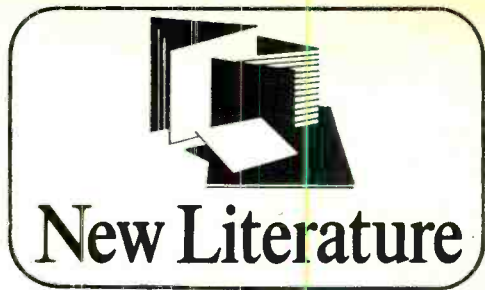

New Literature

PTS TUNER PARTS REPLACEMENT CATALOG

PTS Electronics has put together for radio-TV repairmen, dealers, and service technicians the latest edition of their Tuner Parts and Replacement Guide Catalog—No. III. Aside from the usual updated listings for antenna coil replacements and shafts, the new edition also contains listings for uhf tuner parts, tuner chemicals and tools, and assembly diagrams for both vhf and uhf tuners. The catalog is available for \$1—redeemable on the first minimum parts order. Address: PTS Electronics, Inc., P.O. Box 272, Bloomington, IN 47401.

ICS ELECTRONICS COURSES CATALOG

A catalog that describes their new home-study Electronics Technology programs is available from International Correspondence Schools. Other new ICS courses described in the catalog include Television Service Technician and FCC Radiotelephone License training. Address: International Correspondence Schools, Scranton, PA 18515.

RCA R-F AND MICROWAVE DEVICES CATALOG

Solid-state r-f and microwave devices are described in brochure No. RFT-700K recently published by RCA. In "RF and Microwave Devices," a quick-selection guide shows power-versus-frequency curves for the company's entire product line, with power levels to 80 watts and frequencies to 3.5 GHz. The electrical characteristics of all devices are summarized by type. To facilitate comparison and selection, the types are retabulated according to application. Block diagrams illustrate typical circuit applications, while photos are used to show all package styles. Address: RCA Solid State Division, Box 3200, Somerville, NJ 08876.

BROOKSTONE HARD-TO-FIND TOOLS CATALOG

Crammed into its 64 pages, Brookstone's latest "hard-to-find" tools catalog manages to list, describe, and photographically show thousands of tools for every area of interest. Featured are hand tools and accessories for the wood-working and cabinetry specialist, machinist, leather worker, and electronics enthusiast. New sections are devoted to garden tools and outdoor gear. Address: Brookstone Co., 13 Brookstone Bldg., Peterborough, NH 03458.

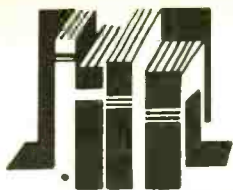

Electronics Library

HOW TO REPAIR ELECTRONIC MUSICAL INSTRUMENT AMPLIFIERS

by Byron Wels

This fact-filled book covers the repair and maintenance of the amplifying systems used with guitars, pianos, and organs, as well as the repair of the musical instruments themselves. It begins with a discussion of how electronics is used in musical instruments and goes on to pickups and microphones and the amplifiers with which they are used.

Published by Tab Books, Blue Ridge Summit, PA 17214. 288 pages. \$8.95 hard cover, \$5.95 soft cover.

TUBE SUBSTITUTION HANDBOOK, Sixteenth Edition

It will probably come as a shock to those people trained to "think" semiconductors that there is still an enormous quantity of tube-type equipment around—led by color TV receivers. For these people, and even those in the know, this book is a handy—and often indispensable—item.

Published by Howard W. Sams & Co., Inc., 4300 West 62 St., Indianapolis, IN 46268. Soft cover. 96 pages. \$1.75.

MANUAL FOR INTEGRATED CIRCUIT USERS

by John D. Lenk

The integrated circuit story from the user's point of view is told in this new book. It describes how existing commercial IC's can be used to solve design and application problems by concentrating on simple, practical approaches to IC use through rules of thumb for selecting external component values. Coverage of both linear and digital IC's as well as FET digital logic and interfacing circuits for digital logic are included.

Published by Reston Publishing Co., Inc., Box 547, Reston, VA 22090. Hard cover. 416 pages. \$16.95

CORRECTION: In this department in the March 1973 issue we erroneously reported that the Tab Books "Light Dimmer" Book/Kit was available for \$3.95 for both book and kit. The price we quoted for the two is incorrect; it should be \$4.95. Prices for other book/kits vary. We are sorry for any inconvenience this mixup might have caused Tab Books and our readers.

JULY 1973



PACE makes another BREAKTHROUGH



23 CHANNEL CB TRANSCEIVER

- ALL crystals supplied
- 5 Watts of Transmit
- Pace plus modulation
- Ceramic microphone
- Locking latch rack

Pace Model 223



\$119.95

From the PACE U. S. Engineering Team that introduced the first all transistor CB transceiver, the Model 223 offers another breakthrough in both Price and Quality. Taking advantage of U.S. mass production techniques and engineering knowhow, the PACE Model 223 provides the truly great bargain for todays CB operator who wants performance and price with the quality guarantee of a U.S. manufacturing firm. With a NO compromise design approach the PACE engineers built a double conversion receiver with a full 6 section tuned filter network for maximum receiver performance even under adverse conditions - we can guarantee performance for 2 years because we shake every one in the roughest QC test procedure ever designed for 2 way radios.

If you compare before you buy you'll join the Proud Pace owner's club!

((P)) PACE COMMUNICATIONS

Division of PATHCOM INC. 24049 South Frampton Ave.
Harbor City, California 90710 • (213) 325-1290
Export: 2200 Shames Drive, Westbury, New York 11590

CIRCLE NO. 25 ON READER SERVICE CARD

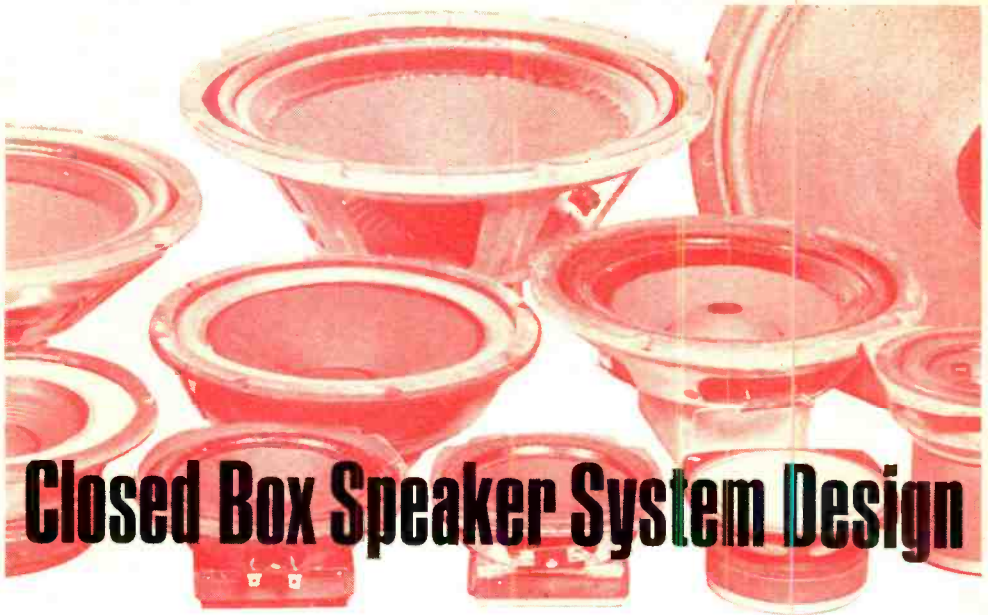

Closed Box Speaker System Design

PART 2: SIMPLIFIED DESIGN CHARTS ENABLE YOU TO BUILD YOUR OWN SPEAKER ENCLOSURES

BY DAVID B. WEEMS

LAST MONTH, we discussed the characteristics of the closed-box speaker system, the effects of cabinet size on system performance, and how to test woofers. In this conclusion of our two-part series, we will discuss the practical aspects of putting together a speaker system after the optimum speaker size and enclosure volume have been calculated.

Designing Without Test Equipment.

Knowing the approximate mass and compliance of a woofer is insurance against the possibility that you have an atypical speaker. But it is not necessary to know these exact figures to obtain a reasonable degree of success. If you know the cone resonance, you can predict the system resonance by referring to the simplified design charts shown in Figs. 5 through 11. These charts show values that have been averaged from tests conducted on many different kinds of high-compliance speakers that are commonly available to the hobbyist.

In some charts, particularly those for larger speakers, the resonance lines are not parallel. The reason for the apparent discrepancy arises from the fact that speakers with higher resonant frequencies tend to

have lighter cones than those with lower resonant frequencies. After the compliance limit is attained in low-resonance woofers, further reduction in resonant frequency must be accomplished by adding mass to the cone. Greater mass, for a given chart, produces a more horizontal line on the chart.

To predict system resonance without knowing the mass or compliance of a woofer, you need only to go to the simplified chart for the nominal diameter of your speaker. Choose the line on the chart that matches the woofer's free-air resonance, or, if the correct figure is not shown, interpolate to find the location for the woofer frequency. Mark a point there and draw a line through the point, making the line parallel to the nearest resonance line.

As an example of how to use the charts, assume that you have a 6-in. speaker. You would refer to the 6-in. speaker chart of Fig. 7 and locate a resonance line for 50 Hz. Draw a vertical line for the enclosure volume. If the volume is to be about 0.33 cu ft, the predicted system resonance will be about 77 Hz. If more space is available, you might set the enclosure volume at the value that will yield a box compliance equal to the speaker's compliance. To do this, mul-

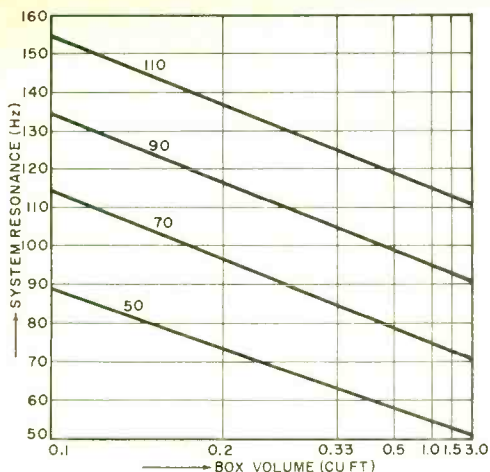

Fig. 5. Simplified design chart for 4-in. speakers. Numbers on diagonal lines indicate free-air resonance. To use, find speaker's free-air resonance. Locate point on chart for that frequency, using speaker resonance lines as guides, and draw line parallel to nearest resonance line on chart. Read volume for desired system resonance.

multiply the speaker's free-air resonance by 1.41 to obtain a desired system resonance of 70 Hz. Now, draw a horizontal line at 70 Hz on the chart. Where this line crosses the resonance line, extend a vertical line to the bottom of the chart to find the proper enclosure volume. For our 6-in. woofer, the diagonal line crosses the 70-Hz line at 0.5 cu ft; this would be the choice for optimum box volume.

Enclosure Details. After finding the correct enclosure volume, the next step is to make certain that this volume is available to the woofer if box compliance is to be correct. In small sealed boxes, the volume of the internal bracing can occupy enough space to become a significant factor. Also, the volumes of the tweeter and/or midrange sub-enclosures (which should be used if they are not self-enclosed) must be subtracted.

The interior depth of the enclosure should be at least 1.5 times that of the woofer (unless the woofer is unusually long). No inside dimension should be more than three times that of any other dimension. A typical ratio of external enclosure dimensions is 5:3:2. For a bookshelf speaker system, the box might be 15 in. long, 9 in. wide, and 6 in. deep. To arrive at the correct dimensions, the ratio of length to width

can be set first, then enough depth can be added to provide the correct volume. If the depth is not enough to meet the requirement of 1.5 times the woofer depth, the other dimensions can be juggled a bit until the dimension ratios and the internal volume figures are right.

The best cabinet material to use for a given speaker system depends on the size of the enclosure. Plywood is the traditional choice and is quite satisfactory. Enclosures for 8-in., 10-in., and 12-in. speakers should be made from ¾-in. plywood that is glued and firmly screwed together with the aid of corner glue blocks and extra bracing on large panels. For small woofers, ½-in. plywood is adequate; the enclosure itself can be assembled with glue and nails. Small panels are much more rigid than are large ones of the same material and thickness. Also, small woofers are limited in their power-handling ability and will not be driven to the same sound level as large woofers.

Back panels should be installed with screws against a stop with an air-tight gasket all around. A single layer of rubber tape glued around the back stop will serve well as a gasket. A perfect seal can also be obtained by running a bead of flexible caulking compound (or silicone rubber compound) around the back stop, but this makes future back removal difficult.

The inside walls of the enclosure should be covered with a damping material such as fiber glass wool to damp out-of-phase mid-range reflections. The thickness of the material depends on its density. At least 1 in. of dense material is the minimum requirement for most cabinets. The material should be added a layer at a time until the

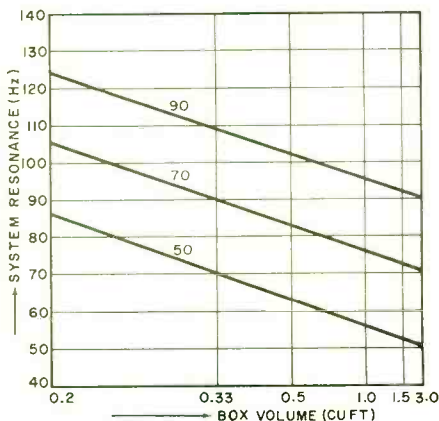

Fig. 6. Design chart for 5-in. speakers.

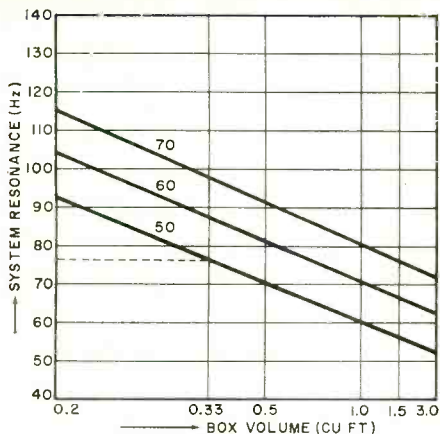

Fig. 7. Chart for 6-in. speakers. Dashed line shows example in text.

system sounds "right". Most damping materials have limited effect on low-frequency response except to slightly increase the effective volume of the enclosure and lower the resonance of the system. The padding does this by absorbing and giving up heat, which makes the air in the enclosure operate isothermally (at a constant temperature). When sound is propagated isothermally, its velocity decreases. The formula for C_{mb} states that this factor varies inversely with the square of the speed of sound (c). So, as c is decreased, C_{mb} increases and the enclosure appears to be larger than it actually is. The system resonance in such

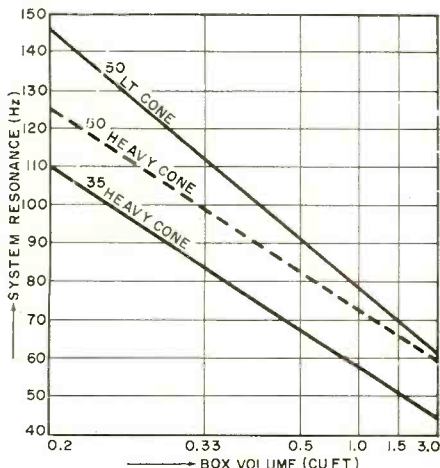

Fig. 8. For 8-in. speakers. Use the dashed line for speakers with free-air resonance near 50 Hz, with heavy cone. Use upper line for full-range speakers with free-air resonance of 50 Hz. Cone types will vary greatly.

cases may be reduced by as much as 15 percent.

Another effect of the damping material, if enough of it is used, is that it lowers the Q of the system by damping the resonant peak. The higher the frequency of the system's resonance, the more effect the damping material will have on system Q . The optimum value of Q varies inversely with the resonant frequency of the system. For smaller high-resonance systems, a lower value of Q is desirable because a peak is more objectionable at higher frequencies. Hence, small enclosures may benefit from being loosely filled with damping material. Any loss of bass can be compensated for by boosting the bass at the amplifier—if the turnover frequency of

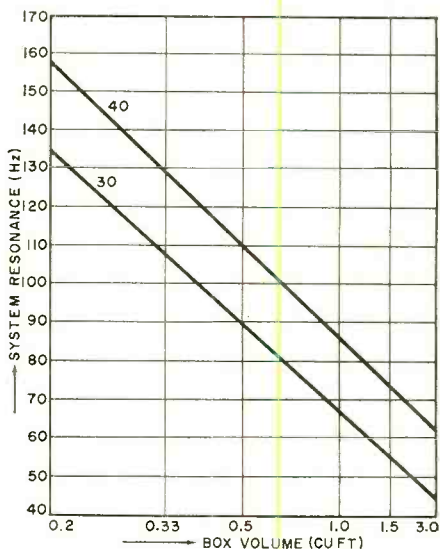

Fig. 9. Design chart for 10-in. woofers.

the tone controls is not too high. But Q is more directly controlled by the magnet design of the speaker than by box stuffing. This is particularly true at the lower frequencies.

High-Compliance Woofers. High-compliance woofers are made with many types of suspension materials. A traditional material was specially treated cloth that might be formed in a sine-wave pattern, an accordion pleat, or a half-roll. Butyl rubber and polyurethane foam are also used for speaker cone surrounds. Some of these materials react to climatic differences or use by having a change in compliance. Typically, a woofer's resonant frequency will drop after being "broken in." But in other cases, the resonant frequency rises with time.

The experience gained in making the tests for the design charts given in this article indicated that the degree of change or stability could not be determined just by observing the type of suspension material used. Polyurethane foam tended to be sta-

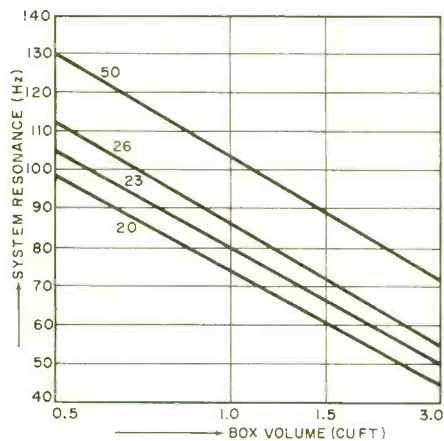

Fig. 10. For 12-in. woofers. Upper line is for a typical high-efficiency speaker with free-air resonance of 50 Hz. It shows that such speakers are not suitable for compact closed box.

ble, but one such speaker was found to have changed more over a period of a few years than any other speaker tested for this.

To guard against undue change in resonance, a new speaker should be exercised for a while before testing. The tests should be conducted under conditions of normal air humidity (similar to that of the room in which the speaker will be used). A test conducted in a humid basement may show a significantly lower resonance than one conducted in a dry attic.

If new woofers are stored in their shipping cartons for some time before use, the boxes should be turned on a side so that the cones are vertical. The heavy cones of some high-compliance large woofers will drift out of position if stored with the cone horizontal and the axis of the speaker vertical. If this occurs, it can be detected by inspecting the spider assembly for flatness. A drifted cone will have moved the voice coil away from its proper position in the region of maximum magnetic flux density, a situation that will produce more distortion than was designed into the speaker.

When a low-resonance woofer is installed behind a speaker board, the cutout should be large enough to permit the suspension to flex without hitting the board. Any friction

between the suspension and the board will raise the resonant frequency and generate distortion. Front mounting of speakers is desirable, particularly for high-frequency drivers. But behind-the-panel mounting is permissible if the front edges of the holes in the speaker board are rounded off to eliminate the sharp edges.

One high-compliance woofer characteristic that is sometimes overlooked is its high-frequency response. The crossover frequency for the typical high-compliance woofer should be placed at a lower point in the audio spectrum than for a conventional woofer. There are several reasons for this. The voice coils of high-compliance woofers must be long so that the cone can move freely and yet not take the voice coil out of the high-flux range. This longer coil adds inductance to the electrical circuit and acts as a low-pass filter. Too, high-mass cones do not respond well to high frequencies.

A rule of thumb is to use no tweeter with the small full-range speakers. A two-way system is suggested for woofers up to 10 in. in a nominal diameter. Most 12-in. and 15-in. woofers operate best when the crossover point is at 500 Hz or, at most, 1000 Hz. For systems that use these woofers, either a small full-range speaker must be selected for the tweeter or a three-way crossover network and a separate midrange speaker and tweeter must be used.

The closed-box enclosure appears to be utterly simple. It is—in the sense that there is no unique volume that is mandatory for a

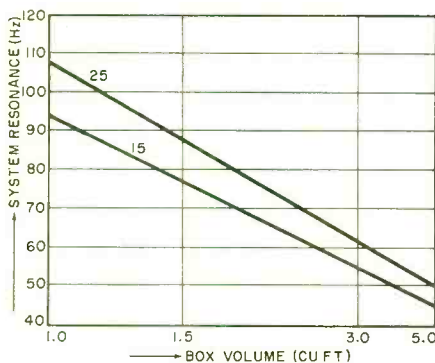
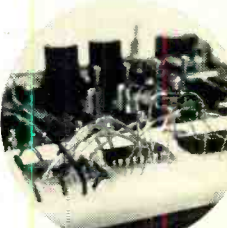
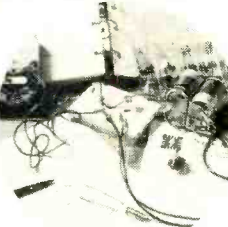
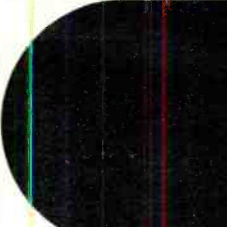
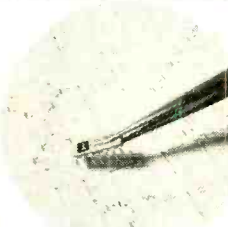
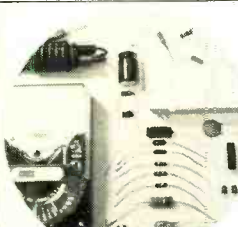
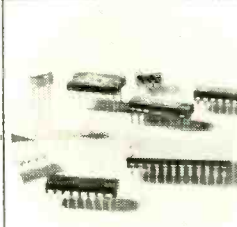

Fig. 11. Design chart for 15-in. woofers.

given speaker. But haphazard enclosure design will not provide satisfactory bass response and suitable power-handling ability. A reasonable value for box volume insures good performance, a challenge that can be met by the average audio buff. ♦

<p>Communications Engineering</p>	<p>Aeronautical & Navigational</p>	<p>Television Engineering</p>	
<p>Automatic Control Engineering</p>		<p>Missile & Spacecraft Guidance</p>	
<p>Radar & Sonar Engineering</p>	<p>Digital Communications</p>		<p>Industrial Electronics</p>
	<p>Microwave Engineering</p>		<p>Satellite Communications</p>
<p>Cable Television Engineering</p>	<p>Electronic Engineering Technology</p>	<p>Nuclear Instrumentation & Control</p>	<p>Special Programs for Electronic Engineers</p>

ADVANCED ELECTRONICS CAREER TRAINING AT HOME

Computer
Engineering

If you are too busy to go to college to learn advanced electronics, CREI brings college level training to you. CREI programs give you practical engineering training that you can apply in your work to move ahead to higher paying jobs. And CREI lets you specialize in exactly the area of electronics you want. You have a choice, depending on your qualifications, of 18 different programs.

Not only are CREI programs college-level but arrangements are available for you to earn college credit applicable to advanced degrees.

Only CREI offers you a choice of 18 programs in advanced electronics

Electronic
Systems
Engineering

For over 45 years CREI programs have been recognized by leading technical organizations as effective home study training in advanced electronics.

NEW OPTIONAL LAB PROGRAM



CREI now offers a supplementary ELECTRONIC DESIGN LABORATORY PROGRAM to make learning advanced electronics easier and to give you actual experience to use in your work. Only CREI offers this complete college type laboratory program. You learn to actually design electronic circuits. At the same time you get extensive experience in tests and measurements, breadboarding, prototype building and other areas important to your career.

Qualifications to Enroll. To qualify for enrollment in a CREI program, you must be a high school graduate (or equivalent). You should also be working in electronics or have previous training in this field.

Send for FREE book. If you are qualified, send for CREI's newly published book describing your career opportunities in advanced electronics. This full color book is filled with facts about career opportunities for you.

Nuclear
Engineering
Technology



Accredited Member, National Home Study Council

CREI, Dept. E1207D
3939 Wisconsin Avenue
Washington, D. C. 20016

Rush me your FREE book describing my opportunities in advanced electronics. I am a high school graduate.

Name _____ Age _____

Address _____

City _____ State _____ ZIP _____

If you have previous training in electronics, check here

Employed by _____

Type of Present Work _____

Veterans and servicemen, check here for G. I. Bill information

CREI

**CAPITOL
RADIO
ENGINEERING
INSTITUTE**

A Division of McGraw-Hill
Continuing Education Co.
3939 Wisconsin Avenue,
Washington, D. C. 20016

Special Programs
for
Non Electronic
Engineers



New Products

MAGITRAN SOUND PANEL SPEAKERS

The Magitran Co. has introduced a new and advanced version of their picture-frame speaker systems built around Poly Planar flat polystyrene drivers. The walnut-styled solid wood picture frame Model DS60 speakers feature a unique snap-on/snap-off concept for the silk screen art that fits over the drivers. The art, varying in style from Currier & Ives to colorful abstract designs, is available in 12 different designs and colors plus a tweed brown speaker grille cloth. The framed speaker systems are ultra-thin, permitting them to be hung from a wall or stood up unobtrusively via a pair of frame-coordinated wooden floor stands. The speaker elements are rated at 28 watts rms (60 watts peak) and will work with amplifiers with 4- to 8-ohm outputs. Frequency response is 40-20,000 Hz.

Circle No. 71 on Reader Service Card

EDMUND SCIENTIFIC MULTIMETERS

A pair of multimeters for the technician, hobbyist, and home appliance handyman are currently being sold by Edmund Scientific

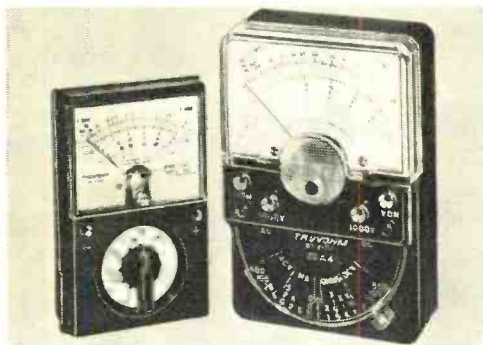

Co. Their Stock No. 71,740 instrument is an 18-range unit that features a lever-type range selector and a 3-in. meter. It measures: dc volts to 1000 V in five ranges at 20,000 ohms/V; ac potentials to 1000 V in four ranges at 1000 ohms/V; current in four ranges to 500 mA dc; and resistance in four ranges to 60 megohms. The 11-range Stock No. 71,739 multimeter is tiny enough to fit in a shirt pocket. It measures: ac and dc potentials to

1000 V, each in four ranges; current in two ranges to 100 mA dc; and resistance to 150,000 ohms. Accuracy of the movement is 2 percent, while sensitivity is 1000 ohms/volt on both ac and dc.

Circle No. 72 on Reader Service Card

POLY PAKS CHRONOMETER KIT

The "Kronos KR100" chronometer available from Poly Paks features an LSI clock chip made by National Semiconductor and a 32-page brochure with pictorials and easy-to-understand step-by-step instructions for assembling the kit. The chronometer includes three setting controls and a "hold" button. Facilities are built in for operation on a 12- or a 24-hour readout format and 50- or 60-Hz power sources. There are three clock formats from which to choose; the first has MAN-3 LED readouts, the second has MAN-1 LED readouts, and the third has gas-discharge readouts. All readouts are of the 7-segment type, and all clocks have hours/minutes/seconds display formats.

Circle No. 73 on Reader Service Card

PAIA ELECTRONIC INSTRUMENT PROCESSOR

PAIA Electronics, Inc., has announced the availability of their "Synthespin MK-II" electronic instrument processor that produces such



special effects as acoustic tremolo, phaser/wah, shimmering pseudo-reverberation, and more. The unit features IC design, a wide range of "rotating" speeds (0.2 to 15 cycles/second), and voltage-control programming jacks. The MK-II can be operated in either an automatic or a manual mode, controlled with optional foot pedals. The unit is available factory wired and tested as the Model 1702A or in kit form as the Model 1702K.

Circle No. 74 on Reader Service Card

XCELITE ANY-ANGLE HEX DRIVERS

A line of Allen hex type screwdrivers and interchangeable blades with an unusual "ballpoint" tip design that permits any-angle driving is available from Xcelite Inc. The tools are said to be able to handle obstructed hex screws that cannot be reached straight-on. Nine sizes, from 0.050 in. through 3/16 in., are available. Also

available are fixed-handle types, singly or a complete set in a handy roll kit with extra pockets for associated tools, and interchangeable Series 99 blades, singly or in a compact set that includes regular detachable handle, 4-in. extension, and a sturdy transparent plastic case.

Circle No. 75 on Reader Service Card

LAFAYETTE MOBILE CASSETTE PLAYER

The Lafayette Radio Electronics "Auto Mate" cassette player is equipped to provide quality stereo sound playback from prerecorded cassette tapes when used in a car, rover, or boat. It is so compact (6½" x 6" x 1½") that it can



be installed in the glove compartments of most cars. Placing a cassette into the front-panel slot starts the playback automatically. The user then has full control via separate volume and tone controls and a slide-type balance control. Two pushbuttons provide for fast-forward tape motion and cassette ejection. The playback deck, which easily mounts via two included brackets, is designed to operate from 12-volt negative-ground electrical systems.

Circle No. 76 on Reader Service Card

NORTRONICS CARTRIDGE ALIGNMENT TAPE

The Recorder Care Division of Nortronics Co., Inc., now has available the Model AT-820 8-track stereo alignment tape for cartridge players. The tape permits rapid test and adjustment of most important functions on home and mobile cartridge players. Cycle playing time is approximately 8 minutes. Tests on the tape include: program and channel identification by voice, track height, azimuth, frequency response and speaker phasing, and tape speed. Other tests include wow and flutter, switching, and crosstalk. Four programs of stereo music permit the testing of overall machine performance.

Circle No. 77 on Reader Service Card

RCA TV MARKER/SIGNALYST GENERATOR

RCA's new Model WR-525A Marker/Signalyst is designed for servicing TV receivers and CATV, MATV, and closed-circuit systems. It can be used with sweep-alignment generators to check TV tuners and overall r-f/i-f receiver alignment on all vhf and many uhf channels.



FREE

1973 LAFAYETTE CATALOG 730

Ready Now!

Your Complete Electronics Buying Guide

- Stereo/Hi-Fi Components • CB Transceivers & Walkie-talkies • PA Systems • Tools & Test Equipment
- Police/Fire Monitor Receivers • Antennas • Photography Equipment • Ham Gear • Books, Parts, and More!

Send Today!

Lafayette Radio Electronics
P.O. Box 10, Dept. 35073
Syosset, L.I., N.Y. 11791

35073

NAME _____

ADDRESS _____

CITY _____

STATE _____ ZIP _____

CIRCLE NO. 17 ON READER SERVICE CARD

ABOUT YOUR SUBSCRIPTION

Your subscription to POPULAR ELECTRONICS is maintained on one of the world's most modern, efficient computer systems, and if you're like 99% of our subscribers, you'll never have any reason to complain about your subscription service.

We have found that when complaints do arise, the majority of them occur because people have written their names or addresses differently at different times. For example, if your subscription were listed under "William Jones, Cedar Lane, Middletown, Arizona," and you were to renew it as "Bill Jones, Cedar Lane, Middletown, Arizona," our computer would think that two separate subscriptions were involved, and it would start sending you two copies of POPULAR ELECTRONICS each month. Other examples of combinations of names that would confuse the computer would include: John Henry Smith and Henry Smith; and Mrs. Joseph Jones and Mary Jones. Minor differences in addresses can also lead to difficulties. For example, to the computer, 100 Second St. is not the same as 100 2nd St.

So, please, when you write us about your subscription, be sure to enclose the mailing label from the cover of the magazine—or else copy your name and address exactly as they appear on the mailing label. This will greatly reduce any chance of error, and we will be able to service your request much more quickly.

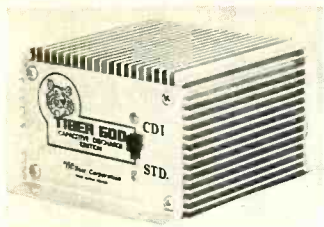

12 REASONS YOUR CAR NEEDS TIGER CDI

Instant starting in any weather - Eliminates tune-ups - Increases gas mileage - Increases horsepower 15% - Improves acceleration and performance - Spark plugs last up to 70,000 miles - Reduces engine maintenance expense - Amplifies spark plug voltage to 45,000 volts - Maintains spark plug voltage to 10,000 RPM - Reduces exhaust emissions - Dual ignition switch - An Unconditional LIFETIME GUARANTEE - Installs in 10 minutes on any car with 12 volt negative ground - No rewiring - Most powerful, efficient and reliable Solid State Ignition made.

SATISFACTION GUARANTEED or money back.

TIGER 500 assembled \$49.95

TIGER SST assembled 39.95

TIGER SST Simpli-Kit 29.95
Post Paid in U.S.A.

Send check or money order with order to:

Tri-Star Corporation

Dept. W, P. O. Box 1946
Grand Junction, Colorado 81501

DEALER INQUIRIES INVITED

CIRCLE NO. 29 ON READER SERVICE CARD

Digital Multimeter



\$145

YOUR personal Digital Multimeter is here! The functions you need most — at the right price — with no sacrifice in quality. Full factory warranty.

- * Autopolarity
- * LSI & C/MOS Circuitry
- * 100% Overrange
- * Large 0.55" Digits

SPECIFICATIONS FOR MODEL 3000

DC VOLTS	1, 10, 100, 1000	RESOLUTION	0.1% All Ranges
AC	1, 10, 100, 1000	ACCURACY	
OHMS	1K, 10K, 100K, 1M, 10M	DC & OHMS	0.5% ± 1 Digit
POWER	105-125 VAC 60 Hz 3W	AC	1.0% ± 1 Digit

Payment with personal check, money order, BankAmericard, and Master Charge card acceptable. Include all raised information on charge cards. Net 30 days to well rated firms. No COD orders. Add \$3 for postage and insurance.

EXPORT model available. Write for details.

LINEAR DIGITAL SYSTEMS corp.
P.O. BOX 954 GLENWOOD SPRINGS, COLORADO 81601

CIRCLE NO. 18 ON READER SERVICE CARD

Continuously tunable, the instrument is calibrated for fundamental signal output on picture-carrier frequencies and will provide dual picture and sound sweep-alignment markers when modulated with a 4.5-MHz signal. Connections for eternal video input make it possible also to modulate the WR-525A with dot, crosshatch, or color-bar signals from an external generator, or with the video output from a TV receiver.

Circle No. 78 on Reader Service Card

HEATHKIT DESK-TOP CALCULATOR KIT

The Heathkit Model IC-2108 desk-top calculator is a four-function unit with a low-profile case and one of the largest, most legible 8-digit, 7-segment displays available. Provisions are made for the user to select either floating or fixed decimal operation at the flip of a switch. A constant key permits chain calcu-



lations, while a clear-entry key allows the removal of any entry from the display without disturbing prior calculations. Negative answer and entry and result overflow are automatically displayed. The color-coded keyboard eliminates confusion when making entries or performing lengthy calculations. The keyboard slopes to the desk for comfortable arm positioning. Available only in kit form, the IC-2108 can be assembled by almost anyone in about two evenings.

Circle No. 79 on Reader Service Card

TOYO 8-TRACK CARTRIDGE PLAYER/RECEIVER

Toyo Radio's new Model 680 is the first luxury component stereo system designed to provide the convenience of 8-track stereo cartridges. It features automatic and pushbutton program selection, digital program lights, jacks for headphones and external speakers. The AM/stereo FM receiver, with built-in stereo beacon and a/c, delivers, 35 watts of music power into two supplied 8-ohm full-range speakers.

Circle No. 80 on Reader Service Card

AKAI CASSETTE TAPE RECORDER

Akai's new top-of-the-line Model GXC-41 cassette recorder develops up to 11 watts of IHF

music power. Driven by a hysteresis motor, the deck has a lifetime glass and crystal ferrite head for record/playback and a ferrite erase head. Also featured is an exclusive Automatic Distortion Reduction System (ADRS) that virtually eliminates the IM distortion usually found in the low-speed recording of the high-frequency range. ADRS varies the recording equalization according to signal level to achieve clear high-frequency sound on cassette recordings.

Circle No. 81 on Reader Service Card

PIONEER 8-TRACK RECORD/PLAY DECK

A digital timer, with reset button, is featured in the new Pioneer of America Model HR-99 8-track cartridge player/recorder deck. De-



signed to measure elapsed recording time in minutes and seconds, rather than footage, the timer provides more accuracy in recording. All material from a single album, for example, can be recorded on one track of a blank tape without any annoying overlap of the material onto a second track. Also featured are manual and automatic recording modes, complemented by lighted VU meters, or automatic level control; auto-stop switch for 1- or 4-track recording; or endless playback; magnetic phono input jack; pause switch; fast-forward button; manual/automatic track change; and tape-end stop.

Circle No. 82 on Reader Service Card

REALISTIC 10-BAND PORTABLE RECEIVER

New from Radio Shack is a 10-band portable receiver that literally puts the whole world at the user's hands. Called the Realistic Patrolman-10, it tunes all of the most wanted bands, including all three vhf police/public service and aircraft bands, plus the uhf band now being used by police, fire, and other emergency services in many major metropolitan areas. The receiver also covers the marine band, three shortwave bands, and the standard AM and FM broadcast bands. It has pushbutton band selection, fine tuning, bfo (for CW and SSB reception), adjustable squelch, and tuning/battery-condition meter.

Circle No. 83 on Reader Service Card

PAGE CB TRANSEIVER

Built into the Pace Communications Model DX 2300B CB transceiver is a silent-running fan

JULY 1973

**THE ONE WORD
FOR PERFORMANCE AND
RELIABILITY IN
ELECTRONIC
IGNITION
JUDSON**

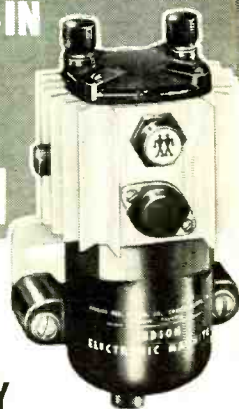

**YOU CAN HAVE
TOMORROW'S
IGNITION ON
YOUR CAR TODAY**

Don't accept "as good as" there are none.

Write Today for Literature

JUDSON
RESEARCH AND MFG. CO
CONSHOCKEN PA. 19428



CIRCLE NO. 16 ON READER SERVICE CARD

TV TUNER SERVICE

VHF, UHF, FM or IF-Subchassis. . .
. . . All Makes

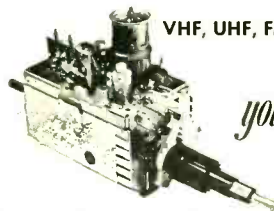

you get...

Fast 8 hr. Service!

You owe it to yourself

to try P.T.S. We are the fastest growing, oldest and now the largest tuner service company in the world. Here is what you get:

1. Fastest Service—8 hr.—in and out the same day. Overnight transit to one of our six plants, for parts, tuners or IF-modules.
2. All tuners cleaned inside and out, repaired, realigned and air tested.
3. On IF-modules all stages checked, all traps set with high calibre test equipment.
4. Fine Quality! Your customers are satisfied and you are not bothered with returning your units for rework!
5. Lower Cost! Up to \$5.50 less than other tuner companies!
6. Friendly, helpful personalized service!

**NEW SERVICE CENTER
PHILADELPHIA, PA.**

P.O. BOX 16855
Phila. Pa. 19142

LIKE TO DO IT YOURSELF?

PTS makes all tuner parts available to you.
Send one dollar (refundable) for our TUNER REPLACEMENT GUIDE AND PARTS CATALOG

• 60 Pages of top information • Blow-up of all tuners • Largest exact tuner replacement guide • Antenna Coil Replacement guide • Multi-Set Replacement Tuner Shift Guide

We offer you finer, faster...

**Precision
Tuner Service**

VHF-UHF-FM \$ 9.95
UV-COMBO \$16.95
IF-MODULE \$12.50

CUSTOMIZED REPLACEMENTS AVAILABLE FOR 42-53 LP (IN) OR REPAIRS!

For fastest service, send fully used VHF tubes, shields and all broken parts to

PTS ELECTRONICS, INC.

HOME OFFICE—
SOUTHEAST—
WEST COAST—
EAST—
SOUTHWEST—
MOUNTAIN—

P.O. Box 272—Bloomington, Ind. 47401
P.O. Box 877—Jacksonville, Fla. 32205
P.O. Box 4135—Sacramento, Calif. 95841
P.O. Box 3188—Springfield, Mass. 01103
P.O. Box 732—Longview, Tex. 75601
P.O. Box 4145—Denver, Colo. 80204

Tel. 812/824-9331
Tel. 904/389-9932
Tel. 916/483-8220
Tel. 413/234-5737
Tel. 214/753-4334
Tel. 303/744-2818

CIRCLE NO. 24 ON READER SERVICE CARD

Midwest Hifi

WHOLESALE
& MAIL ORDER
DIVISION

Protect your wallet.

Don't pay retail prices. Choose from over 100 name brands, and save on freight charges by ordering from the location nearest you.

Write today for our free catalog!
Midwest Hifi Wholesale & Mail Order Div.,
2455b Wisconsin Ave.,
Downers Grove, Ill. 60515 (Attn Peter Eckart)
3309 E. J W Carpenter Frwy.,
Irving, Tex. 75062 (Attn Paul Eisner)

CIRCLE NO. 23 ON READER SERVICE CARD

AT LAST! PROFESSIONAL HOME PROTECTION EVERYONE CAN INSTALL AND AFFORD.

Model FC-100

\$69.95

WIRED

- Start your custom Burglar/Hold-up/Fire Alarm System with the FC-100. Add on Sensors, Alarms and Accessories to suit your own needs.
- "Do-it-Yourself" Installers Handbook included. No technical knowledge needed—No soldering.
- 100% Professional in Design, Reliability, Performance.



'Fail Safe'-SYSTEM BY EICO

A New Concept in "Do-it-Yourself" Home Protection

FREE 32 PAGE EICO CATALOG

For latest catalog on EICO Test Instruments, Stereo, EICOCRAFT Projects, Environmental Lighting, Burglar/Fire Alarm Systems, and name of nearest EICO Distributor, check Reader Service Card or send 25¢ for First Class mail service.

EICO, 283 Malta Street, Brooklyn, N.Y. 11207



CIRCLE NO. 10 ON READER SERVICE CARD

that keeps the rig cool and reliable during continuous operation. Excellent selectivity is provided by a special six-section tuned network filter in a dual-conversion superheterodyne receiver. These filters also greatly narrow the bandwidth for added noise reduction. Superior frequency stability, provided by an extra compensating circuit that offsets frequency drift due to temperature changes, enables the DX 2300B to maintain a consistent 0.25- μ V sensitivity. A special modulation booster is backed by a class A audio power amplifier to provide an efficient upward modulation kick and extended transmitter range.

Circle No. 84 on Reader Service Card

SANSUI AM/STEREO FM TUNER

State-of-the-art design in a moderately priced AM/stereo FM tuner makes the new Sansui Model TU-505 the most advanced unit of its kind in its price range. The sensitive front end

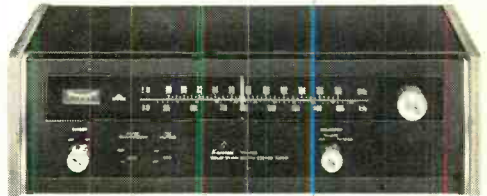

uses a dual-gate MOSFET for high sensitivity, and selectivity is enhanced by the i-f section with an IC and a pair of two-resonator ceramic filters. The tuner has two pairs of outputs for amplifier connection and for direct tape recording off the air. Antenna inputs are provided for both 300-ohm balanced and 75-ohm unbalanced lines, as is a provision for an external AM antenna. Switches are provided for high-frequency noise suppression and for interstation muting.

Circle No. 85 on Reader Service Card

AUDIOVOX MOBILE STEREO FM RADIO

One of the most compact mobile stereo FM receivers, the Model FMX-20, is now avail-

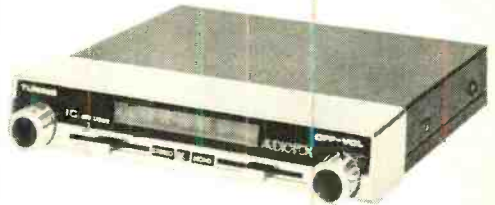

able from Audiovox Corp. It features a large illuminated dial that facilitates easy tuning, a stereo indicator lamp, solid-state circuitry complemented by ceramic filters that insure trouble-free performance, a stereo/mono selector switch, and sliding balance and tone controls—all in a package that measures only 6" x 5" x 1 1/4".

Circle No. 86 on Reader Service Card

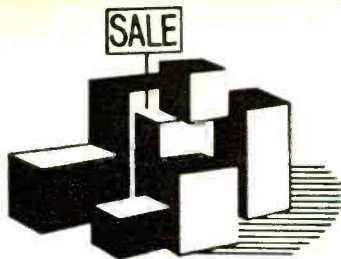

Surplus Scene

By Alexander W. Burawa, Associate Editor

CONTINUING THE LIST OF SURPLUS DEALERS

Last month we began an index of dealers doing business on the Surplus Scene, giving addresses and mentioning the items they stock and sell. So, on with the list.

EEP Corp., 10180 W. Jefferson Blvd., Culver City, CA 90231. Diodes, transistors, voltage regulators, EXAR products; red and green 7-segment and overflow-1/polarity indicators and red LED's.

Colonel Wayne D. Russell, 9410 Walhampton, Louisville KY 40222. Real military surplus receivers, transmitters, transceivers, retransmitters, a-f amplifiers; conversion instructions provided to use equipment in ham and SWL service.

Barry Electronics Corp., 512 Broadway, New York, NY 10012. Military surplus gear; new transformers, variable and fixed capacitors, power resistors, vacuum tubes; telephones, CB transceivers, intercoms; r-f power measuring instruments.

Baynton Electronics Corp., 2709 N. Broad St., Philadelphia, PA 19132. Not really a "surplus" dealer in the usual sense, but they stock a wide assortment of top name-brand lab and service test equipment; waveguide and coaxial components; wire and cable.

Wallen Electronics Co., Inc., 46 N. Manchester St., Brockton, MA 02402. Rent, lease, sell and buy all sorts of gear made by the big-name manufacturers. Items include components and special-purpose tubes; radar and microwave devices; laboratory and service bench equipment; military, aircraft, and marine equipment.

Data Instrumentation Associates, 208 S. Pulaski St., Baltimore, MD 21223. This relatively new company to the surplus business deals primarily in digital, communication, and test equipment made by the big-name companies and acquired from commercial and government sources, as well as a line of 7400-series digital IC's.

Surplus Center, P.O. Box 82209, Lincoln, NB 68501. New and government surplus electronic equipment ranging from CB transceivers through individual parts. Parts listing of primary interest to experimenters and hams.

Herbach & Rademan, Inc., 410 E. Erie Ave., Philadelphia, PA 19134. Surplus dealers to the industry, really, but if you need something exotic like a color-TV broadcast studio on wheels or more down-to-earth items like motors, selsyns, relays, etc.

Lawrence Instruments, P.O. Box 744, Sunbury, PA 17801. Test and measurement gear, 10-turn pots, panel meters, transceiver base stations, equipment slides, equipment bags. Lots more; catalog changes every month.

Electro Craft, Inc., 1124 Dorchester Ave., Dorchester, MA 02125. Primarily sophisticated lab-type test and measurement equipment made by the big-name manufacturers; also a selection of microwave and industrial tubes.

Babylon Electronics, P.O. Box J, Carmichael, CA 95608. Not really a surplus dealer, but the company has a well-rounded inventory of digital and linear IC's, including some CMOS and Schottky TTL devices; calculator-on-a-chip and three-chip calculator set; Numitron and MAN-1 7-segment readouts; digital counter kits.

Digi-Key, Box 126K, Thief River Falls, MN 56701. Don't let the name of the town fool you; this company has some really good buys in factory-first linear and digital IC's, general-purpose silicon transistors, rectifiers, readout tubes, Molex IC socket pins.

Environmental Products, Box 1014 Glenwood Springs, CO 81601. Definitely not a "surplus" dealer but mentioned here for the digital experimenter looking for low-cost power supplies, universal counter/display modules, frequency counter preamp, etc. ♦

SCOPES, meters, test equipment, military and industrial surplus. Write for free "Bargain Bulletins". Lawrence Instruments, P.O. Box 744, Sunbury, Pa. 17801.

MECHANICAL, ELECTRONIC devices catalog 10¢. Greatest Values—Lowest Prices. Fertik's, 5249 "D", Philadelphia, Pa. 19120.

DIGITAL ELECTRONICS) Complete schematics, parts lists, theories—Discrete Component Digital Clock, \$3.00—Sound Sensitive Switch, \$1.50. Increase technical competence, hobby skills—Complete Course in Digital Electronics is highly effective, \$10.00. Free literature. DYNASIGN, Box 60A7, Wayland, Mass. 01778.

SURPLUS electronics for everyone. Free catalog. U.S. inquiries. ETCO, 464 McGill, Montreal, Canada.

FREE Catalog lists resistors, tubes, transistors, rectifiers, condensers, tools, tuners, etc. Hytron Hudson, Dept. PE, 2201 Bergenline Ave., Union City, N.J. 07087.

OSCILLOSCOPE. New 10 MHz trigger sweep and dual trace. Add to any scope. HTP, Box 901, Cupertino, Calif. 95014.

FREE CATALOG
UP TO 50% OFF COMPARABLE KITS*

• BUY DIRECT • SAVE \$\$\$

FREE Catalog—Electronic Kits—Amplifiers—Preamps—Psychedelic Strobes—Burglar Alarms—Digital Tachometer—More: Free Catalog.

SWTPC, Box A32040, San Antonio, Tex. 78284.

IGNITION SYSTEMS: Capacitor, Transistor. Information 10¢. Anderson Engineering, Epsom, N.H. 03239.

AUTHENTIC, INSTRUMENTED, FLYING ROCKETS for casual or serious experimenters. Over 80 scale original, multi-stage or ready-to-fly models. Solid-propellant engines for safe, electric launch system liftoffs up to 2,500 feet. Measure altitude, temp, inversions, more. Real telemetry, electronic tracking, aerial still and movie photography with super-miniaturized equipment. New, detailed tech manual and full-color catalog, 25¢ from ESTES INDUSTRIES, Dept. 18L, Penrose, Colo. 81240.

ALPHA/THETA feedback instruments—\$25. Sensitive circuit of \$75 unit. Ultimate ease of use. Inner Space Electronics, Box 308PE, Berkeley, CA 94701.

ELECTRONIC CDI Ignitions, VHF/UHF monitors, CB radios. Wholesale. Southland, Box 3591, Baytown, Texas 77520.

FREE CATALOG. Parts, circuit boards for Popular Electronics projects. PAIA Electronics, Box C14359, Oklahoma City, OK 73114.

BURGLAR-FIRE alarm supplies and information. Free catalog. Protecto Alarm Sales, Box 357-G, Birch Run, Michigan 48415.

DIGITAL and analog computer modules. LED numeric display kits. FREE LITERATURE. Scientific Measurements, 2945 Central, Wilmette, Illinois 60091.

ELECTRONIC ORGAN KITS, KEYBOARDS, Independent and divider tone generators. All diode keying. I.C. circuitry. Many components. With our kits you can build any type or size organ desired. 25¢ for catalog. DEVTRONIX ORGAN PRODUCTS, Dept. C, 5872 Amapola Dr., San Jose, Calif. 95129.

POLICE—FIRE Frequency Directories \$2.00. Monitor Crystals \$4.95. 25¢ extra for airmail. Crystal Service, P.O. Box 612, East Moline, Illinois 61244.

EXPERIMENTERS—Circuits, V/F converters \$2.00. Others, list 25¢. Yeager, P.O. Box 2213, Olympia, Washington 98507.

DIGITAL ALARM CLOCK KIT. One LSI/DIP does everything, 7 minute snooze, automatic auxiliary power changer, etc. Four .56" displays, DIP, and PC board \$29.95. Above plus two .4" displays \$34.45. Digi-tel Electronics, Box 6585P, Toledo, Ohio 43612.

GENERAL TELEPHONE DATA ENTRY KEYBOARD

Used in calculators, touch-tone, encoding, programming devices. 10 PUSH BUTTONS (0 to 9) & 2 uncommitted. All switches have 2 separate poles & 6 separate buses—totaling 6 buses & 24 poles... Any combination of which can be used! Size: 3.2x2.1". Easy for panel MTK. too.

\$8.88

NATIONAL EQUALS ON "DIGITAL CLOCK ON A CHIP"

*Money Back Guarantee! Any "Chip" *With Spec Sheet! **\$12.88**

Mfr.	Description	Sale
5311	28-pin, ceramic, any readout.	\$12.88
	6-digits: A-B-D	
5312	24-pin, ceramic, any readout.	\$12.88
	4-digits: C-D	
5313	28-pin, ceramic, any readout.	\$12.88
	6-digits: A-C	
5314	24-pin, plastic, LED and incandescent readouts.	6-digits: A-B \$12.88

Code: A—Hold Count; C—1 PPS Output; B—Output Strobe; D—BCD

GENERAL ELECTRIC 3-WATT AUDIO AMP

\$2.95

Delivers 3 watts continuous, 10 watts peak. With heat sink: micro-mini size: 3.8x2.2x.9 to 3.0x sup. 100% efficiency: 8 to 16 ohms. For mono and stereo: phonos, tape, FM, AM, TV, servo. 3 FOR \$6.

LITRONIX FD-7 LED 7-SEG READOUT \$4.95

Pin-for-pin substitute for famous MAN-1, electrically identical to the same. Snaps into 14-pin DIP socket. Requires same drivers, i.e., SN7416 or SN7417. Requires 5V @ 20 mA per segment. 0.27 size character with left decimal. Size: 3/8 x 5/16 x 3/16"

LINEAR Op Amps \$2.50

5312 Micro Power 741 (TO-5) 2.50
5333 Micro power 709 (TO-5) 2.50
5336 PET Input amp (TO-5) 2.50
5337 Precision 741 (TO-5) 2.50
540 70W pwr driver amp (TO-5) 2.04
550 Precision 723 voltage rex. (DIP) 1.17
555 Timer 2 users to 1 hr (A) 1.00
556 5 Times faster than 741C 2.00
558 Dual 741 (mini DIP) .88
560 Phase lock loops (DIP) 3.25
561 Phase lock loops (DIP) 3.25
562 Phase lock loops (DIP) 3.25
565 Phase lock loops (A) 3.25
566 Function generator (A) 3.25
567 Tone generator (A) 3.25
595 Four quadrant multiplier 3.10
702C Hi-grain, DC amp (TO-5) .44
703C RF-IF, amp, 14 chks (TO-5) 1.00
709C Operational amp (A) 1.00
709CV Dp amp (mini DIP) .49
710C D.Herential amp (A) .44
711C Dual diff. comp (A) .44
723C Voltage regulator (A) .44
741C Frequency compensator 709 (A) .49
741CV Freq. comp 709 (Mini DIP) 1.00
747C Dual 741C (A) 1.25
748C Freq. ad. 741C (A) .44
748CV Freq. ad. 741C (mini DIP) .49
709-709 Dual 709C (DIP) 1.00
739-739 Dual stereo preamp 1.98
741-741 Dual 741C (mini DIP) 1.00
7450 Dual peripheral driver (DIP) .69
(A) TO-5 or DIP dual in-line pak

LED READOUTS \$2.95

This display is excellent for small portable electronics, such as DMM's, calculators, etc. Equivalent to Monsanto MAN-4. Operates from 5V, 20 milliamperes, with 47 ohm dropping resistor.

35 WATT AUDIO AMPLIFIER BASIC \$3.33

For Class AB use. Basic includes: Signetics 5410 transistor high power driver TO-5 1C, with a pair of complementary 1-watt plastic transistors, i.e. 2N5209; npn and 2N6109 pnp. With schematics, printed circuit and parts board layouts.

Largest Selection TTL IC's

Type	Sale	Buy 3	10%	Buy 100	Take 20%
SN7400	\$0.30				
SN7401	.30	SN7442	1.25	SN7483	1.50
SN7402	.30	SN7443	1.35	SN7485	1.41
SN7403	.30	SN7444	1.35	SN7486	1.50
SN7404	.35	SN7445	1.35	SN7489	3.75
SN7405	.32	SN7446	1.65	SN7491	1.50
SN7406	.37	SN7447	1.65	SN7492	1.10
SN7407	.55	SN7448	1.50	SN7493	1.10
SN7408	.35	SN7449	.35	SN7494	1.10
SN7409	.35	SN7451	.35	SN7499	1.10
SN7410	.30	SN7453	.35	SN7499	1.10
SN7411	.35	SN7454	.50	SN7499	1.10
SN7413	.95	SN7455	.35	SN74100	1.49
SN7419	.35	SN7460	.35	SN74104	1.25
SN7416	.55	SN7461	.50	SN74105	.55
SN7417	.55	SN7465	.50	SN74106	1.25
SN7420	.30	SN7470	.50	SN74107	.50
SN7421	.35	SN7472	.50	SN74108	1.25
SN7422	.35	SN7473	.65	SN74112	1.25
SN7426	.37	SN7474	.65	SN74113	1.25
SN7430	.30	SN7475	1.30	SN74114	1.25
SN7432	.30	SN7476	.75	SN74121	.70
SN7437	.60	SN7478	.95	SN74122	.75
SN7438	.60	SN7480	.75	SN74123	.70
SN7440	.30	SN7481	1.30	SN74140	.50
SN7441	1.40	SN7482	.95	SN74145	1.40

Best Values for 18 years

Terms: add postage. Rated: net 30
Phone Orders: Wakefield, Mass. (617) 245-3829
Retail: 16-18 Del Carmine St., Wakefield, Mass.
(off Water Street) C.O.D.'S MAY BE PHONED IN
P.O. BOX 942
Wakefield, Mass. 01940

CIRCLE NO. 26 ON READER SERVICE CARD

LIGHT EMITTING DIODES

FLV 100 VIS. LED	5.50
MT2 Photo Transistor	5.90
MCT-2 Opto. Isolator	\$1.49
MCD-2 Opto. Isolator	\$1.49
MCA-2-30 Photo Relay	\$1.95
MV5026 VIS LED	5.65
ME4 IR LED's	5.59
MV522 GRN LED	\$1.49
MV5322 GaAsP LED	5.99

7400	.30	7465	.35
7401	.30	7472	.50
7402	.30	7473	1.00
7403	.30	7474	1.00
7404	.35	7475	1.00
7405	.35	7480	.65
7406	.35	7481	.65
7408	.35	7483	1.25
7410	.50	7484	.70
7412	.50	7489	1.30
7413	1.20	7492	1.00
7420	.30	7493	1.50
7422	.35	7494	1.10
7426	.40	7495	1.10
7430	.30	74107	.75
7438	.60	7481	1.10
7440	.30	74123	1.20
7441	1.50	74153	1.50
7442	1.50	74154	1.95
7445	1.50	74161	1.79
7448	1.50	74192	1.95
7450	.30	74193	1.95
7451	.30	74194	2.35
7452	.30	9309	1.95
7453	.30	9312	1.95
7454	.30	9322	1.95
7460	.30		

VERIPAX PC BOARD

This board is a 1/16" single sided paper epoxy board 4 1/2" x 6 1/2" (standard veripax) DRILLED and etched, which will hold 21 single 14 pin IC's, or 8,16 or LSI DIP IC's with buses for power supply connections. It is also etched for a 22 pin connector. \$5.25 3/\$14.50

Send \$.20 for our latest catalog featuring Transistors and Rectifiers

TRANSISTOR SPECIALS

2N3638 PNP Si TO-5	3W	25V	.5A	10	63	5	\$1.00
2N3584 NPN Si TO-66	35W	250V	2A	10MHz	100Hf		\$1.50
2N965 PNP GE TO-18	.15W	.7V	1A	.300	40		/1.00
2N1605 NPN GE TO-5	.15W	24V	1A	14	125	5	\$1.00
2N5324 PNP GE TO-3	60W	250V	10A	20	35		\$1.50
2N1015D NPN Si TO-82	150W	200V	7.5A	.025	10		\$1.45
2N3724 NPN Si TO-5	.8W	30V	1.4	250	60	3	\$1.00
2N3772 NPN Si TO-3	150W	60V	30A	2	30		\$1.25
2N6109 PNP Si TO-220	36W	40V	4A	8	60		50c
2N5296 NPN Si TO-220	36W	40V	4A	8	60		55c
2N4898 PNP Si TO-66	25W	40V	4A	40	46		\$.60
MJ2511 NPN Si TO-66	10W	225V	.5A	10	40		5.70
2N3055 NPN Si TO-3	115W	100V	15A	2	44		\$1.00

Printed circuit board 4 1/2" x 6 1/2" double sided fiber glass board 1/16" thick, unetched. \$.60 ea. 5/\$2.50

Data-Lit 707 direct replacement for MAN-1 LED seven segment Reouts \$3.75

MAN-4 LED READOUT	\$3.25
MAN-3 LED READOUT	\$2.50

SV 1 Amp. regulated power supplies. These units are similar to analog devices encapsulated SE905 power supplies \$34.95

8223 Field Prog Rom	\$8.00
1101 256 Bit RAM	\$4.00
8225 64 BIT MEMORY	\$4.00

TRIACS

PRV	IA	IOA	15A	20A*
100	.40	.70	1.00	1.20
200	.70	1.10	1.50	1.60
300	.90	1.35	1.90	2.00
400	1.10	1.60	2.30	2.40
500	1.50	2.00	2.70	2.80

*Press Fit

FULL WAVE BRIDGES

PRV	2A	6A
200	95	1.25
400	1.15	1.50
600	1.35	1.75

Silicon Power Rectifiers

PRV	IA	3A	12A	50A
100	.06	.09	.30	.85
200	.07	.16	.35	1.25
400	.09	.20	.45	1.50
600	.11	.30	.70	1.30
800	.15	.40	.85	2.30
1000	.20	.55	1.10	2.75

Silicon Control Rectifiers

PRV	6A	10A	20A	70A
100	.30	.45	1.00	3.50
200	.50	.75	1.25	6.50
300	.60	.90	1.50	
400	.70	1.10	1.75	9.50
500	.80	1.25	2.00	
600	.90	1.40	2.25	11.00

715 73 N Channel FET	\$.75
2N4891 UJT	\$.50
ER900 Trigger Diode	4/\$1.00

NIXIE TUBE RAYTHEON 8754 WITH SOCKET AND DATA SHEET \$2.25 3/\$6.00

HC 2000-7A GOW all silicon, all purpose amprs. These amprs, having a band width of 30MC, are used for servo amprs, audio amprs & power op. amprs. \$24.95

MULTI-TURN TRIM POTS

Similar to Bourns 3010 style 50, 100, 500, 2K, 5K, 10K & 20K ohms. \$2.00 3/\$5.50

PA234 1 Watt Audio Amps	\$1.25
LM 309K SV 1 Amp Regulator	\$2.25
741 OPER. AMP	\$.50
Dual 709	.95
723 Regulator	5.75
TVR-2002 high power 723	\$1.00
703RF 1F Amp	\$.80
CA3065 FM TV Amp	\$1.35
565 Phase Lock Loop	\$3.25
565 One Decoder	\$3.25
560 Phase Lock Loop	\$3.25
563 Phase Lock Loop	\$3.25
538 Dual 741 (Mini Dip)	.88
531 High Slew Oper Amp	\$2.50
536 FET Input Oper Amp	\$3.25
537 Precision 741	\$2.50
540 70W Power Driver	\$2.04
747 Dual 741	\$1.25
LM108 Oper Amp	\$1.95
5556 Oper Amp	\$.75
101 Oper Amp	\$.75
741A Oper Amp	\$.50
320-5V Reg.	\$2.25
320-15V Reg.	\$2.25
4244 Zero Voltage Switch	\$1.25
748 Oper Amp	\$.90

Terms: FOB Cambridge, Mass.

Send check or Money Order. Include postage. Average Wt. per package 1/2 lb. No C.O.D.'s.

Minimum Order \$3.00
Rated companies 30 days net

SOLID STATE SALES

Post Office Box 74A

Somerville, Mass. 02143

Tel. (617) 547-4005

CIRCLE NO. 28 ON READER SERVICE CARD

FIREWORKS NEWS—Monthly magazine covering Fireworks, Construction, Literature, Sources of Supplies, New Firms Products. Free Fireworks Catalogs With Subscriptions! \$9.00 per calendar year. Pyro Press, Box 1202N7, Lexington, Kentucky 40501.

SOUND SYNTHESIZER KITS—Surf \$11.95, Wind \$11.95, Wind Chimes \$16.95, Electronic Songbird \$6.95, Musical Accessories, many more. Catalog free. PAIA Electronics, Box J14359, Oklahoma City, OK 73114

WAVEFORM Generator Kit \$10.00. Stereo Multiplex Kit \$19.95. Free Kit Catalog. Photolum Corp., Box 139, N.Y., N.Y. 10016.

FREE Catalog LED's, I.C.'s parts. Coronet Electronics, 720 Notre Dame W., Montreal, Canada. U.S. Inquiries.

EXPERIMENTER test leads, PC chemicals, solder, adhesives, accessories—Free catalog. Technical Services, Box 687, Arlington, MN 55307.

BRAINWAVE feedback. Professional biofeedback instruments: Electroencephalophone, Electromyometer. J&J, 8102-E, Bainbridge, Wa. 98110.

SUMMER SALE—NEW—Micro Lamps 2.4V, 5V 8c. Ceramic Capacitors .01 mfd 50V 3c. 1K Trimpot 8c. Regulated 5V 1A Bench Supply \$19.95. \$4.00 minimum, include postage. Atlantis, PO Box 1264P, Tucson, Arizona 85711

TELEVISION Signa's: Amplifiers, traps, FM taps, cable. Free brochure. LaSalle Electronics, Box 2153, New Market Station, Niagara Falls, NY 14301.

XENON FLASHTUBES FT106 50W: 2/\$4, 10/\$16. Coils 4/\$3. White Noise Generator Kit \$3.95. Flyer, Mindlight, B2846PE, Van Nuys, CA 91404.

PRESTODIAL Automatic Phone Dialer. Dial 36 numbers automatically. Can be built into fire or burglar alarms. \$59.50 new or \$29.50 rebuilt plus \$1.50 postage. Parts available. C&T Enterprises, Box 19864, Columbus, Ohio 43248.

SAM'S Photofact—841 Sets with Cabinets. \$895, Tommy Douglas, Route #3, Franklin, TN. 37064.

DIGITAL SPEEDOMETER with numeric readout. Plans \$7.50. KIMTRON, Box 80134, Chamblee, Georgia 30341.

FREE Bargain Catalog of Electronic Components. Chaney, Box 15431, Lakewood, Colorado 80215.

SPACE AGE micro size electronic dice you can build with I.C. and LED. Complete plans: \$2.00. Nortix Regd., Box 710, L'Assomption, P.Q., Canada. U.S. Inquiries.

AUTON high RPM Ignition information. Autonics, Box 1581, National City, California 92050.

TTL IC, Semiconductors, parts discount. Price List, 10c. Totelek, Box 222, Goodyear, Arizona 85338.

PRINTED board design, fabrication. PCDS, 1610 Melville, Fairfield, Ct. 06430.

FREE CATALOG—Tremendous electronic bargains. Pacific, Box 4188G, Mountain View, California 94040.

COLOR Organs, Meters, parts. Catalog. Workshop, Box 393PE, Bethpage, New York 11714.

ELECTRONIC TV Antenna, plugs into wall outlet. \$3.95. Sabacy Products, Box 15206P, Lakewood, CO. 80215.

FREE! INDUSTRY'S largest hobby and technical catalog index. Diodes free. Delta Components, Box 34323, Dallas, Texas 75234.

RECORD Telephone conversations automatically. Device operates privately unattended, \$24.95. Manual version for dictating machines \$15.95. Stier Enterprises, Box 3153, Van Nuys, California 91407.

GIVE your Hammond new life with a String Bass, \$128. ETC Electronics Company, P.O. 402, San Luis Obispo, CA 93401.

TEST SET; SCRS Triacs, Rectifiers. Separates the good from the bad in seconds. Wired and Tested. \$39.00 plus shipping (2 lbs.). J. Caldwell, Box 1552, Fort Walton Beach, Florida 32548.

ELECTRONIC GOODIES. Sorensen Voltage Stabilizer Input 95-130V/24A; Output 110-120V, 2000VA New \$150.00. F.O.B. Houston; Write list; Madison Electronics, 1508 McKinney, Houston, Texas 77002. (713) 224-2668.

WANTED

QUICKSILVER, Platinum, Silver, Gold, Ores Analyzed. Free Circular. Mercury Terminal, Norwood, Mass. 02062.

MILITARY SURPLUS EQUIPMENT WANTED. ARC-34C, ARC-51BX, ARC-73, ARC-102, ARC-109, ARC-131, ARC-134, ARN-21C, ARN-52, ARN-65, GRC-106, VRC-12, URC-24, 618T, Also Bendix, Collins GR, HP, Tektronix needed, plus military test sets. We Buy or Trade. Step Electronics, 2412 Highway 301, Ellenton, Florida 33532.

PLANS AND KITS

ANTIHAVITY DEVICE. Brochure rushed free. AGD, Box 3062-2D, Bartlesville, Oklahoma 74003.

FREE KIT CATALOG

Why does every major College, University, Technical School, Research & Development Center buy from us? Because we have the highest quality and lowest prices. Free Catalog. SWTPC, Box H32040, San Antonio, Tex. 78284.

KIRLIAN Electric Field Photography apparatus, plans, instructions, 50pp, \$10. H.S. Dakin, 300 Broadway #39, San Francisco, CA 94133.

LATEST vista digital, linear IC, PC Board Kits. Free Flyer. Photolum Corp., Dept. A, Box 139, N.Y., N.Y. 10016.

FREE CATALOG—Tremendous electronics bargains. Pacific, Box 4188H, Mountain View, California 94040.

ELECTRONIC combination lock solid state. Plans \$2.00, kit \$29.95. Richard Meuse, 9 Appleton Terr., Everett, Mass. 02149.

INVENTIONS WANTED

CASH-ROYALTIES for patented, unpatented inventions. Global Marketing Service, 2420-P 77th, Oakland, California 94605.

PATENT Searches including Maximum speed, full airmail report and closest patent copies. Quality searches expertly administered. Complete secrecy guaranteed. Free Invention Protection forms and "Patent Information." Write Dept. 9, Washington Patent Office Search Bureau, Benjamin Franklin Substation, P.O. Box 7167, Washington, D.C. 20044.

FREE "Directory of 500 Corporations Seeking New Products." For information regarding development, sale, licensing of your patented/unpatented invention. Write: Raymond Lee Organization, 230-GR Park Avenue, New York City 10017.

INVENTORS: Protect your ideas! Free "Recommended Procedure". Washington Inventors Service, 422T Washington Building, Washington, D.C. 20005.

INVENTORS! Either I will sell your Invention before you do, (either through your own efforts or those of another firm) or I will pay you a cash bonus. For Free Invention Evaluation and information, write Gilbert Adams, Invention Broker, Dept. 20, 81 Wall St., New York, N.Y. 10005.

NEW PRODUCTS—INVENTIONS—IDEAS Developed/Marketed by professional organization, FREE INFORMATION "How to Market Inventions To Industry". Lawrence Peska Associates, 500-PE Fifth Avenue, New York City 10036.

LINEAR INTEGRATED CIRCUITS

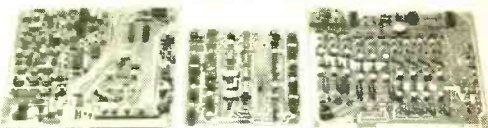

Our latest lot of boards has Linear ICs, as well as Digital ICs, transistors, diodes, precision resistors, tantalum caps, and other components. Linears include MC1741, 75150P, 7274P, MC1710, MOS 310214, LM301, MM580 etc.

STOCK NO.F9661 \$2.75 ea.
2 Diff. boards, \$5.00, 3 Diff. boards \$7.00

G. E. PUSHBUTTON SWITCH

3 section push button switch. 2 SPST and 1 OFF switch. rated at 120/240 VAC, 17 amps. Mounting centers 1 5/8".

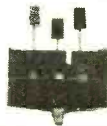

STOCK NO.F9622 .75 ea. 3/2.00

OUR NEW 56 PAGE CATALOG JUST OUT, LOADED WITH NEW AND DIFFERENT ITEMS, NEVER BEFORE AVAILABLE.

Include postage. Excess refunded. MINIMUM ORDER, \$3.00. Write for new 56 page catalog.



DELTA ELECTRONICS CO.

BOX 1, LYNN, MASSACHUSETTS 01903
617-388-4705

CIRCLE NO. 6 ON READER SERVICE CARD

FREE PAMPHLET: "Tips on Safeguarding Your Invention." Write: United States Inventors Service Company, 708-T Carry Building, Washington, D.C. 20005.

INVENTORS—Don't be tricked into thinking your invention is protected. Use the U.S. Patent Office disclosure Service. Simple form and file by mail details \$1.50. K.R. Johnson, 12000 Old Georgetown, Rockville, Md. 20852.

PLASTICS

CASTOLITE pours like water, hardens like glass without heat. Crystal clear, colors. Embed natural flowers, seashells, momentos, anything. Make fine gifts. Form flexible molds over any pattern, size. Reproduce your own designs in plastics, candle wax, metal, plaster, cement. Profitable. Illustrated Manual and Catalog Only \$1.00. CASTOLITE, Dept. 73H/PE, Woodstock, Ill. 60098.

HYPNOTISM

"MALE-FEMALE Hypnotism" Exposed, Explained! "Secret Method"—They Never Know! \$2, Rushed. Guaranteed! Isabella Hall, Silver Springs, Florida 32688.

SLEEP learning. Hypnotic method. 92% effective. Details free. ASR Foundation, Box 7566EG, Fort Lauderdale, Florida 33304.

FREE Hypnotism. Self-Hypnosis. Sleep Learning Catalog! Drawer H400, Ruidoso, New Mexico 88345.

HYPNOTIZE STRANGERS in 30 seconds! Men or Women! Amazing hypnotic disk PULLS subjects into deep hypnosis!! Guaranteed! Send \$2 today!! Hypnodisk, 508 Mourning Dove, Dept. CM-7, Audubon, Pennsylvania 19407.

INSTRUCTION

LEARN ELECTRONIC ORGAN SERVICING at home all makes including transistor. Experimental kit—trouble-shooting. Accredited NHSC, Free Booklet. **NILES BRYANT SCHOOL**, 3631 Stockton, Dept. A, Sacramento, Calif. 95820.

LEARN WHILE ASLEEP, Hypnotize! Strange catalog free. Auto-suggestion, Box 24-ZD, Olympia, Washington 98501.

ASSOCIATE DEGREE IN ELECTRONICS through correspondence instruction. G.I. Bill approved. Free catalog. Grantham, 1509 N. Western, Hollywood, California 90027.

FCC First and Second Tests. \$8.95. Electronic Tutoring, Box 24190, Cleveland, Ohio 44124.

ON THE AIR announcer training at R.E.I. features individual realistic preparation for your Radio/TV career. R.E.I.'s engineering course features intensive training for the FCC First Phone! Complete either course in just five (5) weeks! Call 1-800-237-2251 toll free for brochure. Write: R.E.I., 1336 Main Street, Sarasota, Florida 33577.

SHORTCUTS To Success! Highly Effective, Profitable Short Courses. (75 Choices). Study At Home. Diploma Awarded. Our 27th Year. Free Literature. CIEE-D, Box 10634, Jackson, Miss. 39209.

TAPE RECORDING COURSE: Taught by studio engineers. Free information. NNA, Box 721R, Rye, New York 10580.

F.C.C. EXAM MANUAL
PASS FCC EXAMS! Memorize, study —1973 Tests-Answers for FCC First and Second Class Radio-telephone licenses. Newly revised multiple-choice questions and diagrams cover all areas tested in FCC exams. —plus— "Self-Study Ability Test." \$9.95 postpaid.
COMMAND PRODUCTIONS RADIO ENGINEERING DIVISION P.O. BOX 26348-P SAN FRANCISCO, CALIF. 94126

FCC FIRST CLASS LICENSE through tape recorded lessons with one week personal instruction. Radio License Training, 10600 Duncan, Manhattan Beach, Calif. 90266.

EARN COLLEGE DEGREES at home. Many subjects. Florida State Christian University, P.O. Box 1674, Fort Lauderdale, Florida 33302.

DIGITAL:THEORY,DESIGN,
CONSTRUCTION

LOGIC NEWSLETTER®

SAMPLE COPY \$ 1.00
LOGIC NEWSLETTER
POB 252
WALDWICK,N.J. 07463

MOVIE FILMS

8MM-SUPER 8-16MM MOVIES! Biggest Selection! Lowest Prices! Free Catalog! Cinema Eight, Box PE, Chester, Connecticut 06412.

HIGH FIDELITY

DIAMOND NEEDLES and Stereo Cartridges at Discount prices for Shure, Pickering, Stanton, Empire, Grado and ADC. Send for free catalog. All merchandise brand new and factory sealed. LYLE CARTRIDGES, Dept. P, Box 69, Kensington Station, Brooklyn, New York 11218.

BEST Hi-Fi Stereo Books!—"4-Channel Stereo," only \$3.95. Free Catalog. TAB BOOKS, B.R.S., Pa. 17214.

BUSINESS OPPORTUNITIES

I MADE \$40,000.00 Year by Mailorder! Helped others make money! Start with \$15.00—Free Proof. Torrey, Box 318-N, Ypsilanti, Michigan 48197.

\$200.00 DAILY In Your Mailbox! Your opportunity to do what mail-order experts do. Free details. Associates, Box 136-J, Holland, Michigan 49423.

FREE CATALOGS. Repair air conditioning, refrigeration. Tools, supplies, full instructions. Doolin, 2016 Canton, Dallas, Texas 75201.

MAILORDER MILLIONAIRE helps beginners make \$500 weekly. Free report reveals secret plan! Executive (1K7), 333 Noth Michigan, Chicago 60601.

HIGHLY PROFITABLE ONE-MAN ELECTRONIC FACTORY

Investment unnecessary, knowledge not required, sales handled by professionals. Postcard brings facts about this unusual opportunity. Write today! Barta-DEPG, Box 248, Walnut Creek, CA 94597.

PIANO TUNING LEARNED QUICKLY AT HOME! Tremendous field! Musical knowledge unnecessary. GI approved. Information free. Empire School, Box 327, Miami 33145.

GROW RICH DRIVING YOUR CAR. Magnetic signs, Big Money, very, very easy. Copy Sign, 6644 Santa Monica Blvd., L.A., Calif. 90038.

FREE SECRET BOOK "2042 Unique, Proven Enterprises." Beat inflation with fabulous, successful "Little Knowns." Work home! Haylings-E11, Carlsbad, Calif. 92008.

START SMALL, highly profitable electronic production in your basement. Investment, knowledge unnecessary. Postcard brings facts. Barta-PEM, Box 248, Walnut Creek, California 94597.

POLICE SCANNERS! Fast sales, big profits. Best Crystal Service, P.O. Box 612, East Moline, Illinois 61244.

FREE INFORMATION ABOUT EXTRA INCOME. Make extra money by learning to prepare tax returns in your spare time from America's largest tax service. Dignified and rewarding work. Save money on your own tax return, too. No salesman will call. For information write: H&R Block Tax Training Institute, Dept. BT-1903, 4410 Main, Kansas City MO 64111.

FLOOD of money making offers by direct mail from America's major opportunity companies. \$2.25 to Heil, Box 1372, Lancaster, Pa. 17604.

\$2.00 MONTHLY selling information by mail. Ropchan, Box 5341X, Sherman Oaks, Calif. 91413.

GOVERNMENT SURPLUS

GOVERNMENT Surplus. How and Where to Buy in Your Area. Send \$2.00. Surplus Information, Headquarters Bldg., Box 30177-PE, Washington, D.C. 20014.

ELECTRONIC Equipment and Parts. Big 36 page Free Catalog. Send for your copy today! Fair Radio Sales, Box 1105-P, Lima, Ohio 45802.

JEES Typically from \$53.90 . . . Trucks from \$78.40 . . . Boats, Typewriters, Knives, Airplanes, Clothing, Multimeters, Oscilloscopes, Transceivers, Photographic, Electronics Equipment. Wide-variety, condition. 100,000 Bid Bargains direct from government nationwide. Complete sales directory and surplus categories catalog \$1.00 (Deductible on orders from separate included catalog). Surplus Service, Box 820-J, Holland, Michigan 49423.

GOVERNMENT SURPLUS. Complete sales directory \$1.00. Surplus Publications, Box 26062Z, Los Angeles, Calif. 90026.

TAPE AND RECORDERS

RENT 4-Track open reel tapes—all major labels—3,000 different—free brochure. Stereo-Parti, 55 St. James Drive, Santa Rosa, Ca. 95401.

1930-1962 Radio Programs on tape. Huge Catalog! Sample Recordings! \$1.00 refundable!! AM Treasures, Box 192F, Babylon, N.Y. 11702.

SCOTCH MAGNETIC TAPE (USED)

#150, 1800 FT. 7 INCH REEL, 1 MIL POLYESTER, RECORDED ONCE, BULK ERASED (NO BOX), 99¢ PLUS 100% SHIPPING & HANDLING (MIN. ORDER \$10.00); SLIGHTLY USED 10 1/2 INCH FIBERGLASS REELS, 3/8" HOLE, 50¢ EACH. PLUS SHIPPING BY WEIGHT AND ZONE.



SAXITONE TAPE SALES

1776 Columbia Rd., N.W. Washington, D.C. 20009

RECORD 8TRK cartridges with any player. Instructions, \$2.00. C. Faust, Rancocas, New Jersey 08073.

THOUSANDS of quality old Big Band, Radio Shows on Reels. Catalog 50¢. Bialock's Sound Library, 609 Blue, Richland, Wash. 99352.

TREASURE FINDERS

FREE—Valuable Treasure Finder catalog sent by return mail. Find Coins, Rings, Gold, Silver, Metals, Relics. Write today. JETCO, Dept. CPE, Box 26669, El Paso, Texas 79926.

FISHER DETECTORS You deserve the best. Free literature, FR-L, Dept. PE-7, P.O. Box 490, Belmont, CA 94002.

TREASURE FINDER locates buried gold, silver, coins, treasures. 6 powerful models. \$19.95 up. Instant financing available. Write or call for free catalog. Phone (713) 682-2728 day or night. Dealer inquiries invited. Relco, Dept. A-33, Box 10839, Houston, Texas 77018.

FREE FACT-FILLED CATALOG. World's largest line of metal detectors. Models as low as \$49.50 and up. Two year Guarantee. Three factory locations, U.S. and Canada, plus over 1,000 dealers and 35 Service Centers from coast to coast. No finer instruments made at any price. Budget terms. Write: White's Electronics, Inc., Rm# 391, 1011 Pleasant Valley Road, Sweet Home, Oregon 97386.

EMPLOYMENT INFORMATION

EXCITING Overseas jobs. Directory \$1.00. Research Associates, Box 889-E, Belmont, California 94002.

JOBS GALORE for Electronics Men in San Jose, California. Big classified \$2. R. Sims, 525 University, Palo Alto, California W1307, 94301.

TECHNICIANS desperately needed, employers directory, \$2. Cateis, Box 514, Agnew, CA 95054.

EMPLOYMENT OPPORTUNITIES

ELECTRONICS/AVIONICS EMPLOYMENT OPPORTUNITIES. Report on jobs now open. Details FREE. Aviation Employment Information Service, Box 240E, Northport, New York 11768.

PERSONALS

MAKE FRIENDS WORLDWIDE through international correspondence. Illustrated brochure free. Hermes, Berlin 11, Germany.

JULY 1973



GREGORY ELECTRONICS
Reconditioned & Used
FM 2-WAY RADIO SAVINGS
Partial List—Send for New Catalog

The General Electric

Message Mate

personal pocket
voice receiver
with sel-call



• Fully transistorized. 100% solid state for ultimate in reliability and performance.

• Selective signaling options for individual messages inside & outside of buildings.

150-162 MHz, 162-174 MHz
Specify freq. with order

Charger inc. with nickel-cadmium model. Ask about low band.

\$98.

Lots of 5, less 10% . . . ea. \$88.20
Lots of 10, less 15% . . . ea. \$83.30

less reeds



GREGORY ELECTRONICS CORP.

249-F Rt. 46, Saddle Brook, N.J. 07662
Phone: (201) 489-9000

CIRCLE NO. 14 ON READER SERVICE CARD

IC

FACTORY FIRSTS
NATIONALLY KNOWN BRANDS
SATISFACTION GUARANTEED

ITEM	DIGITAL TTL		ITEM	MIXED TTL	
	1-99	100-999		1-99	100-999
7400N	32c	28c	7458N	32c	28c
7401N	32c	28c	7472N	32c	35c
7403N	32c	28c	7473N	48c	43c
7403N	32c	28c	7474N	48c	43c
7404N	32c	31c	7475N	80c	68c
7410N	32c	28c	7476N	56c	50c
7420N	32c	28c	7480N	56c	50c
7430N	32c	28c	7490N	85c	70c
7440N	32c	28c	7492N	85c	70c
7441N	\$1.50	\$1.35	7493N	85c	70c
7442N	\$1.20	\$1.07	7495N	\$1.20	\$1.08
7447N	\$1.15	\$1.03	74107N	54c	49c
7451N	32c	28c	74121N	60c	51c
7454N	32c	28c			

LINEAR INTEGRATED CIRCUITS

709C MINIDIP	50c	10	450	100	\$42.50
723C TO-5	\$1.00	10	\$3.00	100	\$45.00
741C MINIDIP	55c	10	\$4.60	100	\$43.00
748C MINIDIP	60c	10	\$5.50	100	\$51.00
558C MINIDIP	95c	10	\$8.50	100	\$79.00
NE555A DIP	\$1.37	10	\$7.00		
LM309K TO-3	\$2.50	5	\$11.25		

GENERAL PURPOSE SILICON TRANSISTORS

2N3638	20c	10	\$1.65	2N5134	15c	10	\$1.25
2N3638A	22c	10	\$1.80	2N5137	18c	10	\$1.50
2N3641	23c	10	\$2.00	2N5138	15c	10	\$1.25
2N3643	23c	10	\$2.00	2N5139	15c	10	\$1.25
2N5133	\$1.25	10	\$11.25	2N3055	\$1.00	10	\$9.50

The above full spec. first line TTL and Linear devices are also available with "Relaxed Specs." fully functional at discounts up to 50%. Use Reader's Service Card for Flyer.

1 AMP SILICON RECTIFIERS

1N4003 200PIV	12	\$1	100	\$6	1M	\$45
1N4005 600PIV	10	\$1	100	\$7	1M	\$55
1N4007 1000PIV	7	\$1	100	\$9	1M	\$75

SILICON SIGNAL DIODES

1N4148 (1N914 equiv.)	20	\$1	100	\$4	1M	\$30
-----------------------	----	-----	-----	-----	----	------

MOLEX IC SOCKET PINS

100	\$1.00	200	\$1.80	300	\$2.60	500	\$4.20	700	\$5.80
1000	\$8.20	ea	add	1000	\$7.50				

INTEGRATED CIRCUIT SOCKETS

14 PIN DIP SOLDER	45c	16 PIN DIP SOLDER	50c
14 PIN WIRE WRAP	55c	16 PIN WIRE WRAP	60c

DISPLAY DEVICES

5 Volt 7 Segment Tube	\$3.75		
Display Kit (Tube=7447-7475-7490)	\$5.75	3	\$16.50
7 Segment Led (Max-1 Type)	\$4.00		
Display Kit (Led-7447-7475-7490-Resistors)	\$6.00	3	\$17.50

C.O.D. ORDERS ACCEPTED FOR SAME DAY SHIPMENT
CALL 218-681-6674

Free Catalog—Large Quantity Discounts—Orders Less Than \$10.00 add 25¢—Orders Postpaid

DIGI-KEY PRICE PACESETTER FOR QUALITY IC'S
BOX 126K THIEF RIVER FALLS, MN56701

PRICES SLASHED

CIRCLE NO. 8 ON READER SERVICE CARD

SEMICONDUCTOR SUPERMART

FREE CATALOG

NAME BRAND—
PRIME QUALITY
SEMICONDUCTORS

- MOTOROLA • RCA •
- FAIRCHILD • HEP •
- NATIONAL • SIGNETICS

Other Parts For
Popular Electronics Projects

CIRCUIT SPECIALISTS CO.

Box 3047 Scottsdale AZ 85257

CIRCLE NO. 4 ON READER SERVICE CARD

SPORTS ACTION FILMS

START NOW—BE A COLLECTOR! Super 8 and Standard 8mm all pro sports action films like '72 NHL Stanley Cup, '72 NBA Championship, Ali fight, '71 World Series (Roberto Clemente). Each \$14.95 in color; \$7.95 B&W delivered. Catalog. Elect Dept., SPORTLITE, 20 North Wacker Drive, Chicago, Illinois 60606.

ELECTRICAL SUPPLIES AND EQUIPMENT

PLATING Equipment, Portable Platers, Supplies and "Know-How." Build your own tanks for nickel, chrome, etc. Easy-to-install PVC liners. Rectifier components—all sizes. Schematics, parts lists, formulas, operating instructions for all plating. Guaranteed to save you 25%-75%. Some good units for sale. Write for details. Platers Service Company, 1511-PE Esperanza, Los Angeles. Calif. 90023.

REAL ESTATE

FREE . . . BIG 256-page . . . SUMMER CATALOG! Describes and pictures hundreds of farms, ranches, town and country homes, businesses coast to coast! Specify type property and location preferred. UNITED FARM AGENCY, 612-EP West 47th St, Kansas City, Mo. 64112.

MAGNETS

MAGNETS. All types. Specials—20 disc magnets, or 2 stick magnets, or 10 small bar magnets, or 8 assorted magnets, \$1.00. Maryland Magnet Company, Box 192H, Randallstown, Maryland 21133.

BOOKS

FREE catalog aviation/electronic/space books. Aero Publishers, 329PE Aviation Road, Fallbrook, California 92028.

FREE book prophet Elijah coming before Christ. Wonderful bible evidence. Megiddo Mission, Dept. 64, 481 Thurston Rd., Rochester, N.Y. 14619.

TUBES

RADIO & T.V. Tubes—36¢ each. Send for free Catalog. Cornell, 4213 University, San Diego, Calif. 92105.

RECEIVING & INDUSTRIAL TUBES, TRANSISTORS. All Brands—Biggest Discounts. Technicians, Hobbyists, Experimenters—Request **FREE** Giant Catalog and **SAVE!** ZALYTRON, 469 Jericho Turnpike, Mineola, N.Y. 11501.

SAVE money on parts and transmitting-receiving tubes, foreign-domestic. Send 25¢ for giant catalog. Refunded first order. United Radio Company, 56-P Perry Street, Newark, N.J. 07105.

TUBES "Oldies", latest. Lists free. Steinmetz, 7519 Maplewood, Hammond, Indiana 46324.

TUBES receiving, factory boxed, low prices, free price list. Transletronic, Inc., 1305 40th Street, Brooklyn, N.Y. 11218A, Telephone: 212-633-2800.

REPAIRS AND SERVICES

TV Tuners rebuilt and aligned per manufacturers specification. Only \$9.50. Any make UHF or VHF. Ninety day written guarantee. Ship complete with tubes or write for free mailing kit and dealer brochure. JW Electronics, Box 51C, Bloomington, Indiana 47401.

MUSIC

SONGS — POEMS

Wanted for publishing and
recording consideration.

Accepted songs will be published & recorded
at our expense - for information write to
Talent, 17-PE Longwood Rd., Quincy, Ma. 02169

SONGWRITERS

SONGS & POEMS NEEDED FOR
IMMEDIATE PUBLISHING AND
RECORDING CONSIDERATION! WE
PAY ALL COSTS ON ACCEPTED
SONGS! FOR FREE INFORMATION:
GRAND RECORDING CO., Dept. PE
1354 Hancock St., Quincy, Mass. 02169

DO-IT-YOURSELF

PROFESSIONAL ELECTRONIC PROJECTS—\$1.00 up. Catalog 35¢. PARKS, Box 15201A, Seattle, Wash. 98115.

RUBBER STAMPS

RUBBER address stamps. Free catalog. 45 type styles. Jackson's, Box 443G, Franklin Park, Ill. 60131.

Popular Electronics

INCLUDING **Electronics World**

JULY 1973

ADVERTISERS INDEX

READER SERVICE NO.	ADVERTISER	PAGE NO.
1	Babylon Electronics	116
	Bell & Howell Schools	18, 19, 20, 21
2	Bose	25
	CREI, Capitol Radio Engineering Institute	106, 107, 108, 109
4	Circuit Specialties	122
5	Cleveland Institute of Electronics, Inc.	72, 73, 74, 75
6	Delta Electronics Co.	119
7	Delta Products, Inc.	9
8	Digi-Key	121
9	Dynaco Inc.	17
10	EICO	114
11	E & L Instruments, Incorporated	87
12	Edmund Scientific Co.	124
13	Electro-Voice, Inc.	10
14	Gregory Electronics Corp.	121
15	Heath Company	13
	ICS International Correspondence Schools	36, 37, 38, 39
16	Judson Research and Mfg. Co.	113
17	Lafayette Radio Electronics	111
CLASSIFIED ADVERTISING		116, 117, 118, 119, 120, 121, 122, 123

READER SERVICE NO.	ADVERTISER	PAGE NO.
18	Linear Digital Systems Corp.	112
19	McIntosh Laboratory, Inc.	90
20	MITS Micro Instrumentation & Telemetry Systems, Inc.	97
22	Mallory Distributor Products Company	7
23	Midwest HiFi Wholesale & Mail Order Div.	114
	Motorola HEP Semiconductors	11
	NRI Training	SECOND COVER, 1, 2, 3
	National Technical Schools	54, 55, 56, 57
24	PTS Electronics, Inc.	113
25	Pace Communications	101
26	Poly Paks	117
27	Sansui Electronics Inc.	22
	Shure Brothers Inc.	FOURTH COVER
28	Solid State Sales	118
33	Summit International Corporation	100
29	Tri-Star Corporation	112
30	United Audio Products, Inc.	15
31	Utah Electronics Division	95
32	Xcelite, Inc.	8
		116, 117, 118, 119, 120, 121, 122, 123

PRINTING

1,000 Address Labels, \$1.00 postpaid. Sebacy Products, Box 15206P, Lakewood, CO 80215.

THERMOGRAPHED Business Cards. \$8.50 per 1,000 or send 25¢ for catalog. Amherst Graphics, 342 Oak Manor NW, Massillon, Ohio 44646.

FREE literature Business cards, letterheads, rubber stamps. GEER'S, 111 North Drive, Ottawa, Ohio 45875.

MUSICAL INSTRUMENTS

30% **DISCOUNT** name brand musical instruments. Free Catalog. Freeport Music, 455N, Route 110, Melville, N.Y. 11746.

WHOLESALE! Professional Guitars, PA Systems, Altec Speakers, 240W RMS Amplifiers. Free Catalog, Carvin, Escondido, Calif. 92028.

MISCELLANEOUS

WINEMAKERS: Free illustrated catalog yeasts, equipment. Semplex, Box 12276P, Minneapolis, Minn. 55412.

HOME WATER DISTILLERS. Remove all impurities for pennies a gallon. Portable, no plumbing. Free details. United Vito-Way, Box 2216-V, Everett, Washington 98203.

EMERGENCY HORN—Hand-sized, self-powered. Perfect for emergencies. Can be heard up to one mile. Will also repel attackers or animals, without permanent harm. \$3.50 postpaid. J. Ross, Box 223, Jamaica, N. Y. 11431. Dept. PE.

LIVE IN THE WORLD OF TOMORROW... TODAY!

A BETTER LIFE STARTS HERE

ASTRONOMICAL TELESCOPE KITS



Grind your own mirror for powerful telescopes. Kit contains fine annealed pyrex mirror blank, tool, abrasives, diagonal mirror, and eyepiece lenses. Instruments you build range in value from \$75.00 to hundreds of dollars.

Stock No. 70.003AV .4 1/4" diam. 3/4" thick \$11.25 Ppd.
 Stock No. 70.004AV .6" diam. 1" thick \$17.50 Ppd.
 Stock No. 70.005AV .8" diam. 1 3/4" thick \$25.25 Ppd.
 Stock No. 70.006AV .10" diam. 1 3/4" thick \$44.95 FOB
 30 lbs.
 Stock No. 70.007AV .12 1/2" diam. 2 1/8" thick \$72.95 FOB
 46 lbs.

"FISH" WITH A GIANT MAGNET

Go Treasure Hunting On The Bottom! Fascinating fun, and sometimes very profitable! Tie a line to our 5-pound Magnet—drop it overboard in bay, river, lake or ocean. Trawl it along the bottom. Your "treasured" haul can be outboard motors, anchors, other metal valuables. Five-pound Magnet is war surplus—Alnico V Type that cost the Government \$50. It lifts over 150 pounds on land—much greater weights under water!



Stock No. 70.571AV \$14.00 Ppd.
 Stock No. 70.570AV 3 1/2 lbs. ... \$8.75 Ppd.

140 ELECTRICAL EXPERIMENTS!



Explore the fun world of electricity, magnetism, telecommunications. Exciting new Electrix® Experiment Kit enables you to build a Morse code sender, receiving buzzer & printer; produce electricity with a real generator; assemble a working phone system; build an electric motor; 135 other projects. Illus. 112-pg. 8 1/2 X 11" manual explains easy use of kit's 135 precision parts. Safety approved. Everything you need except 4 "D" cells.

Stock No. 71,647AV \$17.95 Ppd.

(And our FREE CATALOG is packed with exciting and unusual ecological & physical science items—plus 4,000 finds for fun, study or profit... for every member of the family.)

130 EXPERIMENTS IN OPTICS...

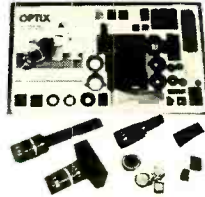

and photography! Optix® Experiments Kit is a complete optical & photography lab for 130 exciting experiments. Lets you recreate the periscope, telescope, microscope, kaleidoscope! Build a 35mm reflex camera with interchangeable lens system! Make, develop photographic film! Enjoy the fun and fascination of having your own optics lab. Fully illustr. 112-pg manual, 8 1/2 X 11", clearly explains usage of this stimulating kit's 114 precision engineered components.
 Stock No. 71,646AV ... \$21.00 Ppd.

3-CHANNEL COLOR ORGAN KIT

Easy to build low-cost kit needs no technical knowledge. Completed unit has 3 bands of audio frequencies to modulate 3 independent strings of colored lamps (i.e. "lows"—reds, "middles"—greens, "highs"—blues. Just connect hi-fi, radio, power lamp etc. & plug ea. lamp string into own channel (max. 300W ea.). Kit features 3 neon indicators, color intensity controls, controlled invidiv SCR circuits, isolation transformer; custom plastic housing; instr.

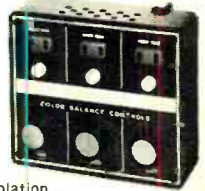

Stock No. 41,831AV \$15.75 Ppd.

SEE THE STARS, MOON, PLANETS CLOSE UP!



3" ASTRONOMICAL REFLECTING TELESCOPE

60 To 180 Power. Famous Mt. Palomar Type See the rings of Saturn, the fascinating planet Mars, Seas and Craters of the Moon, Star Clusters in detail. New improved, aluminized and overcoated 3" diameter f/10 primary mirror, ventilated cell. Equatorial mount with locks on both axes. Equipped with 6X finder telescope, hardwood tripod. Included FREE, VALUABLE "HOW TO USE YOUR TELESCOPE" book; "STAR CHART"

Deluxe 3" Reflector Telescope Stock No. 80,162AV \$62.50 Ppd.
 4 1/4" Reflector Telescope (45x to 270x) Stock No. 85,105AV ... \$111.00 FOB
 6" Reflector Telescope Stock No. 85,187AV ... \$215.00 FOB
 6" Reflector W/ (Electric) Clock Drive No. 85,086AV ... \$249.50 FOB



MAIL COUPON FOR GIANT FREE CATALOG!

164 PAGES • MORE THAN 4000 UNUSUAL BARGAINS!

Completely new Catalog. Packed with huge selection of telescopes, microscopes, binoculars, magnets, magnifiers, prisms, photo components, ecology and Unique Lighting items, parts, kits, accessories — many hard-to-get surplus bargains. 100's of charts, illustrations. For hobbyists, experimenters, schools, industry.

EDMUND SCIENTIFIC CO.
 300 Edscorp Building, Barrington, N. J. 08007

Please rush Free Giant Catalog "AV"

Name _____
 Address _____
 City _____ State _____ Zip _____

COMPLETE & MAIL WITH CHECK OR M.O.

EDMUND SCIENTIFIC CO.
 300 Edscorp Building, Barrington, N.J. 08007

How Many	Stock No.	Description	Price Each	Total

PLEASE SEND GIANT FREE CATALOG "AV" MERCHANDISE Total
 HANDLING CHARGE \$1.00*
 TOTAL \$ _____



I enclose check
 money order for \$ _____

NAME _____
 ADDRESS _____
 CITY _____ STATE _____ ZIP _____

CIRCLE NO. 12 ON READER SERVICE CARD
 Printed in U.S.A.

Popular Electronics

INCLUDING **Electronics World**

READER SERVICE

Here's an easy and convenient way for you to get additional information about products advertised or mentioned editorially (if it has a reader service number) in this issue. Just follow the directions below... and the material will be sent to you promptly and free of charge.

1

On the attached postage-free card, print or type your name and address on the lines indicated.

2

Circle the number (s) that corresponds to the key number (s) at the bottom or next to the advertisement or editorial mention that is of interest to you. (Key numbers for advertised products also appear in the Advertisers' Index.)

3

Simply cut out the card and mail. No postage required.

FREE INFORMATION

The Most Spectacular Sound Exhibition of **STEREO FIDELITY**
Ever Available on one Disc.

STEREO
DEMONSTRATION
RECORD

NOW AVAILABLE ON
STEREO CASSETTE

THESE EXCITING SOUNDS ARE NOW
AVAILABLE ON STEREO CASSETTE!
Place your order by using coupon below.
ONLY \$6.98 POSTPAID

This record is the result of two years of intensive research in the sound libraries of Deutsche Grammophon Gesellschaft, Connoisseur Society, Westminster Recording Company and Cambridge Records Incorporated. The Editors of Stereo Review have selected and edited those excerpts that best demonstrate each of the many aspects of the stereo reproduction of music. The record offers you a greater variety of sound than has ever before been included on a single disc. It is a series of independent demonstrations, each designed to show off one or more aspects of musical sound and its reproduction. Entirely music, the Record has been edited to provide self-sufficient capsule presentations of an enormous variety of music arranged in a contrasting and pleasing order. It includes all the basic musical and acoustical sounds that you hear when you listen to records, isolated and pointed up to give you a basis for future critical listening.

WIDE SEPARATION OF DEMONSTRATIONS

- Techniques of Separation & Multiple Sound Sources
- Acoustic Depth
- Ambiance of Concert Hall
- Sharp Contrasts of Dynamics
- Discreet & Diminished
- Very High & Very Low Pitched Musical Sounds
- Polychord (2 or more melodies at once) With Both Similar & Contrasting Instruments
- Tonal Qualities of Wind, String & Percussion Instruments
- Sounds of Ancient Instruments
- Sounds of Oriental Instruments
- Sound of Singing Voice Both Classically Trained and Untrained
- Plus a Large Sampling of Finger, Snare, Gong, Hand Clapping, Foot Stamping & Other Musical & Percussive Sounds

- STRAUSS: Festive Prelude Op. 61 (excerpt) DGG
- DEBUSSY: Feux d'artifice (excerpt) Connoisseur Society
- BEETHOVEN: Wellington's Victory (Battle Symphony) (excerpt from the first movement) Westminster Records
- MASSIMO: Canzona XXIV a 16 (complete) DGG Archive
- CORRETTI: Concerto Comique Op. 8, No. 6 - La Plaisir des Dames (third movement) Connoisseur Society
- KHAN: Raga Chandramandan (excerpt) Connoisseur Society
- RODRIGO: Conden-Serenade for Harp and Cinnamon (excerpt from the first movement) DGG

13 SUPERB SELECTIONS

- MANITAS DE PLATA: Gypsy Rhumba (complete) Conn. Soc.
- MARCELLO: (arr. King) Psalm XVII "The Heavens are Telling" (complete) Connoisseur Society
- PRÆTORIUS: Terpsichore - La Bourde XXXI (complete) DGG Archive
- BERG: Wozzeck (excerpt from Act III) DGG
- BARTOK: Sonata for two pianos and Percussion (excerpt from the first movement) Cambridge Records
- BEETHOVEN: Wellington's Victory (Battle Symphony) (excerpt from the last movement) Westminster

ORDER YOUR STEREO DEMONSTRATION RECORD OR CASSETTE TODAY

Record \$5.98 Postpaid • Cassette \$6.98 Postpaid

FREE Descriptive Booklet Enclosed includes discussion of the selections on the record, plus a complete description of each selection and the purpose behind its demonstration.

AVAILABLE IN YOUR CHOICE OF 33 $\frac{1}{3}$ RPM OR 45 RPM

The Stereo Demonstration Record is processed and pressed on a newly developed, improved vinyl. It is permanently antistatic, repels dust and dirt and promotes longer stylus wear. The use of this material is conducive to low surface noise and contributes to the production of full dynamics and frequency range. The record continually looks new, sounds new and wears longer!

HERE'S HOW TO ORDER

CASH: Mail your order along with your name, address and remittance in the amount of \$5.98, postpaid.

CHARGE: Your American Express or Bank Americard account! Mail your order, name, address and credit card number. You will be billed at \$5.98, postpaid.

MAIL ALL ORDERS TO: RECORDS, ZIFF-DAVIS SERVICE DIVISION, 595 BROADWAY, NEW YORK, N.Y. 10012
OUTSIDE U.S.A. RECORDS ARE \$8.00, POSTPAID.



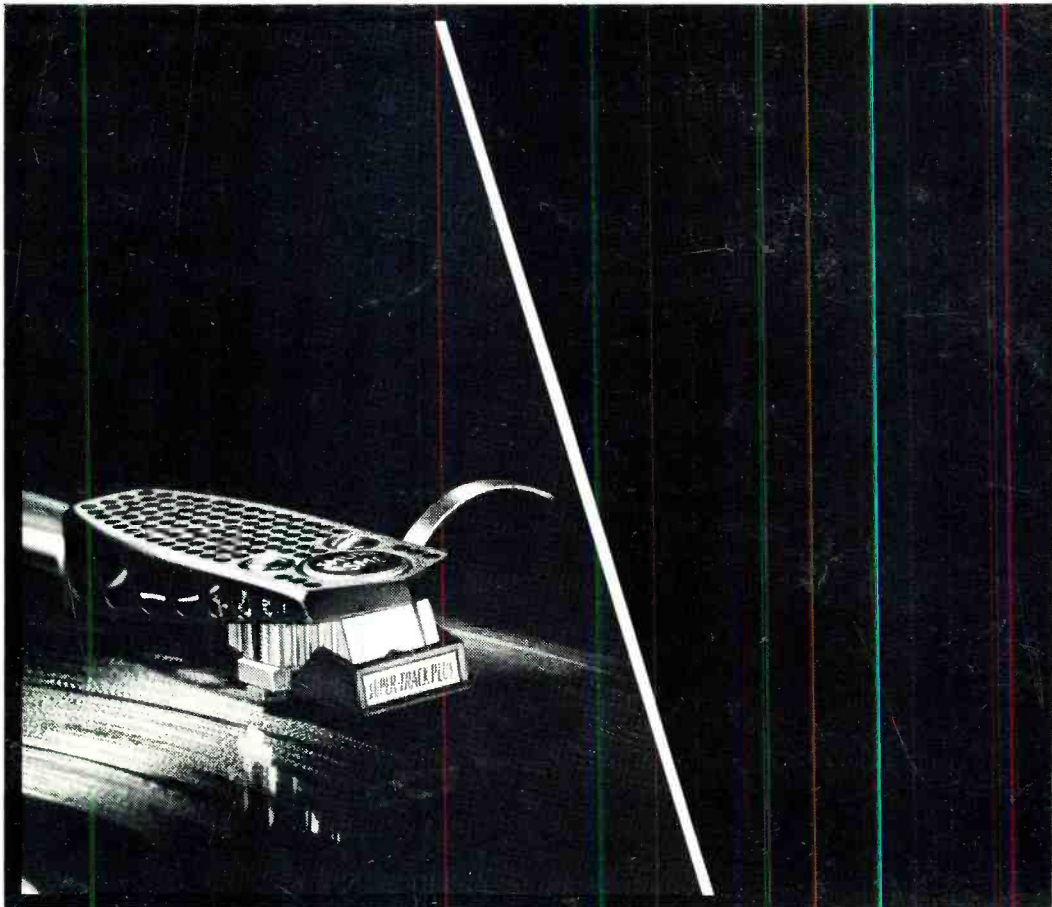

anything II could do III can do better!

Several years ago, we decided that our next challenge would be to go beyond the best there was. Our computers told us we had taken the existing cartridge structure and stylus assembly of the V-15 Type II Improved as far as we could, and that hereafter, any improvement in one performance parameter would be at the expense of performance in some other parameter.

Therefore, over the past several years, a wholly new *laminated* cartridge structure has been developed, as was an entirely new stylus assembly with a 25% reduction in effec-

tive stylus mass! These developments have resulted in optimum trackability at light tracking forces ($\frac{3}{4}$ -1 $\frac{1}{4}$ grams), a truly flat, unaccented frequency response, and more extended dynamic range than was possible even with the Type II Improved, without sacrificing output level!

If you like its sound today, you will like it even more as time goes on. In fact, to go back to any other cartridge after living with the Type III for a short while is simply unthinkable, so notable is its neutral, uncolored sound. You must hear it. \$72.50.

INTRODUCING THE NEW

SHURE V-15 TYPE III Super-Track "Plus" Phono Cartridge

Shure Brothers Inc. • 222 Hartrey Ave. • Evanston, Ill. 60204
In Canada: A. C. Simmonds & Sons Ltd.

CIRCLE NO. 3 ON READER SERVICE CARD